

U  
15  
U635  
no. 15  
c. 4

~~CONFIDENTIAL~~

AL SERIES, NO. 15

15 JUNE 1943

# GERMAN COASTAL DEFENSES

LIBRARY  
ARMY WAR COLLEGE  
PERIODICALS SECTION

REGRADED UNCLASSIFIED BY  
AUTHORITY OF DOD DIR. 5200.1 R  
BY RAKUS ON 5-23-03

PREPARED BY  
MILITARY INTELLIGENCE SERVICE  
WAR DEPARTMENT

~~CONFIDENTIAL~~

76

U  
16

8294

U/L 35

no. 16

C. 4

7710804697

The previous issues of *Special Series* are listed below. All of these issues have been classified as "restricted," with the exception of Nos. 12 and 13, which have been placed in a lower category, "not to be published."<sup>1</sup>

1. *British Commandos* (9 August 1942)
2. *The German Armored Army* (10 August 1942)
3. *German Military Training* (17 September 1942).
4. *The German Motorized Infantry Regiment* (17 October 1942)
5. *The Development of German Defensive Tactics in Cyrenaica—1941* (16 October 1942)
6. *Artillery in the Desert* (25 November 1942)
7. *Enemy Air-Borne Forces* (2 December 1942)
8. *German Tactical Doctrine* (20 December 1942)
9. *The German Squad in Combat* (25 January 1943)
10. *German Antiaircraft Artillery* (8 February 1943)
11. *Morale-Building Activities in Foreign Armies* (15 March 1943)
12. *German Military Abbreviations* (12 April 1943)
13. *British Military Terminology* (15 May 1943)
14. *German Infantry Weapons* (25 May 1943)

<sup>1</sup>One unnumbered issue, *German Military Symbols* (classified as "not to be published"), appeared in January 1943.

# U. S. Army Military History Institute

~~CONFIDENTIAL~~

MILITARY INTELLIGENCE SERVICE  
WAR DEPARTMENT  
WASHINGTON, 15 June 1943

SPECIAL SERIES  
No. 15  
MIS 461

REGRADED UNCLASSIFIED BY  
AUTHORITY OF DOD DIR. 5200.1 R  
BY TRAKERS ON 5/22/03

## NOTICE

1. Publication of *Special Series* is for the purpose of providing officers with reasonably confirmed information from official and other reliable sources.

2. In order to meet the specific request of appropriate headquarters, or in order to conserve shipping space, the distribution of any particular issue of *Special Series* may be modified from the standard. This issue, owing to its high classification, is being given a limited distribution.. Distribution to air units is being made by the Assistant Chief of Air Staff, Intelligence, Army Air Forces.

3. Each command should circulate available copies among its officers. Reproduction within the military service is permitted provided (1) the source is stated, (2) the classification is not changed, and (3) the information is safeguarded.

4. Readers are invited to comment on the use that they are making of this publication and to forward suggestions for future issues. Such correspondence may be addressed directly to the Dissemination Unit, Military Intelligence Service, War Department, Washington, D. C.

Other publications of the Military Intelligence Service include: *Tactical and Technical Trends* (biweekly); *Intelligence Bulletin* (monthly); *Military Reports on United Nations* (monthly).

Requests for additional copies of publications of the Military Intelligence Service should be forwarded through channels for approval.

**PROPERTY OF US ARMY**

~~CONFIDENTIAL~~

UNCLASSIFIED

LIBRARY  
US ARMY WAR COLLEGE  
CARLISLE BARRACKS, PA.



# CONTENTS

	Page
Section I. INTRODUCTION .....	1
1. RELIANCE ON MOBILE FORCES .....	1
2. PATTERN OF DEFENSES .....	2
II. NAVAL FACTORS AND HARBOR OBSTACLES .....	5
3. NAVAL RESPONSIBILITY .....	5
4. NAVAL PATROLS .....	5
5. SPERRBRECHERS .....	6
a. General .....	6
b. Means of Recognition .....	7
6. SIEBEL FERRIES .....	7
a. General .....	7
b. Types .....	9
7. HARBOR OBSTACLES .....	11
a. General .....	11
b. Booms and Nets .....	11
c. Blockships .....	12
d. Mined Installations .....	12
III. BEACH OBSTACLES .....	14
8. GENERAL .....	14
9. UNDERWATER OBSTACLES .....	17
a. Stakes .....	17
b. Booms .....	19
10. BARBED WIRE .....	19
a. General .....	19
b. Specific Types .....	21
(1) <i>Knife rests</i> .....	21
(2) <i>Apron fences</i> .....	21
(3) <i>Vertical fences</i> .....	21
(4) <i>Concertina fences</i> .....	22
(5) <i>Trip fences</i> .....	22
(6) <i>Alarm wires</i> .....	22
(7) <i>Electrified wire</i> .....	22
(8) <i>Combined fences</i> .....	22
c. Standard Technique .....	23
(1) <i>Obstacle in depth</i> .....	23
(2) <i>Wire-netting fence</i> .....	24
(3) <i>Trip-wire obstacles</i> .....	24

Section III. BEACH OBSTACLES—Continued.	Page
11. MINEFIELDS.....	24
a. General.....	24
b. Minefields Layouts.....	26
(1) <i>Tellermine minefield patterns</i> .....	26
(a) <i>Method of spacing</i> .....	26
(b) <i>Hasty minefield</i> .....	27
(c) <i>Deliberate minefield</i> .....	28
(d) <i>Variation of deliberate minefield</i> .....	29
(e) <i>Extensive minefield</i> .....	30
(f) <i>Road blocks</i> .....	32
(2) <i>Heavy antitank minefields</i> .....	34
(3) <i>Antipersonnel minefields</i> .....	34
(4) <i>Minefields in a defile</i> .....	36
c. Minefield Records.....	37
d. Marking.....	37
e. German Conclusions on Minefield Practice.....	39
(1) <i>Minefield layout plans</i> .....	39
(2) <i>Minefield reports</i> .....	39
(3) <i>Temporary nature of minefields</i> .....	39
(4) <i>Minefields behind water obstacles</i> .....	40
12. ANTITANK OBSTACLES AND ROAD BLOCKS.....	40
a. Dragon's Teeth and Ditches.....	40
b. Miscellaneous Obstacles.....	41
(1) <i>Chevaux-de-frise</i> .....	41
(2) <i>Logs and rails</i> .....	42
(3) <i>Wire obstacles</i> .....	43
c. Walls and Promenades.....	43
(1) <i>Walls</i> .....	43
(2) <i>Promenades</i> .....	46
d. Concealment and Deception.....	46
(1) <i>Camouflage and concealment</i> .....	46
(2) <i>Dummy installations</i> .....	48
13. HYPOTHETICAL LAYOUT OF BEACH DEFENSES.....	49
IV. FORTIFICATIONS.....	50
14. GENERAL.....	50
15. CONCRETE SHELTERS.....	52
a. Rectangular Shelter.....	52
b. Standardized Shelter.....	52
c. Dune Shelter.....	55
d. Ostend Shelter.....	58
e. Artillery Observation and Command Post.....	59

## CONTENTS

V

### Section IV. FORTIFICATIONS—Continued.

	Page
16. GUN EMPLACEMENTS.....	60
a. T-Shaped Emplacements.....	60
b. Fort-Type Emplacements.....	62
c. Open Artillery Emplacements.....	63
d. Tank and Tank-Turret Emplacements.....	66
e. Cliff and Cave Positions.....	71
17. MISCELLANEOUS EMPLACEMENTS.....	71
a. Waasenaar Emplacement.....	71
b. Cantilever Type.....	73
c. Underground Type.....	76
d. Open Brick Type.....	77
e. Emplacement for Two Machine Guns.....	77
f. Cliff Pillbox.....	79
g. Promenade Types.....	79
h. Roofless Pillboxes.....	80
i. Infantry Position.....	80
j. Flak Positions.....	85
(1) Towers.....	85
(2) Elevator flak position.....	86
18. CONCLUSIONS.....	86

## ILLUSTRATIONS

### Figure

1. Sketch of Siebel ferry (based on a photograph).....	8
2. Plan of Siebel ferry.....	10, 11
3. Typical dune beach with breakwaters.....	16
4. Close-up view of dunes, showing bunch grass.....	17
5. French beach, showing typical cliffs on flanks.....	18
6. Typical sea wall and promenade in Belgium.....	19
7. Standard German barbed-wire obstacle in depth.....	23
8. Hasty minefield pattern (open spacing).....	27
9. Deliberate minefield pattern (open spacing).....	28
10. Panel arrangement of deliberate minefield.....	29
11. Three methods of arranging minefield panels.....	30
12. Extensive layout of minefields.....	31
13. Tellermine road block.....	32
14. Tellermine railroad-track block.....	33
15. Equilateral triangle layout for antipersonnel minefields.....	35
16. Method of rotating equilateral triangle layout for antipersonnel minefields.....	35
17. Continuous antipersonnel minefield.....	36
18. Minefield gap signboards.....	38
19. Types of steel cheval-de-frise trestles.....	42
20. Angle-iron obstacle.....	42

Figure	Page
21. Cross section of typical European beach promenade.....	44
22. Antitank obstacle at top of promenade steps.....	45
23. Hypothetical layout of beach defenses..... faces	49
24. Rectangular shelter on Breton coast.....	53
25. Standardized shelter on English Channel coast.....	54, 55
26. Sketch of dune shelter.....	56
27. Photograph of shelter built in dunes.....	57
28. Ostend shelter.....	58
29. Artillery observation and command post.....	59
30. T-shaped emplacement.....	60
31. Sketch of fort-type emplacement.....	64, 65
32. Fort-type emplacement.....	67-69
33. Outpost of fort-type emplacement.....	70
34. Emplacement with tank turret.....	72
35. Tank turret on harbor mole.....	73
36. Pillboxes in cliff position.....	74
37. Emplacements in cliff position.....	75
38. Waasenaar emplacement.....	76
39. Cantilever emplacement.....	77, 78
40. Underground emplacement.....	79
41. Open brick emplacement.....	80
42. Emplacement for two machine guns.....	81
43. Cliff pillbox.....	82
44. Promenade emplacement.....	83
45. Promenade emplacement, designed for enfilading fire.....	83
46. Roofless pillbox.....	84
47. Infantry position built into promenade.....	84
48. Flak tower.....	87
49. Elevator flak position.....	88



## **Section 1. INTRODUCTION**

---

### **1. RELIANCE ON MOBILE FORCES**

Germany is at present committed to a strategic defensive on her Western Front, and in recent months she has had to spur herself to feverish activity to add new fortifications on that front. Despite this recent emphasis on fortifications, however, there is no factual basis for the popular belief that the German High Command is suffering from a "Maginot Complex."

The Germans well understand that fortifications are truly offensive in character when their employment is based on the military maxim of economy of force. They cannot defend adequately at all points, but by the use of permanent fortifications to maintain an effective defense with a minimum of man power, they hope to keep the bulk of their force in reserve for offensive action wherever a major attack appears.

Consequently, when a landing is made on the shores of Europe, the German High Command will make its major effort against the invading forces with swift, hard-hitting armored and motorized units. These ground organizations will be closely supported by the German Air Force, which now has more than enough well-equipped air bases on the Western Front to accommodate all its air fleets. The Germans would endeavor to bring to bear at any given point a preponderance of strength over the invader, and to employ the tactics of separation and defeat in detail.

The value and strength of coastal fortifications must not, however, be minimized. They constitute a formidable factor of defense, and the Germans will rely on them to hold the invading forces until reserves can be committed against the main threat and until larger forces can be deployed from interior positions in the occupied countries and from within Germany itself.

The underlying principles of German offensive and defensive tactics and strategy are now generally known, and they have been discussed in other publications of the Military Intelligence Service. Available material about types of German coastal installations is assembled in this study in order that it may serve as an informational supplement to the training documents which prescribe the tactics and technique for neutralizing fortifications. Thorough training in technique, and knowledge of the characteristics of fortifications, will enable an assault force to break through a system of fixed defenses with a minimum loss of men and material, thus conserving its strength for the main task of engaging and destroying the mobile enemy forces behind it.

## 2. PATTERN OF DEFENSES

The outer line of Germany's coastal defense zone is in the sea itself, where patrol boats (*Vorpostenboote*) cruise in the English Channel and the North Sea, and along the rest of the Atlantic Coast of Europe, not only to flash warnings of hostile aircraft but to give the alarm if a seaborne force approaches. Minefields bar the way through strategic waters, and closer inshore, along the landing beaches, the Germans have embedded steel and

wooden obstacles just below the water's surface to trap assault boats and tank-landing craft.

Then, from the water's edge and for miles inland, the terrain that is favorable for invasion along the coast of Europe is organized in depth with coastal defenses, field and permanent fortifications, and airfields.

The defenses are especially elaborate along the coast of France, Belgium, and The Netherlands. Since the beginning of the Allied campaign in North Africa, however, the Germans have hastily begun to improve the fortifications of the northern Mediterranean coast. Italy, too, with German collaboration if not under outright German control, has started to mend her defenses in the south and on the islands of Sicily and Sardinia.

This study is based mainly, however, on the defenses that have been developed on the western coast of France and the Low Countries, these being the most modern, and the most typical for purposes of illustrating German methods. Any variations in other regions are due mainly to different local conditions and types of terrain; for example, camouflage and the disposition of emplacements amid the sand dunes of Belgium would naturally differ from those on the rocky sides of a Norwegian fiord.

But despite all their efforts, the Germans have not been able to entrench themselves on every mile of the coast line of the occupied countries. Some positions have had to be weakened in order to conserve forces for the Eastern Front. In some places, no doubt, the defenses are surprisingly thin, consisting of nothing more than desolate beaches, protected by

one or two lines of barbed wire, minefields and machine guns, and patrols of small units.

Permanent or improvised, all of the German defenses can be breached or reduced by troops who have been thoroughly trained and adequately equipped. For each type of defense, whether it be a row of steel stakes under water, or a reinforced concrete emplacement, there is a technical method by which that type can be destroyed. Equipment, technique, and tactics have been developed for dealing with the fort and its immobilized fire power.

## Section II. NAVAL FACTORS AND HARBOR OBSTACLES

---

### 3. NAVAL RESPONSIBILITY

The water approaches to beaches, harbors, and other possible landing points constitute the forward area of German coastal defenses, and responsibility for this area rests in the German Navy. To engage enemy forces before they reach land, the Navy not only employs surface units of all types, but also controls a certain number of land installations, including long-range batteries, some anti-aircraft batteries, and a line of lookout stations. The responsibility of the German Army for land defense begins on the beach, the fortifications and other positions of which are manned by defensive coastal commands as well as by offensive troops.

### 4. NAVAL PATROLS

Fast vedette<sup>1</sup> and patrol boats are used in all the coastal waters of western Europe. In cooperation with the lookout stations on shore, they guard against seaborne as well as air attacks. One of their chief functions at present is to flash warnings of the approach of Allied air formations that sweep across the continent. The patrol boats go out in great numbers,

---

<sup>1</sup>The naval meaning of *vedette* is similar to the military meaning. A *vedette boat* is a small vessel used to watch an enemy, and give notice of danger.

particularly at night. As sentinels on a watery outpost line, they may prove highly effective in nullifying the vital element of surprise on which any seaborne task force would rely heavily in approaching a well-defended beach.

In addition to the larger units of the fleet, the Germans have also a considerable number of smaller craft available for the dual purpose of antiaircraft and coast defense. Standard types of these smaller vessels are submarine chasers, **S**- and **R**-boats (motor torpedo boats and motor minesweepers), Sperrbrechers, and Siebel ferries. The Sperrbrechers and Siebel ferries will be discussed here because they are potentially effective weapons against landing craft.

## 5. SPERRBRECHERS

### a. General

The *Sperrbrecher* ("obstacle breaker"), of which Germany has a fairly large number along the western coast of Europe, is a converted, medium-sized merchant ship that bristles with guns. The number of its weapons, of various types, ranges from 8 to 13, the average number being 9. A typical example of the armament of one of these ships is as follows: two 4.1-inch guns, on platforms erected on the poop deck and the forecastle; two 37-mm guns on a twin mount, on a platform aft; 20-mm antiaircraft guns, on four high platforms; and machine guns, on the stump mainmast and on the bridge.

Sperrbrechers are especially useful as antiaircraft ships, but they are often seen acting as escorts for convoys of **U**-boats and of merchant vessels. As such,

they provide protection against mines and aircraft. They also serve as auxiliary antiaircraft defenses in harbors.

### **b. Means of Recognition**

Some characteristics which usually distinguish the Sperrbrecher from the normal merchant ship are as follows:

- (1) One of the masts have been removed.
- (2) One or more of the masts have been cut down one-half to one-third the usual height, in order to carry a platform for a light antiaircraft gun or searchlight.
- (3) The forward well deck is partly covered by a light deck, which is about the height of the bulwarks; this deck is believed to cover the electrical mine-sweeping gear. The German swastika is nearly always painted in a prominent position on the deck mentioned above, on a hatch, or on the roof of the deck-house, so that it can be clearly seen from the air. It is between 10 and 15 feet in diameter.
- (4) Motor launches, additional boats, and life-saving floats are carried on deck.
- (5) A light mast is usually placed amidships, attached to the navigating bridge or funnel, to carry the wireless aerial and the signal halyards.
- (6) A small number of derricks are carried; sometimes only one is visible, in a position to handle motor launches.
- (7) The large number of guns is always a conspicuous feature.
- (8) Gun platforms on these vessels are usually circular; only a few square ones have been noticed.

## **6. SIEBEL FERRIES**

### **a. General**

The Siebel ferry is actually an Army landing craft, or "invasion barge," of the type that was mentioned frequently at the time when a German seaborne attack

upon Great Britain appeared probable. It is discussed here because a large number of them, heavily armed and apparently under control of the German Navy, are operating in western European coastal waters to supplement port and coastal batteries. (See fig. 1.)

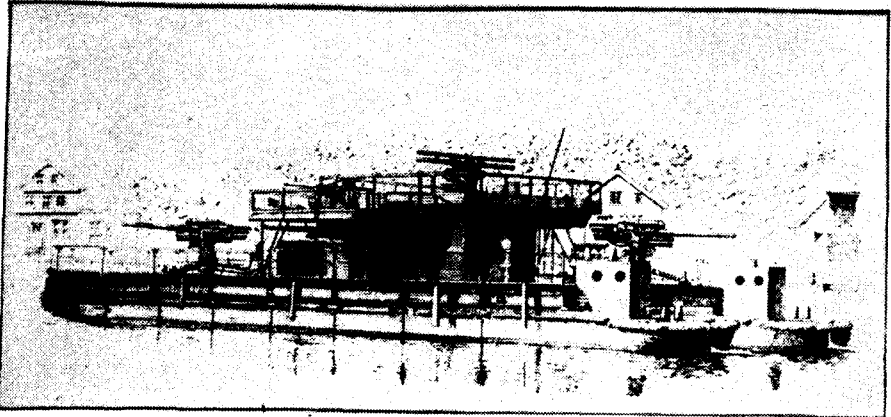

Figure 1.—Sketch of Siebel ferry (based on a photograph).

The Siebel ferry is conspicuous because of its hull, which consists of a pair of steel sectional pontoons, each of which is made up of nine lightly constructed sections and one larger stern section. There is a 20-foot space between the two pontoons, which are equipped with wooden runners to facilitate landings and to protect the craft against damage. The craft is powered by two engines—perhaps airplane engines, installed in the stern section of each ponton, which drive underwater propellers. In some cases these engines may be supplemented by air propellers so that the craft can operate in shallow waters where underwater propellers would foul. The Siebel ferry has a speed of 8 to 9



knots, and it is believed to be highly maneuverable and fairly seaworthy. Its shallow draft reduces its vulnerability in minefields.

The heavy type described in the next paragraph is 75 feet long and 56 feet wide, but there is no information available to show how the three known types differ as to size and construction features. (See fig. 2.)

### b. Types

The three known types of this vessel are as follows: The heavy (*Kampffähre*), the light, and the transport (*Trossfähre*) type. The heavy and light types are heavily armed and are notable, from the point of view of landing troops, for three features:

- (1) They are fully mobile offshore and therefore are not good counterbattery targets.
- (2) They cannot be plotted like normal coast defenses.
- (3) They might be very effective against landing craft and assault landing troops.

The heavy type usually carries three 88-mm dual-purpose guns, and two 37-mm or two 20-mm anti-aircraft machine guns, and one 4-meter-base stereoscopic range-finder with predictor. (Fig. 2 ② shows the layout of guns.)

The armament of the light type consists of four 37-mm or four 20-mm guns, one in each of the four corners of the deck, and possibly a fifth gun in the center. The 20-mm guns may be of the four-barreled type.

The transport type has only open deck space and is designed for transportation of personnel, supplies, and

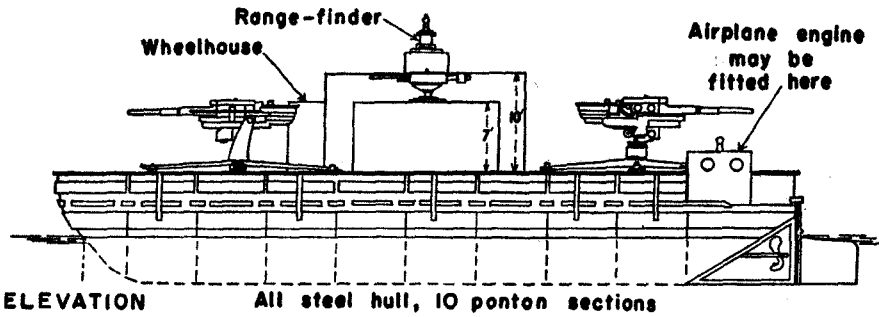

①

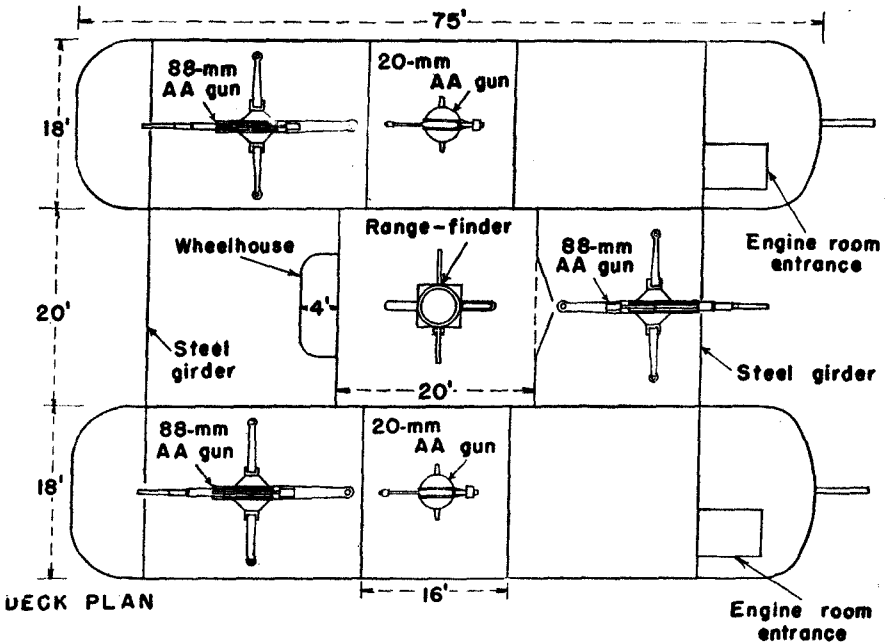

②

Figure 2.—Plan of Siebel ferry.

vehicles, and for ship-to-shore lighterage. Its armament usually consists only of one anti-aircraft machine gun.

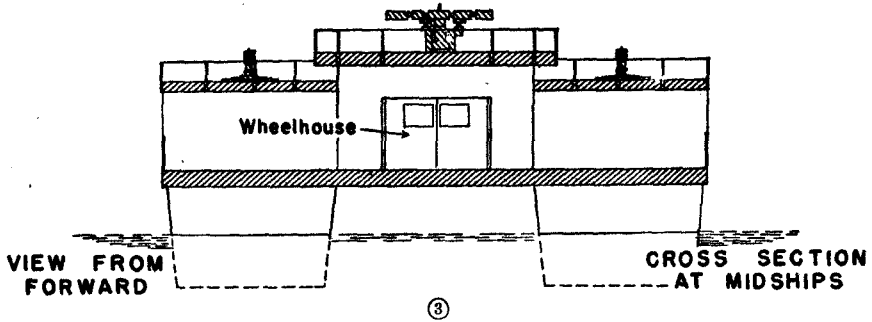

Figure 2 (continued).—Plan of Siebel ferry.

## 7. HARBOR OBSTACLES

### a. General

In the event of an invasion of the European continent, the Germans will make a determined effort to prevent the Allies from occupying the important ports. Among the defenses of these ports are fields of marine mines (both free and controlled), booms, and blockships. The latter would be sunk to obstruct channels when a major landing operation is started. This section will give available details on those obstacles which are essentially the concern of engineer and other ground troops.

### b. Booms and Nets

The Germans have been increasing recently the already large number of booms installed across harbor entrances and approach channels. Such booms have also been placed across the entrances of underground

concrete shelters for submarines and motor torpedo boats. They are usually laid in one to four lines.

The antiboat booms consist of linked timber rafts of various sizes and shapes, studded, in some instances, with long, sharp spikes. Other types of booms are made from a series of plain timbers linked together, a double line of timbers separated by floats, or a series of T-shaped rafts. Nets are suspended from some of the booms.

Antisubmarine nets often consist of wire cable nets suspended from steel barrel-floats and mooring buoys. The meshes of the nets are usually about 1 yard square. These nets are about 240 feet in length and from 60 to 120 feet in vertical depth.

### **c. Blockships**

The Germans are known to have a considerable number of concrete barges, sometimes called "Bruges barges" after the city where many of them were built. In designing these the Germans have taken into account the ultimate purpose of submerging them to block channel and harbor entrances. Ordinary merchant ships will also be used for this purpose. In approximate dimensions the barges, which are of cellular construction, are 27 feet long, 16 feet wide, and 12 feet high. As an aid in identification, it may be noted that two types of roofs have been observed on the superstructure—flat and gabled.

### **d. Mined Installations**

In and around harbors and canal openings the Germans will probably have mined the quays, seawalls,

breakwaters, pillboxes, shelters, river and harbor bridges, and other typical installations that might be useful if seized by an invading force. The Germans may deliberately leave facilities of this kind intact in order to blow them up after they have been occupied by landing forces.

## **Section III. BEACH OBSTACLES**

---

### **8. GENERAL**

The critical points of Europe's Atlantic coast are, of course, those beaches which are suitable for major landing operations. Germany's maximum effort in men, materials, and weapons on her Western Front has been directed toward the fortification of these potential gateways to the interior.

Forbidden zones have been defined by the Germans, and their inhabitants have been evacuated therefrom, not only to facilitate the organization and construction of defenses but also to prevent the native population from joining or assisting any landing forces. Seaside homes and other buildings along the coast have been razed to provide fields of fire, or space for the construction of reinforced concrete forts, ammunition dumps, and gun emplacements.

Those buildings that have been allowed to stand near the beaches have been incorporated in the defenses. Many attractive villas are still deceptively innocent and peaceful in appearance, but only the exteriors remain the same. The interiors of some have been converted into steel-and-concrete emplacements, and they have been armed with guns of varying sizes. Many of the houses have not been fortified so elaborately, but have been turned into effective positions for smaller guns and machine guns by the filling-in of doors and

windows with brick or concrete. Passages have been cut through continuous rows of fortified houses so that the occupying troops may pass from one to another without being exposed to observation and fire from the beach. Corner houses which command stretches of roads and intersections have likewise been converted into emplacements for weapons.

The sea walls and the promenades or boardwalks along the beach fronts have also been fortified by the installation of emplacements from which guns could be brought to bear on the beach and the water beyond. In some places the dunes are no longer mere heaps of sand dotted with bunch grass. They have been hollowed out, and reinforced concrete shelters and emplacements have been built within them. Such concrete works are occupied by antiaircraft and heavy gun crews, and by infantry units that would come out to engage landing forces. (See sec. IV, pp. 50-89.)

As for the beach proper, the Germans have devised a variety of obstacles of more or less conventional type. These will be discussed in detail in this section.

The photographs in figures 3 to 6, inclusive, give an idea of common features of the beaches in the Low Countries and France. Figure 3, a picture of the coast line on the Island of Walcheren, Zeeland, in The Netherlands, shows a line of dunes and the breakwaters that run at right angles as well as parallel to the beach. The dunes characteristic of the beaches of The Netherlands and Belgium are also shown in figure 4. (Note the bunch grass.) Figure 5 is an example

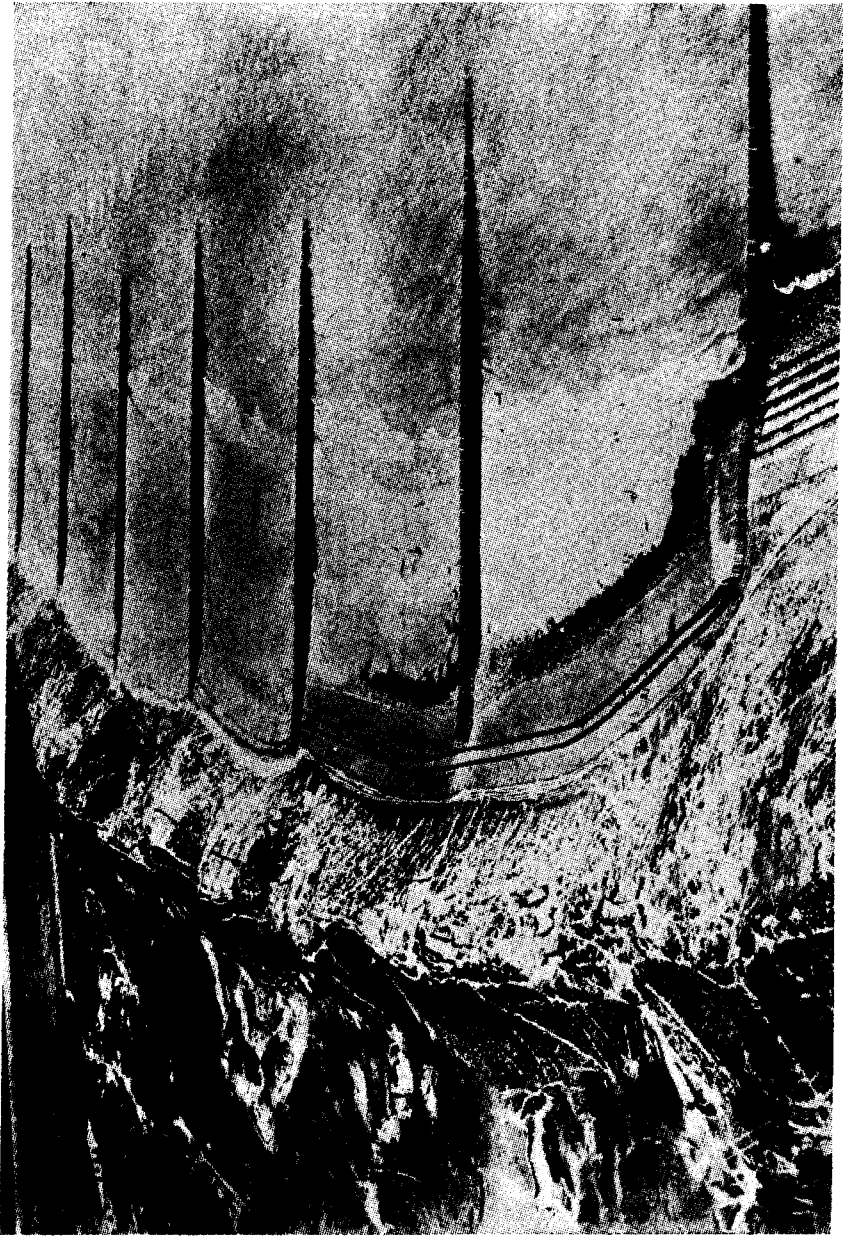

Figure 3.—Typical dune beach with breakwaters.



of the beaches along the English Channel coast of France. Many of these beaches are flanked by cliffs which dominate the landing areas. A stretch of sea wall is shown in figure 6. Such walls are normally supplemented by obstacles to convert them into barriers, and gun and troop positions are constructed in the face of the walls. (See pars. 12c and 17g and i.)



Figure 4.—Close-up view of dunes, showing bunch grass.

## 9. UNDERWATER OBSTACLES

### a. Stakes

In the shallow water off beaches with gentle slopes, the Germans have embedded rows of steel stakes and wooden logs. They are set at an angle, their upper ends pointing outward from the beach. Submerged barbed wire and mines may be used in conjunction with these obstacles, which are intended to trap landing boats, or personnel who may be compelled to leave their boats to wade ashore.

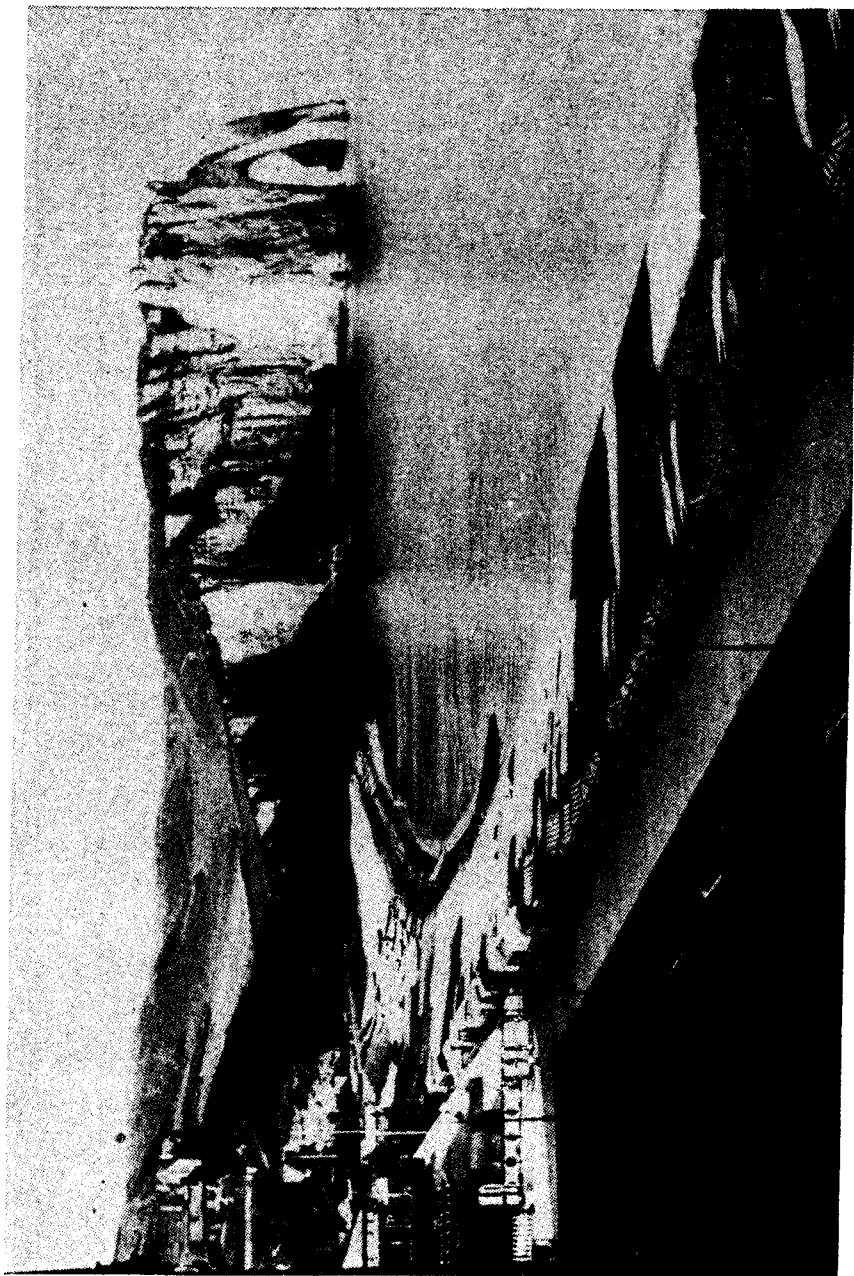

Figure 5.—French beach, showing typical cliffs on flanks.

### b. Booms

As obstacles against landing craft, light booms of simple construction are placed by the Germans in front of good landing beaches. They consist, usually, of conical buoys, linked by wire rope that runs through the tops and bases of the buoys. Rafts are similarly employed. Explosives and warning devices may be affixed to these booms.

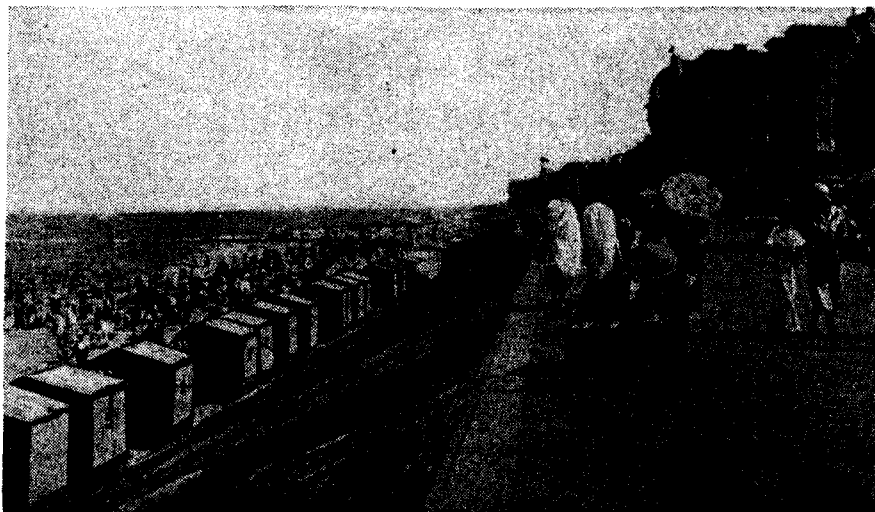

Figure 6.—Typical sea wall and promenade in Belgium.

## 10. BARBED WIRE

### a. General

This part of the discussion deals with German wire technique, as observed in The Netherlands, Belgium, and France. On the beaches, barbed wire is usually erected in straight lines, parallel to the shore and in front of fortified areas. In the spaces between forti-

fied areas the lines of wire jut out at right angles toward the sea.

The depth of wire obstacles around emplacements and fortified areas varies with the topography and importance of the site. In some places it may be 30 to 60 yards; in other positions the depth may range from 70 to 130 yards, or may go up to 200 yards. Generally, the distance from the outside edge of wire to the nearest pillbox or other firing position is not less than 30 yards.

Dense entanglements are installed in gullies and in the crevices of cliffs, whence the wire may continue as single fences along the top margin of the cliffs. The entanglements usually begin to thin out half-way up the side of gullies. In front of these obstacles the Germans sometimes erect small-mesh wire, apparently to slow up the employment of bangalore torpedoes.

The Germans often use wire to fence off all sides of a minefield. These fences consist of a single row of pickets with five or six strands of wire. In conjunction with road blocks, a wire entanglement or fence is employed on each side of the road, and the gap between is closed by movable gates of various types. Concrete walls and other more substantial types of barriers are now replacing wire entanglements as road blocks in many places. A thin belt of wire is usually erected outside of antitank ditches. Wire is employed on practically all wall barriers and concrete emplacements, which often have iron staples in them for the stringing of apron and other types of entanglements.

A new type of German barbed wire now in use is

thicker than ordinary wire, is made of a noncorrosive metal, and is rectangular in section. It has three-quarter-inch barbs at intervals of 4 inches.

**b. Specific Types**

Some details of specific types of wire obstacles in The Netherlands, Belgium, and France are listed below. The dimensions are approximate.

(1) *Knife rests*.—Knife rests, or *cheval-de-frise* obstacles, strung with wire, have been observed on beaches above high-water mark. Some examples consist of four trestles connected by a cross bar. The dimensions are as follows:

Height.....	4 feet
Span of trestle legs.....	4 feet
Distance between trestles.....	4 to 5 feet
Length of four-trestle unit.....	16 to 20 feet

(2) *Apron fences*.—These may be single or double aprons. Screw pickets or angle-irons embedded in concrete to a depth of about 18 inches are used to hold them. Sometimes a coil of concertina may be placed under double-apron fences. Another variation is to place a coil of concertina on the tops of such fences. The dimensions are as follows:

Height.....	4 to 5 feet
Height (with coil on top).....	7 to 8 feet
Width.....	Up to 30 feet

(3) *Vertical fences*.—Vertical fences are invariably installed in two or three lines, 4 to 8 feet apart. Each fence has five or six strands of wire, and is 4 to 6 feet high. Wooden posts, angle-irons, and screw pickets

are used as supports. Various types of entanglements and mines are often used in the spaces between fences.

(4) *Concertina fences*.—Single, double, or triple coils of concertina are used with angle-irons or screw pickets. Triple coils are often affixed to the rails of the promenades that are so common along the beaches of western Europe.

(5) *Trip fences*.—Trip wires in diagonal or diamond-shaped trace are frequently found in front of major obstacles, usually between the high-water mark and the first barbed-wire entanglement, or they are erected in fields before main defensive positions or obstacles. Their dimensions are as follows:

Height -----	4 to 6 inches
Length of each diagonal or diamond-shaped trace..	4 to 6 feet
Width of whole obstacle.....	12 to 20 feet

(6) *Alarm wires*.—There is evidence that many wires have some form of alarm device connected to them, such as grenades, small explosive charges, and insulated live wire, which would ring a bell if cut.

(7) *Electrified wire*.—Electrified barbed wire, held by insulators to pickets, has been reported, but it is not likely to be encountered on a large scale.

(8) *Combined fences*.—A typical combined fence may consist of the following units in the order given: a trip wire, a trestle fence or knife rest, and (10 to 20 yards farther back) an apron fence. The total depth of such a combination may be 30 to 60 yards. On the sea fronts of towns, the usual practice is to have an apron or knife-rest fence on the beach, and a concertina or apron fence on the top of the sea wall and promenade.

### c. Standard Technique

For comparative purposes, some notes on available information about wire-obstacle practice, as prescribed in German training documents, are given below.

(1) *Obstacle in depth.*—This is constructed to a depth of approximately 33 feet, and consists of plain

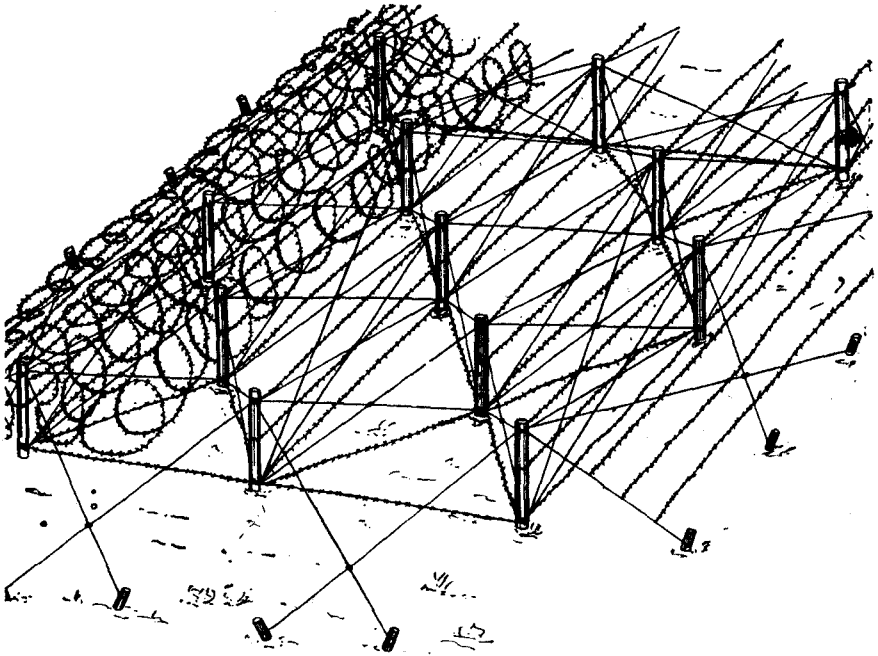

Figure 7.—Standard German barbed-wire obstacle in depth.

wire fences erected at intervals of about 5 feet and connected with more crisscrossed plain wire. (See fig. 7.) The spaces between the fences are filled in with barbed wire in spirals that are fastened to each other and to the pickets of the crisscross wire. Trees are used to support the wire if it is erected in woods. An obstacle in depth of this kind is usually erected in

places where it is screened as far as possible from enemy observation, as, for instance, in woods, hollows, sunken roads, and heavily overgrown reverse slopes.

(2) *Wire-netting fence*.—The Germans prescribe the use of wire netting as a hasty obstacle against infantry. They state that it is most effective in woods and on the near side of hedges, and recommend that it be secured to the ground with wire and pickets. A training manual illustrates an example 6 feet 6 inches high.

(3) *Trip-wire obstacles*.—According to German practice, obstacles of this type should be at least 30 feet in depth. They are formed by driving into the ground irregular rows of wooden pickets, 2 feet long and 3 inches in diameter, and stretching plain or barbed wire between the pickets at a height of 4 to 8 inches. The interval between pickets is 10 to 13 feet, and between rows 7 to 10 feet. The freshly cut heads of the pickets are painted to blend with the surroundings. These obstacles can be effectively concealed in grass, heather, and gullies, particularly if rusty wire is used, and they may be combined with traps.

## 11. MINEFIELDS

### a. General

During the North African campaign the Germans made great use of minefields and developed minefield technique to a high degree of effectiveness. They have applied this experience widely in western Europe, where they have had plenty of time to lay out fields behind important beaches and in their rearward defenses. The German Army teaches that mines are a very powerful defensive weapon, and that their skilled



employment in combination with other weapons strengthens defense, especially when the defender is considerably inferior in numbers. The Germans also teach that the employment of mines must be under strict control and in the hands of well-trained, courageous troops. Their basic doctrine prescribes the use of minefields in advanced positions, in the vicinity of the main line of resistance, and in the depth of the position.

The material and diagrams set forth below in this section have been taken wholly, with slight alteration, from the recently published TM 5-325, *Enemy Land Mines and Booby Traps* (April 19, 1943), chapter 2, section XI, and Changes No. 1 (May 17, 1943).

The principles which guide the Germans in selecting a minefield location are essentially the same as U. S. principles. Maximum use is made of natural and artificial barriers to compel vehicles to cross the minefield. Roadways are usually mined at points where vehicles cannot detour, the aim being to cause the cratering of the road and damage to vehicles. Mines are also used wherever it is desired to augment the difficulties of passing natural or artificial obstacles.

Extensive use is made of mines in preparing a hasty defense against counterattack. Under such conditions, because of lack of time for proper burial and concealment, the mines are generally not concealed, but are laid on the ground surface until there is an opportunity to bury them. When the ground is covered with snow, land mines may not be buried until the melting of the snow makes concealment necessary.

Although standard patterns may be prescribed in

training pamphlets, there is considerable variation in the actual layout of German minefields. The Germans leave gaps in minefields for their own use, but normally they will place a small field about 50 paces behind the gap to act as a stopper. By the use of dummy mines, the Germans leave paths for the passage of their own vehicles. Tellermines are normally used to form anti-tank minefields, whereas heavy antitank mines are used for road blocks.

### **b. Minefield Layouts**

(1) *Tellermine minefield patterns.*—(a) *Method of spacing.*—The measurements which establish the location of individual mines in a field are ordinarily made by pacing. Consequently, considerable variation from the intended pattern may be encountered. For “close spacing,” the interval varies from 3 to 5 yards; none is less than 2 yards. If spaced at 3-yard centers, the detonation of one mine will invariably detonate the one next to it. In “open spacing,” Tellermines are laid 10 yards apart.

According to a German document, the distance between Tellermines, center to center, should be 5 paces (13 feet) when laid in the ground, or 10 paces (26 feet) when laid on the surface.

In North Africa, minefields of 6 rows have been found in which German Tellermines and Italian B-2 mines have been laid in alternate rows; individual mines were laid from 5 to 8 yards apart. These mines also have been found installed together in a haphazard manner throughout an entire minefield. In some minefields in Cyrenaica, Tellermines were laid on 9-foot centers.

In one instance, the firing of 1 mine set off a field of 980 mines, set 9 feet apart, by sympathetic detonation.

(b) *Hasty minefield*.—A layout for a hasty minefield is shown in figure 8. It has panels 30 paces across the front by 30 paces in depth, or approximately 80 by

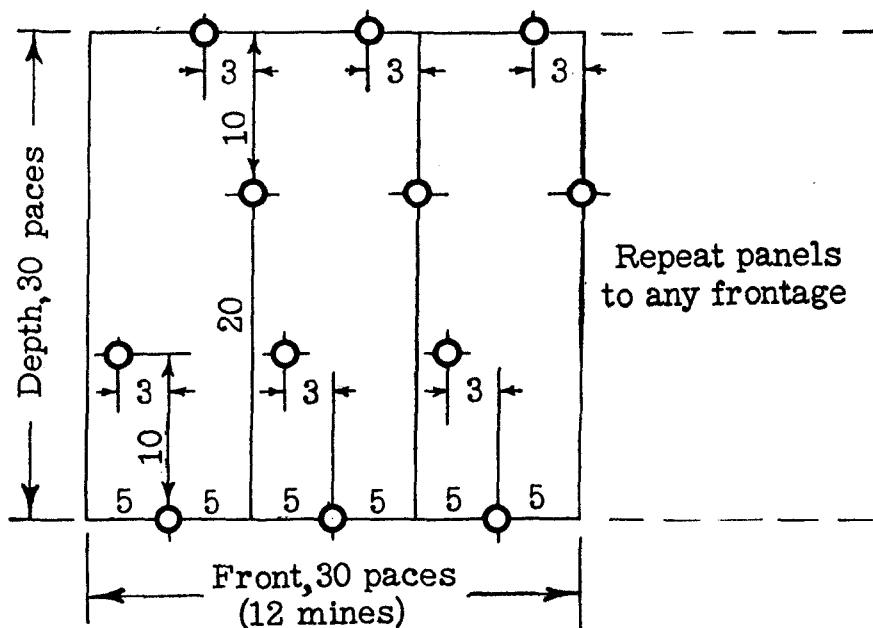

NOTE: All dimensions in paces

Figure 8.—Hasty minefield pattern (open spacing).

80 feet. Each panel contains 12 mines. The resulting density is 1 mine for each  $6\frac{1}{2}$  feet of front, and thus would be classified as open-spaced. The panels are repeated side by side to cover the desired length of front.

(c) *Deliberate minefield*.—The layout for a somewhat more deliberate type of minefield is shown in figure 9. This is also open-spaced. The panel is 30

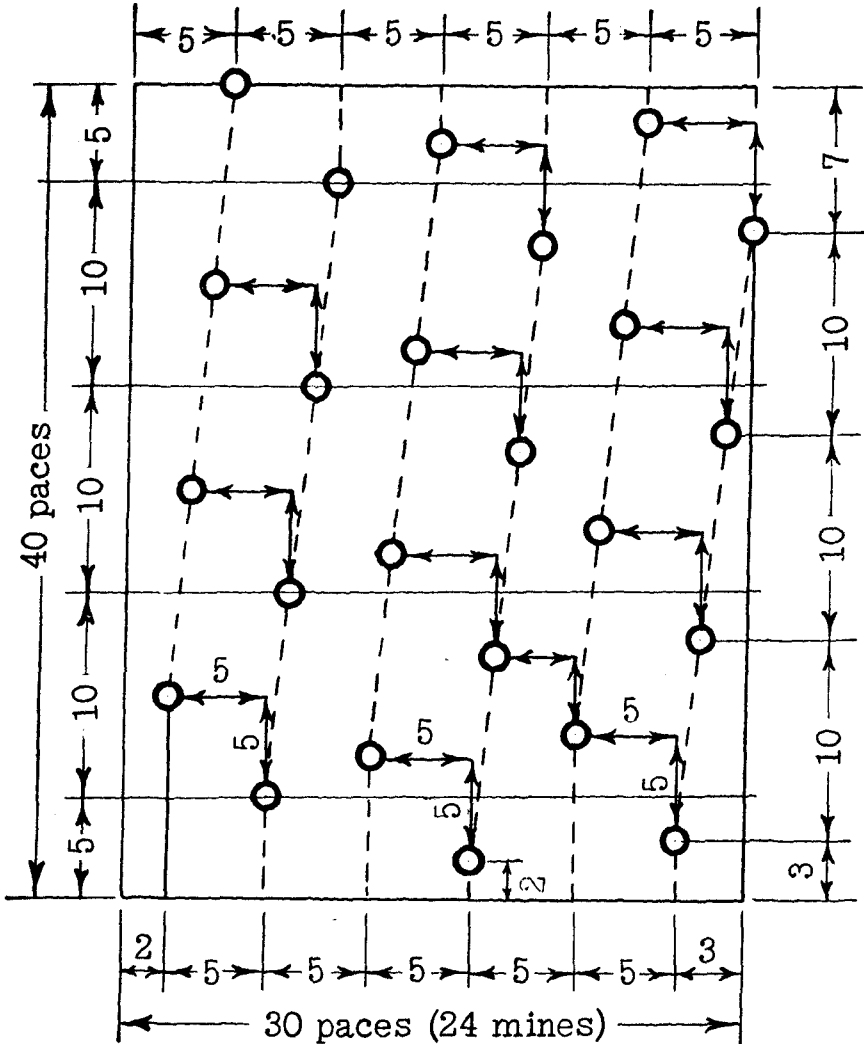

NOTE: All dimensions in paces

Figure 9.—Deliberate minefield pattern (open spacing).

paces across the front by 40 paces in depth, or approximately 80 feet by 105 feet. It contains 24 mines, giving a density of 1 mine per meter ( $3\frac{1}{4}$  feet of front). These panels are combined to form staggered patterns of 3 panels each. Each panel is offset 20 paces ( $52\frac{1}{2}$  feet) from the adjacent panels, as shown

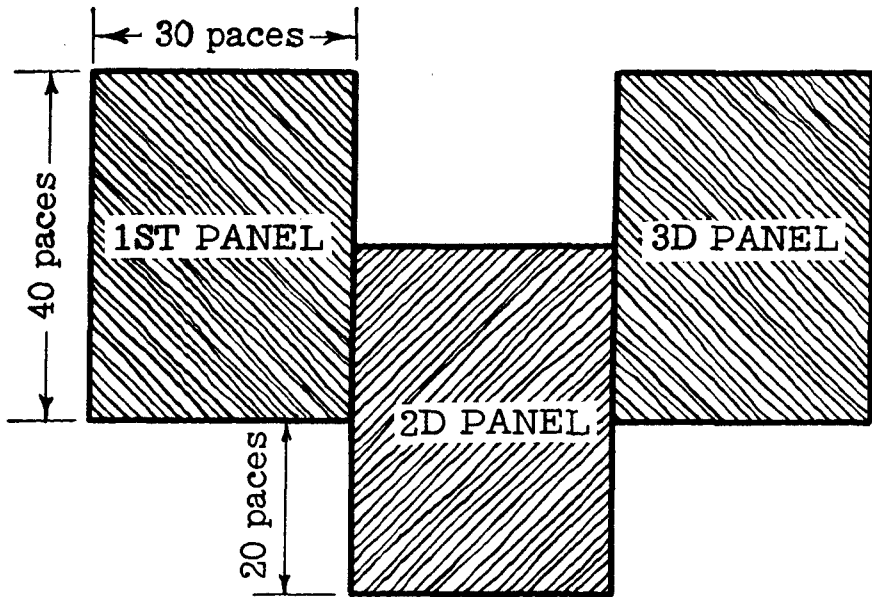

Figure 10.—Panel arrangement of deliberate minefield.

in figure 10. These patterns of 3 panels each may be further combined to form a more extensive minefield layout.

(d) *Variation of deliberate minefield.*—In a report dated September 1942, from North Africa, it is stated that a variation in the pacing of the deliberate minefield shown in figure 9 was found. The variation consisted of the horizontal and vertical coordinates being 6 paces and the minimum spacing between mines

being 7 paces. When open spacing was employed, the above dimensions were doubled.

Another variation of this more deliberate minefield is a panel having close spacing and measuring 15 paces across the front by 40 paces in depth, or approximately 40 feet by 105 feet. It contains 24 mines, giving a density of 2 mines per meter ( $3\frac{1}{4}$  feet) of front.

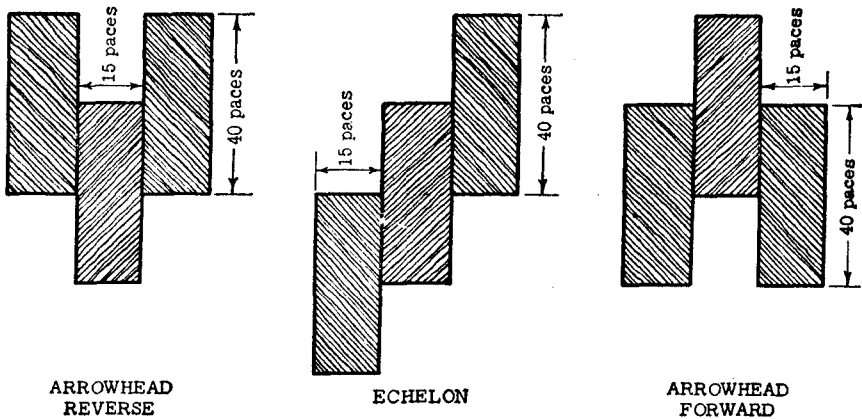
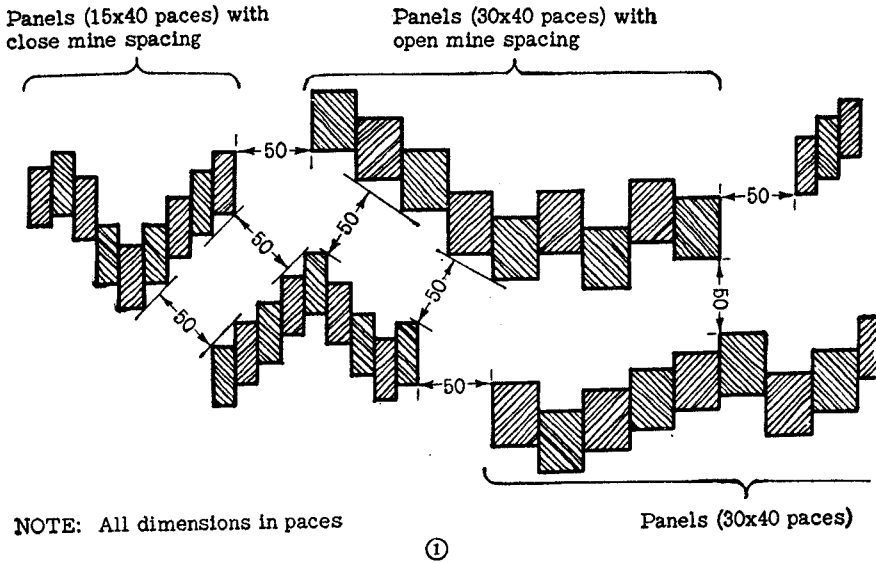

Figure 11.—Three methods of arranging minefield panels.

These panels are normally combined in groups of 3 in arrowhead reverse, in echelon, or in arrowhead forward formation, as shown in figure 11. These groups of 3 panels each are further combined to form large minefields or a part of an extensive layout, as shown in figure 12 ①.

(e) *Extensive minefield.* — An extensive minefield layout may combine groups of open-spaced and close-spaced panels (see fig. 12 ①). A minimum distance of 50 paces (131 feet) between fields is maintained.

Figure 12 ② shows a German-Italian plan of an extensive minefield in which the deliberate minefield pat-



NOTE: All dimensions in paces

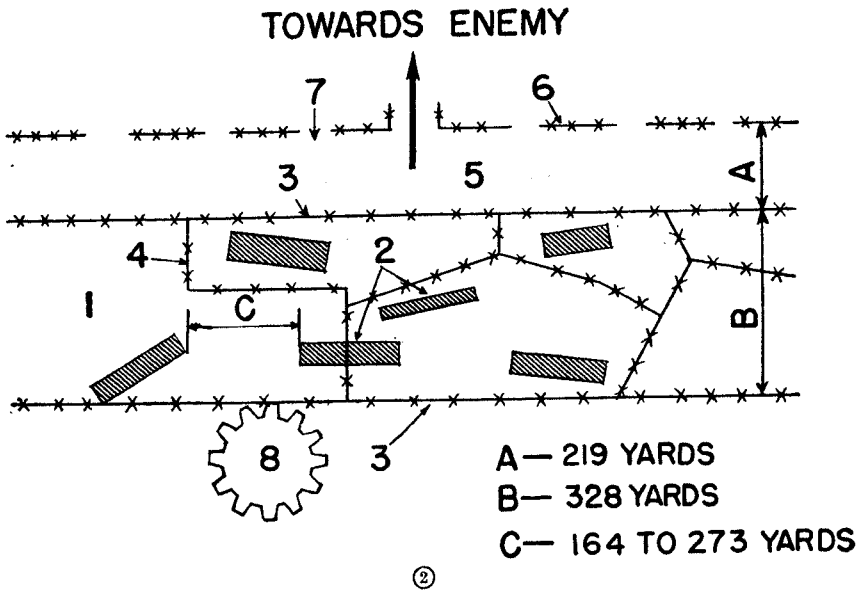

Figure 12.—Extensive layout of minefields.

tern was used. The main minefield area (1) with mine zones (2) laid in patterns is bordered in the front and rear with barbed wire (3) and with other barbed wire (4) running irregularly through the minefield for the purpose of deception. In front of the main minefield (1) is a minefield (5) of scattered mines marked

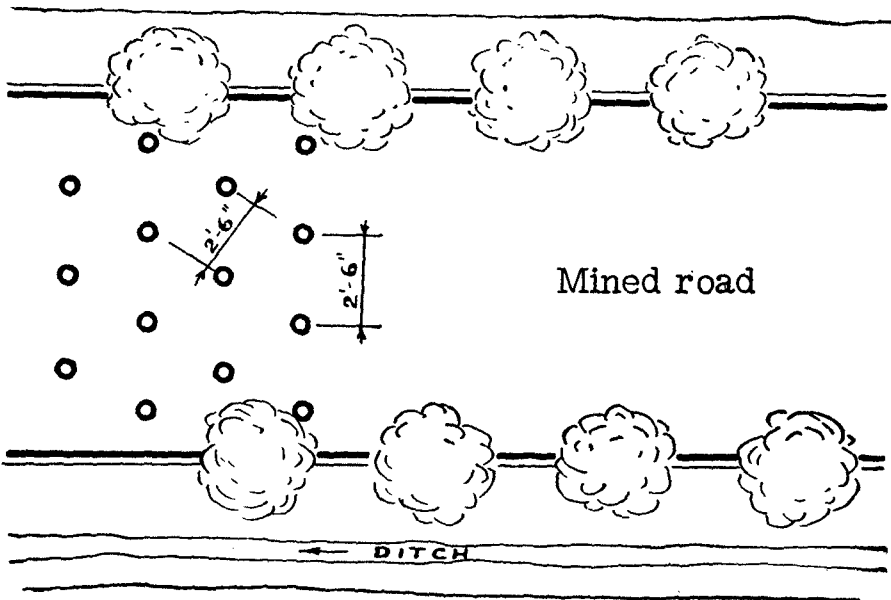

Figure 13.—Tellermine road block.

in front with a broken line of barbed wire (6). The gaps (7) are intended for deception. A strongpoint (8) is located to the rear of the main minefield.

(f) *Road blocks*.—Tellermines may be used in road blocks, alone or in conjunction with artificial barriers. The interval between mines is about 1 pace ( $2\frac{1}{2}$  feet), and slightly less than this between rows. Thus four rows, as shown in figure 13, give a density of one mine to each  $7\frac{1}{2}$  inches of width in the roadway.



When the Germans mine a road, yet continue to use it for their own needs, one-half of the road is left unmined. Detours which the Germans have used to bypass their own road blocks may be heavily mined when the area is given up to the advance of opposing forces. If the nature of the road surface permits, mines are buried. Mines are sometimes laid indis-

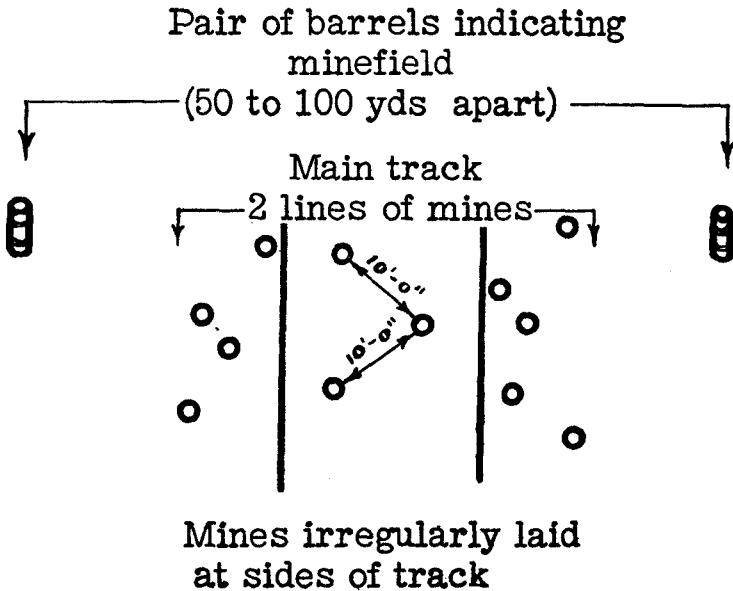

Figure 14.—Tellermine railroad-track block.

criminate on the shoulders of the roads. In North Africa, railroad tracks leading out of towns have been mined as in figure 14. Other road blocks have been found where mines were laid in a few "chuck" holes in the roads, while other holes were left empty. Of course, all holes had to be carefully examined. For 10 kilometers (about 6¼ miles) south of Agedabia, road blocks were laid at all kilometer stones, which were used as markers.

(2) *Heavy antitank minefields*.—The German heavy antitank mine is normally used to form antitank road blocks on main lines of communication. The road blocks formed by these mines usually contain between 15 and 20 mines laid in 1 of 2 patterns, as follows:

(a) In a line diagonally across the road, 20 mines occupying about 100 yards of road.

(b) In a checkerboard pattern, with the mines placed  $6\frac{1}{2}$  to 8 feet apart and each row of mines covering the gaps of the preceding row. The depth of the minefield may be 15 to 20 yards or more. In some cases Tellermines have been found mixed with heavy mines.

(3) *Antipersonnel minefields*.—The antipersonnel mines are placed in fields and are on occasion very precisely located by means of standard layout equipment. This equipment consists of an equilateral triangle made up of 10 rings, each 40 centimeters ( $15\frac{3}{4}$  inches) in internal diameter, and 18 cords, each 4.4 meters (14.43 feet) long. (See fig. 15.) Each side of this triangle, formed by the joining of the cords and rings, is, therefore, 43.3 feet long and is made up of 3 cord lengths and 4 rings. The triangle is laid out on the ground with 1 edge along a base line, and an antipersonnel mine is planted in each ring. The triangle is then turned through 60 degrees on the corner of the triangle farthest from the base line, and more mines are laid at each ring. (See fig. 16.) This procedure is repeated to form some such continuous field as shown in figure 17.

The field as shown is registered for map-record purposes by extending the base line 100 meters (328

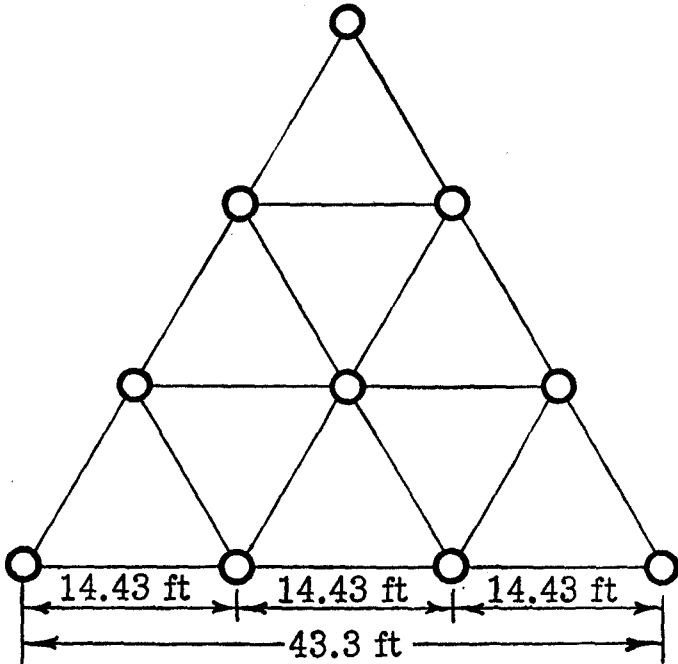

Figure 15.—Equilateral triangle layout for antipersonnel minefields.

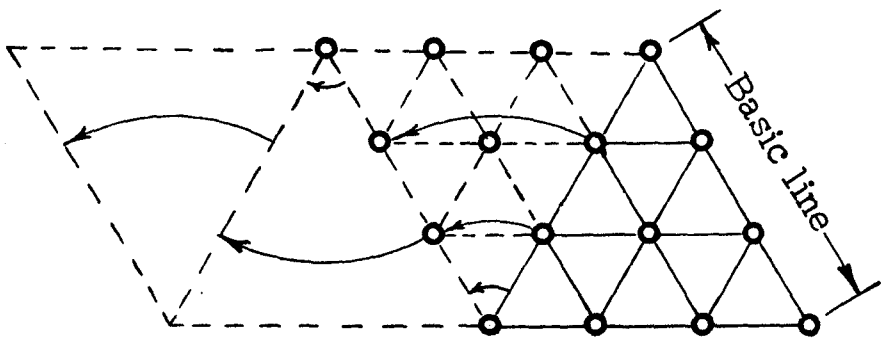

Figure 16.—Method of rotating equilateral triangle layout for antipersonnel minefields.

feet) rearward and marking it with pickets at 20-meter (65.6-foot) intervals (Points P1, P2, P3, P4, P5, and P6), except that for safety the point P6 is set back 2 meters (6.6 feet) from the corner mine, making the interval from P5 to P6 only 18 meters (59 feet).

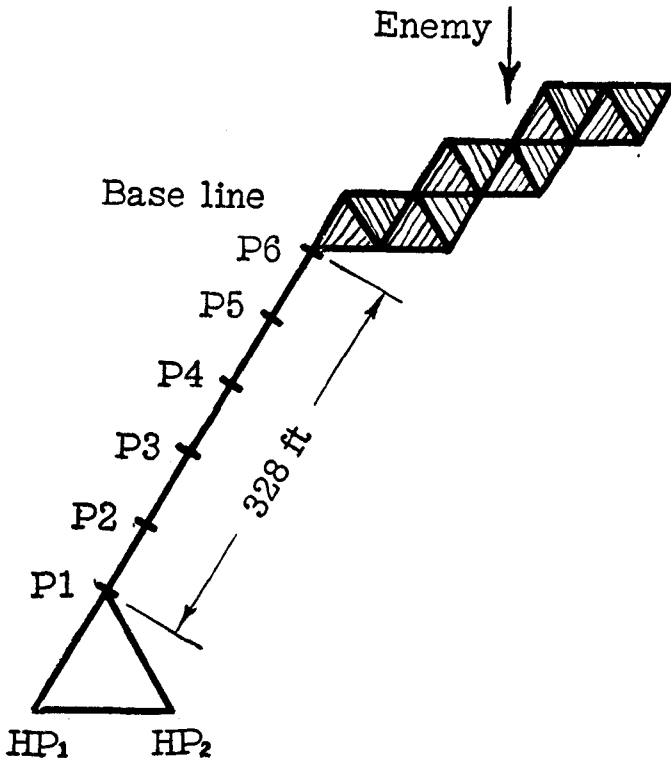

Figure 17.—Continuous antipersonnel minefield.

The Point P1 is registered on two reference points HP<sub>1</sub> and HP<sub>2</sub>, and the azimuth of the extended base line P1 to P6 is recorded.

(4) *Minefields in a defile.*—The mines are laid out in regular rows from a line based on outstanding existing features which lie on the forward edge of the pro-

posed minefield. The interval between rows varies between 2 feet 4 inches and 5 feet. The number of rows is not fixed, but the minefield is designed to give a density of at least one mine to 1 foot 2 inches of front. The mines are carefully concealed. An accurate record is kept of the extent of the minefield and of any gaps which may have been left for the Germans' own use.

### **c. Minefield Records**

Minefields are mapped on a scale of 1:2,500, and the complete scheme is transferred to a 1:10,000 map.

### **d. Marking**

Minefields laid in advance of an enemy approach are marked by holes, sticks, branches, or wires as warning to German troops. A report of a minefield at Ben Temrad states that mines were laid at very irregular spacing, but always in or near a vehicular track. The mines laid across the vehicular tracks were generally marked with small stone cairns at the corners of the fields. Mines were also laid along tracks, and these seemed to be marked by cairns at either end of the mined sections.

In May 1942, an order issued by the German 90th Light Division stated that the existing methods of marking minefields were inadequate. Minefields were to be marked either by a strong wire fence 1 meter (39 inches) high or stone walls 40 cm (16 inches) high. However, substitute materials such as barrels, concertina wire, tin cans, derelict vehicles, etc., might be used. In a report from Agedabia, a perimeter mine-

field, without markings, was located 20 yards behind the perimeter wire. Mines laid on roads or railroad tracks in North Africa were usually found installed close to some easily identifiable landmark, such as a kilometer stone, track junction, or a small stone cairn. Minefields and road blocks were also found marked by a 40-gallon oil drum, usually with a patch of red paint

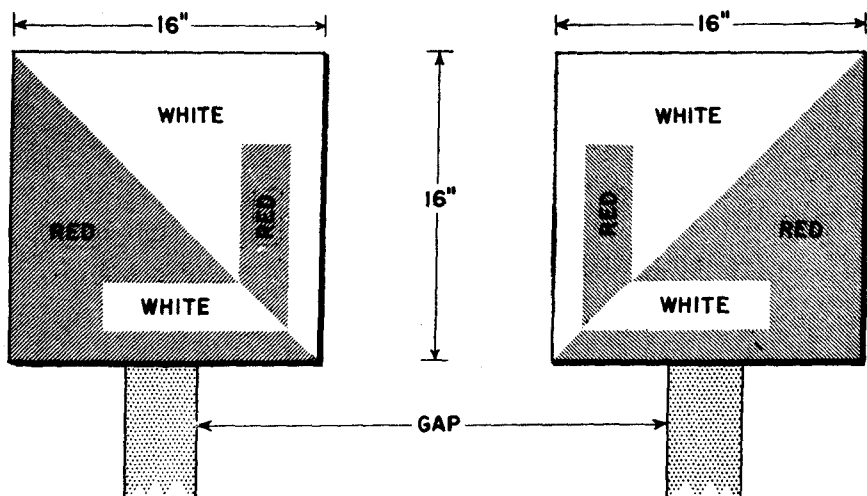

Figure 18.—Minefield gap signboards.

and holes in the top which marked routes past the minefields.

In May 1942, an order issued by the German 15th Armored Division described minefield-gap identifying signboards (see fig. 18) in red and white which were to be mounted on posts 3 feet 6 inches to 5 feet high. In the northern sector of the El Alamein line, minefield gaps were found which were marked by luminous tubes 1 inch long placed on top of the mines. They marked a route for patrols and were visible 3 yards

away. Gaps have been reported to be 7 to 10 yards wide. Often the front edge of minefields is not marked, but the rear edge is usually marked by some form of fence, such as a trip wire on short pickets. Occasionally the rear edge of a minefield has been found unmarked. A common marking for minefields is a single row of concertina wire along the center of the minefield and parallel to the rows of mines. In a large minefield there may be several unmarked rows of mines along the front, a row of concertina wire, more rows of mines, then another row of concertina wire, and so on, with a row of concertina wire marking the rear edge of the minefield. Only one case has been reported of continuous wire running irregularly within a minefield.

#### **e. German Conclusions on Minefield Practice**

The Germans have drawn the following conclusions from their experiences with minefields:

(1) *Minefield layout plans.*—Accurate minefield plans are extremely important, since the unit employed in laying the land mines may not be the one to take them up.

(2) *Minefield reports.*—Prompt reports, accompanied by layout plans of all minefields, should be submitted to designated higher authority. If this is done, the publication of adequate warning will prevent losses of men and vehicles in their own minefields.

(3) *Temporary nature of minefields.*—Minefields should always be viewed as temporary, to be taken up again as our own troops advance. For this reason it is desirable to keep the troops engaged in land-mining

in the section where they have laid fields, so that they may remove the mines, if necessary, which they themselves set out.

(4) *Minefields behind water obstacles.*—In planting a minefield behind a water obstacle, the mines should be laid close to the water's edge. If mines are located several yards back, it is possible for the enemy to land personnel skilled in neutralizing them.

## **12. ANTITANK OBSTACLES AND ROAD BLOCKS**

### **a. Dragon's Teeth and Ditches**

One of the common forms of tank obstacles employed by the Germans is the "Dragon's Teeth," which consists of rows of reinforced, tapered concrete pedestals, cast monolithically on a common base. The concrete blocks vary in height up to 6 feet, and they are designed to immobilize a tank by bellying it. Fields of these blocks, used on a vast scale in the German West Wall and now installed also on the European coast, usually consist of four to eight rows in front of prepared positions. They are usually laid in straight lines to simplify artillery registration on them. In front of each of these fields the Germans normally dig an antitank ditch, at least 10 feet wide and, in exceptional cases, up to 60 feet wide.

Antitank ditches have also been dug at the approaches to coastal roads and key positions, and it is not unusual to find two ditches spaced only a few feet apart. Normally, these ditches have passages to permit the flow of single-line traffic. The rear walls of these ditches are usually revetted with concrete, earth, or brick, and some of them have steel rails projecting from the top.



Around strongly defended ports will be found anti-tank ditches 20 to 40 feet wide and up to 3 miles in length. They are usually laid in a zigzag course. Ditches of this length are most common in The Netherlands, but they are also found to a lesser extent in Belgium and France. In the construction of such a ditch in The Hague, the Germans demolished a row of three-story houses, more than a mile long.

These ditches are usually protected by a thin belt of wire, and by gun emplacements and pillboxes sited to enfilade the zigzag course of the ditch. Where streams or other water sources are available, the ditches have a sluice arrangement to keep them partially filled with water, or to flood them in the face of an attack.

Antitank ditches installed in front of defensive positions are usually 9 to 12 feet wide and up to 8 feet deep.

When employed thus, they are sited as follows:

(1) The ditches completely surround fortified positions, and radio-direction and other radio installations. Usually there is a thin belt of barbed wire 10 to 20 yards in front of the ditch and a thicker belt about 50 yards to the rear of the ditch.

(2) The ditches are dug in front of fortified areas on beaches, behind beach wire, and at the foot of sand dunes.

(3) The ditches are dug in front of antitank walls and sea walls in coastal towns. They are usually without revetment, and may be dug 10 to 20 yards in front of the wall, or immediately in front of the wall.

## **b. Miscellaneous Obstacles**

(1) *Chevaux-de-frise*.—Portable barriers of the cheval-de-frise type are commonly used by the Germans to block streets and important highway inter-

sections. In some coastal places these obstacles are moved into position every night, evidently as a safeguard against commando raids. In other spots they

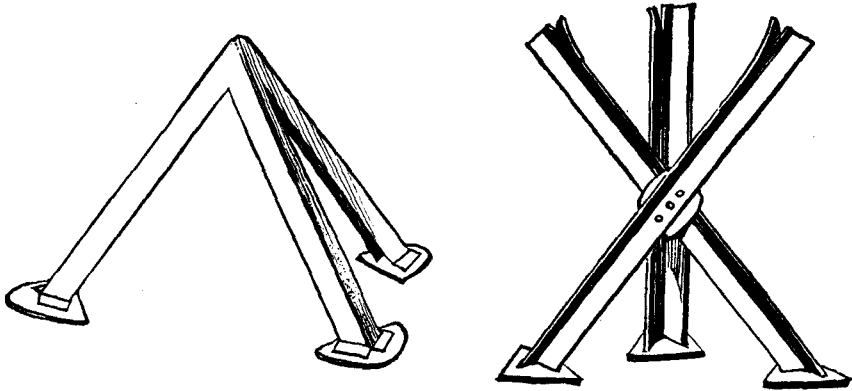

Figure 19.—Types of steel cheval-de-frise trestles.

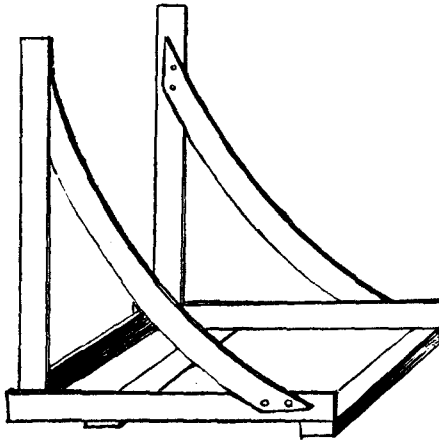

Figure 20.—Angle-iron obstacle.

are merely kept ready for placing during alerts. Two types of trestles for chevaux-de-frise are illustrated in figure 19.

(2) *Logs and rails*.—Logs and steel rails of varying heights are employed for making fixed and movable

obstacles. Usually they are laid in "asparagus beds," the individual rails being spaced about 4 feet apart. Angle-iron frames with upright steel rails, set in pairs on a common base, are also laid in rows to form barriers. The example shown in figure 20 is more than 6 feet high. Various kinds of "swinging gate" obstacles are used in large numbers to block streets.

(3) *Wire obstacles*.—The Germans sometimes use concertina wire, disposed in depth, as a road block. (See also par. 10, above.) They are also apt to conceal antitank and antipersonnel mines in these obstacles.

### c. Walls and Promenades

(1) *Walls*.—At many points along the western European coast the Germans have built concrete walls to serve as antitank and antipersonnel obstacles. Such walls usually are placed to obstruct the ends of thoroughfares and other easy exits from beaches and harbors, and to block the approaches to key positions back of the beaches. Their dimensions are from 6 to 8 feet in thickness, and up to 20 feet in height. In various places in Belgium the Germans have installed behind these walls several types of antitank barriers which were removed from the Belgian defense lines of 1940. Both stationary and portable flame-throwers may also be encountered at these barriers.

Walls installed across the full width of a street are 6 to 8 feet high and may be from 8 to 11 feet thick. They are reinforced with concrete bars, the ends of which protrude from the tops of the walls to serve

as pickets for barbed wire. The backs of these walls are generally sloped and may have fire steps from which to operate antitank guns. Walls of these same dimensions are sometimes constructed in V shapes at beach exits, especially on open beaches outside town limits. The point of the V is toward the sea. Some

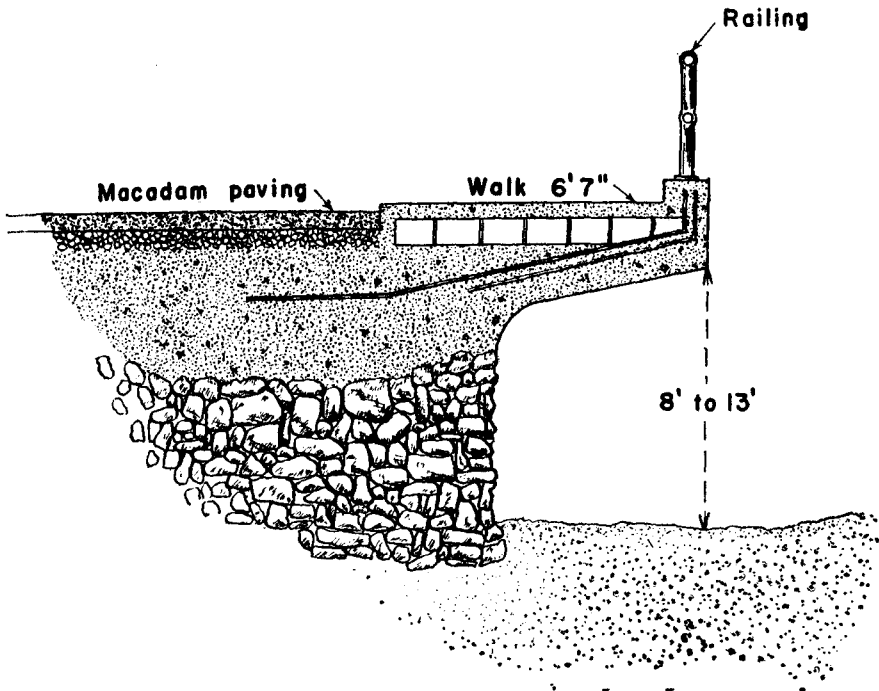
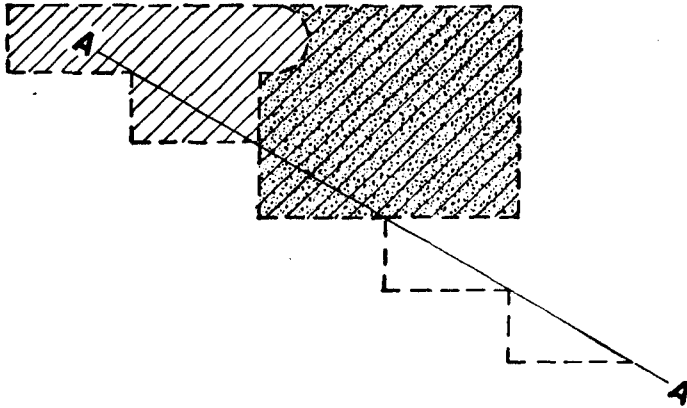

Figure 21.—Cross section of typical European beach promenade.

wall obstacles blocking the ends of thoroughfares opening on beaches have gaps in them to permit the passage of a single vehicle at one time. These obstacles are of two types. In the first, a section of wall is built at each side of the road, and the gap between

them is closed, when necessary, by steel rails, girders, or gates that fit into sockets of the walls. The other type also has two sections of wall, but these are not directly opposite each other. They are "en chicane," or staggered, one section being as much as 16 feet behind the other, on the opposite side of the road. This arrangement compels a vehicle to slow down and zigzag to pass through.



**A—A** General profile of the dike  
from Ostend to Mariakerke

**Figure 22.**—Antitank obstacle at top of promenade steps.

Long stretches of concrete antitank walls are built along the rear edges of beaches and across the estuaries of streams, with gaps to permit the flow of water. Where the regular sea walls are not very high above the level of the sand, they are sometimes adapted as antitank barriers by excavating accumulated sand drifts and gravel from their seaward bases, or by heightening them with concrete. In some cases there

is an outward bulge below the top front edge of these walls to make them more difficult to negotiate.

(2) *Promenades*.—The promenades or boardwalks so common along the beaches of The Netherlands, Belgium, and France must also be considered as formidable obstacles, for infantry as well as for motor and armored vehicles. In many places they have been strengthened with reinforced concrete, and emplacements have been built into them. A typical example of such a promenade is shown in cross section in figure 21. (Other examples of the defensive use of promenades may be found in sec. IV, par. 17g and i, below). Figure 22 shows how concrete blocks are used to discourage tanks from negotiating the stairway leading from a beach to the walk of a promenade.

#### **d. Concealment and Deception**

(1) *Camouflage and concealment*.—The Germans consider camouflage, concealment, and deception as very important and effective means of defense and have used these factors extensively in protecting coastal installations from ground as well as aerial observation. Troop shelters, pillboxes, hangars, dumps, and submarine and speedboat shelters have been constructed underground at all strategic points of the European coast. All open emplacements and the entrances of surface and underground installations have been skillfully disguised to add the protection of near-invisibility to the strength of reinforced concrete. The camouflage varies to blend with the different types of terrain in German-occupied countries.

Forms of camouflage and concealment that have been noted are as follows:

(a) Garnished nets, turf, and seaweed are used to conceal concrete bunkers in northwest France.

(b) Tanks, probably worn out or obsolete, have been buried in the sands of the coastal regions of France and Belgium, the gun turrets painted to blend with the sand. Private houses in the same area have been converted into gun emplacements without altering their external appearances.

(c) Some underground machine-gun nests are concealed by a natural earth covering about 3 feet thick.

(d) Certain large shelters capable of accommodating approximately 500 men each are camouflaged green, gray, and black. (This is a fairly common German camouflage combination.)

(e) Extensive use has been made of nets to camouflage harbor installations.

(f) In northern France props have been used to conceal surface hangars and airfields in order to make them look like a village from the air. On one airfield was installed a light wood framework, painted to look like the side of a farm house. A false top was painted to represent tiles. A number of other false buildings, including a replica of a church, were also installed in the same place.

(g) Numerous camouflaged shelters for individual planes are also reported. In one place they were built among trees at the edge of a wood. The shelters were of wood, with gabled roofs, were covered with netting, and had trees painted on the doors. In other places individual hangars take the form of farm buildings and hollow haystacks. Many shelters have been camouflaged to look like sand dunes or have been buried in dunes in areas with long, sandy stretches.

(h) In rocky country, the combination of camouflage around concrete forts is likely to consist of rocks and nets. In one region where the sand has a yellowish tinge, the Germans have camouflaged their installations with yellow patterns, broken by green stripes.

(i) Pillboxes and light-gun emplacements are concealed with heaps of the rubble caused by Allied bombings.

(2) *Dummy installations.*—The use of dummy works and weapons is extensive and serves the double purpose of distracting aerial observation from actual defenses and of inducing the enemy to make wasteful attacks on barren areas while the real defenses remain in operation. A common practice is to install dummy anti-aircraft-gun positions and dummy guns, and even to simulate gun flashes in such positions, usually along lines of probable air approach. Sometimes real, mobile guns fire from the dummy positions in an effort to confound aerial reconnaissance. The practice is also extended to other types of artillery. Railway-gun turntables suspected of being faked have been noted in aerial reconnaissance. Dummy observation posts have also been reported. In some places that are heavily mined and wired but do not have a great many weapons, sham turrets and wooden guns are planted in barbed-wire lines.

Many dummy airfields exist along the coast of western Europe. Mock or disused planes and dummy buildings are installed on these fields, and at night they are likely to flash landing lights. From time to time the dummy aircraft are moved around to help fill out the impression of a field in actual operation.

Dummy installations are likely to be deliberately ostentatious or poorly camouflaged, in order to draw fire and distract attention from real and cleverly concealed fortifications.



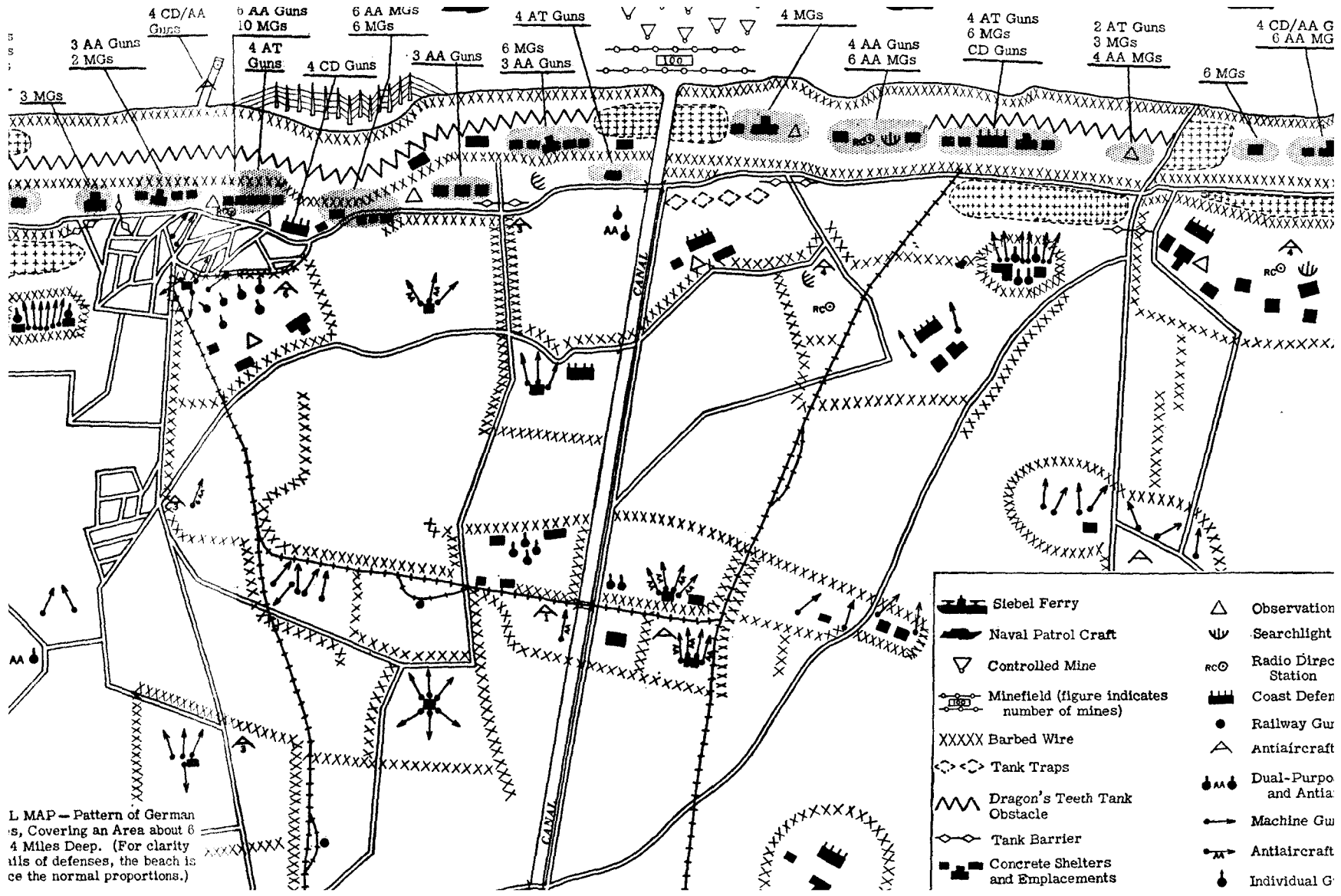

### **13. HYPOTHETICAL LAYOUT OF BEACH DEFENSES**

In order to offer a sample pattern of what the beach defense zone of western Europe is like, a hypothetical map of German beach defenses has been included in this section. The hypothetical map (fig. 23) is composite in style and is based on a study of known positions. It is typical of the defenses of a strategic landing beach with gentle gradient, backed by sand dunes.

## Section IV. FORTIFICATIONS

---

### 14. GENERAL

The beach obstacles already described are the lesser installations of the elaborate system of coastal fortifications which the Germans have constructed. The backbone of the defenses consists of reinforced concrete works, including units of many different types and sizes. In some places the defenses are rather light—barbed-wire fences, minefields, machine guns, or anti-aircraft guns in small numbers—but in all the strategic areas the Germans have taken advantage of the great deal of time at their disposal to lay out their defenses carefully and in depth, taking the maximum advantage of terrain features.

In some regions the Germans, before planning new defenses or improving old ones, held amphibious maneuvers to discover vulnerable approaches. Then the plans for fortifications were made in the light of lessons learned. They also profited from lessons drawn from actual operations, such as the Dieppe and various commando raids.

The Germans have used reinforced concrete lavishly in constructing forts, underground shelters, pillboxes, dumps, and emplacements for light and heavy weapons and for troops, as well as waterfront shelters for submarines and motor torpedo boats. Maximum use has also been made of existing French, Belgian, and Dutch coastal fortifications, which have been strengthened by

the addition of armor plate, guns, and other matériel from the Maginot Line and other interior fortified positions, by resiting of emplacements, and by additional concrete construction.

The major part of this work has been performed by the *Organisation Todt* (*O. T.*), a semimilitary agency that was formed primarily to build Germany's West Wall opposite the Maginot Line before the opening of the war. Organized into labor battalions, this agency employs a large number of locally hired and conscripted workers in carrying out its projects.

The following figures, which give average dimensions, are offered as a general guide to the strength of Todt-built concrete works on the coast:

	Observation posts	Personnel shelters	Ammunition magazines
Thickness of walls.....	3 to 5 feet.....	2½ to 3 feet....	3 feet.
Thickness of roofs.....	6½ feet.....	3 to 5 feet.....	3 feet.
Depth of soil on underground works.	6½ feet.....	0 to 3 feet.....	0 to 4 feet.

This section is devoted to descriptions of various unit-types of German field and permanent fortifications which are common on the Atlantic coast. They are discussed individually, and in detail if data is available, for the purpose of showing their characteristics and providing a basis for estimating their structural strength and weaknesses. It must be borne in mind, however, that each unit is only one component of a "hedgehog," or well-calculated system of all-around defense, and that the individual unit con-

tributes its own fire power to, and derives support from, the other elements of the system. (See par. 18, below.)

## **15. CONCRETE SHELTERS**

### **a. Rectangular Shelter**

A type of concrete shelter found on the Breton Peninsula in the vicinity of Quimper is shown in figure 24. It is 38 feet long and 19 feet wide, by exterior measurement. The interior height is reported to be 7 feet. Its walls are 39 inches thick. The roof is of the same thickness but is reinforced with steel bars, seven-tenths of an inch thick. On one side is an escape ladder, reached from the interior by means of an opening in the roof 27 inches square. This type of fortification is usually made with a loophole (the location of which is unknown), which is closed when not in use with a wooden frame filled with sand.

Each shelter has three or four ventilating chimneys with sandstone flues, and these are built out from the structure proper in order that there will be no weak sections in the walls. This tends to nullify the effect of grenades or other explosive charges that might be dropped into the chimneys, which also have many elbows or bends.

### **b. Standardized Shelter**

A concrete shelter that appears to have been standardized by the Germans and installed along the Channel coast is shown in figure 25. It will be noted that the over-all thickness of the concrete, except for the 12-

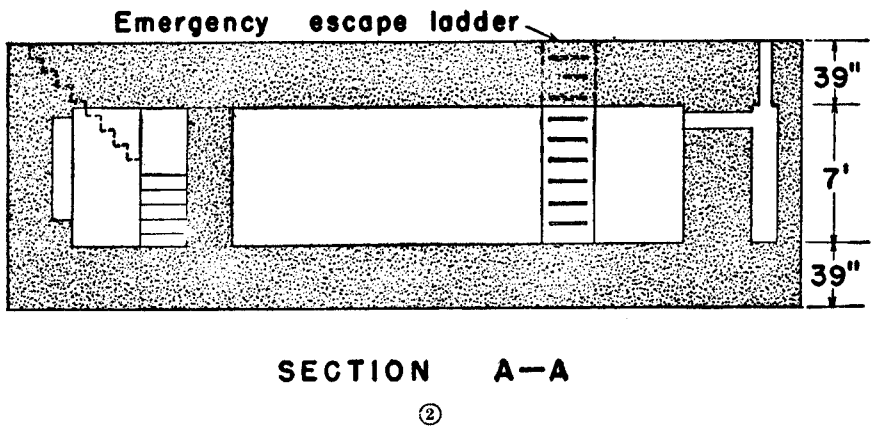
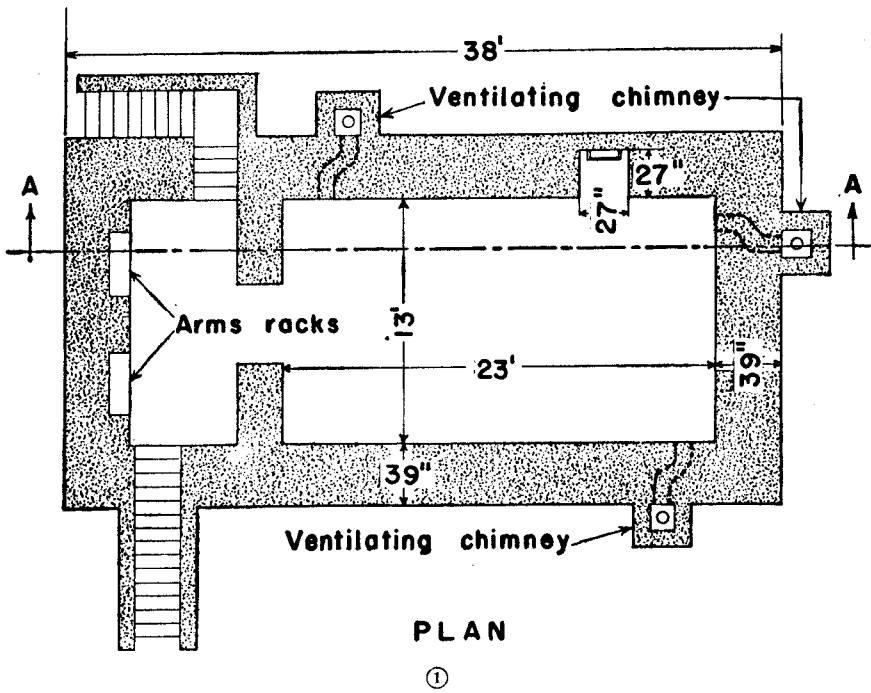
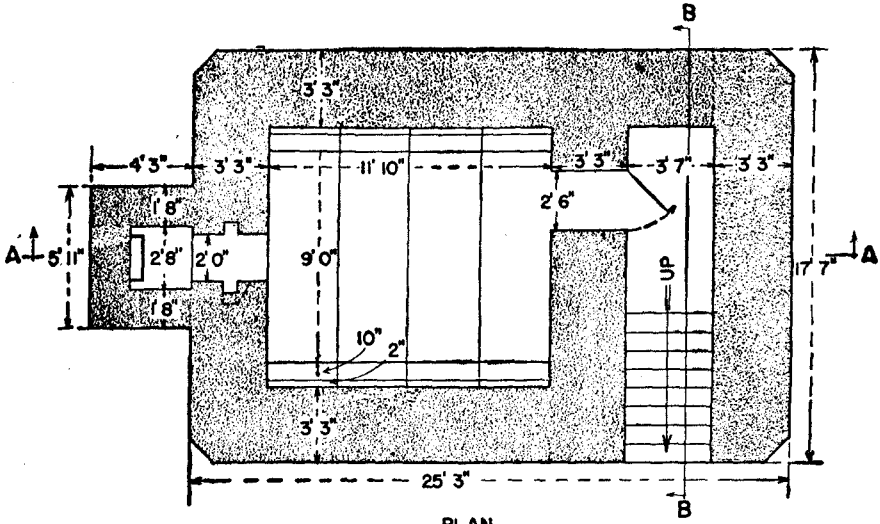
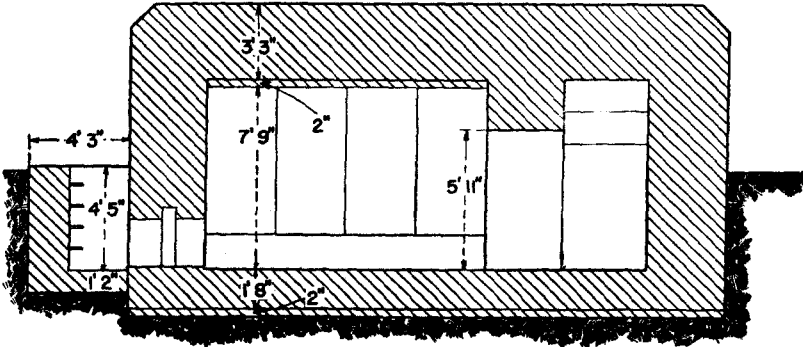

Figure 24.—Rectangular shelter on Breton coast.



PLAN

①



SECTION A-A

②

Figure 25.—Standardized shelter on English Channel coast.

inch retaining wall at the emergency exit, is 3 feet 3 inches.

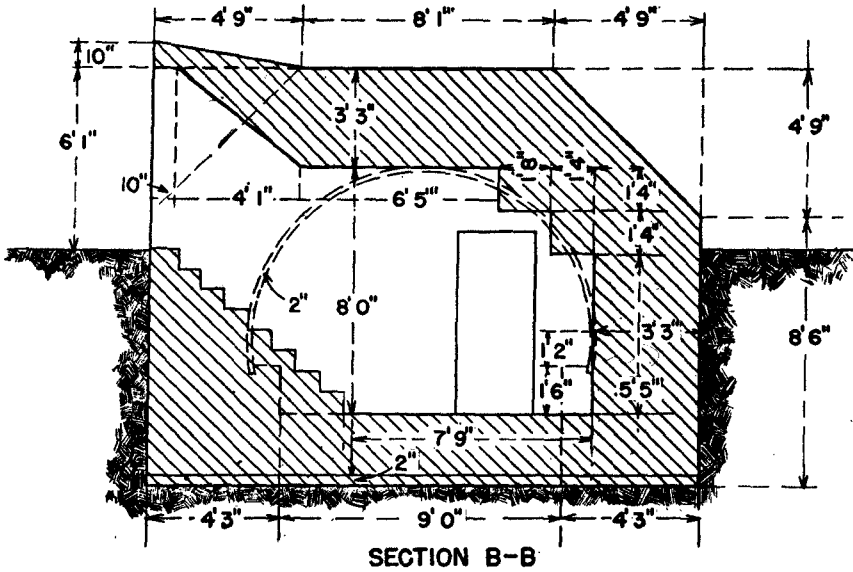

Figure 25 (continued).—Standardized shelter on English Channel coast.

**c. Dune Shelter**

Another type of reinforced concrete shelter, reported to be common in the “golden sand” dunes in the vicinity of Erquy, on the north central coast of the Breton Peninsula, is shown in figure 26. Shelters of this kind are buried in the dunes and camouflaged with turf. They are about 14 feet 8 inches square, with walls 2 feet 6 inches thick. The interior is divided by a concrete wall into two bays, each 4 feet 3 inches wide.

Figure 27 shows a photograph of a shelter that may be a variation of the type described above. It was con-



structed at Nieuport, on the Belgian coast. The photograph shows it before it was covered with earth.

It is reported that the dunes between Mariakerke and Middlekerke in Belgium have been hollowed also,

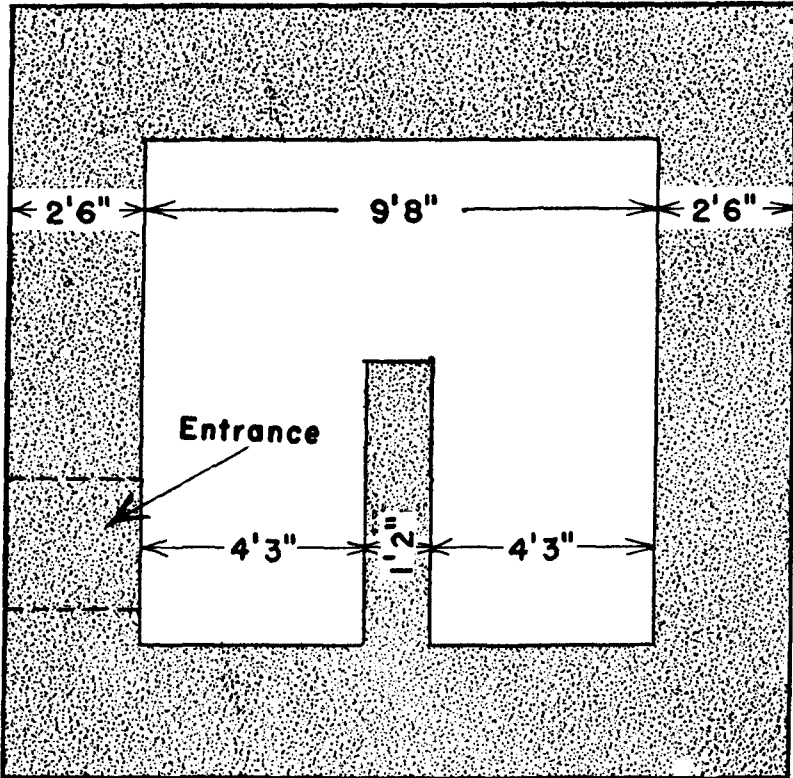

Figure 26.—Sketch of dune shelter.

and that concrete shelters, probably of this type, have been built into them. Reports indicate that the Germans have installed batteries of guns up to calibers of 210 mm behind these dunes. Antiaircraft guns and antiaircraft machine guns are included in the battery positions. In some dune areas, the Germans have

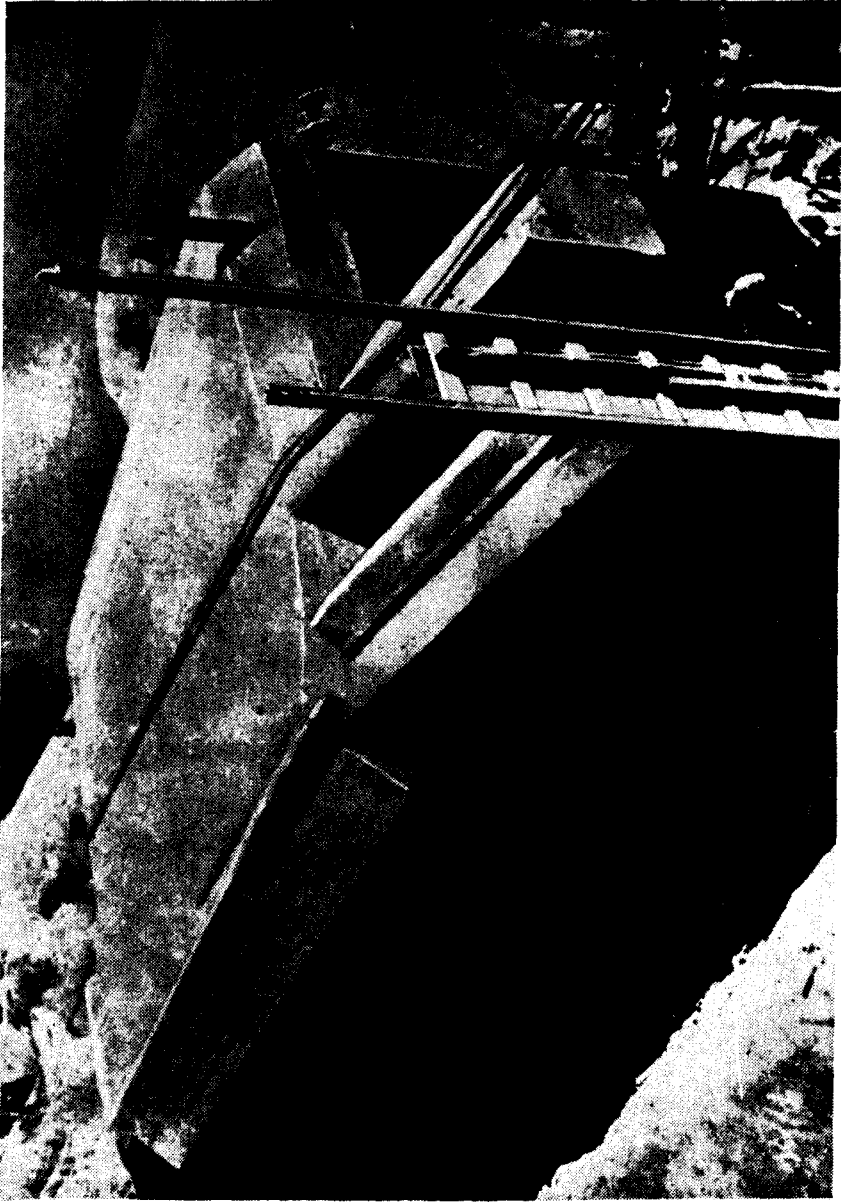

Figure 27.—Photograph of shelter built in dunes.

been compelled by the narrowness of the dune zones to dispose their batteries in straight lines, parallel to the beaches.

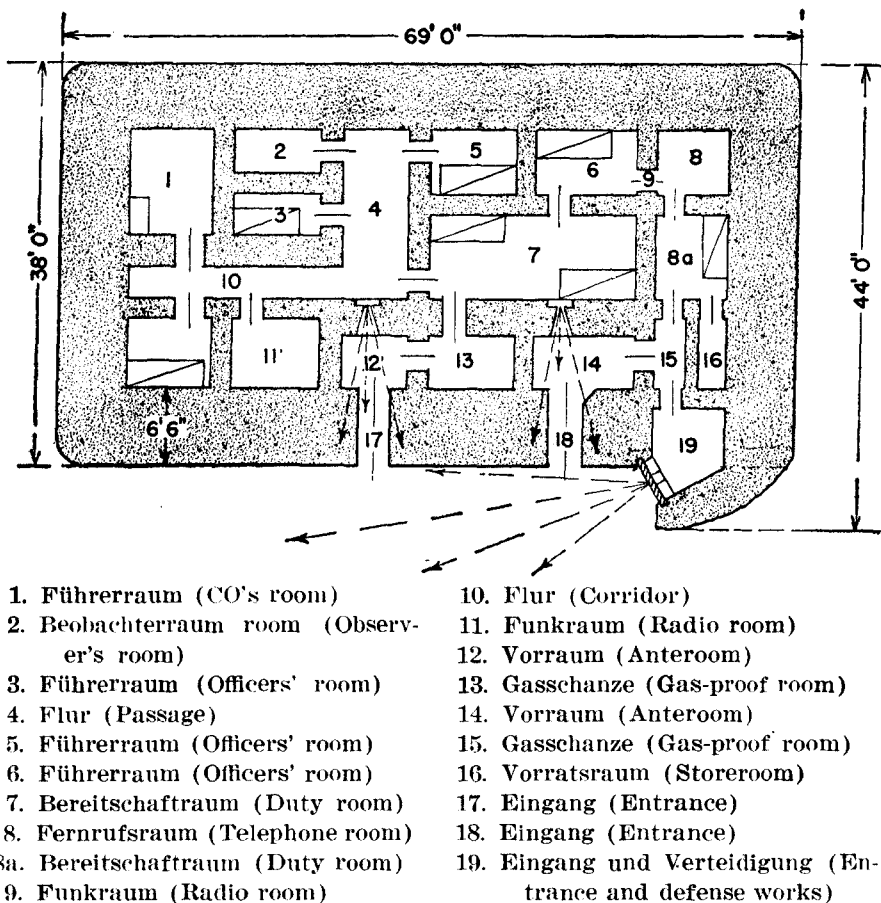

Figure 28.—Ostend shelter.

#### d. Ostend Shelter

The interior plan of a German shelter, apparently designed for the defense of important intersections within a city, is shown in figure 28. One of these shelters has been constructed in Square Stephanie, in

the Belgian coastal city of Ostend. The roof and walls are about  $6\frac{1}{2}$  feet thick, and the rooms are almost 7 feet high. The nature of the weapons at the main entrance and in the walls commanding the secondary entrances is not known.

**e. Artillery Observation and Command Post**

Figure 29 shows a type of combined artillery observation and command post. The dimensions for the interior are approximate only. There have been

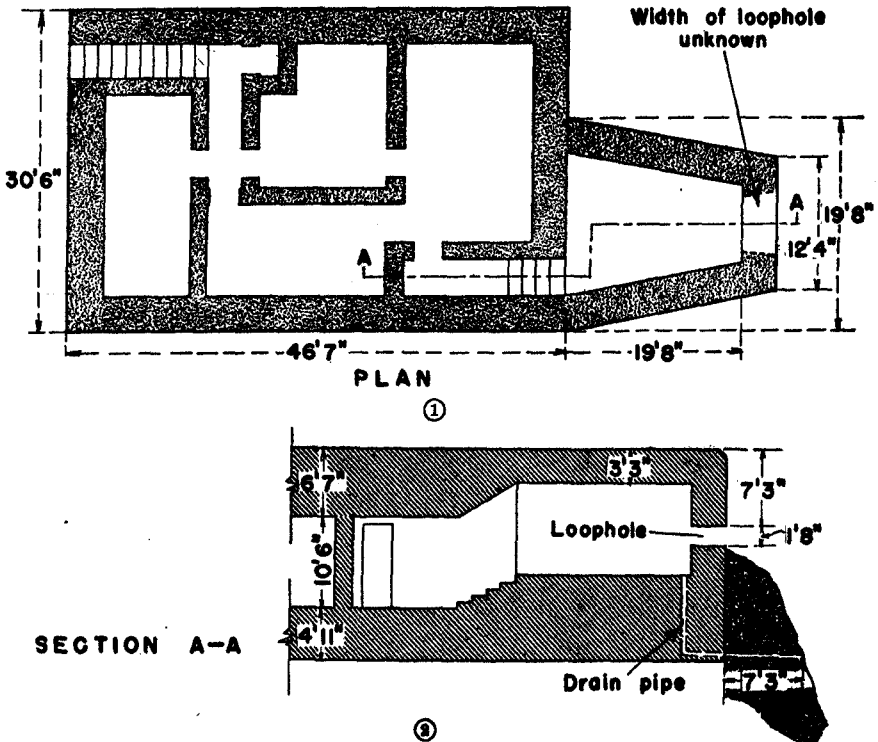

**Figure 29.—Artillery observation and command post.**

reliable reports of the siting of such shelters perilously close to the edges of cliffs. If this proves true,

the foundations of the shelters might be undermined by gunfire directed at the face of the cliff below the shelter. There are, however, probably few instances of such sitings.

## 16. GUN EMPLACEMENTS

### a. T-Shaped Emplacements

One type of works of which a number have been built from a single pattern on the French coast, north-west of Brest, and about which some details of

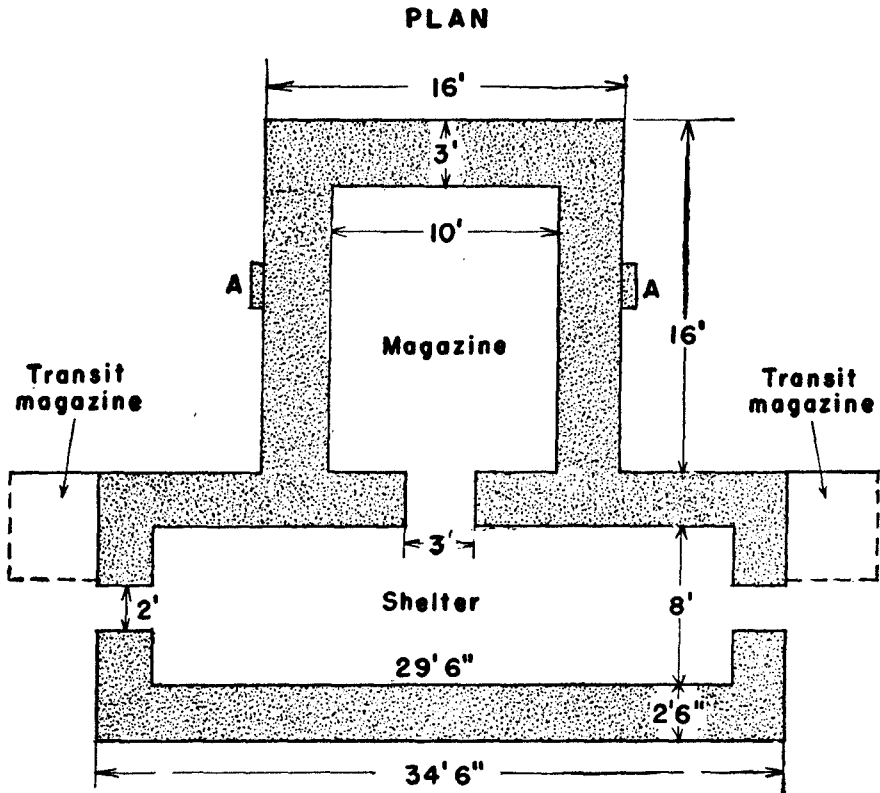

A— Armored air vents, and in some cases an iron ladder to gun platform on top.

Figure 30.—T-shaped emplacement.

construction are available, are T-shaped concrete emplacements reinforced with steel (fig. 30.) They combine in one structure a gun platform, an ammunition magazine, and a shelter for the gun crew. These emplacements are reported to be sited on cliffs and headlands, 2 or 3 miles apart, where their guns can sweep most of the bays and creeks. Seaweed, turf, and garnished nets are used to camouflage them. They are usually constructed deep in the ground so that the roof is flush with the surface.

The leg of the T—in other words, the narrowest part, which is approximately 16 feet square—invariably faces toward the sea. It is this part of the emplacement, which has no openings except armored air vents on one or both sides, that is used as a magazine. Where the roofs of the shelters are above the ground, an iron ladder leads up to them. An armored door connects the forward section with the long, narrow chamber that serves as cover for the gun crew in the rear. This chamber is approximately 32 feet long, and has a door at each end. Some of these works have storage tanks, with a capacity of more than 1,300 gallons, sunk into the ground nearby. Some are also equipped with two small bunkers which serve as transit magazines between the main munitions dump and the guns. These are situated outside, at the entrances of the rear section.

The roof of the magazine probably serves as the gun platform, and is strong enough to sustain an anti-aircraft or coast defense gun of considerable size, but the gun may also be sited elsewhere, nearby. Around each emplacement are pits for machine guns and automatic

rifles for local defense, and nearly all of the emplacements have a zigzag communication trench leading to the rocks on the edge of the coast.

### **b. Fort-Type Emplacements**

Some details are available on two large concrete German structures, each mounting a single 240-mm gun, located east of Calais (fig. 31). They may be described as small forts. They are situated about 800 feet apart on the first line of dunes, approximately 35 feet back of the high-water mark. To blend them with the tone of the dunes, the Germans have camouflaged them yellow, with irregular green stripes.

The concrete of these forts is reported to be reinforced with iron bars eight-tenths of an inch thick. The front walls are more than 9 feet thick and the side walls 7 feet. The rear walls are a little more than 6 feet, and the roof is 12 feet thick in the center and 9 feet around the sides.

The length of the structures is approximately 50 meters (162 feet), and the width 65 to 80 feet. The front is V-shaped, but one leg of the V is 49 feet and the other 16 feet. The interior is divided into three chambers 15 to 18 feet high, the center one housing the gun. The central chamber has an opening at the front that is about 26 by 16 feet, and is protected by a steel shield only about four-tenths of an inch thick. The part of the roof over the gun is movable, is made in three units, and overhangs nearly 9 feet at the front of the fort.

The chambers at each end of the fort are used as munitions magazines, and they have 43-foot cellars. The forts are entered through two doors, one in each of the side chambers, at the rear. In the back wall of the central chamber are three openings 3 feet high and 18 inches wide to allow for the displacement of air when the gun is fired. Steel doors open from the magazine to the gun chamber; they are 4 feet wide and 6 feet high.

These forts are reported to be vulnerable at the movable section of the roof, and at the armor-shielded opening of the central or gun chamber.

Only meager information is available on a reinforced-concrete gun emplacement built by the *Organisation Todt*, shown in figure 32. The facts available indicate a resemblance to the fort described in the preceding paragraph. It is possible that this emplacement is a variation of that described above. Examples of this type are also reported to be on the English Channel coast. One particular point of similarity is the opening at the front, over the gun, protected by a steel shield. A notable feature of this emplacement is what appears to be an elaborate duct for ventilation over the gun. An outpost position for local protection of the emplacement is shown in figure 33.

### c. Open Artillery Emplacements

Open emplacements for coast defense guns have been constructed in great numbers by the Germans. They usually have reinforced concrete walls constructed on a circular concrete slab. Earth or sand is banked up





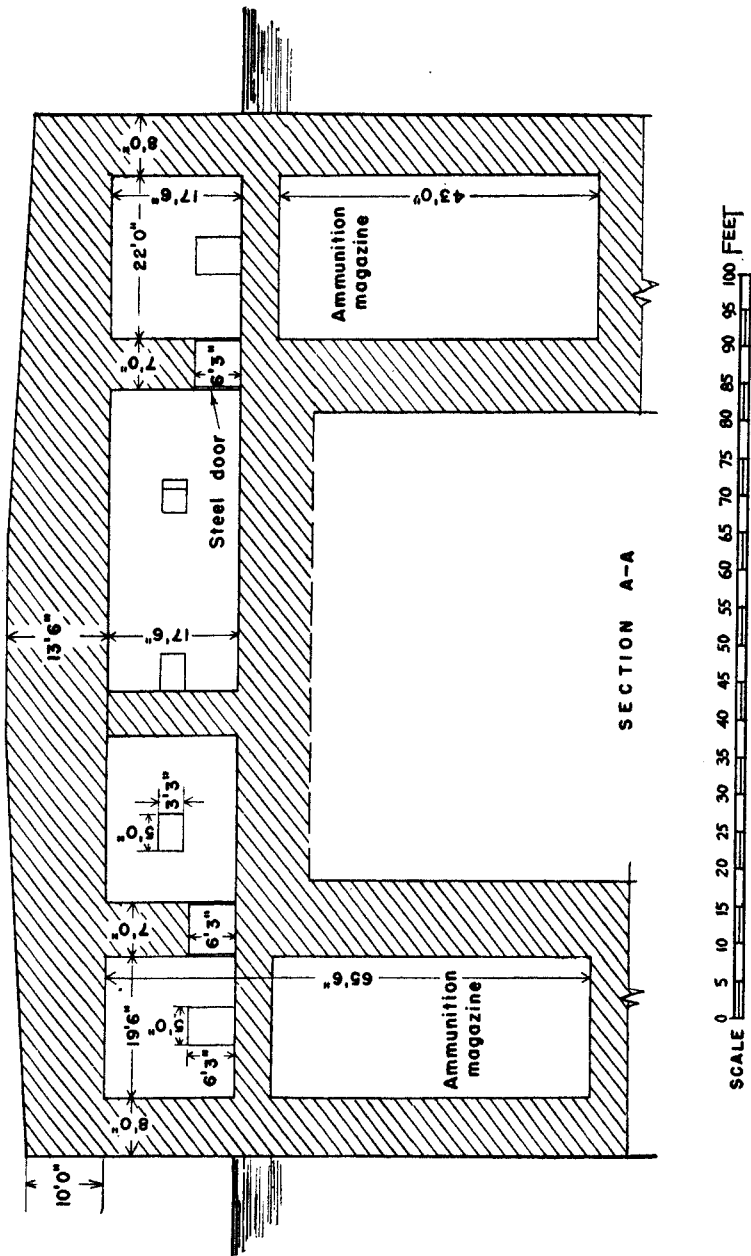

Figure 31 (continued).—Sketch of fort-type emplacement.

to the top of the outside face of the walls, and supplementing this are blast and splinter-proof walls of sandbags.

Approximate dimensions of these emplacements, based on interpretations of aerial photographs, are as follows:

<i>Guns</i>	<i>Diameter of emplacements</i>
(1) 7.5 cm (2.9 inches)-----	20 feet
(2) 10.5 cm (4.1 inches)-----	25 to 35 feet
(3) 15 cm (5.9 inches)-----	35 to 45 feet (older positions are smaller, about 30 to 35 feet)
(4) Heavier guns-----	50 feet and over
(5) Railway guns-----	75 and 95 feet

#### **d. Tank and Tank-Turret Emplacements**

Many sectors of the French and Belgian coasts include in their defense lines old tanks and tank turrets embedded in the ground or mounted in concrete emplacements.

After the Dieppe raid, the Germans began to construct emplacements for medium tanks in that city at points overlooking the beach. The concrete walls of these works are 2 feet thick. At the same time they also began to construct emplacements with tank turrets along the Belgian coast, between Ostend and Mariakerke.

Some forms of these defenses are as follows:

(1) Tanks, fully armed with antitank and machine guns, are sheltered behind specially built concrete emplacements in such a way that only the turrets show above the ground. Thus the tanks, particularly obsolescent types, get extra protection

without entirely losing mobility. In the emplacements is a ramp that allows the tank to back out, so that if a position is lost, the tank may withdraw to a similar emplacement in the rear.

**PLAN**

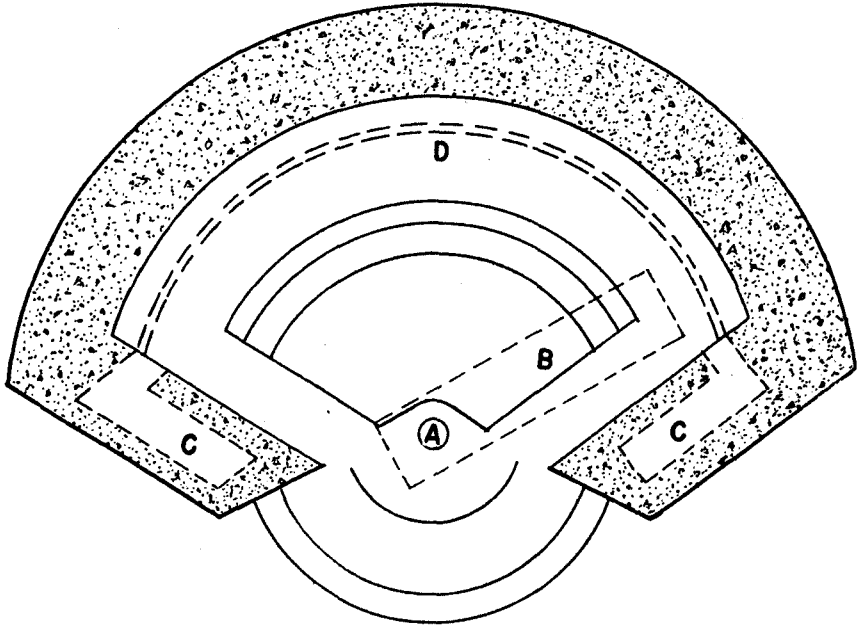

**A - Pivot**

**B - Mount**

**C - Probable shell recess**

**D - Track for shell and cartridge**

①

**Figure 32.—Fort-type emplacement.**

One of these emplacements on the Belgian coast was sheltering a French Renault tank. A Renault half-track (*chenillette*) was seen in an emplacement at Lisseweghe. The position was on the main road and was camouflaged with branches of trees.

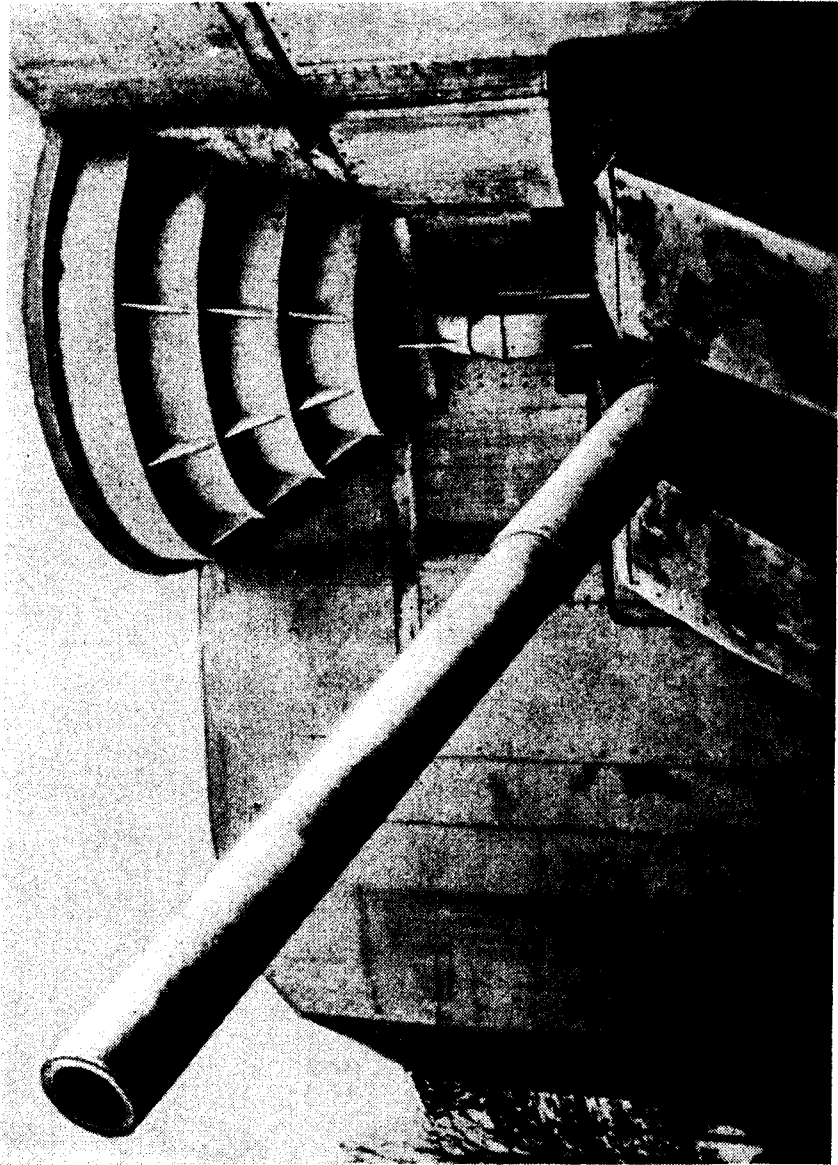

② Front view.



③ Rear view.

Figure 32 (continued).—Fort-type emplacement.



Figure 33.—Outpost of fort-type emplacement.

- (2) Tanks are buried in sand, and camouflaged.
- (3) Tank guns are mounted in concrete pillboxes. (See fig. 34.)
- (4) Tank turrets or cupolas are mounted on roofs of pillboxes.
- (5) Tank turrets are embedded in concrete foundations on harbor moles. (See fig. 35.)

#### **e. Cliff and Cave Positions**

The Germans have installed gun emplacements in caves and hollows in the cliffs along the French coast. It is assumed that these positions have been considerably improved with concrete. Such positions, for machine guns as well as for artillery, may be found, to cite one example, in the 2-mile stretch of steep cliffs between Lion-sur-Mer and Asnelle-sur-Mer, northwest of the city of Caen, France.

Cave positions proved highly effective in the German defense of Dieppe during the Allied raid. After a smoke screen drifted away and uncovered the attackers, machine guns and artillery opened up on them from positions concealed in caves in the cliff face. Some evidence was found to indicate that 88-mm or French 75-mm guns were in these positions. The guns were impossible to detect even at close range until they fired. Some of these positions are in figures 36 and 37.

## **17. MISCELLANEOUS EMPLACEMENTS**

### **a. Waasenaar Emplacement**

Assembled here is information concerning known types of German machine-gun emplacements, which vary in size and type to fit local terrain conditions. In



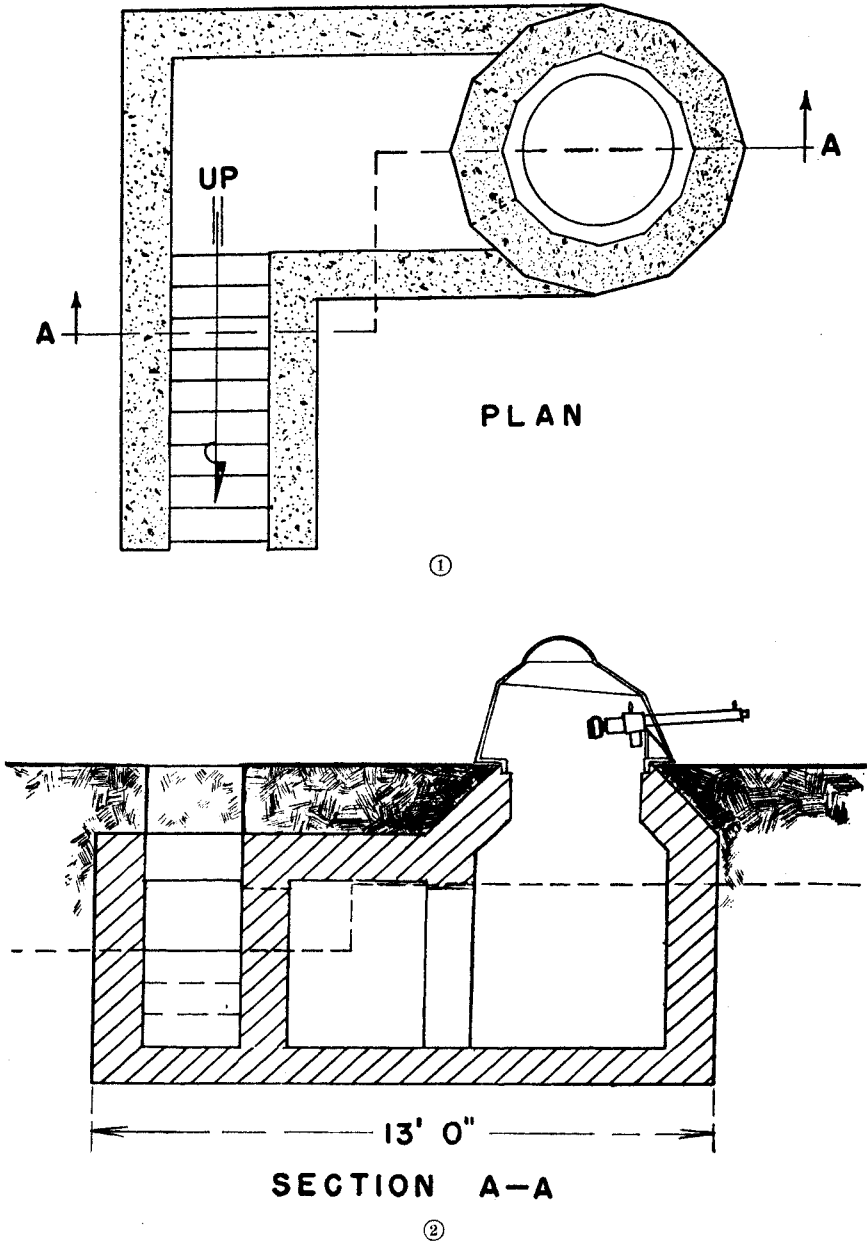

Figure 34.—Emplacement with tank turret.

figure 38 is illustrated a concrete type that has been installed at intervals of about 55 yards on the sand dunes of the Waasenaar district of Holland.

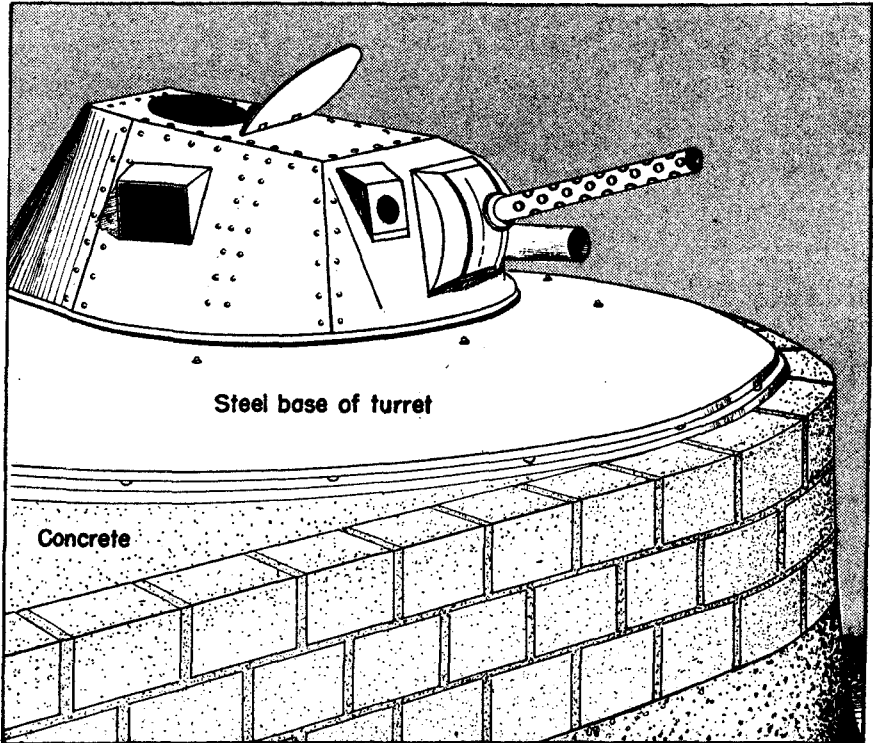

Figure 35.—Tank turret on harbor mole.

### b. Cantilever Type

A type of reinforced concrete emplacement, believed to house an antitank gun, light machine guns, small arms, or combinations of these weapons, is shown in figure 39. It will be noted that the embrasure permits a wide field of fire. Also noteworthy is the bonding of the concrete apron wall into the face of the cliff.



Figure 36.—Pillboxes in cliff position.

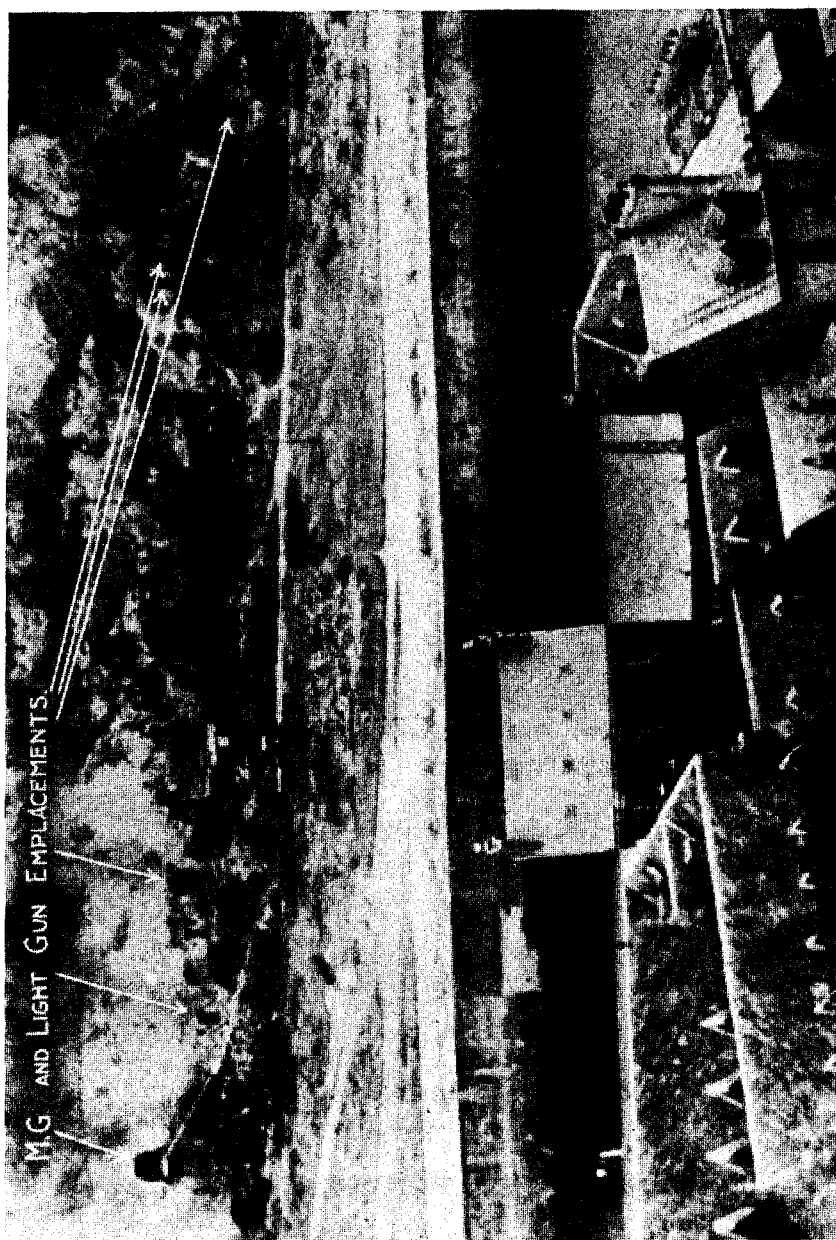

Figure 37.—Emplacements in cliff position.

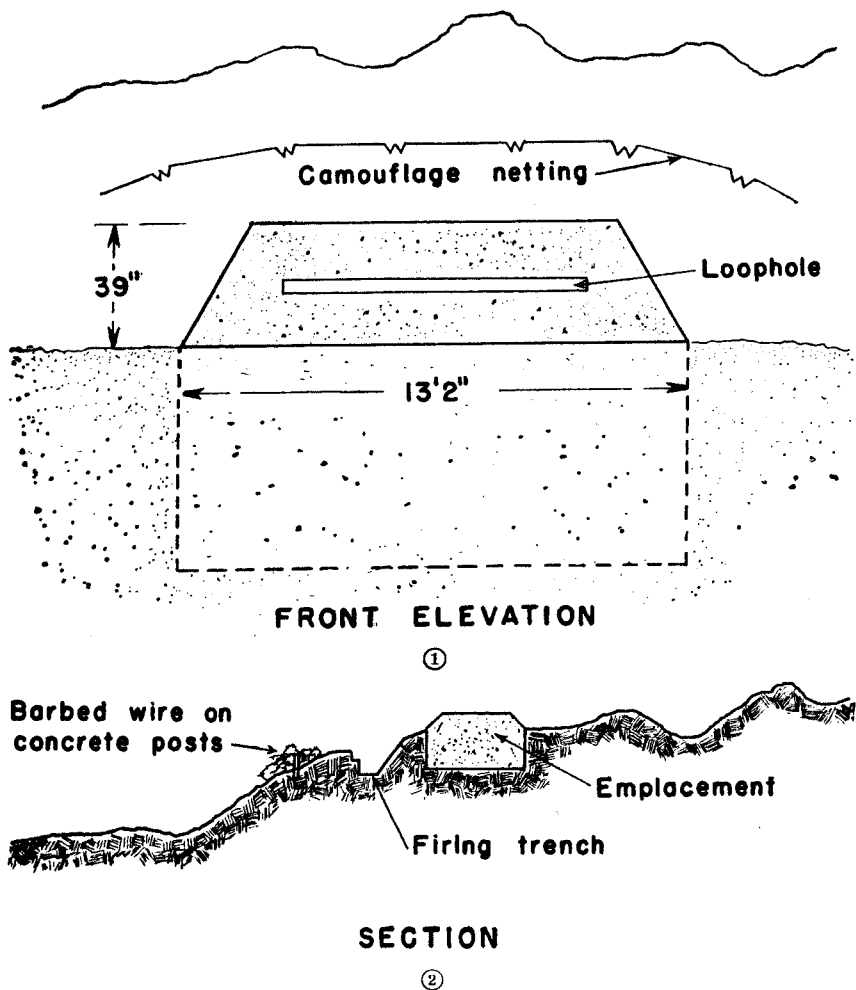
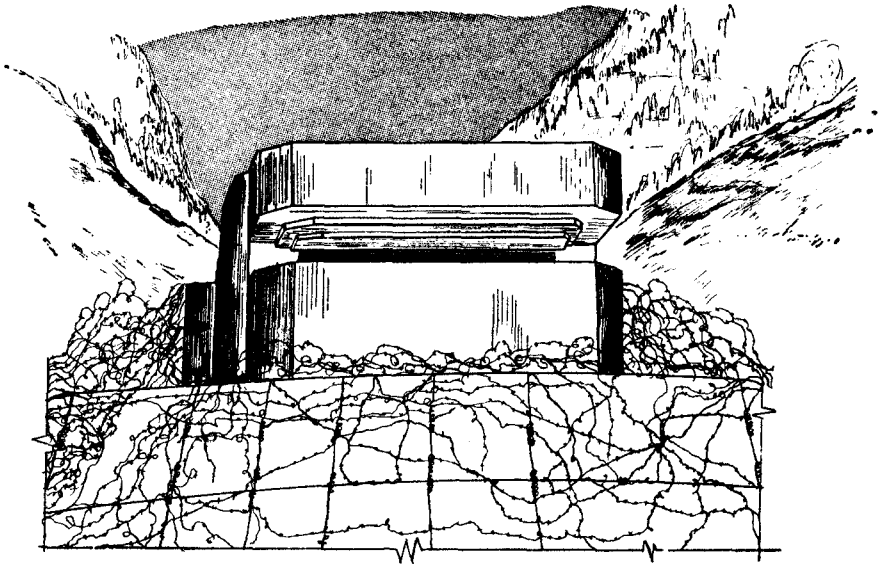

Figure 38.—Waasenaar emplacement.

### c. Underground Type

Another type of concrete emplacement is depicted in figure 40. Its front wall is curved and slotted with loopholes, the arrangement of which is not known. The internal measurements shown are estimated. The concrete ranges in thickness from 2 feet 7 inches to 3

feet 3 inches. This type is covered with earth to a depth of about 40 inches. In addition to the accommodations in the emplacement, members of the crew have shelters 15 feet away.



FRONT VIEW

①

**Figure 39.—Cantilever emplacement.**

#### **d. Open Brick Type**

An emplacement made of brickwork and concrete, roofless, is typical in the Middlekerke—Westende area of Belgium (fig. 41). The foundation and steps are of concrete. A brick retaining wall, about 12 inches thick and 4 or 5 feet high, holds the soil.

#### **e. Emplacement for Two Machine Guns**

A type of emplacement for two machine guns is illustrated in figure 42. It has a third embrasure in which a

third weapon can be mounted to cover the entrance. Twelve men can be accommodated in this structure. The machine guns are mounted in the end walls. This

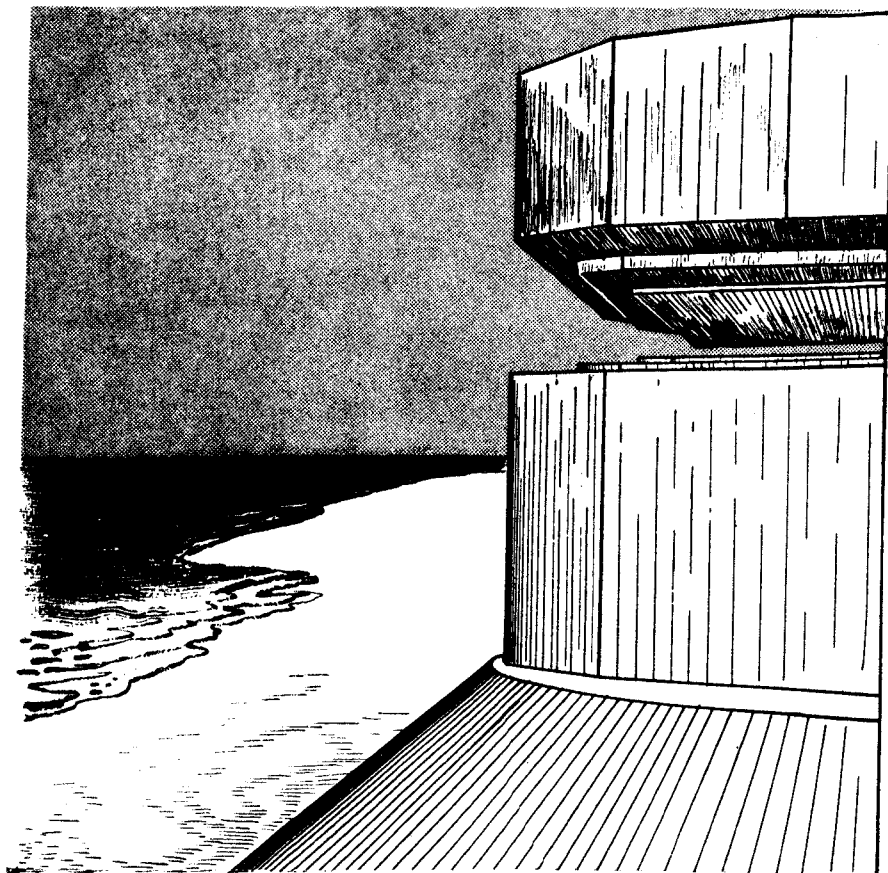

SIDE VIEW

②

Figure 39 (continued).—Cantilever emplacement.

type of emplacement is usually built into the side of a hill to make it possible for the machine guns to cover the slopes of both flanks. A common type in Germany's

West Wall, this emplacement has also been adapted to the defenses of the coasts of occupied countries.

#### f. Cliff Pillbox

The pillbox shown in figure 43 has two embrasures and, like many other examples of German fortifications,

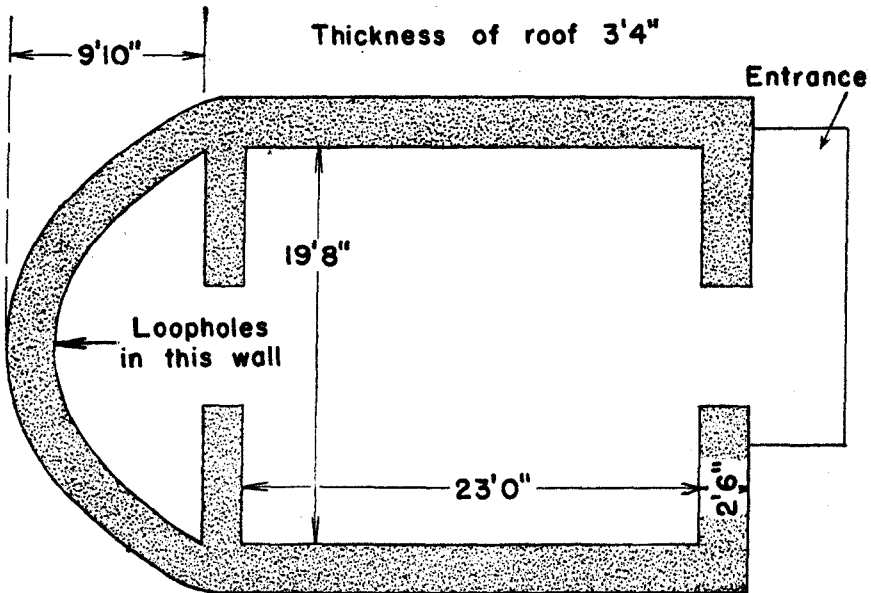

Figure 40.—Underground emplacement.

is built into the side of a cliff, hill, sand dune, or sea wall. The depth of the earth covering on the roof of the example in the illustration is unknown.

#### g. Promenade Types

Two types of machine-gun emplacements built into the sea-wall promenades that are so common along the coasts of the Low Countries and France are shown in figures 44 and 45. The one in figure 45 abuts from the



promenade to make enfilading fire possible. Both types are entered through manholes in the promenade.

### h. Roofless Pillboxes

A number of roofless pillboxes, like that illustrated in figure 46, have also been observed.

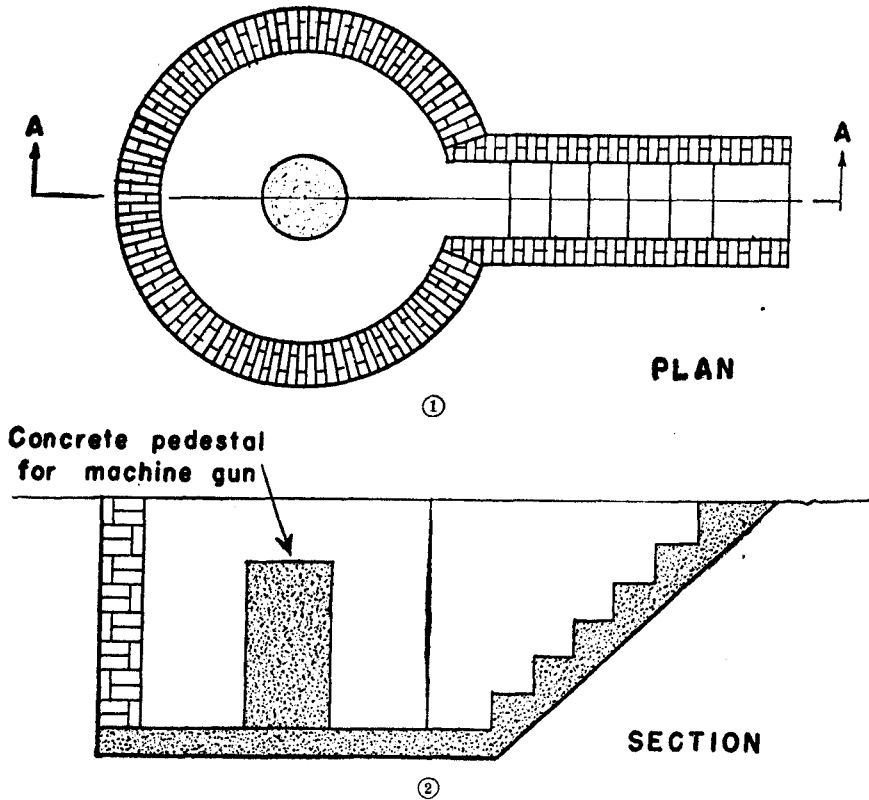
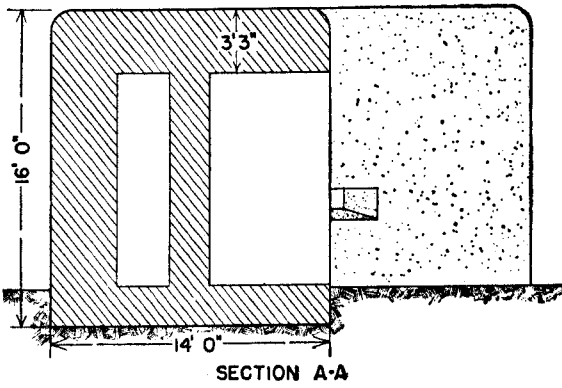
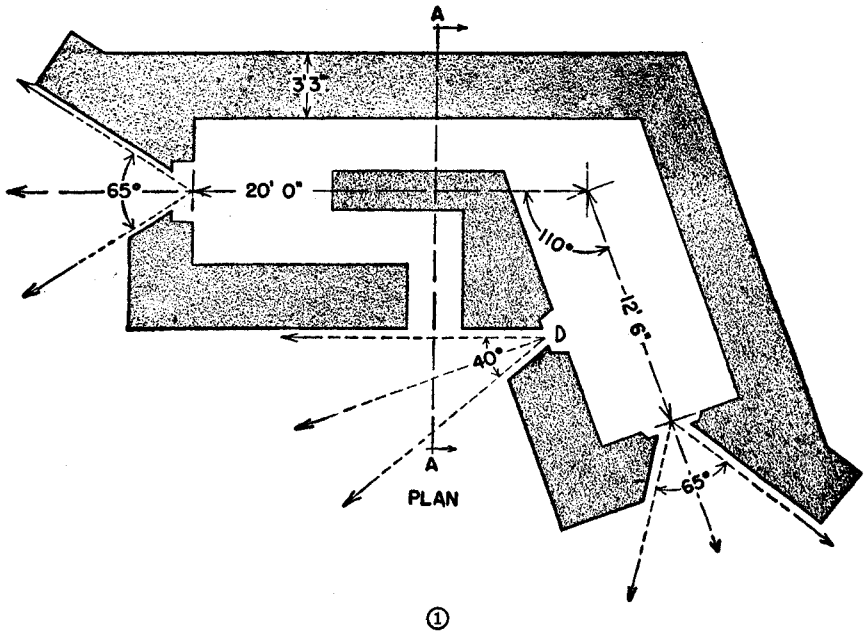

Figure 41.—Open brick emplacement.

### i. Infantry Position

Along the promenade between Ostend and Maria-kerke in Belgium, the Germans have installed infantry firing positions, as shown in figure 47, at intervals



②

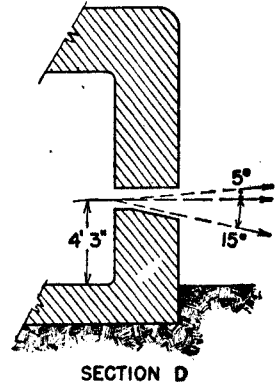

③

Figure 42.—Emplacement for two machine guns.

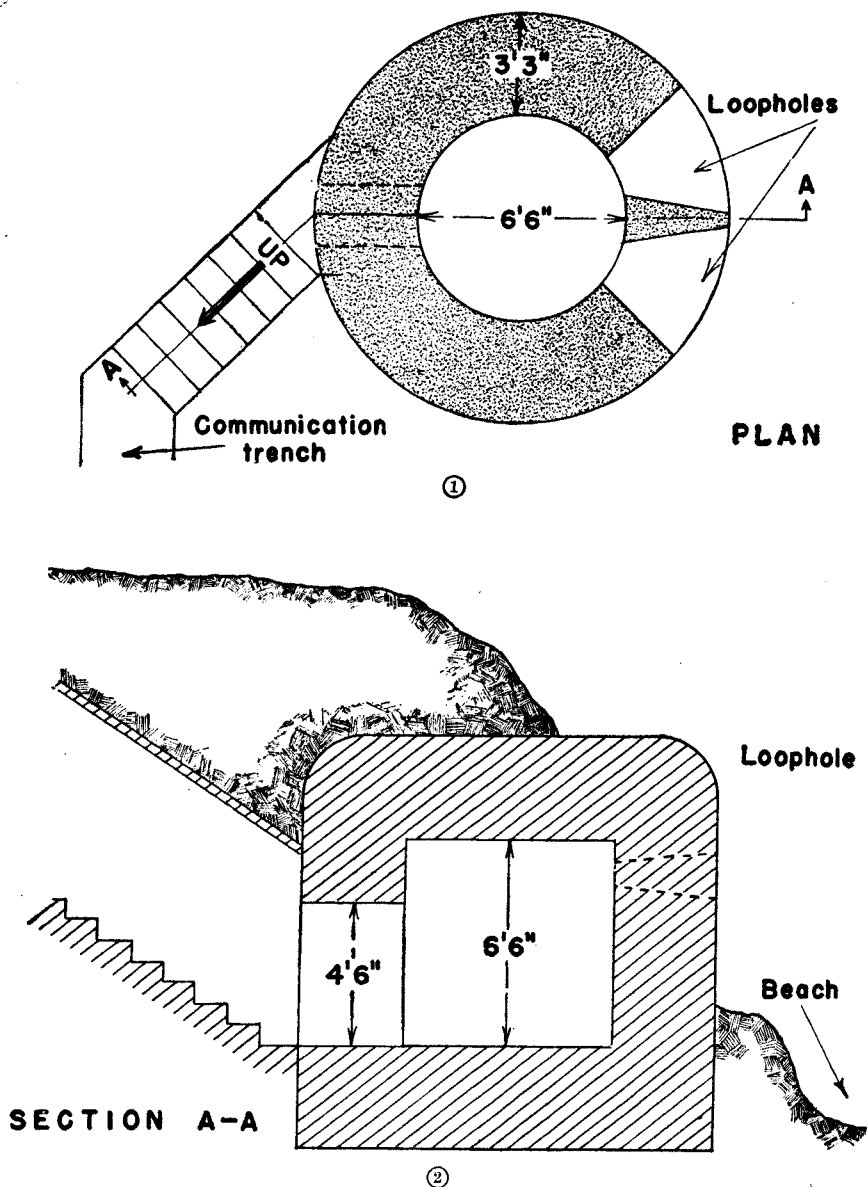

Figure 43.—Cliff pillbox.

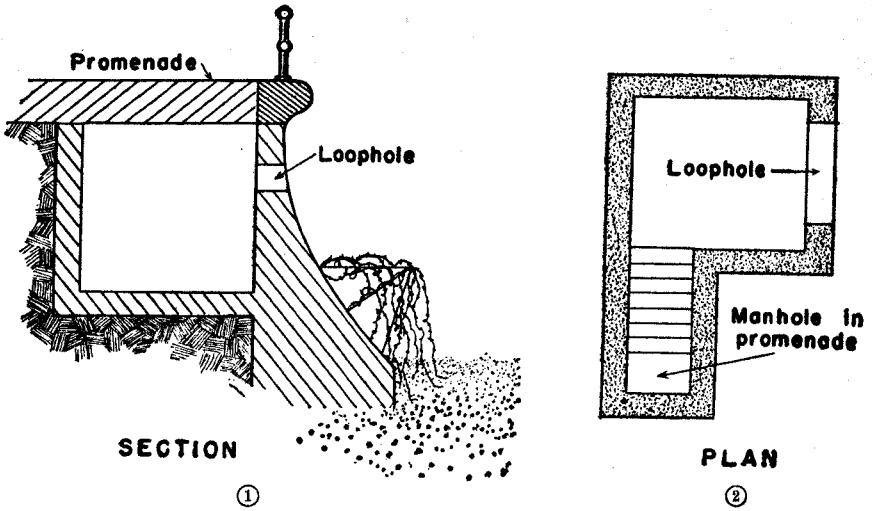

Figure 44.—Promenade emplacement.

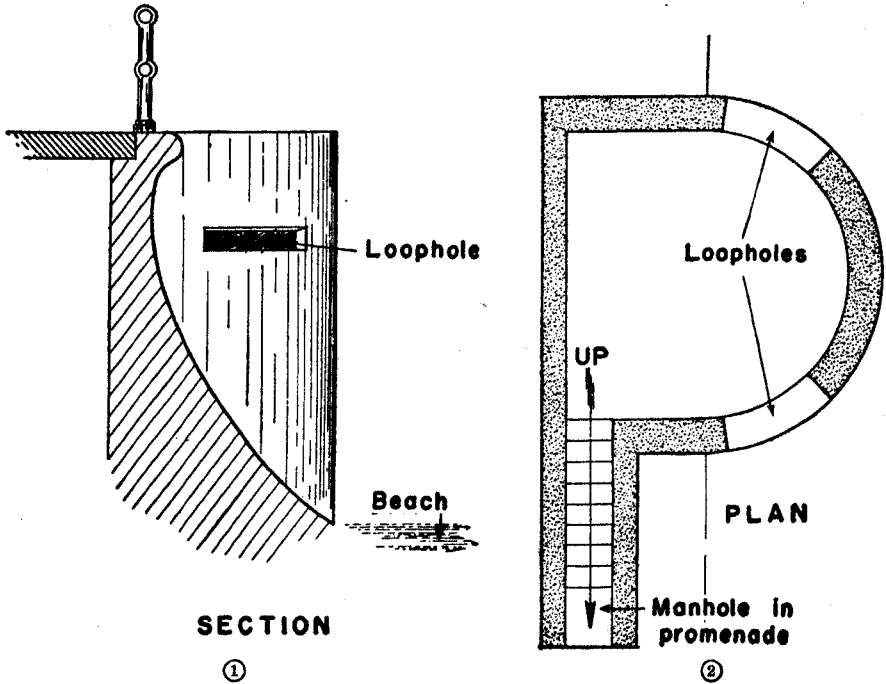

Figure 45.—Promenade emplacement, designed for enfilading fire.

varying from 55 to 110 yards. The size or capacity of each unit is unknown. These positions constitute the first line of defense at this point. They have been

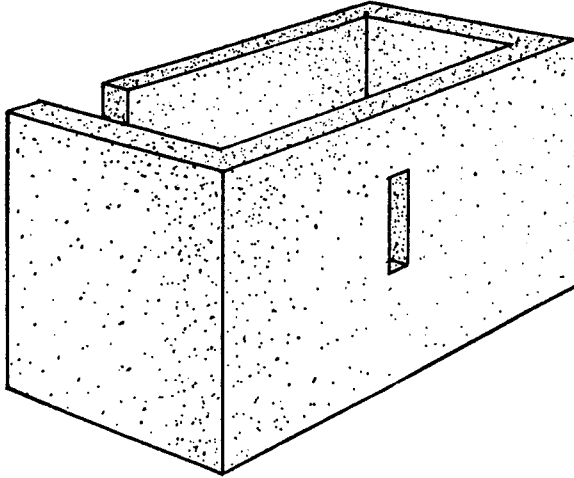

Figure 46.—Roofless pillbox.

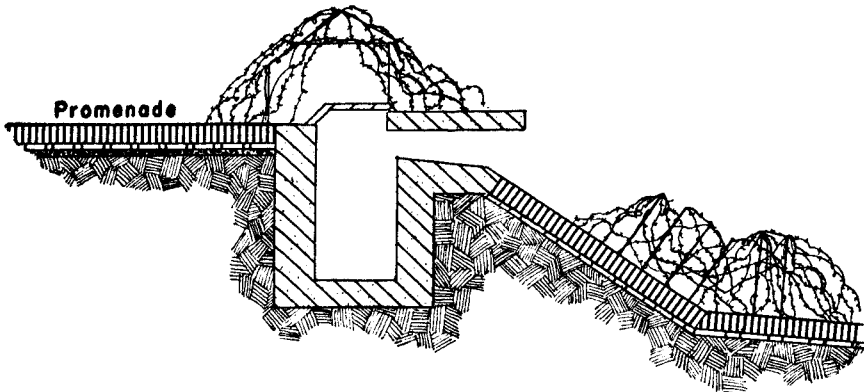

Figure 47.—Infantry position built into promenade.

dug out of the dike and have been reinforced with concrete. They include sites for automatic weapons as well as for riflemen. Loopholes have been cut into

the stone wall of the promenade. Platforms have been installed to receive mounts for machine guns and automatic weapons of from 20 to 35 mm, and tables of firing data, including points of gun elevation and zones of fire, have been posted in each position. These fortifications are entered by communication trenches.

One defect of these positions is that they are flooded every time a storm whips in a high sea. The water pours through loopholes, communication trenches, and other openings. The personnel who man these defenses are quartered in the hotels bordering the sea front. Civilians have been evacuated from all the hotels and houses along the dike and adjacent thoroughfares.

#### **j. Flak Positions**

(1) *Towers*.—Flak or antiaircraft towers have been constructed in many coastal parts of the occupied territories. Their construction varies from light towers, made mainly of wood, to solid concrete structures.

The light towers are common along the coast line. In height, they range from 65 to 82 feet, and it is believed they usually mount 20-mm (0.79-inch) guns. The main supports consist of four poles 59 to 74 feet high, and in diameter 12 to 14 inches at the bottom and 6 to 7 inches at the top. Each of these supports is set into concrete blocks that are 6½ feet square and 6½ to 12 feet deep. At the base, iron uprights reinforce the poles, which are also strengthened higher up by bolted crosspieces. At the top of the tower formed by these poles are two platforms, the upper one having a 7-inch wall, made of 1-inch planking filled in with

brick and sand. This wall is 39 inches high. The lower platform is open at the sides and is used for munitions storage.

A portable type of light tower is also reported. It is 26 feet high and made with 0.8-inch steel tubes. It is believed that the tubes are cut to a standard pattern and are issued to anti-aircraft units as required.

In figure 48 is shown a type of concrete flak tower, with an interior munitions chamber and burster slabs to prevent floor rupture or the overturning of the structure by delayed-action projectiles. A concrete shelter for gun crews is shown between the flak towers.

(2) *Elevator flak position.*—A novel type of position seen along the Atlantic coast is the disappearing 20-mm flak battery mounted on an elevator. (See fig. 49.)

## 18. CONCLUSIONS

For a proper evaluation of the types of fortifications described in this study, they must be thought of as being integrated into a deep zone of mutually supporting strongpoints, based on key terrain features and capable of all-around defense.

The depth of the zone of fortifications varies according to the depth of the useful beach terrain and its vulnerability to attack, and depends also on the limitations imposed by the length of the coast line which must be defended.

The Germans adhere to the principle of seacoast defense by concentration of the main fires on and beyond the beaches. This follows from the fact that an invasion from any expected direction must be sea-

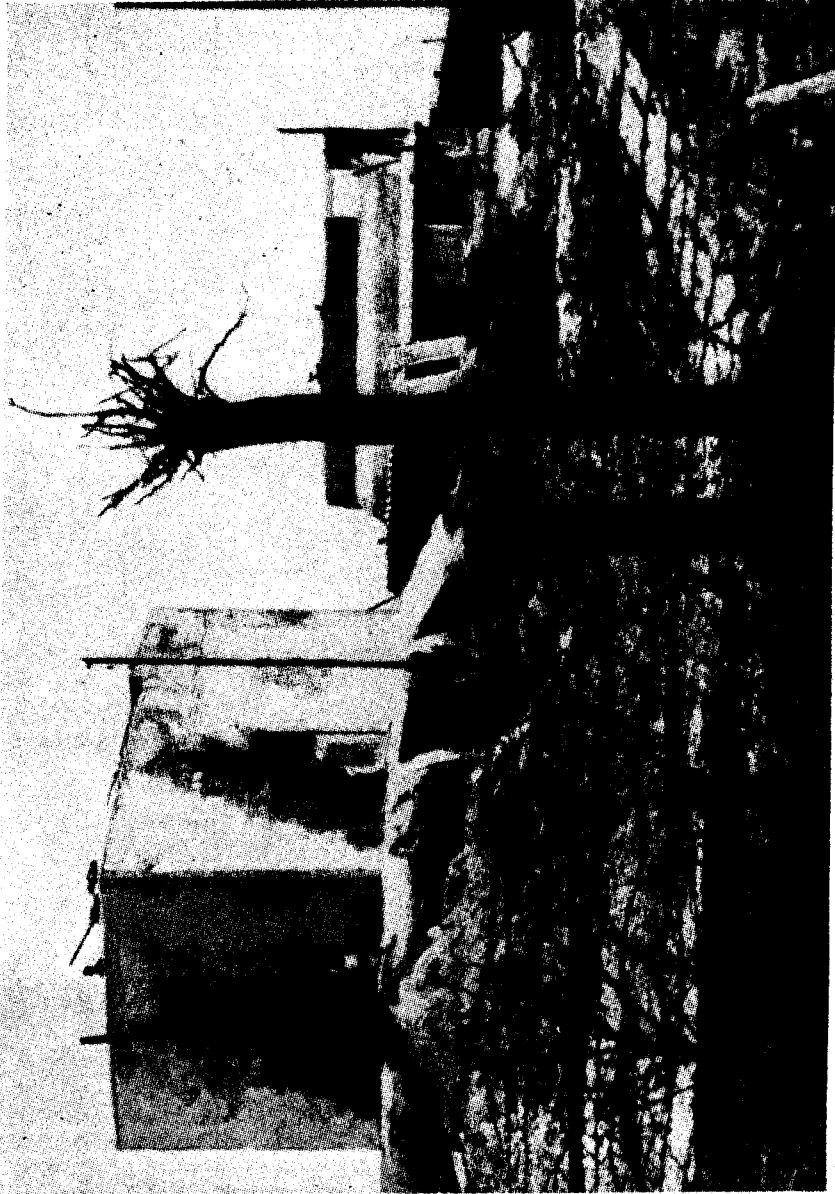

Figure 48.—Flak tower.



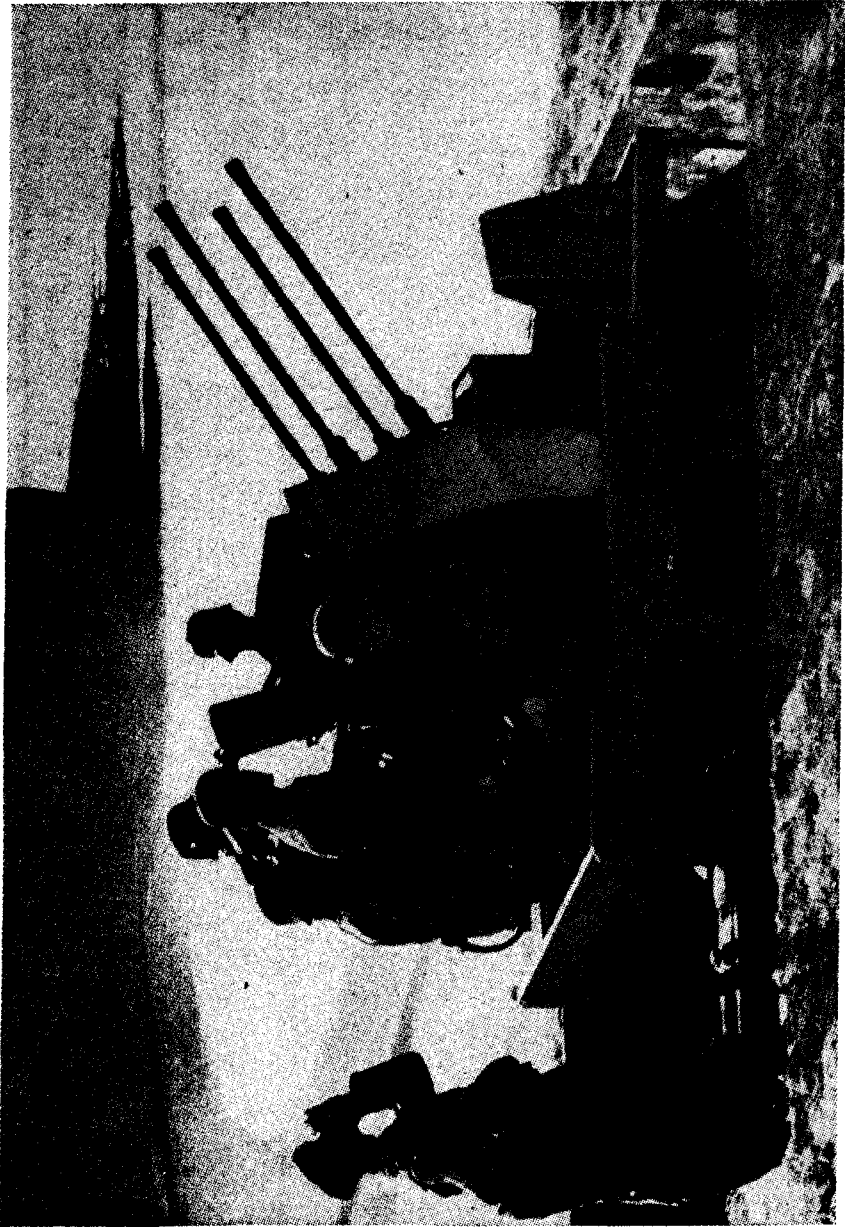

Figure 49.—Elevator flak position.

borne, and that the attacking forces will be most vulnerable to defensive fires just before and during the attempted landing.

The German organization of defensive positions into strongpoints follows the familiar "hedgehog" (*Igel*) principle of grouping complementary works, each work contributing predetermined fire for the defense of its own ground and for covering the dead spaces of neighboring positions. The strongpoints in turn are similarly arranged to form a deep, irregular pattern of defenses commanding all critical terrain. Minefields, wire, and other obstacles are freely used, both tactically and protectively. The complete arrangement is designed to absorb penetration, and to wear down, restrict, and impede the attack until the counterattack can be launched.