

Cornell University Library

BOUGHT WITH THE INCOME OF THE

SAGE ENDOWMENT FUND

THE GIFT OF

Henry W. Sage

1891

A. 365183

11
XII 16

Cornell University Library
VM365 .H67

The submarine torpedo boat, its character



3 1924 030 902 286
olin

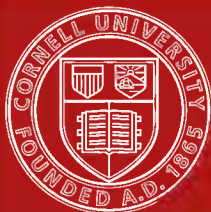

Cornell University
Library

The original of this book is in
the Cornell University Library.

There are no known copyright restrictions in
the United States on the use of the text.

<http://www.archive.org/details/cu31924030902286>

THE SUBMARINE TORPEDO BOAT

*ITS CHARACTERISTICS AND
MODERN DEVELOPMENT*

BY

ALLEN HOAR

JUNIOR MEMBER AMERICAN SOC. OF CIVIL ENGINEERS

84 Illustrations — 4 Folding Plates



NEW YORK
D. VAN NOSTRAND COMPANY
25 PARK PLACE

1916
E.V.

COPYRIGHT, 1916, BY
D. VAN NOSTRAND COMPANY

THE PLIMPTON PRESS
NORWOOD MASS U.S.A.

TO THE MEMORY OF
MY FATHER

PREFACE

It has been the purpose of the author in writing this volume to place before the public a book which would be of interest to the general reader, and also of value to the technical man and naval engineer, who, while not specializing in this line, is desirous of reliable information upon the subject. The author has therefore, in a non-technical language in so far as possible, brought to the attention of the reader the inherent characteristics of the submarine boat, the problems involved in its design and construction, the difficulties of operation, its present limitations and its future possibilities.

The present European conflict has aroused a general interest in the submarine torpedo boat and has acted as an incentive to many popular writers to flood the press with a great number of misconceptions and erroneous statements. Many of them were unfamiliar with the technical and engineering considerations, and in fact seemingly wholly misinformed. It is only when some understanding of the problems involved has been gained, that the public may begin to realize what has been accomplished in this field of modern "engineering warfare," what further might be expected, and the utter improbability of submarine battleships, transports and the like, which have been pet exploitations of popular writers.

Since going to press the submarine has once more been brought into brilliant prominence by the successful

3800 mile voyage of the German submarine *Deutschland*. This vessel, unattended, has successfully eluded all surface craft during her long trip which began at Heligoland on June 23 and ended at Baltimore July 9. For a part of her voyage the *Deutschland* was forced to run submerged to escape detection by the blockading English and French cruisers. Captain Koenig, her commander, has stated that in all she made 90 miles of this trip under the surface. Although this is perhaps slightly farther than any other submarine has gone alone it is not by any means the only long voyage made by this type of vessel. Submarines of the *F*, *H*, and *K*, classes in the U. S. Navy have made the trip from San Francisco to Pearl Harbor, Hawaii, under their own power, a distance of 2100 miles, and on the Atlantic coast the *K* boats have several times made the trip between New York, Pensacola, and Colon, a somewhat longer distance. Ten of the British *H* boats built by the Fore River Ship Building Company recently made the voyage to England, and from there five of them continued on their way to the Dardanelles, a voyage quite as long as that made by the *Deutschland*. These British *H* boats are practically identical with our own *H* class and are of about 450 tons displacement.

To those familiar with this type of craft there is nothing remarkable in just the mere mileage covered by the *Deutschland* on this voyage, but the performance of this vessel is spectacular because it has succeeded in leaving a well blockaded port and traversed waters abounding in hostile craft undetected to the end. It is very difficult at this time to obtain any exact or reliable information as to the real dimensions of this vessel. It has been variously given out in widely conflicting statements,

purporting to have been uttered by Captain Koenig, as from 200 to 315 feet in length, 20 to 30 feet in breadth and from 1000 to 4000 tons in displacement. There seems to be little doubt, however, from what reliable information can be had, that this vessel is of the same general type as those submarines laid down by Germany in the early part of 1914, the principal characteristics of which are given in the appendix, as 214 feet in length, 20 feet beam and 900 submerged displacement.

A boat of this size if stripped of all torpedo tubes, torpedoes and handling gear, and with weight of power plant restricted to a capacity for 14 knots on the surface and 10 knots submerged, would afford a net cargo tonnage of about 75 to 100 tons. This is a practical illustration of the possibilities for new uses of the submarine as a blockade runner on Government enterprise.

The successful performance of the *Deutschland* must not confuse her as being in the class of the submarine transports and the like mentioned above. This vessel is a logical development of a tried type and not the product of momentary hysteria. Previous to the successful accomplishment of the *Deutschland*, there recently appeared in print a photograph purporting to be of a 5000-ton German submarine boat which was reported to be about to ply back and forth transporting cargo between New York and Kiel as a blockade runner. It is quite possible that this statement was based upon the known intention of the *Deutschland*. However, it is rather an exaggeration of the true dimensions of the vessel. While it is of course not impracticable in itself to build a submarine capable of transporting a limited amount of cargo, the reported dimensions of this craft, about 450 feet in

length and 40 feet in beam, make it incredible. A submarine vessel of this size would be excessively unwieldy, and to make its accredited speed of ten knots an hour across the Atlantic, it would require such an enormous weight in power plant equipment and fuel oil, that, together with the necessary percentage of weight to be allotted to the ballast system for submergence, there would be but a very small percentage of the gross tonnage left for cargo transportation. It would be, to say the least, scarcely an economic means of transportation, no matter what the hazard for surface vessels might be.

In the first chapter on the history of submarine development, an attempt has been made to point out rather sketchily only the more important incidents which have had a direct bearing upon the actual development of the submarine boat of today. While the inventors and inventions dealing with the subject number into the thousands, a very large proportion of them are merely freak ideas having no practical value at all, and yet there are a great many very ingenious and worthy of consideration. Space, however, in this little volume forbids going into them, indeed, to do so would require several volumes the size of this. The reader who is interested in this phase of the subject is referred to "Submarine Navigation, Past and Present," in two volumes, by Allan H. Burgoyne.

The chapters on the future development of the submarine, and means of defense against it were written somewhat over a year ago, and the author is gratified to state that after two years of employment of the submarine in actual warfare in Europe he finds no occasion to change in any respect his opinions expressed on these matters in this volume. Of late it is interesting to note that much

stress is laid upon the effectiveness of the small speedy surface craft as a defense against the submarine. The successful employment of these light craft is, however, restricted to the conditions set forth in the chapter on defense, and its effectiveness is really more moral than physical, since the deck of one of these little craft affords a very poor gun platform from which to shoot with accuracy. Our own submarines acting off our own coasts have not much to fear from this type of opponent, but rather would have them to act in consort with.

The Author wishes to express his thanks to both the Electric Boat Company and the Lake Torpedo Boat Company for the many excellent photographs which they furnished him.

WASHINGTON,
July, 1916

ALLEN HOAR

CONTENTS

CHAPTER	PAGE
I. EARLY HISTORY AND DEVELOPMENT.	I
II. DEVELOPMENT OF THE PRESENT-DAY SUBMARINE.	15
III. CHARACTERISTICS AND REQUIREMENTS.	26
IV. TYPES OF SUBMARINES (Submarines and Submersibles)	38
V. DESIGN OF THE SUBMARINE TORPEDO BOAT (General Factors)	58
VI. THE POWER PLANT	110
VII. FUTURE DEVELOPMENT	134
VIII. MEANS OF DEFENSE AGAINST SUBMARINE ATTACK	143
IX. TACTICAL EVOLUTIONS OF THE SUBMARINE.	153
X. THE TORPEDO	174
XI. TENDERS AND SALVAGE SHIPS	185
XII. LIST OF ACCIDENTS	192
XIII. SUBMARINE MINES	195
APPENDIX I.	203
INDEX	205

LIST OF ILLUSTRATIONS

	PAGE
1. Bushnell's <i>Turtle</i>	2
2. Fulton's <i>Nautilus</i>	5
3. <i>Le Plongeur</i>	7
4. The <i>Fenian Ram</i>	8
5. Hovgaard's Submarine.....	9
6. Nordenfelt's Turkish Submarine	11
7. <i>Le Morse</i>	12
8. The <i>Argonaut Jr</i>	13
9. The <i>Argonaut First</i>	13
10. U. S. S. T. B. <i>Holland</i>	17
11. U. S. Submarine <i>B-3</i>	19
12. British <i>A</i> class	21
13. British <i>B</i> class	23
14. Forward Deck of Submarine <i>G-4</i>	27
15. U. S. Submarine <i>C-3</i>	29
16. <i>C-1</i> Making a dive	31
17. <i>C-1</i> Coming to the surface	31
18. Living quarters on Lake boat.....	33
19. German <i>U-5</i> in a heavy sea	35
20. U. S. Submarine <i>G-1</i>	39
21. U. S. Submarine <i>G-4</i>	41
22. British Submarine <i>H-20</i>	43
23. Diagram of early Holland type	45
24. Diagram of Electric Boat type.....	45
25. Diagram of Laubeuf type	47
26. Diagram of Lake type	47
27. Diagram of Krupp type	49
28. Diagram of Laurenti type	49
29. Figure 2. Diving Boat.....	51
30. Figure 3. "Even Keel" type	53
31. Experimental submarine with forward propellers.....	55
32. Figure 4. Forward propulsion type.....	56
33. U. S. Submarines <i>K-5</i> and <i>K-6</i>	59
34. French submarine of Laubeuf type.....	63

35. Transverse section through engines	81
36. <i>F-3</i> entering the Golden Gate, California	83
37. Crew's quarters, Electric Boat	85
38. U. S. Submarine <i>K-6</i>	87
39. Midship section, Electric Boat	89
40. Steering station, E. B. type	90
41. Diving station, Electric Boat	91
42. Submarine signal set	96
43. Torpedo tube installation	99
44. <i>G-1</i> showing deck tubes	101
45. Lowering torpedo through hatch	103
46. Submarine German type gun	104
47. Submarine <i>G-1</i>	107
48. Submarine <i>C-5</i>	111
49. 900 B.H.P. M.A.N. Diesel Engine	117
50. Southwark-Harris Diesel Engine	118
51. Submarine <i>D-1</i>	121
52. Main Motors <i>G-1</i>	123
53. Switchboard and valve manifolds	125
54. 900 B.H.P. Italian submarine engine	129
55. Engine space, experimental boat	132
56. U. S. Submarine <i>L-1</i>	135
57. U. S. Submarine <i>K-5</i>	139
58. Wake of torpedo	140
59. Visible disturbance of periscope	143
60. High angle fire gun for aeroplanes	149
61. British submarines	155
62. German submarine <i>U-28</i>	157
63. Effectiveness of torpedo fire at various ranges	163
64. Diagram of Limit Angle of Submarine attack	164
65. Diagram of effect of error in estimation of course	165
66. Submarine <i>H-3</i> coming to the surface	167
67. Submarine <i>K-5</i> at full speed	169
68. Submarines in column formation	171
69. Hoisting on board a torpedo	175
70. Section through a torpedo	177
71. Spent torpedo coming to the surface	179
72. Diagram of torpedo angle fire	183
73. Torpedo fitted with lance-head	184
74. German submarine tender	186
75. Monitor <i>Tonopah</i> and flotilla	187
76. French submarine entering "Kangaroo ship"	189

LIST OF ILLUSTRATIONS

xv

77. Open bow of "Kangaroo ship".....	189
78. Italian Mother ship.....	190
79. Simple contact mine.....	198
80. Diagram showing method of sinking mines.....	199

PLATE

I. Stability curves.....	<i>Facing page</i> 44
II. Speed and power curves.....	74, 75
III. Section through engine.....	114, 115
IV. Plan and profile of 600-ton Laurenti submarine.....	Appendix
V. Plan and profile of 800-ton German submarine.....	Appendix
VI. Profile of 830-ton Electric Boat type submarine.....	Appendix

The Submarine Torpedo Boat

Its Characteristics and Modern Development

CHAPTER I

EARLY HISTORY AND DEVELOPMENT

ALTHOUGH the submarine has only recently become recognized as being of any practical value in Naval Warfare, the first known device of this kind was conceived by a Hollander, Dr. Cornelius van Drebbel, and was constructed by him in 1624. This boat was merely a wooden shell, decked over and covered with leather, and fitted up so as to be capable of sinking below the surface of the water. It was a one-man affair and propelled by oars passed through the sides of the boat, and working in flexible leather stuffing-boxes to keep them watertight. With this very crude device Dr. van Drebbel successfully demonstrated the practicability of submarine navigation. †

No further developments of any consequence along these lines were effected until taken up in this country by David Bushnell in 1772. Bushnell, who was then a student at Yale, was the first to invent and construct a submarine boat actually used in warfare. His *Turtle*, so called because of its peculiar shape, was just large enough to accommodate one man in a sitting posture; it was steered in the ordinary manner and propelled by a screw-propeller turned by hand from an interior crank. Submersion was accomplished by taking on water ballast, and a torpedo was carried outside the hull, so arranged that it could be at-

tached to the hull of an enemy's vessel by means of a screw operated from within. After being screwed to the hull of the enemy's vessel, the torpedo was then to be released from the submarine and fired by a time clock device which was set in motion by the withdrawing of a pin when released.

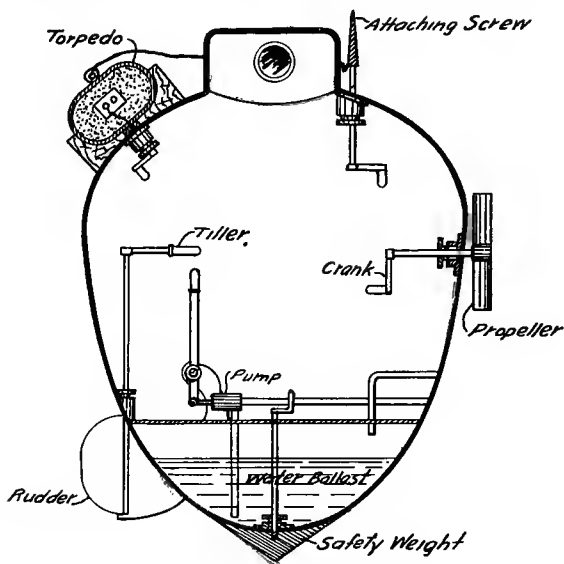

Bushnell's "Turtle." 1776

In 1775 Bushnell was called upon to take his submarine and make an attack upon the British vessels lying in New York harbor. Unfortunately for Bushnell, he was too frail physically to undertake this arduous task in person, so a corporal from Putnam's army, Ezra Lee, was chosen and trained to navigate the craft and to make an attack upon the British flagship *Eagle* which was lying off Staten Island.

Lee succeeded in navigating the submarine and reached

a vantage point under the *Eagle's* stern, but owing to the copper sheathing on the vessel's bottom and the small downward resistance of the *Turtle*, he found it difficult to attach the torpedo. As daylight approached he became nervous and, probably because of the need of fresh air, gave up the attempt, cutting adrift the torpedo and making his own escape. The torpedo exploded as was intended and as it had been timed to, but as it had drifted some little distance down stream from the *Eagle*, it did no harm other than to throw up a veritable geyser of water giving those on board a mighty scare:

After this one attempt, notwithstanding the fact that the little vessel had demonstrated both the practicability of its maneuvering qualities and of its armament, Bushnell's *Turtle* became the object of much ridicule and was never afterward given fair consideration. Bushnell, thoroughly discouraged at the treatment accorded his ingenious device and the lack of appreciation of its value, soon disappeared from the pages of the history of the submarine torpedo boat.

— Robert Fulton, the inventor of the steamboat, was the next to make any practical advancement in the development of the submarine, taking it up from the point at which Bushnell left off. He first laid his plans before the American Naval authorities in 1799 but received no encouragement from them. Thereupon he journeyed to France where three years were spent in trying to gain recognition. Finally, Napoleon Bonaparte gave him audience. Bonaparte became at once interested in the proposition and appointed a commission to investigate and report upon it. After due deliberation a favorable report was returned with the result that the sum of 10,000 francs was appropriated

for the construction of a boat and the conducting of experiments.

The *Nautilus* was finally built according to Fulton's plans and tried out on the Seine, but of course, like Bushnell's *Turtle*, it was propelled by hand power and could only be operated at a very slow speed. This vessel was intended for offense against the English fleet and was to be capable of crossing the English Channel. Several attacks against the blockading English fleet were unsuccessful, however. The English by keeping themselves posted about what was going on simply kept out of range of Fulton's sorties. Bonaparte, therefore, in a fit of impetuous rage and disgust, decided that the *Nautilus* was of no military value and dropped the entire matter, calling Fulton a hair-brained fool.

Fulton next took his idea to England, where he was cordially received by William Pitt, who at once grasped the significance of the device and believed, with Fulton, that it would annihilate the naval supremacy of nations.

The Admiralty, however, refused to encourage the development of any device which they believed would, if broadly taken up, relieve England of her naval supremacy. They offered Fulton a sum of money to suppress the invention and to prevent the enemy from using it. This offer Fulton refused, but finding that at this time he would be unable to accomplish anything further with his submarine, he returned to the United States and devoted all his energies to the development of the steamboat.

The next sixty years saw nothing of any practical value in the development of the submarine, until during the period of the Civil War the Confederates built a number of small boats which they called "Davids." These vessels

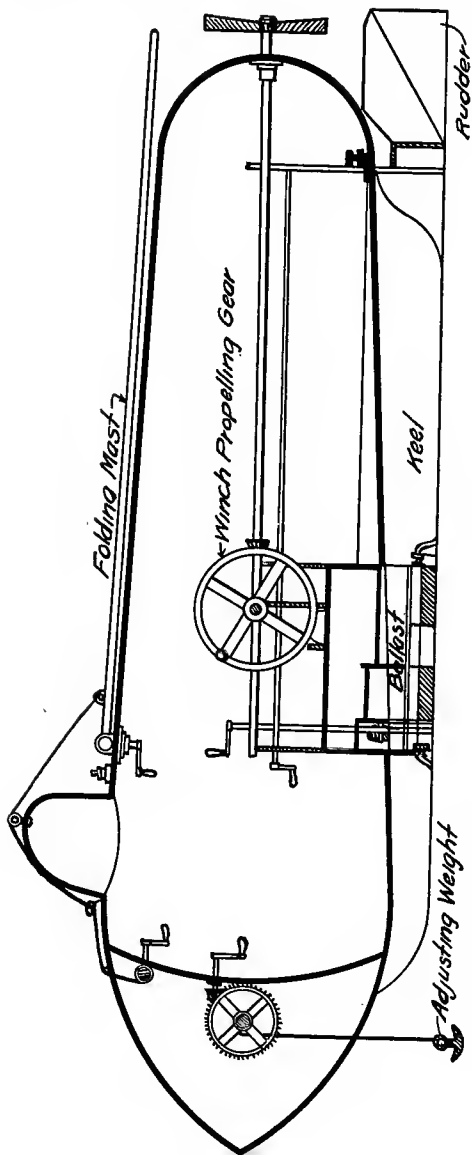

Fulton's Nautilus. 1803

were built of steel and were propelled by steam engines, the only radical departures from the earlier types. They carried torpedoes fixed to the ends of outriggers or spars and their mode of attack was to ram the vessel upon which the attack was to be made with these torpedoes, causing the latter to explode by the shock, and blow up the boat. I believe that none of these "Davids" succeeded in making an attack under water, but one of them did succeed in ramming with a spar torpedo the Federal gunboat *Housatonic* while she was at anchor, the ensuing explosion sinking the "David" as well as the gunboat.

In 1863 the French again took up the problem of submarine boats and succeeded in turning out *Le Plongeur*, which was the first large submarine ever built, having a displacement of nearly 500 tons. It was in fact larger than anything that had been constructed up to very recent years. It was equipped with compressed air engines for motive power and carried a number of containers for holding air under pressure for driving the engines. At this time however, compressed air engineering was still in an undeveloped state, and the vessel was able to remain under water but a very short time and could only make a speed of four or five knots. *Le Plongeur* was also found to be uncontrollable under water, having no stability. However, the French Government experimented with this boat until 1874 and then gave up the project of submarines once more as being impractical.

Mr. John P. Holland in this country was the next of note to take up submarine development. His first boat, called the *Fenian Ram*, was built at New Haven, Conn., in the early eighties, for the Fenian Society of New Haven, the necessary funds having been raised by the Society

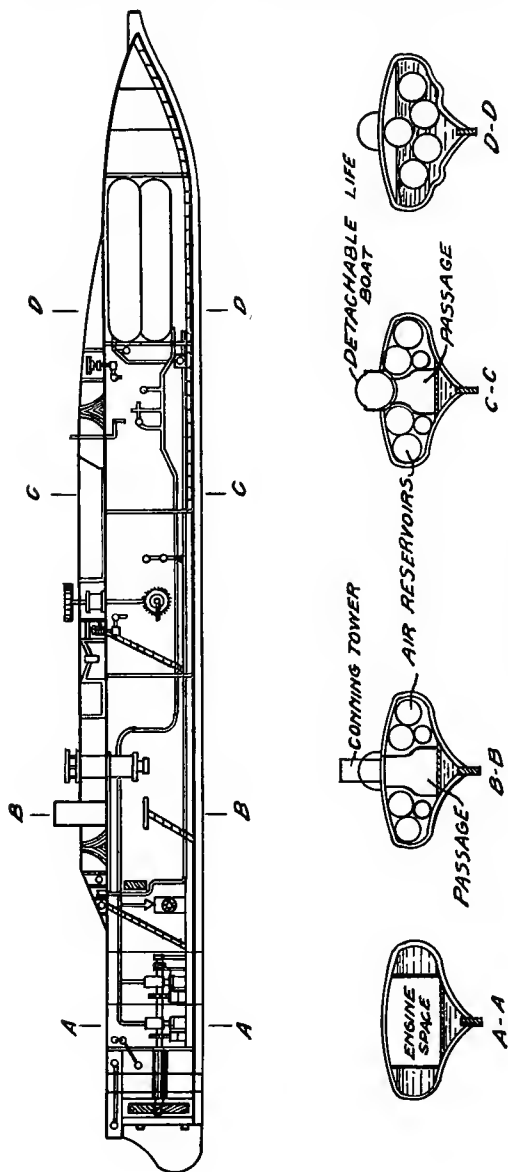

Le Plongeur. 1863

through popular subscription for the rather visionary purpose of making an attack upon the English Coast and the destruction of England's fleet, as an aid in securing Home Rule for Ireland. The heralded war did not materialize however, and the vessel was never put to any practical use.

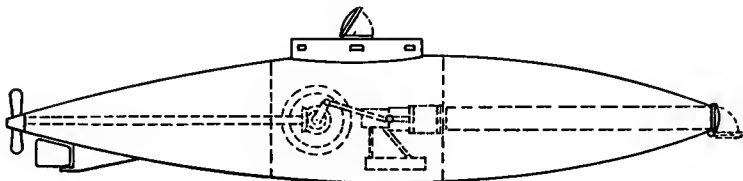

Holland's Fenian Ram. 1877

In the next few years the two factors which have made the present development of the submarine possible, reached the period where they were become of some practicable value. These factors are the automobile torpedo and the electric storage battery. The automobile torpedo furnished the submarine with a weapon with which it could make an attack upon another vessel without disastrous results to itself and in fact afforded a means of reaching the ship attacked which lack of speed on the part of the submarine itself had hitherto made impossible. The storage battery effected the first satisfactory means of propelling the vessel under water.

After the completion of the *Fenian Ram* Holland continued to develop the submarine boat and to him must be accorded the credit for bringing it to its present day state of practical value. He constructed four or five experimental boats and in 1890 built the first submarine to meet the requirements set forth by the United States Navy Department. This vessel was called the *Holland*

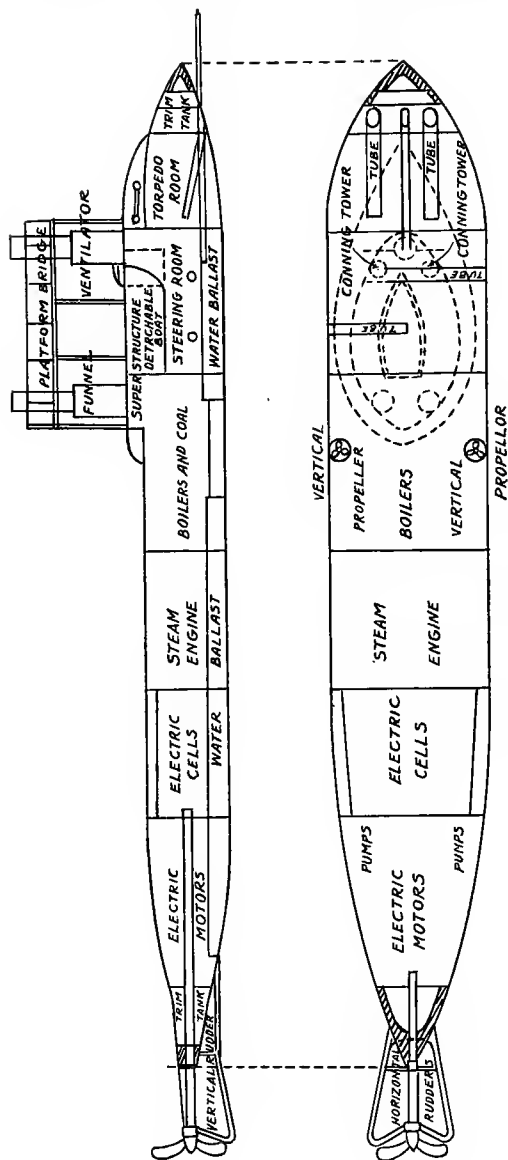

Hovgaard's Submersible

and is now at the United States Naval Academy at Annapolis.

The *Holland* was fitted with gasoline engines for surface propulsion and with electric storage batteries and motors for submerged cruising. It was the first boat in naval service to be equipped in this manner, and in fact was the first submarine having any power by which it could be run when submerged to any considerable depth. In Europe attempts had been made to use the steam engine while submerged by running ventilating pipes to the surface. These vessels could submerge to a depth just barely sufficient to cover their decks and were therefore in a very precarious position, at the mercy of the elements as well as the hostility of the enemy. One of the novel features of the Holland boat was the ability to dive by inclining the axis of the boat and plunging to the desired depth. This had never been accomplished before and was viewed with much skepticism by other engineers.

Meanwhile in Europe, Lieutenant Hovgaard of the Danish Navy had taken up the problem of submarine development, while in England it had been pursued by a Swedish engineer, Mr. Nordenfelt. Nordenfelt believed that the best solution of the problem lay in the evolution of a single power unit system for both surface and submerged work, and adopted as a means to this end the steam engine. He was only partially successful however, and not at all so from a tactical standpoint.

The French Government once more took up the problem and in 1888 designed a boat which was operated by primary batteries; these were later taken out and replaced by accumulator cells. Later, in the early nineties, *Le Morse* of the same type was built. It may be of interest to state

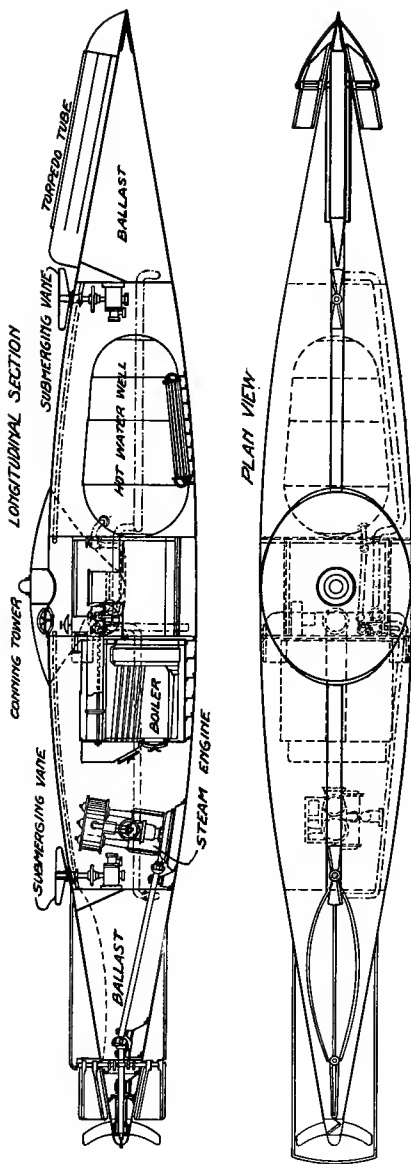

Nordenfelt's Turkish Submarine. 1887

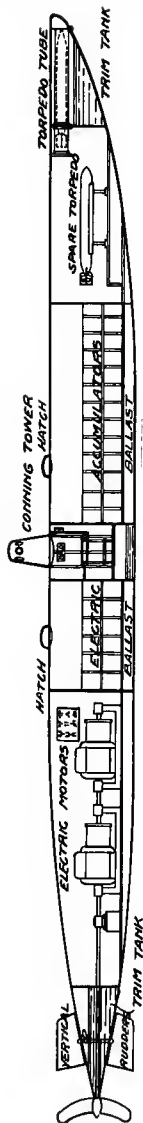

Le Morse. 1899

here that *Le Morse* was one of the first boats to be fitted with a periscope, which however was a very crude affair. In the middle nineties, after receiving competitive plans, the French adopted a type designed by Laubeuf, a naval constructor. To this type they have adhered more or less ever since. The *Narval*, built according to the Laubeuf plans and launched in 1899, was a double hull boat and fitted with fore and aft hydroplanes.

During this period the number of inventors and inventions relating to submarine boats ran up into the hundreds. The inventors counted amongst their numbers doctors, lawyers, priests, farmers, and shoemakers; in fact men from almost every walk of life, and as might be expected almost nothing of any practical value was accomplished by them. One name stands out however, that of Bauer, a German, and should be recorded in the pages of submarine history. Bauer was the first German to take up this development and evolved some excellent and very practical ideas. These ideas he laid before the German Government, but was confronted with political enmity as well as professional jealousy and publicly derided. He then took his plans to Russia where he was given the support nec-

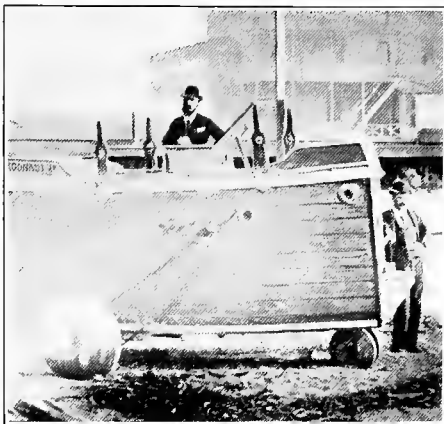

By courtesy Lake Torpedo Boat Co.
Lake's First Submarine. The Argonaut Jr.

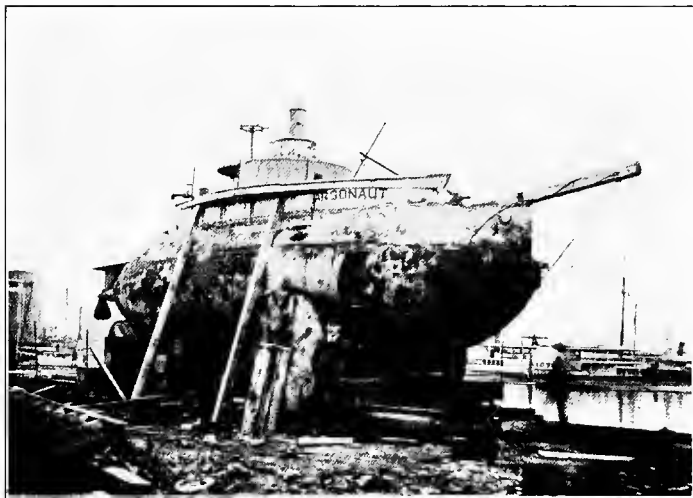

By Courtesy Lake Torpedo Boat Co.
Simon Lake's Argonaut First

essary to build a boat. Misfortune however seemed to dog his footsteps, through no fault of his own, until he died without having accomplished his purpose.

In the United States, Mr. Simon Lake took up the development of submarines shortly after Holland. His first designs were primarily for the recovery of lost treasure and wrecking purposes, but later he went in for the development of war craft as well and has made great progress along the lines of the control and the military efficiency of the submarine. Mr. Lake is probably one of the best informed of the submarine builders today. He was, in fact, the first to advocate the ship-shape hull form and the use of hydroplanes, having submitted plans involving these features to the Navy Department about five years before the *Narval* was designed.

CHAPTER II

DEVELOPMENT OF THE PRESENT-DAY SUBMARINE

ALTHOUGH the inception of the submarine boat dates back to the seventeenth century, it has been only within the last fifteen years that any systematic or practical development was begun. In fact in 1902 Lieutenant L. H. Chandler, U.S.N., in discussing tactical torpedo warfare before the Naval Institute at the United States Naval Academy said in closing his remarks, "The submarine has not yet developed far enough to be of any practical use in warfare," and "is not yet ripe for consideration." The rapid development then that has taken place between that time and the present day may be realized by the results shown in the present European conflict.

The rapid advance during these last few years has been due to the systematic study given to the submarine both from a military and an engineering standpoint by naval experts and authorities who have had experience in handling the subject, and by the requirements laid down by naval officers who have gained experience in this particular field under actual service conditions.

In 1893, the United States Navy Department when first contemplating the adoption of submarines to service requirements laid down a set of standards to which all submarines to be acceptable must conform. These requirements included, safety; controllability, submerged; surface speed; submerged speed; endurance, both on the

surface and submerged; offensive power; stability; and visibility of the object to be attacked.

These requirements were given relative value in the order named and have not changed greatly up to the present time, and where changed, only in point of their relative values.

The development attained in these years might be more strongly pointed out by a comparison between the *Adder* class built for the United States Navy in 1899, the acme of submarine construction and efficiency at that time, and the *M-1* laid down in 1914, and the equivalent of any of the foreign boats. The *Adder* had a submerged displacement of 122 tons, a submerged speed of 7 knots, a surface speed of 9 knots, a radius of action on the surface of 500 nautical miles, and a radius of action at a 4.5 knot speed submerged of about 70 nautical miles. She carried one torpedo tube in the bow, and was propelled by gasoline engines on the surface and by electric motors and storage batteries when submerged.

The *M-1* is a twin screw ship of about 630 tons submerged displacement, has Diesel engines of about 1600 brake horse power for driving on the surface at a speed of 14 knots, and has a radius of action on the surface of 5500 nautical miles. Submerged, she is driven by electrical machinery and is capable of making a speed of 10.5 knots for one hour or a speed of 8.5 knots for three hours. At a speed of 4.5 knots submerged she will be able to make about 65 miles. She carries four torpedo tubes in the bow and a spare torpedo for each tube.

It may be seen from the foregoing comparison that the submarine has made great strides ahead except in the particular features of submerged speed and radius of ac-

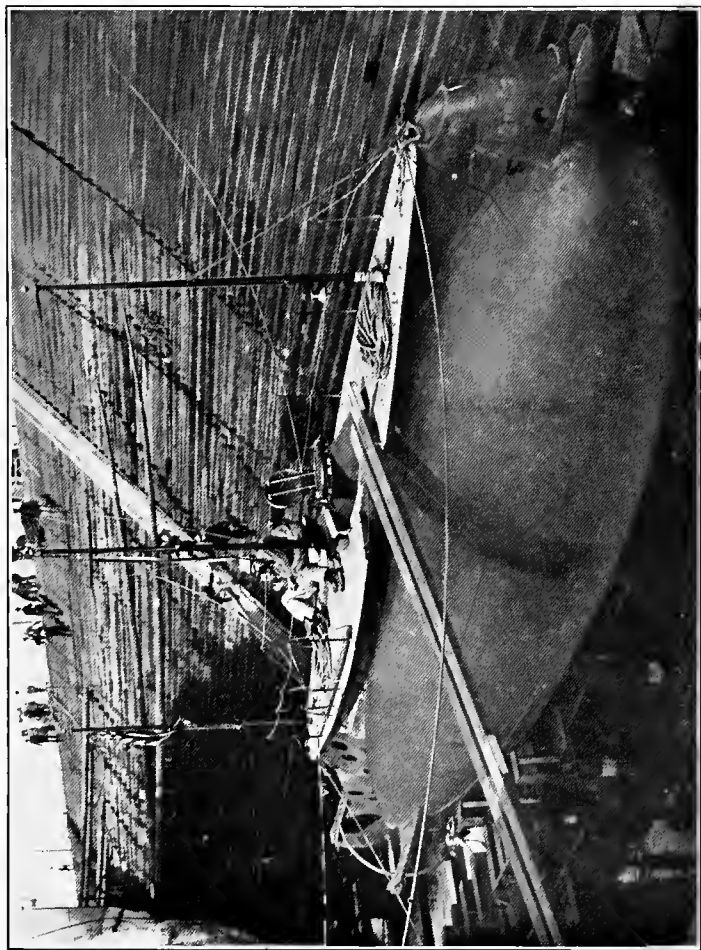

© *Int. Film Service Co.*
The "Holland," the First Submarine of the U. S. Navy. Length 53 ft., beam 10 ft., displacement 74 tons. No longer in service

tion submerged. As regards these, the writer is firmly convinced that a limit has been reached with the present dual power system for propulsion. For, with the dual power system, either the submerged speed and radius of action must be sacrificed to gain an increase in surface radius and speed or vice versa. With the development in size of the submarine much higher powered engines must be installed to overcome the necessarily increased speed resistances. The high power engines of the internal combustion type demand heavier construction than do the smaller engines, and as the percentage of weight allotted to the power plant in a submarine remains constant with the displacement, the other functions keeping the same balance, it is easily seen that the engines in this case must absorb a greater proportion of this percentage and the motors and batteries a lesser proportion, consequently detracting from the submerged radius and speed.

The real limit of the radius of action of a submarine at the present time is the endurance or the physical ability of the crew to stand prolonged hardships. For, although conditions are now much improved, a submarine does not yet afford its crew many hotel accommodations. It will be necessary to better these conditions before any greatly extended cruises can be made with any certain degree of safety. There is also a great deal of room for improvement to be made in the sea-worthiness of the submarine.

The United States Navy has continued in building the Holland boat, which is known now as the Electric Boat, the company having reorganized several years ago under the name of the Electric Boat Co. Since 1911, the Navy Department has also adopted the Lake boat of which there are now three in the service and several under con-



Courtesy Electric Boat Co.

U. S. Submarine B-3. 170 tons displacement, 82'5" in length, and 12' 5 $\frac{1}{2}$ " beam

struction. This Navy has also one of the Italian Laurenti type boats which was built by the Cramp Ship Building Co. Both the Lake and the Laurenti boats are known as the *G* class and have practically the same distinguishing features.

England, in 1903, purchased the right to build the Holland type of boat from the Electric Boat Co., and have continued to use this type with various slight modifications from the original form and with a continual development in size. The superstructure has been increased in size as it has been in the United States Navy, and in some of the boats water ballast tanks have been added under the superstructure in order to obtain an increased reserve buoyancy. Great secrecy is maintained over the designs of the British, however, and really very little is known about them. It is claimed by some that the *F* class of boats laid down in 1914 have a submerged displacement of 1200 tons with a speed of 18 knots on the surface and 12 knots under water.

In France there seems to have been no strict adherence to any one type of boat, nor rational advancement and steady development in any one direction. Development over there indeed seems to have been of a very erratic nature. They have not seemed to have decided on any one type, building extensively both submarines proper and submersibles; one year tending to increase materially the displacement of these craft, and the next year dropping back to the building of smaller boats.

In fact they seem to be willing to try anything once, and as a consequence, France has probably spent more money in submarine development than any other nation, but because of the lack of systematic progress in the

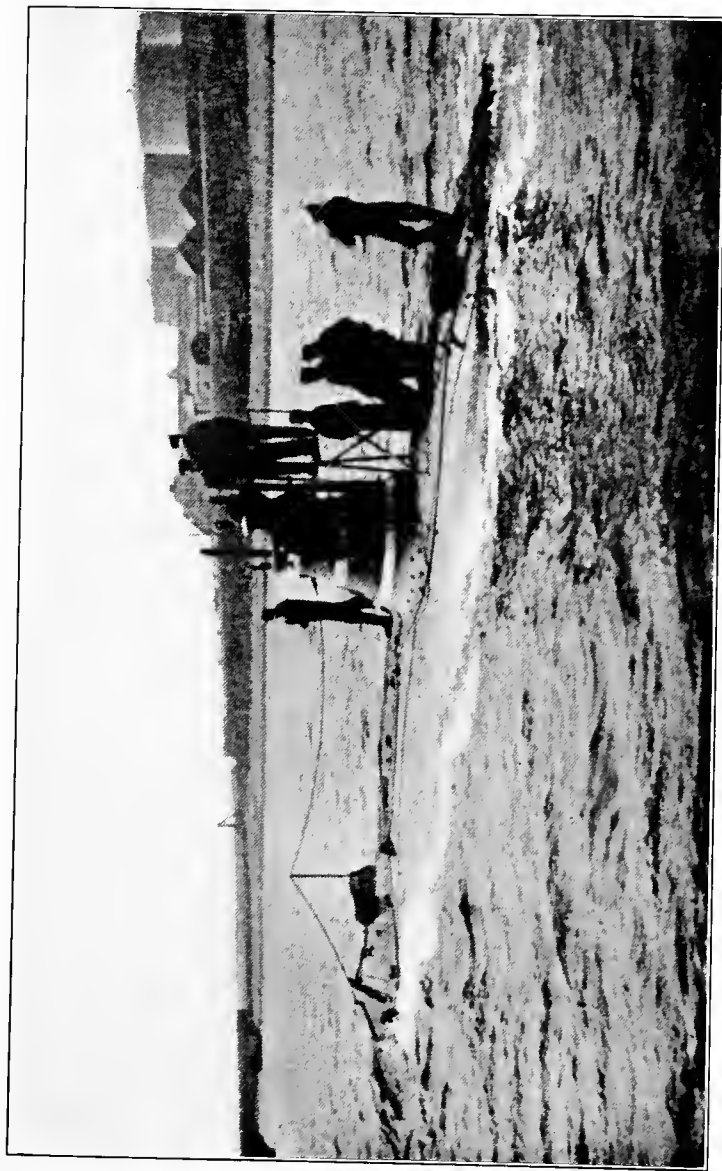

Photo-Copyright, International Film Service

British Submarine of the A class

field has secured less efficient results than any other nation.

Germany did not take up the development of submarines until rather late, but characteristic of this nation, having once decided to go into the field, a sufficient sum of money was at once appropriated to meet the expenses and the Krupps were given the commission to undertake the problem of development. The Germans have also tried out the d'Quevilley type, a French product, but with what success is not known; however, as the French had experimented for some years with this type and had gained no apparent success it is doubtful that the Germans have done anything more. The essential feature of the d'Quevilley boat is the single unit power system, using the steam engine. The steam for submerged propulsion is generated by means of a soda boiler; the principle of the system being to utilize heat in the form of steam generated by a slaking process as is demonstrated in the slaking of lime. This principle is not new however, having been tried out in this country in 1885 by Prof. J. H. L. Tuck on his submarine boat *Peacemaker*.

Going into the field comparatively late, as Germany did, she was enabled to profit to a considerable extent by the experiences of the other countries.

The boats *U-9* to *U-16*, which have taken such a prominent part in the submarine activities off the English Coast, have an extreme length of 142 feet, a moulded breadth of 12 feet 4 inches and a mean draught in the surface condition of 9 feet 8 inches. They have a submerged displacement of about 300 tons and a surface displacement of 235 tons. These vessels are all of the submersible double-hull type of construction with a cigar shaped inner hull

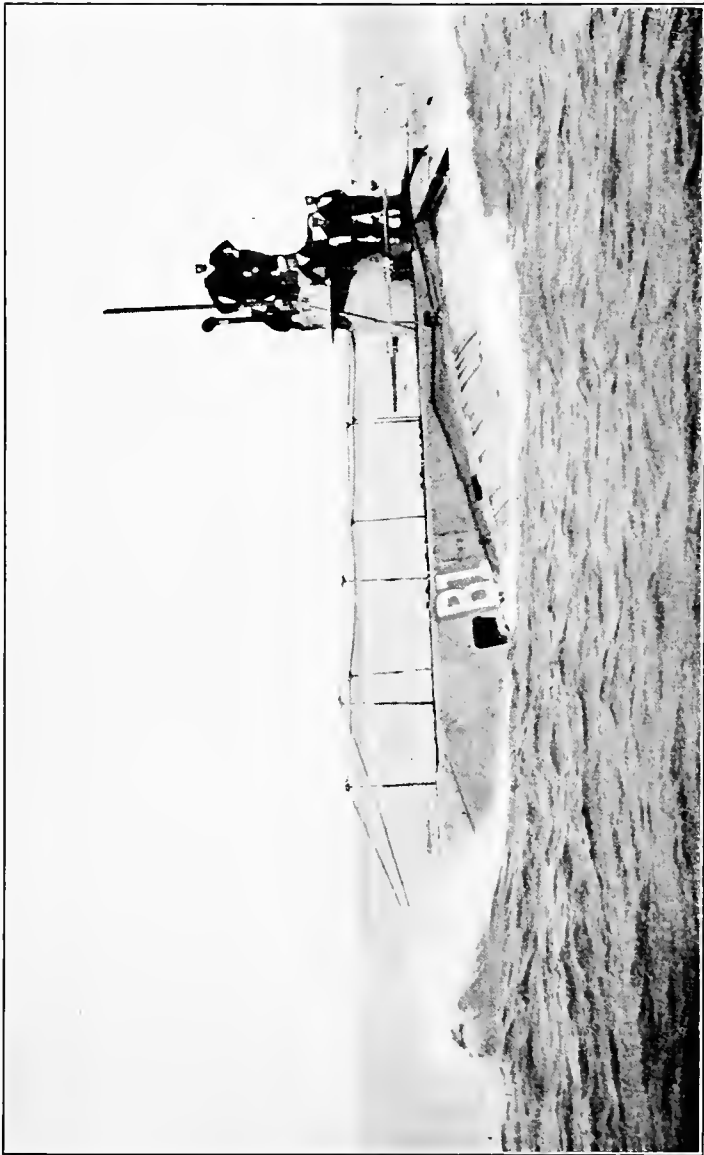

British Submarine B-1

capable of resisting hydrostatic pressure due to a depth of 165 feet.

The watertight hull is formed of nine circular welded sections, the amidship three of which are cylindrical and the others fore and aft are slightly conical. Each section is divided by bulkheads into a watertight compartment. The bow section contains two torpedo tubes and accessories and can carry altogether three torpedoes; the next section is occupied by the crew and storeroom for batteries, and contains also a galley and lavatory accommodations. The amidship sections contain the inner ballast tanks and steering and all other navigating and operating gear. The engine room contains internal combustion engines of the Diesel type and electric motors, and the last watertight section is reserved for another battery of electric accumulators. Between the deck platform and the inner hull all the kerosene fuel tanks are fitted.

The propelling power for surface navigation is derived from two two-cycle heavy-oil engines aggregating 600 B.H.P. driving two reversible screws. Two electric motors developing 320 H.P. are used for propulsion when the boat is submerged. The engine room auxiliaries comprise two main and one auxiliary motor driven bilge pumps, two hand pumps, air compressors and other accessories. Particular attention has been given to equipping with various means of salvage and safety appliances and air purifying devices. The surface speed is 12 knots and the submerged speed is 8.6 knots. At an economic speed of 10 knots, the radius of action on the surface is 1200 miles and at 6 knots submerged the radius is claimed to be 60 miles.

Looking back we can see that up to the time of Holland, what development there had been was of a very erratic

nature and of no practical value. From this time on there was a period of a great deal of experimentation and practical demonstration, until in 1900 the submarine was brought up to a point of being of some practical use for naval purposes, and since then under service conditions and requirements it has reached a stage of development where its military values have been amply demonstrated and assured in actual service of war.

CHAPTER III

CHARACTERISTICS AND REQUIREMENTS

IN a service submarine it is essential that it be capable of keeping to the sea and making headway in any kind of weather. This is at once evident for a submarine intended to go to sea. There is at the present time a tendency to divide submarines into two classes, namely, coast defense submarines and sea-going submarines. However, it is obvious that to be of any military value, even in the smaller craft intended for coast defense work, it is just as essential that it be able to venture outside the mouth of a protected harbor in stormy weather as it is for one of the larger sea-going boats, for it is at such a time that an invading fleet of the enemy is most likely to make an attack.

In connection with sea-worthiness it is just as necessary that the submarine be absolutely controllable in any kind of weather, both when upon the surface and when running submerged, and it is obvious that stability is a necessary factor in obtaining both of these characteristics, as it is also evident that safety is to a great extent dependent upon the presence of all these qualities. As the tactical value of a submarine torpedo boat as an offensive instrument of naval warfare depends entirely upon its ability to go upon long and extended cruises far from any friendly base, and unattended, the supreme importance of these qualities is apparent.

In spite of much that has been said to the contrary, controllability is a quality woefully lacking in service

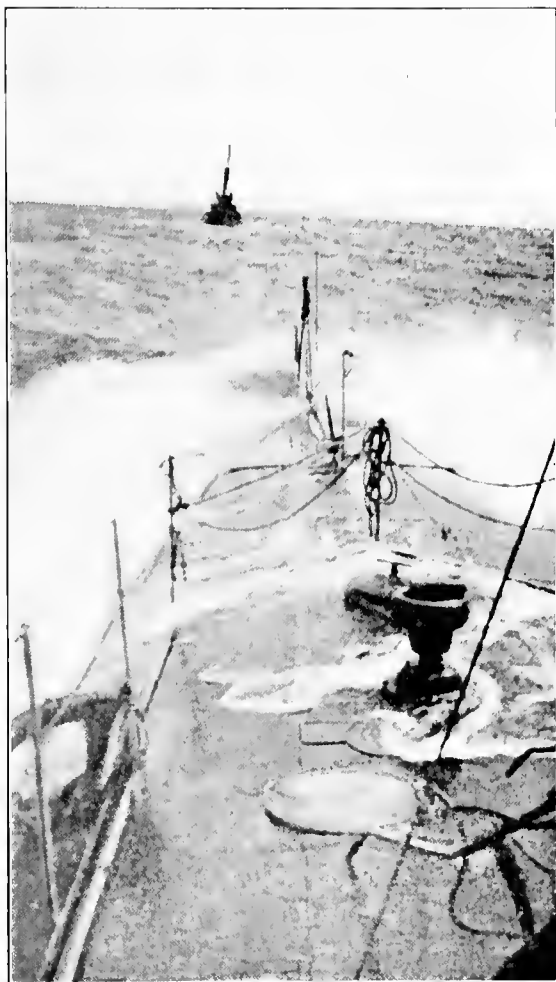

Forward deck of Submarine G-4. Driving into a swell at full speed

boats at the present time. Under water it has been effected to some extent by a general adaptation of fore and aft hydroplanes, which tend within certain limits to control the boat in a vertical plane on a nearly even keel. This method is however still accompanied by a very small margin of safety, and is objectionable on the score that it is sluggish in action.

Reliability of engines and power plant is a very important and necessary adjunct to the sea-worthiness, for should the power plant of a vessel of this character fail while at sea, especially in heavy weather, it would undoubtedly be attended with very disastrous results for but little provision can be made for the spreading of canvas to gain steerage way because of the lack of the necessary stability in a submarine boat for this manner of propulsion. The power plant should therefore be as simple as is possible in construction in order to enable temporary repairs to be made at sea, when any difficulty does arise, with the limited means which may be found on board. Spares for all the parts which would be difficult to repair must be carried in stowage. The installation of the plant must be made with these contingencies in view, and must be carried out in such a way as to leave the machinery accessible in every part so as to enable the making of these repairs in an expeditious manner.

Speed is also a requisite of prime importance, for upon this characteristic depends the submarine's ability to make a successful attack as well as to get safely away again. Although the torpedo has been developed so that now it has an effective range of 10,000 yards at a speed of 27 knots and a maximum speed of 43 knots at a range of 1000 yards, the range from which a submarine attack can be

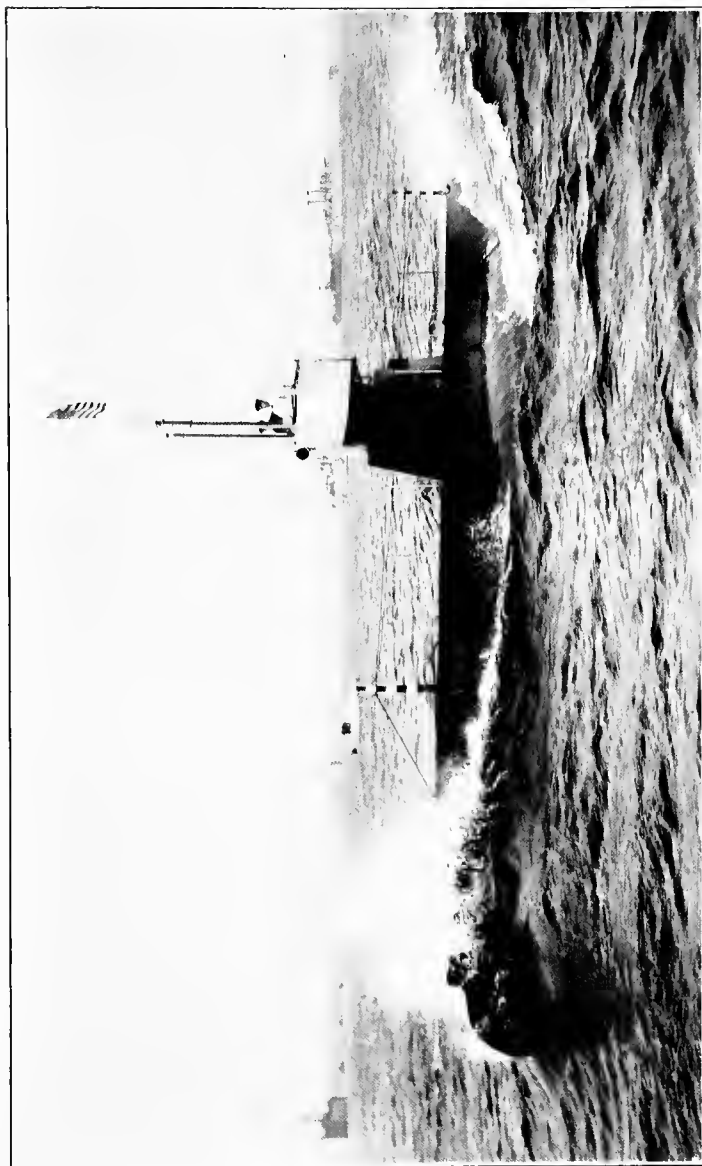

Courtesy Electric Boat Co.

U. S. Submarine C-3. 273 tons displacement. Note heavy bow wave formation which is contributory to a loss of control when arriving at a critical speed dependent upon ratio of length to beam. This has resulted in the loss of several English and French boats

made with any certainty of scoring a hit is well within 1500 yards and probably not more than 800 yards. Many of the submarine experts take the stand that the submarine should be designed essentially as a surface boat, but one having the ability to navigate under water, and, therefore that the matter of submerged speed is of secondary importance. This assumption is far from the truth and has been conclusively shown to be so by the results of the German submarine attacks in the present European conflict, for the only successful attacks have been those made upon ships of slow speed or when cruising at from seven to eight knots an hour. While a submarine will probably never be able to attain the speed of a destroyer, it should be able to protect itself from this craft, its arch enemy, by superior maneuvering ability and quickness of action when submerged. A required speed would therefore be, for submerged running, at least that of the normal cruising speed of the battleship, say sixteen knots an hour, and for surface work a probable speed of from eighteen to twenty knots an hour to allow it to travel with the fleet as an auxiliary and component part.

To submerge quickly, by that I mean to change from the normal surface running condition to the totally submerged condition, is extremely important, not only to get out of sight before being seen by an approaching ship, for should an enemy's ship catch sight of a submarine it would immediately take warning and run away, but to afford protection to itself. It is quite probable that a destroyer cruising along at a normal speed and not smoking heavily will sight a submarine as soon if not before it is itself sighted, on account of the much more elevated station of the lookout and consequent increased range of vision.



C-1 Coming to the Surface after a Submerged Run



U.S.S.T.B. C-1 Making a Dive

great speed the destroyer could cover the intervening distance in from six to eight minutes or at least could approach near enough to make an effective attack by gunfire upon the submarine with disastrous results to it, unless it had first been able to effect cover under water. The complete change from light to submerged condition should therefore be effected in from two to three minutes.

The effectiveness of a submarine attack depends for the most part upon its ability to load and fire several torpedoes in quick succession, for it takes considerable maneuvering greatly handicapped by lack of speed to get into position for firing. This is occasioned by the fixed position of the torpedo tubes as an integral part of the hull, and means that the axis of the submarine must be brought to train upon the target. Having once attained this position, a target and especially one of high speed will remain in the zone of fire for only a very short period of time. The submarine must therefore be equipped with armament efficiently designed and capable of quick operation in order to take the greatest possible advantage of these few seconds.

The real necessity of this may be better understood by the uninitiated after taking into consideration the great disadvantages under which the submarine is working, and the really small chance that is afforded her of making a successful hit. The periscope, the eye of the submarine when under water, affords a very poor means of judging the distance or range of the object to be attacked, and although the eye-piece of the periscope is graduated with cross-hairs to better enable this calculation to be made, the base line for which these graduations are provided must remain more or less indeterminate and consequently the

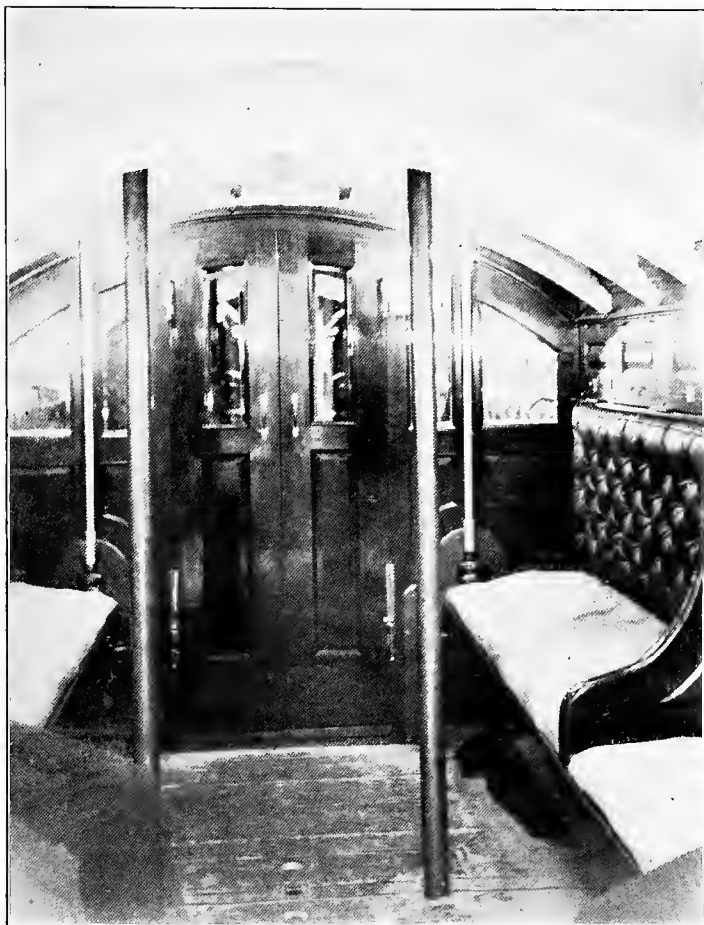

By Courtesy Lake Torpedo Boat Co.

Living quarters aboard Lake Submarine "Sig" and class built for Russia. These boats of only about 200 tons displacement afford much better living accommodations than do any of our larger modern boats where every bit of weight and space available has been given up to increase speed and radius of action

resulting calculations not very accurate. Next, the speed of the target must be arrived at and the necessary observations and calculations made to determine this. With the limited means at hand for performing this feat, the correct solution resolves more upon the experience and good judgment of the observer than upon anything else. Having found the range and the speed of the vessel to be attacked, it is now necessary to direct the submarine along a course which will intersect that of the vessel at the exact point where she will be at the end of the interval of time it will take the torpedo to make the run from the position of the submarine to this point. A very slight miscalculation in either the distance, the speed, or the direction in which the ship is traveling will preclude all chances of making a hit unless the range is very short.

Habitability in a submarine, while probably not of so great importance in a coast defense boat, is certainly of extreme importance in a cruiser type submarine. Upon it depends the ability of the submarine to keep to the sea for any protracted length of time. A submarine may be designed with sufficient space for fuel and stores to last for many days, but she can accommodate only a limited number of men, the physical endurance of whom is the true gauge for the radius of action of the vessel. It is true that in times of great nervous stress, such as in time of war, men seem to be able to undergo extreme hardships for almost unbelievable lengths of time, but there is, under these conditions, the ever present danger of some weaker member of the crew breaking down and in a moment of abstraction doing something inadvertently to endanger the ship and all on board. This great nerve strain upon the men in time of war, when they are called upon to



Photo-Copyright, International Film Service
German U-5 in a heavy sea off the Coast of Belgium

exert an incessant and exacting vigil, is intensely exhausting, and unless they can be relieved for periods of relaxation and sound rest, they must soon reach a state of collapse.

An interesting article has been written and published by the Associated Press, from an interview obtained with Lieutenant Hersing who commanded the German *U-51* during her long cruise from the North Sea to Constantinople, a voyage of about 2400 miles. This article accurately describes the effect of long cruises upon the personnel.

Captain-Lieutenant Hansing in command of the *U-16* has also described it as "fearfully trying on the nerves." He also says, "The atmosphere becomes fearful, an overpowering sleepiness often attacks new men, and one requires the utmost will power to remain awake. I have had men who did not eat for the first three days out, because they did not want to lose that time from sleep."

Upon some vessels sleeping quarters have been provided for the crew in the superstructure. The use of this space for the purpose is however restricted to times of peace or when in port, for in war time at sea, with a possibility of having to submerge at any instant, it would hardly be practicable. The best that has been effected so far for accommodations is a number of thin mattresses thrown down on the tank tops in the battery and torpedo compartments upon which the men may snatch what rest they can. The contractors for submarines are required to furnish berths or folding cots for the officers and hammocks for the crew, but the limited amount of space on board makes it almost impossible for these to be used, especially when cruising in war trim, for then the forward torpedo compartment, which is usually used as the officers' quarters, must be kept

clear of all unnecessary paraphernalia to allow unhampered and quick handling and loading of the torpedoes. Nor is the dampness and wet caused by the sweating of the steel hull conducive to a great deal of comfort at the best. This feature has been overcome to some extent by sheathing the living quarters wherever possible with cork slabs, but is still one to cause extreme discomfort and even ill health if exposed to it for very protracted periods at a time.

CHAPTER IV

TYPES OF SUBMARINES

SUBMARINES AND SUBMERSIBLES

THE broad term submarine is used generally to designate all vessels capable of navigating totally submerged. But strictly speaking these vessels are considered to be of two distinct types: submarines proper, and submersibles.

The early Holland boats and many of the French boats were of the former type. They were distinctive in that they were designed with a spindle shaped hull, and when in the surface condition had a very small part of the hull emerging above the surface of the water with a consequently small percentage of reserve buoyancy, about six per cent in fact.

The submersible was designed with a ship-shape form of hull, fundamentally to increase the amount of reserve buoyancy in the surface condition and to afford a greater free-board for the purpose of increasing the sea-worthiness of the boat. The Lake boat with its large watertight superstructure, and the Italian Laurenti and the German Krupp types, both of the latter of double hull construction, are examples of the submersible type of boat and have a reserve buoyancy of from thirty to forty per cent of the total submerged displacement.

These distinctions are not now so strongly drawn however, as none of the modern boats are of the strictly sub-



Photo-Copyright, International Film Service

Submarine G-1 showing large rounded water-tight superstructure with working platform above

marine type; both types in fact have been modified — the submarines by increasing the amount of reserve buoyancy and by enlarging the superstructures; and the submersibles by decreasing to some extent the size of the superstructures and the excessive amount of reserve buoyancy, so that now the best practice seems to be to provide a reserve buoyancy of from about twenty to thirty per cent for both types.

A great deal of contention has been made by the adherents to one or the other of these forms as to the inherent advantages and disadvantages of each, so it might be well to discuss from an impersonal point of view the relative values of each.

The question of stability seems to be the main point of contention between the two. Along this line it is quite evident that the ship form of hull of the submersible will have a greater longitudinal stability when on the surface due to its metacentric height, which in this case is similar to an ordinary ship, the center of gravity being above the center of buoyancy on account of the relatively high position of the centers of gravity of the hull and the machinery weights. The surface stability then, in this case depending upon the inertia of the water plane areas and form, results in a short rolling period.

In the single hull construction of circular cross section of the submarine proper, it will be immediately seen that the position of the center of gravity of the hull is well below the axis and the machinery weights can be kept lower. In this case the position of the metacenter coincides with that of the center of buoyancy, due to the circular form of cross section, and with the non-watertight superstructure this relation is always constant no matter what angle of

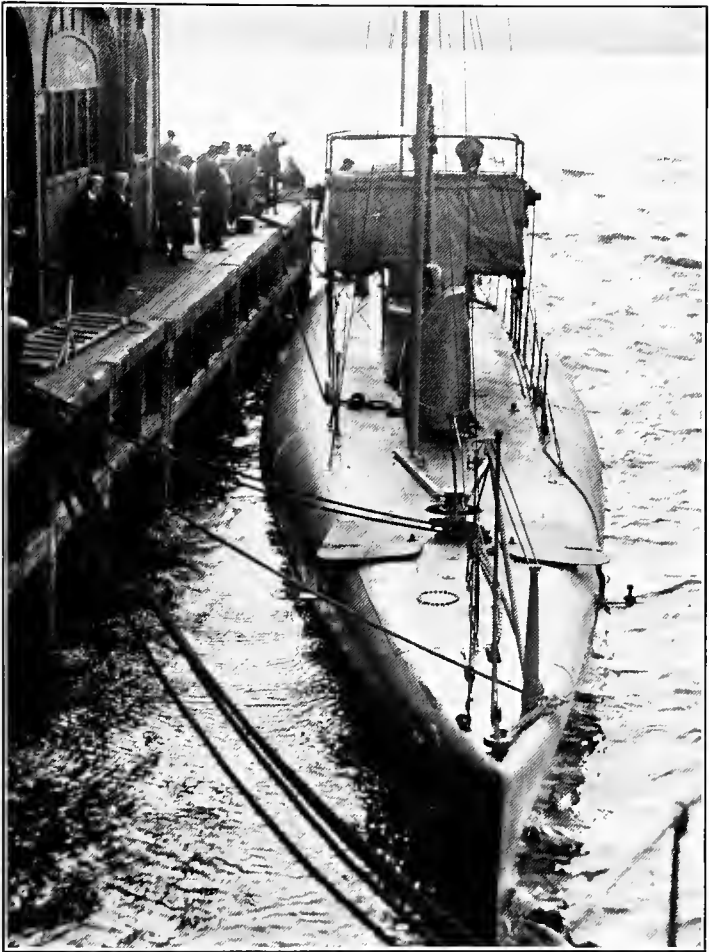

Photo-Copyright, International Film Service

U.S. Submarine G-4, Laenti Type, Note Large Deck Surface and Ship-
Shape Form of Hull Construction

heel is taken. Then with G.M. less than in the ship form of hull type but with B.G. which in the circular hull corresponds to G.M. positive, the rolling period is lengthened and a peculiar steadiness takes place. This is evidenced when in a heavy sea by an almost entire lack of rolling and by a peculiar flanking motion which seems to shift the ship bodily to one side.

It would seem then, that although the ship form of hull does have a greater metacentric height than upon the surface, as far as sea-worthiness is concerned it would be a matter of personal taste whether one preferred the heavy rolling of the one or the steadiness of the other accompanied by the peculiar lateral shift.

It might be of interest here to state that the *G* class of boats of our Navy, which are of the submersible type, have been known to roll as much as 76 degrees on each beam when in a heavy sea. Nothing like this has ever been experienced in a submarine proper of circular cross section. While the *G-1, -2, and -3*, strictly speaking, have hulls of circular cross section, the extra large watertight superstructures with which these boats are fitted give them to a marked degree the same characteristics and cause them to behave practically in the same manner as the strictly ship-shaped hull type of boat. In all fairness to this class of boats, however, it must be stated that the particular case cited above took place in a very heavy storm. The vessel while rolling heavily shipped water in her watertight superstructure accidentally, which occasioned the extreme angle she took.

The stability submerged is quite a different matter. In this condition the position of the center of buoyancy of the single hull construction is raised and the center of

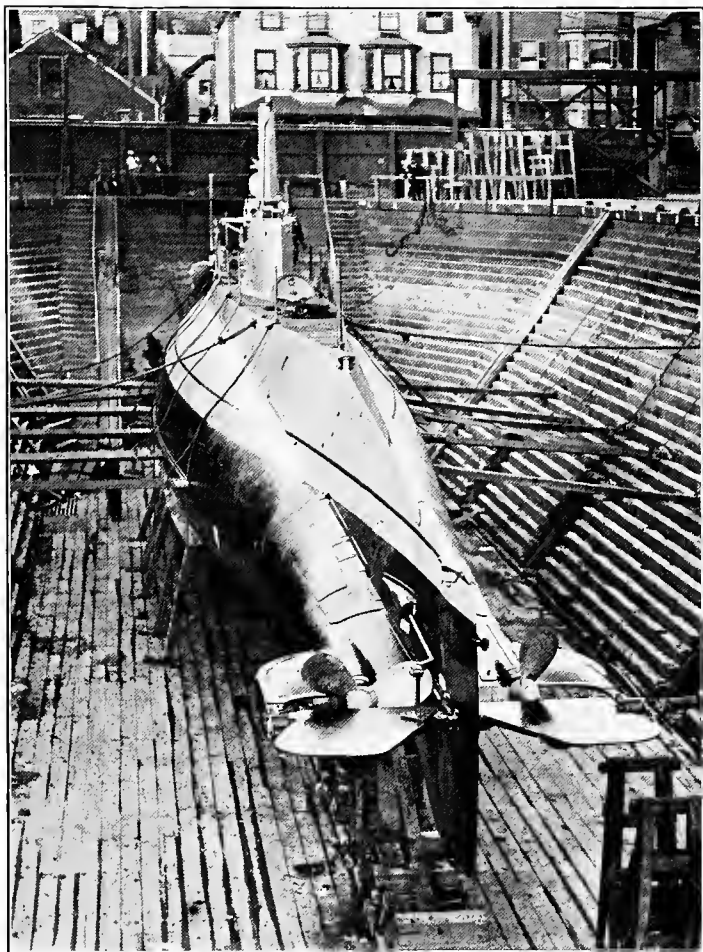

Photo-Copyright, International Film Service

British Submarine H-20

Built by the Fore River Ship Building Co., and similar to the U.S. Navy H class. Note circular hull

gravity lowered, one by the increase of displacement due to the emerged volume, and the other by the added weight of ballast taken into the tanks in the lower portion of the hull. Therefore, B.G. becomes greater and the stability is consequently increased.

Now in the double hull ship form of construction, it is evident that in trimming, the position of the center of buoyancy must be raised and the center of gravity lowered, because the stability of the vessel under water cannot depend upon form or inertia, but must rather depend upon the principle analogous to that of the suspension of a weight from a supporting element, therefore C.G. must pass and take a position below C.B. The double hull or wide superstructure owing to its shape cannot be constructed sufficiently strong to withstand much pressure, so must be filled with water when submerged as is the open superstructure of the submarine. This fact brings the C.B. of the submersible back to practically the same position of C.B. in the single hull type, but the position of C.G. is much higher in the double hull boat owing to the relatively high position of the center of gravity of its hull weights due to the large superstructure. G.B. then, and consequently the stability, is less in this type when submerged than in the single hull or submarine type of construction.

To illustrate the foregoing a set of stability curves has been prepared, Figure 1, for both types of boats, each reduced to the same total displacement submerged for fair comparison.

In summing up it may be well to point out here the relative tactical values effected by these rival types.

The ship form boat is evidently better suited to high

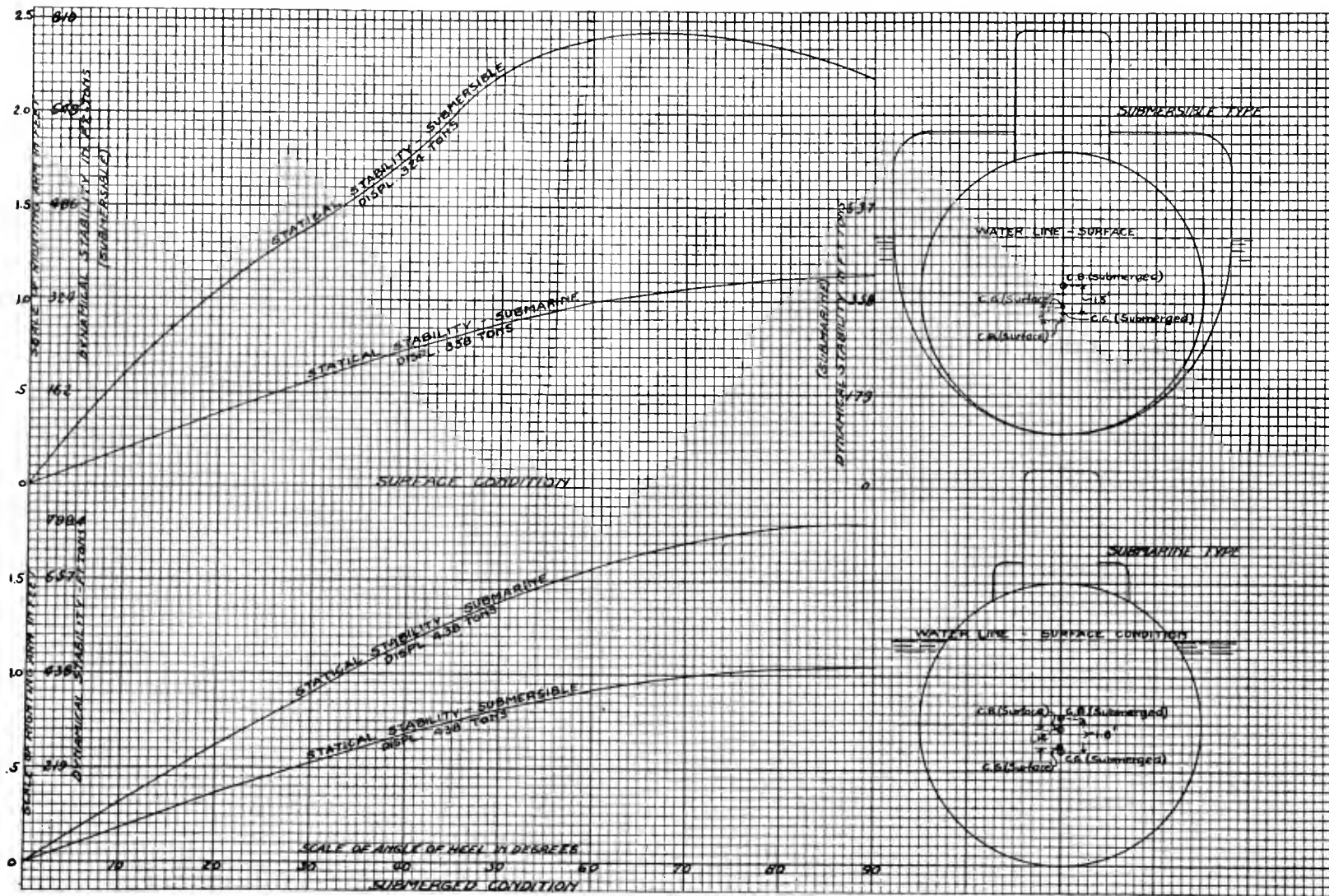
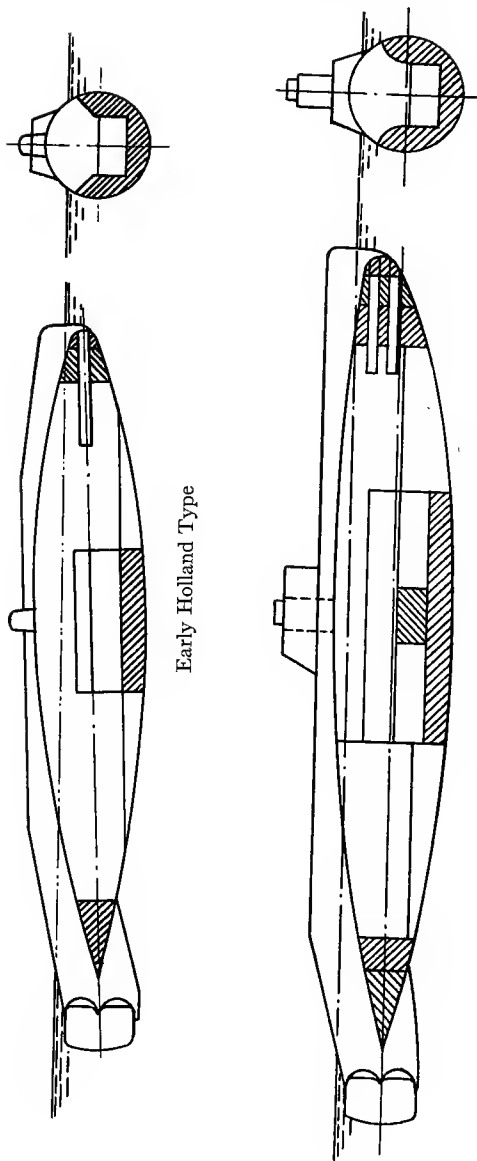

Plate I. Chart showing stability curves for Surface and Submerged conditions



Early Holland Type

Late Holland, Electric Boat Co. Type

surface speeds on account of the high free-board, but owing to its much greater wetted surface in comparison with the single hull boat when submerged, it cannot make as great speed under water with the same outlay of power as this other type because of the greatly increased skin friction.

With the single hull boat a very high surface speed will probably be unattainable because of the relatively greater ratio of displacement on the surface to the available power as compared with the double hull construction, and because of the lack of longitudinal stability of this condition.

The choice of selection then, would resolve itself not so much upon a question as to whether one type is of greater inherent stability than the other, but upon the decision as to whether the surface or the submerged speed is to be considered as of greater tactical value from a military standpoint.

THE DIVING BOAT *versus* THE SUBMERGING BOAT

A further distinction of types which is perhaps more real than in the previous classification is signified by what is known as the diving type and the submerging type. These types are interrelated to submarines and submersibles and are the crucial distinctive features of performance between the two.

The diving boats were controlled by horizontal rudders at the stern and got under water by inclining the axis of the boat and diving.

The submerging boats, often called the "even keel" boats, are forced under water bodily by means of hydroplanes situated equally distant fore and aft of the center of buoyancy of the boat. By inclining these planes the

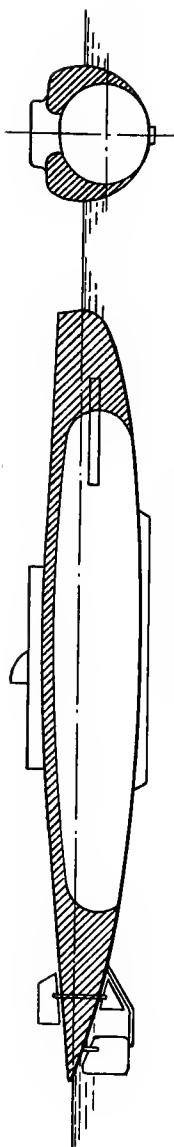

French, Lauboeuf Type

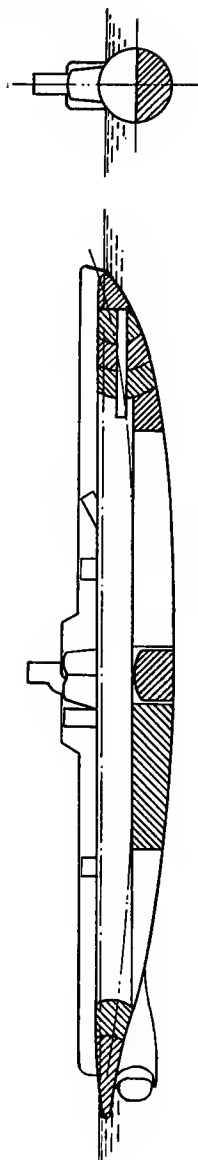

Lake "Even Keel" Type

thrust of the water exerts an upward or downward pull upon them, according to the direction of the inclination and tends to move the boat bodily up or down with the axis of the vessel remaining practically horizontal, or in other words, to cause a vertical movement. The "even keel" boat is also fitted with the usual diving rudders aft, but here they are used not for the purpose of diving but to counteract any tendency of the planes to throw the vessel from an even keel condition. For this reason they are called trimming rudders by the advocates of this system.

However, with the development of dimensions it was found to be impractical to submerge the vessels of the diving type by means of the stern rudders alone, and these boats were also fitted with forward diving rudders. The distinction as a real difference of operation then no longer exists to any marked degree between the two.

I say real difference of operation when to be more correct I should say difference of performance, as I mean behavior of the vessel itself while submerging rather than mechanical operation. The actual operation is performed on the one hand by setting the forward diving rudders to a certain inclination and by constant operation of the stern diving rudders, while on the other hand the "even keel" boats are managed by constant operation of the hydroplanes in addition to the stern diving rudders.

The contention between the advocates of the two types seems to have been upon the subject of which method of submerging was the most compatible with safety.

The handling of the early boats of the diving type seems to have been attended with some fair degree of safety, but this was because those boats were small, relatively quick

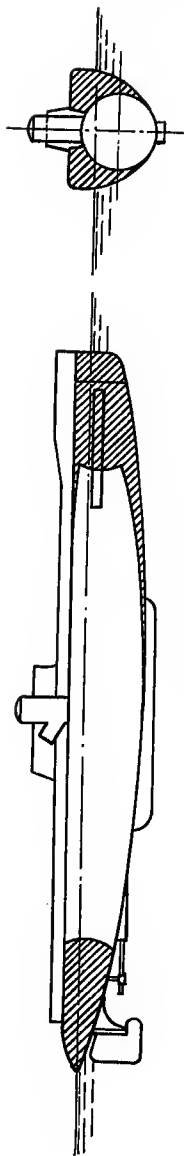

German, Krupp Type

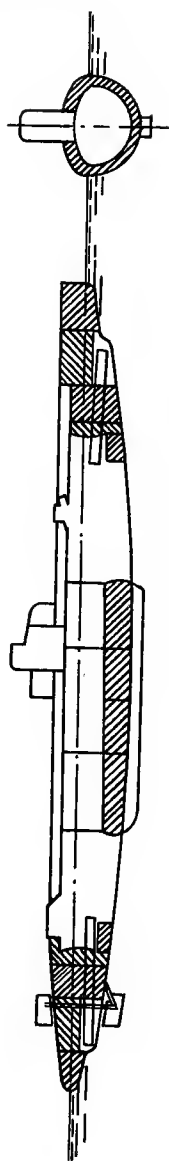

Italian, Laurenti Type

of action, and possessed but very slow speeds. In the longer boats intended for the diving type it was found that to get these boats under water with even a small percentage of reserve buoyancy, it necessitated so great a turning moment by means of the stern diving rudders, that when once the boat was gotten under way it was very apt to lose control of her and end in disaster. The forward diving rudders were then put into use to meet this contingency and to neutralize the effects of the plunging.

The still greater amount of reserve buoyancy which is carried under by the "even keel" boat, it is easily demonstrable, demands the hydroplane method of submergence. These broad planes, together with the effect of the trimming rudders aft to aid in preserving a horizontal equilibrium, tend to give in some degree a greater safety in performing the operation of submerging, theoretically at least.

In the diving type then the method of submergence has finally resolved into an inclined movement part way between a dive and a vertically oblique movement, and in the "even keel" boat the submergence may be said to be in an entirely oblique direction. It is quite evident therefore, that to obtain this latter motion it must be at the expense of a great amount of power and in a necessarily sluggish manner, for the vessel is being forced in a direction that projects its greatest area to the contrary thrust of the water, which must of necessity detract from the submerged speed. To overcome this in the slightest degree means that the vessel must be inclined by the head one or two degrees, and thereby presenting the broad expanse of the superstructure deck to aid in acting as a submerging plane. The increased safety factor of this type over the

diving type is therefore more apparent than real, for it is highly probable that with this broad plane presented to the thrust of the water to aid in overcoming the upward moment of the reserve buoyancy, and, with the smaller stability lever arm inherent in the submersible, the hazard of loss of control is almost as great as it is in the diving

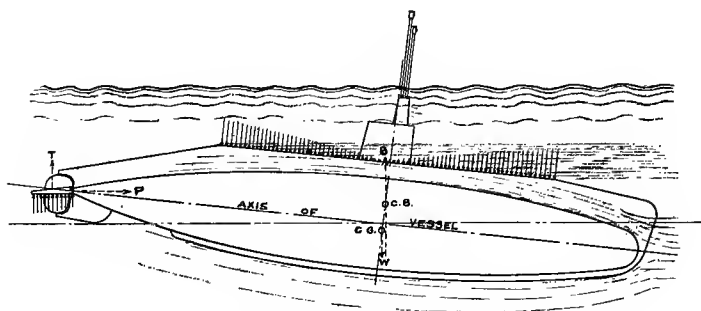

Figure 2. Diving Boat

boat, unless the submergence of the "even keel" boat be kept within certain small limits of inclination and speed.

Neither of these types however, will ever lend themselves to a greatly increased speed under water over that now attained, without the possibility of utter loss of control, attended with more or less dire results.

The opposing factors and forces and the attending results may be more clearly understood by referring to the diagrams in Figures 2 and 3.

In Figure 2 is shown diagrammatically the hull of a diving boat in a position to change trim and with the angle of inclination of six degrees by the head. The forces present and at work are: the reserve buoyancy B , acting upwards; the vertical moment W , of the weight of the vessel acting

about the center of buoyancy, tending to right the boat and acting downwards; the force T , of the water impinging against the inclined rudders to overbalance the righting moment W and the upward pull of the reserve buoyancy; the downward pull of the bow induced by the thrust of the water against the top of the hull forward of a swinging line drawn through the center of buoyancy, tending to upset the boat; and similar forces acting upon the hull aft of the swinging line tending to keep the boat in equilibrium by balancing the forces upon the hull forward of the swinging line — the remaining force is the propelling force of the vessel acting in the direction of the axis of the ship but unable to effect that direction.

From the relation existing between the contending forces, it is seen that by vigilance and careful balancing of the opposing forces, the moment T can be made to govern the trim of the vessel within certain limits, and the resultant thrust of the forces acting upon the hull brought to balance the upward pull of the reserve buoyancy, the vessel pursuing a course determined by the resultant of all the forces.

By observation of the diagram it will be seen that the swinging line cuts the line of the hull at a point progressively aft of the center of buoyancy as the angle of inclination increases, thereby projecting a greater area forward and a lesser area aft to the thrust of the water, with a constantly increasing overbalancing moment. It will also be seen that unless kept within very small limits of inclination this moment will overcome any possible righting moment of the rudders, with a consequent loss of control and subsequent disaster.

It is because of this fact that it is found impossible to

submerge larger vessels of this type without the use of forward diving rudders; the increased value of the upward moment of the reserve buoyancy to be overcome necessitated a greater angle of inclination accompanied by greater speed, and the larger surface of the hulls when presented

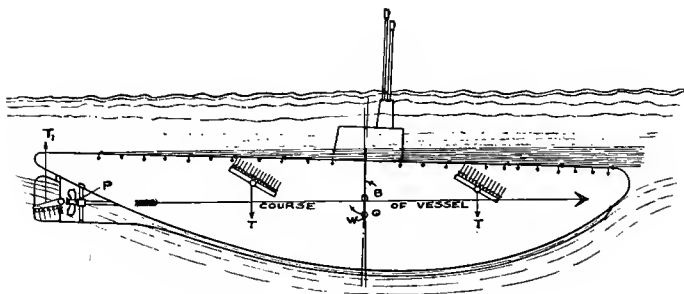

Figure 3. "Even Keel" Boat

at this angle and speed brought about such materially increased downward thrusts that, when once started on her plunge, there was small chance of being able to catch the vessel again by the diving rudders aft. With increased speeds the thrusts would be still greater and the angle of inclination must be made proportionately less, therefore affecting the tactical value of the boat.

In the "even keel" boat the forces at work are practically the same as shown by Figure 3. The better control in this type is brought about by being able to submerge by adjusting the hydroplanes. Theoretically, as the planes are of the same area and symmetrically disposed around the center of buoyancy, the moments of the planes being therefore equal, the "even keel" boat should be able to submerge with the axis of the boat parallel with the

surface of the water. Practically, however, that portion of the vessel above the center of buoyancy offers a considerably greater projected area to the thrust of the water than that portion of the hull below, and results in an unbalanced moment which must be overcome by the trimming rudders aft, and the boat must be trimmed to a slight inclination by the head. This type then, because of the broader and better resisting form of plane afforded by the big flat superstructure deck, unless proper vigilance is exercised, is very little removed as far as the factor of safety is concerned from the so-called diving type. The effects of this broad flat superstructure are even more accentuated by an increase of speed.

To overcome these inherent tendencies to lose control at a critical speed, a method was devised and tried out on a small submarine on the Pacific Coast a few years ago. This method is illustrated by Figure 4.

The system of control was essentially that of a diving boat, but involves a radical departure from the present practice in that it placed the propellers at or near the bow of the boat, and the diving rudders at or near the stern, both being equally distant from the center of buoyancy.

The claim for this system was that the boat is positively controlled at all times, either when on the surface or when running submerged, and in both a horizontal and a vertical plane. When in motion the action of the vessel is independent of the metacentric height, and is submerged by inclining the diving rudders and plunging. The vessel may be plunged with a large percentage of reverse buoyancy which in this type tends to add to the controllability and not to detract from it as in the others. It was believed that the concurrent celerity of action with absolute free-

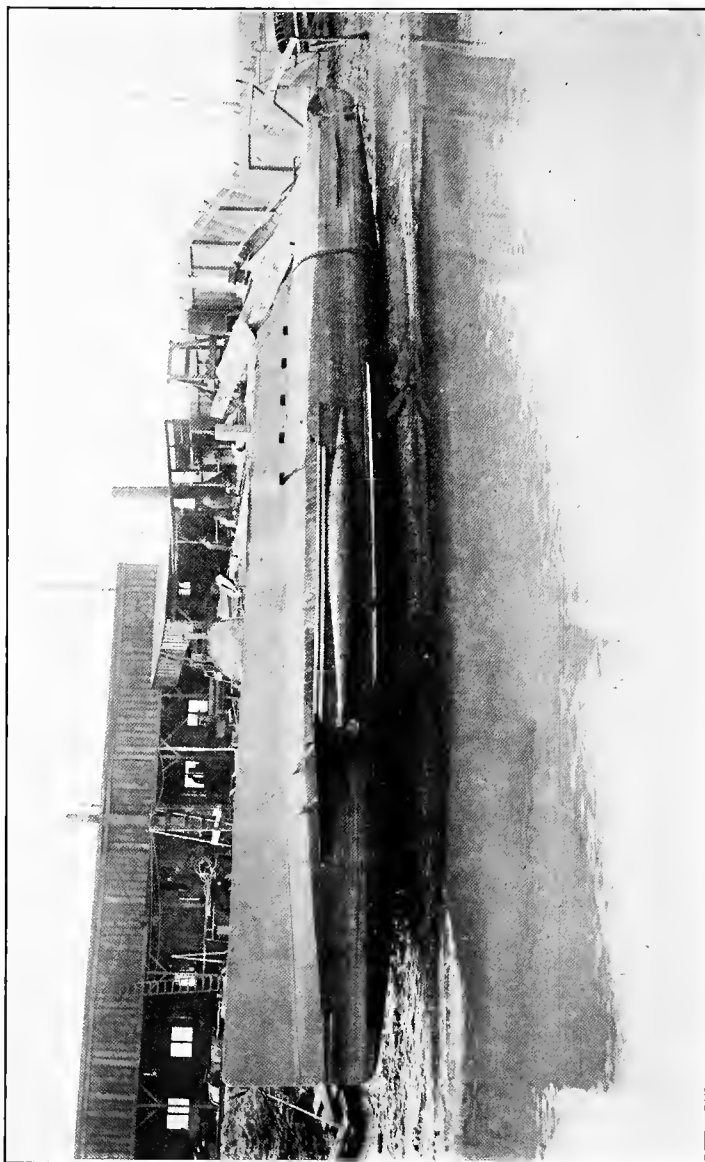

Experimental Submarine with Propellers Forward

dom from danger by "rooting" and the consequent loss of control would be found to be of great military advantage. The theory of contending forces was reasoned as follows:

The forward position of the propellers being the center of the applied force causes the direction of the force or the movement of the vessel to be always along the line of its

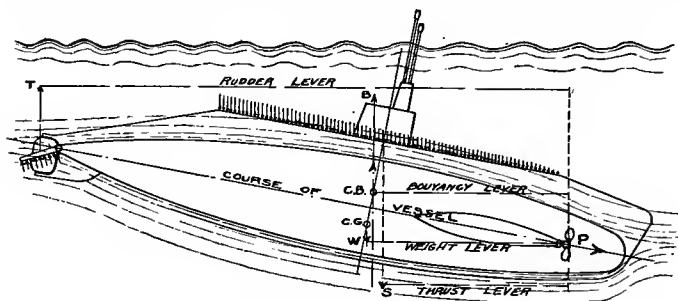

Figure 4. Forward Propulsion

axis, and is the common pivotal point about which the moments for all the forces are at work. The long lever arm between this position of the propellers and the position of the rudders affords the maximum turning moment which can be obtained and insures positive control at all times. This is evidenced by the fact that the thrust of the water upon the upper portion of the hull, no matter at what angle of inclination, always acts when diving to depress the stern, in opposition to the upward thrust of the rudders, and is never threatening to upset the whole balance, but on the contrary it tends to right the boat and therefore make for increased controllability.

By referring to Figure 4 it will be seen that the upward force of the reserve buoyancy B is in this case a moment upward about P ; the thrust S is a moment downward

about P ; and the thrust T of the impinging water against the rudders is a controllable upward force balancing the moment of the thrust of the water against the top of the hull. The force P tends to pull the vessel always along the line of its axis, and the righting moment W becomes in this case an important safety factor because it acts as do all the forces about the point P .

Higher speeds were believed to be possible in all conditions because there could be no loss of control due to increased speed, wave formation, or any tendency of the water to pile up on the bow, for any increased resistance due to greater speed must always tend to straighten the vessel out on her course instead of causing her to "root." This is because the thrusts acting in opposite direction to the propelling force, act always behind and away from the point at which the force producing motion is applied.

There is a question what material effect this position of the propellers might have upon their efficiency. Placed in this position the wheels would be working upon a solid column of water undisturbed by the passage of the vessel, and must therefore unquestionably exert a stronger pull or propulsive force.

However, the efficiency gained in this manner is overcome to a greater or lesser degree by the force of the column of water leaving the wheels and impinging against the hull. This result it is thought would not be as detrimental as would at first appear, however, on account of the manner in which the propellers are placed — wide apart and tending to deliver the greater part of these water columns away from the hull. In any event whatever loss in efficiency which might occur should be more than compensated for by the gain in safety and tactical value.

CHAPTER V

DESIGN OF THE SUBMARINE TORPEDO BOAT

GENERAL FACTORS

IN laying down the design for a new submarine boat, considering the term in its broadest aspect as covering all vessels capable of navigation when completely submerged, the constructor must consider the problem as a vessel of a certain displacement, and impose upon himself certain arbitrary conditions to be met which may be more or less conflicting in character, in which case a solution must be reached by compromise, keeping in mind certain relative values in order to attain an all around tactically efficient craft as compared to some recognized standard of ideals.

The selection of type then, should be governed by a careful weighing of its inherent characteristics as effecting the main objective of the desired results to be attained.

The submersible lends itself essentially to a relatively great surface stability, high surface speeds, and possibly to an extended cruising radius and comfort of the crew while at sea; while on the other hand it has less stability when submerged and offers greater resistance in this condition due to its increased wetted surface and form of superstructure than does the submarine proper. The submarine proper by reason of its form cannot adapt itself to high surface speeds on account of the danger of "rooting" but

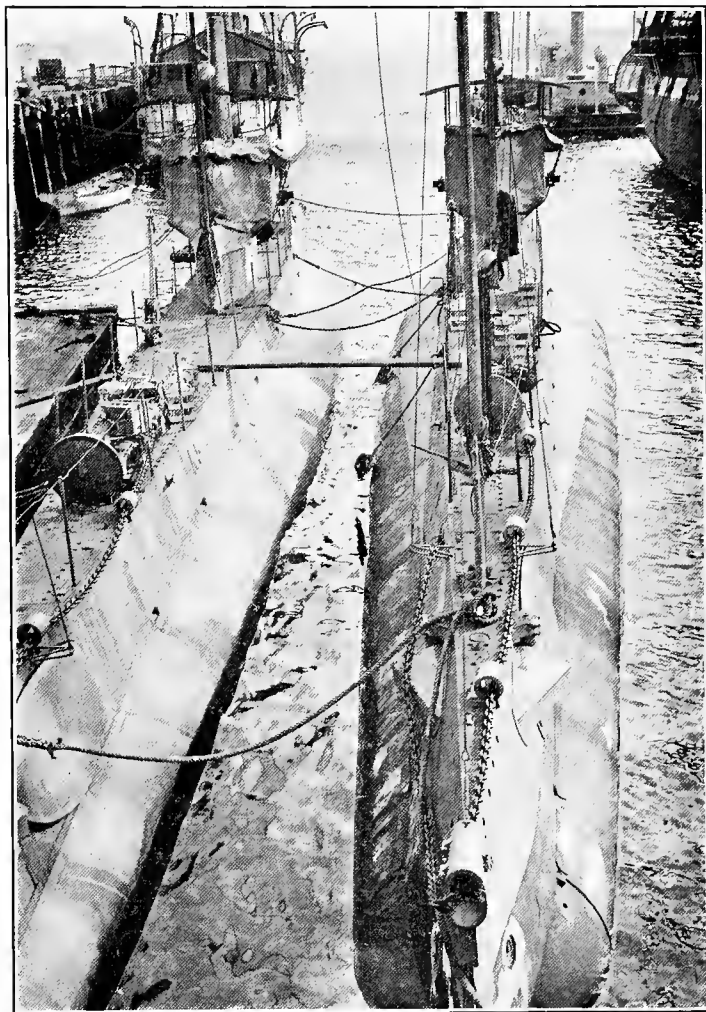

Photo-Copyright, International Film Service

Submarines K-5 and K-6 Trimmed Light and Showing Clearly the Lines of the Hull. Forward Diving Rudders Shown Folded Back Against the Superstructure

is essentially the form for under-water navigation, having greater stability in that condition and offering less resistance to propulsion than the submersible.

Summing up, the question of type then resolves itself into the question of whether a maximum surface or submerged speed is sought.

At present it has become the tendency to adopt the lines of the torpedo boat to make for less surface resistance and increased speed. This has necessitated a double hull construction, the outer hull having the torpedo boat lines and the inner hull being of circular cross section to resist the pressure of submersion. The speed gained in this construction has however been shown in practice to be very inconsiderable and it is questionable whether it justifies the necessary extra expense of construction. As submarines can never attain the speed of which a torpedo boat is capable is it probable that better results may be gained by a compromise of the single hull form by effecting a design having a full entrance and a long fine run. This would afford the least possible resistance and retain at the same time all the advantages of the single hull construction.

As the displacement calculations are similar to those of ordinary ships and are familiar to all engaged in the practice of naval architecture or marine engineering they will not be gone into here.

STABILITY

It is important with respect to the stability of the vessel that the center of gravity of the hull weights be kept as low as possible. The significance of this may be seen when it is considered that this factor is about thirty-five per cent

of the total weight of the ship. To attain this object the superstructure must be as light as good practice will permit and all weights above deck must be kept as small as possible. The shell plating should be made heavier at the keel to give stiffness against "hogging" and be tapered down to the required thickness at the top of the hull for resistance against the pressure of submersion.

Great care should be exercised in the distribution of weights, for, unlike a surface vessel, with a comparatively small reserve buoyancy present and especially in a submerged condition when the buoyancy is practically destroyed, the submarine is suspended like a balance scale and must be in equilibrium in a horizontal position. The balancing moments about this point must be gained as far as possible by the distribution of all machinery, equipment and fixed articles, because the displacement limitations allow only a relatively small amount in weight of permanent ballast to be utilized, which can be of but little assistance in effecting the trim.

All machinery and battery weights must be kept as low as possible and as is consistent with good practice and accessibility, for the center of gravity of the completed ship can be much affected by their positions, and the laws of submarine navigation demand that the center of gravity and the center of buoyancy be kept as far apart as possible.

BALLAST SYSTEM

A general principle applicable to all submarines is the destruction of reserve buoyancy to submerge, by taking on additional weight in the form of water ballast. The main ballast system, whether in one tank centrally located or comprised of fore and aft tanks, is designed to nearly

neutralize the effect of the reserve buoyancy, usually about from twenty to thirty per cent of the total displacement. This main ballast system is designed to be kept completely filled when submerged in order that the contained large bodies of water may not surge forward and aft and so destroy the trim of the vessel. The main ballast tank is supplemented by fore and aft trim tanks and an auxiliary adjusting and compensating tank. The forward and aft trim tanks must have sufficient capacity to overcome any change in moments due to a disarrangement or movement of the weights on board, and to bring the vessel back to an even keel by the transfer of water from one tank to the other. The auxiliary ballast tank must be large enough to completely overcome the reserve buoyancy and to compensate for the variations of consumable stores and weights on board, and in addition to compensate for the difference in density of the water of flotation. A small adjusting tank is sometimes provided for the purpose of delicately adjusting the buoyancy of the vessel by taking in or blowing out a few pounds of water.

To maintain trim when submerged it is essential that the center of gravity of the auxiliary ballast tanks should coincide longitudinally with the center of gravity of the emerged volume of the vessel and this coincidence must remain throughout the process of submergence. Otherwise serious alterations of trim in a fore and aft direction will take place with probably disastrous results.

APPORTIONMENT OF WEIGHTS

No hard and fast rule can be laid down for guidance in the matter of apportionment of weights. This of course depends, in the first place, upon what particular tactical

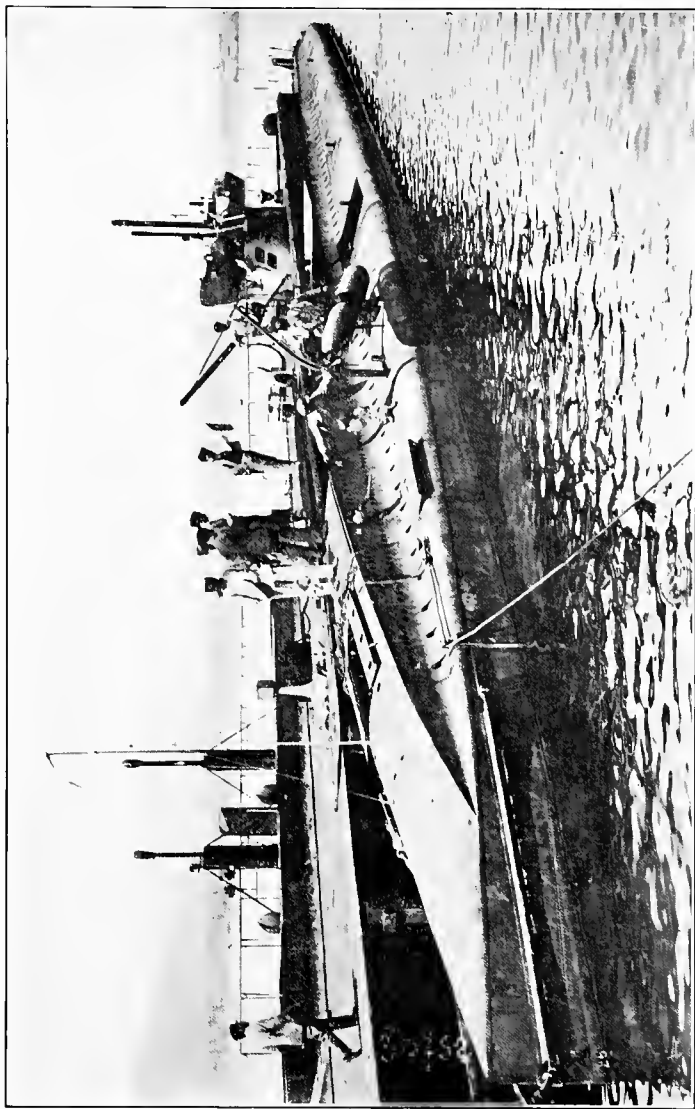

Copyright Underwood & Underwood

French Submarine of the Laubeuf type taking on board torpedoes

feature is most sought, and is a matter of judgment and experience of the constructor. If a high surface speed is sought this may be gained at a sacrifice of submerged speed or reserve buoyancy, or perhaps by a reduction in weight of fuel storage and consequent reduction in radius of action. The weight of the hull is practically constant with the displacement, and the apportionment of the other weights may be varied to meet the ends and fancies of the constructor. However, a correct balance of surface to submerged speed and attendant radii of action, and at the same time have either efficient, can only be attained by doing away with the dual power system.

This may be more strongly pointed out by considering for the moment the present tendency to materially increase the size of submarines, having in view the desire to increase the speed and the radius of action for surface work. The increase in displacement of course at once demands proportionately increased engine power. The power necessary to gain a comparative speed may be arrived at by using Froude's law of comparison; for instance, taking a vessel of a displacement of 400 tons and engine power of 600 B.H.P. which drives her at a 14 knot speed at full power. To find the power necessary to drive a ship of 800 tons having otherwise the same characteristics of contour, appendages, et cetera, the ratio of power would be,

$$P = \frac{600}{\left(\frac{400}{800}\right)^{\frac{3}{2}}} = 1340$$

This does not mean that the two ships would have the same speed, but that their speeds would be corresponding

speeds. The corresponding speed of the new ship would be in the ratio,

$$V = \frac{14}{\left(\frac{400}{800}\right)^{\frac{1}{2}}} = 15.7 \text{ knots}$$

The percentage of the total weight of the submarine which may be allotted to the power plant is constant with the displacement and is usually about 33 per cent. Now it may be seen that to gain this greater speed we have doubled the displacement and consequently the weight available for the power plant, but the horse power is more than doubled, therefore requiring a greater proportion of this available weight for oil engines than is given in the smaller boat. This of course leaves a correspondingly less proportion of the total available weight for electrical equipment, and consequently a reduction of speed and cruising radius when in a submerged condition.

EFFECT OF FORM UPON RESISTANCE

The resistance of the ship is greatly affected both by the form of hull and by the ratio of length to the diameter. In 1906 Mr. Mason S. Chace conducted a series of experiments in the model basin at Washington, D. C., with a number of models built on a scale of 1 inch to 1 foot, some of them 12 feet long. The result of these experiments showed that for the speed length ratio of $\frac{V}{\sqrt{L}} = .8$ the resistance curves are fair, but at a speed of $\frac{V}{\sqrt{L}} = 1$, the curve shows a marked hump followed by a hollow, and at a speed

of $\frac{V}{\sqrt{L}} = 1.25$ the resistance runs up so rapidly as to put such speeds out of the question. Submerged, the resistance curves are free of humps, but are much higher than those for the floating condition all the way up to a speed of $\frac{V}{\sqrt{L}} = 1.3$ when they are nearly coincident. The resistance submerged for a speed length ratio of $\frac{V}{\sqrt{L}} = 1$ is approximately 1.15 times the resistance of the surface condition. In the past it has been common practice to limit the beam length ratio to about one to ten, but the results of these experiments show conclusively that to attain the higher speeds for which we are at present striving, with an economical outlay of power, it will be necessary to increase this ratio to one to twelve, or even greater. This departure would also tend to give greater steadiness in a sea way. Constructively this greater beam length ratio need not cause any worriment. It will be found a very simple matter to add the necessary longitudinal stiffness by strengthening the keel and longitudinals, and it is probable that quite a saving in the hull weights may be made, due to the decrease in diameter. The metacentric height and stability could also be increased by a better distribution of weights.

A still further increase in stability and some decrease in resistance can be effected by carrying the fullest part of the ship well forward of the midship section, that is, in other words, giving it a heavy fore-body with a full entrance and a long fine run. This design would of course carry forward the center of buoyancy. The advantage of this upon the controllability when submerged and under

way may be realized by considering the greater rudder moment gained and a correspondingly less upsetting moment caused by the force of the water impinging against the top of the hull forward. It will obviously then help to overcome the inherent tendency of the boat to dive at its critical speed. The flow of water to the propellers would also be much more free and the influence of the wake be sensibly decreased.

SPEED AND POWER ESTIMATION

In estimating the speed and power required for the propulsion of a proposed design the three factors entering into the propulsive efficiency are: the engine efficiency, the propeller efficiency, and the hull efficiency. The propulsive efficiency is the ratio between the E.H.P. or tow rope horse power, including the resistance due to all appendages, and the I.H.P. taken at the cylinders of the engine, and generally averages about 50 per cent of the I.H.P. In actual practice however this value ranges from 42 per cent to 62 per cent, and it becomes necessary to fix this coefficient with some degree of precision in order to obtain any very accurate results. This may be done by assigning to each factor which enters into the composition of the propulsive efficiency a value which experience or experiment has shown to be what might be expected in a new problem. The engine efficiency may vary from 75 to 90 per cent according to the type and characteristics of the engine selected and the efficiency may be assumed for the calculations according to past experience with a similar type of engine, or the guaranteed efficiency of the engine builders may be taken.

The E.H.P. necessary to drive the bare hull through

the water at a certain speed is best obtained by the aid of an experimental model in a towing basin. The method of reasoning and the determination of resistances by this means is carried out in the following manner. Suppose we have a paraffin model 12 feet long constructed on a scale of 1 inch to 1 foot and it is desired to find the E.H.P. for the full sized vessel at a speed of 16 knots. We must first find the corresponding speed at which the model must be pulled to give the corresponding tow rope resistance. The corresponding speed of the model is found by the ratio,

$$V_m = \frac{16 \times 12}{144} = 1.333 \text{ knots.}$$

When towed at this speed the resistance is measured and found to be 4.9435 pounds.

The wetted surface of the vessel is 3700 square feet, therefore the wetted surface of the model is

$$S_m = \frac{3700 \times 12^2}{144^2} = 25.7 \text{ square feet.}$$

The friction factor and the exponent given in Froude's Tables (see Table 1) are

$$f = .00908$$

and

$$n = 1.94$$

Therefore the frictional resistance is

$$.00908 \times 25.7 \times 1.333^{1.94} = .4075 \text{ lbs.}$$

The friction factor and exponent for the full sized vessel taken from Table 2 is

$$f = .00910$$

and

$$n = 1.825$$

Therefore the total frictional resistance equals

$$.0091 \times 3700 \times 16^{1.825} = 82960 \text{ lbs.}$$

and the frictional E.H.P. equals

$$.00307 \times 82960 = 255 \text{ E.H.P.}_f$$

By subtracting the frictional resistance of the model from the tow rope resistance, we have the residual resistance equal $4.9435 - .4075 = 4.536$ lbs.

The corresponding residual resistance of the ship equals

$$R_w = \frac{4.536 \times 144^3}{12^3} = 7838 \text{ lbs.}$$

and at 16 knots the E.H.P. required to overcome the residual resistance equals

$$.00307 \times 16 \times 7838 = 385 \text{ E.H.P.}_w$$

The total E.H.P. will then be

$$255 + 385 = 640$$

for the bare hull alone. The resistance due to the appendages must be added to this to make up the total E.H.P.

The hull appendage resistance may be roughly taken to be about 10 per cent of the hull resistance and may be assumed to vary directly as the ratio $\frac{B}{LWL}$ and while this is probably not strictly correct any error which might occur will be on the right side and will result in a slightly higher estimation of the resistance than actually exists. The range of this value as determined by numerous experiments is found to be from 5 to 20 per cent. Should the model be towed with any of the appendages the percentage resistance due to these appendages should be subtracted from the total appendage resistance and the

remainder added to the E.H.P. given by the model test. Assuming for the proposed design a beam-length ratio of .84, take 8.5 per cent as the appendage resistance and the total E.H.P. becomes

$$640 \times .085 + 640 = 695 \text{ E.H.P.}$$

The hull efficiency or the thrust deduction factor as it is called, is the next factor to be considered in computing the propulsive efficiency. This factor is evidenced by the difference in resistance shown when towing a model with no propellers behind and when towing the same model at the same speed with propellers of the same proportion to the ship's screw as the model is to the ship working behind at a rotary speed such as to give a thrust equal to the resistance of the model. With the propellers working behind the resistance is found to be increased a definite amount, termed thrust deduction, and is caused by the suction influence of the propellers upon the after part of the ship. This suction influence extends far enough forward of the screws to cause a marked diminution of the pressure against the after part of the ship thereby causing a virtual increase in resistance. The propellers must therefore exert a thrust equal to this resistance.

* This thrust deduction factor has been determined by numerous experiments and is found to vary directly with the value of the block coefficient of a model having a standard set of lines, and varies from 1 with a block coefficient of .5, to 1.6 with B.C. = .9. The curve from 1.17 the value of the thrust deduction factor corresponding to a block coefficient of .69, is found to be flat all the way up to 1.6

* The Dyson Method. See "Design of Screw Propellers" by Capt. C. W. Dyson, U. S. N.

the thrust deduction factor corresponding to a block coefficient of .9. To find the thrust deduction for a proposed design which departs in form from the standard set of lines it is necessary to find the slip block coefficient corresponding to the block coefficient of the standard form. The slip block coefficient of the new design may be assumed to equal the standard block coefficient times the standard midship section coefficient divided by the actual M.S. coefficient and is the B.C. to be used in determining the thrust deduction and the propeller calculations.

The total *E.H.P.* then becomes *E.H.P.* × *C*, and the

$$I.H.P. = \frac{E.H.P. \times C.}{P.C.}$$

P.C., the propulsive coefficient, is determined by the propeller computation. To make the propeller computations it is necessary to know the allowable tip speed and this is calculated by the formula,

$$T.S. = \pi D.R.$$

the number of revolutions per minute and the diameter having first been selected and being within the proper limitations for the proposed design. It has been found by experiment upon various model screws that the P.A. ÷ D.A. ratio, to obtain the best performance, varies accordingly with the T.S., and the P.C. is also found to be dependent to a great extent upon this ratio.

In making the selection of the propellers we are confronted with a problem of which there is no exact solution. It must be borne in mind that we have two distinct conditions under which to operate, namely, when on the surface and when submerged. The resistance submerged is greatly increased over that for the surface condition because of

the increased volume of displacement and wetted surface. This means that the indicated thrust per square inch of disc area is increased and consequently the slip is made much greater. To overcome this it would be necessary to increase the area of the blade in order to obtain a greater projected area otherwise a greater projected area must be obtained by altering the pitch and turning the screw up to a greater number of revolutions to get the speed.

Changeable pitch propellers of the size used on submarines have never been found to give satisfaction and in fact are usually less efficient in both conditions than a single fixed propeller would be. We are forced then to decide which condition, whether the surface or submerged, we wish to favor. The best method is to select a compromise propeller to fit as nearly as possible the two conditions.

This may be done by designing separately a propeller to meet each condition and then effecting a compromise between them by taking an intermediate pitch for the final propeller. It will always be found to be good policy to allow an excess of area to favor the deficient side. The final adjustment of the blades should not be made until after a number of trials.

A further consideration to be taken in designing the propellers, is the wide difference in the speed-power curves of the internal combustion engines, the motors and the characteristic E.H.P. curve for various speeds. The R.P.M. power curve of the reciprocating engine is high in point of power at low speeds and is very nearly a straight line, while the E.H.P. curve is low in point of power at low speeds and comparatively higher at high speeds than the engine.

The corresponding speed-load curve of the motors must

be higher in point of revolutions than the engines in order to make up for the loss of the increased slip submerged. The reciprocating engine is generating more power at low speeds than is absorbed by the propellers; this is due to the translation of straight line motion into rotary motion. Therefore it would seem that the best practice would be to design the motor with correspondingly lower speeds for equal power than the engine in the range below half load and with higher speeds than the engine in the range above half load.

On Chart II are shown typical speed-power curves for internal combustion engines, motors and E.H.P. The existing relations are clearly defined.

The formulae to be used in the computations are:

$$\text{Speed in feet per min.} = S \times 101.33$$

$$\text{Pitch} \times \text{revolutions} = P \times R = \frac{S \times 101.33}{1 - s}$$

S = Speed in knots per hour.

C = thrust deduction factor for standard *B.C.* corresponding to design.

$P.C._1$ = propulsive coefficient standard corresponding to $P.A. \div D.A.$

$$\text{Estimated } I.H.P. \text{ for speed } S = I.H.P. = C \frac{E.H.P.}{P.C._1}$$

$$\text{Diameter of propeller} = \sqrt{\frac{291.8 \times I.H.P. \times C^2}{P. \times R. \times I.T._d}}$$

$$P.C. = \text{actual propulsive coefficient} = \frac{P.C._1}{C}$$

$$I.H.P. = \frac{P. \times T.S. \times D. \times I.T._d}{916.7 \times C^2}$$

$I.T._d$ = indicated thrust per square inch of disc area.

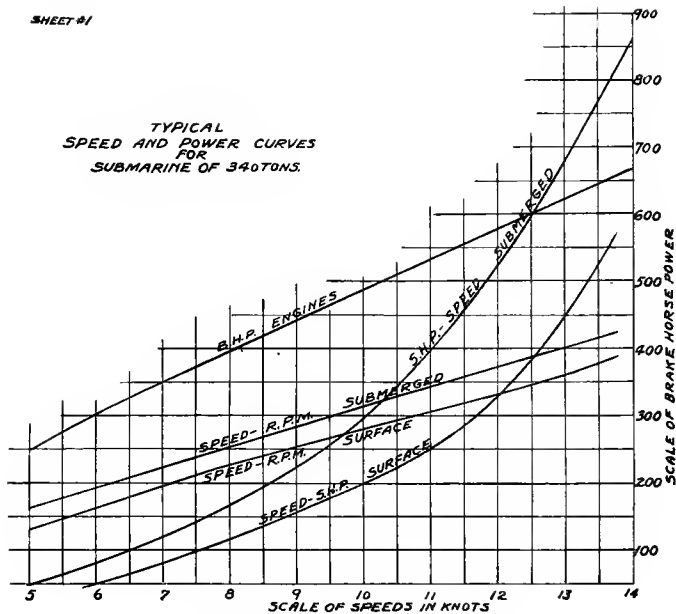

Plate II. Speed and Power Curves

SHEET #2

TYPICAL
R.P.M., POWER, AND SPEED
CURVES
BOTH SURFACE AND SUBMERGED
FOR SUBMARINE OF 340 TONS D.

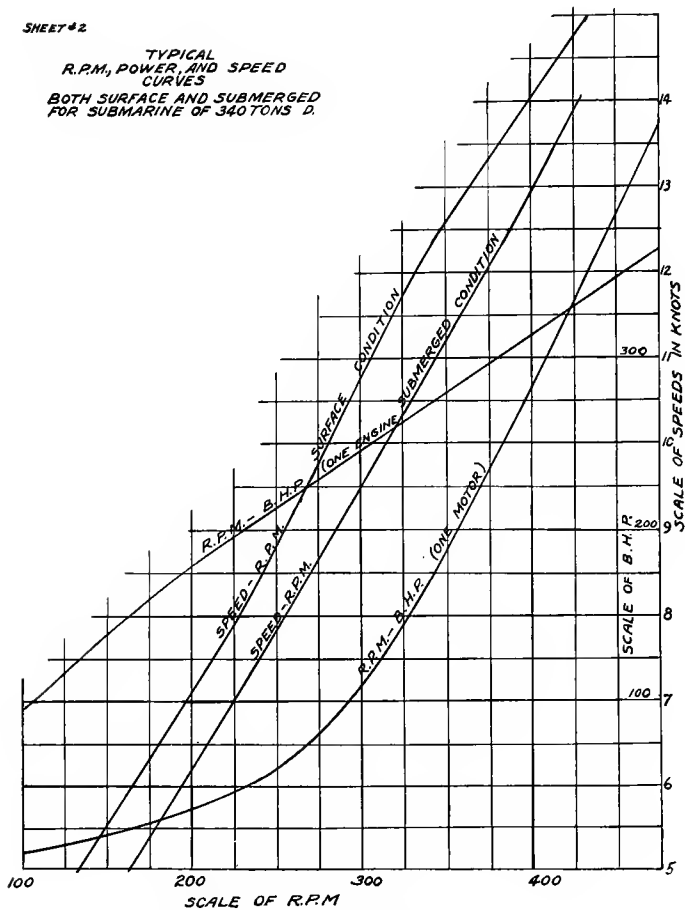

Plate II. Speed and Power Curves

$$R. = \text{revolutions} = \frac{T.S.}{\pi D.}$$

$$P. = \frac{P. \times R. \times \pi D.}{T.S.} = \text{pitch of propellers}$$

$P.T._p$ = propulsive thrust per square inch of projected area corresponding to $P.A. \div D.A.$

$E.T._p$ = effective thrust for standard $B.C.$ for $P.A. \div D.A.$

$$\text{Apparent slip} = I - s. = \frac{P.T._p}{E.T._p}$$

$$\text{Pitch} = P = \frac{101.33 S. \times E.T._p \times \pi D.}{T.S. \times P.T._p}$$

$I.T._d$ = indicated thrust per square inch of disc area

$$= \frac{I.T.}{\frac{\pi}{4} \times D.^2 \times 144}$$

$I.T._p$ = indicated thrust per square inch of projected area

$$= \frac{I.T.}{\frac{P.A.}{D.A.} \times \frac{\pi D.^2}{4} \times 144}$$

$$P.T._p = I.T._p \times P.C._1$$

$I.T.$ = total indicated thrust on one screw equals

$$\frac{I.H.P. (\text{Est}) \times 33000}{P. \times R.} = I.T.$$

$$P.T. = \text{propulsive thrust} = I.T. \times P.C._1$$

$$S.T. = \text{speed thrust} = \frac{I.H.P. \times 33000}{S. \times 101.33}$$

$$E.T. = \text{effective thrust} = S.T. \times P.C._1$$

$$\frac{I.T.}{S.T.} = \frac{S. \times 101.33}{P. \times R.} = \frac{P.T.}{E.T.} = \frac{I.T. \times P.C._1}{S.T. \times P.C._1} = I. - s.$$

$$I.T._d \text{ per square inch disc area} = \frac{I.H.P. \times 132000}{P. \times R. \times \pi D^2}$$

$E.T._p$ effective thrust in pounds per square inch on pro-

$$\text{jected area} = \frac{E.H.P. \times 33000}{S. \times 101.33 \times P.A. \text{ in in.}}$$

The reader is here referred to the work of Captain C. W. Dyson, U.S.N. entitled, *Screw Propellers and Estimation of Power for Propulsion of Ships*, which is a complete and comprehensive treatise upon the estimation of power and the design of screw propellers.

Another method of computing the power for propulsion is by Froude's Laws of Comparison. This method offers a very simple and expedient way of solving the problem when the actual performances of a geometrically similar vessel are known.

The rules governing this method of computation are:

1. Corresponding Speeds

$$S : S_1 = \sqrt{L} : \sqrt{L_1} = S = S_1 \sqrt{\frac{L}{L_1}}$$

2. Displacements

$$D : D_1 = L^3 \div L_1^3 = D = \frac{D_1 L^3}{L_1^3}$$

3. Corresponding Speeds

$$S : S_1 = \sqrt[6]{D} : \sqrt[6]{D_1} = S = S_1 \sqrt[6]{\frac{D}{D_1}}$$

4. Horsepowers

$$P : P_1 = \sqrt[6]{D^7} : \sqrt[6]{D_1^7} = P = P_1 \sqrt[6]{\frac{D^7}{D_1^7}}$$

This law is, however, not strictly correct.

5. Variations of Power with Speed

$$P : P_1 = S^3 : S_1^3$$

This may be assumed to be correct for occasions where the difference of speed is small but at very high speeds the exponent may go as high as 4 or greater.

6. Variation of Power with Displacement for small changes in draught

$$P : P_1 = D^{\frac{3}{2}} : D_1^{\frac{3}{2}} \text{ for large ships of moderate speeds,}$$

and,

$$P : P_1 = D^{\frac{5}{4}} : D_1^{\frac{5}{4}} \text{ for ships of high speed.}$$

A third method of computing the resistance when no other data is at hand is called the independent method. By this method the total resistance is divided into two parts, the surface or frictional resistance, and the residual or wave making resistance.

The formula for the calculation of the frictional resistance is

$$R_f = f.S.V^n \text{ in which}$$

V is the speed in knots,

S is the wetted surface in square feet,

f and n are the quantities deduced from Froude's experiments and found in any standard work, Table 2.

The wave making resistance is found by the formula

$$R_w = \frac{b.D^{\frac{3}{2}} V^4}{L} \text{ where}$$

D is displacement in tons,

V is the speed in knots per hour,

L is the length in feet on the L.W.L.

b is a value ranging from .35 for fine ships; .40 for

moderately fine, .45 for ships broad in proportion to length but with fine lines, .5 for freighters.

TABLE I
Surface-Friction Constants for Paraffin Models in Fresh Water
 Exponent $n = 1.94$

Length Ft.	Coefficient	Length Ft.	Coefficient	Length Ft.	Coefficient
2	0.01176	10.0	0.00937	14.0	0.00883
3	0.01123	10.5	0.00928	14.5	0.00877
4	0.01083	11.0	0.00920	15.0	0.00873
5	0.01050	11.5	0.00914	16.0	0.00864
6	0.01022	12.0	0.00908	17.0	0.00855
7	0.00997	12.5	0.00901	18.0	0.00847
8	0.00973	13.0	0.00895	19.0	0.00840
9	0.00953	13.5	0.00889	20.0	0.00834

TABLE II
Surface-Friction Constants for Painted Ships in Sea Water
 Exponent $n = 1.825$
 FROUDE

Length Ft.	Coefficient	Length Ft.	Coefficient	Length Ft.	Coefficient
8	0.01197	40	0.00981	180	0.00904
9	0.01177	45	0.00971	200	0.00902
10	0.01161	50	0.00963	250	0.00897
12	0.01131	60	0.00950	300	0.00892
14	0.01106	70	0.00940	350	0.00889
16	0.01086	80	0.00933	400	0.00886
18	0.01069	90	0.00928	450	0.00883
20	0.01055	100	0.00923	500	0.00880
25	0.01029	120	0.00916	550	0.00877
30	0.01010	140	0.00911	600	0.00874
35	0.00993	160	0.00907		

$$E.H.P. = 0.00307 \left(f.S.v.^{n+1} + \frac{b.D^{\frac{2}{3}}V^5}{L} \right)$$

The wetted surface $S = C\sqrt{D \times L}$. where

S equals surface excluding rudder, bossings, etc.

D equals displacement.

L equals length immersed.

C equals constant given in Table 3 corresponding to the ratio of beam — draught : $\frac{B}{H}$ as given by Taylor.

TABLE III
Constants for Wetted Surface
 Given by TAYLOR

B-H	Constant	B-H	Constant	B-H	Constant	B-H	Constant
2.0	15.63	2.4	15.50	2.8	15.55	3.2	15.71
2.1	15.58	2.5	15.50	2.9	15.58	3.3	15.77
2.2	15.54	2.6	15.51	3.0	15.62	3.4	15.83
2.3	15.51	2.7	15.53	3.1	15.66		

PROPULSIVE SYSTEM

The propulsion of the submarine is acquired at the present time by two distinct power units — the internal combustion engine for surface propulsion and electric motors and storage batteries for submerged propulsion. This system is attended with many complications and undesirable features which until recently have been accepted as necessary evils. A solution of this problem is being sought for now by several engineers and considerable success has already been attained.

It is evident that the first and most essential condition to be attained in the propulsive system is absolute relia-

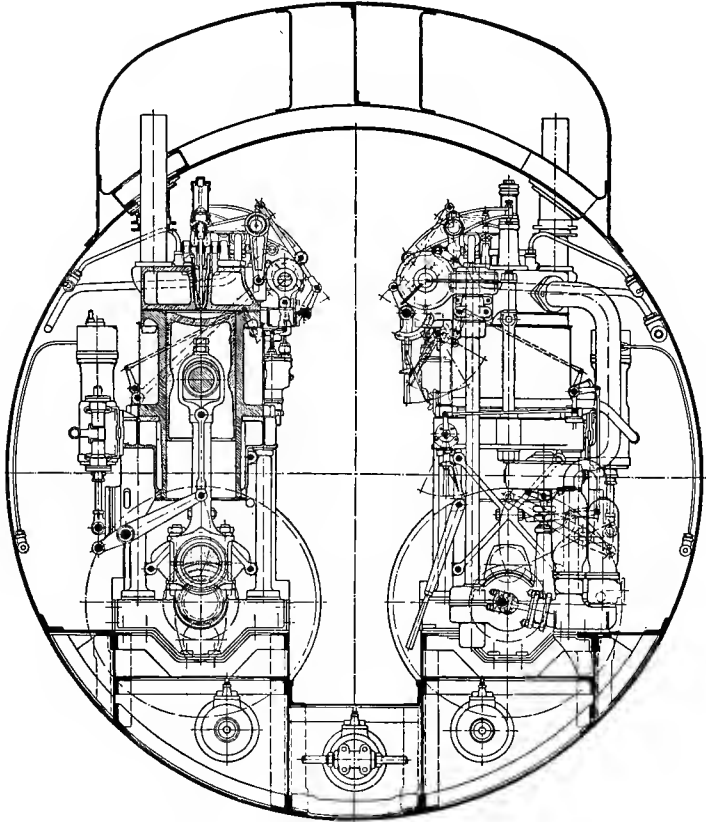

Courtesy Lake Torpedo Boat Co.

Cross-section through engines

bility. A breakdown at sea may signify very disastrous consequences. Each and every factor entering into the design of the machinery must be subordinated to this one.

Having firmly established the importance of reliability, the next factors in importance are accessibility and simplicity of construction. For if all parts of the mechanisms are open and easy to get at for proper inspection and care there will be less danger of a breakdown at sea at some critical time. Simplicity will lend itself to facility of inspection as well as to expedite the making of repairs when a breakdown or a mishap does occur. In the interest of simplicity it is the author's belief that large reversible engines of the Diesel type should be abandoned. By doing this a great deal of complicated mechanism and a number of valves will be done away with and much of the undesirable of this type of engine eliminated. It is certainly possible to design and construct a suitable reversing clutch that will have greater assurity of action and less danger of failure than has the reversing gear of the Diesel engine. A more complete discussion of these matters will be taken up in another chapter.

HABITABILITY

At its best, service on a submarine at sea is almost a dog's life. It has been pointed out before that the physical endurance of the crew is one of the chief factors limiting the radius of action of a vessel, therefore every possible means should be introduced to add to their comfort and contentment. The quarters must necessarily remain cramped in space, but suitable berthing accommodations may be had for the full complement as well as dry lockers for storing their clothing and personal belongings. Wide superstructure decks, in order that the members of the crew may stretch their legs in fair weather and get a breath of fresh air will also do much to extend a feeling of well being.

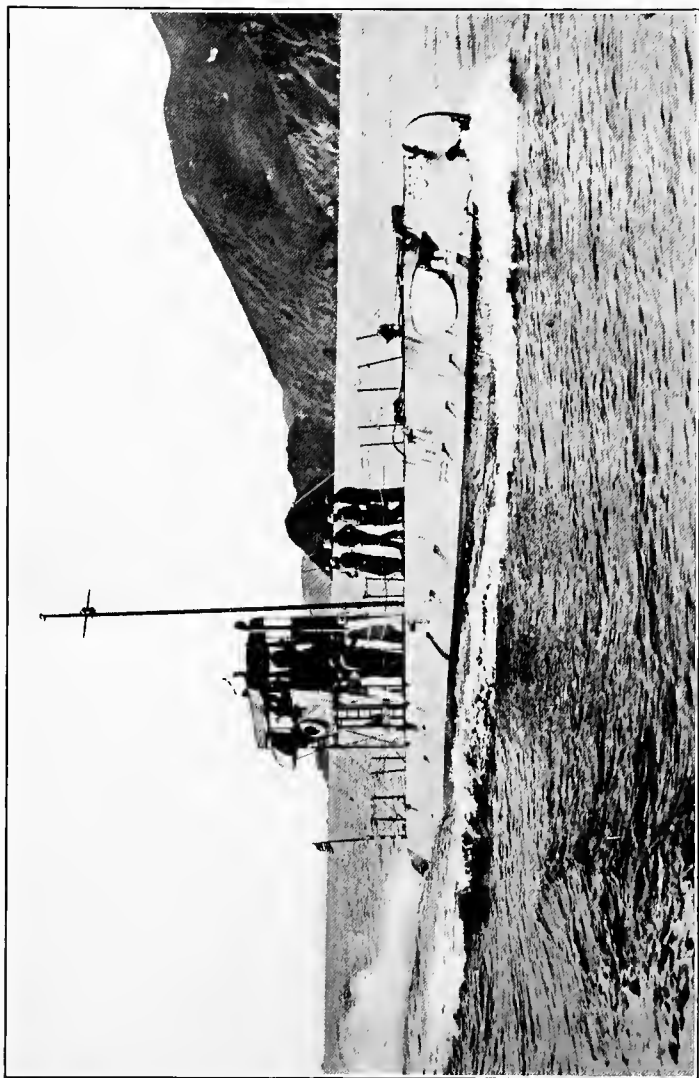
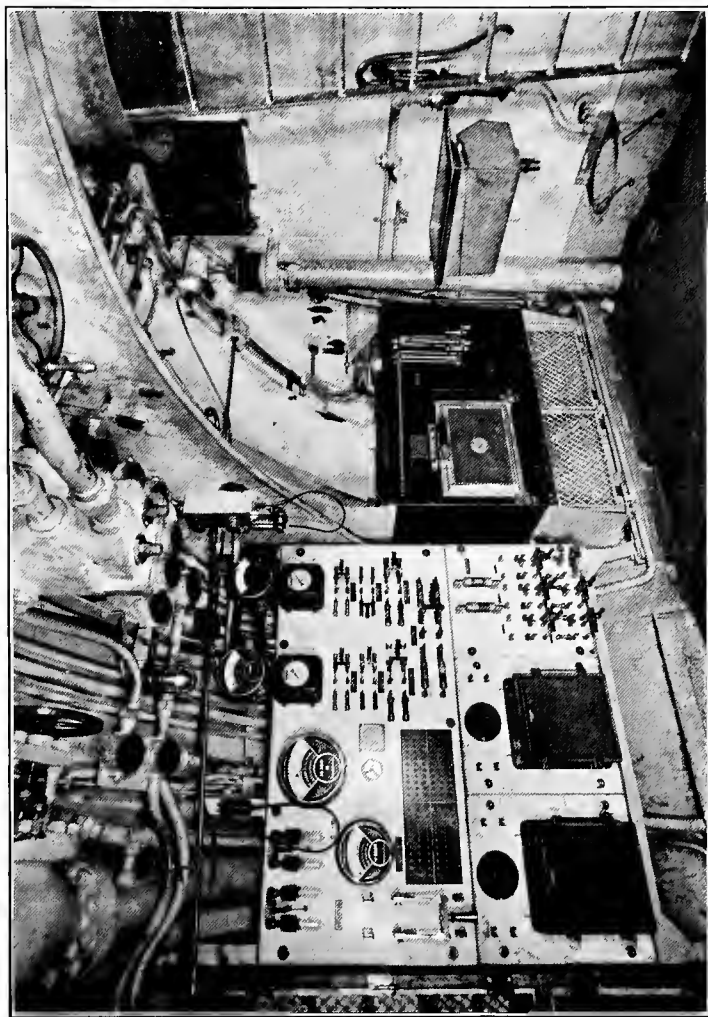

Photo-copyright, International Film Service
F-3 entering the Golden Gate, San Francisco, after a 2100 mile cruise from Honolulu. Stormy weather was encountered 13 days out of 15. All hands were sea-sick practically the entire trip, and utterly exhausted when reaching port

The living quarters must be sheathed in cork or other insulation against dampness and moisture, and adequate means provided for properly heating and drying the interior. Unless this is accomplished the effect on the personnel living for days in cramped wet quarters and a soggy atmosphere, even if this were all, may be imagined.

The question of heating is vividly apparent to anyone who has made a winter cruise at sea on a vessel not supplied with heat. Many of the earlier boats were not supplied with heat at all. Of late electric heaters have been provided to some extent, but these have been found to consume such large quantities of electrical energy from the batteries that their use is being abandoned. In the late boats steam heaters and coils are being installed. When the combustion engines are running it is quite possible to use the jacket water or heat from the exhaust gas to perform this object.

Properly prepared and well cooked food is another very essential factor for the comfort and health of the crew. In the early boats the only food afforded the crew was cold and canned food and coffee heated over an oil stove. In the latest boats, however, an electric stove has been provided with four or five heating plates, an oven and a coffee urn. A fireless cooker and a hot water reservoir are also added and an ice box is provided large enough to carry several days' supply of fresh meats and perishables, and especially built lockers are installed for keeping other foods in dry condition. When the members of the crew know that they can turn in after a disagreeable watch, secure hot well cooked food and a dry comfortable place to sleep, the general feeling of contentment of all is bound to be much better. In fact the absolute efficiency of the



Courtesy Electric Boat Co.
Interior of Crew's quarters on Electric Boat Co. Type, showing auxiliary switch-board, electric range and coffee urn. Auxiliary hand pump shown at top of picture, and entrance hatch at extreme right

personnel and therefore the boat, is at once raised. The more comforts that can be provided for the men the longer they will be able to undergo the remaining hardships.

RADIUS OF ACTION

The proper balance of all stores and supplies must be determined upon when designing a vessel for a certain desired radius of action. The lack of this care or thought in making up the design is evident in nearly every one of our submarines now in commission. Some of the boats have a maximum fuel tank capacity for a cruise of 4,500 miles and not enough lubricating oil to last 1,000 miles. In others a fresh water supply for only two or three days could be carried. Thus is seen the importance of properly balancing each item. Storage for provisions should be made to carry enough to last one and one-half times the maximum cruising radius. On boats of the larger type, intended for making long cruises, it will be found impractical to carry a sufficient fresh water supply, so a small distilling apparatus will have to be installed.

The required radius of action of the boat will of course depend upon the purpose for which she is intended. In a large cruiser type it should be at least thirty days and perhaps more, because the purpose of that type for this country would be to make an offensive attack upon a foreign coast, which for us in every case must be a long distance away from any base of supplies. The seagoing submarine must be capable of traveling 1,500 to 2,000 miles to make an attack, and of remaining for a time in foreign waters without having to depend upon the aid of a tender or other vessel and, if necessary, to return home without aid. She will of course replenish her stores from

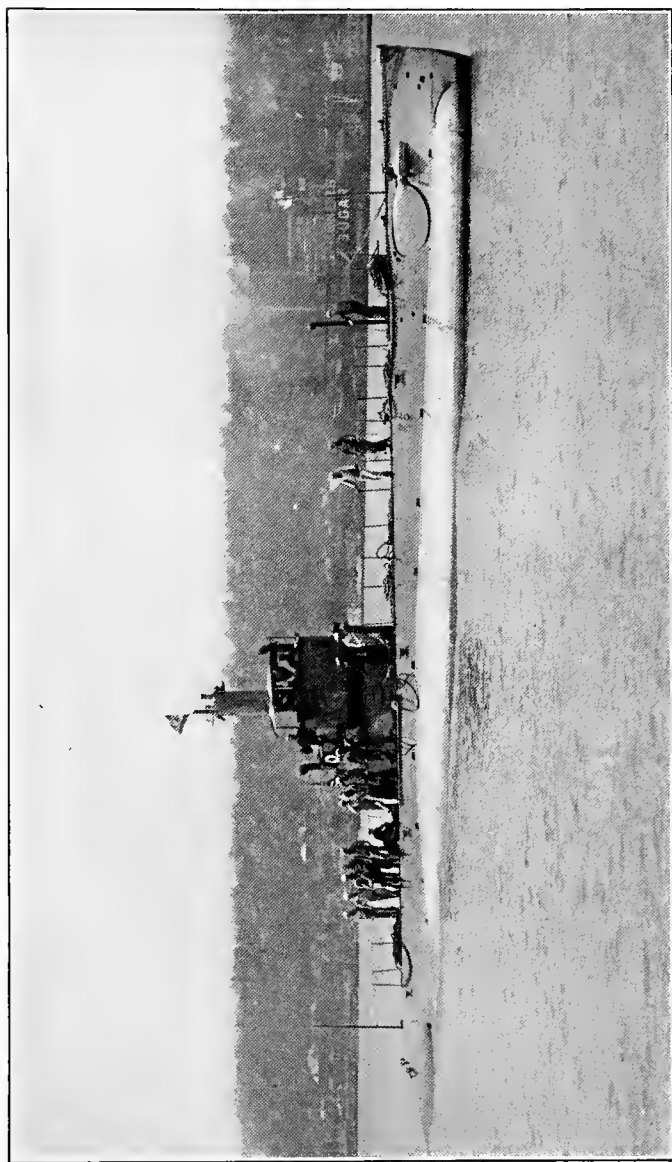

Photo-copyright, International Film Service

Submarine K-6. Note large roomy bridge rigged on top of conning tower and well protected from the weather

a tender or cruiser if in their company and opportunity affords, but it must not be necessary to put another vessel to the trouble and disadvantage of refilling tanks, etc., when the moment is not strictly opportune.

The radius of action submerged should be sufficient to enable a successful under-water attack and a safe retreat. In this respect it is my belief that to cover a distance of thirty or thirty-five miles in two hours is of a greater military advantage than to be able to cover fifty miles in seven hours.

Air storage capacity should be supplied to enable enough compressed air to be carried to supply the crew for seventy-two hours with fresh air for breathing purposes when the vessel is at rest under water.

NAVIGATION

The problem of navigation has been greatly simplified in recent years by the advent of the gyroscopic compass. Before this valuable addition to the equipment of a submarine, navigation was more or less a combination of dead reckoning and luck, by reason of the fact that the ordinary magnetic compass could not be relied upon to any extent whatever. The hull being of magnetic material and there always being present large electrical currents, fluctuating and under various conditions, brought about variations and deviations of the magnetic needle which one would not realize until he has experienced them personally. The character of these deviations made it impossible to compensate and correct for with any degree of accuracy. Attempts were made to overcome these difficulties by mounting the compass in a composition helmet outside the hull, and fitting with a reflector to cast the image down

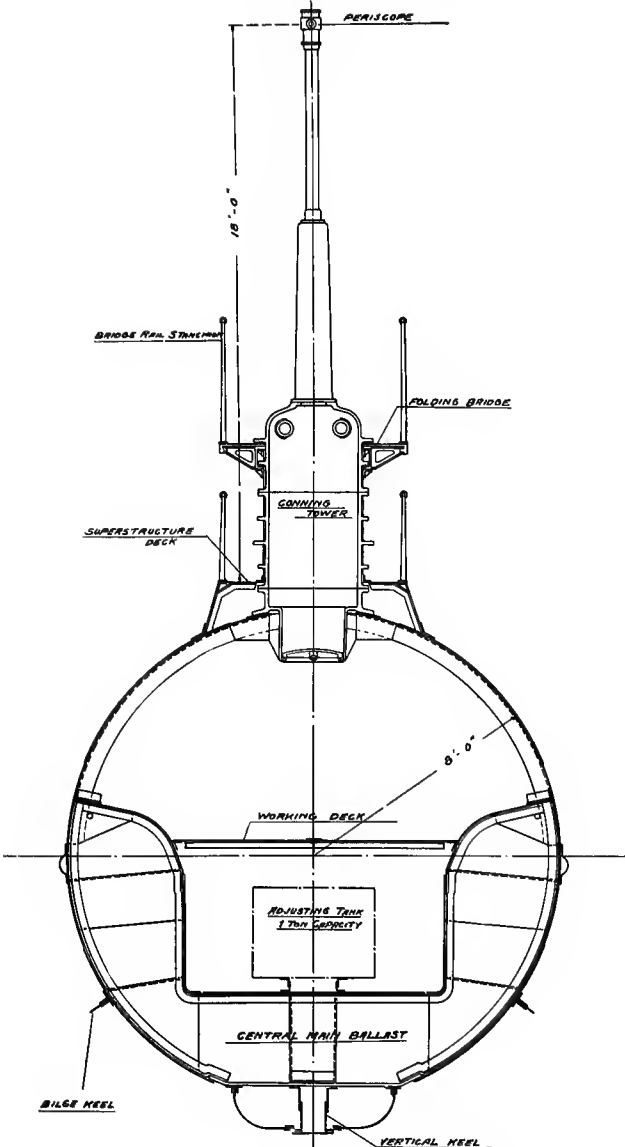

Midship Section, Electric Boat Co. Type

in the hull in order that the helmsman might read it. Some of the periscopes were fitted with small compasses at the top so that the image of the compass card was reflected to the lower half of the eyepiece of the instrument, — these were however too small and sluggish to be relied

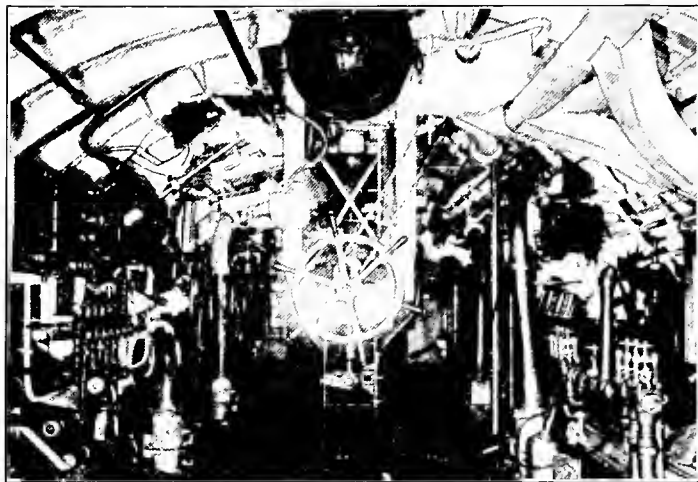

Courtesy Electric Boat Co.

Steering Station in Central Control Compartment. Shows ventilating fan and ducts and valve manifolds

upon. All this has been done away with now, and with the gyroscopic compass it is possible to set a course to a fraction of a degree.

Surface navigation has been made much easier by providing a large bridge rigged on the top of the conning tower and fitted with suitable cover and weather cloths. It is a great improvement over the small low platform formerly fitted, barely out of reach of a washing sea and affording practically no protection from the weather.

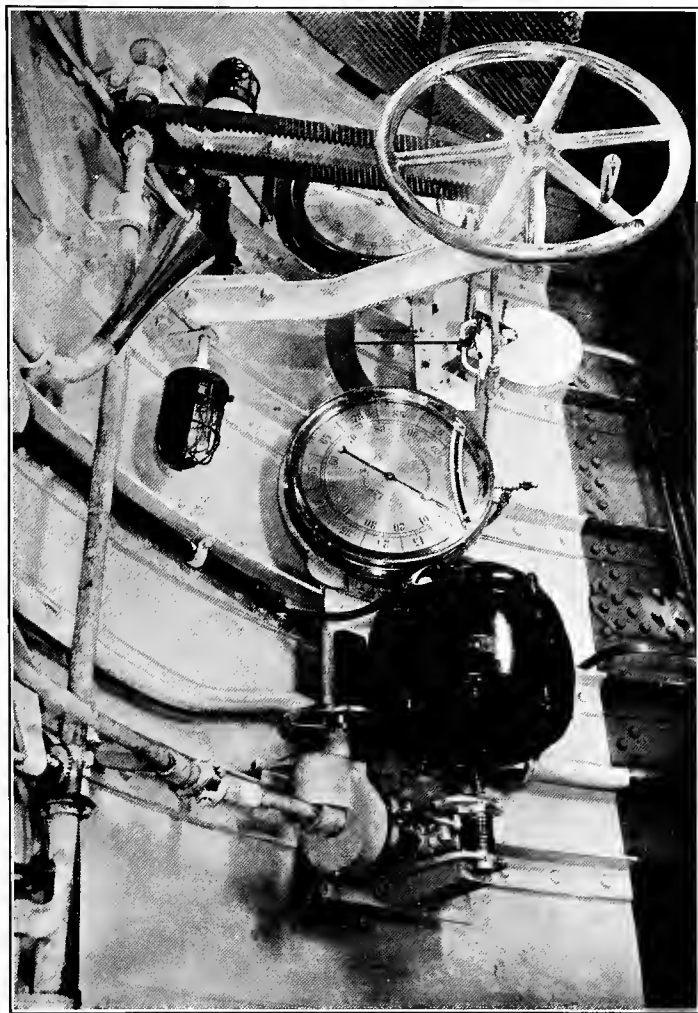

Courtesy Electric Boat Co.
Interior view of Electric Boat Co's type showing diving station, depth gauges, trim gauge, and speaking tube

They are only portable affairs however and must be built so as to be quickly stowed when getting ready to submerge. This is accomplished in some cases by hinging down and fastening to the conning tower fair-water, and by storing the stanchions and rails in recesses provided in the fair-water for this purpose.

The conning tower too has been greatly improved of late. From a mere protrusion outside of the hull large enough for a man to squeeze into it has been increased to a good sized chamber fitted with a steering station and all interior communications and signals.

Steering stations are provided in the central control compartment within the hull, in the conning tower, and connections for a portable one on top of the conning tower. In addition to the gyroscope master compass, standard repeating compasses are fitted to each steering station. The steering gear should comprise both power and hand gear, and should be designed so that when worked by power the hand gear will always be in operation and ready for instant use. Mechanical rudder indicators should also be fitted at each station so that the helmsman may see at any instant the exact position of the rudder.

Too much stress cannot be laid upon the tactical performance of the vessel, for upon this feature will depend greatly the effectiveness of the ship to get into a position to attack and even more so will it depend upon this quality for its own safety from attack by a destroyer. Hampered by the lack of speed it must be able to out-maneuver any adversary, and in case of an attacking destroyer be able to play tag well enough to enable the submarine to launch a torpedo at her. The tactical diameter should not exceed

four lengths of the boat. This is a quality woefully lacking in submarines at the present time.

The only method of accomplishing this has been by placing the propellers at the forward end of the boat. By this means it has been found possible to turn the boat about in less than three lengths. Submerged it is the only possible way of steering the vessel in a horizontal plane without broaching or performing the evolutions of a spiral.

Under water navigation is carried on by the aid of the gyroscopic compass and the periscopes. Two periscopes are now always required in order that there may be two lookouts when submerged and when running awash a third lookout in the conning tower. The advantage of this is at once apparent. The eyepieces or image reflecting ends of both periscopes are within the hull in the central operating compartment. They must be so installed that no injurious vibrations are produced when traveling full speed submerged. Formerly they were constructed so as to be drawn down into the hull for a considerable portion of their length when submerged but this was of no advantage for their purpose is to allow the hull of the boat to remain submerged as deep as possible while the object glass of the periscope is above the surface; the method has now been abandoned.

The first periscope about which there is anything known was invented in France in 1854 by Marie Davy, but it was about fifty years before they began to take any practical shape. The earlier periscopes were frail and leaky, and became cloudy with moisture of condensation within a short while, making them useless. The image became inverted when looking to the rear, and they were alto-

gether very unsatisfactory. The modern periscopes are constructed so that they may be revolved in any direction and the image remain always erect, and in addition they are fitted with a movable pointer on a fixed dial which indicates the bearing of the object with respect to the axis of the boat. Ordinarily the periscopes are used without the aid of magnifying glasses in order that the image may appear at its true distance, but monocular and binocular magnifying eyepieces are fitted so as to be quickly brought into operation that the object may be picked up and made clearly distinguishable.

Various means for range finding have been fitted to the periscopes. One method is to project telemeter scales or cross-hairs into the eyepiece of the instrument, graduated vertically and horizontally in hundredths. If an object of known dimension under observation measured five gradations in the eyepiece its distance would be one hundred times the corresponding real dimension divided by five. Several variations of this system are in use, but they are all open to the same objection, that the dimensions of the object must be assumed and that even if a good guess is made the object may present a projected view to the observer instead of a broadside view and this considerably shortens the true length. Another method of which there are also variations is the double-picture micrometer arrangement, in which two pictures of the same object cut each other in the lens. The two pictures may be shifted with reference to one another, until the tops of the masts of a ship under observation in one picture are level with the water line in the other, and the angle of shift measured to determine the distance. This method too, is only roughly approximate for it has to deal with

the measurement of a very small angle and an assumed dimension for a base line. So far however, variations of these two systems are the best means at our disposal.

The periscopes should have a field of vision of as near 45° as possible, compatible with proper illumination when showing objects at their true distances. All lenses and prisms must be free from imperfections and from spherical and chromatic aberration. The magnetic eyepieces should have a power of about 4° , and a field as near 15° as possible. The binocular type should be preferred owing to the lesser degree of eye strain it affords, and soft rubber guards should be fitted.

It is essential that these instruments be designed so as to allow all lenses and prisms to be accessible for cleaning. Arrangements must also be made for circulating dry air through each instrument and for hermetically sealing them after drying.

SIGNALLING AND INTERIOR COMMUNICATION

The advance in signalling devices and interior communications has kept pace with the rapid improvement made in other lines of equipment for submarines. For surface navigation they consist of practically the same methods used on any other vessel, signalling being done by wireless communications, sirens, flag and shape in the day, and by wireless, sound and light signals at night. Portable search-lights are also fitted on the bridge.

It is only within the last five years however, that any means of signalling under water has been perfected. Now all boats are fitted with submarine bells and receiving and sending apparatus. It has been found that sound waves are transmitted under water nearly four times as

fast as in air, or about 4700 feet per second. The principle of the submarine signalling device is to produce sound waves under water by means of a sending apparatus on the one hand, and to detect these waves by means of a receiving apparatus on the other.

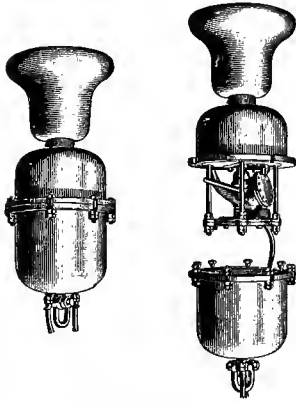

Submarine bell and sounding mechanism

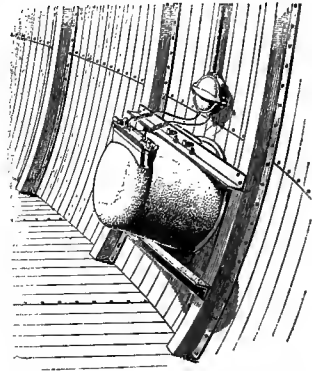

Submarine sound receiving apparatus fixed to side of hull

The sound waves affect the receiving apparatus by setting up vibrations which are transmitted by a microphone and wires to an ordinary telephone receiver in the hands of the listener. It is quite possible with this set of instruments to detect the presence of a ship when still some distance away. The distance and direction of the ship picked up can be judged fairly closely by the intensity of the vibrations set up in the microphone. It only needs the addition of an accurate direction indicator to reach perfection; in which case the submarine though blind under water will be pretty well equipped to meet a submarine adversary.

Some very interesting experiments, it is understood, have recently been conducted by an officer, upon improved methods of radio rigging, the object being to enable the wireless to be used while the hull of the boat is still submerged and to keep it free from short circuiting. This will be a big improvement, for it is now necessary to break all electrical connections and close a watertight joint before going under water, and this means that no wireless messages may be received or sent until opportunity affords time enough upon the surface for a man to come on deck, replace the rigging, and make an electrical connection.

The old method of bell pulls for engine room signals has now been replaced by reliable electrically operated indicators. These are in connection with a large warning gong so that when the gong strikes the operator has only to look at the indicator and read the order to be executed. Other interior communications are afforded by sight signals and voice tubes or telephones.

ARMAMENT

The armament of the submarine boat consists of from one to four torpedo tubes, usually located in the bow; some of the larger vessels have tubes in the stern and under the superstructure deck also, and as many spare torpedoes as can be conveniently carried.

The arrangement of the tubes and their outer doors should be such that they are entirely independent, — that is, so that any one tube may be loaded and fired without interfering with the loading and firing of any other. Owing to the fixed position of the tubes with reference to the hull of the boat, it is necessary to aim the torpedo by point-

ing the boat at the object to be fired upon. This disadvantage means that the target if moving will remain in the zone of fire but a very short time. It is evident then that to attain the greatest degree of effectiveness the tubes must be capable of loading and firing without interference, and at short intervals. Tubes placed under the superstructure and mounted so as to be revolvable and capable of train on either broadside, would be distinctly valuable, in that they would greatly prolong the interval in which a ship would be in the zone of fire, and they would permit the submarine to fire from any position. This feature would be of inestimable value in the case of an attacking destroyer, enabling the submarine to effectually repel such attack. The main objections to this system however are that the tubes once fired are inaccessible for reloading, and that the torpedo is subject to injury by wetting unless fired immediately.

Firing was at first done by the old lanyard method, and by a man stationed at the tube when he received the order from the commanding officer at the lookout. At present the firing is controlled by the officer himself at the periscope, who fires the torpedo by means of air equipment, when the boat is on the target, the operation of the tube doors being effected by the crew stationed at the tubes, who send back word when all is ready.

Endeavors are now being made to effect an electrical system of firing, equipped so as to provide automatic indicators for showing which tubes are ready, and providing a quick firing interval.

Much improvement has yet to be made in methods of handling the torpedoes; in bringing them on board and loading them within the hull; in overhauling them; and

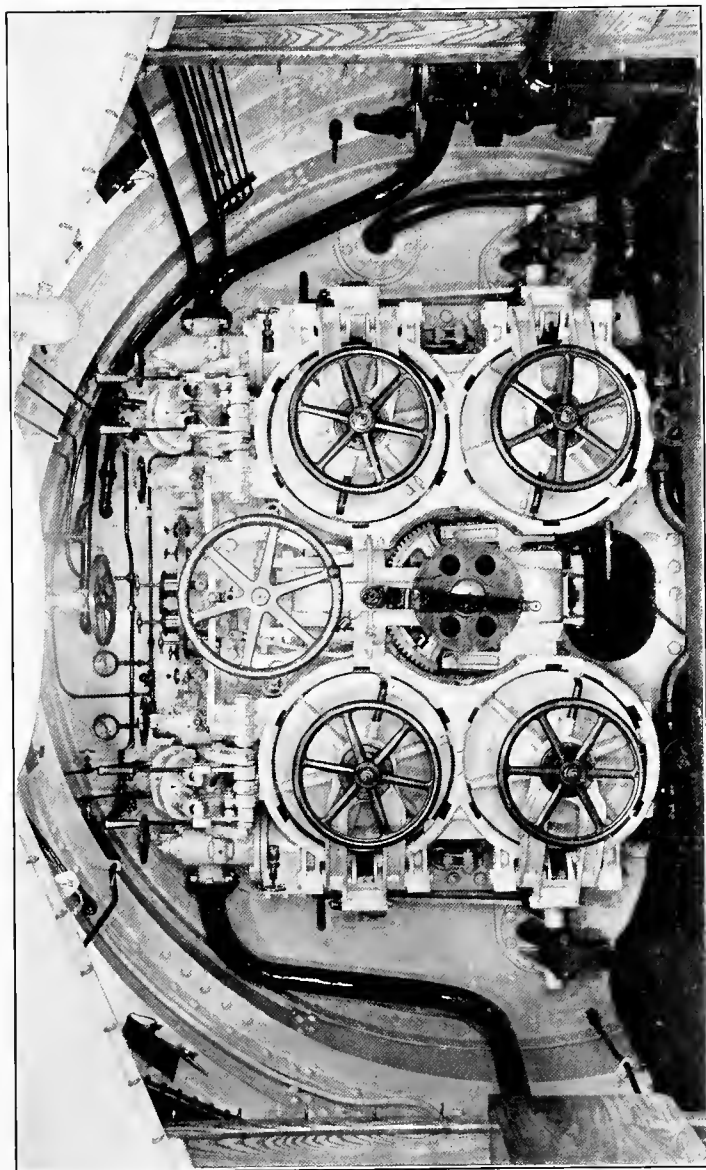

Courtesy Electric Boat Co.
Forward Torpedo Bulkhead, showing usual four bow tube arrangement of Electric Boat Co., torpedo tube breech mechanisms, cap revolving gear, and blow and drain valves and connections

in handling them and loading them into the tubes. In the earlier vessels no provisions at all were made for getting them on board, and they had either be to taken to pieces to get them within the hull or had to be sucked in through the tubes. A great deal of time was thus spent in getting them on board. All the late boats are provided with specially constructed hatches and light portable deck cranes to handle them, but the getting a torpedo on board is still far from being a speedy operation.

The torpedo firing stations at the periscopes are provided with torpedo directors. These instruments solve mechanically the problem of angles for firing when the necessary data is known — speed, course and distance of target, and speed of torpedo — and eliminate the personal equation in the making of computations. The personal equation however is not eliminated from the determination of the necessary data, speed and course of target and distance. Small discrepancies in making these observations lead to very wide errors, even with use of the director, unless the distance is relatively short.

The armament should also comprise a specially designed quick firing rifle mounted in the superstructure in such a manner as to be quickly brought into position for firing and as quickly put back in a watertight storage space when forced to submerge quickly. This gun would offer a means of repelling light unarmed speed craft. It could also be used against aeroplanes or dirigibles quite effectively. Many of the modern boats are equipped with such guns.

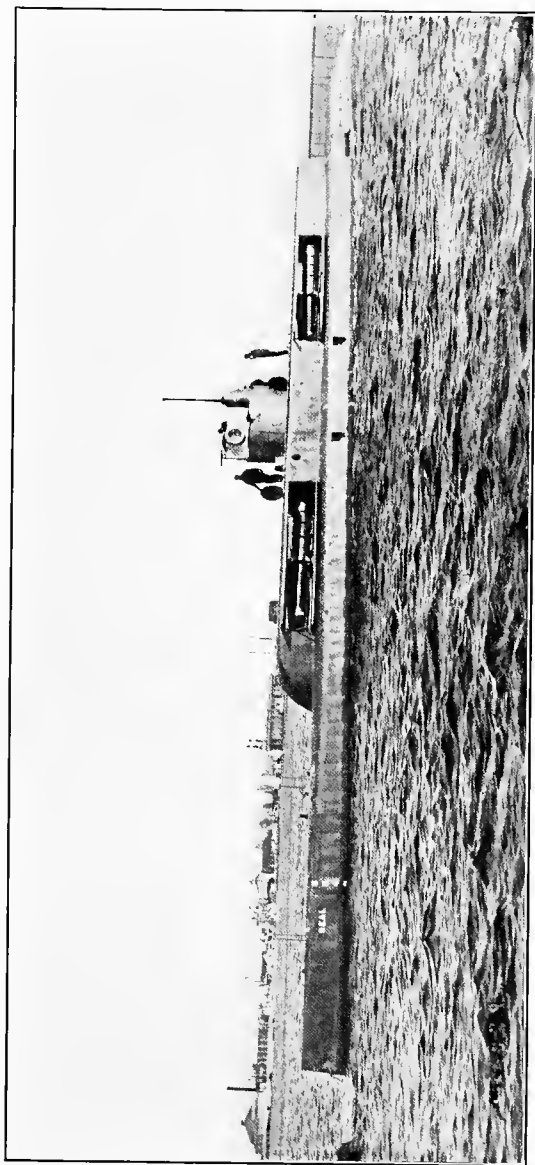

Photo-copyright, International Film Service

Submarine G-1 showing revolving tubes under superstructure

SAFETY

Under the head of safety come many factors which are interdependent upon other conditions of requirements; are characteristic of such, and are inherent with type and design. These matters must be left to the best judgment and to what experience has taught the constructor for their solution.

Primarily the hull of the vessel must be designed to stand an extreme water pressure to which the vessel may be subjected, allowing an ample factor of safety. The normal depth of submergence for all tactical purposes will never be below fifty feet, but provision must be made to insure against the collapse of the hull in case some unavoidable accident should cause this depth to be greatly exceeded. It is not practical however to design the hull with sufficient strength to withstand the pressure of water of whatever depth in which the boat may be navigating, for now the submarine is called upon to make long cruises and in deep waters hundreds of miles from the coast. She may however be expected to spend the greater part of her time operating along the coast from some base and it may be possible to take this depth as the basis of design.

Most of the boats of the present time are designed to withstand pressure due to a two hundred foot head of water using a safety factor of two. This is a reasonable basis of design and although the boat may be expected to operate a good part of her time in waters much deeper it gives the crew a chance to retain control of the vessel or perhaps leave her before the point of collapse is reached. At any rate should it be impossible to regain control within

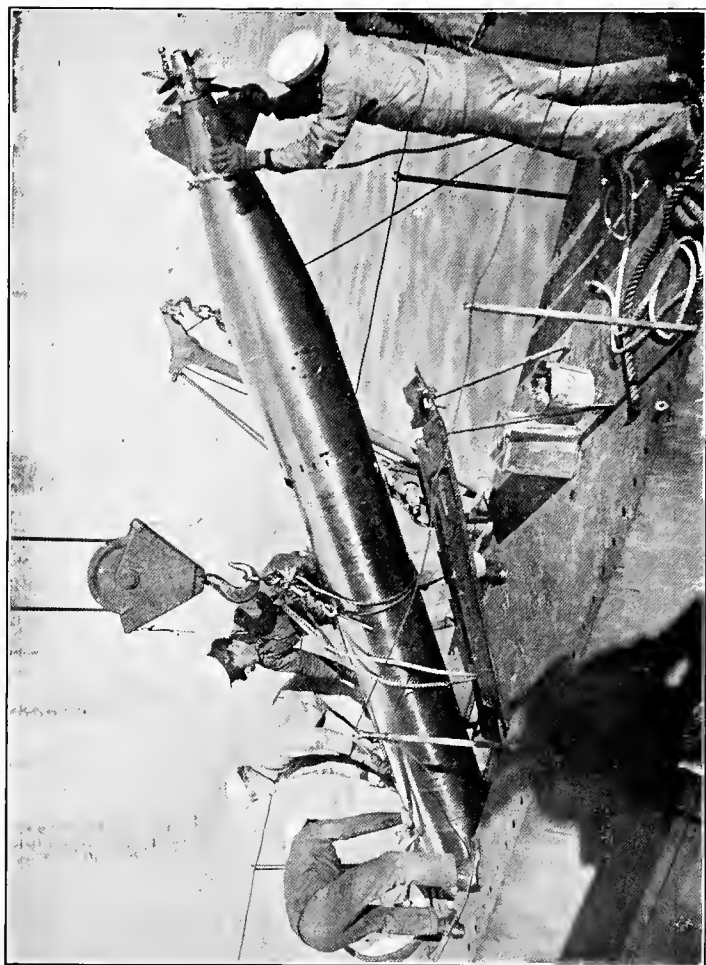

Photo-copyright, International Film Service

Loading a torpedo through special hatch on board K-5

this depth is it hardly possible that a wider margin of safety would afford any better chance.

It has been found by experiment and by testing to destruction full sized sections of a submarine that the resist-

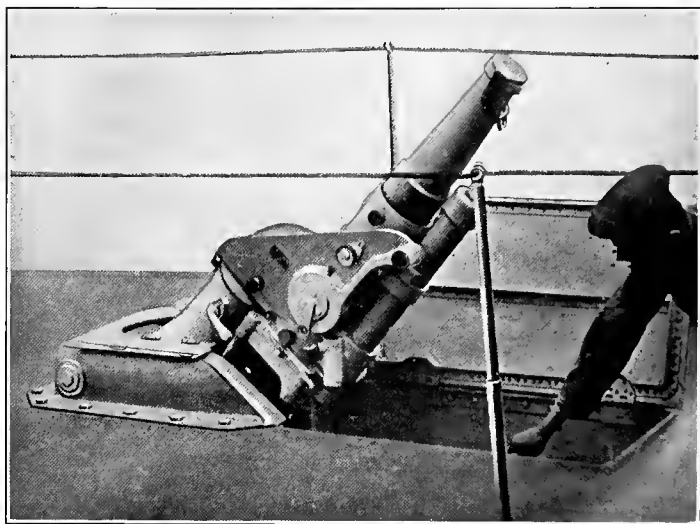

Photo-copyright, International Film Service

Type of submarine gun housed in superstructure

ance of the frame to withstand collapse varies directly as the section modulus of the frame and inversely as the diameter of the boat, the frame being considered as bearing all of the load unassisted by the extra thickness of the shell plating. From the foregoing experiments the following formula has been deduced:

$$R = \frac{P \times \text{diameter of the boat in feet}}{C}$$

Where P = collapsing pressure,

$C = 826.845$ constant derived from experiment,

R = required section modulus.

Hence assuming 200 pounds as a safe allowable collapsing pressure and 12 feet as the diameter of the boat, substituting the values, the formula reads,

$$R = \frac{200 \times 12}{826.845} = 2.93 \text{ the required section.}$$

Neglecting the extra thickness due to the shell plating this modulus calls for a section $5 \times 3 \times 12.8$ pounds angle and will resist collapse against a head of 454 feet.

From the same tests it was determined that the elastic limit of the metal was the limiting stress of the plating against permanent set, and that the thickness should be increased directly as the diameter of the boat. For the thickness of shell plating the following formula has been deduced:

$$T = \frac{P \times \text{diameter in inches}}{2 \times E}$$

Where P = collapsing pressure,

T = thickness of the plate,

E = elastic limit = 30,000.

Substituting values as before we have

$$T = \frac{200 \times 12 \times 12}{2 \times 30,000} = .48 \text{ inches, thickness of plate.}$$

Safety in surface navigation may still be materially increased by altering the form of the superstructure forward so as to give greater free-board and by effecting some-

what the flaring bow lines of a speed boat. These features will materially aid in overcoming the inherent tendency of the vessel to dive when approaching the critical speed.

A greater reserve buoyancy may be acquired if it is desired by fitting the scuppers with shutters or valves to make the sides of the superstructure watertight when on the surface.

The ballast and the fuel tank systems should be fitted with both pumping connections and connections for quick emptying by means of blowing with compressed air. The pumping system should comprise both motor driven pumps and hand pumps, all to be capable of pumping against the maximum depth of submergence. The air system should comprise a high pressure air storage reservoir, for storing up sufficient air for torpedoes, ventilation and blowing, and a set of reducing valves for bringing the pressure down from the storage pressure to that of a low pressure system for use in blowing and other operations.

Positive depth gauges must be fitted for telling the depth of submergence by registering the pressure of the outside water. These should be large so as to be easily read and must be of extreme sensitiveness.

Automatic means for controlling the depth of submergence should also be installed arranged in such a way as to blow the tanks if the desired depth is by any chance exceeded or by altering the angle of the hydroplane or diving rudder in order to bring the vessel back to the desired depth.

The conning tower should be constructed so as to be capable of operation as an air lock to assist the members of the crew to escape from the vessel if it should be found necessary. Oxygen helmets should also be provided for

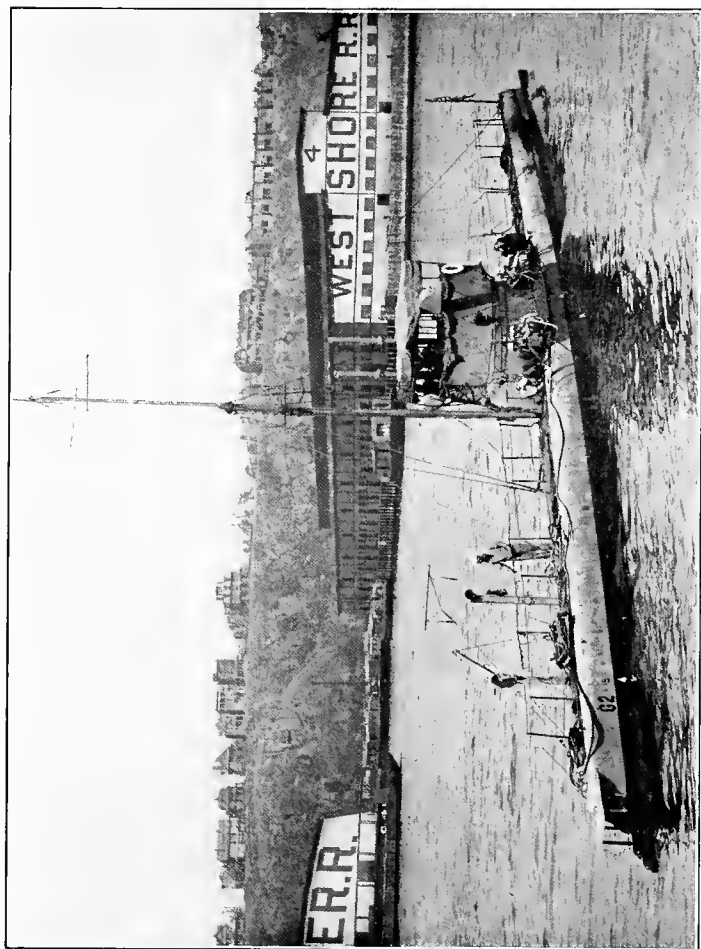

Photo-copyright, International Film Service

U.S. Submarine G-2. Lake type. Note large watertight superstructure

this use, and suitable storage space provided for them in a convenient location.

Efficient ventilation must be provided for the battery tanks so as to prevent an accumulation of any explosive gases. This system must be separate from the ventilation system of the living spaces. An explosive gas detecting device should be installed in these places and in the engine room and so situated as to be easily inspected. The interior of the boat should be divided into a number of watertight compartments, thus localizing any accidents which might happen. The division of the boat by bulkheads will also aid in the ventilation and give greater comfort to the crew when on long voyages by shutting out from the living quarters the sickening fumes of the oil engine. The early boats were not so divided but it is common practice to do so now.

A big additional factor of safety is added by fitting drop keels. These are cast iron keels filled with lead, attached to the keel of the vessel. By the simple throwing of a lever they are arranged so as to be instantly released and thereby casting off some five or ten tons dead weight, which should under almost any conditions bring the vessel to the top at once.

A position marker buoy should be attached to the superstructure in a manner that it can be released instantly necessity arises. It is attached to the ship by a long line normally wound on a reel which unwinds as the buoy floats to the surface. In this way if anything happens to the vessel so that she is unable to come to the surface her position is shown by the buoy. The buoy should also contain telephone connection with the boat so that communication may be had with the surface. It is an added

feature to have a whistle or signal device included in order to attract attention to the buoy.

Finally, external air connections on the hull should be had and located so as to be easily accessible for a diver to attach thereto an air hose from the surface.

Suitably strengthened holes fore and aft in the superstructure for attaching hoisting slings, and towing shackles at the bow or the equivalent should be provided. In fact in a vessel of this type it is absolutely essential that every means be taken to prevent accident, and adequate means provided to save both the crew and the vessel in case accident does happen.

CHAPTER VI

THE POWER PLANT

THE first operable means of motive power installed in a submarine was the steam engine, but this was later abandoned, and it has been considered that no practical solution of the problem of power was reached until the advent of the internal combustion engine. It is true that the present stage of development of the submarine boat started from the adoption of this means for propelling power. Strange as it may seem then, the tendency at the present time is to return to steam power for this purpose. There are good and sufficient reasons for this tendency however, which will be discussed at some length later on.

The gasoline engine was the first of the internal combustion engines to be adopted, and these are installed on the *A*, *B*, *C*, *D*, and three of the *G* class boats of our Navy. Owing to the high state of perfection and reliability that this type of engine has reached in the last few years, the engines installed on these boats with the exception of *G-1* and *G-2* have given very satisfactory service. In reference to the engine trouble of *G-1* and *G-2*, this has been due to faulty installation and design of foundations rather than to any primary difficulty or fault of the engines themselves. In view of the more recent development and improved efficiency, this type of engine could be expected to give even greater satisfaction and service at the present

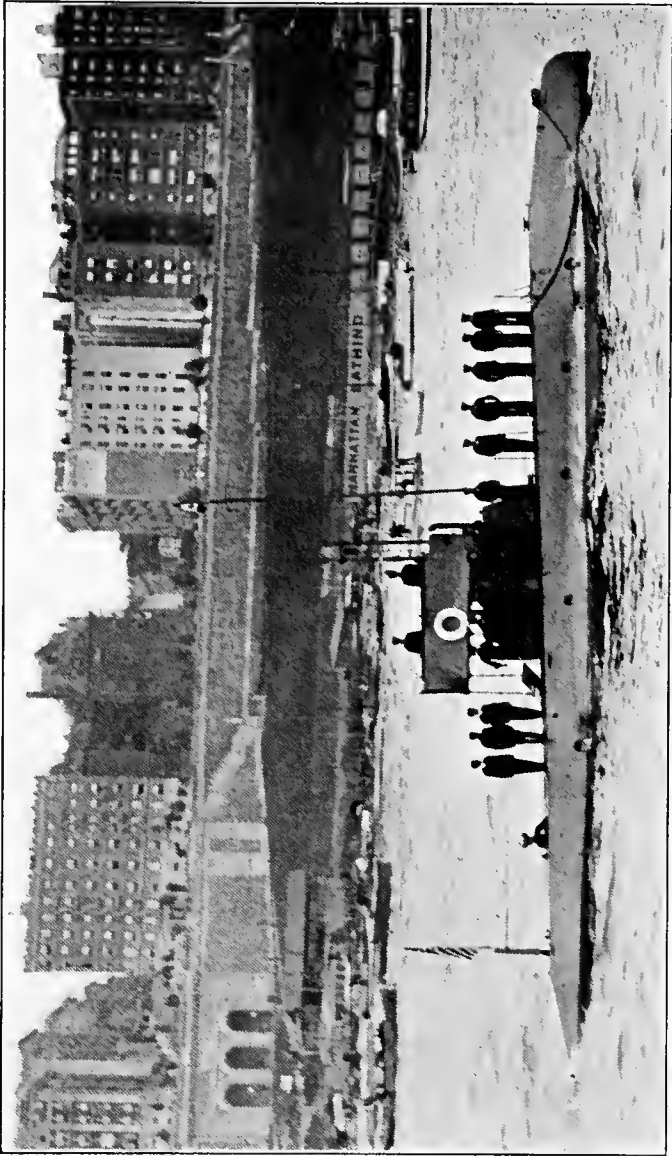

Photo-copyright, International Film Service

U.S. Submarine Torpedo Boat C-5

time. The gasoline engine afforded a relatively light compact form of prime mover, and was structurally simple and easy of repair. Its ailments were easily understood and quickly remedied, and in fact, today it has become so generally well known that almost any young boy can manage one. The gas engine however, had its drawbacks and these were: the cost of operation due to the high price of gasoline; danger of fire and explosion from gasoline vapor, and danger of asphyxiation by escaping carbon-dioxide gases. The first of these objections is real, but the others, in so far as they can be easily remedied and eliminated, cannot rightly be considered so. In fact there is no serious accident of record due primarily to these causes. Gasoline it must be admitted is a great "searcher," but still it should be possible to construct tanks sufficiently tight to hold it, and in any event, by means of a proper system of ventilation the probabilities of any such mishaps are at once eliminated.

For these reasons however, in all of the later boats the gasoline engine has been superseded by heavy oil engines of the Diesel type. The main reason for this change, and there can be no other, is on account of the great economy of fuel consumption of the Diesel engine. This engine burns a cheap fuel, almost any low grade oil which can be vaporized, and will develop one brake-horse-power per hour on from .55 to .63 of a pound of fuel. This is of course a great feature in favor of it. Some of the engine dealers guarantee a fuel consumption as low as .45 of a pound of fuel per B.H.P. per hour, but I do not know of any case where this economy has been attained under actual service conditions.

Theoretically the Diesel engine is extremely simple, but

in actual practice and construction it is exceedingly far from being so. The theory of the Diesel principle is: that on the first down stroke of the piston the cylinder is filled with fresh air, which is then compressed by the following up stroke of the piston to a pressure of about 500 pounds per square inch. This compression of the air raises its temperature to about $1,000^{\circ}$ F. At the instant the piston reaches the top dead center a small quantity of fuel oil is injected along with a fresh quantity of air under a pressure of about 900 pounds per square inch. This injection takes place usually through a period of one-tenth of the downward stroke of the piston. The fuel which is broken up into a fine spray by the pressure of the air entering with it, immediately it comes in contact with the hot air within the cylinder starts up combustion due to the temperature of the contained air being much higher than the flash point of the oil. The combustion continues through part of the stroke, supposedly until all of the oil has been completely burned, and expansion takes place during the remainder of the stroke on account of the expansive force of the pressure and temperature of the gaseous products of combustion. During the first part of the stroke the aim is to have the combustion proceed at a rate which will cause the volume of the gas to increase in the same ratio as the volume of the cylinder during this combustion so as to keep the pressure constant until the fuel is completely consumed. At the end of the stroke the exhaust valves are opened and the burnt gases are pushed out by the next up stroke of the piston.

The foregoing statements apply more particularly to the four stroke cycle Diesel, but the principle of the two stroke cycle is essentially the same. The chief difference

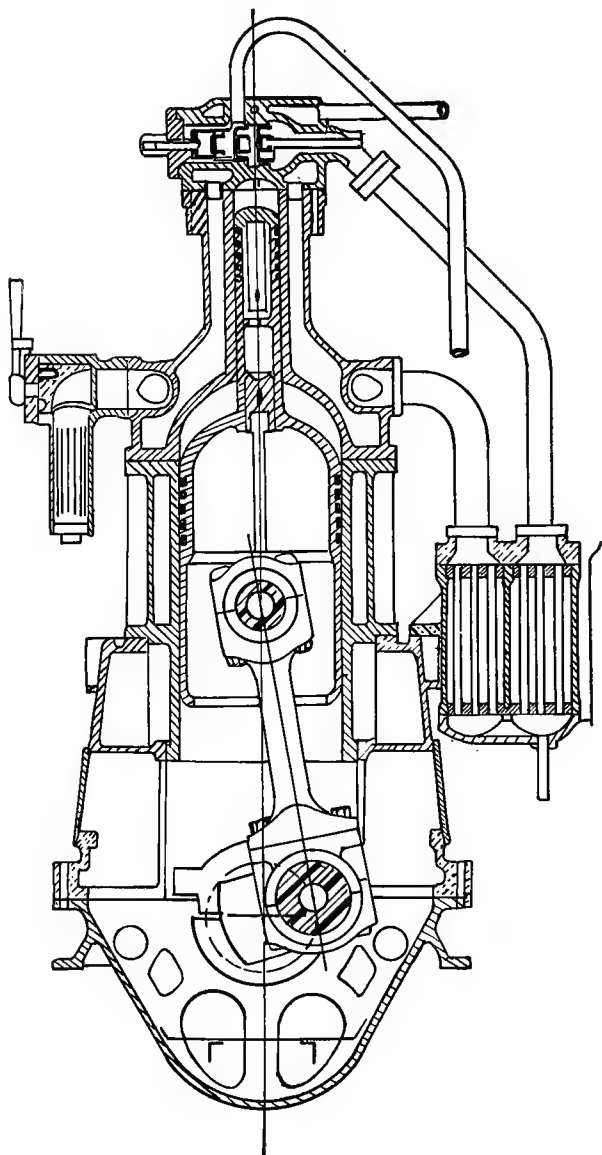

Section through air compressor

Plate III. Sections through 2-Cycle Nurnberg Engine

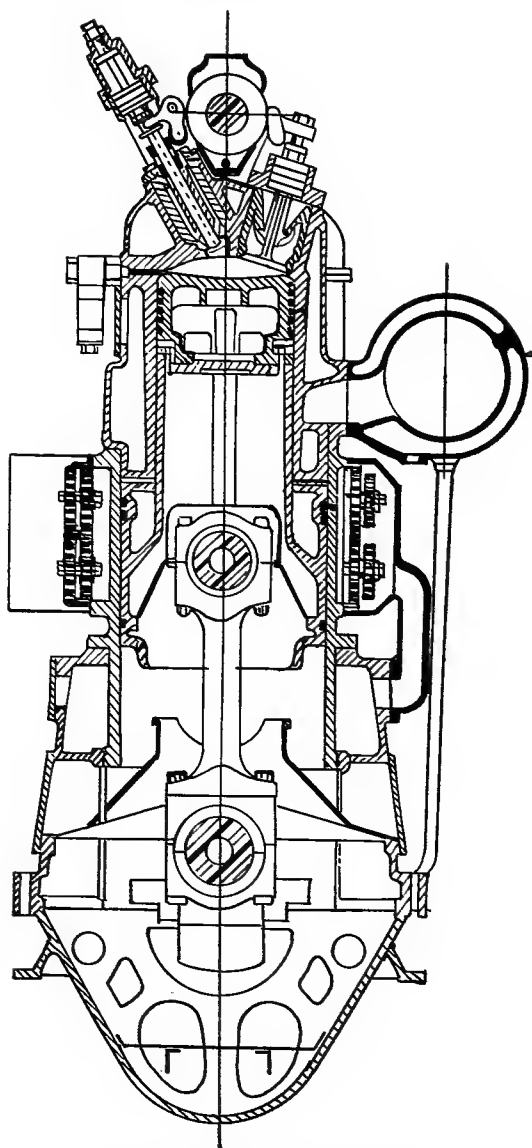

Section through working cylinder

Plate III. Sections through 2-Cycle Nurnberg Engine

between them being that in the two stroke cycle engine the exhaust of the burnt gases and the intake of the charge of fresh air take place at practically the same time when the piston is near the bottom of the stroke. In some designs the scavenging air is admitted at the top of the cylinder through valves in the cylinder head and so blows the burnt gas down and out the exhaust ports at the bottom of the cylinders. Those parts are uncovered by the piston as it nears the bottom dead center. Other designs do away with all valves but the air starting and fuel injection valves in the cylinder heads. In this case the scavenging air enters through ports in the side of the cylinder, which are uncovered by the piston shortly after the exhaust ports situated on the opposite side of the cylinder. With the two stroke cycle, then, the valve gear is much simplified and a great deal of very exasperating valve trouble is done away with, but on the other hand the scavenging air for this type must be injected under pressure, usually about nine pounds, which necessitates the addition of a low pressure air compressor and greatly complicates the mechanism of the machine. The economy of the two stroke cycle is also much lower than in the four stroke cycle.

The primary cause of the serious difficulties which are to be met with in the Diesel engine is the excessive temperatures which are generated in its cylinders, — the maximum temperature reached being about 3,000° F. This high temperature together with the high pressure in the cylinder imposes two distinct conditions which must be met by the designer in calculating the stress upon the walls. These conditions apply also to the cylinder heads and pistons. It is quite conceivable that

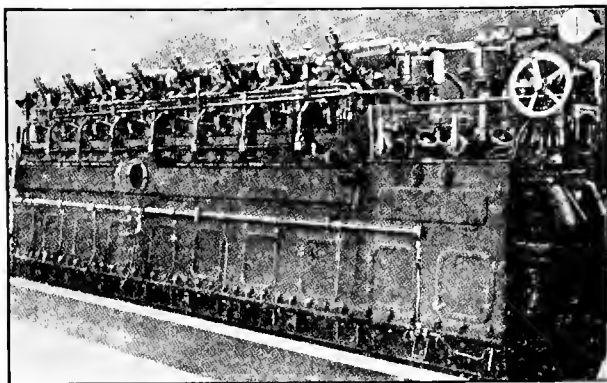

900 B.H.P. M.A.N. Submarine Type Diesel Engine. Operating side

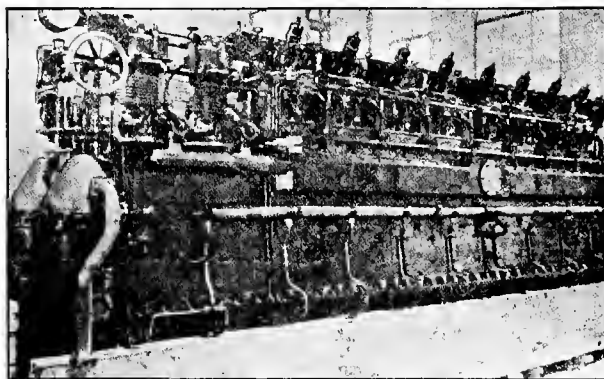

8 Cylinder 2-Cycle 900 B.H.P. Nurnberg Submarine Motor, showing compressor end. Note complications of cylinder heads

a thick cylinder exposed to high temperature and to high inside pressure as well will be actually stressed more than a thinner one. It is also a known fact that cast iron

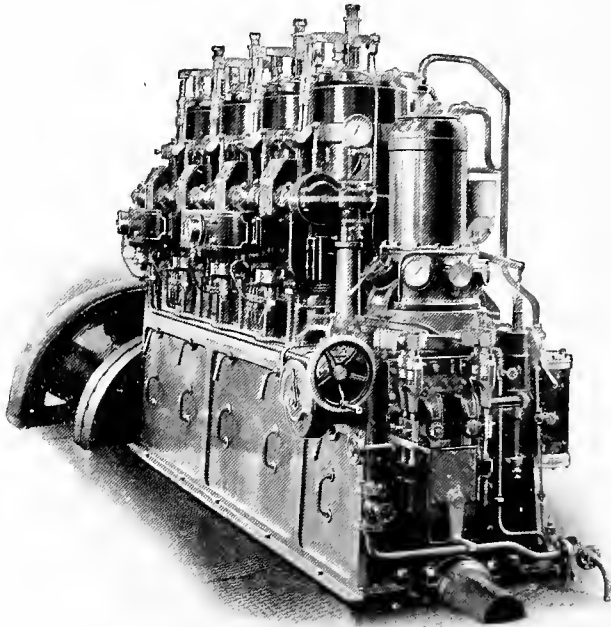

2 Stroke Cycle Southwark-Harris Diesel Type Engine

appreciably changes its form and dimensions when submitted to continuous high temperatures and develops a state of high internal compression as it tends to expand. This tension is too unevenly distributed throughout the metal on account of the cooler outer surface, thus accentuating the detrimental effects upon the metal. The answer to this difficulty seems therefore to be one of metal-

lurgy. A new metal must be developed, one having properties of greater tensile strength, little distortion from excessive heat, and still be no heavier than iron, before the Diesel engine can be successfully adapted to the needs of a submarine boat.

I do not mean to decry the Diesel engine as a type, for it has proven to be an ideal form of prime mover in stationary practice and has met with considerable success in ordinary marine practice, but in both of these cases the conditions encountered are as dissimilar to those encountered in a submarine as can be.

The ideal submarine engine must be a high speed powerful machine of comparatively light weight, simple and accessible in construction, and above all reliable. The proper solution of the Diesel engine for reliability and accessibility will permit neither high speed nor light weight to enter into its characteristics, unless its extremely high pressures and temperatures are first considerably lowered. It is quite possible that this might be effected to some extent, but there seems to be no concerted effort in this direction. Simplicity however, is a quality which is highly improbable will ever be reached in this type of engine on account of its numerous troublesome auxiliaries.

In the *E* and the *F* class boats light four stroke cycle Diesel engines were installed, but have never given satisfaction. Primarily the cause of the trouble with the engines of the *E* boats is the inadequacy of their construction. Attempting to keep the weight of these engines down to within certain limitations, they were constructed of built-up sections of plates and angles riveted together. The result of this manner of construction might well have

been foreseen; they have simply shaken to pieces and set up new difficulties which serve to accentuate the inherent troubles of the Diesel principle. All the later boats were fitted with medium weight two stroke cycle engines. Both the *H* and *K* boats, however, have had their share of engine trouble as well. The main difficulties with these engines seem to be in properly lubricating and cooling the pistons, and considerable trouble has occurred in the way of seized pistons and cracked cylinders. It is hoped that in the newer boats many of these difficulties will be overcome.

In view of all this then, is not the present reliability of the gasoline engine to be greatly preferred to the economy of the Diesel engine? In time of war, the purpose for which these boats are constructed, it seems to me that efficiency is the required object to be attained no matter what the cost. If the gasoline engine be attended with other risks, are the dire possibilities of these risks any greater than the unreliability of the Diesel engine? A fair comparison of the two types of engines may be had by considering for the moment the *D* class of boats, some of the last to be fitted with the gas engine, and the performance of any of the later boats. The ever readiness and general efficiency of the *D* boats is to be favorably compared with any of the larger and newer boats in our own or any foreign navy.

Much comment has been made of late upon the generally considered remarkable performance of the German submarines in the present war, and of the apparently successful results shown by the Krupp and the German M.A.N. Diesel engines with which many of these boats are equipped. As a matter of fact these engines cannot be

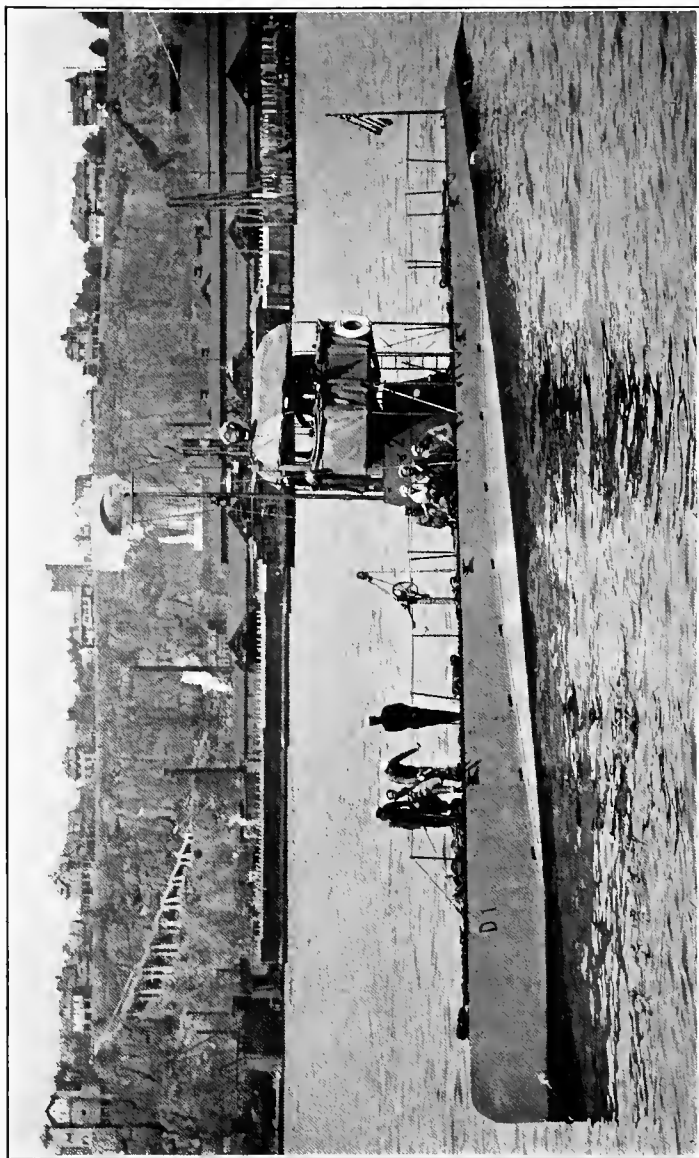

Photo-copyright, International Film Service

U. S. Submarine Torpedo Boat D-1

considered to be in any way superior or more reliable than the M.A.N. Diesel built by the New London Ship and Engine Building Co., and the Sulzer Diesel engine built by the Busch Bros. Co., and in use on our own boats.

Previous to the outbreak of war all of these boats were, as a matter of course, thoroughly overhauled and put in first class condition and maintained ready for instant use. This fact alone accounts for their early successes. It has been reported on good authority that the continued activity of the German submarines is accomplished by working them in relays, a certain number doing duty while the others are being overhauled at their bases. In this way, after each cruise, which is said to last from ten days to a fortnight, a boat is given a thorough overhauling and is therefore ready for work when her turn comes to put to sea again. It must also be noted that those submarines which were heard from most frequently in the early part of the campaign were the older and smaller type of boats and equipped with gasoline engines.

MOTORS AND STORAGE BATTERIES

At the present time all submarines are propelled under water by electric induction motors, the electrical energy being supplied from accumulator cells. Big advancement has been made in the design of electrical equipment for submarine installation, especially in the methods of controls.

The present motors are ruggedly built, have their armatures mounted upon the main shafting of the engines, and are well insulated. They are of the interpolar, direct current, ventilated type, capable of running in

either direction and under variable load without adjustment of the brushes. A potential difference of about 70 volts is allowed at the field terminals to provide for speed regulation when running as a motor and for adjustment

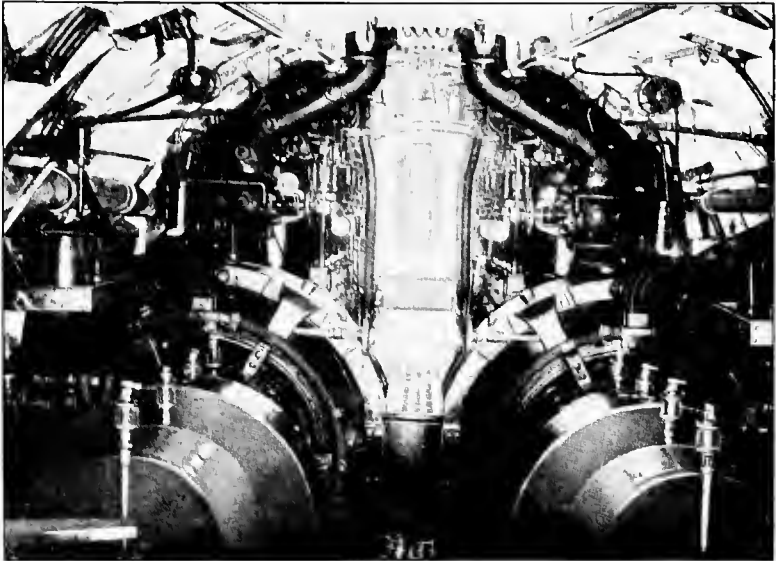

Main Motors, Submarine G-1. Main engines in background, forward of motors

of voltages when running as a generator. They are often run at an overload of as much as ninety per cent without injurious heating.

The first controls to be used were plain knife switches. These are now all enclosed to eliminate the danger of sparking, and in some cases oil baths are provided. The starters for the main motors are of the contactor type master drum control with interlocking features. This

type is advantageous in that it permits the location of the control to be had in the most convenient place. Its only drawback is the complexity of its construction, but with the high voltage now handled it has become an absolute necessity. Automatic circuit breakers of the latest type are provided in all feeder circuits and wherever necessary.

STORAGE BATTERIES

Although the efficiency of the motor has been greatly advanced the problem of the storage battery still remains one of much dissatisfaction and it is quite improbable that the inherent defects of it will ever be overcome.

There are two distinct types of storage batteries in general use at the present time; the first is known as the lead battery and the second as the Edison battery.

The lead battery is the only type that has been used aboard submarines up to the present time. I understand however, that there is now one if not more of the boats having the old batteries replaced by Edison cells.

The lead batteries, as their names would imply, have active plates of lead material using sulphuric acid of a density of about 1.23 as an electrolyte.

There are several methods of manufacturing the lead plates, the three forms best known being the Planté plate, the Pasted plate, and the Ironclad plate, the latter being a particular form of the Pasted plate.

The Planté plate is manufactured with the lead made into a fine grid which is cast, grooved, or spun in such a way as to afford a large superficial area for the electro-chemical action to take place upon. The grid is then subjected to this electro-chemical process which reduces

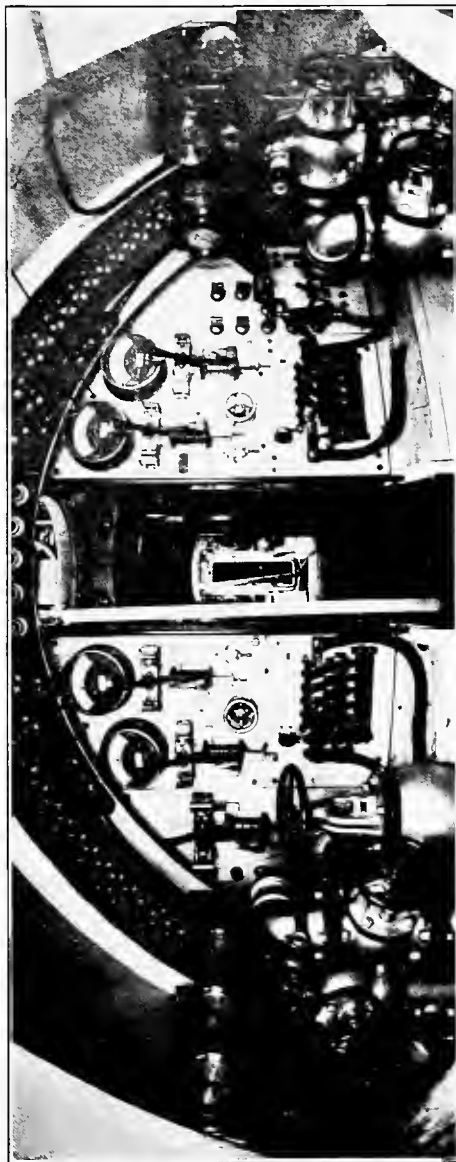

By Courtesy Lake Torpedo Boat Co.

Showing main switchboard and valve manifolds on lake boat

the exposed lead surface to peroxide of lead for the positive plates, and to spongy lead for the negative plates.

The Pasted plate is manufactured by pressing a pasty composition of lead and a small percentage of antimony into the annular spaces of a structural frame formed up of network. The plates are then subjected to an electro-chemical process as before, reducing the plates to peroxide of lead for the positive plates, and to spongy lead for the negative plates.

The Ironclad plates are formed into positive plates only. They consist of metal frames supporting hard-rubber tubes set side by side. The active material is formed by running antimony lead rods full length in the center of the rubber tubes which are perforated, and otherwise filling in the tubes with red lead. It is then reduced electro-chemically into peroxide of lead for positive plates.

In the batteries of the submarines, the Planté positive plate is used in combination with the Pasted negative plate, or else the Ironclad plate is used with the Pasted negative plate, these combinations seeming to give the most satisfactory results.

The Edison storage battery uses nickel oxide as the active material for the positive plates, and iron oxide as the active material for the negative plates. The electrolyte used is caustic soda. The positive plates are made up of a steel frame supporting perforated steel tubes which contain a quantity of nickel hydrates for forming the active material. The negative plates are made up of two perforated steel sheets forming pockets between them in which is contained iron oxide for the active material.

In addition to the enormous amount of weight, in round numbers about 60 tons, and the valuable space which it occupies the lead battery is objectionable upon the score of its inherent dangerousness. There is the ever present danger of explosive gases collecting with the contingent result of battery fires and terrific explosions, the only means of fighting which seems to be to leave the ship and let them reek their havoc. There is also the continual danger from the generation of chlorine gas which is deadly poison, and which is liable to be generated at any time if salt water finds its way to the batteries, and lastly, the danger to the hull itself from leaking or the slopping over of the sulphuric acid from the cells. The acid immediately attacks the steel plates of the battery tank, and unless the installation has been made in such a way as to afford perfect inspection frequently, which is not the general case and in fact is almost impossible because of space limitation, the metal is soon eaten through by the chemical action of the acid.

The advocates for the Edison battery are claiming for this type the entire elimination of all these bad features of the lead battery. This however is not true, for the Edison battery is quite as liable to battery fires and explosions as is the lead battery, and in fact generates hydrogen gas, both when charging and discharging, more freely than does the lead battery, and it is due to this gas that most battery troubles and accidents are had. It is free from the deadly fumes of chlorine gas and trouble with leaking acid.

On the other hand the lead battery has an average discharge voltage at the three hour rate of discharge of about 1.83 volts per cell, whereas the Edison battery

has at the three hour rate of discharge of but from 1.1 to 1.2 volts per cell. This would mean then that with the Edison battery the number of cells would have to be increased about sixty per cent, to get the same voltage, over the lead battery and would require considerably more floor space.

The weight of the Edison battery is also much higher than that of the lead battery, and this is an all important factor. In view of this fact then, and that the Edison battery is less than 72 per cent as efficient as the lead battery, it would seem that to install new equipment that requires more weight and space than that which is already installed, and which therefore must necessarily detract from the efficiency of other factors now obtained, would be far removed from the ideals that we are trying to gain in submarine development, because it would in this case be making a sacrifice of other factors without bettering the condition or increasing the efficiency of the factor for which all these sacrifices are made.

The cost of the Edison battery is much more than the lead battery but on this score the life of the Edison battery greatly exceeds that of the other, so the price may be conceded to be in favor of the Edison if anything.

The present reversion to the steam engine as a means for surface propulsion is brought about by the inherent difficulties found in the heavy oil engine of large powers and because now the steam engine has reached a state of efficiency and reliability found in no other form of prime mover.

As far as economy is concerned, by combining the use of high pressure steam with a high degree of superheat and using high mean referred pressure, it is quite pos-

sible by using an improved form of oil burning boiler to secure an economy as low as .7 to .8 of a pound of fuel per B.H.P. per hour. This is but little in excess of the Diesel engine consumption, and by using the steam

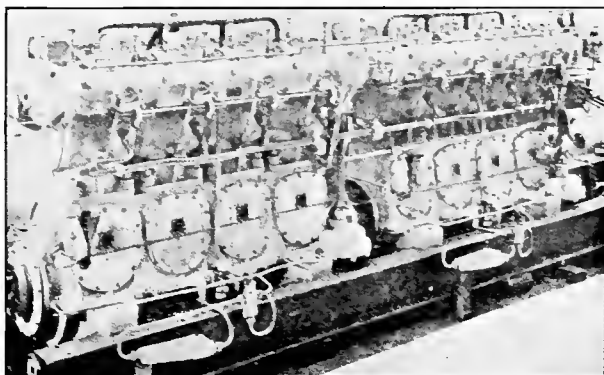

300 B.H.P. Italian Submarine Engine. Two 4 cylinder engines arranged tandem

engine the attendant improvement in conditions would be manifold. The weight for the steam plant for the same power of Diesel plant would be much less. The mean effective pressure is higher in the steam unit and its cylinders are subjected to but little more than one-fourth of the extreme pressure and not to one-fourth of the extreme temperature of the Diesel unit. The steam unit is also the more simple and the more easily accessible of the two.

The ideal form of power plant for the submarine, as may be easily understood, is one that is capable of operation both when on the surface and when in the submerged condition, that is, in other words, a single unit which will do away with the present dual system. The problem then is to find some method by which the prime

mover to be used for surface propulsion can be made to furnish the power for submerged work as well, thus doing away with the present storage battery system and its inherent dangers and limitations.

The problem has been attacked by many in the last few years, notably among them an Italian engineer by the name of del Proposto, and a Spanish engineer named d'Quevilley.

The del Proposto proposition is essentially an air proposition, using the internal combustion engine to propel the boat and to drive an air compressor for storing up air in tanks when on the surface. In the submerged condition the mechanical energy of the stored air is used back through the compressor and through all or part of the cylinders of the internal combustion engine, as air motors for the propelling power. It is understood that del Proposto built a boat and had his system installed. But little is known of the results obtained and it is believed that the performance of the equipment did not come up to his expectations. His troubles would evidently be mechanical difficulties resulting in inefficiency.

The d'Quevilley proposition is that of a soda-boiler, using the steam generated from a process of slaking caustic soda. When the vessel is about to submerge, the exhaust steam from the engines is turned into this soda-boiler, producing a secondary steam caused by the action of the soda in absorbing the water vapor. The heat evolved by this action forms a secondary steam which is used through the engines and the cycle continues. This process goes on until the caustic soda has become saturated, when the vessel must return to the surface and the soda reconcentrated.

A boat of this type has been built in France and the process has also been tried out in Germany, but it is not believed that any great success was obtained on the trials. The principle of this system is old, having first been tried out in this country by Prof. J. H. L. Tuck of San Francisco in his submarine boat *Peacemaker*, in I believe 1885. The boat was built by the Submarine Motor Co. of New York, and tried out up the Hudson River before a United States Naval Board. The same principle has since been laid before the Navy Department by a Chilian inventor, and it has also been worked upon by several European engineers.

Another system of propulsion has lately been perfected under patents held by the L. A. Submarine Boat Co. of California, now the Neff System of Submarine Propulsion, which provides means for utilizing the same power unit both when on the surface and when submerged. This system which has been developed by the author, contemplates the use of the main engines to accomplish this result, and it is claimed that any form of prime mover may be used with satisfactory results. A boat with the system installed has been built and put through trials under inspection by a Naval Board and the results were found to be satisfactory in every way. By means of the equipment both greatly increased submerged speed and increased radius of action submerged were shown. The military advantages of these two factors would appear to be of prime importance.

At present it is rather much of a question to say what new turn the power plant for a submarine will take. It is highly probable though, that if the Diesel engine is retained it will be of the non-reversible type, of heavier

construction, and will drive generators for supplying current to induction motors connected to the propeller shafts. This would permit of a greater speed range and would eliminate starting and reversing troubles, as well

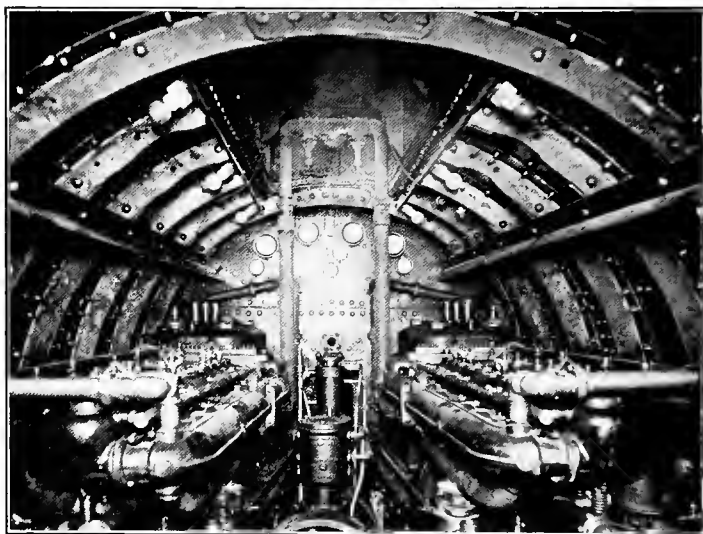

Engine Space, experimental boat built by the L. A. Submarine Boat Co., showing single unit plant power

as to cause the constructor less worry about the proper distribution of weights as affecting the trim of the boat. The size and weight of the motors could be kept down by using polyphase alternating currents of high frequency, or direct currents of high voltage, say 500 volts for surface work, and if used from storage batteries as at present when submerged this could be cut down to 250 volts. By the elimination of the storage batteries the same voltage submerged as on the surface would be used.

Or perhaps if we revert to steam we will find the solution in the turbine either directly coupled to the propeller shafts or arranged in turbo-generator sets. This means would surely materially decrease the weight of the plants on account of the great rotary speed, and most certainly would add to the reliability of the unit as a whole.

CHAPTER VII

FUTURE DEVELOPMENT

It is by no means an easy matter to undertake to foretell what the future development of the submarine will bring about. We may draw certain conclusions from the past performance and development of these vessels and by careful consideration of the many inherent difficulties found in their characteristics arrive at a safe and sane conservative deduction. It is assuredly no reason, however, that because a certain performance is improbable of mechanical accomplishment today, it is impossible of ultimate accomplishment. We of this age of achievement should, before making any rash statements, always keep this in mind.

In the past ten years alone the submarine has steadily advanced in size to four times what it was then, the surface speeds have been doubled, the radius of action on the surface enlarged in even greater proportion, and the military equipment and features immensely improved. Already from being little steel tanks so completely filled with machinery and appurtenances that the few members of the crew could scarcely crawl around in them, and even had there been room they would scarcely have dared to move for fear of disturbing the equilibrium of the boat and upsetting her, the submarine has become a large comparatively roomy craft in which a crew consisting of two officers and from twenty to thirty men can live for days at a time. Great as has already been the

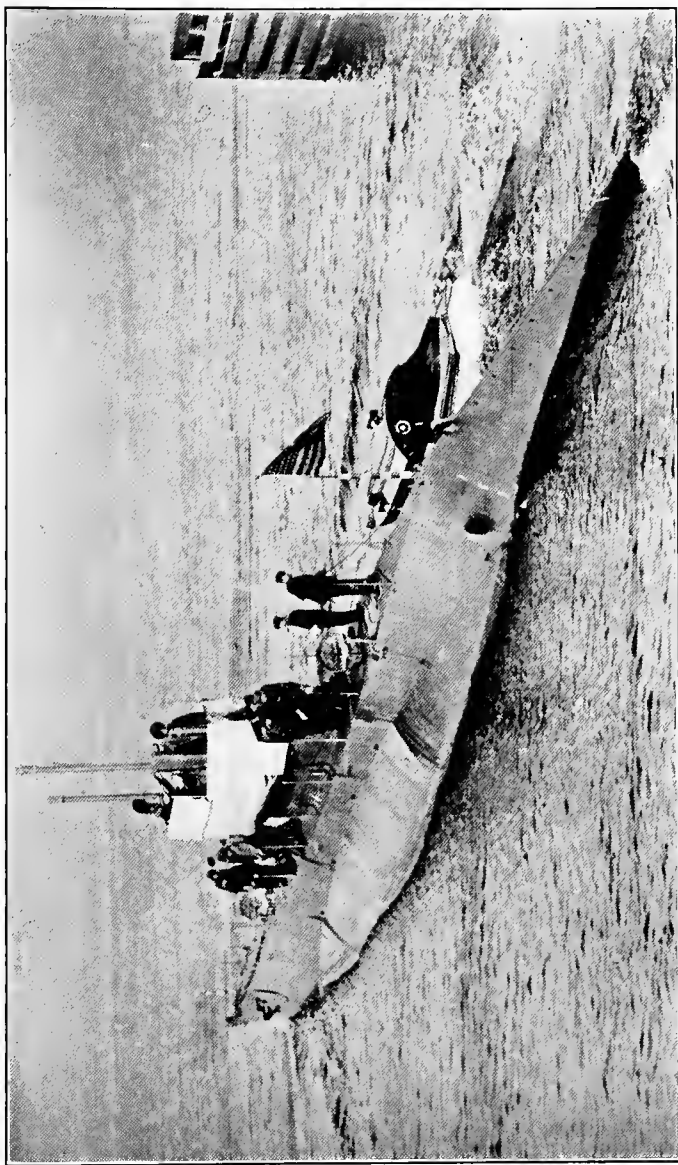

Photo-copyright, International Film Service

Submarine L-1 leaving the Fore River Ship Yard to under-go preliminary trial trip before acceptance by the Government. Four of this class have recently been completed and are now undergoing acceptance trials

progress, the submarine has by no means yet reached the limit of its development.

Beyond question of any doubt immediate improvement will be made in the directions of increased surface speed, radius of action on the surface, and in the size of the submarine itself. The future will unquestionably bring forth a submarine capable of operating freely at great distances from her base, and will combine to a certain extent the qualities of a surface cruiser and those of the under-water craft.

There are at the present time a number of large submarines of the sea-going type, ranging from 1200 to 1500 tons displacement submerged, under construction in various foreign countries, and one in this country. The dimensions of these boats far exceed anything that may have been dreamed of a few years ago. The *Schley*, being built at the Fore River Ship Building Co. for the United States Navy, is of about 1200 tons displacement when totally submerged, has a designed speed of 21 knots for the surface and 12 knots for the submerged condition, and will contain some 3700 engine brake horse power. The results at the trials of these monster submarines will be awaited with no little interest and it is certain that their performances will furnish us with much food for thought.

At the present time there is much being written about what the immediate future is going to evolve, and many writers are speculating wildly about sea-going submarines of 4000 and 5000 tons displacement. The curious fact about these writers however, is that none of them may claim to have any experience in the construction of submarine boats or even any practical knowledge in the theories of naval engineering. Increasing the size of the

submarine to these extreme proportions would not necessarily give an added efficiency to these craft, for there is a proper balance of all the military factors entering into it which must be maintained. What if any advantage would accrue from this extreme departure is a question of serious doubt. Much has also been said about submarines of torpedo boat speed, and while this is a quality which is highly desirable from a military point of view, it is one that is impossible of accomplishment, for the destroyer has even now a speed of thirty to thirty-five knots and has not the limitations of weights imposed upon it that the submarine must necessarily have.

Although the submarine is well out of the experimental stage at the present time, there remain a great many disconcerting problems to be solved before anything like perfection is reached. It is greatly to be feared that to jump from the gradual development in size which has so far been exercised to boats of 2000 tons or more displacement will only serve to accentuate the present inherent and unsolved difficulties. The proper solution of these things will eventually be found, but a rational system of development must be followed in order to effect this end.

Many of our boats are now capable of making a cruise of about 4500 miles. It would seem that very little increase would be needed in this factor for some time to come at any rate. More than this we need speed and especially submerged speed. Lacking in this respect, the effectiveness of the submarine as an offensive instrument of warfare has been prominently brought out in the present European war. Without it the submarine must remain a passive means of defense, depending upon her invisibility and the chance that an enemy may, unaware

of her location, approach within effective range of her torpedoes, or she may under cover of darkness take up a position along the well established routes of trade and lie there submerged to await and prey upon the enemies' merchant vessels. Neither of these tactics, however, can effect in any serious way the outcome of the naval maneuvers.

To be able to assume its rightful place in warfare, the submarine must therefore materially increase its under-water speed. To do this we are brought face to face with the complex problem of the power plant. With the present installation of Diesel engines for surface work and electric motors and storage batteries for submerged work it is out of the question, for to materially increase the power for under-water propulsion would mean that we must so materially decrease the power for surface running, or else the radius of action, and that we would be unable to get anywhere to make use of the improved under-water condition. On the other hand, we are now with a fair surface speed enabled to get within but a certain distance of a battleship when we must cast aside this advantage and take cover under water both to protect ourselves from gunfire and to keep from being seen. In this condition the submarine has only about three-quarters of her surface speed, considerably less than the normal cruising speed of a battleship, and therefore, unless the submarine be visited with the good luck that the battleship be steaming towards her, the distance between them becomes wider instead of less.

That the solution of this problem is a vital point is at once apparent. Many means have been propounded in the past and are being worked out in an endeavor to

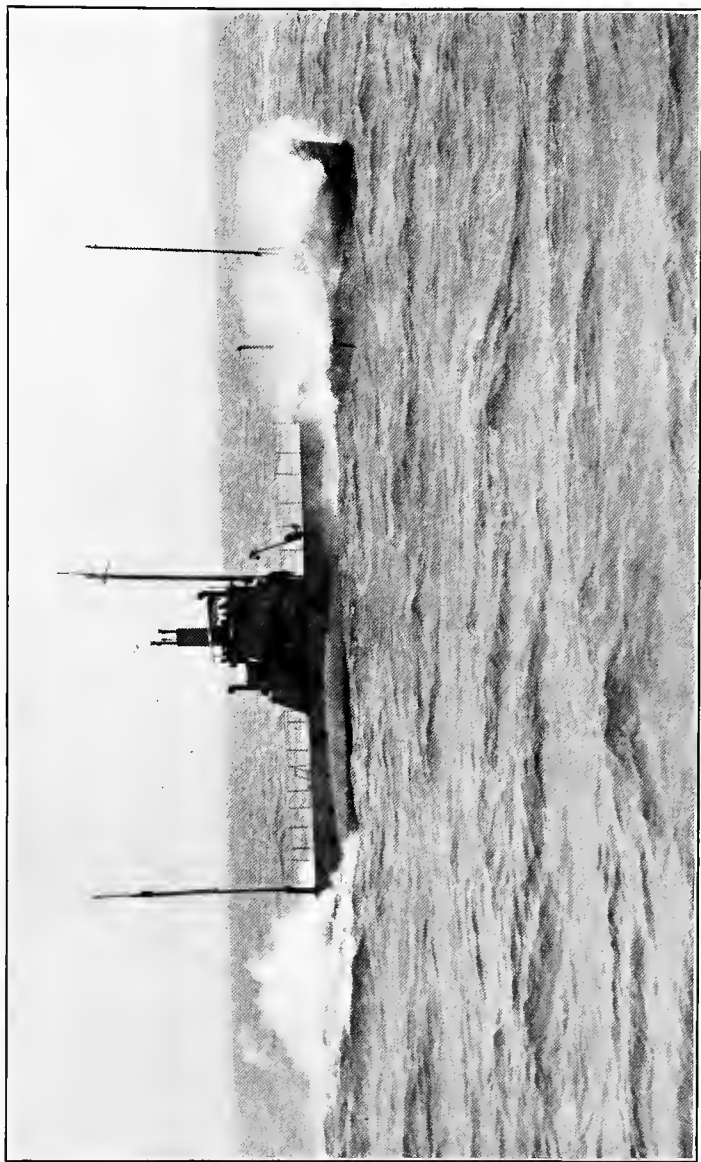

Photo-copyright, International Film Service

U.S. Submarine K-5 in surface cruising condition. Note the substantial roomy bridge and weather protection. This class of boats is capable of cruising 4500 miles in any weather

secure the desired results. The solution obviously means the doing away with the dual power system, and will probably evolve into an all internal combustion engine or steam engine plant. It may be confidently expected that some such means for remedying the present shortcomings will be speedily put into general practice. With the advent of such a system, surface speeds of twenty knots and submerged speeds of sixteen to eighteen knots would be feasible.

The objection has been raised by some that such a system must leave a trail of bubbles behind it as does a

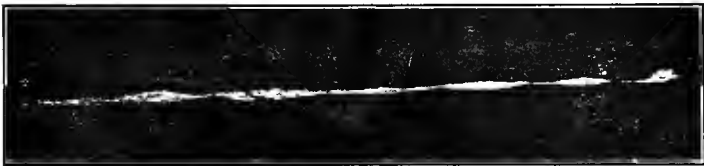

Photo-copyright, Underwood and Underwood

Wake of Torpedo Showing Trail of Air Bubbles

torpedo and that the position of the submarine would therefore be disclosed to the battleship. This has not been found to be the case however, and in fact with the submarine running at a normal cruising depth no disturbance of any great amount takes place upon the surface. Granting for the moment that a submarine did leave a wake like the torpedo, it is well known that the trail of a torpedo may be followed from the bridge of a battleship only for about 800 yards with any chop on at all, and this is easy range for torpedo fire. It is also much more difficult to detect this disturbance of the torpedo when coming towards the ship from an unknown quarter. Even though the submarine were discovered when at a

distance of say 3000 yards from a battleship, which is highly improbable, it would take the battleship from four to six minutes to get under full speed from a cruising speed of twelve knots, and therefore with an increase in underwater speed of the submarine the chances of making a successful hit are still very good.

The present difficulties to be met with in a system of this kind are those inherent in the Diesel engine, which so far has given no satisfaction at all. Much improvement however has already been made and much may still be looked for in this direction. Very slow speed engines of this type driving high speed electric generators through the intermediate agency of mechanical reduction gearing may do much to solve this problem. There is also much to be looked for in the further development of the steam boiler construction of the oil burning type. It is quite within reason that this may be made to compete strongly with the Diesel engine in point of economy and it is certainly more reliable. The use of high speed turbines with electric reduction gear also offers a very promising solution of the power problem.

Altogether the submarine may be expected to become a very effective weapon in the near future. Further improvements in the armament and the rapid handling of the torpedoes may be looked for. Mine laying apparatus, cable cutting devices, and small caliber guns are even now provided.

What effect the indubitable future of the submarine will have upon the design of the battleship has of late become a much mooted question. I cannot agree in this respect with those who take the stand that the day of the battleship is over. On the contrary I believe that the

battleship must always remain the Queen of the Seas, and must be the deciding factor in any naval engagement. Without it there can be no bombardment of an enemy's coast nor any conveying of transports or landing of an invading army on foreign soil.

If we are ever forced into war we most certainly want to win. To win a war it is absolutely necessary to carry the campaign into the enemy's country and to stop him there. If on the other hand the enemy succeeds in gaining a foothold in this country, we may hold him back indefinitely but cannot make him quit, unless we in the meantime have gained a more strategic hold upon his own soil. To be forced to fight upon our own soil means that no matter whether we are really defeated or whether we gain a partial victory by being able to hold back the enemy until he is tired out, we are actually the losers in point of comparative suffering and damage inflicted.

It is quite probable, however, that the battleship as she now stands will be greatly modified. I do not think this will take the form of added armor below the waterline as do some. To do this would only mean that more powerful torpedoes would be made which would have greater rupturing effect upon the heavier armor than it does even now. On the contrary, perhaps the battleship will lighten somewhat the armor she already carries and be constructed with a greater number of divisional bulkheads backed up by air pressure chambers in order to localize the effects of explosions. I believe that her greatest change will be an increase in speed. Superior speed has always been and must ever continue to be her only protection against the submarine.

CHAPTER VIII

MEANS OF DEFENSE AGAINST SUBMARINE ATTACK

THERE as yet seems to have been no really practicable means devised for defense against the offensive operation of the submarine. Practically invisible as it is and having



International Film Service

Submerged run with periscopes exposed. Note disturbance and wake caused by passage of periscope through the water

the impenetrability of the water for its protection, it is immune from counter attack. Perhaps the most serious casualty which it is possible to inflict upon it would be the chance hitting and destruction of its periscopes when temporarily exposed above the surface. This of course would mean that the submarine must remain submerged hors de combat until nightfall, or else take the conse-

quence of exposing above the surface her conning tower and more vulnerable hull.

There has been a great deal said about the possibility of shooting off the periscopes of the submarine. This chance is in reality very small, and would be more luck than good marksmanship were it successfully accomplished. When the small moving target that the periscope offers is considered this can be at once realized. The tube, of a neutral gray tint difficult in itself to distinguish, is of from three to four inches in diameter, is exposed only two or three feet of its length and only this much for very short intervals of time — just long enough to check the course and the range. Even at the close range of 500 yards it is an almost impossible target, and when the range greatly exceeds this it becomes well nigh invisible. It is to be doubted that any effectiveness could be had even with the use of shrapnel.

Ever since the submarine has been accepted as a possible instrument of warfare, some means has been sought to successfully cope with her. In England especially, much thought and study has been given to various devices for meeting this contingency. In the face of her seeming inability to quell the German submarine raids in the present conflict, it would seem that all this theorizing had been very unfruitful. Probably had England given as much study to the submarine itself as to the means for defense against it she would be better able to cope with the situation.

Obviously the destroyer becomes the natural adversary of the submarine boat. With her great speed and superior maneuvering ability it is within the compass of the destroyer to keep on the trail of the submarine and run her

down when she chances to expose her periscopes to take bearings. The destroyer is however vulnerable to the torpedo, and it is only the slothful maneuvering qualities of the submarine when under water that prevents the certain success of counter attack on her part. Almost all of the theories of attack upon the submarine have been based upon the superior performance of the destroyer for their successful execution.

One of the pet theories is that a mine or bomb exploded in the water within the vicinity of the submarine will transmit such pressure through the water as to cause the hull of the submarine to collapse. To illustrate the consequences of this action, the instance is always cited of the killing of fish by the concussion caused by exploding dynamite under water. The execution of this means of defense was to be carried out by fitting the destroyers with outriggers to which torpedoes were attached to the outer ends. The torpedoes were to be fired by either a time fuse device or by electrical detonators. The outrigger or spar held the torpedo a considerable distance away from the destroyer and was to be lowered into the water and fired over where the submarine was supposed to be.

Experiments with this method were carried out by the English Navy by exploding torpedoes in the water close to floating casks. It was claimed by them that the results proved conclusively that a torpedo having a moderate weight of explosive charge would, if exploded within 70 or 80 feet of a submarine, cause very disastrous results. Later on the French, induced by these experiments as reported, placed a number of live sheep in a submarine boat and discharged a torpedo containing about a hundred

pounds of gun-cotton at a distance of about 150 feet from it. The results showed no ill effects to either the sheep or the boat. Had a heavier charge been exploded and at a closer distance the results might possibly have shown more serious effects.

Probably a more feasible plan is to tow by means of the destroyer a mine to be exploded by an electrical detonator. This plan is objectionable however, because it is found to be quite difficult to locate the position of a towed mine over a submarine, especially if the submarine be continuing any but a straight course. The mine when towed also tends to rise and skim along the surface, and if exploded on top of the water, even though it were directly over the submarine, it would do little if any damage to her submerged at a normal cruising depth.

A third method proposed for active defense against the submarine is that two destroyers be sent out abreast pulling a drag between them with the intention of fouling the conning tower or periscopes of the submarine and upsetting her. Destroyers operating under this condition would however be placed at a very great disadvantage. In fact they would be virtually pulling a sea anchor, and it is certain that the destroyers in this case must be distinctly at the mercy of the submarine instead of being any particular menace to her.

A drag of any sort must necessarily alter considerably the speed of a destroyer as well as to put her at a great inconvenience and extreme disadvantage when maneuvering.

A method which is known to have been adopted by the English destroyers against the German submarines in the North Sea during the early part of the present war, was to fill the bottoms of the hulls of the destroyers

with a couple of feet of solid concrete and then attempt to run down or ram the submarines. At first the English destroyers did meet with some success by this method. By keeping a strict watch for the periscopes to appear and immediately running them down, they succeeded in sinking a small number of the German submarines.

The Germans soon put a stop to this however, by setting adrift in the proximity of the British fleet a number of imitation periscopes to which were attached contact mines. The destroyers after running down two or three of these masked mines with more or less disastrous results to themselves soon gave it up as a bad job.

The most practicable means for active defense, I believe, lies in a complement of several high speed launches. These small boats should have a speed of thirty knots or more and should have as little draught as is compatible with a fair degree of sea-worthiness, in order to make them practically immune from torpedo attack. They would be equipped with a special quick firing rifle of small caliber and powerful search-lights. Their duties would be essentially those of a patrol or picket boat.

Being practically immune from under-water attack they would scour the sea night and day for a chance shot at an appearing conning tower or hull. Enough of these inexpensive little boats would quite effectively clear a submarine blockade and prevent submarine raids upon merchant vessels plying in the well established routes of trade. The submarine must come to the surface sooner or later to get a fresh supply of air and for the purpose of charging her storage batteries, and must remain upon the surface some little time to do so. The time for doing this would naturally be at night, but if there are enough

of these small patrols in the vicinity it would not be long before one of them picked her up in the search-light.

The presence of the patrols, each patrol being assigned to cover a certain area, would keep the submarines under water except for very short intervals, and so long as they can be prevented from coming up long enough to charge their storage batteries they can remain in foreign waters only within the scope of their submerged radius of action, and this is very limited. The submarine attack would therefore be limited to quick raids which are no great menace to commerce, and cannot in any sense constitute a blockade. The ambushade of or the lying in wait for vessels would be quite effectively stopped, and it is only in this respect that the Germans have demonstrated any ability to prey upon commercial shipping. The above means of defense would of course be limited to the prevention of blockades, it would not be practicable for fleet maneuvers on the high seas.

Of late much has been said of the aeroplane as a means of fighting the submarine. Its value in this respect cannot be very great. In fact the chief attribute accorded it, ability to detect the presence of the submarine from its high vantage point, has been disproved by last winter's maneuvers in the Southern waters. At various times during the maneuvers, aeroplanes were sent aloft to try to locate the positions of the submarines but with no success.

The theory of dropping bombs upon the submarine from an aeroplane cannot be conceded as having any real value at all. Admitting for the moment, that by careful calculation of elevation and speed of the aeroplane, and consideration of gravity and effect of atmospheric con-

ditions upon the projectile, a bomb could be dropped so as to strike the water directly over a submarine, the force of its impact with the water must explode the bomb

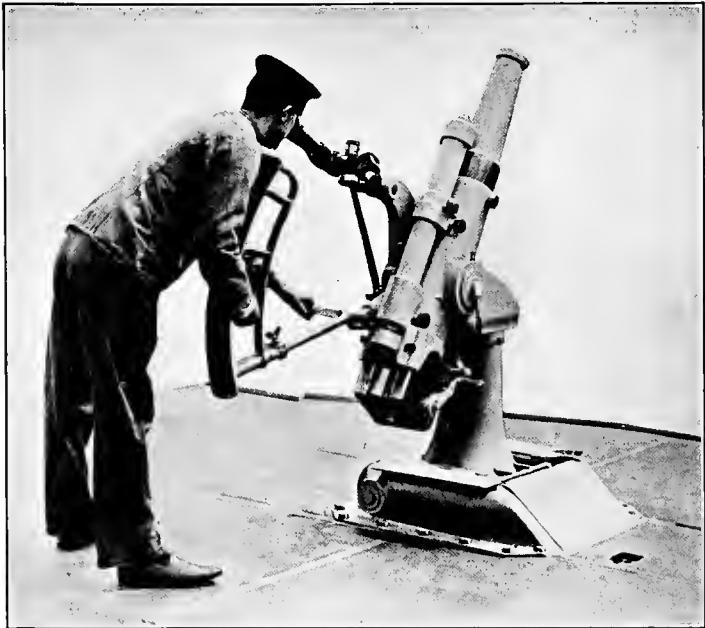

Photo-copyright, International Film Service

Submarine gun elevated for repelling attack by Aero-plane

practically upon the surface and do no damage whatever to the submarine. The probability of dropping a bomb with such accuracy is, moreover, very remote. Nor can much better results be expected from gunfire from the air. Unless the projectile was fired almost vertically downward, the force of the impact with the water would cause it to ricochet before it had penetrated the surface a foot. Even were the submarine upon the surface, the

aeroplane would offer an easier target to gunfire from the submarine than the submarine would in turn afford the aeroplane.

Another theory of using a contact mine suspended from an aeroplane by a wire is equally impractical. In fact the vibrations of wire and the resistance of the mine to passage through the air would set up such extreme gyrations as to make it almost impossible to strike any definite object at all.

The passive defense of bays and port entries may be successfully maintained in a number of ways. Primarily of course by mines arranged in rows across the mouth and entrance of the bay or harbor; although it has recently been demonstrated that the submarine is capable of both passing safely under the mines and of cutting them adrift from their moorings as well as to explode them by counter mining.

Various means for entanglements have also been suggested; such as stretching heavy fishnets at intervals, and in some cases by fastening small charges of gun-cotton to the nets, arranged with batteries and circuit closers so that they are exploded if a submarine becomes entangled in the net. Another scheme is to stretch spans of cable across the channel, supported at intervals by cork floats and weighted down at the ends to hold them in place.

After all then, it may be truthfully said that as yet we have been able to devise no adequate means of defense against the submarine. Some means have been suggested for defense of coast or harbor, but at sea so far the only means of defense seems to be in the superior speed of the surface craft.

That the submarine may wage war against submarine is quite possible but highly improbable, as it entails the almost certain destruction of both craft. No man has as yet been able to devise any means for penetrating the murky depths of the sea as far as vision is concerned, and it is this utter blindness under water that prohibits conflict of submarine versus submarine. Men have clashed before in utter blackness, however, and it may be that when put to desperate undertaking, some young daredevil will stake his own life and those of his crew upon the wheel of chance and tempt the fates with this new kind of warfare.

If this sort of conflict is ever resorted to, it will probably resolve itself into a jockeying for position on the part of the opposing commanders, with the purpose of each to get his opponent broadside exposed to a headon attack by himself and to ram. The opportunity for use of the torpedo would be practically nil under these circumstances and this weapon would probably be reserved for bigger game. Friend might be distinguished from foe by sound signals. This would of course betray the position of the submarine to its opponent as well, but sound signalling would undoubtedly be resorted to at intervals at any rate as a decoy to draw on the opponent; it naturally being the policy of the commander to change his position immediately a signal is sounded.

At the best this mode of fighting must remain an unsatisfactory sort of game of blind-man's-buff, and would not be generally undertaken at the present time. Future inventions for delicate and accurate direction indicators to be used in conjunction with magnetic or vibratory submarine sound receivers are quite possible

and if effected would do much to further this new sort of warfare. The Fessenden oscillator goes a long way towards this accomplishment even now, and is an indication of what might be expected in the future along these lines.

CHAPTER IX

TACTICAL EVOLUTIONS OF THE SUBMARINE

SUBMARINE warfare, like all other naval fighting, resolves itself into defensive and offensive operations.

The defensive operations of the submarine consist chiefly of the protection of harbors and the prevention of an enemy's fleet from bombarding seaports and from landing an invading army anywhere along the coast. The effectiveness of the weapon in this respect is a well demonstrated fact, but to successfully carry out a program of protection by its means, it is evident that with the extensive coast lines this country has, we must provide a considerable number of coast defense submarines for the purpose. These boats should be distributed in groups of six or eight at various bases along the coast and more particularly at points where it is considered essential for strategic reasons to concentrate defense.

These groups accompanied by mobile tenders should be located particularly at the strategic points as follows: On the East Coast at Eastport, Me., Portsmouth, N.H., Provincetown, Mass., Woods Hole, Mass., Newport, R.I., New York, N.Y., Delaware Breakwater, Norfolk, Va., Charleston, S.C., Key West, Fla., Pensacola, Fla., Galveston, Texas, and at the eastern entrance to the Panama Canal. On the West Coast at some port in Alaska, Port Townsend, Wash., Columbia River, Ore., San Francisco, Cal. (2 groups), Santa Barbara, Cal., San Pedro, Cal.,

San Diego, Cal., and at the west entrance to the Panama Canal. Also there should be a group stationed at the Hawaiian Islands, a group at Guam, and at least three groups among the Philippine Islands. This would call for a total number of some two hundred submarines of the coast defense type.

The offensive action or attack to destroy, involves problems new and more difficult, and here the province of the submarine is to destroy the fleets of the enemy and all vessels with which it attempts to carry on military operations; to make raids upon the enemy's shipping and ports, and to carry out an effectual blockade at all his principal harbors; and to constitute a supplemental arm to the battle fleet upon the high seas.

The ability to perform these functions calls for a somewhat different type of boat from the coast defense submarine, inasmuch as it must have a greater cruising radius, be more sea-worthy, and have a much higher surface speed to enable it to accompany without in any way hindering the evolutions of the fleet.

In the present European conflict the activities of the submarine have for the most part been restrained to what might be styled merely naval raids. There have however been several occasions in which they have taken no little part in the actual tactical evolutions of the opposing fleets. It was decidedly the presence of the German submarines which caused Vice-Admiral Beatty to discontinue the pursuit of the German battle cruisers *Seydlitz*, *Doerflinger* and *Moltke* in the second fight of the North Sea. It was a running fight in which the heavily punished German battle cruisers escaped by leading the British ships into a group of submarines, the mere sight

of which caused the English Admiral to quit the pursuit and seek safety for his own fleet.

On another occasion a British submarine is given the credit for disabling the German ship *Moltke* in the Russian

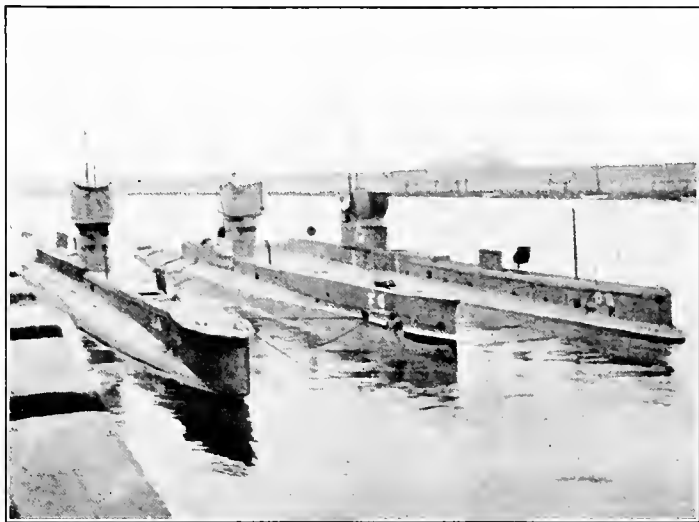

British Submarines E-4, E-9 and D-5

action in the Gulf of Riga, placing that vessel at the mercy of the Russian fleet and deciding the victory.

The English submarines were successfully employed as a barrier of protection strewn across the Channel during the transportation of troops to the shores of Belgium and France. Since then these submarines have been incessantly employed on the enemy's coast and in Heligoland Bight, obtaining and supplying the English fleet commanders with information regarding the composition and movements of the enemy's patrols. While engaged in

this work they have successfully outwitted well-executed anti-submarine tactics by torpedo craft and gunfire.

The British *E-9* succeeded in torpedoing and sinking the light German cruiser *Hela* in Heligoland Bight and escaping from a pursuing flotilla of German destroyers; on another occasion she successfully torpedoed the German destroyer *S-126* off the mouth of the Ems River while running at high speed. There is also little doubt that it is the menace of the submarines which caused the British main fleet to maintain its base remote from the North Sea, and at the same time it is unquestionably due to the presence of the British submarines employed in these waters and off the German ports that the immobility of the German battle fleet is in a great part responsible.

The earliest success of the German submarines was the sinking of the British cruiser *Pathfinder* while patrolling the North Sea at slow speed. Within two weeks after this the German *U-9* succeeded in destroying the *Hogue*, *Aboukir* and *Cressy* all within a few minutes of each other off the Hook of Holland. The attack was made just after daybreak when the *U-9* found herself confronted with these three cruisers all within 1,000 yards of each other and steaming along at about 7 knots an hour. Next, the *Hawke* was caught in the North Sea and the *Formidable* was sunk while cruising at slow speed and engaged in bombarding the Belgian coast. The English gunboat *Niger* was sunk, while at anchor, in the open roadstead of Deal.

The success of the Germans, it has been asserted, in the attacks upon the *Thescus* and the Russian cruiser *Pallada*, was effected by the use of a neutral flag. It was reported in each case that a merchant or fishing vessel

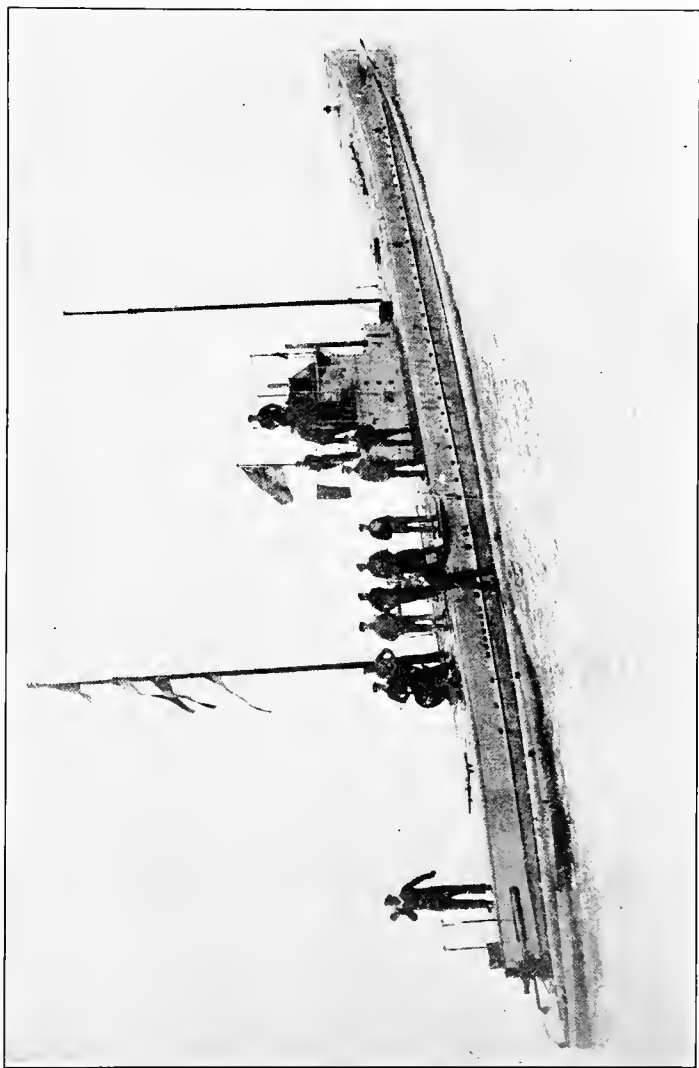

Photo-copyright, International Film Service

German Submarine U-28

flying the Dutch ensign was used as a decoy, enabling the German submarine to come up and discharge a torpedo at the cruiser when she was practically at rest. On the other hand, in their attacks upon the general shipping, the German submarines, unsuspected of being in waters so far away from their bases, were enabled to take up positions where previous reports indicated that the enemy's ships would be found, and arriving there, would come to an "awash" condition and wait for the ships of the enemy to appear, and then submerging would lie in wait for the ship to approach within effective torpedo range, or else would direct their courses so as to cross that of the enemy.

This method of attack will probably continue to be one of the main attributes of the offensive submarine in as much as it is one wherein the inherent qualities of this type of boat are particularly well suited. The part which the submarine will play in the actual tactical evolutions, however, will continue to grow and become of prime importance. The submarine will then have to be reckoned with, and safely, for the control of the seas must not be jeopardized by unnecessarily risking the loss of any capital ship.

In the Dardanelles, the German *U-51* after making a 2400 mile cruise from a base on the Belgian coast succeeded in sinking the *Triumph* and the *Majestic*. The French cruiser *Leon Gambetta* and the Italian *Guiseppe Garibaldi* were sunk by Austrian submarines in the Mediterranean.

The British *E-11* and *E-14* have also met with considerable success in the Dardanelles. The *E-11* after passing inside through 5 rows of mines sunk the Turkish *Messoudiyeh* in the Sea of Marmoro. She also chased a supply

ship and torpedoed her alongside a pier at Rodosto, and even entered the harbor of Constantinople sinking a transport alongside the arsenal. The *E-14* also accounted for a Turkish gunboat in her passage into the Sea of Marmoro. Inside she sank a transport on April 29, a gunboat on May 3, and a large transport loaded with troops on May 10, and chased a small supply ship aground on May 13.

The submarine has thus through its enterprise effectively hampered the operations of the capital ships, if nothing more.

DEFENSIVE OPERATIONS

The tactics of the submarine for harbor defense are simple. The waters outside of the harbor entrance are divided into zones so situated with respect to each other that they will effectually cover all approaches to the harbor. Each of the boats comprising the submarine flotilla which is to defend this particular port will be assigned by the flotilla commander to one of these zones. The boat will then take her position in the center of the zone assigned to her and at such a distance from the port as to prevent the enemy from ever coming within range of gunfire. Trimming to the "awash" condition and with radio up the submarine will here come to anchor and proceed to keep a sharp lookout for the enemy.

Outside of this line of defense, the destroyers or other scouts in touch with the movements of the enemy will keep the submarines apprised of his position and probable course by means of the radio. To facilitate the sending of warning signals, the sea within a radius of 150 miles will be further divided into districts blocked off into small squares designated by numerals, and the points of the compass given short code words to designate the course pur-

sued by the enemy. The warning would then consist simply of the number designating the position of the enemy and a code word giving his course.

Having received warning of the approach, the submarines will rig down the radio, pull up anchor, and make ready to submerge immediately that smoke is discerned on the horizon. After the enemy has appeared the submarines will remain stationary long enough to ascertain the speed, course, and formation he is following. The submarine nearest then starts out to meet him, exposing her periscope only just enough from time to time to enable her to correct her course. Once within easy torpedo range, she will continue to push in as close as possible with periscope continuously exposed just above the water and begin to open fire with her torpedoes. The other boats of the flotilla will close in behind the leader and direct their attack to other parts of the formation previously agreed upon.

For fear of disclosing their position to the enemy, no signals of any kind can be exchanged between the boats of the flotilla after submerging. Therefore very explicit instructions must be given the captains of each boat before taking up his position in the zone. These instructions must cover the general tactics to be pursued for every possible formation of the enemy and for his direction of approach. Each captain will carry out these instructions independent of each other, and must run the possible risk of collision until within easy range of the objectives. Once within this range, however, the submarine signalling bells may be kept constantly ringing to apprise each of the others' location and to prevent further danger of collision. From this point, too, warnings and instructions may be communicated from one boat to another.

Only a part of the boats comprising the flotilla should take part in the actual assault; the remaining boats to take up advanced positions in the zones so as to still effectively cover the approaches to the harbor.

After having fired all of her torpedoes, the submarine should continue the attack by ramming if possible. All her means of attack having been exhausted, the submarine must then return under water to her tender for a fresh supply of torpedoes and to have her batteries recharged. If she has not a sufficient residuum of current left in her batteries to make the return trip under water, she may rest on the bottom until nightfall, when she may come to the surface and proceed back to her base under her internal combustion engines and charging her storage batteries on the way.

Four or five submarines with a total of sixteen or twenty torpedoes fired as a first load should, when attacking in this manner, be able to do for six or seven ships at least. Enough damage would be inflicted to cause the enemy to turn from his present purpose at any rate.

With the usual four bow tube arrangement and by using the eighteen inch gyroscopic controlled torpedo, the most effective system of firing to be pursued would be to fire two torpedoes straight ahead, and to fire the other two, one off either bow by adjusting the gyroscope to cause the torpedo to take a course a certain number of degrees from the straight course pursued, sufficient to compensate for a probable error in the estimation of the range, speed and course of the target. Under these conditions it is almost certain to land one of the torpedoes in its mark.

An error of one knot in estimating the speed of the target will cause a difference in position of one hundred and one

feet for every minute elapsed between the instant of firing the torpedo and the instant at which it crosses the path of the objective. The radius of the circle of visibility with the periscope exposed three feet above the surface of the water is 4000 yards. At this range it would take about five and a half minutes for the torpedo to reach the target, and therefore even were all the calculations correct, it would still be highly improbable that a successful hit be made, for in so long an interval of time it would be possible for a ship to both considerably alter her speed and her course.

The speed of the target may be solved mechanically by measuring the angles of her image in the periscope, with respect to the course held by the submarine, at certain intervals of time and by plotting these points on a specially constructed scale. This method would be only approximate however, as it depends for its accuracy upon the definite range of the target. At long ranges this error might be considerable.

At 1000 yard range the conditions are much more favorable for a successful hit. In this case the time elapsed between the discharge of the torpedo and the instant of its interception with the course of the objective is about one minute. An error of two knots in the estimation of the speed of a 600-foot ship would, providing all other calculations were perfect, still offer favorable chance of a hit. Other errors might creep in however, and therefore it is well not to disclose the position of the submarine by opening fire until within about eight hundred yards of the quarry. This might be considered easy range and in any event there would still be opportunity to send another torpedo from a practicable range should the first one miss.

In the following diagrams are shown the effectiveness of the torpedo at different ranges, the limit angle for effective firing from easy range, and the effect of errors in the estimation of the speed and the course of the enemy.

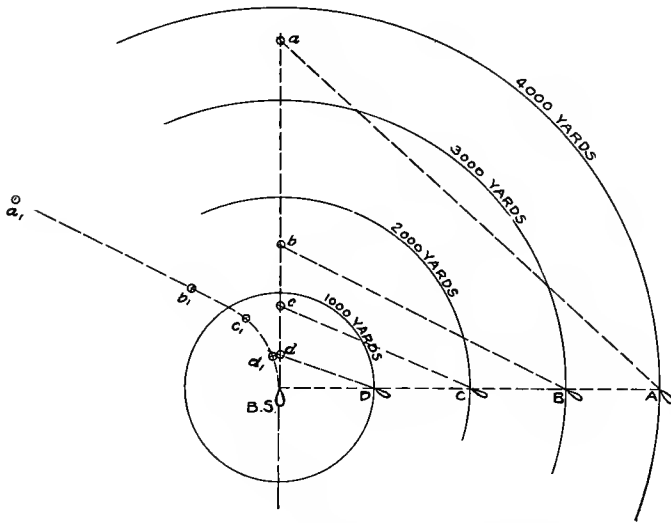

Effectiveness of torpedo fire from various ranges

a	=	calculated	position	of	ship	@	4000	yd.	torpedo	interval				
b	=	"	"	"	"	"	3000	"	"	"				
c	=	"	"	"	"	"	2000	"	"	"				
d	=	"	"	"	"	"	1000	"	"	"				
a ₁	=	actual	position	of	ship	@	4000	yd.	torpedo	interval	by	change	of	course
b ₁	=	"	"	"	"	"	3000	"	"	"	"	"	"	
c ₁	=	"	"	"	"	"	2000	"	"	"	"	"	"	
d ₁	=	"	"	"	"	"	1000	"	"	"	"	"	"	

For night work the submarines remain on the surface and pursue tactics similar to those of the surface torpedo craft. It has been satisfactorily demonstrated in many maneuvers at night that it is extremely difficult to make

out the low hull of the submarine even when in the full glare of a search-light; and by submerging when coming in contact with them, it is a very easy matter to get through the line of the enemy's scouts and pickets.

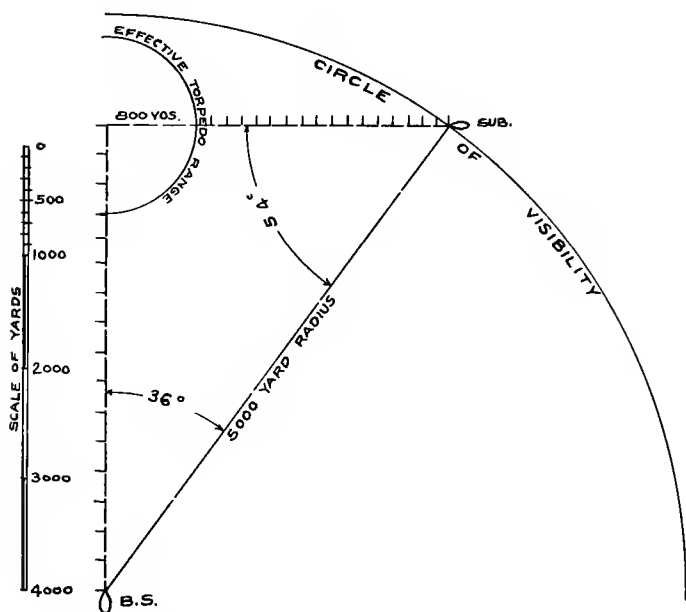

Diagram showing limit angle of effective submarine attack

When: Speed of battleship is 18 knots, and
Speed of submarine is 8 knots

In this respect the tactical capability of the submarine has a direct bearing upon the strategy of the blockade. The usual formation for a blockade is for the battle fleet to take a position in daytime about twenty-five miles off shore at the entrance to the blockaded port with scouts and pickets disposed at intervals shoreward. With the

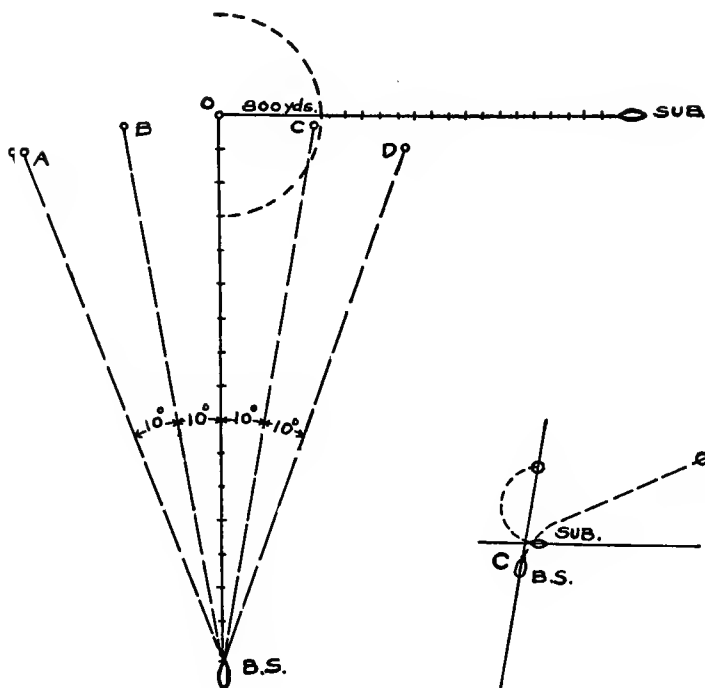

Fig. A

Fig B

Diagram showing effect of error in estimating the direction of the enemy's course

- A. Error 20° , B.S. 2400 yds. off. No shot.
- B. " 10° , " 1600 " " Poor chance.
- C. " 0° , " 800 " " Good shot.
- C. " 10° , Sub. comes up ahead of B.S. and has to come about. Turning circle not less than 500 yds. B.S. sights Sub. and changes course. When Sub. has completed turn, B.S. is at C_1 , (See small Fig. B), 1400 yds. off. Shot improbable.
- D. Error 20° , Sub. comes up ahead and 700 yds. beyond B.S. No shot.

oncoming darkness of night the battle fleet draws off to some distance farther seaward, say what would be an eight hour steaming distance for a destroyer making the round trip, to prevent the possibility of being attacked by destroyers which might find their way through the line of pickets. It has however, been found to be very difficult for the destroyers to find the darkened ships of the battle fleet at night even when their general position is known. The submarines would therefore, after eluding the enemy's pickets, pass out and take a general position around that of the daytime position of the enemy's battle fleet, submerge there and wait for its return at daybreak.

The tactics for the coast defense work of the submarine are essentially the same as for harbor defense except that the operations are performed on a broader basis.

Having received word that the enemy is approaching the coast, the submarines will proceed at their highest speed in column and "awash" with the purpose of intercepting his course. The submarines will be able to distinguish the smoke and masts of the hostile fleet long before they themselves can be seen. Upon sighting the masts of the enemy the submarines will remain upon the surface long enough to determine his course and speed, and then the entire group will immediately submerge and proceed in a fan shaped formation in his general direction.

The speed to be maintained and the general instructions to be followed would be given out by the flotilla commander before submerging. The substance of these instructions should be such as to enable the submarines to reach a position on either bow of the enemy's column before being discovered, and thus subject him to a cross-fire and prevent any concerted maneuver on his part.



Photo copyright, International Film Service

Submarine H-3 coming to the surface after a submerged run during maneuvers off San Pedro, Calif.

The approach would be with only an occasional exposure of the periscopes until within torpedo range, when the attack should be continued with periscopes exposed just enough to keep a constant bearing on the enemy and all speed possible maintained until within easy firing distance. Each submarine having fired its first salvo of torpedoes, will submerge, reload as quickly as possible and return to the attack. After exhausting every means of doing the enemy damage, they withdraw submerged to their base or lie in wait under water as before until nightfall.

OFFENSIVE OPERATIONS

The offensive operations of the submarine will devolve almost entirely upon the large sea-going type of boat.

These operations may be distinctly classified under three heads; namely, the maintenance of blockades, the prosecution of naval raids, and participation in the actual tactical evolutions of the battle fleet.

In the first instance, a group of submarines would be stationed outside the entrance to the principal ports of the enemy and would patrol its waters to effectually prevent the exit or the entrance of any ship. It would also be within the province of the submarine to drag for or otherwise destroy any mines with which the entrance of the harbor might be strewn, and having once cleared the channel, to proceed inside the harbor and destroy whatever war vessels or shipping was found there.

To maintain the blockade for any length of time it would be necessary to have stationed at some known location and within easy steaming distance, a tender or other supply ship, in order that the submarines could work in relays — a part of them always being on duty while the

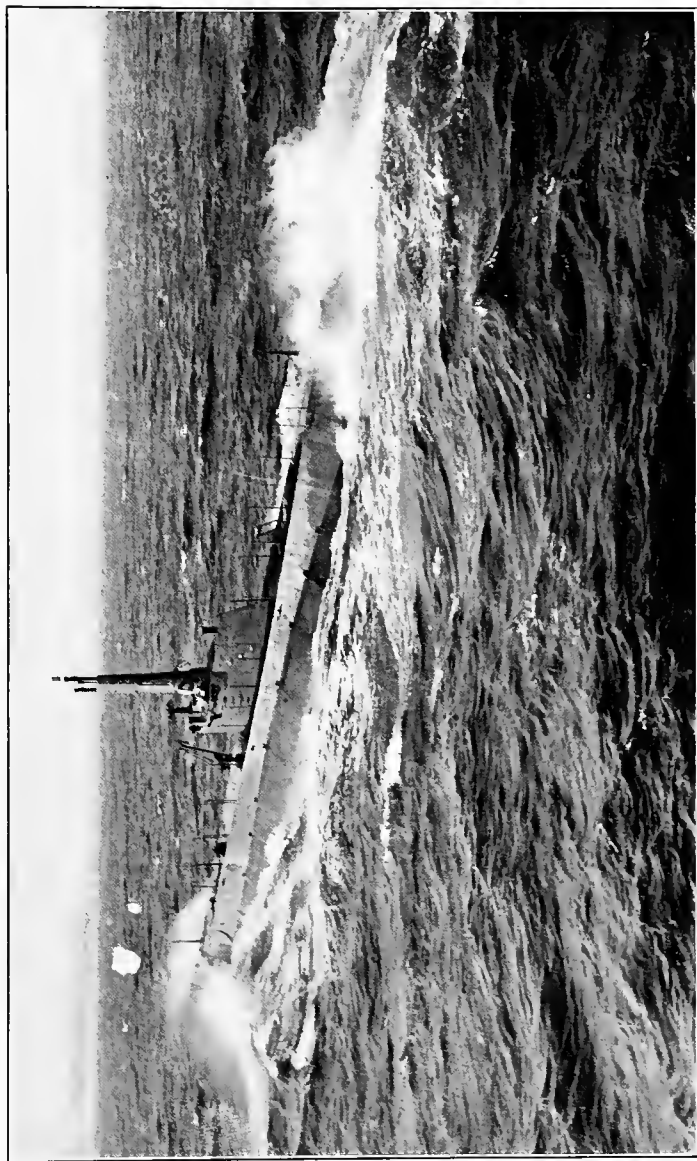

Photo-copyright, International Film Service
Submarine K-5 at full speed on the surface, with decks cleared ready to submerge. War condition

others were receiving fresh supplies from the tender. The constant vigil, monotonous routine, and the nervous strain of blockade duty, together with the extreme hardships — for the submarine in this role would be forced to spend the greater part of the time under water — would exhaust the crew when on this duty probably quicker than would any of the other roles of the submarine. Therefore it would be well to change crews every time the boat was forced to go to the tender for supplies. It would be an easy matter to train an extra crew for each boat, and not at all a difficult matter to find room for them on board the tender.

In the role of the raider the submarine would proceed to sea in the surface condition. Her purpose would be to discover all the information regarding the enemy's disposition and composition that she could and to prey upon any ship of the enemy she could find. The commanding officer would be given instructions to proceed to sea for a certain length of time and to keep within a certain general locality. Her operations would be independent of any other craft, and would combine to a certain extent those of a surface cruiser with those of the underwater craft.

Catching sight of smoke or a mast on the horizon, she would immediately submerge and strike a course so as to intercept the vessel seen. If upon drawing into range the vessel was found to belong to the enemy, and engaged in carrying on military operations, the submarine would proceed with attack as described for the coast defense boats.

In conjunction with the activities of the battle fleet, the problem of maneuvering the submarines must be solved

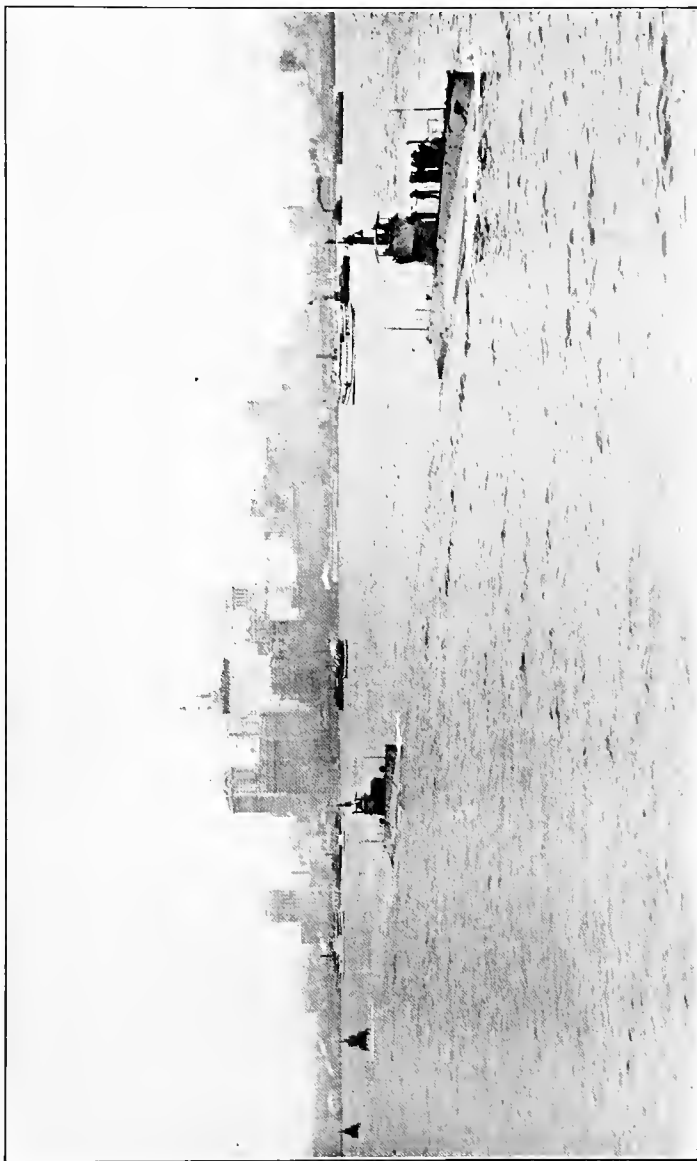

Photo-copyright, Underwood and Underwood

Submarines proceeding in column formation, surface condition

by the commander-in-chief. The strategy involved will be to dispose of them in such a manner as to enable the subsequent evolutions of the fleet to draw the enemy up to within range of their position.

The tactics of the submarine after contact with the hostile fleet will be practically the same as for the coast defense work. It will be the chief duty of the flotilla commander to get all of his boats into contact with the enemy at the same time. After this it is up to the individual captains of the several boats to carry out the successful maneuvering of their own vessels.

In the cruising formation the submarines would be disposed on either flank of the fleet. Immediately the enemy was sighted they would be trimmed to the "awash" condition and ready for instant use. The commander-in-chief of the fleet having decided upon his plan of action, would then order the submarines submerged and send them off in a certain direction and endeavor to draw the enemy across their zone of fire by his evolutions with the fleet; or he may decide to divide his submarines into two divisions, sending them out in different directions, and endeavor to entice the hostile fleet between the cross fire from them.

The duty of the submarines would be to get into easy range of the hostile fleet as quickly as possible and open fire on them. But at the same time they must not in any way interfere with the movements of the capital ships of their own fleet.

The ensuing evolutions of the battle fleet will depend upon the comparative speed, rifle range, and strength of the enemy, and must be carried out with due cognizance of a possible danger of being drawn into torpedo range

from submarines which might be accompanying the enemy. Should the enemy be accompanied by submarines the advantage will manifestly be upon the side possessing the submarines having the greater under-water speed.

CHAPTER X

THE TORPEDO

AFTER all is said and done about the submarine boat, the fact remains that without the modern automobile torpedo it becomes valueless as an instrument of warfare.

In 1864 Captain Lupuis of the Austrian Navy conceived the idea of a new form of destructive engine to be used in naval warfare. The proposed weapon was a very crude affair resembling a small surface boat in shape, which was to be driven by a propeller turned by clock work from within and guided by means of ropes from the shore. The fore part of the little boat was to carry a heavy charge of gunpowder which was to be exploded by a trigger device operated by a contact spar fitted to the bow. When the spar struck the side of a ship the impact would pull the trigger and explode the charge.

The only bit of importance attached to this device however, is that in its conception Captain Lupuis consulted Mr. Robert Whitehead, an English civil engineer residing in Fiume, Austria, about some of the mechanical problems involved. The idea brought to Mr. Whitehead in this way without a doubt was the first occasion that he had ever given thought to such a device. His imagination was set to work though, and after about two years he built his first torpedo, which was made of boiler plate, carried eighteen pounds of gun-cotton and had a speed of six knots for a very short distance. It was the forerunner of

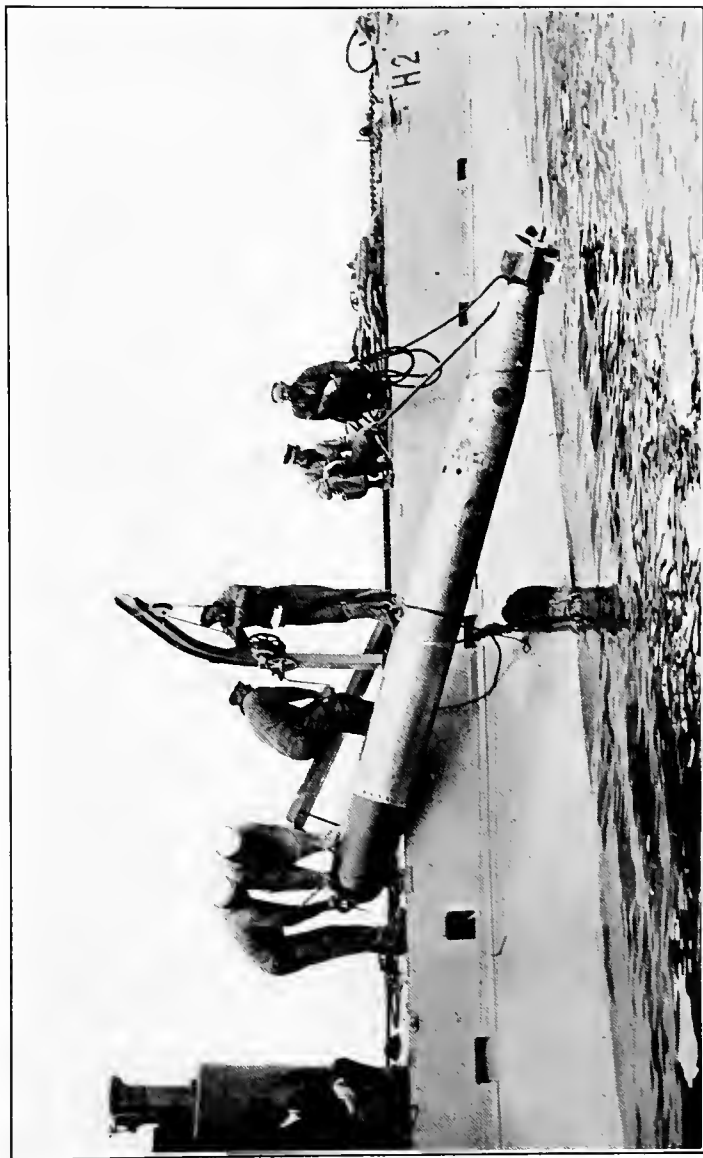

Photo-copyright, International Film Service

Hoisting on board a spent torpedo after practice

the present automobile torpedo, with its speed of thirty-five knots and its 4000 yard range.

There are several makes of torpedoes on the market at the present time, all of them having practically the same characteristics and construction. The torpedo itself is divided into sections. The forward one contains the explosive charge and the firing pin. When the head of the torpedo strikes a ship or any other rigid object the firing pin or plunger is driven against a percussion cap containing fulminate of mercury and situated in the center of the bursting charge. The explosion of this cap detonates the high explosive contained in the chamber with sufficient force to rupture the plating of any battleship and in all probability to cause her magazines to explode. In order that no accident might occur the firing pin is normally held away from the percussion cap by a spring and a lock device consisting of a collar which is fixed to the pin outside the nose of the torpedo. This collar is fitted with pitched blades which cause it to revolve when passing through the water and thus releases the firing pin from its restraining action after running twenty-five or thirty yards upon its course.

For practice firing the above described loaded war head is substituted by a collapsible dummy head. This dummy head has the same weight and appearance of the war head but is made of thin soft metal so that it collapses on striking and thus proves a hit. It contains no explosive.

The section immediately abaft the head is the air flask, which is charged with air compressed to about 2200 pounds per square inch. The mechanical energy contained in the compressed air serves to drive the torpedo. The tank will hold enough air to drive the torpedo 4000

- 1. Safety Catch.
- 2. Firing Pin.
- 3. Percussion Cap.
- 4. Explosive.
- 5. Air Flask.
- 6. Immersion Chamber.
- 7. Hydrostatic Valve.
- 8. Pendulum Weight.
- 9. Driving Engine.
- 10. Tripping Valve.
- 11. Gyroscope.
- 12. Propeller Gears.
- 13. Steering Rudders.
- 14. Propellers.

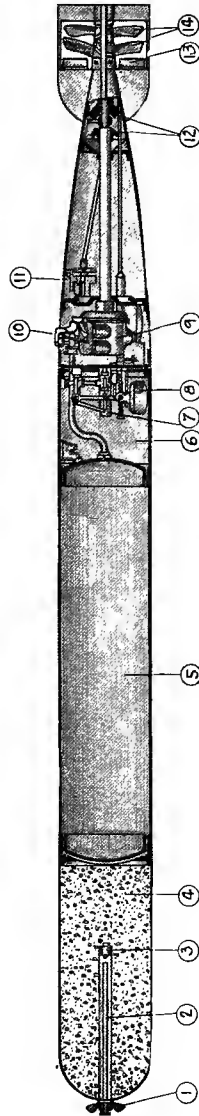

Cross-section through a modern automobile torpedo

yards at a speed of 28 knots or 2000 yards at a speed of 38 knots.

Next abaft the air flask is the immersion chamber. In this chamber is contained the very delicate apparatus for controlling the depth of the torpedo. It is an ingenious combination of a hydrostatic piston and a pendulum weight in mechanical connection with a horizontal rudder at the tail end. The operation of the pendulum and the piston working together is such as to counteract a too violent action of either acting individually. By this mechanism if the torpedo gets below its adjusted depth, sea pressure acting upon the hydrostatic piston causes it to push in, throwing the rudder to a "hard up" position which immediately brings the nose of the torpedo up; but this upward movement of the nose causes the pendulum to swing aft, and the moment of its weight acts directly in opposition to the hydrostatic piston and neutralizes its effect to the extent that the torpedo assumes a gentle and not too abrupt rise; otherwise it would probably jump out of the water. The control in a downward direction is effected in the same manner but with the operations reversed. The depth of the immersion of the torpedo is adjusted by a tension nut acting on a coil spring attached to a hydrostatic piston. The tension caused by this nut is carefully calibrated by experiment so that to change the adjustment for depth it is only necessary to turn the nut until it intercepts one of the graduations. The operation of the rudder itself is controlled by a steering engine which is in turn controlled by a valve actuated by the hydrostatic piston.

The driving engine is contained in the next section abaft the immersion chamber. Formerly the Whitehead tor-

pedoes were fitted with small three cylinder single acting engines, the cylinders being arranged about the crank shaft radially. It is believed now, that since the Bliss-Leavitt people of this country have adopted the turbo-

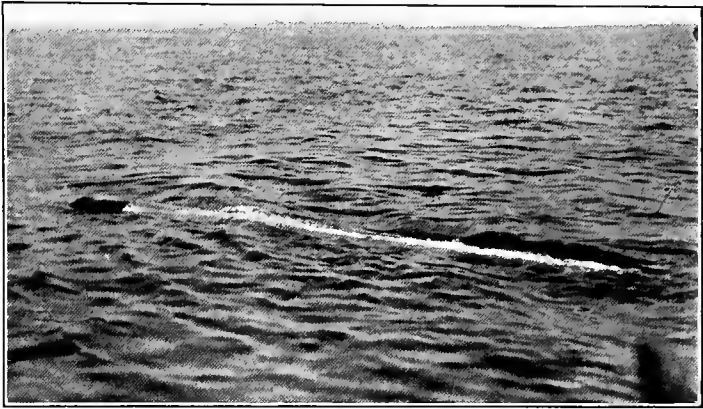

Photo-copyright, International Film Service

Spent torpedo coming to the surface

motor for propulsion, the Whitehead people have done so too. The engine—both types are similarly connected—is connected to the air flask by piping in which are placed two valves. One of these is a shut-off valve which is opened by a wrench before the torpedo is placed in the launching tube ready to be fired. The other is an automatic valve which is opened by a tripping device as the torpedo leaves the tube. A lever from the valve projecting above the torpedo, by striking against the projection in the tube is thrown back and the valve opened. There is a further lever however, which must be thrown down before the engine can start. This is actuated by the resist-

ance of the water after the torpedo has left the tube, thus preventing the racing of the engine.

In the early torpedoes, in fact until quite recently, steering in a horizontal plane was effected, or rather the torpedo was kept on a horizontal course, solely by the action of oppositely revolving propeller blades. This was effected by two propellers placed tandem at the tail, the after one being keyed to the engine shaft and the forward one being keyed to a loose sleeve fitted on the shaft and driven in an opposite direction by means of a set of bevel gearing. The necessity of having two propellers working in opposite directions arises from the thrust or tendency of a propeller to throw itself away from the direction in which it is revolving. Fixed vanes or guides were also provided at the stern. These were not however to steer the torpedo but rather to effect a steadiness, and tend to keep the torpedo on a straight course.

In actual practice though it was found that no matter how carefully the torpedo had been tested and balanced it would behave in a very erratic manner when fired. Instances have been known when the torpedo would run a certain distance and then swerve to the right or left or perhaps dive to the bottom. In fact the writer has seen them perform a complete circle, coming back like a boomerang and hitting the side of the ship from which they were fired.

No practicable remedy was found for this objectionable feature until the advent of the gyroscope. Now by means of an ingenious device known as the Obry gear, acting in conjunction with rudders placed at the stern, the torpedo is steered in a horizontal plane just as is a ship. By the use of the Obry gear the torpedo can now be held true to

a course, the direction in which it is first aimed from the launching tube, or the gear can be so adjusted that the torpedo can be fired in one direction and after running a certain distance the gyroscopic influence of the gear acting on the rudders will cause it to take up and continue an entirely different course.

This can be better understood by a short description of the gyroscope which is the essential part of the Obry gear. The principle of the gyroscope is that a flywheel which is spinning with a high momentum in a certain plane has a very strong tendency to continue spinning in that plane and to resist any effort to turn it into another plane. The actuating force of the gyroscopic flywheel is given by the tension of a very strong coil spring, or as in some of the most recent designs by a small electric motor. The axis of the gyroscopic wheel being once placed in a fore and aft direction in the torpedo and the spinning set up, no matter how it turns to right or left the spinning gyroscope, by its inherent directive force, built up of a composition of centrifugal force and gravity, will cause the torpedo to turn back to its original course. If we wish to send the torpedo in a direction different from the direction of the launching tube, the gyroscope is turned into the plane of the direction in which it is desired the torpedo shall run and the spinning of the flywheel started. The action of the gyroscope upon the steering rudders is then such as to cause the torpedo to be swung into the desired direction and held there.

The importance of this latter method is shown by the method of attack of a destroyer, the tubes of which are situated on the main deck well amidships. In making a head-on attack these tubes are swung diagonally across

the beam of the ship so as to discharge off either bow. The gyroscopes are first started to spin in a direction in the plane of the target and the torpedoes fired. The directive force of the gyroscope acting on the steering rudders brings the course of the torpedo back into the direction of the target after a short run. It will easily be seen that by this system of angular firing, torpedoes fired simultaneously off each bow will cover a considerable front of the enemy and will therefore afford better chances of making a hit.

Another device of some importance which has lately been fitted causes a valve to open after the torpedo has run a certain distance, flooding the after compartment and causing the torpedo to sink. This is done so that if a loaded torpedo has been fired and failed to hit its mark and explode it will not be left floating, a menace to friend as well as to foe.

All the latest torpedoes are equipped with means of heating the compressed air stored in the flask before it reaches the engine. The heater is situated in the air passage between the reservoir and the engine and is automatically lighted as the torpedo is discharged. The heating of the air greatly increases the efficiency of the torpedo as anyone who is familiar with compressed air phenomena will understand. By its means both the effective range and the speed of the torpedo have been materially augmented.

The new 21" hot air torpedo manufactured by the Bliss-Leavitt Company in Brooklyn has an effective range of 10,000 yards and a maximum speed of 43 knots per hour, and will carry about 500 pounds of high explosive. So we see that from a machine of a doubtful 800 yard range and a speed of 8 or 10 knots the torpedo has become a weapon

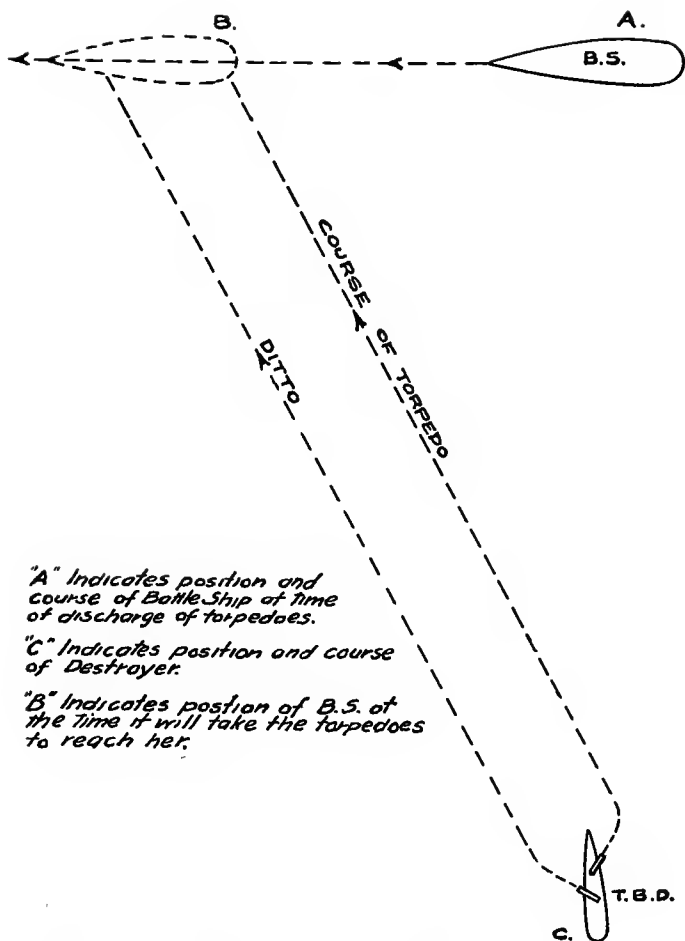

Diagram showing course of torpedoes set for angle firing in head-on attack

of most formidable accuracy and destruction. The latest fruition in this particular field is the Davis armor piercing torpedo. The salient feature of this new torpedo is that instead of just the ordinary explosive charge in the head it contains also what is in reality a gun barrel loaded with an explosive projectile. Upon striking a ship, the contact



Torpedo with lance-head fixed for cutting through nets

fires this gun as well as the bursting charge and discharges the projectile right into the bowels of the ship where it in turn explodes.

The cost of the present 18" torpedo is about \$5,000, and of the big new ones about \$7,500. The United States Naval Torpedo Station at Newport, R.I. is at work perfecting a new torpedo of long range and high speed which is said to exceed in these respects anything yet attained. At any rate it is quite certain that the torpedo has reached a state of perfection in this country equal to any torpedo found aboard. And in case of necessity, with the Government shops at Newport which are undergoing extensive enlargements, and the shops of private concerns, we are quite well equipped to turn out torpedoes in large quantities, even though it does take considerable time for their manufacture.

CHAPTER XI

TENDERS AND SALVAGE SHIPS

UNTIL the last few years very little attention has been paid to the requirements for adequate tenders for the submarines. In fact until very recently this Government has requisitioned for this service all the old monitors and other obsolete craft which were only makeshifts at best and not at all suited for this purpose. It is only within the last year that a ship, the *Fulton*, especially designed for this service has been launched. There are now however two other mother-ships for submarines of the same type under construction.

The function of the mother-ship is to provide a mobile base, one for each group of submarines, with all equipment for properly caring for her charges. She must accompany them on all expeditions and be ready to stand by and give assistance should anything go wrong.

Her equipment consists of suitable large air compressors and electric generators for charging the air flasks and storage batteries respectively of the submarines, and she must have every facility for making any necessary repairs to the machinery and equipment of the submarines for which occasion might arise.

She furnishes living and messing quarters for the crews of the submarines, except when the submarines are actually en voyage, and also carries extra fuel, spare parts for the machinery, and spare torpedoes, the very limited amount

of space on board the submarines themselves preventing the stowage of these articles there.

France, Italy and Germany all have vessels especially fitted for this purpose. All are more or less equipped with extravagant devices of various kinds for the purpose of

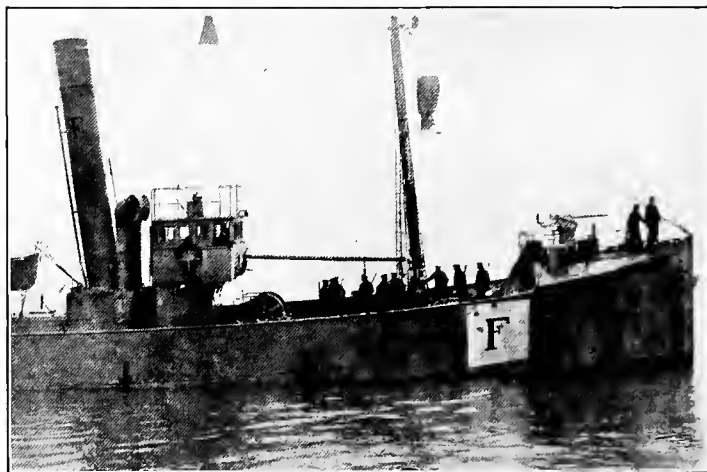

© *Int. Film Service Co.*

A type of German tender and fuel ship being used as a base for submarines in the present war

carrying out salvage operations as well, should any of the submarines meet with serious accident causing her to sink and be unable to rise again by her own efforts.

Indeed in France the Schneider Works went so far as to construct a number of vessels to be employed solely in transporting submarines. These "kangaroo" vessels were so constructed that several of the bow plates could be removed and the submarine floated into a circular tank built into the hold of the vessel. After the bow plates were replaced the water was pumped out of the tank,

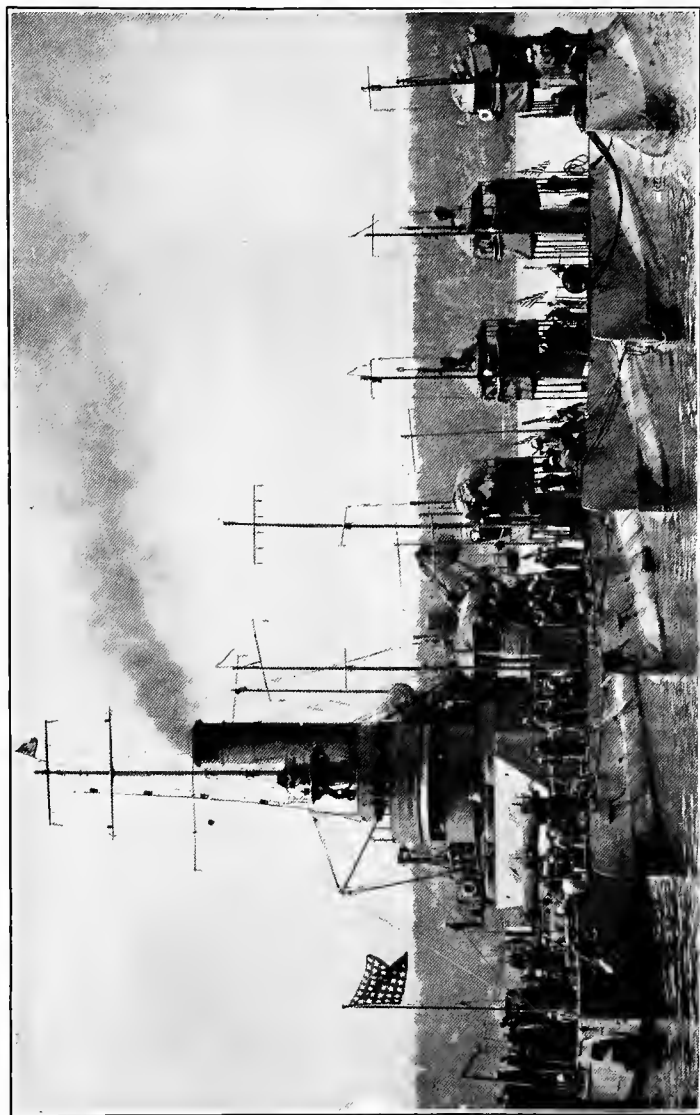

Photo-copyright, Underwood and Underwood
Monitor "Tonopah" being used as a mother-ship for the 2nd submarine flotilla, consisting of D-1, D-2, D-3, E-1 and E-2

leaving the submarine high and dry, and the vessel was ready to go on her way. The original purpose of the design was to build a vessel in which submarines built in France could be transported over seas to foreign countries for which they were built, and in cases where the trip would be too perilous or long for the submarines to make themselves.

The Fiat San Giorgio Co. in Italy, not long ago completed a model tender and salvage ship combined, and which is in reality a dry dock vessel as well. The vessel in question is a good sized craft having a normal displacement of about three thousand tons, and has twin screws each being driven by a Diesel engine developing about fifteen hundred brake horse power. She is capable of a sustained maximum speed of fourteen knots per hour, and at an economical cruising speed of ten knots per hour has sufficient fuel tank capacity to give her a cruising radius of four thousand miles.

This new craft is at once a supply ship, a repair ship, a dry dock, a salvage ship, and also provides adequate berthing and messing quarters for all the crews of the submarines comprising her particular flotilla. She is capable of lifting one of the submarines from great depths if at any time it becomes necessary, and transporting the injured vessel into port or to some beach where necessary repairs can be made.

This vessel is well equipped with every means for supplying her charges with compressed air and for charging their storage batteries, and carries on board enough reserve accumulator cells to completely outfit two submarines in a few hours time. There is a well equipped machine shop and foundry on board with every facility for making all



French submarine, Laubocuf type, making ready to enter "Kangaroo" ship



Submarine entering through the open bow construction

ordinary repairs, and in addition to this she carries in storage a supply of extra parts and fittings for each boat of her flotilla. She also carries a considerable supply of fuel oil for the submarines and thirty-six spare torpedoes. Besides quarters for a complement of 131 men and ample

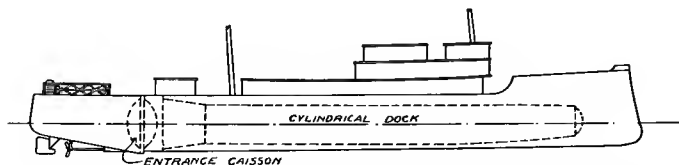

Type of Italian "Mother" and drydock ship for salvage and repair of submarines

accommodations for all the crews from the submarines there is provided a commodious and extremely well equipped sick bay.

The testing and dry dock feature of the ship is attained by having a cylindrical steel caisson constructed within the outer hull of ordinary ship form. The cylindrical section has an overall length of two hundred and ten feet and a diameter of twenty-three feet which affords sufficient space for conveniently docking and repairing a submersible one hundred and ninety feet long. The submarine is floated into the dock through a movable caisson fitted to the after end of the cylindrical section. The ship at this point is built with two extended sterns or pontoons with the caisson lock entrance between, or in other words like a catamaran. This way of constructing the entrance to the dock permits the forward end of the cylinder to be permanently sealed and therefore enables the vessel to retain the ordinary bow form. In fact she retains the ordinary ship form of construction way aft to the entrance caisson.

For salvage work there are fitted several powerful cranes and windlasses perfectly capable of lifting 1500 to 2000 tons of dead weight. There are also supplied two specially designed diving boats, and all the necessary diving apparatus and equipment for wrecking work.

The tender is further provided with a rather formidable armament comprising a number of six inch quick firing rifles and torpedo tubes, and is quite capable of repelling the attacks from any of the ordinary light craft. Any of the submarines which are temporarily out of commission are thus afforded excellent protection under her wings. A submarine tender of this sort is well named the mother-ship.

CHAPTER XII

LIST OF ACCIDENTS

DURING the development of the submarine boat there have occurred from time to time a number of serious accidents in which the submarine has taken its toll of human life just as have most other new scientific developments.

The greater number of these casualties took place in the early years of experimentation and were due for the most part to faulty design and indeed to the lack of engineering knowledge on the part of those concerned. When it is remembered that men from almost every walk of life, doctors, farmers, shoemakers, and even priests, have at one time or another been seized with the idea that they alone have conceived the acme of submarine invention, it is to be wondered at that there were not even more fatalities.

Since the period of systematic and sane development began, when it was taken up by practical engineers and naval men, there have been relatively very few serious accidents. The accidents which have occurred since that time have been more or less unavoidable in character and have been due to many different causes.

Following is a list of the more serious accidents which have befallen submarines in the service of the navies of the world.

1864. Confederate submarine *Hunley*. Operated by steam engines and unable to submerge, was swamped at 4 different times by seas entering open hatch and crews lost. Was raised after each

- accident and again put in commission. Finally destroyed by explosion of own torpedo while ramming and sinking the *Housatonic*. All on board lost. Total loss of life on this boat 32.
1887. *Nordenfeldt III*. Russian submarine wrecked on the coast of Denmark. Boat unseaworthy and lacked stability.
1901. *Triton*, French diving submarine, loss of control while plunging and struck bottom causing considerable damage. Saved by release of drop-keel.
1902. *Fullon*, United States, explosion of battery gases ignited by electric spark. 4 injured.
1903. *A-1*, English, explosion of gases caused by sparking motor. 6 injured.
1903. *Narval*, French submersible, collision with tug boat due to a misty periscope. Saved by double hull construction.
1903. *Silure*, French submersible, collision and severely damaged, but saved by release of drop-keel and able to reach shore before foundering.
1904. *A-1*, British, sunk by collision with steamer. Caused by faulty periscope. 13 lives lost.
1904. *Porpoise*, United States, leaky main ballast valves caused boat to sink in 125 feet of water. Raised after a few hours, no serious damage done.
1904. *Shark*, United States, same cause, sank to depth of 40 feet but immediately brought back to the surface before she had reached the bottom.
1904. *Delphine*, Russian submarine, trimmed too low in the water with the hatches open, swells from passing steamer entered sinking her with all on board. 23 lives lost.
1905. *A-5*, British, boat filled with gasoline vapors when filling tanks through carelessness of open vents, electric spark from switch caused ignition and explosion. 4 killed and 7 injured.
1905. *A-8*, British, suddenly plunged while running upon the surface and filled through open hatch. Caused by lack of longitudinal stability and exceeding the critical speed. 15 lives lost.
1905. *Farfadet*, French submarine, foundered by water entering open hatch of conning tower. Sunk to the bottom and became buried in sticky mud, making it very difficult to raise her. Imprisoned crew answered divers signals 32 hours after boat sunk. 15 lives lost.
1905. *Anguille*, French, explosion from unknown cause when no one was on board. Damaged vessel's machinery.
1905. *Gymnote*, French submarine, explosion of battery gases. 2 injured.
1905. *A-4*, British, sank through water entering through open ventilator. All saved.
1906. *Lutin*, French submarine, sank stern first while maneuvering, unknown cause. All on board lost, 14.

1909. *Foca*, Italian, explosion of gas caused by sparking of motors. 13 lives lost.
1909. *Kambata*, Russian, sank. 20 lives lost. Collision with battleship.
1909. *C-11*, British, collision at night. 13 lives lost.
1910. *No. 6*, Japan, sank through water entering by leaky main valve. All on board lost, 14.
1911. *U-3*, German, sank. 27 men on board, all but 3 escaped through torpedo tubes. Ventilator left open.
1912. *A-3*, British, lack of stability, boat swamped. 14 lives lost. Collision.
1912. *Vendémaire*, French, sank. All on board lost, 24. Ran down while emerging.
1912. *B-2*, British, sank. 15 lives lost. Collision at night.
1912. *F-1*, United States, washed ashore in severe storm at Watsonville, California, considerable damage to hull and interior of boat by leaking acid from the batteries. Caused by insufficient and faulty moorings. 2 lives lost.
1913. *E-5*, British, battery explosion. 3 killed.
1913. *C-14*, English. Ran into by lighter and sunk. No one lost.
1914. *A-7*, British, lack of stability and reserve bouyancy when exceeding critical speed caused boat to plunge. All lost.
1915. *F-4*, United states, sunk in 400 feet of water while maneuvering. Cause unknown but it is believed that the entire crew was incapacitated immediately accident occurred inasmuch as no signals were sent out nor position marker buoy released. Probable cause battery explosion. It was days before the boat was located and will be very difficult to raise on account of the great depth at which she lies. The first serious accident in the United States Navy. 22 lives lost.

CHAPTER XIII

SUBMARINE MINES

LIKE the submarine torpedo boat, the conception of the submarine mine dates back a great many years.

The first recorded use of this sort of engine of destruction was in 1585 at the Siege of Antwerp, when floating mines of a kind were used quite successfully against the Spaniards. These so-called mines were in reality small boats carrying heavy loads of gun-powder which was covered over with pieces of timber and weighted down with good sized chunks of iron and rock. After lighting a slow burning fuse leading to the powder charge, these small vessels were set adrift in the current so as to be borne down upon the fleet of the enemy. When the fuse had burned down to the powder the explosion would occur scattering the pieces of rock and iron in all directions.

The real ancestor of the modern submarine mine was however, evolved by David Bushnell, the father of the submarine boat. Bushnell's mine consisted of a keglike container filled with gun-powder and discharged by an ingenious arrangement of a flint-lock actuated by a time clock mechanism. The clockwork was set in operation by the release of a pin when the mine was set free and the explosion occurred thereafter at a definite time accordingly as the mechanism had been adjusted.

Fulton was the next to take up mines and he carried out a great deal of experimental work with them in this country and abroad. Several years later Samuel Colt,

another American, evolved a means of exploding mines under water by electricity. This latter development was the forerunner of our present system of mining for coast defense work.

The effectiveness of the submarine mine was first demonstrated in the Civil War when they were used extensively by the Confederates. As the Southerners had hardly any Navy, the Union gunboats were constantly ascending their rivers and inflicting considerable damage. To put a stop to this the Southerners began to mine their streams and harbors with kegs and beer barrels filled with gunpowder and by so doing succeeded in destroying many Northern ships.

Mines were again used in the Franco-Prussian War by Germany, who made good use of them in protecting her coasts. England had also used them in the Crimean War but with little significant success.

In spite of what had been accomplished with mines European naval experts, however, refused to place much confidence in them and were but little interested in the subject. In fact at the time of the Russo-Japanese War, England and other countries had about decided to cut them out entirely from their defense equipment.

The Russo-Japanese War, however, changed naval opinion on the subject. During its many engagements the real value of the submarine mine was substantially proven. Up to this time mines had been used almost entirely for the protection of harbors and points of strategic value, but now for the first time they were used in the open sea for offensive warfare.

It was by the use of mines that the Japanese were enabled to enfeeble and so demoralize the Russian fleet

that any concentrated fleet action was prevented. The contingent result of this strategy was practically the annihilation of the Russian fleet.

The plan of attack was to have a mine-layer follow in the wake of the formation of the battle fleet, dropping mines over the stern as she proceeded. The battle fleet would then make a turn and maneuver so as to bring the opposing fleet onto the mine field and to destruction. The Russians were not slow in learning their lesson, however, and soon adopted the same kind of tactics, succeeding in destroying ten of the Japanese ships in this way.

There are three types of mines in use at the present time: first, ground mines, which are usually of large dimensions and very heavy. These are laid directly upon the bottom and are used in such places where strong currents would prohibit the use of the ordinary anchored mines; second, anchored mines, which are attached by a cable to a weight on the bottom and held to float at a depth where they will be struck and exploded by passing ships; third, floating mines, which are dropped overboard and float upon the surface until they are run upon by some ship and exploded.

The simplest form of mine is the contact mine. It consists of an iron casing which is connected by cable to an anchor weight, the latter being sufficiently heavy to hold it in place. The casing in which the explosive charge is carried is provided with one or more projecting arms or levers which act as triggers. If one of these triggers is struck by a passing vessel, it is driven in against the percussion cap causing it to explode and fire the bursting charge. Mines having only one firing pin are designed to roll when struck by a passing ship until the projecting

lever is brought into contact with the bottom of the ship. All floating mines are of the simple contact type.

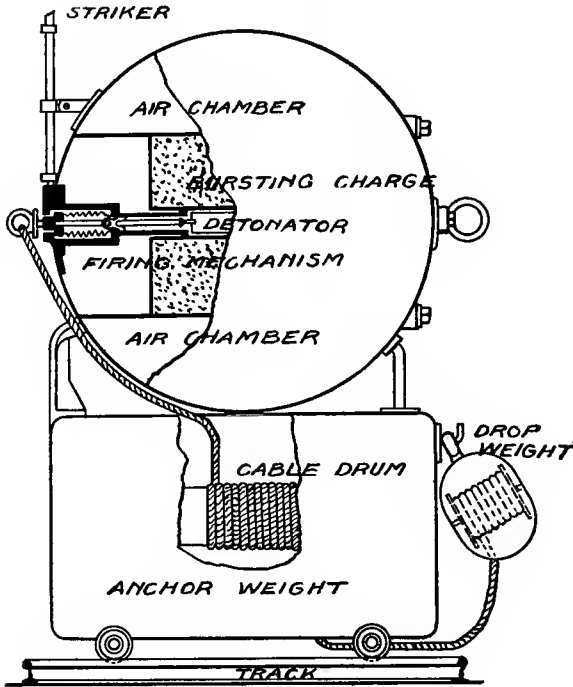

Simple contact mine

For harbor defense work this simplest form of contact mine is however as dangerous to friend as to foe, and therefore electrically fired detonators in many different forms are almost universally used at the present time. The electro-contact mine is constructed on the same general principles as the simple contact mine, except that the firing pin when driven in by a passing ship, instead of

exploding a percussion cap, closes an electric circuit. There is however another break in the electric circuit which must be closed before the mine can be exploded; this is effected by leading an electric cable down through the anchor and thence to a shore station where the circuit is broken by a switch. Unless this switch is closed the mine cannot be fired. In this way if no ships of the enemy are in the vicinity the switch at the shore station can be left open and all friendly shipping can pass in and out with absolute safety.

Another form of electro-contact mine has the firing mechanism and the bursting charge in separate cases; the contact buoy contain-

ing the firing mechanism is held a few feet below the surface and connected to the mine proper by cable. The mine itself, which is several feet below the buoy, is anchored as before, and is in electrical connection with a shore station. There are to this type of mine two distinct and separate circuits; a signal circuit leading from the contact

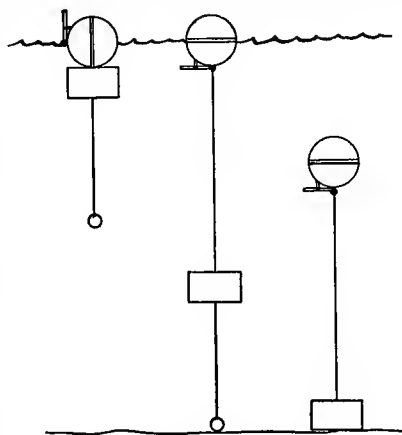

Diagram showing depth regulation of contact mines

When the mine is dropped overboard, the drop-weight sinks first, as in figure on the left, and causes the drum of the anchor-weight cable to unwind until the drop-weight reaches the bottom, as in central figure. This causes the drum to stop unwinding, and the anchor-weight then pulls the mine below the surface, the depth of the drop-weight cable length, as in the figure on the right.

buoy, and a firing circuit leading to the mine itself. When the firing pin of the contact buoy is struck the signal circuit is closed causing a bell to ring or a lamp to light at the shore station. To discharge the mine the observer at the keyboard of the shore station has then only to close the switch in the firing circuit of the mine which corresponds to the signal given.

Where the depth of the water is too great or the current too swift to make practicable the use of these mines ground mines are resorted to. The ground mines are very heavy and contain exceedingly heavy charges of explosive, the amount depending upon the depth at which they are placed.

A method commonly employed in firing ground mines is to have two shore stations in electrical connection with the mine and a break in the circuit at each station. These two breaks must be closed simultaneously in order to explode the mine. To effect the simultaneous closing of the breaks, each station is provided with a telescope mounted upon a swivel base which is constructed so as to practically constitute a selective switch. The switch points of the base are arranged to close the break in that circuit leading to the particular mine upon which the telescope is directly bearing at that instant. To explode a mine the observers at each shore station have therefore only to keep their telescopes bearing upon the approaching ship and when the ship is directly over any mine each telescope sighting upon it will have simultaneously closed the breaks and the firing circuit completed. Should a ship not pass directly over a mine the two breaks cannot be closed at the same time thus preventing the useless explosion of a valuable mine.

The explosives most commonly used in submarine mines are wet and dry gun-cotton, dynamite, and explosive gelatine compositions. These are superior to gun-powder because they are not affected by moisture, when a leak in the casing would cause gun-powder to become useless, and because they have from six to eight times the expansive force of gun-powder. Many new higher explosives have recently been perfected for this use however, which are said to greatly exceed in destructive force anything which has been known heretofore. It is claimed for some of the new explosives that a mine loaded with a charge of five hundred pounds would have enough bursting force to rupture the bottom plates of a modern battleship if exploded within a radius of one hundred feet, provided it was properly immersed.

Even where the explosion of the mine fails to blow a hole in the ship's bottom, the shock of the explosion may cause serious damage by putting out of commission delicately adjusted machinery and electrical equipment. The tremendous concussion may also cause the detonation of the high explosives stored in the magazines of the ship, causing her complete destruction.

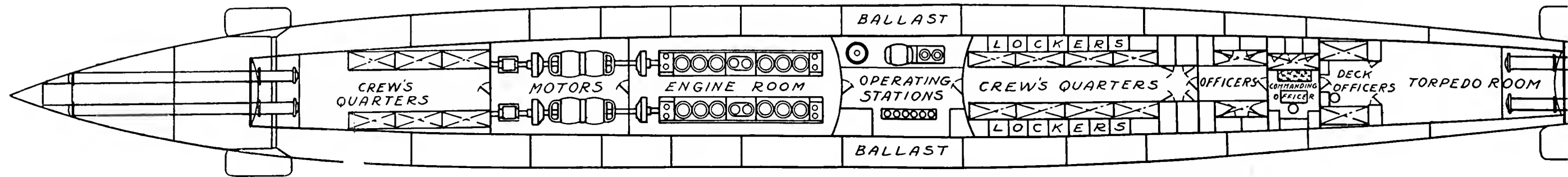
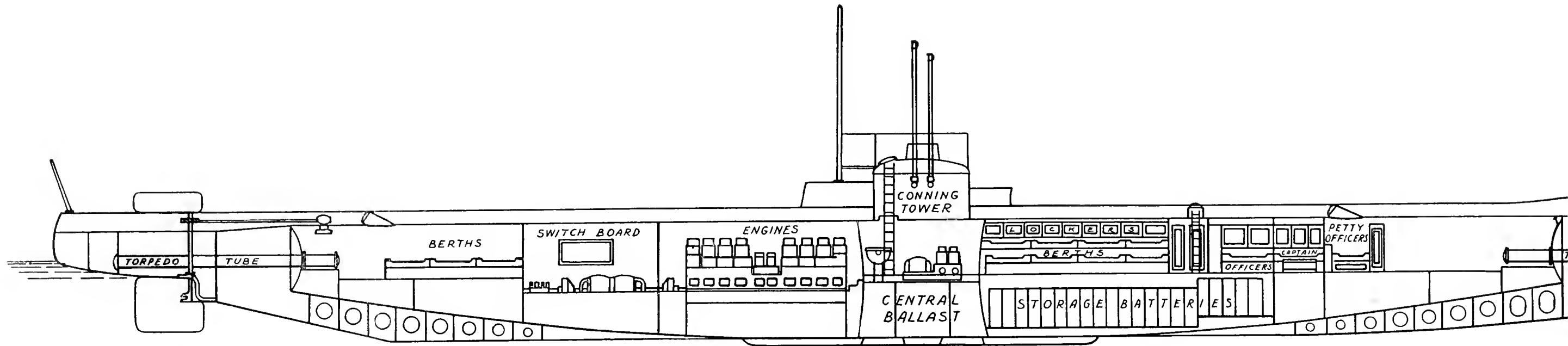

PLATE IV. PLAN AND PROFILE OF 600-TON LAURENTI SUBMARINE

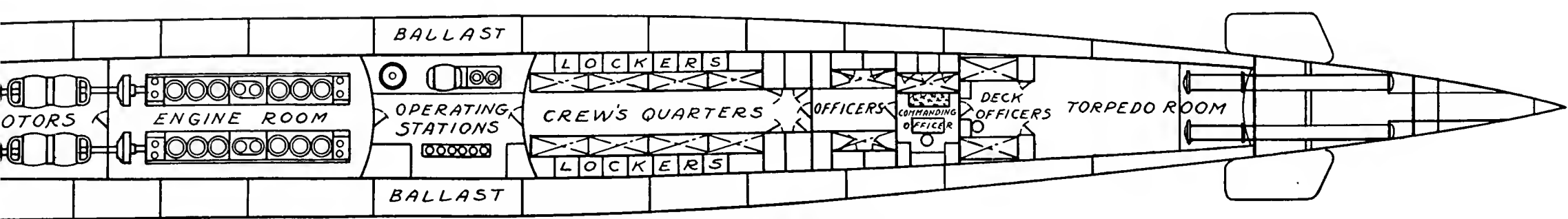
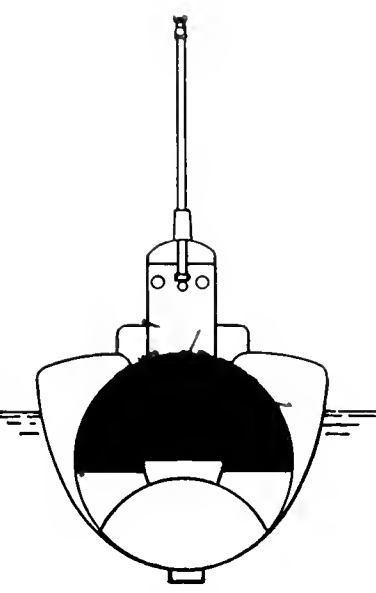
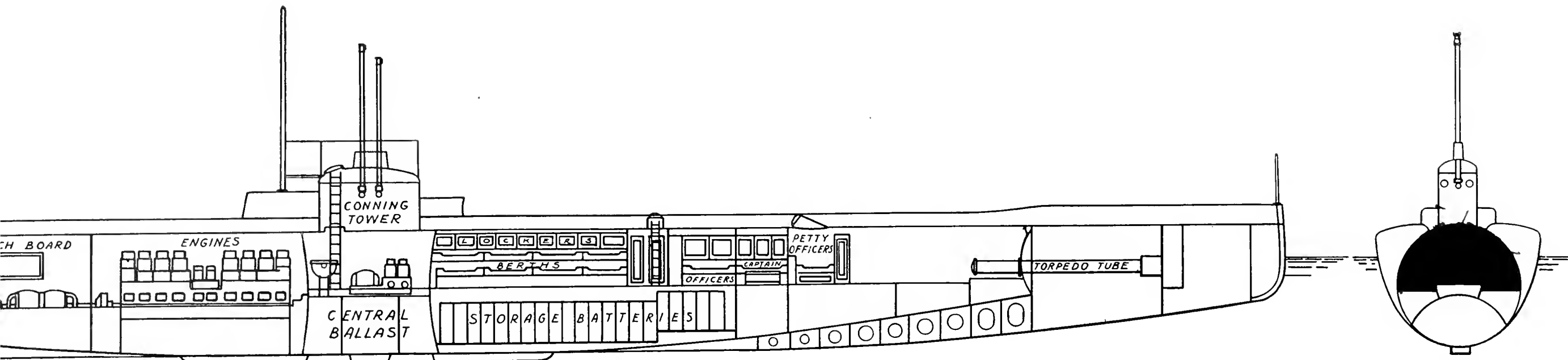

PLATE IV. PLAN AND PROFILE OF 600-TON LAURENTI SUBMARINE

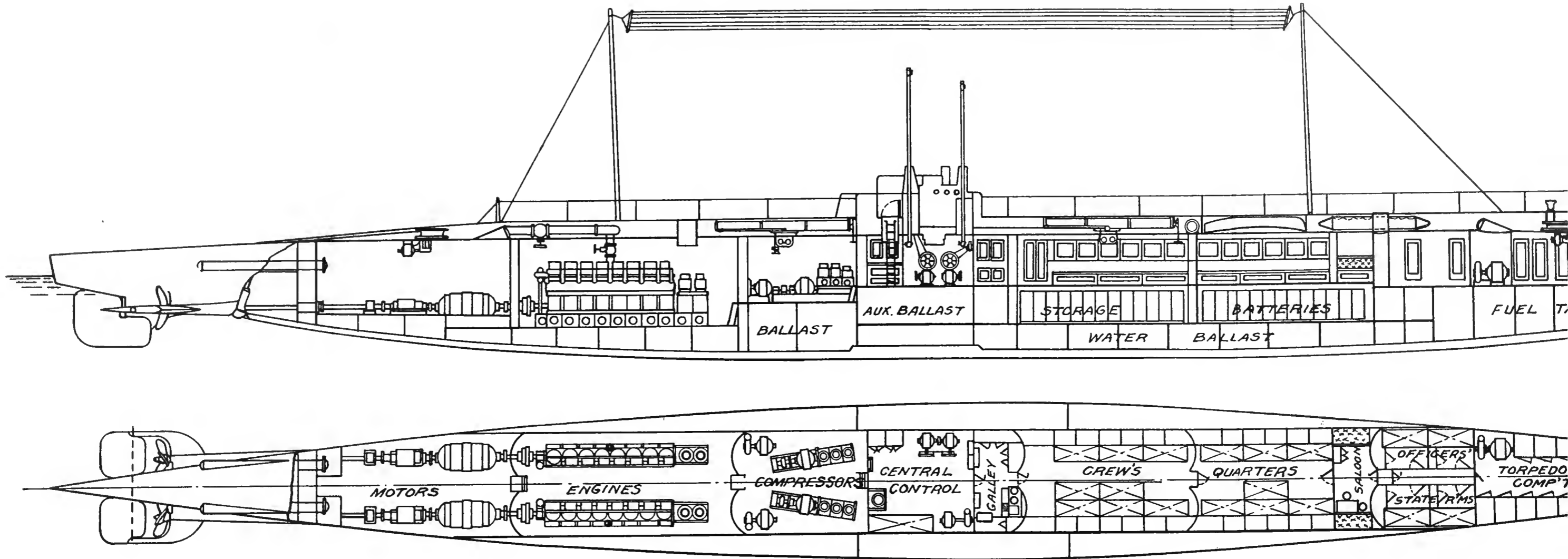

PLATE V. PLAN AND PROFILE OF 800-TON GERMAN SUBMARINE

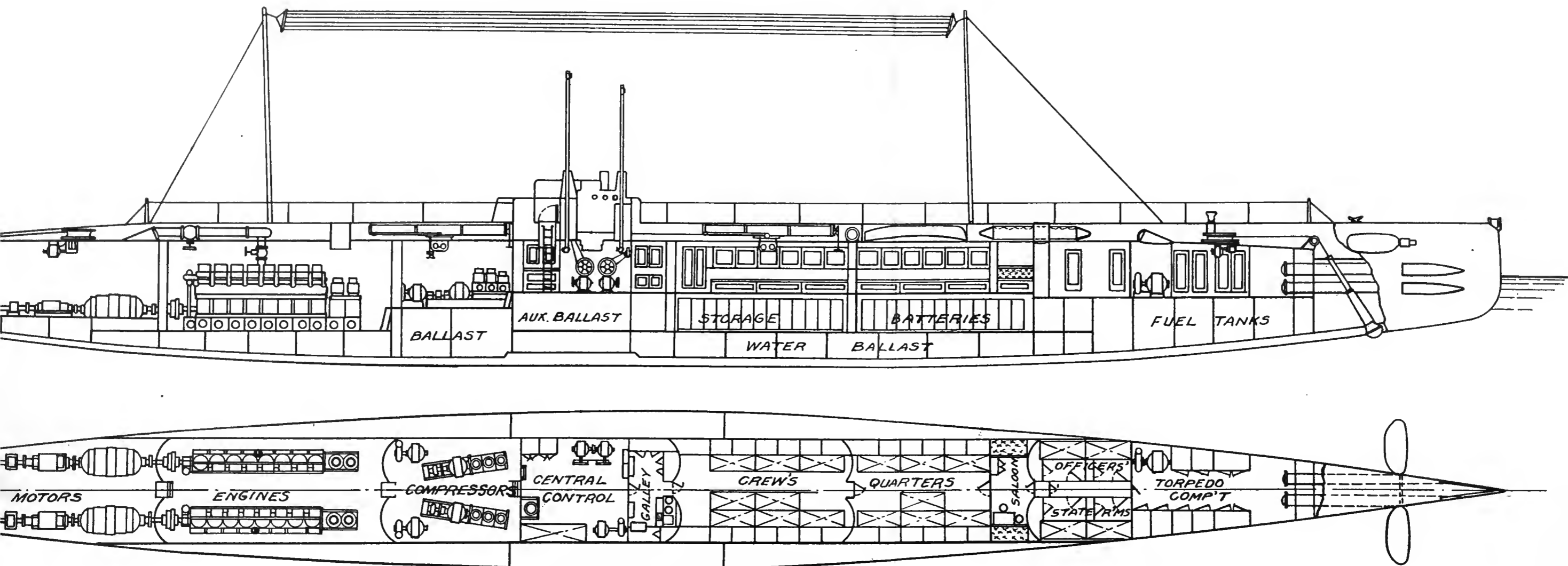

PLATE V. PLAN AND PROFILE OF 800-TON GERMAN SUBMARINE

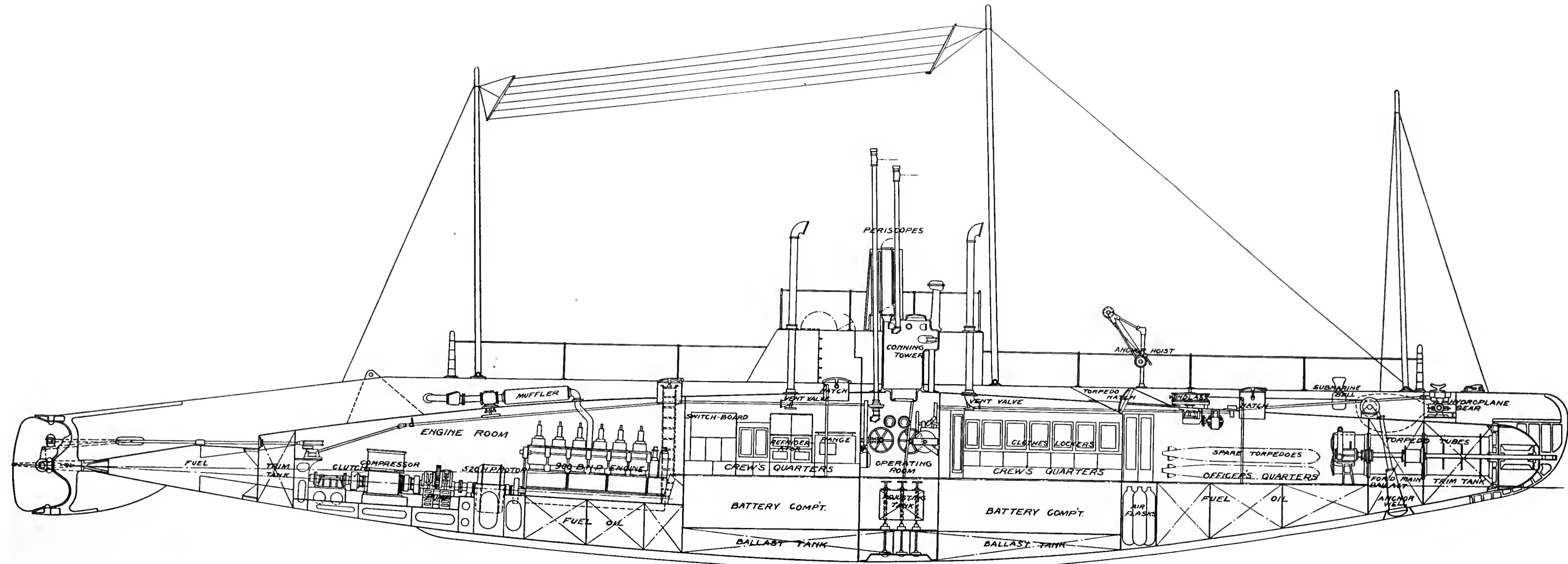

PLATE VI. PROFILE OF 830-TON ELECTRIC BOAT TYPE SUBMARINE

APPENDIX I

LIST OF SUBMARINES IN THE PRINCIPAL NAVIES

TABLE I. — UNITED STATES SUBMARINES

No.	Class	Displacement Surface Tons	Engines B. H. P.	Speed Surface	Radius Miles	Motors B. H. P.	Speed Subm.	No. Tubes
6	A	106	160	8.5	70	7.25	1
3	B	145	250	8.75	500	115	8.	2
5	C	240	500	10.5	2300	230	9.	2
3	D	288	600	13.	3000	330	9.5	4
2	E	287	500	13.	3500	520	11.	4
3	F	330	620	13.5	3800	620	11.25	4
3	G-1-2-3	400	1200	14.	600	9.5	6
1	G-4	370	1000	14.	600	9.5	4
3	H	358	950	14.	4300	620	10.5	4
8	K	392	950	14.	4500	680	10.5	4
11	L	450	950	14.	5000	680	10.5	4
1	M	488	1600	16.	5500	...	10.5	4
7	N*	348	950	13.	4000	680	11.	4
16	O*	485	14.	5500	...	11.	4
	Schley*	1100	4000	20.	6000	...	12.	8

*Building

TABLE II. — GERMAN SUBMARINES

Class	U-1	U-2 to U-8	U-9 to U-12	U-13 to U-20	U-21 to U-32	U-33 to U-38
Displacement Surf.	185	237	250	450	650	675
“ Subm.	240	300	...	550	800	835
Length	128' 3"	141' 8"	213' 3"	...
Breadth	11' 10"	12' 4"	20' 0"	...
B. H. P. Engines	400	600	...	1200	1800	2500
B. H. P. Motors	240	320	...	600	800	...
Max. Speed, Surf.	11 Kn.	12 Kn.	...	15 Kn.	16 Kn.	17 Kn.
“ “ Subm.	8 “	8.5 “	...	9 “	10 “	10 “
Radius Surface	1200 m.	1500 m.	...
No. Tubes	1	2	2	3	4	...
No. Guns				1-1.45"	2-3.46"	“Engineering”

The German building program contemplated 72 submarines by 1917 and it has been reported on good authority that all of these boats were laid down in 1914 soon after the outbreak of the war. The dimensions of these boats are reported as length 214 ft.; beam 20 ft.; surface displacement 750 metric tons, submerged, 900 tons; speed on the surface 20 knots and 10 knots submerged; B. H. P. engines 4000, and radius of action on the surface 5000 miles.

AUSTRIA to July 1, 1914

Built 6 Tons 1686
 Building 6 " 5370

TABLE III. — ALLIES' SUBMARINES

To July 1, 1914

British				French		
Year	No.	Tons		Year	No.	Tons
1903		1903	2	840
1904		1904
1905	10	3160		1905
1906	7	2216		1906	20	11324
1907	12	3852		1907
1908	8	2568		1908
1909	8	4915		1909
1910	8	6420		1910	3	2084
1911	6	4948		1911	1	984
1912	9	8010		1912	9	5100
1913	11	8496		1913	6	4900
	79	44,585	Totals*		41	25,232

* Built at outbreak of war.

	Russia		Japan		Italy	
	No.	Tons	No.	Tons	No.	Tons
Built	30	6506	13	2672	19	5475
Building	19	13284	2	1200	8	5842

INDEX

A

- Accessibility of machinery and engines, necessity for, 28
- Accidents, list of, 192
- Accommodations for berthing, 36
- Action, Radius of, 18, 86, 137
- Adder*, U. S. submarine boat, 16
- Advantage of destroyer over submarine, 30
- Aeroplane versus submarine, 148
- Air connections required for safety, 106, 109
- Angle fire method of torpedo attack, 161, 181
- Apportionment of weights, 62
- Armament, 97
- Arrangement of torpedo tubes, 97
- Attack, submarine tactics for, 158
- Attack upon submarine by destroyer, 30, 144
- Automobile torpedo, *see* torpedo

B

- Balance of chief factors, proper, 137
- Ballast system, 61
- Base strategy, 153
- Battery ventilation, 108
- Batteries, storage, 124
- Battleship, effect of submarine upon design of the, 141
- Bauer, tribulations of, 12
- Beam-length ratio, effect upon resistance, 65
- Bliss-Leavitt Torpedo Co., 179, 182

- Blockade, effect of submarines upon the strategy of, 164
- Blockade, maintenance of submarine, 168
- Boiler (soda), method of propulsion, 22
- Bombs, use of, against submarines, 145
- Bonaparte, Napoleon, and Fulton, 3
- Booms, use of, for harbor protection, 150
- Bridge, navigating, 90
- British submarine development, 20
- British submarine of the *F* class, 20
- British submarine operations in the Dardanelles, 158
- British submarine operations in the North Sea, 154
- Buoy, position marker, 108
- Buoyancy, position of, center of, 44
- Buoyancy reserve, percentage of, 38
- Bushnell, David, 1, 195
- , lack of appreciation of, 3
- , *Turtle*, 1

C

- Calculations for propellers, 73
- Calculations for strength of hull, 104
- Campaign in the Dardanelles, submarine, 158
- Campaign in the North Sea, submarine, 154
- Center of buoyancy, position of, 44

- Center of gravity, position of, 40, 44
 Chief characteristics of the *Adder*, 16
 Chief characteristics of the *M-1*, 16
 Chief characteristics of the submarine torpedo boat, 15
 Chief characteristics of the *U-9*, 22
 Circle of visibility, radius of, 162
 Circular hull type of boat, 38
 Civil War, use of the submarine in, 4
 Civil War, use of the submarine mine in, 196
 Coast defense operations, 166
 Colt, Samuel, 195
 Communications, interior, 95
 Compass, gyroscopic master, 90
 Compass variations effected by hull, 88
 Compromise in design, necessity of, 58
 Conning tower, 92-106
 Contact mines, 197
 —, depth control, 199
 Control, automatic depth, 106
 Control by use of forward propellers, 54
 Control, factors and margin of safety in the different types, 51
 Cork sheathing in living quarters, 37
 Cost of the automobile torpedo, 184
 Course, effect of error in estimation of, 165
 Cruising radius, real limit of, 18
 Curves, typical speed and power, showing difference between engines and motors, 75
- D
- Dardanelles, submarine operations in the, 158
 "Davids," the, 4
 Davy, Marie, 93
 Deck tubes, 97
 Defense against the submarine, means of, 142
 Defense, mode of coast, 166
 Defense, mode of harbor, 158
 Defensive operations of the submarine, 158
 Del Proposto system of propulsion, 130
 Depth control of contact mine, 199
 Depth control of submarine, 106
 Design, effect of submarine, on battleship, 141
 Design of the submarine
 —, armament, 97
 —, apportionment of weights, 63
 —, ballast system, 61
 —, effect of form upon resistance, 65
 —, frame resistance formula, 104
 —, habitability, 34, 82
 —, navigation, 88
 —, propulsive system, 18, 28, 65, 80, 110, 130, 140
 —, radius of action, 18, 86, 137
 —, safety, 102
 —, signalling and interior communication, 95
 —, speed and power curves, 74-75
 —, speed and power estimation, 67
 —, stability, 60
 Destroyer versus the submarine, 30, 144
 Determination of E. H. P. in the model basin, 68
 Development, beginning of systematic, 15

- Development, future, 134
 —, in England, 20
 —, in France, 20
 —, in Germany, 22
 Deviation of the compass erratic, 88
 Diameter, tactical, 92
 Diesel engine, theory of, 112
 —, difficulties in design, 116
 —, German types, 120
 Difficulties in rapidly increasing submarines over their present size, 137
 Diving type, characteristics of performance of, 46
 —, equilibrium forces of, 51
 —, impracticability of large boats of the, 48
 Double hull type of construction, 22
 d'Quevilly system of propulsion, 130
 Dragging for submarines, 147
 Drop keels, 108
 Dual system of power plant, the limitations of the, 18
 Dyson, Captain C. W., on propeller design, 77
- E
- Eagle*, attack on the British flagship, 2
 Edison nickel-iron storage battery, 126
 Effect of beam-length ratio upon resistance, 65
 Effect of error in estimation of range, 162
 Effect of error in the estimation of speed and course of enemy, 163
 Effect of form upon resistance, 65
 Effect of submarine on battleship design, 141
- Effect of submarine on the strategy of blockade, 164
 Effective torpedo range, limit of, 28, 162
 Efficiency, tactical, 138
 E. H. P., determination of, 68
 Electric Boat Co., 18
 Electro-contact mines, 198
 Engines, Diesel, 112
 —, four cycle and two cycle, 115
 —, gasoline, 110
 —, speed and power curves of, 75
 steam, 128
 English submarine activities, 154, 158
 Entanglements for harbor defense, 150
 Equilibrium of diving boats, 51
 Equilibrium of "Even Keel" boats, 53
 Estimation of power, by comparison, 77
 —, by independent method, 78
 —, by model basin testing, 67
 Even keel submergence, 46, 53
 Evolutions, tactical, of the submarine, 153
- F
- F* class, British, 20
Fenian Ram, Holland's, 6
 Fiab, San Giorgio Co., 188
 Firing, angle method of, 161, 181
 Firing, necessity for rapid, 32, 98
 Firing, system of torpedo, 32, 97
 Floating mines, 196
 Form of hull, effect on resistance, 65
 Form of superstructure, 105
 Formulas, propeller, 75
 Forward propellers, effect of, 54, 93
 France, submarine development in, 20

Franco-Prussian War, use of mines, 196
 Froude's laws of comparison, 64, 77
 Fuel ships, 186
 Fulton, Robert, 3, 195
 Fulton's *Nautilus*, 4
 Future development, 134

G

Gas engines, 110
 German submarine development, 22
 German submarine operations, 156, 158
 Gravity, center of, 40, 44
 Ground mines, 200
 Gyroscope, the, 181
 Gyroscopic control of torpedo fire, 180
 Gyroscopic master compass, 90, 92

H

Habitability, 34, 82
 Hansing, Lieut., statement of, 36
 Harbor defense tactics, 158
 Harbor entanglements and booms, 150
 Hersing, Lieut., interview with, 36
 Holland, John P., 6
Holland, the, 8
 Holland type submarines in England, 20
 ——— in United States, 18
 Holland's *Fenian Ram*, 6
Housatonic, sinking of the, 6
 Hovgaard, Lieut., 10
 Hull, calculations for strength of, 104
 ———, circular type, 38
 ———, double, 22, 44
 ———, efficiency of, 70
 ———, resistance, 69
 ———, ship-shape form of, 38

Hull, single, 40
 Hydroplanes, 28, 46

I

Impracticability of large boats of the diving type, 48
 Independent method of estimation of power, 78
 Installation of machinery, 28
 Interior communication, 95
 Interview of Capt. Hersing on 2400 mile cruise to the Dardanelles, 36
 Invisibility of the submarine, 143
 Ironclad plates, 126

K

Keel, drop, 108
 ———, even, 46, 53
 Krupp Diesel type engines, 120
 Krupp, German submarine development by, 22

L

Lake, Simon, inventor, 14
 Lake type, 18
 L. A. Submarine Boat Co., type, 131
 Large type submarine, 136
 Lauboeuf type, 12
 Laurenti type, 20
 Law, Froude's, 64, 77
 Lead accumulator cells, 124
 Lee, Corporal Ezra, 7
Le Morse, 8
Le Plongeur, 6
 Limit of effective torpedo range, 28
 Limitations of present dual system of propulsion, 18
 List of accidents, 192
 List of requirements of U. S. N., 15
 Loading gear for torpedoes, 97
 Lupius, Capt., 174

M

- Maintenance of submarine blockade, 168
 Maintenance of trim, 62
 Means of defense against the submarine, 143
 Metacentric height, 42
 Method of advance during attack, 160
 Method of torpedo fire, 32
M-1, U. S. submarine, characteristics of, 16
 Mines, in Civil War, 196
 —, in Franco-Prussian War, 196
 —, in Russo-Japanese War, 196
 Mines, submarine, contact, 197
 —, ground, 200
 —, electro-contact, 198
 —, method of employment of floating mines, 196
 —, use of, against the submarine, 145
 Mine-layer, operations of, 197
 Model basin, experiments for resistance, 65, 68
Morse, Le, 8
 Motors, electric, 122
 Motors, typical speed-power curve of, 75

N

- Narval*, the, 12
Nautilus, the, 4
 Navigation, 88
 —, submerged, 93
 —, surface, 90
 Nordenfelt's submarines, 10
 North Sea, submarine operations in the, 154

O

- Obry gear, 180
 Operations of the submarine, defensive, 158
 —, offensive, 168
 Operations of mine layer, 197

P

- Peacemaker*, the, 22
 Pasted plate, 126
 Periscope, the, 12, 32, 93
 —, vulnerability of the, 144
 Pitt, William, 4
 Planté plate, 124
Plongeur, Le, 6
 Position marker buoy, 108
 Power, estimation of, 67, 78
 Power plant, 78, 110
 —, installation and reliability of, 28
 —, limitations of present system of, 18
 —, percentage of weight allotted to, 65
 —, single unit system of, 140
 Propellers, advantage of forward, 93
 —, Capt. C. W. Dyson on design of, 77
 —, computation and formulas, 73
 —, selection of, 71
 Proper balance of all factors, 137
 Proposto system of propulsion, del, 130
 Pulsive system, 18, 28, 65, 80, 110, 130, 140
 Pumping for ballast and fuel systems, 106

Q

- Quarters, for men, 34, 36, 82, 84
 —, food facilities, 84

Quarters, heating, 84
 d'Quevilly system of propulsion,
 22, 130
 Quick submergence, necessity for, 30

R

Radius of action, 18, 86, 137
 Radius of circle of visibility, 162
 Raider, submarine in role of, 170
 Range, effective, 28, 162
 —, effect of error in estimation of,
 162
 Range finding, 94
 Ratio of beam to length, effect of, 65
 Relative stability of different types,
 40
 Reliability of power plant, 28
 Requirements, list of U. S. N., 15
 Reserve buoyancy, 38
 Resistance, effect of beam-length
 ratio on, 65
 —, effect of form on, 65
 Rule for wetted surface, 80
 Russo-Japanese War, the use of
 mines and their importance in, 196

S

Safety factors, 102
 Salvage ships, 186
Schley, the U. S. submarine, 136
 Sea-going type of submarine, 136
 Sea-worthiness, 26
 Selection of propellers, 71
 Selection of type, 58
 Ship-shape form of hull, 38
 Signaling devices, 95
 Single unit system of propulsion,
 140
 Sleeping quarters, 36
 Soda boiler system of propulsion,
 22, 130

Speed and power estimation, 67
 Speed boats as submarine catchers,
 147
 Speed, effect of error in estimation of,
 162
 —, importance of, 28
 Speed of automobile torpedo, 176
 Stability, 26, 40, 42, 60, 62
 Steam engine, 6, 10, 110, 128
 Steering stations, 92
 Steering mechanism of automobile
 torpedo, 180
 Storage batteries, 8, 122
 Strategic bases, 153
 Strategy of the blockade, 164
 Strength of hull, 102
 Submarine, definition of, 58
 Submarine blockade, 168
 Submarine characteristics and re-
 quirements, 26
 Submarine in battle, 172
 Submarine in the role of raider,
 170
 Submarine operations in the Dar-
 danelles, 158
 Submarine operations in the North
 Sea, 154
 Submarine signal system, 95
 Submarine size increase, 134, 137
 Submarine tenders, 185
 Submarines and submersibles, 38
 Submarines in the Civil War, 4
 Submarines versus aeroplanes, 148
 Submarines versus submarines, 151
 Submergence, depth, 102
 —, diving type, 46
 —, even keel, 46, 53
 Submerged navigation, 93
 Submerged speed and radius of
 action, 18
 Submergence, necessity for rapid, 30

- Submerging, equilibrium factors of, 53
 Submerging type versus the diving type, 46
 Superstructure, form of, 105
- T
- Tactical diameter, 92
 Tactical efficiency, 138
 Tactical evolutions, 153
 Tactical value, 26
 Tactics of the sea-going submarine, 168
 Taylor, Admiral D. W., rule for wetted surface, 80
 Tenders, submarine, 185
 Thrust deduction factor, 70
 Torpedo, automobile, 8, 161, 174
 —, air flask, 176
 —, air heaters, 182
 —, angle fire, 182
 —, automatic sinking device control, 182
 —, Bliss-Leavitt, 179
 —, cost of, 184
 —, Davis, 184
 —, engine, 178
 —, government factory at Newport, R. I., 184
 —, hydrostatic piston, 178
 —, immersion chamber, 178
 —, Obry gear, 180
 —, steering mechanism, 180
 —, wake of, 140
 —, warhead, 176
 Torpedo, deck tubes, 97
 Torpedo, methods for fixing, 32, 161, 181
 Torpedo, gear for loading and handling, 97
 Torpedo range, 28
 Torpedo tubes, 97
 Torpedo rake, 140
 Trim, maintenance of, 16
 Tuck, Prof. J. H. L., 22, 131
 Types, double hull, 22, 44
 —, d'Quevilly, 22
 —, Electric Boat Co., 18
 —, Lake Torpedo Boat Co., 18
 —, Laurenti, 20
 —, Sea-going, 136
 —, Submersible, 38, 42, 58
 —, Submarines proper, 38, 40, 42, 58
- U
- U-9*, chief characteristics of, 22
U-51, exploit of the German, 36
 Unsolved difficulties in design of large type, 137
 Use of mines and bombs against the submarine, 145
- V
- Van Drebbel, Dr. Cornelius, 1
 Variations of the magnetic compass, 88
 Ventilation of storage batteries, 108
 Visibility circle of, 162
 —, of air bubbles, 140
 —, of periscope as a target, 144
- W
- Wake of Torpedo, 140
 Warhead of the torpedo, 176
 Weight, Effect on design, 61
 Weight of storage batteries, 127
 Weight of power plant, 65
 Weights, apportionment of, 62
 Wetted surface formula, 80
 Whitehead, Robt., 174
 Wireless, 97

D. VAN NOSTRAND COMPANY

25 PARK PLACE

NEW YORK

SHORT-TITLE CATALOG

OF

Publications and Importations

OF

SCIENTIFIC AND ENGINEERING
BOOKS



This list includes the technical publications of the following English publishers :

SCOTT, GREENWOOD & CO. JAMES MUNRO & CO., Ltd.
CONSTABLE & COMPANY, Ltd. TECHNICAL PUBLISHING CO.
ELECTRICIAN PRINTING & PUBLISHING CO.,

for whom D. Van Nostrand Company are American agents.

Descriptive Circulars sent on request.

SHORT-TITLE CATALOG
 OF THE
Publications and Importations
 OF
D. VAN NOSTRAND COMPANY
25 PARK PLACE

Prices marked with an asterisk (*) are NET
 All bindings are in cloth unless otherwise noted

Abbott, A. V. The Electrical Transmission of Energy.....	8vo,	*\$5 00
—— A Treatise on Fuel. (Science Series No. 9.).....	16mo,	0 50
—— Testing Machines. (Science Series No. 74.).....	16mo,	0 50
Adam, P. Practical Bookbinding. Trans. by T. E. Maw.....	12mo,	*2 50
Adams, H. Theory and Practice in Designing.....	8vo,	*2 50
Adams, H. C. Sewage of Seacoast Towns.....	8vo,	*2 00
Adams, J. W. Sewers and Drains for Populous Districts...	8vo,	2 50
Adler, A. A. Theory of Engineering Drawing.....	8vo,	*2 00
—— Principles of Parallel Projecting-Line Drawing.....	8vo,	*1 00
Aikman, C. M. Manures and the Principles of Manuring..	8vo,	2 50
Aitken, W. Manual of the Telephone.....	8vo,	*8 00
d'Albe, E. E. F. Contemporary Chemistry.....	12mo,	*1 25
Alexander, J. H. Elementary Electrical Engineering.....	12mo,	2 00
Allan, W. Strength of Beams under Transverse Loads. (Science Series No. 19.).....	16mo,	0 50
Allan, W. Theory of Arches. (Science Series No. 11.)...	16mo,	
Allen, H. Modern Power Gas Producer Practice and Applica- tions.....	12mo,	*2 50
—— Gas and Oil Engines.....	8vo,	*4 50
Anderson, J. W. Prospector's Handbook.....	12mo,	1 50

Andes, L. Vegetable Fats and Oils.....	8vo,	*4 00
— Animal Fats and Oils. Trans. by C. Salter.....	8vo,	*4 00
— Drying Oils, Boiled Oil, and Solid and Liquid Driers....	8vo,	*5 00
— Iron Corrosion, Anti-fouling and Anti-corrosive Paints. Trans. by C. Salter.....	8vo,	*4 00
— Oil Colors and Printers' Ink. Trans. by A. Morris and H. Robson.....	8vo,	*2 50
— Treatment of Paper for Special Purposes. Trans. by C. Salter.....	12mo,	*2 50
Andrews, E. S. Reinforced Concrete Construction....	12mo,	*1 25
— Theory and Design of Structures.....	8vo,	3 50
— Further Problems in the Theory and Design of Structures	8vo,	2 50
Andrews, E. S., and Heywood, H. B. The Calculus for Engineers	12mo,	1 25
Annual Reports on the Progress of Chemistry. Eleven Vol- umes now ready. Vol. I, 1904, to Vol. XI, 1914, 8vo, each.....		*2 00
Argand, M. Imaginary Quantities. Translated from the French by A. S. Hardy. (Science Series No. 52.).....	16mo,	0 50
Armstrong, R., and Idell, F. E. Chimneys for Furnaces and Steam Boilers. (Science Series No. 1.).....	16mo,	0 50
Arnold, E. Armature Windings of Direct Current Dynamos. Trans. by F. B. DeGress.....	8vo,	*2 00
Asch, W., and Asch, D. The Silicates in Chemistry and Commerce	8vo,	*6 00
Ashe, S. W., and Keiley, J. D. Electric Railways. Theoretically and Practically Treated. Vol. I. Rolling Stock	12mo,	*2 50
Ashe, S. W. Electric Railways. Vol. II. Engineering Pre- liminaries and Direct Current Sub-Stations.....	12mo,	*2 50
— Electricity: Experimentally and Practically Applied.	12mo,	*2 00
Ashley, R. H. Chemical Calculations.....	12mo,	*1 00
Atkinson, A. A. Electrical and Magnetic Calculations.....	8vo,	*1 50
Atkinson, J. J. Friction of Air in Mines. (Science Series No. 14.).....	16mo,	0 50
Atkinson, J. J., and Williams, E. H., Jr. Gases Met with in Coal Mines. (Science Series No. 13.).....	16mo,	0 50

4 D. VAN NOSTRAND COMPANY'S SHORT-TITLE CATALOG

Atkinson, P. The Elements of Electric Lighting.....	12mo,	1 50
— The Elements of Dynamic Electricity and Magnetism.	12mo,	2 00
Atkinson, P. Power Transmitted by Electricity.....	12mo,	2 00
Auchincloss, W. S. Link and Valve Motions Simplified....	8vo,	*1 50
Austin, E. Single Phase Electric Railways.....	4to,	*5 00
Ayrton, H. The Electric Arc.....	8vo,	*5 00
Bacon, F. W. Treatise on the Richards Steam-Engine Indica- tor.....	12mo,	1 00
Bailes, G. M. Modern Mining Practice. Five Volumes.	8vo, each,	3 50
Bailey, R. D. The Brewers' Analyst.....	8vo,	*5 00
Baker, A. L. Quaternions.....	12mo,	*1 25
— Thick-Lens Optics.....	12mo,	*1 50
Baker, Benj. Pressure of Earthwork. (Science Series No. 56.)	16mo,	
Baker, I. O. Levelling. (Science Series No. 91.).....	16mo,	0 50
Baker, M. N. Potable Water. (Science Series No. 61.)	16mo,	0 50
— Sewerage and Sewage Purification. (Science Series No. 18.)	16mo,	0 50
Baker, T. T. Telegraphic Transmission of Photographs.	12mo,	*1 25
Bale, G. R. Modern Iron Foundry Practice. Two Volumes.	12mo.	
Vol. I. Foundry Equipment, Material Used.....		*2 50
Vol. II. Machine Moulding and Moulding Machines.....		*1 50
Ball, J. W. Concrete Structures in Railways.....	8vo,	*2 50
Ball, R. S. Popular Guide to the Heavens.....	8vo,	*4 50
— Natural Sources of Power. (Westminster Series)....	8vo,	*2 00
Ball, W. V. Law Affecting Engineers.....	8vo,	*3 50
Bankson, Lloyd. Slide Valve Diagrams. (Science Series No. 108.).....	16mo,	0 50
Barba, J. Use of Steel for Constructive Purposes.....	12mo,	1 00
Barham, G. B. Development of the Incandescent Electric Lamp.....	8vo	*2 00
Barker, A. Textiles and Their Manufacture. (Westminster Series).....	8vo,	2 00
Barker, A. F., and Midgley, E. Analysis of Textile Fabrics,	8vo,	3 00
Barker, A. H. Graphic Methods of Engine Design....	12mo,	*1 50
— Heating and Ventilation.....	4to,	*8 00

Barnard, J. H. The Naval Militiaman's Guide.	16mo, leather,	1 00
Barnard, Major J. G. Rotary Motion. (Science Series No. 90.)	16mo,	0 50
Barrus, G. H. Boiler Tests.	8vo,	*3 00
— Engine Tests.	8vo,	*4 00
The above two purchased together.		*6 00
Barwise, S. The Purification of Sewage.	12mo,	3 50
Baterden, J. R. Timber. (Westminster Series)	8vo,	*2 00
Bates, E. L., and Charlesworth, F. Practical Mathematics and Geometry for Technical Students.	12mo,	
Part I. Preliminary and Elementary Course.		*1 50
Part II. Advanced Course.		*1 50
— Practical Mathematics.		*1 50
— Practical Geometry and Graphics.		*2 00
Batey, J. The Science of Works Management.	12mo,	*1 25
Beadle, C. Chapters on Papermaking. Five Volumes. 12mo, each,		*2 00
Beaumont, R. Color in Woven Design.	8vo,	*6 00
— Finishing of Textile Fabrics.	8vo,	*4 00
Bechhold, H. Colloids in Biology and Medicine. Trans. by J. G. Bullowa.		(In Press.)
Bedell, F., and Pierce, C. A. Direct and Alternating Current Manual.	8vo,	*2 00
Beech, F. Dyeing of Cotton Fabrics.	8vo,	*3 00
— Dyeing of Woolen Fabrics.	8vo,	*3 50
Beckwith, A. Pottery.	8vo, paper,	0 60
Beggs, G. E. Stresses in Railway Girders and Bridges.		(In Press.)
Begtrup, J. The Slide Valve.	8vo,	*2 00
Bender, C. E. Continuous Bridges. (Science Series No. 26.)	16mo,	0 50
— Proportions of Pins used in Bridges. (Science Series No. 4.)	16mo,	0 50
Bengough, G. D. Brass. (Metallurgy Series)		(In Press.)
Bennett, H. G. The Manufacture of Leather.	8vo,	*4 50
Bernthsen, A. A Text-book of Organic Chemistry. Trans. by G. M'Gowan.	12mo,	*2 50
Berry, W. J. Differential Equations of the First Species.	12mo (In Preparation.)	
Bersch, J. Manufacture of Mineral and Lake Pigments. Trans. by A. C. Wright.	8vo,	*5 00

Bertin, L. E. Marine Boilers. Trans. by L. S. Robertson..	8vo,	5 00
Beveridge, J. Papermaker's Pocket Book....	12mo,	*4 00
Binnie, Sir A. Rainfall Reservoirs and Water Supply..	8vo,	*3 00
Binns, C. F. Manual of Practical Potting.....	8vo,	*7 50
— The Potter's Craft.....	12mo,	*2 00
Birchmore, W. H. Interpretation of Gas Analysis....	12mo,	*1 25
Blaine, R. G. The Calculus and Its Applications.....	12mo,	*1 50
Blake, W. H. Brewer's Vade Mecum.....	8vo,	*4 00
Blasdale, W. C. Quantitative Chemical Analysis....	12mo,	*2 50
Bligh, W. G. The Practical Design of Irrigation Works..	8vo,	*6 00
Bloch, L. Science of Illumination.....	8vo,	*2 50
Blok, A. Illumination and Artificial Lighting.....	12mo,	*1 25
Blucher, H. Modern Industrial Chemistry. Trans. by J. P. Millington	8vo,	*7 50
Blyth, A. W. Foods: Their Composition and Analysis...	8vo,	7 50
— Poisons: Their Effects and Detection.....	8vo,	7 50
Böckmann, F. Celluloid.....	12mo,	*2 50
Bodmer, G. R. Hydraulic Motors and Turbines.....	12mo,	5 00
Boileau, J. T. Traverse Tables.....	8vo,	5 00
Bonney, G. E. The Electro-plater's Handbook.....	12mo,	1 20
Booth, N. Guide to Ring-Spinning Frame.....	12mo,	*1 25
Booth, W. H. Water Softening and Treatment.....	8vo,	*2 50
— Superheaters and Superheating and their Control..	8vo,	*1 50
Bottcher, A. Cranes: Their Construction, Mechanical Equip- ment and Working. Trans. by A. Tolhausen....	4to,	*10 00
Bottler, M. Modern Bleaching Agents. Trans. by C. Salter.	12mo,	*2 50
Bottone, S. R. Magnetos for Automobilists.....	12mo,	*1 00
Boulton, S. B. Preservation of Timber. (Science Series No. 82.)	16mo,	0 50
Bourcart, E. Insecticides, Fungicides and Weedkillers..	8vo,	*4 50
Bourgougnon, A. Physical Problems. (Science Series No. 113.)	16mo,	0 50
Bourry, E. Treatise on Ceramic Industries. Trans. by A. B. Searle	8vo,	*5 00
Bowie, A. J., Jr. A Practical Treatise on Hydraulic Mining.	8vo,	5 00
Bowles, O. Tables of Common Rocks. (Science Series.)	16mo,	0 50

Bowser, E. A. Elementary Treatise on Analytic Geometry.	12mo,	1	75
— Elementary Treatise on the Differential and Integral Calculus12mo,	2	25
Bowser, E. A. Elementary Treatise on Analytic Mechanics,	12mo,	3	00
— Elementary Treatise on Hydro-mechanics.12mo,	2	50
— A Treatise on Roofs and Bridges.	*2	25
Boycott, G. W. M. Compressed Air Work and Diving.	.8vo,	*4	00
Bragg, E. M. Marine Engine Design.12mo,	*2	00
— Design of Marine Engines and Auxiliaries.(<i>In Press.</i>)		
Brainard, F. R. The Sextant. (Science Series No. 101.)	.16mo,		
Brassey's Naval Annual for 1911.8vo,	*6	00
Brew, W. Three-Phase Transmission.8vo,	*2	00
Briggs, R., and Wolff, A. R. Steam-Heating. (Science Series No. 67.)16mo,	0	50
Bright, C. The Life Story of Sir Charles Tilson Bright.	.8vo,	*4	50
Brislee, T. J. Introduction to the Study of Fuel. (Outlines of Industrial Chemistry.)8vo,	*3	00
Broadfoot, S. K. Motors Secondary Batteries. (Installation Manuals Series.)12mo,	*0	75
Broughton, H. H. Electric Cranes and Hoists.	*9	00
Brown, G. Healthy Foundations. (Science Series No. 80.)	.16mo,	0	50
Brown, H. Irrigation.8vo,	*5	00
Brown, Wm. N. The Art of Enamelling on Metal.12mo,	*1	00
— Handbook on Japanning and Enamelling.12mo,	*1	50
— House Decorating and Painting.12mo,	*1	50
— History of Decorative Art.12mo,	*1	25
— Dipping, Burnishing, Lacquering and Bronzing Brass Ware12mo,	*1	00
— Workshop Wrinkles8vo,	*1	00
Browne, R. E. Water Meters. (Science Series No. 81.)	.16mo,	0	50
Bruce, E. M. Pure Food Tests.12mo,	*1	25
Bruhns, Dr. New Manual of Logarithms.8vo, cloth,	2	00
	Half morocco,	2	50
Brunner, R. Manufacture of Lubricants, Shoe Polishes and Leather Dressings. Trans. by C. Salter.8vo,	*3	00

8 D. VAN NOSTRAND COMPANY'S SHORT-TITLE CATALOG

Buel, R. H. Safety Valves. (Science Series No. 21.)	16mo,	0 50
Burley, G. W. Lathes, Their Construction and Operation,	12mo,	1 25
Burstall, F. W. Energy Diagram for Gas. With text.	8vo,	*1 50
— Diagram sold separately.		*1 00
Burt, W. A. Key to the Solar Compass.	16mo, leather,	2 50
Buskett, E. W. Fire Assaying.	12mo,	*1 25
Butler, H. J. Motor Bodies and Chasis.	8vo,	*2 50
Byers, H. G., and Knight, H. G. Notes on Qualitative Analysis	8vo,	*1 50
Cain, W. Brief Course in the Calculus.	12mo,	*1 75
— Elastic Arches. (Science Series No. 48.)	16mo,	0 50
— Maximum Stresses. (Science Series No. 38.)	16mo,	0 50
— Practical Designing Retaining of Walls. (Science Series No. 3.)	16mo,	0 50
— Theory of Steel-concrete Arches and of Vaulted Struc- tures. (Science Series.)	16mo,	0 50
— Theory of Voussoir Arches. (Science Series No. 12.)	16mo,	0 50
— Symbolic Algebra. (Science Series No. 73.)	16mo,	0 50
Carpenter, F. D. Geographical Surveying. (Science Series No. 37.)	16mo,	
Carpenter, R. C., and Diederichs, H. Internal-Combustion Engines	8vo,	*5 00
Carter, E. T. Motive Power and Gearing for Electrical Ma- chinery	8vo,	3 50
Carter, H. A. Ramie (Rhea), China Grass.	12mo,	*2 00
Carter, H. R. Modern Flax, Hemp, and Jute Spinning.	8vo,	*3 00
— Bleaching, Dyeing and Finishing of Fabrics.	3vo,	*1 00
Cary, E. R. Solution of Railroad Problems With the Use of the Slide Rule.	16mo,	*1 00
Cathcart, W. L. Machine Design. Part I. Fastenings.	8vo,	*3 00
Cathcart, W. L., and Chaffee, J. I. Elements of Graphic Statics and General Graphic Methods.	8vo,	*3 00
— Short Course in Graphic Statics.	12mo,	*1 50

Caven, R. M., and Lander, G. D. Systematic Inorganic Chemistry	12mo,	*2 00
Chalkley, A. P. Diesel Engines	8vo,	*3 00
Chambers' Mathematical Tables	8vo,	1 75
Chambers, G. F. Astronomy	12mo,	*1 50
Charpentier, P. Timber	8vo,	*6 00
Chatley, H. Principles and Designs of Aeroplanes. (Science Series.)	16mo,	0 50
— How to Use Water Power	12mo,	*1 00
Child, C. D. Electric Arcs	8vo,	*2 00
Child, C. T. The How and Why of Electricity	12mo,	1 00
Christian, M. Disinfection and Disinfectants	12mo,	*2 00
Christie, W. W. Boiler-waters, Scale, Corrosion, Foaming,	8vo,	*3 00
— Chimney Design and Theory	8vo,	*3 00
— Furnace Draft. (Science Series.)	16mo,	0 50
— Water, Its Purification and Use in the Industries	8vo,	
Church's Laboratory Guide. Rewritten by Edward Kinch	8vo,	*2 50
Clapperton, G. Practical Papermaking	8vo,	2 50
Clark, A. G. Motor Car Engineering.		
Vol. I. Construction	8vo,	*3 00
Vol. II. Design	(In Press.)	
Clark, C. H. Marine Gas Engines	12mo,	*1 50
Clark, J. M. New System of Laying Out Railway Turnouts,	12mo,	1 00
Clarke, J. W., and Scott, W. Plumbing Practice.		
Vol. I. Lead Working and Plumbers' Materials	8vo,	*4 00
Vol. II. Sanitary Plumbing and Fittings	(In Press.)	
Vol. III. Practical Lead Working on Roofs	(In Press.)	
Clerk, D., and Idell, F. E. Theory of the Gas Engine. (Science Series No. 62.)	16mo,	0 50
Clevenger, S. R. Treatise on the Method of Government Surveying	16mo, mor.,	2 50
Clouth, F. Rubber, Gutta-Percha, and Balata	8vo,	*5 00
Cochran, J. Treatise on Cement Specifications	8vo,	*1 00
— Concrete and Reinforced Concrete Specifications	8vo,	*2 50

10 D. VAN NOSTRAND COMPANY'S SHORT-TITLE CATALOG

Coffin, J. H. C. Navigation and Nautical Astronomy	12mo,	*3 50
Colburn, Z., and Thurston, R. H. Steam Boiler Explosions. (Science Series No. 2.)	16mo,	0 50
Cole, R. S. Treatise on Photographic Optics	12mo,	1 50
Coles-Finch, W. Water, Its Origin and Use	8vo,	*5 00
Collins, J. E. Useful Alloys and Memoranda for Goldsmiths, Jewelers	16mo,	0 50
Collis, A. G. High and Low Tension Switch-Gear Design	8vo,	*3 50
— Switchgear. (Installation Manuals Series.)	12mo,	0 50
Coombs, H. A. Gear Teeth. (Science Series No. 120)	16mo,	0 50
Cooper, W. R. Primary Batteries	8vo,	*4 00
Copperthwaite, W. C. Tunnel Shields	4to,	*9 00
Corey, H. T. Water Supply Engineering	8vo (<i>In Press.</i>)	
Corfield, W. H. Dwelling Houses. (Science Series No. 50.)	16mo,	0 50
— Water and Water-Supply. (Science Series No. 17.)	16mo,	0 50
Cornwall, H. B. Manual of Blow-pipe Analysis	8vo,	*2 50
Cowell, W. B. Pure Air, Ozone, and Water	12mo,	*2 00
Craig, J. W., and Woodward, W. P. Questions and Answers about Electrical Apparatus	12mo, leather,	1 50
Craig, T. Motion of a Solid in a Fuel. (Science Series No. 49.) 16mo,		0 50
— Wave and Vortex Motion. (Science Series No. 43.)	16mo,	0 50
Cramp, W. Continuous Current Machine Design	8vo,	*2 50
Creedy, F. Single-Phase Commutator Motors	8vo,	*2 00
Crocker, F. B. Electric Lighting. Two Volumes. 8vo. Vol. I. The Generating Plant		3 00
Vol. II. Distributing Systems and Lamps		
Crocker, F. B., and Arendt, M. Electric Motors	8vo,	*2 50
— and Wheeler, S. S. The Management of Electrical Ma- chinery	12mo,	*1 00
Cross, C. F., Bevan, E. J., and Sindall, R. W. Wood Pulp and Its Applications. (Westminster Series.)	8vo,	*2 00
Crosskey, L. R. Elementary Prospective	8vo,	1 00
Crosskey, L. R., and Thaw, J. Advanced Perspective	8vo,	1 50
Culley, J. L. Theory of Arches. (Science Series No. 87.)	16mo,	0 50
Dadourian, H. M. Analytical Mechanics	8vo.	*3 00
Danby, A. Natural Rock Asphalts and Bitumens	8vo,	*2 50

D. VAN NOSTRAND COMPANY'S SHORT-TITLE CATALOG 11

Davenport, C. The Book. (Westminster Series.)	8vo,	*2 00
Davey, N. The Gas Turbine.	8vo,	*4 00
Davies, F. H. Electric Power and Traction	8vo,	*2 00
— Foundations and Machinery Fixing. (Installation Manuals Series.)	16mo,	1 00
Dawson, P. Electric Traction on Railways	8vo,	*9 00
Deerr, N. Cane Sugar	8vo,	7 00
Deite, C. Manual of Soapmaking. Trans. by S. T. King	4to,	*5 00
De la Coux, H. The Industrial Uses of Water. Trans. by A. Morris	8vo,	*4 50
Del Mar, W. A. Electric Power Conductors	8vo,	*2 00
Denny, G. A. Deep-Level Mines of the Rand	4to,	*10 00
— Diamond Drilling for Gold		*5 00
De Roos, J. D. C. Linkages. (Science Series No. 47.)	16mo,	0 50
Derr, W. L. Block Signal Operation	Oblong 12mo,	*1 50
— Maintenance of Way Engineering. (In Preparation.)		
Desaint, A. Three Hundred Shades and How to Mix Them.	8vo,	8 00
De Varona, A. Sewer Gases. (Science Series No. 55.)	16mo,	0 50
Devey, R. G. Mill and Factory Wiring. (Installation Manuals Series.)	12mo,	*1 00
Dibdin, W. J. Purification of Sewage and Water	8vo,	6 50
Dichman, C. Basic Open-Hearth Steel Process	8vo,	*3 50
Dieterich, K. Analysis of Resins, Balsams, and Gum Resins	8vo,	*3 00
Dinger, Lieut. H. C. Care and Operation of Naval Machinery	12mo.	*2 00
Dixon, D. B. Machinist's and Steam Engineer's Practical Calculator	16mo, mor.,	1 25
Doble, W. A. Power Plant Construction on the Pacific Coast. (In Press.)		
Dommett, W. E. Motor Car Mechanism	12mo,	*1 25
Dorr, B. F. The Surveyor's Guide and Pocket Table-book.	16mo, mor.,	2 00
Draper, C. H. Elementary Text-book of Light, Heat and Sound	12mo,	1 00
Draper, C. H. Heat and the Principles of Thermo-dynamics. New and Revised Edition	12mo,	2 00

12 D. VAN NOSTRAND COMPANY'S SHORT-TITLE CATALOG

Dron, R. W. Mining Formulas.....	12mo,	1 00
Dubbel, H. High Power Gas Engines.....	8vo,	*5 00
Duckwall, E. W. Canning and Preserving of Food Products.....	8vo,	*5 00
Dumesny, P., and Noyer, J. Wood Products, Distillates, and Extracts.....	8vo,	*4 50
Duncan, W. G., and Penman, D. The Electrical Equipment of Collieries.....	8vo,	*4 00
Dunstan, A. E., and Thole, F. T. B. Textbook of Practical Chemistry.....	12mo,	*1 40
Duthie, A. L. Decorative Glass Processes. (Westminster Series).....	8vo,	*2 00
Dwight, H. B. Transmission Line Formulas.....	8vo,	*2 00
Dyson, S. S. Practical Testing of Raw Materials.....	8vo,	*5 00
— and Clarkson, S. S. Chemical Works.....	8vo,	*7 50
Eccles, W. H. Wireless Telegraphy and Telephony....(<i>In Press.</i>)		
Eck, J. Light, Radiation and Illumination. Trans. by Paul Hogner.....	8vo,	*2 50
Eddy, H. T. Maximum Stresses under Concentrated Loads,	8vo,	1 50
Edelman, P. Inventions and Patents.....	12mo,	(<i>In Press.</i>)
Edgcumbe, K. Industrial Electrical Measuring Instruments.	8vo.	
Edler, R. Switches and Switchgear. Trans. by Ph. Laubach.	8vo,	*4 00
Eissler, M. The Metallurgy of Gold.....	8vo,	7 50
— The Metallurgy of Silver.....	8vo,	4 00
— The Metallurgy of Argentiferous Lead.....	8vo,	5 00
— A Handbook of Modern Explosives.....	8vo,	5 00
Ekin, T. C. Water Pipe and Sewage Discharge Diagrams	folio,	*3 00
Electric Light Carbons, Manufacture of.....	8vo,	1 00
Eliot, C. W., and Storer, F. H. Compendious Manual of Qualitative Chemical Analysis.....	12mo,	*1 25
Ellis, C. Hydrogenation of Oils.....	8vo,	*4 00
Ellis, G. Modern Technical Drawing.....	8vo,	*2 00
Ennis, Wm. D. Linseed Oil and Other Seed Oils.....	8vo,	*4 00
— Applied Thermodynamics.....	8vo,	*4 50
— Flying Machines To-day.....	12mo,	*1 50

— Vapors for Heat Engines	12mo,	*1 00
Erfurt, J. Dyeing of Paper Pulp. Trans. by J. Hubner. 8vo.		
Ermen, W. F. A. Materials Used in Sizing	12mo,	*2 00
Evans, C. A. Macadamized Roads	(<i>In Press.</i>)	
Ewing, A. J. Magnetic Induction in Iron	8vo,	*4 00
Fairie, J. Notes on Lead Ores	12mo,	*1 00
— Notes on Pottery Clays	12mo,	*1 50
Fairley, W., and Andre, Geo. J. Ventilation of Coal Mines. (Science Series No. 58.)	16mo,	0 50
Fairweather, W. C. Foreign and Colonial Patent Laws	8vo,	*3 00
Fanning, T. T. Hydraulic and Water-supply Engineering. 8vo.		*5 00
Fay, I. W. The Coal-tar Colors	8vo,	*4 00
Fernbach, R. L. Glue and Gelatine	8vo,	*3 00
— Chemical Aspects of Silk Manufacture	12mo,	*1 00
Fischer, E. The Preparation of Organic Compounds. Trans. by R. V. Stanford	1 mo,	*1 25
Fish, J. C. L. Lettering of Working Drawings	Oblong 8o,	1 00
Fisher, H. K. C., and Darby, W. C. Submarine Cable Testing. 8vo,		*3 50
Fleischmann, W. The Book of the Dairy. Trans. by C. M. Aikman	8vo,	4 00
Fleming, J. A. The Alternate-current Transformer. Two Volumes	8vo,	
Vol. I. The Induction of Electric Currents		*5 00
Vol. II. The Utilization of Induced Currents		*5 00
— Propagation of Electric Currents	8vo,	*3 00
— A Handbook for the Electrical Laboratory and Testing Room. Two Volumes	8vo, each,	*5 00
Fleury, P. White Zinc Paints	12mo,	*2 50
Flynn, P. J. Flow of Water. (Science Series No. 84.)	16mo,	0 50
— Hydraulic Tables. (Science Series No. 66.)	16mo,	0 50
Forgie, J. Shield Tunneling	8vo. (<i>In Press.</i>)	
Foster, H. A. Electrical Engineers' Pocket-book. (<i>Seventh Edition.</i>)	12mo, leather,	5 00
— Engineering Valuation of Public Utilities	8vo,	*3 00
— Handbook of Electrical Cost Data	8vo. (<i>In Press.</i>)	
Fowle, F. F. Overhead Transmission Line Crossings	12mo,	*1 50
— The Solution of Alternating Current Problems	8vo (<i>In Press.</i>)	

Fox, W. G. Transition Curves. (Science Series No. 110.)	16mo,	9 50
Fox, W., and Thomas, C. W. Practical Course in Mechanical Drawing12mo,	1 25
Foye, J. C. Chemical Problems. (Science Series No. 69.)	16mo,	0 50
— Handbook of Mineralogy. (Science Series No. 86.)	16mo,	0 50
Francis, J. B. Lowell Hydraulic Experiments4to,	15 00
Franzen, H. Exercises in Gas Analysis12mo,	*1 00
French, J. W. Machine Tools. 2 vols.4to,	*15 00
Freudemacher, P. W. Electrical Mining Installations. (Installation Manuals Series.)12mo,	*1 00
Frith, J. Alternating Current Design8vo,	*2 00
Fritsch, J. Manufacture of Chemical Manures. Trans. by D. Grant8vo,	*4 00
Frye, A. I. Civil Engineers' Pocket-book12mo, leather,	*5 00
Fuller, G. W. Investigations into the Purification of the Ohio River4to,	*10 00
Furnell, J. Paints, Colors, Oils, and Varnishes8vo,	*1 00
Gairdner, J. W. I. Earthwork8vo (<i>In Press.</i>)	
Gant, L. W. Elements of Electric Traction8vo,	*2 50
Garcia, A. J. R. V. Spanish-English Railway Terms8vo,	*4 50
Garforth, W. E. Rules for Recovering Coal Mines after Explosions and Fires12mo, leather,	1 50
Garrard, C. C. Electric Switch and Controlling Gear (<i>In Press.</i>)	
Gaudard, J. Foundations. (Science Series No. 34.)16mo,	0 50
Gear, H. B., and Williams, P. F. Electric Central Station Distributing Systems12mo,	*3 00
Geerlign, H. C. P. Cane Sugar and Its Manufacture8vo,	*5 00
Geikie, J. Structural and Field Geology8vo,	*4 00
— Mountains, Their Origin, Growth and Decay8vo,	*4 00
— The Antiquity of Man in Europe8vo,	*3 00
Georgi, F., and Schubert, A. Sheet Metal Working. Trans. by C. Salter8vo,	3 00
Gerber, N. Analysis of Milk, Condensed Milk, and Infants' Milk-Food8vo,	1 25
Gerhard, W. F. Sanitation, Water-supply and Sewage Disposal of Country Houses12mo,	*2 00

D. VAN NOSTRAND COMPANY'S SHORT-TITLE CATALOG 15

— Gas Lighting. (Science Series No. 111.)	16mo,	0 50
Gerhard, W. P. Household Wastes. (Science Series No. 97.)	16mo,	0 50
— House Drainage. (Science No. 63.)	16mo,	0 50
— Sanitary Drainage of Buildings. (Science Series No. 93.)	16mo,	0 50
Gerhardi, C. W. H. Electricity Meters.	8vo,	*4 00
Geschwind, L. Manufacture of Alum and Sulphates. Trans. by C. Salter	8vo,	*5 00
Gibbs, W. E. Lighting by Acetylene	12mo,	*1 50
Gibson, A. H. Hydraulics and Its Application	8vo,	*5 00
— Water Hammer in Hydraulic Pipe Lines	12mo,	*2 00
Gibson, A. H., and Ritchie, E. Y. Circular Arc Bow Girder	4to,	*3 50
Gilbreth, F. B. Motion Study. A Method for Increasing the Efficiency of the Workman	12mo,	*2 00
— Primer of Scientific Management	12mo,	*1 00
Gillmore, Gen. Q. A. Limes, Hydraulics Cement and Mortars.	8vo,	4 00
— Roads, Streets, and Pavements	12mo,	2 00
Golding, H. A. The Theta-Phi Diagram	12mo,	*1 25
Goldschmidt, R. Alternating Current Commutator Motor	8vo,	*3 00
Goodchild, W. Precious Stones. (Westminster Series.)	8vo,	*2 00
Goodeve, T. M. Textbook on the Steam-engine	12mo,	2 00
Gore, G. Electrolytic Separation of Metals	8vo,	*3 50
Gould, E. S. Arithmetic of the Steam-engine	12mo,	1 00
— Calculus. (Science Series No. 112.)	16mo,	0 50
— High Masonry Dams. (Science Series No. 22.)	16mo,	0 50
— Practical Hydrostatics and Hydrostatic Formulas. (Science Series.)	16mo,	0 50
Gratacap, L. P. A Popular Guide to Minerals	8vo,	*3 00
Gray, J. Electrical Influence Machines	12mo,	2 00
Gray, J. Marine Boiler Design	12mo,	*1 25
Greenhill, G. Dynamics of Mechanical Flight	8vo,	*2 50
Greenwood, E. Classified Guide to Technical and Commercial Books	8vo,	*3 00
Gregorius, R. Mineral Waxes. Trans. by C. Salter	12mo,	*3 00
Griffiths, A. B. A Treatise on Manures	12mo,	3 00

Griffiths, A. B. Dental Metallurgy	8vo,	*3 50
Gross, E. Hops	8vo,	*4 50
Grossman, J. Ammonia and its Compounds	12mo,	*1 25
Groth, L. A. Welding and Cutting Metals by Gases or Electric- ity. (Westminster Series.)	8vo,	*2 00
Grover, F. Modern Gas and Oil Engines	8vo,	*2 00
Gruener, A. Power-loom Weaving	8vo,	*3 00
Güldner, Hugo. Internal-Combustion Engines. Trans. by H. Diedrichs	4to,	*10 00
Gunther, C. O. Integration	12mo.	
Gurden, R. L. Traverse Tables	folio, half mor.,	*7 50
Guy, A. E. Experiments on the Flexure of Beams	8vo,	*1 25
Haenig, A. Emery and the Emery Industry	12mo,	*2 50
Hainbach, R. Pottery Decoration. Trans. by C. Slater	12mo,	*3 00
Hale, W. J. Calculations of General Chemistry	12mo,	*1 00
Hall, C. H. Chemistry of Paints and Paint Vehicles	12mo,	*2 00
Hall, G. L. Elementary Theory of Alternate Current Work- ing	8vo,	*1 50
Hall, R. H. Governors and Governing Mechanism	12mo,	*2 00
Hall, W. S. Elements of the Differential and Integral Calculus 8vo,		*2 25
— Descriptive Geometry	8vo volume and 4to atlas,	*3 50
Haller, G. F., and Cunningham, E. T. The Tesla Coil	12mo,	*1 25
Halsey, F. A. Slide Valve Gears	12mo,	1 50
— The Use of the Slide Rule. (Science Series.)	16mo,	0 50
— Worm and Spiral Gearing. (Science Series.)	16mo,	0 50
Hancock, H. Textbook of Mechanics and Hydrostatics	8vo,	1 50
Hancock, W. C. Refractory Materials. (Metallurgy Series. <i>In Press.</i>)		
Hardy, E. Elementary Principles of Graphic Statics	12mo,	*1 50
Harrison, W. B. The Mechanics' Tool-book	12mo,	1 50
Hart, J. W. External Plumbing Work	8vo,	*3 00
— Hints to Plumbers on Joint Wiping	8vo,	*3 00
— Principles of Hot Water Supply	8vo,	*3 00
— Sanitary Plumbing and Drainage	8vo,	*3 00
Haskins, C. H. The Galvanometer and Its Uses	16mo,	1 50
Hatt, J. A. H. The Colorist. Second Edition	square 12mo,	*1 50

Hausbrand, E. Drying by Means of Air and Steam. Trans. by A. C. Wright.....	12mo,	*2 00
— Evaporating, Condensing and Cooling Apparatus. Trans. by A. C. Wright.....	8vo,	*5 00
Hausmann, E. Telegraph Engineering.....	8vo,	*3 00
Hausner, A. Manufacture of Preserved Foods and Sweetmeats. Trans. by A. Morris and H. Robson.....	8vo,	*3 00
Hawkesworth, J. Graphical Handbook for Reinforced Concrete Design.....	4to,	*2 50
Hay, A. Continuous Current Engineering.....	8vo,	*2 50
Hayes, H. V. Public Utilities, Their Cost New and Deprecia- tion.....	8vo,	*2 00
— Public Utilities, Their Fair Present Value and Return, 8vo,		*2 00
Heather, H. J. S. Electrical Engineering.....	8vo,	*3 50
Heaviside, O. Electromagnetic Theory. Three volumes. 8vo, Vols. I and II, each,		*5 00
Vol. III,		*7 50
Heck, R. C. H. Steam Engine and Turbine.....	8vo,	*3 50
— Steam-Engine and Other Steam Motors. Two Volumes. Vol. I. Thermodynamics and the Mechanics.....	8vo,	*3 50
Vol. II. Form, Construction and Working.....	8vo,	*5 00
— Notes on Elementary Kinematics.....	8vo, boards,	*1 00
— Graphics of Machine Forces.....	8vo, boards,	*1 00
Heermann, P. Dyers' Materials. Trans. by A. C. Wright. 12mo,		*2 50
Hellot, Macquer and D'Apligny. Art of Dyeing Wool, Silk and Cotton.....	8vo,	*2 00
Henrici, O. Skeleton Structures.....	8vo,	1 50
Hering, D. W. Essentials of Physics for College Students. 8vo,		*1 75
Hermann, G. The Graphical Statics of Mechanism. Trans. by A. P. Smith.....	12mo,	2 00
Herring-Shaw, A. Domestic Sanitation and Plumbing. Two Parts.....	8vo,	*5 00
— Elementary Science of Sanitation and Plumbing....	8vo,	*2 00
Herzfeld, J. Testing of Yarns and Textile Fabrics.....	8vo,	*3 50

18 D. VAN NOSTRAND COMPANY'S SHORT-TITLE CATALOG

Hildebrandt, A. Airships, Past and Present.....	8vo,	*3 50
Hildenbrand, B. W. Cable-Making. (Science Series No. 32.)	16mo,	0 05
Hildich, H. Concise History of Chemistry.....	12mo,	*1
Hill, J. W. The Purification of Public Water Supplies. New Edition.....		52
— Interpretation of Water Analysis.....		(In Press.)
Hill, M. J. M. The Theory of Proportion.....	8vo,	*2 50
Hiroi, I. Plate Girder Construction. (Science Series No. 95.)	16mo,	0 50
— Statically-Indeterminate Stresses.....	12mo,	*2 00
Hirshfeld, C. F. Engineering Thermodynamics. (Science Series.).....	16mo,	0 50
Hobart, H. M. Heavy Electrical Engineering.....	8vo,	*4 50
— Design of Static Transformers.....	8vo,	*2 00
— Electricity.....	8vo,	*2 00
— Electric Trains.....	8vo,	*2 50
— Electric Propulsion of Ships.....	8vo,	*2 00
Hobart, J. F. Hard Soldering, Soft Soldering, and Brazing.	12mo,	*1 00
Hobbs, W. R. P. The Arithmetic of Electrical Measurements	12mo,	0 50
Hoff, J. N. Paint and Varnish Facts and Formulas.....	12mo,	*1 50
Hole, W. The Distribution of Gas.....	8vo,	*7 50
Holley, A. L. Railway Practice.....	folio,	6 00
Hopkins, N. M. Experimental Electrochemistry.....	8vo,	
— Model Engines and Small Boats.....	12mo,	1 25
Hopkinson, J., Shoolbred, J. N., and Day, R. E. Dynamic Electricity. (Science Series No. 71.).....	16mo,	0 50
Horner, J. Practical Ironfounding.....	8vo,	*2 00
— Gear Cutting, in Theory and Practice.....	8vo,	*3 00
Houghton, C. E. The Elements of Mechanics of Materials.....	12mo,	*2 00
Houllievigüe, L. The Evolution of the Sciences.....	8vo,	*2 00
Houstoun, R. A. Studies in Light Production.....	12mo,	*2 00
Hovenden, F. Practical Mathematics for Young Engineers,	12mo,	*1 00
Howe, G. Mathematics for the Practical Man.....	12mo,	*1 25

Howorth, J. Repairing and Riveting Glass, China and Earthenware.....	8vo, paper,	*0 50
Hubbard, E. The Utilization of Wood-waste.....	8vo,	*2 50
Hubner, J. Bleaching and Dyeing of Vegetable and Fibrous Materials. (Outlines of Industrial Chemistry.) . . .		*5 00
Hudson, O. F. Iron and Steel. (Outlines of Industrial Chemistry.)	8vo,	*2 00
Humphrey, J. C. W. Metallography of Strain. (Metallurgy Series)	(In Press.)	
Humphreys, A. C. The Business Features of Engineering Practice	8vo,	*2 50
Hunter, A. Bridge Work	8vo (In Press.)	
Hurst, G. H. Handbook of the Theory of Color	8vo,	*2 50
— Dictionary of Chemicals and Raw Products	8vo,	*3 00
— Lubricating Oils, Fats and Greases	8vo,	*4 00
— Soaps	8vo,	*5 00
Hurst, G. H., and Simmons, W. H. Textile Soaps and Oils,	8vo,	*2 50
Hurst, H. E., and Lattey, R. T. Text-book of Physics	8vo,	*3 00
— Also published in Three Parts:		
Vol. I. Dynamics and Heat	8vo,	*1 25
Vol. II. Sound and Light	8vo,	*1 25
Vol. III. Magnetism and Electricity	8vo,	*1 50
Hutchinson, R. W., Jr. Long Distance Electric Power Transmission	12mo,	*3 00
Hutchinson, R. W., Jr., and Thomas, W. A. Electricity in Mining	12mo,	
Hutchinson, W. B. Patents and How to Make Money Out of Them	12mo,	1 25
Hutton, W. S. Steam-boiler Construction	8vo,	6 00
Hutton, W. S. The Works' Manager's Handbook	8vo,	6 00
Hyde, E. W. Skew Arches. (Science Series No. 15.)	16mo,	0 50
Hyde, F. S. Solvents, Oils, Gums and Waxes	12mo,	*2 00
Induction Coils. (Science Series No. 53.)	16mo,	0 50
Ingham, A. E. Gearing. A practical treatise	8vo,	*2 50
Ingle, H. Manual of Agricultural Chemistry.	8vo,	*3 00

Innes, C. H. Problems in Machine Design.....	12mo,	*2 00
— Air Compressors and Blowing Engines.....	12mo,	*2 00
— Centrifugal Pumps.....	12mo,	*2 00
— The Fan.....	12mo,	*2 00
Ivatts, E. B. Railway Management at Stations.....	8vo,	*2 50
Jacob, A., and Gould, E. S. On the Designing and Construction of Storage Reservoirs. (Science Series No. 6.)...	16mo,	0 50
Jannettaz, E. Guide to the Determination of Rocks. Trans. by G. W. Plympton.....	12mo,	1 50
Jehl, F. Manufacture of Carbons.....	8vo,	*4 00
Jennings, A. S. Commercial Paints and Painting. (West- minster Series.).....	8vo,	*2 00
Jennison, F. H. The Manufacture of Lake Pigments....	8vo,	*3 00
Jepson, G. Cams and the Principles of their Construction... — Mechanical Drawing.....	8vo (In Preparation.)	*1 50
Jervis-Smith, F. J. Dynamometers.....	8vo,	*3 50
Jockin, W. Arithmetic of the Gold and Silversmith....	12mo,	*1 00
Johnson, J. H. Arc Lamps. (Installation Manuals Series.)	12mo,	*0 75
Johnson, T. M. Ship Wiring and Fitting. (Installation Manuals Series).....	16mo,	*0 75
Johnson, W. McA. The Metallurgy of Nickel..... (In Preparation.)		
Johnston, J. F. W., and Cameron, C. Elements of Agricultural Chemistry and Geology.....	12mo,	2 60
Joly, J. Radioactivity and Geology.....	12mo,	*3 00
Jones, H. C. Electrical Nature of Matter and Radioactivity	12mo,	*2 00
— New Era in Chemistry.....	12mo,	*2 00
Jones, J. H. Tinsplate Industry.....	8vo,	*3 00
Jones, M. W. Testing Raw Materials Used in Paint....	12mo,	*2 00
Jordan, L. C. Practical Railway Spiral.....	12mo, Leather,	*1 50
Joynson, F. H. Designing and Construction of Machine Gear- ing.....	8vo,	2 00
Jüptner, H. F. V. Siderology: The Science of Iron.....	8vo,	*5 00
Kapp, G. Alternate Current Machinery. (Science Series No. 96.).....	16mo,	0 50

Keim, A. W. Prevention of Dampness in Buildings	8vo,	*2 00
Keller, S. S. Mathematics for Engineering Students.		
	12mo, half leather,	
— Algebra and Trigonometry, with a Chapter on Vectors.		*1 75
— Plane and Solid Geometry.		*1 25
— and Knox, W. F. Analytical Geometry and Calculus.		*2 00
Kelsey, W. R. Continuous-current Dynamos and Motors.		
	8vo,	*2 50
Kemble, W. T., and Underhill, C. R. The Periodic Law and the Hydrogen Spectrum.	8vo, paper,	*0 50
Kemp, J. F. Handbook of Rocks.	8vo,	*1 50
Kennedy, A. B. W., and Thurston, R. H. Kinematics of Machinery. (Science Series No. 54.)	16mo,	0 50
Kennedy, A. B. W., Unwin, W. C., and Idell, F. E. Compressed Air. (Science Series No. 106.)	16mo,	0 50
Kennedy, R. Modern Engines and Power Generators. Six Volumes.	4to,	15 00
Single Volumes.	each,	3 00
— Electrical Installations. Five Volumes.	4to,	15 00
Single Volumes.	each,	3 50
— Principles of Aeroplane Construction	12mo,	*1 50
— Flying Machines; Practice and Design.	12mo,	*2 00
Kennelly, A. E. Electro-dynamic Machinery.	8vo,	1 50
Kent, W. Strength of Materials. (Science Series No. 41.)	16mo,	0 50
Kershaw, J. B. C. Fuel, Water and Gas Analysis.	8vo,	*2 50
— Electrometallurgy. (Westminster Series.)	8vo,	*2 00
— The Electric Furnace in Iron and Steel Production.	12mo,	*1 50
— Electro-Thermal Methods of Iron and Steel Production,		
	8vo,	*3 00
Kinzbrunner, C. Alternate Current Windings.	8vo,	*1 50
— Continuous Current Armatures.	8vo,	*1 50
— Testing of Alternating Current Machines.	8vo,	*2 00
Kirkaldy, W. G. David Kirkaldy's System of Mechanical Testing.	4to,	10 00
Kirkbride, J. Engraving for Illustration.	8vo,	*1 50
Kirkwood, J. P. Filtration of River Waters.	4to,	7 50
Kirschke, A. Gas and Oil Engines.	12mo.	*1 25

22 D. VAN NOSTRAND COMPANY'S SHORT-TITLE CATALOG

Klein, J. F. Design of a High speed Steam-engine	8vo,	*5 00
— Physical Significance of Entropy.	8vo,	*1 50
Knight, R.-Adm. A. M. Modern Seamanship.	8vo,	*7 50
	Half Mor.	*9 00
Knott, C. G., and Mackay, J. S. Practical Mathematics.	8vo,	2 00
Knox, J. Physico-chemical Calculations	12mo,	*1 00
— Fixation of Atmospheric Nitrogen. (Chemical Mono- graphs.)	12mo,	0 75
Koester, F. Steam-Electric Power Plants.	4to,	*5 00
— Hydroelectric Developments and Engineering.	4to.	*5 00
Koller, T. The Utilization of Waste Products.	8vo,	*3 00
— Cosmetics.	8vo,	*2 50
Kremann, R. Application of Physico Chemical Theory to Technical Processes and Manufacturing Methods. Trans. by H. E. Potts.	8vo,	*3 00
Kretchmar, K. Yarn and Warp Sizing.	8vo,	*4 00
Lallier, E. V. Elementary Manual of the Steam Engine. 12mo,		*2 00
Lambert, T. Lead and its Compounds.	8vo,	*3 50
— Bone Products and Manures.	8vo,	*3 00
Lamborn, L. L. Cottonseed Products.	8vo,	*3 00
— Modern Soaps, Candles, and Glycerin.	8vo,	*7 50
Lamprecht, R. Recovery Work After Pit Fires. Trans. by C. Salter	8vo,	*4 00
Lancaster, M. Electric Cooking, Heating and Cleaning.	8vo,	*1 50
Lanchester, F. W. Aerial Flight. Two Volumes. 8vo. Vol. I. Aerodynamics		*6 00
Vol. II. Aerodnetics		*6 00
Larner, E. T. Principles of Alternating Currents.	12mo,	*1 25
La Rue, B. F. Swing Bridges. (Science Series No. 107.)	16mo,	0 50
Lassar-Cohn, Dr. Modern Scientific Chemistry. Trans. by M. M. Pattison Muir.	12mo,	*2 00
Latimer, L. H., Field, C. J., and Howell, J. W. Incandescent Electric Lighting. (Science Series No. 57.)	16mo,	0 50
Latta, M. N. Handbook of American Gas-Engineering Practice. 8vo,		*4 50

— American Producer Gas Practice	4to,	*6 00
Laws, B. C. Stability and Equilibrium of Floating Bodies.	8vo,	*3 50
Lawson, W. R. British Railways, a Financial and Commercial Survey	8vo,	*2 00
Leask, A. R. Breakdowns at Sea	12mo,	2 00
— Refrigerating Machinery	12mo,	2 00
Lecky, S. T. S. "Wrinkles" in Practical Navigation	8vo,	*8 00
Le Doux, M. Ice-Making Machines. (Science Series No. 46.)	16mo,	0 50
Leeds, C. C. Mechanical Drawing for Trade Schools. oblong, 4to,		
High School Edition		*1 25
Machinery Trades Edition		*2 00
Lefèvre, L. Architectural Pottery. Trans. by H. K. Bird and W. M. Binns	4to,	*7 50
Lehner, S. Ink Manufacture. Trans. by A. Morris and H. Robson	8vo,	*2 50
Lemstrom, S. Electricity in Agriculture and Horticulture	8vo,	*1 50
Letts, E. A. Fundamental Problems in Chemistry	12mo,	*2 00
Le Van, W. B. Steam-Engine Indicator. (Science Series No. 78.)	16mo,	0 50
Lewes, V. B. Liquid and Gaseous Fuels. (Westminster Series.)	8vo,	*2 00
— Carbonisation of Coal	8vo,	*3 00
Lewis, L. P. Railway Signal Engineering	8vo,	*3 50
Lieber, B. F. Lieber's Standard Telegraphic Code	8vo,	*10 00
— Code. German Edition	8vo,	*10 00
— Spanish Edition	8vo,	*10 00
— French Edition	8vo,	*10 00
— Terminal Index	8vo,	*2 50
— Lieber's Appendix	folio,	*15 00
— Handy Tables	4to,	*2 50
— Bankers and Stockbrokers' Code and Merchants and Shippers' Blank Tables	8vo,	*15 00
Lieber, B. F. 100,000,000 Combination Code	8vo,	*10 00
— Engineering Code	8vo,	*12 50
Livermore, V. P., and Williams, J. How to Become a Competent Motorman	12mo,	*1 00

Livingstone, R. Design and Construction of Commutators.....	8vo,	*2 25
— Mechanical Design and Construction of Generators....	8vo,	*3 50
Lobben, P. Machinists' and Draftsmen's Handbook.....	8vo,	2 50
Lockwood, T. D. Electricity, Magnetism, and Electro-telegraphy.....	8vo,	2 50
— Electrical Measurement and the Galvanometer....	12mo,	0 75
Lodge, O. J. Elementary Mechanics.....	12mo,	1 50
— Signalling Across Space without Wires.....	8vo,	*2 00
Loewenstein, L. C., and Crissey, C. P. Centrifugal Pumps.....	8vo,	*4 50
Lomax, J. W. Cotton Spinning.....	12mo,	1 50
Lord, R. T. Decorative and Fancy Fabrics.....	8vo,	*3 50
Loring, A. E. A Handbook of the Electromagnetic Telegraph. (Science Series No. 39).....	16mo,	0 50
Low, D. A. Applied Mechanics (Elementary).....	16mo,	0 80
Lubschez, B. J. Perspective.....	12mo,	*1 50
Lucke, C. E. Gas Engine Design.....	8vo,	*3 00
— Power Plants: their Design, Efficiency, and Power Costs. 2 vols.....	(In Preparation.)	
Lunge, G. Coal-tar Ammonia. Two Volumes.....	8vo,	*15 00
— Manufacture of Sulphuric Acid and Alkali. Three Volumes 8vo,		
Vol. I. Sulphuric Acid and Alkali. In three parts....		*18 00
Vol. II. Salt Cake, Hydrochloric Acid and Leblanc Soda. In two parts.....		*15 00
Vol. III. Ammonia Soda.....		*10 00
Vol. IV. Electrolytic Methods.....	(In Press.)	
— Technical Chemists' Handbook.....	12mo, leather,	*3 50
— Technical Methods of Chemical Analysis. Trans. by C. A. Keane. In collaboration with the corps of specialists.		
Vol. I. In two parts.....	8vo,	*15 00
Vol. II. In two parts.....	8vo,	*18 00
Vol. III. In two parts.....	8vo,	*18 00
The set complete.....		*48 00
— Technical Gas Analysis.....	8vo,	*4 00
Luquer, L. M. Minerals in Rock Sections.....	8vo,	*1 50

Macaulay, J., and Hall, C. Modern Railway Working. Eight vols.	4to,	20 00
Each volume separately.....		3 00
Macewen, H. A. Food Inspection.....	8vo,	*2 50
Mackenzie, N. F. Notes on Irrigation Works.....	8vo,	*2 50
Mackie, J. How to Make a Woolen Mill Pay.....	8vo,	*2 00
Maguire, Wm. R. Domestic Sanitary Drainage and Plumbing	8vo,	4 00
Malcolm, H. W. Submarine Telegraph Cable.....	(In Press.)	
Mallet, A. Compound Engines. Trans. by R. R. Buel. (Science Series No. 10.).....	16mo,	
Mansfield, A. N. Electro-magnets. (Science Series N ^o 64)	16mo,	0 50
Marks, E. C. R. Construction of Cranes and Lifting Machinery	12mo,	*1 50
— Construction and Working of Pumps.....	12mo,	*1 50
— Manufacture of Iron and Steel Tubes.....	12mo,	*2 00
— Mechanical Engineering Materials.....	12mo,	*1 00
Marks, G. C. Hydraulic Power Engineering.....	8vo,	3 50
— Inventions, Patents and Designs.....	12mo,	*1 00
Marlow, T. G. Drying Machinery and Practice.....	8vo,	*5 00
Marsh, C. F. Concise Treatise on Reinforced Concrete....	8vo,	*2 50
Marsh, C. F. Reinforced Concrete Compression Member Diagram.....		1 50
Marsh, C. F., and Dunn, W. Manual of Reinforced Concrete and Concrete Block Construction.....	16mo, mor.,	*2 50
Marshall, W. J., and Sankey, H. R. Gas Engines. (Westminster Series.).....	8vo,	*2 00
Martin, G. Triumphs and Wonders of Modern Chemistry.	8vo,	*2 00
Martin, N. Reinforced Concrete.....	8vo,	*2 50
Martin, W. D. Hints to Engineers.....	12mo,	*1 00
Massie, W. W., and Underhill, C. R. Wireless Telegraphy and Telephony.....	12mo,	*1 00
Mathot, R. E. Internal Combustion Engines.....	8vo,	*6 00
Maurice, W. Electric Blasting Apparatus and Explosives ..	8vo,	*3 50
— Shot Firer's Guide.....	8vo,	*1 50

Maxwell, J. C. Matter and Motion. (Science Series No. 36.)	16mo,	0 50
Maxwell, W. H., and Brown, J. T. Encyclopedia of Municipal and Sanitary Engineering.....	4to,	*10 00
McCullough, E. Practical Surveying.....	8vo,	*2 50
McCullough, R. S. Mechanical Theory of Heat.....	8vo,	3 50
McGibbon, W. C. Indicator Diagrams for Marine Engineers,	8vo,	*3 00
— Marine Engineers' Drawing Book.....	oblong, 4to,	*2 00
McIntosh, J. G. Technology of Sugar.....	8vo,	*4 50
— Industrial Alcohol.....	8vo,	*3 00
— Manufacture of Varnishes and Kindred Industries. Three Volumes. 8vo.		
Vol. I. Oil Crushing, Refining and Boiling.....		*3 50
Vol. II. Varnish Materials and Oil Varnish Making.....		*4 00
Vol. III. Spirit Varnishes and Materials.....		*4 50
McKnight, J. D., and Brown, A. W. Marine Multitubular Boilers.....		*1 50
McMaster, J. B. Bridge and Tunnel Centres. (Science Series No. 20.).....	16mo,	0 50
McMechen, F. L. Tests for Ores, Minerals and Metals....	12mo,	*1 00
McPherson, J. A. Water-works Distribution.....	8vo,	2 50
Melick, C. W. Dairy Laboratory Guide.....	12mo,	*1 25
Merck, E. Chemical Reagents: Their Purity and Tests. Trans. by H. E. Schenck.....	8vo,	1 00
Merivale, J. H. Notes and Formulae for Mining Students,	12mo,	1 50
Merritt, Wm. H. Field Testing for Gold and Silver. 16mo, leather,		1 50
Meyer, J. G. A., and Pecker, C. G. Mechanical Drawing and Machine Design.....	4to,	5 00
Mierzinski, S. Waterproofing of Fabrics. Trans. by A. Morris and H. Robson.....	8vo,	*2 50
Miller, G. A. Determinants. (Science Series No. 105.)....	16mo,	
Milroy, M. E. W. Home Lace-making.....	12mo,	*1 00
Mitchell, C. A. Mineral and Aerated Waters.....	8vo,	*3 00
— and Prideaux, R. M. Fibres Used in Textile and Allied Industries.....	8vo,	*3 00

Mitchell, C. F. and G. A. Building Construction and Drawing.	12mo	
	Elementary Course,	*1 50
	Advanced Course,	*2 50
Monckton, C. C. F. Radiotelegraphy. (Westminster Series.)	8vo,	*2 00
Monteverde, R. D. Vest Pocket Glossary of English-Spanish, Spanish-English Technical Terms.	64mo, leather,	*1 00
Montgomery, J. H. Electric Wiring Specifications.	12mo,	*1 00
Moore, E. C. S. New Tables for the Complete Solution of Ganguillet and Kutter's Formula.	8vo,	*5 00
Morecroft, J. H., and Hehre, F. W. Testing Electrical Machinery.	8vo,	*1 50
Morgan, A. P. Wireless Telegraph Construction for Amateurs.	12mo,	*1 50
Moses, A. J. The Characters of Crystals.	8vo,	*2 00
— and Parsons, C. L. Elements of Mineralogy.	8vo,	*2 50
Moss, S. A. Elements of Gas Engine Design. (Science Series.).....	16mo,	0 50
— The Lay-out of Corliss Valve Gears. (Science Series).	16mo,	0 50
Mulford, A. C. Boundaries and Landmarks.	8vo,	*1 00
Mullin, J. P. Modern Moulding and Pattern-making.	12mo,	2 50
Munby, A. E. Chemistry and Physics of Building Materials. (Westminster Series.).....	8vo,	*2 00
Murphy, J. G. Practical Mining.	16mo,	1 00
Murphy, W. S. Textile Industries, 8 vols.		*20 00
— (Sold separately.)	each,	*3 00
Murray, J. A. Soils and Manures. (Westminster Series.)	8vo,	*2 00
Naquet, A. Legal Chemistry.	12mo,	2 00
Nasmith, J. The Student's Cotton Spinning.	8vo,	3 00
— Recent Cotton Mill Construction.	12mo,	2 00
Neave, G. B., and Heilbron, I. M. Identification of Organic Compounds.	12mo,	*1 25
Neilson, R. M. Aeroplane Patents.	8vo,	*2 00
Nerz, F. Searchlights. Trans. by C. Rodgers.	8vo,	*3 00

Nesbit, A. F. Electricity and Magnetism	(In Preparation.)	
Neuberger, H., and Noalhat, H. Technology of Petroleum.		
Trans. by J. G. McIntosh	8vo,	*10 00
Newall, J. W. Drawing, Sizing and Cutting Bevel-gears	8vo,	1 50
Newbiging, T. Handbook for Gas Engineers and Managers,		
8vo,		*6 50
Nicol, G. Ship Construction and Calculations	8vo,	*4 50
Nipher, F. E. Theory of Magnetic Measurements	12mo,	1 00
Nisbet, H. Grammar of Textile Design	8vo,	*3 00
Nolan, H. The Telescope. (Science Series No. 51.)	16mo,	0 50
North, H. B. Laboratory Experiments in General Chemistry		
12mo,		*1 00
Nugent, E. Treatise on Optics	12mo,	1 50
O'Connor, H. The Gas Engineer's Pocketbook	12mo, leather,	3 50
Ohm, G. S., and Lockwood, T. D. Galvanic Circuit. Trans. by		
William Francis. (Science Series No. 102.)	16mo,	0 50
Olsen, J. C. Text book of Quantitative Chemical Analysis	8vo,	*4 00
Olsson, A. Motor Control, in Turret Turning and Gun Elevating.		
(U. S. Navy Electrical Series, No. 1.)	12mo, paper,	*0 50
Ormsby, M. T. M. Surveying	12mo,	1 50
Oudin, M. A. Standard Polyphase Apparatus and Systems	8vo,	*3 00
Owen, D. Recent Physical Research	8vo,	*1 50
Pakes, W. C. C., and Nankivell, A. T. The Science of Hygiene.		
8vo,		*1 75
Palaz, A. Industrial Photometry. Trans. by G. W. Patterson,		
Jr.	8vo,	*4 00
Pamely, C. Colliery Manager's Handbook	8vo,	*10 00
Parker, P. A. M. The Control of Water	8vo,	*5 00
Parr, G. D. A. Electrical Engineering Measuring Instruments.		
8vo,		*3 50
Parry, E. J. Chemistry of Essential Oils and Artificial Per-		
fumes	8vo,	*5 00
Parry, E. J. Foods and Drugs. Two Volumes	8vo.	
Vol. I. Chemical and Microscopical Analysis of Food		
and Drugs		*7. 50
Vol. II. Sale of Food and Drugs Acts		*3 00
— and Coste, J. H. Chemistry of Pigments	8vo,	*4 50

Parry, L. Notes on Alloys.....	8vo,	3 00
— Metalliferous Wastes	8vo,	2 00
— Analysis of Ashes and Alloys.....	8vo,	2 00
Parry, L. A. Risk and Dangers of Various Occupations.....	8vo,	*3 00
Parshall, H. F., and Hobart, H. M. Armature Windings....	4to,	*7 50
— Electric Railway Engineering.....	4to,	*10 00
Parsons, S. J. Malleable Cast Iron.....	8vo,	*2 50
Partington, J. R. Higher Mathematics for Chemical Students		
	12mo,	*2 00
— Textbook of Thermodynamics.....	8vo,	*4 00
Passmore, A. C. Technical Terms Used in Architecture ...	8vo,	*3 50
Patchell, W. H. Electric Power in Mines.....	8vo,	*4 00
Paterson, G. W. L. Wiring Calculations	12mo,	*2 00
— Electric Mine Signalling Installations.....	12mo,	*1 50
Patterson, D. The Color Printing of Carpet Yarns.....	8vo,	*3 50
— Color Matching on Textiles.....	8vo,	*3 00
— Textile Color Mixing.....	8vo,	*3 00
Paulding, C. P. Condensation of Steam in Covered and Bare		
Pipes.....	8vo,	*2 00
— Transmission of Heat Through Cold-storage Insulation		
	12mo,	*1 00
Payne, D. W. Iron Founders' Handbook.....	(In Press.)	
Peddie, R. A. Engineering and Metallurgical Books....	12mo,	*1 50
Peirce, B. System of Analytic Mechanics.....	4to,	10 00
Pendred, V. The Railway Locomotive. (Westminster Series.)		
	8vo,	*2 00
Perkin, F. M. Practical Method of Inorganic Chemistry ..	12mo,	*1 00
— and Jagers, E. M. Elementary Chemistry.....	12mo,	*1 00
Perrine, F. A. C. Conductors for Electrical Distribution ...	8vo,	*3 50
Petit, G. White Lead and Zinc White Paints.....	8vo,	*1 50
Petit, R. How to Build an Aeroplane. Trans. by T. O'B.		
Hubbard, and J. H. Ledebor.....	8vo,	*1 50
Pettit, Lieut. J. S. Graphic Processes. (Science Series No. 76.)		
	16mo,	0 50
Philbrick, P. H. Beams and Girders. (Science Series No. 88.)		
	16mo,	
Phillips, J. Gold Assaying.....	8vo,	*2 50
— Dangerous Goods.....	8vo,	3 50

30 D. VAN NOSTRAND COMPANY'S SHORT-TITLE CATALOG

Phin, J. Seven Follies of Science	12mo,	*1 25
Pickworth, C. N. The Indicator Handbook. Two Volumes	12mo, each,	1 50
— Logarithms for Beginners	12mo, boards,	0 50
— The Slide Rule.....	12mo,	1 00
Plattner's Manual of Blowpipe Analysis. Eighth Edition, re- vised. Trans. by H. B. Cornwall.....	8vo,	*4 00
Plympton, G.W. The Aneroid Barometer. (Science Series.).....	16mo,	0 50
— How to become an Engineer. (Science Series No. 100.)	16mo,	0 50
— Van Nostrand's Table Book. (Science Series No. 104.)	16mo,	0 50
Pochet, M. L. Steam Injectors. Translated from the French. (Science Series No. 29.).....	16mo,	0 50
Pocket Logarithms to Four Places. (Science Series.)....	16mo, leather,	0 50 1 00
Polleyn, F. Dressings and Finishings for Textile Fabrics.....	8vo,	*3 00
Pope, F. G. Organic Chemistry.....	12mo,	*2 25
Pope, F. L. Modern Practice of the Electric Telegraph....	8vo,	1 50
Popplewell, W. C. Prevention of Smoke.....	8vo,	*3 50
— Strength of Materials.....	8vo,	*1 75
Porritt, B. D. The Chemistry of Rubber. (Chemical Mono- graphs.)	12mo,	*0 75
Porter, J. R. Helicopter Flying Machines.....	12mo,	1 25
Potts, H. E. Chemistry of the Rubber Industry. (Outlines of Industrial Chemistry.).....	8vo,	*2 00
Practical Compounding of Oils, Tallow and Grease	8vo,	*3 50
Pratt, K. Boiler Draught.....	12mo,	*1 25
— High Speed Steam Engines.....	8vo,	*2 00
Pray, T., Jr. Twenty Years with the Indicator.....	8vo,	2 50
— Steam Tables and Engine Constant.....	8vo,	2 00
Prelini, C. Earth and Rock Excavation.....	8vo,	*3 00
— Dredges and Dredging	8vo,	*3 00
— Graphical Determination of Earth Slopes.....	8vo,	*2 00
— Tunneling.....	8vo,	*3 00
Prescott, A. B. Organic Analysis.....	8vo,	5 00
— and Johnson, O. C. Quantitative Chemical Analysis.....	8vo,	*3 50
— and Sullivan, E. C. First Book in Qualitative Chemistry	12mo,	*1 50

Prideaux, E. B. R. Problems in Physical Chemistry.....	8vo,	*2 00
Primrose, G. S. C. Zinc. (Metallurgy Series.).....	(In Press.)	
Pullen, W. W. F. Application of Graphic Methods to the Design of Structures.....	12mo,	*2 50
— Injectors: Theory, Construction and Working.....	12mo,	*1 50
— Indicator Diagrams	8vo,	*2 50
— Engine Testing	8vo,	*4 50
Pulsifer, W. H. Notes for a History of Lead.....	8vo,	4 00
Putsch, A. Gas and Coal-dust Firing.....	8vo,	*3 00
Pynchon, T. R. Introduction to Chemical Physics.....	8vo,	3 00
Rafter, G. W. Mechanics of Ventilation. (Science Series No. 33.).....	16mo,	0 50
— Potable Water. (Science Series No. 103.).....	16mo,	0 50
— Treatment of Septic Sewage. (Science Series.)....	16mo,	0 50
— and Baker, M. N. Sewage Disposal in the United States	4to,	*6 00
Raikes, H. P. Sewage Disposal Works.....	8vo,	*4 00
Ramp, H. M. Foundry Practice	(In Press.)	
Randau, P. Enamels and Enamelling	8vo,	*4 00
Rankine, W. J. M. Applied Mechanics.....	8vo,	5 00
— Civil Engineering.....	8vo,	6 50
— Machinery and Millwork.....	8vo,	5 00
— The Steam-engine and Other Prime Movers.....	8vo,	5 00
— and Bamber, E. F. A Mechanical Textbook.....	8vo,	3 50
Raphael, F. C. Localization of Faults in Electric Light and Power Mains.....	8vo,	*3 00
Rasch, E. Electric Arc Phenomena. Trans. by K. Tornberg.	8vo,	*2 00
Rathbone, R. L. B. Simple Jewellery.....	8vo,	*2 00
Rateau, A. Flow of Steam through Nozzles and Orifices. Trans. by H. B. Brydon.....	8vo,	*1 50
Rautenstrauch, W. Notes on the Elements of Machine Design,	8vo, boards,	*1 50
Rautenstrauch, W., and Williams, J. T. Machine Drafting and Empirical Design.		
Part I. Machine Drafting.....	8vo,	*1 25
Part II. Empirical Design.....	(In Preparation.)	

Raymond, E. B. Alternating Current Engineering.....	12mo,	*2	5c
Rayner, H. Silk Throwing and Waste Silk Spinning... 8vo,		*2	5c
Recipes for the Color, Paint, Varnish, Oil, Soap and Drysaltery Trades	8vo,	*3	50
Recipes for Flint Glass Making.....	12mo,	*4	50
Redfern, J. B., and Savin, J. Bells, Telephones. (Installation Manuals Series.).....	16mo,	0	50
Redgrove, H. S. Experimental Mensuration.....	12mo,	*1	25
Redwood, B. Petroleum. (Science Series No. 92.)....	16mo,	0	50
Reed, S. Turbines Applied to Marine Propulsion....	8vo,	*5	00
Reed's Engineers' Handbook.....	8vo,	*5	00
—Key to the Nineteenth Edition of Reed's Engineers' Handbook	8vo,	*3	00
—Useful Hints to Sea-going Engineers.....	12mo,	1	50
Reinhardt, C. W. Lettering for Draftsmen, Engineers, and Students.....	oblong 4to, boards,	1	00
Reiser, F. Hardening and Tempering of Steel. Trans. by A. Morris and H. Robson.....	12mo,	*2	50
Reiser, N. Faults in the Manufacture of Woolen Goods. Trans. by A. Morris and H. Robson.....	8vo,	*2	50
—Spinning and Weaving Calculations.....	8vo,	*5	00
Renwick, W. G. Marble and Marble Working.....	8vo,	5	00
Reynolds, O., and Idell, F. E. Triple Expansion Engines (Science Series No. 99.).....	16mo,	0	50
Rhead, G. F. Simple Structural Woodwork.....	12mo,	*1	00
Rhodes, H. J. Art of Lithography.....	8vo,	3	50
Rice, J. M., and Johnson, W. W. A New Method of Obtaining the Differential of Functions.....	12mo,	0	50
Richards, W. A. Forging of Iron and Steel..... (<i>In Press.</i>)			
Richards, W. A., and North, H. B. Manual of Cement Testing.		*1	50
Richardson, J. The Modern Steam Engine.....	8vo,	*3	50
Richardson, S. S. Magnetism and Electricity.....	12mo,	*2	00
Rideal, S. Glue and Glue Testing	8vo,	*4	00
Rimmer, E. J. Boiler Explosions	8vo,	*1	75
Rings, F. Concrete in Theory and Practice.....	12mo,	*2	50
—Reinforced Concrete Bridges.....	12mo,	*5	00
Ripper, W. Course of Instruction in Machine Drawing... folio,		*6	00

Roberts, F. C. Figure of the Earth. (Science Series No. 79.)	16mo,	0 50
Roberts, J., Jr. Laboratory Work in Electrical Engineering	8vo,	*2 00
Robertson, L. S. Water-tube Boilers	8vo,	*2 00
Robinson, J. B. Architectural Composition	8vo,	*2 50
Robinson, S. W. Practical Treatise on the Teeth of Wheels. (Science Series No. 24.)	16mo,	0 50
— Railroad Economics. (Science Series No. 59.)	16mo,	0 50
— Wrought Iron Bridge Members. (Science Series No. 60.)	16mo,	0 50
Robson, J. H. Machine Drawing and Sketching	8vo,	*1 50
Roebbling, J. A. Long and Short Span Railway Bridges	folio,	25 00
Rogers, A. A Laboratory Guide of Industrial Chemistry	12mo,	*1 50
— Industrial Chemistry	8vo,	*5 00
Rogers, F. Magnetism of Iron Vessels. (Science Series No. 30.)	16mo,	0 50
Rohland, P. Colloidal and its Crystalloidal State of Matter. Trans. by W. J. Britland and H. E. Potts	12mo,	*1 25
Rollins, W. Notes on X-Light	8vo,	5 00
Rollinson, C. Alphabets	Oblong 12mo,	1 00
Rose, J. The Pattern-makers' Assistant	8vo,	2 50
— Key to Engines and Engine-running	12mo,	2 50
Rose, T. K. The Precious Metals. (Westminster Series.)	8vo,	*2 00
Rosenhain, W. Glass Manufacture. (Westminster Series.)	8vo,	*2 00
— Physical Metallurgy, An Introduction to. (Metallurgy Series.)	8vo,	*3 50
Roth. Physical Chemistry	8vo,	*2 00
Rothery, G. C., and Edmonds, H. O. The Modern Laundry. 2 vols.	4to, leather,	12 00
Rouillion, L. The Economics of Manual Training	8vo,	2 00
Rowan, F. J. Practical Physics of the Modern Steam-boiler. 8vo,		*3 00
— and Idell, F. E. Boiler Incrustation and Corrosion. (Science Series No. 27.)	16mo,	0 50
Roxburgh, W. General Foundry Practice. (Westminster Series.)	8vo,	*2 00
Ruhmer, E. Wireless Telephony. Trans. by J. Erskine- Murray	8vo,	*3 50

34 D. VAN NOSTRAND COMPANY'S SHORT-TITLE CATALOG

Russell, A. Theory of Electric Cables and Networks.....	8vo,	*3 00
Sabine, R. History and Progress of the Electric Telegraph.....	12mo,	1 25
Sanford, P. G. Nitro-explosives.....	8vo,	*4 00
Saunders, C. H. Handbook of Practical Mechanics.....	16mo,	1 00
	leather,	1 25
Sayers, H. M. Brakes for Tram Cars.....	8vo,	*1 25
Scheele, C. W. Chemical Essays.....	8vo,	*2 00
Scheithauer, W. Shale Oils and Tars.....	8vo,	*3 50
Schellen, H. Magneto-electric and Dynamo-electric Machines	8vo,	5 00
Scherer, R. Casein. Trans. by C. Salter.....	8vo,	*3 00
Schidrowitz, P. Rubber, Its Production and Uses.....	8vo,	*5 00
Schindler, K. Iron and Steel Construction Works.....	12mo,	*1 25
Schmall, C. N. First Course in Analytic Geometry, Plane and Solid.....	12mo, half leather,	*1 75
Schmall, C. N., and Schack, S. M. Elements of Plane Geometry	12mo,	*1 25
Schmeer, L. Flow of Water.....	8vo,	*3 00
Schumann, F. A Manual of Heating and Ventilation.	12mo, leather,	1 50
Schwartz, E. H. L. Causal Geology.....	8vo,	*2 50
Schweizer, V., Distillation of Resins.....	8vo,	*3 50
Scott, W. W. Qualitative Chemical Analysis. A Laboratory Manual.....	8vo	*1 50
Scribner, J. M. Engineers' and Mechanics' Companion.	16mo, leather,	1 50
Scudder, H. Electrical Conductivity and Ionization Constants of Organic Compounds.....	8vo,	*3 00
Searle, A. B. Modern Brickmaking.....	8vo,	*5 00
— Cement, Concrete and Bricks.....	8vo,	*3 00
Searle, G. M. "Sumners' Method." Condensed and Improved. (Science Series No. 124.).....	8vo.	0 50
Seaton, A. E. Manual of Marine Engineering.....	8vo,	8 00
Seaton, A. E., and Rounthwaite, H. M. Pocket-book of Marine Engineering.....	16mo, leather,	*3 50
Seeligmann, T., Torrilhon, G. L., and Falconnet, H. India Rubber and Gutta Percha. Trans. by J. G. McIntosh	8vo,	*5 00

Seidell, A. Solubilities of Inorganic and Organic Substances	8vo,	*3	00
Seligman, R. Aluminum. (Metallurgy Series)	(In Press.)		
Sellew, W. H. Steel Rails	4to,	*12	50
— Railway Maintenance	(In Press.)		
Senter, G. Outlines of Physical Chemistry	12mo,	*1	75
— Textbook of Inorganic Chemistry	12mo,	*1	75
Sever, G. F. Electric Engineering Experiments	8vo, boards,	*1	00
— and Townsend, F. Laboratory and Factory Tests in Elec- trical Engineering	8vo,	*2	50
Sewall, C. H. Wireless Telegraphy	8vo,	*2	00
— Lessons in Telegraphy	12mo,	*1	00
Sewell, T. The Construction of Dynamos	8vo,	*3	00
Sexton, A. H. Fuel and Refractory Materials	12mo,	*2	50
— Chemistry of the Materials of Engineering	12mo,	*2	50
— Alloys (Non-Ferrous)	8vo,	*3	00
— The Metallurgy of Iron and Steel	8vo,	*6	50
Seymour, A. Modern Printing Inks	8vo,	*2	00
Shaw, H. S. H. Mechanical Integrators. (Science Series No. 83.)	16mo,	0	50
Shaw, S. History of the Staffordshire Potteries	8vo,	*2	00
— Chemistry of Compounds Used in Porcelain Manufacture	8vo,	*5	00
Shaw, W. N. Forecasting Weather	8vo,	*3	50
Sheldon, S., and Hausmann, E. Direct Current Machines	8vo,	*2	50
— Alternating-current Machines	8vo,	*2	50
— Electric Traction and Transmission Engineering	8vo,	*2	50
Shields, J. E. Notes on Engineering Construction	12mo,	1	50
Shreve, S. H. Strength of Bridges and Roofs	8vo,	3	50
Shunk, W. F. The Field Engineer	12mo, mor.,	2	50
Simmons, W. H., and Appleton, H. A. Handbook of Soap Manufacture	8vo,	*3	00
Simmons, W. H., and Mitchell, C. A. Edible Fats and Oils	8vo,	*3	00
Simpson, G. The Naval Constructor	12mo, mor.,	*5	00
Simpson, W. Foundations	8vo (In Press.)		
Sinclair, A. Development of the Locomotive Engine	8vo, half leather,	5	00
Sindall, R. W. Manufacture of Paper. (Westminster Series.)	8vo,	*2	00

36 D. VAN NOSTRAND COMPANY'S SHORT-TITLE CATALOG

— and Bacon, W. N. The Testing of Wood Pulp	8vo,	*2 50
Sloane, T. O'C. Elementary Electrical Calculations	12mo,	*2 00
Smallwood, J. C. Mechanical Laboratory Methods		
	leather, 12mo,	*2 50
Smith, C. A. M. Handbook of Testing. Vol. I. Materials		*2 50
— and Warren, A. G. New Steam Tables	8vo,	*1 25
Smith, C. F. Practical Alternating Currents and Testing	8vo,	*2 50
— Practical Testing of Dynamos and Motors	8vo,	*2 00
Smith, F. E. Handbook of General Instruction for Mechanics.		
	12mo,	1 50
Smith, H. G. Minerals and the Microscope	12mo,	*1 25
Smith, J. C. Manufacture of Paint	8vo,	*3 50
Smith, R. H. Principles of Machine Work	12mo,	*3 00
— Elements of Machine Work	12mo,	*2 00
Smith, W. Chemistry of Hat Manufacturing	12mo,	*3 00
Snell, A. T. Electric Motive Power	8vo,	*4 00
Snow, W. G. Pocketbook of Steam Heating and Ventilation.		
		(In Press.)
Snow, W. G., and Nolan, T. Ventilation of Buildings. (Science		
Series No. 5.)	16mo,	0 50
Soddy, F. Radioactivity	8vo,	*3 00
Solomon, M. Electric Lamps. (Westminster Series.)	8vo,	*2 00
Somerscales, A. N. Mechanics for Marine Engineers	12mo,	*1 50
— Mechanical and Marine Engineering Science	8vo,	*5 00
Sothorn, J. W. The Marine Steam Turbine	8vo,	*5 00
— Verbal Notes and Sketches for Marine Engineers	8vo,	*5 00
Sothorn, J. W., and Sothorn, R. M. Elementary Mathematics		
for Marine Engineers	12mo,	*1 00
— Simple Problems in Marine Engineering Design	12mo,	*1 00
Southcombe, J. E. Chemistry of the Oil Industries. (Out-		
lines of Industrial Chemistry)	8vo,	*3 00
Soxhlet, D. H. Dyeing and Staining Marble. Trans. by A.		
Morris and H. Robson	8vo,	*2 50
Spang, H. W. A Practical Treatise on Lightning Protection	12mo,	1 00
Spangenburg, L. Fatigue of Metals. Translated by S. H.		
Shreve. (Science Series No. 23.)	16mo,	0 50
Specht, G. J., Hardy, A. S., McMaster, J. B., and Walling. Topo-		
graphical Surveying. (Science Series No. 72.)	16mo,	0 50
Spencer, A. S. Design of Steel-Framed Sheds	8vo,	4 00

Speyers, C. L. Text-book of Physical Chemistry.....	8vo,	*2	25
Spiegel, L. Chemical Constitution and Physiological Action. (Trans. by C. Luedeking and A. C. Boylston.)... (<i>In Procs.</i>)			
Sprague, E. H. Hydraulics.....	12mo,	1	25
Stahl, A. W. Transmission of Power. (Science Series No. 28.)			
	16mo,		
— and Woods, A. T. Elementary Mechanism.....	12mo,	*2	00
Staley, C., and Pierson, G. S. The Separate System of Sewerage.			
	8vo,	*3	00
Standage, H. C. Leatherworkers' Manual.....	8vo,	*3	50
— Sealing Waxes, Wafers, and Other Adhesives.....	8vo,	*2	00
— Agglutinants of All Kinds for All Purposes.....	12mo,	*3	50
Stansbie, J. H. Iron and Steel. (Westminster Series.)...	8vo,	*2	00
Steadman, F. M. Unit Photography.....	12mo,	*2	00
Stecker, G. E. Cork. Its Origin and Industrial Uses.....	12mo,	1	00
Steinman, D. B. Suspension Bridges and Cantilevers. (Science Series No. 127.).....			0 50
Stevens, H. P. Paper Mill Chemist.....	16mo,	*2	50
Stevens, J. S. Theory of Measurements.....	12mo,	*1	25
Stevenson, J. L. Blast-Furnace Calculations....	12mo, leather,	*2	00
Stewart, G. Modern Steam Traps.....	12mo,	*1	25
Stiles, A. Tables for Field Engineers.....	12mo,	1	00
Stodola, A. Steam Turbines. Trans. by L. C. Loewenstein.	8vo,	*5	00
Stone, H. The Timbers of Commerce.....	8vo,	3	50
Stopes, M. Ancient Plants.....	8vo,	*2	00
— The Study of Plant Life.....	8vo,	*2	00
Stumpf, J. Una-Flow Steam Engine.....	4to,	*3	50
Sudborough, J. J., and James, T. C. Practical Organic Chem- istry.....	12mo,	*2	00
Suffling, E. R. Treatise on the Art of Glass Painting.....	8vo,	*3	50
Sur, F. J. S. Oil Prospecting and Extracting.....	8vo,	*1	00
Swan, K. Patents, Designs and Trade Marks. (Westminster Series.).....	8vo,	*2	00
Swinburne, J., Wordingham, C. H., and Martin, T. C. Electric Currents. (Science Series No. 109.).....	16mo,	0	50
Swoope, C. W. Lessons in Practical Electricity.....	12mo,	*2	00

Tailfer, L. Bleaching Linen and Cotton Yarn and Fabrics.	8vo,	*5 00
Tate, J. S. Surcharged and Different Forms of Retaining-walls.		
Science Series No. 7.	16mo,	
Taylor, F. N. Small Water Supplies.	12mo,	2 00
— Masonry in Civil Engineering.	8vo,	*2 50
Tenney, E. H. Test Methods for Steam Power Plants.	12mo,	*2 50
Terry, H. L. India Rubber and its Manufacture. (Westminster Series.)	8vo,	*2 00
Thayer, H. R. Structural Design.	8vo,	
Vol. I. Elements of Structural Design.		*2 00
Vol. II. Design of Simple Structures.		*4 00
Vol. III. Design of Advanced Structures.		(In Preparation.)
— Foundations and Masonry.		(In Press.)
Thiess, J. B., and Joy, G. A. Toll Telephone Practice.	8vo,	*3 50
Thom, C., and Jones, W. H. Telegraphic Connections.		
	oblong 12mo	1 50
Thomas, C. W. Paper-makers' Handbook.		(In Press.)
Thompson, A. B. Oil Fields of Russia.	4to,	*7 50
Thompson, S. P. Dynamo Electric Machines. (Science Series No. 75.)	16mo,	0 50
Thomson, G. Modern Sanitary Engineering, House Drainage, etc.	8vo,	*3 00
Thornley, T. Cotton Combing Machines.	8vo,	*3 00
— Cotton Spinning.	8vo,	
First Year.		*1 50
Second Year.		*2 50
Third Year.		*2 50
— Cotton Waste.	8vo,	*3 00
Thurso, J. W. Modern Turbine Practice.	8vo,	*4 00
Tidy, C. Meymott. Treatment of Sewage. (Science Series No. 94.)	16mo,	0 50
Tillmans, J. Water Purification and Sewage Disposal. Trans. by Hugh S. Taylor.	8vo,	*2 00
Tinney, W. H. Gold-mining Machinery.	8vo,	*3 00
Titherley, A. W. Laboratory Course of Organic Chemistry.	8vo,	*2 00
Toch, M. Chemistry and Technology of Mixed Paints.		
— Materials for Permanent Painting.	12mo,	*2 00
Tod, J., and McGibbon, W. C. Marine Engineers' Board of Trade Examinations.	8vo,	*1 50

Todd, J., and Whall, W. B. Practical Seamanship	8vo,	*7 50
Tonge, J. Coal. (Westminster Series.)	8vo,	*2 00
Townsend, F. Alternating Current Engineering.	8vo, boards,	*0 75
Townsend, J. Ionization of Gases by Collision	8vo,	*1 25
Transactions of the American Institute of Chemical Engineers. Five volumes now ready. Vols. I to VI, 1908 to 1913, 8vo, each,		*6 00
Traverse Tables. (Science Series No. 115.)	16mo,	0 50
	mor.,	1 00
Treiber, E. Foundry Machinery. Trans. by C. Salter.	12mo	1 25
Trinks, W., and Housum, C. Shaft Governors. (Science Series No. 122.)	16mo,	0 50
Trowbridge, W. P. Turbine Wheels. (Science Series No. 44.) 16mo,		0 50
Tucker, J. H. A Manual of Sugar Analysis.	8vo,	3 50
Tunner, P. A. Treatise on Roll-turning. Trans. by J. B. Pearse.	8vo text and folio atlas,	6 00
Turnbull, Jr., J., and Robinson, S. W. A Treatise on the Compound Steam-engine. (Science Series No. 8.) 16mo,		
Turrill, S. M. Elementary Course in Perspective	12mo,	*1 25
Twyford, H. B. Purchasing.	8vo,	*3 00
Underhill, C. R. Solenoids, Electromagnets and Electromag- netic Windings.	12mo,	*2 00
Underwood, N., and Sullivan, T. V. Chemistry and Tech- nology of Printing Inks.	8vo,	*3 00
Urquhart, J. W. Electro-plating.	12mo,	2 00
— Electrotyping.	12mo,	2 00
Usborne, P. O. G. Design of Simple Steel Bridges.	8vo,	*4 00
Vacher, F. Food Inspector's Handbook.	12mo,	3 00
Van Nostrand's Chemical Annual. Third issue 1913. Leather. 12mo,		*2 50
— Year Book of Mechanical Engineering Data.	(In Press.)	
Van Wagenen, T. F. Manual of Hydraulic Mining.	16mo,	1 90

40 D. VAN NOSTRAND COMPANY'S SHORT TITLE CATALOG

Vega, Baron, Von. Logarithmic Tables.....	8vo, cloth,	2 00
	half mor.,	2 50
Vincent, C. Ammonia and its Compounds. Trans. by M. J. Salter.....	8vo,	*2 00
Volk, C. Haulage and Winding Appliances.....	8vo,	*4 00
Von Georgiovis, G. Chemical Technology of Textile Fibres..		
Trans. by C. Salter.....	8vo,	*4 50
— Chemistry of Dyestuffs. Trans. by C. Salter.....	8vo,	*4 50
Vose, G. L. Graphic Method for Solving Certain Questions in Arithmetic and Algebra. (Science Series No. 16.)		
	16mo,	0 50
Vosmaer, A. Ozone.....	(In Press.)	
Wabner, R. Ventilation in Mines. Trans. by C. Salter..	8vo,	*4 50
Wade, E. J. Secondary Batteries.....	8vo,	*4 00
Wadmore, J. M. Elementary Chemical Theory.....	12mo,	*1 50
Wadsworth, C. Primary Battery Ignition.....	12mo,	*0 50
Wagner, E. Preserving Fruits, Vegetables, and Meat....	12mo,	*2 50
Waldram, P. J. Principles of Structural Mechanics....	12mo,	*3 00
Walker, F. Aerial Navigation.....	8vo,	2 00
— Dynamic Building. (Science Series No. 98.).....	16mo,	0 50
Walker, J. Organic Chemistry for Students of Medicine.	8vo,	2 50
Walker, S. F. Steam Boilers, Engines and Turbines.....	8vo,	3 00
— Refrigeration, Heating and Ventilation on Shipboard..	12mo,	*2 00
— Electricity in Mining.....	8vo,	*3 50
Wallis-Taylor, A. J. Bearings and Lubrication.....	8vo,	*1 50
— Motor Vehicles for Business Purposes.....	8vo,	3 50
— Refrigeration, Cold Storage and Ice Making.....	8vo,	*4 50
— Sugar Machinery.....	12mo,	*2 00
— Aerial or Wire Ropeways.....	8vo,	3 00
Walsh, J. J. Chemistry of Mining and Mine Ventilation,		
	12mo,	*2 00
Wanklyn, J. A. Water Analysis.....	12mo,	2 00
Wansbrough, W. D. The A B C of the Differential Calculus.	12mo,	*1 50
— Slide Valves.....	12mo,	*2 00
Waring, Jr., G. E. Sanitary Conditions. (Science Series No. 31.)		
	16mo,	0 50
— Sewerage and Land Drainage.....		*6 00
— Modern Methods of Sewage Disposal.....	12mo,	2 00
— How to Drain a House.....	72mo,	1 25

Warnes, A. R. Coal Tar Distillation.....	8vo,	*2 50
Warren, F. D. Handbook on Reinforced Concrete.....	12mo,	*2 50
Watkins, A. Photography, (Westminster Series.).....	8vo,	*2 00
Watson, E. P. Small Engines and Boilers.....	12mo,	1 25
Watt, A. Electro-plating and Electro-refining of Metals.....		*4 50
— Electro-metallurgy.....	12mo,	1 00
— The Art of Paper Making.....		*3 00
— The Art of Soap-making.....	8vo,	3 00
— Leather Manufacture.....	8vo,	*4 00
Webb, H. L. Guide to the Testing of Insulated Wires and Cables.....	12mo,	1 00
Webber, W. H. Y. Town Gas. (Westminster Series.).....	8vo,	*2 00
Weisbach, J. A Manual of Theoretical Mechanics.....	8vo,	*6 00
— and Herrmann, G. Mechanics of Air Machinery....	8vo,	*3 75
Welch, W. Correct Lettering.....	(In Press.)	
Weston, E. B. Loss of Head Due to Friction of Water in Pipes	12mo,	*1 50
Weymouth, F. M. Drum Armatures and Commutators..	8vo,	*3 00
Wheatley, O. Ornamental Cement Work.....	8vo,	*2 00
Wheeler, J. B. Art of War.....	12mo,	1 75
— Field Fortifications.....	12mo,	1 75
Whipple, S. An Elementary and Practical Treatise on Bridge Building.....	8vo,	3 00
White, C. H. Methods in Metallurgical Analysis. (Van Nostrand's Textbooks.).....	12mo,	*2 50
White, G. T. Toothed Gearing.....	12mo	*1 25
Wilcox, R. M. Cantilever Bridges. (Science Series No. 25.)	16mo,	0 50
Wilda, H. Steam Turbines. Trans. by C. Salter..	12mo,	*1 25
— Cranes and Hoists. Trans. by Chas. Salter....	12mo,	1 25
Wilkinson, H. D. Submarine Cable Laying and Repairing	8vo,	*6 00
Williamson, J. Surveying.....	8vo,	
Williamson, R. S. Practical Tables in Meteorology and Hypsometry.....	4to,	2 50
Wilson, F. J., and Heilbron, I. M. Chemical Theory and Cal- culations.....	12mo,	*1 00
Wilson, J. F. Essentials of Electrical Engineering....	(In Press.)	

42 D. VAN NOSTRAND COMPANY'S SHORT-TITLE CATALOG

Wimperis, H. E. Internal Combustion Engine.....	8vo,	*3 00
— Primer of the Internal Combustion Engine.....	12mo,	1 00
— Application of Power to Road Transport.....	12mo,	*1 50
Winchell, N. H., and A. N. Elements of Optical Mineralogy.....	8vo,	*3 50
Winslow, A. Stadia Surveying. (Science Series No. 77.).....	16mo,	0 50
Wisser, Lieut. J. P. Explosive Materials. (Science Series No. 70.).....	16mo,	0 50
Wisser, Lieut. J. P. Modern Gun Cotton. (Science Series No. 89.).....	16mo,	0 50
Wolff, C. E. Modern Locomotive Practice.....	8vo,	*4 20
Wood, De V. Luminiferous Aether. (Science Series No. 85.).....	16mo,	0 50
Wood, J. K. Chemistry of Dyeing. (Chemical Monographs.).....	12mo,	*0 75
Worden, E. C. The Nitrocellulose Industry. Two vols.....	8vo,	*10 00
— Technology of Cellulose Esters. In 10 vols.....	8vo.	
Vol. VIII. Cellulose Acetate.....		*5 00
Wren, H. Organometallic Compounds of Zinc and Magnesium. (Chemical Monographs.).....	12mo,	*0 75
Wright, A. C. Analysis of Oils and Allied Substances.....	8vo,	*3 50
— Simple Method for Testing Painter's Materials.....	8vo,	*2 50
Wright, F. W. Design of a Condensing Plant.....	12mo,	*1 50
Wright, H. E. Handy Book for Brewers.....	8vo,	*5 00
Wright, J. Testing, Fault Finding, etc. for Wiremen (Installation Manuals Series).....	16mo,	*0 50
Wright, T. W. Elements of Mechanics.....	8vo,	*2 50
— and Hayford, J. F. Adjustment of Observations.....	8vo,	*3 00
Young, J. E. Electrical Testing for Telegraph Engineers....	8vo,	*4 00
Zahner, R. Transmission of Power. (Science Series No. 40.).....	16mo,	
Zeidler, J., and Lustgarten, J. Electric Arc Lamps.....	8vo,	*2 00
Zeuner, A. Technical Thermodynamics. Trans. by J. F. Klein. Two Volumes.....	8vo,	*8 00
Zipser, J. Textile Raw Materials. Trans. by C. Salter....	8vo,	*5 00
Zur Nedden, F. Engineering Workshop Machines and Processes. Trans. by J. A. Davenport.....	8vo,	*2 00

D. VAN NOSTRAND COMPANY

are prepared to supply, either from
their complete stock or at
short notice,

Any Technical or Scientific Book

In addition to publishing a very large and varied number of SCIENTIFIC AND ENGINEERING BOOKS, D. Van Nostrand Company have on hand the largest assortment in the United States of such books issued by American and foreign publishers.

All inquiries are cheerfully and carefully answered and complete catalogs sent free on request.

25 PARK PLACE

NEW YORK

