

ION EXCHANGE

THEORY AND APPLICATION

Edited by

FREDERICK C. NACHOD

*Sterling-Winthrop Research Institute
Rensselaer, New York*



1949

**ACADEMIC PRESS INC., PUBLISHERS
NEW YORK, N. Y.**

Copyright 1949
By ACADEMIC PRESS INC.
125 EAST 23RD STREET, NEW YORK 10, N. Y.

All Rights Reserved

NO PART OF THIS BOOK MAY BE REPRODUCED IN
ANY FORM, BY PHOTOSTAT, MICROFILM, OR ANY
OTHER MEANS, WITHOUT WRITTEN PERMISSION
FROM THE PUBLISHER

PRINTED IN THE UNITED STATES OF AMER

THE MURRAY PRINTING COMPANY
WAKEFIELD, MASSACHUSETTS

Foreword

The task of an editor can be likened to that of a coach; his efforts cannot be successful if he does not work with a good team. The present editor has been very fortunate in enlisting the co-operation of some of the foremost experts in the field of ion exchange in this country and thus this text truly represents a team effort. Thanks are also due to Academic Press Inc. for helpful advice, and to my wife for patient assistance in the correspondence involved.

Kinderhook, New York

FREDERICK C. NACHOD

Contributors

- NORMAN APPLEZWEIG, *Hygrade Laboratories, Newark, New Jersey*
- W. C. BAUMAN, *Dow Chemical Company, Midland, Michigan*
- RICHARD J. BLOCK, *New York Medical College, New York, New York*
- D. G. BRAITHWAITE, *National Aluminate Corporation, Chicago, Illinois*
- C. CALMON, *Permutit Company, New York, New York*
- M. E. GILWOOD, *Permutit Company, New York, New York*
- F. K. LINDSAY, *National Aluminate Corporation, Chicago, Illinois*
- A. B. MINDLER, *The Permutit Company, New York, New York*
- FREDERICK C. NACHOD, *Sterling-Winthrop Research Institute, Rensselaer,
New York*
- ALLEN F. REID, *Southwestern Medical College, Dallas, Texas*
- WILLIAM RIEMAN III, *Rutgers University, New Brunswick, New Jersey*
- JACK SCHUBERT, *Argonne National Laboratory, Chicago, Illinois*
- SIDNEY SUSSMAN, *Liquid Conditioning Corporation, Linden, New Jersey*
- HENRY C. THOMAS, *Yale University, New Haven, Connecticut*
- HOWARD L. TIGER, *Liquid Conditioning Corporation, Linden, New Jersey*
- HAROLD F. WALTON, *University of Colorado, Boulder, Colorado*

Introduction

FREDERICK C. NACHOD

Sterling-Winthrop Research Institute, Rensselaer, New York

Ion exchange has had a curious history. It has been known for almost a hundred years but the manifold applications as well as the complexity of the theoretical aspects are only a few decades old.

This history has been characterized by its discontinuity in development. Two English soil scientists, Way and Thompson (1, 2) are credited with the discovery of ion exchange. Their work was concerned with the action of water-soluble fertilizer salts such as ammonium sulfate and potassium chloride and the curious fact that such salts could not easily be leached out from the soil by the action of rain water. The phenomenon then discovered remained dormant until the German chemist Gans in the year 1910, after studying the colloidal chemistry of aluminosilicates, realized that it could be applied to the softening of hard water (3, 4, 5). While the softening of water by naturally occurring mineral was known, the search for higher capacity materials such as synthetic aluminosilicate gels (6) and fused aluminosilicates (5) gave a new impetus to the water conditioning industry.

None of these exchangers lend themselves to the exchange of hydrogen ions, and attempts by Borrowman to use huminlike substances (7) were commercially unsuccessful.

In 1935, organic ion exchange materials that could be used for hydrogen interchange were successfully prepared. A number of investigators following different lines of thought contributed to this development. Liebknecht in Germany (8) and Smit in Holland (9) sulfonated coals of different geological age and arrived at high-capacity organic exchange materials with good physical properties. Two Englishmen, Adams and Holmes, condensed phenolsulfonic acids with formaldehyde and thus obtained resins which had suitable exchange characteristics (10). They went one step further and produced anion exchange resins by condensing polyamines with formaldehyde. By using successively both types of resins, it was for the first time possible to remove all electrolytes from water by a process other than distillation (11). It was thus made possible to produce water of the same quality as distilled water for a fraction of the cost of distillation.

Systematic resin research was initiated in the Wolfen laboratories of the I. G. Farbenindustrie as early as 1935 and this work has been summarized extensively by Griessbach (12).

While recent studies by Wiklander have cast light on some fundamental relationships of ion exchange reactions (13), the development of ion exchange as a unit process and its application outside the field of water treatment is very recent indeed and it can be aptly said that "an old process found new uses" (14). In the past five years, the ion exchange principle has been applied to almost all fields of chemistry, and one must not be surprised that such divergent problems as alkaloid recovery and the refining of precious metals have made use of it. Ion exchange now takes its place among the more common unit processes such as distillation, adsorption, and filtration, and we no doubt will witness more novel applications of it in industry as time goes on.

BIBLIOGRAPHY

1. Way, J. T., *J. Roy. Agr. Soc. Eng.* **11**, 313 (1850); **13**, 123 (1852).
2. Thompson, H. S., *J. Roy. Agr. Soc. Eng.* **11**, 68 (1850).
3. Gans, R., *Jahrb. kgl. preuss. geol. Landesanstalt* **26**, 179 (1905); **27**, 63 (1906).
4. Gans, R., *Centr. Mineral. Geol.* **22**, 728 (1913).
5. Gans, R., German Patent 197,111 (1906); U. S. Patents 914,405 (March 9, 1909), 943,535 (Dec. 14, 1909), 1,131,503 (March 9, 1915).
6. Rudolf, G., U. S. Patent 1,304,206 (May 20, 1919).
7. Borrowman, G., U. S. Patent 1,793,670 (Feb. 24, 1931).
8. Liebknecht, O., U. S. Patents 2,191,060 (Feb. 20, 1940), 2,206,007 (June 25, 1940).
9. Smit, P., U. S. Patents 2,191,063 (Feb. 20, 1940), 2,205,635 (June 25, 1940).
10. Adams, B. A., and Holmes, E. L., *J. Soc. Chem. Ind.* **54**, 1-6 T (1935).
11. Tiger, H. L., and Sussman, S., *Ind. Eng. Chem.* **35**, 186 (1943).
12. Griessbach, R., *Ver. deut. Chemiker Beihfte* **31**, 1 (1939); *Angew. Chem.* **52**, 215 (1939).
13. Wiklander, L., *Ann. Roy. Agr. Coll. Sweden* **14**, 1 (1946).
14. Sussman, S., and Mindler, A. B., *Chem. Inds.* **56**, 789 (1945).

Ion Exchange Equilibria

HAROLD F. WALTON

Chemistry Department, University of Colorado, Boulder, Colorado

CONTENTS

	<i>Page</i>
I. Cation Exchange	3
1. Introductory	3
2. Equations for Ionic Exchange Equilibria	5
(a) Empirical Equations	5
(b) Equations Based on the Mass Law	7
(c) Equations Derived Kinetically	11
3. The Exchanging Powers of Different Cations	13
(a) Simple Metallic Cations	13
(b) Complex Metallic Cations	16
(c) Organic Cations	17
(d) The Hydrogen Ion	17
4. Temperature and Cation Exchange Equilibria	20
5. The Effect of Anions	21
6. The Swelling of Cation Exchangers	21
7. Summary	23
II. Anion Exchange	23
1. Introductory	23
2. Absorption Isotherms of Acids	24
3. Exchange of Adsorbed Anions	26
4. Summary	26
Bibliography	27

I. CATION EXCHANGE

1. *Introductory*

The distribution of cations between a solution and a solid exchanger has been extensively studied with many different exchangers. The usual procedure has been to take an exchanger which is previously saturated with a cation A, and shake it with a solution containing a salt of a second cation, B, until the two cations are distributed between solid and solution and no further change with time is noticed. This may take minutes or it

may take weeks, according to the type of exchanger. When the reaction seems to be over, the solution is analyzed, and perhaps the solid too. In this way, the partition of the two exchanging cations is studied.

In the materials which find practical use as ion exchangers, such as the synthetic aluminosilicates, synthetic resins, or sulfuric acid-treated coals, nearly all of the ion exchange takes place in the interior of the granules, which have a gel structure, something like a sponge on the molecular scale. With such materials there is no difficulty in separating the solution and the solid for purposes of analysis, nor in distinguishing clearly between those ions associated with the solid and those associated with the solution. The only complication that arises is that the pores of the gel will contain a certain amount of the dissolved salt, which may be significant if the salt in the solution is high (see Section 6 below). In ion exchangers such as the clays and the soils, however, the particles of solid are very small and have a very large external surface. The ion exchange takes place to a great extent at this external surface, and the exchangeable cations are held in part as a diffuse double layer, shading off gradually into the solution. In this case, it is difficult to say just where the boundary lies between exchanger and solution, and, if the exchanger is separated for analysis, it is impossible to wash it free of adhering solution without also disturbing this diffuse double layer. This makes the investigation of ion exchange equilibria in clays and soil colloids more difficult, both practically and theoretically, than in granular exchangers (1). Nevertheless, ion exchange in clays and soils has been extensively studied on account of its importance in agriculture.

Most of the ion exchange distributions reported in the literature were not true equilibria; that is to say, the same distribution was not reached from both sides. If ion A was originally in the exchanger and ion B in the solution, a different distribution was reached from what would have been reached if ion B had originally been in the exchanger and ion A in the solution. The ion that the exchanger contains originally tends to be retained in the exchanger (2). This hysteresis is more marked with exchanges of univalent for divalent cations, or of univalent for other univalent cations, than with exchanges of one divalent cation for another (3). It seems that the properties of certain exchangers are conditioned by the ion with which they were last saturated. The gel structure of the solid is altered somewhat by the substitution of one cation for another, but this alteration is extremely slow unless the exchanger is practically saturated with the second ion (4). The steady distributions obtained after prolonged shaking of an aluminosilicate gel, for example, with a solution represent pseudoequilibria that are fairly reproducible, though true equilibrium would only be obtained if the gel structure were given time to adjust itself. As we would expect, hysteresis in ion exchange is most

marked with rigid aluminosilicate gels and is almost absent in elastic, high capacity sulfonic acid resins (5), being here significant only for such unsymmetrical exchanges as $\text{Na}^+ - \text{La}^{+++}$.

Generally speaking, the most reliable experimental work on ion exchange equilibria has been done with the new high capacity synthetic resins. They are homogeneous and uniform, react rapidly, are free from hysteresis effects, and can be analyzed for inorganic ions very simply by ashing.

Before starting on a quantitative treatment of cation exchange distributions, it is well to emphasize the following general facts, which are supported by a wealth of experimental evidence. Cation exchange proceeds by equivalents; that is, for every gram equivalent weight of cations taken up by the solid exchanger, one gram equivalent weight of cations must be released. This is necessary to maintain electrical neutrality since, with very minor exceptions, no appreciable amounts of anions are taken into the exchanger from the solution. The cations in the exchanger usually retain their electrical charge, so that the exchanger is actually a highly ionized salt. (Certain hydrogen ion exchangers are notable exceptions. See Section 2(d) below.) The mobile ions in the exchanger mix freely with one another. Save for an isolated observation of Rothmund and Kornfeld (6), there is no evidence of the formation of more than one solid phase, and a pair of cations in an exchanger can be considered to form a continuous range of solid solutions.

2. Equations for Ion Exchange Equilibria. Effect of Ionic Concentrations

(a) *Empirical Equations.* The first equations used to correlate the proportions of exchanging ions in the solid and in the solution were empirical in nature, and, from the practical standpoint of summarizing a mass of experimental data, these empirical equations are very valuable. The most general, derived by analogy with the Freundlich adsorption isotherm (which is itself empirical), is

$$\frac{m_{\text{AX}}}{m_{\text{BX}}} = K \cdot \frac{[\text{A}^+]^{p_1}}{[\text{B}^+]^{p_2}} \quad (1)$$

where m_{AX} and m_{BX} are moles of A and B per gram of the exchanger, $[\text{A}^+]$ and $[\text{B}^+]$ are molar concentrations in the solution, and K , p_1 and p_2 are constants. p_1 and p_2 are less than unity.

A simpler equation of the same form is that of Rothmund and Kornfeld (6):

$$\frac{m_{\text{AX}}}{m_{\text{BX}}} = K \cdot \left(\frac{[\text{A}^+]}{[\text{B}^+]} \right)^p \quad (2)$$

where p , again, is less than 1. This is a most useful equation, as practically all ion exchange distribution data in the literature can be expressed as straight-line graphs by plotting $\log(m_{AX}/m_{BX})$ against $\log([A^+]/[B^+])$. For exchanges between ions of different valency, a better correspondence between data at different total solution concentrations is found if a modified mass action equation of the form

$$\frac{m_{CaX}}{m_{NaX}^2} = K \left(\frac{Ca^{++}}{[Na^+]^2} \right)^p \quad (3)$$

is used. The writer has collected several data from the literature with the aid of this equation, and the K and p values found are given in Table I below (7).

TABLE I

$$\text{Constants in the Equation } \frac{m_{AX}}{m_{BX}} = K \cdot \left(\frac{[A^+]}{[B^+]} \right)^p$$

Exchange	Reference	p	K
NH ₄ X(fusion) + Na ⁺	8	0.67	0.35
NH ₄ X(fusion) + K ⁺	8	0.72	1.0
AgX(fusion) + Li ⁺	6	0.69	0.0062
AgX(fusion) + K ⁺	6	0.46	0.122
AgX(fusion) + Tl ⁺	6	0.50	0.59
Li-bentonite + NH ₄ ⁺	10	0.8	1.25
K-bentonite + NH ₄ ⁺	10	1.1	0.5
NaX(gel) + Ca ⁺⁺	29	0.63	0.67
NaX(gel) + Ba ⁺⁺	29	0.55	1.78
NH ₄ X(fusion) + Ca ⁺⁺	8	0.26	0.95
NH ₄ X(fusion) + Mg ⁺⁺	8	0.17	0.37
Na-sulf. coal + Ca ⁺⁺	4	0.85	2.7
H-sulf. coal + Ca ⁺⁺	4	0.25	3.3
Ca-sulf. coal + Na ⁺	4	0.85	0.11
CaX(fusion) + Na ⁺	8	0.90	0.04
CaX(gel) + Na ⁺	29	0.72	0.21
Ca-casein + Ba ⁺⁺	28	0.75	1.2
Ca-sulf. coal + Ba ⁺⁺	4	0.9	2.1

Notes: (a) The ion A in the equation is the one added in the solution; ion B is the one originally in the exchanger.

(b) The symbol "X" means synthetic aluminosilicate. The "gel" exchangers were made by mixing aqueous solutions, the "fusion" exchangers by melting the components together.

(c) For exchanges between univalent and divalent ions, equation 3 was used.

The success of a logarithmic plot of equations (2) and (3) in correlating experimental data does not, of course, imply that these equations have any real theoretical significance. When data are plotted logarithmically, inconsistencies are much less apparent than if they are plotted on a linear scale.

A drawback of the Rothmund-Kornfeld equation is that the total quantity of exchangeable cations in the solid must be known and this is sometimes difficult to determine, particularly with the more slowly acting inorganic exchangers. An empirical equation which does not involve the concentration of the ion originally in the exchanger is that of Wiegner and Jenny (8):

$$y = K \cdot \left(\frac{c}{a - c} \right)^p \quad (4)$$

where y is the exchange per gram of solid, a the initial equivalent concentration of the added salt, and c the equivalent concentration of the added ions which remain after the exchange has taken place. This equation has been used for exchanges in synthetic aluminosilicates and clays (9, 10). Renold (2) used a somewhat similar equation for a synthetic aluminosilicate.

Another empirical equation, having an analogy with the Langmuir adsorption isotherm, is due to Vageler (11):

$$y = \frac{aS}{a + C} \quad (5)$$

where y is the exchange per gram of solid, a the quantity of added salt per gram of solid, S the maximum exchange capacity of the solid, and C a constant. Quantities are in equivalents.

It is noteworthy that empirical equations, such as (2), (3), and (4), are particularly useful with synthetic aluminosilicates of the gel and fusion types. These are not well defined chemical individuals, and one may expect variations in physical and chemical structure even within a single granule. They will act as mixtures of exchangers rather than as uniform substances. It can be shown that a mixture of exchangers, each one giving a distribution obeying the mass action law (equation (7) below), but with different equilibrium constants K , will give an overall ionic distribution which is qualitatively like that of equation (2), and the less uniform the exchanger is, the smaller will be the index p (4).

(b) *Equations Based on the Mass Law.* In granular exchangers, practically all of the exchange takes place in the interior of the particles, which have a porous gel structure. We are, therefore, justified in considering the exchange as a partition of ions between two phases, gel and solution, the

boundary between which is sharp and distinct. The mass action law should, therefore, apply. For the exchange reaction

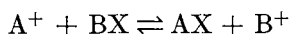

we can write

$$\frac{a_{AX} \cdot a_{B^+}}{a_{BX} \cdot a_{A^+}} = K \quad (6)$$

where a_{AX} and a_{BX} are the activities of ions A and B in the exchanger, a_{A^+} and a_{B^+} their activities in the solution.

The next step is to express the activities as a function of concentrations. The simplest assumption to make is that the activities are directly proportional to the equivalent concentrations of the ions in the solution and in the solid. In this case, we have the laws of mass action in its simplest form:

$$\frac{m_{AX}}{m_{BX}} = K \cdot \frac{[A^+]}{[B^+]} \quad (7)$$

Where the ions A and B are of equal valency, the activity coefficients in solution will cancel out, provided that the concentration is not too high. Equation (7) has been shown to hold with satisfactory accuracy for the $Na^+ - H^+$, $NH_4^+ - H^+$, and $Ca^{++} - Ba^{++}$ exchanges in a sulfonic acid resin (5, 12), for the $Na^+ - K^+$ exchange in bentonite and soil colloids (3), as well as in a few other cases (13, 14, 15, 16, 17, 18), some of which are exchanges between ions of different valency. For the sodium-calcium exchange, for example, the mass law is most simply written

$$\frac{m_{CaX}}{m_{NaX}^2} = K \cdot \frac{[Ca^{++}]}{[Na^+]^2} \quad (8)$$

where the m 's are in moles or equivalents per unit weight of exchanger. This form of the equation was used by Kerr (16) and is often associated with his name. An equation of this type expresses the well-known fact that the distribution of two ions of unequal charge depends upon the dilution; the more dilute the solution, the greater the proportion of the higher valence ion in the exchanger.

Correction for activity coefficients is more easily made in the solution than in the exchanger. This correction is, naturally, more important in the case of exchanges between ions of different valence than in the case of exchanges between ions of the same valence, since the higher the valence the greater is the effect of concentration on the activity coefficient. In dilute solutions, the simple Debye-Hückel theory may be used to estimate the ratio of activity coefficients; thus,

$$\log \frac{\gamma_{Ca^{++}}}{\gamma_{Na^+}^2} = -1.0\sqrt{\mu} \quad (9)$$

where γ is the activity coefficient, μ is the ionic strength, as shown by Walton (4). More accuracy is obtained if we take the experimentally determined values of the activity coefficients of the two salts taking part in the ion exchange; thus, for a solution of calcium chloride plus sodium chloride,

$$\frac{\gamma_{\text{Ca}^{++}}}{\gamma_{\text{Na}^+}^2} = \frac{\gamma_{\text{Ca}^{++}} \gamma_{\text{Cl}^-}^2}{\gamma_{\text{Na}^+}^2 \gamma_{\text{Cl}^-}} = \frac{\gamma^3_{\text{CaCl}_2}}{\gamma_{\text{NaCl}}} \quad (10)$$

The activity coefficients of the individual salts in each case must be taken for an ionic strength equal to that of the mixed solution. This has been done by Boyd *et al.* (5), and by Vanselow (19), who studied the $\text{Ba}^{++} - \text{Ca}^{++}$ exchange between bentonite and chloride solutions and even proposed the measurement of ion exchange equilibria as a means of determining ratios of activity coefficients in mixed solutions.

In some cases, experimental data are available on the activities of electrolytes in mixed solutions; for example, HCl in a solution containing NaCl (20). For precise work on ion exchange in such solutions it would be worth using these data.

A direct potentiometric measurement of the activities of cations (Ti^+ , H^+ , Ag^+) in solutions in equilibrium with clay exchangers was made by Marshall and Gupta (21). Using the measured activities instead of the concentrations improved the constancy of K in equation 7 in some cases, notably the $\text{Ti}^+ - \text{H}^+$ exchange, but not in others.

We shall now consider the activities of the ions in the solid. We know that in an exchanger containing two kinds of cations, the two cations always form a continuous range of solid solutions, and we may expect their activities to be a fairly simple function of their concentrations. In equations (7) and (8), the activities are considered to be proportional to the number of ions per unit weight of exchanger. It is just as logical, however, to take the activity of an ionic species A as proportional to its mole fraction, or the fraction of the total number of cations in the exchanger which are of the type A. In exchanges between ions of the same valence it makes no difference which definition we choose, but, with ions of different valence, the total number of ions in the exchanger is not constant. For the calcium-sodium exchange, we would write

$$\frac{m_{\text{CaX}}}{m_{\text{CaX}} + m_{\text{NaX}}} \div \left(\frac{m_{\text{NaX}}}{m_{\text{CaX}} + m_{\text{NaX}}} \right)^2 = \frac{m_{\text{CaX}} (m_{\text{CaX}} + m_{\text{NaX}})}{m_{\text{NaX}}^2} = K \cdot \frac{a_{\text{Ca}^{++}}}{a_{\text{Na}^+}^2} \quad (11)$$

This equation is Vanselow's (3), and was used by Boyd *et al.* in their study (5).

A refinement introduced by Kielland (22) is to consider that the activity coefficient of an ion in the exchanger is not a constant, but depends upon its mole fraction. Using an equation of van der Waals, he wrote

$$\log \gamma_{AX} = C \cdot X_{BX}^2; \log \gamma_{BX} = C \cdot X_{AX}^2 \quad (12)$$

where C is a constant for the system, and can be positive or negative. X_{BX} and X_{AX} are the mole fractions of BX and AX . He applied this equation successfully to exchanges involving clays. Boyd *et al.* (5) found it unnecessary to use this correction in the exchanges they studied, but they suggest that in cases where the ions in an exchanger do not form ideal solid solutions, the following equation, derived from equations (12), could be used to find the solid phase activities:

$$\log K_c' = \log \frac{A_{B^+}}{A_{A^+}} \cdot \frac{[AX]}{[BX]} = \log \frac{A_{B^+}}{A_{A^+}} \cdot \frac{A_{AX}}{A_{BX}} - C(X_{BX}^2 - X_{AX}^2) \quad (12a)$$

This is criticized by Simons (22a), who points out that equations (12) have theoretical meaning only if the solid phase is a "regular solution," that is, if it has the same entropy as an ideal solution of the same volume and composition. He cites cases of solid solutions which give a linear plot of $\log K_c'$ against $(X_{BX}^2 - X_{AX}^2)$, and yet are not "regular solutions" (22b, c).

A complication which should not be overlooked in dealing with the resinous exchangers, and perhaps also with bentonite, is the effect of swelling. As one cation is replaced by another, the degree of swelling may change, especially where the two cations have different valences. At the same time the exchange characteristics may alter; it seems that the more a resin swells in water, the less it differentiates between different cations in strength of absorption (see section 3(a)). As yet the factor of swelling has received little attention in formulating equations for ion exchange equilibria. However, Gregor (22d) in outlining a general thermodynamic theory of ion exchange has pointed out that the free energy of an ion exchange process includes a quantity $p(\bar{V}_B - \bar{V}_A)$, where p is the swelling pressure of the resin, and \bar{V}_A , \bar{V}_B the relative partial molal volumes of the ions A and B in the resin. $\bar{V}_B - \bar{V}_A$ can be measured directly, and p equals the osmotic pressure difference between the solutions inside the resin and out. It should be possible, Gregor thinks, to predict ion exchange distributions from independently observable quantities. He cites specific volumes of a particular resin with several different exchangeable cations. The smaller the specific volume, the stronger is the ion held by the resin.

Now that ion exchange resins are available which have simple and reproducible exchange characteristics, we may expect to see ion exchange equilibria used more and more to study the stability of complex ions in

solution and to measure activity coefficients of dissolved electrolytes. Some work in this direction has been done by Samuelson (22e), who studied the ferric-metaphosphate complex by ion exchange and photometrically. He concluded that the dissolved complex contained three atoms of P to one of Fe, and that it was about 0.5% dissociated in 0.01 *M* ferric metaphosphate solution. Also Schubert (22f) has used the partition of radioactive strontium between an exchanger and ammonium salt solutions to measure the dissociation constants of strontium tartrate and of the complex ion (Sr citrate)⁻. Where one ion is present in very small amount compared to the other ion, as in radioactive tracer work, the exchange isotherm for the microcomponent assumes a particularly simple form.

(c) *Equations derived kinetically.* In exchangers of the type of clays and humic acids, the particles are very small, and a considerable proportion of the exchange takes place upon the surface of these particles. Ion exchange in this case is a surface adsorption rather than a distribution between two phases. It is impossible to draw a sharp boundary between adsorbed ions and dissolved ions, and even the requirement of electrical neutrality is less stringent than in granular, gel type exchangers. The application of thermodynamic methods to such a system is difficult, and the law of mass action may have little validity. A more hopeful theoretical approach is to consider the rate of exchange of ion A for ion B and vice versa, and to equate the two exchange rates to obtain the equilibrium distribution.

From kinetic considerations, Gapon (23) proposed an equation in which the rate of removal of an ion is proportional to the area of the exchanger surface that it occupies. Thus for the calcium-sodium exchange,

$$\frac{m_{\text{Ca}^{++}}}{m_{\text{Na}^{+}}} = K \cdot \frac{[\text{Ca}^{++}]^{1/2}}{[\text{Na}^{+}]} \quad (13)$$

This equation was compared with those of Kerr and Vanselow (equations 8 and 11 above) for correlating exchange distributions on clays and soils by Magistad *et al.* (24), who concluded that Gapon's equation fitted the experimental results better than the other two. Davis (1) criticized their conclusions, pointing out that one should square *K* in equation 13 before comparing its constancy with *K* in equations 8 and 11, and showed that no one of these three equations explains all of the experimental data. The distribution measurements for clays and soils cited above are sufficiently reproducible that we can say that the equations are inadequate rather than the experiments.

A statistical theory of ion exchange which explicitly recognizes the diffuse character of the adsorbed layer of cations was worked out by Jenny (25) and Davis (26). Each adsorbed ion is considered to occupy a definite "oscillation volume" on the exchanger surface. The probability

that an ion of another kind will enter the oscillation space of the adsorbed ion and displace it is calculated. The equations given by Jenny for ions of equal valence are:

$$w^2 \left(1 - \frac{v_w}{v_b} \right) - w(S + N_w) + SN_w = 0 \quad (14a)$$

and

$$\frac{Z_b}{Z_w} \cdot \frac{N_w}{N_b} = K = \frac{v_w}{v_b} \cdot \exp \left(\frac{v_b - v_w}{V} \right) (N_w + N_b) \quad (14b)$$

where w = number of cations of type "w" absorbed when pure "w" ions are added to an exchanger containing only "b" ions
 S = the maximum number of cations the exchanger will hold
 N_w, N_b = the number of "w" and "b" ions in the solution
 v_w, v_b = the oscillation volumes of ions "w" and "b"
 Z_w, Z_b = numbers of "w" and "b" ions on the exchanger
 V = the total volume of the system.

Davis showed that, if certain approximations are made, the equation yields

$$\frac{Z_b}{Z_w} \cdot \frac{N_w}{N_b} = \frac{v_w \alpha(b) f(u)_b}{v_b \alpha(w) f(u)_w} = K \quad (15)$$

where $\alpha(b), \alpha(w)$ = probability constants for the absorption of "b" and "w" ions

$f(u)_b, f(u)_w$ = functions of the mobilities of ions "b" and "w."

This approximates to the law of mass action. For uni-divalent exchanges, Davis deduced:

$$\frac{Z_b}{Z_w} \cdot \frac{N_w}{(N_b)^{1/2}} = \frac{\beta \left(\frac{2v_w}{V} \right)^{1/2} f(u)_w}{\alpha \left(\frac{v_b}{V} \right) f(u)_b} = K \quad (16)$$

where α and β are constants. This is an approximate equation also, the higher terms in the probability expressions having been neglected, but, if the $f(u)$ and the v are independent of concentration, this is equivalent to the equation of Gapon (13 above).

Equations (14) express the experimental data very well indeed for exchanges on Putnam clay and bentonite. Equations (14b) and (15) show clearly that to a first approximation, the constant K is proportional to the oscillation volumes of the ions, and hence, presumably, to the cube of the radius of the hydrated ion. This is exactly the relation which Jenny himself found, and which is noted below in section 3(a). These equations, therefore, have a precision and logic which is as valid for the clay minerals as the thermodynamic equations are for the resinous exchangers.

3. The Exchanging Powers of Different Cations

(a) *Simple Metallic Cations.* The exchanges of the alkali metal and alkaline earth metal cations have been studied on practically every type of cation exchanger known, and in every case the same order of absorption is found. The divalent ions are held more strongly than the univalent, and, in each series, the strength of binding by the exchanger increases as the atomic weight increases. In the alkali metals, the order of absorption is $\text{Cs}^+ > \text{Rb}^+ > \text{K}^+ > \text{Na}^+ > \text{Li}^+$; in the alkaline earth metals, the order is $\text{Ba}^{++} > \text{Sr}^{++} > \text{Ca}^{++} > \text{Mg}^{++}$. This order is shown by the results of Jenny (8) for an aluminosilicate exchanger summarized in Table II. The same order was found for a sulfonic acid resin by Boyd *et al.* (5); their distributions followed the mass action law, and they were able to express the affinities of the different ions for the exchanger in the form of standard free energies for the reaction $\text{A}^+ + \text{HX} \rightarrow \text{H}^+ + \text{AX}$. Their results are given in Table III.

TABLE II
Exchange Between Various Cations and Ammonium Aluminosilicate

Salt Added	<i>K</i>	<i>p</i>	Salt Added	<i>K</i>	<i>p</i>
LiCl	15.2	0.273	MgCl ₂	29.8	0.088
NaCl	29.5	0.273	CaCl ₂	48.1	0.088
KCl	45.1	0.273	SrCl ₂	49.9	0.088
RbCl	56.8	0.273	BaCl ₂	64.5	0.088
CsCl	58.0	0.273			

Notes: *K* and *p* are the constants in equation 4.

Data of H. Jenny, *Kolloid-Beihfte* **23**, 428 (1927).

TABLE III
Standard Free Energies for the Reaction $\text{A} + \text{HX} \rightarrow \text{H} + \text{AX}$

Ion	$-\Delta F^\circ$ cal./mole at 25°
H ⁺	0
Li ⁺	- 60
Na ⁺	320
NH ₄ ⁺	410
K ⁺	530
Rb ⁺	615
Cs ⁺	860
Ba ⁺⁺	1680
Y ⁺⁺⁺	1830
La ⁺⁺⁺	2110

Synthetic resin exchanger. Data of G. E. Boyd, J. Schubert, and A. W. Adamson, *J. Am. Chem. Soc.* **69**, 2828 (1947).

The exchanging powers of these cations can be correlated with the ionic radii. As the radius of the hydrated ion in solution decreases, the absorption by the exchanger increases. Quantitative correlations have been shown by Jenny (8), Nachod and Wood (27), and Boyd *et al.* (5).

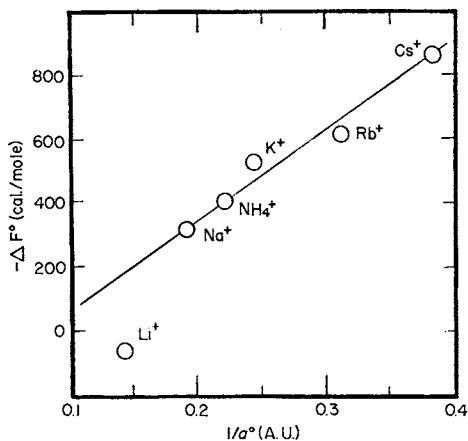

FIG. 1. Ionic radius and free energy of ion exchange. (Boyd *et al.*, (5).) Free energies are for the reaction $A^+ + HX \rightarrow H^+ + AX$. a° is the Debye-Hückel parameter for the distance of closest approach.

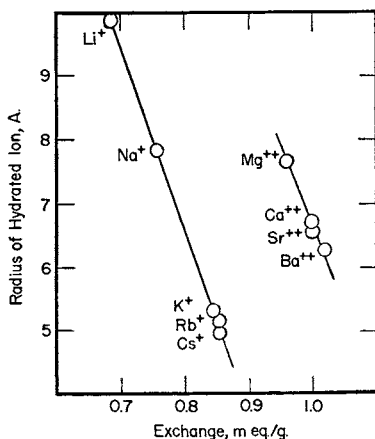

FIG. 2. Ionic radius and extent of exchange. (Nachod and Wood, 27.) The exchanger was sulfuric acid-treated coal. The ionic radii were obtained from the ionic mobilities. One gram quantities of exchanger were shaken with 200 ml. of 0.02 *N* solutions.

The last mentioned authors found that the standard free energies given in Table III were related in a linear manner with the reciprocal of a° , the constant in the Debye-Hückel activity equation that represents the distance

of closest approach of anion and cation in solution. Their results are plotted in Fig. 1, those of Nachod and Wood in Fig. 2.

It would appear that the more hydrated an ion is, the less strongly it is bound by an exchanger; that is, the differences between ions of the same charge are differences in the solution rather than differences in the exchanger. This point of view is supported by experiments of Wiegner (9), in which he compared the exchange of Na^+ and Cs^+ with a calcium aluminosilicate in solutions of water and alcohol. As the percentage of alcohol was increased, sodium and cesium became more nearly alike in displacing power. The less hydrated the ions were, the more equally they were distributed between the exchanger and the solution. Wiegner's data are reproduced in Table IV.

TABLE IV
Effect of Solvent on Ion Exchange

Alcohol Per cent	Exchange meq.	
	Na^+	Cs^+
0.....	0.64	0.98
40.....	0.99	1.10
100.....	1.23	1.25

The conclusion that the different strengths of binding of ions of the same charge are due to differences in hydration is supported by the important work of Samuelson (18), in which he studied two synthetic resin exchangers, one a commercial exchanger containing sulfonic acid groups that swelled only moderately when placed in water (exchanger A) and the other a highly sulfonated polystyrene that swelled very greatly (exchanger B). For exchanger A, the mass action law constants for the reactions $\text{Na}^+ + \text{HX} \rightleftharpoons \text{H}^+ + \text{NaX}$ and $\text{Li}^+ + \text{HX} \rightleftharpoons \text{H}^+ + \text{LiX}$ in dilute solutions were 1.20 and 0.88 respectively; for exchanger B, the mass action constants for the exchanges $\text{H}^+ - \text{Na}^+$, $\text{H}^+ - \text{K}^+$, and $\text{H}^+ - (\text{CH}_3)_4\text{N}^+$ were unity, within the experimental error (*op. cit.*, pp. 59-64); that is to say, an exchanger which is so swollen that cations can be just as hydrated within its pores as in the bulk of the solution will not distinguish between different cations. The same conclusion emerges from the work of Graf (28) on ion exchange between casein and aqueous-alcoholic solution. The swelling of the casein was decreased in three ways: by decreasing the salt content of the solution, by adding alcohol to the solution, and by combining the casein with formaldehyde. In every case, decrease of swelling accentuated the difference in strength of binding between sodium and barium ions.

In general, the differences in exchanging power between different cations are greater in rigid, dense exchangers like the aluminosilicates than

in less dense, elastic exchangers such as sulfuric acid-treated coals and synthetic resins. It is hard to give precise data on this point, as the aluminosilicates do not even approximately obey the mass action law, but a comparison of the relative binding of Li^+ and Cs^+ by an aluminosilicate (Jenny, 8; see Table II above) and by a resin (5; see Table III above) will show the difference. Similarly, Patton and Ferguson (29), working with an aluminosilicate, found a greater difference between Ca^{++} and Ba^{++} than Walton did (4), using a sulfuric acid treated coal. Where ion exchange is to be used to separate cations from one another, it would be better, other things being equal, to use a siliceous exchanger than a carbonaceous exchanger; however, the latter is more easily regenerated.

Studies of the exchanging powers of divalent ions other than the alkaline earth metals were made by Renold (2), by Rothmund and Kornfeld (6), and by Kozak and Walton (30). No definite order was found. The relations are complicated here by the fact that many heavy metal cations form complex ions in solution. In general, the differences between one cation and another are not great; copper is held somewhat more strongly than nickel by a sulfuric acid treated coal, and cadmium more strongly than zinc (30).

Trivalent cations are held more strongly than divalent, as the results of Boyd *et al.* (5) and Renold (2) show. The differences in adsorptive powers of different trivalent ions, although small, are of great interest in connection with the separation of the rare earth elements from one another (see chapter by Schubert). Russell and Pearce (31), using an aluminosilicate exchanger, first showed that this separation was possible. They found that lanthanum was absorbed the least, and that the strength of binding increased with increasing atomic weight; that is, with decreasing (unhydrated) ionic radius. This is the opposite of what is found in the alkali and alkaline earth metals. By combining the differences in strength of absorption with differences in the stability of citrate complexes in solution, very complete separations in the rare earth series have now been achieved (32).*

Ion exchange has even been used to separate isotopes. When a solution of lithium chloride was percolated down a column of exchanger more than a hundred feet long, the salt that emerged at the bottom was enriched in Li^7 . Similar isotopic shifts were obtained with potassium and the nitrogen of the ammonium ion. In each case, the rarer isotope was retained preferentially by the exchanger regardless of isotopic weight (33).

(b) *Complex Metallic Cations.* There are no quantitative data on exchanges involving complex metallic cations. All that is known is that

* The alkali metals have also been separated fairly efficiently by means of an ion exchange column (32a).

certain complex cations can be taken up by certain cation exchangers. Samuelson (18) noted that, when his "exchanger B" was saturated with $\text{Co}(\text{NH}_3)_5\text{Cl}^{++}$, the swelling was greatly diminished. As we might expect, the absorption of complex ions has been mainly noted in the carbonaceous exchangers, which have relatively large pores. Griessbach (34) recorded that a sulfuric acid-treated coal took up the cation $\text{Cu}(\text{NH}_3)_2^{++}$ from an ammoniacal solution of a cupric salt; Nelson and Walton (35) also found that the ions $\text{Cu}(\text{NH}_3)_2^{++}$ and $\text{Ni}(\text{NH}_3)_4^{++}$ could be absorbed by a sulfuric acid-treated coal. Günther-Schulze (36) reported the uptake of ions CuCl^+ and Cu_2Cl_3^+ by a synthetic aluminosilicate exchanger. Samuelson (37), however, found no such effect with a sulfonic acid resin.

(c) *Organic Cations.* Again, very few quantitative distribution studies have been made on exchanges involving organic cations, but the subject is of practical interest, as alkaloids, vitamins, and basic amino acids can be separated and concentrated by cation exchange. Herr (38) used the Freundlich adsorption isotherm to relate the uptake of thiamine to its concentration in solution. The carbonaceous exchangers, with their large pore size and swelling capacity, are used exclusively for the absorption of these large organic cations. The synthetic aluminosilicates have pores which are too small to take up these cations. Thus it has been known for a long time that clay minerals, such as kaolinite and montmorillonite, will absorb basic dye molecules, whereas the synthetic aluminosilicates will not, in spite of the fact that the capacity of the synthetic exchangers for ordinary small cations is much larger. The data of Wiegner (9) show very clearly the effect of ion size on the absorption of organic cations by a synthetic aluminosilicate; they are given in Table V.

TABLE V
Exchange of Substituted Ammonium Ions in a Synthetic Calcium Aluminosilicate

Ion entering	<i>K</i>	<i>p</i>
NH_4^+	16.50	0.444
NH_3CH_3^+	4.16	0.446
$\text{NH}_2(\text{CH}_3)^+$	0.97	0.532
$\text{NH}(\text{CH}_3)_3^+$	0.85	0.442

Note: Data are expressed according to equation 4 above.

(d) *The Hydrogen Ion.* Just as weakly ionized acids are far more common than weakly ionized salts, so many cation exchangers which hold other ions by electrostatic forces combine with hydrogen ions to form a covalent molecule. The degree of ionization of the acid form of ion exchangers differs greatly with different exchangers, and, whereas the order of absorption of the alkali metal cations is the same for all exchangers, the

place of the hydrogen ion falls between Li^+ and Na^+ in the case of the strongly acidic sulfonic acid resins (5, 18), while in the synthetic aluminosilicates it is held with a strength approximating that of the barium ion (8). It is held less strongly by the clays than by the synthetic aluminosilicates, and the investigations of Marshall (21, 39) have shown that some clay acids are more ionized than others; the acid of montmorillonite is 30% ionized, where the acid of beidellite, the mineral of Putnam clay, is ionized only 10%.

The exchange of the hydrogen ion in clays and other inorganic exchangers is not of much practical use, nor can it be studied with any great accuracy, because acids break down the aluminosilicate with liberation of aluminum ions. Exchanges involving hydrogen ions are much more significant in the carbonaceous exchangers. Here the investigations of Griessbach (34; see also the review by Myers, 40) on the degrees of ionization of different types of resin are very enlightening. He presents titration

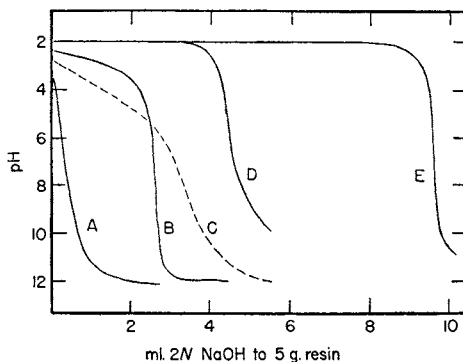

FIG. 3. pH-Titration curves of resinous exchangers. (Bauman, 41; Myers, 40; Griessbach 34.)

- Resin A: Active group, phenolic $-\text{OH}$
 B: Active group, $-\text{CH}_2\text{SO}_3\text{H}$
 C: Active group, $-\text{COOH}$
 D and E: Active group, nuclear $-\text{SO}_3\text{H}$

curves which show clearly the difference between strongly ionized groups, such as $-\text{SO}_3\text{H}$, groups with medium ionization ($-\text{COOH}$), and weakly ionized groups (phenolic $-\text{OH}$). Some of these curves are shown in Fig. 3.* The titration curve obtained by Bauman (41) with a condensation

* Gregor and Bregman (40a) have published titration curves for a number of resins of known chemical constitution which show unequivocally that certain resins contain two or more kinds of acidic groups which give distinct inflection points in the neutralization curves. Exchange rate curves at different pH show also that the strongly acidic groups are neutralized faster than the weakly acidic groups.

product of phenolsulfonic acid and formaldehyde is also included in Fig. 3. The curve shows the neutralization of the sulfonic acid groups but not that of the phenolic groups; these only ionize appreciably above pH 9.5. Resins of this type ("Dowex 30" and "Dowex 50") containing nuclear sulfonic acid groups are very strong acids, and so their exchange capacities for metallic cations are influenced very little by pH. They have been used in recent investigations on rare earth separations by Tompkins and co-workers (32).

In exchangers which are weak acids, the exchange capacity is considerably affected by pH. Griessbach (34, 40) calculated the effect of pH on exchange for a resin which obeyed the Rothmund-Kornfeld equation; if

$$\frac{m_{\text{H}}}{m_{\text{Na}}} = K \cdot \left(\frac{[\text{H}^+]}{[\text{Na}^+]} \right)^p \quad (\text{cf. equation 2, above})$$

then it can be deduced that, as sodium hydroxide is added to a suspension of the exchanger containing originally c moles of sodium ions per liter,

$$\text{pH} = \log \frac{1}{c} + \log \left(1 + \frac{1}{K} \cdot \frac{[\text{Na}^+]}{[\text{H}^+]} \right)^{\frac{1}{p}} \quad (17)$$

This equation qualitatively expresses the titration curves of Fig. 3, but it does not fit any of them exactly, probably because the weakly acid exchangers contain several kinds of acidic groups.

The sulfuric acid-treated coals, which are widely used in industry because of their cheapness and ruggedness, appear to contain a variety of acidic groups, and while in solutions of low pH they behave as homogeneous strong acids of moderate exchange capacity, as the pH is raised their capacity to absorb cations other than hydrogen increases very considerably. When these materials are used in water treatment to remove sodium ions from water and replace them by hydrogen ions, much more sodium is taken up from a sodium bicarbonate solution, which has a buffering action and keeps the pH high, than from solutions of sodium chloride or sulfate. Nelson and Walton (35) shook portions of a sulfuric acid-treated coal with 0.1 M potassium salt solutions of different pH, and found that the uptake of potassium ions by the exchanger increased in a linear manner with pH, being 1.0 milliequivalents/g. at pH 3 and 4.1 milliequivalents/g. at pH 13. Zinc was absorbed from an ammoniacal zinc sulfate solution of pH 11.2 to an extent of 5.0 milliequivalents/g. At pH 11–13, the phenolic hydroxyl groups of this material probably ionize. They may be expected to have an ionization constant of the same order as the second dissociation constant of salicylic acid ($\text{C}_6\text{H}_4(\text{OH})\text{COOH}$), which is 3.6×10^{-14} . The sulfur content of this exchanger was 7.5%, which means that it could contain up to 2.3 milliequivalents of sulfonic acid groups per gram. The

material must, therefore, contain other acidic groups in addition to sulfonic acid, and probably contains carboxyl as well as phenolic hydroxyl groups.

A linear relation of exchange capacity with pH was also found for bentonite and zeolites by Gapon (42):

$$S = a + b \left(\text{pH} - \frac{1}{n} pM \right) \quad (18)$$

where S is the absorption capacity for metal ions, n is the valence of these ions, pM is the negative logarithm of their molar concentration, and a and b are constants. Similar results were obtained by Mukherjee and Mukherjee (43). It is clear that exchange capacity is very sensitive to pH in the case of exchangers that are weak acids, and many of the irregularities of the older distribution studies may be due to a failure to appreciate this fact. Schubert (22f) has shown that even the distribution of two metallic cations (NH_4 and Sr) in a sulfonic acid-phenolic exchanger (Amberlite IR-1) is affected by pH.

4. Temperature and Cation Exchange Equilibria

The influence of temperature on the equilibrium distribution has been little investigated, but it appears to be very small. Rothmund and Kornfeld (6) and Patton and Ferguson (29) say that temperature has no effect on equilibria between ions of the same valence. In the calcium-sodium exchange, Patton and Ferguson, also Vanselow (3), and Magistad *et al.* (24) found that the proportion of calcium in the exchanger increased slightly as the temperature was raised. K in equation (13) above was 102 at 7°, 108 at 30° (24), the exchanger being montmorillonite and the salt concentration 0.010–0.030 N . At higher salt concentrations, the effect is somewhat greater (Patton and Ferguson, 29).

Boyd *et al.* (5) found a small temperature effect on the sodium-potassium distribution between a sulfonic acid resin and 0.1 N chloride solutions; the mass law constant was 0.58 at 13.5° and 0.70 at 30.0°, the higher temperature favoring absorption of sodium by the resin. With a chloride concentration of 10^{-3} N , temperature had no measurable effect.

The low temperature coefficient of ion exchange equilibria shows that the heat of reaction is very small, probably not over 2 cal./mole. Since the ions remain ions when they enter the exchanger, and merely change their environment, no covalent chemical bonds are formed or broken in the process, and we have no reason to expect any large effect of temperature. The only effect of temperature will be on the activity coefficients of the ions, and this effect is very small. It increases with concentration, however. We may expect a large temperature effect only in hydrogen ion

exchanges involving a solid which is a very weak acid, and perhaps also in exchanges where complex ions take part.

5. *The Effect of Anions*

Anions as a rule take no direct part in cation exchange equilibria. Their influence will only be appreciable when they combine with one or more of the cations, as, for example, the citrate ions that form complexes with rare earth cations, or the anions of weak acids in exchanges involving hydrogen ions (see section 3(d)). In most work where salts of different anions were used, the choice of anion had no effect (29). However, a small but definite influence was described by Ungerer (44), who studied the exchange of calcium aluminosilicate with different potassium salts and a few salts of other cations. He found that the amount of exchange increased in the order

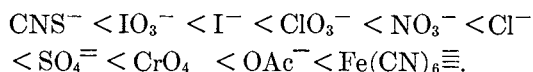

This is in the main the order of the "lyotropic series," the order of increasing hydration. The exchange was greater, the more hydrated the anion, and the effect of the anion was greater, the more hydrated the cation.

A certain combination of anions with the cation exchanger itself has been noted in a few cases, particularly where the cation in the exchanger is of high valence. Jenny (8) found that a gram of sodium aluminosilicate absorbed 0.03 milliequivalent of Cl^- , a gram of magnesium aluminosilicate absorbed 0.26 milliequivalent of Cl^- , and a gram of aluminum aluminosilicate absorbed 0.65 milliequivalent of Cl^- . The absorption of anions by calcium and barium salts of casein in aqueous alcoholic suspensions is also appreciable (28). The simultaneous absorption of anions and cations is met in amphoteric soils, and has been treated quantitatively by Mattson and Wiklander (45).

6. *The Swelling of Cation Exchangers*

Both the sulfuric acid-treated coals and the cation exchanging resins swell considerably when the dry material is placed in water. The swelling facilitates the movement of ions in and out of the granules, and is important both to the speed of the exchange and to the equilibrium distribution (see section 3(a)). Swelling also occurs in clays of the montmorillonite type.

When a dry sodium-saturated exchanger is placed in sodium chloride solution, the concentration of the solution increases, because the solid takes up relatively more water than salt. This is a proof that the sodium in the exchanger exists as ions for, as a result of the Donnan equilibrium,

$$a_{\text{Na}^+} \cdot a_{\text{Cl}^-} \text{ in the gel} = a_{\text{Na}^+} \cdot a_{\text{Cl}^-} \text{ in the solution.} \quad (19)$$

Since the sodium ion concentration in the gel is relatively high (as much as 5 *N* in some materials), the chloride ion concentration must be correspondingly low. This is shown by the relatively small absorption of salt into the gel from the solution (Bauman and Eichhorn, 12; Samuelson, 18; and Walton, 4). Bauman and Eichhorn showed that the Donnan equation accounted for the absorption of hydrochloric acid from solutions by a hydrogen ion exchanger, except at very low concentrations, when the chloride concentration in the gel was greater than that predicted by the Donnan equation.

The extent of the swelling, and hence the concentration of ions in the solution in the gel, depends on the cation in the gel and upon the concentration of electrolyte in the outer solution. With increasing electrolyte concentration, the swelling decreases. Figure 4 is taken from the thesis of Samuelson (18) and shows the swelling of his exchanger "B" with different

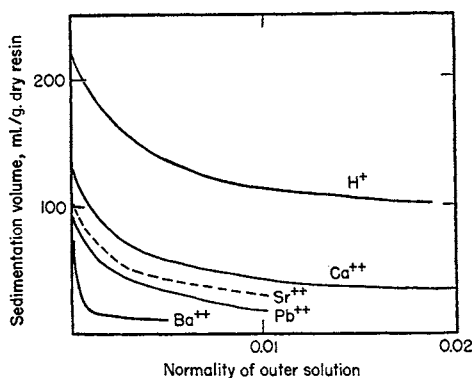

FIGURE 4

Fig. 4. Swelling of an ion exchange resin. (Samuelson, 18, p. 86.) The resin was "B," a highly swelling sulfonated polystyrene. Chloride solutions were used except for $\text{Pb}(\text{NO}_3)_2$. Alkali metal chlorides gave the same swelling as HCl.

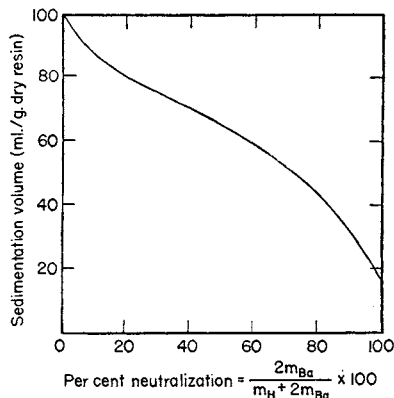

FIGURE 5

Fig. 5. Change of swelling during ion exchange. (Samuelson, 18, p. 88.) The resin was "B." It had an exchange capacity of 4.86 milliequivalents/g.

salt solutions. This material had a very great swelling capacity, and so the effects are exaggerated, but qualitatively similar results were obtained with a commercial cation exchange resin. The univalent ions Li^+ , Na^+ , K^+ , NH_4^+ , $(\text{CH}_3)_4\text{N}^+$, and $\text{C}_6\text{H}_{10}\text{NH}_2^+$ all gave the same swelling as the hydrogen ion.* The decrease of swelling as Ba^{++} is substituted for H^+ is shown as a function of the degree of neutralization in Fig. 5. Similar effects

* Gregor (22d), however, reported significant differences between the swelling with different alkali metal cations.

in montmorillonite were investigated by Alten and Kurmies (46) and Hofmann and Giese (47). As was mentioned above (p. 10), it may be necessary to allow for the changes in swelling during ion exchange in formulating equilibrium equations.

7. *Summary*

The process of cation exchange is a redistribution of cations between one environment and another. The ions keep their electric charges when they enter the exchanger, no covalent bonds are made or broken, and the heat of reaction is very small. The exchanger is merely a negatively charged matrix for its associated cations, and so the different chemical types of exchanger, organic and inorganic, all obey similar distribution laws. We should, however, distinguish between the granular gel type exchangers, in which the cations occupy a distinct phase of nearly uniform electrical potential, and exchangers such as the clays, where a considerable proportion of the cations are located in a diffuse double layer of nonuniform electrical potential at the outside surface of the exchanger.

Some of the distribution equations are empirical, some are modifications of the law of mass action, and some are derived statistically. The strength of binding of cations depends upon their charge and radius, being greater the higher the charge and the smaller the radius in the hydrated condition; that is, the smaller the degree of hydration. The larger the pores of a cation exchanger, the more the environment in the exchanger resembles that of the solution, and the less difference there is between the absorption of different cations.

The hydrogen ion is unique in its ion exchanging powers, because it forms covalent compounds, or weak acids, with many exchangers.

II. ANION EXCHANGE

1. *Introductory*

Anion exchange equilibria have been relatively little studied because it is only recently that satisfactory anion exchanging materials have been available for technical use. The adsorption of anions and the exchange of adsorbed anions has been known for a long time in clays, alumina, apatites, and other minerals, but the capacity of these materials for adsorption is quite small. The modern high capacity anion exchangers are all basic nitrogenous resins.

The main difference between anion exchange equilibria and cation exchange equilibria is that the former are much more sensitive to pH, since the materials are all rather weak bases.* Even the most strongly

* New anion exchangers have appeared on the market in 1948 that are much stronger bases, nearly as strong as sodium hydroxide (51a).

basic resins, the alkylene polyamine resins, only become saturated with acid at relatively high concentrations (0.2–0.4 *N*), and the amount of acid held at saturation is different with different acids, as the following data of Kunin and Myers (51) show:

TABLE VI
Saturation Capacity of Amberlite IR-4B for Different Acids

Acid	Capacity meq./g. resin
HCl	9.20
HC ₂ H ₃ O ₂	6.45
H ₂ SO ₄	11.6
H ₃ PO ₄	27.7

When a resin which has one acid absorbed on it, for example, hydrochloric acid, is treated with a solution of another acid, for example, sulfuric acid, it does not necessarily follow that one equivalent of sulfuric acid will be absorbed for each equivalent of hydrochloric acid displaced; it may be that more than one equivalent is absorbed. "Acid exchange" does not necessarily proceed by equivalents as does cation exchange. However, under the right conditions, true anion exchange is possible, in which one equivalent of one anion displaces exactly one equivalent of a second anion.

2. Absorption Isotherms of Acids

Several studies have been made in which an anion exchanger has been converted into the basic form by treatment with an alkali, washed, and brought into contact with an acid solution. After equilibrium has been reached (which takes a good deal longer than in cation exchange*), the solution is analyzed and the uptake of acid by the exchanger is determined. The relation of acid absorption to the residual concentration of acid in the solution is best expressed by the Freundlich adsorption isotherm:

$$x = k \cdot c^p \quad (20)$$

where x is the quantity of acid absorbed per unit weight of solid, c is the residual concentration of the acid in the solution, and k and p are constants, p being less than one. The data do not always fit the Freundlich isotherm exactly, but it is better than the Langmuir isotherm and other equations which have been used. Such absorption data have been obtained by Bhatnagar *et al.* (48), Edwards *et al.* (49), Myers *et al.* (50), Kunin and Myers (51, 52), and others. Alkylene polyamine resins absorb more acid than metaphenylene diamine-formaldehyde resins and absorb it faster.

*Except with the new strongly basic resins.

p in equation (20) varies from 0.05 to 0.4. Sulfuric acid is absorbed much more strongly than hydrochloric acid on an equivalent basis, a fact which is of importance in water treatment. This may be owing to the stronger electrostatic field of the doubly charged ion, but it is at least partly due to adsorption of the ion HSO_4^- , because the absorption of sulfuric acid at high acid concentrations is greater than the nitrogen content of the resin could explain if two amino groups combined with one sulfate ion.

Bishop (53) measured the absorption of several monobasic acids of different strengths by an alkylene polyamine resin, and found that the quantity of acid absorbed per gram of resin was simply related to the ionic product $[\text{H}^+][\text{A}^-]$ of the dissolved acid HA. He concluded from this that the mechanism of acid absorption by the resin is



A little support for this mechanism comes from the heat given out on absorption of acids which, although not large, is a good deal more than the heat of reaction of cation exchange; the heat of absorption of hydrochloric acid on the resin Amberlite IR-4B was found to be 8.4 kcal./mole (Kunin and Myers, 51). However, other evidence shows that this resin in a neutral and alkaline condition contains appreciable amounts of the ionized hydroxide, $\text{RNH}_3^+\text{OH}^-$. If the neutral resin is treated with a sodium chloride solution, chloride enters the resin, and at the same time the solution becomes alkaline. This could happen only by the process

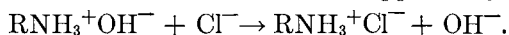

However, the fraction of the resin existing in the form $\text{RNH}_3^+\text{OH}^-$ was not determined, and it must be remembered that this resin is one of the most strongly basic resins available. With resins and basic dyestuffs which are weakly basic, no such exchange of chloride for hydroxyl is found.

The mechanism of the reaction of anion exchangers with acids is discussed by Heymann and O'Donnell (53a), who conclude that in aqueous solution the two processes

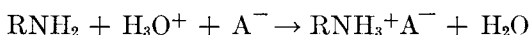

and



cannot be distinguished. It seems to the author, however, that a basic resin with the constitution RNH_2 will swell much less in water than one which is $\text{RNH}_3^+\text{OH}^-$; the latter will swell about as much as its salts RNH_3^+A^- . In practice most basic resins increase their swelling considerably when they absorb acid, indicating a change from the nonionic RNH_2 to the ionic RNH_3^+A^- . The new strongly basic resins mentioned above swell very little during acid absorption, suggesting that they are ionic all

the time, that is, that they are chiefly $\text{RNH}_3^+\text{OH}^-$ in the basic form. A further distinction should be possible on the basis of the Donnan equilibrium in alkaline solutions (cf. Section I, 6 above).

3. Exchange of Absorbed Anions

If a basic resin is treated with an acid, washed, and then stirred with the solution of a salt of another acid, the second anion displaces the first from the resin, and, if this displacement is not too extensive, it proceeds by equivalents. Kunin and Myers (52) showed that the replacement of Cl^- by HCO_3^- proceeded by equivalents up to 1.4 milliequivalents/g. of resin; replacement of Cl^- by $\text{SO}_4^{=}$ proceeded by equivalents up to 0.8 milliequivalent/g. of resin. We do not know from the data presented in this paper whether the exchange was equivalent right up to the saturation limit. We may assume that in some cases it was not, for the saturation capacity of this resin was only 6.45 milliequivalents/g. for acetic acid, for example, as against 9.2 milliequivalents/g. for hydrochloric acid (see Table VI).

Other workers have shown anion exchange to proceed by equivalents. Sussman *et al.* (54) found that the chromate ion displaced the chloride ion by equivalents, and other complex metallic anions, such as ferrocyanide, could enter into the exchange too. Kunin and Myers (52) studied the exchange equilibria between a number of different anions and found that they were best represented by the Freundlich adsorption isotherm. They also presented the following order of strengths of binding of different anions:

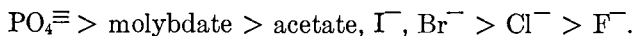
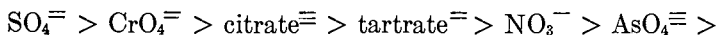

The anions of very weak acids, such as borate, displaced other anions from the exchanger, but were not themselves bound at all.

4. Summary

The exchange of anions between salt solutions and the salts of basic resins proceeds by equivalents, at any rate for a moderate extent of exchange, and the exchange distribution is best expressed by the Freundlich isotherm. Most of the resins used as anion exchangers are rather weak bases, and relatively high concentrations of acids, above 0.2 *N*, are needed to saturate them with acid. Different acids combine in different proportions at saturation. Heat is given out, about 8 kcal./mole, when hydrochloric acid combines with a typical basic resin. The basic resins contain a certain proportion of replaceable hydroxyl ions

BIBLIOGRAPHY

1. Davis, L. E., *Soil Science* **59**, 379 (1945).
2. Renold, A., *Kolloid-Beihefte* **43**, 1 (1935).
3. Vanselow, A. P., *Soil Science* **33**, 95 (1932).
4. Walton, H. F., *J. Phys. Chem.* **47**, 371 (1943).
5. Boyd, G. E., Schubert, J., and Adamson, A. W., *J. Am. Chem. Soc.* **69**, 2818 (1947).
6. Rothmund, V., and Kornfeld, G., *Z. anorg. Chem.* **163**, 129 (1918); **108**, 215 (1919).
7. Walton, H. F., *J. Franklin Inst.* **232**, 305 (1941).
8. Jenny, H., *Kolloid-Beihefte* **23**, 428 (1927).
9. Wiegner, G., *J. Soc. Chem. Ind.* **50**, 65T (1931).
10. Jenny, H., *J. Phys. Chem.* **36**, 2219 (1932).
11. Vageler, P. W. E., *Z. Pflanzenernähr. Düngung u. Bodenk.* **A15**, 329 (1930).
12. Bauman, W. C., and Eichhorn, J., *J. Am. Chem. Soc.* **69**, 2830 (1947).
13. Antipova-Karataeva, *Chimie & Industrie* **43**, 254 (1939).
14. Bacon, R. C., *J. Phys. Chem.* **40**, 747 (1936).
15. Chulkov, *J. Gen. Chem. U.S.S.R.* **9**, 571 (1939).
16. Kerr, H. W., *J. Am. Soc. Agron.* **20**, 309 (1928); *Soil Science* **26**, 384-398 (1928).
17. Møller, *Kolloid-Beihefte* **46**, 1, (1937).
18. Samuelson, O., Dissertation, Tekniska Högskola, Stockholm (1944). Reprinted as No. 179 of *Ingenjörsvetenskapsakademiens Handlingar*.
19. Vanselow, A. P., *J. Amer. Chem. Soc.* **54**, 1307 (1932).
20. Harned, H. S., and Owen, B. B., *The Physical Chemistry of Electrolytic Solutions*. Reinhold Publishing Corporation, New York (1933).
21. Marshall C. E., and Gupta, R. S., *J. Soc. Chem. Ind.* **52**, 433T (1933).
22. Kielland, J., *J. Soc. Chem. Ind.* **54**, 232T (1935).
- 22a. Simons, E. L., private communication.
- 22b. Yutzy, H. C., and Kolthoff, I. M., *J. Am. Chem. Soc.* **59**, 916 (1937).
- 22c. Simons, E. L., and Ricci, J. E., *J. Am. Chem. Soc.* **68**, 2194 (1946).
- 22d. Gregor, H. P., *J. Am. Chem. Soc.* **70**, 1293 (1948).
- 22e. Samuelson, O., *IVA* **17**, No. 1, 9 (1946); *Chem. Abstracts* **40**, 5655; also *Svensk Kem. Tid.* **56**, 277 (1944); *Chem. Abstracts* **40**, 3358 (1946).
- 22f. Schubert, J., *J. Phys. Colloid Chem.* **52**, 340 (1948); Schubert, J., and Richter, J. W., *ibid.* **52**, 350.
23. Gapon, E. N., *J. Gen. Chem. U.S.S.R.*, **3**, 144 (1933).
24. Magstad, O. C., Fireman, M., and Mabry, B., *Soil Science* **57**, 371 (1944).
25. Jenny, H., *J. Phys. Chem.* **40**, 501 (1936).
26. Davis L. E., *J. Phys. Chem.* **49**, 473 (1945).
27. Nachod, F. C., and Wood, W., *J. Am. Chem. Soc.* **67**, 629 (1945).
28. Graf, E., *Kolloid-Beihefte* **46**, 229 (1937).
29. Patton, J. R., and Ferguson, J. V., *Can. J. Research* **B15**, 103 (1937).
30. Kozak, R., and Walton, H. F., *J. Phys. Chem.* **49**, 471 (1945).
31. Russell, R. G., and Pearce, D. W., *J. Am. Chem. Soc.* **65**, 595 (1943).
32. Tompkins, E. R., Khym, J. X., and Cohn, W. E., *J. Am. Chem. Soc.* **69**, 2769 and subsequent papers (1947).
- 32a. Spedding, F. H., Fulmer, E. I., Ayers, B., Butler, T. A., Powell, J., Tevebaugh, A. D., and Thompson, R., *J. Am. Chem. Soc.* **70**, 1671 (1948).
- 32b. Cohn, W. E., and Kohn, H. W., *J. Am. Chem. Soc.* **70**, 1986 (1948).
33. Dean, J. G., U. S. Patent 2,204,072 (1940).
34. Griessbach, R., *Beihefte Z. Ver. deut. Chem.* No. 31 (1939).

35. Nelson, R., and Walton, H. F., *J. Phys. Chem.* **48**, 406 (1944).
36. Günther-Schulze, A., *Z. Elektrochem.* **28**, 89 (1922).
37. Samuelson, O., *IVA*, **17**, 17 (1946); *Chem. Abstracts* **40**, 6360 (1946).
38. Herr, D. S., *Ind. Eng. Chem.* **37**, 631 (1945).
39. Marshall, C. E., and Kimbrill, C. A., *J. Phys. Chem.* **46**, 1077 (1942).
40. Myers, R. J., *Advances in Colloid Sci.* **1**, 317 (1942).
- 40a. Gregor, H. P., and Bregman, J. I., *J. Am. Chem. Soc.* **70**, 2370 (1948).
41. Bauman, W. C., *Ind. Eng. Chem.* **38**, 46 (1946).
- 41a. Bauman, W. C., Skidmore, J. R., and Osmun, R. H., *Ind. Eng. Chem.* **40**, 1350 (1948).
42. Gapon, E. N., *J. Gen. Chem. U.S.S.R.* **13**, 382 (1943).
43. Mukherjee, J. N., and Mukherjee, S. K., *Nature* **155**, 149 (1945).
44. Ungerer, E., *Z. Pflanzenernähr. Düngung u. Bodenk.* **A18**, 342 (1930); **A23**, 353 (1932).
45. Mattson, S., and Wiklander, L., *Trans. Faraday Soc.* **36**, 306 (1940).
46. Alten, F., and Kurmies, B., *Angew. Chem. Beiheft* Nr. 21 (1935).
47. Hofmann, U., and Giese, K., *Kolloid-Z.* **87**, 21 (1939).
48. Bhatnagar, S. S., Kapur, A. N., and Puri, M. L., *J. Indian Chem. Soc.* **13**, 679 (1936).
49. Edwards, W. R., Schwartz, M. C., and Boudreaux, G., *Ind. Eng. Chem.* **32**, 1462 (1940).
50. Myers, R. J., Eastes, J. W., and Urquhart, D., *Ind. Eng. Chem.* **33**, 1270 (1941).
51. Kunin, R., and Myers, R. J., *J. Phys. Chem.* **51**, 1111 (1947).
- 51a. Technical data from the Resinous Products and Chemical Company, Philadelphia.
52. Kunin, R., and Myers, R. J., *J. Am. Chem. Soc.* **69**, 2874 (1947).
53. Bishop, J. A., *J. Phys. Chem.* **50**, 6 (1946).
- 53a. Heymann, E., and O'Donnell, I. J., *J. Colloid Sci.* **3**, 479 (1948).
54. Sussman, S., Nachod, F. C., and Wood, W., *Ind. Eng. Chem.* **37**, 618 (1945).

The Kinetics of Fixed-Bed Ion Exchange

HENRY C. THOMAS

*Sterling Chemistry Laboratory, Yale University, New Haven, Connecticut**

	<i>Page</i>
I. The Equations of Conservation	30
II. Rate Laws for Exchange Processes	31
III. Column Performance with Linear Kinetics	34
IV. Interpretation of the Rate Constants	37
V. Experimental Investigations	38
Appendix	40
1. The Laplace Transform	40
2. Formulas for Numerical Computation	42
Bibliography	43

In the following pages will be developed some of the quantitative aspects of the considerations which must be taken into account when an ion exchange column is run under nonequilibrium conditions. For two reasons the treatment of this chapter is incomplete. In the first place the variety of solid substances capable of exchanging ions with a solution is very great, as are the conditions under which such exchanges may be carried out. It seems to this writer that in spite of the considerable amount of excellent experimental work which has been done on the kinetic phenomena involved we have not yet arrived at the time when reliable statements can be made as to the mechanism of the processes involved for a given exchanger. Unfortunately, in the second place, there is a serious gap in the development of the theory. Diffusion in the solid particle of the exchanger has been discussed only for very special cases. Until this complicated problem has been given adequate treatment, especially for deep beds of exchangers, the theory of the subject cannot be said to be even nearly complete. We will content ourselves here with general statements of the problems involved and with a detailed treatment of a single problem which is an important limiting case for possible mechanisms of the exchange process.

* On leave, present address Brookhaven National Laboratory, Upton, L. I., N. Y.

I. THE EQUATIONS OF CONSERVATION

The requirement of mass conservation forms the best starting point for a discussion of the exchange of matter between a solution and an adsorbent. In the problems of interest here the exchanging phases are in relative motion. Since we will be dealing with kinetic phenomena, the velocity of this motion must be taken explicitly into account. We will, however, confine ourselves to the treatment of flow processes at constant rates of flow, in uniformly packed columns of uniform diameter. Variables convenient for the discussion may be defined as follows:

- x = the distance from the input end of the column measured in units of mass of exchanger contained therein.
 \dot{v} = the volume rate of flow of the fluid in the column.
 t = time, measured from the start of the exchange process at the input of the column.
 c_i = the concentration in solution of the ionic species of kind i involved in exchange, measured in equivalents per unit volume.
 q_i = the concentration in the solid of species i , measured in equivalents per unit mass of exchanger.
 α = pore volume of the solid under the conditions of the process, measured in volume per unit mass of exchanger.

For purposes of simplification we must idealize the real process to some extent. Complications due to swelling of the exchanger will not be taken into account; we will thus consider α to be constant. In addition we will not consider any change with time of mass of the adsorber; that is, x and t are to be independent variables. Under these limitations the conservation condition can be written as follows:

$$c_i v \delta t = \left(c_i + \frac{\partial c_i}{\partial x} dx \right) \dot{v} \delta t + \alpha dx \frac{\partial c_i}{\partial t} \delta t + dx \frac{\partial q_i}{\partial t} \delta t$$

or

$$\frac{\partial c_i}{\partial x} + \frac{\alpha}{v} \frac{\partial c_i}{\partial t} + \frac{1}{v} \frac{\partial q_i}{\partial t} = 0 \quad (1)$$

Somewhat more natural variables for the description of the process are those indicated by the obvious physical consideration that the status of the exchange process at a point in the column will depend on the total mass of exchanger over which the solution has passed and on the volume of solution which has passed beyond this point. Thus we select for our variables:

- $x = x$, the mass of exchanger upstream.
 $y = \dot{v}t - \alpha x$, the volume of solution downstream.

In terms of x and y the fundamental conservation condition (1) becomes

$$\frac{\partial c_i}{\partial x} + \frac{\partial q_i}{\partial y} = 0 \quad (2)$$

This equation is the necessary and sufficient condition for the existence of a function F_i specified by

$$dF_i = q_i dx - c_i dy \quad (3)$$

in which dF_i is a perfect differential. If the integration

$$F_i = \int_{x=0}^{x,y} (q_i dx - c_i dy)$$

can be extended to a point (x, y) beyond which both c_i and q_i remain zero, then F_i is the total amount of species i in the column.

In terms of F_i the relations for the calculation of the concentrations are

$$\left. \begin{aligned} c_i &= - \frac{\partial F_i}{\partial y} \\ q_i &= \frac{\partial F_i}{\partial x} \end{aligned} \right\} \quad (4)$$

As will be seen, these expressions afford an expeditious means of setting up a differential equation descriptive of the rate process for one general class of rate laws.

II. RATE LAWS FOR EXCHANGE PROCESSES

It has been fairly conclusively shown (Bauman and Eichhorn, 1 Boyd *et al.*, 2) that one must consider at least two types of mechanism for the exchange processes between a solution of an electrolyte and a solid ion-exchanger. It appears probable that the rate determining mechanism will depend at least in part on the conditions of the experiment. No attempt will be made here to delimit the region of applicability of these rate laws. More critical experimental work will be necessary before generally useful statements can be made in this connection.

If the rate law in question is explicit in the concentrations only, we may immediately write down the general form of the differential equation for the process. Suppose, then, that

$$\frac{\partial q_i}{\partial t} = R(c_i, q_i) \quad (5)$$

Since under our restriction to constant flow rate we have $\partial/\partial t = v(\partial/\partial y)$, this differential equation is

$$v \frac{\partial^2 F_i}{\partial x \partial y} = R \left(-\frac{\partial F_i}{\partial y}, \frac{\partial F_i}{\partial x} \right) \quad (6)$$

The form of the function R , as specified by the rate law under consideration, immediately determines the equation for the flow process. It is apparent that the generally complex overall rate laws of chemical kinetics will lead to nonlinear partial differential equations and thus to difficult mathematical problems. However, for the two simplest of such concentration dependent rate laws complete solutions can be given for the most important case of column performance.

Let us suppose that a cationic exchange process is determined by the rates of opposing second order reactions (Thomas, 3; Walter, 4; Sillen and Ekedahl, 5), so that we may write

$$\frac{\partial q_i}{\partial t} = k_1(a - q_i)c_i - k_2q_i(c_0 - c_i) \quad (7)$$

Here a is the ultimate capacity of the exchanger and c_0 the anion concentration of the solution. (The case for opposing second order and first order reactions has also been treated (Thomas, 6).) This rate law leads at once to a quasi-linear differential equation, which by an appropriate substitution of dependent variable can be reduced to tractable form (Thomas, 3). It has not been shown that the results for rate law (7) are of practical value. The simpler case which corresponds to small extent of reaction has been applied in numerous cases and is of considerable utility. The rate law for $q_i \ll a$ and $c_i \ll c_0$ is

$$\begin{aligned} \frac{\partial q_i}{\partial t} &= k_1ac_i - k_2c_0q_i \\ &= \kappa_1c_i - \kappa_2q_i \end{aligned} \quad (8)$$

with

$$\kappa_1 = k_1a \quad \text{and} \quad \kappa_2 = k_2c_0.$$

It has become apparent that under many conditions an important factor in the rate processes of ion exchange is diffusion through the interior of the solid particle of the exchanger. We are led here to a more complex mathematical problem. It does not appear that this problem has been solved for the case of a deep bed of ion-exchanger, although a similar problem in heat conduction has received complete treatment (Lowan, 7). We must consider concentration gradients in the solid particle itself. This distribution in the particle is determined by an appropriate solution of the equation of diffusion. Thus the rate of the exchange process, which in

any case is the net flow across the boundary of the particle, will depend explicitly on the time during which the process has been taking place. These considerations lead to a functional equation more complex than (6), namely to a differentio-integral equation. We will examine here only a limiting case of this problem: namely, that case for which the internal diffusion constant of the solid is sufficiently high so that no significant concentration gradients exist. We are in effect making the rate-determining process the transport of the ion through the liquid film surrounding the particle. For simplicity let us consider the particles as homogeneous spheres, all of radius r_0 , small compared to the length of the column over which a significant change in solution concentration occurs, and exposed uniformly on all sides to the solution. In general, if c_s is the internal concentration of adsorbed material per unit mass of adsorber,

$$\frac{\partial c_s}{\partial t} = D_s \nabla^2 c_s$$

and

$$q(x, t) = \int_0^{r_0} \frac{3}{r^3} c_s(r, x, t) r^2 dr$$

and also

$$\frac{\partial q}{\partial t} = \frac{3}{r_0} D_s \left[\frac{\partial c_s}{\partial r} \right]_{r=r_0}$$

The simplest reasonable assumption we can make as to transport through the boundary film gives us

$$D_s \left[\frac{\partial c_s}{\partial r} \right]_{r=r_0} = h(kc - c_s)$$

so that

$$\frac{\partial q}{\partial t} = \frac{3h}{r_0} \left\{ kc - c_s(r_0, t) \right\}$$

Here h will depend on film thickness and on the diffusion constant in the solution. Now in the special case where c_s does not depend on r (i.e., for D_s very large) the rate equation immediately becomes

$$\begin{aligned} \frac{\partial q}{\partial t} &= \frac{3h}{r_0} (kc - q) \\ &= \kappa_1 c - \kappa_2 q \end{aligned}$$

with

$$\kappa_1 = 3hk/r_0 \quad \text{and} \quad \kappa_2 = 3h/r_0.$$

We again have a rate law linear in the concentrations. Here, however, an entirely different interpretation is to be assigned to the constants κ_1 and κ_2

than is given to them in the case of chemical kinetics. In the next section the consequences of this rate law will be developed in detail for the case of greatest interest. For brevity we will refer to this limiting rate equation as the equation for *linear* kinetics.

III. COLUMN PERFORMANCE WITH LINEAR KINETICS

The fundamental differential equation for the performance of a column of ion-exchanger in which the rate law has the form (8) is

$$\frac{\partial^2 F}{\partial x \partial y} + A \frac{\partial F}{\partial x} + B \frac{\partial F}{\partial y} = 0 \quad (9)$$

where $A = \kappa_2/v$ and $B = \kappa_1/v$

If we make the simplifying substitution

$$F(x, y) = e^{-(Bx+Ay)} \Psi(x, y) \quad (10)$$

equation (9) becomes

$$\frac{\partial^2 \Psi}{\partial x \partial y} = AB\Psi \quad (11)$$

We must obtain solutions of this equation which reduce to the initial and boundary conditions specified by the particular process of interest. We will consider only those conditions which correspond to a column fed with solution of fixed concentration, the column initially containing a uniform concentration of exchangeable ion. In particular, suppose that the column initially contains ion 1 in equilibrium with solution concentration c_{10} , i.e.,

$$q_{10} = \frac{\kappa_1}{\kappa_2} c_{10} \quad (12)$$

Let c_{10} be sufficiently high so that q_{10} is nearly the ultimate capacity of the exchange material. If now we pass into the column a solution of ion 2 at concentration c_{20} , we will have at all stages of the process

$$\left. \begin{aligned} q_1 + q_2 &= q_{10} \\ c_1 + c_2 &= c_{20} \end{aligned} \right\} \quad (13)$$

These expressions merely give the stoichiometry of the process, it being understood that all concentrations are expressed in equivalents. The initial and boundary conditions are given by

$$\left. \begin{aligned} x = 0, \quad y \geq 0, \quad c_2 = c_{20} \\ x \geq 0, \quad y = 0, \quad q_2 = 0 \end{aligned} \right\} \quad (14)$$

The saturation of the column with ion species 2 corresponds to the elution of ion species 1; we need discuss only one such process to obtain the entire picture and may therefore drop the subscripts in the following argument.

The solution of (11) under boundary conditions (14) may be found by means of the method of the Laplace transform. This method is one of great power and of wide applicability. Some of the detail of the calculation is given in Appendix 1. Here we will merely outline the principal steps. From (4) and (10) we get the following formulas for the concentrations in terms of Ψ

$$\left. \begin{aligned} c &= e^{-(Bx+Ay)} \left(A\Psi - \frac{\partial\Psi}{\partial y} \right) \\ q &= -e^{-(Bx+Ay)} \left(B\Psi - \frac{\partial\Psi}{\partial x} \right) \end{aligned} \right\} \quad (15)$$

The introduction of the boundary conditions (14) gives two ordinary differential equations which are readily solved for the boundary values of Ψ :

$$\left. \begin{aligned} \Psi(x, 0) &= e^{Bx} \\ \Psi(0, y) &= (1 - c_0y)e^{Ay} \end{aligned} \right\} \quad (16)$$

The method of the Laplace transform applied to (11) will now produce for us a solution subject to the conditions (16). This solution is therefore unique. By means of (15) we immediately find the following formulas for c and q :

$$\left. \begin{aligned} \frac{c}{c_0} &= e^{-(Bx+Ay)} \left\{ I_0(2\sqrt{ABxy}) + \varphi(Ay, Bx) \right\} \\ \frac{q}{q_0} &= e^{-(Bx+Ay)} \varphi(Ay, Bx) \end{aligned} \right\} \quad (17)$$

$I_0(2\sqrt{ABxy})$ is the zeroth order Bessel function for imaginary argument, and $\varphi(Ay, Bx)$ is essentially a definite integral, some of the properties of which are also given in Appendix 1. The formulas (17) give the familiar *S*-shaped break-through curves for the effluent of a column.

The numerical computation of the functions involved in (17) is greatly facilitated by the use of an asymptotic formula for φ due to Professor Lars Onsager. This formula is given in Appendix 2 where the asymptotic expansions of other functions necessary in the calculations are also reproduced. Fortunately, in many cases these asymptotic formulas suffice for the computations involved in column performance. For moderately long columns (x large) after sufficient solution has passed so that the column is nearly saturated (y large) both arguments of the integral φ will usually be large enough so that a simple limiting form of the Onsager expansion together with a table of the error integral will give all the accuracy required. For values of the arguments where the computation of φ is difficult there exists an unpublished table due to Dr. S. R. Brinkley, Jr.,

and R. Z. Brinkley. It is hoped that this table will soon be put into easily usable form and made generally available.

On noting that the arguments of all the functions involved in (17) vary inversely as the flow rate, it is immediately apparent that the performance of any column working sufficiently slowly will be described by the limiting formulas for large values of the variables. If we look for the condition of break-through for a column at near equilibrium performance, we find it in the relations

$$\kappa_1 c \simeq \kappa_2 q$$

and

$$cy \simeq qx$$

whence

$$\kappa_1 x \simeq \kappa_2 y$$

or

$$Bx \simeq Ay$$

For sufficiently low flow rate immediately before the break-through point and immediately thereafter not only will the argument of the Bessel functions in the Onsager formula be large but so also will that of the error integral. At the break-through point the argument of the error integral vanishes. We have then the following simple formulas for the break-through curve of such a column:

(a) $Ay < Bx$, column not saturated

$$\frac{c}{c_0} \simeq \frac{1}{2\sqrt{\pi}} e^{-(\sqrt{Bx}-\sqrt{Ay})^2} \frac{\left(\frac{Bx}{Ay}\right)^{1/4}}{\sqrt{Bx} - \sqrt{Ay}}$$

(b) $Ay = Bx$, column just saturated under equilibrium conditions

$$\frac{c}{c_0} \simeq \frac{1}{2} + \frac{1}{4\sqrt{\pi}} \frac{\sqrt{v}}{(\kappa_1 \kappa_2 xy)^{1/4}}$$

(c) $Ay > Bx$, column working beyond the break-through point.

$$\frac{c}{c_0} \simeq 1 - \frac{1}{2\sqrt{\pi}} e^{-(\sqrt{Ay}-\sqrt{Bx})^2} \frac{\left(\frac{Bx}{Ay}\right)^{1/4}}{\sqrt{Ay} - \sqrt{Bx}}$$

These expressions give the form of the sharp exponential increase in concentration as the column becomes saturated. In the limit of equilibrium performance this exponential increase in concentration will be indistinguishable from the discontinuous increase of the equilibrium theory.

In the application to performance data one must usually find the constants κ_1 and κ_2 by some cut-and-try procedure. A starting point in

such a computation may be found as follows: if we differentiate the expression for c/c_0 with respect to y and evaluate the slope for $Bx = Ay$, i.e., for $c/c_0 \simeq 1/2$, for sufficiently large $ABxy$ we find the following simple algebraic formula:

Slope at mid-point of break-through curve

$$\simeq \frac{1}{2\sqrt{\pi}} \cdot \frac{1}{y} \left\{ \sqrt{Ay} - \frac{1}{4\sqrt{Ay}} \right\}$$

Thus we have a means for finding κ_2 from the slope of an experimental curve. A knowledge of the equilibrium constant will then give an estimate for κ_1 ; we have a starting point for a curve fitting program.

IV. INTERPRETATION OF THE RATE CONSTANTS

For chemical kinetics the definitions of the constants in the equations for column performance are

$$A = \frac{\kappa_2}{v} = \frac{k_2 c_0}{v}$$

$$B = \frac{\kappa_1}{v} = \frac{k_1 a}{v}$$

The theory for this case thus explicitly predicts the effects of initial solution concentration and of the capacity of the exchanger. For such a rate law the performance of the column should be independent of particle size. The particles must, of course, be sufficiently small so that no concentration gradients due to diffusion can be set up in the solution; or else the flow must be sufficiently turbulent to accomplish the same end. Since, for such purely chemical kinetics no dependence of k_1 and k_2 on flow rate is to be expected, this form of the theory makes an exact prediction of the effect of flow rate. A study of this point could give almost immediate information which might rule out such a mechanism.

If the rate of the transfer of the ion from solution to solid is determined by the rate of the diffusion of the ion through a film of solution surrounding the particle, the rate law is (Boyd *et al.*, 2)

$$\frac{\partial q}{\partial t} = \frac{3D_i}{r_0 \Delta r_0 k} (kc - q)$$

Here the constant $h = D_i/\Delta r_0 k$ has been calculated for spherical particles on the supposition of a linear concentration gradient in the film of solution. One also supposes instantaneous equilibrium between the solid particle and the solution in immediate contact with it. D_i is the diffusion

constant for the ion in solution, Δr_0 , the thickness of the film, and k , the distribution coefficient. For this case, then,

$$A = \frac{\kappa_2}{v} = \frac{1}{v} \frac{3 D_l}{r_0 \Delta r_0 k}$$

$$B = \frac{\kappa_1}{v} = \frac{1}{v} \frac{3 D_l}{r_0 \Delta r_0}$$

We now expect an entirely different behavior of the constants. Decrease in the particle size will cause a proportionate increase in A and B . Other conditions remaining the same, this will give the effect of a more rapid approach to equilibrium. Stated in terms of column performance; the smaller the particle size for a given flow rate, the steeper the break-through curve. The dependence on flow velocity will also be different. The film thickness, Δr_0 , can be expected to be about inversely proportional to the 0.7 power of the flow rate. A and B will then be about inversely proportional to the 0.3 power of v , much less strongly dependent on velocity than in the case of chemical kinetics.

It is apparent that many factors enter to determine the nonequilibrium behavior of an ion-exchange column. Some of these variables produce very similar effects on performance. Before this variety of effects can be properly interpreted one must have a clear idea of the fundamental rate controlling processes involved. Several experimental investigations have been made with the object of determining the nature of these processes. In the following section some of this work will be briefly described. No attempt will be made to evaluate these results; nor is the survey intended to be exhaustive. As has already been suggested, the phenomena involved are really quite complex; it is apparent that many of the results can be interpreted by more than a single mechanism.

V. EXPERIMENTAL INVESTIGATIONS

In the investigations of the fundamental kinetics of the exchange processes the experiments have usually been designed to avoid the mathematical complexity introduced by the superimposed flow process. Experiments have been carried out in a thermostated vessel with rapid stirring, samples for analysis being withdrawn at intervals. Thin beds of solid exchanger have been used with the flow technique. Further refinement of this procedure is made possible by the application of radioactive tracers isotopic with the exchanging ion. Thus the advantages of the flow process, which makes possible the study of the reaction at short contact times, is combined with the simplification introduced by keeping the solution concentration constant.

One of the earliest studies of the rate processes is that of Nachod and Wood (8). These workers measured rates of cation exchange for six types of exchangers: three synthetic resins, a greensand type, sulfonated coal, and a synthetic siliceous gel. They also studied anion exchange on two synthetic resins. The rates of replacement of hydrogen by calcium, calcium by hydrogen, and of sodium by calcium were measured, as was the rate of the anion exchange between resin and solutions of hydrochloric acid. All of these results were adequately interpreted in the concentration range 0.02–0.05 N by a second-order chemical rate law. The rate of anion exchange was found to be much smaller than that for cation exchange.

Another investigation with very similar results has been reported by Juda and Carron (9). The hydrogen-sodium exchange on four carbonaceous exchangers followed reasonably well a second order law taking into account the reverse reaction. Velocity constants were found to depend somewhat on the ionic strength of the solution. Solution concentrations studied were between 0.001 N and 0.02 N .

A comprehensive study of anion exchange has been carried out by Kunin and Myers (10). Four synthetic resin anion exchangers were investigated under a wide variety of conditions. Not only was the effect of concentration and anion species studied, but also the effects of particle size, added salts, temperature, degree of completion of the process, stirring rate, and state of hydration of the particles. Most of the results are quite well interpreted by the assumption that the slow step in the adsorption process is diffusion through the gel structure of the resin. The activation energy of the adsorption of hydrochloric acid was found to be 6.6 kcal., about equal to that for the diffusion of this electrolyte in water. Rates of adsorption of hydrochloric acid from sodium chloride solution were found to be greater than the rate from water solution. This effect is quantitatively accounted for by the increase in the coefficient of diffusion with increase in ionic strength of the solution.

The shallow bed technique using radioactive tracers as analytical means has been applied by Boyd *et al.* (2) in a study of cationic exchange. They conclude that two mechanisms are of importance: at concentrations above 0.1 M in total electrolyte the rate controlling process appears to be diffusion through the gel structure; below 0.003 M the results are accounted for by diffusion through a liquid film surrounding the particle. Essentially the same conclusions result from the work of Bauman and Eichhorn (1). These authors state, however, that a concentration product law is controlling at low concentrations.

The equations for the flow process in deep beds of exchangers for the limiting case of linear kinetics have been applied by several workers (11, 12, 6). The results are perhaps as satisfactory as could be expected when

one considers the approximations and limitations involved in the derivation and application of the equations. As in many another chemical problem the art is here more advanced than the theory. The theory does have a place, however, not only as a guide for future intelligent experimentation, but also as a means for the correlation of present data.

APPENDIX

1. The Laplace Transform

In the application of the method of the Laplace transform to the solution of differential equations the essential difficulty of the problem is placed on the evaluation of an integral in the plane of a complex variable. The powerful methods of integration depending on Cauchy's theorem can thus be applied to the problem. Problems of the type considered in this chapter depend on the evaluation of integrals along a path surrounding an essential singularity of an exponential function. It is convenient to base the discussion on the following integral:

$$\Phi(u, v) = \frac{1}{2\pi i} \int_{\sigma-i\infty}^{\sigma+i\infty} \frac{e^{uz + \frac{v}{z}}}{z - \alpha} dz, \quad \begin{array}{l} z = \sigma + i\tau \\ \alpha \text{ real} \\ \sigma > \alpha \end{array}$$

The infinite path of integration parallel to the imaginary axis can be closed along an infinite circuit in the left half plane. The integrand has singularities only at the origin and at $z = \alpha$, hence the integral may be computed as follows:

$$\begin{aligned} \Phi(u, v) &= \frac{1}{2\pi i} \sum_{m, n, k} \frac{u^m v^n}{m! n!} \alpha^k \int_{-\infty}^{0+} z^{m-n-k-1} dz, \quad m, n, k = 0, 1, 2, \dots \\ &= \begin{cases} 0, & k \neq m - n \\ \sum_{m, n=0}^{\infty} \frac{(\alpha u)^m (v/\alpha)^n}{m! n!}, & k = m - n \end{cases} \\ &= I_0(2\sqrt{uv}) + \varphi\left(\alpha u, \frac{v}{\alpha}\right) \end{aligned}$$

in which $I_0(2\sqrt{uv})$ is the zeroth order Bessel function for purely imaginary argument and φ is the integral

$$\varphi\left(\alpha u, \frac{v}{\alpha}\right) = \sum_{m > n \geq 0}^{\infty} \frac{(\alpha u)^m (v/\alpha)^n}{m! n!} = e^{\alpha u} \int_0^{\alpha u} e^{-t} I_0\left(2\sqrt{\frac{v}{\alpha}t}\right) dt$$

The integral φ crops up so frequently in flow problems of the character here discussed that it will be worthwhile to summarize some of its more important properties. The following formulas may be verified by series expansion or otherwise.

$$\begin{aligned} \varphi(u, v) + \varphi(v, u) &= e^{u+v} - I_0(2\sqrt{uv}) \\ \frac{\partial \varphi(u, v)}{\partial u} &= \varphi(u, v) + I_0(2\sqrt{uv}) \\ \frac{\partial \varphi(u, v)}{\partial v} &= \varphi(u, v) - \frac{\partial}{\partial v} I_0(2\sqrt{uv}) \\ \varphi(0, v) &= 0 \\ \varphi(u, 0) &= e^u - 1 \\ \lim_{u \rightarrow \infty} e^{-(u+v)} \varphi(u, v) &= 1 \end{aligned}$$

In the problem for linear kinetics a slightly more complex integral appears. It may be evaluated by entirely similar means:

$$\frac{1}{2\pi i} \int_{\sigma-i}^{\sigma+i\infty} \frac{e^{uz + \frac{v}{z}}}{(z - \alpha)^2} dz = \frac{1}{\alpha} \left\{ u \frac{\partial}{\partial u} - v \frac{\partial}{\partial v} \right\} \varphi(\alpha u, v/\alpha)$$

The application of the Laplace transform to the solution of the equation

$$\frac{\partial^2 \Psi}{\partial x \partial y} = AB\Psi$$

for the boundary conditions specified in (16) is now entirely straightforward. The method and a theorem of ample generality are given by Courant and Hilbert (13). The transform of Ψ is defined by

$$w(x, z) = z \int_0^\infty \Psi(x, y) e^{-zy} dy$$

The determination of w is reduced to the integration of an ordinary differential equation. The boundary conditions are necessary in the integration of this equation and in the determination of the transform of $\frac{\partial \Psi}{\partial x}$. One finds eventually

$$w(x, z) = \frac{z}{z - A} e^{Bx} - \frac{zC_0}{(z - A)^2} e^{\frac{ABx}{z}}$$

By means of the inverse transform Ψ is represented by complex integrals

$$\Psi(x, y) = \frac{1}{2\pi i} \int_{\sigma-i\infty}^{\sigma+i\infty} \frac{w(x, z)}{z} e^{zy} dz$$

so that

$$\Psi(x, y) = e^{Bx+Ay} - \frac{c_0}{A} \left\{ y \frac{\partial}{\partial y} - x \frac{\partial}{\partial x} \right\} \varphi(Ay, Bx)$$

2. Formulas for Numerical Computation

The computation of the integral $\varphi(u, v)$ for large values of the arguments is made practicable by the following asymptotic expansion due to Prof. Lars Onsager:

$$\begin{aligned} \varphi(u, v) = & \frac{1}{2} \{1 - H(\sqrt{v} - \sqrt{u})\} e^{u+v} - \frac{r}{1+r} I_0 \\ & + \frac{1}{2} \left(\frac{1-r}{1+r} \right) [g \{2 I_0 - (I_{\frac{1}{2}} + I_{-\frac{1}{2}})\} \\ & + g^2 \{6 I_0 - 4(I_{\frac{1}{2}} + I_{-\frac{1}{2}}) + 2 I_1\} \\ & + g^3 \{20 I_0 - 15(I_{\frac{1}{2}} + I_{-\frac{1}{2}}) + 12 I_1 - (I_{\frac{3}{2}} + I_{-\frac{3}{2}})\} \\ & + g^4 \{70 I_0 - 56(I_{\frac{1}{2}} + I_{-\frac{1}{2}}) + 56 I_1 - 8(I_{\frac{3}{2}} + I_{-\frac{3}{2}}) + 2 I_2\}] \\ & + (1-r^2)R_5 \end{aligned}$$

$$r = (u/v)^{\frac{1}{4}} \quad g = r/(1+r)^2$$

$$I_n = I_n(2\sqrt{uv}) \quad H(Z) = \frac{2}{\sqrt{\pi}} \int_0^Z e^{-t^2} dt$$

R_5 , a small remainder term.

In many applications quite large values of u and v must be handled. For such cases a great simplification of this formula may be satisfactory. The leading terms of the asymptotic expansions of all the Bessel functions in the formula for φ are identical:

$$I_n(Z) \sim \frac{e^Z}{(2\pi Z)^{\frac{1}{2}}} \left[1 + \dots \right]$$

For values of $Z = 2\sqrt{ABxy}$ sufficiently large we may drop all but the leading terms in the expansions of the I_n . The expression for $\varphi(u, v)$ then reduces to its first two terms, so that

$$\frac{c}{c_0} = \frac{1}{2} \{1 - H(\sqrt{v} - \sqrt{u})\} + \frac{1}{1+r} I_0 e^{-(u+v)}$$

Here $I_0 \simeq e^Z / (2 \pi Z)^{1/2}$; the values of the error integral are obtained from one of the extensive tables of this function which are available.

For large values of the argument, $H(x)$ may be computed from the asymptotic expansion:

$$1 - H(x) \sim \frac{2}{\sqrt{\pi}} \frac{e^{-x^2}}{2x} \left[1 - \frac{1}{2x^2} + \frac{1 \cdot 3}{(2x^2)^2} - \frac{1 \cdot 3 \cdot 5}{(2x^2)^3} + \dots \right]$$

It is the leading term of this expression which has been used in obtaining the formulas for the limiting performance of a column at low flow rates.

BIBLIOGRAPHY

1. Bauman, W. C., and Eichhorn, J., *J. Am. Chem. Soc.* **69**, 2830 (1947).
2. Boyd, G. E., Adamson, A. W., and Myers, L. S., Jr., *J. Am. Chem. Soc.* **69**, 2836 (1947).
3. Thomas, H. C., *J. Am. Chem. Soc.* **66**, 1664 (1944).
4. Walter, J. E. *J. Chem. Phys.* **13**, 332 (1945).
5. Sillen, L. G., and Ekedahl, E., *Arkiv Kemi Mineral. Geol.* **22A** (16), 1 (1946).
6. Thomas, H. C., *Ann. N. Y. Acad. Sci.* **49**, 161 (1948).
7. Lowan, A. N., *Phil. Mag.* [7] **17**, 914 (1934).
8. Nachod, F. C., and Wood, W., *J. Am. Chem. Soc.* **66**, 1380 (1944).
9. Juda, W., and Carron, M., *J. Am. Chem. Soc.*, **70**, 3295 (1948).
10. Kunin, R., and Myers, R. J., *J. Phys. Coll. Chem.* **51**, 1111 (1947).
11. Beaton, R. H., and Furnas, C. C., *Ind. Eng. Chem.* **33**, 1501 (1941).
12. Boyd, G. E., Myers, L. S., Jr., and Adamson A. W., *J. Am. Chem. Soc.* **69**, 2849 (1947).
13. Courant, R., and Hilbert, D., *Methoden der Mathematischen Physik*. Interscience Publishers, Inc., New York (1937), Vol. II, pp. 202-222.

Fundamental Properties of Ion Exchange Resins

W. C. BAUMAN

The Dow Chemical Company, Midland, Michigan

	Page
I. Cation Exchange Resins	45
1. Introduction	45
2. Structure of Ion Exchange Resins	46
3. Synthesis of a Cation Exchange Resin	48
4. Swelling of Cation Exchange Resins	50
5. Donnan Equilibrium in Cation Exchangers	52
6. Exchange Equilibria in Cation Exchangers	54
7. Exchange Rates in Cation Exchange	58
8. Cation Exchange Resins with Weakly Acidic Groups	61
II Anion Exchange Resins	62
1. Introduction	62
2. Synthesis of a Typical Anion Exchange Resin	63
3. Absorption or Exchange in Anion Exchange Resins	64
4. Swelling of Anion Exchange Resins	67
5. Donnan Effect in Anion Exchange Resins	68
6. Acid Absorption by Anion Exchange Resins	68
7. Anion Exchange Equilibrium	71
8. Exchange Rate of Anion Exchange Resins	73
Bibliography	74

I. CATION EXCHANGE RESINS

1. Introduction

The pioneering work of Adams and Holmes (1) in the synthesis of organic exchange resins and their discussion of the new possibilities of ionic separations by these materials has presented a new unit process to the chemical engineer. The gradual improvement in the exchange capacity and stability of the exchange resins during the last decade has vastly extended the utility of this new tool. This resin development still continues at a rapid pace, so that one may well anticipate that in the near future cation and anion exchange resins can be synthesized with any desired ionic group and with years' stability at all pH values and temperatures up to 100° C. or more. The breadth of application of ion exchange methods is now limited more by economic competition with other unit

processes (evaporation, crystallization, distillation, etc.) than by the deficiencies of the resins. A fundamental knowledge of the chemical structure and behavior of these ion exchange resins is necessary to estimate their value in any new ionic process. The following discussion is devoted to the clarification of this chemical character.

2. Structure of Ion Exchange Resins

The first requisite for an ion exchange resin is complete insolubility in water, alcohol, glycol, or other solvent in the ion exchange process. When one remembers that the resin is expected to serve for a period of 25–50 years in constant contact with solvent and with no loss in weight and no physical or chemical degradation, it becomes clear how severe this insolubility limit is. For example, one normally considers calcium carbonate to be quite insoluble in water, but a bed of calcium carbonate granules would completely dissolve in about one year if operated at the normal exchange rate of 2 gallons/cubic foot/minute. This insolubility is achieved by cross-linking the resin skeleton into one vast molecular network, comparable to that in a thermosetting plastic. The thermosetting plastics are characterized by their insolubility in all solvents and their stability to heat. These are exactly the properties desired in an exchange resin, and hence, the common thermosetting resins such as phenolformaldehyde, melamine formaldehyde, urea formaldehyde, etc. have formed the basis for the early exchange resins. Most of the physical properties of the exchange resin and frequently its chemical stability will depend upon the nature of this cross-linked skeleton. The extent of swelling in a solvent, for example, will be controlled by the tightness of the meshes of the network. A resin with a cross-link for each hundred atoms in the chains will swell perhaps tenfold from the dry to the wet stage, while a resin with a cross-link for each ten atoms in the chains may swell but 20% of its dry volume. The phenol-formaldehyde type exchange resins are unstable to alkaline oxidizing agents, and the urea-formaldehyde exchange resins will not stand strong acid conditions just as their plastic counterparts. This primary requirement of stability to hydrolysis at all pH values and at elevated temperatures makes many of the polymers in the plastic field undesirable from the standpoint of ion exchange manufacture. In fact, it reduces the field to two types of chain formers:

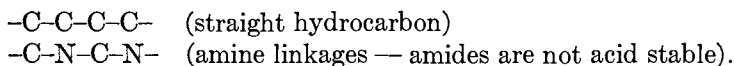

Of these two, the straight carbon chain generally shows the greater stability at elevated temperatures.

To this network skeleton it is merely necessary to affix ionic groups in

order to produce an exchange resin. Thus cation exchangers may be made with $-\text{SO}_3\text{H}$, $-\text{COOH}$, $-\text{OH}$, $-\text{SH}$, etc., and anion exchangers may be made with $-\text{NH}_2$, $-\text{NHR}$, $-\text{NR}_2$, etc. The type of ionic group will determine the ion exchange properties of the resultant resin. *In fact, the ionic character of the group is the same in the resin phase as it is in a simple organic compound.* Thus all sulfonic acid exchange resins are strongly acidic in comparison to carboxylic acid resins, just as phenol sulfonic acid is strong in comparison to salicylic acid; and all aromatic amine resins are weakly basic compared to aliphatic amine resins completely analogous to the weak basicity of aniline and the strong basicity of methylamine.

The selection of the desired type of active group will depend upon the application. No one type is the best for all applications. Thus the conversion of NaCl or Na_2SO_4 to HCl and H_2SO_4 , respectively, will require a strongly acidic resin containing $-\text{SO}_3\text{H}$. A $\text{NaCl}-\text{NaHCO}_3$ mixture is converted to $\text{NaCl}-\text{CO}_2$ most efficiently by a $-\text{COOH}$ resin while the removal of excess alkalinity from water without formation of corrosive acidic water can be accomplished best by a resin containing the phenolic $-\text{OH}$ group. Similarly, the removal of a trace of calcium from a strong sodium chloride solution is best accomplished by a carboxylic acid resin because of its high selectivity for calcium over sodium (2). *Hence, from the standpoint of the type of active group, there is no "best resin" — the selection depends upon the use.*

In general one would predict that the resin network should be loaded with as many active groups as possible in order to achieve maximum exchange capacity. This is true, except that the extent of swelling in water depends on this concentration of active groups as well as upon the extent of the cross-linking. All ion-active groups tend to solubilize the structure, while the cross-links prevent this dissolution. The result of these opposing forces is a limited swelling in water. The important exchange capacity unit is the concentration of active groups per unit volume of the swollen resin, since this is the form of the resin in any practical use. This exchange capacity is at a maximum with frequent cross-links and with high concentration of active groups along the chain. One compromise, however, is usually required. This progressive tightening of the structure to increase the exchange capacity also slows down the diffusion rate of ions through the resin particle, so that the ion exchange rate decreases as the ion exchange capacity increases. The point of maximum efficiency in this respect will depend upon the speed required by the process cycle, e.g., a slow speed will suffice for softening a water containing 3 grains calcium carbonate hardness per gallon, while a high speed would be needed in the removal of 6% salts from a sugar solution. Here also then there may arise a need for more than one type of resin, i.e., one slow speed, high

capacity resin and one high speed, low capacity resin. From a practical standpoint, however, a compromise is usually made by the manufacturer and only one resin is made available — the efficiency of exchange may then be varied by using different particle sizes, or different temperatures, or different flow rates and bed depths.

3. Synthesis of a Cation Exchange Resin

With this general background on the structure of ion exchange resins, let us look more closely into the synthesis of a specific cation exchange resin, a phenol-formaldehyde polymer containing nuclear sulfonic acid groups as described by Wassenegger and Jaeger (3). For simplicity it is assumed that this polymer is being formed by condensing *m*-phenolsulfonic acid,

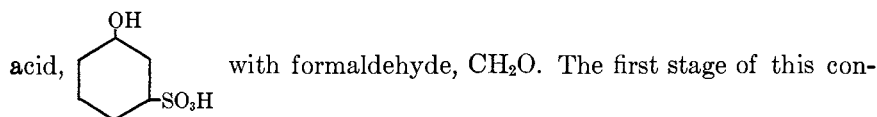

densation is the reaction of two molecules of phenolsulfonic acid with one molecule of formaldehyde with the elimination of water and the formation of a methylene ($-\text{CH}_2-$) bridge:

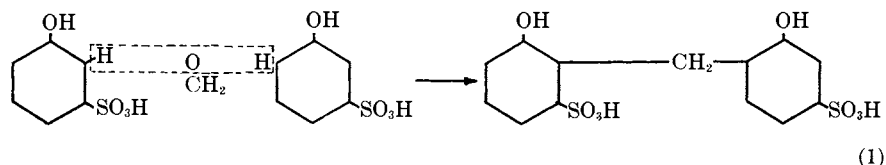

With more formaldehyde the condensation continues with the formation of the chain:

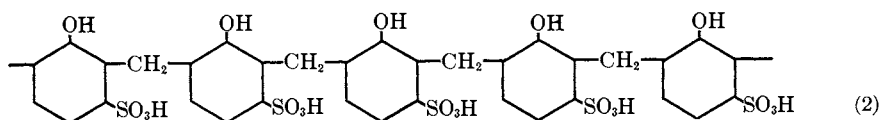

Such long chain compounds containing ionic groups, such as $-\text{SO}_3\text{H}$, $-\text{COOH}$, etc., are now being studied carefully by various investigators (4). In general they are still completely soluble in water. *And the ionic properties of the active groups remain almost identical with the monomer (phenol-sulfonic acid in this case).* The mean acidity remains exactly the same as in the monomer, but the buffering range is increased. The main effect of polymerization is to limit the mobility of the anionic $-\text{SO}_3^-$ groups by tying them together.

At about the proportion of one mole of CH_2O per mole of phenol-sulfonic acid a very significant change takes place. This is the proportion

of CH_2O required for the formation of one long straight chain (2). With more formaldehyde we begin to form methylene bridges between chains:

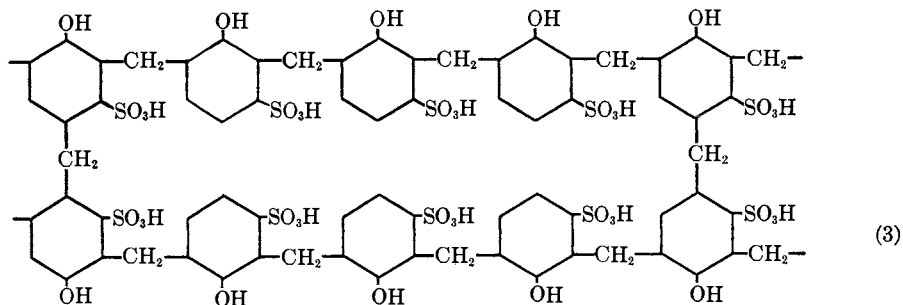

Physically a gelation of the mass sets in. The cross-linking has tied up the structure into one vast network. This immense particle may appear to be soluble in a limited quantity of water, but as more water is added, the meshes of the net become extended to their limit. Beyond this limit any additional water is present as a pure phase — thus forming a two-phase system. Here is the birth of an ion exchange resin.

The essential characteristic distinguishing the ion exchange resin is its insolubility, or limited swelling in water. *The resin phase, however, is essentially an ionic solution practically identical with the previous straight chain sulfonic acid.* The phenolic and sulfonic acid groups show the same ionic properties as in the monomer; e.g., the neutralization (in the presence of NaCl) shows the same range of pH as phenolsulfonic acid. The sulfonic acid group, being a strong acid, shows complete dissociation so that the hydrogen ions are free to diffuse through the resin phase exactly as in solution. The $-\text{SO}_3^-$ anions themselves are free to move with the network and to rotate and vibrate about the network, but their translational motion is limited by the immobility of the network as a whole. Thus the cross-linking has merely limited still further the mobility of the anionic $-\text{SO}_3^-$ groups.

The final exchange resin is formed by still further addition of formaldehyde with a progressive tightening of the network as more cross-links are formed. Physically the weak jelly becomes more and more firm, until finally it is a hard and tough particle containing as little as 30–50% water in the completely swollen state. This hardening is again a continuous process with no sign of crystallization at any point. *The exchange resin particle is essentially still the solution of phenolsulfonic acid in water with which we started* — our polymerization has merely tied the anions together into a single vast fish net.

This concept of a hard resin particle containing 50–70% solids as a “solution” of a high molecular weight sulfonic acid in water has troubled

many, who would prefer to think of the resin as a *two-phase* porous solid containing water in rigid channels. No such channels, however, can be seen in electron micrographs of resin particles. The water content of the particles can not be removed even in a high speed centrifuge. The resin particles swell and shrink continuously as they are wetted and redried. No crystallinity can be found in X-ray studies. All of these facts confirm the essential homogeneity of the resin phase.

In summary then, the essential features of a spherical cation exchange particle are shown in Figure 1. The skeleton network is shown by wavy lines, to which are affixed the $-\text{SO}_3^-$ (or other anionic) groups indicated merely by short dashes. The H^+ cations are then shown in the vicinity

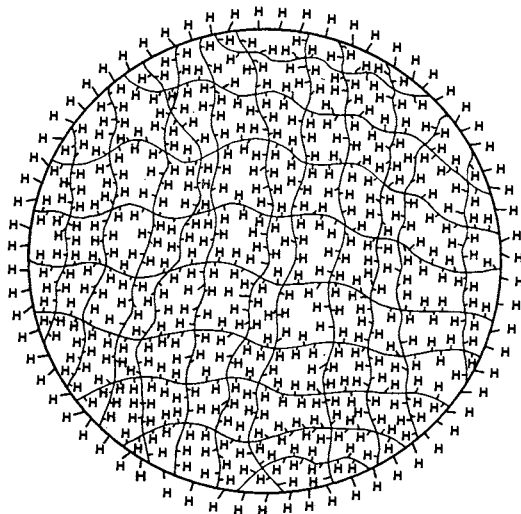

FIG. 1. Basic structure of Dowex 50.

of each anion. In a strong acid resin, such as a sulfonic acid resin, the H^+ cations are completely dissociated from the $-\text{SO}_3^-$ groups and wander freely within the particle, controlled only by the overall requirement of electrical neutrality. In a weak acid resin, such as a carboxylic acid resin, the majority of these H^+ cations will be associated with the $-\text{COO}^-$ anions.

4. Swelling of Cation Exchange Resins

Next let us consider the behavior of this spherical particle of a sulfonic acid exchange resin when placed in various solutions. The simplest case is the immersion in pure water. The water will diffuse into the particle and swell it to the maximum extension of the cross-linked network. The

hydrogen ions will tend to fly out from the surface of the particle into the pure water phase, but in doing so leave an excess of $-\text{SO}_3^-$ negative charges behind. This builds up an electrical double-layer at the surface of the sphere, with a negative charge on the resin side of the surface and a positive charge on the water side. Finely divided resins in the acid form, when stirred up in water, will record low pH on a glass electrode and will corrode iron surfaces rapidly. If, however, the stirring is stopped and the resin allowed to settle, the supernatant liquid will be neutral in pH and will not corrode iron. Hence, the hydrogen ions tend to migrate into the water phase, but are held within a short distance of the resin surface by electrical attraction.

The swelling of ion exchange resins in water and electrolyte solutions has not been studied sufficiently to present a unified theoretical and experimental picture. The general mode of attack on this problem has been outlined by Procter and Wilson (5) in their theory on the swelling of gelatin by HCl solutions. They have shown that the solvent swells the gel until the osmotic pressure difference between the inside and outside solutions is balanced by the elastic force of the extended gel network:

$$\pi_i - \pi_0 = CV \quad (4)$$

where π_i = osmotic pressure of the inside solution
 π_0 = osmotic pressure of the outside solution
 V = volume increase of the gel
 C = bulk modulus of elasticity of the gel network.

It will be noted that the elasticity was calculated simply on the basis of Hooke's law. This elastic force has been developed in more detail for cross-linked resins by Flory and Rehner (5a) to give the swelling of a non-ionic network in a solvent;

$$M_c = -\rho V_1 v_2^{3/2} \left[\frac{1}{2} K v_2^2 + \ln(1 - v_2) + v_2 \right] \quad (5)$$

where $1/v_2$ = ratio of swollen to initial volume of resin
 M_c = molecular weight of resin between points of cross-linkage
 ρ = density of dry resin
 V_1 = molar volume of the solvent
 K = constant whose value depends on the heat change during swelling.

The extension of the Flory-Rehner theory to the highly ionic networks of the ion exchange resins will apparently require the addition of entropy and heat terms comparable to the solution of a highly ionized electrolyte by water. Such a development would not only clarify the fundamental nature of the swelling of exchange resins in their various salt forms, but might also lead to a better understanding of exchange equilibria.

5. Donnan Equilibrium in Cation Exchangers

The next simplest case is the immersion of the acid resin particle in pure HCl solutions. Water again will diffuse into the resin particle, but its swelling force will depend on its activity in the HCl solutions. This

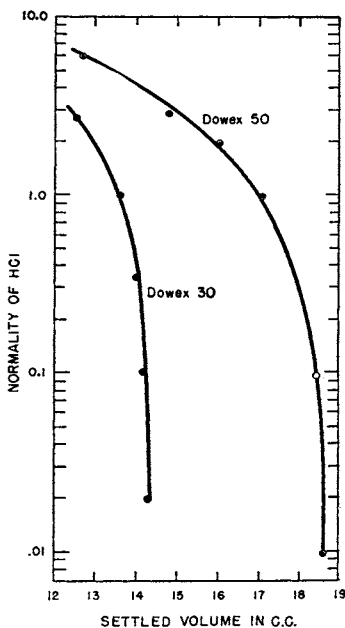

FIG. 2. Volume changes of 10 g. Dowex 30 and 50 in HCl solutions.

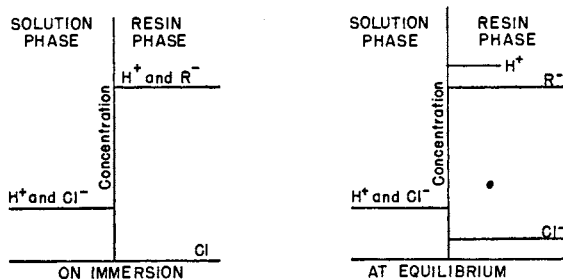

FIG. 3. Donnan effects in cation exchange resins.

activity is less at high concentrations of HCl, so that the swelling of the resin will decrease as the HCl concentration is increased. Experimental results are shown on two sulfonic acid resins, Dowex 30 and Dowex 50, in Fig. 2. The H^+ and Cl^- are also free to diffuse into the resin particle, but the same quantities of each must diffuse in order to maintain neutrality

of charge in both phases. Fig. 3 shows schematically the inside and outside concentrations upon immersion and at equilibrium. We note that the chloride ion has a high driving force to penetrate the particle, but that the hydrogen ion is already higher inside the particle than outside. This leads to the compromise shown in the equilibrium diagram, where the chloride is lower within the particle than in the outside solution (6). This problem is exactly that of two ionic solutions separated by a semipermeable membrane, one of which contains an anion that will not penetrate the membrane. This problem was first studied by Donnan and quite exhaustively by many investigators since (7). Donnan's solution for this case is

$$\frac{\text{Cl}_S^-}{\text{Cl}_R^-} = \sqrt{1 + \frac{R^-}{\text{Cl}_R^-}} \quad (6)$$

This theoretical curve is compared with experimental results on Dowex 30 and Dowex 50 in Fig. 4. The theory accounts for the results quite well at high concentrations, but the deviation is great at low concentrations. No reasonable explanation of this deviation has been found.

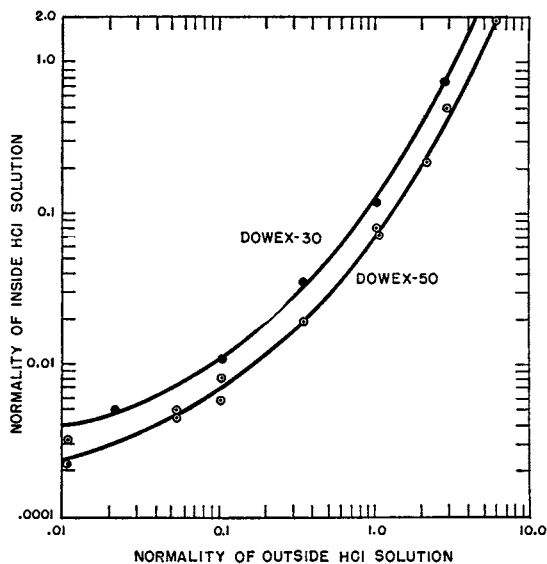

FIG. 4. HCl concentrations inside and outside of Dowex 30 and 50 (hydrogen form).

The rate of this diffusion of HCl in the hydrogen form of Dowex 50 and that of NaCl in the sodium form have been found to be 5.0×10^{-6} cm.²/sec. and 2.5×10^{-6} cm.²/sec., respectively, at room temperature. These are approximately one-fifth the diffusion rates of the same salts in dilute aqueous solution.

6. *Exchange Equilibria in Cation Exchangers**

We now shall consider the ion exchange reaction which takes place when the acid resin sphere is immersed in a salt solution such as NaCl. The water swelling and the chloride distribution are the same as for HCl discussed above. In addition, however, we must consider the equilibrium distribution of the Na⁺ and H⁺ between the resin and solution phases. As in the HCl case, the total cationic concentrations (H⁺ + Na⁺) will generally be much higher in the resin phase than in the solution phase. Hence, there is no chance that both H⁺ and Na⁺ concentrations can be the same in both phases. One might anticipate that the ratio of H⁺/Na⁺ concentrations would tend to become equal in the two phases, and this is exactly what does occur. Donnan's hypothesis is that the activity of any diffusible electrolyte is the same in both phases at equilibrium, giving

$$a_{\text{NaCl}_R} = a_{\text{NaCl}_S} \quad \text{or} \quad a_{\text{Na}_R} a_{\text{Cl}_R} = a_{\text{Na}_S} a_{\text{Cl}_S} \quad (7)$$

and
$$a_{\text{HCl}_R} = a_{\text{HCl}_S} \quad \text{or} \quad a_{\text{H}_R} a_{\text{Cl}_R} = a_{\text{H}_S} a_{\text{Cl}_S}. \quad (8)$$

Dividing we obtain

$$\left(\frac{a_{\text{Na}}}{a_{\text{H}}}\right)_R = \left(\frac{a_{\text{Na}}}{a_{\text{H}}}\right)_S \quad (9)$$

This is the anticipated equality of ratios, expressed in terms of ion activity. If the concentration of total cations in both phases is low, then the activity is the same as the concentration and

$$\left(\frac{C_{\text{Na}}}{C_{\text{H}}}\right)_R = \left(\frac{C_{\text{Na}}}{C_{\text{H}}}\right)_S \quad (10)$$

This, however, is only exactly true for an ion exchange resin of very low capacity in a dilute solution.

For present commercial exchange resins the cation concentration of the resin phase is very high (equivalent to a 2-6 molar solution). At such a density of ions, the concentration is no longer equal to the activity.

The true thermodynamic activity at high concentrations is found experimentally to be different from the actual molar concentration, and this difference is expressed as the activity coefficient:

$$a_{\text{Na}_S} = \gamma_{\text{Na}_S} C_{\text{Na}_S}. \quad (11)$$

The activity coefficients of various univalent chlorides (8) are shown in Fig. 5.

Now for a high capacity exchange resin immersed in a very dilute solution, the activity coefficients in the solution phase are unity, but those

* Cf. also chapter by Walton on Ion Exchange Equilibria, p. 3.

in the resin phase differ from unity. Hence, equation (9) becomes

$$\frac{C_{\text{Na}_R}}{C_{\text{H}_R}} = \frac{\gamma_{\text{H}_R}}{\gamma_{\text{Na}_R}} \frac{C_{\text{Na}_S}}{C_{\text{H}_S}} \quad (12)$$

The concentration ratios in the resin and solution phases are no longer necessarily equal. The ratio $\gamma_{\text{H}_R}/\gamma_{\text{HNa}_R}$, however may be expected to remain nearly constant for wide variations in the $C_{\text{Na}_R}/C_{\text{H}_R}$ ratio, since the ionic strength of the resin phase is constant. This ratio is termed the equilibrium constant in the Na-H exchange:

$$K_{\text{Na-H}} = \frac{\gamma_{\text{H}_R}}{\gamma_{\text{Na}_R}} \quad (13)$$

If we consider the exchange of any monovalent ion, X, with hydrogen ion:

$$K_{\text{X-H}} = \frac{\gamma_{\text{H}_R}}{\gamma_{\text{X}_R}} \quad (14)$$

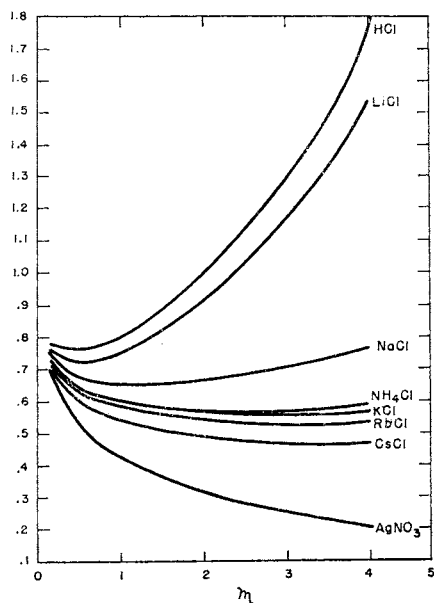

FIG. 5. Activity coefficients of univalent halides at 25°C.

These equilibrium constants have been determined for a number of monovalent ions on cation exchange resins with the results shown in Table I. It is interesting to note that the ions of low activity coefficient, such as Ag^+ and Tl^+ show a high K value, as predicted by equation (14).

As the outside solution concentration is increased, the activity coefficients in this phase also differ from unity. Then

$$\frac{C_{\text{Na}_R}}{C_{\text{H}_R}} = \frac{\gamma_{\text{H}_R} \gamma_{\text{Na}_S}}{\gamma_{\text{Na}_R} \gamma_{\text{H}_S}} \frac{C_{\text{Na}_S}}{C_{\text{H}_S}} \quad (15)$$

and

$$K_{\text{Na}_R \text{H}} = \frac{\gamma_{\text{H}_R} \gamma_{\text{Na}_S}}{\gamma_{\text{Na}_R} \gamma_{\text{H}_S}} \quad (16)$$

TABLE I

Equilibrium Data for Dowex 50

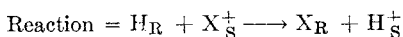

Solution = $N/10$ or $N/100$

X_S^+	K (eq. 14)
Li	0.61
Na	1.20
NH_4	1.20
K	1.50
Cs	2.04
Rb	2.22
Tl	8.60
Ag	8.70

} in
} $N/100$

TABLE II

Equilibrium in NH_4 -H Exchange on Dowex 50

$$K = \frac{C_{\text{HN}_4^+} C_{\text{H}_S}}{C_{\text{NH}_4^+} C_{\text{H}_R}}$$

Normality of solution	K
0.01	1.20
0.10	1.20
1.0	1.15
2.0	0.83
4.0	0.51

The K values in the NH_4 -H exchange on Dowex 50 have been measured and are shown in Table II. Since the activity coefficient of NH_4^+ becomes less than that of H^+ at higher solution concentrations, K should become smaller, and it does.

An interesting case, both practically and theoretically, is the exchange of a divalent ion with a monovalent ion — for example, in the softening

of water, the Ca-Na exchange. Following through the same Donnan equilibrium equations, we obtain

$$\frac{a_{\text{CaR}}}{a_{\text{Na}^2\text{R}}} = \frac{a_{\text{CaS}}}{a_{\text{Na}^2\text{S}}} \quad (17)$$

and, in dilute solution,

$$\frac{C_{\text{CaR}}}{C_{\text{Na}^2\text{R}}} = \frac{\gamma_{\text{Na}^2\text{R}}}{\gamma_{\text{CaR}}} \frac{C_{\text{CaS}}}{C_{\text{Na}^2\text{S}}} \quad (18)$$

as before

$$K_{\text{Ca-Na}} = \frac{\gamma_{\text{Na}^2\text{R}}}{\gamma_{\text{CaR}}} \quad (19)$$

The constancy of K has been shown for the Ca-H exchange on Dowex 50 as indicated in Fig. 6. The experimental points agree well with the theoretical slope of 2.

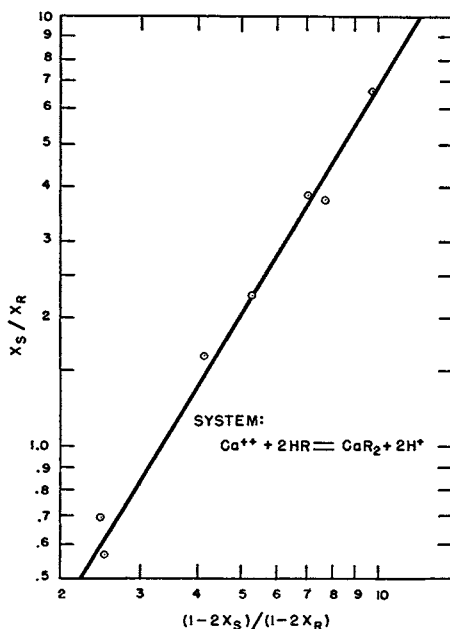

FIG. 6. Equilibrium Ca-H exchange for Dowex 50.

Now in terms of equivalent fractions (rather than mole fractions since a mole of calcium exchanges for 2 moles of sodium):

$$\frac{X_{\text{CaR}}}{X_{\text{Na}^2\text{R}}} = K \frac{C_{\text{R}}}{C_{\text{S}}} \frac{X_{\text{CaS}}}{X_{\text{Na}^2\text{S}}} \quad (20)$$

For the same Ca/Na ratio in solution, the calcium pick-up on the resin is a function of the total solution concentration, C_s . The resin will absorb calcium ions very selectively over sodium ions at low solution concentrations (e.g., in fresh water), and will release calcium ions easily with high strength NaCl regeneration. This is the reason that water softening by ion exchange is an efficient operation. It also accounts for the ready removal of calcium and magnesium salts in demineralization in comparison to the difficult removal of sodium ions.

The same equation leads to the prediction that this selectivity for divalent ions over monovalent ions increases with an increase of the exchange capacity, C_R , of the exchange resin. This has never been checked.

In summary, the ion exchange reaction proceeds to an equilibrium state in which the activity ratio of the two ions is the same in both solution and resin phases.

7. Exchange Rates in Cation Exchanges

We turn next to a brief survey of the speed of the ion exchange reaction. Consider the rate of exchange of ions upon the sudden immersion of a sphere of exchange resin (in the hydrogen form) in a large volume of a dilute NaCl solution. We have already noted that the ionic concentration in the resin phase is very high in present commercial exchangers (as high as 6 molar) and that the ion diffusion rate is about one-fifth as fast as in pure water. If the outside solution has a very low ionic concentration (e.g., about 0.005 molar as in fresh water), there are 1000 times as many H^+ ions per unit volume on the resin side of the interface as Na^+ ions on the solution side. As would be anticipated, ionic diffusion in the resin can easily replace the surface H^+ ions as fast as they are exchanged, so that the surface reaction is rate controlling.

Experimental data with various exchange resins has indicated that this surface reaction rate is proportional to both the sodium ion activity in the solution phase and the hydrogen ion activity in the resin phase:

$$R_1 = k_1 a_{H_R} a_{Na_S} \quad (21)$$

As the reaction proceeds, it slows down because of the build-up of Na^+ in the resin phase and H^+ in the solution phase and their interaction by a similar mechanism:

$$R_2 = k_2 a_{Na_R} a_{H_S} \quad (22)$$

The net reaction rate, R_n , is given by

$$R_n = R_1 - R_2 = k_1 a_{H_R} a_{Na_S} - k_2 a_{Na_R} a_{H_S} \quad (23)$$

At equilibrium, $R_n = 0$, and

$$k_1 a_{H_R} a_{Na_S} = k_2 a_{Na_R} a_{H_S} \quad (24)$$

Comparing equations (24) and (9), we see that $k_1 = k_2$.

Then

$$R_n = k_1(a_{\text{HR}} a_{\text{NaS}} - a_{\text{NaR}} a_{\text{HS}}) \quad (25)$$

As with most surface reactions, this reaction rate constant, k_1 , is dependent upon a large number of factors. It is directly dependent upon the surface area of the ion exchange particles. It is essentially dynamic in nature, depending upon the turbulence of the solution in a stirring experiment, and the rate of flow of solution relative to the particles in a tower test. The rate increases with increasing temperature, but not as rapidly as homogeneous reactions — apparently doubling for about a 20° temperature increase.

For dilute solutions, $a_{\text{NaS}} = C_{\text{NaS}}$ and $a_{\text{HS}} = C_{\text{HS}}$:

$$R_n = k_1 \gamma_{\text{HR}} C_{\text{NaS}} C_{\text{HR}} - k_1 \gamma_{\text{NaR}} C_{\text{HS}} C_{\text{NaR}}.$$

Both forward and reverse reaction rates have been determined for 20–24 mesh spheres of Dowex 50 at room temperature, giving

$$k_1 \gamma_{\text{HR}} = 28$$

and

$$k_1 \gamma_{\text{NaR}} = 25$$

when R_n is expressed in moles exchanged per liter of resin (settled under water) per minute and concentrations are expressed also in moles per liter. The ratio of these values

$$\frac{\gamma_{\text{HR}}}{\gamma_{\text{NaR}}} = 25 = 1.1. \quad \text{This compares favorably with the equilibrium}$$

constant of 1.2 measured in a static experiment.

When we consider the speed of exchange of all the alkali metal ions, we obtain

$$R_n = k_1 \gamma_{\text{HR}} C_{\text{XS}} C_{\text{HR}} - k_1 \gamma_{\text{XR}} C_{\text{HS}} C_{\text{XR}}.$$

The forward reaction rate of the hydrogen resin with each of the alkali metal ions should be the same, since the rate constant is $k_1 \gamma_{\text{HR}}$ for each. The reverse reaction rate, however, proceeding with the rate constant $k_1 \gamma_{\text{XR}}$ should be slower for ions of lower activity coefficient at high electrolyte concentration. The experimental results are shown in Figs. 7 and 8. Within the experimental accuracy of $\pm 0.05\text{pH}$, the forward reaction rate is the same for all ions. The reverse reaction rate is slower for ions of higher molecular weight, as predicted.

Consider further the significance of this value for $k_1 \gamma_{\text{HR}}$ of about 28. Then $R_n/C_{\text{HR}} = 28 C_{\text{S}}$. If this rate is maintained as we increase the solution concentration to 1 mole/liter, the total capacity of the resin would

be exhausted in 2 seconds. This is a much faster rate than the diffusion rate of ions in the resin phase. Obviously the surface reaction rate becomes

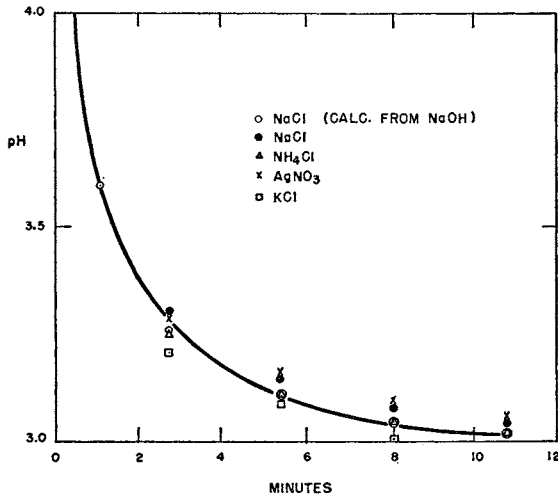

FIG. 7

FIG. 7. Exchange rates for $X_S + X_R$.

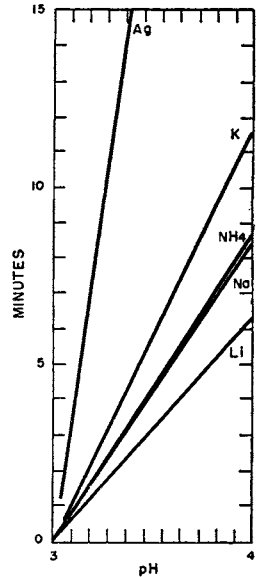

FIG. 8

FIG. 8. Reaction of Dowex 50 (20-24 mesh) in various cation forms with .001 *N* HCl solution.

so fast at high solution concentrations that the inner diffusion rate of ions in the resin phase will become rate controlling. This limiting concentration has been reported to be in the order of magnitude of 0.1 *N* (9). This would indicate that the softening of fresh water is a surface controlled reaction, but the regeneration (even with NaCl as weak as 1%) is controlled by the diffusion rate inside the particles.

The choice of the optimum particle size for a particular ion exchange cycle will be partially determined by this rate control mechanism. Thus if the rate is surface controlled, particles with a given diameter will react twice as fast as particles with twice this diameter; while with diffusion control, the rate will be four times as fast (9). Hence, smaller diameters will have a greater advantage in concentrated solutions than in a very dilute solution. Though in all cases particles of small diameter have a theoretical advantage over larger particles, practical considerations on the need for high backwash rates to remove sediment and for maintaining low pressure drop demand a compromise.

Much remains to be done in the quantitative evaluation of the speed of ion exchange reactions at various temperatures, for different particle

sizes, and at all solution concentrations. Only a few papers have been published on this subject (10). Much additional data will be required to check present theories and to apply them to the practical problems of designing efficient equipment for specific ion exchange applications.

8. *Cation Exchange Resins with Weakly Acidic Groups*

The discussion up to this point has been confined to cation exchange resins of the sulfonic acid types where both the acid and salt forms of the exchanger may be considered to be completely dissociated. This sulfonic acid type has been used most extensively in the general field of ion exchange, since the high acid strength of the sulfonic acid group yields a constant exchange capacity over a broad pH range in a salt cycle and excellent conversion of salts of strong or weak acids to the corresponding free acids in the acid cycle. Because of this greater use, the fundamental properties of the sulfonic acid resins have been studied more than those of the weakly acidic resins. As the use of resins is extended to special applications, however, it is logical to expect more and more interest in these weakly acidic resins.

The general characteristics of exchangers containing $-\text{COOH}$, phenolic $-\text{OH}$, and $-\text{Si}-\text{OH}$ are known from published work (11). Typical pH titration curves for such exchangers have been shown by Griessbach (11) and by Gregor (12). As anticipated, these resins show the typical buffering ranges of monomeric carboxylic acids and phenols, respectively. Gregor has reported that the equilibrium pH curve is attained slowly with the weakly acidic exchange resins. This is readily verified with any of the carboxylic acid or phenolic resins on the market. A resin containing $-\text{SO}_3\text{H}$, $-\text{COOH}$, and $-\text{OH}$ in the same molecular structure, when titrated with NaOH will show almost instantaneous neutralization of the $-\text{SO}_3\text{H}$ groups, a 2-4 hour drift to obtain a pH equilibrium with the $-\text{COOH}$ groups, and a 24 hour drift with the phenolic groups. This seems difficult to understand, since the diffusion coefficient within the particle should be the same for the neutralization of all groups. The rate difference is accounted for by the diffusional driving force within the particle: the product of the concentration of Na^+ at the surface of the particle and the concentration of H^+ at the center of the particle (see equation 21). Both of these concentrations are very high in the case of the sulfonic acid, so that the particle supplies H^+ to the surface in exchange for Na^+ at a rapid rate, as we have seen before. With the $-\text{COOH}$ group, though the Na^+ may be high at the surface of the particle, the H^+ concentration is limited to about 10^{-4} to 10^{-5} moles/liter by the limited dissociation of the $-\text{COOH}$ group. The Na^+ can diffuse into the particle only as rapidly as the H^+ diffuses out, so that the whole exchange is slowed down very markedly by the very low concentration of H^+ in the particle. This rate is then even much

slower for the phenolic groups, whose dissociation constant is about 10^{-10} .

That this slow neutralization of the $-\text{COOH}$ and $-\text{OH}$ groups is not owing to a low diffusion coefficient is further shown by the rapid exchange of Na^+ and Ca^{++} , or other salt pairs, on these weakly acid resins. The sodium form of these resins completely softens waters containing high sodium ion concentration: i.e., these resins show a much higher selectivity for Ca^{++} and Mg^{++} ions over Na^+ than do the sulfonic acid resins (2). The selectivity is so high in fact that regeneration with NaCl is inefficient even with concentrated brine. Hence, in water treatment the utility of this type of resin is chiefly in the demineralization and dealkalizing of carbonate waters.

This high selectivity for H^+ and for the divalent ions displayed by the carboxylic acid resins points the way toward new applications of ion exchange resins in the recovery of metals from wastes. The removal of iron from water and the recovery of copper are typical examples (13). The process may be extended to the removal of trivalent ions of high molecular weight for which the resin will have a very high selectivity, since it is generally possible to remove even these ions by acid regeneration. In general, the selective separation of a single ion from a solution containing many other ions is a field for exchange resins of the weak acid type. Much additional work on the manufacture and study of these resins is needed.

II. ANION EXCHANGE RESINS

1. Introduction

The general discussion of the fundamental properties of cation exchange resins is a solid groundwork for the consideration of anion exchange resins. The requirement of a physically and chemically stable cross-linked network is identical for both cation and anion exchangers. The anion exchangers are built up from monomeric amines by polymerization in the same fashion as the cation exchangers, yielding cross-linked gels that are homogeneous ionic "solutions" of the amine network in water.

2. Synthesis of a Typical Anion Exchange Resin

As an example of such an amine polymerization we can consider the

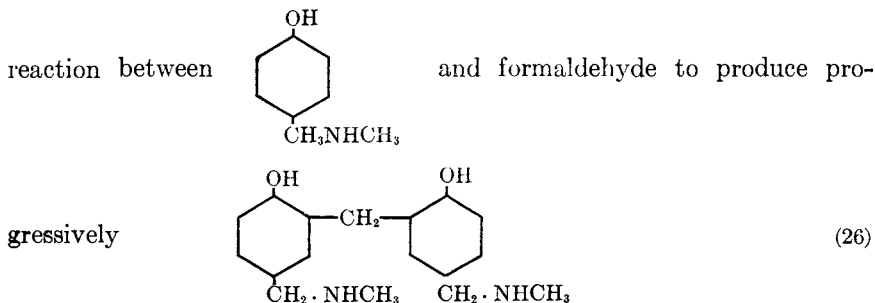

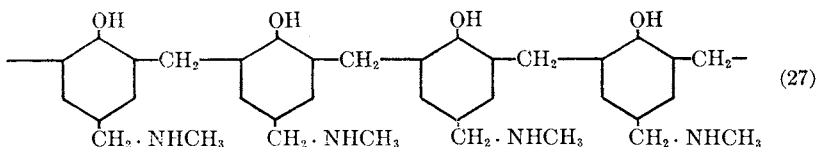

and finally

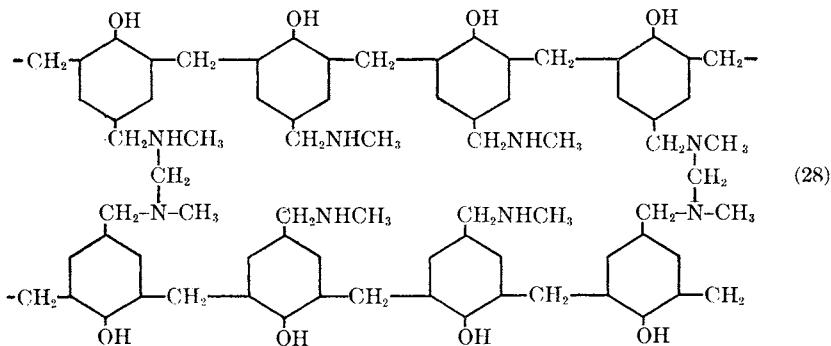

As described by Cheetham and Myers (14) this type of polymerization is applicable in general to the reaction of phenol, formaldehyde, and an amine. The amines usually used are the ethylene polyamines. It is

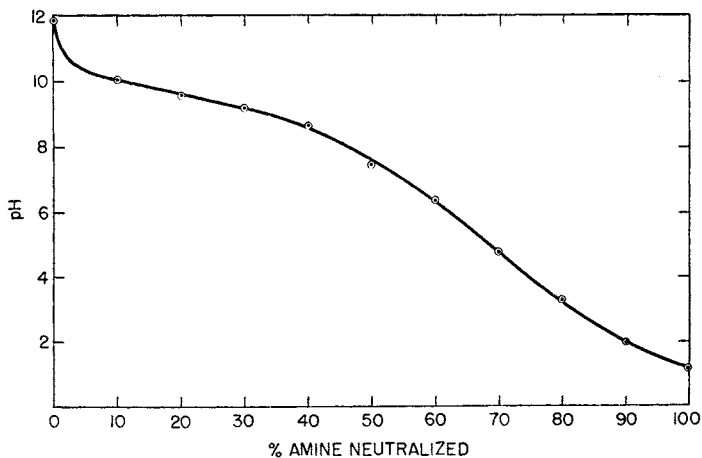

Fig. 9. Neutralization of triethylenetetramine with HCl.

readily seen that the resultant polymer contains primary, secondary, and tertiary aliphatic amines. A typical titration of such a polymeric amine is shown by triethylenetetramine in aqueous solution, as in Fig. 9. The

basic strength of the amine groups in even this simple molecule vary progressively from pH8 down to pH3. This identical behavior is found in the anion exchange resin as shown in Fig. 10. In general, commercial exchange resins show this same wide variation in the basic strength of the amine groups.

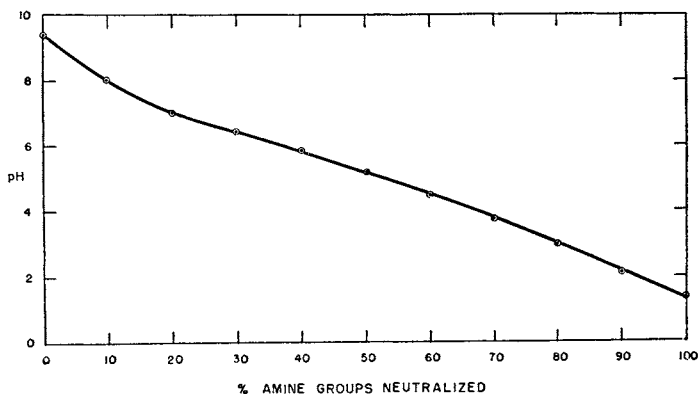
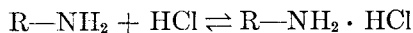

FIG. 10. Neutralization of anion exchange resin with HCl.

3. Absorption or Exchange in Anion Exchange Resins

The fundamental behavior of anion exchange resins has been handled by many investigators as an absorption process, although the most recent work tends to support a straightforward exchange process. Possibly the best proof of the exchange mechanism is the change in pH of an anion exchange resin when transferred from water to a salt solution (15). The addition of salt should have little effect, if the mechanism is the absorption



In the exchange reaction,

$\text{R-NH}_2 \cdot \text{OH} + \text{Cl}^- \rightleftharpoons \text{R-NH}_2\text{Cl} + \text{OH}^-$, however, the addition of NaCl or KCl will drive the equilibrium to the right and raise the pH value. A change of Cl^- concentration of a hundred fold may be expected to raise the pH value by about 2, and this is very close to the experimental results of Kunin and Myers (15).

With the earliest resin exchangers, based on *m*-phenylenediamine, the quantity of acid adsorbed was found to be a function of the particle size (16). These resins had a very hard, impervious structure, so that the reaction was a surface phenomenon. The newer exchange resins with their looser gel structure permit the reaction of the whole mass of each particle, so that the capacity is no longer dependent upon particle size (17).

Myers, *et al.* (17) went on to show that the quantity of acid absorbed by a gram of Amberlite IR-4 was a marked function of the acid type, varying from zero absorption for H_3BO_3 to an equivalent absorption of H_3PO_4 which was apparently almost three times as great as the equivalent nitrogen content of the resin. This seemed to be a clear cut proof of an absorption mechanism rather than an exchange mechanism, since an exchange theory limits the maximum absorption to the stoichiometrical equivalent of the amine groups. Additional work, however, has shown that the maximum absorption of strong monovalent acids is closely measured by the nitrogen content of the resin, and that this apparent excess capacity is obtained only with polyvalent acids (15). A more careful study of the absorption of H_3PO_4 indicates, furthermore, that even this excess capacity is not real. Figure 11 shows a pH titration curve of H_3PO_4 with NaOH . We note that only the first H^+ is a strong acid and may be completely neutralized by a weakly basic resin, as shown in Fig. 10. The second H^+ , being neutralized in the pH 6-8 range, may be partly neutralized by the resin. Hence, the main reaction is

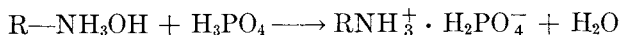

with a very small further neutralization to $(\text{RNH}_3^+)_2 \text{HPO}_4^-$. Figure 11 indicates that the formation of the stable phosphate would require a resin

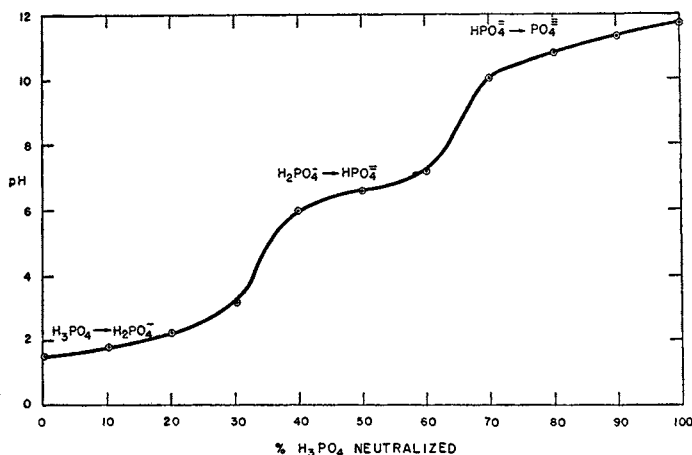

FIG. 11. Neutralization of phosphoric acid with NaOH .

whose basic groups have a strength of pH 11-12, as strong as KOH or NaOH . No commercial exchange resin approaches this high basicity at present. Now with the use of the equivalent weight of 98 g., measured absorption of H_3PO_4 is approximately equal to the equivalent nitrogen

content, so that the experiment confirms and fortifies the exchange mechanism theory.

The complete absence of any H_3BO_3 absorption is also readily explained on the basis of pH curves. Figure 12 shows the titration of H_3BO_3 with

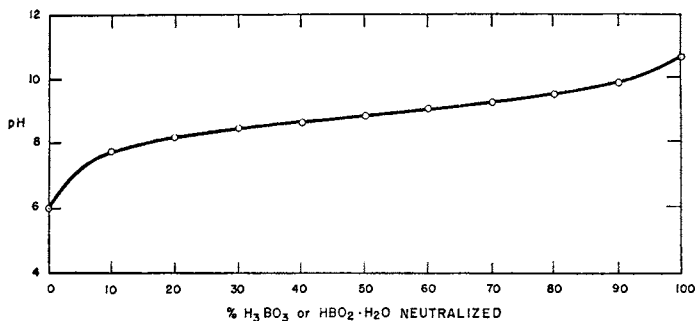

FIG. 12. Neutralization of boric acid with NaOH.

NaOH on a glass electrode. Comparing this curve with the pH curve of the resin (Fig. 10) we note that the resin is too weakly basic to neutralize any of the H_3BO_3 . This merely means that the borate salt of the amine resin is completely hydrolyzed in water and hence, does not exist in aqueous medium. By similar methods it may be shown that other weak acids such as H_2SiO_3 , phenol, HCN, etc., are not absorbed; while somewhat stronger acids such as CO_2 , H_2S , benzoic acid, salicylic acid, etc., are absorbed to a limited extent, by only the strongest of the basic amine groups. Likewise it can be shown that in fresh water only one form of the resin is stable at pH 7 or higher, namely, the hydroxide or basic form. This excludes the possibility of anion exchange in neutral and alkaline media with the resin shown in Fig. 10. Some of the newer resins are somewhat more basic than this, so that they may show one-quarter of their total capacity available at pH 7. Active work is being carried out to develop more basic exchange resins, but little detailed data have been published on them (18).

Hence, in a qualitative fashion, the anion exchange resins appear to behave in a manner completely analogous to the cation exchange resins. Physically they have the same single-phase gel structure, containing ion active groups attached firmly to a cross-linked molecular network. As such, the fundamental properties should be determined by the same type of laws as those which we have developed for the cation exchange resins. We should be able to apply laws of concentrated solution to the resin phase, and Donnan's hypothesis to the equilibrium between the resin phase and the outside solution phase.

4. Swelling of Anion Exchange Resins

The basic form of the resin in pure water is shown in Fig. 13. Since all commercial resins are weakly basic, the figure shows the majority of the hydroxide groups fixed to the amine network and only a very small frac-

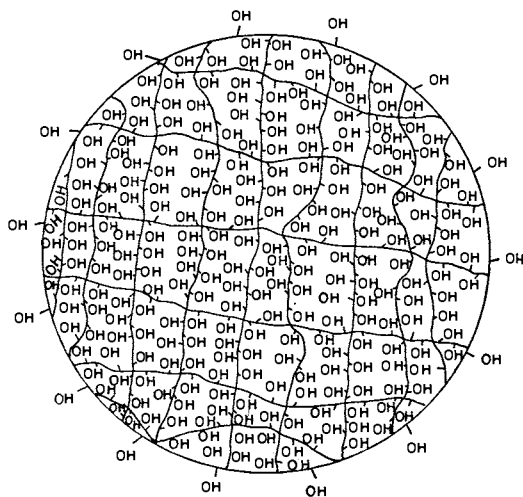
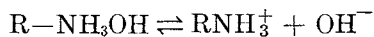

FIG. 13. Basic structure of anion exchange resin.

tion ionically dissociated and free to migrate in the resin phase. This dissociation may be expected to be similar to that of a weak base in water, so that



$$\frac{[\text{RNH}_3^+]_{\text{R}} [\text{OH}^-]_{\text{R}}}{[\text{RNH}_3\text{OH}]_{\text{R}}} = K_{\text{R}}, \text{ where } [\quad]_{\text{R}} \text{ indicates concentration of}$$

constituents in moles per liter of resin phase and K_{R} is the equilibrium constant. As we have noted before, all actual amine resins contain secondary and tertiary amines also, and hence show multiple K_{R} values. This leads to a more complex behavior than predicted by the theory which follows and which has been limited, for the sake of simplicity, to an idealized resin with a single amine type present in the structure. The structure is swollen by water, but only to a limited extent in the basic form because of its weakly ionic character. All anion resins swell more in their completely ionized salt forms. As with cation exchangers, the free migration of OH^- ion from the resin particle into the outside solution is limited by the formation of an electrical potential at the particle surface—much weaker, however, than the sulfonic acid cation exchangers because of the weak ionization of the amine groups. This atmosphere of OH^- ions around

the particles is shown by a pH increase when finely divided resins is stirred around a glass electrode (19).

5. Donnan Effect in Anion Exchange Resins

The relative concentration of a base between the inside and outside of an anion exchange particle has apparently not been investigated. The Donnan theory should apply, so that in NaOH solution,

$$\frac{Na_s^+}{Na_R^+} = \sqrt{1 + \frac{R^+}{Na_R^+}} \quad (29)$$

the concentration of R^+ , however, will be only the ionized portion of the total number of amine groups so that its value will be low. Hence, one would predict that the Na^+ concentration will be about the same in the resin phase as it is in the solution phase. In the case of NaCl diffusing into the chloride form of the resin, the same equation will hold but R^+ will be equal to the total concentration of amine groups, hence, the Na^+ concentration should be much lower within the particle than without.

6. Acid Absorption by Anion Exchange Resins

Now consider the equilibrium between the resin in various stages of neutralization with HCl and in various NaCl concentrations. This is the pH curve of the resin in water and in NaCl solution. On the addition of HCl to the basic form of the resin, the reaction is

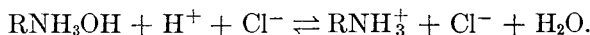

The equilibrium expression is

$$\frac{[RNH_3^+]_R [Cl^-]_R}{[RNH_3OH]_R [H^+]_S [Cl^-]_S} = K \quad (30)$$

The Donnan hypothesis leads to the expressions

$$a_{H^+}_R a_{Cl^-}_R = a_{H^+}_S a_{Cl^-}_S \quad (31)$$

$$a_{H^+}_R a_{OH^-}_R = a_{H^+}_S a_{OH^-}_S \quad (32)$$

$$\frac{a_{Cl^-}_R}{a_{OH^-}_R} = \frac{a_{Cl^-}_S}{a_{OH^-}_S} \quad (33)$$

$$\frac{[Cl^-]_R}{[OH^-]_R} = K_e \frac{[Cl^-]_S}{[OH^-]_S}, \quad \text{where } K_e = \frac{\gamma_{Cl^-}_S \gamma_{OH^-}_R}{\gamma_{Cl^-}_R \gamma_{OH^-}_S} \quad (34)$$

Then

$$K = \frac{K_R K_e}{K_w}, \quad (35)$$

where

$$K_w = [H^+]_S [OH^-]_S = 10^{-14}.$$

The fraction, X_R , of the resin neutralized by HCl is closely equal to $\frac{[\text{RNH}_3^+]_R}{C_R}$, and also to $\frac{[\text{Cl}^-]_R}{C_R}$, (where C_R is the total capacity of the resin),

when in pure water (no NaCl). Hence,

$$\frac{X_R^2}{1 - X_R} = \frac{K}{C_R} [\text{H}^+]_s^2. \quad (36)$$

For low concentrations of NaCl addition ($[\text{Cl}^-] = 10^{-4}$ to 10^{-1}),

$$\frac{X_R^2}{1 - X_R} = \frac{K}{C_R} [\text{H}^+]_s [\text{Cl}^-]_s. \quad (37)$$

At very high concentrations of added NaCl, $\frac{[\text{Cl}^-]_R}{C_R}$ is no longer approximately equal to X_R . For very high NaCl additions and for low fractions X_R , $[\text{Cl}^-]_R \cong [\text{Cl}^-]_s$. A plot of these equations is shown in Fig. 14 for the following conditions: $K_R = 10^{-6}$, $K_e = 1$, $K_w = 10^{-14}$, $C_R = 5$ moles/liter.

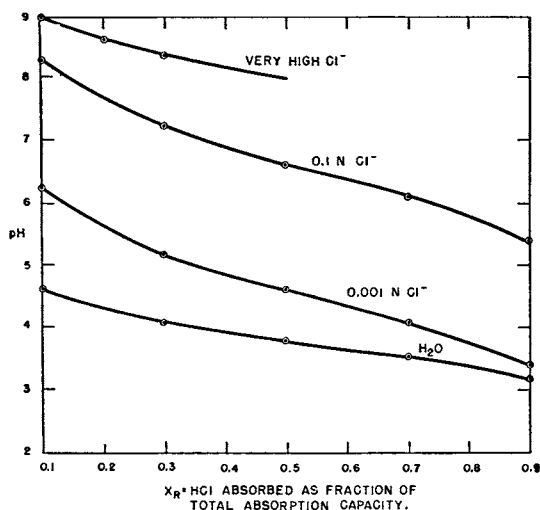

Fig. 14. Acid absorption on anion resin. K_R = resin D. Dissociation constant = 10^{-6} .

As expected, it is much sharper than actual pH curves because of the assumption of a single amine type. The effect of added NaCl is similar to experimental results. One interesting fact is that the pH curve is more acidic than that of the pure amine except in the presence of quite strong chloride. This accounts for the difficulty in manufacturing, even from aliphatic amines, an anion resin, which is basic in dilute solution.

The equilibrium in the absorption of a weak acid is slightly more complex. $\text{RNH}_3\text{OH} + \text{HA} \rightleftharpoons \text{RNH}_3^+ + \text{A}^- + \text{H}_2\text{O}$.

$$\frac{[\text{RNH}_3]_{\text{R}}^+ [\text{A}^-]_{\text{R}}}{[\text{RNH}_3\text{OH}]_{\text{R}} [\text{HA}]_{\text{S}}} = K \quad (38)$$

$$\frac{[\text{A}^-]_{\text{R}}}{[\text{OH}^-]_{\text{R}}} = K_e \frac{[\text{A}^-]_{\text{S}}}{[\text{OH}^-]_{\text{S}}} \quad (39)$$

$$K = K_{\text{R}} \frac{K_e K_a}{K_{\text{W}}}, \quad (40)$$

where $K_a = \frac{[\text{H}^+]_{\text{S}} [\text{A}^-]_{\text{S}}}{[\text{HA}]_{\text{S}}}$, the equilibrium constant of the weak acid.

In water as before,
$$\frac{X_{\text{R}}^2}{1 - X_{\text{R}}} = \frac{K_{\text{R}} K_e}{C_{\text{R}} K_{\text{W}}} [\text{H}^+]_{\text{S}}^2. \quad (41)$$

Hence, the pH of a resin 10% saturated with a strong acid is the same as for a weak acid, providing the size of the anions is about the same (K_e is the same). The total quantity of unabsorbed acid, however, is much greater for the weak acid, since

$$\frac{X_{\text{R}}^2}{1 - X_{\text{R}}} = \frac{K_{\text{R}} K_e K_a}{C_{\text{R}} K_{\text{W}}} [\text{HA}]_{\text{S}}. \quad (42)$$

In order to obtain the same saturation value, X_{R} , it is necessary to have a large excess $[\text{HA}]_{\text{S}}$ if K_a is small (the acid is weak). In fact if K_a is very small, it is impossible to get $[\text{HA}]_{\text{S}}$ large enough to achieve a high value of X_{R} ; i.e., there is no absorption of a very weak acid.

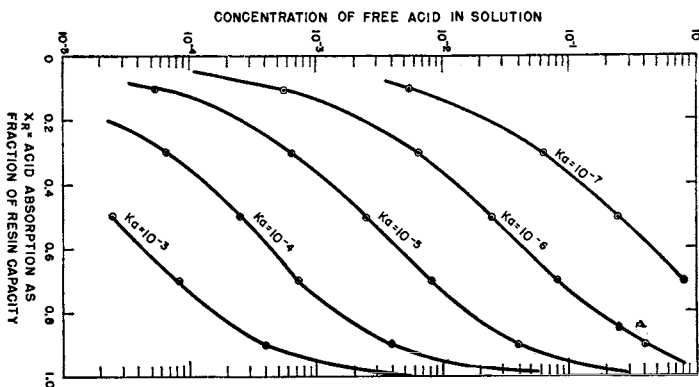

FIG. 15

These facts indicate that the pH-per cent saturation curve in the absorption of a weak acid is misleading since it looks similar for both

weak and strong acids. Thus Kunin and Myers have concluded that in the absorption of acids "the ionization is not an important factor" except that, "for such acids as weak as boric and silicic acids, the exchange is nil." A plot of the equivalents absorbed per equivalent resin vs. the concentration of free acid in solution at equilibrium is of more value. Such a plot is shown in Fig. 15 for the following conditions: $K_R = 10^{-6}$, $K_e = 1$, $K_w = 10^{-14}$, $C_R = 5$, $K_a = 10^0$ to 10^{-10} . *It shows clearly that the extent of absorption of a weak acid by a resin containing weakly basic groups is controlled principally by the ionization constant of the acid (20).*

7. Anion Exchange Equilibrium

The process of direct anion exchange between two salt forms of an anion exchange resin is readily studied only for salts of very strong acids, since this exchange occurs simultaneously with neutralization in the case of salts of weak acids. Thus the case $\text{RNH}_3\text{Cl} + \text{NO}_3^- \rightleftharpoons \text{RNH}_3\text{NO}_3 + \text{Cl}^-$ is readily handled; but for weak acids, the exchange $\text{RNH}_3\text{Cl} + \text{A}^- \rightleftharpoons \text{RNH}_3\text{A} + \text{Cl}^-$ occurs simultaneously with neutralization $\text{RNH}_3\text{Cl} + \text{A}^- + \text{H}_2\text{O} \rightleftharpoons \text{RNH}_3\text{OH} + \text{HA}$. If HA is a very weak acid (H_3BO_3 or phenol or H_2SiO_3), the second reaction occurs to the exclusion of the first; for acids of medium strength (benzoic, salicylic, carbonic), both reactions are of about equal importance; while for even moderately strong acids (formic, acetic, oxalic, citric), appreciable neutralization of the most weakly basic groups in the anion exchanger will occur.

The simple case of anion exchange is handled by the Donnan hypothesis, as before, giving

$$\frac{[\text{NO}_3^-]_{\text{R}}}{[\text{Cl}^-]_{\text{R}}} = K_e \frac{[\text{NO}_3^-]_{\text{S}}}{[\text{Cl}^-]_{\text{S}}}, \quad \text{where } K_e = \frac{\gamma_{\text{NO}_3^-} \text{S}}{\gamma_{\text{Cl}^-} \text{S}} \frac{\gamma_{\text{Cl}^-} \text{R}}{\gamma_{\text{NO}_3^-} \text{R}} \quad (43)$$

Referring to the activity coefficients of monovalent anions, we find that the coefficient of NO_3^- is low, while chloride, bromide, and iodide are closely equal. This should indicate a selective absorption for nitrate over chloride, and approximately equal selectivity for chloride, bromide, and iodide. This checks the experimental data for Amberlite IR-4 presented by Kunin and Myers (15). A close check can also be obtained on the form of the equilibrium curve as presented by these authors for the NO_3^- - Cl^- equilibrium. Their experimental curve and the corresponding theoretical curve for $K_e = 1.8$ are shown in Fig. 16. The agreement is excellent.

The valence factor may be handled readily in a theoretical fashion, but little supporting data are available. Of all the polyvalent acids studied, only one has more than one of the H^+ ions sufficiently ionized to neutralize any of the weakly basic groups on the present anion exchangers, namely,

H_2SO_4 . Even H_2SO_4 shows some HSO_4^- salt according to the results of Kunin and Myers, but this is to a small enough extent to be neglected for the purpose of a rough check on the valence factor. The theoretical development is the same as discussed for the Ca-Na exchange on cation exchangers, giving

$$\frac{[\text{SO}_4^{--}]_R}{[\text{Cl}^-]_R^2} = K_e \frac{[\text{SO}_4^{--}]_S}{[\text{Cl}^-]_S^2} \quad (44)$$

Though much qualitative information has been presented to show that sulfate is absorbed in preference to chloride in dilute solutions, the only

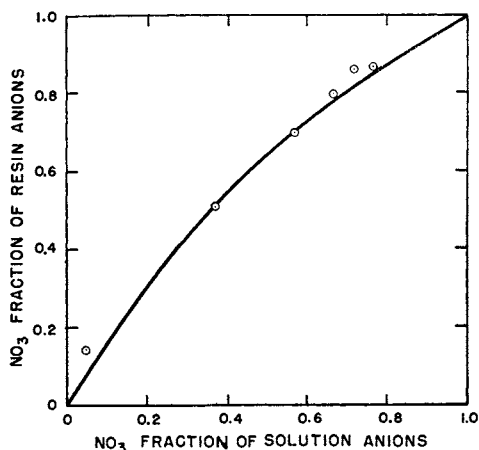

FIG. 16. $\text{NO}_3^- - \text{Cl}^-$ equilibrium on Amberlite IR-4B.

quantitative data on the equilibrium are given by Kunin and Myers (21). The divalent-monovalent mass action law cannot be checked with the data in their more recent paper (see Fig. 2, *J. Am. Chem. Soc.* **69**, 2874 (1937)), since the solution concentrations are not stated. In the earlier paper two points are given for this exchange equilibrium. Applying these data to the equation

$$\frac{X_R}{(1 - X_R)^2} = \frac{KC_R}{C_S} \frac{X_S}{(1 - X_S)^2}, \quad (45)$$

where X_R and X_S are the equivalent fraction of the sulfate in the resin and solution respectively while C_R and C_S are the total anion capacity of the resin and solution respectively, it is found that KC_R is equal to 1.0 and 1.44 for the two points. This is reasonable agreement, considering the possibilities of forming both SO_4^{--} and HSO_4^- salts. Using the constant 1.2,

we obtain the results shown in Fig. 17. For Amberlite IR-4, we note that sulfate is absorbed with high selectivity over chloride in very dilute solution, but that above 1.2 normal the chloride is absorbed in preference to sulfate.

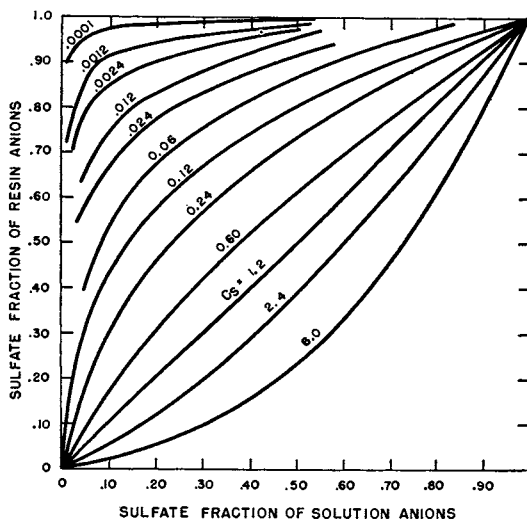

FIG. 17. $\text{Cl}^- - \text{SO}_4^{2-}$ equilibrium on Amberlite IR-4.

In conclusion, the equilibrium data on anion exchange resins are consistent with the concept that the fundamental exchange mechanism is the same as that for cation exchangers — a Donnan type equilibrium between the outside solution and the resin phase, which in itself is conceived as a solution. The anion exchange equilibria, however, are complicated by the wide variation in basicity of the active amine groups and by the partial hydrolysis of all the resin salts.

8. Exchange Rate of Anion Exchange Resins

Papers presented by Nachod and Wood (10), and by Kunin and Myers (21) have discussed the exchange rate in the reactions of anion exchange resins. The absorption of acids by these resins has been shown in both publications to be slow in comparison with cation exchange. This, however, is probably caused as much by the weakly basic character of the resins, as by the slower diffusion of anions through the gel structure of the anion exchangers. We have already noted in cation exchange resins that the rate of NaOH neutralization becomes progressively slower as weaker acidic groups are neutralized, in spite of the fact that the diffusion coefficient remains constant. For this reason it is not a fair comparison of

diffusion coefficients in cation and anion exchange gels, when we match the rate of absorption of acids by a commercial anion exchange resin with the exchange rates of cation exchange resins of the sulfonic acid type. The comparison should be much better in matching the rate of anion exchange between the chloride and nitrate or between chloride and sulfate with cation rates between sodium and potassium or between sodium and calcium, respectively. This latter comparison can now be made by comparing the results of Kunin and Myers on the Cl^- - SO_4^{2-} exchange rate on Amberlite IR-4 with the Na^+ - Ca^{++} exchange rate on various cation exchangers studied by Nachod and Wood. In both cases approximately 90% of the overall reaction occurs in the first 5 minutes, indicating that the exchange was equally fast for both cation and anion exchange resins. Though this comparison itself is not exact (particle sizes are not exactly the same, concentrations are not the same, and in neither case do we know whether particle diffusion or surface is rate controlling), it does show that the diffusion rates are probably of the same order of magnitude in anion exchange resins as in cation exchange resins.

The absorption of acids by anion exchange resins has been shown to be controlled by diffusion in the gel particles by Kunin and Myers, except for resins prepared from a porous base. They have found agreement with the parabolic diffusion law during the early stages of the absorption-indicative of diffusion control, as discussed by Boyd and his coworkers (9). At higher concentrations and with greater absorption, this simple law does not hold. The experimental data appear to be very extensive, so that a close analysis along the lines of Boyd's excellent theoretical development should broaden our knowledge of anion exchange rates.

BIBLIOGRAPHY

1. Adams, B. A., and Holmes, E. L., *J. Soc. Chem. Ind.* **54**, 1-6T (1935); British Patents 450, 308-9 (1936).
2. Bauman, W. C., and Hunter, M. J., U. S. Patent 2,409,861 (1946).
3. Wassenegger, H., and Jaeger, K., U. S. Patent 2,204,539 (1940).
4. Kern, W., *Z. physik. Chem.* **181**, 249 (1938); Speiser, R., Hills, C. H., and Eddy, C. R., *J. Phys. Colloid Chem.* **49**, 334 (1945); Bartlett, P. D., and Nozaki, K., *J. Am. Chem. Soc.* **68**, 1495 (1946); Katchalsky, A., and Spitnik, P., *J. Polymer Sci.* **2**, 432 (1947); Fuoss and Cathers, *ibid.* **2**, 12 (1947).
5. Procter, H. R., and Wilson, J. A., *J. Chem. Soc.* **109**, 307 (1916).
- 5a. Flory, P. J., and Rehner, J., Jr., *J. Chem. Phys.* **11**, 512, 521 (1943).
6. Walton, H. F., *J. Phys. Chem.* **47**, 371 (1943).
7. Taylor, H. S., *Treatise on Physical Chemistry*. Van Nostrand, New York (1931), 2nd ed., p. 406 p. 1580.
8. Harned, H. S., and Owen, B. B., *The Physical Chemistry of Electrolytic Solutions*. Reinhold, New York (1943), Appendix.
9. Boyd, G. F., Adamson, A. W., and Myers, I. S., *J. Am. Chem. Soc.* **69**, 2836 (1947).

10. Nachod, F. C., and Wood, W., *J. Am. Chem. Soc.* **66**, 1380 (1944); **67**, 629 (1945); du Domaine, J., Swain, R. L. and Hougen, D. A., *Ind. Eng. Chem.* **35**, 546 (1943); Thomas, H. C., *J. Am. Chem. Soc.* **66**, 1664 (1944); Walter, J. E., *J. Chem. Phys.* **13**, 229 (1945); Beaton, R. H., and Furnas, C. C., *Ind. Eng. Chem.* **33**, 1501 (1941); Boyd, G. E., Myers, L. S., and Adamson, A. W., *J. Am. Chem. Soc.* **69**, 2849 (1947); Bauman, W. C., and Eichhorn, J., *ibid.* **69**, 2830 (1947); Juda, W., and Carron, M., *J. Am. Chem. Soc.* **70**, 3295 (1948).
11. Griessbach, R., *Z. Ver. deut. Chem. Beihefte.* **31**, 1 (1939); Walton, H. F., *J. Phys. Chem.* **47**, 371 (1943); du Domaine, J., Swain, R. L., and Hougen, O. A., *Ind. Eng. Chem.* **35**, 546 (1943).
12. Gregor, H. P., Paper presented at American Chemical Meeting, September, 1947.
13. Beaton, R. H., and Furnas, C. C., *Ind. Eng. Chem.* **33**, 1501 (1941); Tiger H. C., and Goetz, P. C., U. S. Patent 2,397,575 (April 2, 1946); Schmidt, R. W., *Ind. Eng. Chem.* **34**, 744 (1942); Lindsay, F. K., *ibid.* **35**, 378 (1943).
14. Cheetham H. C., and Myers, R. J., U. S. Patent 2,341,907 (1944).
15. Kunin, R., and Myers, R. J., *J. Am. Chem. Soc.* **69**, 2874 (1947).
16. Schwartz M. C. Edwards, W. R., Jr., and Boudreaux, G., *Ind. Eng. Chem.* **32**, 1462 (1940).
17. Myers, R. J., Eastes, J. W., and Urquhart, D., *Ind. Eng. Chem.* **33**, 1270 (1941).
18. Manning, W. E., *Proc. Ann. Water Conf. Engrs. Soc. West. Penn. 6th Ann. Conf.* 1945; Gilwood, M. E., *ibid.*, 7th Ann. Conf. (1946).
19. Jenny, H., *J. Colloid Sci.* **1**, 33 (1946).
20. Bishop, J. A., *J. Phys. Chem.* **50**, 6 (1946).
21. Kunin, R., and Myers, R. J., *J. Phys. Chem.* **51**, 1111 (1947).

Ion Exchange Equipment Design

M. E. GILWOOD

The Permutit Company, New York, New York

CONTENTS		<i>Page</i>
I.	Introduction	77
II.	The Process	78
III.	Sweetening Off — Sweetening On	79
IV.	The Equipment	80
V.	The Tank	80
VI.	Distributors — Collectors	82
	1. Introduction	82
	2. The Upper Distributor	83
	3. The Regenerant Distributor	83
	4. The Bottom Collector (Underdrain System)	83
VII.	The Supporting Media	85
VIII.	The External Piping and Valves	85
IX.	Regenerant Introduction	89
X.	Regenerant Handling and Preparation	89
	1. Sodium Chloride	89
	2. Sulfuric Acid	90
	3. Sodium Carbonate and Sodium Hydroxide	90
	4. Ammonium Hydroxide	90
XI.	Rinse and Backwash Controls	90
XII.	Automatically Operated Units	91
XIII.	Multiple Unit Plants	96
XIV.	Miscellaneous Controls and Control Devices	96
XV.	Regenerant Recovery	98
XVI.	Noncolumnar Operation	98
	Bibliography	99

I. INTRODUCTION

In previous chapters considerable information has been presented on the theory of ion exchange and ion exchangers. This chapter describes the equipment arrangements and mechanical devices employed in connection with the practical large scale use of ion exchangers. Most ion exchange (or zeolite) equipment is employed for water treatment and the historical development of ion exchange equipment is based almost wholly on water treatment practice. Since similar equipment design is employed for ion exchange units used in other industries, such as sugar purification, chemical

processing, etc., most of this chapter is devoted to description of various types of ion exchange equipment employed in water treatment practice. Some mention will be made of the modifications necessary in designing units for other applications. It should be stated that the proper design of ion exchange units requires much experience and involves many pitfalls. The prospective user of ion exchangers should therefore contact reputable manufacturers of ion exchange equipment for recommendations.

II. THE PROCESS

Ion exchangers are most efficiently utilized in columnar bed operation. By flowing the solution to be treated through a stationary columnar bed of granules effective "countercurrent" operation is obtained. When these particles no longer exchange ions to a sufficient extent with the solution being treated the bed is termed "exhausted." The inflowing solution comes in contact first with the most exhausted portion of the ion exchange bed. On leaving the unit the treated solution comes in contact with the least exhausted portion. If the treated solution leaving the unit has not had a sufficient proportion of its ions exchanged during its passage then the bed needs "regeneration." The ion exchange material is restored to its original active or "regenerated" condition by treatment with a solution containing some selected ion in sufficiently high concentration.

Practically all ion exchange columns are operated in such a manner that during the "treatment" or "operating" step, the incoming liquid passes downwardly through a vertical column of the ion exchanger (9). The following description, therefore, is given in connection with the operation of such downflow operated ion exchange units.

In order to circumvent a patent situation, some equipment manufacturers formerly supplied upflow operated ion exchange units. However, with the expiration of these patents, all ion exchange equipment suppliers now employ downflow operated units. There are some occasional applications where advantages may be obtained by employing upflow operated ion exchange columns. However, these are few.

In practice, ion exchanger operation is divided into several cyclic steps:

- (a) The operating run.
- (b) Cleansing the ion exchange bed of mechanically filtered dirt or precipitates by backwashing or upflow washing.
- (c) Introduction of regenerant.
- (d) Displacement of regenerant and rinsing of the bed.

The arrangement most generally used for ion exchange equipment is shown in Fig. 1.

A. During the *operating run* the influent liquid is introduced through inlet pipe A and distributor B into the upper part of tank C. The fluid then percolates through the granular ion exchange bed D, the granular supporting medium E, the bottom collector F, and passes out to service through outlet pipe G.

B. During the *backwash* operation pressure water is introduced through pipe P and the bottom distributor F, and then flows up through the supporting layer E, the ion exchange bed D, out through B, and finally goes to waste through outlet M.

C. *Introduction of regenerant* — frequently termed “regeneration” or “brining”: The regenerant is introduced by a pump or pumping device (J) from tank L, through pipe H and distributor K, and percolates downward through the ion exchange bed D, the supporting medium E, the bottom collector F, and out to waste through waste pipe N to the sewer.

D. *Rinse*. Upon completing the introduction of regenerant, the regenerant remaining in the bed is displaced and rinsed from the unit by introducing water through A and B, down through the ion exchange bed D and out to waste through pipe N. When the excess regenerant has been rinsed sufficiently from the bed, the ion exchange bed is in proper condition for treating another quantity of liquid.

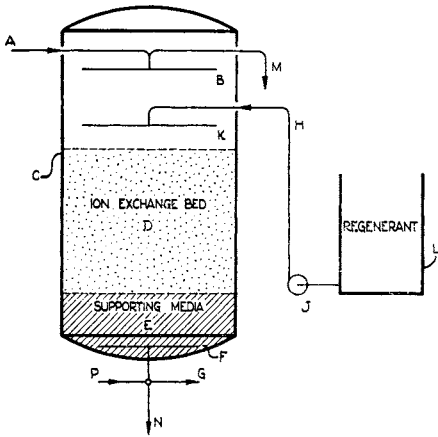

FIG. 1. Ion exchanger arrangement.

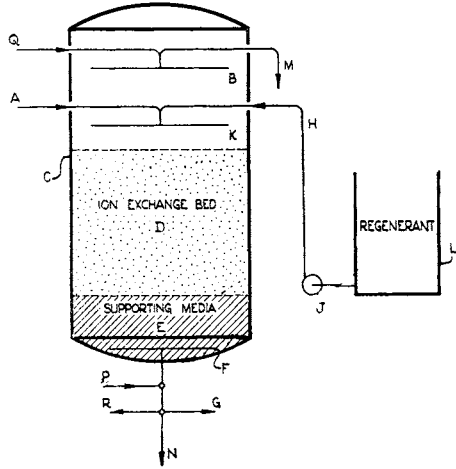

FIG. 2. Ion exchanger arrangement when including sweetening off and sweetening on operations.

III. SWEETENING OFF — SWEETENING ON

When the solution to be treated is other than water, and is valuable, it is necessary to incorporate two additional steps in the restoration or “regeneration” procedure.

Sweetening Off. The first step is displacement of the valuable solution from the ion exchange unit. At the end of the operating run, prior to backwashing, the solution is displaced by passing water through the bed.

This step has acquired the name "sweetening off" from sugar industry terminology.

During the operating run the liquid undergoing treatment is introduced into the unit close to the ion exchange bed through inlet A and lower distributor K (Fig. 2). It leaves the unit through outlet pipe G. During the sweetening off operation water is passed into the unit through inlet pipe Q (Fig. 2) and then the liquid in the unit is displaced through R to a recovery tank until it has all been recovered. The unit at this stage contains only water, and upon backwashing only water will be discharged to the sewer.

Sweetening On. Upon completion of the rinsing operation the unit is completely filled with water. When the solution to be treated by the ion exchanger is passed into the unit immediately after completing the rinsing step, the first effluent from the ion exchange bed will be water. Within a short period the concentration of the solution being treated will increase in the ion exchanger effluent. Finally, the effluent concentration will reach that present in the influent. If it is not desired to dilute the solution treated by the ion exchange bed, it is necessary to separate that portion of the effluent from the ion exchange unit which is below an arbitrarily fixed minimum concentration. This step has acquired the name of "sweetening on." The diluted solution from the ion exchanger is passed to a recovery tank. In practice the solution to be treated is introduced close to the ion exchange bed through inlet pipe A (Fig. 2) and lower distributor K and then flows downwardly into the bed, displacing the water below distributor K through waste pipe N. When the concentration of valuable constituents in the water leaving the unit reaches a predetermined concentration, the treated liquid is diverted to outlet R and recovered. When the concentration of valuable constituents in the effluent has increased sufficiently the treated effluent is diverted to outlet pipe G and the unit is returned to its "operating run."

IV. THE EQUIPMENT

A typical ion exchange unit is illustrated in Fig. 3. This is a "zeolite" water softener in which sodium chloride is used for regenerating the ion exchange bed. This unit is designed for operation under pressure. The similarity in appearance to a pressure sand filter (1) is readily discernible.

V. THE TANK

For pressure units (e.g., see Fig. 3) the tank is generally a steel shell of thickness and construction sufficient to withstand the maximum pressure at which it is desired to operate the installation. The shells must be fitted

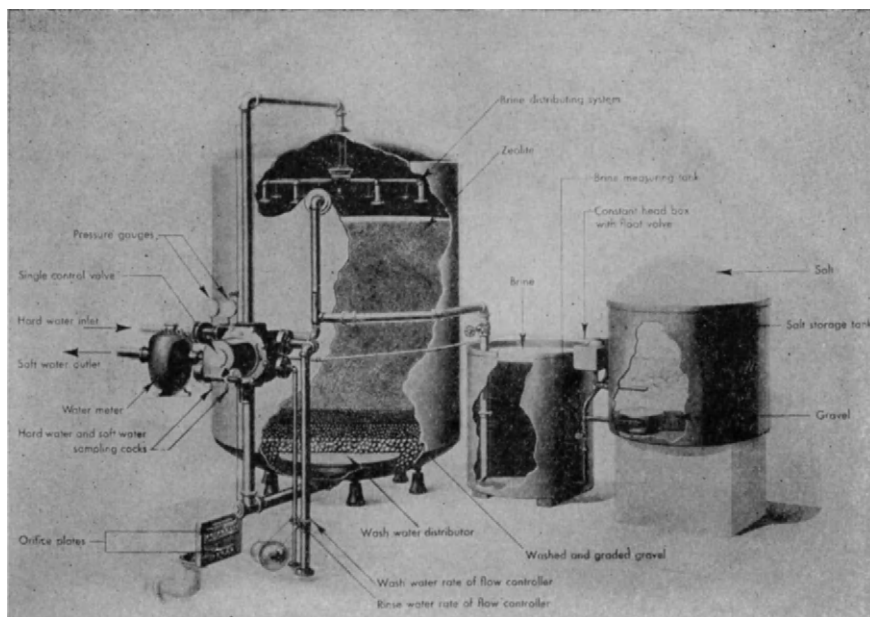

FIG. 3. Manually operated zeolite water softener with multiport single valve.*

with reinforced openings for piping connections. A manhole is provided in the top head to make the interior available for inspection, repairs, etc. Suitable supports for the tank shell must be provided to allow free circulation of air under the tank. Otherwise the bottom of the tank will get moist and corrode. A suitably designed support is illustrated in Fig. 4.

When the ion exchange unit is to be operated on a cycle in which contact with acid or corrosive liquids occurs the steel shells must be protected with rubber or plastic linings. Such linings must be sufficiently thick and impermeable to avoid pinholes. Some pressure units have also been designed of special alloys to withstand corrosive conditions. Special alloys have been used where it is necessary to avoid pickup of objectionable metals. However, generally rubber lined units are the most commonly used and have given complete satisfaction in many years' operation.

For gravity operated units, open tanks of reinforced concrete, wood, or steel have been used. The reinforced concrete tanks are usually of rectangular cross section. In such gravity units level controls are generally used to avoid overflowing or draining the units. However, since most ion exchange units are operated under pressure, we will devote the bulk of this discussion to pressure units. The principles of design and operation are similar in both types of plants.

*Figures 3-18 by courtesy of The Permutit Company.

VI. DISTRIBUTORS — COLLECTORS

1. Introduction

For proper operation of an ion exchange unit it is essential that liquids be distributed uniformly across the surface area of the bed and collected uniformly after passage through it. Unless proper precautions are taken the ion exchange bed will not remain level. Uneven flow distribution will



FIG. 4. Jackleg tank support.

move the material laterally during the operating run, making the bed vary in depth. Uneven distribution results in more flow through some portion of the tank and leads to low exchange efficiencies.

Different types of distributors are used depending on the size of the unit, type of operation, characteristics of the ion exchanger employed, etc.

2. *The Upper Distributor*

The upper distributor is used for introducing influent water during the operating run and rinsing operation and for collecting the backwash effluent. This unit must be carefully designed to make sure that distribution in each step is uniform, and must be located at the proper distance above the ion exchange bed to permit sufficient expansion of the bed during backwashing so that it will be possible to wash mechanically entrapped dirt from the bed during this operation. The distributor must be of sufficient mechanical strength and made of suitable materials to avoid corrosive attack. For small units it is possible to employ a simple baffle and obtain suitable flow characteristics, but this is not generally the case. For many applications a radial distributor system with proper hydraulic design of the orifices is required.

3. *Regenerant Distributor*

The regenerant distributor "K" is usually located close to the ion exchange bed to avoid excessive dilution of the regenerant introduced into the unit (10). Even distribution of regenerant across the bed surface is essential for complete regeneration of all portions of the ion exchange bed. The regenerant distributor is usually mechanically supported by the distributor "B."

4. *The Bottom Collector (Underdrain System)*

Good design of the bottom collector is likewise essential. If all the treated effluent were collected through a single outlet, there would be considerable short-circuiting to that point even though proper distribution was maintained by the upper distributors. Therefore, it is necessary to employ a carefully designed system to collect the effluent across the entire bottom area of the ion exchange bed.

Improper distribution through this underdrain system during backwashing may upset the gravel. This will then lead to short-circuiting during the regeneration and operating run, and, after a period of operation, the ion exchange unit will not have the proper efficiency. Eventually the unit may require unloading to re-lay the supporting media. The underdrain system must be designed to discharge the backwash water laterally to prevent upward jet action.

Header and lateral distributors are common in larger units. Strainers, which screw into the laterals, are designed to collect and distribute the liquid efficiently and are so spaced as to assure a uniform distribution throughout the cross section area of the tank. A typical strainer is illustrated in Figs. 5 and 6. Steel deflector baffles (lined with rubber if corrosive conditions prevail) are used on smaller units.

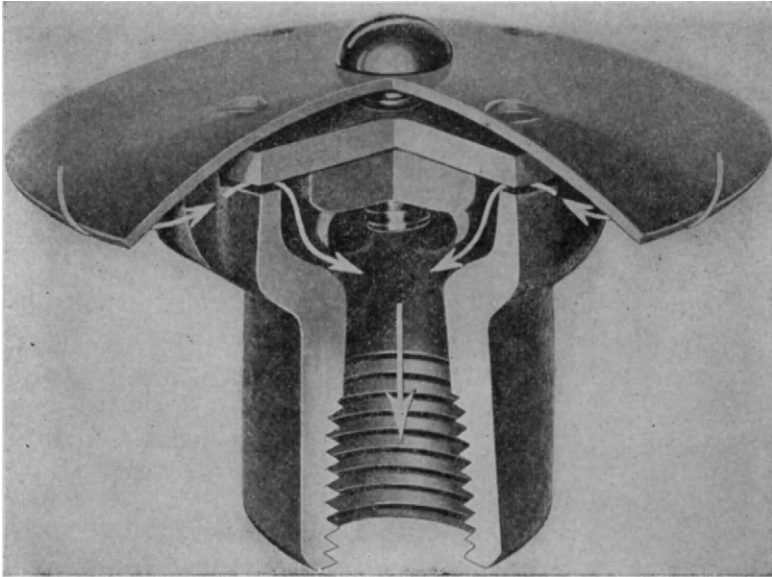

FIG. 5. Cut away view of expansible strainer (arrow showing flow during operating run).

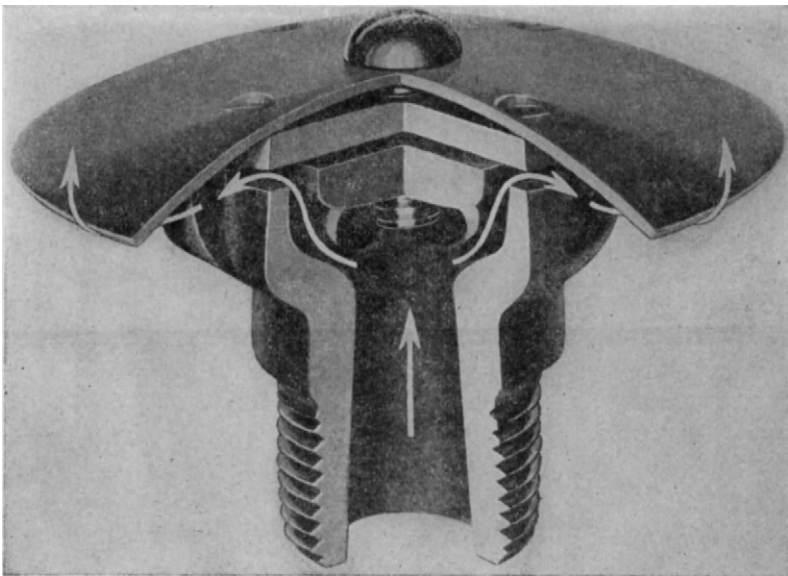

FIG. 6. Cut away view of expansible strainer (arrow showing flow during backwash).

VII. THE SUPPORTING MEDIA

For support of the ion exchange bed it is necessary to employ layers of several sizes of graded gravel. In some cases anthracite coal of proper size has been used to support the ion exchange bed. However, generally siliceous gravel free of soluble contaminants is more desirable, because it is heavier and is less likely to be upset in case of occasional improper operation of the unit. The gravel must be carefully selected where acid liquids are passed through the units. Otherwise dissolution of nonsiliceous gravel will contaminate the effluent. The gravel used varies in size from $1\frac{1}{2}$ to $1/16$ inch in diameter.

VIII. THE EXTERNAL PIPING AND VALVES

There are several arrangements of the external piping for ion exchange units. On the early units a nest of gate valves was installed. A typical arrangement of this type is illustrated in Fig. 7. In view of the fact that

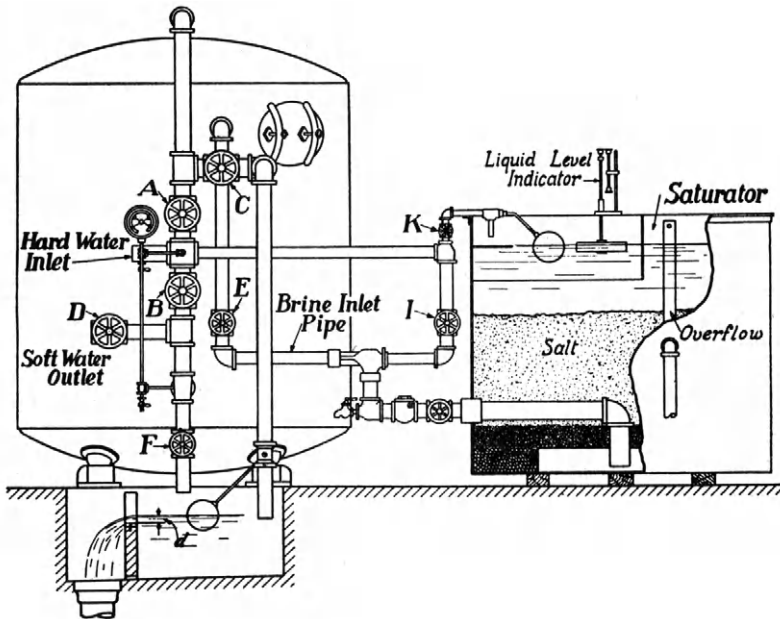

Fig. 7. Manually operated valve-nest zeolite softener.

there are so many valve operations during a single backwash, regeneration, and rinse, much ingenuity has been applied to simplifying the valve and piping arrangements. Modern ion exchange units are fitted with special valves capable of directing the flow of liquids through the ion exchange unit in the backwashing, regenerating, rinsing, and service steps, with a

single revolution of the valve mechanism. By employing such single valves it is possible to avoid using as many as eight gate valves that would otherwise be necessary (2, 12). As a result the possibility of error by the operating personnel is greatly reduced. A typical single valve commonly used is illustrated in Figs. 8 and 9. The valve and interconnecting piping are mounted on the ion exchange tank as shown in Fig. 3.

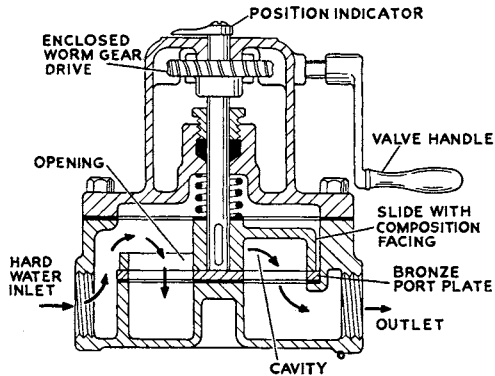

FIG. 8. Manually operated multiport valve, sectional view.

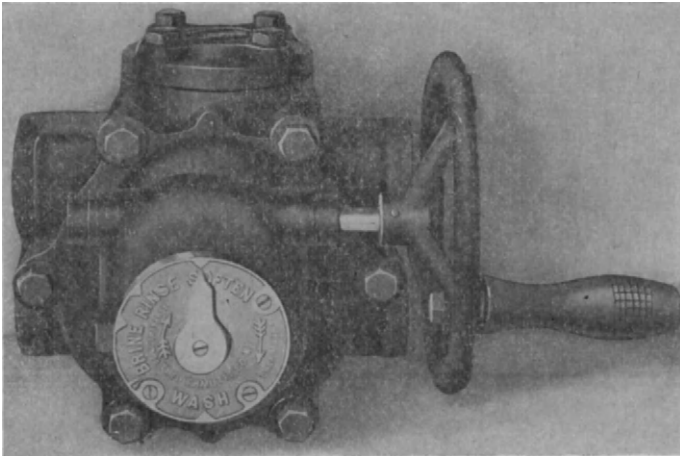

FIG. 9. Manually operated multiport valve.

This valve passes through four settings with one revolution of the valve mechanism:

(a) When the pointer is moved from the "Soften" position the unit is taken off its "operating run." When the valve is rotated sufficiently for the pointer to reach "Wash," the backwash or upflow wash is started.

(b) "Regeneration" — the backwash is ended and the regeneration started by rotating the valve to "Brine."

(c) "Rinsing" — the regenerant introduction is ended by rotating the valve to "Rinse," which places the unit in the displacement or rinsing position.

(d) The "rinse" is ended and the unit started on its next operating run by rotating the valve to the "Soften" position.

This multiport valve consists of a flat, composition faced, distributing slide (or disc), which is kept in tight contact with a stationary port plate. The flat slide disc is rotated from one position to another and permits the proper liquids to enter the appropriate ports in each step of the cycle. The influent is admitted to the top of the disc and is then directed, by an opening in the disc, to a port plate opening.

The effluent leaving the ion exchange unit flows through a cavity in the contact surface of the disc to the proper outlet pipe. The inlet water pressure acting on the top of the disc, aided by the pressure of a spring, holds the valve disc firmly against the port plate. This pressure and a certain amount of flexibility inherent in the composition face insure a valve that remains tight at all times. The valve action is smooth since the nature of the materials used makes it impossible for the moving parts to corrode or stick. A completely housed worm gear reduction rotates the valve stem

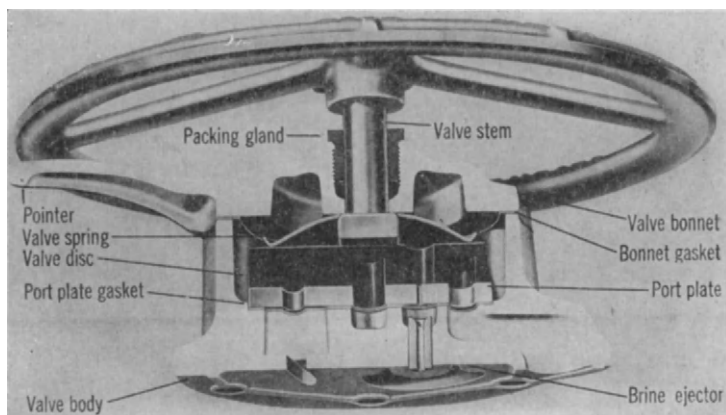

FIG. 10. Multiway valve with integral regenerant ejector, sectional view.

at a slow and steady rate, thus providing a gradual increase and decrease of the rate-of-flow at the start and end of each operation. This minimizes the possibility of upsetting the supporting gravel bed by hydraulic shocks.

Where corrosive liquids are being treated in the ion exchange unit, the metal valve parts are made of corrosion resistant metals or are lined or coated with suitable protective coatings. The piping is usually either rubber lined or hard rubber.

Small units are usually designed with the multiport valve mounted on the top of the ion exchange unit tank. This permits eliminating the external piping (3, 6). A valve of this type is illustrated in Fig. 10. A typical ion exchange unit of this type is illustrated in Fig. 11 (a household water softener). Another type of single multiport valve is designed in

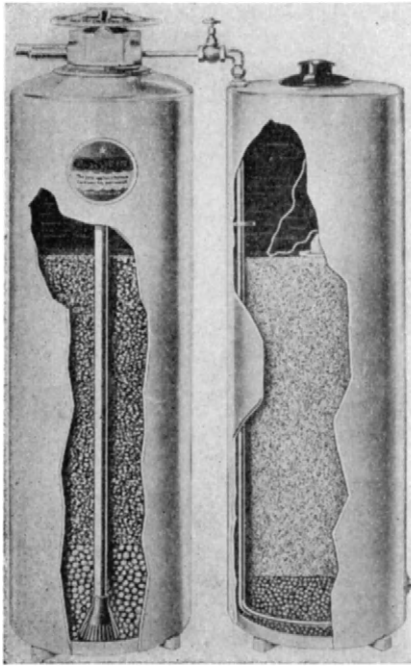

FIG. 11. Manually operated small zeolite water softener with multiport valve.

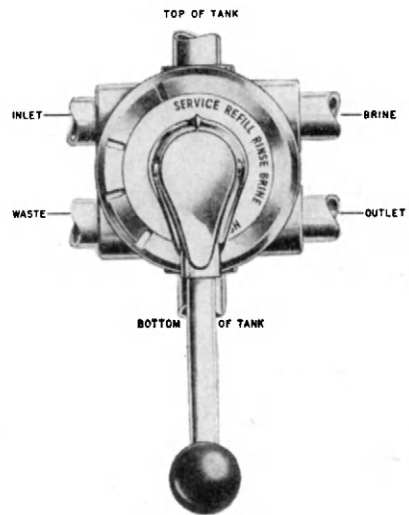

FIG. 12. Lift-turn single valve.

such a manner that the rotating disc is separated from the port plate by lifting a lever prior to rotation (5). The port plate is covered with a soft rubber gasket against which the disc is pressed when it is in the proper position. The disc is free to rotate when separated from the soft rubber gasket. After being rotated to the proper position, it is pressed against the gasket on the stationary port plate. A typical "lift turn" valve is illustrated in Fig. 12.

IX. REGENERANT INTRODUCTION

One of two methods is usually employed for introducing the regenerant into the ion exchange unit, depending on the type and amount of regenerant. In most installations a hydraulic ejector is found most convenient. The ejector has two functions:

(a) To dilute the regenerant to the proper concentration.

(b) To supply sufficient head to lift the regenerant from the regenerant tank into the ion exchange unit.

Usually the ejector is separate from the multiport valve and is interconnected with the regenerant tank and the water supply. The ejector is supplied with pressure "operating" water when the multiport valve is turned to the "regeneration" or "brining" position. However, the multiport valves installed on smaller ion exchange units (see Fig. 10) have an ejector integrated into the internal structure of the valve mechanism. This makes it possible to further simplify the piping arrangement on such units.

On very large installations the regenerant is introduced by means of a centrifugal pump. The regenerant is diluted where necessary by mixing dilution water with the concentrated regenerant being pumped.

X. REGENERANT HANDLING AND PREPARATION

The equipment necessary for regenerant handling and preparation varies with the type of regenerant. The usual regenerants employed for commercial ion exchange units are: salt, NaCl; acid, H₂SO₄; alkali, Na₂CO₃, NaOH, NH₄OH.

1. Sodium Chloride

The sodium chloride brine used in ion exchange installations is generally prepared in a salt saturation tank. Salt of coarse grain size is filled into the "saturator" tank. The bottom of this tank has a gravel supporting layer to retain the salt crystals and to filter the saturated brine. It is common practice to provide the salt storage tank with an automatic float control water inlet valve located in a separate float chamber outside of the tank. The saturated brine formed in the saturator is permitted to fill a measuring tank, which is provided with proper indicators to show the correct volume required for each regeneration. From this tank the proper quantity of saturated brine is drawn and injected into the ion exchange unit. The arrangement is illustrated in Fig. 3. The salt saturator and brine measuring tanks are made of steel and should be protected by heavy galvanizing or by a brine resistant protective coating.

Where large amounts are required for regeneration it is economical to purchase salt in bulk shipments. It is then generally desirable to install a

large concrete wet salt storage basin capable of holding more than a carload of salt. Pumps are employed to transfer the brine from the basin to the measuring tank from which the correct quantity of brine is introduced into the ion exchange unit.

2. Sulfuric Acid

Sulfuric acid is measured out volumetrically from a concentrated acid measuring tank into a dilution tank. It is usually agitated in the dilution tank with air, although mechanical agitators may be employed. The acid drawn from the acid dilution tank is diluted further to the proper concentration upon passage through the hydraulic ejector on its way into the ion exchange unit. Where large quantities of acid are required, sufficiently large steel storage tanks are provided for storing tank car lots of the concentrated sulfuric acid. The acid measuring and dilution tanks must be corrosion resistant. Lead lining is generally recommended. If large quantities are to be handled suitable corrosion resistant pumps are used. A typical acid measuring, dilution, and introduction system is included on the left-hand side of the ion exchange plant, see Fig. 14.

3. Sodium Carbonate and Sodium Hydroxide

These alkalis are weighed and dissolved directly in an alkali tank provided with a high speed agitator. Steel tanks are satisfactory for this purpose. The alkali may be dissolved at the required dilution strength or may be dissolved in more concentrated form and then diluted further by an ejector or other means. A typical alkali handling system is included in Fig. 14, on the right-hand side of the ion exchange plant.

4. Ammonium Hydroxide

Ammonium hydroxide is employed in some plants for regenerating anion exchange units. More complicated handling equipment is required for it than for sodium carbonate and sodium hydroxide. It has only been used in very large installations since it can then be purchased in tank car lots of liquid NH_3 . In this form it is somewhat cheaper per equivalent than sodium hydroxide or even sodium carbonate. The liquid NH_3 is drawn from the tank car, generally by its own pressure, into steel storage tanks. From there it is introduced in measured amounts directly into water in a solution tank. The ammonium hydroxide forms readily and is then pumped into the ion exchange units.

XI. RINSE AND BACKWASH CONTROLS

The flow rate of both the backwash and rinse water must be carefully controlled. This is done by installing rate of flow controllers in the back-

wash outlet and rinse outlet lines. These rate of flow controllers generally consist of float valves of the butterfly type. The float valves maintain a definite head of water behind an orifice plate in a sump, thus providing a constant rate of flow during the operation regardless of any fluctuations in the pressure in the supply line. The orifices are installed on an orifice board of the type shown in Fig. 3. Since the rinse flow rate and the backwash flow rate are usually not the same, it is necessary to employ two separate outlet pipes each with float control and either two sets of orifices or, if possible, a different head over the same set of orifices. It is essential to provide suitable stilling baffles in the sump in order to have satisfactory flow rate control.

In small installations where pressure conditions do not vary much, simpler control devices are employed. In some installations it has been found advantageous to install a rate of flow meter on the inlet of the ion exchange unit. In such cases the flow rate is adjusted by a throttling valve to the rate desired, while watching the rate-of-flow meter. If the flow rate during the rinsing or backwashing operation varies it is immediately indicated on the rate-of-flow meter, and the operator readjusts the throttling valve.

XII. AUTOMATICALLY OPERATED UNITS (4, 7, 8, 11, 13, 14)

Ion exchange units with provisions for automatic backwashing, regeneration and rinsing, and return to service, have become commonplace in the past fifteen years. Such automatic units have several advantages over the manually operated units:

(a) They are not disturbed by the human vagaries of the operating personnel and therefore the operating cycles are performed with consistency and lack of error.

(b) They reduce the amount of labor required for operating the units.

(c) They can be made smaller than the manual units required at a given plant because it is possible to operate the units on more repetitive cycles per day, without an increase in the operating personnel required.

The simplest automatic ion exchange unit employs an electric motor to rotate the disc slide of the rotary multiport valve (7, 8). Such an automatic multiport valve is illustrated in Fig. 13. By replacing the manual single multiport valve, illustrated in Fig. 3, by the motor operated valve, illustrated in Fig. 13, and supplying the necessary electrical controls, an automatic zeolite softener is obtained (11). An automatic two step cation-anion exchanger demineralizing plant is shown in Fig. 14.

The length of the "operating run" is controlled by an electric contact head flow meter, usually installed on the effluent line. When a pre-determined amount of effluent has been delivered by the ion exchange unit

during the operating run, this meter closes an electric switch that starts the motor connected to the multiport valve. The motor remains in operation until the disc slide of the valve reaches the backwash position. At

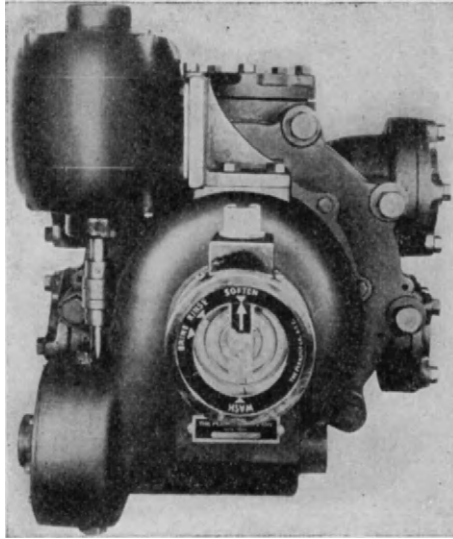

FIG. 13. Motor-operated automatic multiport valve.

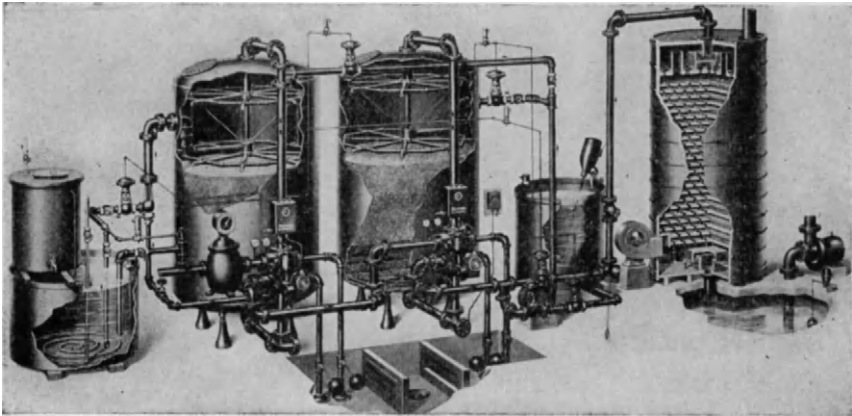

FIG. 14. Automatic two step demineralizing plant.

this point an electrical contact switch in the valve opens and stops the motor. At the same time an electrical timer is started. After the required amount of time for backwashing has elapsed, the timer switch initiates the

motor again. The motor rotates the slide disc to the "regeneration" or "brine" position.

In this position of the valve, pressure water opens a pilot valve in the regenerant line and simultaneously starts water flowing through a hydraulic ejector to draw the regenerant into the ion exchange unit. When a pre-

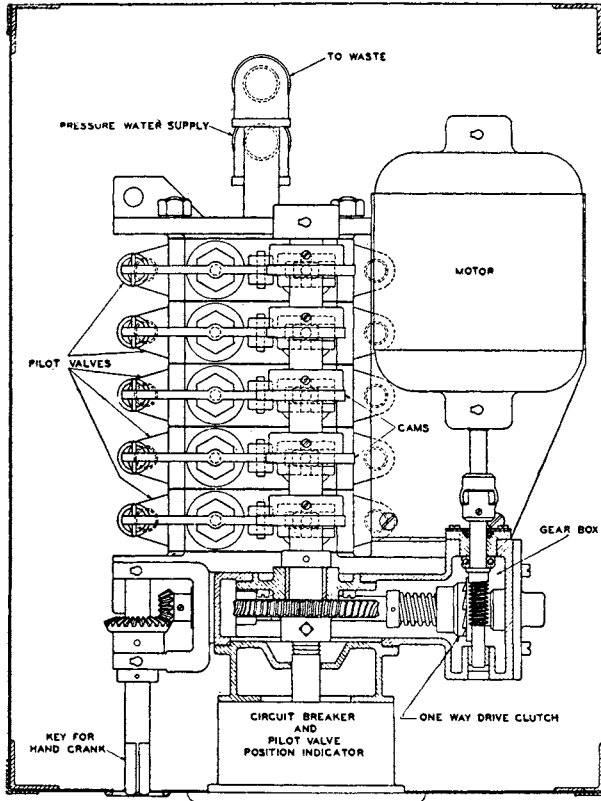

FIG. 15. Hydraulic valve, poppet valve arrangement.

determined amount of regenerant has been drawn from the regenerant tank, a float switch in this tank closes, establishing a circuit that starts the motor. The slide disc is rotated to the rinse position. The pilot valve in the regenerant line is closed and the water flow through the hydraulic ejector is stopped. When the slide disc reaches the "rinse" position an electric contact is broken and the motor is stopped.

Since the rate of flow through the unit in the rinse position is controlled by the setting on the "rinse rate-of-flow" controller float valve, the volume of rinse water can be governed by an electric timer. After the

necessary time has elapsed this switch closes, again starting the motor and turning the slide disc to the "service" (or soften) position. The unit is thus returned to the fully regenerated condition and is able to start another operating run.

Where it is desired to "sweeten off" and to "sweeten on" it is necessary to provide some additional pilot operated valves.

On very large ion exchange units single multiport valves of sufficient size are not available. In such cases a valve nest arrangement like that illustrated in Fig. 7 is employed. However, since the valves are automatically operated in this case most of the disadvantages of valve nest units are eliminated. In these installations the valve discs are opened and closed by hydraulic pistons or diaphragm motors.

To actuate the opening and closing of the numerous valves in proper sequence a master pilot valve assembly (see Figs. 15 and 16) and a set of timers are employed. This type of control consists essentially of a battery

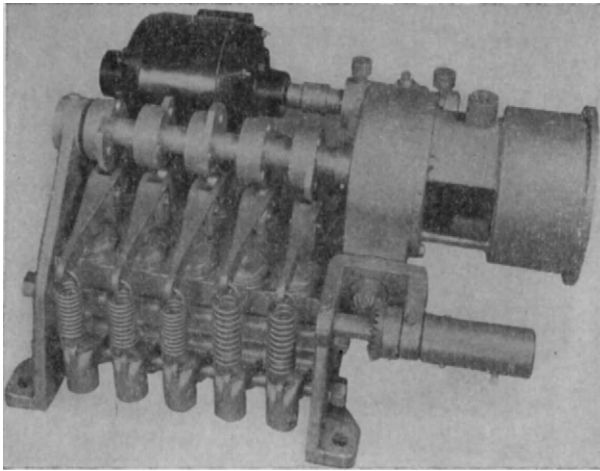

FIG. 16. Master poppet pilot valve assembly.

of individual, double-acting twin poppet pilot valves operated by the cams on a common shaft (13). Each of these pilot valves operates one hydraulic valve. The hydraulic valves are mounted at the front of the ion exchange unit. The master pilot valve assembly is mounted in an operating cabinet or operating table on the "main operating floor."

One individual poppet pilot valve is illustrated in Fig. 17. The pilot valve has two water connections to the two ends of the hydraulic cylinder. The pilot valve casing also has two chambers, one connected to the pressure water supply and the other to waste. Each of the two water connections

to the hydraulic cylinder is controlled by a double acting poppet so that each cylinder connection may be placed in communication with either pressure water supply or waste. One rocking operating lever actuates

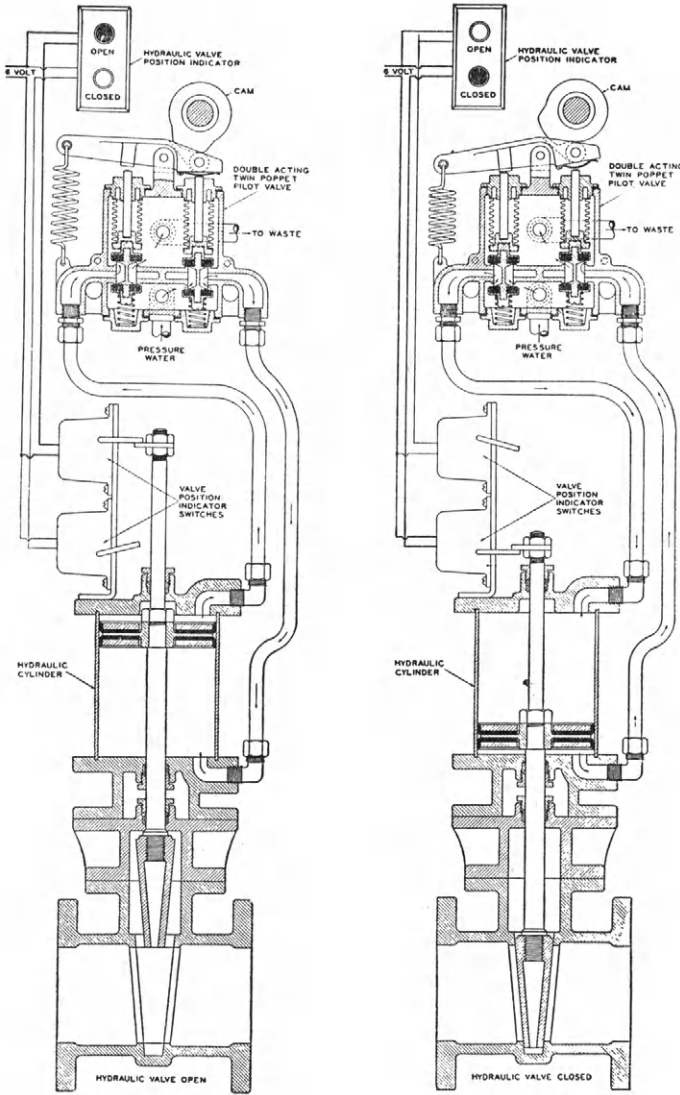

FIG. 17. Master poppet pilot valve.

the stems of the two poppets so that they move in opposite directions. Thus with the lever positioned for opening the hydraulic valve, the bottom of the cylinder receives pressure water while the top of the cylinder dis-

charges to waste. With the lever positioned for closing the hydraulic valve, the top of the cylinder receives pressure water and the bottom of the cylinder discharges to waste. The rocking of the lever is accomplished by a cam contacting a roller mounted on the lever.

The poppet valves required for control of each softener unit are mounted as illustrated in Fig. 16. The shaft on which the cams are mounted is turned by an electric motor. However, a crank is provided for operating the pilot valves by hand. The shape of the cams and their angular position on the cam shaft determines the sequence of valve operations. This results in great flexibility. The master Pilot Control can readily be adapted to any desired cycle of operating steps. The operating cycle can also be subsequently changed simply by altering the cam arrangement.

The cam shaft motor is controlled by a group of switches. The switch that initiates the reconditioning cycle of an automatic ion exchange unit of this type is usually actuated by a flow meter or a time clock. The duration of the individual steps — sweetening off, backwashing, regenerating, rinsing, and sweetening on is controlled by time switches and float switches as described previously in connection with the automatic multiport valve operation. In each case these switches energize the motor after an operating step has been completed. When the cam shaft has then moved to the next position, the motor is again de-energized by a circuit breaker attached to the cam shaft. Thus, correct positioning of the master control is always assured.

XIII. MULTIPLE UNIT PLANTS

At most ion exchange installations there are advantages in employing a battery of units instead of a single large unit. By using a battery of units it is possible to treat the influent solution continuously while another unit is out for regeneration or reconditioning. Many such multiple unit installations are automatically operated. In these cases interlocking devices must be provided so that not more than one unit will be out of service for regeneration at any one time. Figure 18 illustrates a typical automatic multiple unit plant where the units are interlocked in this manner.

XIV. MISCELLANEOUS CONTROLS AND CONTROL DEVICES

1. Ion exchange units are generally provided with pressure gauges at the inlet and outlet. These gauges are desirable in order to keep the operator informed of the change in pressure loss through the ion exchange beds as the operating run proceeds.

2. Integrating flow meters of the crest type are usually provided with ion exchange units. Disc meters are used on smaller installations. On very large installations orifice or Venturi tube operated integrating flow meters are employed.

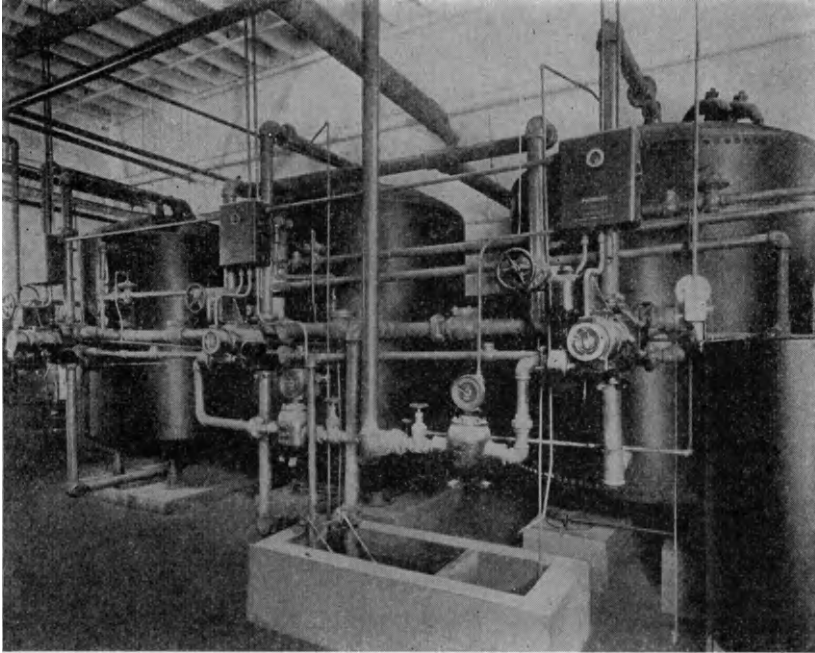

FIG. 18. Automatically operated multiple unit zeolite water softener installation.

3. Rotameters are employed to advantage in some instances. Indication and control orifice type rate of flow indicators are also used in some cases.

4. On demineralizing installations it is common practice to employ conductivity devices with an indicator such as a magic eye as shown in Fig. 19, to indicate the end of the operating run of either the cation or anion exchange unit.

5. In some cases electronic pH meters have been used to advantage for indicating the beginning and end of the various ion exchange operations.

6. Numerous types of flow rate controllers, proportionators, etc. are employed depending on the specific service conditions.

7. In some applications of ion exchange, such as in sugar purification, it has been found advantageous occasionally to keep the pressure unit filled only part way up the tank, the remainder of the tank being filled with air.

The liquid level is maintained only a short distance above the top of the ion exchange bed. In these cases it is necessary to provide a supply of pressure air since some air is constantly being dissolved in the liquid passing through the unit. Furthermore, suitable liquid level controls must be provided to keep the liquid level at the proper point. During the backwashing operation, it is, of course, still necessary to expand the ion exchange bed sufficiently to wash it and proper air relief valves must be provided.



FIG. 19. Conductivity meter and controller.
(Courtesy of Industrial Instruments Company.)

XV. REGENERANT RECOVERY

In large installations where the cost of chemicals for operating is of great importance to the overall economy of the process, regenerant recovery systems are frequently installed. That portion of the rinse effluent which contains appreciable excess regenerant and which is not too greatly contaminated by the ions released from the ion exchanger during regeneration is collected in a separate tank. This is saved for the next regeneration of an ion exchange unit. It is pumped into the ion exchange unit just ahead of the introduction of the fresh regenerant solutions. By this method it is possible to reduce the amount of fresh regenerant required.

XVI. NONCOLUMNAR OPERATION

There have been some applications of ion exchangers to processes where it is not possible, because of physical characteristics of the liquid being treated, to employ the ion exchangers in columnar bed operation.

In the few cases where this has arisen the ion exchange granules have been agitated as a slurry with the liquid which is to be treated. The granules are then separated from the liquid by some procedure like centrifuging. The exhausted ion exchanger is then collected in a columnar bed and treated with regenerant to restore it to its original condition. This procedure has been employed in a large scale commercial operation in the pectin industry (see the chapter by A. B. Mindler) and has been given consideration for other applications.

In columnar operation some effort has also been expended on the idea of continuously removing the exhausted portion of an ion exchange column from the bed and regenerating the ion exchanger externally to the column. This would permit keeping the ion exchange column in continuous operation and avoid shutdowns. However, all such "translocation" schemes have thus far proven unsuccessful and have not been adopted for commercial use.

BIBLIOGRAPHY

1. Badger, W. L., and McCabe, W. L., *Elements of Chemical Engineering*. 2nd ed., McGraw-Hill, New York (1936), p. 468.
2. Brice, N. E., and Snyder, H. G., U. S. Patent 1,620,717 (March 15, 1927).
3. Brice, N. E., U. S. Patent 1,937,330 (Nov. 28, 1933).
4. Caps, J. E., U. S. Patent 1,495,317 (May 27, 1924).
5. Clark, T. B., U. S. Patent 2,111,169 (March 15, 1938).
6. Colvin, R. H., U. S. Patent 1,910,753 (May 23, 1933).
7. Dotterweich, A. J., U. S. Patent 1,933,370 (Oct. 31, 1933).
8. Dotterweich, A. J., U. S. Patent 1,954,405 (April 10, 1934).
9. Gans, R., U. S. Patent 1,195,923 (Aug. 22, 1916).
10. Nordell, E., and Hughes, W. J., U. S. Patent 1,827,603 (Oct. 13, 1931).
11. Pick, E., *Instruments* 6, 215 (1933); Greer, W. N., and Perley, G. A., paper presented at the 113th meeting of the American Chemical Society, Chicago, 1948.
12. Pick, E., U. S. Patent 2,146,983 (Feb. 14, 1939).
13. Pick, E., U. S. Patent 2,240,163 (April 29, 1941).
14. Staegemann, E., U. S. Patent 1,914,333 (June 13, 1933).

Ion Exchange in Water Treatment

C. CALMON

The Permutit Company, New York, New York

CONTENTS		Page
I.	Introduction	102
II.	Sources of Water Supplies	104
III.	Impurities in Water Supplies	105
IV.	Quality Tolerances of Water	106
	1. Drinking Water Standards	106
	2. Industrial Standards	107
V.	Expression of Analytical Results	107
VI.	Ion Exchangers Employed in Water Treatment	108
	1. Siliceous Cation Exchanger	108
	2. Sulfonated Coal Derivatives	109
	3. Sulfonated Resin Exchangers	109
	4. The Anion Exchangers	109
VII.	Properties of Ion Exchangers for Water Treatment	110
VIII.	Calcium and Magnesium Removal — Softening	112
	1. Calcium and Magnesium in Water	112
	2. Objections to Calcium and Magnesium in Water	112
	3. Removal of Calcium and Magnesium by Cation Exchangers on the Sodium Cycle	113
IX.	Iron and Manganese Removal	118
	1. Iron and Manganese in Water	118
	2. Objections to Iron and Manganese in Water Supplies	119
	3. Removal of Iron and Manganese by Cation Exchangers	119
	4. Removal of Iron and Manganese by Manganese Zeolites	120
X.	Removal of Alkalinity by Cation Exchangers	121
	1. Alkalinity in Water	121
	2. Undesirable Qualities of Alkalinity	121
	3. Removal of Alkalinity by Cation Exchangers	122
XI.	Total Electrolyte Removal — Demineralization	125
	1. Principles of the Demineralizing Process	126
	2. Step I: The Hydrogen Cycle	127
	3. Step II: The Anion Exchange Cycle	130
	4. Special Operating Methods	132
	5. Desalting of Sea Water	132
XII.	Silica Removal	132
	1. Silica in Water	132
	2. Effect of Silica in Boiler Feed Waters	133
	3. Silica Removal Methods	134
	4. Direct Anion Exchange Method	134
	5. The Fluosilicate Method	136

XIII.	Fluoride Removal	139
1.	Fluoride in Water and Dental Fluorosis	139
2.	Removal of Fluoride by Hydroxy Apatite	140
3.	Removal of Fluoride by Organic Ion Exchanger	142
XIV.	Ammonia Removal	143
1.	Ammonia in Water	143
2.	Removal of Ammonia by Cation Exchangers	143
XV.	Miscellaneous Applications	144
1.	Sterilization	144
2.	Waste Water	145
3.	Softening Sea Water	145
4.	Phenol Removal	145
5.	Dechlorination and Chloramine Formation	145
6.	Potassium Exchanger	145
XVI.	Maintenance of Ion Exchange Beds	145
1.	Microbial Fouling of Ion Exchange Beds	145
2.	Deposition of Iron Oxide Floc and other Precipitants	146
3.	Brine Disposal from Sodium Zeolite Softeners	146
	Bibliography	147

I. INTRODUCTION

Water is never found pure in nature. Treatment or conditioning is usually necessary if it is to be used for drinking or industrial purposes. The type of treatment will depend on the special requirements of the process in question. Also, since waters vary a great deal in composition as well as in type of impurities, nearly every water problem has its individual characteristics and, therefore, requires an individual solution.

Water has been a great factor in human and industrial distribution. Many industries settled in regions away from their source of raw materials because of the special water requirements. The development and application of the ion exchange process to water treatment has reduced the limitations imposed by waters of many localities, and thus made possible the industrial development of many parts of the United States. There is almost no portion of the globe where industrial development has taken place in recent times in which ion exchangers are not employed, whether it be the oil fields of Arabia, the new cities of Siberia, or the Hanford plutonium plant in the State of Washington.

From the first application of ion exchangers to water treatment (Gans, 44) to the present marks a period of forty years. For the first thirty years the cation exchangers, also called colloquially "zeolites," were of the siliceous type. They were either the processed natural products (56), such as the glauconites and bentonites, or the synthetic siliceous gels, prepared from aluminum compounds and sodium silicate (30). These siliceous ion exchangers had their limitations; they could be used only in a

narrow range of pH, for they peptized in highly basic solutions and dissolved in acid media. Their use, therefore, was mostly confined to water treatment for the removal of calcium and magnesium, for which the regenerant used is a neutral sodium chloride solution. The reaction of these in water softening is represented by the equation:

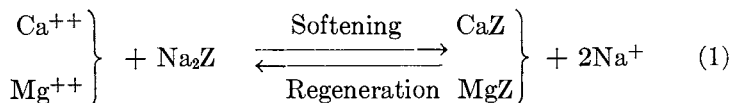

where Z is the anionic portion of the exchanger in question.

The first cation exchangers stable in high and low pH media were the sulfonated coals (118); later the sulfonated phenolic resins (79), based on the work of Adams and Holmes (1), became available. These exchangers, owing to their resistance over a broad pH range, can be used on the sodium cycle, given in equation (1), and the hydrogen cycle, in which the regenerant is a strong acid, such as sulfuric or hydrochloric. With the latter cycle, it is not only possible to exchange the metallic cations for hydrogen, but also to remove the alkalinity in water (7) through the conversion of the bicarbonate ions to carbonic acid, which is eliminated by degasification. Thus, in any water containing bicarbonate alkalinity, a partial reduction in the electrolyte content is obtained. The reactions involved in the hydrogen cycle can be shown by the following equations:

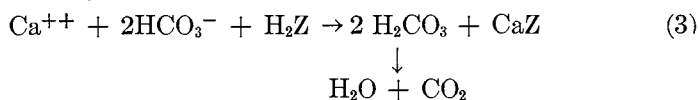

Along with the synthetic organic cation exchangers, Adams and Holmes prepared synthetic anion exchangers, which could absorb acids and be regenerated with an alkali. This made possible the removal of all the strong electrolytes in water by means of ion exchangers, first by passing the water through a hydrogen exchanger, which converts the salts to their corresponding acids, and then through an anion exchanger, which removes the strong acids. The latter reaction can be represented by the following equations:

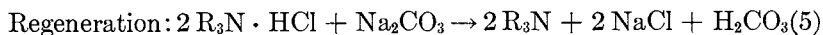

One problem which remained unsolved until a few years ago was the removal of silica from water by means of ion exchangers. Silicic acid, formed on passage of a water containing silica through a hydrogen cation

exchanger, was not absorbed by the anion exchanger because of the low basicity of the anion exchangers available. Highly basic anion exchangers (49, 68a, 111, 112) have been developed since 1945, and with these it is possible to remove the silica by direct ion exchange. Another solution to this problem was through the conversion of the silica to the fluosilicate ion (14, 73), which, being the anion of a strong acid, is absorbed by all anion exchangers. The introduction of these methods for silica removal made possible the removal of all electrolytes from water by means of ion exchange.

The great impetus given to the development of ion exchangers for the field of water treatment was primarily due to the needs of boiler plants. Construction of more efficient and higher capacity boilers created a demand for huge quantities of water of extremely high purity. With the increase in pressure and temperature of boiler operation, more rigid demands were made of ion exchangers. With the improvements made in exchangers to meet the requirements of the water treatment field, new applications of the ion exchangers in fields other than water treatment became possible.

The problem of water supplies grows in importance as industry's need for water increases. We have been careless with our water resources as with other natural deposits. Waste and pollution are becoming a national menace, and steps to correct these evils are being taken by many of the States. The recovery of sewage and waste waters has already begun (57, 125). The use of brackish waters in many localities may soon become a necessity. Ion exchange will play a very important part in the conservation of water supplies.

II. SOURCES OF WATER SUPPLIES

The various sources of water supplies may be classified into the following — rain water, surface waters, ground waters, and sea water.

Rain water contains dissolved gases picked up from the atmosphere, and suspended matter, such as dust, smoke, and microscopic organisms. Also, rain water always contains some traces of salts. Even after twenty-two hours of precipitation, rain water was found to have a measurable quantity of calcium and sodium salts. The concentration of chloride in rain water depends on the distance from the sea.

Surface waters consist of streams, creeks, rivers, reservoirs, ponds, and lakes. Usually they are low in dissolved electrolytes, but they may be turbid and have a high organic matter content. Moreover, they are subject to rapid changes in composition due to rain, drought, and industrial and domestic pollution, thus often making treatment difficult. The quantity and type of electrolytes dissolved in surface waters will depend on the character of the soil with which the water comes in contact, and on the

length of time and intimacy of the contact. Decaying plants and animal waste contribute organic matter to surface waters.

Ground waters may be from springs, shallow wells, deep wells, or mines. Springs may be shallow or deep, and, therefore, their character, except for possible surface contamination, will be the same as those of the neighboring wells. The waters of shallow wells may be soft or hard depending on the surrounding strata. They are usually free of turbidity and are low in organic matter. Deep well waters are usually clear but have high concentrations of dissolved salts.

The salt concentration of *sea water* will depend on the distance from the shore and the degree of dilution and pollution from rivers and other water bodies. Brackish water, the contamination of ground waters with sea water in coastal areas, is a major water problem in some areas of the United States.

III. IMPURITIES IN WATER SUPPLIES

The impurities present in water supplies may be suspended matter, such as clays, silt, humates, and organisms, dissolved electrolytes and organic matter, and dissolved gases.

Suspended and colloidal substances are easily removed by the standard methods of coagulation, sedimentation, and filtration. Some colloidal particles, such as CaCO_3 or $\text{Mg}(\text{OH})_2$, formed during chemical treatment of waters are removed by filters prior to passing such treated waters through ion exchange beds. The effect of these impurities on ion exchangers is important in that they may cause clogging of the beds, loss of capacity, build up pressure loss, and generally reduce the efficiency of the system. Similarly, the precipitation of iron salts in the form of gelatinous flocs on ion exchange beds should be prevented, otherwise chemical treatment of the beds becomes necessary. Organisms cause growths in beds, and therefore must be removed by sterilization and filtration.

The dissolved gases found in waters are nitrogen, oxygen, carbon dioxide, ammonia, and hydrogen sulfide. Nitrogen is inert and of little importance. For the removal of oxygen to very low concentrations, deaeration or vacuum degasification is generally practiced. Sulfites may be added to unite with oxygen to form the sulfate. Carbon dioxide is usually removed by degasification. Anion exchangers can be used to remove carbon dioxide. Ammonia can be removed by ion exchange methods, and for hydrogen sulfide removal, aeration or chlorination is practiced. The use of cation exchangers for the removal of sulfide is being introduced.

The bulk of the *soluble materials* in water are in the ionic state, therefore the ion exchange process lends itself to their removal. The cations and anions most frequently found in water supplies are given in Table I.

The concentration of each in water supplies and the objections of these will be discussed in the section on removal methods.

TABLE I
Common Ionic Constituents of Water Supplies

Cations		Anions	
Calcium	Iron	Bicarbonate	Nitrate
Magnesium	Manganese	Chloride	Nitrite
Sodium	Ammonium	Sulfate	Fluoride
Potassium	Hydrogen	Silicate	Sulfide

Waters containing selenium and other heavy metals are known but these are few in number and will not be discussed here since ion exchange methods have not yet been used to remove them. Methods of chemical precipitation or adsorption can be found in nearly every book on water treatment and need no discussion in this chapter.

IV. QUALITY TOLERANCES OF WATER

1. *Drinking Water Standards*

The U. S. Public Health Service has set up standards for the chemical and bacteriological characteristics of waters used for drinking and culinary purposes (122). The chemical characteristics may not exceed the limiting values given in Table II.

TABLE II
U. S. Public Health Service Standards for Drinking Water

Constituent	Parts per Million
Total Solids	500-1000
Magnesium	125 as Mg
Chloride	250 as Cl
Sulfate	250 as SO ₄
Alkalinity	400 at pH 8.0 to 9.6 160 at pH 10.5 to 10.6
Normal carbonate alkalinity	120
pH	10.6 at 25° C.
Phenolphthalein alkalinity, pH 8.3	15 + 0.4 × Total Alkalinity
Alkalinity of lime-soda treated waters	Total hardness + 35 p.p.m. as CaCO ₃
Fluoride	1.0 as F
Copper	3.0 as Cu
Lead	0.1 as Pb
Arsenic	0.05 as As
Selenium	0.05 as Se
Iron and manganese	0.3 as Fe and Mn
Zinc	15.0 as Zn
Barium, chromium, etc.	0.0
Phenolic compounds	0.001 as Phenol

2. Industrial Standards

The quality tolerances of a water for industrial purposes will depend on the process or product in question. It is very difficult to set limits for water quality as each manufacturer must balance the cost of treatment against the benefit gained. Through their associations various industries (31, 89) have recommended standards based on their experiences with their products. The following are examples of water requirements for specific applications.

(a) *Steam Generation Plants (98)*. Generally a water low in total dissolved solids, free of calcium, magnesium, bicarbonate, carbon dioxide, oxygen, silica, and turbidity is desired. The suggested limits for these will depend on the operating conditions of the boiler.

(b) *Pulp and Paper (114)*. A clear water, free of suspended matter and bacteria, low in iron, manganese, and organic matter, and not high in hardness or alkalinity is desired, but the limits will depend on the quality and color of the products.

(c) *Textiles (84)*. The water should be extremely low in hardness, iron, and manganese, and free of suspended and organic matter.

(d) *Carbonated Beverages (77, 95)*. A low alkalinity, a sparkling clarity, and an absence of organic matter are some of the requirements.

(e) *Cooling Waters (88)*. To prevent scale formation and deposition, the water should not be excessively hard and should be relatively free of suspended matter. It should not be corrosive. Also, algae and slime growths must be prevented.

V. EXPRESSION OF ANALYTICAL RESULTS

The concentrations of most common ions in water are expressed as parts per million (p.p.m.), which is equivalent to milligrams per liter of water. Some are expressed in terms of calcium carbonate but many are expressed in terms of the constituent in question. Thus, chloride is expressed as p.p.m. Cl, sulfates as SO_3 or SO_4 , iron as Fe, manganese as Mn, etc. One should, therefore, be careful in calculating data given in the literature as large errors can be made if the terms used for expressing the concentrations are not known.

In order to eliminate a possible source of error in expressing results, the term milliequivalents per liter (meq./l.) or equivalents per millicn (e.p.m.) has been introduced (5). The two are the same if the specific gravity of the solution is 1. However, the engineering and technical papers still express concentration in grains per gallon and capacity of ion exchange beds as kilograins per cubic foot. Table III shows the relation between the systems of expression as well as the units used in foreign literature.

TABLE III
Conversion Data of Units in Water Treatment

1 e.p.m. or 1 meq./l.	= 50 p.p.m. as CaCO ₃
1 grain CaCO ₃ /U. S. gallon (g.p.g.)	= 17.1 p.p.m. as CaCO ₃
1 kilograin (Kgr.)	= 1000 grains
1 kilograin as CaCO ₃ /cu. ft. (Kgr./cu. ft.)	= 45.8 meq./l.
1 English degree (or °Clark)	= 1 grain CaCO ₃ /Imperial gallon
	= 14.3 p.p.m. as CaCO ₃
1 French degree	= 1 part CaCO ₃ /100,000 parts of water
	= 10.0 p.p.m. as CaCO ₃
1 German degree	= 1 part CaO/100,000 parts of water
	= 17.9 p.p.m. as CaCO ₃

VI. ION EXCHANGERS EMPLOYED IN WATER TREATMENT

The ion exchangers used at the present in the field of water treatment may be classified according to the following outline:

Cation Exchangers

- A. Inorganic or siliceous gels
 1. Processed natural products (clays and greensands)
 2. Synthetic gels
- B. Sulfonated organic materials
 1. Processed natural products (coal derivatives)
 2. Synthetic resins (phenolic and aromatic hydrocarbon polymers)
- C. Carboxylic acid resins
 1. Oxidized natural products (coal derivatives)
 2. Condensation and polymerization products

Anion Exchangers

- A. Inorganic compounds (hydroxy apatites).
- B. Organic resins
 1. Amine-formaldehyde condensation products
 2. Polymers containing quaternary nitrogen

The choice of a particular ion exchanger will depend on the desired treatment, the characteristics of the water to be treated, regenerant cost, and the operating conditions.

1. *Siliceous Cation Exchanger.* The siliceous cation exchangers consist of the naturally occurring zeolites and glauconites, and the synthetic gel type, known as precipitated synthetics or wet process synthetics. During the thirty or more years of their use for water softening, a wealth of information and experience in handling these exchangers has been obtained (101, 108). In spite of the great versatility and higher capacities of the organic

exchangers, the siliceous exchangers are still extensively used. The siliceous exchangers are used on the sodium cycle only. They are also used as carriers for manganese oxides for the removal of iron and manganese from water.

The usual siliceous synthetic gels are prepared from sodium silicate and aluminum salts. The final product (23) has a general formula of $\text{Na}_2\text{O} \cdot \text{Al}_2\text{O}_3 \cdot n\text{SiO}_2 \cdot x\text{H}_2\text{O}$, in which n has usually a value of 5 to 6. For the desalting of sea water for emergency purposes, a special siliceous gel (26) is prepared in which the sodium is replaced by silver and barium. Because of the extreme sensitivity of synthetic gel exchangers to aggressive waters, i.e., waters of pH less than 6.8, or of low silica, or of a hardness less than 10 grains/gallon, they are used only with hard, clean waters and for household use where space is at a premium and where the volume of water softened per cubic foot of exchanger per day is relatively small.

2. *Sulfonated Coal Derivatives.* The first commercial exchangers to be used on both the hydrogen and sodium cycles were the sulfonated carbonaceous exchangers which are produced by reacting special coals with fuming sulfuric acid, or gaseous SO_3 (103, 123). These exchangers along with the sulfonated resins are desirable for boiler feed water treatment because of their nonsiliceous character.

3. *Sulfonated Resin Exchangers.* The sulfonated resins are either the phenol sulfonic acid derivatives (12, 128), or the nuclear sulfonated aromatic hydrocarbon polymers (13, 14a, 35). Among these materials there is quite a variation in physical characteristics and exchange capacity as well as in their stability to various operating conditions.

The new nuclear sulfonated hydrocarbon polymer exchangers (13) prepared in bead form appear to have some excellent operating characteristics owing to their ability to withstand more extreme operating conditions such as higher temperatures and oxidizing agents. However, long term tests in the field have as yet not been reported.

In the German literature mention is frequently made of carboxylic type resins (58), which are used for the removal of alkalinity. In the United States, although mention is made of a carboxylic acid material, its application has thus far been limited (99), but with the improvement in the new carboxylic acid resins (68a) in capacity and stability, the utilization of these will increase in due time.

4. *The Anion Exchangers.* A hydroxyapatite, $3(\text{Ca})_3(\text{PO}_4)_2 \cdot \text{Ca}(\text{OH})_2$, has been developed for the removal of fluoride (2). The fluoride is removed through exchange with the hydroxyl ion and the bed is regenerated with sodium hydroxide. Further discussion on the compound will be found under "Fluoride Removal."

The synthetic organic anion exchangers are amine derivatives. The

amines used are either the polyethylene polyamines (42, 72), guanidines (111), or metaphenylene diamine (124). The latter gives resins of low capacity and is used mostly by European manufacturers, either by itself or in conjunction with the other amines. The polyethylene polyamine and guanidine type resins have high capacities, the latter possessing more basic groups. New highly basic anion exchangers containing quaternary nitrogen groups are making their appearance on the commercial market.

Table IV gives an outline of some of the densities and operating capacities of the ion exchangers used in the field of water treatment at the present time. Owing to some drop in capacity on long operation, units are designed on the basis of lower capacities than given in Table IV.

TABLE IV
Properties of Ion Exchangers Used in Water Treatment

Type of exchanger	Wet density, g./l.	Operating capacity, meq./l
Siliceous Cation Exchangers		
Processed glauconite	1000 to 1450	130 to 280
Synthetic gels	400 to 500	450 to 700
Sulfonated Organic Cation Exchangers		
Sodium cycle	250 to 550	350 to 1500
Hydrogen cycle	250 to 550	180 to 1800
Carboxylic Cation Exchangers		
Anion Exchangers	250 to 450	450 to 1000
Synthetic amine resins	200 to 400	500 to 1200

VII. PROPERTIES OF ION EXCHANGERS FOR WATER TREATMENT

Owing to the rapid changes in the development of ion exchangers in recent years, the standardization of test methods for evaluating ion exchangers has lagged so that a great many of the results given in the literature are based on methods developed by individual manufacturers, or based on the properties of an individual product. Attempts to characterize commercially available exchangers have been reported very recently (68b, 120a).

The Tentative Manual of Zeolite Test Procedures, published by the American Water Works Association (6), only covers cation exchangers on the sodium cycle and does not include the high capacity resins that came into the field a few years ago. Moreover, most of the data given in the literature on the newer exchangers were determined on a laboratory scale. It is, therefore, difficult to give a true comparative study of the ion exchangers based on field operations.

The important properties to be sought in ion exchangers for water treatment are high operating efficiency, good mechanical and physical

properties, and long stability under the conditions of operation. The factors involved under these properties are summarized in the following outline:

Desirable Qualities of Ion Exchangers for Water Treatment

- I. *Operating efficiency*
 1. Good effluent quality
 2. Fast rate of reaction
 3. Sharp endpoint breakthrough
 4. High regeneration efficiency
 5. High operating capacity
 6. Low rinse volume
 7. Low color leaching
- II. *Mechanical and physical properties*
 1. Minimum head loss for a given flow rate
 2. Maximum backwash rate for a given bed expansion
 3. Hard particles
 4. Low contraction and expansion of bed during cycle
- III. *Stability to*
 1. Abrasion
 2. Oxidizing agents
 3. Fouling and sliming
 4. Temperature conditions
 5. pH range
 6. Repeated cycles

Water treatment by a single ion exchange bed is a cyclic process. In the simplest form the equipment used consists of a shell in which the bed of exchanger is supported by granular layers of graded gravel or anthracite. Above the bed is a free space for backwashing. The water, regenerant, or any other solution that may be used in conjunction with the process is evenly delivered by a distributing system at the top of the bed, and at the bottom another distributor is used for backwashing the bed. The design of equipment for ion exchange reactions is of great importance in the performance of an exchanger (see chapter on design, pp. 77-99). The proper distribution of water and regenerant, good backwashing of the exchanger without losses of bed, and undue abrasion of the particles are essential.

The cycle of operation may be divided into four steps.

1. Backwashing, for loosening up the bed and removing accumulated dirt and slime.
2. Regeneration, with a strong brine, acid, or alkali solution.
3. Rinsing, to free the bed of excess regenerant and salts.

4. Exchange operation, in which the water to be treated is percolated through the bed to a point where the effluent shows a specific quantity of the undesirable ions.

VIII. CALCIUM AND MAGNESIUM REMOVAL — SOFTENING

1. *Calcium and Magnesium in Water*

The calcium and magnesium concentrations of natural waters vary greatly. Waters with less than 10 p.p.m. and more than 1800 p.p.m. of calcium and magnesium can be found in fresh water supplies. Usable fresh water supplies fall in the range up to 500 p.p.m. The anions in conjunction with the two cations in waters are in the following relative order of abundance, (1) bicarbonate, (2) sulfate, (3) chloride, and (4) nitrate. Calcium is quite frequently twice the concentration of the magnesium content.

2. *Objections to Calcium and Magnesium in Water*

Calcium and magnesium in water are commonly called "hardness" because of the hard films and scales (Fig. 1) caused by their salts when they

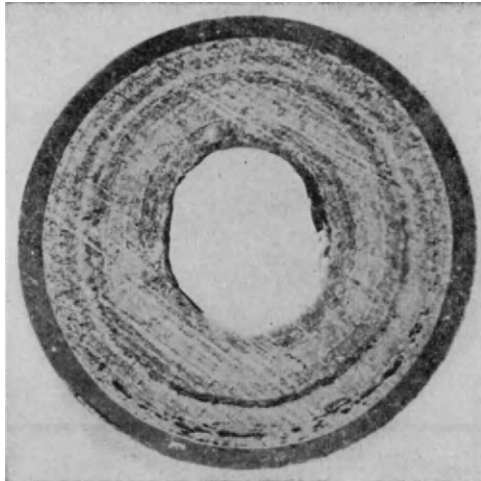

FIG. 1. Scaled hot water pipe.

are deposited in pipes or vessels. The removal of these ions from water is, therefore, called "softening." Moreover, calcium and magnesium form insoluble soaps, causing large waste of detergent as well as the adherence of the precipitated soap curds to the materials being washed. Calcium and magnesium also affect the quality of certain foods when canned (81).

3. *Removal of Calcium and Magnesium by Cation Exchangers on the Sodium Cycle*

Water softening is still by far the largest field in which ion exchangers are employed. The more recently developed organic exchangers are replacing the natural siliceous exchangers in many of the old installations because of their higher capacity and lower sensitivity to certain operating conditions, and because they do not impart silica to the water.

Nearly all cation exchangers used in water treatment have a particle size of $- 16 + 50$ mesh (U. S. Standard Sieve Series). Although higher capacities are obtainable with the lower mesh size particles, larger particles are preferred because fine materials cause packing. Moreover, very fine materials are hard to backwash without losses. The minimum bed depth of exchanger for commercial units varies with the material in question. Too low beds, however, reduce the efficiency of the exchanger. The yearly replacement of an exchanger due to attrition losses usually amounts to a few per cent of the bed, but some exchangers tend to disintegrate on long use. Although plants having beds of exchangers for more than twenty-five years are known to be still in operation, there are some instances where deterioration of the exchangers has taken place much sooner than expected. In order to insure good results, it is necessary to have the proper exchanger for the water in question, a properly designed unit and proper operation.

(a) *Salt Regeneration.* Regeneration is accomplished with brine solutions whose strength is varied with the type of equipment and the exchanger used. The salt specifications call for a minimum of calcium and magnesium and no phenolphthalein alkalinity. The latter applies to the siliceous exchangers which are sensitive to alkali. Large installations near the seashore have utilized sea water as a regenerant.

The salt concentration for optimum capacity appears to be about seven per cent for the siliceous and the sulfonated coal type of exchangers. A slightly higher concentration for the resin types is recommended. For the nuclear sulfonated hydrocarbon polymers, the capacity is increased with the increase in salt concentration.

The quantity of the regenerant used per cubic foot of bed will depend on the operating capacity of the exchanger. Dosages from 2.36 to 15 pounds of salt per cubic foot of exchanger are in use, the former being the quantity used for the natural siliceous exchangers, and the latter for the sulfonated hydrocarbon polymers. For household uses, where regenerations are very infrequent, the use of larger dosages to obtain higher capacities does not involve much cost. However, too infrequent backwashing, if long runs are made, may cause packing and clogging of the bed. The operating capacity of an exchanger is that capacity which gives the desired operating efficiency, measured by the weight of salt used per kilograin of capacity

obtained. A value of 0.5 pound or less of NaCl per kilograin is considered within the practical range for large installations.

Since nearly all commercial cation exchangers have fast rates of reaction (61a, 83), the contact time between the brine solution and the bed is usually less than 30 minutes. No great benefit is observed in the manner of regeneration, whether it be upflow or downflow. In the case of sea water regeneration, as will be shown later, regeneration is upflow since backwashing of the beds is done at the same time.

(b) *Rinsing*. The volume of rinse water for removing the displaced salts and excess sodium chloride will depend on the type of material in the unit. About 20 gallons of water per cubic foot of exchanger may be an average value. The rinse rate must be controlled to provide proper contact time between the brine it is displacing and the ion exchange bed.

(c) *Softening Run*. The start of the run is taken at the point of the rinse where the water quality meets with the requirements of the process. In some cases this point is determined by the number of drops of a standard soap solution necessary to give a lather in a given volume of treated water. For an extremely low hardness water, a more diluted A.P.H.A. soap (5) may be used. In a similar way, the endpoint or breakthrough of hardness is determined. As the breakthrough is sharp, very little water has to pass before a high concentration of hardness appears in the effluent. Automatic hardness testers, which indicate the breakthrough of calcium and magnesium, are available.

Very high flow rates can be used, but they have an effect on the volume of water treated. In upflow softening, the density of the exchanger and the grain size of the particles are factors in the efficiency of operation.

TABLE V
*Capacity of a Sulfonated Coal Type Exchanger
for Hardness Removal from Influent of Varied Composition*

Influent Ca ⁺⁺ and Mg ⁺⁺ Na ⁺	p.p.m. as CaCO ₃	200	400	800	200	400	800
	p.p.m. as CaCO ₃		-31-			-1000-	
Regenerant dosage Lbs./cu. ft.	Capacity Kgr./cu. ft.	Capacity Kgr./cu. ft.					
5.25	9.2	9.3	8.7	7.0	7.0 ^b	NSW	
3.15	7.8	7.8	7.5	6.3 ^b	5.9 ^b	NSW	
2.36	6.6	6.6	6.0 ^b	5.4 ^b	5.1 ^b	NSW	
1.32	4.8	4.7	NSW ^c	NSW	NSW	NSW	

^a Kgr. as CaCO₃/cu. ft. = 45.8 meq./l.

^b Hardness leakage equivalent to 8-15 drops B & B soap (24) to 40 ml. water.

^c NSW — hardness in effluent more than 54 p.p.m.

The composition and the concentration of the electrolytes in the influent affect the quality of the effluent as well as the capacity of the bed. The presence of sodium ions will affect the exchange equilibrium with the result that, if the sodium concentration is too high, leakage of hardness will be observed. Table V shows the effect of the calcium and magnesium concentration, sodium concentration, and regenerant dosage on the capacity of a sulfonated coal type exchanger.

It is evident from the data in Table V that for the above exchanger increased hardness in the influent is not a great factor as long as the sodium concentration is low, and the salt dosage for regeneration is above 2.36 lbs./cu. ft. However, with the sodium content increased to 1000 p.p.m., the capacity is lowered and the effluent has hardness throughout the run, the amount depending on the hardness content of the raw water and the regenerant dosage.

Walton (126) states, in his discussion on the efficiency of the softening run, that the portion of the bed nearest the outlet will be mostly in the sodium condition since the run is usually stopped when calcium and magnesium appear in the effluent. In case of municipal waters, effluents may contain a higher hardness content than required for industrial purposes, but the endpoint is taken when there is still a great deal of capacity for softening left in the bed. The bed, therefore, will be practically saturated

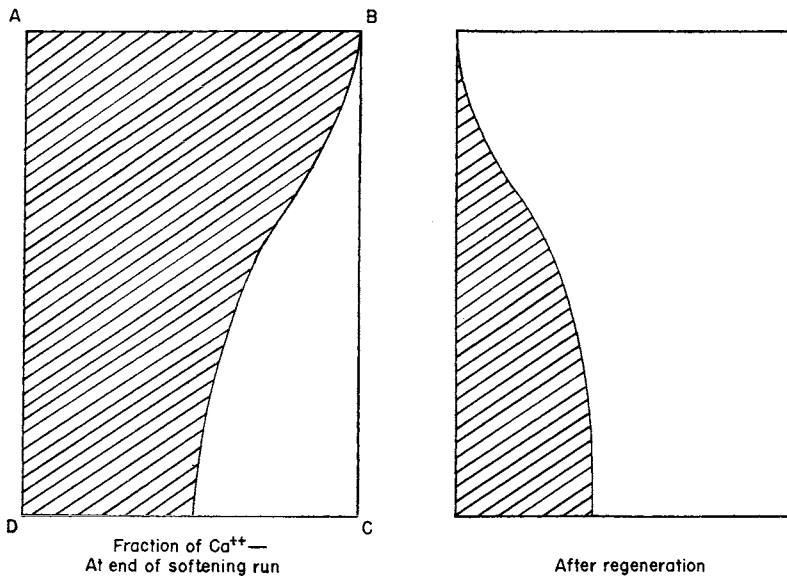

FIG. 2. Graphical representation of ionic distribution in cation exchange beds (126). (Reprinted from *J. Franklin Inst.* **232**, 13, 1941.)

with calcium and magnesium in the layer nearest the inlet, and the proportion of these ions to sodium in the bed will decrease as one proceeds toward the outlet. Walton represents the above graphically, as shown in Fig. 2. During the regeneration, the calcium and magnesium will be displaced most thoroughly in the upper layer of the bed, while in the lower layer some calcium and magnesium will remain. To convert the whole bed to the sodium condition would require a very large excess of the regenerant, thus greatly reducing the economy of the process. The area of the rectangle in Fig. 2 may be looked upon as the ultimate exchange capacity of the particular exchanger, while the difference in the areas of the shaded portions of the graph represents the operating capacity (117) that will be a function of the regenerant dosage used.

Myers and Eastes (79) have investigated the operating characteristics of a sulfonated resin exchanger with influents containing a ratio of sodium to calcium from 1 to 22. The type of curves obtained with various influents will depend on the equilibrium relations of the particular exchanger and the rate of reaction between the exchanger and the solution.

For practical purposes, the presence of sodium may be looked upon as additional hardness, and the capacity of some of the exchangers may be calculated on a basis of a "compensated hardness" by the empirical relation

$$\text{Compensated Hardness} = \text{Total Hardness} \times \frac{(390 + \text{Sodium})}{400}$$

in which the hardness and the sodium are expressed in grains per gallon. Change in the relation may be necessary as the more recent cation exchangers are evaluated. Walton has applied the Rothmund-Kornfeld equation to study the distribution of ions between the exchanger and the solution at the end of the softening run so as to predict the efficiency of operation, but its application is limited in view of the assumptions made.

Du Domaine, *et al.* (41) studied the exchange of Ca^{++} through a sodium siliceous exchanger and Na^+ through a calcium siliceous exchanger, and derived a mathematical relation for evaluating the performance of a synthetic siliceous exchanger under conditions of variable depth, rate of water flow, initial hardness of water, initial base exchange capacity, particle size, and activity of exchanger. Thomas (115) extended the mathematical description of the performance of a cation exchange column, but the final equation contains Bessel functions, the solutions of which are too difficult at present for commercial application. As these mathematical relations are tested and simplified and the ion exchangers become more standardized, the application of these relations will grow in importance. Up to the present, however, the empirical method has been the guide for plant application.

(d) *Backwashing.* When the breakthrough appears, the bed is backwashed to remove any suspended matter which may have deposited on the beds. The usual rate is from 4 to 6 g.p.m.*/sq. ft. for a given period, depending on the amount of deposition of suspended matter on the bed. After backwashing, the bed is ready for another cycle.

(e) *Regeneration with Sea Water.* The use of sea water for regenerating cation exchange beds on the sodium cycle is reported in the literature (59, 121). Plants in Sarasota (92), Hollywood (113) and Fernandina (87), Florida, have such installations. The cost of the pipe line is compensated by the saving in salt, which makes this method practical for large users of water such as municipalities and large industrial installations. When sea water is used, regeneration and backwashing may be done simultaneously after the softening operation. Prior to its use as a regenerant, the sea water is chlorinated, coagulated with alum, and filtered. To prevent corrosion, special noncorrosive pipe lines of asbestos cement are used. After a controlled volume of sea water is allowed to pass the units, the beds are rinsed free of salts with a downward flow of fresh water. In the Fernandina plant, a 340 p.p.m. hardness water is reduced to zero hardness at a cost of three dollars per million gallons.

It can be stated that the capacity of an exchanger is reduced to about 50% of its usual operating capacity when sea water is used as a regenerant (132). Table VI gives the results obtained with a sulfonated coal type exchanger on regeneration with a synthetic sea water. The influent water

TABLE VI

Performance of a Sea Water Regenerated Sulfonated Coal Type Exchanger for Softening an Extremely Hard Water

Gallons sea water/ cu. ft.	Capacity Kgr. as CaCO ₃ /cu. ft.	Effluent quality p.p.m. hardness as CaCO ₃
50	5.1	34
40	5.2	34
40	4.9*	34
30	4.8	34
30	4.8*	34
25	4.7*	34
21	4.6	34

* 83% full strength of sea water as regenerant. (Unpublished data of the Permutit Company by A. W. Kingsbury and A. S. Atkinson.) Synthetic sea water contained 3.0% salts of which one-fifth were those of calcium and magnesium.

in question was extremely hard, containing 1188 p.p.m. of hardness. The hardness was reduced to an average of 34 p.p.m. With phenolic cation exchangers, capacities of 9.6 kgr./cu. ft. can be obtained with 40 gallons of

* g.p.m. = gallons per minute.

sea water per cubic foot of bed when using a water containing 425 p.p.m. of hardness to an end point of 8 drops B and B (24) soap solution. With the sulfonated aromatic hydrocarbon polymers, capacities of 16 kgr./cu. ft. of bed can be obtained with the same water dosage and influent.

(f) *Utilization of Regenerant Effluent.* When regenerating with a brine solution, the last portion of the regenerant effluent and the initial rinse water contains less hardness than the initial portion of the regenerant. Reclamation of part of regenerant for use in subsequent regenerations, therefore, may be practiced. There are several patents (22, 32) showing various plant arrangements for brine recovery.

(g) *Corrosion.* Owing to the elimination of the scale forming constituents by softening, soft water may be corrosive to metallic pipes. A post treatment is usually given to the water through pH adjustment. In municipal plants, where water is softened to about 85 p.p.m. hardness, the pH is adjusted to about 8.5; or more often so as to give a slightly positive Langelier Index* (69).

(h) *Chemical Treatment and Combined Lime-Soda and Ion Exchange Treatment.* Due to the simplicity of operation and the completeness of hardness removal, cation exchange softeners are much more widely used than the chemical precipitation methods. Chemical precipitation plants are still used but are limited in number compared to the number of cation exchange plants. Combined treatment, chemical precipitation followed by cation exchange, is employed in a limited number of plants.

IX. IRON AND MANGANESE REMOVAL BY ION EXCHANGERS

1. *Iron and Manganese in Water*

Iron and manganese may occur in water as organic compounds, colloidal oxides, or as ferrous and manganous bicarbonates. The first two are removable by coagulation, sedimentation, and filtration and, therefore, are of no interest here. This process is less satisfactory when the metals are present in the ionic state, whereas cation exchange is readily applicable.

Ferrous and manganous bicarbonates are formed in water when the oxidized, insoluble compounds of these metals are reduced in the absence of dissolved oxygen and in the presence of dissolved carbon dioxide. This occurs when rain water percolates into the soil and passes over decaying organic matter that is liberating carbon dioxide. During the winter months, when bodies of water are covered with ice and thus prevented from being naturally aerated, iron and manganese may be found in reservoir waters.

* The Langelier Index or Saturation Index is a value calculated from an equation derived by Langelier to indicate whether a water of known pH, calcium, alkalinity, and total solids content will deposit or dissolve calcium carbonate scale.

Iron bearing well water commonly contains less than 5 p.p.m., but waters containing up to 40 p.p.m. may be found. Acid mine waters containing as much as 80 p.p.m. iron have been reported. Manganese in well waters rarely exceed 3 p.p.m., although in a few wells more than 10 p.p.m. manganese have been found.

2. *Objections to Iron and Manganese in Water Supplies*

Iron imparts an astringent taste to drinking water, and affects adversely the flavor and appearance of tea and coffee. Iron in excess of 0.3 to 0.5 p.p.m. causes rusty stains on plumbing fixtures and laundry, while like amounts of manganese impart black stains. These metals cause discoloration of the products of the textile and pulp and paper industries. For these reasons, the U. S. Public Health Service has established a maximum allowable limit of 0.3 p.p.m. for iron and manganese in drinking water. The pulp and paper industries have set a tolerance of 0.1 p.p.m. for iron and 0.05 p.p.m. for manganese. Upon oxidation, these metals tend to precipitate, causing clogging in pipe lines and unsightly turbidity in domestic waters. They also foster the growth of certain organisms in water conduits.

3. *Removal of Iron and Manganese by Cation Exchangers*

As water is softened by a sodium cation exchanger, the ferrous and manganous ions are also removed through exchange for sodium.

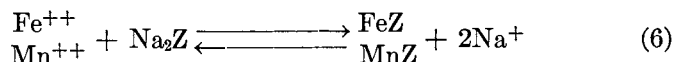

When the bed is exhausted, the unit is regenerated with brine after thorough backwashing to remove any foreign particles that may have settled in the bed. Since the ferrous and manganous ions will be oxidized and precipitated if they come in contact with air, the water is pumped through the softeners under pressure. Iron is reduced by this method to an average of less than 0.1 p.p.m. The exchangers reported in the literature to have been used for this purpose are of the natural siliceous (36) and the sulfonated coal type (71). Some resins also show excellent removal of ionic iron and manganese. The synthetic gel type exchangers, due to their porosity and tendency to clog, are not recommended.

For economic reasons, municipal waters are often softened to about 85 p.p.m., or to a slightly lower value, while the cation exchange method softens water to "zero" hardness. If cation exchange for Fe and Mn reduction is desired for municipal use (85), part of the water may be bypassed in such proportion that the final iron and manganese content of the blended waters meets with the U. S. Public Health Service standards. If the iron and manganese content is too high to permit satisfactory reduction

by this means, a special unit containing "manganese zeolite," to be discussed later, may be used, or an aerator and filter system, which removes the iron and manganese without softening, may be installed for treating the by-passed water. Figure 3 gives the flow diagram for such an installation. Large municipal plants of such natures are in operation.

Myers (78) reports the removal of iron without softening by a calcium exchanger prepared from phenol-2,4-disulfonic acid, resorcinol, and formaldehyde. The $\text{Fe}(\text{OH})_3$ removal on such a bed was by filtering action, while the soluble Fe^{++} was removed by exchange with Ca^{++} . Backwashing removed the insoluble iron floc, while the exchanged iron was removed by regenerating the bed with a 5% CaCl_2 solution.

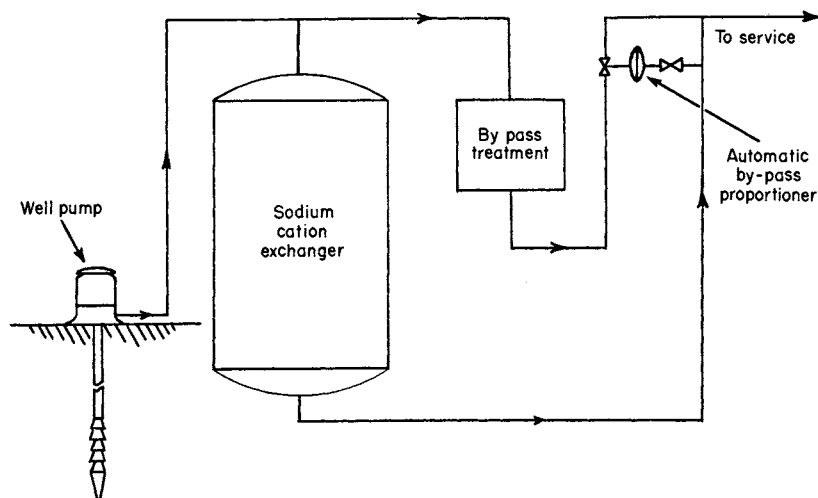
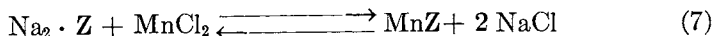

FIG. 3. Removal of iron and manganese by cation exchange and by-pass treatment.

4. Removal by "Manganese Zeolites" (33, 8)

For clear well waters that do not contain excessive amounts of iron and manganese (< 1 p.p.m.), a special "manganese zeolite" is available. It is prepared (45) by treating sodium glauconite (processed greensand) with manganous chloride to form the manganous exchanger.



The manganous exchanger is treated with potassium permanganate, resulting in precipitation of the higher oxides of manganese on the granules in accordance with the reaction,

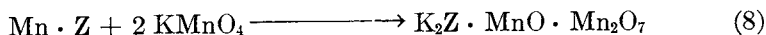

In this form the material serves as a source of oxygen which oxidizes the

ferrous and manganous ions to the ferric and manganic states. In the oxidized states, the iron and manganese precipitate as the insoluble hydroxides. The iron removal reaction can be shown by the following equation,

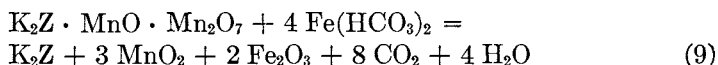

The precipitated oxides which accumulate in the bed are removed by periodic backwashing. Since the waters used with this type of an exchanger are low in iron and manganese, long runs are possible. When the oxidizing capacity of the bed is diminished, the exchanger is regenerated with a 1/2% solution of potassium permanganate and then rinsed free of the salts.

The "manganese zeolite" beds are used for waters which require limited preliminary aeration, where simplicity of operation and control is desired, or where the last traces of iron and manganese are to be removed from effluents from which the bulk of these undesirable ions have been removed by other processes.

Davis (36) describes a 1.5 million gallons/day plant for the removal of manganese from a water containing 2.5 to 2.9 p.p.m. The "manganese zeolite" beds, prepared by treating a sodium greensand exchanger with potassium permanganate, have operated successfully for 6 years. The required regenerant has been 0.6 pounds of potassium permanganate per pound of manganese removed.

X. REMOVAL OF ALKALINITY BY CATION EXCHANGE

1. Alkalinity in Water

Alkalinity in water is primarily due to the bicarbonate ion. Some waters may have carbonate ions, but these waters are few in number. Instances of alkalinity due to silicate, borate, or phosphate ions have been reported. Well waters usually have higher alkalinities than surface waters. Well waters with alkalinities of 500 p.p.m. are known. There are waters, especially some mine waters, which contain free mineral acidity due to the formation of sulfuric acid through the oxidation of sulfides or hydrolysis of iron salts.

In water treatment the terms phenolphthalein alkalinity and methyl orange alkalinity are frequently used. The former refers to the alkalinity above a pH of 8.3 (phenolphthalein endpoint), and the latter refers to the alkalinity in the pH range 8.3 to 4.3 (methyl orange endpoint).

2. Undesirable Qualities of Alkalinity

Low bicarbonate alkalinity is desired for boiler feed water, ice manufacture (7), and carbonated beverages (77). The removal of alkalinity is of

greatest importance in steam boiler operation, as under boiler conditions bicarbonate decomposes into CO_2 and NaOH . Carbon dioxide released in the steam makes the condensate highly corrosive. The neutralization of the acidic compounds in bottled drinks by high alkalinities gives an off flavor. In ice manufacture, a high bicarbonate content will cause a cloudiness in the ice, and make it brittle if frozen quickly.

3. Removal of Alkalinity by Cation Exchangers

Before the development of the organic cation exchangers, which could be used on the hydrogen cycle, alkalinity was neutralized with a mineral acid after the water was softened by a siliceous exchanger. A very interesting fact observed in conjunction with this phase of work with the siliceous

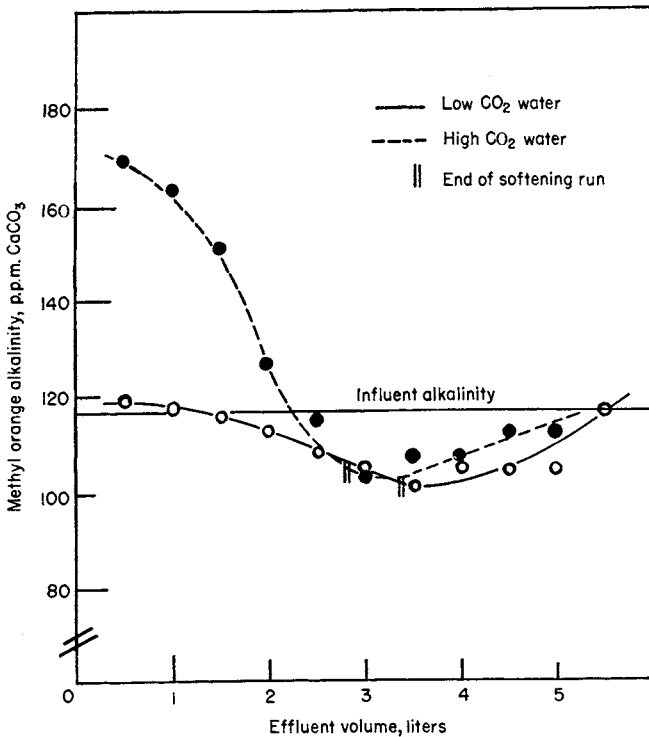

FIG. 4. Methyl orange alkalinity variations during softening of waters with a natural siliceous cation exchanger.

exchangers was that the alkalinity varied during the course of the softening run (16). The amount of variation was shown by King and Smith (65), to depend on the CO_2 content of the influent water. They explained their observations on the basis of hydrogen zeolite formation. Free carbon

dioxide in water is in equilibrium with H^+ and HCO_3^- . When the CO_2 content of the water is low, the HCO_3^- in the water will react with the sodium exchanger so as to form hydrogen exchanger and sodium carbonate. Carbonate or phenolphthalein alkalinity is found in low CO_2 waters on passage through a sodium exchanger. In high CO_2 waters, the alkalinity goes up in the initial part of the run by a value equivalent to the conversion of the CO_2 to HCO_3 , and the alkalinity drops as the run continues. Toward the end of the run, the bicarbonate concentration in the effluent is less than that of the raw water. The reverse takes place with the CO_2 content. Figure 4 shows curves for the alkalinity of effluents from a siliceous cation exchanger. Two waters were used (27), one containing 0 to 2 p.p.m. CO_2

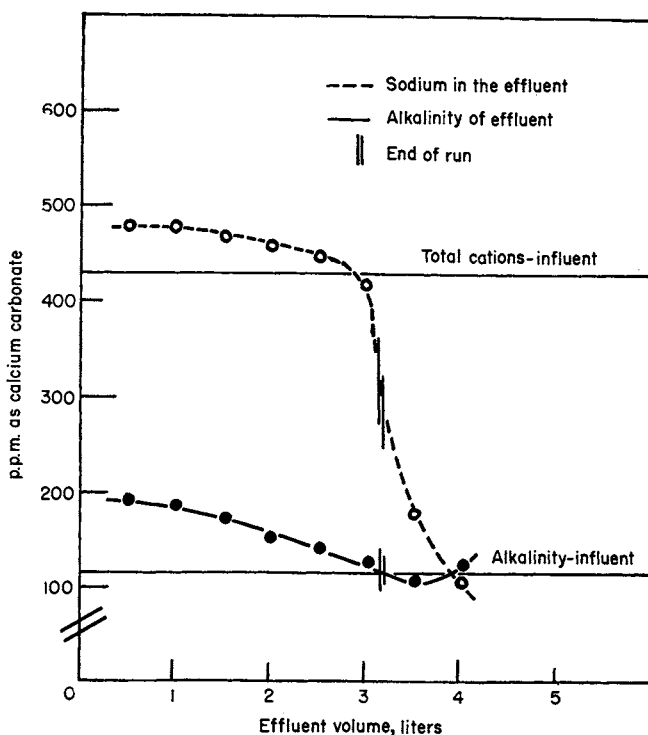

FIG. 5. Sodium and methyl orange alkalinity variations during softening of a water containing 33 p.p.m. CO_2 with a natural siliceous exchanger.

and the second containing about 26 to 30 p.p.m. CO_2 . Figure 5 shows the increase in the cation content of the effluent above that of the raw water, indicating that hydrogen from H_2CO_3 has replaced some sodium from the exchanger. On regeneration with a brine solution, the pH of the regenerant

effluent is slightly lowered, the amount depending on the CO_2 content of the influent of the previous run.

With some of the new cation exchangers (sulfonated aromatic hydrocarbon polymers), the alkalinity variation during the run has not been observed with waters containing as much as 30 p.p.m. of CO_2 .

(a) *Combined Sodium and Hydrogen Cycles.* With the advent of the hydrogen exchangers, it became possible to remove the alkalinity by passing a portion of the water through a hydrogen exchange unit and the remainder through a sodium exchanger, and blending the effluents in such a way that the mineral acidity formed in the effluent of the hydrogen exchanger is neutralized by the alkalinity in the effluent of the sodium exchanger. By this method all of the hardness and some of the sodium (if the bicarbonate exceeds the calcium and magnesium content), as well as the bicarbonate ions, are removed, and thus a partial reduction in the electrolyte content is obtained. A formula for determining the proportions of the water to be treated by each exchanger is given as follows (7):

$$\text{Per cent through hydrogen exchanger} = 100 \times \frac{Ar - Am}{Ar + FMA},$$

in which Ar is the methyl orange alkalinity of the raw water, Am is the methyl orange alkalinity desired in the final mixed water, and FMA is the

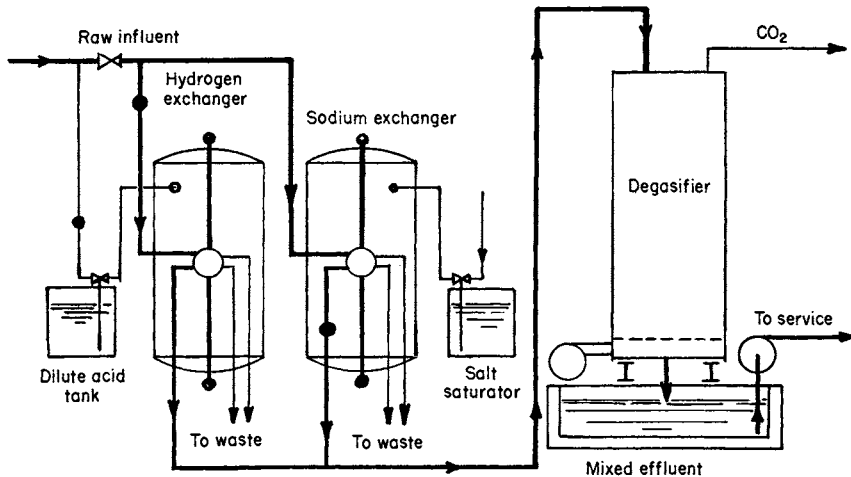

FIG. 6. Alkalinity removal by combined sodium and hydrogen exchangers.

free mineral acidity in the effluent from the hydrogen exchanger, all expressed as p.p.m. CaCO_3 . A flow diagram for such a system is given in Fig. 6. The degasifier is for the removal of CO_2 .

(b) *Starvation Regeneration or Acid-Salt Regeneration (52, 93).* Some

of the cation exchangers which contain weak acidic groups, can be made to produce the effect of split treatment in a single unit described above. This result is achieved by regenerating the exchanger with a mixed solution of acid and sodium chloride, or single treatments consisting of acid followed by salt, or salt followed by acid. The quantity of acid used is usually just sufficient to convert the carboxyl or weak acidic groups of the exchanger to the acid state. The term "starvation regeneration" is used because of the small quantity of acid used. The carboxylic acid group, due to its weak acid strength, cannot split neutral salts in a manner given in equation (2). It does react with the bicarbonate ion because the carbonic acid formed is a weaker acid. Thus the sodium portion of the exchanger (SO_3Na groups) will exchange with the calcium and magnesium ions, and the hydrogen portion (COOH groups) of the exchanger will react with the bicarbonate to carbonic acid. The final effluent will be free of alkalinity and hardness. These exchangers are applicable to waters high in alkalinity and low in chloride and sulfate. If the chloride and sulfate contents are too high, a nonuniform alkalinity as well as an acidic effluent may be obtained.

(c) *Special Cation Exchangers* (58, 127). The use of special cation exchangers with weak acid groups is frequently described in the German literature. They are used primarily to avoid neutral salt splitting since any acid in the effluent is highly corrosive to plant equipment. The carboxylic group acts in the same manner in these exchangers as described above. However, even with these specially prepared carboxylic acid resins, some neutral salt splitting is observed because of some strong acid groups being present. To overcome this difficulty a buffer filter (50, 130) containing a weak acid exchange resin regenerated with sodium chloride and acid is added to the hydrogen exchange unit in series. Any hydrogen ions from the initial unit are exchanged for sodium in the second unit so that a neutral and soft effluent can be obtained.

In the United States literature, Shoemaker (99, 100) has described a two-bed system, the first unit being the standard cation exchanger on the hydrogen cycle and regenerated in the usual manner, and the second unit being a weak acid exchanger termed a "hydrogen accumulator." Although a low uniform alkalinity for the final effluent is claimed by the technique described, hardness leakage may be expected.

XI. TOTAL ELECTROLYTE REMOVAL — DEMINERALIZATION

Until 1937 the only method for producing electrolyte free water on a large commercial scale was by distillation. The huge demand for electrolyte free water for boilers and for such process industries as plastics, cellulose products, synthetic rubber, catalysts, silver products, dielectrics, etc. has led to the widespread use of ion exchange demineralizing or de-

ionizing plants, as the cost of electrolyte free water by this process is only a fraction of the cost of distilled water, if the ionic concentration is within normal limits (10, 47, 75, 86, 120). From 1940 to 1945 the number of demineralizing plants almost doubled yearly. Units are now available to deliver from one to thousands of gallons of electrolyte free water per minute. Water demineralization is the second largest field of ion exchange application in water treatment.

1. Principles of the Demineralizing Process

Figure 7 shows a flow diagram of the two step demineralizing process. In step I, the influent passes the hydrogen exchange bed where the metallic cations are exchanged for hydrogen. The bicarbonate ion is converted to

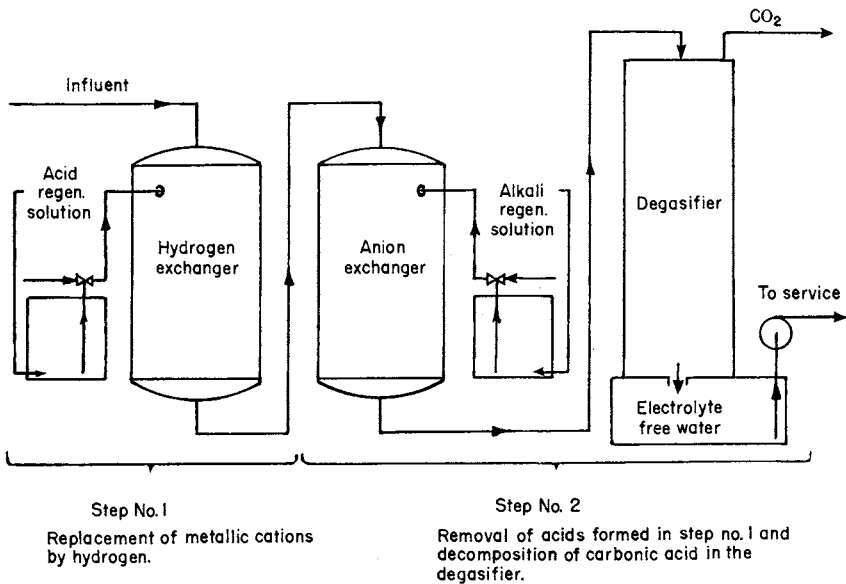

FIG. 7. Two step process for water demineralization.

carbonic acid, and the chlorides and sulfates become hydrochloric and sulfuric acid, respectively. The acid effluent from the hydrogen exchanger is then percolated through the anion exchanger, or acid absorber, as it is often called, and the acid is removed. The carbonic acid is removed by degasification. The removal of silicic acid, which is also a weak acid, will be discussed later.

Regeneration of the hydrogen exchanger is accomplished by introducing a solution of either sulfuric or hydrochloric acid, while the anion exchanger can be regenerated with sodium carbonate, sodium bicarbonate,

sodium hydroxide, or ammonium hydroxide. Choice of regenerant will be affected by the process involved and the availability of these reagents.

2. Step I: The Hydrogen Cycle

Only the organic cation exchangers are used for the hydrogen cycle. Their efficiency depends greatly on the ionic species and concentration in the water to be treated, as well as on the type and quantity of regenerant. Also, the chemical structure of the exchangers, such physical characteristics as particle size, and bed depth, and operating factors such as flow rate affect the efficiency.

(a) *Ionic Species.* The ratio of the bicarbonate ion concentration to that of the chloride and sulfate present in the influent water affects the performance of the hydrogen exchanger. The bicarbonate ion reacts with the exchanged hydrogen to form carbonic acid, which is a weak acid. This results in the reaction with bicarbonate going to completion. However, with the chloride and sulfate ions, strong acids are formed, and they are in equilibrium with the exchanged ions.

It is generally found that the hydrogen exchangers give higher capacities when bicarbonate waters are used. Also, when the chloride and sulfate content is very high, leakage of the metallic cations takes place. Since the latter can not be removed by the anion exchanger, they will appear in the final effluent. Special techniques, such as recirculation, have to be used when the chloride and sulfate contents reach values of 500 p.p.m. or more. An electrolyte content of less than 1 p.p.m. was found when a solution containing 100 p.p.m. of chloride and sulfate was demineralized, but for a water containing 500 p.p.m. of the ions, about 10 p.p.m. of electrolytes were found in the effluent, and with a 1000 p.p.m. water, a 40 p.p.m. leakage was noted. Leakage was observed in the form of neutral salts, indicating incomplete conversion in the cation exchanger.

The type of cations present in the influent also affect the capacity of hydrogen exchangers. Calcium and magnesium, being divalent, are more strongly held by the cation exchanger than is sodium. For this reason, higher capacities for the divalent ions should be expected in pure solution. This holds true for the chloride and sulfate salts of these metals. The bicarbonate salts do not show such a valence effect of the cation because the reaction, $\text{HCO}_3^- + \text{H}^+ \rightarrow \text{H}_2\text{CO}_3$, is so complete that it overshadows the valence effect. Little difference is noted between calcium and magnesium when hydrochloric acid is used as a regenerant, but there is a considerable difference between the two when sulfuric acid is used as the regenerant. The latter, however, is more commonly used because of its low cost. Table VII shows the capacities obtained with a sulfonated coal type exchanger with pure salt solutions of calcium and magnesium. Since

waters contain mixtures of salts as well as bicarbonate, the latter will be found to be the more dominating factor.

TABLE VII
*Capacity of Sulfonated Coal Type Hydrogen Exchanger
with Calcium and Magnesium Solutions*

Salt in Solution	Capacity (meq./l.)	
	H ₂ SO ₄ as regenerant*	HCl as regenerant*
CaCl ₂	224	342
MgCl ₂	323	332

* 605 meq./l.; 0.4 *N* solutions.

Studies with single and mixed salts were made by Kemmer and Thompson (64) on a sulfonated coal type hydrogen exchanger, but in their tests the endpoint was taken to a point where hardness appeared. Thompson (116) has made a study on the effect of the various salts present in water on the capacity of a sulfonated resin exchanger.

(b) *Regeneration.* With the low capacity exchangers a 2% solution of sulfuric acid is recommended as the regenerant for plant use. Lower concentrations may be used where the ratio of calcium to the total cation content of the influent is very high. The acid (2 to 6 lb./cu. ft. of bed) is introduced into the bed in a period of 10 to 15 minutes followed by a rinse of 40 to 70 gallons of water per cu. ft. of bed. For the high capacity cation exchangers, highly concentrated solutions (10 to 20%) of hydrochloric acid are used. To use sulfuric acid of high concentration, special techniques are necessary.

Recovery of the waste acid can be accomplished as the CaSO₄ precipitates out on standing, so that the clear acid, containing sodium and magnesium sulfates, with some calcium sulfate, may be passed through the bed on the next run and then followed up with fresh sulfuric acid. If desired, the first regenerant effluent, which is high in metallic cations, may be discarded, and the last portion, which has an appreciable content of acid, may be used in the subsequent run or through another bed.

The point at which the effluent from the hydrogen exchanger is directed to the anion exchange bed is taken when the free mineral acidity of the effluent is a few p.p.m. above the sum of the chloride and sulfate content of the raw water. The hydrogen exchanger is regenerated when the breakthrough of the metallic cations takes place, as evidenced by a drop in the free mineral acidity of the effluent. The first portion of effluent after the breakthrough will show sodium ions as calcium and magnesium will replace the sodium held by the exchanger. Initially, the three metallic cations replace the hydrogen, but as the run progresses, the sodium is

pushed toward the lower portion of the bed until sodium breaks through. This is not true with some exchangers which show a leakage of hardness throughout the run.

(c) *Characteristic Curve of Effluent from a Hydrogen Exchanger (94).*

Figure 8 shows a characteristic curve for the effluent of a hydrogen exchanger. For the determination of this curve, a water containing

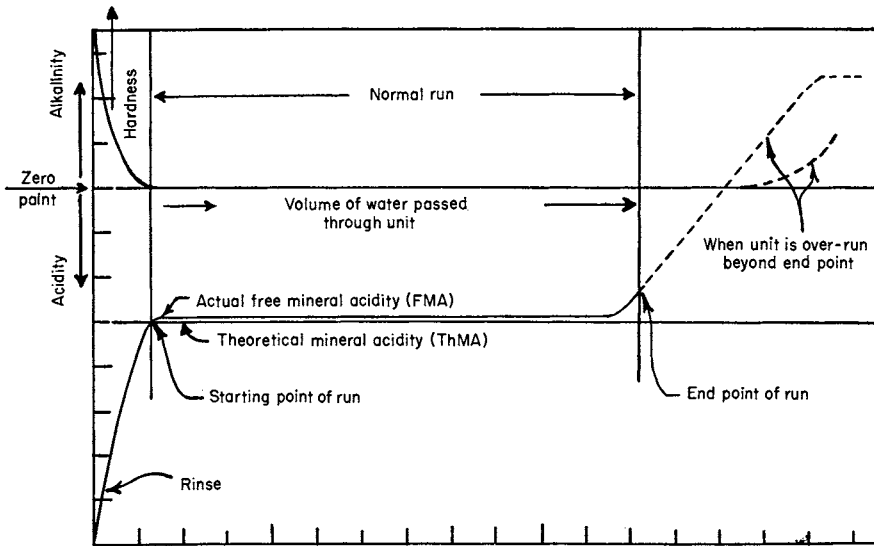

FIG. 8. Characteristic curve of effluent from a hydrogen exchanger. (Sulfonated coal derivative.)

300 p.p.m. of Cl^- and SO_4 , 137 p.p.m. of HCO_3^- and 390 p.p.m. of Ca^{++} and Mg^{++} , was used. One can observe that no hardness is found in the effluent, and that the free mineral acidity is nearly equal to the sum of the chloride and sulfate ions, which is often called "theoretical mineral acidity" (ThMA). The breakthrough is sharp and in a short time after the breakthrough, alkalinity appears.

(d) *CaSO₄ Precipitation.* Since one of the products formed during the regeneration of a cation exchange bed with sulfuric acid is calcium sulfate, there is a possibility of precipitating calcium sulfate in the bed. The solubility of CaSO_4 is 31 meq./l. at 25° C., but to have the regenerant effective, the acid concentration must be higher than this figure. In most cases the 2% solution of sulfuric acid solution as a regenerant shows little danger of CaSO_4 precipitation, as the solution remains supersaturated for some time.

The use of sodium hexametaphosphate as a stabilizer for CaSO_4 is mentioned in the literature. Bell (19) claims that upon addition of 25 to

1000 p.p.m. of sodium hexametaphosphate, depending on the degree of supersaturation with respect to CaSO_4 , the precipitation of CaSO_4 in sulfuric acid is prevented. Although the use of sodium hexametaphosphate for prevention of CaSO_4 precipitation deposition on cation exchange beds when regenerating with sulfuric acid is suggested in the literature (9), tests run by Simon (102) indicated that in order to use high concentrations of sulfuric acid, extremely high quantities of sodium hexametaphosphate are necessary. Proper concentration of acid and a proper regeneration period appear to be the best methods for avoiding CaSO_4 deposition. The use of NaCl for the removal of calcium prior to the sulfuric acid regeneration has been mentioned frequently but very few plants have thus far utilized the double regeneration involved by this procedure.

3. Step II: The Anion Exchange Cycle

(a) *Regeneration and Rinse.* As was previously pointed out, the regenerant commonly used for the anion exchange bed is sodium carbonate. Sodium hydroxide or ammonium hydroxide may be used where available. The dosage is usually less than 1.5 times the operating capacity, and the strength of the regenerant is about 2 to 5%. The period of regenerant introduction is 10 to 15 minutes, followed by a rinse to remove the salts

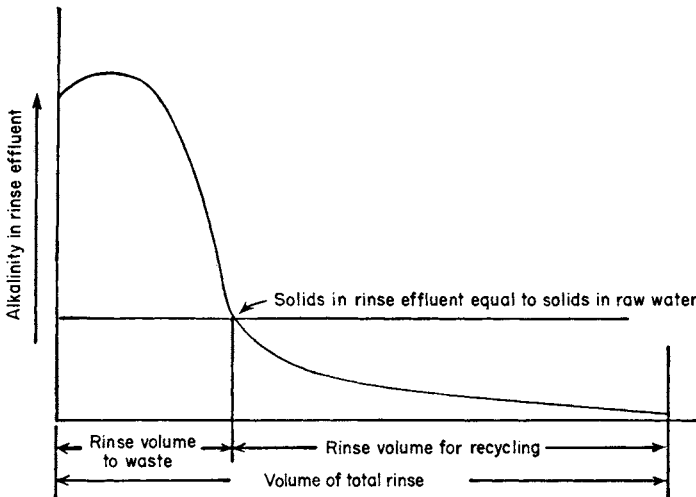
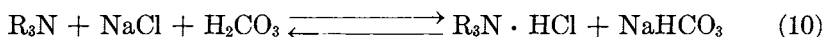

FIG. 9. Rinse recycling from anion exchanger.

and excess alkali. A total rinse volume of about 50 to 150 gallons/cu. ft. is customary. To save some of the rinse effluent, which is low in electrolyte content, because water from the hydrogen exchanger is used for rinsing, part of the rinse water may be recycled to the hydrogen exchanger. Figure 9

shows a typical rinse curve. Recycling is begun at the point where the total ionic strength is equivalent to that of the raw water.

(b) *Quality of Demineralized Water.* The demineralizing run is started when the conductivity meter indicates a low electrolyte content. Table VIII shows the quality of several industrial demineralized waters (82). Most soluble organic matter, if present, will pass the units and show up in the final effluent. It is important that replacement of the cations in the hydrogen exchanger be complete, since the anion exchanger will not remove the metallic cations. The presence of a few p.p.m. of sodium bicarbonate in the demineralized water is due to the reaction in the anion exchanger between the carbonic acid and neutral salts, which may be present in the effluent of the hydrogen exchanger.



For a given regenerant dosage, the capacity of the exchanger will depend on the ratio of the chloride to the sulfate as well as on the concentration of these ions. The capacity for the sulfate is much greater than for the chloride. For this reason it is assumed that the sulfate is partially removed as HSO_4^- rather than as $SO_4^{=}$. In general, the higher the acid concentration, the higher is the capacity. Rate of flow is important with some anion exchangers as their rate of reaction is much slower than that of the cation exchangers.

TABLE VIII

Composition of Raw and Demineralized Water at some Industrial Plants

Ionic constituents*	Raw	Demineralized	Raw	Demineralized	Raw	Demineralized
Ca ⁺⁺ and Mg ⁺⁺	43	0	116	0	261	0
Na ⁺	21	3	33	3	16	2
Total cations	64	3	149	3	277	2
HCO ₃	34	3	58	3	188	2
Cl ⁻	6	0	3	0	14	0
SO ₄ ⁼	24	0	88	0	75	0
Total anions	64	3	149	3	277	2

* Expressed as p.p.m. CaCO₃

Another feature observed with some anion exchangers is the swelling during runs. Excessive swelling and deswelling during the cycle may cause mechanical breakdown of the particles on repeated runs.

Backwashing of the anion exchanger bed at the end of the run is carried out at a rate of 4-6 g.p.m./sq. ft.

4. *Special Operating Methods*

Partial recycling and multiple demineralization are special methods of operating demineralizing units in cases where (1) the raw waters contain relatively high contents of sulfates and chlorides, and (2) a lower electrolyte content than those tabulated above is desired.

Partial recycling is accomplished by returning a portion of the effluent to the raw water influent in order to lower the electrolyte content of the latter prior to its passage through the hydrogen exchanger. By this means a better quality effluent is obtained. This process is more frequently used than multiple demineralization.

Multiple demineralization is effected by treating the water two or more times in succession through a series of units, or by collecting the effluent from the first treatment in a storage tank, and recycling it through the same units. Four bed systems (74), in which four alternate beds of a hydrogen and anion exchanger are used, are recommended for obtaining extremely high quality water and good regenerant efficiency. Fundamentally, this procedure is a multiple demineralization which is applicable to waters of very high electrolyte content.

5. *Desalting of Sea Water*

At present the two step ion exchange process for demineralizing water is not applicable to strong salt solutions, such as sea water, which contains 3 to 3.5% salts, the major portion of which is sodium chloride. By simple calculation it is evident that, even if the ultimate exchange capacities of the high capacity ion exchangers are used, the volume yield of electrolyte free water from sea water would be slightly higher than the volume of the exchangers. This does not include the regenerant and rinse volumes. Distillation, therefore, is still the standard practice for preparing potable water from sea water. For emergency purposes, however, a kit (Fig. 10) containing special cation exchangers (26) has been developed for desalting sea water. This kit, as it will be described in another portion of this book, has become a standard piece of emergency equipment for aircraft flying overseas.

XII. SILICA REMOVAL

1. *Silica in Water*

Silica in water may be found in colloidal and ionic forms. Colloidal silica is removed by standard methods of coagulation and filtration. Dissolved silica, which is believed to exist as ions of ortho and meta silicic acids (106), requires special methods for its removal. The amount of dissolved silica found in water depends on local conditions, but it can be

stated that all natural water supplies have silica as a constituent. In surface waters the silica content may vary from slightly less than 2 p.p.m. to slightly over 60 p.p.m. as silica. In ground waters the upper limit may go up to 110 p.p.m. These values do not apply to highly alkaline waters, which may contain exceedingly high values of silica.

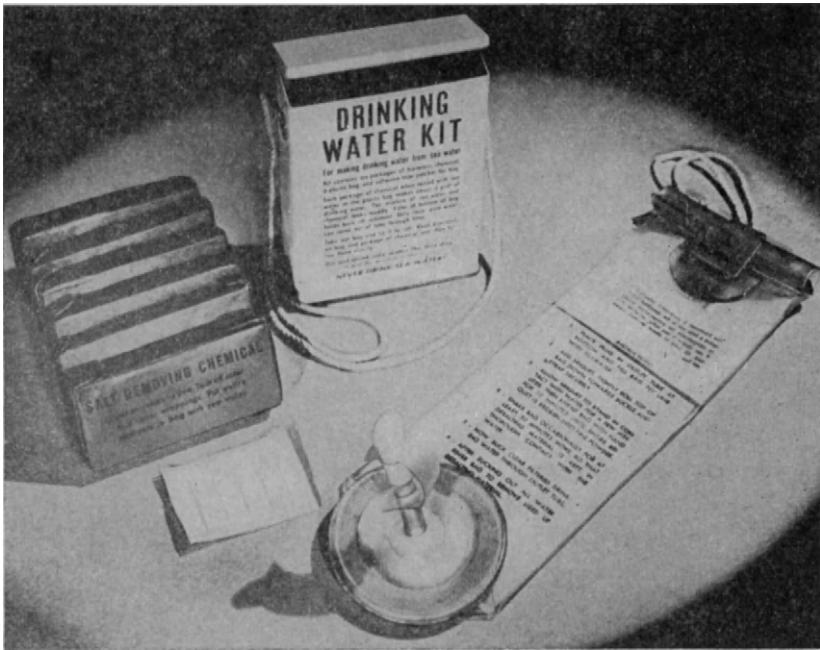

FIG. 10. Sea water desalting kit showing briquets, container, and plastic bag. (Courtesy of The Permutit Company.)

2. Effect of Silica in Boiler Feed Waters

Silica is very objectionable in boiler feed water because of its scale forming properties. The scale is very adherent and difficult to remove. Owing to its low thermal conductivity, relatively thin layers of silica scale may cause boiler tube or boiler wall failures. The form in which it deposits on boiler walls will depend on the other constituents present in the boiler feed water. If calcium is present, the scale will be calcium silicate. Soluble aluminum will cause analcite deposition.

The problem of silica has become of special importance in the operation of high pressure steam boilers. From the results of investigations with various types of boilers both here and abroad (98), the claim is made that some salts and silica pass over with the steam as a solution when the boiler

is operated at a pressure and temperature above certain critical values. The silica content of the steam increases with increasing silica content of the boiler feed, and with the increase of the temperature and pressure of operation (107). It is decreased in the presence of NaCl, Na₂SO₄, NaOH, and Na₂PO₄. The salts in the steam are deposited in the superheaters and on the turbine blades. In the first part of the turbine, sodium chloride and sodium hydroxide are found mixed with silica. Further down the turbine, where the steam temperature and pressure drop, silica forms a very troublesome encrustation which decreases the capacity and efficiency of the turbine. To remove this hard, adherent scale (43), operators resort to scraping, sand blasting with fine ash, blowing NaOH in with the steam, or other drastic methods. If for a given pressure of operation, 4.5 p.p.m. SiO₂ in the boiler gives a steam practically free of silica, and if the concentration in the boiler is 15-fold, the boiler feed water should contain less than 0.3 p.p.m. silica (130). The ion exchange process for silica removal, developed since 1945, can produce water of such quality.

3. Silica Removal Methods (46)

Silica is generally removed by means of colloidal metallic oxides, such as MgO (119), Al₂O₃ (21) and Fe₂O₃ (97). This can be done in conjunction with lime-soda treatment for the removal of hardness and alkalinity, or as a separate step. When these methods are employed, the treatment is designed to produce a residual silica content of 1 to 3 p.p.m., as lower values require high dosages of the adsorbents which make the process costly. Granular beds of some of these metallic oxides were tried, but the regeneration of these proved to be inefficient.

Although a low silica content is not commonly required in the usual demineralized water, there are some applications for which it is desirable to obtain a demineralized water having a negligible silica content. Demineralizing which included removal of silica from water would make it possible to employ such water advantageously in some cases for boiler feed water supply. Silicic acid, H₂SiO₃, is a very weak acid and is not absorbed by the usual anion exchangers in the conventional demineralizing process. A practical process for the direct removal of silica employing highly basic anion exchangers was first reported by Gilwood (46). Anion exchangers with highly basic amino groups are now available for the removal of silica. An indirect method for the removal of silica by ion exchange, suggested by Bauman (14), utilizes the conversion of the silica in water to SiF₆²⁻ through the addition of a fluoride to the raw water, prior to its passage through the hydrogen cation exchanger. H₂SiF₆ is a strong acid and is, therefore, absorbed by all the anion exchangers available.

4. Direct Anion Exchange Method

In the direct anion exchange method, the water is passed first through a hydrogen cation exchange bed to remove the metallic cations and is then passed through the highly basic anion exchange resin bed. The highly basic anion exchanger removes the strong mineral acids, such as HCl and H₂SO₄, as well as the weak carbonic acid. Since all of these acids are stronger acids than silicic acid, they will reduce the capacity of the anion exchanger for silica removal. Therefore, it is generally advantageous to remove the carbonic acid by degasification and in some cases it is desirable to remove the HCl and H₂SO₄ from the water before it enters basic anion exchanger bed. A plant arrangement incorporating these steps (25a, 46) is illustrated in Fig. 11.

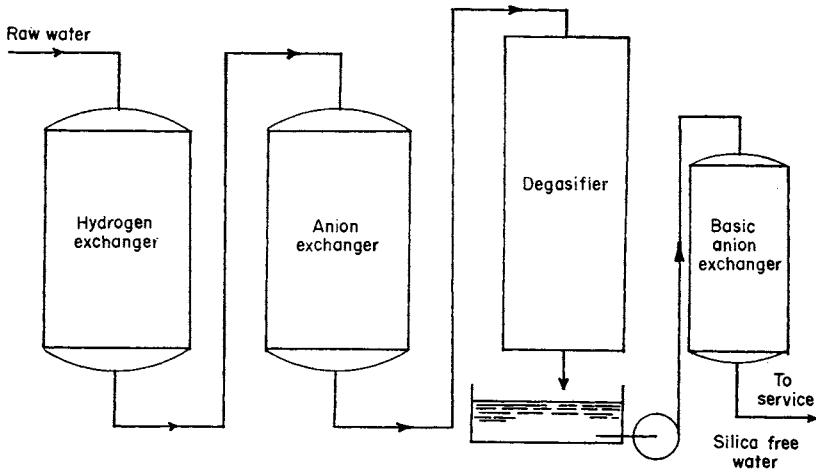

FIG. 11. Water demineralization with silica removal by basic anion exchanger.

The manner in which the highly basic anion exchangers react with the silica is at present not definite. Equation 4 can explain the removal just as the assumption that the highly basic amino groups may be looked upon

TABLE IX

Salt Splitting Capacity of Various Commercial Anion Exchangers

Anion exchanger	Salt splitting capacity meq./l.
A	300
B	200
C	112
D	82
E	14

as a strong base (R_4NOH), which reacts with the silicic acid. Even in the most basic anion exchangers available, only a portion of the amino groups may be considered to be strongly basic. This is evident when the salt splitting ability (basicity) of such anion exchangers are determined. Table IX shows the basicity or salt splitting capacity of various anion exchangers as determined by passing a known solution of sodium chloride through the regenerated anion exchange bed and measuring the amount of sodium hydroxide formed.

The regeneration of the basic anion exchanger is accomplished with sodium hydroxide. The silica treated effluent in the direct anion exchange method averages 0.1 to 0.3 p.p.m. It is very important to operate the hydrogen exchanger in such a way as to have no cation leakage taking place, as any cations found in the hydrogen exchange effluent above certain values will cause silica leakage in the final effluent.

The capacity of these silica absorbing exchangers will depend on the silica content of the influent. The higher the silica content, the higher will be the capacity. If the basic anion exchanger is used in a two-unit demineralizing system, and not as shown in Fig. 11, the capacity of the exchanger will be determined by the total electrolyte content of the raw water. If it is used as shown in Fig. 11, the capacity will be based on the silica only.

The direct silica removal method has the advantage that neither sodium fluoride nor special regenerations are necessary. It can also be used with very high silica waters without substantial increase in cost, compared to the fluosilicate method. At present the direct method appears the most practical for the removal of silica to very low values. New highly basic anion exchangers, in which nearly all of the active groups are strongly basic, are becoming available. The total capacity of these exchangers may, therefore, be utilized for silica removal.

5. The Fluosilicate Method (14, 46, 62)

(a) *The Process.* In the simplest arrangement, the process consists of a two bed system, one a hydrogen exchanger and the other any anion exchanger. To the influent is added fluoride in excess of the stoichiometric equivalent of the silica as it enters the hydrogen exchange bed. The silica and the fluoride react there to form the fluosilicate ion as given in the following equations,

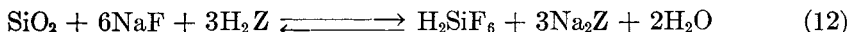
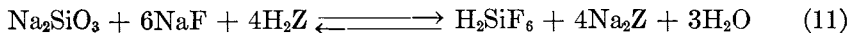

The effluent from the cation exchanger is then passed through the regenerated anion exchanger which has been conditioned with HF. The

fluosilicate ion is absorbed by the anion exchanger, resulting in an almost silicate-free water.



The final silica content of the effluent will depend on the completeness of regeneration of the anion exchanger, amount of excess fluoride fed, flow rate, and other factors which will be discussed later. The flow diagram for the process is the same as for a demineralizing unit shown in Fig. 7, except that a fluoride feed is added.

(b) *Hydrogen Exchanger.* The hydrogen exchanger is regenerated with 2 to 4 pounds of sulfuric acid per cubic foot of bed if a low capacity cation exchanger is used. After the bed is rinsed free of the excess acid and liberated salts, a strong sodium fluoride solution is passed through and the HF formed is passed to the regenerated and rinsed anion exchanger. This conditioning appears to be for the purpose of creating a fluoride zone in the anion exchange bed so as to allow further reaction if any unreacted silica appears in the effluent from the hydrogen exchanger. With some waters good quality effluents are obtained when the anion exchange bed is conditioned with HCl instead of HF (28), therefore it would appear that this conditioning is for the purpose of preventing the $SiF_6^{=}$ from coming in contact with highly basic groups that may be present in the anion exchanger. The $SiF_6^{=}$ will react with hydroxide to give silica, which will appear in the effluent.

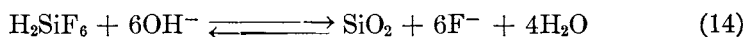

If an anion exchange bed, after a run with a water containing $SO_4^{=}$, $SiF_6^{=}$, Cl^- and F^- , is analyzed by sectioning, the uppermost section will be found to contain mostly sulfate, the next section the fluosilicate, and the lowest sections will be composed of the chloride and fluoride. This preferential exchange for the various anions has been shown (68) to depend on the valence and structure of the anions and the ionization of the acid. The replacement of Cl^- and F^- by $SiF_6^{=}$ may be viewed as a zone of chloride and fluoride preceding the fluosilicate and thus preventing it from coming in contact with the highly basic groups of the anion exchanger.

The quantity of sodium fluoride added to the influent is about 50 to 75% above the value calculated from equation 12. This excess is needed, no doubt, to produce a mass action effect.

(c) *The Anion Exchanger.* The anion exchanger is regenerated with a dilute solution of sodium hydroxide. The quantity is so chosen that the solubility of Na_2SiF_6 , given as 6.97 g./l. of solution (91) is not greatly exceeded. By treating the anion exchange bed with an acid solution before regeneration, sodium carbonate may be used as a regenerant (14). The quality of regenerant used will affect both the quality of the effluent and

the length of the run. The higher the dosage, the better is the quality of the effluent and the longer is the run. In general, the optimum operating conditions will depend on the anion exchanger selected for the unit. After regeneration it is rinsed free of alkali and salts. The conditioning with HF is followed and then the bed is once more rinsed with the effluent from the hydrogen exchange unit.

(d) *Quality of Effluent.* Table X gives a representative laboratory run obtained with a water containing 16 p.p.m. of silica. Throughout the run, except for the first 2 liters, the effluent silica was below 0.4 p.p.m. and the fluoride was about 0.1 p.p.m. The effect of fluoride in high pressure boilers is not yet known. It is evident that the fluoride breakthrough may be used as the endpoint of the run. During the course of the run, the bed should not be disturbed, as this will cause an immediate increase of the silica in the effluent, owing, no doubt, to the disturbance of the fluoride and chloride zone which appears to be essential for proper operation.

TABLE X
Effluent Quality of a Water Treated for Silica Removal by the Fluosilicate Method

Effluent volume (liters)	pH	Total electrolytes by Solu-Bridge (p.p.m. as NaCl)	p.p.m. Fluorine as F	p.p.m. Silica as SiO ₂
1	7.2	2.1	0.1	4.3
2	—	1.5	0.1	2.0
5	6.0	2.5	0.1	0.4
10	5.1	2.4	0.1	0.3
15	5.3	2.6	0.1	0.15
25	4.8	4.6	0.1	0.0
30	4.8	4.8	0.1	0.25
35	5.0	6.0	0.3	0.35
40	5.4	9.0	1.0	0.40
45	3.7	23.0	2.0	0.45

(Raw Water, p.p.m. as CaCO₃—Ca⁺⁺ and Mg⁺⁺—120; Na⁺—99; Cl⁻—44; SO₄⁻—57; HCO₃⁻—118; SiO₂—16 p.p.m. as SiO₂)

(Sulfonated coal type hydrogen exchanger, polyethylene polyamine anion exchanger—200 ml. beds-sodium hydroxide as regenerant for anion exchanger—60% NaF in excess of theoretical fed to the influent.)

(e) *Limitation of the Process.* Economic consideration limits the usefulness of the fluosilicate process for silica removal. Although sodium fluoride may be replaced by calcium fluoride (14), or the fluoride may be recovered through a cyclic process (62), the addition of fluoride adds highly to the regeneration costs and lowers the capacity of the exchangers. At best the method is applicable to waters of low silica content, but in view of the stability and simplicity of operation of the highly basic exchangers, the direct anion exchange method appears to be the preferred process for silica removal.

XIII. FLUORIDE REMOVAL

1. *Fluoride in Water and Dental Fluorosis*

Water supplies containing fluoride in excess of the limit set by the United States Public Health Service is a problem in many parts of the

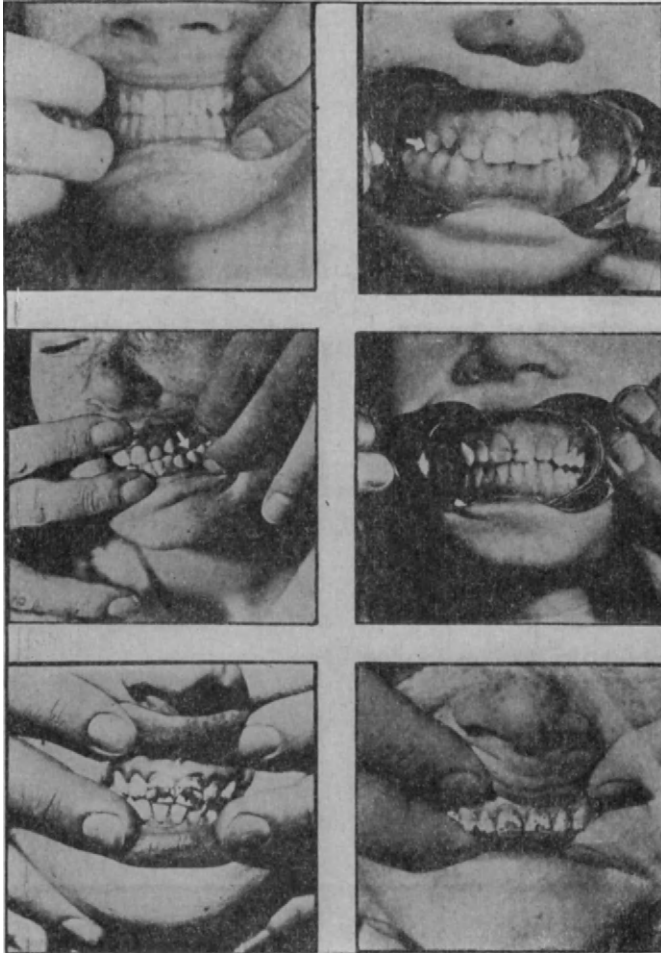

FIG. 12. Dental fluorosis. (Courtesy United States Public Health Service.)

Normal	Questionable
Very Mild	Mild
Moderate	Severe

United States (34, 38). It has been definitely shown that excess fluoride in drinking water is the cause of a dental disease known as mottled enamel,

or dental fluorosis (39). The distribution and severity of the disease can be said to be an indication of the fluoride concentration of the drinking water.

Children are susceptible to mottled enamel if, at the age when the permanent teeth are formed, they drink water containing more than 1 p.p.m. of fluoride. A child's first teeth, which begin to develop in the fetal stage, are unaffected, as the fluoride apparently does not pass from the mother through the placental connections. In mottled enamel (109), "the teeth lose their customary lustre and become chalky white; later they develop disfiguring patches of yellow, brown or black staining and may ultimately become pitted and absolutely black. The defect once established is permanent and incurable." Figure 12 shows normal and mottled teeth found in children using water that contains fluoride.

A quantitative relation between the fluoride content in the drinking water supply and the percentage of mottled enamel incidence, according to compilation made by Dean of the United States Public Health Service, is given in Table XI. The clinical severity of the disease is also a function of the fluoride concentration. Similar results were shown by Deatherage (40) for children examined in Illinois communities using fluoride containing waters for drinking purposes.

The observation by Dean (37) that the incidence of dental caries was less in communities where the drinking water supply contained fluoride, as compared to communities which were using fluoride free waters, has led to large scale tests in several large American cities, where fluoride in small quantities is being added to the drinking water. Evaluation of these tests have not yet been completed.

Fluorides in water are owing to the presence of fluoride minerals in the soil strata of the locality. The minerals may be found in volcanic deposits, phosphate bearing rocks, or may be of granitic origin, e.g., fluorite, tourmaline, cryolite, or biotite. Water supplies containing as high as 14 p.p.m. of fluoride were in use at one time.

2. Removal of Fluoride by Hydroxy Apatite

The removal or reduction of fluoride to the limit set by the United States Public Health Service for drinking waters is a necessity for many communities which have only water supplies containing more than 1 p.p.m. of fluorides available. McGeorge (104) recommended the use of bone or other forms of "carbonate apatites," and the Smiths (105) have shown bone contact to be effective in removing fluoride. Equilibrium studies showed the removal to follow the Freundlich absorption isotherm. Regeneration of the bone is accomplished by alkali and acid rinse. Although there are

TABLE XI
Relation Between Fluoride Domestic Waters of Various Concentrations and the Degree of Severity of Endemic Dental Fluorosis (Mottled Enamel)
 Observations on 5,824 white children of 32 cities of 10 states

CITY AND STATE	CHILDREN EXAMINED		FLUORIDE (F) CONCENTRATION (PPM) IN PUBLIC WATER SUPPLY	PERCENTAGE DISTRIBUTION OF SAMPLE ACCORDING TO DEGREE OF DENTAL FLUOROSIS						INDEX OF DENTAL FLUOROSIS	VARIATION OF INDEX OF DENTAL FLUOROSIS WITH FLUORIDE CONCENTRATION OF THE COMMUNAL WATER SUPPLY
	NUMBER	PERCENT AFFECTED		NORMAL	QUESTIONABLE	VERY MILD	MILD	MODERATE	SEVERE		
BAUXITE ARK.	26	100.0	14.1			3.9	3.9	38.5	53.8	3.4	
ANKENY IOWA	21	100.0	8.0			9.5	47.6	42.8	3.3		
CHETOPA KAN.	65	100.0	7.6			9.2	21.5	10.6	58.5	3.2	
POST TEX.	38	100.0	5.7			10.5	50.0	39.5	3.3		
LUBBOCK TEX.	189	97.8	4.4	1.1	1.1	12.2	21.7	46.0	17.9	2.7	
CONWAY SO. CAR.	59	88.2	4.0	5.1	6.7	20.4	32.2	23.7	11.9	2.1	
AMARILLO TEX.	289	90.3	3.9	3.1	6.6	15.2	28.0	33.9	13.2	2.3	
PLAINVIEW TEX.	97	87.6	2.9	4.1	6.3	34.0	26.8	23.7	3.1	1.8	
COLO SPRGS. COLO.	40.4	73.8	2.6	6.4	19.8	42.1	21.3	8.9	1.5	1.3	
CLOVIS N. M.	138	71.0	2.2	13.0	16.0	23.9	35.4	11.0	0.7	1.4	
GALESBURG ILL.	273	47.6	1.9	21.3	27.1	40.3	6.2	1.1		0.69	
ELMHURST ILL.	17.0	40.0	1.8	28.2	31.8	30.0	8.8	1.2		0.67	
JOLIET ILL.	4.47	25.3	1.3	40.5	34.2	22.2	3.1			0.46	
AURORA ILL.	63.3	15.0	1.2	53.2	31.8	13.9	1.1			0.32	
KEWANEE ILL.	123	12.2	0.9	52.8	35.0	10.6	1.6			0.31	
PUEBLO COLO.	61.4	6.5	0.6	72.3	21.2	6.2	0.3			0.17	
ELGIN ILL.	403	4.2	0.5	60.5	35.3	3.5	0.7			0.22	
MARION OHIO	263	6.1	0.4	57.4	36.5	5.3	0.8			0.25	
LIMA OHIO	45.4	2.2	0.3	84.1	13.7	2.2				0.09	
ZANESVILLE OHIO	459	1.5	0.2	85.4	13.1	1.5				0.08	
MICHIGAN CITY, IND.	236	0.0	0.1	97.5	2.5					0.01	
WAUKESGA ILL.	423	0.2	0.0	97.9	1.9	0.2				0.01	

Compiled from Dean, H. Trendley, "The Investigation of Physiological Effects by the Epidemiological Method," in *Fluorine and Dental Health*, Publ. No. 10. A.A.A.S., Washington, 1912.

INDEXES OF DENTAL FLUOROSIS FALLING WITHIN SPECIFIED RANGES

0.0-0.4	INDEXES OF LITTLE OR NO PUBLIC HEALTH CONCERN RESPECTIVE OF DENTAL FLUOROSIS
0.5-0.6	SLIGHTLY IMPORTANT FROM STANDPOINT OF DENTAL CARE PREVALENCE
0.7-0.8	MODERATELY IMPORTANT
0.9-1.0	VERY IMPORTANT
1.1-1.2	MARKED
1.3-1.4	VERY MARKED
1.5-1.6	RECOMMENDED
1.7-1.8	EXCESSIVE
1.9-2.0	FLUORIDES
2.1-2.2	REMOVAL OF EXCESSIVE FLUORIDES IN WATER IS RECOMMENDED

plants using processed bone for fluoride removal, little information is found in the literature for large plant operation.

Adler *et al.* (3) have prepared a synthetic hydroxy apatite, $3\text{Ca}_3(\text{PO}_4)_2 \cdot \text{Ca}(\text{OH})_2$, in which the fluoride removal is accomplished by anion exchange. The apatite is regenerated with sodium hydroxide and rinsed with an acid to neutralize the excess alkali. The reaction may be represented by the following equation:

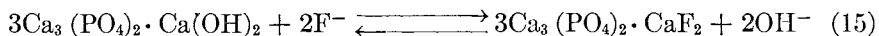

For regeneration of 1 pound of exchanger, 1.5 liters of a 1% solution of sodium hydroxide and 1.1 liters of HCl containing 0.7% HCl by weight are required. The capacity for fluoride removal is given as 1.8 g. fluorine/kg. of exchanger. However, appreciable losses of exchanger take place during regeneration because of the use of hydrochloric acid as a rinse.

Goodwin and Litton (48) report pilot plant studies of fluoride removal by hydroxy apatite from a Texas water containing 5.2 p.p.m. fluoride. Instead of using acid for neutralizing the excess alkali, they used carbon dioxide, which was shown by Behrman and Gustafson (17) to reduce the loss of exchanger during regeneration and to maintain the initial capacity and particle size. The flow rate was 1.5 gallons/minute and the average fluoride concentration in the effluent was 0.42 p.p.m. During the 50 runs made only 1 pound of the bed was lost. This amounted to 1.4%. The authors estimate a 5% replacement for every 300 cycles.

3. Removal of Fluoride by Organic Ion Exchangers

Myers and Herr (80) report the removal of fluoride from water by an anion exchanger which has been impregnated with an aqueous solution of an aluminum salt. Prior to introduction of the aluminum salt, the anion exchanger is treated with a dilute acid solution to prevent the precipitation of aluminum hydroxide. The authors believe that an anion exchanger having amino methyl substituents holds on to the aluminum compounds which adsorb the fluoride ions. The process was investigated with waters of pH of 5.9–8.1 and fluoride concentrations from 6.5 to 500 p.p.m. The capacity for water containing 6.5 p.p.m. of fluorine was 149 meq./l. Regeneration is accomplished by first treating the bed with an alkali until all the fluoride is displaced, followed in turn by the acid and aluminum salt solutions.

By the use of a two bed system, i.e., hydrogen exchanger plus anion exchanger, fluoride can be reduced to any value desired, but the cost is too high for community use because of the removal of the other ions and the operation is too complicated for household use. The process, therefore, is not used.

Behrman and Gustafson (18) suggested that the water be passed through a hydrogen exchanger, and that the HF formed be adsorbed by a bed of MgO or MgCO₃, which is later regenerated with lime. This has the same shortcomings as the demineralization process for fluoride removal and, in addition, the regeneration of adsorbents such as MgO is not efficient.

XIV. AMMONIA REMOVAL

1. Ammonia in Water

Ammonia in water results from the reduction of nitrates from decaying plant and animal matter by certain soils, metals, or organisms. It may also be owing to direct addition as in the chloramine process of water sterilization. Rain water always has a trace of ammonia. In steam condensates, free ammonia may be the result of the breakdown of organic nitrogenous compounds under boiler conditions, but more often it is introduced into water supplies through the discharge of sewage into streams.

Ammonia in water serves many organisms as a source of energy and food supply. Elimination of the ammonia helps to reduce organic growth in pipe lines.

Ammonia in steam condensates interferes in the determination of its specific conductance and, therefore, a correction is necessary if ammonia is present. Ammonia in water causes corrosion of copper and copper alloys by dissolving copper as the copper ammonium complex. In steam, ammonia has a corrosive effect on the copper bearing parts of the boiler plant. It should be eliminated where nonferrous parts are used. However, recent work reported by Cerna (29) showed that ammonia is desirable in an all steel boiler system, as it provides a high feedwater and condensate alkalinity without concentration of alkalinity in the boiler water. It also appears that, in the absence of oxygen, a concentration of ammonia up to 10 p.p.m. NH₃ does not attack some nonferrous metals used in boiler tubes. In one plant feeding ammonia in the absence of dissolved oxygen eliminated corrosion in the economizer and heat exchange valves. If ammonia is to be removed, cation exchangers appear to be applicable.

2. Removal of Ammonia by Cation Exchangers

Buswell and Suter (25) showed that a sulfonated coal-type hydrogen exchanger removed nearly all the ammonia from a water containing 2.7 p.p.m. of ammonia as NH₃. The average ammonia content of the effluent was about 0.12 p.p.m. or 4.4% of the original quantity. The breakthrough of the ammonia appears at about the point where the total solids begin to increase.

As the run is continued, the ammonia concentration increases in the effluent until a point is reached where the effluent ammonia exceeds that of the influent due to displacement of NH_4 by Ca and Mg ions. Figure 13 shows the analysis of the run as obtained by Buswell and Suter (25).

Joos (61) reports a plant where a condensate containing 50 to 100 p.p.m. ammonia is passed through a sulfonated resin on the hydrogen cycle, and the ammonia is reduced to zero. A pilot plant with 100 runs showed the method to be practical for boiler plant conditions.

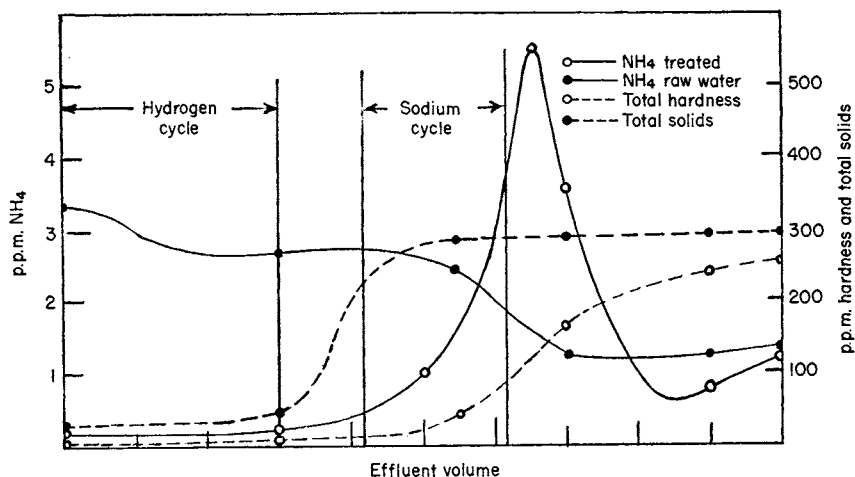

FIG. 13. Removal of ammonia by a sulfonated coal type cation exchanger (25).

XV. MISCELLANEOUS APPLICATIONS

1. Sterilization

Anion exchangers impregnated with silver or other oligodynamic metals are recommended for water sterilization by Barnes and Ham (11). It is claimed that the anion exchanger acts faster and better in destroying bacteria than a cation exchange resin similarly treated. The improved effect is ascribed to a removal of the bacteria by some attraction. The resin can be compressed into a briquet or pill form and dropped in water, or the water can be filtered through the exchanger. However, some silver appears to go into solution during treatment, thus reducing the applicability of the process.

The use of silver siliceous exchangers for its oligodynamic action is the subject of several patents (55, 60).

2. *Waste Water*

Many streams are being polluted by industrial wastes that contain heavy metals. The removal of these objectionable metals from dilute solutions by ion exchangers is possible (15, 51). In some cases the recovery of these waste products may pay the cost of operation (76, 110).

3. *Softening Sea Water*

Softening of sea water by a carbonaceous exchanger for boiler feed-water and regenerating the bed with the boiler concentrate are subjects of a Russian patent (90).

4. *Phenol Removal*

Water containing phenol is passed through a cation exchanger of the carboxylic type or through an anion exchanger and the phenol is absorbed by the exchanger (96).

5. *Dechlorination and Chloramine Formation*

A proposal for the use of an ammonium exchanger for chloramine formation (70) and the removal of excess chlorine (67) by an exchanger are also mentioned in the literature.

6. *Potassium Exchanger*

Some investigators have shown that potassium salts instead of sodium in boiler water prevents the formation of silica scale in the boiler and deposition on turbine blades (54). Since potassium salts are expensive, the recovery of potassium by using the boiler concentrate as a regenerant for a cation exchanger is suggested (63). The beneficial effect of potassium salts may be mitigated by other difficulties introduced (20, 129). However, this demonstrates the possibilities of the ion exchange method in the field of water treatment.

XVI. MAINTENANCE OF ION EXCHANGE BEDS

1. *Microbial Fouling of Ion Exchange Beds*

It has been the practice to chlorinate continuously or to apply an occasional sterilization treatment to siliceous exchange beds in order to prevent and destroy slime and organic growths introduced by contaminated water. Examination of the slimes will reveal iron bacteria, protozoa, diatomaciae, and bacteria including an abundance of *Aerobacter aerogenes*. In view of the sensitivity of the coal type and the sulfonated phenolic cation exchangers to chlorine, new germicides and preservatives of the chlorophenolic type (4) have been recommended from time to time. In

some instances surface active agents have been tried with a 1/2% $\text{Na}_2\text{S}_2\text{O}_4$ solution (78). Proper backwashing of the bed at the end of the run, as well as the use of clear effluents, appear to be the best preventive method (131). If beds are to remain idle, care should be taken that no growths develop.

2. Deposition of Iron Oxide Floc and other Precipitants

The deposition of iron and alumina floc, as well as CaCO_3 and $\text{Mg}(\text{OH})_2$ if the water is pretreated by coagulation or lime soda, will affect the capacity of the ion exchange beds. Turbidity and other suspensions may clog the pores of the granules.

The methods for reconditioning of siliceous zeolites made necessary by contamination vary. Usually an acid or alkali treatment is prescribed, followed by a treatment with sodium silicate and alum, or with sodium aluminate followed by the silicate and alum. Klein (66) reports a greensand that had lost all its capacity, restored to the original value by the following treatment: The material was first screened to remove gravel dust and fines. After being treated with strong acid at elevated temperature, it was washed and dried. Next, it was treated with sodium aluminate, dried, and then washed free of excess alkali. Stabilization was accomplished by treatment with a 2% sodium silicate solution, followed by an alum solution. Methods suggested for gel type siliceous zeolites (108) are the use of acetic acid, chlorination, crushing of larger particles and removing the finer particles (< 50 mesh), and treatment of the larger particles with alkali, sodium silicate, and alum.

Organic ion exchangers are treated with a strong acid, rinsed with water and followed by a rinse of a weak alkali solution. In general, however, before treatment is applied, it should be determined whether the difficulties encountered are due to contamination of the bed, deterioration of the material, or improper operation of the units.

3. Brine Disposal from Sodium Zeolite Softeners

The disposal of regenerant wastes from ion exchangers must be considered. The disposal methods mentioned by Haney (53) are evaporation ponds, uncontrolled dilution, controlled dilutions, and brine disposal wells. Of the above methods, according to Haney, controlled dilution appears to offer a general means of handling wastes from ion exchange units.

BIBLIOGRAPHY

1. Adams, B. A., and Holmes, E. L., *J. Soc. Chem. Ind.* **54**, 6T (1938).
2. Adler, H., U. S. Patent 2,417,462 (March 18, 1947).
3. Adler, H., Klein, G., and Lindsay, F. K., *Ind. Eng. Chem.* **30**, 163 (1938).
4. Allen, W. W., U. S. Patent 2,400,677 (May 21, 1946).
5. American Public Health Association, Standard Methods for the Examination of Water and Sewage. American Public Health Association, New York (1946).
6. A. W. W. A., *J. Am. Water Works Assoc.* **35**, 721 (1943).
7. Applebaum, S. B., *J. Am. Water Works Assoc.* **30**, 947 (1938).
8. Applebaum, S. B., *Proc. Ann. Water Conf., Eng. Soc. West. Penna.* **7**, 123 (1947).
9. Atterberry, R. W., and Herr, D. S., *Ind. Eng. Chem.* **37**, 100 (1945).
10. Bachmann, F., *J. Am. Water Works Assoc.* **36**, 876 (1944).
11. Barnes, R. B., and Ham, G. P., U. S. Patent 2,434,190 (Jan. 6, 1948).
12. Bauman, W. C., *Ind. Eng. Chem.* **38**, 46 (1946).
13. Bauman, W. C., and Eichhorn, J., *J. Am. Chem. Soc.* **69**, 2830 (1947).
14. Bauman, W. C., Eichhorn, J., and Wirth, L. F., *Ind. Eng. Chem.* **39**, 1453 (1947).
- 14a. Bauman, W. C., Skidmore, J. R., and Osmun, R. H., *Ind. Eng. Chem.* **40**, 1350 (1948).
15. Beaton, R. H., and Furnas, C. C., *Ind. Eng. Chem.* **33**, 1500 (1941).
16. Behrman, A. S., and Gustafson, H. B., *Ind. Eng. Chem.* **28**, 1279 (1936).
17. Behrman, A. S., and Gustafson, H., *Ind. Eng. Chem.* **30**, 1011 (1938).
18. Behrman, A. S., and Gustafson, H., U. S. Patent 2,376,897 (May 29, 1945).
19. Bell, E. B., U. S. Patent 2,304,791 (Dec. 15, 1942).
20. Berk, A. A., and Rogers, N. E., *Trans. Am. Soc. Mech. Engrs.* **67**, 329 (1945).
21. Betz, L. D., Noll, C. A., and Maguire, J. J., *Ind. Eng. Chem.* **30**, 1320 (1940).
22. Bowers, H. L., U. S. Patent 2,065,962 (Dec. 29, 1936).
23. Bruce, W. M., U. S. Patent 1,906,202 (Apr. 25, 1933).
24. Buswell, A. M., *J. Am. Water Works Assoc.* **9**, 892 (1922).
25. Buswell, A. M., and Suter, M., *Ind. Eng. Chem.* **31**, 1704 (1939).
- 25a. Calise, V. J., and Lane, M., *Chem. Eng. Progress* **44**, 269 (1948).
26. Calmon, C., U. S. Patent Application.
27. Calmon, C., and Simon, G. P., Permutit Co., Unpublished Data (1947).
28. Calmon, C., and Saunders, G. H., Permutit Co., Unpublished Data (1947).
29. Cerna, W. W., *Power* **91**, 72 (1947).
30. Collins, L. F., *J. Am. Water Works Assoc.* **29**, 1472 (1937).
31. Committee on Qualitative Tolerances of Waters for Industrial Uses, *J. New England Water Works Assoc.* **54**, 261 (1940).
32. Contant, P. M., Fischer, A. J., and Kivell, W. A., U. S. Patent 2,415,936 (Feb. 18, 1947).
33. Cox, C. R., Laboratory Control of Water Purification, Case — Sheppard — Mann Publishing Corp., New York (1946).
34. Churchill, H. V., *Ind. Eng. Chem.* **23**, 996 (1931).
35. D'Alelio, G. F., U. S. Patent 2,366,007 (Dec. 26, 1945).
36. Davis, D. E., *Water Works Eng.* **96**, 1012 (1943).
37. Dean, H. T., *J. Pediat.* **18**, 782 (1940).
38. Dean, H. T., and Elvove, E., *Eng. News-Record* **120**, 591 (1938).
39. Dean, H. T., and McKay, F. S., *Am. J. Pub. Health* **29**, 590 (1939).
40. Deatherage, C. F., Fluorine and Dental Health. Publication No. 19, A. A. A. S., p. 89 (1942).

41. Du Domaine, J., Swain, R. L., and Hougen, O. A., *Ind. Eng. Chem.* **35**, 546 (1943).
42. Eastes, J. W., U. S. Patent 2,402,384 (June 18, 1946).
43. Forty, D., *Proc. Annual Water Conf., Eng. Soc. West. Penna.* **7**, 79 (1947).
44. Gans, R., *Gasbel.* **50**, 1026 (1907); *Chem. Abstracts* **2**, 681 (1908).
45. Gans, R., U. S. Patent 951,641 (March 5, 1910).
46. Gilwood, M. E., *Proc. Ann. Water Conf., Eng. Soc. West. Penna.* **7**, 94 (1947); *Power* **91**, 86 (1947).
47. Gilwood, M. E., and Calise, V. J., *Proc. Ann. Water Conf., Eng. Soc. West. Penna.* **5**, 11 (1944).
48. Goodwin, R. C., and Litton, J. B., *Ind. Eng. Chem.* **33**, 1046 (1941).
49. Griessbach, R., Wassenegger, H., Brodersen, K., Rieche, A., and Maier-Bode, H., U. S. Patent 2,228,514 (Jan. 14, 1941).
50. Griessbach, R., *Angew. Chem.* **52**, 215 (1939).
51. Grindley, J., *J. Soc. Chem. Ind.* **64**, 339 (1945).
52. Gustafson, H. B., U. S. Patent 2,376,414 (May 29, 1945).
53. Haney, P. D., *J. Am. Water Works Assoc.* **39**, 1215 (1947).
54. Harkinson, L. E., and Baker, M. D., *Trans. Am. Soc. Mech. Engrs.* **67**, 317 (1945).
55. Hattobe, T., and Yamamoto, Z., Japanese Patent 128,654 (Feb. 6, 1939); *Chem. Abstracts* **34**, 8130 (1940).
56. Hepler, J., and Theroux, F. R., *Mich. State Coll. Bull.* No. 61 (1935).
57. Hauck, C. F., *Proc. Ann. Water Conf., Eng. Soc. West. Penna.* **7**, 155 (1947).
58. I. G. Farbenindustrie A. G., British Patent 289,085 (Sept. 29, 1927).
59. Inglesen, H., and Adams, B. A., *J. Soc. Chem. Ind.* **50**, 123-4 T (1931).
60. Irwin, C. M., U. S. Patent 2,066,271 (Dec. 29, 1936).
61. Joos, C. E., *Power Plant Eng.*, **49**, 122 (1945).
- 61a. Juda, W., and Carron, M., *J. Am. Chem. Soc.* **70**, 3295 (1948).
62. Jukkola, W. W., *Proc. Ann. Water Conf., Eng. Soc. West. Penna.* **7**, 89 (1947).
63. Kaufman, C. E., U. S. Patent 2,395,331 (Feb. 19, 1941).
64. Kemmer, F., and Thompson, J., *Power Plant Eng.* **47**, 82 (1943).
65. King, R. E., and Smith, O. M., *Ind. Eng. Chem.* **31**, 727 (1939).
66. Klein, A. J., *J. Soc. Chem. Ind.* **63**, 262 (1941).
67. Kriegsheim, H., U. S. Patent 1,197,640 (Sept. 12, 1916).
68. Kunin, R., and Myers, R. J., *J. Am. Chem. Soc.* **69**, 2874 (1947).
- 68a. Kunin, R., and Barry, R., Kunin, R. and McGarrey, F. X., Division of Industrial and Engineering Chemistry 114th Meeting, American Chemical Society (Sept. 1948).
- 68b. Kunin, R., *Anal. Chem.* **21**, 87 (1949).
69. Langelier, W. F., *J. Am. Water Works Assoc.* **38**, 169 (1946).
70. Leighton, John W., U. S. Patent 2,122,476 (July 5, 1938).
71. Lindsay, F. K., *Ind. Eng. Chem.* **35**, 378 (1943).
72. Little, J. R., U. S. Patent 2,259,169 (Oct. 14, 1941).
73. Lourier, Y. Y., and Kliachko, V. A., *Compt. rend. acad. sci. USSR*, **49**, 40 (1945).
74. Manrig, W. D., *Proc. Ann. Water Conf., Eng. Soc. West. Penna.* **6**, 121 (1945).
75. Miller, D., *Proc. Ann. Water Conf., Eng. Soc. West. Penna.* **4**, 121 (1943).
76. Mindler, A. B., and Gilwood, M. E., *Proc. Ann. Water Conf., Eng. Soc. West. Penna.* **7**, 181, (1947).
77. Mott, J., *J. Am. Water Works Assoc.* **32**, 1512 (1940).
78. Myers, F. J., F. I. A. T. PB Report 42, 802 (1946).
79. Myers, R. J., and Eastes, J. W., *Ind. Eng. Chem.* **33**, 1203 (1941).
80. Myers, R. J., and Herr, D. S., U. S. Patent 2,373,632 (April 10, 1945).

81. Nachod, F. C., and Nordell, E., *The Chemistry and Technology of Food and Food Products*. Interscience Publishers, Inc., New York (1944), Vol. II.
82. Nachod, F. C., and Sussman, S., *J. Chem. Education* **21**, 56 (1944).
83. Nachod, F. C., and Wood, W., *J. Am. Chem. Soc.* **66**, 1380 (1941); **67**, 629 (1945).
84. Nordell, E., *Am. Dyestuff Repr.* **20**, 8 (1931).
85. Nordell, E., *J. Am. Water Works Assoc.* **28**, 1480 (1936).
86. Nordell, E., *Chem. & Met. Eng.* **50**, 192 (1943).
87. Nordell, E., and Richheimer, C. E., *Paper Trade J.* **110**, 47 (1940).
88. Permutit Co., *Water Conditioning Handbook*. New York (1944).
89. Powell, S. T., *J. Am. Water Works Assoc.* **40**, 8 (1948).
90. Prokhorov, F. G., and Yankovskii, K. A., USSR Patent 64,446 (Feb. 28, 1945).
91. Rees, A. G., and Hudleston, L. J., *J. Chem. Soc.* **50**, 1648 (1931).
92. Richheimer, C. E., *J. Am. Water Works Assoc.* **29**, 1712 (1937).
93. Riley, R., U. S. Patent 2,127,320 (Aug. 16, 1938).
94. Riley, R., *Paper Trade J.*, **107**, 74 (1938).
95. Saunders, D. J., *National Carbonator and Bottler* Aug. 1939.
96. Schulz, G., German Patent 729,549 (Nov. 26, 1942).
97. Schwartz, M. C., *J. Am. Water Works Assoc.* **30**, 659 (1938).
98. Schwartz, M. C., *J. Am. Water Works Assoc.* **34**, 1214 (1942).
99. Shoemaker, M. J., *Proc. Ann. Water Conf., Eng. Soc. West. Penna.* **5**, 1 (1944).
100. Shoemaker, M. J., U. S. Patent 2,368,574 (Jan. 30, 1945).
101. Shreve, R. N., *Greensand Bibliography to 1930*, U. S. Dept. Commerce Bulletin No. 328 (1930).
102. Simon, G. P., Permutit Co., Unpublished Data (1947).
103. Smit, P., U. S. Patent 2,171,408 (Aug. 29, 1939).
104. Smith, H. V., and Davey, W. B., *Ariz. Agr. Expt. Sta., Tech. Bull.* **81**, 1249 (1939).
105. Smith, H. V., and Smith, M. C., *Water Works Eng.* **90**, 1600 (1937).
106. Splittgerber, A., *Mitt. Ver. Grosskesselbesitzer* **73**, 206 (1939).
107. Straub, F. G., and Grabowski, H. A., *Trans. Am. Soc. Mech. Engrs.* **67**, 309 (1945).
108. Streicher, L., Pearson, H. E., and Bowers, A. E., *J. Am. Water Works Assoc.* **39**, 1133 (1947).
109. Suckling, E. V., *The Examination of Waters and Water Supplies*. The Blakiston Co., Philadelphia, (1944).
110. Sussman, S., Nachod, F. C., and Wood, W., *Ind. Eng. Chem.* **37**, 618 (1945).
111. Swain, R. C., U. S. Patent 2,251,234 (July 29, 1941).
112. Swain, R. C., U. S. Patent 2,285,750 (June 9, 1942).
113. Sydow, W., *Am. City* **54**, 42 (1939).
114. TAPPI Water Committee, *Industrial Waters for Pulp, Paper and Paperboard Manufacture*, (1942).
115. Thomas, H. C., *J. Am. Chem. Soc.* **66**, 1664 (1944).
116. Thompson, R. B., *Proc. Ann. Water Conf., Eng. Soc. West. Penna.* **6**, 135 (1945).
117. Tiger, H. L., *J. Am. Water Works Assoc.* **26**, 357 (1934).
118. Tiger, H. L., *Trans. Am. Soc. Mech. Engrs.* **60**, 315 (1938).
119. Tiger, H. L., *Trans. Am. Soc. Mech. Engrs.* **64**, 49 (1942).
120. Tiger, H. L., and Sussman, S., *Ind. Eng. Chem.* **35**, 186 (1943).
- 120a. Tompkins, E. R., *J. Chem. Education* **26**, 32, 92 (1949).
121. Turner, E. T., U. S. Patent 1,722,603 (July 30, 1929).
122. U. S. P. H. S., *Public Health Repts.* **58**, 69 (1943).
123. United Water Softeners Ltd., British Patent 450,574 (July 2, 1936).

124. United Water Softeners Ltd., and Holmes, E. L., British Patent 472,404 (Sept. 20 1937).
125. Veatch, N. T., *J. Am. Water Works Assoc.* **40**, 1 (1948).
126. Walton, H. F., *J. Franklin Inst.* **232**, 13 (1941).
127. Wassenegger, H., U. S. Patent 2,319,359 (May 18, 1943).
128. Wassenegger, H., and Jaeger, K., U. S. Patent 2,204,539 (June 11, 1940).
129. Webb, W. L., *Trans. Am. Soc. Mech. Engrs.* **67**, 325 (1945).
130. Wesly, W., *Chem. Ztg.* **24**, 338 (1943).
131. Williams, W. L., *J. Am. Water Works Assoc.* **39**, 779 (1947).
132. Zink, E., Permutit Company, Unpublished Data (1947).

Multistage Systems in Ion Exchange

ALLEN F. REID

Southwestern Medical College, Dallas, Texas

	Page
I. Introduction	151
II. Applications	152
III. Notation	152
IV. Multistage Process Design and Operation	152
V. Radium-Barium Fractionation	155
VI. General Process Considerations	156
VII. Process Examples	156
Bibliography	157

I. INTRODUCTION

It is generally found that where homogeneous mixtures are to be separated it is, in the long run, more practical to use several stages of fractionation. Where two liquids are separated by distillation it is much more efficient to use a rectifying column than to try to get relatively pure fractions by a simple batch distillation, using only one "theoretical plate"; in many cases, indeed, it would require several such operations, each time utilizing a smaller and smaller fraction of the original material and purifying that to a greater and greater extent. Thus the utility of a separation procedure is frequently determined by the adaptability of that process to multistage fractionation. In a major portion of uses to which ion-exchange materials are put, that factor is of importance.

The ion-exchange materials themselves are inherently well adapted to a certain characteristic type of fractionation. The "layering" effect as a solution passes through a column of ion-exchange material operates so that as the solution comes near equilibrium with the resin it passes on to fresh resin where more of the solute is removed and equilibrium is approached, and then passes on further, and so on. Thus with a very long column of washed resin one could expect to sorb all of the sorbable solutes in the solution in successive fractions. Such a chromatographic sorption technique is basically the operation of a number of separate plates in series such as is encountered in the operation of a rectifying column, but it differs in one important respect: the operation is essentially batchwise and not

continuous. In many applications this difference is not important; continuous operation can be accomplished by having two or more alternate columns with a suitable sorption-regeneration cycle. There are, however, some applications in which it would be well to have a multistage system with essentially a countercurrent flow of the fractions to be separated adapted to continuous operation. This chapter is devoted to a description of such a method.

II. APPLICATIONS

One of the applications for which ion-exchange substances can be used to advantage is the separation of solutes. If one of these is sorbed by the exchanger and the other one is not, the separation is straightforward. Where the materials to be separated are all sorbed by the exchange material, separation by chromatographic fractionation, as elsewhere described (1), will sometimes solve the problem. A multistage process involving reflux and counter-flow similar to other countercurrent fractionation procedures is desirable for the cases in which the selectivity by the ion-exchange material under any practical circumstances is small compared to the degree of fractionation required. Such separation as the fractionation of isotopes, in which the relative selectivity of an ion-exchange material between the isotopes would at best be small, is a case in point.

III. NOTATION

In this comparatively new field notation has not yet been completely standardized. In this paper the following notation was chosen for its convenience, its similarity to conventional notation, and to follow the pattern being set:

HR designates the acid form of a cation-exchanger.

MR designates the combination form of the exchanger matrix with the cation M.

[HR], [MR] designate the number of moles of the exchanger available for exchange per bulk liter of the material.

As the use of "exchange" as a verb form might lead to confusion in interpretation, various forms of "sorb" are used to indicate the uptake of the described ions with the release of any displaced ions.

IV. MULTISTAGE PROCESS DESIGN AND OPERATION

As an illustration of the method, the separation of cations A and B is to be accomplished by selective sorption on the cation-exchange resin HR. The reactions are:

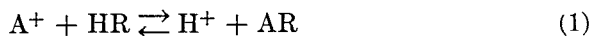

If the equilibrium constants of the reactions are different it is evident that single-stage fractionation is easy. However, it is not necessary to operate under equilibrium conditions; for example, if a solution is passed very rapidly through the resin bed it might very well leave a greater relative concentration of A in the resin bed if the forward direction of equation (1) is faster than that of equation (2), even though at equilibrium $\frac{[A^+]}{[B^+]} = \frac{[AR]}{[BR]}$.

So the criterion may be taken that if at any time when a solution of A and B is passing through the resin $\frac{[A^+]}{[B^+]} \neq \frac{[AR]}{[BR]}$, fractionation is possible. A convenient single-stage fractionation factor may be defined:

$$\alpha = \frac{[AR][B^+]}{[BR][A^+]} \quad \text{where } [A^+] \text{ and } [B^+] \text{ are the concentrations of the ions in a solution which has passed through the resin portion to which } [AR] \text{ and } [BR] \text{ refer.}$$

The operation of the process is not dependent on any particular mechanism of the exchange. Different ion-exchangers will function differently in that respect but for consideration of the process the simple equations (1) and (2) may be taken as describing the unit sorptions.

Basically the operation of the illustrative multistage system is made up of three steps:

(1) Selective sorption by the resin of a portion of the ions of the solution at each stage.

(2) Regeneration of the resin in each stage with the acidified output solution of a previous stage.

(3) Deacidification of the regenerant so that it may be passed through an intermediate stage for selective sorption.

With the feed material a solution of A^+ and B^+ and under the conditions that $\frac{[AR]}{[BR]} > \frac{[A^+]}{[B^+]}$ after a solution has passed through an exchange

cell, the operation of a typical system may be followed by referring to Fig. 1. Passage of solutions follow the single-line and double-line routes alternately. Assuming a steady state has been reached, material at feed concentration in the reservoir above P is passed through the resin at an appropriate pH. About half of the solutes are sorbed in P with an A:B ratio higher than in the feed and approximately equal to that in the effluent solution from M. In the same step the effluent from M is acidified so that in the next step in passing through P it picks up the previously deposited cations. This solution is then conditioned in a deacidifier to a

pH approximately that of the feed material. It should be noted that the total salt concentration is also approximately the same, as the effluent from M is about one-half the original concentration and the remaining half is picked up in regeneration of P. However, this solution is relatively

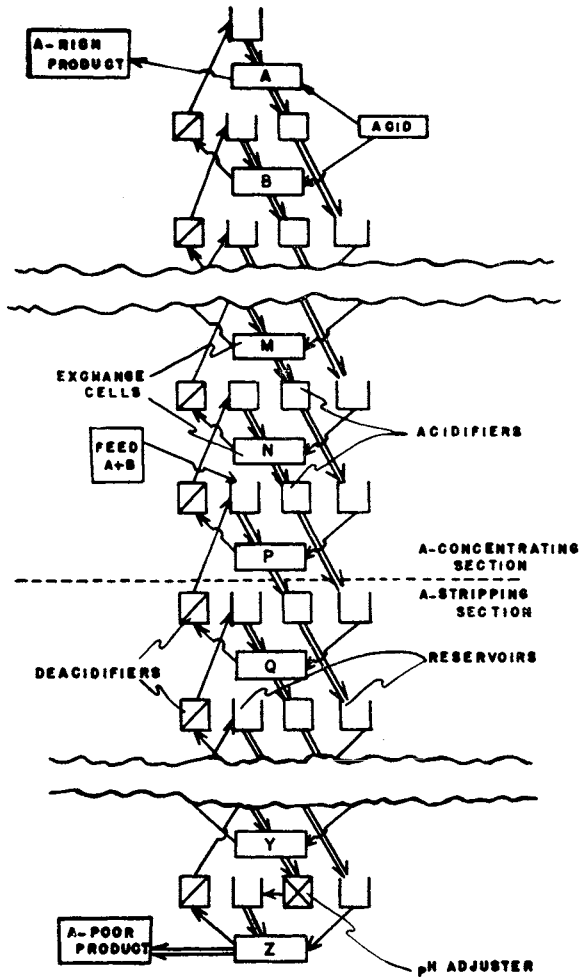

FIG. 1. Flow diagram of a multistage ion-exchange system.

more concentrated in A^+ and is subsequently routed through N. In the meantime the effluent from P, depleted in A^+ , is acidified, picks up sorbed cations from resin bed R, is deacidified and then routed through Q. In this way salts enriched in A^+ are moved up the system and salts depleted in A^+ are moved down.

The fraction withdrawn as product occupies the same relationship to concentration in this process as in any similar fractionation. The fractions may be removed in various ways, some of which are illustrated in Fig. 1. At the top the product withdrawal is determined by the amount of acid flushed through A. At the bottom it is determined by the pH of the effluent from Y.

V. RADIUM-BARIUM FRACTIONATION

The type of separation which may reasonably be attacked by this method is illustrated by an experimental radium-barium fractionation (2). Using "Zeokarb H"* it was found that, effectively:

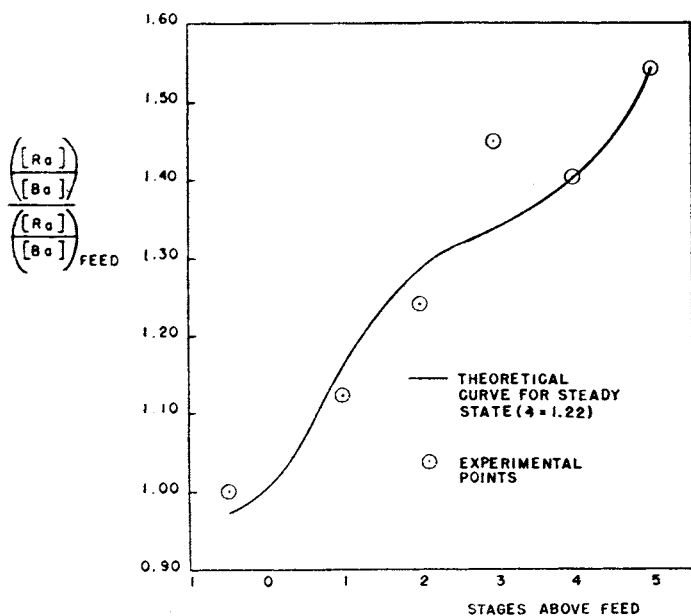
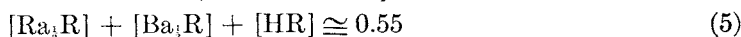
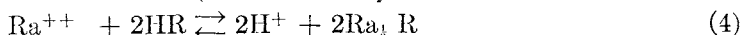
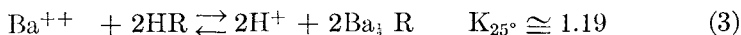

FIG. 2. Radium concentration in process pilot plant.

under conditions convenient for separation. Five separation cells, each containing 2.1 ml. of the resin were set up and 25 ml. portions of solution were directed through in the manner outlined in the foregoing description. The feed solution was 0.046 molar to BaCl_2 , 1.04×10^{-9} molar to RaCl_2 ,

* Furnished by the Permutit Company, New York City.

0.130 molar to HCl. Solutions were brought to 2.0 molar to HCl for regeneration. Deacidification was carried out by evaporation and reconstitution. The operation was carried out at total reflux at the top and feed equals waste at the bottom (no stripping section). The system was loaded with feed solution and then operated for six cycles. Samples were taken at all positions and analyzed for radium and barium. Figure 2 shows a plot of concentration effected compared to that calculated on the assumption that the system had reached a steady state with $\frac{[Ra_{\frac{1}{2}} R][Ba^{++}]}{[Ba_{\frac{1}{2}} R][Ra^{++}]}$ = 1.22. The peculiar form of the theoretical curve is a result of nonuniform holdup in the system. The total salt concentration, particularly at the top, was smaller in the portions than had been planned. This was caused by greater sorption in the resin than was anticipated.

VI. GENERAL PROCESS CONSIDERATIONS

The engineering of the process described can conform very well to standard practice, although some aspects may require unconventional design. In the deacidification step, an anion-exchange resin may be used. Regenerating agents other than acids may be used on occasion. Where intermittent flow is undesirable, two or more parallel systems may be cross-valved so that one is always taking the flow of each reactant. In some separations the ion-exchange system may supply only part of the fractionation; other portions being handled by other methods.

From a theoretical standpoint the greatest efficiency would be obtained per cycle if approximately half the salts were sorbed in the sorption step and if all the salts were desorbed in the regeneration step. However, that half-and-half split may well be sacrificed to save time, reagents, or the like; or where a small amount of highly-fractionated material is desired from a relatively small number of stages.

Because there is a two-stage span for each separation by α , to get a maximum separation of α^n , $2n$ stages are necessary. Where a large number of stages are required, cascading down in stage size from the feed position may be practical.

VII. PROCESS EXAMPLES

A consideration of the economic status of some cation mixtures brings out the need for a process such as the above. 1. There is no completely satisfactory method at the present time for the separation of potassium from potassium-rich brines; proper engineering of a multistage ion-exchange process might suitably take care of this recovery. 2. Although ion-exchange methods have found great utility in the separation of rare earths (3),

extensions and refinements could be introduced by multistage engineering. 3. In the separation of fission products, extreme purity is sometimes necessary, as a small amount (chemically) of a fission product impurity may introduce a prohibitive radioactive impurity. The two practical alternatives would in several cases be addition of a carrier and subsequent conventional chemical separation or relatively *carrier-free* ion-exchange separation. 4. A final example is the separation of isotopes (5, 6.)

Mixtures of anions can also be separated by a similar process using anion-exchange resins. Here the purification of organic acids might well be considered.

It is hard to predict the direction in which a new process will progress most favorably, particularly when its chief utility is in competition with established procedures. But regardless of its ultimate assay, the use of ion-exchange materials in multistage systems must be seriously considered where ionic separations are involved.

BIBLIOGRAPHY

1. Strain, H. H., *Chromatographic Adsorption Analysis*. Interscience Publishers New York (1945).
2. Reid, A. F., *Ind. Eng. Chem.* **40**, 76 (1948).
3. Schubert, J. S., Chapter in this text.
4. Taylor, T. I., and Urey, H. C., *J. Chem. Phys.* **6**, 429 (1938).
5. Eidinoff, M. L., *J. Chem. Phys.* **15**, 527 (1947).
6. Dean, J. G., U. S. Patent 2,204,072 (June 11, 1940) assigned to Permutit Co.

Desalting Sea Water*

HOWARD L. TIGER AND SIDNEY SUSSMAN
Liquid Conditioning Corporation, Linden, New Jersey

CONTENTS	Page
I. Introduction	159
II. Sea Water Desalting Process	160
III. Preparation of Silver Zeolite	165
Bibliography	166

I. INTRODUCTION

In the half century which has passed since Harm first proposed the use of ion exchange for the treatment of sugar juices, these methods have been tried in the attempted solution of a wide variety of unusual problems. Many such cases have been technically successful and a few have reached complete fruition to the extent that they were applied on a full commercial scale. Among these latter is the treatment of sea water to make it potable for emergency drinking use by fliers forced down at sea (1).

Readers of this volume are by now aware that ion exchange processes have been most successful when used for the treatment of solutions of relatively low concentration, generally on the order of a few thousand p.p.m. or less. The magnitude of the problem presented in attempting to desalt sea water by ion exchange can, therefore, be realized by an examination of the abridged composition of an "average" sea water in Table I.

TABLE I
Abridged Composition of Typical "Average" Sea Water

Cations	Concentration		Anions	Concentration	
	Meq./l.	P.p.m. as CaCO ₃		Meq./l.	P.p.m. as CaCO ₃
Na ⁺	431	21,550	Cl ⁻	495	24,750
Mg ⁺⁺	96	4,800	SO ₄ ^{- -}	47	2,350
Ca ⁺⁺	17	850	HCO ₃ ⁻	2	100
Total	544	27,200	Total	544	27,200

Table reprinted from *Ind. Eng. Chem.* **38**, 1131 (1946).

* The work described in this chapter was carried out by various teams in the laboratories of the Permutit Company of New York and Permutit Ltd. of London, in cooperation with various agencies and services of the governments of the United States and Great Britain.

The various physical methods and the chemical methods other than ion exchange that have been proposed from time to time for desalting sea water for such emergency use have been reviewed elsewhere (1).

The ion exchange approach to the solution of this problem may be said to date from 1909 when Gans (2) suggested the use of a silver aluminosilicate (zeolite) for the removal of soluble chlorides from solutions. Although he did not specifically mention the treatment of sea water to produce drinking water, this suggestion was made later by Jeanprost (3), but did not result in any practical attainment of the goal at that time.

II. SEA WATER DESALTING PROCESS

The more recent evolution of the ion exchange demineralizing process naturally led to its suggestion as a possible means for desalting sea water (4), and a British patent was issued on the use of a mixture of cation and anion exchangers for this purpose (5). But calculations and experiments based upon the ion exchange resins available in the early 1940's showed that the volume of drinkable water produced by such a process was too small, when compared to the volume of exchangers required, to make this process of interest even as an extreme emergency measure (6, 7). The best results attained produced only 1.5 volumes of drinking water per volume of combined cation and anion exchange resins.

The development of synthetic resin cation exchangers was also followed by a modification of Gans' silver zeolite suggestion to the effect that silver salts of these resinous materials be used for desalting sea water (8).

Lead zeolites, as well as silver zeolites, have been proposed for the desalting of sea water by Austerweil and Jeanprost (9). The use of a lead salt for the preparation of a potable water appears to be too risky in view of the relatively great water solubility of lead chloride and the toxicity of lead salts in general.

In addition to the straight ion exchange methods, several proposals have also been made for supplementing ion exchange processes by chemical precipitation. Austerweil (10) made an early suggestion of this type based upon the successive treatment of sea water with a copper zeolite and with white lead in accordance with the following equations:

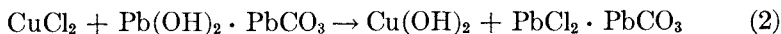
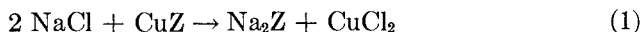

The previous remarks regarding the inadvisability of using a lead zeolite for this purpose are also applicable to this suggestion.

More recently, Meincke (11) patented a desalting process which

depended upon the treatment of sea water with an acid-regenerated cation exchanger together with phenyl mercuric hydroxide.

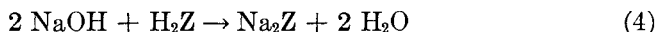
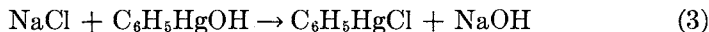

The process has certain obvious disadvantages including the difficulties of maintaining correct dosage with variations in sea water composition and the penalties inherent in failure to do so, and the large amount of reactants required for a small yield of drinkable water.

When the advent of extensive transocean flying early in World War II made the emergency drinking water problem extremely urgent, research on a chemical solution to this problem soon eliminated from serious consideration all approaches but those based upon the ion exchange method utilizing a silver aluminosilicate. Treatment of sea water with a silver zeolite results in the removal of the chlorides of all metals present in accordance with the following equations:

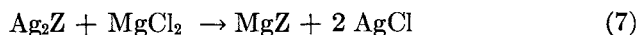
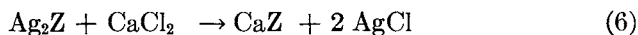
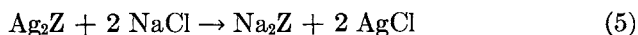

It will be noted that all products of these reactions are insoluble.

By including a barium zeolite (12) among the desalting chemicals, sulfates could also be removed, according to the following equations:

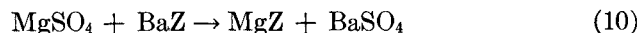
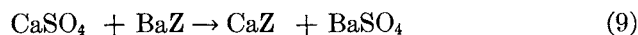
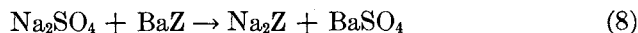

However, the general principle of a combined ion exchange and chemical precipitation method is the basis for the sea water desalting kit ultimately adopted by the armed forces. In this case, treatment with a silver zeolite in accordance with equations (1, 2, and 3) effected the bulk of the solids reduction, but was supplemented by the addition of silver oxide for a portion of the chloride reduction because the greater density and lower equivalent weight of the latter compound permitted a higher volume ratio of treated water to chemical. Note from Table II how an increase in the proportion of silver oxide in the desalting mixture resulted in a reduction in the total weight of the briquet needed to reduce the chloride content of 500 ml. of average sea water to about 2300 p.p.m. as CaCO_3 , a reduction in the size of the briquet, an increase in the treated water yield per unit weight of desalting mixture and also per unit volume of briquetted chemicals.

TABLE II^c
Supplemental Chloride Reduction by Silver Oxide

Briquet No. ¹	Ag ₂ O dosage		Ag ₂ Z Dosage g./Briquet	Total ^b wt. of briquet, g.	Briquet ^c		Treated water				
	g./Briquet	Meg./L. water			Thick- ness, in.	Vol., ml.	Density, g./ ml.	pH	Cl ⁻ (ppm. as CaCO ₃)	ml. water/ g. of briquet	ml. water/ ml. of briquet ^d
1	0	0	64.5	67.6	0.541	43.4	1.56	9.0	2300	6.51	10.2
2	0.87	15	62.4	66.4	0.521	41.8	1.59	9.1	2400	6.62	10.5
3	1.74	30	60.3	65.1	0.509	40.8	1.60	9.4	2400	6.76	10.8
4	2.90	50	57.4	63.4	0.490	39.3	1.61	9.6	2320	6.93	11.2
5	3.50	60	56.0	62.6	0.477	38.3	1.63	10.0	2270	7.03	11.5
6	4.06	70	54.6	61.8	0.464	37.3	1.65	10.5	2090	7.12	11.8

^c Reprinted from *Ind. Eng. Chem.* **38**, 1134 (1946).

^b All briquets include the same fixed amounts of disruptor, activated carbon, and lubricant.

^c All briquets were formed at a pressure of 12.2 tons/sq. in.

^d This is the ratio of net volume of treated water delivered to volume of briquet.

The obvious limit on the use of silver oxide is the high pH produced according to equation (11). Fortunately, the magnesium present in sea water reacts with the hydroxyl ion formed by solution of silver oxide to give the twofold benefit of pH reduction and total solids reduction per equation (12).

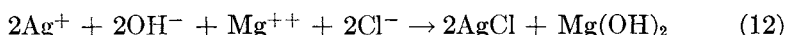

For those cases requiring sulfate reduction, barium hydroxide was also included in the desalting mixture and reacted as follows:



Early experiments showed that barium zeolites, although effective in reducing sulfates, were extremely inefficient probably because of the tenacity with which the heavy divalent barium ions are retained in the exchange positions of the aluminosilicate structure. The analogy to silver oxide reduction of chlorides led to a study of barium oxide and hydroxide for sulfate reduction with the results summarized in Table III.

TABLE III*
Comparative Performance of Barium Compounds

Agent	Equivalent wt.	Capacity at 100% efficiency, meq./g.	Actual capacity meq./g.	Efficiency %	Specific gravity
BaO	76.5	13.2	7.45	56.4	5.72
Ba(OH) ₂	87	11.5	6.52	57.6	4.50
Ba(OH) ₂ · 8 H ₂ O	159	6.3	3.58	56.7	2.19
BaZ	216	4.64	2.2	47.5	0.9

* Reprinted from *Ind. Eng. Chem.* **38**, 1135 (1946).

The limited reactivity of these barium compounds in desalting briquets apparently resulted from the previously mentioned great selectivity of the exchanger for barium ions resulting in an equilibrium distribution of the barium between the zeolite and barium sulfate. This was a mixed blessing for, although the efficiency of the sulfate reduction was thus limited, the stability of the barium zeolite prevented the appearance of any potentially toxic barium ions in the treated water.

Numerous tests carried out with solutions varying in concentration from sea water to distilled water and with contact time ranging from one-half hour to fifty-two hours *never* produced a detectable amount of Ba⁺⁺ in solution. The distilled water tests are particularly significant. In view of the water solubility of barium hydroxide, they prove that the Ba⁺⁺ exchanged with the zeolite as fast as the hydroxide dissolved.

To complete the picture of the total desalting mixture, in addition to silver zeolite, silver oxide and, in some cases, barium hydroxide, the minor constituents included a briquetting mold lubricant, a disruptor for breaking up the compressed chemicals spontaneously upon contact with sea water, and activated carbon for taste improvement. The physical features of the desalting kit, including the design of the reaction vessel and the operating procedure, have been described elsewhere (1, 13, 14, 15).

It is interesting to see how the various ion exchange methods and modified ion exchange methods actually tested for this purpose compared.

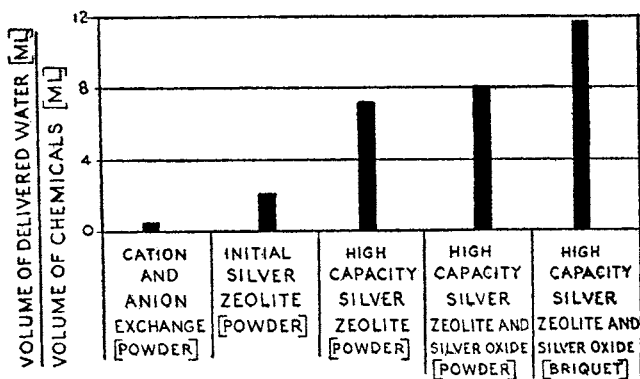

FIG. 1. Ratio of delivered water volume to zeolite volume for five materials, each of which reduces the chloride content of sea water to 40 meq./l. From *Ind. Eng. Chem.* **38**, 1132 (1946).

Figure 1 presents graphically the ratio of volume of delivered treated water to the volume of chemicals required for five different combinations. These data are all based on the reduction of the average sea water given in Table I to a final chloride content of 40 meq./l.

It will be seen that, although a silver aluminosilicate immediately established its superiority over demineralizing by combined cation and anion exchange resins, subsequent chemical research resulted in the preparation of an improved silver zeolite which tripled the effectiveness of the initial silver zeolite. In developing this product, it was necessary to cast aside many of the well-known procedures and limitations inherent in the usual synthetic sodium aluminosilicate art, and to view the problem afresh taking special note of the many deviations possible from the limitations normally imposed by the requirements of a long lived regenerable water softener.

The final two bars indicate the improvements to be gained even with this higher capacity zeolite by including silver oxide in the mixture and by briquetting.

III. PREPARATION OF SILVER ZEOLITE

The preparation of the silver zeolite started with the standard procedure for a sodium aluminosilicate of the synthetic gel type. Solutions of certain aluminum salts were reacted with a solution of sodium silicate in general accordance with the methods used in the preparation of these zeolites for water softening (16, 17, 18, 19, 20, 21). After filtration of the hydrated gel, drying was very carefully carried out under controlled conditions of temperature and humidity to assure a porous gel structure. Crushing and screening of the dried product to pass a 30-mesh screen was followed by a washing step prior to conversion of the sodium aluminosilicate to a silver aluminosilicate. This conversion was effected by treatment of the granular sodium compound with a silver nitrate solution according to the following equation:

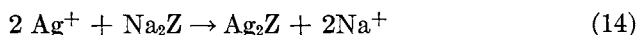

This ion exchange was found to be remarkably efficient and rapid even when small excesses of silver were used. The rate of exchange when using an excess of 0.6 *N* silver nitrate is illustrated in Fig. 2.

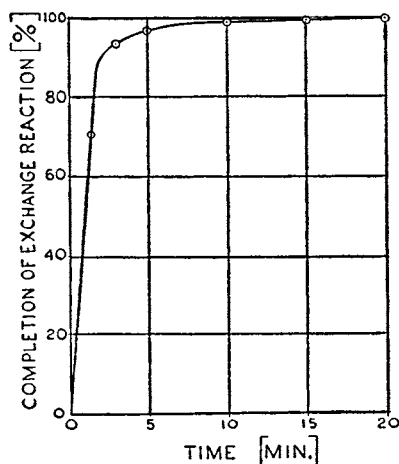

FIG. 2. Speed of exchange in conversion of sodium zeolite to silver zeolite at 0.6 *N* silver nitrate concentration. From *Ind. Eng. Chem.* **38**, 1134 (1946).

The silver zeolite was washed free of silver nitrate, dried, blended with the other ingredients of the desalting mixture, and briquetted.

The serious corrosion problem involved in handling the wet silver zeolite and silver nitrate solutions was solved by using stainless steel and rubber-lined equipment.

Some indication of the magnitude of this operation may be obtained from the fact that, at peak production, the silver zeolite plant was utilizing 4,000–5,000 lbs. of silver nitrate daily to produce 7,000–8,000 lbs. of silver zeolite.

BIBLIOGRAPHY

1. Tiger, H. L., Sussman, S., Lane, M., and Calise, V. J., *Ind. Eng. Chem.* **38**, 1130–7 (1946).
2. Gans, R., *Chem. Ind. Berlin* **32**, 197–200 (1909).
3. Jeanprost, C., *Bull. assoc. chim. suc. dist.* **49**, 206–8 (1932).
4. Parker, A., *Nature* **149**, 184–6 (1942).
5. Permutit Co. Ltd., Pemberton, R. T., Walter, A. J. R., and Holmes, E. L., British Patent 553,233 (May 13, 1943).
6. Tiger, H. L., and Sussman, S., *Ind. Eng. Chem.* **35**, 189–90 (1943).
7. Ingleson, J., *J. Soc. Chem. Ind.* **64**, 305–9 (1945).
8. N. V. Octrooien Maatschappij "Activit," French Patent 805,092 (Nov. 10, 1936).
9. Austerweil, G. V., and Jeanprost, C., U. S. Patent 1,978,447 (Oct. 30, 1934).
10. Austerweil, G. V., *Bull. soc. chim.* (5), **3**, 905 (1936).
11. Meincke, H. D., Jr., U. S. Patent 2,391,258 (Dec. 18, 1945).
12. Akeroyd, E. I., Holmes, E. L., and Klein, A., *Water and Water Eng.* **48**, 556–60 (1945).
13. Anonymous, "Science News in Review," *New York Times*, Nov. 28, 1943; *Am. Airlines Flagship News*, Dec. 1943; *Marine Progress*, Dec. 1943; *Congressional Record*, Nov. 13, 1943; *J. Am. Med. Assoc.* Feb. 3, 1945.
14. Army Air Forces, Specification 40,874 (Dec. 6, 1944).
15. Navy Bureau of Aeronautics, Specification Navaer M-613 (Aug. 15, 1944).
16. Behrman, A. S., *Ind. Eng. Chem.* **19**, 445–7 (1927).
17. Behrman, A. S., U. S. Patent 1,515,007 (Nov. 11, 1924).
18. Bruce, W. M., U. S. Patent 1,906,202 (April 25, 1933).
19. Bruce, W. M., U. S. Patent 1,906,203 (April 25, 1933).
20. Larian, M. G., and Mann, C. A., *Ind. Eng. Chem.* **28**, 196–200 (1936).
21. Wheaton, H. J., U. S. Patent 1,586,745 (June 1, 1926).

Applications of Ion Exchange to the Separation of Inorganic Cations

JACK SCHUBERT

Argonne National Laboratory, Chicago, Illinois

	<i>Page</i>
I. Introductory Remarks	167
1. Scope of Chapter	168
2. Terminology	168
3. Materials and Methods	169
II. General Principles Involved in Ion Exchange Separations	174
1. Equilibrium Adsorption and Desorption	175
2. Nonequilibrium Column Operations	186
III. Separation Schemes	205
1. Group Separations of the Fission Products	206
2. Alkali Metals	207
3. Alkaline Earths	209
4. Rare Earths	209
5. Transuranics	216
6. Colloids	217
7. Transition Elements	218
IV. Concluding Remarks	220
Bibliography	221

I. INTRODUCTORY REMARKS

Until the discovery of the synthetic organic ion exchangers by Adams and Holmes (1) in 1935 ion exchange processes were limited to a single major application — the softening of hard water. At present the ion exchange process is of such general application that “it deserves to rank with distillation, solvent extraction and filtration as one of the unit processes of chemical industry” (2). The rapid and still accelerating expansion in utility of ion exchange reactions on the laboratory and industrial level is due to a unique combination of properties possessed by these synthetic organic ion exchangers, namely their high capacity in acid solutions, chemical and physical stability, rapidity and reversibility of the exchange reactions, and the approximate independence of capacity on particle size.

The exigencies of the problems facing the Plutonium Project led to the use of ion exchange processes for the separation, concentration, and purification of the fission products. A high point of these investigations was reached with the development of remarkably simple, rapid, and effective

ion exchange methods for the separation and preparation of spectrographically pure rare earths (3-9). The history of these achievements has been reported by Johnson, Quill, and Daniels (10). Probably the most important single factor responsible for the very successful ion exchange separations of inorganic cations obtained by the Plutonium Project workers was the use of organic acid complexing agents under such conditions that the normal differences in adsorbability existing among the cations were greatly enhanced.

1. *Scope of Chapter*

The principles and procedures involved in both equilibrium and non-equilibrium cation exchange processes will be discussed only to the extent that they are directly related to the practical problem of separating inorganic cations. The rare earth separations will be explained to the greatest extent and with the most detail since the methods employed are applicable for separating all types of cations. It is intended to provide the reader with information sufficient to serve as a guide in the field of cation exchange separations.

All of the procedures to be described will be those utilizing synthetic cation exchangers only. The important results obtained for the recovery of metals by adsorption of the anionic complex ions on an anion exchanger are described in the chapter by Nachod and Sussman. In a sense, the problem of softening water can be viewed as a process for the separation of calcium from sodium. Water treatment, however, involves several unique problems and is discussed at length in the chapter by Calmon.

2. *Terminology*

Some of the terms commonly employed in the work on cation exchange separations are as follows:

Elute — to wash out.

Elutriant — the eluting solution.

Adsorption — the retention or extraction of ions by an ion exchanger.

Color throwing — appearance of color in solution after contact with exchanger because of solubility of the exchanger itself.

Desorb — often used interchangeably for elute.

Eluate — the washing obtained by elution.

Effluent — that which flows out.

Influent — that which flows in.

Chromatographic elution — an elution process in which each one of the cations comprising a narrow adsorption band at the top of a column is moved down the column at a different rate than the others so that the

bulk of each cation passes into the effluent separated from most of the other components.

Break-through — that point at which the presence of a substance in the influent of material being percolated through a bed of an ion exchanger is found in the effluent.

Carrier-free — a radioelement to which no stable isotope is added. Of course the presence of isotopic impurities must always be assumed though not detectable by the spectrograph or other means of the usual analytical techniques.

Citrate solution — a solution of citric acid adjusted to a given pH with concentrated ammonium hydroxide.

Yttrium group of rare earths — consists of yttrium and the elements of atomic number 63–71.

Cerium group of rare earths — consists of the elements of atomic number 57–62.

G. M. Tube — Geiger-Müller tube used for detecting and counting radioactive particles.

3. Materials and Methods

Cation Exchangers. Most of the early Plutonium Project cation exchange studies utilized the synthetic resin Amberlite-IR-1. Later an improved form of Amberlite-IR-1 known as Amberlite-IR-100 was employed principally because its greater insolubility resulted in less color-throwing. In recent studies (7, 8) it was found that the newly developed resin, Dowex 50 (11), possessed the following important advantages: (a) a combining capacity about three times that of the Amberlite resins at a pH = 3, (b) nuclear sulfonic acid groups as the sole ion active group at all pH values (c) its spherical shape gives a minimum void space when packed in a column which aids in the development of sharper bands (8) and (d) an extraordinary stability toward common chemical reagents, even at 100°. However, the flow rates at which operations with Dowex 50 are employed are roughly one-third those used with Amberlite resins, all other factors being equal. When a Dowex 50 column is operated at 100° the flow rate can be increased so that the time for achieving a given separation is less than is required when operating with the Amberlite resins at room temperature (8).

Synthetic adsorbents such as Amberlite-IR-1 and IR-100 contain several exchanging groups which differ in their acid dissociation constants. The equilibrium cation capacity, therefore, expressed as milliequivalents per gram of oven-dried (110°) hydrogen form, increases as the pH of the equilibrating solution increases (12, 13, 14). The maximum capacity is a function of the total number of exchanging groups present. However, with

easily hydrolyzable cations the maximum cation exchange capacity may not be attained because of the tendency of the cation to become colloidal as the pH of the solution approaches the precipitation value of the cation.

Under ordinary operation, i.e., pH 2-3, the capacity of Amberlite-IR-1 is about 2 meq./g. of the anhydrous hydrogen resin, HR. At a pH of 8.8 the capacity for Na^+ was found by Kettle to be 5.42 meq./g. of HR (13). The capacity of Dowex 50 is nearly independent of pH and has been found to be 5-6 meq./g. of HR (11, 15).

The actual capacity of cation exchangers in column operation depends on several variables such as flow rate, particle size, cation concentration, and pH of the influent solutions. The maximum capacity is given by the equilibrium values.

On the average the moisture content of the air-dried exchanger is approximately 20% by weight. Only the wet or air-dried form should be employed because excessive drying of the exchanger, at least with the Amberlites, results in a greatly lowered capacity (13). The original exchange capacity is regained upon prolonged soaking in water.

While the synthetic resins appear to be stable toward most organic and inorganic reagents it may not be advisable to use nitric acid in concentrations above 2M in repeated cycles. In certain cases, however, especially when repeated cycles are not necessary, it is not out of order to employ a reagent which may attack the resin over a prolonged period. The Amberlite resins exert an appreciable reducing action. Amberlite-IR-1 has been found to reduce Hg^{++} to Hg^+ and Ag^+ to metallic silver (13).

In an ion exchange separation it is desirable to employ the exchanger in a specified particle size range. A commonly used particle size which is suitable for most separations is 60-80 mesh as obtained from dry sieving of the air-dried resin through U. S. Standard Sieves. For difficult separations it may be desirable to use much smaller particle sizes. Wet sieving of the resin may be preferred in some cases.

Before using the exchanger in a separation process it is good practice to run at least two conditioning cycles. A conditioning cycle usually consists of alternate cycles of HCl and NaCl passes. The cation with which the resin is finally left depends upon the particular separation scheme. In addition, it is advisable to subject the resin to one or more cycles with the solutions which are to be employed in the actual separation.

Types of Columns. Pyrex glass tubing is a satisfactory structural material. The resin bed may be supported by placing a circular piece of glass cloth† 1/32" or less in thickness over a one hole rubber stopper fitted

* meq. = milliequivalent.

† Suitable glass cloth may be purchased from the Filter Media Corporation, Irvington-on-Hudson, New York.

with a glass stopcock. The end with the glass cloth is inserted in the column in such a manner that the overlapping part is held between the column wall and the inserted rubber stopper. Three useful types of columns are shown in Figs. 1, 2, and 3. Glass wool or porous glass discs are commonly used supports for the resin bed. The usual volumetric burettes are convenient to use. A reflux type of column similar in principle to a Soxhlet extractor and which involves the re-use of an acid eluant is of special value when it is desired to keep the volume of eluting solution at a minimum (16).

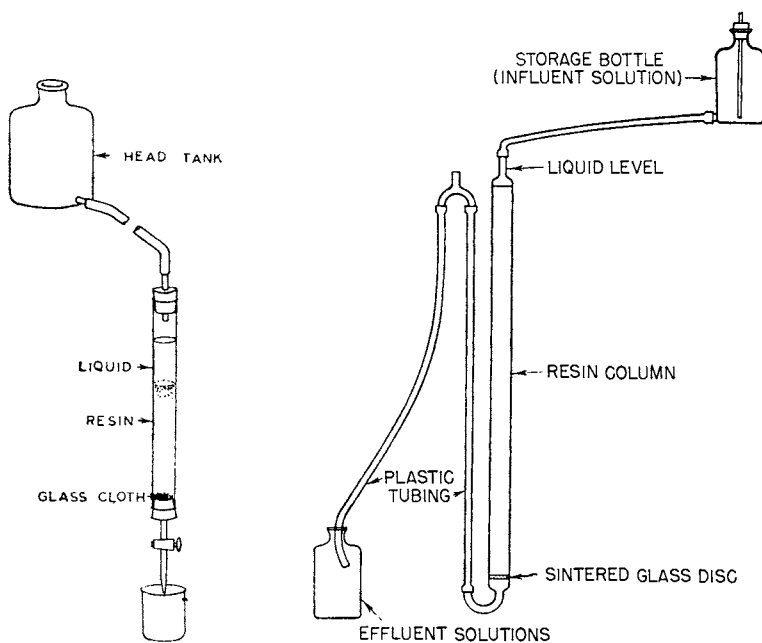

FIGURE 1

FIGURE 2

FIG. 1. Useful type of column for ion exchange operations.

FIG. 2. Typical column apparatus — the flow rate is adjusted by varying the height of the storage bottle. The vent in the effluent tube ensures a continuous liquid layer over the resin bed. Reproduced from Harris and Tompkins (7).

When a rapid knowledge and control of flow rate is desired it is advantageous to introduce a flow meter* at the outlet of the column. In the event that radioactive tracers are employed it may be desirable to obtain a continuous automatic recording of the radioactivity in the effluent as exemplified in Fig. 4 (17).

* Useful models are the Fischer and Porter "Rotameter" types manufactured by the Fischer and Porter Co., 1106 County Line Road, Hatboro, Pa.

The adsorbent bed was back-washed with demineralized water to remove the "fines" and to ensure the removal of any air so as to prevent channeling. Next, the adsorbent was "pre-conditioned" by allowing solution of the same composition as was to be employed in the experiment, except containing no radioactivity, to pass through the bed until the effluent was of the same composition as the influent. The desired tracer was added then to the influent reservoir, and the thin walled Transflex tube carrying the effluent was coiled about a glass-walled G. M. tube (Eck and Krebs) mounted inside a heavy lead shield so that the growth of the radioactivity in the effluent could be detected and recorded. The continuous record of the break-through of tracer activity was obtained by use of a pen and ink electronic recorder (Esterline-Angus).

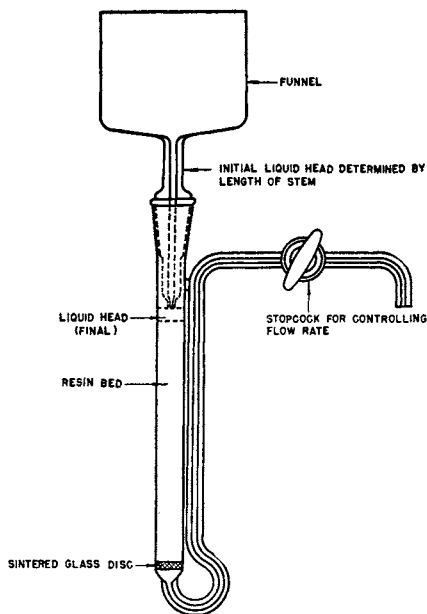

FIG. 3. Experimental column — the funnel is removable to facilitate resin addition and removal. Reproduced from Tompkins *et al.* (3).

For operating columns at elevated temperatures a jacketed column can be employed so that the temperature in the resin bed can be controlled either by circulation of a liquid from a thermostat or by passage of steam through the jacket as illustrated in Fig. 5 (8).

The Pyrex glass tube, A, was 120 cm. long and 6 mm. in diameter. The ion exchanger was retained by a small plug of Pyrex glass wool which rested upon a constriction at the lower end of the column. The cations were adsorbed as a narrow band at the topmost part of the bed from a volume not exceeding 2 ml. Following the adsorption step, the air above the resin bed was completely displaced by solution to develop the chromatogram, and an Allihn condenser, D, was attached to the upper end of the column. This condenser was maintained at the same temperature as the column, and

thereby served to "pre-heat" the influent elutriant solution. When steam was being passed through the jacket, the temperature of the condenser was controlled by means of the valve, E, in such a manner that the influent solution was caused to boil gently. This was desirable in order that dissolved gas be removed from the solution before it reached the bed. The expelled gas was collected in the bulb, F.

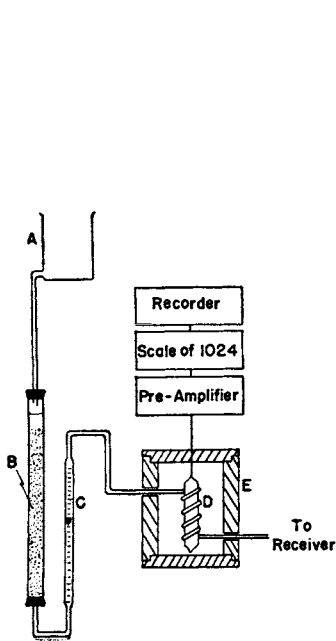

FIGURE 4

FIG. 4. Experimental arrangement for adsorption column studies: A, solution reservoir; B, adsorbent bed; C, flowmeter; D, Geiger-Müller counting tube; E, lead shield. Reproduced from Boyd *et al.* (17).

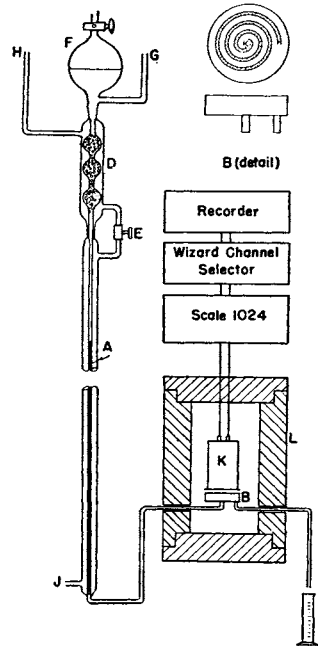

FIGURE 5

FIG. 5. Experimental arrangement employed in adsorption column separations: A, adsorbent bed, Amberlite IR-1 or Dowex-50; B, counting cell; C, receiver; D, Allihn condenser; E, throttle valve; F, gas entrainment bulb; G, elutriant inlet; H, thermostat fluid inlet; K, mica end-window Geiger-Müller counting tube; L, two-inch lead radiation shield. Reproduced from Ketelle and Boyd (8).

The radioactivity in the effluent solutions was detected by a thin mica window bell-type G. M. counter tube, K, which was surrounded by a two inch thick lead shield, L. The tube was connected to a scale of 1024 which in turn transmitted impulses to a Wizard recorder. The latter, through electrical contacts and relays, could be adjusted to close any of four channels on a Simplex time stamper. These channels corresponded to the digits, tens, hundreds, and thousands wheels of the Wizard recorder. By means of a selector switch, it was possible to record the time at which any channel carried a pulse, or to record only every tenth of one-hundredth scaler when the level of radioactivity was sufficiently high that such a record sufficed. In this way, a continuous record of the

radioactivities emerging from the adsorbent bed was made possible. The time between pulses was proportional to the reciprocal of the activity in the solution contained in the counting cell.

In the pilot plant operations of rare earths by Spedding *et al.* (9) the columns had a bed height of 8 feet and diameter of 4 inches.

A total of 24 columns was erected in a vertical position on 4 in. \times 4 in. wood supports arranged in a manner convenient for the collection of 45-liter volumes of eluate. The columns were Pyrex pipes 10-ft. long with 4-in. inside diameter. The tops of the columns were closed with standard flanges and stainless steel plates 1/2 in. in thickness. Neoprene gasket material was used between the glass and stainless steel plates to make an air- and water-tight seal. The bottoms were closed in a similar manner, except that a 40-mesh Monel screen was sealed between the two gaskets to retain the resin. The top and bottom plates were fitted with 1/4 in. stainless steel pipes to serve as inlet and outlet. The eluting solutions were allowed to flow, by gravity, from a constant head tank supplied from a main storage tank by means of a centrifugal pump.

A detailed description of a remote control, shield ion exchange apparatus and the procedures for processing curie levels of fission products has been reported by Cohn, Parker, and Tompkins (18). The same apparatus and procedures, slightly modified, are used to prepare many of the fission products which are distributed by the Clinton Laboratories (19).

Aqueous solutions which contain appreciable concentrations of substances with a high alpha or high beta decay rate are decomposed and evolve H_2 and O_2 . In addition, considerable amounts of H_2O_2 are formed. The gas evolution hinders the operation of the resin column because of bubble formation. This problem was met and minimized by mixing spongy palladium with the resin (20).

II. GENERAL PRINCIPLES INVOLVED IN ION EXCHANGE SEPARATIONS

The planning and interpretation of ion exchange separation schemes are dependent upon a knowledge of the interactions among the adsorbing ions, the eluting ions, and the exchanger. Most ion exchange separations are performed under nonequilibrium conditions. Insofar as chemical factors are involved a knowledge of the equilibrium states furnishes a rapid and reliable method for evaluating the direction that chemical variables will exert upon nonequilibrium operations. For the case where the distribution of the solute between the exchanger and the liquid phase remains constant throughout the column it is relatively simple to extrapolate equilibrium data to column operation. The application of the information available regarding the equilibrium and nonequilibrium reactions of cation exchangers to cation separations will be treated in some detail in the paragraphs to follow. An acquaintance is assumed with the equilibrium and kinetic theories of ion exchange reactions which are described in the respective chapters by Walton and Thomas.

1. *Equilibrium Adsorption and Desorption*

The Adsorption and Desorption Strengths of Cations. The affinity of a cation for the cation exchanger increases with increasing valence. On a group basis, therefore, the order of adsorption affinity of cations is as follows: monovalent < divalent < trivalent cations. For cations of the same valence the adsorption affinity increases with decreasing hydrated ionic radius (13, 21) or, with what amounts to the same thing, with increasing basicity. By taking the Debye-Hückel parameter, a° , as a relative measure of the hydrated radius, the relative adsorption affinity of cations of the same valence is obtained directly from activity coefficient — concentration plots (13). Thus, for a series of salts with common anions, the higher their curves lie in the plot, the larger is a° and hence the weaker, relatively, is the adsorption of the cation component by the cation exchanger. Accordingly, from activity coefficient data the sequence of adsorption among the alkali metals will be: $\text{Cs}^+ > \text{Rb}^+ > \text{K}^+ > \text{NH}_4^+ > \text{Na}^+$; for the alkaline earth cations: $\text{Ba}^{++} > \text{Sr}^{++} > \text{Ca}^{++} > \text{Mg}^{++}$; while with the divalent transition metals the series will be: $\text{Zn}^{++} > \text{Cu}^{++} > \text{Ni}^{++} > \text{Co}^{++} > \text{Fe}^{++}$. From the activity coefficient plots of the rare earths (22) it is possible to predict the following series of decreasing adsorbability: $\text{La}^{+3} > \text{Ce}^{+3} > \text{Pr}^{+3} > \text{Nd}^{+3} > \text{Sm}^{+3} > \text{Eu}^{+3} > \text{Y}^{+3} > \text{Sc}^{+3}$

The greater the affinity with which a cation is held by the exchanger the more difficult it is to elute it by any other cation. Obviously, it also follows that the desorption or eluting strength is greater for the cation with the strongest adsorption ability.

Hysteresis. In exchange reactions involving the Amberlite resins and the cation pairs $\text{La}^{+3} - \text{H}^+$ or $\text{Ba}^{++} - \text{Na}^+$ some hysteresis effects were noted (13). Additional unpublished studies with Amberlite IR-1 have indicated the following (23):

(a) In reactions involving exchange between cations of the same valence no hysteresis was encountered.

(b) Exchange between cations of different valence results in hysteresis. The extent of hysteresis expressed as the ratio of the exchange constants is increased when the disparity in valence between the exchanging cations is increased. When the valence difference is kept constant then it appears that the extent of hysteresis is greater when the disparity in the hydrated radii of the cations increases.

(c) In exchange reactions between a monovalent cation and a polyvalent cation, the exchange constant is smaller for the case when the adsorbent is saturated initially with the monovalent cation. In the case where the exchange took place between a monovalent and divalent cation the maximum value for the exchange constant ratio was found to be about 4.

It must be understood that even when the major part of the original

saturating cation has been replaced by another cation the resin will still give the exchange constant found when the original saturating cation was present. Only when the resin has been converted* to another cation form by treatment with a large excess of that cation is the "memory," as Walton (24) termed it, lost. In an experiment (15) made to determine the presence of hysteresis effects in reactions between rare earths and the ammonium form of Dowex 50, the percent of the rare earth adsorbed on the resin was varied. Such an experiment is not likely to show hysteresis and none was found.

Hysteresis, when it occurs, is probably a manifestation of stereochemical factors. An excellent investigation of the relation between these stereochemical factors and the equilibrium capacity of synthetic cation exchangers has been reported by Akeroyd and Broughton (25).

Difficulties from hysteresis effects arise when an attempt is made to estimate the exchange constant for a cation exchange reaction from given pairs of "half-reactions." If, in the latter reactions, hysteresis is known to occur then the question arises as to which of two existing half-reaction constants should be applied, especially when the calculated cation exchange reaction itself involves hysteresis. There is need for a thorough and systematic study of the hysteresis phenomenon.

The Effect of Tracer and Foreign Cation Concentration on the Distribution Coefficient. In any adsorption method in which small amounts of substances are extracted from solution, it is desirable to be able to ascertain the highest concentration of that substance which can be carried efficiently by the adsorbent under a given set of conditions. It is also desirable to be able to estimate the concentrations of extraneous ions that can be tolerated before the distribution coefficient begins to drop abruptly. The distribution coefficient, K_d , for a given cation is expressed as follows:

$$K_d = M_s/M_l \times \text{Volume of solution, } v/\text{mass of resin, } m \quad (1)$$

where M_s and M_l are the fractions of the cation in the resin and liquid phases respectively. The ratio M_s/M_l is conveniently expressed as per cent adsorbed/100% - per cent adsorbed.

The distribution coefficient remains constant regardless of the change in the value of v/m (14, 15).

*It is difficult to precisely define the point at which complete conversion has occurred because the process occurs asymptotically. However, complete conversion is usually accepted to mean that the number of milliequivalents of cation present per gram of resin is approximately equal to the total number of available exchange groups present in the resin at a given pH. When converting a resin to a desired cation form it is best to pass a large excess of a concentrated salt solution of the cation through a bed of the resin as slowly as possible.

The most successful application of equilibrium data to column operation is under conditions where K_d remains constant. The concentration of tracer cations or of extraneous cations at which K_d begins to decrease abruptly can be calculated very simply and requires only one experimental point, namely the per cent of the cation adsorbed when present on a tracer level, i.e., in the region where K_d is constant.

For illustrative purposes consider one of the systems described by Tompkins and Mayer (15). They equilibrated 10 ml. of a solution which was 0.368M in NH_4^+ , 0.23M in citrate and containing tracer amounts of Ce^{+3} with 1.371 g. of the ammonium form, NH_4R , of Dowex 50. The resin contained a total of 7.45 meq. of NH_4^+ . In practice the per cent of Ce^{+3} adsorbed was measured from these solutions where all factors except Ce^{+3} were kept unchanged. The Ce^{+3} concentration was adjusted to a given level by an addition of known amounts of carrier cerium salt.

From the mass action equations (13) it can be shown that to a first approximation:

$$K_d \propto (\text{NH}_4\text{R}) \quad (2)$$

Therefore, K_d will remain constant as long as the concentration or mole fraction of cation in the resin remains practically unchanged. This will be the case when the tracer cation is present in radiochemical concentrations regardless of the extent to which the tracer is adsorbed.

From the data given in reference 15 and by applying equation (2) we see that:

$$K_d = 53 = \% \text{ Ce}^{+3} \text{ ads.} / 100\% - \% \text{ Ce}^{+3} \text{ ads.} \times 10 / 1.371$$

whence we find that 88% of the Ce^{+3} is adsorbed when present on the tracer level.

A concentration of Ce^{+3} of $10^{-5}M$ in a volume of 10 ml. is equal to 3×10^{-4} meq. Since 88% of the Ce^{+3} is adsorbed, the amount of NH_4^+ remaining on the resin is 7.45-0.00026 or, for practical purposes, no change in NH_4R and hence in K_d takes place. However, when the solution is $5 \times 10^{-2} M$ in Ce^{+3} then a total of 1.5 meq. of Ce^{+3} is present. If 88% of this amount was adsorbed then 7.45-1.32=6.13 meq. of NH_4^+ would remain in the resin. This would result in K_d decreasing to 6.13/7.45 = 0.824 of its original value or to $53 \times 0.824 = 43.6$. In this manner the data shown in Fig. 6 were calculated. At very high concentrations of the tracer cation this simplified method of calculation does not hold, but in all instances, one obtains with great accuracy that value of the concentration of the tracer where K_d undergoes an abrupt decrease. Numerous such calculations for systems involving several different valence type of tracer cations always gave complete agreement with the experimental data (23).

All other factors being equal it is apparent that K_d and hence, the per cent adsorbed of a tracer cation will remain constant over a wider range of concentrations with higher capacity exchangers as was found experimentally (15).

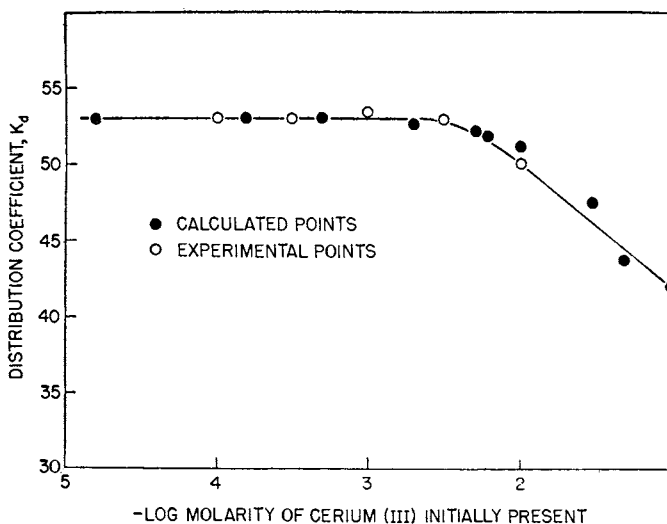
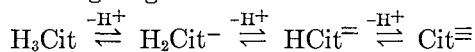

Fig. 6. Variation of K_d with concentration of rare earth, in 0.23 M citrate. Experimental data taken from paper by Tompkins and Mayer (15).

The effects that extraneous cations will have on the adsorption of a tracer are estimated rapidly in the same manner. The only information that is required is one experimental point giving the per cent adsorption of the foreign cation or cations under the given conditions.

Presence of Unionized Substances. Inasmuch as unionized substances possess negligible cation activity they are incapable of affecting the adsorption or desorption of cations. In acid solutions, $\text{pH} \cong 1$, concentrations of citric or acetic acids as much as 0.8 M were without effect on the adsorption of alkaline earth or rare earth cations by the Amberlite resins (26). Additionally, no appreciable elution of adsorbed radiostrontium from Amberlite IR-1 was observed when 0.5 M citric acid at a $\text{pH} \cong 1.8$ was employed as the elutriant (3).

Complexing Action of Citric Acid. The dissociation of citric acid proceeds in the following stages:



where Cit^{3-} represents the anionic part, $\text{C}_6\text{H}_5\text{O}_7^{3-}$, of the citric acid molecule. At 25° the three dissociation constants of citric acid are (27):

$$pK_1 = 3.057 - 0.504 \sqrt{\mu} + .41\mu$$

$$pK_2 = 4.759 - 1.512 \sqrt{\mu} + 1.25\mu$$

$$pK_3 = 6.400 - 2.520 \sqrt{\mu} + 2.23\mu$$

where μ is the ionic strength. Any one of the three ions, H_2Cit^- , $HCit^{=}$ or $Cit^{=}$ is capable of complexing cations. The higher charged citric acid anions usually form the stronger complex ions (26). At a $pH \cong 7$ citric acid is nearly completely dissociated to $Cit^{=}$. The relative amounts of the various ionic species present in dilute citric acid solutions at different pH 's are given in Table I.

TABLE I

*The per cent of each of the ions present in a solution of citric acid ($\mu = 0.1$ and $t = 25^\circ$)**

pH	H_3Cit	H_2Cit^-	$HCit^{=}$	$Cit^{=}$
1.0	98.9	1.1	4.5×10^{-4}	6.7×10^{-9}
1.5	96.5	3.5	4.4×10^{-5}	2.1×10^{-7}
2.0	89.6	10.3	0.041	6.1×10^{-6}
2.5	73.1	26.6	0.33	1.6×10^{-4}
3.0	45.5	52.4	2.06	0.0031
3.5	20.0	71.4	8.9	0.042
4.0	5.85	67.3	26.5	0.39
5.0	0.16	18.1	71.2	10.6
6.0	8.8×10^{-4}	1.0	39.7	59.2
7.0	1.4×10^{-6}	0.016	6.3	93.7
8.0	1.5×10^{-9}	0.0017	0.67	99.3

* Calculated from the equations of Bjerrum and Unmack (27).

The rare earths are strongly complexed by citrate solutions at a $pH \cong 3$ as evidenced from equilibrium measurements (15, 26) and by the ease with which such solutions elute the adsorbed rare earths. It appears that at a $pH \cong 3$ or less the predominating complex rare earth ion present in citrate solution is $M(H_2Cit)_3$ where M^{+3} represents the trivalent rare earth cation. The equations for the exchange and complexing reactions involved may be written as follows (8, 15):

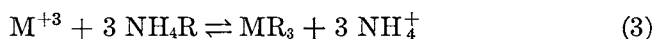

and



Applying the mass law to these equilibria and utilizing the first dissociation constant, K_1 of citric acid, the distribution coefficient, K_d is given by the following expression (8):

$$K_d = K_{\text{exchange}} K_{\text{complex}} / K_1^3 (NH_4R/NH_4^+)^3 (H^+/H_3Cit)^3 \quad (5)$$

The dependence of K_d upon pH and NH_4^+ concentration is illustrated by equation (5). (The effect of a variation in the exchange capacity of the adsorbent has already been discussed). Inasmuch as a decrease in H^+ concentration is accompanied by an increase in NH_4^+ concentration

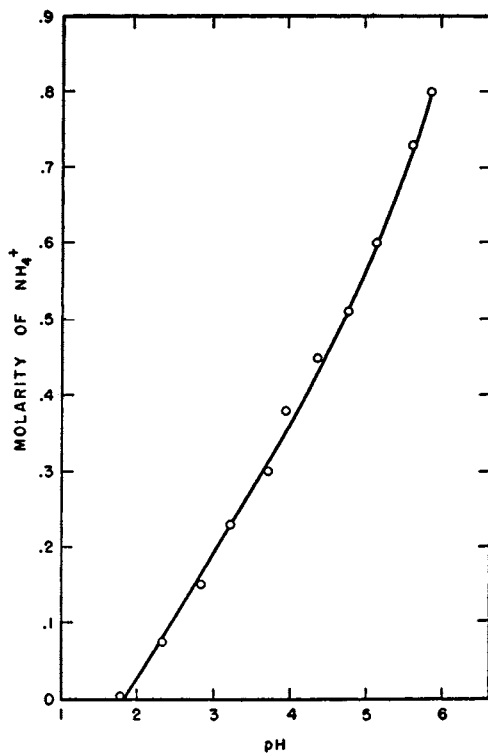

FIG. 7. The concentration of ammonium ion in a 5% (0.24 *M*) solution of citric acid as a function of pH.

(Fig. 7) it is to be expected that K_d will decrease rapidly as the pH increases. The decrease will be mitigated by a lowering in the concentration of H_3Cit . At much higher pH's, i.e., $\text{pH} \sim 4$, however, where the polyvalent citric acid anions are present in appreciable concentrations (see Table I), then the stronger complexing action of the HCit^- and Cit^{2-} ions will cause K_d to decrease more rapidly than the effect of increasing NH_4^+ concentration alone. The marked effect of NH_4^+ and pH on K_d in the systems just described are clearly seen in Figs. 8 and 9 respectively.

The temperature dependence of K_d of the rare earth citrate system has not been studied, but from a consideration of the variation of the dis-

sociation constants of citric acid with temperature it would appear that up to 50° little change in K_d would be expected (8). Above this temperature K_d should tend to increase.

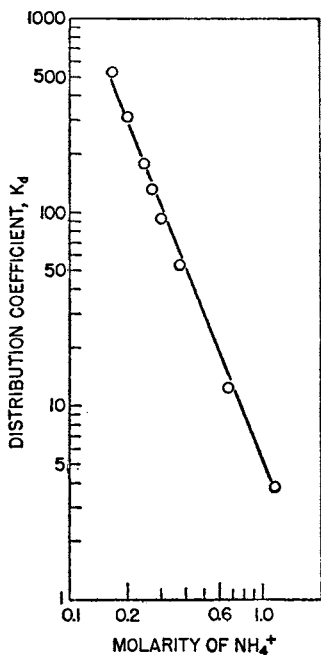

FIGURE 8

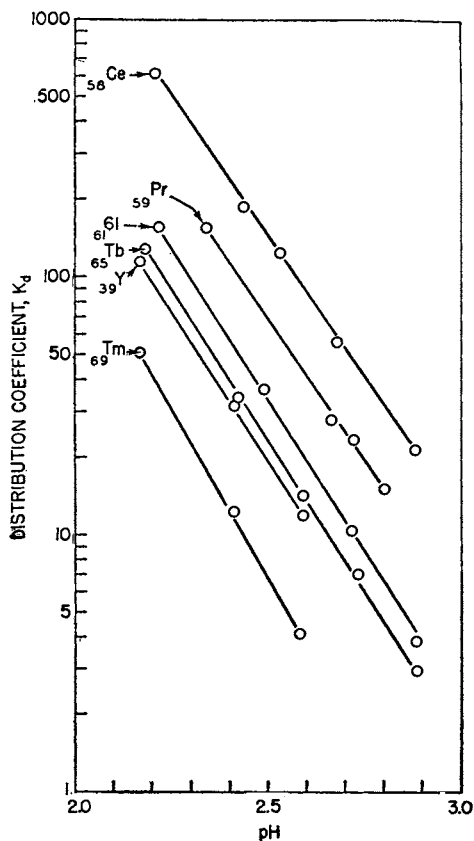

FIGURE 9

FIG. 8. The effect of ammonium ion concentration on the distribution coefficient of cerium. Ten milliliters of solution, $0.23 M$ in citrate at a pH of 2.8, and $3 \times 10^{-4} M$ in Ce^{+3} were equilibrated with 1.371 g. of the ammonium form of Dowex 50. Constructed from tabulated data of Tompkins and Mayer (15).

FIG. 9. The effect of pH on K_d of several rare earths measured in $0.23 M$ citrate. The solutions were 10 ml. in volume and consisted of $0.23 M$ citrate, $0.5 M \text{NH}_4\text{ClO}_4$ and $< 10^{-6} M$ in each rare earth. They were equilibrated with 0.3657 g. of the ammonium form of Dowex 50. Constructed from tabulated data of Tompkins and Mayer (15).

The alkaline earths are known to form complexes with Cit^{\equiv} and HCit^{\equiv} ions (26, 28). As expected, the complexes formed with Cit^{\equiv} are much

stronger than those formed with HCit^{\ominus} . In Table II are tabulated the dissociation constants for some of the alkaline earth and rare earth complex ions. Preliminary measurements indicate that between 25° and 37° the

TABLE II

The dissociation constants of some alkaline and rare earth citrate complex ions and including the exchange constants for the reaction between NH_4R and the corresponding cation

Cation	Complex ion	Dissociation constant for the complex ^{a, b}	Exchange constant ^{b, c}	Reference
Ce^{+3}	$\text{Ce}(\text{H}_2\text{Cit})_3$	6.3×10^{-7}	125	15
Pr^{+3}	$\text{Pr}(\text{H}_2\text{Cit})_3$	4.4×10^{-7}	91	15
Y^{+3}	$\text{Y}(\text{H}_2\text{Cit})_3$	2.3×10^{-7}	53	15
Sr^{+2}	$\text{Sr}(\text{Cit})^{\ominus}$	1.5×10^{-3}	13	14
Ba^{+2}	$\text{Ba}(\text{Cit})^{\ominus}$	5.0×10^{-3}	14	26
Ba^{+2}	$\text{Ba}(\text{HCit})$	$\cong 0.1$ (pH $\cong 4.5$)	—	26

^a Measured by the ion exchange method (31).

^b The dissociation and exchange constants for the alkaline earths were measured in solutions $0.16 M$ in NH_4^+ and at a pH 7 while those for the rare earths were measured in solutions $0.5 M$ in NH_4^+ and at a pH 2.60.

^c Calculated from the mass action expressions (13, 26) in which the concentrations of NH_4R and NH_4^+ were given in moles per liter.

TABLE III*

The distribution coefficients, K_d , of lanthanum and actinium in citric acid as a function of pH
Solution: 5 ml., $0.25 M$ in citric acid, tracer ^{139}La and ^{227}Ac , pH adjustment made by addition of concentrated NH_4OH , Dowex 50, ammonium form, 150-200 mesh, 0.5 g.

pH	Distribution coefficient, K_d	
	^{139}La	^{227}Ac
2.0	2760	—
3.0	190	1990
3.2	85	—
3.3	—	1220
3.4	14	—
3.5	—	500
3.6	5	144
3.8	0	43
4.0	0	18
4.2	0	6.9
4.4	—	2.2
4.6	—	1.0

* After Hagemann (49).

dissociation constants of the strontium and barium citrate increase from 30 to 50% (26).

It is obvious that in citric acid solution at any one pH the rare earths and alkaline earths will exist as a mixture of several different complex ions (29, 30). The proportion of each form present is a function of the strength of the complex formed between the cation and an ion of citric acid and the concentration of each of the latter. At any one concentration of citric acid the pH determines the relative concentrations of the ionic species present (Table I). At a given pH it simplifies matters to refer to the predominating cation complex present in the citrate solution. The pH at which citric acid appreciably complexes cations of different valences varies by at least one pH unit. Hence it is very simple to separate the alkaline earths from the rare earths, for example, by utilizing desorbing solutions of widely different pH (Fig. 9a).

It is important to note from the data in Table II that those cations which are most strongly held by the resin also form the weakest complex

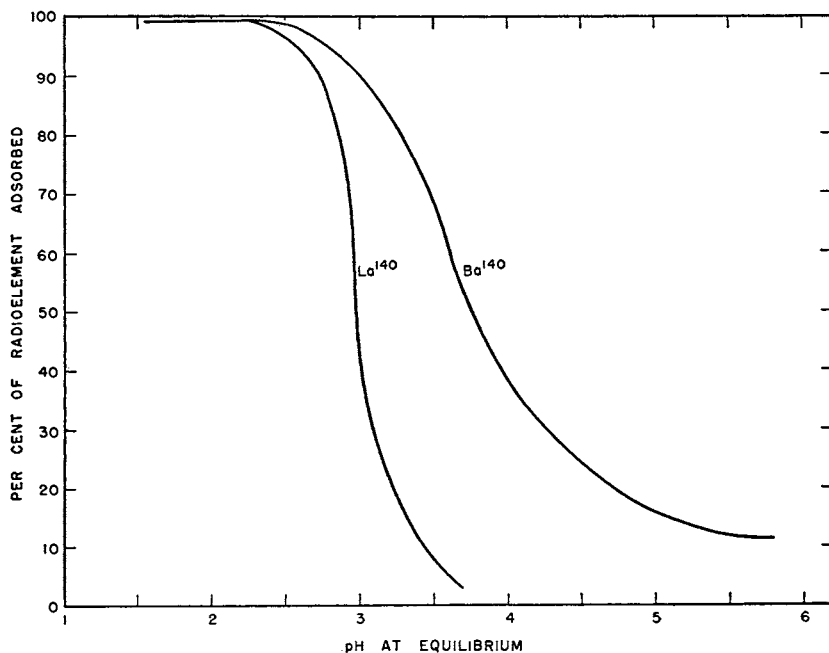

Fig. 9a. Adsorption of Ba^{140} and La^{140} by the hydrogen form of the cation exchanger, Amberlite IR-1, from 5% (0.24 M) citric acid as a function of pH. The weight of resin was 0.50 g. air-dried and the volume of solution was 25 ml. The solution pH was adjusted by adding ammonium hydroxide. Reproduced from Schubert and Richter (26).

ions. Thus the citrate, by this fortunate combination of events, markedly enhances the normal differences in adsorbability existing between two cations of the same valence. This is related to the fact that the affinity of the cation for the exchanger is a function of the hydrated cationic radius while the strengths of the complex ions depends on the nonhydrated cationic radius. The data of Tables II, III and of Fig. 9 show that the order of ease of desorption of the rare earths from the exchanger with citrate solutions is in the reverse of their atomic number, i.e., the higher the atomic number the easier it can be eluted. With the alkaline earths, on the other hand, the ease of removal is in the direct order of their atomic number, i.e. the lower the atomic number the more easily it can be eluted. In order to place the quasi rare earths, ${}_{21}\text{Sc}$, ${}_{39}\text{Y}$ and ${}_{89}\text{Ac}$, into this scheme it simplifies matters to assign them arbitrary "atomic numbers." These "atomic numbers" are based on the known basicity characteristics (33) of these rare earths which in turn are related to the adsorption affinities. Thus for practical purposes scandium = at. no. $71\frac{1}{2}$, yttrium = at. no. $65\frac{1}{2}$ and actinium = at. no. $56\frac{1}{2}$.

In evaluating the separability of pairs of cations it is convenient to employ a numerical index called the separation factor (8). This separation factor is simply the ratio of the distribution coefficients (8, 32) and is given by the expressions:

$$\alpha = K_d^{M_1}/K_d^{M_2} = K_{\text{ex.}}^{M_1}/K_{\text{ex.}}^{M_2} \times K_{\text{complex}}^{M_1}/K_{\text{complex}}^{M_2} \quad (6)$$

When the separation factor is about 1.2, for example, the two cations can be separated efficiently by chromatographic elution techniques.

TABLE IV^a*Comparison of Complexing Agents^b*

Solution: 10 ml., $5 \times 10^{-6} M$ in Eu, $< 10^{-6} M$ in 61, 50 g. of the complexing compound per liter, NH_4^+ as required to adjust to pH; resin, Dowex 50, ammonium form, 40-60 mesh, 0.4572 g.

Complexing compound	pH at which K_d of Eu = 21.9	K_d 61/ K_d Eu
Citric acid	3.05	1.45
Tartaric acid	2.85	1.94
Lactic acid	3.40	1.71
Sulfosalicylic acid	5.4	1.49
Ethyl acetoacetate	7.4	1.33
Acetylacetone	7.2	1.91
Oxalic acid	1.7	1.32
Citric acid in 50% EtOH	3.0	1.31

^a Reproduced from *J. Am. Chem. Soc.* **69**, 2859 (1947).

^b Phthalic acid, malonic acid, dihydroxytartaric acid and pyrogallol form precipitates with Eu and 61.

The Use of Complexing Agents other than Citric Acid in Cation Exchange Separations. A rapid evaluation of the relative merits of a complexing agent for separating cations can be made by measuring the ratio of the distribution coefficients in the presence of a known concentration of the complexing agent under controlled conditions. In this manner a scheme for separating any given pair of cations can be approximated from a few simple equilibrium measurements. Excellent separations of rare earths with tartrate eluting solutions have been made (3, 18). A series of preliminary complex ion studies by Tompkins and Mayer (15) has indicated the existence of several complexing agents that may be superior to citrate (Table IV).

Adsorption and Desorption of Colloids. Tracer levels of very insoluble metals such as zirconium, columbium, and protoactinium may be highly adsorbed by the cation exchanger. In such cases, however, the substances are adsorbed not by the usual cation exchange mechanism but by physical surface adsorption (31, 34). The capacity of an exchanger for these materials is much less than the corresponding cation exchange capacity. In the case of zirconium it was found that the capacity of the Amberlite resins for the colloid was about twenty-five times less than that for cation adsorption (36). In contradistinction to the adsorption of a

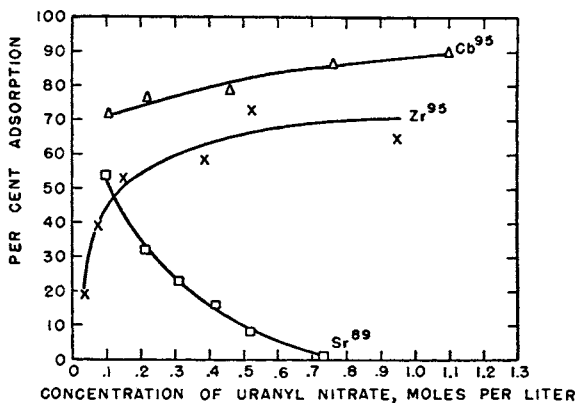

FIG. 10. Adsorption of carrier-free Zr^{95} , Sr^{89} , Cb^{95} by the uranyl form of the cation exchange resin, Amberlite IR-1. Ratio of the volume of solution to the weight of air-dried UO_2R_2 was 100/1 for Zr and Cb adsorption, and 25/1 for Sr adsorption. After Schubert (34).

cation, the adsorption of tracer concentrations of colloidal substances — radiocolloids — will remain relatively unaffected or even increased with increasing bulk or supporting electrolyte concentration. Thus the bulk electrolyte may act as a coagulating agent and enhance the degree of adsorption of the radiocolloid. This behavior serves as a very convenient

and efficient method for separating cations from radiocolloids as shown in Fig. 10.

Additionally the distribution coefficient, K_d , for radiocolloids does not remain constant when the ratio v/m is varied unless a complexing agent is present. Thus, the per cent adsorption usually remains nearly constant when the ratio v/m is varied over wide limits (34).

The desorption of radiocolloids is most completely carried out by the use of complexing agents. The elements Zr, Cb, and Pa are easily desorbed by dilute solutions of oxalic acid or hydrofluoric acid without removing adsorbed cations (3, 35).

Macroscopic concentrations of colloids are easily purified from cations under conditions such that the bulk of the colloid is unadsorbed while the cationic impurities are adsorbed. Conditions for purifying zirconium from iron, titanium, beryllium, and lanthanum have been established (36).

Details of the processes mentioned in this paragraph will be given in the section on separation schemes.

Activity Coefficient Relationships. The equilibria in cation exchange reactions are dependent upon the thermodynamic activities of the solution cations. Oftentimes it is possible to predict approximately the adsorption of a cation over a wide range of ionic strength from only one experimental point. This is done by applying the mass action equations (13) and by estimating the variations of the activity coefficient. The activity coefficient data available in the literature, particularly in the case of mixtures, are far from complete but with the aid of empirical and semiempirical generalizations and some experience one can arrive at good practical estimates. A valuable compilation of activity coefficient data for mixed electrolytes and some general rules are given in the book by Harned and Owen (37).

A few generalizations which have been found quite helpful are:

(a) At a given ionic strength and acid concentration, the activity coefficient of a strong acid is greater in solutions of a salt of a given valence type, which in the pure solvent possesses the greater activity coefficient.

(b) In mixtures of electrolytes the salt which is present in higher concentrations will determine the nature of the variation of the activity coefficient of the other component to an increasingly greater extent as the concentration of the former is increased relative to the concentration of the latter. When the activity coefficient of the major component at a given ionic strength is greater than that of the lesser component, the activity coefficient of the latter will be increased from the value it would have had in its own solution at the same ionic strength. The reverse is also true.

(c) The departure from the Debye-Hückel equations at high concentrations is no more marked for polyvalent electrolytes than it is for a typical uni-univalent salt such as potassium chloride (38).

2. *Non-equilibrium Column Operations*

General Considerations. The most effective method for separating cations when the separation factors are small consists of adsorbing the cation mixture in the narrowest possible band at the top of the resin bed and subsequently eluting the adsorbed cations stepwise, i.e., chromatographic elution. Generally, the separations obtained will be greater when the operations approach the equilibrium state. Within limits some of the factors which lead to improved separations are: (a) decreasing the flow rate of the elutriant, (b) decreasing the particle size of the exchanger, (c) eluting at elevated temperatures, (d) increasing the length of the exchanger bed, (e) reduction of adsorbed ion concentration to a minimum, and (f) use of higher capacity exchangers.

After a mixture of cations is adsorbed on a column of a cation exchanger it is possible to effect a separation by predominantly cationic displacement action or predominantly complex ion formation, or by a combination of these two reactions. Cationic displacement, which utilizes the differences in adsorption affinities of adsorbed cations, works well when the separation factor is large, as it is when the cations to be separated are not of the same valence. The simplest example of such a process is elution of cations of lower valence only with dilute acid and then removal subsequently with more concentrated acid solution of the higher valence cations (18).

Separations that utilize complex ion formation are especially useful in those instances where the separation factor is very low. Of course there must always exist some degree of cationic activity in these reactions. Adsorbed colloids can and often must be removed by complex ion formation. In such cases cation activity is not a factor.

When the recovery and concentration of trace quantities of cations are desired, it is sometimes of value to operate the column to the breakthrough point. The effluent is discarded and the adsorbed cations are eluted in as small a volume as possible. If the adsorption affinity of the trace cations is much stronger than that of the contaminating ions then such an operation will result in a considerable purification inasmuch as the bulk of the contaminants will have passed into the effluent. Further purification could be attained by selectively removing contaminants which are still retained by the column without desorbing the trace cations. The resulting concentrate of trace cations can be further resolved by re-adsorption followed by chromatographic elution. A discussion of a method for

achieving volume reduction by a cycle of elution, acidification, dilution, re-adsorption, and re-elution is given on p. 204.

Application of Plate Theory to Column Separation Calculations. The plate theory of Martin and Synge (39) which was based on the analogy of chromatographic processes to distillation and solvent extraction columns was applied by Mayer and Tompkins (32) to cation exchange separation columns. The plate theory is probably the most practical and simplest method for extrapolating equilibrium data to column conditions. It yields a good approximation to the experimental curves even for columns containing as few as 10 plates provided K_d remains constant (40). A cm.³ of Dowex 50 in a column may contain about 10^{21} exchange groups. The maximum possible number of plates for a column of this resin would be 10^7 per centimeter of length, i.e., the average number of exchange positions per linear centimeter within the column. Actually even with tracer levels of solute, a plate is seldom less than 1 mm. in length (40).

The discussion and illustrative material given in this section are derived for the most part from the papers of Mayer and Tompkins (32) and Tompkins (40).

In a study (32) of the separability of Eu and element 61 the values of K_d (Eu) and K_d (61) were first determined by equilibration of the radioisotopes of Eu and 61 with Dowex 50 in a solution of the elutriant. The elutriant was a solution 0.25 *M* in citrate, 0.294 *M* in NH_4^+ and at a pH of 2.90. To determine K_d at equilibrium, 0.275 g. and 0.278 g., respectively, of the ammonium form of the resin was shaken with 10 ml. of the elutriant solution containing Eu and 61 tracers. The values obtained for the K_d 's were 19.4 for Eu and 29.9 for 61. Hence $K_d(61)/K_d(\text{Eu}) = 1.542$, which indicates a relatively simple separation.

A column consisting of finely divided Dowex 50, $1.0 \text{ cm.}^2 \times 10.8 \text{ cm.}$ in length was set up for the separation. This column contained 2.83 g. of resin with a density of 1.45 g./cc. Hence the liquid phase of this column designated as the "free volume," $V = 10.8 - 2.83/1.45 = 8.84 \text{ ml.}$

Let the ratio M_s/M_1 in equation (1) be designated as C . Then

$$K_d = C \times v/m. \quad (7)$$

The term C is numerically equal to the number, n , of free volumes, V , of solution which will have passed through the column ($F = nV$) when the concentration of solute in the eluate is at a maximum, i.e., $C = F_{\text{max}}$. Therefore, from the equilibrium values of K_d we can locate the peaks of the elution curves.

From equation (7):

$$\begin{aligned} C &= K_d \times m/v; \text{ thus } C(\text{Eu}) = 19.4 \times 2.83/8.84 = 6.20; \text{ and } C(61) \\ &= 29.9 \times 2.83/8.84 = 9.56. \end{aligned}$$

When 6.20 V or 54.7 ml. of elutriant has passed through the column the Eu concentration should have reached its maximum, while at 9.56 V or 84.5 ml. of elutriant the concentration of 61 should have reached its maximum.

The elements Eu and 61 were adsorbed at the top of the resin bed and eluted under near equilibrium conditions with the 0.25 M citrate solution at a pH of 2.90. In passing the eluting solution through the column the first V to appear in the effluent is discarded because it contains inert solution. Thereafter fractions of effluent no more than 0.5 V were collected until the first element, Eu, appeared as determined by qualitative tests of the radioactivity. Subsequently smaller and smaller "cuts" were collected as the peak of the curve was approached. When the peak was passed then the volumes collected were increased. A similar procedure was used for collecting the "cuts" containing 61. The fractions collected for 61 were about one and a half times as large as those for Eu inasmuch as it was expected that the elution curve would be that much wider.

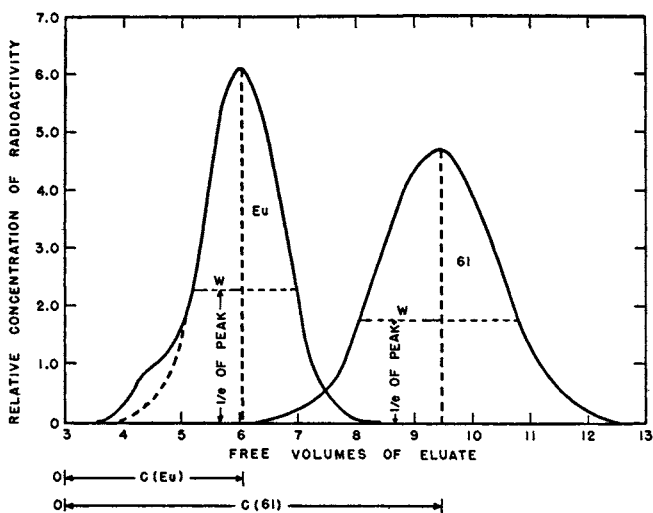

FIG. 11. Elution curves of europium and element 61. After Mayer and Tompkins (32).

The values of C obtained from the elution curves (Fig. 11) were 9.41 for 61 and 6.08 for Eu, in good agreement with the equilibrium values.

It is good practice to make a preliminary test run with a small column in order to determine the optimum conditions necessary for a given separation. The degree of separation will depend upon the width of the individual elution curves which in turn is related to the fractionating efficiency of the column, i.e., the number of theoretical plates, p . Once p

is known it is possible to calculate the extent to which the elution curves will overlap or the length of column necessary to give a desired degree of separation, i.e., recovery of 95% of the total Eu present 99% pure in a single cycle.

The number of theoretical plates, p , can be approximated by the equation suggested by Matheson (41) and given by the formula:

$$p = 2C(C + 1)/W^2 \quad (8)$$

where W is simply the half width of the elution curve at an ordinate value of $1/e$ of the maximum (where e is the base of the natural logarithm and = 2.718). When C is large then

$$p \cong 2C^2/W^2 \quad (9)$$

Consider the system just presented for the column separation of Eu from 61. From the elution curve in Fig. 11 the measured value of W is 1.38 and since $C(61) = 9.41$ and applying equation (8):

$$p = 2 \times 9.41 \times 10.41/(1.38)^2 = 103$$

Similarly for Eu:

$$p = 2 \times 6.08 \times 7.08/(0.91)^2 = 104$$

One can proceed to calculate the theoretical elution curves and to calculate the degree of cross contamination present at any given volume of elutriant passed through the column. On the assumption that the elution curves have the form of the normal curve of error (this assumption becomes increasingly valid as the number plates becomes larger (39)) the value of the sigma unit, t , may be calculated according to the formula:

$$t = p^{1/2} (F - C)/[C(1 + C)]^{1/2} \quad (10)$$

and when C is large

$$t \cong p^{1/2} (F - C)/C \quad (11)$$

The ordinates and areas under the curve corresponding to different values of t are given in mathematical tables.* The values of t for elements 61 and Eu from equation (10) can be tabulated for different values of F . For each calculated value of t the corresponding ordinate is divided by the value of the ordinate when $t = 0$, namely 0.3989. The ratio of the ordinates for each value of F multiplied by the concentration at the peak value for each element can be tabulated. The ratio of the result of this calculated for each element at a given value of F is equivalent, in the present case, to the ratio of 61 to Eu at a particular cut of eluate. From the area under the elution curve for the given value of F at each value of t the total amount of each element eluted and the degree of purity can be calculated.

* Handbook of Chemistry and Physics. Chemical Rubber Publishing Company.

As a specific example consider the Eu-61 elution curves where $F = 7.47$ (Fig. 11). From equation (10) we find:

$$t(\text{Eu}) = \sqrt{104} (7.47 - 6.08) / \sqrt{6.08 \times 7.08} = 2.14$$

and

$$t(61) = \sqrt{103} (7.47 - 9.41) / \sqrt{9.41 \times 10.41} = 2.00$$

From the mathematical tables we find that for these values of t the ordinates are 0.0404 and 0.0540 respectively. The ordinate for these elution curves should be, therefore:

$$\text{Eu} = 0.0404 / 0.3989 \times 6.16 = 0.63$$

and

$$61 = 0.0540 / 0.3989 \times 4.72 = 0.64$$

At this volume of elutriant, $F = 7.47 = 66$ ml., the area under the curve when $t(\text{Eu}) = 2.14$ is given as 0.4838, which means that 98.4% of the total Eu had been eluted while for $t(61) = 2.00$ we find that the area = 0.4773, hence 2.3% of element 61 had been eluted.

Increasing the number of plates, p , will not change C , but from equation (10) it is seen that t is proportional to $p^{\frac{1}{2}}$. Thus one can pick any degree of separation by arbitrarily choosing a value of t that, for a given

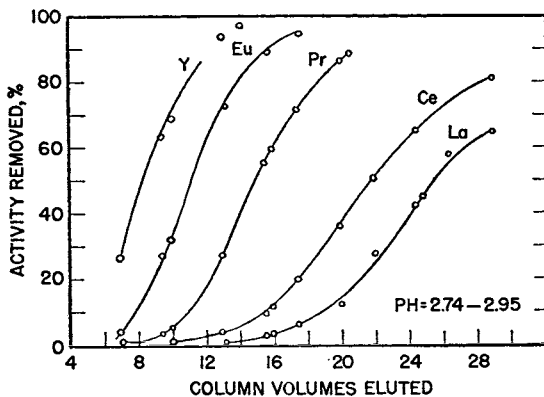

FIG. 12. Elution of some radioactive rare earths from Amberlite IR-1 with 5% citrate solutions: resin, Amberlite IR-1, 40-60 mesh, in acid form; bed, 0.75 sq. cm. \times 12.5 cm.; influent, 5% citric acid, converted with NH_4OH to pH shown at top; rate, ~ 1 ml./sq. cm. min. Each rare earth was adsorbed and eluted from a separate column. Reproduced from Marinsky *et al.* (5); Tompkins *et al.* (3).

value of F , will give a low ordinate value. In this manner, the ordinates and hence areas of cross contamination as, for example, the region in Fig. 11 where $V = 7.5$ can be reduced to a minimum.

The plate theory, despite its limitations (see the chapter by Thomas) does offer a rapid and simple method of estimating column operation from

equilibrium batch data. It may be possible to extend, empirically, the application of the theory to operating conditions far from equilibrium by studying the variation of a single factor, e.g., the variation of p with flow rate.

Order of Elution of the Rare Earths and the Identification of Element 61. The predicted and observed order of desorption of the rare earths from equilibrium data are given on p. 184. This pattern is so reproducible* that it has been used in column operations to identify unknown rare earths and to isolate and characterize element 61 (5). In Fig. 12 it is shown clearly that the order of elution of the rare earths is the reverse of the

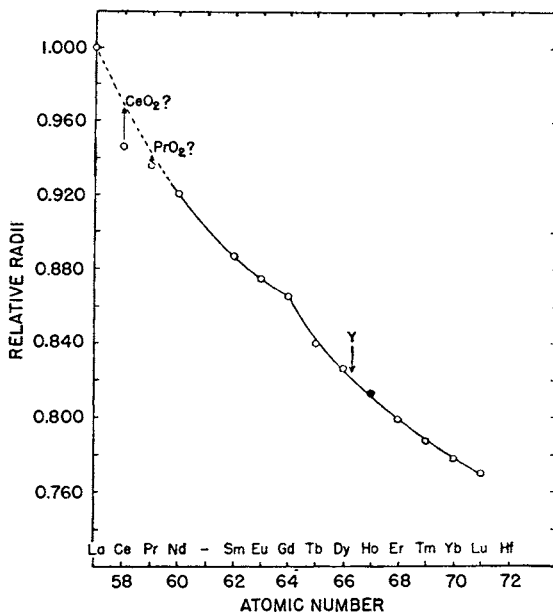

FIG. 13. Relative (cubic) radii of trivalent rare earth ions: $R_{La}^{+++} 1.291$ A. for cubic sesquioxide; \circ , H. Bommer, *Z. anorg. allgem. Chem.*, 241, 273 (1939); \bullet , V. M. Goldschmidt, *Ber.*, 60, 1263 (1927); these data were computed by Dr. M. Bredig. Reproduced from Kettle and Boyd (8).

atomic number (the opposite result is found with the alkaline earths). The position of yttrium is as expected from its ionic radius relative to the other members of the rare earths (Fig. 13) and to its arbitrarily assigned "atomic number" of $65\frac{1}{2}$, p. 184.

* It should be pointed out that the order of elution of one or more cations in a group can be altered, or even reversed completely in those cases where a different elutriant is used or when the concentration of the same elutriant is changed. These effects are mainly due to complex ion formation. The reproducible nature of a given elution order, in any event, will still hold.

The ion exchange separations technique led to the first positive chemical identification of isotopes of element 61, 47h, and 3.7y half-life (5). In this work, Marinsky, Glendenin, and Coryell took a sample containing the praseodymium group of elements which had been isolated from a fission product mixture (Pr, Nd, and 61), adsorbed them on an Amberlite-IR-1 column and subsequently eluted them with 5% ammonium citrate at a pH of 2.75 (Fig. 14). Subsequently, at least 3 mg. each of the yellow chloride and rose colored nitrate of element 61 were prepared. Similar elution experiments on activities produced by slow neutron irradiation of neodymium led to the identification of a new 1.7h isotope of neodymium.

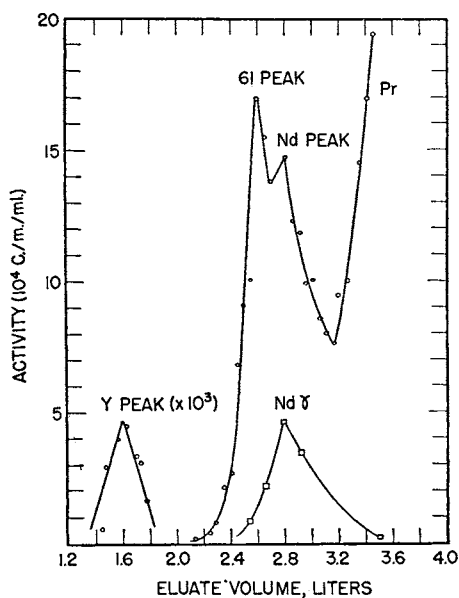

Fig. 14. Elution curves of intermediate rare earth fractions: resin, Amberlite IR-1, 100 mesh, acid form; bed, 1 sq. cm. \times 125 cm.; influent 4.75% citric acid, converted to pH 2.75 with NH_4OH ; rate, 1-2 ml./min. Reproduced from Marinsky *et al.* (5). Conditions cited by Tompkins *et al.* (3).

Analysis of Rare Earth Mixtures. The chapter by W. Rieman reviews the already considerable value of ion exchange reactions to analytical chemistry. The results of the preceding paragraph are indicative of the use to which ion exchange can be used for the analysis of traces of rare earths. For example, Ketelle and Boyd (8) took a sample of spectrographically pure erbium and subjected a 5-mg. aliquot to neutron bombardment. The irradiated sample was processed on a Dowex 50 column. An extremely good separation was obtained of traces of lutecium, ytterbium,

thulium and sodium (Fig. 15). No rare earths lighter than erbium were detected. The eluate fraction containing the thulium activity was con-

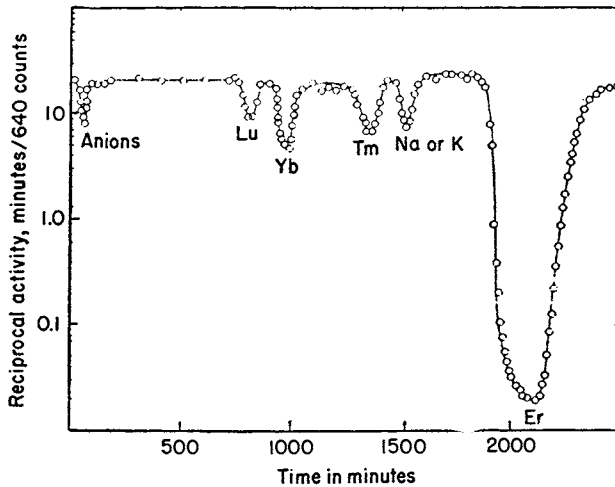

FIG. 15. Neutron activation analysis of spectrographically pure erbium oxide: bed dimensions, 97 cm. \times 0.26 sq. cm.; flow rate, 0.5 ml./sq. cm./min.; 5% citrate buffer at pH 3.2; temperature, 100°; 5.0 mg. of Er_2O_3 irradiated in Clinton neutron chain reactor and then fractionated by Dowex 50 ion exchange column. Reproduced from Ketelle and Boyd (8).

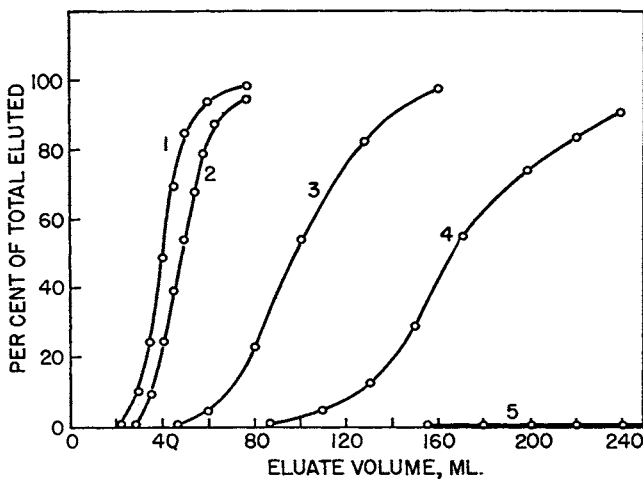

FIG. 16. Elution of tracer $\text{Sr}^{89,90}$ by 2% citrate and the effect of pH: resin, Amberlite IR-1, 40-60 mesh, hydrogen form; bed, 1 sq. cm. \times 10 cm.; influent, 2% citric acid, converted to pH shown with ammonia; rate, 1 ml./min.

Curve	1	2	3	4	5
pH	8.0	6.0	5.0	4.5	4.0

Reproduced from Tompkins *et al.* (3).

centrated on a small column and the activity was assayed. From the measured number of disintegrations the total number of atoms of Tm^{170} (produced from Tm^{169}) present could be computed from the known half-life of 125d. By standard radiochemical techniques (42) it was possible to calculate the number of Tm^{169} atoms present as impurity in the original erbium, namely 0.001% or 10 p.p.m. Even smaller amounts of Tm impurity could be detected if longer bombardments were made to activate the thulium more nearly to saturation.

Effect of pH and Citrate Concentration. The ease of elution of an alkaline earth by citrate solutions increases with increasing pH as a consideration of the complex ion equilibria would indicate. Experimental data (3) on the elution of tracer Sr by 2% citrate as a function of pH are shown in Fig. 16. The same general relationships also hold true for the rare earths. However, when the pH approaches the precipitation value for the rare earth then the tendency toward hydroxide formation tends to

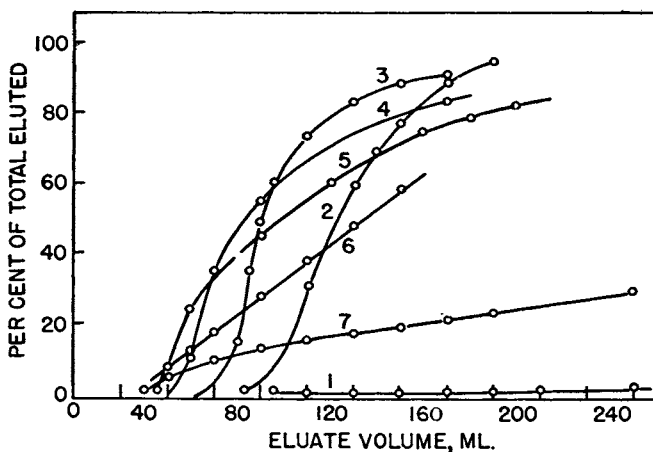

FIG. 17. Elution of tracer Y^{91} from Amberlite IR-1 by 2% citrate solutions: resin, Amberlite IR-1, 40-60 mesh, acid form; bed, 1 sq. cm. \times 10 cm.; influent, 2% citric acid, converted to pH shown with NH_4OH ; rate, about 1 ml./sq. cm./min.

Curve	1	2	4	5	6	7
pH	3.0	3.5	4.0	6.0	7.5	8.0

Reproduced from Tompkins *et al.* (3).

offset the extent of complex ion formation. The data presented in Fig. 17 appear to support this contention. A similar study with Dowex 50 would be instructive inasmuch as the increased capacity of Amberlite IR-1 with pH may be a contributing factor to the behavior observed in Fig. 17. One advantage of using a high pH for elution lies in the fact that a lower concentration of citric acid can be employed while still retaining most of the

rare earth found as the citrate complex. This is due to the stronger complexing action of the polyvalent anions of citric acid. A good illustration of the effect of pH on the separation of Y and Ce is given in Fig. 18.

There is reason to believe that the separation factors, i.e., the ratio of the distribution coefficients between pairs of cations may decrease as the pH is increased beyond certain limits. Such data were reported by Tompkins and Mayer (15) for a system involving the effect of pH in citrate solutions of Eu and element 61.

Recent unpublished work by D. H. Harris has indicated that there may actually be optimum pH's for the separation of some of the pairs of adjacent rare earths.

It is important to recognize the important factors when selecting a pH and concentration of citrate for elution purposes. In general, for a given concentration of citrate, the volume necessary to elute a rare earth will be less the nearer the pH approaches 5. Below a pH of about 2.55 the elution of the rare earths is greatly reduced. When no separation of cation is desired or where the separation has proceeded to the point where only one element remains on the column then the pH or concentration of the elutriant citrate solution can be increased in order to save time and to minimize effluent volumes.

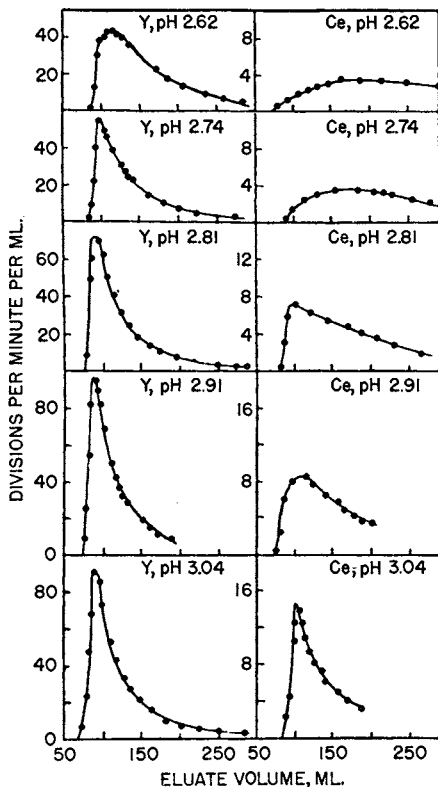

FIG. 18. The elution of Ce and Y tracers in 5% citrate at various pH values: flow rates 3 cm./min.; column dimensions, 1 cm. \times 60 cm. Reproduced from Spedding *et al.* (4).

cause the adsorption bands to become merged as they move down the column, resulting in a large loss of separation efficiency. In a system described by Spedding *et al.* (9) 0.5% citrate solution was used to elute a mixture of Sm and Nd. They found that at a pH of 5.00 these rare earths were eluted in a total volume of 3 liters with little separation. At a pH

of 4.50 a volume of 8 liters was required for elution and some separation was found. At a pH of 4.0 excellent separation of the Sm from Nd was observed though at least 11.5 liters of elutriant were needed.

At constant pH the elution of the rare earths will be affected by the citrate concentration. At a pH of $\cong 3$ no appreciable elution of the rare earths is observed at a concentration of 1–2% citrate (3, 4) while with concentrations of 5% or greater of citrate the rare earths are easily removed.

Most of the rare earth separations are made with the hydrogen (acid) form of the resin. Hence the exchange of the NH_4^+ in the citrate buffer with the H^+ from the resin is reflected in the low pH of the first effluents. The rate of movement of a given rare earth band does not become appreciable until the pH rises to the point where a stable complex ion is formed. Inasmuch as each rare earth is eluted only when the pH reaches a critical value that is uniquely related to the basicity of that rare earth under given conditions, it is possible to make use of precise pH measurements as an aid in selecting desirable fractions of eluate. Such a practice has found frequent use on the Plutonium Project for cation separations in general, especially by Tompkins, Cohn, and their co-workers.

In practice it is preferable to have the resin in the ammonium form originally to avoid the complicating and possibly disadvantageous effects of changing pH on the separation factor.

TABLE V

*The optimum pH range necessary to obtain efficient separations of rare earths when eluting with citrate solutions of varying concentrations**

Resin	Citrate concentration (%)	Optimum pH range	References
Amberlite-IR-1 or IR-100	5.0	2.6–2.9	3, 4, 8
Amberlite-IR-1 or IR-100	0.5	3.8–4.3	9
Amberlite-IR-1 or IR-100	0.1	5.0–5.5	30
Dowex 50	5.0	2.9–3.3	7,8

* For the alkaline earths it has been found that a 5% citrate solution at pH = 5 will give satisfactory separations when the Amberlite resins are used (3). To effect an elution and separation of the alkaline earths from Dowex 50 columns with 5% citrate a pH ≥ 7 may be necessary. A 0.5 M citrate solution at pH = 7.5–8.0 was found satisfactory (48).

In Table V are summarized the findings of several groups of investigators with regard to the optimum elutriant compositions for obtaining satisfactory rare earth separations. The greater difficulty encountered in removing adsorbed cations from Dowex 50 as compared with the Amberlites is reflected in the higher pH of the citrate solutions used with the former resin.

Effect of Rare Earth Concentration. The separation of milligram and gram amounts of rare earths proceeds at least as well as when tracer quantities ($\sim 10^{-8} M$) are employed provided that the ratio of resin to cation is such that K_d is not appreciably altered. (The relation of K_d to rare earth concentration at equilibrium is discussed on p. 176). The complexing action of the citrate solutions diminishes the effective cation concentration of the rare earths and thus permits multigram quantities of rare earths to be separated on relatively small resin beds. The early work of Tompkins, *et al.* (3), and Spedding and co-workers (4) demonstrated the feasibility of separating tracer and milligram quantities of rare earths. Subsequently Spedding and co-workers (6) extended this work and have prepared some of the rare earths in kilogram quantities in purity greater than 99.9% (4, 6, 9).

The equilibrium capacity (see p. 169) of Dowex 50 in terms of milligrams of rare earth oxide, R_2O_3 where R has a mass number of 140, is about 300 mg./g. of the anhydrous hydrogen form of the resin. The capacity

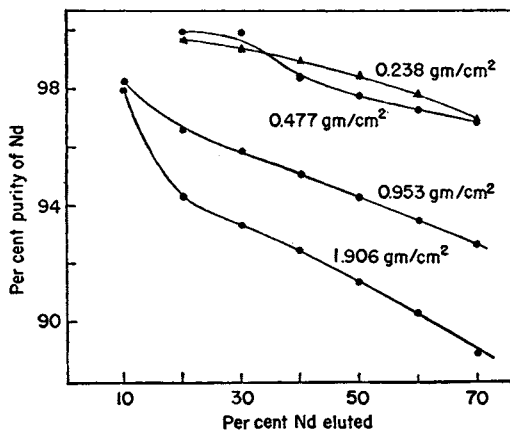

FIG. 19. The effect of weight of sample on the separation: column dimensions, 16 mm. \times 175 cm.; flow rate, 6 cm./min.; pH 2.66; composition of starting material, 83% Nd with 17% Pr. Reproduced from Spedding *et al.* (6).

of the Amberlite resins under the usual operating conditions is about $1/3$ that of Dowex 50. In column operation by the chromatographic elution technique an important consideration is the fraction of the column length occupied by the adsorbed rare earths. With tracer concentrations of cation, for the best results it is necessary to adsorb cations in as narrow a band as possible at the top of the column. The best procedure is to carry out the adsorption step (*a*) as close to equilibrium as possible, (*b*) from a solution of low ionic strength and (*c*) from as small a volume as possible.

In Table VI are tabulated the results of a study of sample size as related to bed length. The purity curves are shown in Fig. 19. From these and other data it was concluded (6) that "there is a certain weight of sample which will afford the same separation as a smaller sample of the same material, or improve it. Increasing the sample above this weight reduces the degree of separation obtained."

TABLE VI*

Effect of sample size on bed length used for adsorption

Column	Weight of sample g./sq. cm.	Total bed length cm.	Length used in adsorption, cm.	Effective bed length cm.
1	0.238	178	8-9	170
2	0.476	173	19	154
3	0.953	168	35-38	131
4	1.906	168	68-71	100

* The columns were 16-mm. in diameter. The rare earth samples were 83% Nd and 17% Pr and the weights adsorbed are calculated as R_2O_3 . After Spedding *et al.* (6).

The large capacity of Dowex 50 is a decided advantage when processing large amounts by weight of cations. It is claimed that when 200 mg. of either Ce or Y are eluted from an approximately $1 \text{ cm.}^2 \times 10 \text{ cm.}$ column of Dowex 50 the separations obtained were equivalent to the tracer runs. In the column runs made by Harris and Tompkins (7) a maximum of about 350 mg. of a Ce + Pr mixture ($\sim 400 \text{ mg. per cm.}^2$ of column area) were processed on Dowex 50 columns which were $0.5\text{--}1 \text{ cm.}^2$ in diameter and 120 cm. in length. Subsequent experiments (7) indicated that as much as $2,000 \text{ mg./cm.}^2$ of the rare earths could be processed on the same size columns. This is a several fold increase in capacity over any previous work with the Amberlites.

In larger scale experiments Spedding and associates using Amberlite columns 8-ft. high and 4 in. in diameter, see p. 174, found that a total of 100 g. of R_2O_3 could be handled efficiently at a single load. Larger amounts, e.g., 125 g. gave markedly poor separation.

Particle Size. All other factors being equal one obtains sharper separations the smaller the particle size of the adsorbent. On a theoretical basis this is what one would expect because decreasing the particle size is equivalent to an increase in p , the number of theoretical plates in the column. The basis for this lies in the equivalence between the parameter, y , in the mass transfer theories (17) and p , as was shown by Boyd and Matheson (43). Hence, p , is given by the equation:

$$p = (3 D^l / r_0 \Delta r_0 f) (x/v) \quad (12)$$

where D^l is the ionic diffusion constant in the liquid phase, r_0 the radius

of a spherical particle of exchanger, Δr_0 the fluid film thickness surrounding the exchanger particles, f the fractional bed void, x the bed depth and v is the linear flow velocity.

Equation (12), therefore, predicts that the fractionating efficiency will increase with decreasing particle size and decreasing bed void space. The void space, f , will be at a minimum for a resin bed composed of spherical particles of a uniform diameter.

Most of the separations reported by Tompkins (3, 7) and associates were made with 40–60 mesh and 60–80 mesh resin while Spedding *et al.* (4, 6, 9) screened out the large particles (< 20 mesh) and removed the fines by backwashing. Inasmuch as the bulk of the Amberlite resins when delivered by the manufacturer (40) consists of resin particles 20, 30, and

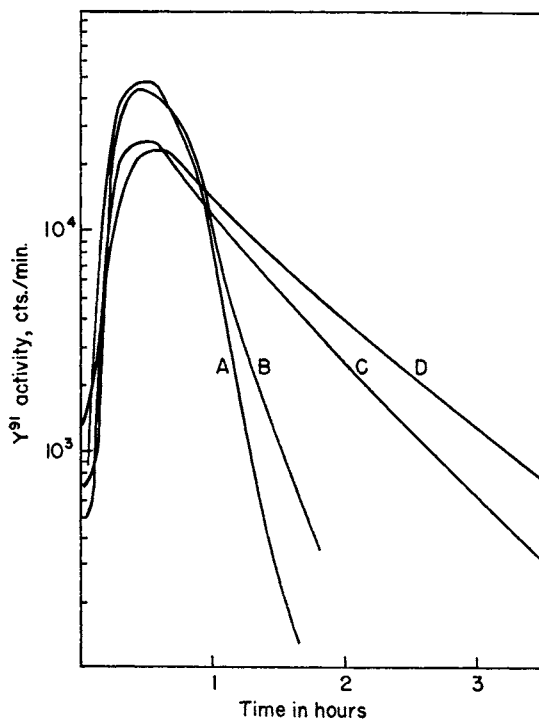

FIG. 20. Effect of mesh size of Amberlite IR-1 on desorption band width: A, 270/325 mesh; B, 170/200 mesh; C, 50/60 mesh; D, 30/40 mesh. Reproduced from Kettle and Boyd (8).

40 mesh sizes it is apparent that the method used by Spedding *et al.* other factors being equal, would generally result in reduced separation efficiency, i.e., greater cross contamination, as measured by the yields of very pure material obtained in a single cycle. At the time Spedding *et al.* carried out

their work, however, sieving to 30–40 mesh resin, for example, with the resins available at that time, would have involved 90% discard.

Figure 20 shows how the mesh size affects the shape of the elution curves of Y. The “tailing” of the elution bands produced by the large particles would result in considerable cross contamination when separating cation mixtures and a loss of resolution as was observed in the separation of the yttrium group of rare earths with Dowex 50 resins (8).

Flow Rate. Generally an increase in flow rate, from theoretical (equation 12) and experimental grounds, has the effect of decreasing the number of plates in a column. The actual chemical ion exchange reaction,

TABLE VII

Flow rates commonly used by different groups for obtaining rare earth separations

Resin	Usual mesh size	Flow rate (per min.)	Reference
Amberlite-IR-1 or IR-100	20–40	3–6 cm.	4, 6
Amberlite-IR-1 or IR-100	20–40	0.5 cm.	9
Amberlite-IR-1 or IR-100	100	1–2 ml./cm. ²	5
Amberlite-IR-1 or IR-100	40–60	1–2 ml./cm. ²	3
Amberlite-IR-1 or IR-100	170–200	1.2 ml./cm. ²	8
Dowex 50	40–60	0.2–0.4 ml./cm. ²	7
Dowex 50	120–140	2.2 ml./cm. ² (100°)	8
Dowex 50	270–325	1.0 ml./cm. ² (100°)	8

as most ionic reactions, takes place too rapidly to measure so that the rate controlling steps probably are entirely diffusional in nature (11, 17, 21, 44).

Some of the more commonly employed flow rates for a given particle size resin are tabulated in Table VII. Lower flow rates must be employed with Dowex 50 as compared to the Amberlite resins, p. 169. However, by operating at elevated temperatures the viscosity of the elutriant decreases thus increasing D^1 , the ionic diffusion coefficient in the liquid phase. This in turn has the effect of increasing the number of plates as shown by equation (12). The net result is that excellent separations can be obtained with Dowex 50 at 100° with flow rates five times greater than those employed at room temperature.

The effect of flow rate on the separation of cations is clearly shown in Fig. 21. It should be added that these curves were not obtained under the optimum pH conditions. In practice a lower pH is employed (7).

Under most conditions of operation it is usually found that below a given flow rate the increased separation obtained is not sufficient to warrant its use when time of operation is a factor. It appears that the change in p with decreasing flow rate becomes less and less and may remain nearly constant when the flow rate drops to a low value (45). The particular

value of the flow rate where p is nearly constant will probably depend on such factors as ionic strength, particle size, the type of cation, etc.

Column Length and Diameter. The number of plates in a column, p , is expected to increase with increasing bed length, and be nearly independent of the diameter at low solute concentrations. Because of diffusional factors (17) there is a practical limit to the proportionality between bed length and p and the degree of separation obtained. It appears that at

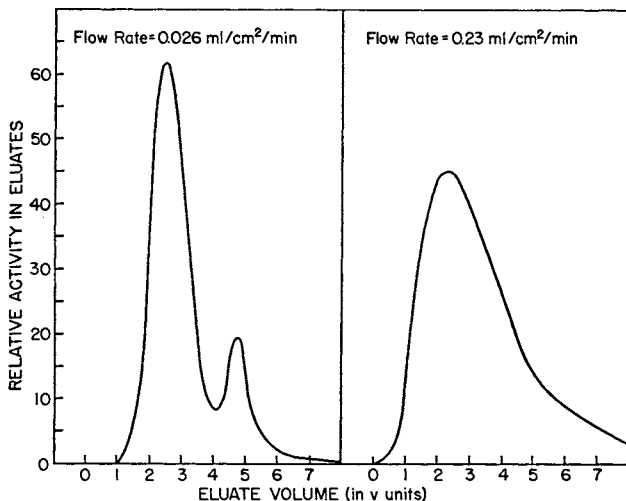

FIG. 21. The effect of flow rate on the separation of Pr and Ce. The height of the Pr peak (which was removed first) was 0.43 times as high as its actual value because of added absorber. The elutriant was 0.25 M citrate at pH % 3.50; columns, 0.867 sq. cm. \times 15 cm., ammonium form of Dowex 50, 170-200 mesh. After Mayer and Tompkins (32).

TABLE VIII*

The effect of length of resin bed on separation of Nd and Pr

Per cent Nd eluted	Per cent purity of eluted Nd	
	175 cm. column	850 cm. column
10	89.1	—
20	89.1	—
30	89.0	99.1
40	87.3	98.0
50	85.1	96.5
60	82.7	94.2
70	79.5	91.9
80	77.8	—
% Nd eluted at Pr breakthrough	3.5	22.5

* The columns were 16 mm. in diameter and were loaded with 1 g. of a rare earth mixture composed of 43.4% Pr and 56.6% Nd. The elutriant, a 5% citrate solution at pH = 2.65, was passed through at a rate of 6 cm./min. After Spedding *et al.* (6).

some critical bed length the broadening of the bands becomes so great that, for practical purposes, no improvement in separation can be obtained.

Data obtained by Tompkins, *et al.* (45) showed that the width of an elution curve varies directly with the log of the column area. Their data indicated that increasing the diameter of a column decreases its efficiency. The reason for this dependence is not clear.

A study of the effect of length of column on the separation of Nd and Pr was made by Spedding and associates (6). From part of their results shown in Table VIII it is evident that the separations were better for the longer column.

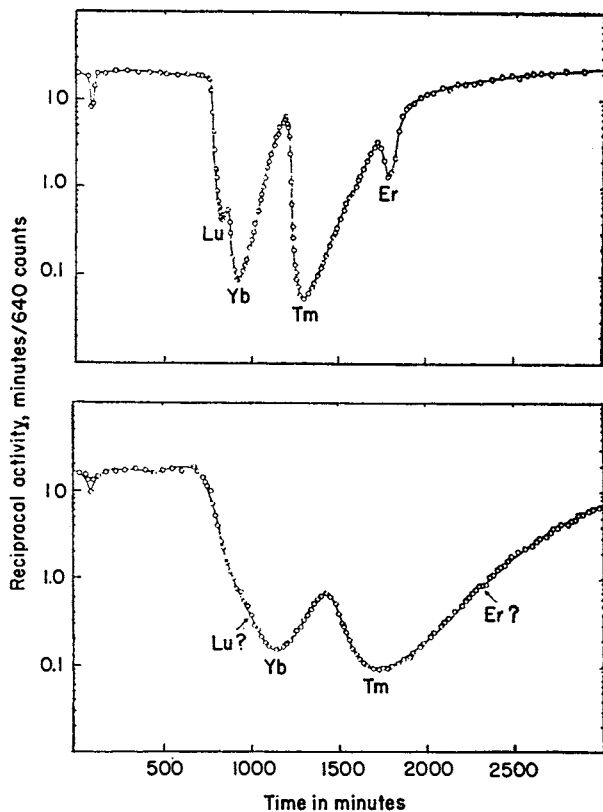

FIG. 22. Effect of temperature on the separation of the yttrium group earths with a 270/325 mesh Dowex 50 column: bed dimensions, 91 cm. \times 0.26 sq. cm.; upper curve for 100°, flow rate 0.35–0.45 ml./sq. cm./min., and 5% citrate buffer at pH 3.2; lower curve for 20°, flow rate 0.55 ml./sq. cm./min. and pH 2.98. Reproduced from Ketelle and Boyd (8).

Studies on the effect of diameter on separation efficiency showed that if the weights of material used are in the ratio of the cross-sectional

areas no changes in separation efficiency are encountered (6). With tracer levels of cations it is, of course, unnecessary to even consider the cross-sectional area unless the columns are extremely narrow, in which case wall effects and channeling may have adverse effects. As an empirical rule, an extremely narrow column in which such events are liable to occur is one where the diameter contains less than twenty resin particles (17).

Temperature. The principal effect of temperature on column operation is the increased diffusion rate resulting from the reduced fluid viscosity, p. 201. The overall net effect of interest for separation efficiency is the fact that at 100°, for example, the number of plates may be several times greater than for a similar operation conducted at room temperature. Because of the reduced fluid viscosity "larger flow rates are possible with the same hydrostatic head. This gain may be utilized by employing finer adsorbent particles thereby additionally sharpening the band edges, or, it may be used to obtain the same degree of separation in a correspondingly shorter time." (8).

The improvement in separation efficiency obtained at 100° as compared to room temperature is shown in Fig. 22. A higher pH was used for elution in 100° runs because of the apparent and expected increase in K_d . The unusual stability of the Dowex 50 resin to elevated temperatures is evidenced by the fact that it did not give any indication of decomposition even after several months of operation (8).

Mold growth in Citrate Solutions. Spedding *et al.* (9) found that mold growth in the citrate solutions led to frequent shut downs and erratic results in the pilot plant separations of rare earths. The formation of oxalic acid probably gave the most serious interference because of the formation of insoluble rare earth oxalates. By adding 0.1% phenol to the citrate solution mold growth was completely inhibited. Concentrations of phenol, as high as 1%, had no effect on the shape or position of the elution curves.

Volume Reduction and the Recovery of Cations from Citrate Solution. The evaporation of large eluate volumes has some obvious disadvantages. Probably the simplest and most effective procedure for 5% or less concentrated citrate solutions is as follows: Acidify the citrate solution with concentrated HCl to a pH of about 2. The resulting solution is so low in effective cation displacement properties relative to the rare earths that a very small column and very high flow rate will suffice to adsorb the rare earths. For greatest efficiency such a column is run to an arbitrary breakthrough point. The adsorbed rare earths can be eluted in a small volume with 6 *M* or stronger HCl. Concentration factors of the order of 100 per cycle may be obtained (18).

With the alkaline earths a similar procedure as described above can be followed. However, in order to minimize the effect of NH_4 concentra-

tion the acidified solution must be diluted. An illustration is provided for the case of tracer Ba^{140} which was eluted from a 20-cc. column of Amberlite IR-1 by 40 ml. of 5% citrate at $\text{pH} = 6.0$. This eluate was acidified to $\text{pH} = 2.5$ with concentrated HCl and diluted to 400 ml. (i.e., 1/2% citrate) and re-adsorbed by a 2-cc. Amberlite IR-1 column in 20–80 minutes with less than 10% loss. The Ba^{140} was eluted subsequently with 4 ml. of 5% citrate at $\text{pH} = 6.0$, thus resulting in a tenfold net volume reduction (18, 29).

A volume reduction factor of 10 for Zr was achieved by eluting with 5% citrate at a $\text{pH} = 2.4$ and re-adsorbing at a $\text{pH} < 1.8$ (18).

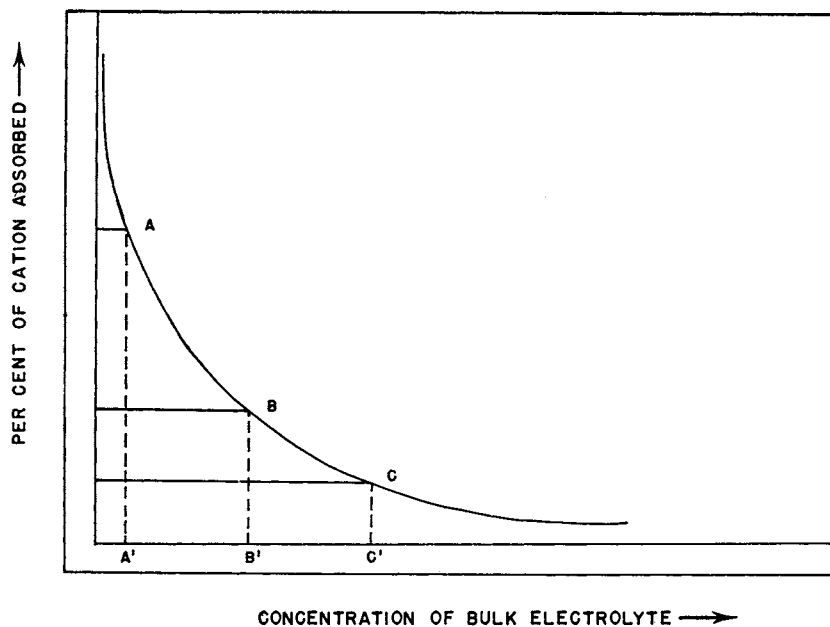

FIG. 22a. Effect of dilution of the bulk electrolyte on the adsorption of a tracer cation by a cation exchanger.

Within limits a small increase in dilution will result in a proportionately much greater increase in the value of K_d . This follows from mass action principles and is shown by the adsorption of a cation as a function of concentration of a bulk electrolyte (Fig. 22a). Thus, in the region AB a given dilution results in a much larger increase in the capacity of the ion exchanger than the same dilution factor in the region BC.

III. SEPARATION SCHEMES

Many of the separation schemes described here will be improved upon in many ways. The so-called "optimum" operating conditions represent a

compromise or a choice among several closely linked factors and depend upon the objective sought. Usually it is desired to separate and recover the largest amounts of pure material in the shortest possible time. Of course, in special cases, for example, where exceptional purity or the isolation of a new isotope is desired the time factor may be secondary. Many of the Plutonium Project separations were developed on an empirical basis for specific and urgent purposes; therefore it was not possible to carry out a systematic exploration of many of the variables involved. In the light of the principles discussed in the previous paragraphs it can be predicted that more efficient and "streamlined" separation processes can and will be developed in the future.

1. Group Separations of the Fission Products

In a general way one can effect a nearly quantitative separation of some of the principal groups of fission products in only one cycle. The scheme shown in Fig. 23 is adaptable to any size column. An adjustment

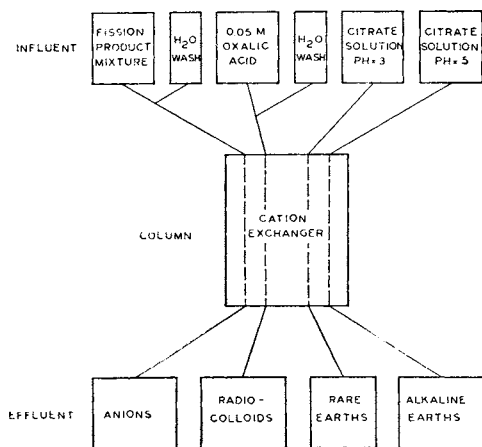

FIG. 23. Group separations of a mixture of fission products adsorbed on the hydrogen form of a resinous cation exchanger. Based on data from paper of Tompkins *et al.* (3).

in the pH of the citrate solutions for elution of the alkaline and rare earth fractions may be necessary for different cation exchangers. With the Amberlites the conditions shown will usually suffice but for Dowex 50 the pH of the elutriant should be increased at least half a unit.

It is possible to separate the alkaline earths from the rare earths without complex elution but by predominantly cationic displacement, p. 187. This can be accomplished by the use of 0.5 *M* or 1.0 *M* NH_4Cl to

elute the alkaline earths followed by 6 *M* or stronger HCl to remove the rare earth fraction. The basis for this operation lies in the fact that the displacing action of NH_4^+ in the stated concentration is far too small to permit appreciable movement of the rare earths down the column. An example of this type of separation is as follows: through a 1 $\text{cm}^2 \times 10 \text{ cm}$. column of 40–60 mesh Amberlite-IR-100 resin (HR or NH_4R) containing the narrow band of adsorbed divalent and trivalent earths is percolated 1 *M* NH_4Cl

at a flow rate of 0.5 ml./cm.²/min. The alkaline earths are completely eluted with 100 ml. of solution (3) leaving the rare earths to be eluted with 6 M HCl.

2. Alkali Metals

An inspection of the separation factors in Table IX give strong indication that cationic displacement alone would suffice to quantitatively separate individual alkali metals from one another.

Cohn and Kohn (47) have published preliminary results on the separation of the alkali metals using a column (32) (p. 188) which contained 8.84 ml. of Dowex 50 in the hydrogen condition. A neutron-

TABLE IX

The separation factors* of some cations relative to sodium in the absence of complexing agents

Cation	Separation factor ($K_{ex}^{M_1} / K_{ex}^{Na^+}$)
H ⁺	0.59
NH ₄ ⁺	1.16
K ⁺	1.43
Rb ⁺	1.64
Cs ⁺	2.48
Ba ⁺⁺	9.1
Y ⁺⁺⁺	13
La ⁺⁺⁺	20

* Calculated from the exchange constants at infinite solution as tabulated by Boyd *et al.* (13)

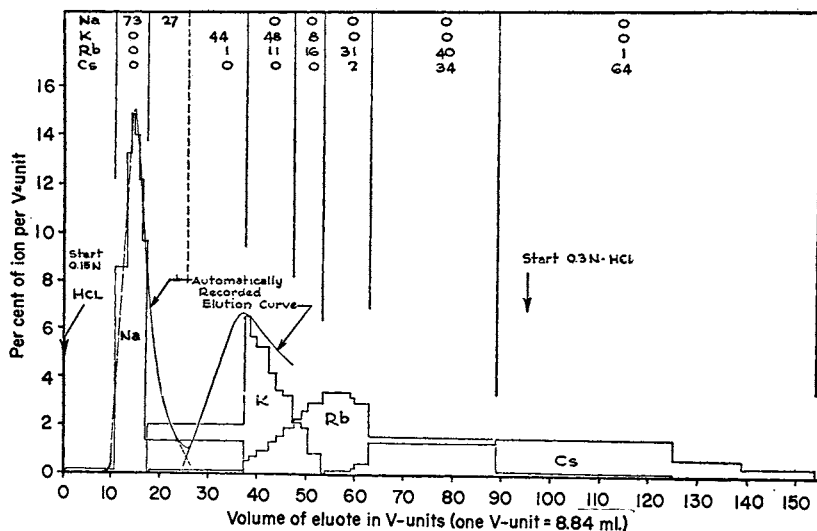

FIG 24. The separation of the alkali metal ions by elution from an ion exchanger. Reproduced from Cohn and Kohn (47).

activated mixture of 1.0 mg. Na, 10 mg. K, 8 mg. Rb, and 13 mg. Cs (as chlorides) was adsorbed and subsequently eluted beginning with 0.15 *N* HCl at a flow rate of ~ 0.3 ml./min. The effluent was analyzed radiometrically for Na²⁴, K⁴², Rb⁸⁶ and Cs¹³⁴. It is shown in Fig. 24 that the separation of Na and K is nearly quantitative, with some overlap in the ensuing pairs.

The data in Table IX also show that a group separation of the alkali metals from polyvalent cations could be a very simple and efficient procedure merely by selecting, say, a solution of hydrochloric acid of a concentration sufficiently high to elute the alkali metals only, i.e., 0.15–0.25 *M*. Because of the very favorable separation factors involved here it would be advantageous to operate the column to the alkali metal breakthrough point unless an extensive fractionation of individual cations was desired.

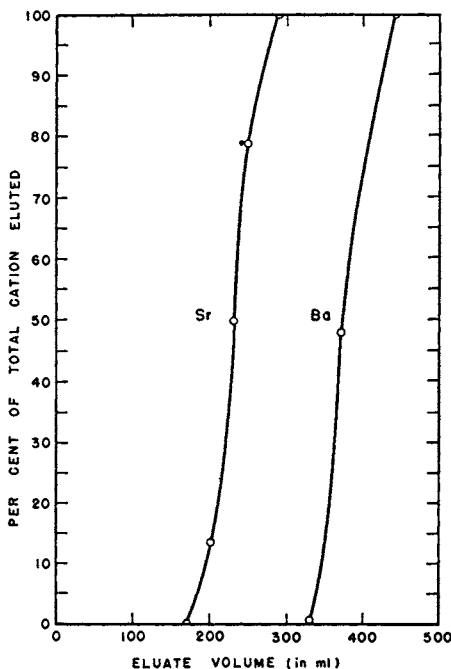

FIG. 25. Separation of fission-produced strontium (Sr^{89} , Sr^{90}) and barium (Ba^{140}) by complex elution: bed, 1 sq. cm. \times 100 cm.; influent, 5% citrate at a pH % 5.0; flow rate of 1–2 ml./sq. cm./min. After Tompkins *et al.* (3).

A single stage batch process can be used as well to effect a separation of the alkali metals from polyvalent cations. This can be accomplished by addition of citric acid to a mixture of these cations and adjusting the pH to about 6. The polyvalent cations will be chemically bound as soluble

anions while the alkali metals would be available for adsorption by the cation exchanger.

3. Alkaline Earths

Barium-Strontium. A simple and rapid separation of Ba^{140} from $Sr^{89,90}$ was attained (3) by chromatographic elution with citrate solution at $pH = 5.0$. Details of this process are given in Fig. 25. The equilibria involved are described on p. 181. A single cycle gave at least 75% yields of each element in a purity exceeding 99%.

Radium-Barium. A multistage separation of the chlorides of radium and barium utilizing predominantly cationic displacement is described in the chapter by A. F. Reid. A nearly complete separation of strontium and barium and of barium and radium using a single column has been reported by Tompkins (48). A column consisting of colloidal agglomerates of Dowex 50, $1\text{ cm.}^2 \times 15\text{ cm.}$ was employed. A mixture of 20 micrograms of radium, 20 mg. of barium with Ba^{140} tracer and 20 mg. of strontium with $Sr^{89,90}$ tracer was adsorbed at the top of the column. The elution was carried out by passing 0.5 *M* citrate solution at a $pH\ 7.5-8.0$ at a rate of 0.3 ml./minute.

Practically all the Sr appeared in the 10–50 ml. volumes of effluent, the Ba from about 70–90 ml. and the Ra in the 135–180 ml. cuts. The La^{140} daughter from the Ba^{140} was removed in approximately the first 10 ml. of elutriant.

“The results of this investigation indicate that the separation of radium from barium on a commercial basis could be much more easily effected by this column method than by the current procedure based on fractional crystallization.”

Lead-Barium. The adsorption affinity of Pb^{++} would be expected to exceed that of Ba^{++} , as indicated by the relative positions of their activity coefficient plots. Studies were made (48a) on the adsorption of carrier-free Ba^{140} by the lead form of Amberlite IR-1 as a function of lead nitrate concentration. For the reaction

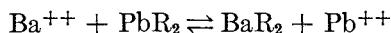

the exchange constant (13), K_c , was found to be 0.7 in pure solutions 0.1 to 1.0 *M* in $Pb(NO_3)_2$. This difference in adsorption affinity is sufficiently great so that a separation employing cationic displacement only should be effective.

4. Rare Earths

The separation of the rare earths from one another has been accomplished with tracer levels, $\sim 10^{-8}\text{ M}$, to 100 g. batches. The materials processed include rare earths from fission, concentrates from Monazite

sands and ores such as risorite, blomstrandine, and gadolinite. The practical nature of these cation exchange processes is shown in the fact that many of the fission products which are being distributed (19) by the Clinton Laboratories are prepared by the ion exchange procedures described in this chapter (3, 18). Additionally the preparation of the following rare earths have been reported (9): Nd, 800 g. 99.9% Nd_2O_3 , < 0.1% Pr_6O_{11} ; Pr, 35 g. 99% Pr_6O_{11} , 1% Nd_2O_3 ; Sm, 160 g. > 99.9% Sm_2O_3 . Spectrographically pure preparations of gram quantities of each of the odd numbered rare earths, and 10-g. quantities of the even numbered rare earths have been produced (D. H. Harris, private communication). There is no doubt that most of the individual rare earths can be prepared, if desired, on the macroscopic scale with a purity exceeding the criterion of spectrographically pure.*

The general conditions for rare earth separations have been discussed at length in earlier paragraphs. In this section details will be given of some of the successful separation processes.

Nd-Pr-Ce Separation (7). A dilute solution of the chlorides of Nd, Pr, and Ce containing about 90 mg. of Nd^{+3} + ~ 100 mg. of Pr^{+3} and ~ 80 mg. of Ce^{+3} was adsorbed on a column containing the ammonium form of 60–80 mesh Dowex 50. The column had an area of 0.50 cm^2 and a resin height of 122 cm. The average flow rate was 0.42 $\text{ml./cm}^2/\text{min}$. The elutriant was 5% citrate. In Table X the data of Harris and Tompkins (7) are reproduced giving the composition and yield of each component for the different fractions. The recoveries, on a mass basis, of spectrographically pure rare earth in this single stage run were ~ 85% Nd, ~ 91% Pr, and 88% of the cerium. The actual recoveries were probably higher but analytical difficulties, presumably caused by the solubility of the rare earth oxalates in the citrate solution, prevented a complete recovery of the rare earths in the eluates.

Ce-La (7). An adsorbed mixture consisting of about 60 mg. La and 200 mg. of Ce was separated by eluting with 5% citrate at a pH of 2.9. The column, containing the acid form of 40–50 mesh Dowex 50, was 110 cm. in height and had an area of 0.90 cm^2 . The flow rate was 0.21 $\text{ml./cm}^2/\text{min}$. The cerium was removed in about the first 1650 ml. of eluate while the La was removed in about a 300 ml. volume beginning approximately at 1725 ml. Actually a pH of 3.2 to 4.0, it is said, would suffice to give a good separation in less time and in a smaller volume.

Ac-La. The adsorption data in Table III show that ${}_{89}\text{Ac}$ is more basic than ${}_{57}\text{La}$. These results according to Hagemann (49) indicate that

* The actual purity of rare earths is known only to the limits of present methods of analysis. The shapes of the elution curves and measurement of contaminating radioactive impurities are probably the most sensitive methods available at present.

the separation of La and Ac by chromatographic elution with citrate could be achieved with ease. Inasmuch as the separation factors are so large, e.g., ~ 30 at pH = 3.6, one can readily devise a workable column procedure by applying the plate theory as described on p. 188.

Pilot Plant Separations (9): Nd-Sm-Pr. The resin beds employed by Spedding *et al.* in this work were 8-ft. high by 4 in. in diameter and are

TABLE X^a

Separation of Nd, Pr, and Ce by chromatographic elution with citrate solution^b

Fraction number ^c	Volume ml.	Per cent of total ^d	Weight mg. neodymium ^e
1	990	—	—
2	825	—	—
3	715	—	—
4	555	35.0	26.9
5	228	50.4	41.8
6	75	6.91	5.1
7	124	4.84	3.9
8	94	1.89	1.3
9	103	0.82	0.4
10	76	0.23	—
			Praseodymium
11	142	4.11	3.2
12	115	21.2	17.8
13	155	27.7	25.1
14	130	17.0	14.1
15	155	11.7	10.7
16	175	5.92	8.8
17	300	5.07	8.4
18	280	3.75	2.7
19	190	1.34	0.4
20	225	0.86	—
21	275	.59	—
22	195	.42	—
23	205	.22	—
24	175	.13	—
			Cerium
25	245	10.2	6.2
26	290	35.0	23.4
27	820	54.7	40.5
28	630	0.12	—

^a After Harris and Tompkins, p. 2798, ref. 3.

^b The initial conditions and column dimensions are given on p. 210.

^c The pH of the elutriant solution was 2.80 during fraction 1; pH 2.90 during fractions 2–17 inclusive; pH 2.96 during fractions 18–26, inclusive; pH 3.60 during fractions 27–28, inclusive.

^d Estimated from the radioactivity.

^e All recovered rare earths were spectroscopically pure.

described on p. 174. Each was conditioned with 5% solutions of the following: rock salt 135 l.; citrate, pH = 5, 135 l.; NaCl, U.S.P., 90 l.; HCl, 90 l.; citrate, pH = 5, 90 l.; HCl, 90 l.; H₂O distilled, 20 l. The maximum size sample processed was 100 g. as R₂O₃. The elutriant solutions, 0.5% citrate at a pH = 3.9, were passed through at a flow rate of 0.5 cm./min. The elution data are given in Table XI.

TABLE XI^a
Typical elution data for a 50-g. sample of Neodymium carbonate^b

Eluate, liters	R ₂ O ₃ g.	R ₂ O ₃ per liter, g.	Sm ₂ O ₃ %	Nd ₂ O ₃ %	Pr ₆ O ₁₁ %
411-457	0.382	0.008	45.5	0	0
458-495	2.807	.074	64.8	0	0
496-532	1.685	.046	78.5	0	0
533-563	0.332	.011	76.0	0	0
564-595	.113	.0035	71.6	28	0
596-620	.094	.004	29.5	70	0
621-662	.622	.015	1.1	98.5	0
663-685	.577	.025	Trace	99.5	0
686-729	1.565	.036	0	100	0
730-753	1.164	.049	0	100	0
754-798	3.176	.071	0	100	0
799-831	2.856	.087	0	100	0
832-868	3.829	.109	0	100	0
869-890	2.616	.119	0	100	0
891-935	6.371	.142	0	100	0
936-963	4.321	.1543	0	97.2	2.1
964-1003	3.777	.095	0	60.2	39.6
1004-1029	1.609	.062	0	13.4	89.0
1030-1071	2.0169	.048	0	2	96.5
1072-1093	0.667	.030	0	0	95
1094-1138	0.7790	.018	0	0	94.5

^a After Spedding *et al.* (9).

^b The composition of this material based on a total R₂O₃ content of 73.5% was: Nd₂O₃, 80.1; Sm₂O₃, 10.4; Pr₆O₁₁, 8.4; and Gd₂O₃, 1%.

The percentage yield of any one spectrographically pure rare earth in these runs is about 50% at the most. On a weight basis, however, this represents a comparatively large amount. By recycling the effluents further recoveries of very pure materials are obtained.

They prepared a very pure sample of Sm by taking the Sm-Gd fractions from these runs and treating by the method of Marsh (50). "An 0.5% sodium amalgam was added to a near neutral solution of the Sm-Gd chlorides; the mercury and water phases were separated and the Sm leached from the mercury with dilute hydrochloric acid. By this pro-

cedure the Sm is obtained free from the other rare earths with the exception of Eu and Yb.”

Monazite Sand Concentrates-Yttrium Group Separations. The same conditions employed for separating the cerium group earths, p. 211, were applied by Spedding *et al.* (9) to the separation of the heavy (yttrium) group of rare earths. The sources of the material were concentrates remaining after the separation of the cerium group from Monazite sands. One concentrate, designated as “crude yttrium oxalate” contained, after ignition, about 17% CeO₂, 12% Nd₂O₃, 8% Sm₂O₃, 25% Y₂O₃, 5% Dy₂O₃, 0.6% Er₂O₃, 0.6% Ho₂O₃, and 17% silicon dioxide.

These ignited oxides are not readily soluble in acids but it was found that prolonged refluxing with dilute mineral acids extracted about 40% of the oxide, leaving a residue of silica, oxides of the cerium group, and a small amount of yttrium oxide. The following procedure was adopted for processing the crude yttrium oxalate:

Ignite the crude yttrium oxalate, at 800°, for eight hours under good oxidizing conditions. Place suitable portions of the oxide in reflux vessels and add double the volume of 6 N hydrochloric acid. Bring to a boil and reflux for 2 hours; a definite change in color of the residue, from dark brown to light tan, is observed during the refluxing process. Add a large excess of water and decant the supernatant liquid into a

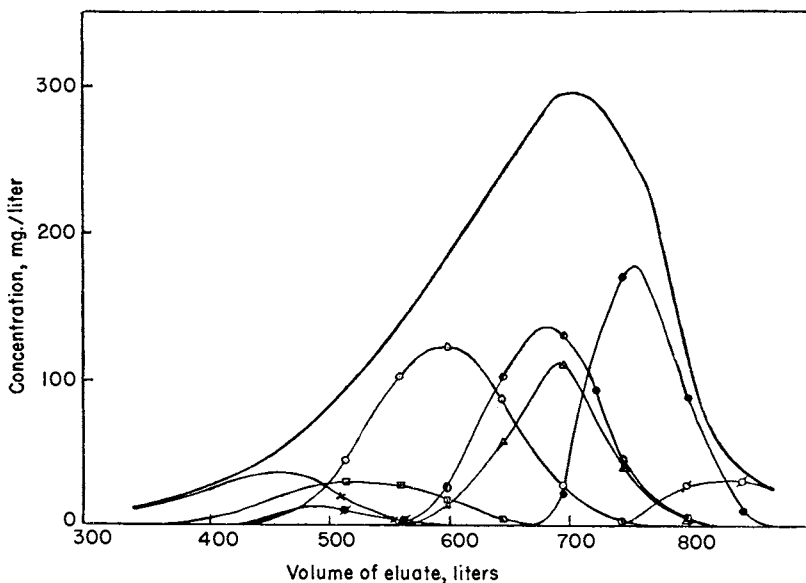

FIG. 26. Elution curves for acid soluble fraction from Lindsay “crude yttrium oxalate” at pH 3.9: —, total R₂O₃; X, Er₂O₃; ⊖, Ho₂O₃; □, Dy₂O₃; ○, Y₂O₃; ●, Gd₂O₃; △, Sm₂O₃; ●, Nd₂O₃; —○—, Pr₆O₁₁. Reproduced from Spedding *et al.* (9).

vessel for precipitation. Dilute the solution until the acid content is at or below 0.5 *N* and add 100% excess of the theoretical amount of oxalic acid. Filter off the oxalate and ignite to the oxide.

A 100 g. sample (as R_2O_3) of the acid soluble fractions was put through the ion exchange process. The elution curves are reproduced in Fig. 26. In practice the different fractions are collected and reprocessed. Except for the Gd-Sm pair, the separations were "excellent." The latter pair was separated readily by the sodium amalgam procedure. These methods have resulted in the preparation of multigram quantities of Gd and Y salts and some erbium and dysprosium.

Demonstration of the Complete Separation of all the Rare Earths.

Extremely clean-cut separations of even closely related pairs of rare earth were obtained by Ketelle and Boyd by operating a 97 cm. \times 0.26 cm.² bed of Dowex 50 maintained at 100°, p. 215. A 4.75% citrate solution at an optimum pH = 3.2 was used as the elutriant for the separation of the yttrium group, while an optimum pH = 3.4 was found effective for the separation of the cerium group. The higher flow rates, which it was possible to use at 100°, enabled preparation of very pure milligram amounts of lutecium, ytterbium, thulium, erbium, holmium, and yttrium to be made in 30 hours.

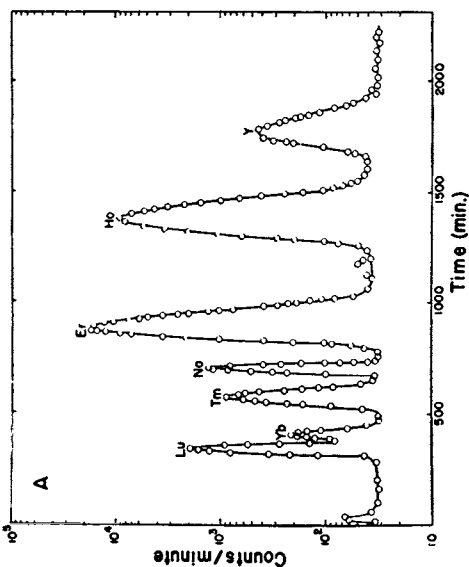
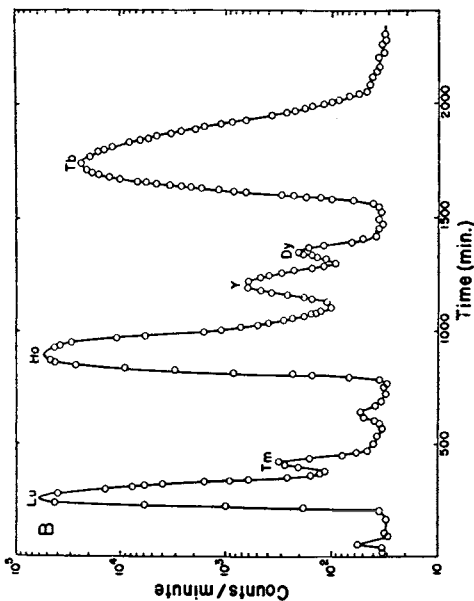

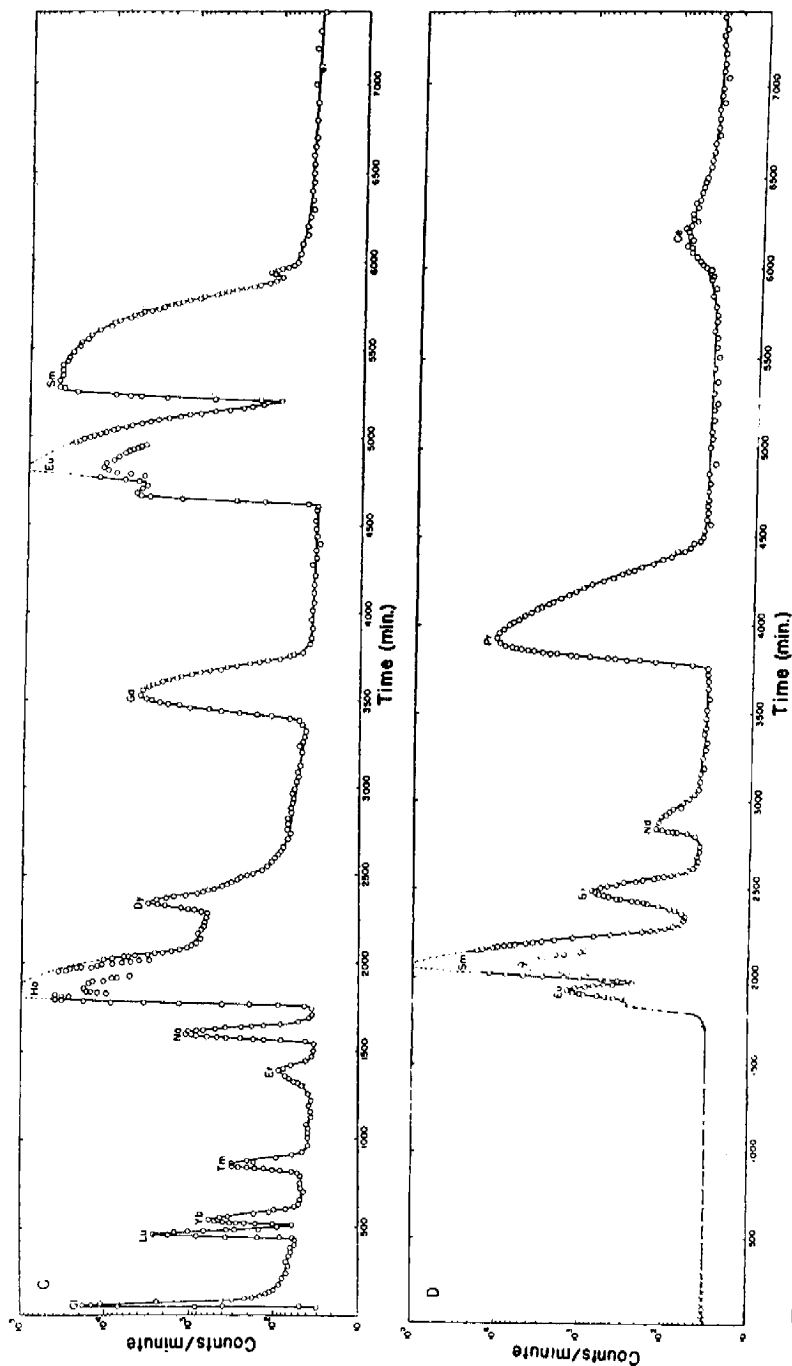

Fig. 27. Demonstrations of rare earth separations effected with a 270/325 mesh Dowex-50 column at 100°; bed dimensions, 97 cm. by 0.26 sq. cm.; flow rate, 1.0 ml./sq. cm./min. except in A where 2.0 ml./sq. cm./min. was used; (A) fractionation of activities produced by neutron irradiation, 0.8 mg. spectrographic grade Pr_2O_3 (Hilger) (pH 3.20); (B) fractionation of heavy rare earth mixture consisting of 0.1 mg. each of Lu_2O_3 , Yb_2O_3 and Tb_2O_3 (Trn, (Er), Y and Dy present as impurities) (pH 3.20); (C) fractionation of intermediate rare earth mixture consisting of 0.1 mg. Ho_2O_3 and 1.0 mg. each of Dy_2O_3 , Gd_2O_3 and Sm_2O_3 (Cl, Lu, Yb, Tm, Er and Na present as impurities, pH 3.25 for 4550 minutes, then pH 3.33); (D) fractionation of light rare earth mixture consisting of 0.1 mg. each of Sm_2O_3 and Nd_2O_3 , plus 0.01 mg. each of Pr_2O_3 , Ce_2O_3 and La_2O_3 (Eu present as impurity, 61 produced by 1.7 h $\text{Nd}^{149} \rightarrow 47$ h 61^{149} , pH 3.33 for 1610 minutes, then pH 3.40. Reproduced from Kettle and Boyd (8).

The data and conditions of operation are presented in Fig. 27. The appearance of sodium among the rare earths (Fig. 27, C) is probably due to a balanced combination of the complexing action of the citrate in hastening the movement of the earths and the relatively slow movement of the Nd because of small cationic activity ($0.2 M NH_4^+$) of the elutriant. According to Tompkins (private communication) the position of a monovalent ion in respect to the rare earths changes with the pH. With cesium, for example, the shift with increase in pH is slow while that of the rare earths is much more rapid, thus the relative positions of their elution curves will vary. Closer control of pH, especially in the regions where the pH of the elutriant was changed, would have given better separations in some instances, as, for example, the first three peaks in Fig. 27, D.

Text References to other Rare Earth Separations. In previous paragraphs, methods and details have been given for the separation of several other rare earth mixtures. Thus, the conditions for separating various mixtures are as follows: Eu-61, p. 188, Fig. 11; Y-61-Nd-Pr, p. 193, Fig. 14; Y-Ce, Fig. 18; Lu-Yb-Tm-Er, p. 203, Fig. 22.

5. Transuranic Elements

Americium-Curium Separations and Purification. Curium is prepared from americium (at. no. 95) as follows (20):

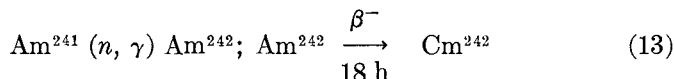

hence it was necessary to separate Cm from many times its weight of americium. Am^{241} emits alpha particles with a 500 y half-life, while Cm is an alpha emitter with a 150d half-life.

Both of these elements bear a striking resemblance to the rare earth elements (51), especially to those of atomic numbers 60-64. From ion exchange data (51) Am appears to be especially close to element 61, while Cm bears a similarly close relation to samarium (at. no. 62). It is difficult to obtain aqueous solutions of Am in other than the + 3 oxidation state and since it appears impossible in the case (51) of Cm, the use of ion exchange methods as a separation procedure seemed to be the best possible procedure for separating and purifying these elements.

In one separation procedure (20) described by Werner and Perlman, a mixture of Am and Cm was adsorbed from a citrate solution at pH = 1.5 on a 50-cm. \times 8-mm. diameter bed of the ammonium form of Dowex 50 in which was intermingled some spongy palladium (p. 174). Chromatographic elution with a 5% citrate solution at pH = 3.05 resulted in the removal of two well defined peaks with the curium peak preceding the

americium peak. Further processing resulted in the recovery of more than 90% of the Cm free of Am.

Further purification of both Am and Cm was obtained by Thompson *et al.* (51) by employing fluosilicate solutions for elution. In this case the order of elution is changed so that the Cm peak is close to that of cerium (III), while the Am peak appears to fall between cerium (III) and lanthanum. "By proper combination of separation using fluosilicate and citrate separately, americium (III) and curium (III) can be separated very completely from rare earths with good yields."

6. Colloids

Separation of Zr-Cb from Fission Products. On p. 185 is discussed the nature of the adsorption of radiocolloids and colloids by the synthetic cation exchangers. The Zr-Cb components of the fission product mixture are strongly adsorbed under conditions similar to those utilized for cations in general. Since these elements form stable and soluble complex ions with oxalic acid it was possible to elute them readily as was first demonstrated by Russell (cited in ref. 10). The selective elution of Zr and Cb is accomplished with 0.5% oxalic acid. Cb can also be eluted with 10% citric acid (pH \sim 1.8), while Zr can be eluted with 5% citrate at pH = 2.4, p. 205. It is not stated to what extent these elutriants may separate Zr from Cb (18). None of the divalent and trivalent cations are removed by this treatment because of the negligible cation activity. The flow rates that can be employed and the column dimension, in particular, can be varied over wide ranges because of the relative independence of the adsorption of radiocolloids to these factors (34). Actually single stage batch separations can be made by utilizing a solution with a salt or acid concentration sufficiently high to repress the adsorption of cations as shown in Fig. 10.

Isolation of Protoactinium. According to Thompson (35) on the basis of unpublished studies by Van Winkle, Schubert, and others, methods for the separation and purification of protoactinium utilizing the cation exchanger, Amberlite-IR-1, were developed. The behavior of Pa is analogous to Zr and Cb and hence it is strongly adsorbed from solutions of very high ionic strength — thus providing evidence for its colloidal nature (31). The adsorbed Pa can be eluted from the resin by hydrofluoric or oxalic acid (35). No further details of this process have been made available.

Purification of Colloidal Zirconium Solutions. The capacity of a cation exchanger for colloidal material is very low, p. 185. When zirconium nitrate is dissolved in water it exists mainly in a colloidal state, hence it becomes a simple matter to remove cationic impurities from zirconium salts by means of a cation exchanger.

In experiments described by Ayres (36), a stock solution of zirconium nitrate, $\text{ZrO}(\text{NO}_3)_2 \cdot 2 \text{H}_2\text{O}$, was prepared by dissolving 10 g. of this salt in a liter of water. The resin bed of Amberlite-IR-100 was 1 cm. in diameter by 50 cm. in height and was used in either the acid or sodium form. The solutions were passed through the bed at a flow rate of 5–6 ml./min. A compilation of the purification data is shown in Table XII.

TABLE XII^a
Purification of Zirconium from Lanthanum, Iron and Titanium

Elements in mixture (as oxides)	Volume of feed solution (ml.)	Concentrations (mg.)	
		Influent	Effluent
Fe_2O_3^b	200	233.6	5.5
ZrO_2		900	890
TiO_2	150 ^c	168.5	27.3
ZrO_2		267.8	253.5
La_2O_3^d	240	$\cong 520$	<5
ZrO_2		900	$\cong 900$

^a After Ayres (36).

^b The iron was present as the nitrate salt, $\text{Fe}(\text{NO}_3)_3$.

^c The influent solutions were 0.2 M in nitric acid.

^d The lanthanum was present as the nitrate salt.

A sample of the ore, *alvite*, which contains a high percentage of hafnium was treated after removal of silica and conversion of the residue to the nitrate. Most of the Zr + Hf was recovered while 80% and 95% of the Ti and Fe were removed.

Experiments similar in principle to the above were carried out by Austerweil (52) who purified cobalt nitrate solutions by passing them through a cation exchanger previously converted to the cobalt form. These experiments are indicative of the rapidity and efficiency of the method. It can easily be adapted to large scale procedures.

7. Transition Elements

It occurred to Nelson and Walton (53) that the increased exchange capacity in alkaline solutions of organic cation exchangers possessing exchanging groups of different acid strengths could be of value in the adsorption and separation of heavy metals which formed metal-ammonia

complex ions. They found that the metals Ni^{++} , Cu^{++} , and Zn^{++} were adsorbed principally as the $\text{Cu}(\text{NH}_3)_2^{++}$, $\text{Ni}(\text{NH}_3)_4^{++}$, and zinc (intermediate complex) respectively. The adsorbed complexes were eluted by dilute sulfuric acid. In later work (54) an attempt was made to separate Cd-Zn and Ag-Cu systems. Through a 2 ft. \times 2 cm. in diameter bed of the carbonaceous exchanger, Zeo-Karb, was passed a solution of a pair of these cations in NH_4OH until one of the metal ions appeared in the effluent. Subsequent elution with sulfuric acid did not give any appreciable separations.

A separation of Cu^{++} was attempted by Glueckauf (55) as a test of chromatographic theory. A mixture of Cu^{++} and Mn^{++} was adsorbed on the acid form of Zeo-Karb and eluted under near equilibrium conditions with 1 *N* H_2SO_4 . Some separation was observed with the Mn peak appearing first. However, for practical use the conditions given were too time consuming, particularly for the degree of separation observed.

There is little doubt that the chromatographic elution with a suitable complexing elutriant can be developed for separating these transition elements with the same degree of efficiency as is obtained by the citrate elution of the alkaline and rare earths.

Zirconium-Hafnium. The extreme similarity in chemical behavior between zirconium and hafnium compounds and the resulting difficulties involved in separating them are well known. From a preliminary study of the elution of tetrapositive ions from Dowex 50, Street and Seaborg (55a) recently devised an effective ion exchange method for separating zirconium and hafnium from each other. The conditions were first developed with microgram amounts of material and the radioactive tracers, Zr^{95} and Hf^{181} . The procedure given below enabled them to obtain 10 mg. of hafnium oxide which contained about 0.1% of zirconium oxide by weight.

Thirty-five milligrams of zirconium oxide and 15 mg. of hafnium oxide were dissolved in sulfuric and hydrofluoric acids, hafnium and zirconium tracer added, and the mixture fumed to dryness. The residue was taken up in concentrated hydrochloric acid and the hydroxides precipitated with ammonium hydroxide and washed. The hydroxides were again dissolved in hydrochloric acid and the oxychlorides crystallized by evaporation. One cubic centimeter of 250 to 500 mesh Dowex 50 spheres, in the ammonium form, were suspended in 30 cc. of 2 *M* perchloric acid and the oxychlorides added a few milligrams at a time over a period of 15 minutes, the mixture being continually agitated by bubbling air through it. Under these conditions, i.e., 0.01 *M* zirconium and hafnium in 2 *M* perchloric acid, about 80% of each went on the resin. The slurry of resin was placed on the top of an ion exchange column 1 sq. cm. in area and 30 cm. long, which had been packed with the same resin and washed with 6 *M* hydrochloric acid to convert it to the acid form. Upon elution with 6 *M* hydrochloric acid two distinct peaks were obtained. The first peak, which appeared after 70 ml. of 6 *M* HCl had been passed was composed of nearly pure hafnium while the second peak which appeared after a passage of about 110 ml. of elutriant, was composed of nearly pure zirconium.

In view of the marked colloidal properties of zirconium and hafnium it might be preferable to convert these elements to the soluble anionic complexes such as the fluoride or citrate. These complexes can be adsorbed on an anionic exchanger and subsequently subjected to chromatographic elution.

Rhenium-43. These elements exist as anions in solution and Motta (private communication) has found that they were strongly adsorbed from 0.1 *M* HCl solutions by the anion exchanger, Amberlite IR-4. The distribution coefficients, K_d , for 43 and Re in 0.1 *M* HCl were 1300 and 590 respectively, indicating that a column separation of these elements using an anion exchanger should be a simple matter.

IV. CONCLUDING REMARKS

The results described in this chapter have furnished overwhelming evidence for the fact that the most effective ion exchange methods for separating and purifying similar cations are accomplished by markedly increasing the value of the separation factor through the use of complexing agents. Attempts to separate the rare earths by cation exchange (56, 56a) by the use of predominantly cationic displacement methods only were largely ineffectual. It will be of interest to extend previous investigations on the fractionation of the isotopes of lithium and potassium with cation exchangers (57) by the use of chromatographic complex elution techniques. Obviously, these techniques will find wide application for the separation and purification of organic cations. Such processes have already found industrial application in the recovery of alkaloids, as is discussed in the chapter by Applezweig and Nachod.

Cation exchange reactions will take place in nonaqueous media. In some of their cation exchange studies Adams and Holmes (1) dissolved the chloride of antimony (and arsenic) in alcohol because it was not possible to obtain an aqueous solution of the antimony of the required concentration. Nonaqueous solvents, such as HCl in ether, for example, may find valuable applications for separating mixtures of complexed or uncomplexed cations.

Economically, it may not be feasible to employ cation exchangers for the complete processing of many metals on the hundred pound or tonnage basis. Such a limitation is due principally to the relatively small capacity of ion exchangers, as was pointed out by Sussman and Mindler (58) in their discussion of the costs involved in ion exchange processes. Ion exchange reactions do offer unique advantages for the separation, concentration, and purification of metals present in dilute solution. In studies on the recovery of copper by a cation exchanger it was shown that the use of 1 lb. of H_2SO_4 performed the same duty as the evaporation of about 4200 lbs. of water (59). Ample evidence has already been presented for the great advantages offered by ion exchange reactions for the processing of radioactive materials,

BIBLIOGRAPHY

1. Adams, B. A. and Holmes, E. L., *J. Soc. Chem. Ind.* **54**, 1T (1935).
2. Walton, H. F., *J. Chem. Education* **23**, 454 (1946).
3. Tompkins, E. R., Khym, J. X., and Cohn, W. E., *J. Am. Chem. Soc.* **69**, 2769 (1947).
4. Spedding, F. H., Voigt, A. F., Gladrow, E. M., and Sleight, N. R., *J. Am. Chem. Soc.* **69**, 2777 (1947).
5. Marinsky, J. A., Glendenin, L. E., and Coryell, C. D., *J. Am. Chem. Soc.* **69**, 2781 (1947).
6. Spedding, F. H., Voigt, A. F., Gladrow, E. M., Sleight, N. R., Powell, J. E., Wright, J. M., Butler, T. A., and Figard, P., *J. Am. Chem. Soc.* **69**, 2786 (1947).
7. Harris, D. H., and Tompkins, E. R., *J. Am. Chem. Soc.* **69**, 2792 (1947).
8. Ketelle, B. H., and Boyd, G. E., *J. Am. Chem. Soc.* **69**, 2800 (1947).
9. Spedding, F. H., Fulmer, E. I., Butler, T. A., Gladrow, E. M., Gobush, M., Porter, P. E., Powell, J. E., and Wright, J. M., *J. Am. Chem. Soc.* **69**, 2812 (1947).
10. Johnson, W. C., Quill, L. L., and Daniels, F., *Chem. Eng. News* **25**, 2494 (1947).
11. Bauman, W. C., and Eichhorn, J., *J. Am. Chem. Soc.* **69**, 2830 (1947).
12. Walton, H. F., *J. Phys. Chem.* **47**, 371 (1943).
13. Boyd, G. E., Schubert, J., and Adamson, A. W., *J. Am. Chem. Soc.* **69**, 2818 (1947).
14. Schubert, J., and Richter, J. W., *J. Phys. Colloid Chem.* **52**, 350 (1948).
15. Tompkins, E. R., and Mayer, S. W., *J. Am. Chem. Soc.* **69**, 2859 (1947).
16. Frizzell, L. D., *Ind. Eng. Chem. Anal. Ed.* **16**, 615 (1944).
17. Boyd, G. E., Myers, L. S. Jr., and Adamson, A. W., *J. Am. Chem. Soc.* **69**, 2849 (1947).
18. Cohn, W. E., Parker, G. W., and Tompkins, E. R., *Nucleonics*, **3**, 22 (1948).
19. Manhattan Project, *Science* **103**, 697 (1946).
20. Werner, L. B., and Perlman, I., paper entitled "The Preparation and Isolation of Curium," U. S. Atomic Energy Commission, AECD-1898.
21. Nachod, F. C., and Wood, W., *J. Am. Chem. Soc.* **67**, 630 (1945).
22. Mason, C. M., *J. Am. Chem. Soc.* **60**, 1638 (1938); **63**, 220 (1941).
23. Schubert, J., Manhattan Project Report CN-1873, issued January, 1945.
24. Walton, H. F., *J. Phys. Chem.* **47**, 371 (1943).
25. Akeroyd, E. I., and Broughton, G., *J. Phys. Chem.* **42**, 343 (1938).
26. Schubert, J., and Richter, J. W., *J. Am. Chem. Soc.* **70**, 4259 (1948).
27. Bjerrum, N., and Unmack, A., *Kgl. Danske Videnskab Selskab, Math-fys. Medd.* **9**, 1 (1929).
28. Muus, J., and Lebel, H., *Kgl. Danske Videnskab. Selskab, Math-fys. Medd.* **13**, No. 19 (1936).
29. Schubert, J., Manhattan Project Report CN-2563, issued February, 1945.
30. Spedding, F. H., Fulmer, E. I., Ayers, B., Butler, T. A., Powell, J., Tevebaugh, A. D., and Thompson, R., *J. Am. Chem. Soc.* **70**, 1671 (1948).
31. Schubert, J., *J. Phys. Colloid Chem.* **52**, 340 (1948).
32. Mayer, S. W., and Tompkins, E. R., *J. Am. Chem. Soc.* **69**, 2866 (1947).
33. Moeller, T., and Kremers, H. E., *Chem. Revs.* **37**, 97 (1945).
34. Schubert, J., paper entitled "The Radiocolloidal Properties of Some Fission Products," U. S. Atomic Energy Commission, AECD-1910.
35. Thompson, R., paper entitled "Studies on the Chemistry of Protoactinium," U. S. Atomic Energy Commission, AECD-1897.
36. Ayres, J. A., *J. Am. Chem. Soc.* **69**, 2879 (1947).
37. Harned, H. S., and Owen, B. B., *The Physical Chemistry of Electrolytic Solutions* Reinhold Publishing Corporation, New York (1943).

38. Robinson, R. A., *J. Am. Chem. Soc.* **59**, 84 (1937).
39. Martin, A. J. P., and Synge, R. L. M., *Biochem. J.* **35**, 1385 (1941).
40. Tompkins, E. R., *J. Chem. Education* **26**, 32 (1949); **26**, 92 (1949); U. S. Atomic Energy Commission, Isotopes Division Circular C-10.
41. Matheson, L. A., private communication to Tompkins, cited in reference 40.
42. Seaborg, G. T., *Chem. Revs.* **27**, 199 (1940).
43. Boyd, G. E., and Matheson, L. A., paper entitled "Correlation of Theories of Ion Exchange Column Separations" which was presented before the Division of Physical and Inorganic Chemistry at the 113th meeting of the American Chemical Society, April, 1948.
44. Boyd, G. E., Adamson, A. W., and Myers, L. S., Jr., *J. Am. Chem. Soc.* **69**, 2836 (1947).
45. Tompkins, E. R., Harris, D. H., and Khym, J. X., unpublished work cited in reference 40.
46. Matheson, L. A., and Boyd, G. E., unpublished data cited in reference 40.
47. Cohn, W. E., and Kohn, H. W., *J. Am. Chem. Soc.* **70**, 1986 (1948).
48. Tompkins, E. R., *J. Am. Chem. Soc.* **70**, 3520 (1948).
- 48a. Schubert, J., Manhattan Project Report CN-2583, Issued February, 1945.
49. Hagemann, F., paper presented at the symposium on "The Chemistry of the New Elements" at the Syracuse meeting of the Division of Physical and Inorganic Chemistry of the American Chemical Society, June 30, 1948.
50. Marsh, J. K., *J. Chem. Soc.* 398, 523 (1942); 531 (1943); cited in reference 9.
51. Thompson, S. G., James, R. A., and Morgan, L. O., paper entitled, "The Tracer Chemistry of Americium and Curium," U. S. Atomic Energy Commission, AECD-1907.
52. Austerweil, G., *Compt. rend.* **193**, 1013 (1931).
53. Nelson, R., and Walton, H. F., *J. Phys. Chem.* **48**, 406 (1944).
54. Kozak, R., and Walton H. F., *J. Phys. Chem.* **49**, 471 (1945).
55. Glueckauf, E., *J. Chem. Soc.* p. 1308 October (1947).
- 55a. Street, K. Jr., and Seaborg, G. T., *J. Am. Chem. Soc.* **70**, 4268 (1948).
56. Russell, R. G., and Pearce, D. W., *J. Am. Chem. Soc.* **65**, 595 (1943).
- 56a. Lister, B. A., and Smith, M. L., *J. Chem. Soc.* **1948**, 1272.
57. Taylor, T. I., and Urey, H. C., *J. Chem. Phys.* **5**, 597 (1937); **6**, 429 (1938).
58. Sussman, S., and Mindler, A. B., *Chem. Inds.* **56**, 789 (1945).
59. Beaton, R. H., and Furnas, C. C., *Ind. Eng. Chem.* **33**, 1500 (1941).

Ion Exchange as a Tool in Analytical Chemistry

WILLIAM RIEMAN III

Rutgers University, New Brunswick, New Jersey

CONTENTS		Page
I.	Biochemical Analysis	223
1.	Determination of Ammonia in Urine	223
2.	Determination of Urea in Urine	224
3.	Determination of Morphine in Urine	224
4.	Determination of Thiamine and Riboflavin	225
5.	Determination of Total Amino Acids in Urine	226
6.	Determination of Glycocyanine and Arginine	226
II.	Inorganic Qualitative Analysis	226
1.	Precipitation of the Hydrogen-Sulfide Group	226
2.	Removal of Phosphate Ion	227
3.	Chromatographic Separations	227
III.	Inorganic Quantitative Analysis	227
1.	Separation of Pure Salts into their Ions	227
2.	Study of Complex Ions and Chrome Tanning Liquors	228
3.	Determination of Total Salt Concentration	229
4.	Determination of Sulfate Ion	230
	(a) Volumetric	230
	(b) Gravimetric	230
5.	Determination of Chloride Ion	230
6.	Determination of Selenite Ion	230
7.	Determination of Phosphate Ion	230
8.	Determination of Iron and Aluminium	231
9.	Determination of Potassium	231
10.	Determination of Traces of Copper in Milk	231
11.	Determination of Traces of Other Metals	232
	Bibliography	232

The purpose of this Chapter is to discuss the various applications of ion exchange to analytical chemistry. Because of space limitations, the details of the analytical procedures are not included.

In a lecture at the International Congress for Applied Chemistry in 1909, P. Siedler (1) said, "Possibly the Permutits may also be found useful in quantitative analysis." He offered, however, no specific suggestions toward this end.

I. BIOCHEMICAL ANALYSIS

1. *Determination of Ammonia in Urine*

The first practical application of ion exchange to analytical chemistry was achieved in 1917 by Folin and Bell (2) in the determination of ammonia in urine. The well-known Nessler method cannot be applied to this deter-

mination until the ammonia is separated from creatinine, which interferes by reducing the iodomercurate ion, HgI_4^{2-} . This separation had previously been accomplished by selective adsorption of creatinine on blood charcoal (3) or by volatilization of ammonia from alkaline solution. Folin and Bell (2) achieved a more satisfactory separation by the use of Permutit.*

The outline of this method follows. A measured volume of urine is diluted and treated with Permutit, previously saturated with sodium ion. At the pH of urine (5.5 to 7.5) the ammonia exists almost entirely as the ammonium ion. On the other hand, creatinine is a much weaker base ($K_b \cong 3.7 \times 10^{-11}$); and at the same pH, it exists chiefly as the free base. Thus the Permutit holds the ammonium ion by exchange but does not retain creatinine. After washing the exchanger free from creatinine, it is treated with sodium hydroxide. This serves both to liberate the ammonium ion and to convert it to ammonia. After dilution of the solution to a definite volume, an aliquot is subjected to the Nessler determination.

Results by this method have a relative mean difference of $\pm 2\%$ from the results obtained by volatilization and titration of the ammonia.

2. Determination of Urea in Urine

Urea can be determined by enzymatic hydrolysis with urease and subsequent determination of the liberated ammonia. If the sample contains ammonia, as in the case of urine, one must determine the ammonia separately and apply a correction, or else separate the ammonia before the determination of urea.

Youngberg (4) used Permutit to retain ammonia as ammonium ion and then determined urea in the filtrate. His method has a relative mean error of $\pm 1\%$.

3. Determination of Morphine in Urine

Oberst (5) developed a method for the colorimetric determination of morphine in urine. The color is developed by a mixture of sodium tungstate, phosphomolybdic acid, and phosphoric acid (6). Since many of the normal constituents of urine also develop a color with this reagent, a lengthy series of separations is necessary.

The urine is saturated with sodium bicarbonate, then treated in a liquid-liquid extractor with a mixture of ethanol and chloroform, which extracts the morphine. The organic solvent is acidified and evaporated, leaving a residue of impure morphine hydrochloride. This is dissolved in dilute hydrochloric acid and shaken with a mixture of amyl alcohol and

* Permutit is a registered trademark of The Permutit Company of New York. However, in the literature the term has frequently been used generically to denote an ion-exchange material.

chloroform, which extracts certain impurities but not the morphine. The remaining aqueous solution is made alkaline with sodium bicarbonate and again shaken with amyl alcohol and chloroform. The morphine now dissolves in the organic solvent. This is acidified and evaporated to obtain another residue of morphine hydrochloride. The residue is dissolved in water and treated with Permutit, which retains the morphine cation but not the remaining impurities. After liberating the morphine from the Permutit with sodium carbonate, the colorimetric determination is performed.

Samples of urine containing 2 mg. or less of morphine yield results with a mean error of ± 0.02 mg.

4. *Determination of Thiamine and Riboflavin*

In alkaline solution, thiamine is readily oxidized to thiochrome. This compound, when dissolved in isobutyl alcohol, fluoresces under ultraviolet light. These properties form the basis of a fluorimetric determination of thiamine. However, two difficulties arise when one attempts to determine thiamine in foodstuffs by this method. In the first place, part of the vitamin in foods occurs as the esters of pyro- and orthophosphoric acids. On oxidation these esters yield a fluorescent compound that is soluble in water but not in isobutyl alcohol. This difficulty is overcome by hydrolyzing the esters prior to the oxidation. In the second place, foodstuffs contain other substances that behave like thiamine and interfere in the determination. Hennessy and Cerecedo (7) succeeded in separating thiamine from these interfering substances by ion exchange. Connor and Straub (8) studied this procedure and modified it somewhat. Kemp and Bandelin (9) designed a convenient apparatus for use in the determination.

The outline of the method of Connor and Straub (8) follows. The pulverized sample is heated with 0.04 *N* sulfuric acid to extract the vitamin. The pH is adjusted to about 4.5 with an acetate buffer; and the enzyme, clarase, is added to hydrolyze the esters of thiamine. The mixture is centrifuged. The clear centrifugate is heated and passed through a column of Decalso previously saturated with potassium ion. This retains the cation of thiamine but none of the interfering substances. A hot concentrated solution of potassium chloride displaces the thiamine from the column. An aliquot of this solution is treated with sodium hydroxide, potassium ferricyanide, and isobutyl alcohol. The fluorescence of the organic solution is compared with standards in a photoelectric fluorimeter.

The mean recovery of known quantities of thiamine or its esters was 95% with a mean deviation of $\pm 3\%$.

Connor and Straub (10) also showed that riboflavin can be conven-

iently determined in the aqueous solution from which Decalso has removed the thiamine.

5. *Determination of Total Amino Acids in Urine*

Beta-naphthoquinone sulfonic acid reacts with amino acids to give a red color, the intensity of which is proportional to the quantity of amino-acid nitrogen. This reaction can be used for the colorimetric determination of amino acids provided that ammonium ion, which also gives a color reaction with this reagent, is absent. Folin (11) treated a measured sample of urine with sodium Permutit, which retained the ammonium ion but not the amino acids. He then determined the amino acids in the filtrate.

6. *Determination of Glycocyamine and Arginine*

Glycocyamine (guanidoacetic acid) reacts with α -naphthol and sodium hypobromite to form an intensely colored compound that is used for the colorimetric determination of glycocyamine. Arginine interferes by producing a similar color with the same reagents. Several investigators (12, 13, 14) used Permutit to separate these two amino acids in the determination of glycocyamine. Treatment of the solution with Permutit and subsequent washing with 0.3% sodium chloride leaves the arginine on the exchanger and the glycocyamine in the solution.

Dubnoff (15) used this principle to determine the arginine also. He washed it from the Permutit with 3% sodium chloride.

Sims (16) reported that Permutit is not sufficiently uniform to give satisfactory separations of these two amino acids, and he recommended that Amberlite IR-100-Na be used.

Another chapter in this book (see the chapter by Block) deals with many other methods of separating the various amino acids from each other, emphasizing the preparative rather than the analytical point of view.

II. INORGANIC QUALITATIVE ANALYSIS

1. *Precipitation of the Hydrogen-Sulfide Group*

Gaddis (17) suggested that an anion exchanger can serve to eliminate the use of hydrogen sulfide by students in the laboratory of semimicro qualitative analysis. She recommends that Amberlite IR-4 be saturated with hydrogen sulfide and stored in well-stoppered bottles. The filtrate from group 1 is then warmed with a portion of this resin. The exchange between sulfide and chloride ions is sufficient to precipitate the sulfides of the hydrogen-sulfide group, with only insignificant contamination by metals of other groups. This mixture is filtered, and the filtrate is analyzed as usual for the metals of the subsequent groups.

The residue, consisting of resin and the precipitated sulfides, is treated with sodium polysulfide and filtered. The filtrate is examined for the thiocomplexes of mercury, arsenic, antimony, and tin.

The residue, containing resin and the sulfides of the copper group, is heated with 4 *N* nitric acid. This dissolves the sulfides and, unfortunately, some of the resin. After filtration, the solution is examined for the metals of the copper group. The dissolved organic matter does not interfere in any of the tests except that it imparts an orange color that interferes with the identification of copper as the blue cupric ammonia ion. However, the ferrocyanide test is entirely satisfactory (17, 18).

This procedure seems to be less sensitive than most semimicro procedures because it is recommended that the unknowns contain at least 2 mg. of any individual ion.

2. Removal of Phosphate Ion

An incidental advantage of the procedure of Gaddis (17) (see above) is that it will remove 8 mg. of phosphate from the unknown solution.

The problem of phosphate removal was studied more thoroughly by Klement (19). He first sought to remove the phosphate by anion exchange with the resin, Wofatit M.* Unsatisfactory results were obtained.

He then applied a cation exchanger and found the following method satisfactory. The filtrate from the hydrogen-sulfide group is evaporated to dryness. The residue is dissolved in dilute hydrochloric acid and passed through a column of Wofatit KS,* which retains all the cations. After washing the column free from phosphoric acid, it is treated with 5 *N* hydrochloric acid to obtain a solution of the cations entirely free from interfering anions.

3. Chromatographic Separations

Chromatographic separations by means of alumina, 8-hydroxyquinoline, or similar substances have so much in common with ion-exchange separations by means of zeolites, Permutits, or resins that it is difficult to draw a sharp line of distinction between the two procedures. However, since Strain (20) has discussed the qualitative chromatographic separation and identification of inorganic ions, these subjects will not be considered here.

III. INORGANIC QUANTITATIVE ANALYSIS

1. Separation of Pure Salts into their Ions

If a quantity of pure salt, sodium oxalate for example, is weighed, dissolved in water, and passed through a column of resinous hydrogen-ion exchanger with adequate washing, the filtrate will contain a quantity of

*I. G. Farbenindustrie, Wolfen, Germany.

oxalic acid exactly equivalent to the sodium oxalate taken. This may be titrated with standard sodium hydroxide, and the result may be regarded as a determination of oxalate ion in the sample. Now the sodium may be washed from the column with hydrochloric acid. The resulting solution may be evaporated to dryness, and the residue may be heated to obtain a quantity of sodium chloride exactly equivalent to the sodium oxalate taken. This sodium chloride may now be weighed or titrated with standard silver nitrate, and the result may be regarded as a determination of sodium in the sample.

In general, so simple a procedure cannot be used to determine any specified cation in a mixture of two or more cations, nor can it be used to determine any specified anion in a mixture of anions. Nevertheless, it may serve a useful purpose in checking the purity or the degree of hydration of a supposedly pure salt.

In spite of the limited usefulness of this type of separation, it has been a favorite field of research, and about 150 salts have been studied (21-29). Some of this work was done on a microchemical scale (30).

Although ferric ion is quantitatively retained by resinous hydrogen-ion exchangers from fresh solutions of ferric chloride more concentrated than 0.0004 *N*, the retention is incomplete from more dilute and from old solutions (29). This is probably due to the slow formation of colloidal particles of basic ferric chloride. Analogously, it has been shown that an exchange column fails to retain all the iron from a solution of ferric salt to which a small quantity of sodium hydroxide has been added (25).

Runneberg and Samuelson (26) found that the usual treatment with a hydrogen-ion exchanger failed to separate sodium or potassium ion from chromate, molybdate, tungstate, phosphomolybdate, or phosphotungstate ion. Probably the acids formed in the exchange suffered decomposition with partial precipitation of molybdic anhydride, tungstic anhydride, or similar compounds, although this explanation hardly seems suitable for chromate. Satisfactory separations were accomplished by treating the exchange column with ammonia solution after the passage of the salt solution. Thus the anions were removed from the column while the alkali cations were retained.

2. *Study of Complex Ions and Chrome Tanning Liquors*

Interesting observations on the stability of various complexes can be obtained by means of ion exchange. Complex cyano anions such as $\text{Fe}(\text{CN})_6^{\equiv}$ and $\text{Mo}(\text{CN})_8^{\equiv}$ will pass through a hydrogen-ion exchanger without decomposition (25). The oxalate complexes of lead, aluminum, and ferric iron are also sufficiently stable to resist decomposition by the exchanger (29). On the other hand, cadmium is quantitatively retained

by the exchanger, even from solutions containing halide or oxalate ion (28).

The determination of total chromium or of total sulfate in a chrome tanning liquor presents no problems of unusual difficulty and requires no extraordinary analytical technique. It is more important to the tanner, however, to know what fraction of the total chromium is present as cation, as uncharged molecule, and as anion, and also to know what anion is complexed with the chromium. Since these questions cannot be answered by ordinary analytical techniques, the analyst must turn to ion exchange.

Gustavson (31-33) passed the tanning liquor first through a resinous hydrogen-ion exchanger, then through a resinous anion exchanger. The former retained the cationic chromium; the latter retained the anionic chromium; and the uncharged molecules were found in the filtrate. Both the cations and anions were eluted from the exchanger with hydrochloric acid and submitted to ordinary chemical analysis.

A weakness of this procedure lies in the fact that the equilibrium among the various species of chromium complexes is slowly shifted as one species is removed by the exchange reaction. This phenomenon was demonstrated by Adams (34) in two ways. First, the percentage of chromium retained by the cation exchanger increased perceptibly if the rate of flow of the solution through the column was decreased. Secondly, when one portion of a solution was passed through a cation exchanger and another portion of the same solution through an anion exchanger, the total chromium withheld exceeded 100%. Fortunately, the shift in the equilibrium among the various species of chromium is slow compared with the rate of ion exchange, and approximately correct results can be obtained by Gustavson's method (31-33).

3. Determination of Total Salt Concentration

If a neutral solution containing several salts is passed through a hydrogen-ion exchanger, the filtrate contains a quantity of acid equivalent to the original salt content. By titration of this acid, the total normality of the original salt solution can be determined. Federova (35) used this method to determine the total salt content of natural waters.

If the unknown contains acid in addition to the salts, the titration of the solution after the exchange indicates the sum of the acid and the salts. One may subtract from this value the quantity of acid originally present, as determined by a separate titration, to find the salt content of the unknown. This is the procedure of Burton and Lee (36) for the determination of the total salt in vegetable tanning liquors. Samuelson (36a) also applied this principle to the determination of calcium in the sulfite cooking acid used in the paper industry.

4. *Determination of Sulfate Ion*

(a) *Volumetric.* Bahrtdt (37) wished to develop a simple, rapid method for the determination of sulfate ion in natural water. The addition of a measured volume of standard barium chloride to the neutral solution and titration of the excess barium ion with potassium palmitate and phenolphthalein indicator worked very well in the absence of calcium and magnesium. However, all natural waters contain some of these interfering ions. Bahrtdt (37) therefore removed these ions before the addition of barium chloride by exchange with the sodium ions of Permutit.

In seven analyses of natural waters with sulfate contents varying from 60 to 600 mg. SO_3 /liter, the mean difference between the results obtained by the recommended procedure and those obtained by the more lengthy gravimetric procedure was ± 2 mg. of SO_3 per liter. This was the first application of ion exchange to inorganic quantitative analysis.

Kehren and Stommel (38) introduced some refinements into Bahrtdt's procedure and decreased the error (as compared with the gravimetric method) to 0.4 mg. SO_3 /liter.

(b) *Gravimetric.* Samuelson (21, 23) suggested that the gravimetric determination of sulfur can be improved in many cases by passage of the solution through a hydrogen-ion exchanger before the precipitation of barium sulfate. Thus cations that are usually coprecipitated to a large extent are removed from the solution.

5. *Determination of Chloride Ion*

Samuelson (21) also suggested that the Mohr titration of chloride could be applied to solutions containing barium, lead, and hydrogen ions by removal of these ions with a sodium-ion exchanger.

6. *Determination of Selenite Ion*

According to Schwaer and Suchý (39), iron, aluminum, cobalt, manganese, and zinc interfere in the polarographic determination of selenite ion. Samuelson (27) suggested that these cations be separated by ion exchange.

7. *Determination of Phosphate Ion*

Samuelson (21, 23) suggested that the gravimetric determination of phosphorus could be facilitated by removal of the interfering cations with a cation exchanger.

Helrich and Rieman (40) devised a rapid, accurate method for the determination of phosphorus in phosphate rock. The sample is dissolved in hydrochloric acid, and the resulting solution is evaporated to dryness and baked on a steam bath. This step is necessary in order to dehydrate the silica and to expel most of the fluoride as hydrofluoric acid. The

presence of gelatinous silica and much fluoride ion introduces a positive error in the titration. The sample is then taken up in dilute hydrochloric acid and passed (without filtration) through a hydrogen-ion exchanger. The filtrate, which contains only hydrochloric and phosphoric acids, is adjusted to a pH of 4.63. At this point, the solution contains only sodium chloride and primary sodium phosphate. It is now titrated with standard sodium hydroxide to a pH of 8.98. This titration converts the phosphate to the secondary anion and gives a measure of the phosphorus present.

The analysis of two samples of phosphate rock from the Bureau of Standards indicates that this method is subject to a mean deviation of only 0.07% P_2O_5 and an even smaller mean error.

8. *Determination of Iron and Aluminum*

Samuelson (41) separated these cations from phosphate ion by absorption on a cation exchanger and subsequent elution with hydrochloric acid. He then determined them by precipitation with ammonia. In this way, he analyzed quickly and accurately both synthetic mixtures and minerals containing iron, aluminum, calcium, and phosphorus.

9. *Determination of Potassium*

Samuelson and his colleagues determined potassium in solutions containing vanadate (22), phosphate (42), and sulfate (43) ions. In each case the potassium ion was separated from the anion by treatment with a cation exchanger previously saturated with hydrogen or ammonium ion. The potassium was then removed from the exchanger by treatment with hydrochloric acid. After evaporation to remove excess hydrochloric acid and (if necessary) ignition to remove ammonium chloride, the remaining potassium chloride was dissolved in water and titrated with standard silver nitrate.

10. *Determination of Traces of Copper in Milk*

The older method for the determination of copper in milk involved the destruction of the organic matter, by either ignition or treatment with oxidizing acids, and subsequent colorimetric determination with dithizone. Cranston and Thompson (44) developed a much faster method by the use of ion exchange. The outline of their method follows.

The milk is acidified with perchloric acid to a pH of about 1. This coagulates the casein and fat, and also liberates any copper ions previously held by the casein. After filtration, the solution is adjusted to a pH of 5.0 with ammonia, and it is passed through a column of Amberlite IR-100H. This retains the copper quantitatively. The copper is then removed from the column with hydrochloric acid. It may now be determined either with dithizone or polarographically.

11. *Determination of Traces of Other Metals*

Riches (45) passed 2 ml. of 0.1 *N* ammonium phosphate containing about 1.4 microequivalents each of cadmium, copper, manganese, nickel, and zinc ions through a bed of 1 ml. of Amberlite IR-100. The bivalent cations were retained by the exchanger. He then eluted them with 30 ml. of *N* hydrochloric acid and determined each metal polarographically. The recoveries were 96% Cd, 97% Cu, 87% Mn, 97% Ni, and 93% Zn. Riches suggested that this procedure should be useful in the analysis of plant material.

The determination of thulium and the qualitative detection of other rare earths in spectrographically pure erbium is described elsewhere in this book (see the chapter by Schubert).

BIBLIOGRAPHY

1. Siedler, P., 7th International Congress for Applied Chemistry, 262 (1909).
2. Folin, O., and Bell, R. D., *J. Biol. Chem.* **29**, 329 (1917).
3. Folin, O., and Denis, W., *J. Biol. Chem.* **26**, 497 (1916).
4. Youngberg, G. E., *J. Biol. Chem.* **45**, 391 (1921).
5. Oberst, F. W., *J. Lab. Clin. Med.* **24**, 318 (1938).
6. Folin, O., and Denis, W., *J. Biol. Chem.* **12**, 239 (1912).
7. Hennessy, D. J., and Cerecedo, L. R., *J. Am. Chem. Soc.* **61**, 179 (1939); Hennessy, D. J., *Ind. Eng. Chem. Anal. Ed.* **13**, 216 (1941); cf. also *Cereal Chem. Bull.* **2**, No. 2. (1942).
8. Connor, R. T., and Straub, G. J., *Ind. Eng. Chem. Anal. Ed.* **13**, 380 (1941).
9. Kemp, C. R., and Bandelin, F. J., *J. Am. Pharm. Assoc.* **34**, 306 (1945).
10. Connor, R. T., and Straub, G. J., *Ind. Eng. Chem. Anal. Ed.* **13**, 385 (1941).
11. Folin, O., *J. Biol. Chem.* **51**, 393 (1922).
12. Bodansky, M., *J. Biol. Chem.* **115**, 641 (1936).
13. Davenport, H. W., and Fisher, R. B., *Biochem. J.* **32**, 602 (1938).
14. Dubnoff, J. W., and Borsook, H., *J. Biol. Chem.* **138**, 381 (1941).
15. Dubnoff, J. W., *J. Biol. Chem.* **141**, 711 (1941).
16. Sims, E. A. H., *J. Biol. Chem.* **158**, 239 (1945).
17. Gaddis, S., *J. Chem. Education* **19**, 327 (1942).
18. Gaddis, S., Private communication.
19. Klement, R., *Z. anal. Chem.* **127**, 2 (1944).
20. Strain, H. H., *Chromatographic Adsorption Analysis*. Interscience Publishers, New York (1945).
21. Samuelson, O., *Z. anal. Chem.* **116**, 328 (1939); Goehring, M., and Darge, I., *Z. anal. Chem.* **125**, 180 (1943).
22. Samuelson, O., *Svensk Kem. Tid.* **51**, 195 (1939); *Chem. Abstracts* **34**, 1271² (1940).
23. Samuelson, O., *Svensk Kem. Tid.* **54**, 124 (1942); *Chem. Abstracts* **38**, 2896⁶ (1944).
24. Frizzell, L. D., *Ind. Eng. Chem., Anal. Ed.* **16**, 615 (1944).
25. Samuelson, O., *Svensk Kem. Tid.* **57**, 158 (1945); *Chem. Abstracts* **40**, 2417¹ (1946).
26. Runneberg, G., and Samuelson, O., *Svensk Kem. Tid.* **57**, 250 (1945); *Chem. Abstracts* **40**, 2417⁵ (1946).
27. Samuelson, O., *Iva* **17**, 5 (1946); *Chem. Abstracts* **40**, 5657⁹ (1946).

28. Samuelson, O., *Svensk Kem. Tid.* **58**, 247 (1946); *Chem. Abstracts* **41**, 1571g (1947).
29. Djurfelt, R., Hansen, J., and Samuelson, O., *Svensk Kem. Tid.* **59**, 13 (1947); *Chem. Abstracts* **41**, 3009b (1947).
30. Wiesenberger, E., *Mikrochemie ver. Mikrochim. Acta* **30**, 176 (1942); *Chem. Abstracts* **37**, 4654⁹ (1943).
31. Gustavson, K. H., *Svensk Kem. Tid.* **56**, 14 (1944); *Chem. Abstracts* **39**, 4557⁸ (1945).
32. Gustavson, K. H., *J. Intern. Soc. Leather Trades' Chemists* **30**, 264 (1946); *Chem. Abstracts* **41**, 877c (1946).
33. Gustavson, K. H., *Svensk Kem. Tid.* **58**, 274 (1946); *Chem. Abstracts* **41**, 7790i (1947).
34. Adams, R. S., *J. Am. Leather Chem. Assoc.* **41**, 552 (1946).
35. Federova, G. V., *Izvest. VTI* **16**, No. 2, 28 (1946); *Chem. Abstracts* **40**, 5509⁵ (1946).
36. Burton, D., and Lee, G., *J. Intern. Soc. Leather Trades' Chemists*, **29**, 204 (1945).
- 36a. Samuelson, O., *Svensk Papperstidn.* **48**, 55 (1945); *Chem. Abstracts* **39**, 3157⁷ (1945).
37. Bahrdt, A., *Z. anal. Chem.* **70**, 109 (1927).
38. Kehren, M., and Stommel, H., *Chem. Ztg.* **51**, 913 (1927).
39. Schwaer, L., and Suchy, K., *Collection Czechoslov. Chem. Communications* **7**, 25 (1935). *Chem. Abstracts* **29**, 3260⁴ (1935).
40. Helrich, K., and Rieman, W., *Anal. Chem.* **19**, 651 (1947).
41. Samuelson, O., *Svensk Kem. Tid.* **52**, 241 (1940); *Chem. Abstracts* **35**, 1340⁸ (1941).
42. Runneberg, G., and Samuelson, O., *Svensk Kem. Tid.* **57**, 91 (1945); *Chem. Abstracts* **40**, 2416⁸ (1946).
43. Runneberg, G., *Svensk Kem. Tid.* **57**, 114 (1945); *Chem. Abstracts* **40**, 2416⁹ (1946).
44. Cranston, H. A., and Thompson, J. B., *Ind. Eng. Chem., Anal. Ed.* **18**, 323 (1946).
45. Riches, J. P. R., *Nature* **158**, 96 (1946).

Metal Concentration and Recovery by Ion Exchange

SIDNEY SUSSMAN

Liquid Conditioning Corporation, Linden, New Jersey

AND

FREDERICK C. NACHOD

Sterling-Winthrop Research Institute, Rensselaer, New York

CONTENTS

	<i>Page</i>
I. Introduction	235
II. Copper	236
III. Silver	245
IV. Chromium	247
V. Molybdenum, Vanadium, and Iron	251
VI. Precious Metals — The Platinum Group and Gold	253
1. Platinum	253
2. Palladium	254
3. Gold	254
VII. Magnesium	255
VIII. Other Metals	257
1. Rare Earths	257
2. Zirconium	257
3. Bismuth	257
4. Nickel	257
IX. Separations of Metals	258
X. Summary	258
Bibliography	258

I. INTRODUCTION

The earliest base exchange work involved removal from solutions of ions which were metals in the strictest chemical sense. Some time elapsed, however, before interest was directed toward the use of ion exchange methods for the recovery of elements of metallurgical interest. This chapter is limited to a consideration of these metallurgically important applications of ion exchange, i.e., ion exchange as a metallurgical wet process.

Human nature being what it is, gold was the first metal to enter the thoughts of ion exchange researchers. The possible use of manganese zeolites for precipitating gold from dilute solutions was suggested by Gans (1). This initial suggestion involved the precipitation of the metal being

recovered by means of a reactive ion exchanger. Subsequent developments of metallurgical applications involved the use of cation exchangers for true exchange reactions; first with salt regeneration and later with acid regeneration. Finally, with the development of anion exchangers, these materials were applied to the recovery of metals which form anionic complexes.

The development of ion exchange as a metallurgical wet process has not been rapid. For numerous reasons very few such processes have actually been placed into operation. Until about 1935 only salt cycle cation exchange was available as a process and by this means it was difficult, if not impossible, to obtain a salt of the desired metal free from appreciable quantities of the salt used in regeneration. The introduction of acid-regenerated cation exchangers eliminated this objection and resulted in a sharp spurt in activity and, indeed, in some of the initial industrial installations for metal recovery.

Other disadvantages that have acted as deterrents to the wider use of ion exchange in metal recovery are the lack of selectivity under practical operating conditions and the limited capacities of the exchangers available. The latter factor, in particular, is a heavy handicap, limiting the usefulness of the process to those cases where the metal is present in a solution which is extremely dilute by the usual chemical processing standards.

As a result of the limitations mentioned above, ion exchange is fairly well limited to a method of concentrating or purifying solutions of metals. As will be shown later, it provides a very efficient and low cost method for concentrating metals from large volumes of extremely dilute solutions. Recent developments in the synthesis of new types of cation exchange resins of very high capacity and different acidities and anion exchange resins of very high basicity provide new tools which should stimulate further development of this field.

II. COPPER

The recovery of copper from waste liquors of the cuprammonium rayon and brass industries has provided the greatest stimulus to the study of ion exchange metal recovery processes. The German cuprammonium rayon industry developed these methods to a considerable degree and made use of them on a full plant scale. Although the brass industry has not reached this stage, laboratory studies have been made and co-operative pilot plant operations are contemplated by the industry and the State of Connecticut.

It is possible to remove copper from solution by either a cation exchanger or an anion exchanger. The former involves a true ion exchange reaction but the latter involves the formation of a copper ammine complex

with the amino groups of the anion exchange resin. Both methods will be discussed although only the former has had any appreciable application.

As early as 1934 Austerweil and Jeanprost mentioned in a patent (2) that a salt-regenerated greensand would remove cupric ions from copper sulfate solution and that the metal could be recovered by regeneration with a salt solution; in this case sodium acetate. The use of acid-regenerated organic cation exchangers for this purpose was patented a short time later (3). Tiger and Goetz (4) developed a process in which the copper-containing solution was passed through a bed of acid-regenerated cation exchanger which was regenerated by an excess of strong hydrochloric acid when exhausted. The regenerant effluent was distilled to concentrate the copper and to recover the excess hydrochloric acid as the constant boiling solution for re-use in subsequent regenerations.

A careful study of the removal of copper sulfate from solutions by means of an acid-regenerated cation exchanger and its subsequent recovery has been published by Beaton and Furnas (5). Although this study was carried out with a solution of the pure salt, rather than with a plating waste or other industrial waste liquor, it provides a considerable amount of information on exchange rates, equilibria, recovery concentrations of copper, and correlation of theoretical and experimental data.

These authors found a good correlation of their experimental equilibrium data with modified mass action law predictions for the sulfonated coal cation exchanger used. Their results could be expressed by the equation

$$\sqrt{\frac{[\text{CuZ}_2][\text{H}^+]}{[\text{Cu}^{++}]}} = -2\sqrt{K}[\text{CuZ}_2] + N\sqrt{K}$$

where Z denotes the exchanger (Zeolite) and where N represents the number of replaceable ions per unit weight of exchanger

$$N = [\text{HZ}] + 2[\text{CuZ}_2]$$

and K , the equilibrium constant for the reaction, equals

$$\frac{[\text{CuZ}_2][\text{H}^+]}{[\text{HZ}]^2[\text{Cu}^{++}]}$$

The authors offer four possible explanations which, separately or together, probably account for the use of $[\text{H}^+]$ to the first power rather than the second power which would seem to be called for by the ionic equation for the exchange reaction.

In their study of the rate of exchange, Schumann's (6) equation for the transfer of heat between a gas stream and a bed of solid material was applied by analogy to the transfer of copper sulfate between the flowing

solutions and the zeolite bed. Experimental concentration histories agreed rather well with the computed Schumann curves.

An experimental effluent history for a typical run, given in Fig. 1, shows the expected inverse relationship between the copper content and

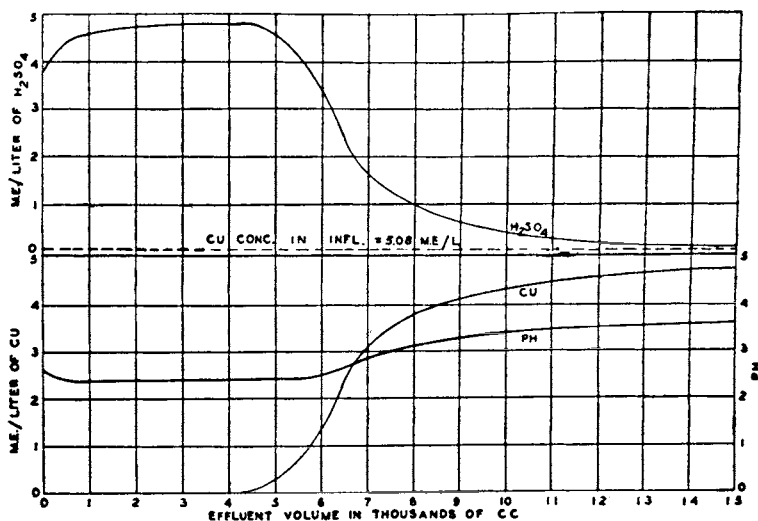

FIG. 1. Experimental fluid history of effluent. From *Ind. Eng. Chem.* **33**, 1508 (1941).

TABLE I
Regeneration of Zeolite Tower Beds^a

Run No.	Grams of dry zeolite	Copper on bed, meq.	H ₂ SO ₄ Regenerant compn.	Rate of flow, cc./min.	Concn. original soln., meq. Cu/l.	Max. concn. of final soln., meq. Cu/l.	Relative ^c concn. change
33	12.75	38.60	1.068 N	2.0	5.08	650	128 fold
34	12.75	40.01	1.068 N	8.0	5.15	433	84 fold
35	12.75	40.52	1.068 N	16.0	5.49	379	69 fold
36	12.75	42.40	0.941 N 0.974 N ^d	2.0	5.24	1158	221 fold
37	12.75	52.52	4.0 N 0.977 N ^d	2.0	20.50	1222	60 fold

^a Reprinted from *Ind. Eng. Chem.* **33**, 1511 (1941).

^b Obtained in second 20-cc. aliquot of effluent.

^c Ratio of maximum concentration in regenerating solution to concentration of original dilute solution.

^d Initial concentration of CuSO₄ in the regenerant.

the sulfuric acid content. Upon regenerating the cation exchanger after this same run, the maximum effluent copper concentration was over a hundred fold higher than the original copper-bearing influent as shown in Fig. 2. Further data on regenerant effluent concentrations attainable are presented in Table I. Runs 36 and 37 in this table are of interest to demonstrate additional concentration effects attainable by fortifying less concentrated copper-bearing portions of the regenerant effluent with fresh acid for re-use in subsequent regenerations.

As Beaton and Furnas particularly pointed out, this concentration effect is of great significance in the application of ion exchange processes. Their data indicate that a copper sulfate solution could be concentrated from 0.005 *N* to 4 *N* by a single ion exchange cycle under ideal conditions. Thus the expenditure for 1 pound of sulfuric acid would give an effect equal to the evaporation of about 4200 pounds of water. This is indeed striking evidence for the applicability of ion exchange processes as methods for concentrating ionic materials from very dilute solutions.

In their study of equilibria, Beaton and Furnas found that their "constants", *N* and *K*, were constant only over a limited range of values. As the ratio of copper to hydrogen ions in the solution increased, a point was reached at which *N* began to increase and *K* began to decrease, as shown in Figs. 3 and 4. The authors speculated, and have since been supported by others, that other less strongly acidic groups in the exchanger begin to exchange at the high pH ranges, thereby contributing to a higher capacity. Piret and Carlson (7) showed that with a cation exchange resin prepared from pyrogallol and formaldehyde the capacity for copper increased twenty fold when the pH of the influent solution was increased from 1.1 to 5.3. Nelson and Walton (8) found a sharp increase in the capacity of a sulfonated coal exchanger for copper (as well as for nickel and zinc) when the pH was increased from about 2.7 to about 11.5.

In the case of practical copper recovery operations, these effects of pH upon cation exchange capacity are particularly important. The two principal copper-containing industrial wastes are plating wastes and cuprammonium wastes. Whereas the former are generally acidic, the

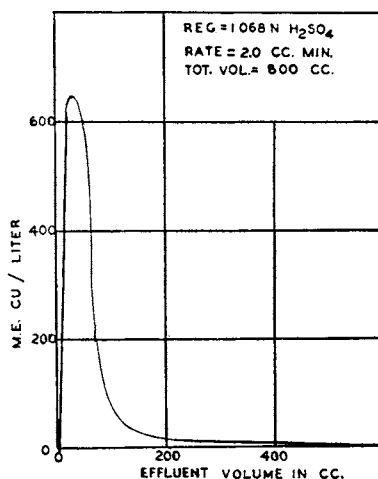

FIG. 2. Concentration history of regenerant solution. From *Ind. Eng. Chem.* **33**, 1511 (1941).

latter have a high pH because of their ammonia content. One would then expect that application of cation exchange methods to the recovery of copper from cuprammonium wastes might be fruitful and this has been the case.

Syrkin and Krynina (9) reported an early attempt to use an inorganic zeolite regenerated with an ammonium salt for the recovery of copper from cuprammonium waste liquors. I. G. Farbenindustrie carried out extensive

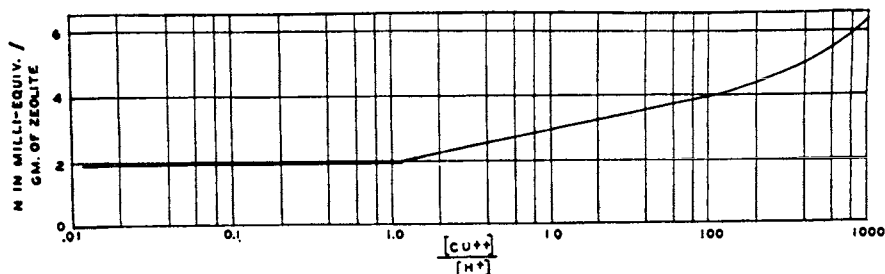

FIG. 3. Variation of N with $\frac{[Cu^{++}]}{[H^+]}$ ratio. From *Ind. Eng. Chem.* **33**, 1507 (1941).

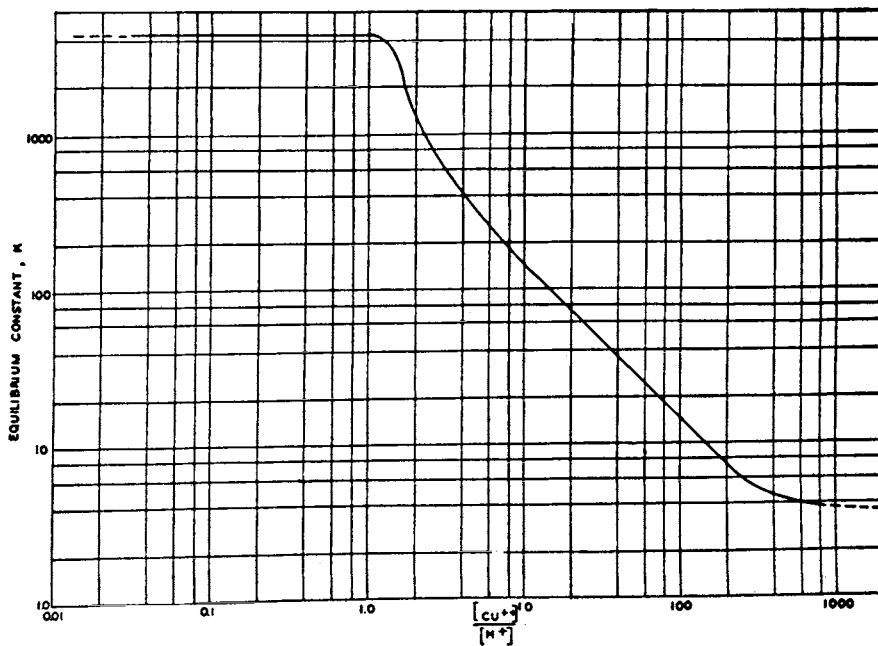

FIG. 4. Variation of equilibrium constant with $\frac{[Cu^{++}]}{[H^+]}$ ratio. From *Ind. Eng. Chem.* **33**, 1507 (1941).

work on the utilization of acid-regenerated cation exchangers in this process which is reported in a long series of domestic and foreign patents, the well-known review by Griessbach (10), and, most completely, in several of the reports published by the Office of Technical Services, particularly that of Gerstner (11). The process was thoroughly investigated by the ion exchange resin group at Wolfen together with the cuprammonium rayon plant at Dormagen. Undoubtedly the war-directed economy of the country applied a considerable stimulus to this investigation and, whereas the process used there might not be economical under other circumstances, a somewhat modified form of this ion exchange recovery is well along in development by an American rayon company.

In Germany the process went into pilot plant in 1939 and full scale operations were started in 1941 and continued at least throughout the war. Installation of the cation exchange process increased copper recovery from 85% obtained by the former cementation process to 93%. In addition to copper recovery, water re-use was a vital consideration in this plant. The cation exchange operation for the removal of copper from the

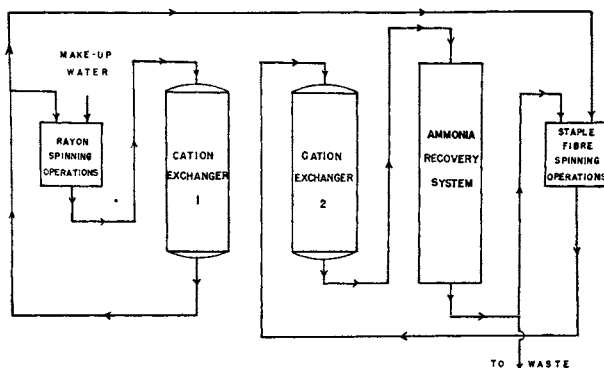

Fig. 5. Flow diagram of water recycle operations in a German cuproammonium rayon plant. From PB Report 19585.

“blue water” was followed by an ammonia recovery system. The effluent from this recovery system was of sufficiently good quality to be re-used as part of the water supply for the rayon processing and all of the water supply for spinning staple fiber. A flow sheet of this recovery and re-cycling system is given in Fig. 5.

From the copper cycle viewpoint, the process involved sand filtration of the blue water followed by passage through the cation exchange unit and the ammonia recovery system. Waste spinning acid was used to regenerate the cation exchangers. After sand filtration, the regenerant effluent was heated and treated with hot 20% sodium carbonate solution

to precipitate basic copper sulfate, which was concentrated on a thickener, filtered on a vacuum filter, and re-used in the rayon process to make up fresh cuprammonium spinning solution. Figure 6 shows an overall flow sheet of the process. The entire plant contained four cation exchange units

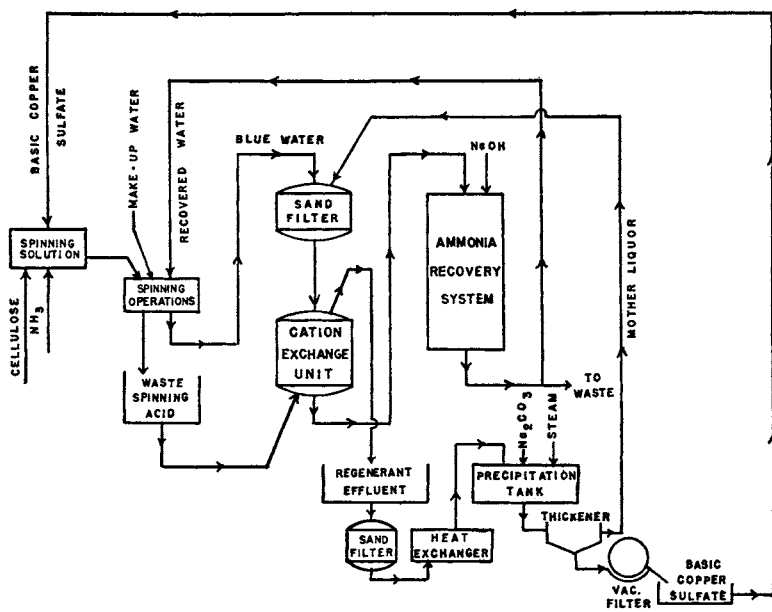

Fig. 6. Flow diagram of cation exchange copper recovery system in a German rayon plant. From PB Report 19585.

operating on rayon "blue water" which contained about 30% of the copper present in the spinning solution and six cation exchange units operating on staple fiber waters or wash waters which, together with the waste spinning acid, contained about 70% of the copper present in the spinning solution. These units were rather substantial in size as may be seen from Table II which summarizes data concerning the individual cation exchange units in this plant. The equipment was made of plastic-lined steel.

This plant operation had a number of interesting aspects from the ion exchange viewpoint. The copper was adsorbed as the cuprodiammine complex $(\text{Cu}(\text{NH}_3)_2^{++})$ thus confirming earlier laboratory data (10). Those familiar with commercial ion exchange practice will recognize that 14 g.p.m./sq. ft. is a phenomenally high flow rate; better than twice the normal rate. Apparently, however, the copper ammine-cation exchanger reaction is extremely rapid at these high pH values. One of the writers of this chapter (S.S.) has had an opportunity to confirm the fact that at

least three American-made cation exchangers will completely remove copper from cuprammonium rayon waste waters at these high operating rates and has heard of even substantially higher flow rates being used successfully in laboratory experiments with these solutions.

TABLE II

Data Concerning Cation Exchange Copper Recovery Units at Dormagen-I. G. Werke

EQUIPMENT DATA			
Diameter	9.85 ft.		
Cross-sectional area	75.3 sq. ft.		
Resin bed depth	13.8 ft.		
Resin volume	1025 cu. ft.		
Resin weight	21 tons		
OPERATIONAL DATA			
Rate	1060 gal./min.		
Rate	14.1 gal./min./sq. ft.		
Pressure drop	7.4–36.7 lb./sq. in.		
Feed — temperature	38° C.		
— composition	(see below)		
Regenerant — composition	(see below)		
— dosage	0.28 lb. H ₂ SO ₄ /kilograin (as CaCO ₃) of adsorbed copper		
Regeneration time	8 hours		
Regenerant effluent	(see below)		
Capacity of resin	2.1 tons of copper per unit per cycle		
	45.1 kilograins (as CaCO ₃)/cu. ft.		
	3.14 meq./g.		
TYPICAL CONCENTRATION DATA (meq./l.)			
	Copper	Ammonia	H ₂ SO ₄
Feed-rayon waste water	2.8	41.2	—
Feed-staple waste water	6.3	70.5	—
Waste spinning acid (regenerant)	283	—	245
Regenerant effluent	378	—	61

The exchange capacity reported in this plant also appears to be unusually high for the type of resin involved and experiments with cation exchange resins of similar composition in this country have resulted in capacities only one-half to two-thirds as high as this. Several explanations are possible for these discrepancies. In the first place, the copper content of the feed in the German installation was from 4 to 10 times as high as that in the American experiments. Secondly, the capacities in our experiments were based upon backwashed and drained volumes in accordance with our usual practice, whereas no data are revealed on the method used for determining the volumes reported in the German operations. On the basis of other reports from the I.G., it is probable that minimum compacted bed volumes were used. Both of the above factors would tend to give higher capacities for the German operations.

All was not simple and clear with this copper recovery process in actual operation. The plant was started with Wofatit P as the cation exchanger, but after about 80 cycles in the course of 3 months the resin softened and peptized. Pressure drops through the exchanger beds increased sharply requiring more frequent backwashing. Loss of fines during backwashing increased and the cation exchanger lost capacity. Laboratory experiments had shown this resin to have a constant capacity indefinitely with no such signs of physical breakdown. Research soon established that the resin was undergoing oxidation in the large units as a result of a combination of factors including dissolved oxygen in the solutions, high pH (11.5), high temperature (38° C.), and the catalytic effects of the copper.

Inasmuch as practical difficulties made it almost impossible to keep the solutions oxygen-free, a new resin, Wofatit D, was installed. This resin was prepared by reacting phenol, formaldehyde, and sodium bisulfite, condensing with additional phenol and formaldehyde, and finally processing with 98% sulfuric acid. Better, but not completely satisfactory, results were obtained with Wofatit D. By means of a special operating technique, a two-year average life was attainable. Each year the contents of three cation exchange units were removed and the softened material, amounting to about one-third of the total, was discarded. The remainder was used to refill two of the units and the third unit was refilled with new resin. This latter unit generally operated very well, but the other two units showed a somewhat higher head loss. After about a year of operation, the fresh material began to develop higher head losses. At the end of the war a new resin had been developed which, it was claimed, overcame most of the difficulties and operated satisfactorily for better than 500 cycles in the laboratory, but it had not yet been placed into commercial operation. The improved stability was attained by reducing the proportion of sulfonic acid groups in the resin with a resultant sacrifice of one-quarter to one-third in capacity (12).

A very similar plant was operated at the Bemberg Seide Werke with operations and results substantially the same as those reported above (12, 13).

As mentioned earlier in this chapter, copper-containing solutions will also react with anion exchangers retaining the copper in the exchanger bed. Myers (14) has applied this process to the removal of small amounts of copper from gasoline.

In unpublished experiments one of us (S.S.) has found that anion exchangers are capable of removing copper from aqueous solutions in which it is present as the simple cupric ion and also from those in which it is present as the cuprammonium complex. Thus, copper was removed from a copper sulfate solution upon passage through a bed of a salt of an anion

exchange resin, and also from an ammoniacal copper sulfate solution upon passage through a bed of alkali-regenerated anion exchange resin. The exact mechanisms of these reactions have not been completely established, but apparently the overall reactions are ammine formation in the first case and a trans-ammination or ammine interchange in the second case. If we represent the anion exchanger base (regenerated) by RN, we may illustrate these reactions by the following equations:

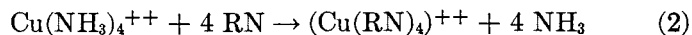
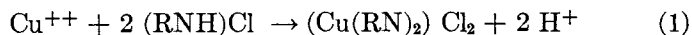

Experimental evidence has been obtained for the diammine in equation (1) on the basis of the ratio of liberated H^+ to adsorbed Cu^{++} . It is not certain, however, whether the tetrammine or the diammine is formed in the reaction represented by equation (2).

Excellent recoveries of the adsorbed copper were obtained during repeated cycles. However, the copper removal capacities of anion exchange resins are only about 20% of their acid removal capacities. The fact that this is even lower than the 50% capacity which might be anticipated upon the basis of copper diammine formation probably stems from steric effects which prevented all of the substituted amino groups of the resin from entering into complex formation.

III. SILVER

The recovery of silver by cation exchangers has been mentioned (3, 7) but the greatest effort to utilize ion exchange in the recovery of this metal has been directed toward the application of anion exchangers for the adsorption of the numerous anionic complexes of silver. In this way, the recovery of silver from various photographic film manufacturing and processing wastes has been investigated in this country and abroad. Although parallel approaches were followed the German investigation reached a greater degree of development, probably as a result of the proximity of film manufacturing and ion exchanger manufacturing operations in a single plant of one company. Pilot plant experiments were carried out and a full scale plant unit was built but had not yet been placed in operation when the war ended.

The German developments were applied to the recovery of silver from waste waters obtained by washing film coating equipment (15). After preliminary separation of some of the silver bromide, chloride, or iodide present by centrifuges, the residual 2-10 p.p.m. of silver present was converted to a complex anion by treatment with sodium thiosulfate or sodium cyanide. The latter was preferred because of the greater solubility of the complex. In the American experiments attention was primarily

concentrated on wastes from fixing baths. Since these already contained silver in the form of the thiosulfate complex, very little attention was paid to the use of the cyanide complex, with the exception of a few experiments on silver cyanide plating wastes.

In either case, the solution containing an anionic silver complex was passed through a *salt* of an anion exchanger and the silver was removed by a true anion exchange. After saturation of the anion exchanger bed, the silver was liberated as the anionic complex by treatment with sodium hydroxide and the exchanger was then treated with an acid to convert it to the salt form ready for re-use. (See equations 3-5.)

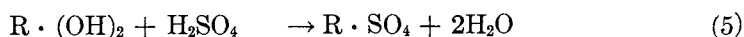
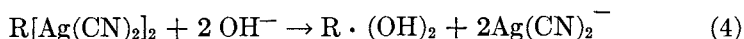
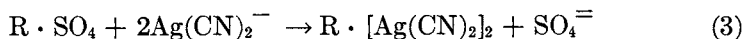

Using the sulfate salt of Wofatit M, an anion exchange resin prepared from *m*-phenylene diamine, polyethylenediamine, and formaldehyde, the Germans processed previously centrifuged solutions containing 2-10 p.p.m. of silver and obtained an effluent containing less than 1 p.p.m. of silver. Regenerant effluent concentrations as high as 1500 p.p.m. of silver were obtained. The exchanger capacity was 8 g. silver/liter. Laboratory scale testing had indicated a life of at least 50 cycles with no change in the properties of the exchanger.

At the Wolfen I.G. plant a unit containing 35 cubic feet of Wofatit M was constructed of plastic-lined steel to handle the film factory's silver-

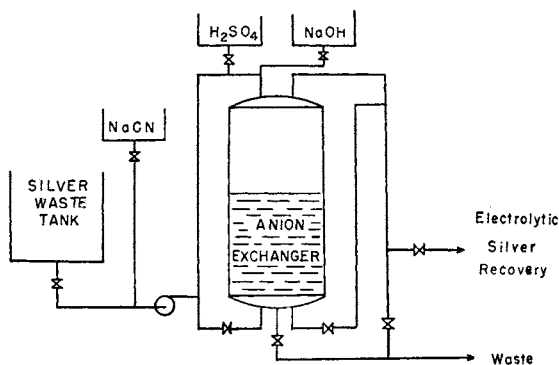

FIG. 7 Flow diagram of German silver recovery installation (13, p. 61).

containing wastes. This was scheduled to treat wastes containing a total of 3-6 kg. silver daily, but had not yet been placed into operation at last report (January 1946). Figure 7 is a flow sheet of this installation.

Although the principal attempts to recover silver have employed anionic complexes, there has been at least one installation where ion exchange was employed for the removal of silver cations from a waste effluent. In the manufacture of silver aluminosilicate for seawater desalting kits (described in another chapter of this book) an excess of silver nitrate was used in the conversion of sodium aluminosilicate to silver aluminosilicate. In order to avoid loss of the expensive reagent and contamination of the receiving stream, a bed of fresh sodium aluminosilicate was used to strip the last of the excess silver from the waste water. Silver removal was complete. In this case, no attempt was made to recover the silver because the scavenger bed in one run became the reaction bed in the next.

IV. CHROMIUM

Chromium salts are of particular interest in connection with the waste effluents of electroplating. This industry is aware of the potential utility of ion exchange in this connection. Several investigations have been made in this field and others are under way under the sponsorship of several states.

In attempting to treat waste waters containing chromates, the form in which chromium most commonly appears in electroplating wastes, Grindley (16) used demineralizing among other methods. He concluded that the usual regeneration processes would not regenerate cation and anion exchangers which had been used for treatment of chromate-containing liquors.

Sussman *et al.* (17) made a more extensive study of chromate recovery by anion exchange. It was found that a three-step cyclic process, like that described in connection with silver recovery, was necessary. The anion exchanger was treated with a simple acid, generally hydrochloric, to convert it to the salt form. This resin salt was then used to treat a neutral chromate solution, the chromate ions being removed by anion exchange. Regeneration with alkali removed the chromate from the exchanger. Thus the three steps of the process consisted of conversion of the anion exchanger from base to salt, adsorption of the chromate, and elution of the chromate with alkali.

Whereas it was theoretically possible to displace the chromate by a true anion exchange involving a neutral salt, equilibrium experiments established the fact that this was not nearly as efficient as the use of an alkali. Figure 8 illustrates the threefold improvement in chromate recovery obtained when using ammonium hydroxide as the regenerant as compared with that obtained when using ammonium chloride or ammonium sulfate.

The adsorption of the chromate by the anion exchange resin salt was a true anion exchange reaction, one of the first to be disclosed in the literature. Figure 9 illustrates this chromate-chloride exchange and demonstrates the

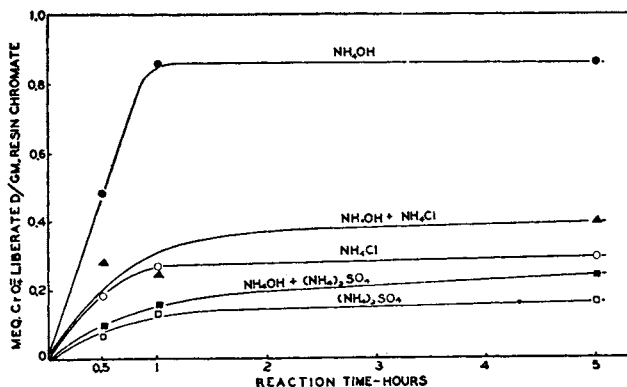

FIG. 8. Liberation of adsorbed chromate (equilibrium experiments). Results are interpolated at 25 meq./liter final chromate concentration from adsorption isotherms obtained with equivalent amounts of 1 *N* recovery agents. Mixed recovery agents were 0.5 *N* in each component. A single batch of saturated anion exchange resin chromate was used for all experiments. From *Ind. Eng. Chem.* **37**, 620 (1945).

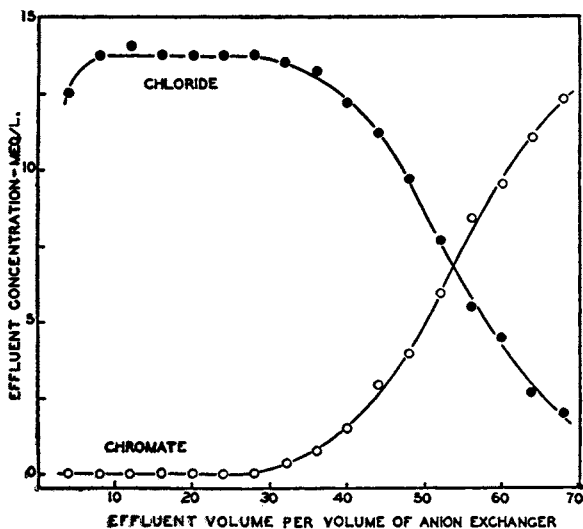

FIG. 9. Chromate-chloride exchange during adsorption of chromate by an anion exchange resin chloride. 13.6 meq. Na_2CrO_4 /liter of solution passed through a 50-ml. bed of anion exchange resin chloride at 50 ml./minute. From *Ind. Eng. Chem.* **37**, 620 (1945).

true exchange character of the reaction. The resin chloride was more effective than the sulfate in removing chromate as shown in Fig. 10. An explanation for this phenomenon is offered by Sussman *et al.* (17).

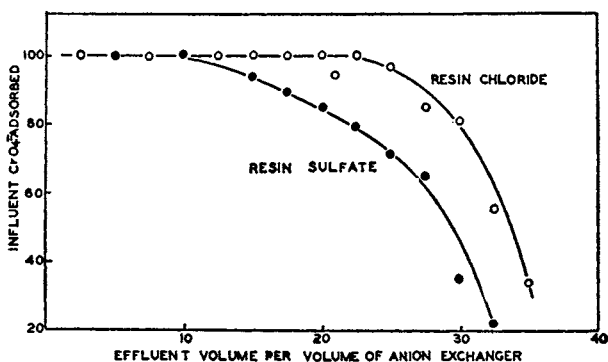

FIG. 10. Comparative chromat adsorption efficiencies of an anion exchange resin chloride and sulfate. 18.1 meq./liter Na_2CrO_4 adsorbed by 100-ml. beds of anion exchanger resin chloride and sulfate at a flow rate of 25 ml./minute. From *Ind. Eng. Chem.* **37**, 621 (1945).

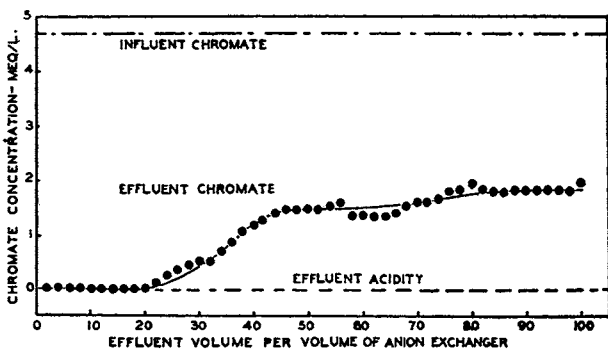

FIG. 11. Adsorption of chromate from an acid solution. Adsorption by a 100-ml. bed of alkali-regenerated anion exchange resin from a feed containing 4.72 meq. Na_2CrO_4 and 5.95 meq. H_2SO_4 /liter, introduced at 25 ml./minute. From *Ind. Eng. Chem.* **37**, 621 (1945).

Attempts to remove chromate from an acid solution approximating a plating waste in composition were partially successful. In this case Fig. 11, an alkali-regenerated anion exchange resin was used and the excess acid present in the waste was depended upon to convert the resin to the salt form. Unfortunately, the acid present was sulfuric acid and the exchange was less efficient than that obtained with the resin hydrochloride, as shown above. Initial conversion of the resin to the chloride form would

not help when using this feed because the chloride would immediately be displaced by the sulfate when the solution was placed in contact with the exchanger.

In the experiments on the chloride-chromate cycle, chromium recoveries averaged about 85% over the series of repeated cycles summarized in Table III. The chromium unaccounted for in the recovery procedure was apparently retained in the anion exchanger bed and could be measured

TABLE III*

Repeated Cyclic Chromate Adsorption and Recovery on an Anion Exchange Resin Chloride

(100-ml. bed of anion exchange resin chloride in 23-mm.-diameter tube; feed flow rate, 50 ml./min.; recovery and regenerant flow rates, 5 ml./min.; regenerant, 200 ml. of 1.4 N HCl; feed, 13.5 meq./liter CrO_4^{--} ; end point, 2.0 meq./liter CrO_4^{--} in effluent).

Run No.	Adsorption capacity meq./l.	NH_4OH Recovery		Chromate recovery %
		Normality	Dosage, eq./l.	
1	781	1.0	2.6	76
2	705	2.8	10.5	84.8
3	648	13.4	53.6	81.2
4	662	13.4	46.9	85.5
5	665	13.4	46.9	84.0
6	630	13.4	46.9	85.2
7	624	13.4	46.9	89.5

* Reprinted from *Ind. Eng. Chem.* **37**, 620 (1945).

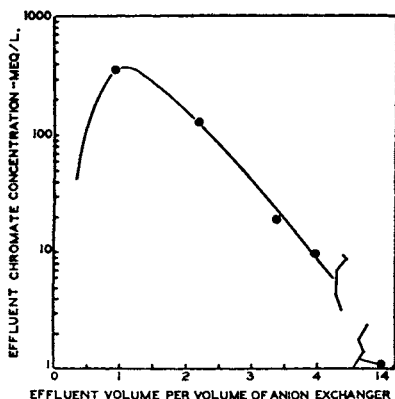

FIG. 12. Chromate concentration in a typical recovery effluent. Recovery agent was 13.4 N NH_4OH applied in a dosage of 46.9 equivalents/liter of anion exchanger. From *Ind. Eng. Chem.* **37**, 622 (1945).

quantitatively by ashing the anion exchanger and analyzing the ash for chromium. Apparently some oxidation of the anion exchange resin takes place, reducing the chromate to chromic ion and thus converting it to a

form which is not removable from the bed under the experimental conditions. Periodic treatment of the anion exchanger with an excess of an acid solution should permit recovery of this reduced chromium.

The elution of chromium by ammonium hydroxide provided concentrations of effluent better than 25 times as high as the influent chromium. Figure 12 shows a typical recovery curve. Recycling the recovery effluent fractions containing lower concentrations of chromate, together with added alkali, will definitely result in greater average chromate concentrations in the recovery liquor.

V. MOLYBDENUM, VANADIUM, IRON

In demonstrating the broad general nature of the anion exchange technique for adsorbing metals which form complex anions, Sussman *et al.* (17) also carried out experiments with salts of molybdenum, vanadium and iron.

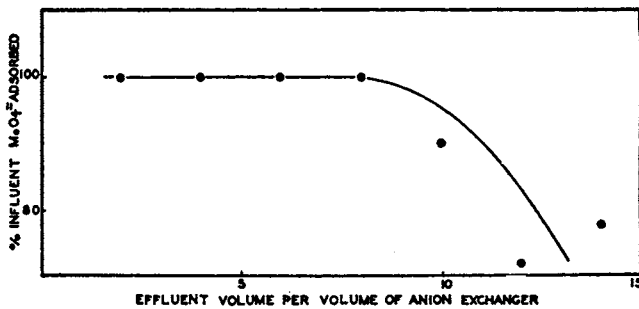

Fig. 13. Molybdate adsorption efficiency. Adsorption from 25 meq. ammonium molybdate/liter by a 100-ml. bed of anion exchange resin chloride (flow rate, 26 ml./minute). From *Ind. Eng. Chem.* **37**, 622 (1945).

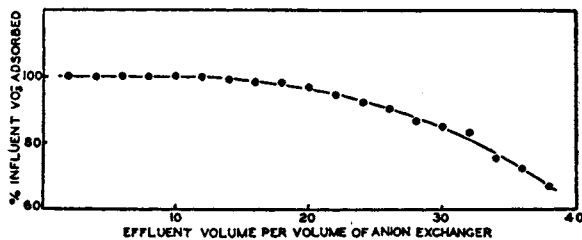

Fig. 14. Vanadate adsorption efficiency. Adsorption from 12.8 meq./liter ammonium metavanadate by a 100-ml. bed of anion exchange resin chloride (flow rate, 50 ml./minute). From *Ind. Eng. Chem.* **37**, 622 (1945).

Figure 13 shows the efficiency of an anion exchange resin salt for the removal of molybdates from solution. Recovery of the molybdates from the anion exchanger was carried out with a salt solution and resulted in a

77% recovery of the adsorbed metals. Reasoning from the results obtained in the case of chromium, improved recovery would undoubtedly result from the use of an alkaline regenerant.

Data on the removal of vanadium from a vanadate solution by a bed of an anion exchange resin salt are summarized in Fig. 14. The adsorbed vanadate was recovered virtually quantitatively by treatment with 2.8 *N* ammonium hydroxide.

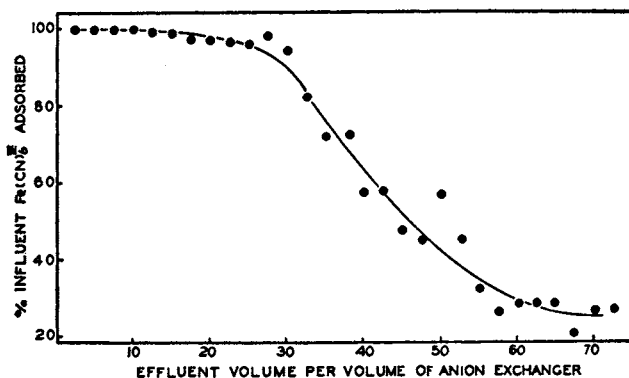

FIG. 15. Ferrocyanide adsorption efficiency. Adsorption from 20 meq. potassium ferrocyanide/liter by a 100-ml. bed of anion exchange resin chloride (flow rate, 25 ml./min.). From *Ind. Eng. Chem.* **37**, 623 (1945).

Iron, when present as a complex anion, can also be removed from solutions by this method although this is of greater interest chemically than metallurgically. Figure 15 shows the removal of ferrocyanide ion from a solution of potassium ferrocyanide by an anion exchanger salt. Using a sodium hydroxide regenerating solution, 97% of the adsorbed ferrocyanide was recoverable.

Whenever these metals occur in the form of cations, it is of course possible to recover them by cation exchange, although in the case of some members of this group, such as iron, that is hardly justifiable economically. One interesting application of this cation exchange procedure for recovering metals of this group was published by Jones (18). He reported on the recovery of molybdenum, vanadium, nickel, and zinc from petroleum oils. A natural zeolite was mixed with the oil, heated to an appropriate temperature and pressure, and then separated. The metallic constituents were recovered from the zeolite by treating the latter with a dilute acid to recover the metals and then with salt to regenerate the zeolite for re-use. It is hardly likely that inorganic zeolites will stand up for very many cycles under this regenerating procedure, and it is even less likely that the organic cation exchangers will stand up under the temperature conditions required here.

VI. PRECIOUS METALS — THE PLATINUM GROUP AND GOLD

Complex anions are readily formed by the precious metals (gold and the platinum group) in the presence of free acidity. Sussman *et al.* (17) have reviewed the methods commonly used for recovery of these metals from waste solutions and have demonstrated that alkali-regenerated anion exchangers can be used for their recovery.

1. Platinum

Inasmuch as one of the common methods for handling such wastes depends upon adsorption by an activated carbon, it was of interest to compare results obtained when using the anion exchange method with

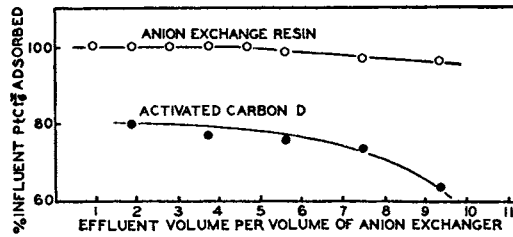

Fig. 16. Comparative chloroplatinate adsorption efficiencies of an anion exchanger and an activated carbon. Adsorption of 19.7 meq. chloroplatinic acid /liter by 53-ml. beds of adsorbent at 10 ml./minute. From *Ind. Eng. Chem.* **37**, 624 (1945).

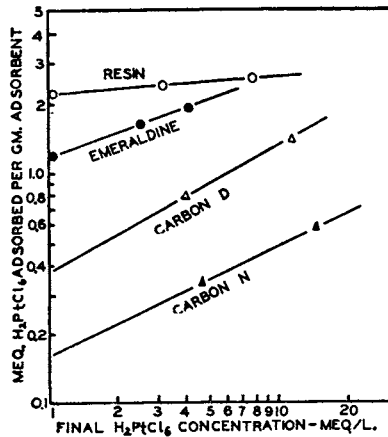

Fig. 17. Chloroplatinate adsorption isotherms. Equilibrium adsorption from chloroplatinic acid solutions on two anion exchangers and two activated carbons. From *Ind. Eng. Chem.* **37**, 623 (1945).

those obtained when using activated carbon as the adsorbent. In the case of platinum, as chloroplatinate ion, both equilibrium and dynamic (tube type) experiments demonstrated the superiority of anion exchangers, both

aliphatic amine resins and the older emeraldine, for both completeness of platinum removal (Fig. 16) and ultimate capacity for platinum (Fig. 17).

One unusual feature of the precious metals pointed out by one of us (F.C.N.) is that their value is so high that recovery by ashing of an anion exchange resin containing the adsorbed metal may be warranted (19). Laboratory experiments have demonstrated complete recovery of the precious metal by ashing the anion exchanger and dissolving the ash in aqua regia. In fact, as far as current laboratory explorations of this process have proceeded, this appears to be the one practical way of recovering the platinum completely. Attempts to regenerate the anion exchanger with ammonium hydroxide at room temperature are frustrated by the insolubility of ammonium chloroplatinate. Use of hot regenerant solutions resulted in the recovery of only 35% of the adsorbed platinum. Even less was recovered in the effluent solution when a sodium carbonate solution was used as the regenerant.

2. Palladium

Palladium, as chloropalladic acid, was adsorbed by anion exchangers to a smaller extent than platinum as may be seen by a comparison of Fig. 18 with Fig. 17.

3. Gold

As reported earlier gold was one of the first of the metals to be recovered by ion exchange. Gans (1) suggested the possible use of manganese zeolites for precipitating gold from dilute solution. About thirty years later Burrell (20) proposed the recovery of gold from solutions by means of

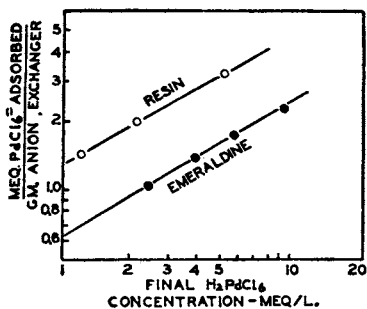

FIGURE 18

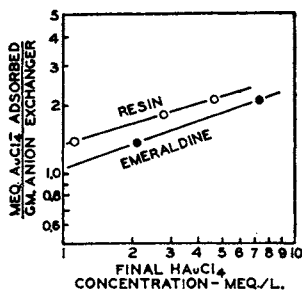

FIGURE 19

FIG. 18. Chloropalladate adsorption isotherms. Equilibrium adsorption from chloropalladic acid solutions on two anion exchangers. From *Ind. Eng. Chem.* **37**, 624 (1945).

FIG. 19. Chloroaurate adsorption isotherms. Equilibrium adsorption from chloroauric acid solutions on two anion exchangers. From *Ind. Eng. Chem.* **37**, 624 (1945).

cation exchange resins. Baur (21) made a study of the adsorption of gold from dilute solutions on numerous adsorbents including a synthetic sodium aluminosilicate cation exchanger. He was concerned with the recovery of gold from sea water and on the basis of an estimated gold concentration of about 5mg./m.³ of sea water, his data, obtained with sodium chloroaurate, indicated a capacity of 0.001 mg. gold/g. of this cation exchanger. In view of the fact that this gold was present as a complex anion, it is quite possible that the gold was removed from solution by adsorption on the cation exchanger rather than by ion exchange.

One would expect that gold, commonly occurring in waste solutions as a complex anion, could also be removed by the anion exchange technique described above for the platinum metals and this was found to be true. Figure 19 shows the adsorption isotherms for chloroaurate solutions with two different types of anion exchanger. As might be expected from the equation showing the formation of the chloroaurate ion, an increase in the hydrochloric acid-auric chloride ratio was found to increase the capacity of the anion exchangers for gold.

VII. MAGNESIUM

Recovery of magnesium from sea water by processes involving cation exchange and anion exchange have been patented in Great Britain. One patent (22) involved the precipitation of magnesium as the hydroxide, solution of the precipitate by acid, removal of the magnesium from solution by means of a sodium cation exchanger, and, finally, regeneration of the cation exchanger with a salt solution thereby yielding a solution of magnesium chloride contaminated with small amounts of magnesium sulfate and sodium chloride. It is difficult to see the value of this particular process. It would appear to be much more practical to dissolve the initial magnesium hydroxide precipitate directly in a hydrochloric acid solution.

The second of these patents (23) included an even more complicated and ingenious process. Magnesium hydroxide, precipitated from sea water by lime, was reacted in a slurry mixture with the hydrochloric acid salt of an anion exchanger to form a mixture of magnesium chloride and the regenerated anion exchanger. After separation of the solution from the solid, the anion exchanger was treated with hydrochloric acid and was re-used in a subsequent step. The magnesium chloride solution was passed through an acid-regenerated cation exchanger to form a hydrochloric acid solution which was used for the above conversion of the anion exchanger to its salt. The resulting magnesium salt of the cation exchanger was then regenerated with sulfuric acid in order to form the regenerated cation exchanger and a magnesium sulfate solution. Although the process was alleged to give a more concentrated solution of the product, it is difficult

for the writers to see what, if any, advantage this series of reactions, however ingenious, offers over simple solution of the original magnesium hydroxide precipitate in sulfuric acid.

Other workers in this field (24, 25) however, have patented useful processes which appear economically feasible. These made use of cation exchangers as means for concentrating magnesium salts from sea water or other brines. In the first of these patents, brines containing 0.01 to 0.4 gram-atoms of magnesium per liter together with 0.02 to 16 gram-atoms of alkali metals per liter were treated with a cation exchanger which was subsequently regenerated with a salt, other than a magnesium salt, in concentrations greater than 1.8 *N*. Although either the sodium or hydrogen cycle may be used, the former is preferred. By the use of the cation exchanger the magnesium/sodium ratio in a brine was changed from 0.2 to 0.67, and even higher. For optimum results, it was found necessary to have sufficiently long contact time, high regenerant concentrations, and a height/diameter ratio of at least 5 in the cation exchanger bed.

Minimum regenerant concentrations were 10–15% and saturated salt solutions were preferred. The height/diameter ratio was important in order to minimize mixing of the sea water and regenerant as one was displaced by the other. A fourth factor of interest was dilution of the sea water feed after completing magnesium saturation of the exchanger, that is, after the effluent magnesium became equal to the influent magnesium. Dilution of additional quantities of sea water with at least one, and preferably two to five, volumes of fresh water resulted in some additional magnesium adsorption, apparently as a result of shifts in equilibrium relationships.

The magnesium rich mid-portions of the regenerant effluent were removed for evaporation and recovery of the magnesium salts. The leaner first and final portions were saturated with salt and used for the first regenerant portions on subsequent cycles thereby building up the magnesium concentration. About 70% of the adsorbed magnesium was recoverable in the mid-fraction which was used directly without this re-cycling.

The second patent (25) reported the use of a special carboxylated cation exchange resin for the recovery of magnesium from brines and sea water by a slightly different process. The magnesium was displaced from the cation exchanger with a solution of an acid having an ionization constant at least 1.8×10^{-5} . The acid concentration must be at least normal. Regeneration of the resin was then effected with a solution of an alkali which also contained a salt of that alkali with a strong acid. A synthetic sea water containing 0.5% magnesium chloride by weight gave a regenerant effluent the richest 80% of which contained about 13% magnesium chloride

by weight, corresponding to approximately a 25-fold enrichment by this single treatment. In this case 15% hydrochloric acid was the elution agent and the cation exchanger was prepared for re-use by treatment with a solution containing 5% sodium hydroxide and 10% sodium chloride.

As magnesium recovery processes, the practical utility of these patents is probably limited by the low cost and ready availability of the lime used in the ordinary recovery processes.

VIII. OTHER METALS

1. *Rare Earths*

The rare earths provide an interesting example of metals whose value is sufficiently high so that ion exchange methods are of very definite interest in their commercial preparation despite the necessity for special regenerating chemicals and techniques. The ion exchange treatment of these metals is covered more adequately elsewhere in this book (cf. chapter by Schubert, p. 167).

2. *Zirconium*

An interesting application of ion exchange for metal purification has been reported by Ayres (26). In the purification of zirconium, he prepared a solution in which zirconium was present in colloidal form and was not adsorbed by the resin whereas the impurities present as cations were removed by cation exchange. By this means zirconium was separated from iron, titanium, beryllium, and lanthanum.

3. *Bismuth*

Although no ion exchange applications for the recovery of bismuth have as yet been reported, data obtained by Piret and Carlson (7) have indicated the distinct possibility of recovering this metal from acid solutions by cation exchange.

4. *Nickel*

Among other ion exchange examples, Austerweil and Jeanprost (2) disclosed the separation of small amounts of nickel from solutions of cobalt nitrate. A greensand cation exchanger was saturated with a 10% solution of chemically pure cobalt nitrate. A solution of technical cobalt nitrate, containing nickel nitrate in the ratio of about 1:12 of the cobalt nitrate, was then passed through the exchanger. Nickel was retained by the exchanger, leaving a purified cobalt nitrate in solution.

Synthetic gel type sodium aluminosilicate cation exchangers have been successfully applied by us to the removal of traces of nickel from con-

densates from evaporators equipped with Monel tubes, prior to use of the condensate in an application for which the presence of nickel was highly undesirable. Recovery of the nickel was not required in this case, although it could doubtless be accomplished if economically justified.

IX. SEPARATIONS OF METALS

Partial or complete separations of various metallic ions are involved in almost all of the ion exchange processes reported in this chapter. Separations of the barium-radium system are reported elsewhere (cf. the chapter by Reid, p. 151). A few additional cases are reported here because of the data they present.

Separation of copper and zinc by cation exchange has been reported by Griessbach (10). Starting with a solution containing 15 g./liter zinc and 5 g./liter copper, passage through a bed of cation exchange resin gave an effluent containing up to 17.6 g./liter zinc and no copper for a substantial portion of the run. Analysis of sections from the exchanger column showed molecular ratios of zinc to copper ranging from about 1 at the top of the column to about 17 near the bottom.

Copper and nickel, cadmium and zinc, and silver and copper were at least partially separated on a sulfonated coal cation exchanger by Kozak and Walton (27). Separation of the last pair was particularly effective.

X. SUMMARY

The material presented in this chapter indicates that the application of ion exchange processes to concentration and recovery of many metallurgically important metals has reached a point where these processes are technically sound, but there is still some question of their economic justification in a free economy. It is the feeling of the authors that we are standing at the threshold of a period during which industrial use of ion exchange for metal concentration and recovery will increase substantially as the result of improved ion exchangers and techniques, increased attention to waste water problems, and increased familiarity with the techniques of ion exchange on the part of chemists and chemical engineers.

BIBLIOGRAPHY

1. Gans, R., *Chem. Ind.* **32**, 197-200 (1909).
2. Austerweil, G., and Jeanprost, C., U. S. Patent 1,978,447 (October 30, 1934).
3. Ets. Phillips and Pain, French Patent 808,997 (February 19, 1937).
4. Tiger, H. L., and Goetz, P. C., U. S. Patent 2,397,575 (April 2, 1946), also Canadian Patent 396,040 (April 22, 1941).
5. Beaton, R. H., and Furnas, C. C., *Ind. Eng. Chem.* **33**, 1500-13 (1941).
6. Schumann, T. E. W., *J. Franklin Inst.* **208**, 305 (1929).

7. Piret, E. L., and Carlson, R. W., *Proc. Minn. Acad. Sci.* **9**, 70-2 (1941).
8. Nelson, R., and Walton, H. F., *J. Phys. Chem.* **48**, 406-10 (1944).
9. Syrkin, Z. N., and Krynkina, A. Y., Russian Patent 50,548 (February 28, 1937).
10. Griessbach, R., *Ver. Deut. Chemiker Beihefte No. 31*, 16 pp., Verlag Chemie, Berlin (1939).
11. Gerstner, Report PB 19585, Office of Technical Services, Washington (1946).
12. Topp, N. E., Report PB 41238 (B. I. O. S. Final Report 621, Item No. 22), pg. 16, Office of Technical Services, Washington (1946).
13. Myers, F. J., Report PB 42802 (FIAT Final Report 715), pp. 21-22, Office of Technical Services, Washington (1946).
14. Myers, R. J., U. S. Patent 2,341,329 (February 8, 1944).
15. Myers, F. J. (Reference 13) pp. 33-5.
16. Grindley, J., *J. Soc. Chem. Ind.* **64**, 339-44 (1945).
17. Sussman, S., Nachod, F. C., and Wood, W., *Ind. Eng. Chem.* **37**, 618-24 (1945).
18. Jones, M. C. K., U. S. Patent 2,383,972 (September 4, 1945).
19. Nachod, F. C., U. S. Patent 2,371,119 (March 6, 1945).
20. Burrell, H., U. S. Patent 2,161,936 (June 20, 1939).
21. Baur, E., *Helv. Chim. Acta* **25**, 1202-25 (1942).
22. Ocean Salts Ltd. and Adams, B. A., British Patent 536,266 (May 8, 1941).
23. Ocean Salts Ltd. and Adams, B. A., British Patent 541,450 (November 27, 1941).
24. Grebe, J. J., and Bauman, W. C., U. S. Patent 2,387,898 (October 30, 1945).
25. Hunter, M. J., and Bauman, W. C., U. S. Patent 2,409,861 (October 22, 1946).
26. Ayres, J. A., *J. Am. Chem. Soc.* **69**, 2879 (1947).
27. Kozak, R., and Walton, H. F., *J. Phys. Chem.* **49**, 471-2 (1945).

Catalytic Applications of Ion Exchangers

SIDNEY SUSSMAN

Liquid Conditioning Corporation, Linden, New Jersey

CONTENTS		Page
I.	Introduction	261
II.	Inorganic Catalysts.	262
	1. Oxidations	262
	2. Reductions	264
	3. Condensations and Other Reactions	264
	4. Petroleum Refining	264
III.	Organic Catalysts — Acid Regenerated Cation Exchangers	265
	1. Advantages	266
	2. Catalysts	267
	3. Catalyst Preparation	267
	4. Reactions Catalyzed	268
	(a) Esterification	268
	(1) Catalyst re-use	268
	(2) Continuous operation	269
	(3) Acid-sensitive compounds.	269
	(b) Ester Hydrolysis	269
	(c) Ester Alcoholysis	270
	(d) Ester Acidolysis	270
	(e) Acetal Synthesis	270
	(f) Acetal Alcoholysis	270
	(g) Alcohol Dehydration	270
	(h) Sucrose Inversion	271
IV.	Anion Exchangers	271
V.	Summary	271
	Bibliography	272

I. INTRODUCTION

For over thirty years ion exchangers and their derivatives have been suggested and used as catalysts for a wide variety of reactions, both inorganic and organic. The catalytic function is sometimes clearly allied to the ion exchange properties of the material and in other cases the reverse is true. However, because of their close mutual relationship to ion exchanging products, both types of catalysts are discussed in this chapter.

II. INORGANIC CATALYSTS

1. *Oxidations*

As early as 1915 zeolite catalysts were patented for the oxidation of ammonia (1). These catalysts were aluminosilicates in which the alkali metal and, in some cases, part of the aluminum were replaced by heavy metals. A chromium aluminosilicate, for example, was said to catalyze the oxidation of ammonia to nitrogen oxides with 97–98% conversions when operating at red heat and atmospheric pressure.

At about the same time a British patent (2) was issued describing improvements in oxidation reactions, particularly the oxidation of sulfur dioxide to sulfur trioxide, by the use of zeolitic catalysts produced by introducing vanadium as an exchangeable base into the usual aluminosilicate zeolites. The vanadium in these catalysts was so loosely combined that it tended to agglomerate at the reaction temperatures because of its relatively low melting point. As a result, this particular catalyst did not achieve commercial success.

About ten years later, however, Alphons O. Jaeger developed for this same reaction a zeolitic catalyst in which vanadium was present as part of the nonexchangeable nucleus of the zeolite (3). This improved catalyst was more effective than the earlier catalysts and did not lose its activity by agglomeration.

Jaeger and co-workers have been issued better than sixty patents covering the preparation of such catalysts and their application to sulfur dioxide oxidation, other oxidations, and a wide variety of inorganic and organic reactions as mentioned later in this chapter. The catalysts are generally complex zeolites of the same general type as the aluminosilicates, although particular catalysts may be entirely free from either aluminum or silicon, and contain one or more heavy metals in the exchange or non-exchange positions of the gel structure. Metals such as tungsten, molybdenum, manganese, vanadium, titanium, chromium, and uranium are mentioned in a typical catalyst preparation patent (4) and many other heavy metals are mentioned in other patents of this series. However, catalysts containing tetravalent (5) or quinquivalent (6) vanadium were apparently the most effective.

The many zeolitic catalysts reported by Jaeger were prepared by methods essentially the same as those used for the preparation of the precipitated synthetic gel sodium aluminosilicate base exchangers used for water softening. Solutions of a soluble silicate, a salt of a catalytically reactive metal and a metalate salt were mixed to form a gel or precipitate. The product was filtered, shaped if desired, and dried. The effects of drying conditions upon pore size and other factors influencing catalytic

activity were well recognized. In some cases, the zeolitic gel was deposited on inert carriers in order to increase the available catalytically active surface.

A modification of Jaeger's original vanadium catalyst (7) was one of the first zeolitic catalysts to be installed on a substantial commercial scale (8). Later modifications of the catalysts (9, 10, 11) were much more efficient contact masses, exceeding the best platinum catalysts in efficiency. Nonsiliceous zeolites containing vanadium in nonexchangeable positions were long lived and showed extraordinary resistance to both high temperatures and the usual poisons for platinum. Jaeger (3) reports a test in which the vanadium catalyst was treated with about two-thirds of its own weight of catalyst poisons, including compounds of arsenic, selenium, antimony, hydrofluoric acid, and hydrochloric acid. No diminution in activity could be observed and, indeed, after the addition of arsenic compounds to the reaction gas, a slight increase in catalytic activity was noticeable. The net result of these new catalysts was that contact sulfuric plants were freed from the earlier restrictions on the purity of the reacting gases. In fact, with these zeolitic catalysts, it was possible to operate a contact sulfuric acid plant on smelter gases.

The vanadium zeolite catalysts were much more efficient than platinum catalysts on a commercial scale. In one forty-ton plant, the first 10% of the contact mass, in which the temperature rise was at its greatest, converted 80% of the sulfur dioxide to sulfur trioxide. This conversion is considerably better than that of the best commercial results with platinum catalysts. A fifty-ton vanadium zeolite plant operated with a conversion of more than 99.9% on 5% sulfur dioxide influent gas.

Jaeger has also reported the use of these zeolitic catalysts for other oxidation reactions including the oxidation of ammonia to nitric acid, methanol to formaldehyde, naphthalene to phthalic anhydride, anthracene to anthraquinone, and many other oxidations of organic compounds (12, 13, 14).

Similar complex vanadium-containing zeolite catalysts have been reported from abroad (15). Tin-containing complexes were reported to hold the vanadium better than silicon-containing complexes. For the oxidation of sulfur dioxide to sulfur trioxide, the optimum catalyst composition was reported to be $\text{Na}_2\text{O} \cdot \text{V}_2\text{O}_5 \cdot 4 \text{SnO}_2 \cdot x\text{H}_2\text{O}$. This catalyst gave a 99.5% conversion to sulfur trioxide at 400° when operating on an influent gas containing 6.5–10% of sulfur dioxide.

A British patent (16) describes the preparation of catalysts for the production of oxygen-containing compounds from carbon monoxide and steam. These catalysts are zeolites precipitated at a pH between 6.8 and 8 and contain at least one element from each of two groups. The first of

these groups includes the alkali metals and numerous other heavy metals such as vanadium, chromium, molybdenum, manganese, iron, cobalt, nickel, silver, copper, zinc, cadmium, lead, antimony, bismuth, and the alkaline earths. The second group contains beryllium, magnesium, aluminum, cerium, the rare earths, boron, silicon, titanium, zirconium, thorium, uranium, and tungsten.

Aluminum zeolites have been reported to be satisfactory catalysts for the oxidation of nitric oxide to nitrogen peroxide at 200–300°C. and for the oxidation of nitrosyl chloride to nitric oxide and chlorine at 200–400°C. (17). Natural zeolites, such as chabazite, are also reported to catalyze oxidation of nitrosyl chloride to chlorine and nitrogen dioxide at 100–400°C. (18).

2. Reductions

Among the numerous reactions which Jaeger found to be catalyzed by the various zeolitic catalysts were numerous hydrogenations including ammonia synthesis (19), reduction of nitrobenzene to aniline, and of pyridine to piperidine (20), and hydrogenation of non-nitrogenous organic compound such as naphthalene, acetylene, and linseed oil (21). For these last reductions, zeolitic catalysts containing nonexchangeable nickel, copper, or manganese were recommended.

3. Condensations and Other Reactions

The same investigator also reported a great number of condensations and other reactions of organic compounds which were catalyzed by zeolite catalysts. One patent (22) states that these catalysts are suitable for esterifications, polymerizations, condensations, and the water gas reaction. Another (23) refers to a wide variety of reactions including dehydrogenation of alcohols to aldehydes and ketones, dehydrations of alcohols to olefins and of organic acids to anhydrides, deamination of aniline to diphenylamine, and a combined decarboxylation and deamination as in the reaction of phthalic acid with ammonia and hydrogen to form benzamide.

Lead zeolites of the synthetic gel aluminosilicate type have also been shown to have catalytic effects for condensation reactions (24). By the use of this catalyst formaldehyde was condensed with aliphatic or mixed ketones as, for example, in the synthesis of methyl vinyl ketone from acetone and formaldehyde.

4. Petroleum Refining

Probably the largest single user of zeolitic catalysts and catalysts derived from zeolites is the petroleum industry. Virtually all of the petroleum cracking and re-forming catalysts currently in use are either zeo-

litic themselves, whether of natural or synthetic origin, or were prepared by the processing of materials which were initially zeolitic.

Among the naturally zeolitic products are the various clays containing montmorillonite. Most of the alumina-silica cracking catalysts are initially prepared as sodium or ammonium aluminosilicates and are later converted to the desired products which are free of alkali metal ions. Thus Connolly (25) described the preparation of a petroleum cracking catalyst by leaching with acid a synthetic gel type sodium aluminosilicate. In another approach to the preparation of similar catalysts, a synthetic ammonium aluminosilicate was heated to a temperature sufficiently high to break down the ammonium complex and to drive off the liberated ammonia (26). The residual alumina-silica granules were stated to be catalysts for polymerizing hydrocarbon vapors containing diolefins.

The more recent bead type catalysts are similarly prepared. Marisic (27) described the preparation of these catalysts by preparing a sodium aluminosilicate under conditions where gelation occurs while the droplets are falling through a layer of oil, washing with naphtha and water, treating with an ammonium chloride solution, drying slowly at 180°F. until no more shrinkage occurs, and finally heating gradually to 1050°F. so that the ammonium zeolite is decomposed with loss of ammonia. The catalysts so prepared were used for petroleum cracking.

The entire field of petroleum catalysts is so vast that we can little more than mention it in a review of this type. From the ion exchange viewpoint, however, it is interesting to note that a recent publication points out a rough parallel between the cation exchange capacity of natural clays and kaolins and their catalytic activity in cracking. It was found that treatments harmful to the catalytic activity also lower the exchange capacity (28).

Aside from cracking, ion exchangers have also been utilized in the desulfurization of petroleum products such as sour naphtha. Jones (29) has described desulfurization processes with sodium aluminosilicates, while Nachod (30) has patented processes involving copper and lead aluminosilicates.

III. ORGANIC CATALYSTS — ACID REGENERATED CATION EXCHANGERS

The development of stable acid-regenerable cation exchangers which are essentially insoluble strong acids presented organic chemists with a new catalyst for many reactions. A rather comprehensive preliminary study (31) demonstrated the catalytic effect of these ion exchangers for a variety of organic reactions including esterification, acetal synthesis, ester alcoholysis, acetal alcoholysis, alcohol dehydration, ester hydrolysis, and

sucrose inversion. Ester acidolysis has also been carried out with these new catalysts (32).

Although cation exchangers are more expensive per equivalent of available hydrogen ion than the sulfuric, hydrochloric, or various sulfonic acids normally used as acid catalysts for organic reactions, use of the exchangers can be justified in many instances on the basis of special advantages derived from their physical or chemical properties, as demonstrated by their adoption for several industrial installations in at least one of which a cation exchanger has been in use as an esterification catalyst for about five years.

1. *Advantages*

Ease of separation of the catalyst from the reaction products is one of the outstanding advantages of the cation exchangers. For batch operations the catalyst may be removed by simple filtration or decantation, and no additional chemical treatment of the reaction mixture is required before proceeding with separation of the products. Thus the difficulties commonly encountered when liming or otherwise neutralizing soluble acid catalysts in organic media are entirely avoided. This advantage of cation exchanger catalysts is especially apparent when the reaction products are viscous or high boiling liquids.

The simple physical separation of the catalyst is an important factor in making it possible for cation exchangers to compete economically with the much less expensive soluble acid catalysts. After separation from the reaction mixture no additional treatment is necessary in order to re-use the cation exchangers as catalysts. This, of course, reduces the cost of catalyst per unit of product. Such catalyst re-use has been demonstrated for at least five to ten successive runs on both laboratory and industrial scales.

Allied to the re-use of cation exchanger catalysts in batch operations is the ability to employ these catalysts in fixed beds for continuous operation. Such operations have been carried on abroad on a sizable scale.

Cation exchangers are much less prone to cause damage to organic compounds than are other acid catalysts. For example, the discoloring effects of sulfuric acid are eliminated, resulting in higher quality products. It has even been possible to distill rather high-boiling reaction products directly from the cation exchanger catalyst without adverse effects. Acid-sensitive compounds which normally resinify when brought into contact with the usual acid catalysts have been directly esterified for the first time in the presence of a cation exchanger.

Catalysis by cation exchangers should also minimize the corrosion and metal contamination problems encountered when using the soluble acid catalysts.

2. Catalysts

Synthetic resin and sulfonated coal cation exchangers have both been used as catalysts. Several investigators have successfully applied phenol-formaldehyde sulfonic acid resins (34) and rather substantial continuous units have employed a resin made by condensation of phenol, formaldehyde, and sodium sulfite, followed by treatment with sulfuric acid (35). The results obtained with different cation exchangers as catalysts are qualitatively similar but vary in some quantitative aspects. Differences have been found in reaction rates, solubility of the catalyst with resultant coloring of the reaction products, and temperature stability of the catalyst.

The catalytic effects of several commercially available cation exchange resins have not yet been reported. One of these, the recently announced sulfonated polystyrene cation exchange resin (36) has already proved to be a superior catalyst for ester hydrolysis because of its acid strength, decreased solubility, and increased thermal stability.

The laboratory investigations reported in the literature have been carried out with cation exchanger granules corresponding in size to those normally offered for water treatment use (approximately 10-50 mesh). Finer material, actually production "fines", has been used industrially in at least one batch type operation.

For continuous operation with fixed catalyst beds, cation exchanger particles approximately one-quarter inch in size have been used in commercial operation and the use of pieces as large as 1.5 inches has been proposed for other installations of this type. These large catalyst particles were prepared by bonding the active cation exchange resin granules with a phenol-formaldehyde resin binder, baking, and crushing to the desired size. By using the minimum amount of binder necessary to obtain the desired mechanical strength, porosity and high active surface area were largely retained (35).

3. Catalyst Preparation

For catalyst use the cation exchangers must, of course, be in the hydrogen or acid-regenerated form. The usual procedure for preparing the cation exchanger for use as a catalyst includes treatment with a large excess of sulfuric or hydrochloric acid, followed by extensive rinsing with demineralized or distilled water until the rinse effluent is substantially free of the anion of the acid used, or until the pH of the rinse effluent is constant and approximates that of the rinse influent. Treatment with a quantity of 5-10% acid corresponding to at least four times the exchange capacity will generally provide a suitable catalyst.

4. Reactions Catalyzed

(a) *Esterification.* Since esterifications probably make up the bulk of the industrially significant acid-catalyzed organic reactions, it is not surprising that most of the work carried out to date with cation exchangers, as acid catalysts has involved esterification reactions. With this type of reaction, various types of cation exchanger have been used successfully, catalyst re-use and continuous operation have been demonstrated even on a plant scale, acid-sensitive compounds have been reacted without side reactions, and compounds with a wide variety of properties have been caused to react.

In a typical experiment (31) oleic acid containing 25% by weight (dry basis) of air dry sulfonated coal cation exchanger was refluxed with four moles of *n*-butanol. The *n*-butanol acted as an azeotropic water carrier in addition to reacting with the oleic acid. After water evolution had stopped the catalyst was removed by filtration, washed with *n*-butanol, and re-used in subsequent esterifications. The *n*-butyl oleate was obtained in almost quantitative yield by distillation of the combined filtrate and washings.

Other compounds prepared by esterification in the presence of cation exchangers include triacetin, glycol diacetate, ethyl chloroacetate, dimethyl adipate, and butyl esters of various higher fatty acids.

A rate study of the esterification of oleic acid with butanol in the presence of a cation exchange resin indicated that the reaction was essentially second order after an initial slow rate induction period. The velocity constant for the reaction was found to be directly proportional to the surface area of the catalyst per unit weight of reactants (37).

(1) *Catalyst re-use.* Typical laboratory results obtained by continued re-use of a cation exchanger catalyst in the esterification of *n*-butanol with oleic acid are summarized in Table I, which indicates no apparent loss in catalytic activity during five cycles.

TABLE I*
Re-Use of Esterification Catalyst

Run	Sulfonated coal Cation Exchanger G.	Source	Time, hr.	Product, G. Oleic acid	<i>n</i> -Butyl oleate	Ester yield, %
Blank	0	—	5	72.8	0	0
A	15	Fresh Catalyst	2	0.65	84.6	99.5
B	(15)	Run A	2.25	1.3	81.3	95.8
C	(15)	Run B	3	1.5	84.2	99.0
D	(15)	Run C	6.5	1.1	83.2	97.8
E	(15)	Run D	4.5	0.8	81.7	96.1

* Reprinted from *Ind. Eng. Chem.* **38**, 1229 (1946).

One industrial installation employing sulfonated coal cation exchanger "fines" as the catalyst in the preparation of *n*- and isobutyl fatty acid esters is able to use the catalyst for about 10 cycles before physical breakdown makes replacement by fresh material necessary (33). Catalyst consumption could probably be reduced in this installation by use of certain resinous cation exchangers, larger catalyst particle size, or conversion to a continuous system (which is planned).

(2) *Continuous operation.* The granular form of cation exchangers makes them particularly amenable to use in continuous systems employing a fixed catalyst bed through which the reactants are passed. Such operations have been carried out on a large scale.

In the continuous esterification of adipic acid with methanol, the mixed reactants were passed down through a cation exchange resin filled column while additional quantities of the alcohol or a carrier liquid were introduced in the lower part of the column. Water and the carrier liquid were removed at the head of the column and the ester was recovered from the bottom of the column. The dimethyl adipate was 99.97% pure as recovered and required no further purification. Space velocities corresponding to 0.5–1.5 kg. acid/liter of contact space per hour were employed.

In other continuous esterifications, the catalyst column was held at 5–10° above the boiling point of the ester. The reactant acid and alcohol were passed down through the column, and the ester taken off at the top.

(3) *Acid-sensitive compounds.* The great sensitivity of furfuryl alcohol to strong acids has heretofore prevented the direct esterification of this compound. Although the strong acids normally employed as esterification catalysts resinify this alcohol, furfuryl alcohol was directly esterified with acetic acid in the presence of an acid-regenerated cation exchanger. Yields were only 10–20% but there was no evidence of resin formation.

(b) *Ester Hydrolysis.* Experiments using a sulfonated coal cation exchanger as catalyst for hydrolysis of esters were reported to be unsuccessful or only slightly successful. A later report indicated successful hydrolysis of methyl, ethyl, *n*-butyl, and benzyl acetates at 25° using a resinous cation exchanger (38). With methyl and ethyl acetates in aqueous solution, hydrolysis was a first order reaction. With *n*-butyl or benzyl acetate present as a separate phase, the reaction was zero order. Under these experimental conditions, the cation exchange resin was found to be a more efficient catalyst than an equivalent amount of a strong soluble acid.

Continuous hydrolysis of an unidentified ester has also been reported (32). A mixture of ester and water was introduced in the upper part of a tower filled with cation exchange resin granules and steam was injected near the bottom. The water entering the system was proportioned so that

the acid was completely soluble in it when hot. The acid solution was drained off at the base of the column and liberated alcohol was taken off at the top of the column.

Recent unpublished work in this country has demonstrated highly successful continuous hydrolysis of aliphatic esters using a sulfonated polystyrene cation exchange resin in a fixed bed.

(c) *Ester Alcoholysis*. Ester interchange between methanol and amyl acetate was effected by heating in the presence of an acid-regenerated cation exchanger (less than 10% of the weight of ester). The relatively slow reaction rate in this case was apparently caused by the low catalyst dosage in terms of available hydrogen ion. This was demonstrated by a parallel experiment in which the catalyst was sulfuric acid equivalent to the hydrogen ion content of the amount of cation exchanger used in the first experiment. Reaction rates were the same in both runs.

Continuous ester alcoholysis with a fixed cation exchanger bed has also been carried out. When dimethyl adipate and butanol were passed downward through a cation exchanger packed column at 200–220°, methanol distilled from the top of the column and dibutyl adipate was recovered from the bottom. Work was also undertaken with formic acid esters.

(d) *Ester Acidolysis*. Acidolysis of dimethyl adipate with adipic acid to form monomethyl adipate was greatly accelerated by a cation exchange resin catalyst. In the absence of any catalyst at 200° about eight hours were required to reach equilibrium. This time was reduced to one-half to one hour when the resin catalyst was used. The same reaction was also carried out in a continuous system with fixed catalyst bed.

(e) *Acetal Synthesis*. Mixed glycerol formals were produced in about 90% yield by heating glycerol with 10–15% by weight of air dry cation exchanger and an equivalent amount of paraformaldehyde.

Somewhat higher yields were obtained in the preparation of di-(*n*-butoxy)-methane from *n*-butanol and paraformaldehyde. The catalyst was 12% by weight of the *n*-butanol. This preparation was particularly interesting in that the product, boiling at 177–179°, was distilled directly from the reaction flask without prior separation of the cation exchanger catalyst. Despite this treatment no charring or discoloration was apparent in the flask or in the product.

(f) *Acetal Alcoholysis*. The catalytic effect of cation exchangers in effecting alcoholysis of acetals was demonstrated by converting di-(*n*-butoxy)-methane to methylal. The original acetal was refluxed with methanol in the presence of 20% by weight of air-dry cation exchanger and methylal, in the form of the methanol-methylal azeotrope, was distilled from the mixture as formed.

(g) *Alcohol Dehydration* Some evidence of intramolecular dehydration

was obtained by heating isobutanol or castor oil in the presence of a sulfonated coal cation exchanger. In the latter case, however, the reaction required a temperature sufficiently high to cause some decomposition of the catalyst as indicated by the evolution of sulfur dioxide. It is probable that the new sulfonated polystyrene cation exchange resins, having greater thermal stability, will be more successful as a catalyst in such applications.

(h) *Sucrose Inversion*. Substantial inversion of sucrose was effected in qualitative tests on a 33% aqueous solution at 25°, 50°, and 90° using 2% by weight of air-dried cation exchanger. Table II summarizes the results of these experiments. Fehling's test was used to detect the presence of invert sugar and the degree of inversion is indicated roughly by plus signs ranging from a trace (+) to a very strongly positive test (+++). Catalytic sucrose inversion has proved to be particularly amenable to continuous operation with a fixed bed of cation exchanger.

TABLE II*
Sucrose Inversion

Minutes	<i>Result of Fehling Test at Reaction Time of:</i>					
	0	2	4	8	10	30
Blank (no catalyst)	—	—	—	—	—	—
25°C.	—	—	—	—	+	++
50°C.	—	—	—	+	++	+++
90°C.	—	—	+	++	+++	++++

* Reprinted from *Ind. Eng. Chem.* **38**, 1230 (1946).

IV. ANION EXCHANGERS

A recent publication gives the first clear cut example of catalysis by an anion exchanger (39). Refluxing of an aqueous solution of nicotino-nitrile with an approximately equal weight of a strongly basic anion exchange resin resulted in 86–90% yields of nicotinamide.

V. SUMMARY

Ion exchangers, both inorganic and organic, have been used for over 30 years as catalysts. A wide variety of reactions have been effected with the aid of these materials and wide commercial acceptance has been attained in petroleum refining and sulfuric acid manufacture for the inorganic zeolites. Recent work has indicated that this catalytic activity may be related to the ion exchange properties of the catalysts.

Acid-regenerated cation exchangers of both resin and sulfonated coal types have been successfully applied as catalysts in a wide variety of

organic reactions normally carried out in the presence of soluble strong acids. While more expensive per equivalent of hydrogen than the usual acid catalysts, the cation exchangers have chemical and physical properties which justify the added expense in some instances. Adoption of the process for several industrial installations confirms this view. With newer, more rugged cation exchangers being made available, this application is receiving rapidly increasing research attention.

BIBLIOGRAPHY

1. Permutit A.-G., German Patent 298,981 (May 2, 1915).
2. Johnson, J. Y. (to Badische Anilin und Soda Fabrik), British Patent 8462 (June 24, 1915).
3. Jaeger, A. O., *Ind. Eng. Chem.* **21**, 627-32 (1929).
4. Jaeger, A. O. and Bertsch, J. A., (to Selden Co.) U. S. Patent 1,696,546 (December 25, 1928).
5. Jaeger, A. O. (to Selden Co.) British Patent 348,669 (January 22, 1929).
6. Jaeger, A. O., and Bertsch, J. A., British Patent 266,007 (February 15, 1926).
7. Jaeger, A. O., and Bertsch, J. A., U. S. Patent 1,657,754 (January 31, 1928).
8. Nickell, L. F., *Chem. & Met. Eng.* **35**, 153 (1928).
9. Jaeger, A. O., U. S. Patent 1,675,308 (June 26, 1928).
10. Jaeger, A. O., U. S. Patent 1,675,309 (June 26, 1928).
11. Jaeger, A. O., U. S. Patent 1,694,123 (December 4, 1928).
12. Jaeger, A. O., British Patent 295,270 (August 8, 1927).
13. Jaeger, A. O. (to Selden Co.) U. S. Patent 1,694,620 (December 11, 1928).
14. Jaeger, A. O. (to Selden Co.) U. S. Patent 1,786,950 (December 30, 1930).
15. Adadurov, I. E., Borekov, G. K., Lisyanskaya, Z. M., *J. Chem. Ind. U. S. S. R.* **8**, 606-12 (1931).
16. Soc. Chimique de la grande Paroisse, British Patent 343,807 (February 7, 1930).
17. Klingelhofer, W. C., Jr., (to Solvay Process Co.) U. S. Patent 2,159,528 (May 23, 1939).
18. Beekhuis, H. A., Jr., (to Solvay Process Co.) U. S. Patent 2,261,329 (November 4, 1941).
19. Jaeger, A. O. (to Selden Co.) British Patent 307,457 (March 8, 1928).
20. Jaeger, A. O. (to Selden Co.) British Patent 304,640 (January 23, 1928).
21. Jaeger, A. O. (to Selden Co.) U. S. Patent 1,931,846 (October 24, 1933).
22. Jaeger, A. O. (to Selden Co.) U. S. Patent 1,896,240 (February 7, 1933).
23. Jaeger, A. O. (to Selden Co.) British Patent 309,024 (April 3, 1928).
24. Brant, J. H., and Hasche, R. L. (to Eastman Kodak Co.) U. S. Patent 2,245,567 (June 17, 1941).
25. Connolly, G. C. (to Standard Oil Development Co.) U. S. Patent 2,253,285 (August 19, 1941).
26. Hyman, J. (to Velsicol Corp.) U. S. Patent 2,137,492 (November 22, 1938).
27. Marisic, M. M. (to Socony-Vacuum Oil Co.) U. S. Patents 2,384,942 and 2,384,946 (September 18, 1945).
28. Bitepazh, Y. A., *J. Gen. Chem. U. S. S. R.* **17**, 199-207 (1947).
29. Jones, M. C. K., U. S. Patent 2,319,738 (May, 18, 1943).
30. Nachod, F. C. (to Atlantic Refining Co.) U. S. Patent 2,442,982 (June 8, 1948).
31. Sussman, S., *Ind. Eng. Chem.* **38**, 1228-30 (1946).

32. Dierichs, A., PB Report 866, Office of Technical Services, Department of Commerce, Washington (1945).
33. Anonymous, *Chem. Inds.* **61**, No. 3, 381 (1947).
34. Myers, R. J., Eastes, J. W., and Myers, F. J., *Ind. Eng. Chem.* **33**, 697 (1947).
35. Myers, F. J., PB Report 42802 (FIAT Final Report 715), p. 21, Office of Technical Services, Department of Commerce, Washington (1946).
36. Bauman, W. C., Skidmore, J. R., and Osmun, R. H., *Ind. Eng. Chem.* **40**, 1350-5 (1948).
37. Levesque, C. L., and Craig, A. M., *Ind. Eng. Chem.* **40**, 96-9 (1948).
38. Thomas, C. G., and Davies, C. W., *Nature*, **159**, 372 (March 15, 1947).
39. Galat, A., *J. Am. Chem. Soc.* **70**, 3945 (1948).

The Use of Ion Exchange Adsorbents in Biochemical and Physiological Studies

NORMAN APPELZWEIG

Hygrade Laboratories, Inc., Newark, New Jersey

CONTENTS		Page
I.	Introduction	275
II.	Applications to Biochemical Problems	277
	1. Isolation and Purification of Compounds	277
	2. Analytical Techniques.	282
III.	Studies Involving the Use of Exchange Adsorbents in Biological Systems	285
	1. Adsorption of Ions by Plant Cells	285
	2. Blood Coagulation	285
	3. Immunochemical Reactions	288
	4. Enzyme Reactions	289
	5. <i>In Vivo</i> Studies	290
	Bibliography	291

I. INTRODUCTION

The probing of the complexities of vital processes requires the endless evolution and application of new investigative methods. All fields of technical endeavor are under the constant scrutiny of biochemists and physiologists in search of new principles or processes that may be forged into weapons of attack.

From the workshop of the mechanical engineer to the atomic pile of the nuclear physicist, techniques and technicians are consistently being borrowed to construct new instruments with which to observe the elusive phenomena of life. In return, the basic methodology of the physical, chemical and biological sciences has been richly endowed with ingenious techniques devised in biochemical and physiological laboratories.

It is fitting that the techniques of ion exchange should prove to be useful to biologists. Although the present day methods seem to be adaptations of water purification processes, the first observation of ion exchange in soils and the elucidation of its principles almost a century ago may be credited to biologists (30, 80). Since then biochemists have made fundamental contributions toward the understanding of the nature of ion exchange and its utilization as a laboratory tool (4).

Ion exchange adsorption as a laboratory tool may be compared with distillation (Fig. 1). It is thus possible to carry out the following processes:

A. Replacement of undesirable ions by desirable ions (as in distillation of NH_3 after addition of NaOH).

B. Concentration of dilute ions for isolative or analytical purposes (as in concentration of solute by distilling off solvent).

C. Separation of compounds having different adsorption characteristics (as in fractional distillation).

D. Purification of compounds by removal of ionic contaminants (as in removal of volatile contaminants by distillation).

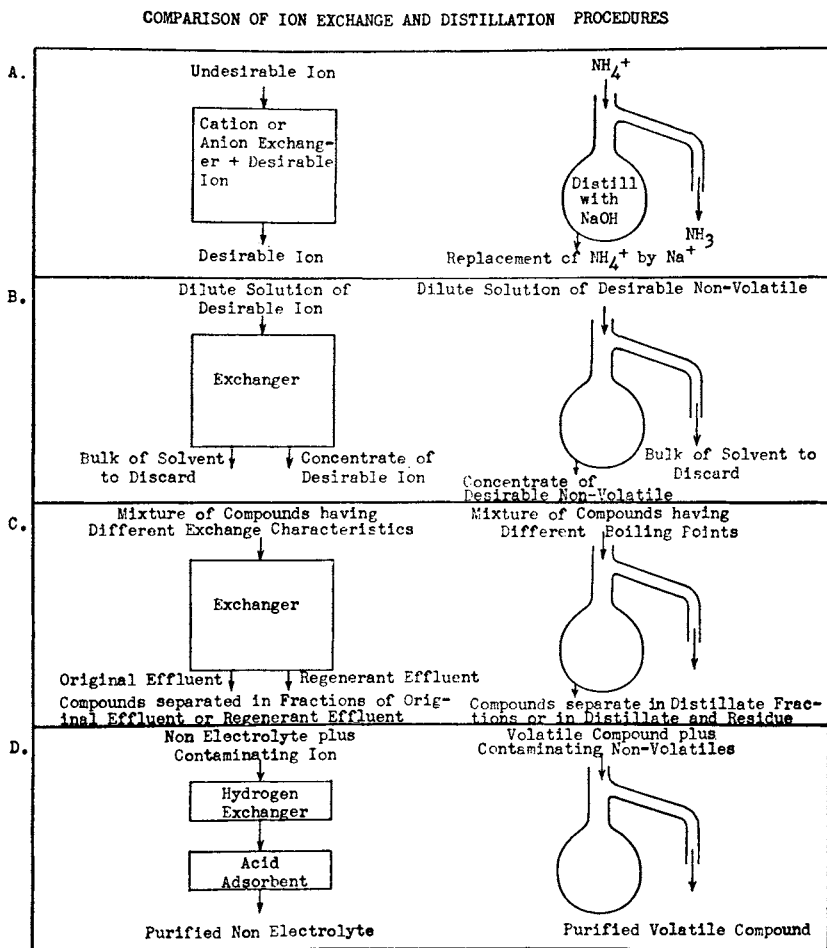

Fig. 1. Comparison of ion exchange and distillation procedures.

II. APPLICATIONS TO BIOCHEMICAL PROBLEMS

Since the concentration, isolation and purification of organic materials from natural sources or dilute reaction mixtures are prime problems for the biochemist, it can be seen how potently these techniques may be applied.

A summary of typical applications of ion exchange adsorption to biochemical problems is shown in Table I. Specific techniques which are considered to be important and illustrative examples are discussed below in greater detail.

1. *Isolation and Purification of Compounds*

Concentration of Organic Cations. An observation, in 1921, that adrenaline could be removed from solution by shaking with Permutit prompted Whitehorn to investigate the use of this ion exchanger as a reagent for amines (82). He investigated not only what kinds of substances can be removed from solution by ion exchange, but also in what ways this reaction can be affected by chemical and physical conditions. The adsorption of fifty-two organic compounds was studied qualitatively, and fundamental facts concerning the quantitative aspects of ion exchange were disclosed.

Whitehorn showed that Permutit could be used to separate relatively strong nitrogenous bases, having a dissociation constant of 5×10^{-9} or greater, from weaker bases and nonbasic substances. He found that more of a given base could be removed from neutral solution than from acid or alkaline solution. Bases could also be removed from solution in varying concentrations of ethyl alcohol, in amyl alcohol, and in ether.

For the quantitative removal of bases from solution, it was shown that filtration through the exchanger is preferable to agitation because (a) there is no accumulation of the sodium salt formed by the reaction which would tend to reverse it; (b) successive portions of a relatively large volume of fluid can be rapidly brought into intimate contact with the exchanger; and (c) easily oxidizable substances are saved from destruction.

To liberate the bases from the exchanger, Whitehorn investigated the use of sodium hydroxide, sodium cyanide, and potassium chloride. Of these, he found a saturated aqueous solution of potassium chloride to be the most generally useful reagent. Using this technique, he reported the recovery of 92% of adsorbed ethylamine nitrogen and 85% of adsorbed choline nitrogen.

The fundamental observations of Whitehorn provide the necessary background for the use of ion exchangers in the recovery of organic cations.

A number of workers (11, 18, 34, 79) have investigated the possibility of using ion exchange to sort amino acids into three groups: the acidic

TABLE I
Typical Applications of Ion Exchange Techniques

Object	References
A. REPLACEMENT OF UNDESIRABLE ION BY DESIRABLE ION	
Ca ⁺⁺ by Na ⁺ in milk to produce soft curd	52
Ca ⁺⁺ by Na ⁺ in blood to prevent coagulation	5, 76
Production of colloids by double decomposition	10
Addition of H ⁺ at a controlled rate for hydrolysis	58
H ⁺ by basic ions to reduce acidity	
Basic ions by H ⁺ to reduce alkalinity	
Basic ions by H ⁺ to provide analytical determination of total base	66
B. CONCENTRATION OF DILUTE IONS FOR ISOLATIVE OR ANALYTICAL PURPOSES	
Penicillin	24
Glucose 1-phosphate	57
Concentration of crude drug extracts	3
Organic acids	9, 55
NH ₄ ⁺ in urine	33
Metal traces	1, 35
Alkaloids	2, 6, 61
Amines	82
Epinephrine in blood	83
Gonadotropic hormone	47, 50
Hypertensin	24
Amino acids	11, 12, 13, 18, 19, 22, 26, 32, 34, 74, 79
Analysis of group II ions	36
Thiamine	21, 39, 40, 41, 62
C. SEPARATION OF COMPOUNDS HAVING DIFFERENT ADSORPTION CHARACTERISTICS	
Mixtures of basic, acidic and neutral amino acids	11, 18, 22, 32, 34, 79
Glutamine and arginine	8
Arginine and histidine	22
Arginine and glycoeyamine	74
Tryptophane and other amino acids	79
Citrulline and allantoin	7
Pectin-methylesterase and pectin-polygalacturonase	56
Pituitary oxytocic and pressor principles	68
Thiamine and riboflavin	41
Hydrochloric and sulfuric acids	60
Hydrochloric and tartaric acids	55

TABLE I (Continued)

D. PURIFICATIONS OF COMPOUNDS BY REMOVAL OF IONIC CONTAMINANTS	
Demineralization of water	38, 51, 78
Purification of gelatin solutions	44
Purification of muscle extract	65
Purification of pectin solution prior to analytical electrodeposition	85
Purification of Cori ester	57
Removal of malic acid from apple syrup	17
Removal of heavy metals from apple syrup	17
Removal of formic acid from formaldehyde	59
Removal of HCl from β -alanine hydrochloride	16
Removal of nitrogenous impurities from artichoke syrups	31
Removal of epinephrine from suprarenal cortex extract	63
Removal of ammonium sulfate from biological preparations	3
Purification of cinchona alkaloids	2, 3, 6

amino acids, held by the acid-binding resins; the basic amino acids by cation exchange; and the essentially neutral amino acids which might reasonably be expected not to be held by exchange adsorbents. Using synthetic resin exchangers, Freudenberg *et al.* (34) found that all amino acids could be taken up by a cation exchanger and preferential elution would have to be used in recovery of different fractions. Tryptophane was specifically separated from other amino acids by Turba *et al.*, using an organic cation exchanger (79).

Englis and Fiess (32) and, later, Cleaver *et al.* (22) reported on the conduct of amino acids in various exchange reactions. Their work confirmed the fact that hydrogen exchangers were capable of adsorbing all amino acids to some extent.

Archibald was able to prepare glutamine solution free of contaminating arginine by passage of the contaminated solution through a bed of Decalso (8). The effluent contained 90% of the glutamine, but no arginine. The column was then washed with water to yield all of the glutamine left in the column and 25% of the adsorbed arginine. A final washing with 3% sodium chloride yielded the remaining 75% of adsorbed arginine and no glutamine.

The use of a hydrogen exchanger to adsorb quinine from acid solution and to concentrate the alkaloids in a totaquine preparation was reported by Applezweig (2). The recovery of the alkaloids from the exchanger was accomplished by means of alkali regeneration and solution in an organic solvent. The adsorption of quinine on the darkly colored cation exchanger and its subsequent elution was also observed visually by the use of ultra violet light (4). (Cf. also chapter by Applezweig and Nachod.)

Removal of Ionic Impurities. Platt and Glock (65) used demineralization to purify an extract obtained from muscle preliminary to the estimation of the inositol content. By this treatment, the inositol-containing solution was obtained in a purer condition than by the conventional precipitation procedures previously used.

A simplified procedure for preparation of adenosine triphosphate in high purity as the sodium salt and free from contaminating heavy metal traces was reported by Polis and Meyerhof (67).

A galactogen from beef lung was prepared in a pure state by Wolfram, *et al.* (86) with the aid of demineralizing cation and anion exchangers.

A neat illustration of one of the many ways in which acid-binding resins can be used is that of Buc *et al.* (16). This group, while working upon an improved synthesis of β -alanine, was faced with the problem of liberating β -alanine from its hydrochloride. The use of lead oxide for this purpose was found to be tedious and troublesome. Attempts to use aniline or pyridine in methanol were unsuccessful. A method using pinene for this purpose gave only a 50% yield. Buc, *et al.* found that, when an aqueous solution of pure β -alanine hydrochloride is passed through a bed of the acid-binding resin, the resulting effluent is substantially chloride-free. The yield of chloride-free β -alanine is 93% when pure β -alanine hydrochloride is used, or 83–88% when the crude hydrochloride is used. Since the monoaminomonocarboxylic and the basic amino acids are not adsorbed by acid-binding resins, this method would prove generally useful for obtaining other amino acids from their anion salts.

Tandem column operation is often useful where the desired ingredient of a mixture is exchangeable. McCready and Hassid (57) found that the preparation of the Cori ester from starch by Hanes' procedure can be very much shortened by using ion exchange adsorbents. Following phosphorylation of the starch in the presence of phosphate buffer and the precipitation of inorganic phosphate, the reaction mixture was first passed through a column of hydrogen exchange adsorbent, which removed cations from solution. The effluent was then run through an acid-adsorbing column, where the glucose 1-phosphate, being a strong acid with high exchange capacity, was adsorbed. Soluble impurities including dextrans, proteins, and weak organic acids passed through unchanged. The glucose 1-phosphate was then eluted from the adsorbent with dilute alkali and isolated as the crystalline dipotassium salt.

Separation of Macromolecules. In 1932, Lejwa (50) purified the gonadotropic hormone by shaking urine with Permutit for two hours and then eluting the adsorbed hormone with dilute NH_4OH . Active crystalline material was thus obtained which assayed 1,000 mouse units/mg.

Katzman, *et al.* (47) were able to prepare concentrates of the hormone

possessing 85,000 I.U./mg. by adsorption on Permutit and elution with an alcoholic solution of ammonium acetate. Adsorption from acidified pregnancy urine was found to take place at pH 4, but very little hormone was adsorbed at pH 5. If the hormone functions as a cation in the ionic exchange, then this would indicate that pH 4 is below its isoelectric point. Since evidence by other investigators places the isoelectric point between pH 3 and 3.5, the authors admit that it is possible that some other physical phenomenon is responsible for the adsorption.

Potts and Gallagher (68) used "Folin Permutit" to separate, in high yield, the oxytocic and pressor principles of pituitary extract. The pressor hormone, a more basic ampholyte than the oxytocic principle, is adsorbed on the base exchanger. The separated principles offer a marked advantage for the further purification of the two products, since the losses are slight and the separation of the two activities is fairly complete. The pressor principle was adsorbed from aqueous solution and eluted with 10% sodium chloride solution.

McColloch and Kertesz (56) reported separation of pectin-methyl-esterase and pectin-polygalacturonase from a commercial pectinase by the action of a cation exchange resin. The authors explained their results in the following way:

The removal of pectin-methylesterase, but not of pectin-polygalacturonase, will be accomplished where the pH of the solution is below the isoelectric point of the methylesterase but still above that of the polygalacturonase. The authors had observed the different behavior of these two enzymes towards acids, and the fact that they had different pH optima made it likely that they would behave differently on ion exchange columns. They believe that the method will prove applicable to the separation of some other enzymes.

Concentration and Purification of Antibiotics. A chromatographic procedure for the isolation of streptomycin has been described by Carter, *et al.* (20). These workers found that "alkaline alumina removes streptomycin from neutral aqueous solutions, and elution with aqueous acid is slow and incomplete. Acid-washed alumina does not remove streptomycin from an aqueous solution but does so from aqueous methanol. This information provided the basis for a chromatographic method of purification. If a faintly acid solution of crude streptomycin chloride in 70-80% methanol is percolated over a sulfuric acid-washed alumina column (pH 5 to 6), an inactive fraction first appears followed by an active fraction. The active material contains sulfate ion but no chloride. Evidently chloride ion has been replaced by sulfate from the column and the streptomycin sulfate thus formed then passes through the column less rapidly since the sulfate is much less soluble than the chloride in methanol."

The use of Decalso and Amberlite IR-100 for the concentration and purification of streptothricin has also been described (48). Yields obtained are higher than with other methods of purification.

2. Analytical Techniques

One of the earliest adaptations of base exchange to laboratory problems was that of Folin (33), who, in 1917, developed a method for the determination of ammonia in urine. Sodium Permutit (later called Folin Decalso), is used to "adsorb" the ammonia. After washing, the adsorbent is treated with sodium hydroxide and Nessler's reagent, the ammonia nitrogen being determined colorimetrically.

Whitehorn, whose studies on adsorption of organic cations (83) were inspired by Folin's ammonia adsorption technique, later developed a chemical method for estimating epinephrine in blood, using silicic acid as the exchange adsorbent and sulfuric acid as the eluent.

Another typical application is that of Oberst, who used Permutit in the determination of morphine in the urine of morphine addicts (61). Saturated sodium carbonate was used to liberate the alkaloid in the presence of the Folin-Denis phenol reagent. The blue color formed by the reaction of the alkaloid with the reagent was read colorimetrically.

The exchange of metallic cations for hydrogen offers the possibility of an "acid machine." If a solution containing cations is passed through a hydrogen exchange column, the effluent will be found to contain an amount of acid equivalent to the cations originally present.

Polis and Reinhold (66) have used this principle to determine total base in serum. 0.2 ml. of serum is added dropwise to a micro column of a synthetic hydrogen exchange resin. The column is washed with water and the effluent titrated with standard alkali. Since base that is combined with carbonate or bicarbonate will yield H_2CO_3 , it is necessary to do a CO_2 combining-power determination on another portion of the same serum. The two results, when taken together, represent a value for total base which compares very favorably with that obtained by the more cumbersome method of electrodialysis.

Williams and Johnson (85) have devised an improved technique for the determination of pectin. They found that pectin can be quantitatively determined by electro-deposition, provided the electrolyte concentration of the solution is low. Ion exchange resins were used to effect this lowering of electrolyte concentration. Here, again, is a method of broad possibilities: the isolation of electrically charged colloids by electrodeposition from solutions which have been "deashed" by ion exchange.

Trace Chemistry. The use of zeolites in the concentration of metals offers great promise. Abrahamczik (1) has shown that by permutitic

exchange minute amounts of iron can be isolated and determined. Ten liters of distilled water containing 0.0025 p.p.m. ferrous iron were run through a 50×450 mm. column of "Neopermutit" (about 400 g.). One hundred ml. of warm saturated sodium chloride solution were then passed slowly through the column in the reverse direction, followed by 150 ml. of wash water. Iron was determined colorimetrically in an aliquot of the combined solutions, and 90% of what was added was found.

Minute traces of copper in powdered and fluid milk can be determined with great accuracy by use of ion exchange. Ignition or acid digestion of the sample is eliminated, the copper being made available by reducing the pH with perchloric acid. Copper is then concentrated on an exchanger in the H-cycle, stripped from the exchanger by dilute HCl and determined polarographically using an additive standard.

Thiamine. Cerecedo and Hennessy used zeolites for the isolation of vitamin B₁ (21). Extracts of rice polishings, brewer's yeast, and wheat germ were passed hot over a bed of Decalso (a synthetic siliceous zeolite) which had previously been stirred with sulfuric acid at a pH of 4. The adsorbed vitamin was then released by exchange with ammonium ion from a hot molar solution of NH₄NO₃. A single silver precipitation, followed by a precipitation with silicotungstic acid, yielded highly potent concentrates, from which, on recrystallization, crystals of pure vitamin hydrochloride could be obtained. The method of Cerecedo and Hennessy has become a standard one for the determination of vitamin B₁ in foodstuffs and physiological fluids (39, 40).

Recently, Herr (41) studied the use of synthetic cation exchange resins in the separation, recovery, and concentration of thiamine. It was found that the acid-regenerated form of the resin completely removes thiamine, for which the resin has a large capacity, in the presence of riboflavin. Since riboflavin is not adsorbed under the conditions in which thiamine is completely removed, the separation is satisfactory. Thiamine is eluted in excellent yields by passage of strong mineral acid through the column.

The purity of the eluate was found by Herr to be satisfactory for thiochrome analysis.

Papageorge and Lamar (62) have further simplified the determination of thiamine by elimination of the adsorption column. Thiamine is removed from urine samples by shaking with Permutit in a centrifuge tube. The adsorbent is washed and treated with eluent in the same tube.

*Amino Acids and other Metabolites.** Among the bases which Whitehorn

*After completion of this manuscript, two articles on the use of ion exchange in the separation of pyrimidine nucleosides were called to the attention of the writer. Both articles appear in *Nature*, **161**, 931 (1948). D. T. Elmore passed aqueous solutions of cytidine and uridine down columns of "Zeo-Karb 215." While cytidine was retained

found removable from solution by Permutit, were the basic amino acids, arginine, histidine, and lysine. Dubnoff (26) applied this finding to the separation of arginine from a protein hydrolysate for subsequent estimation by the Sakaguchi reaction.

Sims (74) has improved on the Dubnoff determination of arginine by chromatographically separating it from glycoeyamine. Both compounds give the Sakaguchi reaction. By careful control of the flow rate and salt concentration in a sodium resin exchange cycle, the glycoeyamine is successively passed down the column and eluted in advance of the arginine.

The use of strong neutral salt solution for the removal of the basic amino acids from siliceous sodium zeolites interferes seriously with subsequent isolation and purification steps. Block (cf. his chapter, p. 295), in 1942, developed a method for the separation of basic amino acids from the other constituents of protein hydrolysates based on the use of hydrogen exchange resins (11, 12). The basic amino acids are recovered in the form of a concentrate by treating the adsorbates with 7% HCl. Cannan (18) used a basic resin for the separation of the dicarboxylic amino acids from protein hydrolyzates. Estimations of the glutamic acid and aspartic acid in egg albumin, β -lactoglobulin, and edestin were reported. The adsorbed dicarboxylic acids are eluted, according to Cannan's procedure, with 0.25 *N* hydrochloric acid. The amino acids in the eluate are readily crystallizable, or they may be estimated by determination of amino nitrogen and carboxylic values, since the resin was found to be remarkably selective for the dicarboxylic acids.

A method for the determination of citrulline and allantoin based upon the cation exchange removal of the former from serum containing both compounds was described by Archibald, in 1944 (7). In developing this method, Archibald investigated quantitatively the adsorption by Zeo-Karb and Amberlite IR-100 of citrulline, allantoin, allantoic acid, alloxanic acid, alloxan, alloxantin, parabanic acid, methylurea, phenylurea, and thymol.

The concentration of the metabolite *N*'-methylnicotinamide may be determined in urine by adsorption from a small aliquot at pH 4.5 on a column of Decalso, elution with KCl, alkalization and extraction of the resulting fluorescent compound with normal butanol (43).

by the cation exchanger due to its basic amino group, uridine was not. Cytidine was afterwards eluted from the column by dilute aqueous ammonia. A mixture of the two nucleosides was separated giving a 99% recovery for uridine, and a 71 to 78% recovery for cytidine. R. J. C. Harris and J. F. Thomas applied this same technique to a hydrolyzate of 20 g. of yeast ribosenucleic acid from which guanosine and adenosine have been removed. 2.4 g. of uridine was isolated from the effluent and elution of the exchanger was 2%, aqueous pyridine yielded 150 mg. cytidine,

III. STUDIES INVOLVING THE USE OF EXCHANGE ADSORBENTS IN BIOLOGICAL SYSTEMS

The varied applications of exchange adsorbents in the *in-vitro* studies discussed above suggest many possibilities for their use in studies involving the more complex reactions which occur within the living organism.

1. Adsorption of Ions by Plant Cells

Breazeale (15) demonstrated the fact that plants can adsorb potassium from a potassium zeolite system. Horner (45) studied the growth, nodulation, and composition of soybeans in a culture medium which contained a base exchanging clay treated with varying amounts of calcium. Hutchins (46) used a clay treated with either phosphoric acid or a mixture of calcium hydroxide and monocalcium phosphate as a source of combined phosphorus in studies on the nutrition of soybean plants.

By the use of both Permutit (Decalso) and aniline black (Deminerlite), Schlenker (71) was able to prepare a complete medium for plant culture which contained all the essential cations and anions adsorbed upon the exchangers. From evidence derived by actual plant growth it was shown that these adsorbed ions become available to the plants and can be used to promote good growth.

The usefulness of demineralized water in deficiency cultures has been demonstrated by Hewitt (42). Schroeder, *et al.* (72) have found, however, that demineralized tap water is not satisfactory for boron deficiency cultures.

The preparation of a calcium free culture medium which permits subsequent accurate spectrographic determination of Ca was described by Eastman (27).

To shed light on the probable fate of plant growth regulators in soils, Weaver (81) studied the reactions of certain plant growth regulators with ion exchangers. The degree of adsorption by certain cation exchange materials (Amberlite IR-100 'H,' ZeoKarb 'H,' Decalso, Zeo-Dur, De-Acidite, Amberlite IR-4B) and the readiness with which the compounds are eluted after having been adsorbed were reported.

The plant growth regulators studied were 2,4-dichlorophenoxyacetic acid, and its ammonium, calcium and copper salts, 2,4,5-trichlorophenoxyacetate and isopropyl phenyl carbonate. It seems probable that in soils, 2,4-D or a relatively insoluble 2,4-D salt might be converted to soluble forms by ammonium, sodium or other ions present in the soil solution.

2. Blood Coagulation

The treatment of blood with a sodium exchanger was suggested by Steinberg (76) as a means for obtaining "uncoagulated blood." By passing

blood over a sodium treated resinous cation exchanger during its collection or by mixing blood directly with the resin immediately, Steinberg found that blood would "remain in a fluid state indefinitely." The properties of the resin treated blood are shown in Tables II and III from Steinberg.

Unfortunately, the values for calcium in exchanged and unexchanged blood were not given by Steinberg. The quantitative aspects of this exchange have been investigated by Applezweig and Rice (5) who found that approximately 80% of the blood calcium is removed. (See Tables IV and V.)

TABLE II
Influence of Oxalate or Resin Treatment upon Properties of Blood

	Specimen	Resin treated	Direct or Oxalic*
RBC, million/cu. mm.	1	4.85	4.78
	2	4.76	4.60
	3	3.73	3.52
	4	4.90	4.05
	5	5.21	5.00
Hemoglobin, g./100 cc.	1	14.8	14.5
	2	13.5	13.2
	3	12.5	11.6
	4	14.5	14.2
	5	14.0	13.5
Sediment rate, mm./hour	1	3.5	9.2
	2	8.0	13.5
	3	15.0	22.0
Hematocrit, %	1	37.0	32.0
	2	33.0	28.5
WBC, per cu. mm.	1	6,250	5,200
	2	7,400	6,700
	3	10,500	8,800
Platelet count, per cu. mm.	1	310,000	260,000
	2	240,000	220,000
	3	375,000	320,000
	4	270,000	250,000
Prothrombin time, sec.	1	16.8	21.2
	2	24.2	25.6
	3	13.6	15.4
	4	15.4	17.2

* Direct refers to finger puncture.

TABLE III

Serological and Biochemical Studies of Resin and Oxalate Treated Blood (Steinberg)

Determination	Resin treated ^a	Oxalated ^{ab}
Sugar, mg. %	111.2	114.0
Urea nitrogen, %	14.3	13.8
Uric acid, %	4.1	4.4
Total protein, g.	7.31	7.25
A/G ratio	2.03	2.16
Albumin, g.	4.90	4.75
Globulin, g.	2.41	2.20
Fibrinogen	0.268	0.324
Non-protein nitrogen, mg. %	29.1	26.4
Inorganic phosphorus, mg. %	2.6	2.2
Sugar (24 hours), mg. %	22.5	45.0
Specific gravity — whole blood	1.0623	1.0608
Specific gravity — plasma	1.0285	1.0278
Oxygen capacity, cc.	22.73	21.99
Cephalin-cholesterol flocculation test	Negative	Negative
Creatinine, mg. %	1.2	1.2
Cholesterol, mg. %	182.0	194.0
Serology: ^b		
Wassermann	Negative	Negative
Wassermann	++++	++++
Kahn	Negative	Negative
Kahn	++++	++++
Mazzini	Negative	Negative

^a Average of five samples.^b Serum for Serology.

Since the amount of calcium that remains is theoretically sufficient to promote clotting, it is assumed that this residual amount is in a bound or nonionized form and, as such, is capable of promoting coagulation.

In reaching conclusions concerning the concentration of calcium ion required for the clotting process after the addition of oxalates or citrates, it was necessary to assume certain relationships between the two systems involved, i.e., calcium oxalate or citrate on the one hand and Ca proteinate on the other. Ion-exchange methods offer a new approach to the study of this mechanism since calcium is removed simply by exchange with sodium without addition of extraneous anions. Thus, only the natural equilibria in the blood need to be considered.

Quick (69) reported that the use of exchange resins enabled him to study the quantitative relationship between calcium and prothrombin. He found that the optimum or critical concentrations of calcium chloride for maximum prothrombin activity of both human and dog plasma were

TABLE IV

Residual Calcium in Blood Tested With Sodium Exchanger (Applezweig and Rice)
(Calcium concentrations are expressed as mg./100 ml.)

Sample No.	Exchanger	Original Ca	Residual Ca
1	Amberlite	10	2.3
2	Zeo-Karb	9.2	2
3	Amberlite IR-100	11.3	1.7
4	Zeo-Karb	10.3	2.2
Average		10.2	2.1

TABLE V

Recalcification Times (Applezweig and Rice)

Ml. of 0.25% CaCl ₂ added to 1 ml. of sample	"Exchange" plasma	Citrated plasma
1 ml.	7 min.	5 min.
0.5 ml.	5 min.	3 min.
0.1 ml.	9 min.	7 min.
0.05 ml.	11 min.	11 min.

below the level of the free or ionized calcium. Unfortunately, this paper contains no data regarding the composition of the "exchange plasma." Quick seems to have assumed that treatment with an exchange resin removes all the calcium both free and combined. His values for optimal calcium concentrations are, therefore, based entirely upon the calcium which he added back to the system.

The present author has attempted the preparation of Freundlich isotherms for the removal of calcium from serum with several exchange adsorbents including Amberlite IR-100, the exchanger used by Quick. In every instance it was found impossible to remove the calcium completely, even when large quantities of exchange adsorbents were used. It is therefore difficult to accept the results reported by Quick unless these values are revised to include the residual calcium in the "exchange plasma."

3. Immunochemical Reactions

In a similar manner, the role of various cations in other physiological phenomena may be explored. It has been generally assumed, for example, that serum calcium is associated with complement function. Ecker and Pillemer (28) studied the effects of calcium "disonizing" anions upon complement and reasoned that calcium plays a role of doubtful significance in complement fixation. In Ecker's laboratory, human, rabbit, and guinea

pig sera that had been treated with a sodium exchanger were found to have lost none of their complement activity (29). This would seem to confirm the belief that ionic Ca^{++} plays a negligible role.

Breazeale, *et al.* (14) in studies on serological precipitation-flocculation tests found that the reactivity of sera could be shifted from negative to positive and vice versa by treatment with zeolites. These investigators found that the Kahn antigen adsorbs "reagin" out of syphilitic serum thereby producing a sero-negative serum. By treating this experimentally produced sero-negative serum with calcium zeolite, they again obtained positive flocculation reactions to the various tests. Later they were able to apply this same principle to a test for syphilis by employing a suspension of pure sodium zeolite as an indicator.

TABLE VI

Ion Exchange in Serological Reactions

The effect of treating pooled sera with CaZ, NaZ and Kahn antigen on the sero-activity and calcium content. (20 samples, Pierce and Breazeale.)

Treatment	Reaction to:		Mg. of Ca/100 ml. of se a
	Kahn	Kline	
No treatment	Negative	Negative	10.0
CaZ treated	4-plus	4-plus	80.0
NaZ treated	Negative	Negative	4.5
Kahn antigen adsorbed	Negative	Negative	3.5

Pierce and Breazeale (64) then investigated the removal of divalent cations from solutions by beef heart antigens and found the Kahn and Hinton antigens to be capable of removing calcium and magnesium from aqueous solution (see table VI). The *floc*, formed by this reaction, released the divalent ions again when it was washed with saline. On the basis of these observations, a new theory of the mechanism of syphilis serology was advanced, namely: in positive sera there must be either an increase in ionization of divalent cations or some profound vectorial shift with respect to the ionization constant of calcium compounds thereby causing the antigen to *floc*. At any rate, it was shown that beef heart antigens act purely in the capacity of an ion-exchanger and shift from a sodium salt to either a calcium and/or magnesium salt, thereby producing a *floc*.

4. Enzyme Reactions

Wilkinson and Martin (84) investigated the effect of Amberlite IR-4, an anion exchange resin, on the kinetics of peptic digestion. They found that when various amounts of substances such as Amberlite were added,

the final amount of peptic action was nearly the same although the rates differed considerably.

Since these authors were interested in the use of anion exchangers for the treatment of peptic ulcer, the *initial rate* was a matter of concern to them. The influence of Amberlite IR-4 upon the rate of pepsin hydrolysis is illustrated in Fig. 2 taken from Wilkinson and Martin. It was found that 3 g. of resin reduced the speed of action of 100 mg. of 3400 unit pepsin

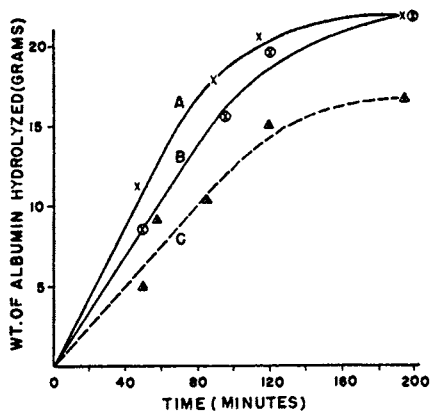

FIG. 2. Kinetics of pepsin hydrolysis.

0.5 g. Amberlite IR-4

0.1 g. NF Pepsin

A — Standard ($m = 1.00$)

B — Amberlite IR-4 present ($m = 0.89$)

C — Amberlite IR-4 filtered off after adsorption ($m = 0.54$)

m — slope (given as fractional proportion of the standard).

From Wilkinson and Martin, *Arch. Biochem.* **10**, No. 2 (1946).

to 39% of its original value when the resin remained in contact with the digestion mixture, and to 17% when the resin was filtered off after being shaken with the pepsin. The authors explained this by assuming that there is a residual activity of adsorbed pepsin, the action taking place at the surface of the Amberlite IR-4; or that the pepsin is reversibly adsorbed and a new equilibrium is reached in the reaction vessel which liberates a small amount of pepsin.

5. *In Vivo* Studies

The investigation of the physicochemical aspects of the action of anion exchange resins in peptic digestion by Wilkinson and Martin lent support to the proposal that the resins be used in gastric ulcer therapy. Segal, *et al.* (73) and later Wilkinson and Martin (84) and Kraemer and Lehman (49) performed *in vivo* experiments and initiated clinical trials with anion exchange resins.

Martin and Wilkinson (53) first concerned themselves with the general effects of the feeding of exchange resins upon the animal nutrition. They found that there was no adsorption of thiamine and riboflavin at the pH of the normal human stomach or intestine by Amberlite IR-4. Ascorbic acid was strongly adsorbed at the pH of the stomach but desorption was complete at the pH of the normal intestinal tract. No defective nutrition was found with diets containing 5% of the resin.

These authors also studied the adsorption of putrefactive chemicals by ion exchange materials (54). Indole and skatole were most effectively adsorbed by Amberlite IR-4 while putrescine, cadaverine, tyramine, histamine and guanidine in mice fed Amberlite IR-4 and Permutit indicated that these agents were effective in causing a relative restriction of the adsorption, *in vivo*, of these toxic agents.

Subsequent clinical trials (49, 75) have shown that finely powdered anion exchangers are highly effective for the control of gastric hyperacidity and pain. They do not produce the annoying side effects of constipation and diarrhea and cannot upset the acid-base balance of the blood.

Perhaps one of the most interesting and promising applications of ion exchangers is in the field of therapeutic procedure for the depletion of sodium ion from the body. Dock and his co-workers (25) were successful in withdrawing sodium from the body by administration of Ionac resins, and more work has recently been reported by Greenblatt and Gilwood (37), who showed that edema in hypertension patients was relieved by oral administration of ion exchange resins.

There is certainly, now, reason to believe that ion exchange materials will be found among the drugs of tomorrow, and many important new applications are to be anticipated.

BIBLIOGRAPHY

1. Abrahamczik, M., *Mikrochemie* **25**, 228 (1938).
2. Applezweig, N., *J. Am. Chem. Soc.* **66**, 1990 (1944).
3. Applezweig, N., U. S. Patent Application.
4. Applezweig, N., *Ann. N. Y. Acad. Sci.* **49**, 295 (1948).
5. Applezweig, N., and Rice, M., Unpublished data.
6. Applezweig, N., and Ronzone, S., *Ind. Eng. Chem.* **38**, 576 (1946).
7. Archibald, R. M., *J. Biol. Chem.* **156**, 121 (1944).
8. Archibald, R. M., *J. Biol. Chem.* **159**, 693 (1945).
9. Bhatnagar, S. S., Kapur, A. N., and Bhatnager, M. S., *J. Ind. Chem. Soc.* **17**, 361 (1940).
10. Bird, P. G., U. S. Patent 2, 244, 325 (June 3, 1941).
11. Block, R. J., *Proc. Soc. Exell. Biol. Med.*, **51**, 252 (1942).
12. Block, R. J., *Chem. Revs.* **38**, 501 (1946).
13. Block, R. J., *Arch. Biochem.* **11**, 235 (1946).
14. Breazeale, E. L., Pierce, L. T., and Breazeale, J. F., Unpublished data.

15. Breazeale, J. F., *Ariz. Agr. Exp. Sta. Tech. Bull.* 21 (1928).
16. Buc, S. R., Ford, J. H., and Wise, E. D., *J. Am. Chem. Soc.* **67**, 92 (1945).
17. Buck, R. E., and Mottern, H. H., *Ind. Eng. Chem.* **37**, 635 (1945).
18. Cannan, R. K., *J. Biol. Chem.* **152**, 401 (1940).
19. Cannan, R. K., *Ann. N. Y. Acad. Sci.* **47**, 135 (1946).
20. Carter, H. E., Clark, R. K. J., Dickman, S. R., Loo, Y. H., Skell, P. S., and Strong, W. A., *J. Biol. Chem.* **160**, 337 (1945).
21. Cerecedo, L. R., and Hennessy, D. J., *J. Am. Chem. Soc.* **59**, 1617 (1937).
22. Cleaver, C. S., Hardy, R. A., and Cassidy, H. G., *J. Am. Chem. Soc.* **67**, 1343 (1945).
23. Cranston, H. A. and Thompson, J. B., *Ind. Eng. Chem. Anal. Ed.* **18**, 323 (1946).
24. Cruz Coke, E., Gonzalez, F., and Hulsen W., *Science*, **101**, 340 (1945).
25. Dock, W., *Trans. Assoc. Am. Physicians* **59**, 282 (1946).
26. Dubnoff, J. W., *J. Biol. Chem.* **141**, 711 (1941).
27. Eastman, E. J., *J. Optical Soc. Am.* **36**, 57 (1946).
28. Ecker, E. E., and Pillemer, L., *Ann. N. Y. Acad. Sci.* **43**, 65 (1942).
29. Ecker, E. E., and Pillemer, L., Seifter, S., and Appelzweig, N., Unpublished data.
30. Eichorn, E., *Pogg. Ann.*, **105**, 126 (1858).
31. Englis, D. T., and Fiess, H. A., *Ind. Eng. Chem.* **34**, 864 (1942).
32. Englis, D. T., and Fiess, H. A., *Ind. Eng. Chem.* **36**, 604 (1944).
33. Folin, O., and Bell, R. D., *J. Biol. Chem.* **29**, (1917).
34. Freudenberg, K., Walch, H., and Molter, H., *Naturwissenschaften* **30**, 87 (1942).
35. Furnas, C. C. and Beaton, R. H., *Ind. Eng. Chem.* **33**, 1500 (1942).
36. Gaddis, S. J., *J. Chem. Education* **19**, 327 (1942).
37. Greenblatt, I. J., and Gilwood, M. E., paper read at the Chicago 113th meeting of the American Chemical Society (1948).
38. Harrison, J. W. E., Myers, R. J., and Herr, D. C., *J. Am. Pharm. Assoc.*, **32**, 121 (1945).
39. Hennessy, D. J., *Ind. Eng. Chem. Anal. Ed.* **13**, 216 (1941).
40. Hennessy, D. J., and Gerecedo, L. R., *J. Am. Chem. Soc.* **61**, 179 (1939).
41. Herr, D. S., *Ind. Eng. Chem.* **37**, 631 (1945).
42. Hewitt, E. J., *Nature* **158**, 623 (1946).
43. Hochberg, M., Melnick, D., and Oser, B. L., *J. Biol. Chem.* **158**, 265 (1945).
44. Holmes, Eric L., U. S. Patent 2,240,116 (April 29, 1941).
45. Horner, G. H., *Missouri Agr. Exp. Sta. Res. Bull.* 232 (1936).
46. Hutchins, T. B., *Missouri Agr. Exp. Sta. Res. Bull.* 243 (1936).
47. Katzman, P. A., Godfrid, M., Cain, C. K., and Doisy, E. A., *J. Biol. Chem.* **148**, 501 (1943).
48. Kocholaty, W. and Junowicz-Kocholaty, R., *Arch. Biochem.* **15**, 55 (1947).
49. Kraemer, M. and Lehman, D. J., *Gastroenterology* **8**, 202 (1947).
50. Lejwa, A., *Biochem. Z.* **256**, 238 (1939).
51. Liebig, G. F., Vanselow, A. P., and Chapman, H. D., *Soil Science* **55**, 371 (1943).
52. Lyman, J. F., Browne, E. H., and Otting, H. E., *Ind. Eng. Chem.* **25**, 1297 (1933).
53. Martin, G. J., and Wilkinson, J., *Gastroenterology* **6**, 315 (1946).
54. Martin, G. J. and Wilkinson, J., *Arch. Biochem.* **12**, 95 (1947).
55. Matchett, J. R., *et al.*, *Ind. Eng. Chem.* **36**, 951 (1944).
56. McColloch and Kertesz, *J. Biol. Chem.* **160**, 149 (1945).
57. McCready, R. M., and Hassid, W. Z., *J. Am. Chem. Soc.* **66**, 560 (1944).
58. Myers, P. B. and Rouse, A. H., U. S. Patent 2,325,483 (July 6, 1943).
59. Myers, R. J., *Ind. Eng. Chem.* **35**, 858 (1943).
60. Myers, R. J., Eastes, J. W., Urquhart, D., *Ind. Eng. Chem.* **33**, 1270 (1941).

61. Oberst, M. S., *J. Lab. Clin. Med.* **24**, 318 (1938).
62. Papageorge, E. and Lamar, M. V., *Arch. Biochem.* **14**, 315 (1947).
63. Pffiffer, J. J. and Swingle, W. W., *Am. J. Physiol.* **96**, 180 (1931).
64. Pierce, L. F., and Breazeale, E. L., *J. Investigative Dermatol.* **252**, 249 (1942).
65. Platt, B. S. and Glock, G. E., *Biochem. J.* **36** Proc. XVIII (1942).
66. Polis, B. D., and Reinhold, J. G., *J. Biol. Chem.* **156**, 231 (1944).
67. Polis, B. D., and Meyerhof, O., *J. Biol. Chem.* **169**, 389 (1947).
68. Potts, A. M. and Gallagher, T. F., *J. Biol. Chem.* **154**, 349 (1944).
69. Quick, A. J., *Am. J. Physiol.* **148**, 211 (1947).
70. Riches, J. P., *Nature* **158**, 96 (1946).
71. Schlenker, F. S., *Am. J. Botany* **27**, 525 (1940).
72. Schroeder, W. T., Davis, J. F., and Schafer, J., *J. Am. Soc. Agron.* **38**, 754 (1946).
73. Segal, H. L., Hodge, H., Watson, J. S. Jr., and Scott, W. J. M., *Gastroenterology* **4**, 484 (1945).
74. Sims, E. A. H., *J. Biol. Chem.* **158**, 239 (1945).
75. Spears, M. M., and Pfeiffer, M. C. J., *Gastroenterology* **8**, 191 (1947).
76. Steinberg, A., *Proc. Soc. Exptl. Biol. Med.* **56**, 124 (1944).
77. Sussman, S., Nachod, F. C., and Wood, W., *Ind. Eng. Chem.* **37**, 618 (1945).
78. Tiger, H. L., and Sussman, S., *Ind. Eng. Chem.* **35**, 186 (1945).
79. Turba, F., Richter, M., and Kuchar, F., *Naturwissenschaften* **31**, 508 (1943).
80. Way, J. T., *Roy. Agr. Soc. Engl.* **11**, 313 (1850).
81. Weaver, R. J., *Science* **106**, 269 (1947).
82. Whitehorn, J. C., *J. Biol. Chem.* **56**, 751 (1925).
83. Whitehorn, J. C., *J. Biol. Chem.* **683** (1934).
84. Wilkinson, S. and Martin, G. S., *Arch. Biochem.* **10**, 205 (1946).
85. Williams, K. T., and Johnson, C. M., *Ind. Eng. Chem.* **16**, 23 (1944).
86. Wolfrom, M. L., Weisblat, D. I., Karabinos, J. V., and Keller, O., *Arch. Biochem.* **14**, 1 (1947).

The Separation of Amino Acids by Ion Exchange Chromatography

RICHARD J. BLOCK

*The Department of Physiology and Biochemistry, New York Medical College,
Flower and Fifth Avenue Hospitals, New York*

	<i>Page</i>
I. Introduction	296
II. Separation of Basic Amino Acids	297
1. Inorganic Zeolites	297
2. Bleaching Earths	297
(a) Turba's Method	297
(b) Method of Bergdoll and Doty	298
3. Metallic Oxides	298
4. Synthetic Ion Exchange Resins	298
III. The Use of Cation-Exchange Resins for the Large Scale Preparation of Basic Amino Acid Concentrates	299
1. Uptake of Amino Acids	299
(a) Molecular Adsorption	299
(b) Insolubility	299
(c) Variation in the Strength of the Acid Groups of the Exchanger	299
(d) Conversion of a Sulfonic Acid Exchanger into a Carboxylic Acid Exchanger	300
(e) Experimental Suggestions	300
2. Elution with Mineral Acids	301
(a) Simultaneous Elution of all Bases	301
(b) Partial Separation	301
3. Exchange and Displacement Development	303
(a) Simultaneous Removal of all Basic Amino Acids	303
(b) Differential Exchange	303
4. Quantitative Separation of Arginine and Lysine from Histidine, etc.	303
5. Comment	303
IV. Separation of Dicarboxylic Amino Acids	304
1. Metallic Oxides	304
2. Synthetic Anion Exchange Resins	305
V. Separation of the Aromatic Amino Acids	306
1. Active Carbon	306
2. Synthetic Ion Exchange Resins	306
VI. Separation of Neutral Amino Acids	307
1. Adsorption Methods	307
2. Partition Chromatography	307
(a) Silical Gel Method	307
(b) Chromatography on Cellulose and Starch	307
3. Metallic Oxides	310
4. Synthetic Ion Exchange Resins	310
VII. General Comments	312
Bibliography	312

I. INTRODUCTION

As the theoretical aspects of ion exchange are given in detail elsewhere in this monograph, only a brief mention will be made in this chapter.

Austerweil (1) has suggested that the relationship between a cation in aqueous solution and a zeolite fully saturated with only one single different cation is similar to an extraction process, the solid ion-exchange substance playing the part of a nonmiscible solvent for the cation in aqueous solvent. The reaction then follows the fundamental extraction law. Thus, base-exchange reactions are independent of concentration.

Whether this suggestion is tenable or not, there is a second phenomenon which complies with the law of mass action and phase rule. The extraction is accompanied by an equilibrium between the two cations in the solution, which equilibrium is itself determined by the ratio of concentration of the two ion exchangers present; the original one and the newly formed one.

Furthermore, in many instances, especially with the synthetic cation exchange resins, molecular adsorption *per se* plays an important role in addition to the purely chemical phenomena mentioned above. This last mentioned mechanism has been often neglected or forgotten when model experiments employing single or mixtures of a few pure amino acids have been studied in order to develop the theoretical aspects of amino acid separation by ion exchange. As will be brought out later in this chapter, the conclusions reached from some of the model experiments with mixtures of a few amino acids are misleading when applied to the highly complex mixture of amino acids found in hydrolysates of proteins.

As the phenomena of ion exchange, differential adsorption, and partition all appear to be interrelated (66) in the process of the separation of amino acids by ion exchange chromatography, methods employing all these mechanisms or any combination of them will be discussed in this chapter.

The amino acids resulting from the hydrolysis of most proteins may be divided into four main groups for the purposes of this discussion:

Basic amino acids — arginine, histidine, lysine and possibly tryptophane.

Dicarboxylic amino acids — glutamic acid and aspartic acid.

Aromatic amino acids — tyrosine, tryptophane, and phenylalanine.

Neutral amino acids — cystine, cysteine, methionine, serine, threonine, leucine, isoleucine, valine, glycine, alanine, proline, and hydroxyproline.

The halogenated aromatic amino acids, diiodotyrosine, thyroxine, etc., and the basic amino acids hydroxylysine, ornithine, and citrulline have not, to our knowledge, been studied by chromatographic technique as yet and will not be discussed.

II. SEPARATION OF THE BASIC AMINO ACIDS

1. *Inorganic Zeolites*

Whitehorn (2) showed that arginine, lysine and some of the histidine could be exchanged for Na^+ on the synthetic zeolite "Permutit" (sodium aluminum silicate). The adsorbed amino acids were then removed by exchange with aqueous NaCl or KCl. This process was largely neglected until Felix and Lang (2a) attempted to separate arginine and ornithine as well as peptides on Na Permutit, while Dubnoff (3) used "Permutit" to separate arginine (and other basic amino acids) from a protein hydrolyzate (cf. Davenport *et al.*, 3a). After elution, the arginine was estimated by the Sakaguchi reaction (cf. Block and Bolling, 4). Nelson *et al.* (5) found that all the amino acids adsorbed on a "Decalso" column in the Na^+ cycle could be eluted with 10% aqueous pyridine except for arginine and lysine. These, together with pyridine, were then removed by treatment with 2 *N* HCl. Schramm and Primosigh (6) adsorbed the basic amino acids on silica gel and after washing off the other amino acids with water, they eluted the bases with 20% acetic acid. Tiselius (7) has not found this method to be successful probably because of differences in the SiO_2 gel preparations.

2. *Bleaching Earths*

Activated earths such as Fuller's earth, Lloyd's reagent, etc. (aluminum silicates) have been widely used in the concentration of the basic vitamins of the B group since their introduction by Seidell. It was not until 1936 that Ackermann and Fuchs (8, 9) used Lloyd's reagent for the adsorption of the basic amino acids. This process has been improved by Turba (10) and by Bergdoll and Doty (11). The details of their procedures follow:

(a) *Turba's Method (10)*. It is necessary to work rapidly and therefore a thin layer of the adsorbent should be used.

Separation of histidine from the monoamino acids: 2 ml. of a solution containing 5 to 10 mg. of histidine and the same quantity of a monoamino acid, are added slowly to a thin layer of 3 g. of Filtrol-Neutrol: The quantitative transfer is made with a few milliliters of water. The adsorbed material is then thoroughly washed with 30 to 60 ml. of H_2O to remove the monoamino acids. The histidine can then be eluted with 80 ml. of pyridine-sulfuric acid mixture or with dilute $\text{Ba}(\text{OH})_2$.

Separation of arginine and histidine: A mixture of 20 mg. each of arginine and histidine are adsorbed on 12 g. of Floridin XXF. The histidine is washed out with 200 ml. of water during the course of one hour. The arginine is then eluted with pyridine-sulfuric acid mixture or $\text{Ba}(\text{OH})_2$.

Separation of arginine and lysine: An aqueous solution containing 25 mg. of arginine and the same quantity of lysine is added to 25 g. of

Filtrol-Neutrol. The lysine is extracted with 200 ml. of $M/6$ KH_2PO_4 and the arginine is subsequently eluted with 100 ml. of $\text{C}_6\text{H}_5\text{N}-\text{H}_2\text{SO}_4$ mixture.

(b) *The Method of Bergdoll and Doty (11)*. Preparation of hydrolysate: To 10 ml. of amino acid solution containing 1–6 mg. of lysine; 1–4 mg. of histidine and 1–8 mg. of arginine in 0.3 N HCl , 30–50 mg. of Zn dust are added. The reduction of cystine takes place in a few minutes at 80°C .

Preparation of column: In a 400×19 mm. tube add 20 g. of adsorbent ($1/3$ Lloyd's reagent and $2/3$ super cel). Wash with 50 ml. of 1.7 N HCl .

Chromatographic separation: Pass the following solutions through the acid treated Lloyd's reagent column in the following order:

1. 10 ml. of amino acid solution in 0.3 N HCl .
2. 180 ml. of 0.5 N HCl to elute all neutral amino acids.
3. 200 ml. of 1.0 N HCl to elute lysine.
4. 150 ml. of 0.125 M NaHCO_3 to elute histidine.
5. 100 ml. of 10% pyridine in 0.7 N HCl to elute arginine.
6. 40 ml. of 0.5 N HCl to remove pyridine.

Collection of fractions:

1. 0–80 ml. discard.
2. 80–275 ml. neutral amino acids and NH_3 .
3. 275–480 ml. lysine.
4. 480–625 ml. histidine.
5. 625–730 ml. arginine.

The time for the complete run is 4–5 hours. Gentle suction is used.

3. *Metallic Oxides*

Strain (12) reported that activated TiO_2 , prepared from TiCl_4 and K_2CO_3 , will adsorb histidine at pH 10, while Wieland (13) showed that the basic amino acids could be adsorbed from neutral solution by Al_2O_3 .

4. *Synthetic Ion Exchange Resins*

The introduction by Adams and Holmes (14) of synthetic ion-exchange resins capable of binding cations opened the possibility of separating amino acids from the nonnitrogenous compounds in protein hydrolyzates and of separating amino acids from one another. Although Griessbach (15) mentioned that it may be possible to use these resins for the separation of amino acids on the basis of their molecular size, basicity, etc., it was not until 1942 that Block (16, 17) and Freudenberg (18), independently, showed that amino acids could be separated from many other constituents in protein hydrolyzates, including the mineral acids, and that the basic amino acids could be separated from the dicarboxylic and neutral amino acids.

The use of ion-exchange resins for the separation of the basic amino acids may be divided in two categories: the preparation of mixtures for large-scale concentration of arginine, histidine, and lysine, and the separation of the basic amino acids for analytical purposes.

III. THE USE OF CATION-EXCHANGE RESINS FOR LARGE-SCALE PREPARATION OF BASIC AMINO ACID CONCENTRATES

1. Uptake of Amino Acids

This procedure has been subject to a number of papers and patents (16, 17, 19, 20–24) and employs a combination of what Tiselius (7) and Claesson (25) call “displacement development” and “frontal analysis.” The protein hydrolyzate is allowed to flow downward over a column of synthetic cation exchanger in either the H^+ or NH_4^+ cycle until the basic amino acids appear in the effluent from the column. In this way, although in the initial stages all the amino acids are adsorbed on the H^+ resin and many on the NH_4^+ resin, these are gradually displaced by the more strongly bound basic amino acids until 70–80% of the nitrogen on the exchanger is from arginine, histidine, and lysine.

Various suggestions (17, 19, 20, 21, 22) have been mentioned to account for the presence of monoamino monocarboxylic acids on the exchanger after saturation with a protein hydrolyzate containing basic amino acids and after thorough washing with water (the dicarboxylic amino acids and hydroxyproline have never been found on the column at this stage). Leucine, isoleucine, tyrosine, serine, valine, and methionine are usually found, while alanine, threonine, glycine, cystine, and proline may be present. The following possibilities to account for this situation may be worth considering.

(a) *Molecular Adsorption.* The presence of some leucine, isoleucine, valine, tyrosine, phenylalanine, and possibly proline could be explained on this basis.

(b) *Insolubility.* After saturation of the exchanger with the basic amino acids, it is necessary to wash the residual hydrolyzate from the column with water. As the pH rises from that of the hydrolyzate (pH 2–3) to that of water, it may be expected that some of the least soluble amino acids would precipitate in the column. This would account for the presence of tyrosine, cystine, and leucine.

(c) *Variation in the Strength of the Acid Groups of the Exchanger.* The resins used in most of these studies were commercial products prepared by condensation of polyhydric phenols with formaldehyde and sodium sulfite (side-chain sulfonic acid exchangers) or by condensation of sulfonic acids of aromatic hydroxy compounds with HCHO (nuclear sulfonated

resins). Both the method of preparation and the location of the sulfonic acid group on the exchanger would be expected to result in groups of varying acid strength. The latter may account for the fact that certain amino acid molecules once adsorbed are not easily displaced by an incoming basic amino acid; while the former may produce a situation whereby the side-chain of the amino acid already bound effectively blocks the entrance of another amino acid to the active area. Consideration of these facts led us to use the cation exchangers in the NH_4^+ cycle for analytical purposes (cf. below).

(d) *Conversion of a Sulfonic Acid Exchanger into a Carboxylic Acid Exchanger.* If an anion exchanger is saturated with a polybasic acid, such as sulfuric, phosphoric, oxalic, etc., it will function as a cation exchanger; likewise, the treatment of a cation exchange resin with amino acids should result in a column containing many free carboxyl groups capable of binding other amino acids, especially the bases. Thus, under the conditions used in these experiments (influent pH 2-6), the saturation of the $-\text{SO}_2\text{OH}$ groups with arginine, histidine, and lysine may have been only apparent, and the inflow of hydrolyzate was stopped when $-\text{SO}_2\text{OH}$ and $-\text{COOH}$ groups were saturated.

In fact, Wieland (26) and Tiselius (27) have employed the carboxylic resin, Wofatit C (I. G. Farbenind.), in the hydrogen cycle to separate arginine, histidine, and lysine from acidified hydrolyzates and the same resin in the K^+ form to separate arginine and lysine from histidine from a neutralized solution. Block (19, 24), using carboxylic resins (Amberlite XE-12 and XE-47, Resinous Products Co., Philadelphia) which were available in the United States during the war, found that XE-12 did not concentrate the bases and that XE-47, either in the H^+ or NH_4^+ cycle, treated with a protein hydrolyzate at pH 6 was not superior for preparative purposes to the side-chain or nucleated sulfonic acid exchangers.*

(e) *Experimental Suggestions.* Although the experimental details for concentrating the basic amino acids (cf. 16-24, 26, 27) need not be given here, a few points may be briefly mentioned.

The resin column should be as long as possible and

The height should be at least three times the diameter.

The amino acid solution should remain in contact with the resin 10 minutes or longer for best results.

* Amberlite IRC-50 (see Appendix) will quantitatively remove the basic amino acids from a protein hydrolyzate adjusted to pH 4.7 with an anion resin. The IRC-50 was also adjusted to pH 4.7 before use with 1 *M* barium acetate. After washing the column with water until the effluent gave a negative ninhydrin test, the basic amino acids are quantitatively removed by elution with 4% aqueous ammonia, etc. This resin did not remove any basic amino acids in the hydrogen cycle when a dilute protein hydrolyzate of approximately pH 1.5 was passed over it.

Although adequate preparation of basic amino acid concentrates may be prepared from hydrolyzates containing 20 mg. N/ml., better separation, especially of the dicarboxylic and monoamino acids, is achieved if the input concentration is 2 mg. N/ml. or less.

Block (24) has shown that the rate of flow and concentration of amino acids are related inversely.

A number of cation exchangers prepared in the United States have given satisfactory results (24, see appendix). Wofatit K, KS, and C products of the I. G. Farbenindustrie have been used abroad (18, 27, 28). In each case the last mentioned exchanger was of the $-\text{COOH}$ type. The sulfonated coals, which are mixed $-\text{SO}_2\text{OH}$ and $-\text{COOH}$ resins, have not been satisfactory in our hands (24).

It is obviously necessary to wash out all residual portions of the hydrolyzate left in the column at the completion of the adsorption. The rate of washing may be several times that used during the adsorption. Tiselius (27) removes the firmly held leucine by washing with 20% acetic acid. This step should prove valuable for many purposes.

2. *Elution with Mineral Acids*

The discussion so far has been primarily concerned with the partial separation of the basic amino acids from the other constituents of a protein hydrolyzate by ion exchange. The basic amino acids may then be removed separately or simultaneously by the use of various eluants or by displacement development. Here again only a brief summary of much experimental evidence will be given (cf. 16-27).

(a) *Simultaneous Elution of All Bases.* If the cation column is treated with 5% H_2SO_4 , 7% HCl , 20% HCl , or NH_4OH of 4% NH_3 or higher, all the amino acids are removed by elution or exchange. Figure 1 describes a typical elution curve of lysine with 10% H_2SO_4 .

(b) *Partial Separation.* Table I illustrates the differences in eluting a column prepared in the above fashion with mineral acids of different strengths. In each case elution with the weaker acid was continued until an aliquot of the eluant gave a negative test with phospho-24-tungstic acid (21, 24). It was observed that better separation with the acids of different strength was obtained if the column was allowed to stand 24 hours or longer before elution.

The most logical explanations for differential elution of basic amino acids by acids of varying concentration are (1) molecular adsorption, (2) variation in the strength of the acid groups of the exchanger, and (3) conversion of the sulfonic acid exchanger into a cation exchanger containing carboxylic groups.

TABLE I

Influence of Eluting with Acids of Varying Strength on the Composition of the Elutriates

Protein	Eluting acid	Nitrogen distribution		
		Arginine N %	Hisidine N %	Lysine N %
Casein	5% H ₂ SO ₄	27	12	31
Casein	1.5% H ₂ SO ₄	22	17	41
	5% H ₂ SO ₄	45	11	11
Casein	2.5% H ₂ SO ₄	26	16	35
	5% H ₂ SO ₄	47	19	10
Blood meal	2% H ₂ SO ₄	19	25	42
	5% H ₂ SO ₄	30	24	18
Blood meal	10% HCl*	15	22	26
	18% HCl	34	30	15

* In 25% aqueous ethanol.

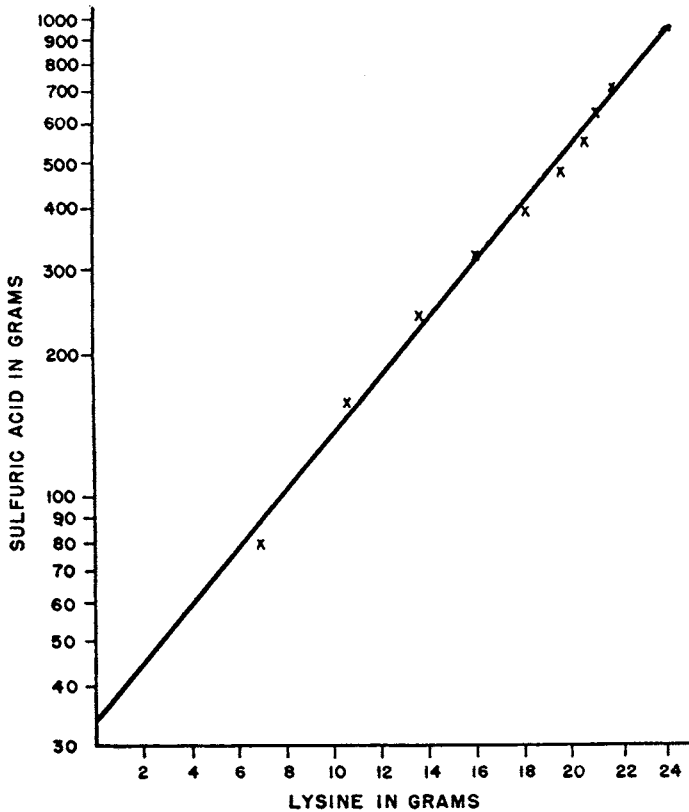
FIG. 1. Elution of lysine. From *Arch. Biochem.* 11, 235 (1946).

3. Exchange and Displacement Development

(a) *Simultaneous Removal of all Basic Amino Acids.* These may be eluted by exchange with aqueous ammonia of 4% NH_3 or higher as well as with other bases and salts (20).

(b) *Differential Exchange.* If the cation exchange resin is treated with aqueous pyridine (1–50%) or other weak bases, first the monoamino acids, then all of the histidine will be eluted. Only traces of lysine and no arginine are removed during $\text{C}_5\text{H}_5\text{N}$ treatment (22, 24). The displacement of histidine with pyridine appears to follow the same asymptotic curve as the elution of lysine with H_2SO_4 (cf. Fig. 1).

This finding is contradictory to the report of Freudenberg *et al.* (18) who claimed that only the neutral and acidic amino acids could be separated from the bases with aqueous pyridine. The discrepancy may, of course, be due to the different cation exchangers used.

After removal of the histidine, lysine is displaced by treatment with 0.4% ammonia. Almost all of the arginine and only a little lysine now remain on the column. They are quantitatively removed with 14% NH_4OH , 6 *N* HCl , etc. (17, 22, etc.).

4. Quantitative Separation of Arginine and Lysine from Histidine, etc.

Five hundred milligrams of cation exchange resin (Duolite-C) is converted into the NH_4^+ cycle in a small glass column, and after removal of the excess NH_4OH with distilled water, a protein hydrolyzate, pH 1.5–2.5, containing 20 mg. of N in 20 ml. of H_2O is passed through the column at the rate of 0.5–1.0 ml./minute. The resin is then washed with 50 ml. of water and the adsorbed tyrosine and other monoamino acids are displaced with 200 ml. of a 1% solution of betaine hydrate. The column is again washed with 50 ml. of H_2O .

The histidine is now eluted with 1% aqueous pyridine until a few milliliters of the effluent give a negative Pauly test (red color with diazotized sulfanilic acid in alkaline solution). A further quantity of 100–150 ml. of 1% pyridine is passed through the resin as a precaution. Histidine may be determined in the pyridine eluant after concentration *in vacuo* (cf. 4).

The column is washed with 30 ml. water and then arginine and lysine are displaced by the addition of 10% NH_4OH . The completeness of elution is ascertained by testing an aliquot of the effluent by the Sakaguchi and ninhydrin reactions (cf. 4). The ammonia is removed by concentration *in vacuo* and the quantity of arginine and lysine in the elutriate is determined (cf. 4).

5. Comments

Englis and Fiess (29) find, in agreement with earlier work (16, 17), that all the neutral amino acids are removed from aqueous solution by

cation exchangers in the H^+ cycle but were unable to effect a separation of lysine, as lysine \cdot HCl, from the neutral amino acids. Cleaver *et al.* (28) studied the exchange of simple mixtures of a few representatives of three classes of amino acids, i.e., basic, neutral, and acidic, on H^+ cationic resinous exchangers. They concluded that the degree of adsorption (exchange) of a diamino-monocarboxylic acid is influenced by the concentration, amount of resin, pH, and type of exchangeable group on the resin. Reducing the size of the resin particles increased its capacity. They also observed that arginine did not displace histidine in an H^+ column in the presence of glutamic acid. This is in agreement with the previously mentioned findings using protein hydrolyzates (16, 17, etc.). Cleaver (28) concluded in agreement with Englis and Fiess (29) that synthetic resinous exchangers in the H^+ cycle were nonselective and could not be used for the separation of the basic amino acids from protein hydrolyzates, and believed that the NH_4^+ exchangers would be more successful. The results given above show the fallacy in the first conclusion (cf. 67).

Sims (30) reported that arginine is not exchanged for Na^+ when Amberlite IR-100H is treated with 0.3% NaCl. Applezweig (31) describes a semimicro exchange column which is useful for exploratory investigations.

IV. SEPARATION OF THE DICARBOXYLIC AMINO ACIDS

1. *Metallic Oxides*

Strain (12) indicated that activated TiO_2 will absorb glutamic acid at pH 3.2. However, it was left for Wieland (13, 32), Schramm (6, 33) and others to develop methods for the quantitative separation of the dicarboxylic amino acids from a protein hydrolyzate and from each other. They were able to isolate the dicarboxylic amino acids by adsorption on Al_2O_3 (Merck-Brockmann) which had been treated with dilute acetic acid or HCl.

After adsorbing the acidic amino acids, the column is washed thoroughly with water until the washings are ninhydrin negative. Then the glutamic acid is eluted with 0.5 *N* acetic acid. The column is again washed with water and the aspartic acid is eluted with 0.5 *N* NaOH or *M*/15 Na_3PO_4 (cf. Bonnicksen, 34). Darling (35) uses the following procedure for the adsorption and elution of the dicarboxylic amino acids:

The column is 450 mm. long by 7 to 8 mm. in diameter. The adsorbent consists of 5 g. Al_2O_3 (Merck). Then 15 ml. of 1 *N* HCl is added in 5 minutes. The precipitate is then decanted with water until the washings are neutral to litmus.

In order to carry out the separation of dicarboxylic acids, the protein hydrolyzate is neutralized and should contain less than 10 mg. dicarboxylic

amino acids. The solution is poured over the Al_2O_3 column and the other amino acids are washed out with 30 ml. or more of H_2O . The glutamic acid is eluted with 55 ml. 0.5 *N* acetic acid followed by 10 ml. water. Aspartic acid is eluted with 5 ml. 3 *N* KOH followed by 40 ml. of 0.005 *N* KOH.

2. Synthetic Anion Exchange Resins

Meyers (36) showed that the following reactions take place when an acid is allowed to come into contact with an anion exchanger in the form of the free base (carbonate) or substituted ammonium salt.

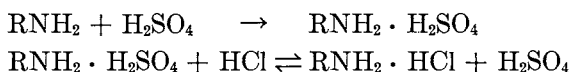

Freudenberg (18) showed that the anion exchanger, Wofatit M, would separate aspartic acid from alanine while Block and Taylor (37) found that the dicarboxylic amino acids could be removed from a protein hydrolyzate in good yield only *after* the basic amino acids and ammonia had been removed by exchange on a cation resin. However, the first quantitative removal of glutamic and aspartic acids was carried out by Cannan (38) in 1944. He showed that if a protein hydrolyzate containing an excess of acid (HCl) was treated with sufficient anion exchange resin (Amberlite IR-4) to raise the pH to 6-7, only the dicarboxylic amino acids were adsorbed. Cannan described this process as follows:

"The neutral amino acids will be present almost entirely in the form of dipolar ions with zero net charge, the acidic amino acids in the form of monoanions, and the ammonia and the basic amino acids, except histidine, in the form of monocations. The histidine will be partially cationic and partially dipolar. The chief anions present will, therefore, be those of hydrochloric acid and of the dicarboxylic amino acids; and it is these alone which should be adsorbed by the resin. Let a , b , and c represent the equivalents of acidic amino acids, bases, and chloride, respectively, in the original hydrolyzate. Then, if α is the fraction of the total anions which is bound by the resin, and if α_a and α_c are the fractions of the total dicarboxylic amino acids and of chloride, respectively, which are bound, electrical neutrality in the solution requires that"

$$a + c - b = (a + c) \alpha = a\alpha_a + c\alpha_c \quad \therefore \alpha = 1 - \frac{b}{a + c}$$

The α is determined by the ratios of bases to acids. Therefore, for complete removal of the dicarboxylic amino acids, HCl must be present in very large excess relative to the bases, or the greater part of the bases must be removed prior to treatment with the resin.

Cleaver (28) also observed that glutamic acid was poorly adsorbed by an anion exchange resin in the presence of arginine · HCl, Tiselius *et al.* (27) adsorbed the dicarboxylic amino acids from a protein hydrolyzate after removal of the bases with Wofatit C.

The adsorbed amino acids, after thorough washing of the resin, are removed by treatment with HCl, H₂SO₄, NH₄OH, etc.

Matchett *et al.* (39) observed that tartaric acid is adsorbed on an anion exchanger (free base) if the cations have first been removed by passage through a cation column in the H⁺ cycle. An even more important observation was their finding that it is possible to exchange tartrate ion for Cl⁻ on a column of Amberlite IR-4 previously treated with HCl without previous removal of the cations. This observation has been employed by Drake (40) for the quantitative separation of the dicarboxylic amino acids.

Three milligrams each of aspartic and glutamic acids are adsorbed on 6.3 ml. of Amberlite IR-4B pretreated with 1 *N* HCl and washed with H₂O. Glutamic acid is removed by exchange with 0.05% acetic acid until a drop of the effluent gives a negative test with ninhydrin. Then the aspartic acid is eluted with 1 *N* HCl.

Consden *et al.* (41) have developed this procedure in the following manner:

The dicarboxylic amino acids are adsorbed on a chromatogram of Amberlite IR-4 maintained at pH 3–4. At this pH, the resin is sufficiently charged to compete successfully with the basic amino acids. After eluting with 1 *N* HCl, the dicarboxylic acids (up to 5 mg./g. resin) are transferred to a chromatogram at pH 2.5. At this pH, glutamic acid is first eluted, followed by aspartic acid. If cysteic acid is present, it may be separated after elution of the dicarboxylic amino acids at pH 2.5 by elution with 1 *N* HCl. The rate of flow through the columns must be kept sufficiently low to ensure equilibrium. This is aided by the use of finely ground resin.

Several patents (42) suggest that glutamic acid may be concentrated with respect to contaminating inorganic salts by chromatographing Steffen's liquor, from beet sugar processing, through a cation column in the H⁺ cycle. Betaine is also concentrated at the same time.

V. SEPARATION OF THE AROMATIC AMINO ACIDS

1. Active Carbon

Activated charcoal has been used extensively for the separation of tyrosine, tryptophane, and phenylalanine from mixtures of amino acids by Cheldelin and Williams, Wachtel and Cassidy, Tiselius and Claesson, and many others (cf. 4 for bibliography). This subject is, however, outside the scope of this review. It will not be discussed further.

2. Synthetic Ion Exchange Resins

Turba (43) used the cation exchange resin Wofatit M previously treated with *N*/5 acetic acid as an adsorbent for tryptophane. The amino acid was eluted with aqueous alcohol or dilute pyridine. Block (17)

adsorbed tryptophane along with arginine, histidine, and lysine on cation exchange resins and eluted it with ammonia. It is apparent that further work in this field would repay investigation.

VI. SEPARATION OF NEUTRAL AMINO ACIDS

1. Adsorption Methods

Tiselius and Claesson (also Wachtel and Cassidy) have used activated carbons for the separation of some of the amino acids by frontal analysis, elution analysis, or displacement development. These procedures are described in detail elsewhere (cf. 4).

2. Partition Chromatography

As mentioned in the Introduction, Austerweil (1) suggested that ion exchange on synthetic zeolites may be considered as a type of partition chromatography. Therefore, a brief description of some of the methods that are primarily dependent on partition chromatography will be discussed.

(a) *Silica Gel Method.* A solution of acetylated amino acids is chromatographed from an organic solvent (CHCl_3 — $\text{C}_4\text{H}_9\text{OH}$, etc.) into a column consisting of a water-retentive support such as activated silica gel or Hyflo-supercel. The column is previously saturated with water (Martin, 44) or with an inorganic base such as an hydroxide or carbonate for acidic substances or a weak inorganic acid such as NaHSO_4 for the extraction of basic ions (Catch 45). Wieland and Fremery (46) use the copper complexes of the free amino acids and phenol liquefied with 10–20% water as the developing agent on water-saturated SiO_2 gel columns. This method eliminates the bothersome acetylation of the amino acids and permits visualization of the bands by the color of their copper complexes rather than by resorting to dyes as in the procedure of Martin, Syngé and their coworkers.

(b) *Chromatography on Cellulose or Starch.* Separation of amino acids in mixtures takes place on a cellulose (or starch) strip or column owing to the different relative solubilities (partition coefficients) and adsorptions of each amino acid between the water which is invariably held in the support and a water immiscible solvent which is allowed to move slowly along the paper (or starch) column past an area which contains the amino acid mixture.

Consden (47) and Dent (48) describe the air-tight boxes for holding the filter paper strips or sheets so that one end of the paper dips beneath the water-saturated organic solvent while the rest of the paper hangs down in a water-solvent saturated atmosphere.

We have found that the rectangular glass aquaria, which may be purchased at any "pet shop," are most suitable for paper chromatography. Aquaria, 52 cm. long by 32 cm. high by 26 cm. wide, have been used. The base of the aquarium is covered with a thick layer of good grade paraffin. The lower portion of the sides and all joints are also paraffined. Troughs are then made along each side of the chamber by placing glass rods on the paraffined base about 2 or 3 cm. from each side. Then, the area between the rods is filled with hot paraffin. After cooling, the trough is rounded and smoothed. Several glass rods running the length of the chamber are then sealed with paraffin to the sides about 5 cm. out and 2 or 3 cm. from the top. These serve as supports for the paper. Our adaptation of Consden's chamber is shown in Fig. 2.

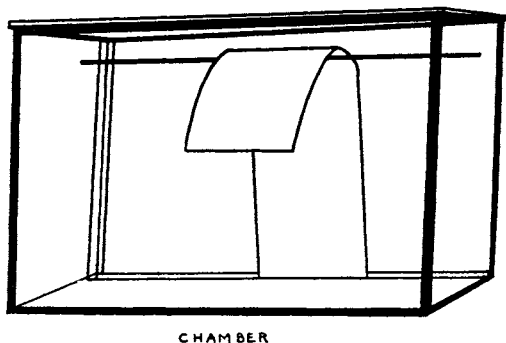

FIG. 2. Chamber for partition chromatography.

The troughs are then filled with the developing reagents. One or more drops (0.01 ml.) of standard or unknown solution are placed on the filter paper 2.5 cm. from one edge, the drops are air-dried, and the edge of the paper is placed in the trough. The chamber is covered with a heavy glass plate. The solvents climb by capillary action up the paper, then past the support rod and down the other side. The transparency of the chamber permits visualization of the progress of the solvent without disturbance. The air can be replaced with illuminating gas, H_2S , etc., as desired, and a beaker containing NH_4OH , HCN , etc., may be placed in the central part of the chamber if necessary.

In order to keep the temperature approximately constant, the chambers are placed in a cabinet of the laboratory desk which is equipped with a household thermostat, heating coil, and a small fan. Several solvents (e.g. isobutyric-isovaleric acids) cause the paraffin to soften. In these cases, it is necessary to use a simple glass trough made by cutting a 5 or 6-cm. glass tube in half and sealing off the ends. This is put in the

paraffin trough. These chambers can be used for both one-dimensional and two-dimensional chromatograms.

Reagents: 1. Phenol is liquefied with water. The chromatogram is carried out in an atmosphere of 0.3% aqueous ammonia in coal gas (Consden, 47).

2. 1,3,5-trimethylpyridine (*s*-collidine) saturated with water (Consden, 47).

3. 1:1 mixture of isobutyric and isovaleric acids saturated with water. This is used in place of phenol (Edman 49).

4. 1:1 mixture of pyridine and technical amyl alcohol. This is used in place of *s*-collidine (Edman 49).

Method: A small drop or streak of 5 to 15 $\mu\text{g.}^*$ of each amino acid in 1 to 4 $\mu\text{l.}^\dagger$ of solution is placed a few centimeters from one end of the filter paper and about 3 cm. apart. The exact location is marked by a pencil. The paper is dried in the air and inserted into the trough containing the water-saturated solvent. The solvent gradually creeps over the paper. After it has run about 15 inches, the paper is removed, dried by a current of warm air from a household electric heater.

The paper is then sprayed with a solution of 0.1% ninhydrin in water-saturated butanol. The paper is again dried. Most of the amino acids will be made evident during this drying as purple, red-purple or in the case of proline and hydroxyproline as yellow spots. If peptides are present, they are only brought out by heating the paper at 80 to 100°C. for 5 to 10 minutes. For independent identification of cystine, cysteine, and methionine, the paper is extracted with ether-acetone in order to remove the solvents and sprayed with platonic iodide (50). Pauly's reaction (cf. 4) is used to identify histidine and tyrosine, and the Sakaguchi test (cf. 4) is used for arginine (48, 50).

The procedure described above results in a one-dimensional chromatogram. If a mixture of amino acids is placed in a corner of an 18-in. \times 18-in. square of paper, and chromatographed with one solvent, say collidine, for some time, the sheet dried, and then placed at right angles to the first run in a second tank containing aqueous phenol and again chromatographed, a further differentiation of the amino acids is accomplished. The identity of the amino acids in each spot is then located by comparison with known amino acids run in one dimension only in the same aquarium at the same time.

Comment: Consden *et al.* (47) identify the amino acids by the distance they travel in per cent of the distance travelled by the solvent. They

* Microgram. † Microliter.

claim that under constant conditions of temperature, etc., each amino acid has a constant R_F value, i.e.,

$$R_F = \frac{\text{Distance travelled by amino acid}}{\text{Distance travelled by solvent}}$$

Our own experience suggests that greater reliance should be placed on simultaneous controls.

Synge (51) has used a column of starch in place of filter paper to chromatograph amino acids. Butanol or butanol:benzyl alcohol (1:1) saturated with water are the solvents employed. Block (51a) has described the quantitative estimation of amino acids on paper chromatograms.

An excellent review on paper chromatography has been published by Martin (52).

3. *Metallic Oxides*

Schramm and Primosigh (6) remove the aromatic amino acids on activated carbon, the bases on silica gel washed with 20% acetic acid, the dicarboxylic amino acids on acid treated Al_2O_3 . HCHO is added to the remaining solution of neutral amino acids (pH 7) and these are separated into two groups: alanine, valine, leucine, isoleucine, proline, and hydroxyproline are in the HCHO effluent, while glycine, serine, cysteine and threonine are adsorbed on the Al_2O_3 . The latter amino acids are eluted with 0.5 *N* KOH. The position of the amino acids on the columns can be followed by first adsorbing a weak acidic dye such as bromthymol blue or methyl red. The amino acids are located in the colorless areas, having replaced the less strongly adsorbed dyes (53).

4. *Synthetic Ion Exchange Resins*

During the development of methods for the large scale preparation of basic amino acid concentrates from protein hydrolyzates by ion exchange columns (16, 17, 24, etc.) as well as when mixtures of a few known amino acids were chromatographed (18, 28, 29, etc.), it was observed that considerable fractionation of the dicarboxylic and neutral amino acids was achieved during the saturation of the exchanger with the basic amino acids. As would be expected, ions of less affinity are replaced by ions of greater affinity and ions of greater affinity are replaced by ions of lesser affinity when these are in excess in the solution (cf. 54). Affinity, in this case, is the algebraic sum of all the factors that control adsorption and desorption on ion exchange resins. Therefore, the composition of the effluent, at different stages, will depend, in part, on the amino acid composition of the input. However, the following summary derived from experiments on blood meal, fish meal, fish scales, casein, soy bean meal, glycinin, etc.,

indicates the potentialities of this type of fractionation. The substances are listed in the order in which they appear in the effluent.

Mineral acids, organic acids, nonionizable substances.

Aspartic acid, glutamic acid, hydroxyproline.

Glutamic acid, hydroxyproline, proline, serine.

Glycine, alanine, glutamic acid, serine, threonine, valine, proline.

Tyrosine, methionine, threonine, serine, valine, glutamic acid, glycine alanine, proline, ammonia.

Tyrosine, valine, cystine, methionine, serine, glycine, alanine, some leucines, threonine.

Cystine, leucines, phenylalanine, methionine, serine, some tyrosine, valine, ammonia, etc.

It is preferable to remove the NH_3 from the hydrolyzate before chromatography. The dicarboxylic amino acids and cysteic acid, if present, may then be removed by passage over an anionic exchanger (cf. above). The resulting mixture of neutral amino acids can then be separated by further chromatography, fractional crystallization or by displacement development (55, 56).

Bendall *et al.* (55) observed that when a cation exchange resin in the H^+ cycle (Zeo-Karb 215) is saturated with individual amino acids, they may be arranged in ascending order of the pH values of the emerging components. Thus, the pH of the emerging solution of aspartic acid is 2.77; that of glutamic acid 3.22; of glycine 5.97; of ammonia 11.00. This suggests that glutamic acid will displace aspartic acid, that glycine will displace both of the dicarboxylic amino acids and that NH_4OH will displace glycine, etc. This process is an improvement on the chromatographic fractionation described above (cf. 17, 24, etc.) and should prove very useful in the future.

Partridge (56) has applied this procedure for the fractionation of an egg albumin hydrolyzate using 0.15*N* NH_4OH as the displacement developer and obtained the following fractions after removal of the aromatic amino acids.

1. Aspartic acid and traces of serine. (Hydroxyproline is probably lacking in egg albumin.)
2. Glutamic acid, serine, threonine, and a small amount of aspartic acid.
3. Glycine, alanine, and a small quantity of glutamic acid and valine.
4. Valine and proline.
5. Leucine, isoleucine, methionine and cystine.
6. Histidine and an unidentified amino acid.
7. Lysine.
8. Arginine remains on the column.

When fraction two was adsorbed on a fresh column and developed with an

ammonical aqueous acetone solution, aspartic acid, glutamic acid and serine could be obtained pure. A somewhat similar type of displacement development using a total of seven ion exchange columns in series has been described previously (57).

VII. GENERAL COMMENTS

A number of useful suggestions on the design and operation of ion exchange resins have appeared in recent years, especially in brochures published by resin manufacturers (cf. 58-61). These discuss preferential adsorption (61), operational rates (57-61), elution (59-61), etc., and are well worth thorough study. Claesson (62) describes the mathematical characteristics of adsorption isotherms while Le Rosen (63), Martin and Synge (64), Robinson (65) and others discuss the general principles of chromatographic analysis. Le Rosen (63) points out that when the concentration of a weakly adsorbed substance is increased, it will tend to elute a more strongly adsorbed material of lower concentration. Thus, the order of appearance of an amino acid in the effluent from a cation exchange column will depend, in part, on the relative concentrations of the amino acids in the influent.

Because of the many factors involved in the fractionation of amino acids, although certain principles should be borne in mind, the only really satisfactory method of determining the optimal conditions to be employed is the method of trial and error.

BIBLIOGRAPHY

1. Austerweil, G., *J. Soc. Chem. Ind.* **53**, 185 (1934).
2. Whitehorn, J. C., *J. Biol. Chem.* **56**, 751 (1923).
- 2a. Felix, K. and Lang, A., *Z. physiol. Chem.* **182**, 125 (1929).
3. Dubnoff, J. W., *J. Biol. Chem.* **141**, 711 (1941).
- 3a. Davenport, H. W., Fisher, R. B. and Wilhelmi, A. E., *Biochem. J.* **32**, 602 (1938).
4. Block, R. J. and Bolling, D., *The Amino Acid Composition of Proteins and Foods*. 2d ed. C. C. Thomas, Springfield, Illinois (1949).
5. Nelson, J. A., McFarlane, W. D., and Boulet, M., *Federation Proc.* **5**, 148 (1946).
6. Schramm, G. and Primosigh, J., *Ber.* **77B**, 417 (1944).
7. Tiselius, A., *Advances in Protein Chemistry* **3**, 67 (1947).
8. Ackermann, D., and Fuchs, H. G., *Z. physiol. Chem.* **240**, 198 (1936).
9. Fuchs, H. G., *Z. physiol. Chem.* **246**, 278 (1937).
10. Turba, F., *Ber.* **74B**, 1829 (1941).
11. Bergdoll, M. S., and Doty, D. M., *Ind. Eng. Chem. Anal. Ed.* **18**, 600 (1946).
12. Strain, H. H., *Chromatographic Adsorption Analysis*. Interscience, New York (1942).
13. Wieland, T., *Naturwissenschaften* **30**, 374 (1942).
14. Adams, B. A., and Holmes, E. L., *J. Soc. Chem. Ind.* **54**, 1 (1935).
15. Griessbach, R., *Melliand Textilber.* **20**, 577 (1939).
16. Block, R. J., *Proc. Soc. Exptl. Biol. Med.* **51**, 252 (1942).

17. Block, R. J. (to C. M. Armstrong, Inc.), U. S. Patent 2,386,926 (Oct. 16, 1945).
18. Freudenberg, K., Walch, H., and Molter, H., *Naturwissenschaften* **30**, 87 (1942).
19. Block, R. J. (to C. M. Armstrong, Inc.), U. S. Patent 2,387,824 (Oct. 30, 1945).
20. Block, R. J. (to C. M. Armstrong, Inc.), U. S. Patent 2,429,666 (Oct. 28, 1947).
21. Block, R. J., U. S. Patent Application (to C. M. Armstrong, Inc.), U. S. Patent 2,462,597 (Feb. 22, 1949).
22. Block, R. J., U. S. Patent Application (1946).
23. Block, R. J., *Federation Proc.* **5**, 123 (1946).
24. Block, R. J., *Arch. Biochem.* **11**, 235 (1946).
25. Claesson, S., *Arkiv Kemi, Mineral. Geol.* **23**, No. 1, 1 (1946).
26. Wieland, T., *Ber.* **77B**, 539 (1944).
27. Tiselius, A., Drake, B., and Hagahl, L., *Experientia* **3**, 651 (1947).
28. Cleaver, C. S., Hardy, R. A., and Cassidy, H. G., *J. Am. Chem. Soc.* **67**, 1343 (1945).
29. Englis, D. T., and Fiess, H. A., *Ind. Eng. Chem.* **36**, 604 (1944).
30. Sims, E. A. H., *J. Biol. Chem.* **158**, 239 (1945).
31. Applezweig, N., *Ind. Eng. Chem. Anal. Ed.* **18**, 82 (1946).
32. Wieland, T. and Wirth, L., *Ber.* **76B**, 823 (1943).
33. Schramm, G., and Primosigh, J., *Ber.* **76B**, 373 (1943).
34. Bonnichsen, R. K., *Arch. Biochem.* **12**, 83 (1946).
35. Darling, S., *Acta Physiol. Scand.* **10**, 91 (1945).
36. Myers, R. J., *Advances in Colloid Sci.* **1**, 317 (1942).
37. Block, R. J., and Taylor, G. P., unpublished experiments at American Maize Products Company, 1941-1942.
38. Cannan, R. K., *J. Biol. Chem.* **152**, 401 (1944).
39. Matchett, J. R., Legault, R. R., Nimmo, C. C., and Notter, G. K., *Ind. Eng. Chem.* **36**, 851 (1944).
40. Drake, B., *Nature* **160**, 602 (1947).
41. Condsen, R., Gordon, A. H., and Martin, A. J. P., *Biochem. J.* **42**, 443 (1948).
42. Bennett, A. N., U. S. Patent 2,375,164; Nees, A. R., and Bennett, A. N., U. S. Patent 2,375,165 (May 1, 1945).
43. Turba, F., Richter, M., and Kuchar, F., *Naturwissenschaften* **31**, 508 (1943).
44. Martin, A. J. P., and Synge, R. L. M., *Biochem. J.* **35**, 1358 (1941).
45. Catch, J. R., Cook, A. H., and Heilbron, I. M., *Nature* **150**, 633 (1942).
46. Wieland, T., and Fremery, H., *Ber.* **77B**, 234 (1944).
47. Condsen, R., Gordon, A. H., and Martin, A. J. P., *Biochem. J.* **38**, 224 (1944).
48. Dent, C. E., *Biochem. J.* **41**, 240 (1947); *Lancet* **251**, 637 (1946).
49. Edman, P., *Arkiv Kemi, Mineral. Geol.* **22**, 1 (1945).
50. Winegard, H. M., Toennies, G., and Block, R. J., *Science* **108**, 506 (1948).
51. Synge, R. L. M., *Biochem. J.* **38**, 285 (1945).
- 51a. Block, R. J., *Science* **108**, 608 (1948).
52. Martin, A. J. P., *Endeavour* **6**, 21 (1947).
53. Schramm, G., and Primosigh, J., *Ber.* **77B**, 426 (1944).
54. N. V. Octrooien Maatschappij "Activit," French Patent 805,092 (Nov. 10, 1936).
55. Bendall, J. R., Partridge, S. M., and Westall, R. G., *Nature* **160**, 374 (1947).
56. Partridge, S. M., *Nature* **163**, 236 (1949).
57. Resinous Products and Chemical Co., Philadelphia, Pa., 1946.
58. Resinous Products and Chemical Co., Laboratory Manual. Amberlite Ion Exchange Resins, Philadelphia, Pa.
59. Alm, A. V., Ion-Exchanger Resins and Their Use. Chemical Process Co., San Francisco (1943).

60. Tiger, H. L., and Sussman, S., *Ind. Eng. Chem.* **35**, 186 (1943)
61. Myers, R. J., and Eastes, J. W., *Ind. Eng. Chem.* **33**, 1203 (1941).
62. Claesson, S., *Arkiv Kemi, Mineral. Geol.*, **24A**, No. 7, 1 (1947).
63. Le Rosen, A. L., *J. Am. Chem. Soc.* **69**, 87 (1947).
64. Martin, A. J. P., and Synge, R. L. M., *Advances in Protein Chemistry* **2**, 1 (1945).
65. Robinson, F. A., *Analyst* **71**, 251 (1946).
66. Cannan, R. K., *Ann. N. Y. Acad. Sci.* **47** (2) 135 (1946).
67. Hems, B. A., Page, J. E., and Waller, J. G., *J. Soc. Chem. Ind.* **67**, 77 (1948).

Sugar Refining and By-Product Recovery

A. B. MINDLER

The Permutit Company, New York, N. Y.

CONTENTS		Page
I.	Introduction	316
II.	Early Work on Ion Exchange	316
	1. Raw Beet Juice	316
	2. Beet Molasses	317
III.	Development of Adsorbents Having Ion Exchange Properties	317
	1. Adsorption and Ion Exchange	317
	2. Carbonaceous Adsorbents	318
IV.	The Removal of Electrolytes	318
	1. Coal Derivatives and Inorganic Gels	318
	2. Coal Derivatives and Anion Exchange Resins	319
	3. Synthetic Resins	319
V.	Aim of Demineralizing Impure Sugar Solutions	320
VI.	Method of Applying Ion Exchange	321
	1. Fundamental Equipment	321
	2. Level Control	321
	3. Piston-like Flow	322
	4. Re-Use of Sweet Water	322
	5. Calcium Sulfate Precipitation	324
	6. Re-Use of Regenerants	324
	7. Instrumentation	324
VII.	Sugar Beet Juice	325
	1. Conventional Process	325
	2. Steffen's Process	326
	3. Application of the Demineralizing Process	326
	4. First Commercial Installation	327
	5. Results of Operation of Isabella Plant	328
	6. Modified Processes	329
	7. Published Reports of Process Costs	329
	8. Miscellaneous Costs of Demineralizing Beet Juices	329
	9. Recovery of By-Products from Beet Juice	330
VIII.	Sugar Cane Juice	331
	1. Conventional Process	331
	2. Application of Demineralizing Process	332
	3. Published Reports of Pilot Plant Work	332
	4. Recovery of Materials from the Demineralization of Sugar Cane	333
	5. Critical Study	334
IX.	Sorgo Juice Demineralization	334

X.	Low Grade Syrup and Blackstrap Demineralization	334
1.	High Purity Refinery Syrups and Liquors	334
2.	Low Grade Syrups	335
3.	Blackstrap Molasses	335
XI.	Starch Conversion Liquor Demineralization	336
1.	Acid Conversion	336
2.	Enzyme Converted Starch	338
3.	Recovery of By-Products	339
XII.	Sugar From Fruit Wastes	339
1.	Citrus Peel Press Juice Demineralization	339
2.	Pineapple Mill Juice Demineralization	340
3.	Apple Juice Demineralization	342
XIII.	Ion Exchange Treatment of Miscellaneous Sugars and Related Compounds	343
1.	Jerusalem Artichokes	343
2.	Polyhydric Alcohols	343
3.	Whey Demineralization	343
4.	Removal of Lead from Maple Syrup	345
5.	Ion Exchange in Sugar Analysis	345
XIV.	Pectin Manufacture	346
XV.	Recovery of Tartaric Acid	346
1.	Anion Exchange	346
2.	Acid Removal	346
	Bibliography	347

I. INTRODUCTION

The largest single field of application of ion exchange outside water conditioning is in the manufacture of sugar. It is interesting to note that the earliest suggestion for using ion exchange commercially was in the treatment of sugar beet juice, not in water treatment. In 1896, Harm was granted a patent on the use of a siliceous earth having ion exchange properties for removing from sugar beet juice the sodium and potassium cations which cause increased molasses production (1). Since that early date, practically all types of sugar solutions have been treated by several different ion exchange processes.

II. EARLY WORK ON ION EXCHANGE

1. *Raw Beet Juice*

Simultaneously with Harm, Rümpler was developing a process for treating sugar beet juice using zeolitic clays for removing sodium and potassium in exchange for calcium in order to obtain higher yields of sucrose. Rümpler (2, 3) found an increase of 8% in the purity of beet juices by passing them through zeolites regenerated with calcium salts. The calcium salts thus formed were considered to be less melassigenic than

the alkali earth salts originally present. Gans (4, 5), the pioneer of water softening by the zeolite process, improved Rümpler's method by using the fused synthetic zeolites which he had been manufacturing. These materials greatly increased the speed of reaction for exchanging calcium from the zeolite for sodium and potassium from the sugar solution; however, none of these endeavors were successful for several reasons. First, the desired reaction did not go to completion because these early workers were trying to exchange monovalent ions in solution for divalent ions on the ion exchanger. Secondly, evaporator scaling was increased by the introduction of more calcium. Thirdly, the viscosity was tremendously increased by the treatment owing to the increased calcium. These characteristics of the treated juice made it almost impossible to concentrate the juice to the point of crystallization and the processes were never commercially adopted (6). Zeolites operating in the lead (7) and ammonium (8, 9) exchange cycles have also been used for treating sugar beet juices and diluted molasses but these processes have likewise remained unused.

2. Beet Molasses

About twenty years after this early work, Bachler (10) reported the results of a series of experiments on the treatment of beet molasses by calcium exchange before Steffenization. He found that he could remove 98.3% of the potassium and 12.5% of the sodium. Organic non-sugars decreased from 30.7% to 23.5% by precipitation as calcium salts. The purity was increased from 57.1% to 63.3% indicating the probability of higher yields of sucrose by Steffenization of calcium zeolite treated molasses.

III. DEVELOPMENT OF ADSORBENTS HAVING ION EXCHANGE PROPERTIES

1. Adsorption and Ion Exchange

The chemistry of refining sugar solutions by ion exchangers and by certain adsorbents has not been clearly differentiated. It is generally known that bone char and some other decolorizing carbons (cf. 10a) and clays, in addition to removing color, also remove ash. However, the removal of ash by these adsorbents is by no means quantitative nor can the chars be regenerated effectively by chemicals. A large portion of the ash taken up by chars is rinsed off during the sweetening off step only to be recycled with the sweet water and other house liquors. The chars are regenerated thermally and the ash remaining in the char, when it is burned, accumulates and gradually causes the char to be ineffective. Some of the refining resulting from carrying out treatment of sugar solutions by ion exchangers appears to be adsorption since color is often removed by passage through sodium exchangers, hydrogen exchangers or even anion exchangers,

with no equivalent amount of ions exchanged in place of color bodies. Unlike chars, however, the ion exchange materials do not throw ash during the sweetening off operation. Regeneration is accomplished chemically for removing both adsorbed impurities and exchanged constituents substantially completely.

2. Carbonaceous Adsorbents

During the early 1930's, a group of Dutch investigators developed adsorbents for treating sugar solutions using dehydrated organic materials. Vegetable matter such as sawdust, lignite, and various coals were treated with sulfuric acid, oleum, phosphoric acid, zinc chloride and other dehydrating materials (11). In this country, Boyd (12, 13) produced a similar material for treating beet juice by sulfonating sawdust, seaweed or kelp mixed with diatomaceous earth and by supporting modified resins on diatomaceous earth. These early materials were generally used once and then discarded in the manner of several conventional vegetable carbons. Continued work with these materials, particularly coal derivatives, produced granular adsorbents which were regenerative with acids or salts and which possessed better decolorizing and handling properties. These materials were used in sugar work to some extent in Europe under the trade names of Collactivit, Dusarit and Activit (14, 15, 16, 16a). However, widespread industrial usage of these materials did not take place because they were designed not primarily for electrolyte removal but for decolorization, which was not complete. Acids which were formed by this treatment had to be neutralized since no method was known for adsorbing them.

IV. THE REMOVAL OF ELECTROLYTES

1. Coal Derivatives and Inorganic Gels

The granular adsorbents discussed above were found to possess good hydrogen or sodium exchange properties and handling characteristics. They were rapidly employed for treating water in both these cycles. Liebknecht conceived the idea of combining the improved granular hydrogen exchange materials with a second step to remove ionized substances completely from solution, not just substitute other cations. He used sulfonated coals for the first step of the demineralizing process to form acids of the salts originally present by hydrogen exchange. These hydrogen cation exchangers were regenerated after exhaustion with acids. For the second step he used inorganic gels such as ferric oxide gel, to remove the acids formed in the first step. These were regenerated with an alkali. Liebknecht recognized the fact that the extension of the demin-

eralizing process from a method of removing electrolytes in water to one of purifying sugar solutions is a logical one. In his patent (17) he stated:

“Not only aqueous solutions can be subjected to this treatment but also solutions of substances which in themselves are inactive in the sense of ion exchange, like for instance sugar solutions, which are to be freed of salt content of lime salts or alkali salts. As is shown, the crystallization of sugar is retarded considerably by these salts. This difficulty is eliminated by the above described process, since sugar solutions are obtained which are completely or nearly completely free of salt.”

2. Coal Derivatives and Anion Exchange Resins

Smit (18) disclosed, in a patent application on the demineralization of sugar solutions, the use of acid regenerated coal derivatives and a meta-phenylenediamine-formaldehyde resin for acid removal. He indicated that most of the salt and color was removed, the latter by the anion exchanger.

3. Synthetic Resins

In 1935, Adams and Holmes (19, 20) discovered that certain resins possess ion exchange properties. Modified phenol-formaldehyde resins produced by sulfonating phenolic resins were used as hydrogen exchangers to form the acids of the salts present in solution. Amino-formaldehyde resins were used as anion exchangers to remove the acids. The active groups of cation exchange resins used for hydrogen exchange are the same as those of sulfonated coals, $-\text{SO}_3\text{H}$. The hydrogen on the sulfonic acid group is exchangeable for cations in solution. Thus,

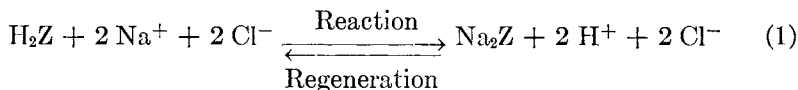

where Z is $(\text{R} - \text{SO}_3)_2$ and typifies a sulfonated coal or resin, and Na and Cl represent ions of a salt in solution. The acids formed from salts by reaction (1) are removed by passage through anion exchange resins of either aliphatic or aromatic structure. When these resins are regenerated with an alkali they have the property of adsorbing acids in a manner similar to the addition reaction of ammonia with HCl.

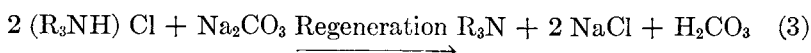
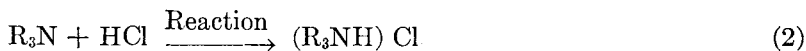

where R_3N is the anion exchanger (base) and HCl is a typical acid in solution. Regeneration is carried out by means of an alkali, usually Na_2CO_3 , but NaOH or NH_4OH may also be used. Figure 1 is a flow diagram of the demineralizing process. There is also some evidence that

the mechanism of the removal of a portion of the acids is the exchange of the anion of the acid in solution for hydroxyl or carbonate ions of the resins. However, conclusive data have not yet been presented to prove which reaction is responsible for acid removal in the second step of the

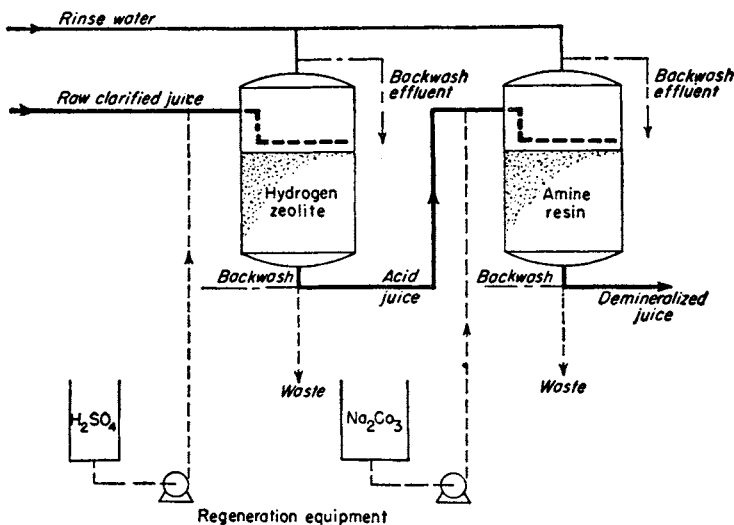
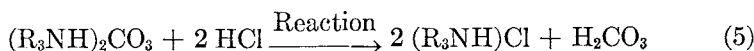
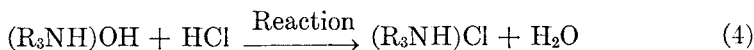

FIG. 1. Flow diagram of two step demineralizing process.

demineralizing process. The reactions below illustrate the anion exchange theory of acid removal.



V. AIM OF DEMINERALIZING IMPURE SUGAR SOLUTIONS

The primary purpose of demineralizing (or deionizing) sugar solutions is the removal of impurities, both inorganic and organic. The benefits of the increase in purity of the treated solutions are manifested in numerous ways depending on the type of sugar solution being processed and the products to be obtained. In sucrose manufacture from both cane and beet the improvement lies in (a) greater yields of sucrose because of higher purities going to the pan, (b) a consequent decrease in molasses formation, (c) decolorization leading to improved sugar quality and final molasses value, (d) elimination of evaporator scaling and intermittent washouts of juice heaters and evaporators, (e) superior working qualities of the massecuite, and (f) some saving in chemicals in beet juice processing. In dex-

trose manufacture, the benefits are much the same as those listed for sucrose with the main emphasis on improved yield, quality, and working characteristics. In syrup manufacture, from low grade sources, the main aim is to remove undesirable flavors which may be caused by either organic or inorganic constituents and the reduction of ash content is of secondary importance. Special decolorizing resins are being developed for this purpose but this work is still in the preliminary stage. Since the raw materials are of such varied character, discussion of these impurities will be found in the latter portions of this chapter.

VI. METHOD OF APPLYING ION EXCHANGE

1. *Fundamental Equipment*

Basically, very few methods of operation have been proposed for applying ion exchange commercially to the treatment of sugar juices. These methods follow closely those employed in treating water and the equipment is substantially the same in both solutions. A cut-away illustration of a typical demineralizing unit is shown in Fig. 14 of the chapter by Gilwood. The solution enters the vessel holding the ion exchange material at some point above the bed and passes downwardly through the granular exchange material. The bed is supported by a false bottom of perforated stainless steel, porous stone or rubber or, more commonly, on a bed of graded gravel, anthracite coal or other inert material. Some type of collecting system beneath the support must be provided to distribute the backwash water and collect the treated sugar solution, regenerant and rinse effluents. These factors are discussed in greater detail in Gilwood's chapter.

2. *Level Control*

One important point of contrast exists between treating water and sugar solutions, namely, dilution of the product. Obviously, when treating water or other solutions that do not require concentration after treatment, it is not necessary to pay attention to minimizing dilution. In sugar demineralizing, however, elaborate schemes have been devised for keeping dilution of the solution being treated to a minimum. Since sugar solutions are heavier than water, it is deemed necessary to drain the water above the bed to a point near the bed level to eliminate mixing of the heavy juice with the large volume of water contained in the rising space used for expansion of the bed during backwashing. Furthermore, a distributor must be provided at a short distance above the bed level for introducing the untreated solution because a high drop of the solution to the bed surface will cause erosion of the surface with consequent channeling and

rapid formation of fines. This distributor must be properly designed to provide for effective distribution of the sugar solution and regenerants which are usually introduced at different rates. In view of the fact that the treating cycle for some types of sugar solutions is often relatively small in terms of volume treated compared to the volume of the bed, it is preferable to maintain the liquid level just above the bed rather than allow the entire shell to fill with untreated sugar solution. This may be done, for example, by means of adjusting the air pressure above the solution by admitting air when the level rises or relieving air when it falls (21) and by other schemes. Float operated valves, electrodes, or other means may be utilized for level control. Other methods are throttling of the treated effluent from the unit depending on the liquid level, throttling of the inlet flow rate of untreated solution and combinations of these methods.

3. *Piston-like Flow*

As sugar solutions are heavier than water, the flow of solutions being treated in granular beds may be described as piston-like, i.e., there is surprisingly little mixing of solutions of different specific gravities (22). This fact was utilized in a novel method of handling sugar solutions by ion exchange as described by Mindler (23, 23a). The sugar solution was introduced beneath the full column of water above the bed through the low level distributor and it was reported that the amount of dilution did not exceed that found when operating by careful level control, namely, about 10%. These data are illustrated in Fig. 2.

4. *Re-use of Sweet Water*

In order to reduce the amount of dilution further it is sometimes the practice to re-use dilute sweet water in the first step of sweetening-off or rinsing the bed free of sugar solution. This sweet water is obtained at the beginning of a treating run when displacing water from the bed with sugar solution and when displacing sugar solution at the end of the run. During sweetening-on of the two beds comprising the demineralizing pair, about 75–80% of the water in the voids of the beds is displaced free of sugar. The remainder contains increasingly higher amounts of sugar, ultimately approaching the sugar content of the untreated solution and continuing at this solids content until the end of the run and the sweetening-off step. A typical sweetening-on and off curve is illustrated in Fig. 3, comparing the dilution resulting when reusing sweet water for sweetening-off, with that obtained when using only water. The additional evaporator load may thus be reduced by about 30% according to these data (23).

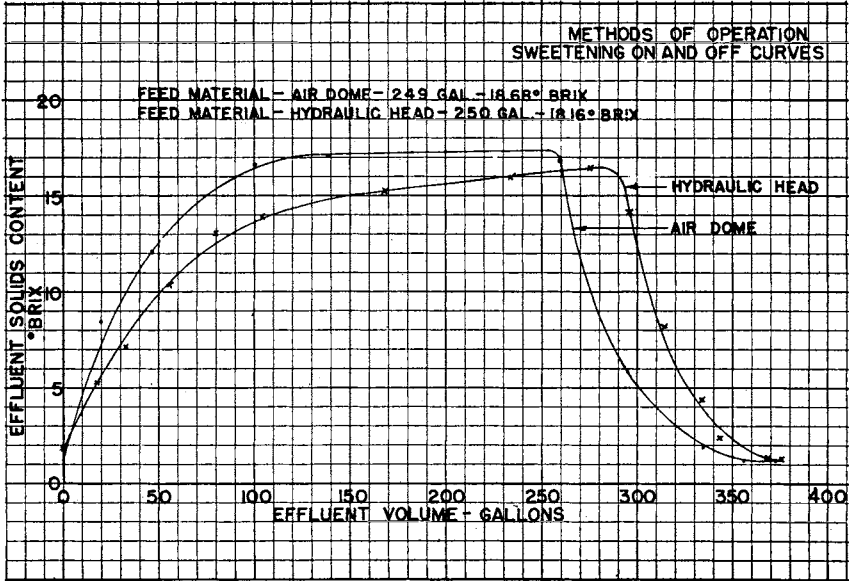

Fig. 2. Comparison of effluent solids content in air dome and hydraulic head methods of operation.

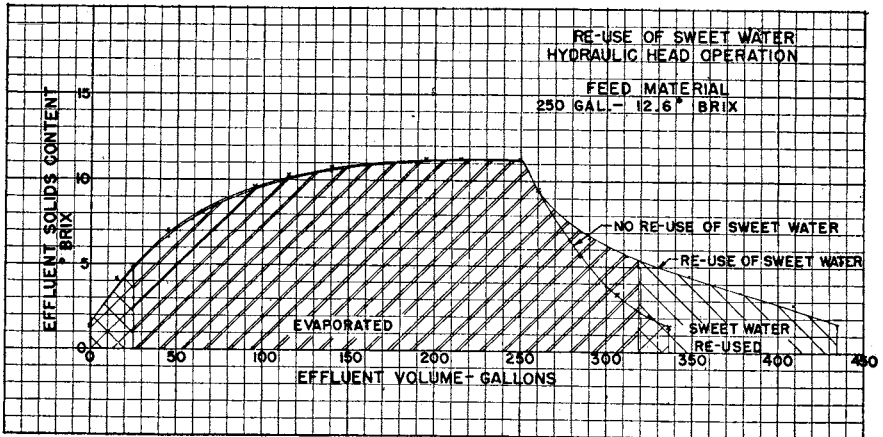

Fig. 3. Evaporation on re-use of sweet water.

5. *Calcium Sulfate Precipitation*

Demineralization of cane and beet juices is generally carried out on lime and heat defecated sugar juice. Since liming adds some calcium to the sugar juice, in spite of the precipitation of some calcium salts during defecation, the hydrogen exchange material becomes exhausted to a large extent with calcium. During regeneration of the ion exchange bed the acid forms salts of the cations taken up from the juice during the previous run. Sulfuric acid is the cheapest regenerant for hydrogen exchangers and is, therefore, commonly used. Thus, large amounts of calcium sulfate are formed in the regenerant effluent. If extreme caution in the choice of the cation exchange material and design of the process and equipment is not exercised, calcium sulfate will precipitate in the bed, causing the ion exchange material to lose capacity. Cation exchangers with rapid speeds of reaction must be used to take advantage of the formation of supersaturated calcium sulfate solutions at high regenerant flow rate without decreasing the regeneration efficiency. The calcium sulfate is thus discharged to waste by passing the regenerant through the bed at a rapid flow rate before it is precipitated out of the supersaturated solution. As an alternate method the use of a sodium chloride regeneration and related schemes to convert the calcium zeolite to sodium zeolite before H_2SO_4 regeneration has been described (24).

6. *Re-Use of Regenerants*

The quantity of impurities removed from sugar juices is much higher than that for water demineralization and relatively large volumes of ion exchange materials are utilized in such installations for treating a comparatively small volume of liquid. The excess regenerant necessary for optimum efficiency of cation exchangers is about 2 or 3 times the theoretical equivalent of the acids formed during the treating cycle; for anion exchangers, about 1.1 to 1.5 times the theoretical equivalent of acids removed. A large portion of the excess regenerants may be utilized by segregating the latter portions of the regeneration effluents and using them in the succeeding regeneration cycle prior to fresh acid or alkali. The fresh acid or alkali may be added to the latter portion of excess regenerant solution or it may preferably be applied as a pure solution after passing the partly spent chemical (25, 26).

7. *Instrumentation*

In addition to providing means for minimizing dilution of the sugar juice during the demineralizing process, a considerable amount of additional instrumentation must be provided for efficient operation. For manual operation, indicating meters are adequate although indicating

and recording meters with alarm contacts are far more desirable. Operation of the equipment is facilitated and less liable to costly error when the latter type of instrumentation is provided. For full automatic operation, recording instruments with alarm contacts and integrating instruments with contactors are required and reliable apparatus can be provided for every step in the operation of a sugar demineralizing plant. These steps are:

- a) Sweetening-on
- b) Demineralizing run through one or more pairs in series
- c) Sweetening-off
- d) Backwash
- e) Regeneration
- f) Rinse

For the sweetening-on and off operations, specific gravity meters are used. For determining the end of the demineralizing run, several types of instruments may be utilized, the proper choice depending on the particular application. If the character of the untreated sugar solution is relatively constant, volume of solution treated as measured by positive displacement meters, integrating flow meters of several types, or timers at constant flow rate may be used. If the electrolyte content is variable, the end of the run may be determined by the pH of the effluent from one of the ion exchange units or by the conductivity of the final effluent (27). Wash and regeneration instrumentation is discussed in the chapter by Gilwood.

VII. SUGAR BEET JUICE

1. *Conventional Process*

A brief description of the conventional process of sugar manufacture from beets may be useful in order to provide a basis of comparison with the ion exchange process. Beet slices or cossettes are extracted with hot water in a diffusion battery, usually consisting of twelve or more diffusers operated countercurrently at about 80°C. The sugar juice resulting from the diffusion process is defecated, by liming to about pH 9 at approximately the temperature of extraction, and then carbonating. The calcium carbonate and salts of some of the acids present in the juice precipitate and in the settling process which follows, the fine particles of pulp are carried down, forming a mud. A second carbonation is carried out at about 100°C. sometimes with the addition of more lime to precipitate additional calcium salts and organic impurities at the higher temperature. This is called "saturation." In most factories an additional treatment, "sulfitation" is carried out as a final step before the clarified juice goes to the evaporator station. In this step the sulfurous acid formed on passing

SO₂ into the juice bleaches the juice, producing a white sugar after crystallization. The clear juice is then evaporated to a syrup which in some cases is again treated by carbonation or by sulfitation to remove excess lime. The thick juice is then sent to vacuum pans where several "strikes" or successive crystallizations and purgings of sugar are carried out. The sugars produced are white in color and have about the same purity as refined cane sugar, but sometimes a "soapy" odor is present. This odor is due to a very small amount of calcium soaps absorbed by the granules and becomes more apparent on standing.

2. Steffen's Process

In the normal beet sugar process, approximately 8-9 gallons of 82° Brix* molasses per ton of beets are formed. This molasses has an apparent purity of about 60, i.e., 60 weight per cent of its apparent solids is sucrose. Little or no dextrose or levulose is present. The ash content is about 11%. Thus, the extraction of additional quantities of sucrose is readily possible by several different methods including osmosis of inorganic impurities or precipitation of sucrose as the strontium, barium, or calcium saccharate. Only the last process is fairly widely used in this country because lime is cheap. In this process, called the Steffen's Process, the molasses is diluted to about 20° Brix or lower at a temperature below 10°C. and freshly burned finely ground quicklime is added sufficient to react with the sucrose. The sucrose precipitates at this low temperature as the tribasic saccharate C₁₂H₂₂O₁₁ · 3 (CaO), which is filtered off. The saccharate may then be broken up in hot water and concentrated for the crystallization of sugar. Alternatively, the precipitate may be used for liming the raw diffusion juice. An undesirable sugar, raffinose, often crystallizes with the sugar produced in the Steffen's Process. The residual mother liquor, after crystallization of tricalcium saccharate, is often concentrated and utilized for recovery of pyrrolidine carboxylic acid, the precursor of monosodium glutamate, a widely used flavoring material.

3. Application of the Demineralizing Process

The demineralizing process has been applied to both the raw diffusion juice and to defecated juice. It has been common practice in water treatment for many years to clarify the influent water before it entered ion exchange units in order to protect the ion exchange beds. This has also been adopted in ion exchange treatment of sugar solutions. Accordingly, most of the work, both on the pilot plant scale and on commercial scale, has been conducted on juice clarified by lime and heat. If such clarification

* The degree Brix is the percentage by weight of solid matter dissolved in a liquid, as this term is used in commercial sugar analysis.

is not employed, the suspended matter in the raw juice causes serious mechanical difficulty in processing the juice by ion exchange. The suspended particles are filtered out on the upper surface of the hydrogen exchanger bed, greatly increasing the pressure losses through the equipment and ultimately stopping the flow. Secondly, while the raw juice contains somewhat lower amounts of electrolytes than defecated juice, some of the constituents precipitated out by the hot defecation step and subsequent cooling are considered to be the cause of rapid capacity loss of the ion exchange materials. Thirdly, application of ion exchange after defecation is more compatible with existing equipment in sugar beet houses. Continuing attempts, however, are being made to utilize centrifuges and various other clarifying methods such as lighter defecation for preparing beet juice for demineralization.

4. *First Commercial Installation*

The demineralizing process has thus been applied on first or second carbonation juice, primarily on the former, in commercial practice. Vallez (28) described a process on defecating a sugar bearing solution at an elevated temperature followed by demineralizing the cooled solution. This process was first practiced on a commercial scale at the Isabella Sugar Company, Mount Pleasant, Michigan, during the 1941 and 1942 crops. The installation at Isabella consisted of four batteries of demineralizing units, each comprised of

a) one hydrogen exchange unit 11'0" in diameter and 11'0" high, containing 550 cu. ft. of Catex, a cation exchanger of the sulfonated coal type,

b) one granular carbon unit 10'0" in diameter and 10'0" high, containing 400 cu. ft. of granular Darco, - 12 + 20 mesh,

c) one anion exchange unit 10'0" in diameter and 10'0" high containing 500 cu. ft. of Anex for the anion exchanger.

The batteries were installed four abreast on three floors with the hydrogen units on the top floor, the carbon units on the floor below and the anion units on the first floor. The regenerating equipment was located on a subfloor below the anion units. Juice flow was conducted by gravity through the process, since the units were not pressure units but vertical cylindrical open tanks. The granular carbon units to which the juice passed after the hydrogen exchange step were used to remove color and colloidal matter coagulated by the acidification step and were added in an effort to protect the anion exchange material in addition to decolorizing the juice (29, 30, 31). The granular carbon was regenerated with hot spent alkali from the anion exchange step (32). The units were operated in parallel and the highly alkaline (pH 11) effluent produced at the start of

the run was blended with the acidic (pH 3.5) effluent at the end of the run from another demineralizing pair operating in parallel (33).

5. Results of Operation of Isabella Plant

The published results of the operations at Isabella Sugar Company may be summarized briefly as follows. Approximately 94% of the inorganic non-sugars and 83% of the organic non-sugar solids were removed from the beet juice. The purity was increased from 91.3 to 98.9%. Inversion losses were claimed to be high at 30°C. operating temperature, but negligible at 20°C. The sugar produced by utilizing the demineralizing process was superior to that produced in the conventional beet sugar process in lower ash content and absence of odor on storage. No information on the economics of the process practised at Isabella has been published.

TABLE I
Summary of Process Costs

	<i>Reference</i>			
	(38)	(39)	(40)	(41)
Scale of experimental work (tons of beets per cycle)	2.65	2.0	300	312
Location of work	Idaho	Utah	Calif.	Utah
Elimination of inorganic non-sugars (%)	95-98	—	98.3	—
Elimination of organic non-sugars (%)	60-75	—	87.0	—
Elimination of non-sugars (%)	—	—	—	77.56
Purity rise (%)	5.64	—	8.96	8.84
Inversion encountered (% on sucrose)	0.2	0.13	0.3	0.26
Dilution encountered (%)	10	—	17	4.28
Increased yield (%)	10.5	11.7	11.5	7.0
Sucrose lost (%)	0.091	—	—	0.24
Cost analysis (basis: per ton beets)				
Regenerants — H ₂ SO ₄ (lbs.)	16	20	18	20.44
Regenerants Na ₂ CO ₃ (lbs.)	13.1	30	18(NaOH)	11.81(NH ₃)
Water used (gal.)	—	—	900	815
Exchanger replacement (cents)	6.7	—	10	—
Labor (hr.)	0.024	—	0.054	0.036
Extra fuel (lbs.)	15	—	—	—
Loss in molasses (gal. 80° Bx.)	5.9	6.0	6.4	3.7
Syrup formed instead of molasses (gal.)	2.16	1.2	1.85	—
Increased sugar yield (lbs.)	34	29	37	22 ¹
Gross profits reported (cents)	38.73 ²	134 ³	165 ⁴	—

1. Assuming 320 lbs. sugar/ton beets
2. Sugar at 4½ cents lb.; molasses at \$18/ton
3. Sugar at 7½ cents lb.; molasses at \$29/ton
4. Sugar at 8 cents lb.; molasses \$20/ton.

6. *Modified Processes*

A number of modifications of the above process have been suggested by various writers. Dahlberg (34) described a process for purifying an alkaline sugar juice at a low temperature by hydrogen exchange and activated carbon, then mixing the acid juice with untreated alkaline juice. Behrman (35) suggested overrunning the acid removal unit of a demineralizing pair until the pH of the effluent was substantially below 7, then neutralizing with alkali or removing carbonic acid by aeration. Gustafson and Paley (36) used a hydrogen zeolite for defecating sugar solutions by mixing the acid juice (pH 1.5–4.0) with recycled sludge. The equipment and process involved is rather complicated and no results of pilot plant or large scale work have been published. Rawlings (37) recommended the combination of defecating, cooling, separation of coagulated matter, and demineralizing.

7. *Published Reports of Process Costs*

The results of several pilot plant and commercial scale studies of the demineralization of sugar beet juice have appeared in the literature within recent years (38, 39, 40, 41, 41a). The results of some of these reports are summarized in Table I.

8. *Miscellaneous Costs of Demineralizing Beet Juices*

Some of the costs involved in demineralizing sugar beet juice have not been reported and are rather difficult to include in the estimations of operating costs. Among these are investment, amortization, maintenance, water costs for cooling the juice and for regeneration, pumping costs, and royalty charges.

a) The investment in ion exchange equipment and accessories installed and housed at the present time is between \$250 and \$400 per ton of beets ground per day, depending on the extent to which the equipment is automatic, location of plant, quality of juice, and other factors.

b) Maintenance costs would probably be about 1–3 cents per ton of beets.

c) Water charges cannot be evaluated here because the type of water treatment, if any is required, depends on the quality of the raw water, and the volume required varies with temperature. For best operation the water should not contain high amounts of dissolved solids, turbidity, calcium, magnesium, or iron. High solids will rapidly exhaust the cation exchanger and high calcium, magnesium, or iron might precipitate insoluble carbonates or hydroxides in the anion exchanger beds if the water is used without prior softening treatment. Turbidity in the water is undesirable because of the danger of affecting the life of the ion exchanger beds.

d) While the regenerant effluents from a demineralizing plant are low in BOD,* caution must be exercised with respect to discharging low pH wastes to stream in view of the fact that the excess acid required is higher than the excess alkali.

e) Pumping costs for both water and sugar juice should be less than 1 cent per ton of beets assuming that the overall combined efficiency of motor and pump is 35%, discharge pressure 35 p.s.i. and power costs are 1 cent/kwhr.

f) In view of the unclear patent situation, royalties for utilizing the processes can not be readily evaluated.

9. Recovery of By-Products from Beet Juice

(a) *Nitrogen Compounds.* Several reports have appeared in the literature describing the recovery of valuable by-products from beet juice demineralization. Nees and Bennett (42) have described a process for recovering betaine, glutamic acid, and other nitrogenous material from

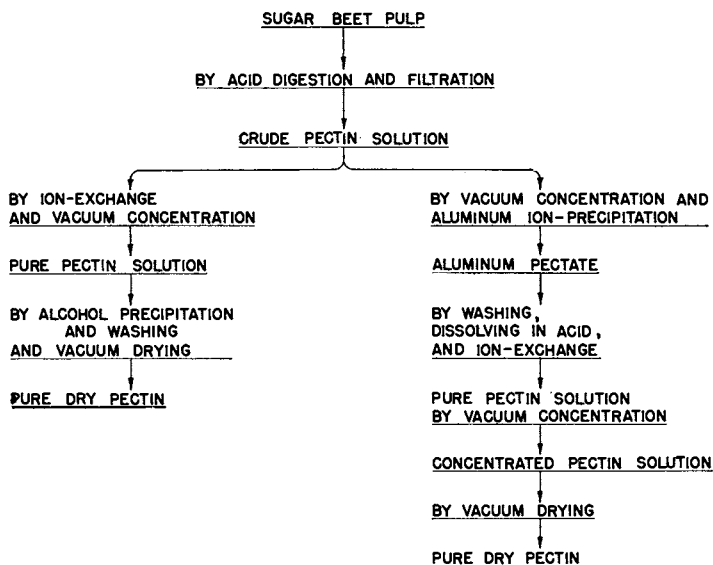

FIG. 4. Schematic flow diagram of pectin manufacture from beet pulp.

sugar beet wastes of Steffens houses. The wastes were passed through a hydrogen exchanger bed where it was found that a portion of the effluent was enriched in betaine and glutamic acid and substantially freed of ash.

* BOD Biological Oxygen Demand, is the oxygen, expressed in parts per million, required during the stabilization of the decomposable organic matter by aerobic bacterial action.

In another process, Bennett used an alcohol extraction of sugar beet waste water to partially concentrate betaine and its salts, then hydrogen exchange to further remove impurities and enrich the solution in betaine. He also suggested a process consisting of the conversion of betaine salts to the neutral betaine hydrate by passage through an anion exchanger to remove the acids (43).

Glutamic acid and its precursor, pyrrolidone carboxylic acid, are both monoamino dicarboxylic acids and thus are taken up by the second step of the demineralizing process, the anion exchange material. The recovery of this valuable flavor accentuating material and of other nitrogen and potassium containing compounds should have an important effect on the economics of the demineralization of sugar beet juice. However, it should be pointed out that glutamic acid is present in only small quantities in beet juice from some geographical areas.

(b) *Pectin*. Announcement has been made of experimental work conducted by the National Resources Research Institute of the University of Wyoming under the auspices of the Sugar Research Foundation on recovering pectin from sugar beet pulp utilizing ion exchange. A flow diagram of two alternate processes has been prepared by Fisk (44) and is reproduced in Fig. 4.

VIII. SUGAR CANE JUICE

1. *Conventional Process*

The conventional process for manufacturing cane sugar is quite similar to that for beet sugar. Instead of using diffusion for extracting the sugar, the cane is cut, crushed and pressed by means of a series of knives and hydraulic rolls in a machine known as a tandem. Before passing through the last rolls of the tandem the partly extracted cane is sprayed with water in order to remove the last portion of sugar from the bagasse. The raw juice is then defecated by means of heat and lime, but sulfitation and carbonation are seldom used for producing raw cane sugar. The clarified cane juice is then concentrated to a syrup and boiled to crystalline raw sugar in several "strikes" or successive crystallizations and purgings of molasses. Most raw sugar is refined either in the sugar house or shipped to refineries located near consumption areas. This is in contrast to beet sugar manufacture where the refining usually is not carried out in a separate step. Clarified sugar cane juice varies greatly in analysis in different parts of the world due to variations in maturity of the cane, but in general cane juice contains much more invert sugar than beet juice. Consequently, the purities are generally somewhat lower for cane juice. Nitrogenous matter is also lower but cane juice contains waxy substances, some of which appear

in the final molasses. The ash and organic non-sugar contents of beet and cane juice are substantially equal. The constituents of the ash of cane juice vary considerably in cane grown in different countries and indeed, in different localities in the same country. Louisiana juice, for example, contains higher amounts of aconitate salts than Cuban juice.

2. Application of Demineralizing Process

Published reports of the demineralization of sugar cane juice consists of only a few papers. Rawlings (45) suggested the demineralization of sugar cane juice clarified by liming to relatively high pH. Shafor (46) disclosed the process of refining raw sugar by adding a bleaching agent, then demineralizing with or without the addition of a reducing agent to destroy residual oxidizing powers of the bleach. In addition to these two modifications, several of those mentioned under sugar beet demineralization also extend to sugar cane juice treatment. Riley and Sanborn (40) reported an increased sugar yield, elimination of the raw sugar step, and recovery of all sugar as white sugar or edible syrup. They indicated that production costs would be reduced by 7.5% and profit increased by 27.3%.

3. Published Reports of Pilot Plant Work

The results of extensive pilot plant work on the demineralization of Louisiana and Cuban sugar cane juices were published by Mindler (23). The conclusions drawn from data obtained in over fifty consecutive runs on Louisiana juice and a hundred and fifty runs on Cuban juice with

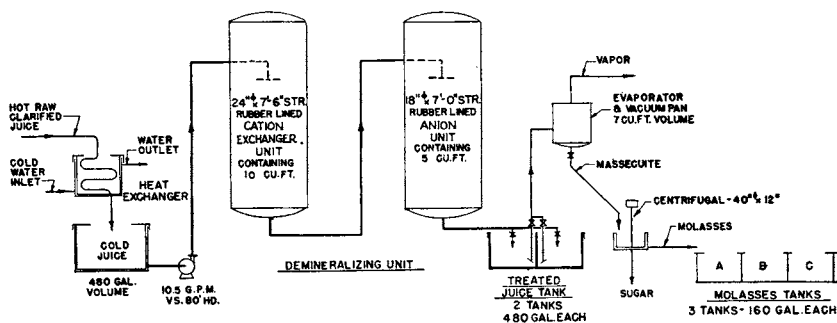

FIG. 5. Flow diagram of sugar cane juice demineralizing process.

equipment illustrated diagrammatically in Fig. 5 may be summarized as follows:

a) One cubic foot of cation exchange material (Zeo-Karb H) and 1/2 cu. ft. of anion exchanger (De-Acidite) demineralized 30 gallons of cooled lime and heat clarified juice,

b) Removal of 90–95% of inorganic ash and 70–75% of non-sugar solids was realized resulting in a purity rise of 6.5% for Cuban juice; 4.7% for Louisiana juice. This purity rise indicated a 6.2% increase in yield for the former; 3.1% for the latter.

c) With new ion exchange materials, substantially all the color in the juice was removed, but after 25 successive runs, the amount of color removed was only 50–75% even though restoration treatments of the ion exchange material were used.

d) Inversion amounted to 0.5% when operating at 30°C. with a flow rate of 6 g.p.m. per square foot of bed area or 24 gallons/cu. ft./hour, through the demineralizing pair (based on the anion unit). The data indicated that a large portion of the inversion encountered may be attributed to catalytic inversion by the hydrogen exchanger.

e) The final molasses was considered suitable for many sugar uses although it was rather dark in color.

f) Evaporator scaling was completely eliminated.

g) Dilution amounted to about 10% when re-using sweet water to sweeten off. Dilution for either the hydraulic head or air dome method of operation was found to be about the same. By the former method, the sugar juice is introduced into the exchanger shell at a point just above the bed beneath the supernatant column of water. The juice stratifies beneath the water column because of the difference in specific gravity of sugar solutions and water.

h) Restoration treatments of both the cation and anion exchangers were effective in maintaining capacities for 150 runs. The capacity losses were 3.3% for the cation exchanger and 8.8% for the anion exchanger. The restoration treatments consisted of a hot alkali treatment (0.5% NaOH at 150°F.) for the cation exchange material and hot acid (10% H₂SO₄ at 140°F.) for the anion exchanger.

4. Recovery of Materials from the Demineralization of Sugar Cane

There are several valuable substances in sugar cane juices which can be recovered from the exhausted ion exchange materials. However, no reports have been published on such processes. Louisiana sugar cane juice for example, contains considerable and varying amounts of aconitic acid. This compound has been found useful as a plasticizer and undoubtedly other uses would be found for it if this acid were in greater supply. Other valuable organic acids such as succinic acid are also present in varying amounts in different cane juices and these may be recovered for sale as by-products. These acids are taken up on the anion exchange material, from which they may be recovered either as the acid by displacement with a stronger acid or as the salt by alkaline regeneration. Some consideration has been given

to the recovery of substances taken up by the cation exchanger, especially potassium and nitrogen compounds for use as a fertilizer, but it is believed that this recovery would not be feasible because of the low concentration of the regeneration effluent and the presence of excess acid unless careful attention is paid to fractionation of the regenerant effluent. An elaborate neutralization and distribution system for the dilute regenerant effluent would be required or alternatively a costly evaporation and drying process. The calcium sulfate present in this solution would cause considerable difficulty under either method of utilization.

5. *Critical Study*

A critical study of ion exchange in the manufacture of raw sugar was made by Fitzwilliam and Yearwood (47) after preliminary experimental work. They concluded that sodium exchange is not an economically feasible means for eliminating evaporator scaling. Likewise, they concluded that demineralizing probably would not be economically justified at least in tropical countries.

IX. SORGO JUICE DEMINERALIZATION

The United States Department of Agriculture has been conducting extensive work on the utilization of sorghum cane for sucrose manufacture. New strains of high sucrose content, disease resistant, big barrel sorghum have been developed and new processes have been devised for producing sugar and recovering by-products from sorghum (48). The impurity in expressed sorghum juice is mainly aconitic acid which, in conventional processes, is removed by liming carefully to pH 8.5–9.0 then adding calcium chloride and allowing the juice to stand for an extended period of time followed by separation of the precipitate. Sometimes another calcium aconitate precipitation is carried out in the syrup stage. By this method most of the aconitic acid can be removed and a satisfactory sugar in good yield can be produced. In pilot plant work, demineralization by the normal two step process of lime and heat defecated sorgho juice (pH 8.5) resulted in the removal of 95% of the electrolytes and raised the purity of the juice from 70.6 to 75.4%. It was possible to recover aconitic acid from the exhausted anion exchanger by displacing it with 15% H_2SO_4 (49).

X. LOW GRADE SYRUP AND BLACKSTRAP DEMINERALIZATION

1. *High Purity Refinery Syrups and Liquors*

Syrup refining processes do not lend themselves readily to the application of demineralizing processes for several reasons. Operating on syrups with relatively high solids content, to minimize subsequent evaporation, reduces the efficiency of ion exchange operations because of the high vis-

cosities encountered, and high electrolyte content. High temperatures are required in order to reduce viscosities and increase diffusion rates, but inversion losses are increased greatly at high temperatures in the acid environment of the first step of the demineralizing process. Furthermore, ion exchange materials, particularly the anion exchangers available at this time, are not too stable at extremely high temperatures. Refinery char sweet waters which are dilute and in which considerable quantities of alkali metals are present, may be demineralized readily for the production of higher yields of sucrose or liquid sugars instead of recycling this ash through the house processes. No data or economic studies on demineralizing char sweet waters and other refinery solutions have been published.

2. *Low Grade Syrups*

A great deal of work was done on treating various low grade syrups by the demineralizing process for the production of high grade syrups during the recent wartime sugar shortage. Block and Ritchie (50) reported the results of large scale demineralization of a blend of Louisiana commercial syrup and high purity refinery molasses and also of inverted Cuban syrup. They successfully purified these low grade sugars retaining the required amount of non-sugar solids in the purified syrups to permit their use during the sugar rationing period. The process used consisted of hydrogen exchange with a sulfonated coal, then granular carbon treatment to remove colloidal matter, taste, and odor, and finally acid removal by means of an anion exchanger. This process was followed by an activated carbon finishing treatment for the removal of residual taste. Some of the difficulties encountered were high losses of sugar due to both mechanical and bacterial causes, high water consumption, and difficult filtrations preparatory to demineralizing. The cation exchanger lost about 8% of its capacity in 230 runs and the anion exchanger 10.9% in 123 runs, although no restoration treatments were carried out.

3. *Blackstrap Molasses*

A great deal of interest was created during the recent wartime sugar shortage in the treatment of diluted blackstrap molasses for the production of edible syrups, but very little data have been published. On the basis of the data on hand, it would appear that there is very little economic justification for demineralizing a material with such a high non-sugar solids content in normal times. The molasses must be diluted to a least 30-40° Brix and filtered before ion exchange treatment. This filtration operation is very difficult but is necessary in order to maintain satisfactory flows through the ion exchange beds and minimize capacity losses. During the demineralizing step the solutions will be further diluted and consequently must be

concentrated to about 70° Brix for marketing. The treated syrup requires a relatively heavy carbon treatment for removing the residual bitter tastes. The product is dark in color, but acceptable for many purposes. Cost estimates indicate that in normal times syrups produced from blackstrap by demineralization can not compete with other types of liquid sugars.

XI. STARCH CONVERSION LIQUOR DEMINERALIZATION

The demineralizing process has been the subject of intense interest in the starch conversion sugar industry. Both the acid conversion processes and the enzyme conversion processes have been shown to be improved by the utilization of ion exchange in place of bone char refining. The elimination of char filters and regenerating equipment results in a saving of space and fuel, improved plant cleanliness and most important, more efficient refining is realized, improving both product quality and yield.

1. Acid Conversion

(a) *Process for Dextrose Manufacture.* Several processes dealing with the ion exchange treatment of acid converted starch sugar liquors have been reported. Cantor (51, 52) disclosed that the ion exchange treatment of dextrose solutions makes it possible to obtain excellent dextrose quality even after several successive crystallizations of the "greens." The "greens" are the mother liquor remaining after separating a "crop" of dextrose crystals. In the conventional dextrose manufacturing process, the second crop of dextrose crystals must be remelted and refined before satisfactory dextrose quality can be obtained. Cantor treated the acid conversion liquor with bentonite clay to remove colloidal matter before ion exchange; alternatively he used bentonite clay and activated carbon. The clarified dextrose solution was then passed through an anion exchanger to remove the acid instead of neutralizing it before concentration and crystallization. He also found that a demineralizing step following acid removal was superior to acid removal alone. By utilizing such an anion-cation-anion removal process it is possible to remove all the cations introduced by the starch and water in addition to those from the acid used for conversion. More important than the removal of the inorganic substances is the removal of organic impurities, such as amino acids and hydroxymethylfurfural, levulinic acid, and hydroxymethylfuroic acid. Color bodies in the dextrose solutions are believed to be complex compounds of these types. Removal of organic and inorganic impurities by the demineralizing process produces a sugar of improved quality in regard to color and ash from several successive crystallizations. These crystallizations require much less time than crystallizations in conventional processes. Furthermore, the processing steps are vastly improved because of easier purging in the centrifugal.

Behrman (53) recommended the use of activated carbon followed by acid adsorption for treating dextrose solutions. His object was to minimize anion exchanger deterioration or fouling by colloids and other impurities present in starch conversion liquor.

(b) *Pilot Plant Work.* Rogge and Handelman (54, 54a) have described the operation of ion exchange refining of dextrose syrup on a large pilot plant scale in considerable detail. The pilot plant processed dextrose liquor producing 5000 pounds of sugar per day and consisted of four pairs

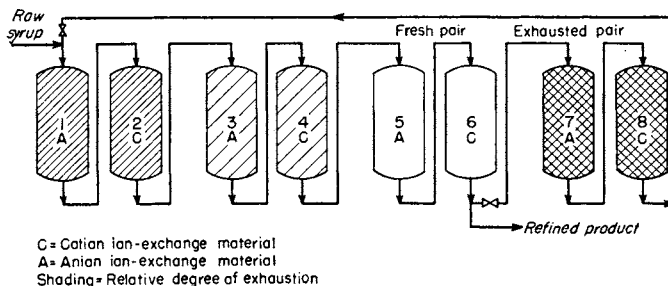

FIG. 6. Three pass countercurrent ion exchange treatment.

of demineralizing units operated by passing the syrup through three pairs in series countercurrently as shown in Fig. 6. The dextrose manufacturing process including ion exchange is shown diagrammatically in Fig. 7. Instead of neutralizing the starch conversion liquor with soda ash as in the conven-

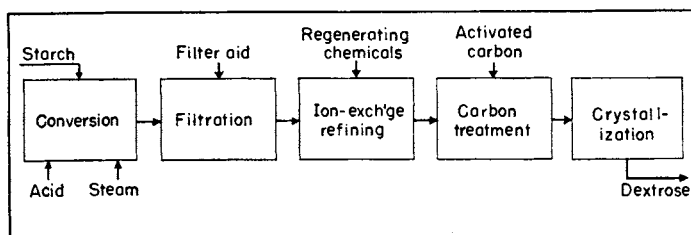

FIG. 7. Schematic flow diagram for dextrose manufacture using ion exchange refining.

tional process, the acid syrup was treated directly by ion exchange, passing the syrup through the anion exchanger bed to remove free acid in accordance with the process discussed above. The acid free syrup was then double demineralized; thus the treatment consisted of acid removal, hydrogen exchange, acid removal, hydrogen exchange, acid removal, hydrogen exchange. In general, the pilot plant work confirmed the benefits discussed in the patents (51, 52) mentioned above.

(c) *Difficulties Encountered.* Some of the difficulties encountered during this work were discussed by Rogge and Handelman. These included the following:

1) The use of the hydrogen unit as the first treatment step for receiving the acid syrup, which was practised in the early work, resulted in poor exchange efficiency because of unfavorable exchange equilibria in the presence of the high acidity of the influent. Thus, only a portion of the ash was regenerated out of the demineralizing system during the normal regeneration step, the bulk of the cations having been displaced from the cation exchanger by hydrogen ions from the acid syrup. The use of an anion exchange unit as the first treatment step for reducing the acidity of the syrup solved this difficulty.

2) On continued use of the anion exchange materials, long rinse periods were required to eliminate excess regenerant and ash throwing by the anion exchange materials. The cause of this difficulty was not established but intermittent restoration treatments with 30% H_2SO_4 at 150°F. and the use of ammonium hydroxide regeneration offered temporary solution to these problems.

3) After 60 cycles of operation, incomplete color removal by the ion exchange materials was noted. Improved performance was obtained by utilizing intermittent restoration treatments consisting of 4% NaOH at 158°F. for the cation exchanger and 30% H_2SO_4 at 150°F. for the anion exchanger.

(d) *Commercial Scale Application.* The ion exchange process has been adopted to replace the conventional refining process at the new plant of Corn Products Refining Company in Corpus Christi, Texas. Here for the first time, dextrose is manufactured from kaffir corn or grain sorghum. This large demineralizing plant is completely automatic (55).

(e) *Glucose Demineralization.* While very little information has been reported in the literature on the treatment of glucose solutions, the company mentioned above has also carried out a great deal of work on this application and has installed a commercial size plant producing a levulose-bearing syrup. The object of this refining process is essentially the same as that for dextrose, namely the removal of ash, color, and organic impurities which cause undesirable flavors.

2. *Enzyme Converted Starch*

During the recent sugar shortage a great deal of experimental work and some commercial scale work was conducted on the demineralization of sugar produced by the enzyme conversion of starch. These sugars generally contain considerable amounts of undesirable matter besides ash, notably nitrogen containing impurities. Ion exchange materials are

capable of reducing these to a considerable degree but their complete removal is difficult. Most of the reduction is accomplished by the cation exchanger operating in the hydrogen cycle due to the adsorption of nitrogen containing compounds by the "solid acid." During the demineralizing process for removing ash and nitrogen compounds, a great deal of additional refining is accomplished. Both color and undesirable flavors are reduced or completely removed. Several demineralizing plants were installed during the sugar shortage but no data have been published.

3. *Recovery of By-Products*

Starch conversion liquors contain some substances, removed by ion exchange, which may be worth the added expense of recovery. While not all of the impurities have been identified, both levulinic acid and hydroxymethylfuroic acid may be worth recovering from the ion exchange beds. The use of relatively concentrated ammonium hydroxide for regenerating anion exchangers may also make it possible to recover fertilizers (ammonium sulfate or chloride), perhaps not as crystals but as crude concentrates for use in the vicinity of the plant.

XII. SUGAR FROM FRUIT WASTES

The demineralizing process has been found extremely valuable in the solution of waste disposal problems in the fruit industry. Several commercial scale plants are operating on the production of valuable sugar syrups from portions of the fruit formerly constituting a waste problem. At the same time, the impurities taken out of ion exchange comprise valuable by-products such as citric acid when recovered.

1. *Citrus Peel Press Juice Demineralization*

The citrus industry is confronted with a serious waste problem in disposal of the peel remaining after removal of the citrus juice or fruit sections. In the past this problem has been met either by dumping, or by liming the peel and then pressing to remove as much water as possible. The pressed peel is then dried for use as cattle feed and the pressed juice is evaporated to a citrus molasses for use either in cattle feed or in alcohol manufacture. Alternatively, the citrus peel press juice is ponded or disposed of in sewage plants, but since the BOD is very high it creates serious problems no matter how it is treated. The analysis of this juice has been reported in the literature (56).

Removal of Impurities. Both orange and grapefruit peel contain glucosides which are quite bitter. The glucoside in orange peel and in the extracted peel juice is hesperidin; in grapefruit it is naringin. These materials have no properties which would lead one to expect removal by

ion exchange, but they are removed to a certain extent presumably by adsorption on ion exchange materials. The syrup produced by demineralizing may be utilized either directly by commercial users such as bakers, bottlers, candy manufacturers, as a flavored table syrup, or as a sweetening agent in the canning industry, for example, for grapefruit sections.

2. Pineapple Mill Juice Demineralization

(a) *Preparation of Mill Juice.* The pineapple industry has the same problem as the citrus industry in the disposal of fruit wastes. After cutting the fruit sections and cores out of the fruit, the hulls contain a considerable amount of residual fruit which heretofore has been pressed for recovery of the juice. The pressed hulls have been dried to produce pineapple bran used for cattle feed. The expressed juice has been limed to precipitate calcium citrate which is settled out, the supernatant sugar solution being filtered with filter aid. A portion of the juice has been then treated with activated carbon and used to dissolve sucrose for preparing syrup in the canning operation. The remainder of the mill juice has been concentrated to a molasses, useful for cattle feed or for alcohol manufacture. Ion exchange has now been applied to the treatment of the clarified pressed mill juice in order to eliminate the molasses formerly produced.

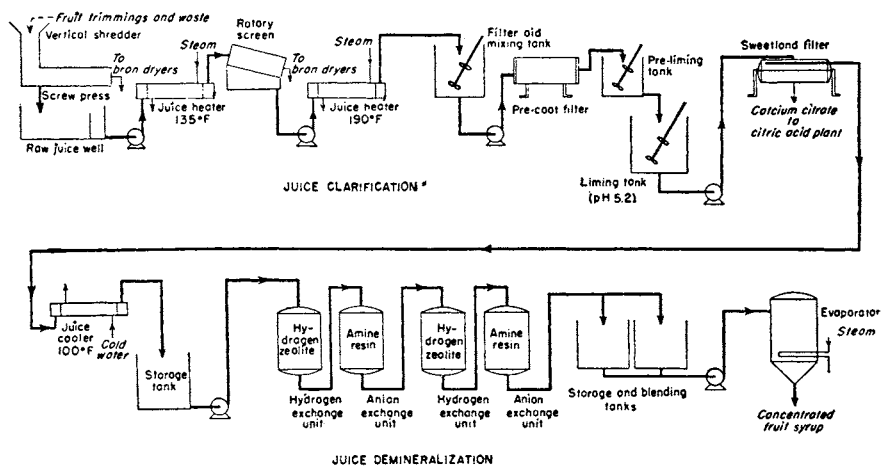

FIG. 8. Flow diagram for pineapple mill juice treatment by ion exchange.

(b) *Demineralizing Process.* The ion exchange process developed by Hawaiian Pineapple Company Limited, Honolulu, is illustrated in diagrammatic form in Fig. 8 (57, 58). The raw material used is the juice obtained by pressing the pineapple shells and other waste portions of the

pineapples. This mill juice is heated to 135°F. and screened to remove coarse matter. It is then heated to about 190°F. to precipitate albumins and filtered with filter aid. The filtered juice is limed to a pH slightly higher than 5.0 and heated almost to the boil to precipitate calcium citrate which is then separated in a Sweetland filter. The filtrate is the impure sugar solution used as influent material to the demineralizing plant. The demineralizing plant consists of five pairs of demineralizing units operated in a two-pass countercurrent system. The clarified juice, cooled to room temperature, is passed through ion exchange units in the following sequence: cation, anion, cation, anion. Upon exhaustion of the first two units, these units are withdrawn from the operating line for regeneration. The influent juice is then introduced into the third and fourth units and the effluent from these is passed through a pair of freshly regenerated cation, anion units placed in the operating line. The processing of raw juice is continued in this manner with the raw juice passing through two demineralizing pairs in series, the first pair being partially exhausted and the second pair freshly regenerated, until the pH of the influent from the first cation unit rises to 3.4 from a low of about 2. Then the exhausted first pair is taken offstream for sweetening-off, recovery treatment, and regeneration, and another freshly regenerated pair is put onstream in the tail position; the pair that had been operating in the tail position and is partly exhausted now receives the raw juice. The treated juice is concentrated and used as canning syrup for pineapple sections.

(c) *Recovery of By-Products.* The exhausted pair is sweetened off (rinsed free of sugar with water) and then a 10% sodium chloride brine solution is passed through both the cation and anion exchanger beds in series (Reaction 6). The sodium exchanges for the calcium ion in the exhausted cation exchanger. In turn, the calcium chloride thus formed is converted to calcium citrate on passage through the citrate exhausted anion exchanger (Reaction 8). The first portion of effluent is a relatively concentrated mixture of calcium citrate and sodium chloride. The calcium citrate from this fraction is recovered. The next portions contain relatively little calcium citrate but considerable sodium chloride. These last two portions are re-used in the next cycle before the introduction of pure brine. The sodium chloride treatment of the cation exchanger in series with the anion exchanger has several functions. First, it permits the utilization of the calcium from the lime used for clarifying the juice for precipitation of the citrate by-product. Second, it eliminates the formation of calcium sulfate in the cation exchanger bed during sulfuric acid regeneration. Third, it constitutes a partial restoration treatment of the cation exchange material to augment the succeeding alkali restoration treatment. The calcium citrate solution in brine is heated almost to boiling. The calcium

citrate precipitates out and is filtered, the sodium chloride brine being returned for re-use in the next regeneration cycle after fortification with fresh NaCl.

(d) *Regeneration.* Both the cation exchanger and anion exchanger beds are then backwashed and regenerated for re-use. The cation units are given a slightly alkaline wash and warm water rinse to remove organic impurities and then they are regenerated with 5% H₂SO₄ (Reaction 7). The anion exchange units are regenerated with 2% sodium hydroxide. (Reaction 9.) Both beds are rinsed substantially free of regenerants before re-use for treating juice in the next cycle.

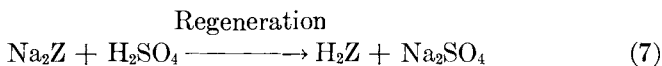
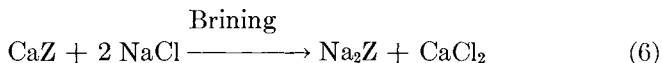

where Z represents the cation exchange material

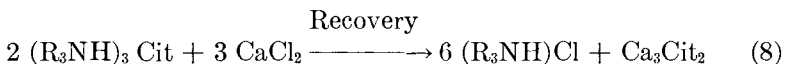

where R₃N represents the anion exchanger base and "H₃ Cit" represents the citric acid with which it is exhausted

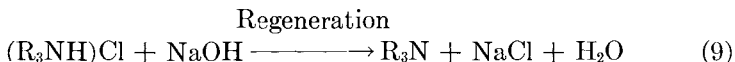

3. Apple Juice Demineralization

(a) *Syrup Production.* A great deal of work has been done, especially during the war period, on the production of substitutes for glycerine as a humectant. One of the raw materials used in this work was apple juice, which was treated by several means including ion exchange. Mottern and Buck (59, 60) were able to produce a bland apple syrup from either limed or unlimed apple juice by ion exchange. At the same time they removed most of the arsenic introduced by the insecticides. The apple juice produced from peels, cores and culls was screened through a 150 mesh sieve to remove the larger particles of suspended matter. This juice was then treated by one of three processes:

(a) Acid removal — reduced arsenic by about 40% and acidity by 82%.

(b) Two-step demineralizing (cation-anion treatment) — reduced arsenic by about 80% and ash by 90%.

(c) Three-step demineralizing (anion-cation-anion treatment) — reduced arsenic by 96–98%. Ash was reduced by 96.6%.

The capacity realized in most of this work was complete treatment of 8 to 10 volumes of apple juice per volume of cation exchanger and 15 to 20 volumes per volume of anion exchanger.

(b) *Syrup Stability.* The treatment of apple juice by ion exchange has been found to influence greatly the stability to fermentation (60a). Removal or partial removal of nutrients such as calcium, magnesium, phosphorus, and nitrogen, necessary for the growth of microorganisms, considerably reduced the liability of spoilage. Treated apple juice was found to be stable to fermentation for several weeks although slight mold growth did occur. On the other hand, untreated juice stored under identical conditions was rapidly fermenting in three days. Hydrogen exchange alone was found to be effective for stabilizing juices but completely demineralized juice possessed greater stability.

(c) *Recovery of By-Products.* The recovery of sodium malate taken up by the anion exchanger was described by Buck and Mottern (61). It was possible to obtain concentrations of over 5% sodium malate solutions using 4% sodium carbonate for regenerating. The recycled sodium carbonate-sodium malate mixture constituting the recovery effluents was fortified to this concentration of alkali prior to re-use for the next regeneration.

XIII. ION EXCHANGE TREATMENT OF MISCELLANEOUS SUGARS AND RELATED COMPOUNDS

1. *Jerusalem Artichokes*

One of the earliest reports on the demineralization of sugar solutions describes the results of treating a syrup produced from Jerusalem artichokes (62). No commercial use has been made of the process for producing sugar syrups from this raw material although substantial removal of impurities was realized.

2. *Polyhydric Alcohols*

The purification of a polyhydric alcohol closely related to sugars by ion exchange has been carried out for several years. Sorbitol is being demineralized on a large scale for the removal of all ash and electrolytes by Atlas Powder Company. No data have been published on this process but a description of the manufacturing steps has appeared (63, 64). The equipment is shown in Fig. 9.

3. *Whey Demineralization*

The crystallization of lactose from whey is a difficult operation but it has been found that demineralization greatly improves the crystallization properties of this sugar. A considerable amount of work is being con-

ducted on demineralizing whey obtained from cheese manufacture. Whey from cheddar cheese factories is deproteinized by heating it, then cooling and filtering out the coagulated protein. The resulting impure lactose solution is demineralized for the removal of calcium, sodium, potassium,

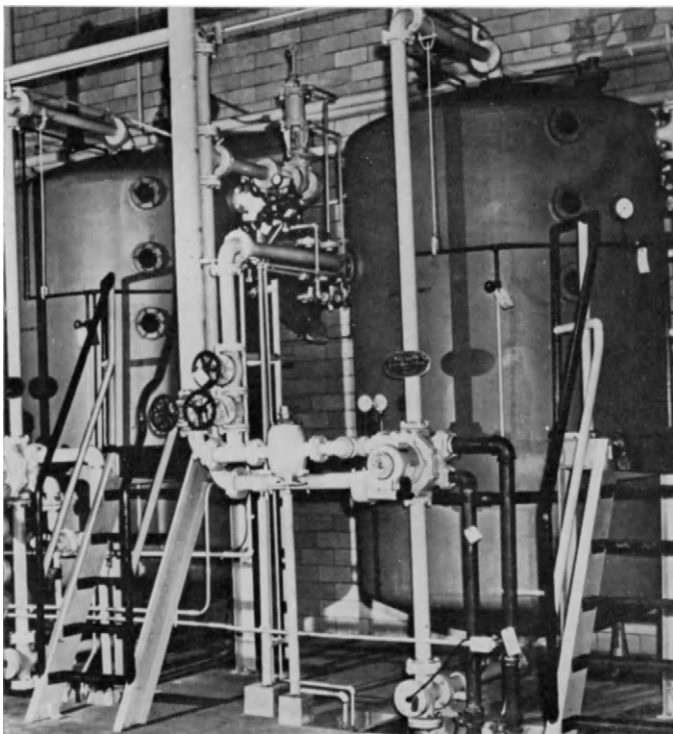

Courtesy of Atlas Powder Co.

FIG. 9. Sorbitol demineralizing plant at Atlas Powder Company, Wilmington, Delaware.

and the citrate, phosphate, and chloride. The demineralizing process removes 95% of the ash and a varying amount of the nitrogen compounds, depending on the type of cation exchanger used. It has also been found that a small amount of the lactose is adsorbed on the cation exchanger and that the adsorption of lactose varies with the type of cation exchanger used. The demineralization of whey is another example of the utilization of a waste material by treatment with ion exchange since the lactose is readily crystallized for sale from the treated and concentrated whey. The removal of undesirable electrolytes may also make it possible to utilize

concentrated demineralized whey in certain specialty milk products. One disadvantage of the demineralizing process for the production of a concentrate is that some of the B vitamins, particularly riboflavin, are partially removed by the first step of the demineralizing process (64a).

4. Removal of Lead from Maple Syrup

Willits and Tressler (65) reported a method for removing lead from maple syrup by cation exchange. Lead is introduced into the syrup from the solder used in manufacturing and repairing the maple sap collecting pails and evaporators. They found that a calcium exchanger successfully removed 97% of the lead reducing it below 1 p.p.m. (dry basis) without affecting the flavor of the syrup or altering the ash content.

5. Ion Exchange in Sugar Analysis

The demineralizing process has been used in analytical work on sugars for removing reducing non-sugar substances which would otherwise appear

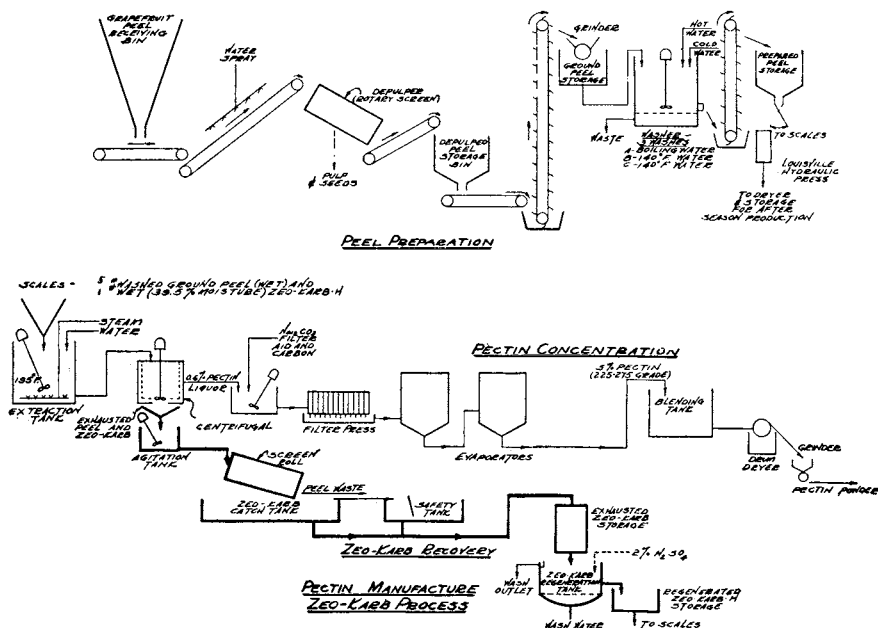

FIG. 10. Flow diagram for pectin manufacture from grapefruit peel.

as reducing sugars (66). The sugar sample is passed through a hydrogen exchanger followed by acid removal (the 2-step demineralizing process) and reducing sugars are then determined by the Lane-Eynon method.

XIV. PECTIN MANUFACTURE

In 1941 an interesting and unique ion exchange process for pectin manufacture from grapefruit peel was placed into commercial scale operation. In view of the close association of pectin with starches and sugars, it is believed that a discussion of this process here will be of interest. A flow diagram of this process, as practiced at Universal Colloids Corp., McAllen, Texas, is shown in Fig. 10 (67, 68). Washed grapefruit peel is mixed with water and Zeo-Karb H at 196°F. for an hour. The suspended Zeo-Karb H removes calcium and magnesium from the peel extract thus lowering the pH and allowing the pectin to enter solution. Removal of these cations makes it possible to effect solution of the pectin at a higher pH. This results in a finished pectin of higher grade and improved yield. After extraction, the Zeo-Karb and grapefruit peel are separated from the pectin solution by means of a centrifugal. The hydrogen zeolite and extracted peel are partially separated in a centrifugal; subsequently they are completely separated by a roll screen and a wash tank. Regeneration of the Zeo-Karb is then done with sulfuric acid and, after rinsing, the Zeo-Karb H is mixed with another batch of grapefruit peel and water for further pectin extraction. The pectin solution is concentrated and dried directly without going through the usual precipitation step with alcohol or aluminum hydroxide.

XV. RECOVERY OF TARTARIC ACID

1. *Anion Exchange*

In addition to the work on the recovery of the fruit and "vegetable" acids discussed in the preceding portions of this chapter, extensive investigation has also been carried out on the recovery of tartrates from winery wastes. Matchett and his associates at the Western Regional Research Laboratories, Albany, California, conducted pilot plant tests on the recovery of tartrate values from winery wastes (69). They used an anion exchanger exhausted with hydrochloric acid to remove the tartrate ions. The tartrate ions were thus exchanged for chloride ions. After exhaustion of the anion exchanger, a sodium chloride brine was passed through the bed regenerating the exchanger to the chloride form and forming sodium tartrate as regenerant effluent. The recovered sodium tartrate was limed to precipitate calcium tartrate which was recovered as the product (69a).

2. *Acid Removal*

An alternate process is that shown in Fig. 11 (49, 70). The dilute potassium acid tartrate (obtained from the extraction of pomace—the skins, stems and seeds of grapes) is introduced first into an acid removal unit. Here the anion exchanger base removes the free acid producing potassium

tartrate. This is passed through a hydrogen exchanger where the potassium ions are exchanged for hydrogen ions. The resulting tartaric acid is removed by the third unit, which contains anion exchanger base. For recovery, the first anion exchanger is treated with 15% H_2SO_4 forming 8–10% tartaric acid. The other anion exchanger is regenerated with 10% KOH forming 10% potassium tartrate. These two recovery solutions are

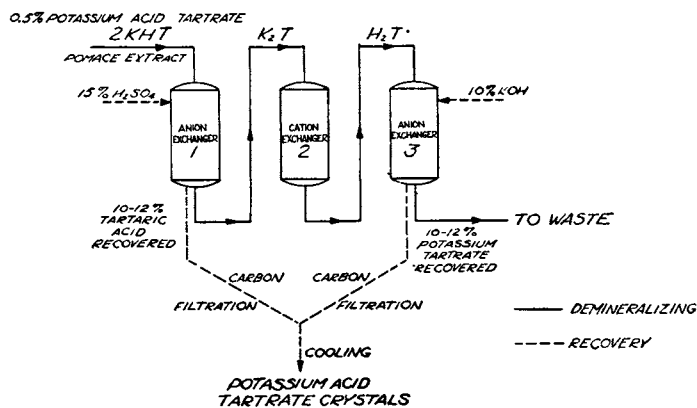

FIG. 11. Flow diagram for tartrate recovery.

then decolorized at a high temperature and mixed. On cooling, large crystals of very pure potassium acid tartrate are obtained. While this recovery process is quite unique because of the rare occurrence of sparingly soluble acid salts, it illustrates the usefulness and flexible properties of ion exchange materials. Here in one single process three different ion exchange operations are used—acid removal, hydrogen exchange and demineralizing.

In summary, it is quite evident from the work on ion exchange in the sugar and fruit acid fields during the past fifty years that this process is not a panacea. While the benefits of ion exchange in sugar treatment are very attractive, there are still many problems to be solved before it can be recommended for general use. However, great strides have been taken recently and it is likely that the use of the process in sugar refining will be accelerated.

BIBLIOGRAPHY

1. Harm, F., German Patent 95,447 (June 2, 1896).
2. Rümpler, A., *Z. Ver. deut. Zucker-Ind.* **53**, 798 (1903).
3. Rümpler, A., *Chem. Ztg.* p. 1078 (1903).
4. Gans, R., German Patent 174,097 (Jan. 12, 1915).
5. Gans, R., *Z. Ver. deut. Zucker-Ind.* **57**, 206 (1907).
6. Claassen, H., *Z. Ver. deut. Zucker-Ind.* **57**, 931 (1907).

7. Jeanprost, C., *Bull. assoc. chim. sucr. dist.* **49**, 189 (1932).
8. Soula, Y., *Bull. assoc. chim. sucr. dist.* **51**, 131 (1934).
9. Austerweil, G., *Sucr. belge* **53**, 421-431 (1934).
10. Bachler, F. R., *Ind. Eng. Chem.* **18**, 180-182 (1926).
- 10a. Deitz, V. R., Bibliography of Solid Adsorbents, U. S. Cane Sugar Refiners and Bone Char Manufacturers and National Bureau of Standards, Washington, D. C., 1944.
11. N. V. Octrooiein Maatschappij, "Activit" French Patent 805,092 (Nov. 10, 1936).
12. Boyd, R., U. S. Patent 2,264,654 (Dec. 2, 1941).
13. Boyd, R., and Schmidt, R. W., *Ind. Eng. Chem.* **34**, 744 (1942).
14. Smit, P., U. S. Patent 2,171,408 (Aug. 29, 1939).
15. Smit, P., U. S. Patent 2,191,063 (Feb. 20, 1940).
16. Smit, P., U. S. Patent 2,205,635 (June 25, 1940).
- 16a. Ramondt, D., *Inds. Agr. et Aliment.* **64**, 269 (1947).
17. Liebknecht, O., French Patent 808,612 (Nov. 14, 1936); corresponding U. S. Patent 2,155,318 (April 18, 1939).
18. Smit, P., U. S. Patent application (filed Oct. 3, 1940) Alien Property Custodian List.
19. Adams, B. and Holmes, E., *J. Soc. Chem. Ind.* **54**, 1-6 (1935).
20. Adams, B. and Holmes, E., U. S. Patent 2,104,501 (Jan. 4, 1938).
21. Shafor, R. W., U. S. 2,365,221 (Dec. 19, 1944).
22. Foss, A., U. S. Patent application (June 23, 1941) Alien Property Custodian List.
23. Mindler, A. B., *Ind. Eng. Chem.* **40**, 1211-5 (1948).
- 23a. Mindler, A. B., U. S. Patent 2,466,662 (April 5, 1949).
24. Rawlings, F. N. and deGeofrey, L., U. S. Patent 2,366,650 (Jan. 2, 1945).
25. Duggan, T. R., U. S. Patent 1,510,469 (Oct. 7, 1924).
26. Rawlings, F. N., U. S. Patent 2,366,651 (Jan. 2, 1945).
27. Greer, W. N. and Perley, G. A., 113th Nat. A. C. S. Meeting, Chicago, Ill. (1948).
28. Vallez, H. A., U. S. Patent 2,388,194 (Oct. 30, 1945).
29. Gutleben, D., *Chem. & Met. Eng.* **51**, 152 (June 1944).
30. Weitz, F. W., *Sugar* **38**, 26-31 (January 1943).
31. Gutleben, D. and Harvey, F., *Intern. Sugar J.* **47**, 11-13 (1945).
32. Behrman, A. S., U. S. Patent 2,388,222 (Oct. 30, 1945).
33. Vallez, H. A., U. S. Patent 2,388,195 (Oct. 30, 1945).
34. Dahlberg, H. W., U. S. Patent 2,359,902 (Oct. 10, 1944).
35. Behrman, A. S., U. S. Patent 2,388,224 (Oct. 30, 1945).
36. Gustafson, H. B. and Paley, L. A., U. S. Patent 2,402,960 (July 2, 1946).
37. Rawlings, F. N., U. S. Patent 2,413,844 (Jan. 7, 1947).
38. Haagensen, E. A., *Sugar* **41**, 36 (April 1946).
39. Porter, L. B., *Sugar* **42**, 22 (May 1947).
40. Riley, F. R. and Sanborn, W. E., *Sugar* **42**, 24 (July 1947).
41. Ellison, H. E. and Porter, L. B., *Sugar* **43**, 30 (March 1948).
- 41a. Dickinson, B. W., *Chem. Eng.* **55**, 114-7 (July 1948).
42. Nees, A. R. and Bennett, A. N., U. S. Patent 2,375,165 (May 1, 1945).
43. Bennett, A. N., U. S. Patent 2,375,164 (May 1, 1945).
44. Fisk, H. G., *Chem. Eng. News* **26**, 677 (1948).
45. Rawlings, F. N., U. S. Patent 2,391,843 (Dec. 25, 1945).
46. Shafor, R. W., U. S. Patent 2,391,649 (Dec. 25, 1945).
47. Fitzwilliam, C. W. and Yearwood, R. D. E., *Intern. Sugar J.* **49**, 69 (1947).
48. Ventre, E. K., U. S. Patent 2,280,085 (April 21, 1942).
49. Unpublished data, The Permutit Co., New York, N. Y.

50. Block, E. and Ritchie, R. J., *Ind. Eng. Chem.* **39**, 1581 (1947).
51. Cantor, S. M., U. S. Patent 2,328,191 (Aug. 31, 1943).
52. Cantor, S. M., U. S. Patent 2,389,119 (Nov. 20, 1945).
53. Behrman, A. S., U. S. Patent 2,388,223 (Oct. 30, 1945).
54. Handelsman, M. and Rogge, R., *Chem. Eng. Progress* **44**, 583 (1948).
- 54a. Newkirk, T. H., and Handelsman, M., *Ind. Eng. Chem.* **41**, 452 (1949).
55. New York Herald Tribune, Sept. 1, 1947 (Financial Section).
56. Nolte, A. J., von Loesecke, H. W., and Pulley, G. N., *Ind. Eng. Chem.* **34**, 670 (1942).
57. Anon., *Food Inds.* **18**, 1846 (1946).
58. Felton, G., *Food Technol.* **3**, 40 (Feb. 1949).
59. Mottern, H. H., and Morris, R. H., 3d, Bur. of Agr. and Ind. Chem. Mimeograph Circ. AIC37 (1944).
60. Buck, R. E., and Mottern, H. H., *Ind. Eng. Chem.* **37**, 635 (1945).
- 60a. Challinor, S. W., Kieser, M. E., and Pollare, A., *Nature* **161**, 1023 (1948).
61. Buck, R. E., and Mottern, H. H., *Ind. Eng. Chem.* **39**, 1087 (1947).
62. Englis, D. T. and Fiess, H. A., *Ind. Eng. Chem.* **34**, 864 (1942).
63. Porter, R. W., *Chem. Eng.* **54**, 114 (Nov. 1947).
64. Johnson, H. C. E., *Chem. Inds.* **61**, 618 (1947).
- 64a. Otting, H. E., *Ind. Eng. Chem.* **41**, 457 (1949).
65. Willits, C. O., and Tressler, C. J., *Food Research* **4**, 461 (1939).
66. Serbia, G. R., *Sugar* **41**, 43-44 (Sept. 1946).
67. Myers, P. B., and Rouse, A. H., U. S. Patent 2,323,483 (July 6, 1943).
68. Boehner, H. L., and Mindler, A. B., *Ind. Eng. Chem.* **41**, 448 (1949).
69. Matchett, J. R., Legault, R. R., Nimmo, C. C., and Notter, G. K., *Ind. Eng. Chem.* **36**, 851 (1944).
- 69a. Legault, R. R., Nimmo, C. C., Hendel, C. E., and Notter, G. K., *Ind. Eng. Chem.* **41**, 466 (1949).
70. Porter, R. W., *Food Inds.* **20**, 691-702 (1948).

Ion Exchange Recovery of Alkaloids

NORMAN APPLEZWEIG

Hygrade Laboratories, Inc., Newark, New Jersey

AND

FREDERICK C. NACHOD

Sterling-Winthrop Research Institute, Rensselaer, New York

CONTENTS

	<i>Page</i>
I. Conventional Methods of Alkaloid Manufacture	351
1. General Principles	351
2. Solvent Extraction	352
3. Extraction with Acidified Water	352
II. Ion Exchange Processes	353
1. The Adsorption of Alkaloids from Aqueous Solution	353
2. Solanaceous Alkaloids	354
3. Cinchona Alkaloids	355
4. Nicotine	359
5. Curare Alkaloids	360
Bibliography	361

I. CONVENTIONAL METHODS OF ALKALOID MANUFACTURE

1. General Principles

Since the use of alkaloids both as therapeutic agents and as poisons predates most of the drugs in common use today, their manufacture is a relatively old and time honored art. Countless descriptions may be found in the technical literature, and especially the patent files, of techniques for the isolation of each of the well known alkaloids. Most of these disclosures, however, concern novel or minor variations in techniques based upon well known general principles.

The actual details of procedures which have been used successfully on a commercial scale still remain closely guarded trade secrets. These procedures are usually empirical ones based on the solubility characteristics of the alkaloid bases and their corresponding salts. Most of the free bases are soluble in organic solvents such as the alcohols, ethers, and chlorinated hydrocarbons but not in water, while the reverse behavior holds for their salts.

The conventional processes for alkaloid manufacture involve the extraction of the dried alkaloid bearing raw material with a solvent (1, 2, 3).

2. Solvent Extraction

Immiscible solvents are highly selective in the removal of alkaloid bases leaving behind the proteins and carbohydrates. Before these solvents may be used, however, it is necessary to liberate the alkaloids in the form of their free bases by alkaline treatment. In the case of oil bearing drugs it is often necessary to defat by a solvent treatment prior to the liberation of alkaloids in order to prevent contamination of the alkaloid extract.

When low boiling solvents such as ether or methylene chloride are used the extract may be concentrated by distillation and the residue dissolved in warm dilute acid. Further purification may be accomplished by filtration, liberation of the alkaloid bases by addition of alkali and re-extraction with an immiscible solvent. This process is often repeated many times. Finally the compounds are usually isolated by crystallization from water in the form of acid salts.

Extracts made with higher boiling solvents such as ethylene dichloride, trichlorethylene, chloroform, benzene, and kerosene are usually agitated together with an aqueous acid solution. After removal of the alkaloids to the aqueous phase the solvents may be re-used directly or recovered via steam distillation. The use of these latter solvents permits the application of continuous liquid-liquid extraction systems. In any case, however, extraction with immiscible solvents involves the use of costly solvents and equipment.

Another and more common practice involves the use of alcohols for alkaloid extraction. Unlike the immiscible solvents, the alcohols penetrate even moist tissues and are usually excellent solvents for both the alkaloidal salts and the free bases. Thus alkaline pretreatment and careful drying of the drug may be avoided. Unfortunately the alcohols also dissolve large quantities of non-alkaloidal constituents of the plant material which must be subsequently separated.

After the raw material has been thoroughly exhausted the alcoholic extract must be concentrated, usually *in vacuo*, and the alkaloids then dissolved in acid for further purification. As in the case of the immiscible solvents, high costs are encountered in alcohol extraction mainly owing to solvent losses particularly during distillation and recovery from the dregs.

3. Extraction with Acidified Water

Alkaloids occur in very low concentration in nature, usually in the order of less than 1%. Since relatively large quantities of raw materials must be extracted, the use of water as an extractant has great appeal. Acidified water is an excellent alkaloid solvent. It is also an excellent solvent for the other plant ingredients and its use is limited by the difficulty in separation of the alkaloids from these contaminants.

In a few cases where the alkaloid content of the raw material is exceptionally high as in cinchona bark (5–8%) and in opium (10–15%), it is possible to build up a concentrated water extract from which the alkaloids may be precipitated by treatment with alkali. In most cases, however, solvent transfer and elaborate further purification of the water extracted alkaloids would be required.

II. ION EXCHANGE PROCESSES

1. *The Adsorption of Alkaloids from Aqueous Solutions*

The isolation of alkaloids from large volumes of highly dilute aqueous extracts may be elegantly accomplished by resorting to adsorption techniques.

A departure from the older methods of alkaloid manufacturers was suggested by Fink (4) who employed a mixture of kaolin and asbestos to adsorb alkaloids from an aqueous extract of cinchona. However, since alkaloids form strongly basic cations owing to their basic nitrogen, ion exchange seemed a natural method for their preparation and manufacture. An attempt to recover alkaloids by means of magnesium silicate goes back to Lloyd (5).

Ungerer (6) studied adsorption isotherms of quinine, cinchonine, and strychnine with a synthetic calcium aluminosilicate, without however realizing the potentialities of ion exchange as a tool in the manufacture of these compounds.

In recent years, Nachod and co-workers (7, 8, 9) and Applezweig (10, 11) re-investigated the new ion exchangers for their application in the manufacture of alkaloids (cf. also 19).

The general equations of how ion exchangers react have been discussed in earlier chapters of this text.* The main point that one must keep in mind in understanding the connection of ion exchange with alkaloids, is that alkaloids in aqueous solutions form large cations by combining with the hydrogen ions (hydronium ions), which in turn can undergo exchange. To remove such large cations from the exchanger matrix, once they have been attached to it, one has to resort to special techniques (7–10). The regenerant may be an alkali which liberates the alkaloid in the form of its base. Owing to its sparing solubility, the base remains in the interstices of the exchange material. This step is then followed by a selective solvent extraction; or both steps may be combined by the use of an alkaline organic solvent. These two processes have been considered in detail by Sussman *et al.* (12). The first of the two processes is shown schematically,

* See chapter by Walton.

HZ denoting the exchanger in the hydrogen condition, and Alk , the alkaloid as free base:

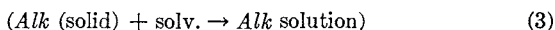
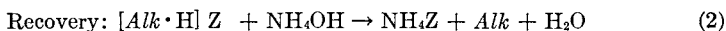

2. Solanaceous Alkaloids

In 1943, after preliminary studies on the exchange behavior of pure atropine sulfate solutions, Applezweig constructed a pilot plant for the extraction of atropine from dried and ground *Datura stramonium* plants. Fifty pound batches of the drug were percolated with 0.5% sulfuric acid until the alkaloids were no longer removed. The extract was passed through a 30-inch high "Zeo Karb-H"* column supported in a 4-inch diameter pyrex tube at a rate of 500–1000 ml./min. When the effluent showed a positive reaction to Mayer's reagent it was switched to a second column while the first was regenerated with ammoniacal (5%) isopropyl alcohol. Upon evaporation of the solvent the residue was dissolved in a minimum quantity of chloroform, filtered, and shaken into dilute sulfuric acid. Atropine sulfate was obtained in good yield following concentration of acid solution and recrystallization.

Using these studies as a base, a continuous system was devised whereby the acid-aqueous menstruum was percolated over the drug, passed through the ion exchange column, and then returned to the drug percolator in a continuous fashion. The drug was thus constantly exposed to an extraction fluid free from alkaloids but saturated with respect to non-cationic ingredients. It was found that such a cyclic system considerably increased both the extraction rate and the total recovery of alkaloids (11).

The cyclic ion exchange extraction system was first used in a commercial installation in the summer of 1944 at the Brownsville, Texas plant of the Debrulle Chemical Company for the isolation of scopolamine from *Datura innoxia* plants. Figure 1 illustrates a section of the installation which included conical percolators and a 12-inch diameter water softening unit charged with Zeo Karb. Sulfuric acid (0.5%) was passed from the percolators by means of a pump through a filter press to the ion exchange column and then back to the percolators.

Operations were begun using dried leaves and stems of *Datura innoxia* but it was soon found that excellent extraction resulted when finely cut fresh plant material was used. This innovation extended the usefulness of the process since the losses and high costs due to drying, grinding, and handling of the plants were avoided.

* Obtained from the Permutit Co., New York.

Previous to the installation of the cyclic ion exchange system at the Brownsville plant the Debrulle Chemical Company had obtained scopolamine by extraction of the dried plants with isopropyl alcohol. The drying of the plants and the vacuum distillation of large quantities of solvent were thus dispensed with. Furthermore, the yields and purity of the ion exchange extract were considerably greater than those obtained by alcohol extraction.



FIG. 1. Cyclic ion exchange plant for the recovery of scopolamine (from *Chem. Inds.* **57**, 455, 1945).

3. *Cinchona Alkaloids*

Attention was next focused on a critical war problem which resulted from the loss of the Far Eastern sources of quinine and its raw materials. Cinchona bark available from South America is of much lower quality and alkaloid content than the East Indian bark and consequently extraction costs and transportation difficulties became factors of prime importance.

A project was set up by the Foreign Economic Administration at Rutgers University College of Pharmacy to devise a method for the extraction of cinchona alkaloids in the field close to the source of the bark. The leaching of alkaloids from low grade cinchona bark by dilute acid was

studied. Recovery of alkaloids from the aqueous menstruum by alkali precipitation was found to give very low yields and required relatively large quantities of acid and alkali, which were not recoverable. As a possible means for improving the recovery of alkaloids from acid solution, ion exchange adsorption was investigated by Applezweig.

Three possibilities were seen for the application of ion exchange to cinchona extraction, namely, to recover alkaloids from the mother liquors of acid extracts of the bark after the major portion had been removed by alkaline precipitation, to purify the crude totaquine obtained by alkaline precipitation, to use ion exchange directly in the acid extraction of the bark by means of a cyclic system (10).

Using pure quinine sulfate solutions 0.033 to 0.0033 *M* and flow rates of 5 to 50 ml./min. a 200 ml. (1-inch diameter) column of "Zeo Karb" was found to retain 7 to 8 g. before "breakthrough." Ammoniacal alcohol used as an eluent gave practically quantitative recoveries.

The adsorption and elution of quinine could be observed visually by illuminating the column with an ultraviolet "black" light (13).

Cinchona alkaloids remaining in mother liquors after precipitation by alkali were found to be completely recoverable by ion exchange (14).

The purification of crude totaquine concentrates by ion exchange was found to be entirely practicable. A comparison of the properties of alkaline precipitated totaquine and the material prepared from it by ion exchange is shown in Table I.

TABLE I*

	Totaquine	
	Alkaline precipitated	Ion exchange
Color	Dark reddish brown	White
Form	Amorphous powder	Crystalline
Total alkaloids, %	23.4	94
Solubility in acid, %	Approx. 45	100
Solubility in CHCl ₃ , %	Approx. 20	100

* Reprinted from Applezweig, N., *J. Am. Chem. Soc.* **66**, 1990 (1944).

Previous experience with cyclic ion exchange extraction of the solonaceous alkaloids and the acid extraction of cinchona bark led to the prediction that ion exchange could be adapted to a field process for the manufacture of cinchona alkaloids in jungle areas.

To obtain the necessary data for the field unit, a pilot plant project was set up at The Engineer Board, Fort Belvoir, Virginia (15). A flow sheet of the pilot plant is shown in Figure 2. It was discovered that if the extract was circulated "upflow" through the exchange columns, the use of a filter to prevent clogging of the exchange beds could be avoided.

Pieces of bark drawn from the maceration tank passed harmlessly through the entire system and returned to the tank.

"Zeo Karb" previously converted to the hydrogen form by treatment with 0.5 *N* sulfuric acid was used as the exchanger and 0.1 *N* sulfuric acid

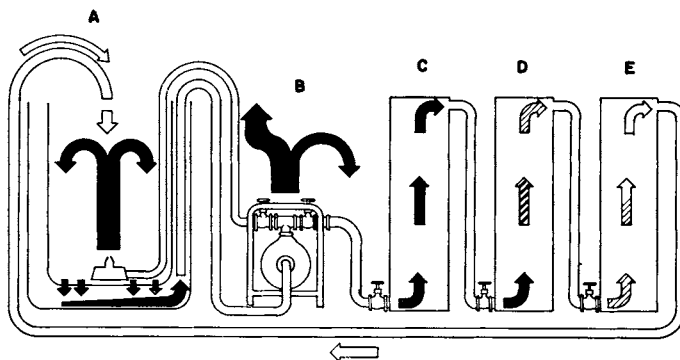

FIG. 2. Flow sheet of pilot plant extraction of cinchona alkaloids (from *Ind. Eng. Chem.* **38**, 578, 1946).

was used as the extraction fluid. Circulation was started with three columns in the line, the first being removed when saturated and a fourth added when necessary. Regeneration was accomplished by treating each column with 12 liters of 0.5 *N* sodium hydroxide, which was followed by a water rinse that removed excess alkali and a great deal of coloring matter. The exchanger was then stripped of its alkaloid content by cycling alcohol through the column. After removal of the alcohol the crude alkaloid concentrate was dissolved in 1 *N* hydrochloric acid and adjusted to a pH of 6.5. Coloring matter and extraneous material were removed by filtration

TABLE II
*Alkaloid Yield from Ion Exchange Process**

Expt. No.	Total time, hr.		Total alkaloid extd., % ^a	Efficiency of recovery, % ^b	Overall recovery, % ^c
	Maceration	Circulation			
1	76	20	63
2	76	20	64	100	76
3	76	20	90	96	86
4 ^d	100	20	93	96	100
Av.	82	20	82.3	98.6	81.2

^a Computed on basis of total alkaloid content of spent bark.

^b Percentage of extracted alkaloids recovered.

^c Computed on basis of total alkaloid content of original bark.

^d The high recovery in expt. 4 is explained by the fact that complete recovery is not achieved within each cycle and residues accumulate on the exchanger which appear in subsequent cycles.

* Reprinted from *Ind. Eng. Chem.* **38** 578 (1946).

and the pH was raised until a white floc appeared. This was filtered off and constituted the rectified totaquine. Mother liquors from this rectification process were returned to ion exchange system for further recovery

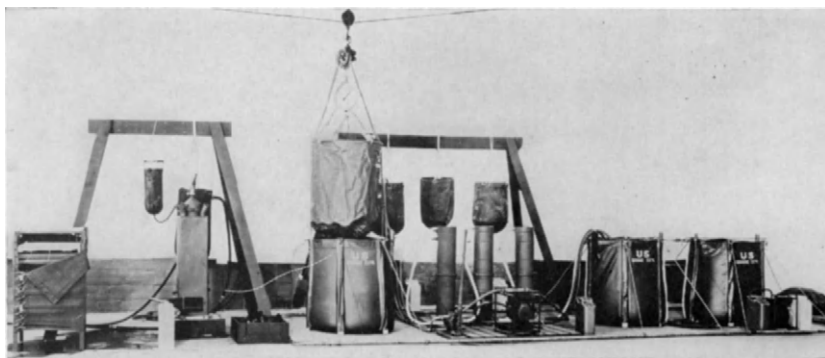

FIG. 3. Portable quinine extraction unit (from *Ind. Eng. Chem.* **38**, 579, 1946).

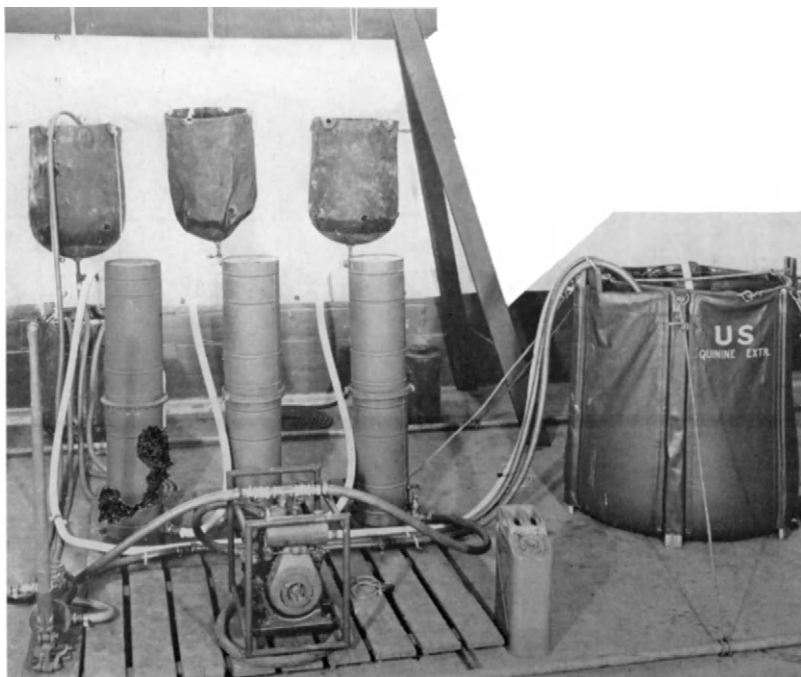

FIG. 4. Field unit for cinchona alkaloid recovery.

(14). The totaquine produced by this process was found to conform to specifications and was suitable for direct use as an antimalarial.

The data obtained with this unit as regards alkaloid recovery are summarized in Table II. Portable field units that were designed on the basis of this data are shown in Figures 3 and 4. These units are capable of extracting the alkaloids contained in 13,000 lbs. of green bark per month with the use of approximately 1,000 lbs. of supplies. Thus the losses and much of the expense involved in the drying, grinding and shipping of Cinchona bark to extraction plants could be eliminated.

4. Nicotine

Nicotine takes a special position among the other alkaloids since it does not find much use as a drug. Its production as an insecticide involves considerable quantities of processed material. In addition to the recovery of the alkaloid, it has also been suggested by Tiger and Dean (16) to use the ground ion exchanger with the nicotine bound to it as a solid insecticide.

The recovery of nicotine as a waste product from tobacco drier stacks has been singularly attractive, since it not only produced a desirable material but at the same time reduced a nuisance in purifying the smoke. This interesting development has been covered recently by Kingsbury *et al.* (17), in their description of the pilot plant work at the P. Lorillard & Company's Old Gold plant in Jersey City, New Jersey. They found that about 3.5 pounds of nicotine were lost in the exhaust gases from tobacco driers per ton of tobacco dried. The concentration of the nicotine in the vents amounted to approximately 5 mg./cu. ft. Calculations indicated that about 175 pounds of nicotine were lost to the atmosphere per week for about 100,000 pounds of tobacco passing the drier so that recovery would appear interesting from an economic viewpoint.

The pilot plant design employed in the work of these authors is shown in Figure 5. Exhaust gases were withdrawn from the vent and contacted countercurrently with treated water in a scrubbing tower. A portion of the resulting nicotine solution was bled off and passed through a cation exchanger unit in which the nicotine was removed according to equation (1) above. Competitive effects produced by metallic cations are apparently not too great, since the nicotine containing water is recirculated or treated water is used for make-up. Depending on the different sources of solvent water, between 3.7 and 6.7 pounds of nicotine can be removed by 1 cu. ft. of ion exchanger.

The recovery of the nicotine from the exchanger can be carried out either in two steps, as shown in equations (2) and (3) above, or in a combination step, as shown on the flow diagram, employing ammoniacal alcohol. Not all of the nicotine initially bound appears to be recoverable.

A case of such a "storage capacity" effect was noted previously in the work with cinchona alkaloids. This is, however, not a serious drawback for the process, since it merely means that the weaker functional groups

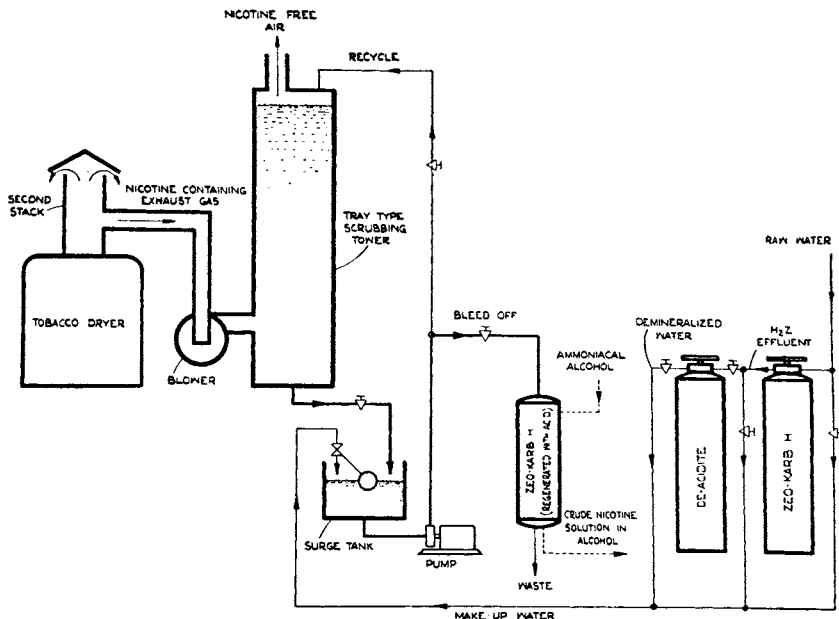

FIG. 5. Nicotine recovery by an ion exchanger.

———— Nicotine removal.
 - - - - - Nicotine recovery.

From *Chem. Eng. Progress* **44**, 497 (1948).

of the exchange material must first be saturated, and the remaining groups can then participate in the reversible exchange reactions without any loss in over-all efficiency (15).

5. Curare Alkaloids

Presumably the only case in which anion exchangers have been employed in the recovery and purification of alkaloids is in the preparation of *d*-tubocurarine chloride, an active principle of *Chondodendron tomentosum*. However, the exchanger is used to reduce the acidity and not to remove the alkaloid from solution. Bashour (18) has patented a process according to which *d*-tubocurarine chloride, present in the mother liquor from preceding crystallizations, can be obtained by contacting it batchwise with an anion exchange resin to remove the excess mineral acid. Ordinary methods of reducing acidity or evaporation do not yield a crystallizable

product from the mother liquor, but by resorting to this method it is claimed that about 40% of the original total tubocurarine chloride can be recovered, thus providing for satisfactory over-all yields.

NOTE ADDED IN PROOF: A method for the determination of alkaloids, either as salts, or present in plant extracts, has just been described by A. Jindra (*J. Pharm. Pharmacol. London* **1**, 87, 1949), which consists of contacting an ethanol solution of the alkaloid salt with a regenerated anion exchanger. The liberated alkaloid base is titrated in the eluant with *N/10* HCl, using a mixture of methyl red and methylene blue as indicator. Good agreement with conventional determinations is reported for the following solutions: *Cinchona* extract, tincture of *Ipecacuanha*, tincture of *Opium*, and tincture of *Nux vomica*.

BIBLIOGRAPHY

1. Applezweig, N., *Encyclopedia of Chemical Technology*. Interscience Publishers, New York, Vol. I, p. 507 (1947).
2. Schwyzer, J., *Die Fabrikation der Alkaloide*. Springer, Berlin (1927).
3. Winterstein, E., and Trier, G., *Die Alkaloide*. Borntraeger, Berlin, 2nd ed. (1927-31).
4. Fink, H., U. S. Patent 2,072,089 (March 2, 1937).
5. Lloyd, J. U., U. S. Patent 1,300,747 (April 15, 1919).
6. Ungerer, E., *Kolloid-Z.* **36**, 228 (1925).
7. Lane, M., Nachod, F. C., and Wood, W., U. S. Patent Application.
8. Lawrence, F. I. L. L., and Nachod, F. C., U. S. Patent Application.
9. Lawrence, F. I. L. L., U. S. Patent Application.
10. Applezweig, N., *J. Am. Chem. Soc.* **66**, 1990 (1944).
11. Applezweig, N., U. S. Patent Application.
12. Sussman, S., Mindler, A. B., and Wood, W., *Chem. Inds.* **57**, 455, 549 (1945).
13. Applezweig, N., *Ann. N. Y. Acad. Sci.* **49**, 295 (1948).
14. Applezweig, N., and Ronzone, S. E., U. S. Patent Application.
15. Applezweig, N., and Ronzone, S. R., *Ind. Eng. Chem.* **38**, 576 (1946); cf. also Engineer Board, Ft. Belvoir, Report **940** (1945).
16. Tiger, H. L., and Dean, J. G., U. S. Patent 2,293,954 (Aug. 25, 1942).
17. Kingsbury, A. W., Mindler, A. B., and Gilwood, M. E., *Chem. Eng. Progress* **44**, 497 (1948).
18. Bashour, J. T., U. S. Patent 2,409,241 (October 15, 1946) assigned to E. R. Squibb & Sons.
19. Winters, J. C., and Kunin, R., *Ind. Eng. Chem.* **41**, 460 (1949).

Miscellaneous Applications of Ion Exchange*

F. K. LINDSAY and D. G. BRAITHWAITE

National Aluminate Corporation, Chicago, Illinois

CONTENTS		Page
I.	Introduction	364
II.	Preparation and Purification of Sols	364
	1. By Methods Employed before the Development of Ion Exchange	364
	2. By Cation Exchangers	365
	3. By Anion Exchangers	366
	4. By a Combination of Cation and Anion Exchangers	367
III.	Milk Treatment	367
	1. Curd Modification by Ion Exchange	367
	2. Treatment of Whey for the Recovery of Lactose	369
IV.	Refining of Hydrocarbons	370
	1. Removal of Copper	370
	2. Removal of Sodium from Petroleum Distillate Residues	370
V.	Purification of Polyalcohols	371
	1. Purification of Ethylene Glycol	371
	2. Purification of Glycerine	372
	3. Purification of Sorbitol	372
VI.	Purification of Formalin	373
VII.	The Purification of Glucose-1-Phosphate	373
VIII.	Soilless Growth of Plants Using Ion Exchange Materials	374
	1. Supply of Nutrients by Salts of Cation and Anion Exchange Resins	374
	2. Use of Exchange Resins to Evaluate Soil Characteristics	375
IX.	Modification of Coagulative Properties of Blood for Transfusion Purposes	375
	1. By Chemical Addition	375
	2. By Ion Exchange	375
X.	Purification of Biologically Active Substances	376
	1. Streptomycin	376
	2. Hypertensin	377
	3. Penicillin	378
XI.	Treatment of Ulcers	378
	1. By Chemical Antacids	378
	2. By Ion Exchange Resins	379
XII.	Recovery and Purification of Vitamin B ₁	380
	1. By Siliceous Materials	380
	2. By Resinous Ion Exchangers	381
	Bibliography	382

* The application of ion exchange to the food industry will be discussed by G. E. Felton in a forthcoming contribution to *Advances in Food Research*, Vol. II.

I. INTRODUCTION

The possibility of preparing ion exchange resins and using such products to completely remove ionized salts from aqueous solutions was disclosed about 1935. Since that time emphasis has been placed primarily upon developing resins with chemical and physical properties that will permit the utilization of this new chemical approach to industrial problems. Although new resin improvements are needed and will undoubtedly develop with the passage of time, ion exchange resins now available in commercial quantities are capable of excellent performance under varied conditions. Because these resins have been available for only a few years a limited number of the possible applications have been studied. New applications, such as inhibiting the development of gas pressure during storage of ground coffee and purification of pharmaceuticals utilizing the amphoteric properties of anion exchangers, are being announced daily (1). The following illustrations are merely examples of the scope of applicability of ion exchangers in industry.

II. PREPARATION AND PURIFICATION OF SOLS

1. *By Methods Employed Before the Development of Ion Exchange*

Since by definition colloidal particles are smaller than can be seen by the use of ordinary microscopes but large enough so that the diameter is of the order of magnitude of five millimicrons (which excludes all molecules except some very high molecular weight complex molecules of materials such as proteins), the two obvious methods of preparation of colloids are condensing simple molecules to form aggregates and reducing large particles to colloidal size. Although shearing in colloid mills, an example of the latter method, is readily applicable to the preparation of emulsions or foams, electrical dispersion or condensation procedures are usually employed for the preparation of colloidal dispersions of solids in liquids. Metal sols, or metal oxide, or hydroxide sols of oxidizable metals can be prepared by employing alternating current and striking an arc between metal poles immersed in the suspending medium. Condensation methods include formation by oxidation, as in the preparation of sulfur sol by oxidation of solutions of sulfides like hydrogen sulfide; by hydrolysis, as in the preparation of ferric hydroxide sols by hydrolysis of ferric chloride; by reduction, as in the preparation of silver sols by reducing solutions of silver salts; by metathesis, as in the preparation of arsenious sulfide sols by passing hydrogen sulfide into arsenious acid solutions.

Sols prepared by chemical reactions usually contain salts as by-product impurities. To purify such sols dialysis, electrodialysis or ultrafiltration can be employed. Dialysis, conducted by immersing an impure sol in a semipermeable membrane sac in a flowing stream of pure water, is slow and

often requires several days to leach the salt impurities from the sol. Because of this slow purification the process is expensive due to both the time consumed and the equipment tie-up. In addition, difficulties are encountered using dialysis to purify sols that require critical ranges of electrolyte concentration for stability. Although these sols are frequently stable for short periods with electrolyte concentrations outside the stabilizing range, the time consumed for small changes in electrolyte concentration using dialysis procedures usually means that difficulties in sol purification are encountered due to gelation because too high or too low an electrolyte concentration has been maintained for an excessive period of time. Electrodialysis is somewhat faster than normal dialysis methods but still is time consuming and has, inherently, all the disadvantages of this method. Ultrafiltration involves the impregnation of ordinary filter papers with collodion or with gelatin that is subsequently hardened by treatment with formaldehyde to form a new filtering medium with pores small enough to retain particles of colloidal size but pass molecular species. The size of the pores of the filtering medium depends upon the paper used and upon the concentration of impregnating solutions as well as upon after treatment. Obviously, the pore size of such filtering systems is variable and is difficult to determine accurately. As in the case of dialysis the mechanism of purifying is not as simple as having pore sizes such that molecules can pass through and particles of colloidal size can be retained. Therefore, all factors affecting adsorption, absorption, and surface phenomena will exert influences upon the process.

2. *By Cation Exchangers*

Ion exchange resins can be employed to both prepare and purify lyophobic sols (2, 3). Acidic oxide sols such as silica sols, tungstic or molybdic acid sols, etc., can be prepared and purified in one step that requires a matter of minutes compared to hours by the above mentioned classical procedures. By passing dilute solutions of metal silicates, metal tungstates, etc., through cation exchange beds that have been regenerated with mineral acid, the metal cations are removed from the solution and replaced with hydrogen ions.

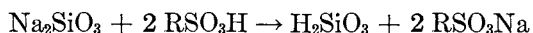

For example, if a 2.5% solution of sodium silicate is passed through an acid regenerated cation exchange bed, silicic acid solution containing almost the theoretical SiO_2 content is obtained. The purified silicic acid solution has a pH of approximately 6.5 and sets to a stiff gel in a few hours. The sodium oxide content of such sols is less than 0.005%. As first prepared the silicic acid solution is almost a true solution as indicated by the absence

of Tyndall effect. Upon standing in this pure state, if stabilizers are not added, the silicic acid gradually condenses to first form colloidal particles that continue to agglomerate until gel formation occurs. The easiest way to stabilize the silica sols and prevent gelation, which also assures obtaining maximum exchange capacity from the resin employed during manufacture, is to allow a little dilute sodium silicate solution to pass through the bed at the end of the operating cycle to give silicate ions that can be absorbed at the particle side of the Helmholtz double layer. Although silica sols can be stabilized with anions other than silicate ions, because of the natural tendency for crystals to extend their own space lattice to take up ions that are common to them, the sols containing silicate ions exhibit the greatest stability.

The soluble salts of many insoluble acidic oxides can be used to prepare sols, but in some cases, as with sodium aluminate or sodium stannate, the sols are unstable during the preparation step and precipitate to form deposits on the exchanger resin particles. When difficulties are encountered due to instability during preparation using this procedure, other approaches described below will usually afford satisfactory alternates.

3. *By Anion Exchangers*

When dilute solutions of salts of weak bases and strong acids are passed through an anion exchange material the hydrolysis equilibrium of the salt is displaced owing to the removal of acid by the exchange resin. In this manner, then, sols of alumina and other metallic oxides can be prepared.

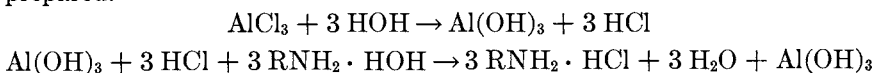

Alumina sols are much more difficult to stabilize than silica sols. Therefore, a more dilute solution of the aluminum salt must be passed through the basic exchanger to reduce the precipitation in the bed to a minimum. In addition, removal of acid by the anion exchange resin does not cause complete hydrolysis of the salts unless extremely dilute solutions, e.g., less than 0.5% are employed.

Basic exchange resins can be used efficiently to purify sols that have been preformed by hydrolysis of salts such as ferric salts. It is well known that when a concentrated solution of ferric chloride is added slowly to a large volume of boiling water a dark red, very stable sol of hydrous ferric oxide forms. The reaction, which may be expressed as follows,

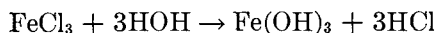

is almost complete, and the ferric sol is stable in the presence of the acid formed during hydrolysis. On passing this hydrolyzed solution through

an anion exchanger the ferric oxide sol passes through the resin unchanged, but the acidity of the solution is reduced. Ferric oxide sols stabilized with small amounts of ferric chloride having a pH of approximately 6.0 have been prepared by this procedure.

4. *By a Combination of Cation and Anion Exchangers*

Ion exchange resins can also be so employed that they are the equivalent of dialysis in the classical methods of purification. For example, sols prepared by double decomposition or other chemical reactions can be passed through a cation exchange resin operated on the acid cycle and then through a basic exchange resin to completely remove ionizable inorganic salts that have been formed as by-products during the preparation of the sols. In the preparation of a silica sol by the addition of mineral acid to a dilute solution of sodium silicate, sodium chloride is formed as a by-product according to the following equation:

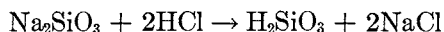

When this preformed sol is passed through a cation exchange resin an acidic sol is formed that is different from the sol prepared by passing a dilute solution of sodium silicate through an acid cation resin as previously described, because in this case the silica is already of colloidal size. After removing the mineral acidity by passing the effluent from the cation exchange resin through a basic exchange resin, an unstabilized silica sol is obtained, and alkali, sodium silicate, lyophobic colloids, or other stabilizers must be added. Since the passage of preformed sols through both cation and anion exchange resins can be at the rate of approximately one gallon per square foot of bed area per minute for 30- to 36-inch bed depths, it is obvious that this procedure of purification is also well adapted to commercial application.

Ion exchange resins have made possible the birth of a new commercial industry — colloidal dispersions.

III. MILK TREATMENT

1. *Curd Modification by Ion Exchange*

The milks of various mammals behave very differently when brought in contact with the gastric juice of the stomach (4). Cow's milk produces a tough, leathery, tenacious mass; mare's milk, a jelly-like curd; and human milk, a fine flocculent curd. The digestive process of the cow is 80% gastric; of the mare 50% gastric; and of the human 20% gastric. In the case of the cow, therefore, a curd is produced that is disintegrated slowly, and the animal gets a maximum of benefit from it before it leaves the stomach. In the case of the human, however, a type of food is produced

that leaves the stomach rapidly and moves on into the intestine where most of the digestion takes place. To make cow's milk acceptable for human infant feeding, it is clear from the above that some method of treatment must be applied that modifies the curd characteristics of the milk.

Modification of cow's milk for infant feeding involves methods of altering the casein and the calcium ion concentration of the milk (5). The following methods have been suggested for accomplishing the desired modification.

1. Dilution with water.
2. Dilution with a protective colloid such as barley gruel or gelatine.
3. The precipitation of calcium ions by the addition of an alkali.
4. The formation of unionized calcium salt by adding a soluble citrate.
5. Partial precipitation of the calcium ions by heating, as in pasteurizing or sterilizing.
6. Curdling the milk by adding acid prior to feeding.

Since calcium must be present to produce a curd by rennet, it should be possible to obtain a soft curd milk by removing calcium from the raw milk by means of ion exchange. Tests carried out indicated that the amount of acidity present affected the calcium removal obtained. At an acidity of 0.16% (calculated as lactic acid) only from 3 to 5% calcium removal was obtained when the milk was passed through a siliceous zeolite. If, however, the acidity was increased to 0.3% (calculated as lactic acid) by the addition of hydrochloric, citric, or lactic acids, and the milk then passed through a zeolite, calcium removal of from 15 to 22% was obtained depending upon the zeolite used. Samples of the treated milk from which only 3 to 5% of the calcium had been removed formed dense curds with rennet. Samples from which 15% of the original calcium had been removed also curdled with rennet, while the sample from which 22% of the calcium had been removed gave no curd. This established the fact that it was necessary to remove approximately 20% of the calcium present in order to produce a non-curding milk. When a brine composed of equal parts of sodium and potassium chlorides is employed in revivifying the zeolites used in the treatment of milk there is little change in the sodium-potassium ratio of the treated milk compared to raw milk. In the removal of phosphorus from the ion exchange material, neutral alkali chlorides were not effective. A weak sodium hydroxide solution containing alkali chloride is necessary for regeneration.

When a sufficient amount of calcium (about 20%) is removed by the ion exchange process to prevent curding with rennet, the taste, color and appearance of the milk are altered very little. The cream line is about the same in the treated as in the untreated milk. The acidity and pH are the

same in the treated as in normal milk, and the bacterial count averages several thousand less in the treated milk. Inasmuch as the amount of calcium and phosphorus present are reduced by the ion exchange treatment process, it was feared that the reduction of these essential constituents might be a factor in causing rickets. Metabolism studies indicated, however, that the remaining calcium and phosphorus were actually utilized to better advantage and that no such problem developed.

A number of patents have been granted pertaining to the use of ion exchange materials in the treatment of milk (6-12). In one of the latest patents the process is outlined as follows:

1. The milk is first cooled to 40-60°F.
2. It is acidified to 0.25-0.35% (calculated as lactic acid) by addition of a hydroxylated food acid. The acidification aids in the restoration of the original acidity of the milk and in the removal of the calcium and phosphorus ions.
3. The acidified milk is maintained at the temperature given above and brought into contact with the ion exchange material.

In the regeneration of the ion exchange product, the spent exchanger is first washed upflow with warm water. A wetting agent is then added and recirculated for ten minutes. This step has been found desirable for the more effective removal of milk fat, protein and phosphorus. A warm water wash is again used to remove the wetting agent. To regenerate, a sodium chloride solution containing acetic acid and a buffering quantity of sodium acetate is first passed through the bed. Following the acidified sodium chloride solution a quantity of potassium chloride solution equivalent to the sodium chloride employed in the initial treatment is percolated through the ion exchange product. To restore alkali to the base exchange material, it is washed with a dilute solution of sodium hydroxide containing sodium aluminate. Following the alkali wash, the revived bed is washed with water and cooled. This completes the regeneration steps and the ion exchanger is again ready to treat milk.

Since twenty-four different companies located in eleven different cities are manufacturing and distributing fluid soft curd milk made by the zeolite treatment process, there is no question about its industrial applicability.

2. Treatment of Whey for the Recovery of Lactose

The M & R Dietetic Laboratories, Inc., have disclosed that the new organic ion exchangers are particularly well adapted to the treatment of wheys from which lactose is to be recovered (13). In one of the processes developed, part of the batch of sweet whey is passed through a cation exchanger in the hydrogen form. The "treated whey" so obtained is

mixed with sweet whey in such proportion as to adjust the pH of the mixture to the isoelectric point of the whey proteins. The mixture is heated to coagulate the proteins, and they are separated from the liquid by filtration. The clarified whey is passed through a hydrogen cation exchanger, thereby removing all metal cations. The effluent from the cation exchanger is then passed through an anion exchanger bed, removing all of the acids, and leaving a clear purified liquid containing substantially all of the lactose. This liquid can be spray dried to produce a powdered lactose, or the lactose can be recovered by standard crystallization procedures.

IV. REFINING OF HYDROCARBONS

1. *Removal of Copper*

To remove undesirable sulfur compounds from petroleum the petroleum industry employs "sweetening processes." Sweetening is usually accomplished by treating the petroleum distillates with copper reagents. Copper chloride or sulfate solutions, alone or mixed with other chlorides such as ammonium or sodium chloride, can be used, as can hydrocarbon soluble copper compounds such as copper naphthenate. Regardless of the reagents or procedure employed, sweetening usually leaves a small amount of copper compounds in the oil that catalyze discoloration and gum formation.

Although clay material similar to siliceous zeolite (14) and synthetic nitrogenous resins (15) have been employed for petroleum purification by percolation methods, the operation is presumably one of purification by adsorption rather than ion exchange. To remove residual copper from sweetened hydrocarbons true ion exchange can be employed, and the copper can be replaced with either sodium or hydrogen depending upon the regeneration procedures used. When cation exchangers in the hydrogen form are used the hydrocarbon must also be subjected to anion exchange to remove the liberated acids (16). When 15 parts of a blend of cracked and straight gasoline containing 1% of its weight of copper naphthenate is intimately mixed with 1 part of hydrogen cation exchanger the hydrocarbon mixture completely loses its green color. After passing through an anion exchanger to remove the naphthenic acid a gasoline of high stability to both color and gum deterioration results.

2. *Removal of Sodium from Petroleum Distillate Residues*

One of many possible methods of treating reduced crude oils to produce lubricating oils is to treat with fused caustic soda (17). After separating the oil from the fused caustic soda and distilling the color stable lubricating oil, the remainder contains from 0.1 to 1.0% sodium salt expressed as sodium hydroxide.

Although residua from petroleum distillations are commonly used as bunker fuels, after the above type caustic treatment, the hydrocarbons contain enough sodium salt impurity to cause difficulties in the furnaces in which they are burned as fuel (18). Residua from the distillation of caustic treated crudes can be processed with hydrogen cation exchangers to make them suitable for use as fuels. Since, as pointed out above, these residues contain from 0.1 to 1.0% sodium as sodium hydroxide, and since the impurity is actually present as caustic soda, only treatment with an acid cation exchange resin is necessary. After passage through a bed of cation exchanger operated on the acid cycle the sodium salt impurity is reduced to 0.03% expressed as sodium hydroxide. After exhaustion the heavy residues can be liberated from the cation exchange beds by passing a small amount of naphtha or kerosene through the bed. The exchanger can then be regenerated with mineral acid following normal procedures.

V. PURIFICATION OF POLYALCOHOLS

1. *Purification of Ethylene Glycol*

Glycols can be prepared from olefin oxides (19) by hydration employing catalysts such as sulfuric acid. Although this method is applicable for the preparation of many glycols it is particularly adaptable to the preparation of ethylene glycol from ethylene oxide. In the hydration of ethylene oxide sulfuric acid equivalent to about 0.5% by weight of the reactants is employed. The final product contains, in addition to excess sulfuric acid catalyst, "combined acids" that cannot be titrated as free acid and cannot be precipitated with barium chloride. To liberate the "combined acid," procedures involving heating with excess caustic have been employed. Following such treatment the alkali must be neutralized. The aqueous solution of the glycol and sodium sulfate, concentrated by evaporation, is then filtered prior to final purification of the glycol by distillation. During the evaporation step considerable difficulty is encountered owing to separation of solid sodium sulfate which plugs lines and valves and deposits on heating surfaces. This results in poor heat transfer and necessitates frequent shut-downs for cleaning.

The troublesome and expensive purification steps outlined above can be eliminated by passing the acidic, aqueous, glycol solution through a bed of basic exchanger (20). Not only is the excess acid removed from the glycol solution, but the "combined acid" constituents are also eliminated. After treatment with anion exchangers, therefore, the purified aqueous solution can easily be concentrated by evaporation to yield a pure product without resorting to distillation.

2. Purification of Glycerine

In most processes involving glycerin purification it is necessary to separate this compound from impurities such as free acids, esters, and inorganic salts. Usually the esters are saponified by heating in the presence of alkali, either in the form of lime or caustic soda. When lime is used, acidification after saponification results in the removal of most of the calcium in the form of insoluble calcium sulfate during the subsequent filtration step. In one process (21) the acidification of lime saponified glycerin solutions with sulfuric acid to a pH of approximately 3, followed by filtration, is sufficient to lower the concentration of soluble cations in the resultant solution so that purification can be realized by passing the filtered, acid solution through an anion exchanger. The de-acidified glycerin is distilled to obtain pure product. Because of the appreciable solubility of calcium sulfate in dilute glycerin solutions, and to insure complete removal of soluble sodium salt impurities, most operators recommend purification after saponification using a two-step ion-exchange process. For example, glycerin sweet waters usually contain in excess of 150 grains per gallon of dissolved inorganic salts with about an equal distribution between calcium and sodium salts. After treatment with cation and anion exchange resins, in a two-step process, the total dissolved salts in such sweet waters can be decreased to less than 2 grains per gallon. Glycerin of purity sufficient for most applications can be obtained by simply concentrating the de-salted sweet water.

3. Purification of Sorbitol

Sorbitol has developed into a bulk industrial chemical within the last ten years. Ion exchange has played an important part in this rapid advance. After the development of a catalytic process (22, 23) the reduction of corn sugar (*d*-glucose) to sorbitol was accomplished easily and quickly in excellent yield. The crude sorbitol solution so obtained has considerable inorganic and ionizable salt impurities that must be removed. The use of sorbitol for production of synthetic vitamin C is an example of the need for exact and complete purification. Sorbitol is converted to ascorbic acid by forming an intermediate, *l*-sorbose, by means of bacterial oxidation. Metal ions inhibit this bacterial oxidation and the effect becomes apparent with 5 p.p.m. nickel, 150 p.p.m. iron and 500 p.p.m. aluminum. The effect of these metals is also cumulative. Metallic ions and acidic impurities are easily reduced to below tolerable limits by passing the reduced corn sugar solution through cation and anion exchangers. The resulting sorbitol solution, after treatment with activated carbon, is concentrated by vacuum evaporation to the 70% commercial solution.

VI. PURIFICATION OF FORMALIN

Formalin is a 37% solution of formaldehyde in water which may contain methanol up to 15%. The increasing demand for formaldehyde with a low acid and metal content for resin manufacture has emphasized the need for an economical method of purification. Unfortunately, most processing increases either the acid or metal content impurities. Since ion exchange offered the potential possibility of removing both these undesirable constituents, this process appeared to be a logical method of formalin purification.

In experimental work carried out on this problem (24) the cation exchanger was regenerated with sulfuric acid and then washed with steam condensate to a pH of 2.5 or above. The anion exchanger was regenerated with a mixed solution of sodium carbonate and sodium bicarbonate and washed until the effluent wash water had a pH of 8.0 or below. Formalin was then passed through the cation exchanger bed to remove metallic contaminants, after which it was passed through the anion exchanger to remove acidic impurities such as formic acid. The operating rate of flow was 0.5 gallons per square foot of ion exchanger bed area per minute. In the operation of both exchanger beds the water was drained down to the level of the resin bed prior to passing the formalin through the column in order to reduce the dilution of the formalin with water to a minimum. After two operating cycles very little formaldehyde was adsorbed by the resin. While a small amount of formaldehyde was lost as weak solution during displacement of water at the beginning of the operating cycle, and of formalin at the end of the operating cycle, 93% recovery of product of usable strength was obtained. In varying the operating rates of flow no improvement was obtained either in resin capacity or product purity when the rate of flow was reduced below 0.5 gallons per square foot per minute. When the rate was increased acid leakage resulted. At the 0.5 gallon per minute per square foot rate of flow, the formalin effluent contained less than 1 p.p.m. each of iron, copper and aluminum. Recording pH meters were found to be satisfactory for determining the point of acid "break-through," thus denoting the end of the operating cycle. Capacities of from 1.5 to 2.0 pounds of formic acid per cubic foot of resin used were obtained. In the work carried out the ion exchange process was proven to be a practical method for removing formic acid and metallic contaminants from formalin.

VII. THE PURIFICATION OF GLUCOSE-1-PHOSPHATE

After the establishment of glucose-1-phosphate as an important intermediary in the synthesis and breakdown of glycogen and starch in the study of the mechanism of carbohydrate formation, a study was undertaken

of the preparation of this chemical so that an adequate supply would be available for further experimentation (25). When the Hanes' method (26) of preparing this ester from starch is employed the product is contaminated with small amounts of dextrans which are very difficult to remove and are often objectionable. If, after the phosphorolysis of starch in the presence of phosphate buffer and the subsequent precipitation of the inorganic phosphate, the reaction mixture is passed through a cation exchange resin operated on the acid cycle to remove cations and then through an anion exchange resin the ester and other strong acids are picked up by the basic exchange material. Other insoluble impurities such as dextrans, proteins, and weak acids are not retained by the exchange material and are, therefore, separated from the ester. The glucose-1-phosphate can then be eluted from the anion exchange resin with dilute alkali and isolated as the crystalline dipotassium salt.

VIII. SOILLESS GROWTH OF PLANTS USING ION EXCHANGE MATERIALS

1. *Supply of Nutrients by Salts of Cation and Anion Exchange Resins*

That plants can be grown without soil has been known for many years. Some other medium such as sand or water is employed to which the nutrients necessary for plant growth have been supplied. Since the roots of plants assimilate food only from solution the food may be supplied to the soilless medium by the addition of solutions of vital salts. About ten years ago soilless growth attracted the attention of technical personnel, and a marked expansion in this method of growing plants resulted almost immediately. Many greenhouses started experimentation testing the idea of supplying chemical plant food by means of nutrient solution addition to plants supported in sand or water media. This procedure offered marked advantages over the common soil methods of growing plants because difficulties due to soil diseases and unsatisfactory soil history, such as drought, are eliminated or minimized by the new approach.

The introduction of ion exchange resins offered a new means of supplying nutrients to soilless media. Early experiments (27) involved the use of potassium, calcium, and magnesium salts of cation exchangers and nitric, sulfuric, and phosphoric acid salts of anion exchangers. Evidence was obtained that indicated the exchanger salts could be mixed in proportions that simulated solution formulations employed in solution culture procedures and that the resins would make essential ions available to the plants growing in the liquid medium. Later experiments (28, 29) have shown that although there is no question about the liberation of necessary anions from basic exchange resins during plant growth in liquid medium, nutrient ions such as calcium and magnesium are not readily available for

plant growth from cation exchange resins. If, however, plant growth media containing proper mixtures of salts of cation and anion exchangers are irrigated daily with dilute solutions of potassium nitrate no cation deficiency symptoms are noted.

2. Use of Exchange Resins to Evaluate Soil Characteristics

Another interesting application of ion exchange resins in plant growth studies is the use of these materials in estimating the effectiveness of plant growth regulators such as 2,4-D (2,4-dichlorophenoxyacetic acid) and its salts (30). In this study the ion exchange resins were used to simulate the zeolitic character of natural soils. It was concluded that the constituents of soil exhibiting cation exchange activity would absorb 2,4-D and its salts from solutions in amounts directly proportional to the increase of acidity in the soils and to the increase in concentration of the plant growth regulator in solution. Since 2,4-D could not be readily leached from the exchange resins it was concluded that most of the active plant growth regulator would be retained by the soil.

IX. MODIFICATION OF COAGULATIVE PROPERTIES OF BLOOD FOR TRANSFUSION PURPOSES

1. By Chemical Addition

As early as 1665 blood transfusions were used in medical practice, but widespread use of transfusions was not employed until recent years because of difficulties incurred by possible coagulation. It has long been recognized that the calcium in the blood affects coagulation and reagents such as oxalates, fluorides, citrates, and heparin have been employed as inhibitors. Oxalates and fluorides modify coagulation of blood by removing the calcium in the form of insoluble calcium compounds that precipitate from the blood. These materials cannot be used to inhibit coagulation of blood used for transfusion purposes, however, because of their toxicity. Citrates function as coagulation modifiers by converting the calcium of the blood to an unionized form. Heparin acts as an antithrombin to inhibit prothrombin, which is necessary for coagulation. The high cost of heparin has limited its application.

2. By Ion Exchange

The calcium of the blood can be removed by ion exchange (31) to give modified blood equivalent to heparinized blood. Resin treated blood has been found satisfactory for hematological, seriological, and biochemical examinations. Blood that has been treated with ion exchangers to replace calcium with sodium loses all properties of coagulation and has a pH of from 6.8 to 7.0 compared to a normal pH of blood of 7.35 to 7.43. It has

been suggested (32) that replacement of calcium with lithium or alkali metal ions other than sodium would probably yield a treated blood of normal pH.

Experiments have already proven that rabbits can be bled, the blood treated with cation exchangers operated on the sodium cycle, and then the blood returned to the rabbits without ill effects. Also, blood from horses and from pigs that have been subjected to ion exchange treatment seemed to be compatible. As investigations continue, therefore, it is possible that the data will demonstrate that difficulties of blood storage for transfusion purposes may be considerably reduced by resin treatment and that not the least of the difficulties eliminated might be that resin treated human blood of all types will be compatible.

X. PURIFICATION OF BIOLOGICALLY ACTIVE SUBSTANCES

1. *Streptomycin*

Streptomycin was first described by Waksman of Rutgers University in 1944. Contrary to many important developments its discovery resulted from a carefully planned, intensified search for an agent which would be effective against gram-negative organisms.

By August 1945, a large pharmaceutical manufacturer had initiated plant construction and is now in large scale production of streptomycin. For the production of a comparatively small tonnage (measured in terms of pounds of finished, dry product) it is necessary to handle tremendous quantities of other materials. Fifty thousand tons of raw materials (including the solvents which are recovered) and 45,000,000 gallons of process water are handled in the production of 250 pounds of finished dry powder.

The manufacture of streptomycin falls into four main steps: inoculation and fermentation, recovery, purification, and finishing (33, 34). The nutrient medium for fermentation consists of a dilute aqueous solution containing 1% glucose, 0.5% peptone, 0.5% meat extract and 0.5% salt. This medium is thoroughly sterilized and then cooled prior to inoculation. After inoculation the temperature is adjusted and fermentation carried out at 25–30°C. The maintenance of complete sterility at this point is highly essential. Fermentation is generally carried out over a period of several days during which time the liquid is subjected to agitation with sterilized air. Aeration is necessary as the streptomycin-producing organism requires oxygen for growth.

The charge from the fermentor is subjected to continuous pressure filtration making use of filter aids to attain maximum clarity of the broth. The clear filtered broth is then mixed with a special grade of activated carbon to extract the streptomycin from solution by adsorption. The

carbon adsorbate is separated by pressure filtration and washed with alcohol to remove impurities. The streptomycin is then eluted from the carbon by treatment with alcohol acidified with hydrochloric acid and is usually recovered from the acid effluent by precipitation as the impure sulfate salt. In one procedure, the hydrochloric acid solution is contacted with an anion exchanger to remove the hydrochloric acid prior to precipitation of the sulfate. The streptomycin is then recovered as the sulfate derivative by addition of sulfuric acid and a solvent. To facilitate further purification it has been found desirable to convert the streptomycin sulfate to streptomycin hydrochloride. This can be accomplished by passing the sulfate derivative through an anion exchanger bed that has been previously exhausted with hydrochloric acid. Since the sulfate ions are held more firmly by the anion exchanger than the chloride ions, the streptomycin sulfate will be converted to streptomycin hydrochloride. The hydrochloric acid released by hydrolysis can then be removed by contacting the effluent from the above anion exchanger unit with an anion exchanger that has previously been regenerated with an alkali. A neutral solution of the streptomycin hydrochloride results.

The finishing of the streptomycin manufacture involves blending, final bacterial filtration, freezing, drying by high vacuum sublimation, milling, weighing into vials, and packaging. From the above it is clear that a great many carefully controlled steps are necessary in the production of this important new product. It is possible that many of these operations may be eliminated by an ion exchange process that will accomplish direct isolation of the streptomycin from the filtered broth, with subsequent recovery in high yields and with a corresponding increase in purity. The concentration and purification of streptothricin has been described by Kocholaty and Junowicz-Kocholaty (34a).

2. *Hypertensin*

When hypertensin is prepared according to the method of Braun, Menendez, *et al.* an impure product is obtained that loses much of its activity when purified by the usual methods (35). When this impure product is treated with an anion exchange resin, the inactive chromogens, polypeptides, etc., are removed without affecting the hypertensin activity. Purification leaving only 0.08 m. g. nitrogen per unit of hypertensin is obtained.

Treatment with cation exchangers results in the pick up of the active principle of the hypertensin. However, since more than thirty materials have been tested in an attempt to elute the hypertensin from the cation resin without success this approach to the purification needs further investigation.

3. *Penicillin*

Cultures of *Penicillium notatum* release, in addition to anti-bacterial penicillin, a variety of impurities that are toxic and prevent the use of untreated filtrate for therapeutic purposes (35). Classical purification is both time consuming and wastes penicillin. If, however, the filtrate is passed through a cation exchange resin at a pH of 6-7, then all the penicillin activity is retained but the toxic materials are eliminated through an anion resin, and the resultant product can be used for injections.

XI. TREATMENT OF ULCERS

1. *By Chemical Antacids*

Gastric juice is composed of pepsin, a proteolytic enzyme, hydrochloric acid and other complex organic substances and inorganic salts. The pepsin acts in the presence of the acid to catalyze the hydrolysis of proteins to proteoses, peptones, and amino acids. Normally there is only a small amount of gastric juice in the empty stomach and the lining membrane is protected by a layer of mucus. In persons addicted to irregular eating, poor nourishment, and nervousness, the increased gastric secretion results in the digestion of the protective mucus, thus producing ulcers.

In 1915, Sippy recommended the use of antacids for treating ulcers. His early recommendations covered the use of such products as bismuth subcarbonate, sodium bicarbonate, magnesium oxide, and calcium carbonate. Later such compounds as tricalcium and trimagnesium phosphates, aluminum hydroxide, aluminum phosphate, and magnesium silicate were used in order to obtain neutralization of the gastric juice without producing excessive alkalosis which was common with Sippy's original powders. In addition to bringing about a neutralization of the gastric juice, these antacids also indirectly attacked the enzyme, as pepsin acts only in low pH medium. As long as these standard antacids allow recurrence of the ulcer and eventually the need for surgical operation they fall short of being a satisfactory remedy. Five major objections to the commonly employed antacids are as follows (36):

1. The salts of aluminum, bismuth, and calcium are constipating.
2. The salts of magnesium are laxative and cause perianal burning.
3. Sodium bicarbonate is absorbed and predisposes to alkalosis and the formation of kidney stones.
4. All carbonates cause belching as CO_2 is released by reaction with the hydrochloric acid of the gastric juice.
5. The aluminum salts have an astringent taste. Since they appear

to exert their best influence in liquid suspension they must be taken in large amounts.

Seven characteristics of the ideal antacid or treatment may be listed as follows (37):

1. Should be insoluble.
2. Should be neutral in aqueous suspension, yet capable of neutralizing acid.
3. Should be non-irritating to stomach and intestines.
4. Should not unduly alter acid-base equilibrium of the body.
5. When taken in reasonable amounts should not alkalize urine with potential danger of precipitating crystalline phosphates in the kidneys and ureter.
6. Should not cause diarrhea or constipation.
7. Should not seriously alter mineral metabolism.

2. By Ion Exchange Resins

Subsequent investigations of the anion exchange resins indicate that they will fulfill the above requirements. In 1945, the acid neutralizing value and toxicity in laboratory rats of an anion exchange resin was investigated (38). Further work has given added evidence that this exchanger is harmless (39). Initial work indicated that it would be necessary to take large quantities of this anion exchanger in order to raise the pH of the gastric juice to the point that the pepsin would become inactive. When a modified form of the anion exchange resin was investigated the following observations were made (40):

1. Rapid adsorption of acid occurred with smaller quantities of the ion exchanger if applied in finely ground form — less than 200 mesh.
2. Acid is picked up in the stomach and carried into the bowel where it is released by reaction with alkalies of the intestinal juices.
3. The resin
 - a) Is non-toxic.
 - b) Does not cause constipation or diarrhea or tend to form masses in the gut.
 - c) Is non-irritating.
 - d) Has no effect on acid-base equilibrium of the body.
 - e) Does not alkalize the urinary tract.
 - f) Has no effect on mineral balance of the body.
4. Complete inhibition of peptic activity was noted. It was concluded from this work that anion exchange resins could be prepared that would approach the ideal antacid.

Chemical studies carried out at the Woman's Medical College of Philadelphia (41) and at the Presbyterian Hospital of Newark (41a) making use of the same modified anion exchanger indicated that relief of pain was almost instantaneous over a wide range of resin dosages. It has been reported that four months of work at the Presbyterian Hospital in New York gave added argument to the idea that the synthetic anion exchange resins will find a place in the treatment of peptic ulcers, for pain was relieved promptly without ill effects (42).

Later work has shown that the efficiency of the anion exchange resin is a result not only of its ability to neutralize acid, but also of its capacity for adsorbing, and thereby inactivating, the pepsin (43). While ordinary antacids will inactivate pepsin by raising the pH of the gastric juice, the anion exchange resin will accomplish this result without sufficient neutralization to produce a change in the hydrogen ion concentration.

From the results that have been obtained thus far it cannot be concluded that the use of the anion exchanger treatment will eliminate the peptic ulcer. Ulcer victims can be encouraged by the fact, however, that a reagent is now available that has all of the good characteristics of other known antacids without having any of their known disadvantages.

[EDITOR'S NOTE: In connection with the above remarks on ulcer therapy, it is of interest to note that Kasdon (52) has reported recently on the anion exchange resin treatment of heartburn in pregnant women. Thirty-one of 35 patients suffering from heartburn obtained complete relief upon oral administration of anion exchange resins, administered before the last month of gestation.]

XII. RECOVERY AND PURIFICATION OF VITAMIN B₁

1. *By Siliceous Materials*

Preparations that were originally called vitamin B have been shown to be complex mixtures containing ten or more active constituents. Yeasts, eggs, and the hulls and germs of cereal grains are the usual sources of vitamin B complex. As is usually the case when production depends upon extraction from natural products the vitamin extracts from yeasts and grain hulls contain many impurities. Purification of such extracts by classical methods such as precipitation, filtration, washing, etc., is long and tedious. It was soon discovered that vitamin B₁ could be selectively adsorbed on naturally occurring silicates, such as fuller's earth (44). As more became known about the components of the vitamin B complex and as individual chemical structures and properties of the vitamins were established, it was apparent that the adsorption on the naturally occurring silicates was probably at least partially due to base exchange phenomena.

The chemical structures of thiamine hydrochloride (vitamin B₁ hydrochloride) and riboflavin (vitamin B₂) are given below.

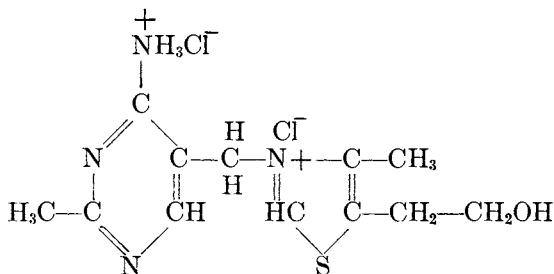

Thiamine hydrochloride

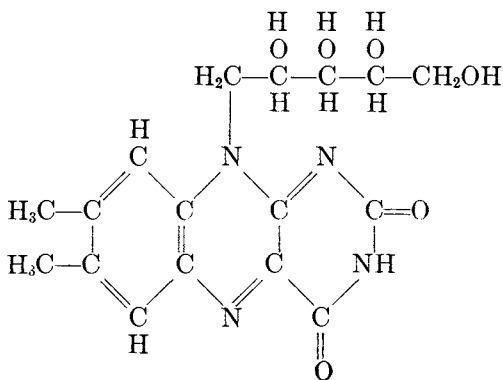

Riboflavin

Vitamin B-1 is a substituted ammonium type base compound, and, therefore, the entire vitamin molecule can function as a cation during basic exchange reactions. Initial experiments were carried out using synthetic zeolites operated on the sodium cycle to remove thiamine from extracts (45, 46, 47). After separating the vitamin B₁ from most of the impurities by the base exchange process the vitamin was liberated from the zeolites by passing a concentrated solution of ammonium salt such as ammonium nitrate solution through the exhausted zeolite material. This concentrated vitamin effluent can be further purified by precipitating and washing insoluble salts of the vitamin such as the silicotungstate salt.

2. By Resinous Ion Exchangers

If synthetic cation exchange resins that can be operated on the acid cycle are employed instead of siliceous exchange materials, vitamin B₁ can be selectively removed from the dilute acidic alcoholic extracts from yeasts or grain hulls and separated by this procedure from riboflavin, which cannot function as a cation (48, 49). When the thiamine is picked

up by passing extracts through an acid cation exchange material it is difficult to liberate, and fairly concentrated solutions of mineral acids (30–37%) must be employed to completely recover the vitamin and regenerate the cation exchange mineral.

Another approach to the purification of vitamin B complex extracts involves the removal of undesirable acidic impurities (50). If the acidulated alcohol-water extracts of brewer's yeast or other extracts of vitamin B complex are evaporated under reduced pressure to a syrupy consistency and allowed to stand, impurities in the form of gummy insolubles separate out and may be removed by filtration or decantation (51). Although most of the impurities that impart bitter taste, dark color, and other undesirable characteristics to the vitamin B complex can be removed by this process, some impurities that are acidic in character still remain in the partially purified solution. These acidic impurities can be removed by passing either the original extract or the partially purified concentrated extract through a basic exchange resin. Since it is preferable to maintain vitamin extracts in a pH range of 3 to 4 the resin bed is sometimes preliminarily exhausted with a weak acid, such as acetic acid, to minimize the change in pH as the extract passes through the exchanger. After purification by passing through the basic resin the vitamin extract can be dried to give a product that is less hygroscopic and has improved taste, odor, and color.

BIBLIOGRAPHY

1. Behrman, A. S., U. S. Patent 2,430,663 (Nov. 11, 1947).
2. Bird, P. G., U. S. Patent 2,244,325 (June 3, 1941).
3. Ryznar, J. W., *Ind. Eng. Chem.* **36**, 821 (1944).
4. Otting, H. E., and Quilligan, J. J., *Milk Dealer* pp. 36–8 (August 1934).
5. Lyman, J. F., Browne, E. H., and Otting, H. E., *Ind. Eng. Chem.* **25**, 1297 (1933).
6. Lyman, J. F., U. S. Patent 1,954,769, M & R Dietetic Laboratories, Inc. (April 10, 1934).
7. Otting, H. E., and Browne, E. H., U. S. Patent 2,072,903, M & R Dietetic Laboratories, Inc. (Mar. 9, 1937).
8. Otting, H. E., Browne, E. H., and Hull, M. E., U. S. Patent 2,102,642, M & R Dietetic Laboratories, Inc. (Dec. 21, 1937).
9. Otting, H. E., U. S. Patent 2,225,506, M & R Dietetic Laboratories, Inc. (Dec. 17, 1940).
10. Otting, H. E., and Quilligan, J. J., U. S. Patent 2,233,178, M & R Dietetic Laboratories, Inc. (Feb. 25, 1941).
11. Hull, M. E., U. S. Patent 2,346,844, M & R Dietetic Laboratories, Inc. (April 18, 1944).
12. Otting, H. E., and Quilligan, J. J., U. S. Patent 2,307,234, M & R Dietetic Laboratories, Inc. (Jan. 5, 1943).
13. Garrett, O. F., Private communication.
14. Jones, M. C. K., U. S. Patent 2,270,058, Standard Oil Development Co. (Jan. 13, 1942).

15. Myers, R. J., U. S. Patent 2,341,329, Resinous Products and Chemical Co. (Feb. 8, 1944).
16. Schindler, H., U. S. Patent 2,367,803, The Pure Oil Co. (Jan. 23, 1945).
17. Pfennig, R. F., and Davis, C. R., U. S. Patent 2,339,875, Standard Oil Development Co. (Jan. 25, 1944).
18. Schutze, H. G., U. S. Patent 2,375,694, Standard Oil Development Co. (May 8, 1945).
19. Balcar, F. R., U. S. Patent 2,135,271, U. S. Industrial Alcohol Co. (Nov. 1, 1938).
20. Metzger, F. J., U. S. Patent 2,409,441, U. S. Industrial Chemicals, Inc. (Oct. 15, 1946).
21. Hoyt, H. E., U. S. Patent 2,381,055, U. S. Industrial Chemicals, Inc. (Aug. 7, 1945).
22. Porter, R. W., *Chem. Eng.* **54**, 114 (1947).
23. Anon. *Resinous Reporter* **8** (14 May 1947).
24. Cristy, G. A., and Lembcke, R. E., *Chem. Eng. Progress* **44**, 417 (1948).
25. McCready, R. M., and Hassid, W. Z., *J. Am. Chem. Soc.* **66**, 560 (1944).
26. Hanes, C. S., *Proc. Roy. Soc. London* **B129** (1940).
27. Schlenker, F. S., *Am. J. Botany* **27**, 525 (1940).
28. Arnon, D. I., and Grossenbacher, K. A., *Soil Science* **63**, 159 (1947).
29. Graham, E. R., and Albrecht, W., *Am. J. Botany* **30**, 195 (1943).
30. Weaver, R. J., *Science* **106**, 268 (1947).
31. Steinberg, A., *Proc. Soc. Exptl. Biol. Med.* **56**, 124 (1944).
32. Sweet, W. J., and Sweeney, O. R., *Proc. Iowa Acad. Sci.* **51**, 299 (1944).
33. Anon. *Resinous Reporter* **8** (6 July 1947).
34. Porter, R. W., *Chem. Eng.* **53**, 54 (1946).
- 34a. Kocholaty, W., and Junowicz-Kocholaty, R., *Arch. Biochem.* **15**, 55 (1947).
35. Cruz-Coke, E., Gonzalez, F., and Hulsen, W., *Science* **101**, 340 (1945).
36. Kraemer, M., and Siegel, L. H., "Synthetic Resin: A New Antacid Treatment of Peptic Ulcers," presented before the 96th Annual Session of A.M.A., Atlantic City (June 13, 1947).
37. Beckman, H., Treatment in General Practice. W. B. Saunders Company, Philadelphia, 4th ed., (1942).
38. Segal, H. L., Hodge, H., Watson, J. S. Jr., and Scott, J. M., *Gastroenterology* **4**, 484 (1945).
39. Segal, H. L., Hodge, H., Watson, J. S. Jr., and Coates, H., *Gastroenterology* **8**, 199 (1947).
40. Martin, G. J., and Wilkinson, J., *Gastroenterology* **6**, 315 (1946).
41. Spears, M. M., and Pfeiffer, M. C. J., *Gastroenterology* **8**, 191 (1947).
- 41a. Anon. *Resinous Reporter* **8** (12 November 1947).
42. Kraemer, M., and Lehman Jr., D. J., *Gastroenterology* **8**, 202 (1947).
43. Martin, G. J., *Am. Druggist* **116**, 84 (1947).
44. Windaus, Tschesche, Ruhkoph, Laguer, and Schultz, *Z. physiol. Chem.* **204**, 123 (1932).
45. Cerecedo, L. R., and Hennessy, D. J., *J. Am. Chem. Soc.* **59**, 1617 (1937).
46. Cerecedo, L. R., and Kaszuba, F. J., *J. Am. Chem. Soc.* **59**, 1619 (1937).
47. Cerecedo, L. R., and Thornton, J. J., *J. Am. Chem. Soc.* **59**, 1621 (1937).
48. Cerecedo, L. R., U. S. Patent 2,114,775 (April 19, 1948).
49. Herr, D. S., *Ind. Eng. Chem.* **37**, 631 (1945).
50. Maizel, B., U. S. Patent 2,364,639, Vico Products Co. (Dec. 12, 1944).
51. Maizel, B., U. S. Patent 2,193,876, Vico Products Co. (Mar. 19, 1940).
52. Kasdon, S. C., *New Eng. J. Med.* **239**, 575 (1948).

APPENDIX*

Characterization and Source of Supply
of Commercially Available Ion Exchangers

I. CATION EXCHANGERS

<i>Trade name</i>	<i>Generic description</i>	<i>Manufacturer</i>
Alkalex	Carboxylic type exchanger from alkaline oxidation of coal.	Research Products Corp. 1015 Washington Ave., Madison 3, Wis.
Amberlite IR-100	Modified phenol-formaldehyde sulfonic acid type resin.	The Resinous Products and Chemical Co.† Philadelphia, Pa.
Amberlite IR-100H, Analytical Grade	A "C.P." form of standard Amberlite IR-100. It should be noted that this is supplied as the hydrogen derivative rather than the sodium salt.	The Resinous Products and Chemical Co.† Philadelphia, Pa.
Amberlite IR-105	A high capacity sulfonic acid type cation exchanger.	The Resinous Products and Chemical Co.† Philadelphia, Pa.
Amberlite IR-120	A very high capacity sulfonic acid type cation exchanger.	The Resinous Products and Chemical Co.† Philadelphia, Pa.
Amberlite IRC-50	A cation exchanger in which the activity is due to the carboxylic group exclusively.	The Resinous Products and Chemical Co.† Philadelphia, Pa.
Catex 27	Sulfonated coal.	Infilco Inc. 325 West 25th Place, Chicago 16, Ill.
Catex 55	Sulfonated coal.	Infilco, Inc. 325 West 25th Place, Chicago 16, Ill.
Crystalite	Sodium aluminosilicate.	Infilco, Inc. 325 West 25th Place, Chicago 16, Ill.

* Cf. also Kunin, R., *Anal. Chem.*, **21**, 89 (1949); Tompkins, E. R., *J. Chem. Education* **26**, 32 (1949); Duncan, J. F., and Lister, B. A. J., *Quart. Rev.* **2**, 307, 318 (1948).

† Name changed September, 1948 to Rohm & Haas Co.

I. CATION EXCHANGERS (*Continued*)

<i>Trade name</i>	<i>Generic description</i>	<i>Manufacturer</i>
Decalco	Synthetic sodium aluminosilicate.	The Permutit Co. 330 West 42d St., New York 18, N. Y.
Dowex 30	Phenol sulfonic acid formaldehyde type resin.	The Dow Chemical Co. Midland, Mich.
Dowex 50	Sulfonated aromatic hydrocarbon polymer.	The Dow Chemical Co. Midland, Mich.
Duolite C-1 Duolite C-3	Sulfonate type resins.	Chemical Process Co. 58 Sutter St., San Francisco, Calif.
Duolite Cation Selector CS-100	Phenol-aldehyde carboxylic acid type resin.	Chemical Process Co. 58 Sutter St., San Francisco, Calif.
Duolite Expanded Cation Exchanger	Synthetic organic exchanger for removal of organic cations.	Chemical Process Co. 58 Sutter St., San Francisco, Calif.
Ionac C-200	Phenol formaldehyde sulfonate.	American Cyanamid Co. 30 Rockefeller Plaza, New York 20, N. Y.
Iron Remover	Specially processed natural organic material.	National Aluminate Corp. 6216 West 66th Place, Chicago 38, Ill.
Liquonex CG	Stabilized greensand.	Liquid Conditioning Corp. 114 East Price St., Linden, N. J.
Liquonex CGH	High capacity greensand (glauconite).	Liquid Conditioning Corp. 114 East Price St., Linden, N. J.
Liquonex CSL	Synthetic gel sodium aluminosilicate.	Liquid Conditioning Corp. 114 East Price St., Linden, N. J.
Liquonex CRM Liquonex CRP Liquonex CRQ	Phenol-formaldehyde resins containing sulfonic acid groups.	Liquid Conditioning Corp. 114 East Price St., Linden, N. J.

I. CATION EXCHANGERS (*Continued*)

<i>Trade name</i>	<i>Generic description</i>	<i>Manufacturer</i>
Liquonex CRW	Sulfonated polystyrene resin.	Liquid Conditioning Corp. 114 East Price St., Linden, N. J.
Nalcite MX	See Dowex 30.	National Aluminate Corp. 6216 West 66th Place, Chicago 38, Ill.
Nalcite HCR	See Dowex 50.	National Aluminate Corp. 6216 West 66th Place, Chicago 38, Ill.
Nalcolite	Synthetic inorganic exchanger.	National Aluminate Corp. 6216 West 66th Place, Chicago 38, Ill.
Permutit Q	Sulfonated hydrocarbon polymer.	The Permutit Co. 330 West 42d St. New York 18, N. Y.
Refinite ZN	Processed zeolite clay from natural bentonites.	The Refinite Corp. Omaha, Neb.
R-P Zeolite	Synthetic aluminosilicate	Research Products Corp. 1015 Washington Ave., Madison 3, Wis.
Zeo-Dur	Processed glauconite.	The Permutit Co. 330 West 42d St., New York 18, N. Y.
Zeo-Karb	Sulfonated coal.	The Permutit Co. 330 West 42d St., New York 18, N. Y.
Zeo-Rex	Phenolic sulfonate type resin.	The Permutit Co. 330 West 42d St., New York 18, N. Y.

II. ANION EXCHANGERS

<i>Trade name</i>	<i>Generic description</i>	<i>Manufacturer</i>
Amberlite IR-4B	Modified phenol formaldehyde polyamine condensate.	The Resinous Products and Chemical Co.† Philadelphia, Pa.
Amberlite IR-4B, Analytical Grade	A "C.P." form of standard Amberlite IR-4B, likewise supplied as the free base.	The Resinous Products and Chemical Co.† Philadelphia, Pa.
Amberlite IRA-400	A very basic anion exchanger, monofunctional in nature.	The Resinous Products and Chemical Co.† Philadelphia, Pa.
Anex 299	Guanidine resin.	Infilco, Inc. 325 West 25th Place, Chicago 16, Ill.
De-Acidite	Aliphatic amine type resin.	The Permutit Co. 330 West 42d St., New York 18, N. Y.
Duolite A-1 Duolite A-2	Synthetic organic exchanger.	Chemical Process Co. 58 Sutter St., San Francisco, Calif.
Duolite A-3	Special exchanger to be used if dextrose is present in the solution undergoing treatment.	Chemical Process Co. 58 Sutter St., San Francisco, Calif.
Ionac A-293 M	Melamine-guanidine-formaldehyde resin.	American Cyanamid Co. 30 Rockefeller Plaza, New York 20, N. Y.
Ionac A-300	Amine-type resin.	American Cyanamid Co. 30 Rockefeller Plaza, New York 20, N. Y.
Liquonex AD	Strongly basic aliphatic amine resin.	Liquid Conditioning Corp. 114 East Price St., Linden, N. J.
Liquonex AF	Polyalkylene polyamine resin.	Liquid Conditioning Corp. 114 East Price St., Linden, N. J.
Permutit S	Strongly basic amine type resin.	The Permutit Co. 330 West 42d St., New York 18, N. Y.

† Name changed September, 1948 to Rohm & Haas Co.

Author Index*

- A**
- Abrahamczik, M., 278 (1), 282, 291
 Ackermann, D., 297, 312
 Adadurov, I. E., 263 (15), 272
 Adams, B. A., 1, 2, 45, 74, 103, 117 (59),
 147, 148, 167, 220, 221, 255 (22, 23),
 259, 298, 312, 319, 348
 Adams, R. S., 229, 233
 Adamson, A. W., 5 (5), 8 (5), 9 (5), 10 (5),
 13 (5), 14 (5), 16 (5), 18 (5), 20 (5),
 27, 31 (2), 37 (2), 39 (2), 39 (12), 43,
 60 (9), 61 (9), 61 (10), 74 (9), 74, 75,
 169 (13), 170 (13), 171 (17), 173 (17),
 175 (13), 182 (13), 186 (13), 199 (17),
 201 (17, 44), 202 (17), 204 (17), 207
 (13), 221, 222
 Adler, H., 109 (2), 142, 147
 Akeroyd, E. I., 161 (12), 166, 176, 221
 Albrecht, W., 374 (29), 383
 Allen, W. W., 145 (4), 147
 Alm, A. V., 312 (59), 313
 Alten, F., 23, 28
 Antipova-Karataeva, 8 (13), 27
 Applebaum, S. B., 103 (7), 120 (8), 121 (7),
 147
 Archibald, R. M., 278 (8, 7), 279 (8), 284,
 291
 Arnon, D. I., 374 (28), 383
 Atterberry, R. W., 130 (9), 147
 Austerweil, G. V., 160 (9, 10), 166, 218,
 222, 237, 257, 258, 296, 307, 312,
 317 (9), 348
 Ayers, B., 16 (32a), 27, 183 (30), 197 (30),
 221
 Ayres, J. A., 185 (36), 186 (36), 218, 221,
 257, 259
- B**
- Bachler, F. R., 317, 348
 Bachmann, F., 126 (10), 147
 Bacon, R. C., 8 (14), 27
 Badger, W. L., 80 (1), 99
 Bahrdt, A., 230 (37), 233
 Baker, M. D., 145 (54), 148
 Balcar, F. R., 371 (19), 383
 Bandelin, F. J., 225, 232
 Barnes, R. B., 144, 147
 Barry, R., 104 (68a), 109 (68a), 148
 Bartlett, P. D., 48 (4), 74
 Bashour, J. T., 360, 361
 Bauman, W. C., 8 (12), 18, 22, 27, 28, 31,
 39, 43, 47 (2), 61 (10), 62 (2), 74, 75,
 104 (14), 109 (12, 13, 14a), 134, 136
 (14), 137 (14), 138 (14), 147, 169 (11),
 170 (11), 201 (11), 221, 256 (24, 25),
 259, 263 (36), 273
 Baur, E., 255, 259
 Beaton, R. H., 39 (11), 43, 61 (10), 62 (13),
 75, 145 (15), 147, 220 (59), 222, 237,
 239, 258, 278 (35), 292
 Beckman, H., 379 (37), 383
 Beekhuis, H. A., Jr., 264 (18), 272
 Behrman, A. S., 122 (16), 142, 143, 147,
 165 (16, 17), 166, 327 (32), 329, 337,
 348, 349, 364 (1), 382
 Bell, E. B., 129, 147
 Bell, R. D., 223, 224, 232, 278 (33), 292
 Bendall, J. R., 311 (55), 313
 Bennett, A. N., 306, 313, 330, 331, 348
 Beohner, H. L., 346 (68), 349
 Bergdoll, M. S., 297, 298, 312
 Berk, A. A., 145 (20), 147
 Bertsch, J. A., 262 (4, 6), 263 (7), 272
 Betz, L. D., 134 (21), 147
 Bhatnager, M. S., 278 (9), 291
 Bhatnagar, S. S., 24, 28, 278 (9), 291
 Bird, P. G., 278 (10), 291, 365 (2), 382
 Bishop, J. A., 25, 28, 71 (20), 75
 Bitepazh, Y. A., 265 (28), 272
 Bjerrum, N., 178 (27), 179 (27), 221
 Block, E., 335, 348
 Block, R. J., 226, 277 (11), 278 (11, 12,
 13), 284, 291, 297, 298, 299 (16, 17,
 19-24), 300 (16, 17, 19-24), 301 (16,

*Numbers in parentheses are reference numbers. They are included to assist in locating references in which the authors' names are not mentioned in the text.

Example: Adler, H., 109 (2), 142, 147, indicates that this author's article is reference 2 on page 109. Numbers in italics refer to the page on which the reference is listed in the bibliography at the end of each chapter.

- 17, 19-24), 303 (4, 16, 17, 20, 22, 24),
304 (16, 17), 305, 306 (16), 309 (4, 50),
310 (16, 17, 24), 311 (17, 24), 312, 313
- Bodansky, M., 226 (12), 232
- Bolling, D., 297, 303 (4), 309 (4), 312
- Bommer, H., 192
- Bonnichsen, R. K., 304, 313
- Boreskov, G. K., 263 (15), 272
- Borrowman, G., 1, 2
- Borsook, H., 226 (14), 232
- Boudreaux, G., 24, 28, 64 (16), 75
- Boulet, M., 297 (5), 312
- Bowers, A. E., 108 (108), 146 (108), 149
- Bowers, H. L., 118 (22), 147
- Boyd, E. E., 5 (5), 8 (5), 9, 10, 13, 14, 16
(5), 18 (5), 20, 27, 31, 37, 39, 39 (12),
43, 60 (9), 61 (9), 61 (10), 74, 74, 75,
168 (8), 169 (8, 13), 170 (13), 171 (17),
172 (8), 173 (17, 8), 175 (13), 177 (13),
179 (8), 181 (8), 182 (13), 184 (8), 186
(13), 192, 193, 194, 197 (8), 199 (17),
200, 201 (8, 17, 44), 202 (17), 203, 204
(17, 8), 207 (13), 214, 215, 221, 222
- Boyd, R., 318, 348
- Brant, J. H., 264 (24), 272
- Breazeale, E. L., 289 (14, 64), 291, 293
- Breazeale, J. F., 285, 289 (14), 291, 292
- Bredig, M., 192
- Bregman, J. I., 18, 28
- Brice, N. E., 86 (2), 88 (3), 99
- Brinkley, R. Z., 36
- Brinkley, S. R., Jr., 35
- Broderson, K., 104 (49), 148
- Broughton, G., 176, 221
- Browne, E. H., 278 (52), 292, 368 (5), 369
(7, 8), 382
- Bruce, W. M., 109 (23), 147, 165 (18, 19),
166
- Buc, S. R., 279 (16), 280, 292
- Buck, R. E., 279 (17), 292, 342, 343 (60,
61), 349
- Burrell, H., 254, 259
- Burton, D., 229, 233
- Buswell, A. M., 114 (24), 118 (24), 143,
144 (25), 147
- Butler, T. A., 16 (32a), 27, 168 (6, 9), 174
(9), 183 (30), 196 (9), 197 (9, 30), 198
(6, 9), 199 (6), 200 (6, 9), 201 (6, 9),
202 (6), 203 (6), 204 (6, 9), 210 (9),
211 (9), 212 (9), 213 (9), 221
- C
- Cain, C. K., 278 (47), 280 (47), 292
- Calise, V. J., 126 (47), 135 (25a), 147, 148,
159 (1), 160 (1), 164 (1), 166
- Calmon, C., 109 (26), 123 (27), 132 (26),
137 (28), 147
- Cannan, R. K., 277 (18), 278 (18, 19), 284,
292, 296 (66), 305, 314
- Cantor, S. M., 336, 337 (51, 52), 349
- Caps, J. E., 91 (4), 99
- Carlson, R. W., 239, 245 (7), 257, 259
- Carron, M., 39, 43, 61 (10), 75, 114 (61a),
148
- Carter, H. E., 281, 292
- Cassidy, H. G., 278 (22), 279 (22), 292, 301
(28), 304 (28), 306, 307, 310 (28), 313
- Catch, J. R., 307, 313
- Cathers, 48 (4), 74
- Cerecedo, L. R., 225, 232, 278 (21, 40), 283
(21, 40), 292, 381 (45, 46, 47, 48), 383
- Cerna, W. W., 143, 147
- Challinor, S. W., 343 (60a), 349
- Chapman, H. D., 279 (51), 292
- Cheetham, H. C., 63, 75
- Cheldelin, 306
- Chulkov, 8 (15), 27
- Churchill, H. V., 139 (34), 147
- Claassen, H., 317 (6), 347
- Claesson, S., 299, 301 (25), 306, 307, 312, 314
- Clark, R. K. J., 281 (20), 292
- Clark, T. B., 88 (5), 99
- Cleaver, C. S., 278 (22), 279, 292, 301 (28),
304, 305, 310 (28), 313
- Coates, H., 379 (39), 383
- Cohn, W. E., 16 (32), 19 (32), 27, 168 (3),
172 (3), 174, 178 (3), 185 (3, 18), 186
(3), 187 (18), 191 (3), 193 (3), 194 (3),
195 (3), 197 (3), 198 (3), 200 (3), 201
(3), 204 (18), 205 (18), 206 (3), 207
(3, 47), 208 (3), 209 (3), 210 (3, 18),
217 (18)
- Collins, L. F., 102 (30), 147
- Colvin, R. H., 88 (6), 99
- Connolly, G. C., 265, 272
- Connor, R. T., 225, 232
- Consdan, R., 306, 307, 308, 309, 313
- Contant, P. M., 118 (32), 147
- Cook, A. H., 307 (45), 313
- Coryell, C. D., 168 (5), 191 (5), 192 (5),
193 (5), 201 (5), 221

Courant, R., 41, 43
 Cox, C. R., 120 (33), 147
 Craig, A. M., 268 (37), 273
 Cranston, H. A., 231, 233, 292
 Cristy, G. A., 373 (24), 383
 Cruz Coke, E., 278 (24), 292, 377 (35), 378 (35), 383

D

Dahlberg, H. W., 329, 348
 D'Alelio, G. F., 109 (35), 147
 Daniels, F., 168, 217 (10), 221
 Darge, I., 228 (21), 232
 Darling, S., 304, 313
 Davenport, H. W., 226 (13), 232, 297, 312
 Davey, W. B., 140 (104), 149
 Davies, C. W., 269 (38), 273
 Davis, 370 (17), 383
 Davis, C. R., 370 (17), 383
 Davis, D. E., 119 (36), 121, 147
 Davis, J. F., 285 (72), 293
 Davis, L. E., 4 (1), 11, 12, 27
 Dean, H. T., 139 (38), 140 (39, 37), 141, 147
 Dean, J. G., 16 (33), 27, 157 (5), 157, 359, 361
 Deatherage, C. F., 140 (40), 147
 De Geofroy, L., 324 (24), 348
 Deitz, V. R., 317 (10a), 348
 Denis, W., 224 (3, 6), 232
 Dent, C. E., 307, 309 (48), 313
 Dickinson, B. W., 329 (41a), 348
 Dickman, S. R., 281 (20), 292
 Dierichs, A., 266 (32), 269 (32), 273
 Djurfelt, R., 228 (29), 233
 Dock, W., 291, 292
 Doisy, E. A., 278 (47), 280 (47), 292
 Dotterweich, A. J., 91 (7, 8), 99
 Doty, D. M., 297, 298, 312
 Drake, B., 300 (27), 301 (27), 305 (27), 306, 313
 Dubnoff, J. W., 226 (14, 15), 232, 278 (26), 284, 292, 297, 312
 du Domaine, J., 61 (10), 61 (11), 75, 116, 148
 Duggan, T. R., 324 (25), 348
 Duncan, J. F., 386

E

Eastes, J. W., 278 (60), 292, 312 (61), 314
 Eastman, E. J., 285, 292

Ecker, E. E., 288, 289 (29), 292
 Eddy, C. R., 48 (4), 74
 Edman, P., 309, 313
 Edwards, W. R., Jr., 24, 28, 64 (16), 75
 Eichorn, E., 275 (30), 292
 Eichhorn, J., 8 (12), 22, 27, 31, 39, 43, 61 (10), 75, 104 (14), 109 (13), 136 (14), 137 (14), 138 (14), 147, 169 (11), 170 (11), 201 (11), 221
 Eidinoff, M. L., 157
 Ekedahl, E., 32, 43
 Ellison, H. E., 328 (41), 329 (41), 348
 Elvove, E., 139 (38), 147
 Englis, D. T., 278 (32), 279 (31, 32), 292, 303, 304, 310 (29), 313, 343 (62), 349

F

Federova, G. V., 229, 233
 Felix, K., 297, 312
 Felton, G., 340 (58), 349, 363
 Ferguson, J. V., 16, 20, 21 (29), 27
 Fiess, H. A., 278 (32), 279 (31, 32), 292, 303, 304, 310 (29), 313, 343 (62), 349
 Figard, P., 168 (6), 198 (6), 199 (6), 200 (6), 201 (6), 202 (6), 203 (6), 204 (6), 221
 Fink, H., 353, 361
 Fireman, M., 11 (24), 20 (24), 27
 Fischer, A. J., 118 (32), 147
 Fisher, R. B., 226 (13), 232, 312 (3a), 312
 Fisk, H. G., 331, 348
 Fitzwilliam, C. W., 334, 348
 Flory, P. J., 51, 74
 Folin, O., 223, 224 (2, 3, 6), 226, 232, 278 (33), 282, 292
 Ford, J. H., 279 (16), 280 (16), 292
 Forty, D., 134 (43), 148
 Foss, A., 322 (22), 348
 Fremery, H., 307, 313
 Freudenberg, K., 277 (34), 278 (34), 279 (34), 292, 298, 300 (18), 301 (18), 303, 305, 310 (18), 312
 Frizzell, L. D., 171 (16), 221, 228 (24), 232
 Fuchs, H. G., 312, 312
 Fulmer, E. I., 6 (32a), 27, 168 (9), 174 (9), 183 (30), 196 (9), 197 (9, 30), 198 (9), 200 (9), 201 (9), 204 (9), 210 (9), 211 (9), 212 (9), 213 (9), 221
 Fuoss, 48 (4), 74

- Furnas, C. C., 39 (11), 43, 61 (10), 62 (13), 75, 145 (15), 147, 220 (59), 222, 237, 239, 258, 278 (35), 292
- G
- Gaddis, S. J., 226, 227 (17, 18), 232, 278 (36), 292
- Galat, A., 271 (39), 273
- Gallagher, T. F., 278 (68), 281, 293
- Gans, R., 1, 2, 78 (9), 99, 102, 120 (45), 148, 160, 166, 235, 254, 258, 317, 347
- Gapon, E. N., 11, 12, 20, 27, 28
- Garrett, O. F., 369 (13), 382
- Gerstner, 241, 259
- Giese, K., 23, 28
- Gilwood, M. E., 66 (18), 75, 126 (47), 134 (46), 135 (46), 136 (46), 145 (76), 148, 291, 292, 321, 325, 359 (17), 361
- Gladrow, E. M., 168 (4, 6, 9), 174 (9), 196 (4, 9), 197 (4, 9), 198 (4, 6, 9), 199 (6), 200 (4, 6, 9), 201 (4, 6, 9), 202 (6), 203 (6), 204 (6, 9), 210 (9), 211 (9), 212 (9), 213 (9), 221
- Glendenin, L. E., 168 (5), 191 (5), 192 (5), 193 (5), 201 (5), 221
- Glock, G. E., 279 (65), 280, 293
- Glueckauf, E., 219, 222
- Gobush, M., 168 (9), 174 (9), 196 (9), 197 (9), 198 (9), 200 (9), 201 (9), 204 (9), 210 (9), 211 (9), 212 (9), 213 (9), 221
- Godfrid, M., 278 (47), 280 (47), 292
- Goehring, M., 228 (21), 232
- Goetz, P. C., 62 (13), 75, 237, 258
- Goldschmidt, V. M., 192
- Gonzalez, F., 278 (24), 292, 377 (35), 378 (35), 383
- Goodwin, R. C., 142, 148
- Gordon, A. H., 306 (41), 307 (47), 309 (47), 313
- Grabowski, H. A., 134 (107), 149
- Graf, E., 15, 21 (28), 27
- Graham, E. R., 374 (29), 383
- Grebe, J. J., 256 (24), 259
- Greenblatt, I. J., 291, 292
- Greer, W. N., 91 (11), 99, 325 (27), 348
- Gregor, H. P., 10, 18, 22, 27, 28, 61, 75
- Griessbach, R., 1, 2, 17, 18, 19, 27, 61 (11), 75, 104 (49), 125 (50), 148, 241, 242 (10), 258, 259, 298, 312
- Grindley, J., 145 (51), 148, 247, 259
- Grossenbacher, K. A., 374 (28), 383
- Gunther-Schulze, A., 17, 28
- Gupta, R. S., 9, 18 (21), 27
- Gustafson, H. B., 122 (16), 124 (52), 142, 143, 147, 148, 329, 348
- Gustavson, K. H., 229, 233
- Gutleben, D., 327 (29, 31), 348
- H
- Haagensen, E. A., 328 (38), 329 (38), 348
- Hagahl, L., 300 (27), 301 (27), 305 (27), 313
- Hagemann, F., 182, 210, 222
- Ham, G. P., 144, 147
- Handelman, M., 337 (54a), 338, 349
- Hanes, C. S., 374 (26), 383
- Haney, P. D., 146, 148
- Hansen, J., 228 (29), 233
- Hardy, R. A., 278 (22), 279 (22), 292, 301 (28), 304 (28), 310 (28), 313
- Harkinson, L. E., 145 (54), 148
- Harm, F., 316, 347
- Harned, H. S., 9 (20), 27, 54 (8), 74, 186, 221
- Harris, D. H., 168 (7), 169 (7), 171 (7), 196, 197 (7), 199, 200 (7), 201 (7, 45), 203 (45), 210 (7), 211, 221, 222
- Harris, R. J. C., 284
- Harrison, J. W. E., 279 (38), 292
- Harvey, F., 327 (31), 348
- Hasche, R. L., 264 (24), 272
- Hassid, W. Z., 278 (57), 279 (57), 280, 292 374 (25), 383
- Hattobe, T., 144 (55), 148
- Hauck, C. F., 104 (57), 148
- Heilbron, I. M., 307 (45), 313
- Helrich, K., 230, 233
- Hems, B. A., 304 (64), 314
- Hendel, C. F., 346 (69a), 349
- Hennessy, D. J., 225, 232, 278 (21, 39, 40), 283 (21, 39, 40), 292, 380 (45), 383
- Hepler, J., 102 (56), 148
- Herr, D. C., 279 (38), 283, 292
- Herr, D. S., 17, 28, 130 (9), 142, 147, 148, 278 (41), 292, 381 (49), 383
- Hewitt, E. J., 285, 292
- Heymann, E., 25, 28
- Hilbert, D., 41, 43
- Hills, C. H., 48 (4), 74
- Hochberg, M., 284 (43), 292

- Hodge, H., 290 (73), 293, 379 (38), 379 (39), 383
Hofmann, U., 23, 28
Holmes, E. L., 1, 2, 45, 74, 103, 110 (124), 147, 150, 160 (5), 161 (12), 166, 167, 220, 221, 279 (44), 292, 298, 312, 319, 348
Horner, G. H., 285, 292
Hougen, O. A., 61 (10), 61 (11), 75, 116 (41), 148
Hoyt, H. E., 372 (21), 383
Hudleston, L. J., 137 (91), 149
Hughes, W. J., 83 (10), 99
Hull, M. E., 369 (8, 11), 382
Hulsen, W., 278 (24), 292, 377 (35), 378 (35), 383
Hunter, M. J., 47 (2), 62 (2), 74, 256 (25), 259
Hutchins, T. B., 285, 292
Hyman, J., 265 (26), 272
- I**
- Ingleson, H., 117 (59), 148
Ingleson, J., 160 (7), 166
Irwin, C. M., 144 (60), 148
- J**
- Jaeger, A. O., 262 (3-6), 267 (7, 9-14), 264 (19-23), 272
Jaeger, K., 48, 74, 109 (128), 150
James, R. A., 216 (51), 217 (51), 222
Jeanprost, C., 160 (3, 9), 166, 237, 257, 258, 317 (7), 348
Jenny, H., 7 (10), 11, 12, 13, 14, 16, 18 (8), 21, 27, 68 (19), 75
Jindra, A., 361
Johnson, C. M., 279 (85), 282, 293
Johnson, H. C. E., 343 (64), 349
Johnson, J. Y., 262 (2), 272
Johnson, W. C., 168, 217 (10), 221
Jones, M. C. K., 252, 259, 265, 272, 370 (14), 382
Joos, C. E., 144, 148
Juda, W., 39, 43, 61 (10), 75, 114 (61a), 148
Jukkola, W. W., 136 (62), 138 (62), 148
Junowicz-Kocholaty, R., 282 (48), 292, 377 (34a), 383
- K**
- Kapur, A. N., 24 (48), 28, 278 (9), 291
Karabinos, J. V., 280 (86), 293
Kasdon, S. C., 380 (52), 383
Kaszuba, F. J., 381 (46), 383
Katchalsky, A., 48 (4), 74
Katzman, P. A., 278 (47), 280, 292
Kaufman, C. E., 145 (63), 148
Kehren, M., 230, 233
Keller, O., 280 (86), 293
Kemmer, F., 128, 143
Kemp, C. R., 225, 232
Kern, W., 48 (4), 74
Kerr, H. W., 8 (16), 11, 27
Kertesz, 278 (56), 281, 292
Ketelle, B. H., 168 (8), 169 (8), 170, 172 (8), 173 (8), 179 (8), 181 (8), 184 (8), 192, 193, 194, 197 (8), 200, 201 (8), 203, 204 (8), 214, 215, 221
Khyrn, J. X., 16 (32), 19 (32), 27, 168 (3), 172 (3), 178 (3), 185 (3), 186 (3), 191 (3), 193 (3), 194 (3), 195 (3), 197 (3), 198 (3), 200 (3), 201 (3, 45), 203 (45), 206 (3), 207 (3), 208 (3), 209 (3), 210 (3), 221, 222
Kielland, J., 22, 27
Kieser, M. E., 343 (60a), 349
Kimbrill, C. A., 18 (39), 28
King, R. E., 122, 148
Kingsbury, A. W., 359, 361
Kivell, W. A., 118 (32), 147
Klein, A., 161 (12), 166
Klein, A. J., 146, 148
Klein, G., 142 (3), 147
Klement, R., 227, 232
Kliachko, V. A., 104 (73), 148
Klingelhoefer, W. C., Jr., 264 (17), 272
Kocholaty, W., 282 (48), 292, 377 (34a), 383
Kohn, H. W., 27, 207, 222
Kolthoff, I. M., 27
Kornfeld, G., 5, 7, 16, 19, 20, 27, 116
Kozak, R., 16, 27, 219 (54), 222, 258, 259
Kraemer, M., 290, 291 (49), 292, 378 (36), 380 (42), 383
Kremers, H. E., 184 (33), 221
Kriegsheim, H., 145 (67), 148
Krynkin, A. Y., 240, 259
Kuchar, F., 277 (79), 278 (79), 279 (79), 293, 306 (43), 313
Kunin, R., 24, 25, 26, 28, 39, 43, 64 (15), 65 (15), 71-74, 75, 104 (68a), 109 (68a), 110 (68b), 137 (68), 148, 361, 385
Kurmies, B., 23

L

Laguer, 380 (44), 383
 Lamar, M. V., 278 (62), 283, 293
 Lane, M., 135 (25a), 147, 159 (1), 160 (1),
 163 (1), 166, 353 (7), 361
 Lang, A., 297, 312
 Langelier, W. F., 118 (69), 148
 Larian, M. G., 165 (20), 166
 Lawrence, F. I. L. L., 353 (8, 9), 361
 Lebel, H., 181 (28), 221
 Lee, G., 229, 233
 Legault, R. R., 306 (39), 313, 346 (69a), 349
 Lehman, D. J., 290, 291 (49), 292
 Lehman, D. J., Jr., 380 (42), 383
 Leighton, John W., 145 (70), 148
 Lejwa, A., 278 (50), 280, 292
 Lembcke, R. E., 373 (24), 383
 Le Rosen, A. L., 312, 314
 Levesque, C. L., 268 (37), 273
 Liebig, G. F., 279 (51), 292
 Liebknecht, O., 1, 2, 318, 319 (17), 348
 Lindsay, F. K., 62 (13), 75, 119 (71), 142
 (3), 147, 148
 Lister, B. A., 220 (56a), 222, 386
 Lisnyankaya, Z. M., 263 (15), 272
 Little, J. R., 110 (72), 148
 Litton, J. B., 142, 148
 Lloyd, J. U., 353, 361
 von Loesecke, H. W., 339 (56), 349
 Loo, Y. H., 281 (20), 292
 Lourier, Y. Y., 104 (73), 148
 Lowan, A. N., 7, 43
 Lyman, J. F., 278 (52), 292, 368 (5), 369
 (6), 382

M

Mabry, B., 11 (24), 20 (24), 27
 McCabe, W. L., 80 (1), 99
 McCulloch, 278 (56), 281, 292
 McCready, R. M., 278 (57), 279 (57), 280,
 292, 374 (25), 383
 McFarlane, W. D., 297 (5), 312
 McGarrey, F. X., 104 (68a), 109 (68a), 148
 McKay, F. S., 140 (39), 147
 Magistad, O. C., 11, 20, 27
 Maguire, J. J., 134 (21), 147
 Maier-Bode, H., 104 (49), 148
 Maizel, B., 382 (50, 51), 383
 Mann, C. A., 165 (20), 166
 Manrig, W. D., 132 (74), 148

Manring, W. E., 66 (18), 75
 Marinsky, J. A., 168 (5), 191, 192 (5), 193,
 201 (5), 221
 Marisic, M. M., 265 (27), 272
 Marsh, J. K., 212, 222
 Marshall, C. E., 9, 18 (21, 39), 27, 28
 Martin, A. J. P., 188, 190 (39), 222, 306
 (41), 307 (44, 47), 309 (47), 310, 312,
 314
 Martin, G. J., 291, 292, 379 (40), 380 (43),
 383
 Martin, G. S., 289, 290, 291 (53, 54), 293
 Mason, C. M., 175 (22), 221
 Matchett, J. R., 278 (55), 292, 306, 313,
 346, 349
 Matheson, L. A., 190, 199, 222
 Mattson, S., 21, 28
 Mayer, S. W., 170 (15), 176 (15), 177 (15),
 178, 179 (15), 181, 182 (15), 184 (32),
 185, 188, 189, 196, 202, 221
 Meincke, H. D., Jr., 160, 166
 Melnick, D., 284 (43), 292
 Metzger, F. J., 371 (20), 383
 Meyerhof, O., 280, 293
 Miller, D., 126 (75), 148
 Mindler, A. B., 2 (14), 2, 99, 145 (76), 148,
 220, 222, 322, 332, 346 (68), 348, 349,
 353 (12), 359 (17), 361
 Moeller, T., 184 (33), 221
 Moller, 8 (17), 27
 Molter, H., 277 (34), 278 (34), 279 (34),
 292, 300 (18), 301 (18), 303 (18), 310
 (18), 312
 Morgan, L. O., 216 (51), 217 (51), 222
 Morris, R. H., 3rd, 342 (59), 349
 Mott, J., 107 (77), 121, 148
 Mottern, H. H., 279 (17), 292, 342, 343
 (60, 61), 349
 Mukherje, S. K., 20, 28
 Mukherjee, J. N., 20, 28
 Muus, J., 181 (28), 221
 Myers, F. J., 120 (78), 146 (78), 148, 244
 (13), 245 (15), 246 (13), 259, 267 (34,
 35), 273
 Myers, L. S., 60 (9), 61 (9), 61 (10), 74
 (9), 74, 75
 Myers, L. S., Jr., 171 (17), 173 (17), 199
 (17), 201 (17, 44), 202 (17), 204 (17),
 221, 222

Myers, P. B., 278 (58), 292, 346 (67), 349
 Myers, R. J., 18, 24, 25, 26, 28, 31 (2),
 37 (2), 39, 39 (2), 39 (12), 43, 63, 64
 (15), 64 (17), 65 (17), 65 (15), 71, 72,
 73, 74, 75, 103 (79), 116, 137 (68), 142,
 148, 244 (14), 259, 267 (34), 273, 278
 (60), 279 (38, 59), 292, 305, 312 (61),
 314, 370 (15), 383

N

Nachod, F. C., 1, 14, 15, 26 (54), 27, 28,
 39, 43, 61 (10), 73, 74, 75, 112 (81),
 114 (83), 131 (82), 145 (110), 149, 168,
 175 (21), 201 (21), 220, 221, 247 (17),
 249 (17), 251 (17), 253 (17), 255 (19),
 259, 265, 272, 279, 293, 353, 361
 Nees, A. R., 306 (42), 313, 330, 348
 Nelson, J. A., 297, 312
 Nelson, R., 17, 19, 27, 218, 222, 239, 259
 Newkirk, T. H., 337 (54a), 349
 Nickell, 263 (8), 272
 Nimmo, C. C., 306 (39), 313, 346 (69a), 349
 Noll, C. A., 134 (21), 147
 Nolte, A. J., 339 (56), 349
 Nordell, E., 83 (10), 99, 107 (84), 112 (81),
 117 (87), 119 (85), 125 (86), 149
 Notter, G. K., 306 (39), 313, 346 (69a), 349
 Nozaki, K., 48 (4), 74

O

Oberst, F. W., 224, 232
 Oberst, M. S., 278 (61), 282, 293
 Ocean Salts, Ltd., 255 (22, 23), 259
 O'Donnell, I. J., 25, 28
 Onsager, Lars, 35, 42
 Oser, B. L., 284 (43), 292
 Osmun, R. H., 23, 109 (14a), 147, 267 (36),
 273
 Otting, H. E., 278 (52), 292, 346 (69a), 349,
 367 (4), 368 (5), 369 (7, 8, 9, 10, 12),
 382
 Owen, B. B., 9 (20), 27, 54 (8), 74, 186, 221

P

Page, J. E., 304 (64), 314
 Pain, 237 (3), 245 (3), 258
 Paley, L. A., 329, 348
 Papageorge, E., 278 (62), 283, 293
 Parker, A., 160 (4), 166
 Parker, G. W., 174, 185 (18), 187 (18), 204
 (18), 205 (18), 210 (18), 217 (18), 221

Partridge, S. M., 311 (55, 56), 313
 Patton, J. R., 16, 20, 21 (29), 27
 Pearce, D. W., 16, 27, 220 (56), 222
 Pearson, H. E., 108 (108), 146 (108), 149
 Pemberton, R. T., 160 (5), 166
 Perley, G. A., 91 (11), 99, 325 (27), 348
 Perlman, I., 174 (20), 216 (20), 221
 Pfeiffer, M. C. J., 291 (75), 293, 380 (41),
 383

Pfennig, R. F., 370 (17), 383
 Pfiffner, J. J., 279 (63), 293
 Phillips, 237 (3), 245 (3), 258
 Pick, E., 86 (12), 91 (11, 13), 94 (13), 99
 Pierce, L. F., 289, 293
 Pierce, L. T., 289 (14), 291
 Pillemer, L., 288, 289 (29), 292
 Piret, E. L., 239, 245 (7), 257, 259
 Platt, B. S., 279 (65), 280, 293
 Polis, B. D., 278 (66), 280, 282, 293
 Pollare, A., 343 (60a), 349
 Porter, L. B., 328 (39, 41), 329 (39, 41),
 343 (63), 348
 Porter, P. E., 168 (9), 174 (9), 196 (9),
 197 (9), 198 (9), 200 (9), 201 (9), 204
 (9), 210 (9), 211 (9), 212 (9), 213 (9),
 221
 Porter, R. W., 346 (70), 349, 372 (22), 376
 (34), 383
 Potts, A. M., 278 (68), 281, 293
 Powell, J., 16 (32a), 27
 Powell, J. E., 168 (6, 9), 174 (9), 183 (30),
 196 (9), 197 (9, 30), 198 (6, 9), 199
 (6), 200 (6, 9), 201 (6, 9), 202 (6),
 203 (6), 204 (6, 9), 210 (9), 211 (9),
 212 (9), 213 (9), 221
 Powell, S. T., 107 (89), 149
 Primosigh, J., 297, 304 (6, 33), 310 (6, 53),
 312, 313
 Procter, H. R., 51, 74
 Prokhorov, F. G., 145 (90), 149
 Pulley, G. N., 339 (56), 349
 Puri, M. L., 24 (48), 28

Q

Quick, A. J., 287, 288, 293
 Quill, L. L., 168, 217 (10), 221
 Quilligan, J. J., 367 (4), 369 (10, 12), 382

R

Ramondt, D., 318 (16a), 348
 Rawlings, F. N., 324 (24, 26), 329, 332, 348

- Rees, A. G., 137 (91), 149
 Rehner, J., Jr., 51, 74
 Reid, A. F., 155 (2), 156 (2), 157, 209, 258
 Reinhold, J. G., 278 (66), 282, 293
 Renold, A., 4 (2), 7 (2), 16, 27
 Ricci, J. E., 10 (22c), 27
 Rice, M., 286, 288, 291
 Riches, J. P. R., 232, 233, 293
 Riehheimer, C. E., 117 (92), 117 (87), 149
 Richter, J. W., 169 (14), 176 (14), 178 (26),
 179 (26), 181 (26), 182 (14, 26), 183
 26), 221
 Richter, M., 277 (79), 278 (79), 279 (79),
 293, 306 (43), 313
 Rieche, A., 104 (49), 148
 Rieman, W., 193, 230, 233
 Riley, F. R., 328 (40), 329 (40), 332, 348
 Riley, R., 124 (93), 129 (94), 149
 Ritchie, R. J., 335, 348
 Robinson, F. A., 312, 314
 Robinson, R. A., 187 (38), 222
 Rogers, N. E., 145 (20), 147
 Rogge, R., 337, 338, 349
 Ronzone, S., 278 (6), 279 (6), 291, 356
 (14, 15), 359 (14), 360 (15), 361
 Rothmund, V., 5, 7, 16, 19, 20, 27, 116
 Rouse, A. H., 278 (58), 292, 346 (67), 349
 Rudolf, G., 1 (6), 2
 Ruhkoph, 380 (44), 383
 Rümpler, A. Z., 316, 317, 347
 Runneberg, G., 228 (26), 231 (42, 43), 232,
 233
 Russell, R. G., 16, 27, 217, 220 (56), 222
 Ryznar, J. W., 365 (3), 382
- S
- Samuelson, O., 8 (18), 11, 15, 17, 18 (18),
 22, 27, 28, 228 (21, 22, 23, 25, 26, 27,
 28, 29), 229 (28, 36a), 230, 231 (41,
 22, 42), 232, 233
 Sanborn, W. E., 328 (40), 329 (40), 332,
 348
 Saunders, D. J., 107 (95), 149
 Saunders, G. H., 137 (28), 147
 Schmidt, R. W., 62 (13), 75, 318 (13), 348
 Schafer, J., 285 (72), 293
 Schindler, H., 370 (16), 383
 Schlenker, F. S., 285, 293, 374 (27), 383
 Schramm, G., 297, 304, 310 (6, 53), 312,
 313
 Schroeder, W. T., 285, 293
 Schubert, J., 5 (5), 8 (5), 9 (5), 10 (5), 11,
 13 (5), 14 (5), 16 (5), 18 (5), 20, 20 (5),
 27, 157 (3), 157, 169 (13, 14), 170 (13),
 175 (13, 23), 176 (14), 177 (13, 23),
 178 (26), 179 (26), 181 (26), 182 (13,
 14, 26, 31), 183 (26, 29), 185 (31, 34)
 186 (13, 34), 205 (29), 207 (13), 209
 (48a), 217 (34, 31), 221, 222, 232, 257
 Schultz, 380 (44), 383
 Schulz, G., 145 (96), 149
 Schumann, T. E. W., 237, 258
 Schutze, H. G., 371 (18), 383
 Schwaer, L., 230, 233
 Schwartz, M. C., 24, 28, 64 (16), 75, 107
 (98), 133 (98), 134 (97), 149
 Schwyzer, J., 351 (2), 361
 Scott, J. M., 379 (38), 383
 Scott, W. J. M., 290 (73), 293
 Seaborg, G. T., 195 (42), 219, 222
 Segal, H. L., 290, 293, 379 (38), 379 (39),
 383
 Seifter, S., 289 (29), 292
 Serbia, G. R., 349 (66), 349
 Shafor, R. W., 322 (21), 332, 348
 Shoemaker, M. J., 109 (99), 125, 149
 Shreve, R. N., 108 (101), 149
 Siedler, P., 223, 232
 Siegel, L. H., 378 (36), 383
 Sillen, L. G., 32, 43
 Simon, G. P., 123 (27), 130 (102), 147, 149
 Simons, E. L., 10, 10 (22c), 27
 Sims, E. A. H., 226, 232, 278 (74), 284,
 293, 304, 313
 Skell, P. S., 281 (20), 293
 Skidmore, J. R., 28, 109 (14a), 147, 267
 (36), 273
 Sleight, N. R., 168 (4, 6), 196 (4), 197 (4),
 198 (4, 6), 199 (6), 200 (4, 6), 201
 (4, 6), 202 (6), 203 (6), 204 (6), 221
 Smit, P., 1, 2, 109 (103), 149, 318 (14, 15,
 16), 319 (18), 348
 Smith, H. V., 140 (104, 105), 149
 Smith, M. C., 140 (105), 149
 Smith, M. L., 220 (56a), 222
 Smith, O. M., 122, 148
 Snyder, H. G., 86 (2), 99
 Soula, Y., 317 (8), 348
 Spears, M. M., 291 (75), 293, 380 (41), 383

- Spedding, F. H., 16 (32a), 27, 168 (4, 6, 9), 174 (9), 183 (30), 196 (4, 9), 197 (4, 9), 301, 198 (4, 6, 9), 199, 200 (4, 6, 9), 200 (4, 6, 9), 202, 203, 204 (6, 9), 210 (9), 211, 212, 213, 221
- Speiser, R., 48 (4), 74
- Spitnik, P., 48 (4), 74
- Spittigerber, A., 132 (106), 149
- Staegemann, E., 91 (14), 99
- Steinberg, A., 278 (76), 285, 286, 287, 293, 375 (31), 383
- Stommel, H., 230, 233
- Strain, H. H., 152 (1), 156 (1), 157, 227, 232, 298, 304, 312
- Straub, F. G., 134 (107), 149
- Straub, G. J., 225, 232
- Street, K., Jr., 219, 222
- Streicher, L., 108 (108), 146 (108), 149
- Strong, W. A., 281 (20), 292
- Suchý, K., 230, 233
- Suckling, E. V., 140 (109), 149
- Sussman, Sidney, 1 (11), 2, 26, 28, 126 (120), 131 (82), 145 (110), 149, 159 (1), 160 (1, 6), 164 (1), 166, 168, 220, 222, 247, 249, 251, 253, 259, 265 (31), 268 (31), 272, 279 (78), 293, 312 (60), 314, 353, 361
- Suter, M., 143, 144 (25), 147
- Swain, R. C., 104 (111, 112), 110 (111), 149
- Swain, R. L., 61 (10), 61 (11), 75, 116 (41), 148
- Sweeney, O. R., 376 (32), 383
- Sweet, W. J., 376 (32), 383
- Swingle, W. W., 279 (63), 293
- Sydow, W., 117 (113), 149
- Synge, R. L. M., 188, 190 (39), 222, 307 (44), 310, 312, 313
- Syrkin, Z. N., 240, 259
- T**
- Taylor, G. P., 305, 313
- Taylor, H. S., 53 (7), 74
- Taylor, T. I., 157 (4), 157, 220 (57), 222
- Tevebaugh, A. D., 16 (32a), 27, 183 (30), 197 (30), 221
- Theroux, F. R., 102 (56), 148
- Thomas, 174, 191
- Thomas, C. G., 269 (38), 273
- Thomas, H. C., 32, 39 (6), 43, 61 (10), 75, 116 (115), 149
- Thomas, J. F., 284
- Thompkins, E. R., 110 (120a), 149
- Thompson, H. S., 1, 2
- Thompson, J., 128 (64), 148
- Thompson, J. B., 231, 233, 292
- Thompson, R., 16 (32a), 27, 183 (30), 186 (35), 197 (30), 217 (35), 221
- Thompson, R. B., 128 (116), 149
- Thompson, S. G., 216 (51), 217 (51), 222
- Thornton, J. J., 381 (47), 383
- Tiger, Howard L., 1 (11), 2, 62 (13), 75, 103 (118), 116 (117), 126 (120), 134 (119), 149, 159 (1), 160 (1, 6), 164 (1), 166, 237, 253, 279 (78), 293, 312 (60), 314, 359, 361
- Tiselius, A., 297, 299, 300 (27), 301 (27), 305, 306, 307, 312, 313
- Toennies, D., 309 (50), 313
- Tompkins, E. R., 16 (32), 19, 27, 168 (3, 7), 169 (7), 170 (15), 171 (7), 172 (3), 174, 176 (15), 177 (15), 178 (3, 15), 179 (15), 181, 182 (15), 184 (32), 185 (3, 15, 18), 186 (3), 187 (18), 188 (32, 40), 189, 191, 193, 194, 195 (3), 196, 197 (3, 7, 48), 198, 199, 200 (3, 7, 40), 201 (3, 7, 45), 202, 203, 204 (18), 205 (18), 206, 207 (3), 208, 209 (3, 48), 210 (3, 18, 7), 211, 216, 217 (18), 221, 222, 385
- Topp, N. E., 244 (12), 259
- Tressler, C. J., 345, 349
- Trier, G., 351 (3), 361
- Tschesche, 380 (44), 383
- Turba, F., 277 (79), 278 (79), 279(79), 293, 297, 306, 312, 313
- Turner, E. T., 117 (121), 149
- U**
- Ungerer, E., 21, 28, 353, 361
- Unmack, A., 178 (27), 179 (27), 221
- Urey, H. C., 157 (4), 157, 220 (57), 222
- Urquhart, D., 24 (50), 28, 64 (17), 65 (17), 75, 278 (60), 292
- V**
- Vageler, P. W. E., 7, 27
- Vallez, H. A., 327, 328 (33), 348
- Van der Waals, 10
- Vanselow, A. P., 4 (3), 8 (3), 9, 11, 20, 27, 279 (51), 292
- Veatch, N. T., 104 (125), 150

- Ventre, E. K., 334 (48), 348
 Voigt, A. F., 168 (4, 6), 196 (4), 197 (4),
 198 (4, 6), 199 (6), 200 (4, 6), 201
 (4, 6), 202 (6), 203 (6), 204 (6), 221
- W
- Wachtel, 306, 307
 Waksman, S., 376
 Walch, H., 277 (34), 278 (34), 279 (34),
 292, 300 (18), 301 (18), 303 (18), 310
 (18), 312
 Waller, J. G., 304 (64), 314
 Walter, A. J. R., 160 (5), 166
 Walter, J. E., 32, 43, 61 (10), 75
 Walton, H. F., 3, 4 (4), 6 (7), 9, 16, 17, 19,
 22, 27, 53 (6), 54, 61 (11), 74, 75, 115
 (126), 116, 149, 167 (2), 169 (12), 174,
 176 (24), 218, 219 (54), 221, 222, 239,
 258, 259, 353
 Wassenegger, H., 48, 74, 104 (49), 109
 (128), 125 (127), 148, 150
 Watson, J. S., Jr., 290 (73), 293, 379 (38),
 379 (39), 383
 Way, J. T., 1, 2, 275 (80), 293
 Weaver, R. J., 285, 293, 375 (30), 383
 Webb, W. L., 145 (129), 150
 Weisblat, D. I., 280 (86), 293
 Weitz, F. W., 327 (30), 348
 Werner, L. B., 174 (20), 216 (20), 221
 Wesley, W., 125 (130), 134 (130), 150
 Westall, R. G., 311 (55, 56), 313
 Wheaton, H. J., 165 (21), 166
 Whitehorn, J. C., 277 (82, 83), 282, 283,
 293, 297, 312
 Wiegner, G., 7 (9), 15, 17, 27
 Wieland, T., 298, 300 (26), 301 (26), 304,
 307, 312, 313
 Wiesenberger, E., 228 (30), 233
- Wiklander, L., 2, 2, 21, 28
 Wilhelm, A. E., 297 (3a), 312
 Wilkinson, J., 291 (53, 54), 292, 379 (40),
 383
 Wilkinson, S., 289, 290, 293
 Williams, 306
 Williams, K. T., 279 (85), 282, 293
 Williams, W. L., 146 (131), 150
 Willits, C. O., 345, 349
 Wilson, J. A., 51, 74
 Windaus, 380 (44), 383
 Winegard, H. M., 309 (50), 313
 Winters, J. C., 361
 Winterstein, E., 351 (3), 361
 Wirth, L., 304 (32), 313
 Wirth, L. F., 104 (14), 136 (14), 137 (14),
 138 (14), 147
 Wise, E. D., 279 (16), 280 (16), 292
 Wolfrom, M. L., 280, 293
 Wood, W., 14, 15, 26 (54), 27, 28, 39, 43,
 61 (10), 73, 74, 75, 114 (83), 145 (110),
 149, 175 (21), 201 (21), 247 (17), 249
 (17), 251 (17), 253 (17), 259, 293, 353
 (7, 12), 361
 Wright, J. M., 168 (6, 9), 174 (9), 196 (9),
 197 (9), 198 (6, 9), 199 (6), 200 (6, 9),
 201 (6, 9), 202 (6), 203 (6), 204 (6, 9),
 210 (9), 211 (9), 212 (9), 213 (9), 221
- Y
- Yamamoto, Z., 144 (55), 148
 Yankovskii, K. A., 145 (90), 149
 Yearwood, R. D., 334, 348
 Youngberg, G. E., 224, 232
 Yutzy, H. C., 10 (22b), 27
- Z
- Zink, E., 117 (132), 150

Subject Index

A

- Acetal alcoholysis, catalysts, 265
 catalyzed by ion exchange, 270
- Acetal synthesis, catalysts, 265
 catalyzed by ion exchange, 270
- Acetylacetone as complexing agent, 184
- Acid-sensitive compounds, 269
- Aconitates, 332
- Aconitic acid, 334
- Actinium, elution order, 184
 separation from lanthanum, 210
- Activated carbon, 162, 164
- Activit, carbonaceous exchanger, 318
- Activity coefficient, 175
- Activity coefficient relationships, 186
- Activity coefficients, correction, 8
- Adenosine, 284
- Adenosine triphosphate, 280
- Adsorption, definition, 168
 equilibrium, 175
 of colloids, 185
 strength of cations, 175
- Affinity of cations, 175
- Air dome method of operation, 323
- Alanine, elution order, 311
- Alcohol dehydration catalysts, 265, 270
- Alcohols, purification, 343, 371
- Alkalex, see Appendix
- Alkali metals, separation, 207
- Alkaline earths, in siliceous catalysts, 264
 separation, 209
- Alkalinity removal, 121
- Alkaloid bases, liberation, 352
- Alkaloid exchange, processes, 354
- Alkaloid ions, 353
- Alkaloids, 17, 351
 determination, 278
 extraction, 352
 method for determination, 361
 recovery, 2
 yield from ion exchange process, 357
- Alkylene polyamine resins, 24
- Allantoic acid, 284
- Allantoin, 284
 determination, 284
 separation of citrulline, 278
- Allihn condenser, 172
- Alloxan, 284
- Alloxanic acid, 284
- Alloxantin, 284
- Aluminosilicates, 1
 preparation of silver zeolite, 165
- Aluminum, determination, 231
 in siliceous catalysts, 264
- Aluminum hydroxide, antacid, 378
- Aluminum phosphate, antacid, 378
- Alvite, ore containing hafnium, 218
- Amberlite, see Appendix
- Americium, separation from curium, 214
- Amines, determination, 278
- Amino acids, 17, 378
 determination, 278, 283
 determination in urine, 226
 removal, 336
 separation, 277
 separation of tryptophane, 278
- Amino formaldehyde resins, 319
- Ammine interchange, role in copper
 exchange, 245
- Ammonia, determination in urine, 223
 elution order, 311
 recovery, 241
 removal, 143
 synthesis, catalysts, 264
- Ammonium exchanger, 317
- Ammonium hydroxide regeneration, 90
- Ammonium ion, concentration in citric
 acid solutions, 180
 determination, 278
 separation factor, 207
 sequence of adsorption, 175
- Ammonium sulfate, removal from biolog-
 ical preparations, 279
- Amyl alcohol, 309
- Analytical results, expression of, 107
- Anex, see Appendix
- Aniline black, 285
- Anions, effect of cation exchange, 21
- Antacids, 378
- Antibiotics, 376, 378
 concentration and purification, 281
- Antimalarials, 369

- Antimony, determination, 227
in siliceous catalysts, 264
- Antithrombin, 375
- Apple juice, demineralization, 342
substitute for glycerine, 342
- Apple syrup, removal of heavy metals, 279
removal of malic acid, 279
- Arbitrary atomic numbers, 184
- Arginine, 279, 297, 300, 304, 305, 307
concentration, 299
determination, 226
separation, 297
separation from glycocyamine, 278, 284
separation from histidine, 278, 297, 303
separation from lysine, 297
separation from protein hydrolysate, 284
separation of glutamine, 278
- Aromatic amino acids, definition, 296
- Arsenic, determination, 227
- Artichokes, 343
- Ascorbic acid, 372
- Aspartic acid, elution, 306
elution order, 311
estimation, 284
- Atropine, 354
- Automatically operated units, 91
- B**
- Backwash, 79, 117
in sugar refining, 325
- Bacterial oxidation, sorbitol manufacture, 372
- Barium, dissociation constant of citrate complex, 182
hydrogen exchange, 183
separation from lead, 209
separation from radium, 209
separation from strontium, 208
sequence of adsorption, 175
- Barium hydroxide, 163
- Barium ion, separation factor, 207
- Barium saccharate, 326
- Barium zeolite, 161
- Basic amino acids, definition, 296
- Bed length, effect of, 199, 202
- Beet juice, by-products, 330
demineralization, 324
treatment, 316, 325
- Bemberg Seide Werke, copper recovery, 244
- Bentonite, 10, 102, 336
- Benzene, 352
- Beryllium, in siliceous catalysts, 264
removal from zirconium, 186
- Bessel functions, 35, 36, 40, 116
- Betaine, 306
by-product from beet juice, 330
- Binding strengths of ions, 15
- Biochemical applications, 277
- Biological oxygen demand, 330
- Biologically active substances, purification, 376
- Bismuth, in siliceous catalysts, 264
recovery, 257
- Blackstrap molasse, 335
- Blomstrandine, 210
- Blood coagulation, 285, 375
prevention, 278
- Blood meal, elution, 302
source of amino acids, 310
- Blue water, 241, 242
- Bone char, 317
- Boron, in siliceous catalysts, 264
- Brass industries, copper recovery, 236
- Break-through, definition, 169
- Break-through point, 36, 114, 373
- Brewer's yeast, 382
- Briquet, 161
- Brix, degree, 326
- Buffer filter, 125
- By pass treatment, 120
- By-products recovery, 339
from beet juice, 330
- C**
- Cadaverine, 291
- Cadmium, determination, 232
in siliceous catalysts, 264
separation from zinc, 258
- Calcium aluminosilicate, alkaloid removal, 353
- Calcium citrate recovery, 341
- Calcium saccharate, 326
- Calcium, sequence of adsorption, 175
- Calcium sulfate precipitation, 324
- Calcium tartrate, 346
- Cane juice, demineralization, 324
treatment, 331
- Carbonaceous adsorbents, 318
- Carbonaceous exchangers, 17

- Carbonated beverages, water standards, 107
- Carbonation juice, 327
- Carrier-free, definition, 169
separation, 157
- Casein, elution, 302
source of amino acids, 310
- Catalysts, 262
preparation, 267
- Catex, see Appendix
- Cation exchange, effect of anions, 21
- Cations, separation factors, 207
- Cellulose in chromatography, 307
- Cerium as tracer, 196
dissociation constant of citrate complex, 182
distribution coefficient as function of pH, 181
distribution coefficient, effect of ammonium ion, 181
effect of flow rate in separation from praseodymium, 202
in siliceous catalysts, 264
separation from lanthanum, 210
separation from neodymium and praseodymium, 210
sequence of adsorption, 175
- Cerium group of rare earths, 169
- Cerium oxide, presence in crude yttrium oxalate, 213
- Cesium ion, separation factor, 207
sequence of adsorption, 175
- Chabazite, as catalyst, 264
- Cheddar cheese, 344
- Chloramine formation, 145
- Chloride ion, determination, 230
- Chloroaurate adsorption isotherms, 254
- Chloroform, 352, 354
- Chloropalladate adsorption isotherms, 254
- Chloroplatinate adsorption isotherms, 253
- Chloroplatinate exchange, 253
- Chondodendron tomentosum, 360
- Chromate-chloride exchange, 248
- Chromatographic elution, 168
- Chrome tanning liquors, 228
- Chromium aluminosilicate as catalyst, 262
- Chromium, determination, 229
in siliceous catalysts, 264
recovery by anion exchange, 247
recovery, cyclic process, 250
- Chromogens, 377
- Cinchona alkaloids, 355, 356
extraction, flow sheet, 357
purification, 279
- Cinchona bark, 353, 355
- Cinchona extract, 361
- Cinchonine, adsorption isotherms, 353
- Citrate complex, dissociation constants, 182
- Citrate solutions, mold growth, 204
- Citric acid, complexing action, 178
complexing agent, 184
dissociation constants, 178
recovery, 339
- Citrulline, 284
determination, 284
separation from allantoin, 278
- Citrus molasse, 339
- Citrus peel press juice demineralization, 339
- Clays, equilibria in, 4
hydrogen exchange in, 18
- Coagulation of blood, 375
- Cobalt, in siliceous catalysts, 264
sequence of adsorption, 175
- Coffee storage, 364
- Collactivit, carbonaceous exchanger, 318
- Collector, 83
- Collidine, 309
- Colloidal applications, 364
- Colloidal dispersions, 367
- Colloidal substance, removal, 105
- Colloids, adsorption and desorption, 185
- Color removal, 339
- Color throwing, definition, 168
- Columbium, separation from zirconium, 217
uranyl ion exchange, 185
- Column length, effect of, 202
- Columns, types, 170
- Combination treatment, 124
- Complexing agents, 184
- Complexing effect of citric acid, 178
- Complex ion formation, influence of separation factor, 187
- Complex ions, 228
- Concentrating section, 154
- Concentration by exchange, 276
effect on exchange, 170
effects on rare earth separation, 198
- Condensation, 48

- Condensation catalysts, 264
 Conditioning cycle, 170
 Conductivity meters, 97
 Constipation action of antacids, 379
 Conversion data, 108
 Cooling waters, standards, 107
 Copper, determination, 227, 232
 determination of traces in milk, 231
 in siliceous catalysts, 264
 recovery, 236
 recovery, concentration history, 239
 removal by anion exchange, mechanism, 245
 removal from hydrocarbons, 370
 separation from nickel, 258
 separation from silver, 258
 separation from zinc, 258
 sequence of adsorption, 175
 Copper aluminosilicate, catalysts, 265
 Copper naphthenate, 370
 Copper zeolite, 160
 Cori ester, 280
 purification, 279
 Corn sugar, 372
 Corrosion, 90
 Corrosive liquids, 88
 Cossette, 325
 Countercurrent fractionation, 152
 Countercurrent operation, 78, 152, 337
 Cross-linking, 47
 Crude drug extracts, concentration, 278
 Crystalite, see Appendix
 Crystallization of sugar, 319
 Cuprammonium rayon industry, copper recovery, 236
 Curare alkaloids, 360
 Curd modification by ion exchange, 367
 Curium, separation from americium, 214
 Cyclic operation, steps, 78
 Cysteic acid, elution, 306
 Cysteine, 309
 Cystine, 299, 309
 Cytidine, separation from uridine, 283
- D**
- Datura innoxia, 354
 Datura stramonium, 354
 Davis equation, 12
 Deacidification, 153
 Deamination catalysts, 264
 Debye-Hückel theory, 8
 Decarboxylation catalysts, 264
 Dechlorination, 145
 Decolorization, 318
 Decolorizing carbons, 317
 Defecating sugar solutions, 329
 Demineralization, 125
 multiple, 132
 Demineralized water, composition, 131
 Demineralizing process, 318
 Demineralizing sugar solutions, 320
 Dental fluorosis, 139
 Desalting of sea water, see sea water desalting
 Design, 77
 Desorb, definition, 168
 Desorption, equilibrium, 175
 of colloids, 185
 Desorption strength of cations, 175
 Desulfurization catalysts, 265
 Dextrins, 373
 Dextrose manufacture, 336
 Dialysis, 364
 Diameter of columns, effect of, 202
 Diarrhea, action of antacids, 379
 Dicarboxylic amino acids, definition, 296
 2,4-Dichlorophenoxyacetic acid, 285, 375
 Diffusion, 29
 Diffusion constant, 33
 Diffusion rate, effected by temperature, 205
 Dilution, effect on tracer adsorption, 205
 methods to minimize, 321
 Displacement development, 299
 Disruptor, 162, 164
 Dissociation constants, of citrate complex, 182
 citric acid, 178
 Dissolved gases, removal, 105
 Distillation, comparison with ion exchange, 275
 Distribution coefficient, effect, 176
 equation, 176
 for radiocolloids, 186
 separation factor, 184
 Distributor, 83
 Donnan effect, 68
 Donnan equilibrium, 21, 52

- Dormagen-I. G. Werke, copper recovery plant, 243
Double layer, 4
Dowex, see Appendix
Drinking water, standards, 106
Duolite, see Appendix
Dusarit, carbonaceous exchanger, 318
Dysprosium oxide, presence in crude yttrium oxalate, 213
- E**
- Edestin, 284
Edible syrups, 335
Effluent, definition, 168
Egg albumin, 284
 source of amino acids, 311
Electrodialysis, 365
Electronic pH meters, 97
Electronic recorder, 172
Element 43, separation from rhenium, 220
Element 61, distribution coefficient as function of pH, 181
 elution curve, 189
 identification, 192
 separation from europium, 188
Eluate, definition, 168
Elute, definition, 168
Elution, of amino acids, 301
 of element 61, 189
Elution curve, of europium, 189
Elutriant, definition, 168
 compositions for rare earths separations, 197
Enzymatic processes, 336
Enzyme converted starch, 338
Enzyme reactions, 289
Epinephrine, determination, 278, 282
 removal from suprarenal cortex extract, 279
Equations, for equilibria, 24
 for kinetics, 34
Equilibria, 5
Equilibrium constants, 6, 55, 56
Equilibrium process, cation exchange, 168
Erbium, temperature effect on separation, 203
Erbium oxide, presence in crude yttrium oxalate, 213
Ester acidolysis, catalysts, 266
 catalyzed by ion exchange, 270
Ester alcoholysis, catalysts, 265
 catalyzed by ion exchange, 270
Ester hydrolysis, catalysis, 265
 catalysts, 267
 catalyzed by ion exchange, 269
Esterification, catalysts, 264, 265
 catalyzed by ion exchange, 268
Ethyl acetoacetate as complexing agent, 184
Ethylene dichloride, 352
Ethylene glycol, purification, 371
Ethylene polyamines, 63
Europium, elution curve, 189, 191
 separation from element 61, 188
 sequence of adsorption, 175
Exchange equilibria, 20, 71
 anion effect, 20
 temperature effect, 20
Exchange plasma, 288
Exchange rates, 58, 61, 73
Experimental technique in ion exchange, 170
Extraction process and ion exchange, 296
Extraneous cations, effects of, 178
- F**
- Ferric oxide gel, 318
Ferric sol, preparation, 366
Ferrocyanide exchange, 252
Filter, 80
First order reaction, 32
Fish meal, source of amino acids, 310
Fish scales, source of amino acids, 310
Flavor removal, 339
Flow meter, 171
Flow rate, effect on exchange, 170, 201
Fluoride removal, 139
 with aluminum and anion exchangers, 142
Folin permutit, 281
Formaldehyde, 1, 48, 63
 purification, 373
 removal of formic acid, 279
Formaldehyde sulfonic acid resins, as catalysts, 267
Formalin, see formaldehyde
Formic acid removal, 373
 from formaldehyde, 279
Fractionation, 151
Fractionation factor, 153

- Free energy, of ion exchange and ionic radius, 14
values, 13
- Freundlich adsorption isotherm, 5, 24, 26
- Frontal analysis, 299
- Fruit waste, sugar recovery, 339
- Functional groups, and pH-titration curves, 18
in ion exchangers, 47
- G
- Gadolinite, 210
- Galactogen from beef lung, 280
- Gapon equation, 11, 20
- Gasoline, 370
- Gastric hyperacidity, 291
- Gastric juice, 378
- Geiger-Müller tube, 169
- Gel structure, 165
- Gelatin purification, 279
- Gelation, 49
- Glauconite, 102, 108
- d*-Glucose, 372
- Glucose demineralization, 338
- Glucose-1-phosphate, 278
purification, 373
- Glucosides, 339
- Glutamic acid, 304, 305
by-product from beet juice, 330
elution, 306
elution order, 311
estimation, 284
- Glutamine, 279
separation from arginine, 278
- Glycerine, purification, 372
substituted by apple juice, 342
- Glycine, elution order, 311
- Glycinin, source of amino acids, 310
- Glycogen, 373
- Glycocyanine, determination, 226
separation of arginine, 278, 284
- Glycol solution treatment, 371
- Gold, recovery by anion exchange, 254
removal by manganese zeolite, 235
- Gonadotropic hormone, 280
determination, 278
- Grapefruit peel, 346
- Gravity, 81
- Ground water, composition, 105
- Group separations, 206
- Guanidine, 291
- Guanosine, 284
- Gum formation, 370
- Gum stability, 370
- H
- Hafnium, presence in alvite, 218
separation from zirconium, 219
- Half reactions, 176
- Heartburn in pregnant women, 380
- Heat of reaction, see reaction energy, 20
- Heavy metals, removal from apple syrup, 279
- Helmholtz double layer, 366
- Heparin, 375
- Hesperidin, removal, 339
- Histamine, 291
- Histidine, 297, 300, 304, 307, 309
concentration, 299
separation from monoamino acids, 297
separation of arginine, 278, 297, 303
separation of lysine, 303
- History of ion exchange, 1
- Holmium oxide, presence in crude yttrium oxalate, 213
- Humectants, 342
- Hydrated ionic radius, 175
- Hydration of ions, 12, 15
- Hydraulic head method of operation, 323
- Hydraulic valve, 93
- Hydrocarbon refining, 370
- Hydrochloric acid, removal from alanine hydrochloride, 279
- Hydrogen ion exchange, 17
- Hydrogen ion, separation factor, 207
- Hydrogenation catalysts, 264
- Hydrogen-sulfide group, determination, 226
- Hydronium ions, 353
- Hydroponics, 374
- Hydroxyapatite in fluoride removal, 140
- Hydroxymethylfurfural, removal, 336
- Hydroxymethylfuroic acid, 336
- Hydroxyproline, 309
elution order, 311
- Hypertensin, 377
determination, 278
- Hypertension treatment, 291
- Hysteresis, 4
in exchange resins, 175

I

Immunochemical reactions, 288
Indole, 291
Industrial standards, 107
Infant feeding, milk modification, 368
Influent, definition, 168
Inorganic cations, separation, 167
Inositol content, estimation, 280
Insecticide, nicotine exchangers, 359
Instrumentation, in sugar refining, 324
Integrating flow meters, 97
Inversion of sugars, 333
Ion exchange beds, microbial fouling, 145
Ion exchange equipment, 77
Ion exchangers, desirable qualities, 111
 properties, 110
 types, 108
Ionac, see Appendix
Ionic concentrations, 5
Ionic radius, 14
 free energy of ion exchange, 14
Ionization of functional groups, 18
Ipecacuanha tincture, 361
Iron, determination, 231
 in siliceous catalysts, 264
Iron, recovery by anion exchange, 251
 removal, 118
 removal from zirconium, 186, 218
Iron, sequence of adsorption, 175
Isobutyric acid, 309
Isoleucine, 299
Isotope separation, 16, 152
Isovaleric acid, 309

J

Jacketed column, 172
Jerusalem artichokes, 343

K

Kaolinite, 17
Kelp, sulfonated, 318
Kerosene, 352
Kinetics, 29

L

Lactic acid as complexing agent, 184
Lactoglobulin, 284
Lactose, 344, 370
 recovery, 369
Langmuir equation, 7
Langmuir isotherm, 24

Lanthanum, hydrogen exchange, 183
 removal from zirconium, 186, 218
 separation from actinium, 210
 separation from cerium, 210
 sequence of adsorption, 175
Lanthanum ion, separation factor, 207
Laplace transform, 35, 40
Law of mass action, see mass action law
Layering effect, 151
Lead aluminosilicate, catalysts, 265
Lead exchanger, 317
Lead, in siliceous catalysts, 264
 removal from maple syrup, 345
 separation from barium, 209
Lead zeolite, 160
Lead-lined equipment, 90
Leakage of hardness, 115
Leucine, 299
 elution order, 311
Level control, 321
Levulinic acid, 336
Lift turn valves, 88
Lignite, sulfonated, 318
Linear kinetics, 34
Liquonex, see Appendix
Lloyd's reagent, 297
Low grade syrups, 335
Lubricant, 162, 164
Lutecium, separation, 193
 temperature effect on separation, 203
Lyophilic colloids, 367
Lyophobic sols, 365
Lyotropic series, 13, 21, 175
Lysine, 297, 300, 307
 concentration, 299
 elution, 302
 separation from arginine, 303
 separation from histidine, 303

M

Maceration time, 357
Macromolecules, separation, 280
Magnesium, in siliceous catalysts, 264
 recovery, 255
 sequence of adsorption, 175
Magnesium silicate, antacid, 378
Malic acid, removal from apple syrup, 279
Manganese, determination, 232
 in siliceous catalysts, 264
 removal, 118

- Manganese aluminosilicate as catalyst, 262
 Manganese zeolites, 120
 for gold removal, 235
 Manually operated softener, 85, 88
 Maple syrup, removal of lead, 345
 Mass action equation, 6
 Mass action law, 6, 12, 15, 177, 179
 Mass transfer theories, 199
 Masecuite, 320, 332
 Master pilot valve assembly, 94
 Mechanism of exchange, 31
 Melassigenic salts, 316
 Memory effect, 176
 Mercury, determination, 227
 Metal traces, determination, 278
 Metallic oxides, adsorption of basic amino acids, 298
 Methionine, 309
 elution order, 311
 Methylene chloride, 352
 Methylnicotinamide, 284
 Methylurea, 284
 Microbial fouling, of ion exchangers, 145
 Milk, adjustment of ionic ratio, 278
 determination of copper, 231
 treatment, 367
 Milk fat, removal, 369
 Miscellaneous applications, 363
 Molasse, 335, 339
 Mold growth in citrate solutions, 204
 Molecular adsorption, 299
 Molybdic acid sols, preparation, 365
 Molybdic anhydride, 228
 Molybdenum aluminosilicate as catalyst, 262
 Molybdenum, in siliceous catalysts, 264
 recovery by anion exchange, 251
 Monazite, 209, 213
 Monel metal, nickel recovery, 258
 Monel screen, in exchange columns, 174
 Montmorillonite, 17
 as catalyst, 265
 Morphine, determination, 282
 determination in urine, 224
 Mottled enamel, 140
 Multiple unit plants, 96
 Multiport valve, 81
 Multistage fractionation, 151
 Multistage systems, 151
 Muscle extract, purification, 279
- N
- Nalcite, see Appendix
 Naphthenic acid removal, 370
 Naringin, removal, 339
 Neodymium carbonate, typical elution data for, 212
 Neodymium, effect of bed length in separation from praseodymium, 202
 identification, 193
 separation, 196
 separation from cerium and praseodymium, 210
 separation from samarium and praseodymium, 211
 sequence of adsorption, 175
 Neodymium oxide, presence in crude yttrium oxalate, 213
 Neoprene gasket, in exchange columns, 174
 Neutral amino acids, definition, 296
 Neutralization, 64, 65, 66
 Network, 46, 50, 51, 63
 Nickel, determination, 232
 in siliceous catalysts, 264
 recovery, 239, 257
 separation from copper, 258
 sequence of adsorption, 175
 Nicotine recovery, 359
 Ninhydrin, 309
 Nitrogen dioxide, catalyst for oxidation, 264
 Nitrogenous bases, exchange, 277
 Nitrosyl chloride, catalyst for oxidation, 264
 Noncolumnar operation, 98
 Nonequilibrium column operations, 187
 Nonequilibrium exchange, 174
 Nonequilibrium process, cation exchange, 168
 Nutrients for plants, 374
 Nux vomica tincture, 361
- O
- Oligodynamic metals, 144
 Operating run, 79, 80
 Opium tincture, 361
 Organic acids, 278
 Organic catalyst, 265
 Organic cations, concentration, 277
 Ornithine, separation, 297
 Oscillation volume, 11

- Oxalic acid, determination, 228
as complexing agent, 184
Oxide sols, 365
Oxydation catalysts, 262
Oxytocic principles, in pituitary extract,
278, 281
- P**
- Palladium, recovery by anion exchange,
254
to remove evolved gases, 174
Parabolic diffusion law, 74
Parabanic acid, 284
Particle shape, effect of, 200
Particle size, effect on exchange, 170, 199
Partition chromatography, 307
Pectin, 331
determination, 282
manufacture, 346
purification, 279
Penicillin, 278, 378
Penicillium notatum, 378
Pepsin, 378
hydrolysis, 290
Peptic activity, inhibition, 379
Peptic ulcer, treatment, 290
Peptides, 297
Peptones, 378
Permutit, see Appendix
Petroleum cracking, catalysts, 265
Petroleum distillate residues, sodium
removal, 370
Petroleum refining, 370
pH effect, 19
pH meters, 373
pH-titration curves and functional groups,
18
Pharmaceutical applications, 290, 376,
378, 380
Pharmaceuticals, purification, 364
Phenol, 63, 309
to eliminate mold growth, 204
removal, 145
Phenol-formaldehyde polymer, 48
Phenol formaldehyde resins, 319
Phenolsulfonic acid, 1, 48
Phenyl mercuric hydroxide, 161
Phenylalanine, 299, 306, 311
Phenylenediamine-formaldehyde resins,
24, 319
Phenylurea, 284
Phosphate ion, determination, 230
removal, 227
Phosphorolysis of starch, 374
Phosphorus, removal, 369
Pilot plant separations, 211
Pilot valve, 94, 95
Pineapple mill juice demineralization, 340
Piston-like flow, 322
Pituitary principles, 278, 281
Plant cells, adsorption of ions, 285
Plants, soilless growth, 374
Plate theory, 188, 191
Platelet count, 286
Plating waste solution, 249
Platinum, recovery by anion exchange, 253
Polyhydric alcohols, purification, 343, 371
Polymerization catalysts, 264, 265
Polypeptides, 377
Polyvalent cations, exchange constants,
175
Pomace, 346
Poppet valve, 93
Pore size, 17
Pore volume, 30
Potassium, determination, 231
sequence of adsorption, 175
Potassium ion, separation factor, 207
Praseodymium, dissociation constant of
citrate complex, 182
distribution coefficient as function of
pH, 181
effect of bed length in separation from
neodymium, 202
effect of flow rate in separation from
cerium, 202
separation from cerium and neodymium,
210
separation from neodymium and sama-
rium, 211
sequence of adsorption, 175
Precious metals, 2
recovery, 253
Pre-conditioning, 172
Pregnancy, hearburn therapy, 380
Pressor principles, in pituitary extract,
278, 281
Pressure, 80
Production of colloids by exchange, 278

- Proline, 299, 309
 elution order, 311
Protective coatings, 88
Protein hydrolysate, separation of arginine, 284
Protein, removal, 369
Proteoses, 378
Prothrombin, 375
 activity, 287
 time, 286
Protoactinium isolation, 217
Pseudoequilibria, 4
Pulp and paper, water standards, 107
Purification by exchange, 276
Putrescine, 291
Pyridine, 309
 as eluant, 306
Pyrolidone carboxylic acid, 331
- Q**
- Quasi rare earths, elution order, 184
Quinine, 279
 adsorption isotherms, 353
Quinine extraction, portable units, 358
Quinine sulfate, 356
- R**
- Radioactive tracers, 39
Radioactivity, recording of, 171
Radiocolloids, distribution coefficient, 186
Radium, separation from barium, 209
Radium-barium fractionation, 155
Raffinose, 326
Rain water, composition, 104
Rare earths, analysis of mixtures, 193
 complete separation, 214
 complex formation with citric acid, 179
 dissociation constants of citrate complex, 182
 elution curve, 191
 elution order, 192
 in siliceous catalysts, 264
 recovery, 257
Rare earth separations, 168, 209
 effect of concentration, 198
 elutriant compositions, 197
Rate constants, 37
Rate laws, 31
Reaction energy of exchange, 20
Reagin, 289
Rectifying column, 151
Refinite, see Appendix
Regenerant recovery, 98
Regeneration, 128
 sugar refining, 325
Rennet, 368
Renold equation, 7
Replacement of ions by exchange, 276
Restoration treatment, 146, 333
Re-use, of catalyst, 268
 of regenerants, in sugar refining, 324
 of sweet water, 322
 R_f value, 310
Rhenium, anion exchange, 220
 separation from element 43, 220
Riboflavin, 381
 determination, 225
 separation from thiamine, 278
Ribosenucleic acid, 284
Rinse, sugar refining, 325
Rinsing, 114
Risorite, 210
Rotameters, 97
Rothmund-Kornfeld equation, 5, 7, 19
Rubber-lined equipment, 166
Rubidium ion, separation factor, 207
Rubidium, sequence of adsorption, 175
- S**
- Samarium, pure sample, 212
 separation, 196
 separation from neodymium and praseodymium, 211
 sequence of adsorption, 175
Samarium oxide, presence in crude yttrium oxalate, 213
Sample size, effect of, 199
Sawdust, sulfonated, 318
Scaling counters, 173
Scandium, elution order, 184
 sequence of adsorption, 175
Scopolamine, isolation, 354, 355
Sea water, composition, 105, 159
 desalting, 132, 159
 production of drinking water, 160
 regeneration, 117
Seaweed, sulfonated, 318
Selective solvent extraction, 353
Selenite ion, determination, 230
Separation by exchange, 276

- Separation calculations, application of plate theory, 188
- Separation factor, influence of complex ion formation, 187
ratio of distribution coefficient, 184
- Separation factors of cations, 207
- Separation schemes, 205
- Separations, general principles, 174
- Sequence of adsorption, 175
- Serine, elution order, 311
- Serological reactions, 289
- Silica, in boiler feed waters, 133
- Silica gel, in chromatography, 307
- Silica removal, by direct anion method, 135
by fluosilicate method, 136
- Silica sols, preparation, 365, 367
stabilization, 366
- Silicon, in siliceous catalysts, 264
- Silicon dioxide, 213
- Silver, anion exchange reactions, 246
in siliceous catalysts, 264
recovery, 245
separation from copper, 258
- Silver nitrate, 165, 166
- Silver zeolite, 160, 165
- Simplex time stamper, 173
- Skatole, 291
- Skeleton network of resins, 50, 67
- Sodium, sequence of adsorption, 175
- Sodium aluminosilicate, catalysts, 265
- Sodium carbonate regeneration, 90
- Sodium chloride regeneration, 89, 113
- Sodium glutamate, flavoring material, 326
- Sodium malate recovery, 343
- Sodium tartrate recovery, 346
- Soil chemistry, 1
- Soil colloids, 4
- Soilless growth, 374
- Solanaceous alkaloids, 354
- Solid solutions, 5
- Sols, preparation and purification, 364, 366
- Solubility characteristics of alkaloids, 351
- Sorbitol, manufacture, 372
purification, 372
- l*-Sorbitose, 372
- Sorghum, by-products from, 334
- Sorgo juice treatment, 334
- Soxhlet extractor, 171
- Soy bean meal, source of amino acids, 310
- Specific gravity meters, 325
- Stabilization of colloids, 365, 367
- Stainless steel equipment, 166
- Starch, 373
enzyme conversion, 338
in chromatography, 307
- Starvation regeneration, 124
- Steam generation, water standards, 107
- Steffenization, see Steffen's process
- Steffen's process, 317, 326
- Sterilization, 144
- Storage capacity effect, 360
- Streptomycin, 281
recovery and purification, 376
- Streptothricin, concentration and purification, 377
- Stripping section, 154, 156
- Strontium, as tracer, 195
- Strontium, dissociation constant of citrate complex, 182
separation from barium, 208
sequence of adsorption, 175
uranyl ion exchange, 185
- Strontium saccharate, 326
- Structure, 46
- Strychnine, adsorption isotherms, 353
- Sucrose inversion, 271
catalysts, 266
- Sugar analysis, ion exchange in, 345
- Sugar beet juice treatment, 325
- Sugar cane juice treatment, 331
- Sugar manufacture, 316
- Sugar refining, 317
by ion exchange, process costs, 328
- Sulfate ion, determination, 230
- Sulfitation, 325
- Sulfonated coal, 109, 318
as catalysts, 267
- Sulfonated resin exchangers, 109
- Sulfosalicylic acid as complexing agent, 184
- Sulfuric acid contact process, catalysts, 263
- Sulfuric acid regeneration, 90
- Supports, 81
- Supporting media, 85
- Surface water, composition, 104
- Suspended matter, removal, 105
- Sweetening-on, 79
sugar refining, 325
- Sweetening-on operation, 322

- Sweetening-off, 79
 sugar refining, 325
 Sweetening processes of hydrocarbons, 370
 Sweetland filter, 341
 Sweet water, re-use, 322
 Swelling, 10, 17, 21, 22
 of ions, 51
 Swelling pressure, 10
 Syphilitic serum, 289
 Syrups, 335
- T**
- Tartaric acid, as complexing agent, 184
 recovery, 346
 Tartrate ions, exchange, 346
 Tartrate recovery, flow diagram, 347
 Technique in ion exchange, 170
 Temperature, 20
 Temperature effects, 203, 204
 Terbium, distribution coefficient as function of pH, 181
 Textiles, water standards, 107
 Theoretical plates, 151
 relation to particle size, 199
 Therapeutic uses of ion exchange, 290, 378
 Thiamine, 17
 determination, 225, 278, 282
 separation from riboflavine, 278
 Thiamine hydrochloride, 381
 recovery and purification, 380
 Thiochrome assay, 283
 Thorium, in siliceous catalysts, 264
 Threonine, elution order, 311
 Thulium, distribution coefficient as function of pH, 181
 isotopes, 195
 separation, 194
 temperature effect on separation, 203
 Thymol, 284
 Tin, determination, 227
 Tin-containing catalysts, 263
 Titanium, in siliceous catalysts, 264
 removal from zirconium, 186, 218
 Titanium aluminosilicate as catalyst, 262
 Tobacco processing, 359
 Tolerances, water standards, 106
 Total salt concentration, determination, 229
 Totaquine, 356
 Totaquine preparation, 279
- Trace chemistry, 282
 Tracer, effect, 176
 Trans-amination, role in copper recovery 245
 Transflex tube, 172
 Transfusion of blood, 375
 Translocation process schemes, 99
 Transuranic elements, 216
 Tricalcium phosphate, antacid, 378
 Trichloroethylene, 352
 2,4,5-Trichlorophenoxyacetate, 285
 Trimagnesium phosphate, antacid, 378
 1,3,5-Trimethylpyridine, 309
 Tryptophane, 306, 307
 separation from amino acids, 278
d-Tubocurarine chloride, 360
 Tungsten, in siliceous catalysts, 264
 Tungsten aluminosilicate as catalyst, 262
 Tungstic acid sols, preparation, 365
 Tungstic anhydride, 228
 Two step demineralizing process, 320
 Two step process, see also demineralization
 Tyndall effect, 366
 Tyramine, 291
 Tyrosine, 299, 306, 309
 elution order, 311
- U**
- Ulcer treatment, 378
 Unionized substances, effect of, 178
 Uranium, in siliceous catalysts, 264
 Uranium aluminosilicate as catalyst, 262
 Urea, determination in urine, 224
 Uridine, separation of cytidine, 283
 Urine, amino acid determination, 226
 ammonia determination, 223
 morphine determination, 224
 urea determination, 224
- V**
- Vageler equation, 7
 Valence effect, 16, 175
 Valine, 299
 elution order, 311
 Valve, 81
 Valve-nest, 85
 Vanadium, in siliceous catalysts, 264
 recovery by anion exchange, 251
 Vanadium aluminosilicate as catalyst, 262

- Vanadium zeolite catalysts for sulfuric acid manufacture, 263
Vanselow equation, 9
Vitamin B₁, see thiamine hydrochloride
Vitamin B₂, see riboflavin
Vitamin B complex, 380
 purification, 382
Vitamin C, 372
Vitamins, 17
Void space, effect of, 200
- W**
- Waste water treatment, 145
Water conditioning industry, 1
Water gas catalysts, 263
Water softening, 112
Weakly acidic groups, 61
Whey demineralization, 343
Whey treatment, 369
Wiegner-Jenny equation, 7
Winery wastes, 346
Wizard recorder, 173
Wofatit, 244
Wolfen I. G. plant, silver recovery, 246
- Y**
- Ytterbium, separation, 193
 temperature effect on separation, 203
- Yttrium as tracer, 195, 196
 elution order, 184
 dissociation constant of citrate complex, 182
 distribution coefficient as function of pH, 181
 sequence of adsorption, 175
Yttrium group of rare earths, 169
 separations, 213
Yttrium ion, separation factor, 207
Yttrium oxide, presence in crude yttrium oxalate, 213
- Z**
- Zeolite, 102, 108
Zeo-Karb, see Appendix
Zinc, in siliceous catalysts, 264
 recovery, 239
 separation from cadmium, 258
 separation from copper, 258
 sequence of adsorption, 175
Zirconium, conditions for purifying, 182
 exchange capacity for, 185
 in siliceous catalysts, 264
 purification from lanthanum, 218
 purification of colloidal solutions, 217
 recovery, 257
 separation from columbium, 217
 separation from hafnium, 219
 uranyl ion exchange, 185