

# ELEMENTS OF ORTHOPÆDIC SURGERY

BY

N. ROSS SMITH

M.B., CH.M. (SYDNEY), F.R.C.S. (ENG.)

*Orthopædic Surgeon, Cornelia Hospital, Poole*  
*Formerly Surgical Registrar, West London Hospital*  
*Surgical Registrar and Senior House Surgeon, Royal National Orthopædic*  
*Hospital, London*  
*Demonstrator in Anatomy, University of Sydney*

FOREWORD BY

R. C. ELMSLIE, O.B.E., M.S., F.R.C.S.

*Orthopædic Surgeon, St. Bartholomew's Hospital*  
*Consulting Surgeon, Royal National Orthopædic Hospital, London*  
*Past President, British Orthopædic Association*  
*Chairman of Council, Chartered Society of Massage and Medical Gymnastics*

---

WITH 99 ILLUSTRATIONS

---

BRISTOL: JOHN WRIGHT AND SONS LTD.  
LONDON: SIMPKIN MARSHALL LTD.

1937

PRINTED IN GREAT BRITAIN BY  
JOHN WRIGHT AND SONS LTD.,  
STONEBRIDGE HOUSE, BRISTOL

## PREFACE

THE aim of this book is to present a concise and practical account of the elements of orthopædic surgery for practitioners and students who do not require the full knowledge given by larger textbooks, and for nurses and masseuses engaged in orthopædic work. Thus the common conditions treated by orthopædic methods are described to the extent which seems necessary, while rarer affections are omitted or merely mentioned in a few words. Pathological appearances are stated briefly but sufficiently for understanding of treatment. The essential steps of operations are indicated, but details needed only by operating surgeons are omitted. In the chapters on Fractures, chiefly the mechanical principles in treatment are considered, so that a sound understanding of the reasons for methods may be readily acquired. In a book of this size it has not been possible to describe all injuries, but only those that are common. In the Introduction a short statement is given of the modern organization of cripple welfare work, appreciation of the need for which is important for all who take part in the practice of orthopædics. In the Appendices a short account is given of physiotherapy, splints, appliances, and plaster-of-Paris technique, which it is hoped will be found useful.

I wish to thank Drs. Coldwell and Allchin for the radiographs which are reproduced as *Figs.* 59, 60, 61, 63, 64, and 91. Dr. Stanley F. Smith has assisted me greatly in the photography of my own cases at the Cornelia Hospital, from which most of the illustrations are derived. Messrs. Down Bros. have kindly lent blocks for *Figs.* 77, 83, 84, and 85; Messrs. Ernst for *Figs.* 7, 9, 31, 48, 92, and 93; and Messrs. Krohne and Sesemann for *Figs.* 2, 3, 10, 86, 87, and 94. I have pleasure in thanking also the publishers, Messrs. John Wright & Sons Ltd., for their courtesy and for the care they have taken in the preparation and printing of the book.

N. ROSS SMITH.

*Bournemouth,*

*January, 1937.*

## FOREWORD

THE organization of orthopædic treatment has become a matter of considerable complication. The work of the surgeon in a special hospital or in the orthopædic department of a general hospital is only one item in the care of those who are actually or potentially physically disabled. Many others are concerned with this care. Some are members of the medical profession, although not specialists in this line of work. Some are members of the auxiliary professions of nursing, massage, and appliance making. Many are laymen, without any medical training or knowledge. The discovery of physical defects depends upon the work of the general practitioner, and upon the examination of children at Infant Welfare Clinics and at school medical inspections. Voluntary organizations for the care of cripples, which exist in many areas, and school care committees, are concerned with the out-of-hospital care of many of the cases, and the county tuberculosis authorities with others.

Orthopædic clinics depend largely upon the work of nurses and masseuses, and often on voluntary help also. Finally, physical education may now be classed as a preventive side of orthopædics. The physical education teacher requires a general and elementary knowledge of the subject in order that he may recognize defects and understand

their importance. It is true that physical education in this country is in an elementary stage of development ; it has received far too little encouragement and recognition, and the number of properly trained teachers is totally inadequate. But the importance seems now to be becoming recognized, and it is to be hoped that in the near future there will be a more adequate supply of teachers with a proper anatomical and physiological basis for their work in addition to their technical training.

All these groups of medical and lay assistants in the realm of orthopædic surgery require a general knowledge of the subject. They must understand the meaning of the terms used, must know the normal and abnormal in structure and function, and have a general idea of the objects and methods of all sorts of treatment. Orthopædic surgery is a subject of considerable complexity. It is very intimately concerned with anatomy and with neuro-muscular physiology, and it includes the pathology of a considerable part of the body. But in addition, orthopædic treatment necessitates knowledge and experience of mechanical principles and methods which enter only to a slight extent into other sections of surgery. Hence the inclusion of the principles of the use of splints and of plaster-of-Paris in a text-book on the subject as well as the methods of physiotherapy, massage, active movements and exercises, manipulations, and treatment by electrical methods, light, heat, and baths. A complete text-book which includes all these details is necessarily bulky, and must include

much that is beyond the comprehension or the needs of the orthopædic assistants that have been named ; but a general outline of the principle involved, such as is included in this book, should be of great assistance to them in their work, and it will enable them to study any particular part of the subject in a larger text-book with greater understanding.

The object of orthopædic surgery may be defined as the restoration (as far as possible) of normal physique and function, and function is more important than anatomical perfection. A damaged or deformed spine must be brought back to its function of holding the erect posture, a damaged arm restored to useful work, a leg to its function of supporting the weight and assisting in progression. Throughout all treatment the ultimate aim has to be borne in mind, and the educational side of the work must therefore not be neglected. The test of the work of an orthopædic organization is the restoration of its patients to normal useful life.

R. C. ELMSLIE.

*London, W.1.*

# ELEMENTS OF ORTHOPÆDIC SURGERY

---

## CHAPTER I

### INTRODUCTION

**D**EFINITION and Scope of Orthopædic Surgery.—Orthopædic surgery is concerned with injury and disease of the bones, joints, voluntary muscles, and peripheral nerves of the limbs and trunk. It is concerned especially with the prevention, correction, or alleviation of disablement or deformity—that is to say, with crippling—due to such injury or disease. The term ‘orthopædic’ is derived from the Greek, and means literally ‘appertaining to the straight child’; but in its modern scope, orthopædics deals with adults as well as children, and with the preventive as much as the curative aspect of crippling. In particular, the subject comprises fractures and other injuries of the limbs and trunk, congenital deformities, and diseases, such as tuberculosis, neoplasms, rickets, rheumatic infection, vascular and nervous diseases, as they affect bones, joints, muscles, and nerves.

**Organization of Cripple Welfare Work.**—There are several aspects of orthopædic work, to which attention must be paid if it is to be carried out efficiently and economically. To co-ordinate work under these aspects, an association of all those hospitals, public authorities, medical, nursing, and social service societies,



and private individuals able to help or with responsibility for cripples, is essential in every area. Such orthopædic associations already exist in many parts of England and in other countries, but others are required wherever the need for orthopædic surgery is present.

*Prevention of Crippling.*—The first aspect of cripple welfare work is prevention. Deformity is nearly always, and disablement frequently, preventable by early and efficient treatment. Thus with proper organization of the treatment of injuries, from the first-aid service to the surgeon and hospital, much of the crippling which at present commonly follows upon accidents does not occur.

Certain of the crippling diseases arise from or are predisposed to by unhygienic conditions of living or feeding. For example, tuberculosis in bones and joints occurs from infection by bacteria contained in milk from tuberculous cows or spread in air breathed out or sputum coughed up by persons with pulmonary tuberculosis. Again, rickets is a result of faulty feeding or inadequate exposure of the body to sunlight, and should not occur under healthy conditions of living. Measures for the prevention of crippling are largely the responsibility of public authorities; but the doctor, nurse, and social worker can do much to guide and instruct in their own spheres.

*Discovery of Cripples.*—There is still much widespread ignorance as to the cause of crippling and of what can be done to prevent or alleviate it. Though the responsibility is primarily with the parents or the patient himself, the efforts of doctors, school medical officers, health visitors, nurses, midwives, and child welfare associations are often necessary to find cases and bring them for treatment. Whenever a systematic search is made in any town or rural area, many untreated cases are discovered. Apart from relief of

mental and physical distress, the importance of early discovery is that the sooner treatment is begun, the more likely it is to be successful and the less the expense of it.

*Treatment.*—The treatment of many orthopædic cases requires the services of both the hospital and the out-patient clinic. To the latter, patients are brought for diagnosis and decision whether or not admission to hospital is required. Most cases can be dealt with as out-patients, needing such treatment as physiotherapy or provision of appliances. Because of the necessity of prolonged after-care and the difficulties of transport, out-patient clinics are often needed, not only at the hospital, but also at outlying towns in the area; at these, out-patient treatment is given and the orthopædic sister and surgeon from the hospital pay regular visits. Indoor treatment for patients requiring investigation, operation, or nursing in bed may be carried out either in a special orthopædic hospital or in the orthopædic department of a general hospital. Tuberculous and other cases for which open-air treatment is desirable are best dealt with in hospitals situated in the country or by the sea.

*Education, Vocational Training, and Employment.*—The problem of education and vocational training exists in many cases. The treatment of an orthopædic case may extend over months or years. It is therefore necessary to provide teaching for children while they are in hospital, and, in some cases, special schooling afterwards, so that they may not grow up mentally as well as physically handicapped. Adults lying in hospital for long periods should be given occupations, such as sewing, and basket, toy, or rug making, to avoid monotony and to provide a mental stimulation which does much to help their recovery from disease. Some patients are so disabled that,

even after treatment, they are suited only for certain occupations, or are unable to follow again an occupation for which they were trained. For these, once the active stage of their treatment is finished, training must be given in an interesting occupation by the aid of which they can later play their part as useful citizens. Such vocational training is carried out in special colleges and workshops. The organization of this side of orthopædic work has also to include means of finding employment for those who have been trained. It must also deal with those patients who are too seriously disabled for any but part-time employment or for work which they can perform at home.

*Psychology of the Cripple.*—There is a psychological side of orthopædic work which is most important. The crippled child soon realizes that he is different from other children, in that he cannot play or work like others, and he may be an object of pity or even ridicule. From this he may develop a feeling of helplessness or inferiority, which is as serious a handicap to his progress in life as his physical disability. The adult patient, too, may be a mental as well as a physical sufferer. A man disabled by injury or disease is often broken in spirit as much as in body. Crippled children are not necessarily, as is popularly supposed, intellectually inferior to other children; only in a minority of cases of congenital deformity or nervous disease is this true; in most cases, since their crippling was acquired by injury or disease, such children are of normal intelligence. This psychological aspect should be kept constantly in mind in treating both adults and children, and care be taken to counteract the above-mentioned tendencies.

## CHAPTER II

### CONGENITAL DEFORMITIES

CONGENITAL deformities are, as the name implies, present at birth. Their cause is unknown. There is no proof that they may be caused by injury to the fœtus or malposition in utero, as has been supposed, or to maternal or fœtal disease; or that heredity is an important factor. All that can be said is that they are due to an error of growth of unknown origin.

There are many varieties of congenital deformity: partial or complete absence of a limb or segment of a limb; supernumerary fingers and toes; absence of bones or muscles; dislocation or malformation of a joint; or mere fixation of an attitude which can be assumed by a normal limb. The commonest deformities are congenital talipes, congenital dislocation of the hip, and congenital torticollis.

### CONGENITAL TALIPES

The term 'talipes' is a general one for most deformities of the foot. It is used for both congenital and acquired deformities, and is qualified, according to the direction of distortion, in the following ways:—

1. *Talipes Equinus* ('dropped foot').—The foot is plantar-flexed so that in standing weight is taken on the ball of the foot and toes and the heel does not reach the ground.

2. *Talipes Calcaneus*.—This is the opposite to talipes equinus, the heel being depressed and taking the weight, and plantar-flexion of the foot being impossible.

3. *Talipes Varus*.—In this the foot is turned inwards ('supinated'), so that the sole looks inwards and perhaps also upwards.

4. *Talipes Valgus*.—The foot is turned outwards ('pronated').

5. *Pes Cavus* ('hollow' or 'claw foot').—The sole is abnormally concave in shape.

6. *Pes Planus*.—The normal concavity of the sole of the foot is absent.

7. *Metatarsus Varus*.—The fore-part of the foot only is turned in ('adducted') so that the inner border of the foot is concave instead of straight.

Combinations of these distortions occur, giving such names as equino-varus, equino-valgus, calcaneo-valgus, calcaneo-cavo-valgus, calcaneo-plano-valgus. Of the congenital deformities, talipes equino-varus ('club-foot') is the commonest variety, the only other common varieties being talipes calcaneo-valgus and pes cavus.

**Talipes Equino-varus** (*Fig. 1*).—In this deformity the foot is turned inwards and slightly plantar-flexed. The forepart of the foot is in-curved (adducted). The sole is often abnormally concave and the heel small. Except in rare cases the bones and joints of the foot are normally present and shaped. But as the child grows and begins to walk, the deformity becomes more fixed and the bones alter adaptively in shape. The muscles also become permanently adapted to the deformity, those supinating and plantar-flexing the foot becoming contracted, while the pronators and dorsi-flexors are lengthened. The other soft tissues are similarly altered. The skin of the outer border of the foot, upon which weight is borne, becomes thickened. These adaptive changes make correction of the deformity increasingly difficult as age advances. Hence the importance of beginning treatment early in infancy.

**TREATMENT.**—If noticed at birth, correction of the deformity should be commenced by manipulating the foot daily in such a way as to undo the distortion. This must be done systematically so as to correct each component of the deformity in order. First, the heel should be grasped while the other hand takes hold of the forepart of the foot and draws it steadily and repeatedly outwards. By this manipulation the adduction of the forepart of the foot will be gradually corrected. Not until this has been achieved and the



*Fig. 1.*—Congenital talipes equino-varus (left).

inner border of the foot made slightly convex should correction of the inversion of the foot be attempted. To do this, the foot must be twisted outwards, using the same grip as before. Finally, when the foot can be easily turned outwards rather more than a normal foot, firm pushing movements upward on the sole should be made, while still steadying the heel with the other hand, so as to correct the plantar-flexion component. The last manipulation should be continued until the foot can be fully dorsiflexed.

By the time the child is a few months old, correction of the deformity is no longer possible except under an anæsthetic, when the manipulations are carried out by the surgeon. It may be necessary by this time for the surgeon to divide the plantar fascia and the tendons of contracted muscles with a tenotome and to make use of an orthopædic wedge (*Fig. 2*) or a wrench (*Fig. 3*) to stretch the foot. In children more than a few years old, the surgeon may have to perform an open operation to correct the deformity. The later the

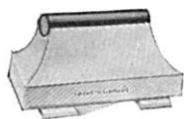

*Fig. 2.*—Orthopædic wedge.



*Fig. 3.*—Tubby's wrench.

patient is brought for treatment, the more difficult is the task of converting the foot into a normal and useful structure.

To prevent relapse of the deformity (*Fig. 4*), the tendency to which is great, some means of fixation must be used between corrective manipulations and after operation. In infants, adhesive strapping is used, applied in strips so as to hold the foot in the best position obtained after manipulation. The strapping must be renewed frequently, and care must be taken to prevent irritation of the skin. In older children, plaster-of-Paris is commonly used. The plaster bandages are applied while the foot is held in the best position obtainable, either over stockinet or wadding, or directly on to

the skin. The bandages must be applied smoothly and the plaster case moulded as it is setting round the bony prominences so as to avoid ridges, which might cause sores. The surgeon repeats the manipulation and reapplies the plaster at intervals of about three weeks, until full over-correction of the deformity has been obtained. The child may be kept in bed during the intervals or allowed to walk in the plaster after an iron walking-heel has been applied.



*Fig. 4.*—Relapsed congenital talipes equino-varus (right). Operative correction is necessary.

When the surgeon is satisfied that the deformity is fully corrected, the child is given a special boot provided with a broad flat heel, the outer edge of which, as well as of the sole, is thickened so as to deflect the weight on to the inner side of the foot. In addition, some surgeons have a steel leg instrument fitted into the inner side of the heel of the boot and a T-strap attached to the outer side of the boot, so that the corrected position of the foot is more firmly



held when the boot is worn (*Fig. 5*). A splint is also provided for night use.

Throughout the growing years the child must be seen three or four times a year by the surgeon, so that boots and appliances may be kept in order and any relapse noted. It may be the duty of the nurse to see the child between visits to the surgeon. She should



*Fig. 5.* — Varus instrument boot and T-strap applied.

see that the boots and appliances are in efficient condition and note any change in the shape of the foot. A nurse or masseuse may also teach the child to exercise the everting and dorsiflexing muscles so as to increase their power, at first assisting the movement and later resisting it. It is only by treating patients at an early age and subsequently exercising vigilant care throughout the growing period that good results can be obtained. If this is done, a well-shaped, strong, and useful foot is the result in the majority of cases.

**Talipes Calcaneo-valgus.**—In this deformity the foot is abnormally dorsiflexed and also everted. The sole is flat and looks forward, outwards, and slightly downwards. The deformity is as common as talipes equino-varus, but is not so disabling and tends to spontaneous correction.

**TREATMENT.**—As soon as recognized it should be treated by manipulation, the foot being repeatedly drawn downwards and inwards. When the child begins to walk, the inner side of the heel of the shoe should be thickened and a support for the long arch of the foot built into the shoe.

**Pes Cavus** (*Fig. 6*).—This deformity is one of exaggeration of the longitudinal arch of the foot, with the loss of normal flexibility. The height of the longitudinal arch varies normally; but pes cavus differs from the normal high-arched foot in being rigid instead of mobile. The deformity may occur from poliomyelitis or other nervous diseases, or be the result of injury to the nerves, muscles, or bones of the foot. In a few cases it may be due to habitual use of high heels or habitual



*Fig. 6.*—Pes cavus (right).

plantar flexion of the foot from walking with a short leg. In most cases there is no ascertainable cause. Often the deformity is present in several members of a family, developing about the age of seven years, and becoming gradually worse.

In the common idiopathic form both feet are usually affected. The height of the longitudinal arch causes the body-weight to be taken entirely on the heels and ball of the foot. At these sites the skin is thickened, and corns and callosities may occur. The anterior

transverse metatarsal arch is flattened and the toes are retracted. The deformity cannot be corrected voluntarily or passively.

Complaint may be made of the deformity, rapid wear and distortion of the shoes, or aching of the foot. Walking is awkward, and in severe deformity may be impossible, because the heel cannot reach the ground.

TREATMENT.—The treatment of slight cases is to provide shoes of adequate length with strong soles, to which is added a 'transverse metatarsal bar'—a bar of leather fixed across the sole at a level behind the

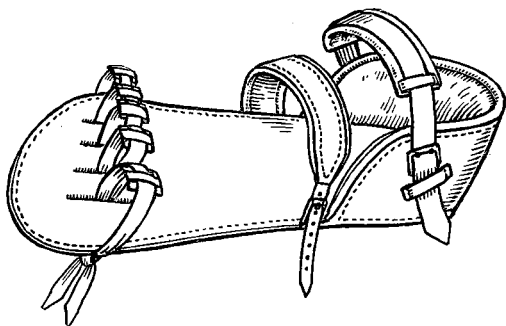

Fig. 7.—Metal sole-plate, with slots and tapes for toes. (Ernst.)

heads of the metatarsals. For night use, a metal sole-plate with slots and tapes for tying down the toes is also provided (*Fig. 7*). Daily stretchings to correct the deformity are performed, and toe-flexing exercises are also given.

The surgeon may divide the plantar fascia with a tenotome and forcibly stretch out the sole of the foot over an orthopædic wedge or with a wrench, then applying plaster-of-Paris for several weeks. For moderate and severe cases Steindler's operation is done. In this, the plantar fascia, the muscles of the

sole, and the plantar ligaments are raised from the under surface of the os calcis with a rugine through an incision on the outer or inner side of the heel; the foot is then wrenched, when these soft structures slide forward and the deformity is fully corrected. After the operation the foot is put up in the corrected position in plaster-of-Paris or bandaged to a metal sole-plate. If the sole-plate is used, the patient is allowed to walk on it in a few days, and the foot must be passively stretched daily. To do this, the heel should be grasped with one hand, while the knee is kept straight, and strong pressure made with the other hand on the ball of the foot. After operative correction, the treatment as for slight cases is followed so as to prevent recurrence.

To correct retraction of the toes, the extensor tendons may be tenotomized at the same time as the Steindler operation is done. In some cases also, the tendon of the extensor hallucis longus is transplanted into the neck of the first metatarsal to help to raise the forepart of the foot. When this transplant is done, the tendon of the extensor digitorum brevis to the great toe is also transplanted to the distal end of the divided extensor hallucis longus tendon, and the interphalangeal joint of the hallux may be arthrodeseed. These measures are taken to prevent flexion of the hallux, which is likely to follow transplantation of the long extensor tendon alone. After the operation, plaster-of-Paris is applied to hold the position of the foot for six weeks.

### CONGENITAL DISLOCATION OF THE HIP

The hip is the only joint at which congenital dislocation is at all common. The joint may be dislocated in infancy by injury, paralysis of the supporting

muscles, or from disease, as at other ages, and dislocation from any of these causes must be distinguished from the congenital variety. Congenital dislocation is more common in girls than boys, and may be unilateral or bilateral. The head of the femur is displaced outwards, upwards, and backwards, while remaining inside the capsule. The acetabulum is usually imperfectly formed. In long-standing cases the head of the femur is misshapen and the capsule is contracted below it; the acetabulum is shallow and filled with fat, and a new or secondary socket has formed on the ilium above and behind the true acetabulum from continued pressure of the misplaced head of the femur.

In an infant the dislocation may be easily overlooked, though broadening of the hip and shortening of the limb are noticeable. If the limb is grasped and moved with one hand while the fingers and thumb of the other hand grip the hip-joint, the head of the femur cannot be felt in the normal position in the groin, but is felt in the buttock. If the limb is pulled upon and then pressed upwards towards the pelvis, it is found to be abnormally mobile in an up and down direction: this is known as 'telescoping'. The great trochanter is raised above Nélaton's line, which passes from the anterior superior iliac spine to the ischial tuberosity and normally touches the tip of the greater trochanter. X-ray examination is a valuable aid to diagnosis in all cases (*Fig. 8*).

When the child begins to walk, a limp is noticeable, due to instability of the hip-joint. When weight is taken on the affected limb, the body lunges to the same side. In bilateral cases, the child walks with a waddling or rolling gait. The lumbar region of the back is abnormally curved forward ('lordosis') (*Fig. 9*) and the child is apt to walk with her hands clasped behind her to help to maintain her balance.

In older children and adults, the hip tends to become more stable from consolidation of the capsule over the misplaced head of the femur. But limping persists, and may be aggravated by the shortening of the limb and development of flexion-adduction deformity at the hip from contracture of the muscles passing between the pelvis and the thigh. Some patients, particularly if the dislocation is only partial ('subluxation'), go on for years without much disability. But sooner or



*Fig. 8.*—Bilateral congenital dislocation of hips.

later most untreated patients find themselves easily fatigued, and, early in adult life, begin to feel pain in the hip, such pain being due either to persistent strain or to the development of osteo-arthritis.

**TREATMENT.**—In the majority of cases, if treatment is undertaken within the first two or three years of life, it is possible to reduce the dislocation and obtain a normal state of the hip. Hence the great importance of recognizing the condition early in infancy. After the age of three years, reduction is much more

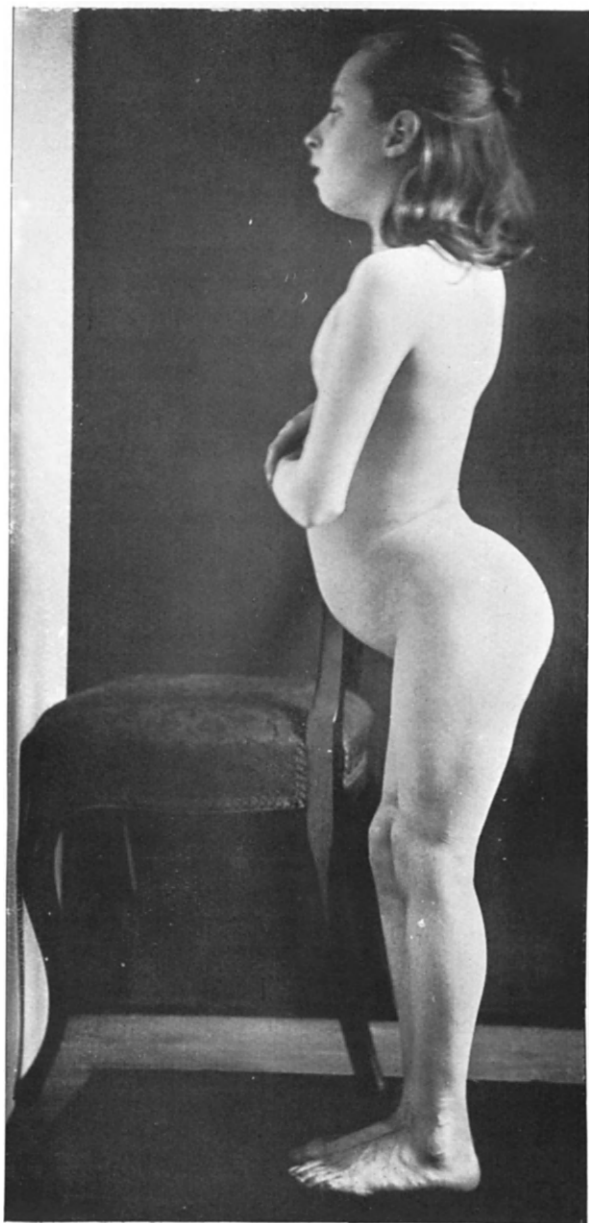

*Fig. 9.*—Double congenital dislocation of hips.

difficult ; after five or six years, it is either impracticable or results in unsatisfactory stiffness of the joint.

Reduction of the dislocation is best undertaken at about the age of six months, and is followed by fixation in plaster-of-Paris for some months until the parts have become adapted to the new (normal) position. Most surgeons attempt reduction in the first instance by manipulation, which is usually successful. The nurse may have to assist in this procedure, and should understand what the surgeon is trying to do.

The usual method of reduction is known as the 'Lorenz' method, though it is nowadays done much more gently than was originally thought necessary. The patient having been anæsthetized and placed on her

back, the assistant steadies the pelvis by grasping and pressing down upon the crests of the ilium. The surgeon then flexes the knee and thigh of the affected limb so as to bring the head of the femur down opposite the



*Fig. 10.*—Pelvic rest.  
(Krohne & Sesemann.)

acetabulum, and then gradually abducts the thigh. During this movement, the adductor muscles are stretched or may need to be divided by subcutaneous tenotomy. If the manipulation is successful, the sound of the head of the femur suddenly entering the acetabulum is heard and the hamstring muscles become taut, so that the knee cannot be fully extended. The child is now placed on a pelvic rest (*Fig. 10*) and one assistant holds the affected limb in the position determined by the surgeon as giving most stability to the hip-joint, while a second assistant holds and steadies the other limb. Plaster-of-Paris bandages are then applied over felt or wadding, encasing the pelvis and lower part of the trunk and extending



downwards on the affected limb to above the knee, or, in some cases, to below the flexed knee.

Much care is needed in nursing so as to prevent the plaster being soiled and softened by urine or fæces. If the child is old enough, she must be trained quickly to the use of the bed-pan or held out frequently over a receptacle. With infants, the best plan is to place sandbags under the back and thighs so as to raise the



*Fig. 11.*—Plaster-of-Paris casing applied after reduction of bilateral congenital dislocation of the hips. (The sand-bags under the thighs and the dish to catch the excreta have been temporarily removed.)

child and allow a kidney dish to remain in position to catch the excreta (*Fig. 11*). For several reasons the surgeon will not wish to change the plaster in less than three months, and with careful nursing there should be no need to do so.

When the plaster is changed, the surgeon may alter the position of the limb. In unilateral cases, he may allow the child to begin walking while still in plaster.

According to the state of the joint shown on X-ray examination, the plaster is retained for six months or longer. Then it is removed and for a few weeks the child is kept recumbent in bed and allowed to move the limb freely. When the surgeon is satisfied that the hip-joint is not likely to re-dislocate and that the muscles of the hip are strong, walking is allowed.



*Fig. 12.*—Showing result of 'shelf' operation for congenital dislocation of right hip.

The nurse should help the child by supporting her from behind, and teach her to keep the toes pointed forward, which makes for stability at the hip.

In those cases in childhood in which reduction of the dislocation cannot be made by manipulation, the surgeon may manœuvre the head of the femur into a position below the anterior superior iliac spine. This is known as 'anterior reposition', and results often in

good function. Alternatively, especially in children over the age of three years, the surgeon resorts to open operation, at which he is able to deal with obstacles to reduction, such as contracture of the capsule below the head of the femur. In cases in which the acetabulum is not deep enough to take the whole head of the femur, or in which the head cannot



*Fig. 13.*—Showing result of 'bifurcation' operation for congenital dislocation of left hip.

be brought into the acetabulum at all, the surgeon constructs a shelf of bone over the head and thereby makes the hip more stable (*Fig. 12*). In adolescents and adults this 'shelf' operation may also be done, or the surgeon adopts some other procedure for stabilizing the hip, of which the operations known as the Lorenz bifurcation (*Fig. 13*) and the Schanz subtrochanteric osteotomies are at present the most in use.

### CONGENITAL TORTICOLLIS

Torticollis or 'wry-neck', meaning twisting of the neck, is fairly common as a congenital deformity. As with other congenital deformities, the essential cause is unknown. A few cases can be traced to an injury of one of the sternomastoid muscles at birth, a condition which is apt to happen in a difficult labour, and is shown for some months by a thickening at one point in the muscle. But in the majority of cases there is no history of such an occurrence, and there is merely shortening of one sternomastoid with nothing to explain it.

Apart from congenital deformity, torticollis may be caused by paralysis of the muscles of one side of the neck, tuberculous or other disease of the bones or joints of the cervical spine, scarring of the skin of the neck from burns or wounds, or it may be part of a general lateral curvature of the spine. In an acute form, torticollis may occur by contraction of the neck muscles from irritation of their nerves by inflamed lymph-glands. Lastly, it may be an hysterical manifestation.

The congenital form is present from birth, is painless, and is not associated with any disease. The head is inclined to the same side, and the chin is turned to the opposite side and tilted upwards (*Fig. 14*). Movements of the head are painless and freely performed except in directions opposite to the deformity. Attempted movement in these directions causes the shortened sternomastoid muscle to stand out. The face is slightly smaller on the same side as the shortened muscles. In older children the cervical spine is altered in shape secondarily, having a lateral curve to the side opposite to that of the shortened sternomastoid.

TREATMENT.—In infancy, if a lump is present in one sternomastoid, the muscle should be stretched

every day by grasping the head and moving it steadily in the opposite directions to the deformity, while the shoulders are held by an assistant. The same treatment should be given in mild cases of deformity when no lump in the muscle can be felt. With more than slight deformity, the surgeon assists the manipulative correction by dividing or lengthening the short sternomastoid muscle. This may be done by subcutaneous tenotomy or through an incision. After operation,



*Fig. 14.*—Congenital torticollis.

some surgeons fix the head for some days in a corrected position with plaster-of-Paris or hold it with sandbags. Thereafter, a prolonged course of stretching daily by a masseuse is necessary to obtain full correction.

It is important to treat all cases at as early an age as possible, before secondary changes in the shape of the bones of the spine have occurred. If cases are treated adequately in the first three or four years of life, complete cure is obtained.

#### **CERVICAL RIB**

In this condition an extra rib, usually incompletely formed, is present on one or both sides of the neck, attached to the seventh cervical vertebra (*Fig. 15*). The

condition is more common in women than in men, and is sometimes familial. In most cases there are no symptoms; when present, they usually do not occur until adult life is reached. The patient may then complain of weakness of the limb when tired, and pain in the inner side of the forearm and hand. The

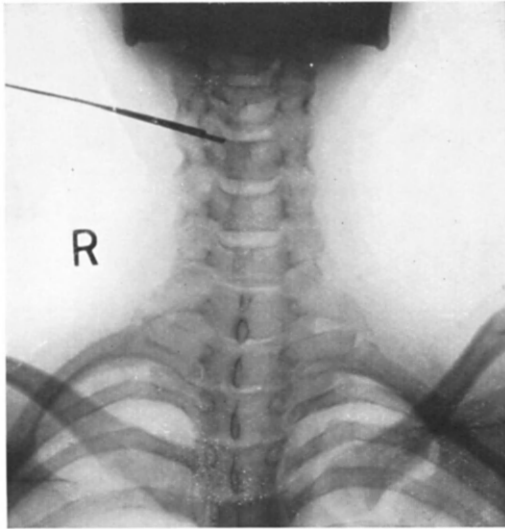

*Fig. 15.*—Bilateral cervical ribs. The abnormal ribs can be seen arising from the seventh cervical vertebra and apparently articulating with the first thoracic ribs.

intrinsic muscles of the hand become wasted, and there may be disturbance of the blood circulation in the hand. These symptoms are due to pressure on the nerves and vessels of the arm as they pass over the abnormal rib in the neck.

**TREATMENT.**—When symptoms are present, the treatment is to remove the rib by operation.

*CHAPTER III***POSTURAL DEFORMITIES**

POSTURAL deformities are the result of deficiency of the mechanism for maintaining the normal erect posture of the body. Every animal has a characteristic posture or attitude in standing. The fully erect posture is peculiar to man. Many other animals make temporary attempts to assume this attitude, and in the apes it is habitually partially attained. But man is the only animal to have perfected the erect posture, using the hind limbs solely for support and progression and leaving the fore-limbs free for other purposes. In the course of man's evolution, during many hundreds of thousands of years, from an ape-like animal, the gradual attainment of the fully erect position has involved adaptations of all the tissues and organs of the body to meet the new mechanical stresses placed upon them, changes which are still going on. For this reason, probably, some individuals are born with their adaptations less perfect than in the majority of men, and in these the erect posture is delayed in development or is never perfectly attained; or it is liable to breakdown under strain.

**Maintenance of Posture.**—The erect posture is maintained solely by muscular action. This action is of a special kind, known as 'postural' contraction to distinguish it from the 'phasic' contraction which takes place in a muscle when a voluntary movement is performed. Postural contraction is the result of a continuously acting nervous reflex, the chief stimulus of which is the stretch of the muscles due to the joints

tending to bend under the influence of gravity. The reflex is affected also by stimulation of the nerves of the skin, eyes, and labyrinth, and the postural reflexes of the whole body are co-ordinated and controlled by nerve centres in the brain. During standing postural contraction is present in all those muscles which resist the action of gravity upon the joints. This neuromuscular mechanism for maintaining posture is not present at birth. A newborn child has no means of holding himself firmly in one position, though he can move his limbs by phasic contraction of his muscles. As he grows, his nervous system continues to develop, including the nerve-fibres concerned in the posture-maintaining mechanism. Thus, after a few months he can hold up his head, and then sit up; but he has first to crawl before he can begin to stand, and he is one to two years old before he can walk steadily. The erect posture is therefore only gradually assumed by the growing child, indicating that it is a relatively new feature in the human species. Even adults are readily fatigued and are unable to maintain the erect attitude constantly for more than a short time.

**Causes of Postural Disorder.**—The maintenance of posture being effected through a nervous reflex, disorders of posture are to be regarded as evidence of an imperfectly developed or functioning nervous system; that is to say, they are functional nervous disorders. The activity of the nervous system may be depressed by acute or chronic illnesses, toxæmia from infected tonsils or other septic foci, imperfect diet, unhygienic conditions of living, mental or physical fatigue from overwork at school or elsewhere, or emotional stress from bad home conditions. All these are possible causes of generalized postural deficiency. In certain parts, such as the foot, they may be accentuated by conditions of local strain.



**Bodily Types.**—Bodily type is another factor contributing to general or local postural disorder. There are several fairly distinct types according to bodily structure.

*Normal Type.*—The trunk is moderate in length and breadth, and the chest rounded and equal in circumference to the upper abdomen, which is also rounded. The lower abdomen is flat, and all the abdominal viscera, except a part of the small intestine and the lower end of the colon, are above the level of the umbilicus. The viscera are supported partly by their fascial connections and the slight forward slope of the lumbar spine, but mainly by the pressure maintained by the postural contraction of the muscles of the abdominal wall, the perineum, and the diaphragm.

*Slender Type.*—Here the whole body is lightly built and deficient in fat. The chest is relatively long, narrow, and flat, while the abdomen is short and the pelvis broad, so that the lower is wider than the upper abdomen. The skeleton is lightly made and flexible. The musculature is poor. The abdominal mesenteries are long, allowing abnormal mobility of the intestines and other organs. In persons of this type the abdominal viscera are apt to descend to an abnormally low level during standing (visceroptosis), and other postural disorders are common.

*Sthenic Type.*—A third type is the heavily built or sthenic type, in which the trunk is disproportionately large in relation to the limbs. The neck is short, the chest broad, the abdomen long, and the pelvis narrow. The viscera are placed high and have short mesenteries. The skeleton is heavily built and less flexible than normal. This type has little tendency to postural deformity.

**Normal Erect Posture.**—The normal erect posture is that position in standing in which the strain of

supporting the body-weight against gravity is taken by the muscles rather than by ligaments. The head is held up and back and the chin drawn in; the chest is held high, the abdomen retracted, and the spine



*Fig. 16.*—Normal erect posture.

extended without exaggeration of the normal forward lumbar curve; the hips and knees are extended, the feet together, parallel, and neither turned in nor turned outward (*Fig. 16*).

**Generalized Postural Deficiency.**—This is shown by the position in standing known as ‘the relaxed attitude’ or ‘the attitude of rest’, which is in truth one of fatigue, because its purpose is to transfer the strain

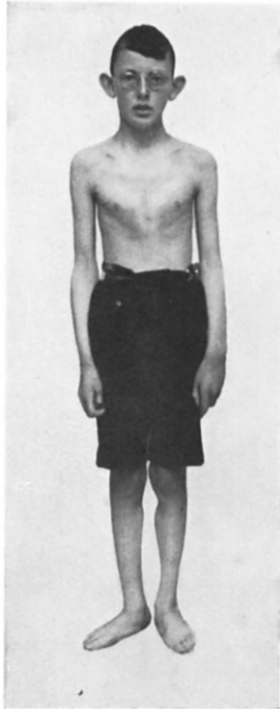

Fig. 17.—Generalized postural deficiency.

of the body-weight from the muscles to the ligaments. The head and shoulders droop forwards (*round shoulders*), the chest is flattened, the backward curve of the thoracic spine is increased (*kyphosis*), and the forward curve of the lumbar region increased (*lordosis*),

with forward tilting of the pelvis and protrusion of the lower abdomen. The hips and knees are slightly flexed, the knees are also abnormally angulated inwards (*genu valgum*), and the feet are apart, depressed, and turned outwards (*flat-foot*), and often show accompanying deformities of the toes, such as *hallux valgus* and *hammer-toe*. This attitude (*Fig. 17*) is not only ugly, but also leads to mechanical interference with the functions of the thoracic and abdominal viscera, and thus to general ill health. The components of the attitude may occur singly when some local cause of strain is present.

A disorder of posture localized to the spine is *lateral curvature (scoliosis)*. This differs from other postural disorders in being a position not ordinarily assumed in fatigue. It appears to be due to lack of balance between the muscles on either side of the spine from some cause not yet understood.

TREATMENT OF POSTURAL DEFORMITY.—All postural deformities are at first and often for a long time reducible by voluntary effort, and therefore capable of cure by the removal of causal factors and re-education. In neglected cases, sooner or later the faulty attitude becomes fixed by alterations in the length and shape of the muscles, ligaments, and bones, making correction difficult or impossible.

The general treatment of postural deformity is : (1) To remove causes of ill-health or of mental or physical fatigue ; (2) To re-educate the patient to maintain the normal habit of posture ; (3) To provide supporting appliances if necessary, while the normal habit is being acquired.

In re-educating a patient to the normal posture, the aim should be to develop a sense of the correct position and then to make maintenance of the position habitual. Exercises should be given always with that aim in mind, not simply with the idea of developing muscles.

Music is valuable by increasing interest in exercises, lessening fatigue, and improving co-ordination of movement. Whenever possible, all exercises should be given with this aid.

*Progressive Exercises for Generalized Postural Deficiency and Postural Kypho-lordosis.—*

1. Lying, correct posture (head extended, chin drawn in, arms at sides, slight space only between lumbar spine and couch when hips extended, legs together).
2. Lying, correct posture, deep controlled breathing through nose (abdomino-thoracic), arms passively abducted during inspiration.
3. Lying, correct posture, deep breathing, arms actively abducted during inspiration.
4. Lying, correct posture, leg-raising and -abduction, singly and both together.
5. Lying, pelvis-tilting backwards and forwards.
6. Squatting ('tailor-sitting'), neck firm, controlled breathing.
7. Tailor-sitting, head-rotation and -flexion.
8. Forward-lying, neck firm, head-extending.
9. Leg-forward-lying, neck firm, head-extending.
10. Wing-sitting, trunk-forward-bending at hips and raise. Hold correct posture.
11. Standing, correct posture (head extended, chin in, chest forward, abdomen retracted, hips and knees extended, feet together, parallel, toes pointed forward). Hold posture, standing against door or post: lower part of sacrum, upper part of thorax, and back of head should touch post. With and without use of a long mirror.
12. Standing, hold correct posture while deep-breathing with arm-parting.
13. Standing, relax and slowly regain correct posture, with and without mirror.
14. Standing, arms at sides, bend knees and touch ground, slowly rise to correct position.
15. Walking round room, changing position of arms every two steps from bend to stretch, back to bend, to yard, etc., holding correct posture.

HOME EXERCISES (twice daily).—

1. Posture correction, sitting and standing in front of door, and constantly.
2. Tailor-sitting, neck firm, deep-breathing through nose.
3. Sleep in prone position, head resting on flexed forearm.

*Exercises for Partly-fixed Postural Kyphosis and Lordosis.*—The following are examples of mobilizing exercises that may be given, supplementary to the above re-educative exercises :—

A. MOBILIZING EXERCISES FOR KYPHOSIS.—

1. Elbow-bending crawl (children).
2. Stretch-grasp-kneeling, chest-forcing downwards. (Bar to be as low as possible if lordosis is also present.)
3. Stretch-tailor-sitting, force arms backwards (actively and passively).
4. Neck-firm-sitting, chest expansion, knee of masseuse against patient's back, draw elbows backward.

B. MOBILIZING EXERCISES FOR LORDOSIS.—

1. Tailor-sitting (or long-sitting), trunk-forward-bending.
2. Crook-lying, tilt pelvis alternately backward and forward.
3. Crook-lying, extend knees and carry feet over head, raising buttocks.
4. Stretch-stride-stand, trunk-bending forward, touching toes with fingers. (*Note* : If the hamstring muscles are shorter than normal, toe-touching is not possible and should not be forced, as harm may be done to the spine.)

## KYPHOSIS AND LORDOSIS

**Kyphosis** means a curvature of the spine convex posteriorly. It may be a postural deformity or due to other causes. When sharply localized to a few vertebræ it is known as *angular kyphosis*, and is indicative of collapse anteriorly of the bodies of the vertebræ from fracture or disease. A long uniform backward curvature (*rounded kyphosis*) may occur in the thoracic region in adolescents, and is irreducible and sometimes painful; the cause of this state of *adolescent kyphosis* (*Fig. 18*) is not clear; but X-ray films show changes in the intervertebral discs and epiphysial plates of the vertebral bodies which are thought to be due to injury. In old persons, a similar rounded *senile kyphosis* occurs, in which there are either degenerative changes

in the intervertebral discs or decalcification and compression of the vertebral bodies. Kyphosis due to postural deficiency (*round shoulders*) is an exaggeration of the normal backward curvature in the thoracic



*Fig. 18.*—Adolescent kyphosis. Irreducible deformity, in this case associated with short hamstring muscles and changes (herniations of the nucleus pulposus) in the intervertebral discs.

region, usually for a long time reducible, with forward drooping of the head and shoulders. Postural kyphosis is often associated with respiratory obstruction from enlarged tonsils and adenoids and consequent poor chest expansion.

**Lordosis** (*hollow-back*) is an exaggeration of the normal forward curve of the lumbar region of the spine (*Fig. 19*). It is essentially a compensatory deformity to kyphosis or to flexion-deformity of the hip so that the

erect attitude and the balance of the body may be maintained. When lordosis is due to postural disorder, there is deficiency of postural contraction in the glutei, allowing the pelvis to tilt forward, and also in the muscles of the abdominal wall, with prominence of the lower abdomen.



Fig. 19.—Postural kypho-lordosis.

**Flat-back** is the opposite state to lordosis, the normal forward lumbar curve being absent. It is often associated with thoracic kyphosis and with shortening of the hamstring muscles, the effect of which is to tilt the pelvis backward, thereby straightening the lumbar spine.

TREATMENT.—See 'Treatment of Postural Deformity', p. 29.



**GENU VALGUM**

Genu valgum (*knock-knee*) is a common deformity in which there is decrease in the angle, open outwards, which the femur normally forms with the tibia at the knee. It is most often a postural deformity; but it



Fig. 20.—Genu valgum.

may be due to rickets (p. 63), paralysis of the muscles of the knee, or injury or disease of the bones of the knee; or it may be compensatory to deformity of the hip or the foot. Normally, when the knees are extended and the ankles brought together the inner sides of the knees are also touching. In genu valgum, on straightening

the knees and bringing them into contact, the ankles are separated by an interval, which increases with the severity of the deformity of the knees and is used as a measure of the deformity (*Fig. 20*). When the knees are flexed, the deformity disappears.

The usual complaint is of awkwardness in walking and frequent stumbling or falling while running. In some cases the deformity itself by its unsightliness attracts notice, or it is discovered only in examination of an associated deformity of the hip or foot.

TREATMENT.—Apart from attention to causes of postural deficiency, the treatment of postural genu valgum consists of: (1) Drill in correct standing and walking, and voluntary corrective exercises; (2) Passive correction by daily manual stretching of the contracted tissues on the outer side of the knee; (3) Constant passive correction, by raising the inner side of the heel of the shoe, or by an appliance (*Fig. 21*); (4) In the worst cases, with separation of the ankles of three inches or more, operative correction.

The treatment of slight cases consists of slightly raising the inner side of the heel of the shoe, so as to alter the line of weight-bearing through the knee-joint and thus exert a gradual corrective influence. Stretching of the shortened tissues on the outer side of the joint may be done by pressing with one hand on the inner aspect of the extended joint, while counter-pressure is made with the other hand on the outer side of the leg below the joint. It should be done for ten minutes thrice daily. Massage and exercises are used also to increase the tone of the quadriceps and muscles of the inner side of the knee. The most valuable exercise is that of standing and walking correctly. Flexing and extending exercises of the knee are given, with exercises for the often associated flat-foot, such as tip-toe raising and knee-bending. The

aim of the exercises is not merely to strengthen the muscles, but also to re-educate their postural reflexes.

More severe cases require gradual correction by a splint. In young children, the splint is made of wood, padded on the inner side with leather, and extends from the hip to the foot on the outer side of



*Fig. 21.*—Caliper splints with 'g.v.' straps applied. (In taking the photograph the child has been wrongly allowed to turn the left limb inwards to show the outer aspect of the splint.)

the limb. To hold the splint in position, broad webbing bands are used, one of which draws the knee firmly towards the splint. This splint may be adapted either for use in bed or in walking. In older children, an appliance of steel, such as the Thomas knock-knee splint, is used; it consists of a bar on the outer side of the limb, fitted into a socket in the side of the heel of the boot, and with a pad at the upper end in contact with the greater trochanter; a second

bar behind the knee prevents flexion of the joint, and a leather band ('g.v. strap') pulls the knee outwards towards the outside bar. Alternatively, a caliper splint with a 'g.v.' strap is used (*Fig. 21*).

For still more severe cases, division of the femur just above the condyles (supracondylar osteotomy), or of the tibia below the condyles, is performed and the deformity at once corrected. The limb is then immobilized in plaster-of-Paris or in a Thomas knee-splint until the bones have united in the corrected position. To prevent recurrence of deformity, the child must continue to wear a knock-knee splint for six months or more after operation.

### FLAT-FOOT

The term 'flat-foot' is used for a number of clinical states due to breakdown of the normal mechanism for maintaining the shape and posture of the foot. These are : (1) Foot-strain ; (2) Pes valgus ; (3) Pes plano-valgus ; (4) Pes planus ; (5) Flattening of the anterior transverse metatarsal arch. The foot is sometimes flat congenitally or as a result of paralysis or of bone or joint lesions.

The foot is used to support the weight of the body in standing and to raise and propel the body in walking. For the first function, the foot is constructed of intersecting longitudinal and transverse arches. For the second, there is provided a joint at the ankle and multiple joints throughout the foot, which give 'spring' and flexibility to the foot and so increase its efficiency as a lever and absorb shocks.

The natural shape of the foot depends on the form of the bones of the arches. It varies considerably in different persons, from the long and narrow to the short and broad. The height of the longitudinal arch also varies naturally between high and low ; it is higher

on the inner than the outer side, and is highest at the talo-calcaneo-scapoid joint. The transverse arch is most marked at the tarso-metatarsal joints ; at the level of the metatarso-phalangeal joints it forms a low arch known as the anterior transverse metatarsal arch. The arches are maintained normally, when weight is borne, by the long and short muscles of the foot, the joints being kept in the ' neutral ' position. It is only when postural contraction in the supporting muscles is deficient that the strain of weight-bearing comes on the ligaments, producing pain and deformity as the ligaments stretch under the strain.

Deficiency of postural contraction in the muscles of the foot may be due to general causes, when other postural disorders, such as round shoulders and knock-knee, are apt to be associated with it. Or it may be purely local, the result of long-continued local strain, which has exhausted the postural reflex. Conditions of local strain are : (1) Rapid increase of body-weight, adding to the burden borne by the foot ; (2) Prolonged standing, especially in a faulty attitude and when unbroken by periods of free activity ; (3) Incorrect use of the feet in walking ; (4) Shoes which give insufficient support, or through ill fitting interfere with the movements of the feet ; (5) Limitation of dorsiflexion at the ankle or of the great toe, which lessens the normal range of movement and imposes a faulty way of walking ; (6) Corns and other minor lesions, which induce protective but faulty ways of standing and walking ; (7) Mal-union of a fracture of the leg, ankle, or tarsus, deflecting the body-weight to the inner side of the foot. The postural reflexes may also be inhibited locally by some painful state, such as a sprain or fracture (*traumatic flat-foot*) or subacute arthritis (*inflammatory flat-foot*) ; in these, the damage to the bone and joint tissues is also a factor.

In the infant, a flat longitudinal arch is natural, because the postural reflexes are not present. Postural contraction appears as the child grows, and the arch has usually developed by the time walking begins. In some children, in whom the postural mechanism is slow to develop, flattening of the arch persists, constituting *infantile flat-foot* (*Fig. 22*).



*Fig. 22.*—Infantile flat-foot (pes plano-valgus).

**Pes Valgus** (*weak or valgus ankle*) is seen especially in late childhood and early adolescence and in the slender type of individual. It is often part of a generalized postural deficiency. The foot is turned outwards at the subastragaloid joint, making the inner side of the ankle prominent (*Fig. 23*); but the longitudinal arch is not lowered.

In adults, the common forms of flat-foot are foot-strain, pes plano-valgus, pes planus, and flattening of the anterior transverse metatarsal arches. They

are more often due to local strain than to general postural deficiency.



Fig. 23.—Postural pes valgus and genu valgum.

**Foot-strain** is the earliest stage in the development of flat-foot. The postural contraction of the muscles maintaining the arches is becoming deficient, so that strain is coming on the ligaments; but actual depression of the arches is slight or absent. The patient complains of aching under the arches and of tenderness on pressure over the joints. The symptoms are usually most acute in high-arched feet, and sometimes are so severe (*acute flat-foot*) as to prevent walking, and are accompanied by œdema and sweating of the feet. This state is apt to appear in persons who return too soon after an illness to an occupation necessitating much standing, and in those who suddenly change their occupation from a sedentary to an active one

**Pes Plano-valgus** is the result of neglected foot-strain; but it may develop so slowly that there are no symptoms of strain. Pain in flat-foot is caused by

rapid stretching of the ligaments. The deformity itself does not cause pain, but is merely unsightly and impairs the normal functions of the foot. *Pes plano-valgus* is a state of persistent pronation (abduction plus eversion) with depression of the longitudinal arch of the foot, the natural effect of gravity when the postural



Fig. 24.—Postural pes plano-valgus.

contraction of the supporting muscles is deficient (*Fig. 24*). The deformity may remain for a long time correctable by a voluntary effort or by a passive movement, or may become fixed (*rigid flat-foot*) by adaptive changes, at first in the soft tissues, later in the bones. If it develops rapidly, the deformity may be accompanied by spasm of the peroneal muscles, which is probably due to a nervous reflex, the stimulus arising in the strained ligaments on the inner side of the foot.

**Pes Planus** is a condition in which flattening of the longitudinal arch is more evident than pronation of the



foot (*Fig. 25*). Persons who acquire this deformity have a naturally low arch, so that when deficiency of postural contraction in the muscles occurs, little pronation or further flattening of the arch can take place.

**Flattening of the Transverse Arch** is most evident at the anterior transverse metatarsal arch at the base



*Fig. 25.*—Postural pes planus.

of the toes. The anterior arch is normally low, and is supported by the intrinsic muscles of the sole passing to the toes. If the normal movements of the toes in walking are prevented by a shoe which is too short, too narrow, or has a high heel causing the foot to be crushed forward into the front of the shoe, the muscles of the toes become weak from disuse and the anterior transverse metatarsal arch thus loses its support. The ligaments of the arch soon stretch and the arch is flattened. With this the toes are dorsiflexed or

'retracted'. The accompanying pain is known as 'metatarsalgia' and may be severe. Corns form on the toes, and hard masses of skin (callosities) on the sole under the heads of the metatarsal bones.

TREATMENT OF FLAT-FOOT.—The aim of this is : (1) To remove causes of postural deficiency ; (2) To restore, if possible, the natural form of the foot ; (3) To relieve strain on the ligaments by holding the foot in the normal attitude until the postural contraction of the muscles has returned ; (4) To re-educate postural contraction.

*Foot-strain* requires no other treatment than removal of causes. This includes education in the correct use of the feet, and provision of proper shoes. Both in standing and walking the feet should be parallel and pointed directly forwards. They should not be turned out, because this throws strain on the inner side of the foot and lessens its power as a lever. In walking, weight should be placed first on the outer side of the heel ; then on the outer border of the foot ; as the heel is raised, the weight should be taken by the ball of the foot and lastly by the toes, the great toe giving the final impulse. The toes should be felt to grip the ground.

In a *correctly made shoe*, the upper fits closely round the heel and waist of the foot, and is roomy enough in front to allow the toes to be straight and to be moved freely. The heel is broad and adjusted in height to the height of the longitudinal arch, a high-arched foot requiring a higher heel than a low-arched ; from three-quarters to one-and-a-half inches is the correct height for most persons. The inner border of the sole is straight, or nearly so, conforming to the normal line of the great toe. The shape and width of the sole correspond to those of the foot when taking weight. The sole is strong but not rigid.

The shank is broad and strong and made of leather without a metal stay, which would rob it of the slight flexibility it should have. The length of the shoe is, as a rule, three sizes larger than of the foot.

*When deformity is present* and irreducible by a voluntary or passive movement, the surgeon may manipulate the foot forcibly under an anæsthetic, sometimes with the aid of an orthopædic wrench. The foot will then be fixed in full supination in plaster-of-Paris for three weeks to allow the ligaments of the inner side to shorten ; or, in slight cases, massage and exercises are begun at once.

When the deformity is flexible or has been made so, in addition to removal of causes and instruction in the correct use of the feet, re-educative exercises are taught, and the shoe is altered to hold the foot in the normal position.

*Re-educative Exercises.*—Re-education consists of frequently repeated voluntary movement to undo the deformity until holding the normal attitude becomes constant and habitual. Exercises follow this principle, and are not merely to strengthen the muscles. In general, the patient is taught to try constantly to correct the position of his foot by the movement of supination (inversion plus adduction) and, if the transverse arch is affected, by flexing movements of the toes. He must be made to realize that his active co-operation is essential for success. Examples of exercises are the following :—

- A. CORRECT STANDING.—Feet pointed forwards, parallel, 4 in. apart, knees straight.
- B. CORRECT WALKING.—Feet pointed forwards, parallel, weight successively on outer part of heel, outer part of ball of foot, inner part of ball of foot, great toe. Final impulse from great toe, other toes gripping ground and steadying.

C. RE-EDUCATION OF POSTURAL CONTRACTION (progressive).—

a. *Longitudinal Arch.*—

1. Sitting, foot on ground, draw up arch and hold position without flexing toes or markedly supinating foot.
2. Standing, feet pointed forwards, knees extended, draw up arches and hold as in (1).
3. Standing, on one foot, hold arch drawn up while swinging other leg.
4. Walking with arches held up, feet pointed forwards and parallel.

b. *Anterior Transverse Metatarsal Arch.*—

1. Sitting, feet on ground, draw up anterior transverse metatarsal arch.
2. Standing and walking, hold up arch.
3. Walking, both longitudinal and transverse arches drawn up, feet pointing forwards and parallel.

D. CO-ORDINATING AND STRENGTHENING EXERCISES (progressive).—

a. *For Longitudinal Muscles of Sole of Foot.*—

1. Sitting, foot off and/or on ground, toe-flexing and -extending.
2. Sitting, grip pencil with toes.
3. Standing, heel-raising and -sinking, gripping ground with toes.
4. Walking, heel and toe.

b. *For Lumbricals, Interossei, and Transverse Muscles.*—

1. Sitting, foot off and/or on ground, flexing metatarsophalangeal and extending inter-phalangeal joints.
2. Sitting, foot off and/or on ground, abduct and adduct toes.
3. Sitting, pick up marbles with toes and place in box.

c. *For Supinators of Foot.*—

1. Sitting, supinate foot and hold.
2. Sitting, circumduct foot, finishing in supinated position and hold.
3. Sitting, pick up a ball with soles of feet.
4. Standing on outside edge of foot.
5. Standing, outside edge, heel-raising and -sinking.
6. Walking, outside edge.

d. *For Calf Muscles.*—

1. Sitting, flexing and extending ankle.
2. Standing, heel-raising and -sinking, feet pointed forwards and parallel.
3. Standing, alternate heel-raising and toe-raising.

4. Standing, heel-raising, knee-bending (knees bent in straight line with toes, parallel, 1 in. apart).
5. Standing, heel-raising, knee-bending, with arm exercises.
6. Walking, goose-step.

*E. HOME EXERCISES* (twice daily).—

1. Tailor-sitting.
2. Standing, draw up arches and hold.
3. Picking up marbles with toes.
4. Outside-edge-walking.
5. Heel-raising and -sinking, gripping ground with toes, feet pointed forwards.

*Special Shoes.*—An orthopædic shoe for flat-foot is merely a properly made shoe, as described above, altered to counteract deformity. To support the longitudinal arch a piece of stiff leather, padded on its under side with felt to conform to the shape of the arch, known as a ‘valgus pad’ or ‘support’, is used. For the transverse metatarsal arch a ‘metatarsal pad’ of spongy-rubber or felt, covered by thin leather, is provided. These supports should be permanently fixed in the shoe. If they are added to a ready-made shoe, the shoe should be made on the lines already stated. Metal appliances, which may be moved from one pair of shoes to another, are not advisable; as supports they are inefficient unless placed in properly made shoes, and in any case they are harmful because of their rigidity, the foot being naturally a flexible structure. When there is pronation (valgus) deformity, a ‘valgus wedge’ is added to the heel of the shoe. This is a piece of leather inserted into the inner side of the heel so as to raise that side. By this means the shoe and foot are tilted into slight supination, and strain on the inner side is relieved.

### HALLUX VALGUS

Hallux valgus is a deformity of the first metatarsophalangeal joint with deflection of the great toe towards the midline of the foot. Occasionally it is congenital,

or due to paralysis or gouty or rheumatoid arthritis of the joint. But usually it is a postural state from wearing shoes which are too pointed or short, or from faulty use of the foot. In young children and in uncivilized races, the great toe is turned slightly inwards (abducted) in standing and walking. This is not permitted in the modern shoe, which tends instead to hold the toe deflected outwards. The abductor muscles are thus persistently strained and lose their postural tone. Turning out the feet in walking accentuates this by throwing pressure on the inner side of the great toe. From the same causes, flat-foot is often associated with hallux valgus.

All degrees of deformity are seen, from slight deflection to a state in which the great toe lies almost at a right angle to the first metatarsal under the second toe. The head of the first metatarsal is made prominent by the displacement of the great toe (*Fig. 26*), and the pressure and friction of the shoe over the prominence cause thickening of the skin and formation of a bursa, known as a *bunion*. This bursa is liable to become painful through inflammation. The continued irritation of the shoe also affects the bone, causing an overgrowth (exostosis) under the bursa. Sooner or later osteo-arthritis develops in the joint and is a further source of pain.

TREATMENT.—The treatment in slight cases is merely to provide properly made shoes and to treat the associated flat-foot in the way described above. The great toe may be passively straightened frequently, and faradic and active exercises of the abductor muscle of the toe may be given. For more severe cases an operation is performed. This consists, according to the degree of deformity and the presence or absence of osteo-arthritis, either of removal of the exostosis and bursa and forcible straightening of the toe, or of

excision of the head of the metatarsal with the exostosis and bursa. After either operation the patient is able to walk in two or three weeks, being provided with a properly made shoe, and the treatment for flat-foot is continued.

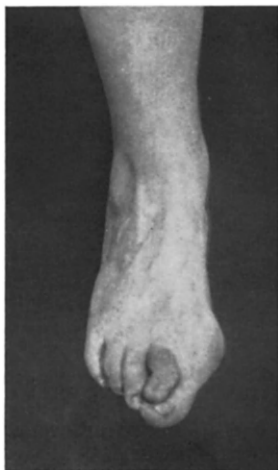

*Fig. 26.*—Hallux valgus and hammer-toe.

### **HAMMER-TOE**

This is a fixed deformity of flexion of a toe, usually the second. It is sometimes congenital; but ordinarily it is acquired by wearing short and narrow shoes, and is thus often associated with hallux valgus. The toe is bent into a C or Z shape, the proximal phalanx being hyper-extended, the middle phalanx sharply flexed, and the distal phalanx flexed or extended (*Fig. 27*). The sharp angle of the proximal inter-phalangeal joint and the tip of the toe are exposed to pressure; painful corns grow at these points and are the usual causes of complaint.

TREATMENT.—In slight cases, the deformity can be corrected by repeated stretching manually, and by wearing at night a metal sole-plate to which the toes are tied down by tapes. In severe cases in adults an



*Fig. 27.*—Hammer-toe.

operation is done, the proximal inter-phalangeal joint being excised; the toe can then be straightened and fixed thus in a splint; it becomes rigid in a few weeks by union of the raw ends of the bones.

### INGROWING TOE-NAIL

This condition is really an ulceration of the nail-fold at the side of the nail. It is usually seen at the outer side of the great toe, and is due to compression of the toe by a tight shoe and neglect of cleanliness and trimming of the nail. The nail-fold becomes painful, red, and swollen, and soon the edge of the nail is embedded in granulation tissue.

TREATMENT.—Early cases are curable by wearing proper shoes and a mild antiseptic dressing held under the nail-fold by adhesive plaster. In chronic cases, an operation is done either to remove the nail or to cut out in one piece the nail-fold, the edge of the nail, and the underlying matrix.



### ONYCHOGRYPHOSIS

This is a state of overgrowth of the nail, commonly affecting the nail of the great toe. It is probably due to persistent irritation from dirt or the pressure of the shoe. The nail is greatly thickened, distorted, and horny.

**TREATMENT.**—The only satisfactory treatment is complete removal of the nail with its matrix.

### CORNS, CALLOSITIES, AND PLANTAR WARTS

**Corns and Callosities.**—A *callosity* is a hard diffuse thickening of the horny layer of the skin, due to intermittent pressure over a long period. A *corn* is a localized dense thickening of the horny layer, usually cone-shaped, due also to intermittent pressure. Hard corns form on the exposed aspects of the toes; soft corns in the soft skin between the toes. Sometimes the pain of a corn is partly caused by an exostosis which has formed on the underlying bone; or the pain may be increased by inflammation under the corn.

**TREATMENT.**—The essential treatment and only means of permanent cure of both corns and callosities is to remove the cause. This may be merely an ill-fitting shoe, or a deformity such as flat-foot or hammer-toe. The hardened skin in either state may be destroyed by caustics, zinc ionization, or diathermic fulguration, or it may be pared away with a knife. Alternatively, temporary relief of pain may be given by fixing adhesive felt padding around the corn or callosity to prevent it from being pressed upon by the shoe.

**Warts.**—A wart is a little tumour composed mainly of epidermis, but containing a vascular connective-tissue core. It is probably due to some infection,

but the nature of this is unknown. The appearance varies considerably. The ordinary kind is rounded and slightly raised, with a cauliflower-like surface. Another kind, common on the hands, is flat with a roughened surface. Usually, warts are not painful, except on the sole of the foot—plantar warts; in this situation a wart is commonly masked by thickening of the horny layer of the skin around it, appearing like a callosity, from which it is distinguished by being more painful on pressure and by having a central cauliflower-like point.

TREATMENT.—Warts may disappear spontaneously. They may be removed with the knife or scissors, or destroyed by caustics, CO<sub>2</sub> snow, diathermic fulguration, or exposure to X rays. For plantar warts, the last two methods only should be employed, either of which is effective.

### SCOLIOSIS

Scoliosis, or lateral curvature of the spine, is a state of persistent lateral deviation of the whole spine, or of any series of vertebræ, from the midline of the body.

The deformity may be congenital, due to malformation of vertebræ or other defects (*Fig. 28*). It may be due to torticollis, obliquity of the pelvis from unequal length of the legs or deformity at the hip or knee, deformity of the chest from chronic empyema, paralysis of the muscles of the back, or destructive injuries or diseases of the spine. But in the majority of cases, scoliosis is a postural disorder, there being no other ascertainable cause of the deformity.

Postural scoliosis develops usually in early adolescence, and is more common in girls than in boys (*Fig. 29*). A faulty attitude in sitting in school and the carrying of heavy school-bags have been blamed; but

it is doubtful whether these can produce more than a slight and non-progressive curvature. Children who develop postural scoliosis have often a neuropathic family history and are mentally fatigued or subnormal, or have imperfect general health.

The patient is in most cases brought for examination, not because of pain, but of alteration of the shape of



*Fig. 28.*—Congenital cervico-thoracic scoliosis.

the body: a high shoulder, a projecting shoulder-blade, one hip 'growing out', or one side of the chest unduly prominent. Examination is carried out with the trunk and limbs bare and the shoes removed. The patient is made to stand with her weight equally on both feet and the arms by the sides. It is well to wait a minute or two until the attention of the patient is relaxed, when the habitual attitude is assumed, and to begin by observation from the front. The

facial expression, position of the head, symmetry of the chest, level of the pelvis, and any deformity of the limbs are noted. In examining from behind, the position of the head and the level of the shoulders are observed. Alteration of the level of the scapulæ is commonly, but not always, a sign of scoliosis. The outlines of the sides of the trunk are compared to see

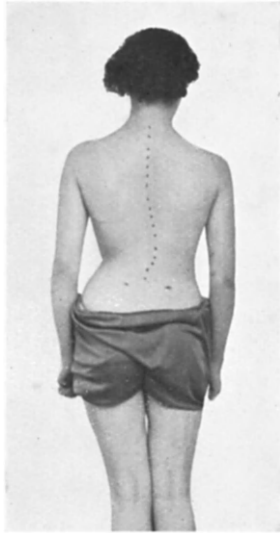

Fig. 29.—Postural scoliosis: total left curve (reducible).

whether one side is more flat or incurved than the other, indicating lateral displacement of the trunk in relation to the pelvis. With this it will be seen whether the arms hang close to or away from the sides. One or both scapulæ may be displaced upward or outward, or may be rotated.

The degree of lateral curvature is made more clear by marking out the tips of the spinous processes with a skin pencil. The curve may be single to one side, involving the whole length of the spine (a *total* curve),

or any part of the spine (a C-curve) (*Fig. 30*). Or the curve may be double (an S curve), or there may be multiple curves. Double and multiple curvatures always alternate to right and left; but the curves may vary in length. For descriptive purposes, the curvature is also named according to the region or regions of



*Fig. 30.*—Postural scoliosis: right lumbar C-curve (irreducible).

the spine affected. Thus there may be total left, right thoracic, left-thoracic-right-lumbar, or other forms of curvature.

Associated rotation of the vertebræ around the vertical axis indicates irreducible deformity; it is always present in double and multiple curves, and sometimes in single curves. It may be obvious when the patient is standing erect by prominence of the back on the convex side of the lateral curve. But it is

shown best by making the patient bend forward and looking along the surface of the back.

After examining from the front and back, the patient should be looked at from the side to determine whether there is any alteration of the normal antero-posterior curves of the spine—that is, whether kyphosis, lordosis, or both are present as well as the lateral curvature.

The reducibility of the deformity is determined by noting how much the lateral curvature disappears when the patient lies prone or is suspended by the head. If the deformity completely disappears, the case is an early one and amenable to treatment. If there is only partial disappearance or no change, the outlook is unfavourable. Irreducibility is due to changes in the muscles, ligaments, and bones of the spine and in the ribs, adaptive to the deformity. Especially is it due to rotation of the vertebræ. Irreducible scoliosis is sometimes called 'structural'.

Finally, the patient is made to lie down and any deformity of the lower limbs is noted and measured. A general examination of the nutritional state, muscular development, eyes, heart, lungs, and other organs is also made. An X-ray examination is advisable to determine whether any congenital anomaly or disease of the spine is present, and to show the degree of distortion of the vertebræ.

TREATMENT.—Treatment by present methods is unsatisfactory. When there is a single reducible curvature, cure is possible. But once adaptive changes have taken place or the curve has become double or multiple, complete cure is unattainable. For this reason early recognition and treatment are most important. In irreducible scoliosis the most that is possible is to arrest progress of the deformity and perhaps to restore partially the symmetry of the trunk.

Apart from the general measures for postural

deficiency (p. 29), treatment consists of postural re-education, preceded and accompanied in some irreducible cases by mobilization of the spine by exercises or passive stretching. In severe irreducible scoliosis, mechanical support should be provided also or alternatively. Re-education is carried out by teaching the patient the correct position of her back, and drilling her to hold the position while she performs exercises of graduated complexity and strength. In this way she acquires the sensation of the normal posture and the habit of maintaining it. The active co-operation of the patient is thus essential for success, and the person giving instruction must exert her personality to obtain the desired effect. The use of a mirror in which the patient can observe her position is valuable. Usually six to twelve months are necessary to effect permanent improvement or cure.

*Exercises for Flexible Postural Scoliosis.*—The following are examples of suitable re-education exercises, in giving which it should be remembered that, as stated above, they are merely means of developing a sense and habit of maintenance of the normal posture. All exercises should be given to music, if possible.

A. RE-EDUCATIVE EXERCISES (progressive).—

1. Lying, correct posture (head midway between shoulders, shoulders level, arms at sides, trunk midway between iliac crests, legs together).
2. Lying, hold correct posture, deep controlled abdomino-thoracic breathing through nose.
3. Lying, hold correct posture, deep breathing with arm movements.
4. Lying, hold correct posture, neck movements.
5. Lying, hold correct posture, hip movements (abduction and flexion), knees extended.
6. Standing, correct posture (as in lying, but with head extended, chin drawn in, chest forward, abdomen retracted, spine extended without exaggeration of the forward lumbar curve, hips and knees extended, feet together, parallel, and pointed forwards), using mirror.

7. Standing, correct posture, deep-breathing through nose.
8. Standing, hold correct posture, deep-breathing with arm movements.
9. Wing-standing, hold correct posture, neck movements.
10. Wing-standing, hold correct posture, hip movements (all), knees extended.
11. Regain correct posture from relaxed positions :—
  - a. Standing, arms at side, flex head and trunk, drop shoulders forwards, relax knees. Then slowly regain correct standing posture.
  - b. Standing, arms at side, knees extended, drop forwards and touch toes. Then slowly regain correct standing posture.
  - c. Standing, arms at side, bend knees and touch ground. Slowly regain correct posture.
  - d. Step forwards with one foot, flex knees, hands to ground outer side of advancing foot, rise slowly to erect position, arms upward-stretch. Then lower arms and regain correct posture.
12. Greek frieze positions, pose.
13. Greek frieze positions, change position with each three steps while walking, running, or skipping.

#### B. STRENGTHENING EXERCISES (progressive).—

1. Leg-forward-lying, neck firm, head-extending.
2. Stretch-stoop-stride-sitting, back-raising.
3. Reach-grasp-stride-sitting, head-bending to convex side of a cervical lateral curve, concentric and eccentric.
4. Stretch-spring-sitting, stretch arm of concave side upwards and sit on buttock of same side.
5. Forward-lying, hip-updrawing on convex side, against resistance.
6. Stretch-stride-stand, swing trunk forwards and downwards, then upwards.
7. Yard-stride-stand, alternate trunk-turning performed with a swing.

#### C. HOME EXERCISES.—

1. Self-correction of standing posture, with mirror.
2. Regain correct posture from relaxed positions.

*Mobilizing Exercises for Scoliosis.*—Mobilization of the spine may be effected by exercises or by head-suspension with a head-sling, which stretches the spine in its whole length and tends to undo both rotation and lateral curvature. Formerly, attempts were made to correct the deformity forcibly by means



of plaster jackets, applied after the trunk had been forced into an improved position ; but the limited success of the method scarcely justifies its use. By no means all cases of scoliosis are suitable for mobilization ; if practised, it must be in association with re-educative and strengthening exercises. Examples of mobilizing exercises are the following :—

*A. LONGITUDINAL STRETCHING.—*

1. Head suspension (for all parts of the spine). If carried out in sitting position, buttocks should be only slightly raised from stool ; if in standing position, patient should be raised on to her toes.
2. Arm-hanging to horizontal wall-bars (for lower thoracic and lumbar spine).

*B. BILATERAL EXERCISES.—*

1. Stride-standing, swing trunk downwards and forwards, knees straight, pick up object placed on outer side of foot of convex side (of spinal curve) with opposite hand. Repeat, reversing.
2. Stride-stand or -sit (to fix pelvis), trunk-forward-bend, trunk-swinging from side to side.
3. Stride-stand, head-bending to right, lowering right shoulder and raising left. Repeat, reversing.
4. Tailor-sitting, arms neck-firm or yard, alternate trunk-swinging to right and left.
5. Stretch-stride-stand, swing trunk forwards and downwards, then upwards and back.
6. For cervical spine : (a) Reach-grasp-stride-sit, or -stand, head-flexing and -extending ; (b) Reach-grasp-stride-sit, or -stand, alternate head-side-bending ; (c) Reach-grasp-stride-sit, or -stand, alternate head-rotating ; (d) Reach-grasp-stride-sit, or -stand, head-rolling.

*C. UNILATERAL EXERCISES.—*

1. For cervical curvature : Reach-grasp-stride-sitting, quick side-bending of head to convex side.
2. For thoracic curvature : Stride-sitting, side-bending to convex side with hand pressure over angles of ribs on convex side.
3. For lumbar curvature : Forward-lying, swinging legs to convex side, with hand pressure over transverse processes on convex side.

(*Note.*—All exercises should be given in time to music.)

*Supporting Appliances.*—Mechanical support for severe cases is provided by a removable corset (*Fig. 31*).

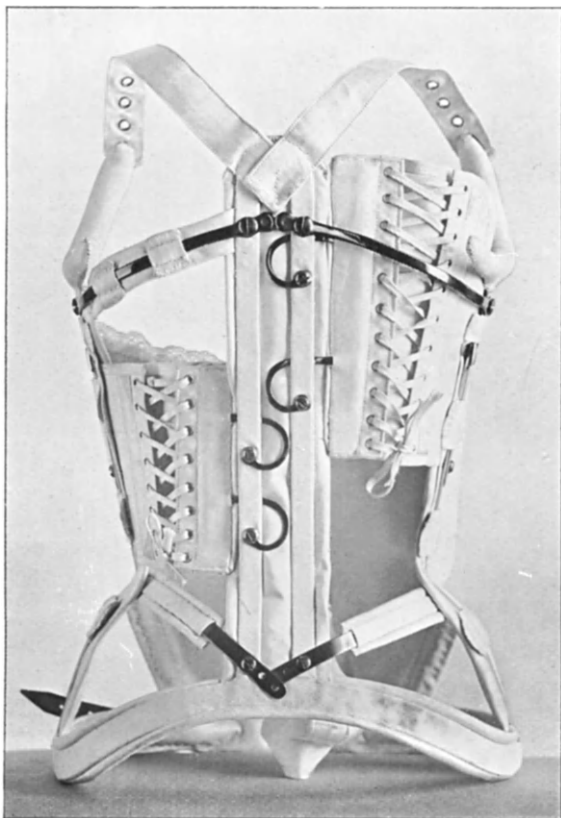

*Fig. 31.*—Steel-and-stay spinal supporting appliance (Ernst).

The most efficient is a steel-and-stay appliance ; but leather, celluloid, and poroplastic felt supports are also used. A spinal supporting appliance has no

curative value ; it merely holds the spine in the best position obtainable and thus relieves aching and prevents further development of the deformity. For use at night, a plaster bed may be given ; this is made (p. 232) while the patient is lying prone with the deformity corrected as much as possible.

*Operative Treatment.*—To obviate the need of an appliance, a spinal fusion operation is done by some surgeons. A plaster bed is first made. At the operation, bone-grafts are placed so that the spine is made rigid over a wide area including the site of maximum lateral curvature. The patient is placed in the plaster bed at the end of the operation and lies continuously in it until bony fusion is complete. The operation is a severe one and is practised only in selected cases.

Scoliosis due to causes other than postural deficiency is treated primarily according to the cause. Thus, for the common curvature due to a short lower limb, all that is usually required is to equalize the limbs by raising the heel of the shoe on the short side. Severe fixed deformity from any cause should always be supported and controlled by an appliance.

*CHAPTER IV***RICKETS**

RICKETS is a so-called 'deficiency' disease, due to faulty feeding and lack of sunlight. It is a disease of the whole body, but the chief manifestations are in the bones. It is most common among children artificially fed and in the first three years of life, though it may occur later during the growing period. Essentially, it is caused by lack of vitamin D, a chemical substance present in maternal and un-boiled cow's milk, cream, butter, and other foods. This vitamin is formed also by the action of sunlight on the natural fats secreted in the skin glands. In the body, it is concerned with the deposit of lime salts in growing bone, by which the bones are hardened. Hence, when the supply of the vitamin is deficient, the bones are softened and the epiphysial cartilages are enlarged, because new cartilage is formed by growth, but remains uncalcified.

A child afflicted with rickets usually looks fat and well, though he is apt to suffer from digestive and respiratory disturbances. The teeth are soft and decay rapidly and the muscles lack normal tone. The head is quadrangular in shape and the fontanelles are large and close late. The chest is flattened from side to side, making the sternum prominent ('pigeon-breast'). On each side of the lower part of the chest is a horizontal groove, known as 'Harrison's sulcus'. The junctions of the ribs and costal cartilages are enlarged, forming a line of nodes on each side, the so-called 'rickety rosary'. The enlargements of the

epiphysial cartilages at the wrist can be seen or felt. The abdomen is prominent.

The deformities in rickets are produced by gravity and weight-bearing, acting on the softened bones and atonic muscles. They tend to vary according to whether the disease is most active when the child is at the stage of sitting, crawling, or walking. The spine may be uniformly backwardly curved, or may develop



Fig. 32.—Bow-leg due to rickets.



Fig. 33.—Genu varum due to rickets.

a lateral curvature if the child is carried habitually by the mother on one arm. The arms and forearms may become curved during crawling. The most common deformities are seen in the lower limbs. There may be outward or forward bowing of the tibia and fibula (*bow-leg*) (Fig. 32); outward bowing of the whole length of the limb, most marked at the knee (*genu varum*) (Fig. 33); forward and outward bowing of the femur; decrease of the normal angle of the neck and shaft of the femur (*coxa vara*); increase of the

normal inward angulation of the limb at the knee (*genu valgum* or *knock-knee*).

Activity of the disease is determined with certainty by X-ray examination, which shows characteristic appearances at the junctions of the epiphyses with the shafts of the long bones. When, sooner or later, the body comes to be supplied with a sufficiency of vitamin D, the bones become hardened ; but the deformities are thereby fixed and persist, though the disease is no longer active.

#### TREATMENT

Rickets is entirely preventable by correct dieting and hygiene. If the infant cannot be naturally fed, artificial food should be supplemented with cod- or halibut-liver oil, which is rich in vitamin D. Frequent exposure of the whole body to air and sunlight should also be made. This is also the treatment of the disease when established. Deformities should be prevented by keeping the child recumbent while the disease is active. He can be prevented from sitting up by means of a cloth chest-band fixed to the sides of the cot with webbing straps. Large napkins should not be used because they may cause outward bowing of the thighs. The child should not be allowed to cross one leg over the other, as the mere weight of one limb on the other is enough to produce deformity.

If deformity is present and the disease active, daily manipulation may mould the soft bone back into normal shape. But this is apt to be painful and is often not possible without an anæsthetic. The surgeon may decide to do this, or to make gradual correction by means of a splint, according to the particular deformity present and the age of the patient.

**Bow-leg**, if slight, is treated by a padded wooden splint, applied on the inner side of the leg from above

the knee to the foot, towards which the bowed leg is drawn by bandaging or by broad webbing straps. When the child is allowed to walk, the lower end of the splint is fitted into a pocket in the upper of the shoe. In more severe cases, the surgeon forcibly bends the bone straight over an orthopædic wedge; or, if the disease has ceased and the bones are hardened, he fractures the bones partially at the point of maximum curvature manually over a wedge (osteoclasia), or divides the bones by open operation (osteotomy). After any of these procedures, the leg is fixed with the deformity corrected, either in wooden splints or in plaster-of-Paris. Subsequently, when the bones have re-united, the child walks with the wooden splint applied as described above.

**Genu Varum** requires a splint reaching to the top of the thigh. In severe cases the deformity may be corrected by division of the femur above the condyles (supracondylar osteotomy).

**Genu Valgum** is more often a postural disorder than due to rickets. The symptoms, signs, and treatment of the deformity are described on p. 34.

**Coxa Vara** is a much less common deformity in rickets than either bow-leg or knock-knee, and is usually not evident until an older age. In this deformity, the angle between the neck and shaft of the femur is diminished. It may be due to causes other than rickets, such as injury or disease of the head or neck of the femur. In rickety deformity, the symptoms are not marked, except in bilateral cases, when lordosis and waddling gait are present. The greater trochanter is at an abnormally high level, above Nélaton's line. Abduction and internal rotation of the hip are limited.

In a young child, the deformity may be corrected by gradually abducting the limbs while the child is

kept on a double abduction frame. In older children, it is necessary to divide the femur just below the greater trochanter (subtrochanteric osteotomy), after which the limb is forcibly abducted and fixed in plaster-of-Paris until the bone has reunited in the corrected position.

**Deformities of the Spine** during the active stage are prevented by recumbency. When present, they may be gradually corrected by fixation in a plaster-of-Paris bed. Later, exercises are used, and in a few cases a spinal supporting appliance is necessary.

**Deformities of the Upper Limbs** rarely call for treatment, since they usually cause no disability.



## CHAPTER V

**DISEASES OF THE NERVOUS  
SYSTEM**

ORTHOPÆDIC treatment is required in those diseases of the nervous system which are accompanied by deformity or by paralysis, that is, by loss of power or control of the voluntary muscles. There are two forms of paralysis: (1) *Spastic paralysis*, due to a lesion of the upper motor neuron, and characterized by defective voluntary control of movement, muscular rigidity, exaggerated tendon reflexes, and normal electrical muscular reactions; (2) *Flaccid paralysis*, due to a lesion of the lower motor neuron, and denoted by loss of power of voluntary movement, muscular relaxation, absent tendon reflexes, and altered electrical muscular reactions. The commonest forms of spastic paralysis treated by orthopædic surgery are *cerebral paralysis of childhood* and '*compression*' *paraplegia*; of flaccid paralysis, they are *acute anterior poliomyelitis*, *peripheral neuritis*, and *peripheral nerve injury*. The last is considered elsewhere (p. 191).

**CEREBRAL PARALYSIS OF CHILDHOOD**

This paralysis may affect only the lower limbs (paraplegia), the upper and lower limbs of one side (hemiplegia), all four limbs (diplegia), or, rarely, one limb alone (monoplegia). It is often congenital, when it is due either to imperfect development of the brain or to injury to the brain during labour. In infancy and early childhood, the paralysis may result from

inflammation of the brain and its coverings (meningo-encephalitis), or develop during the course of a specific fever. The underlying pathological state is degeneration of nerve-cells in the motor area of the brain and the lateral columns of the spinal cord.

In a few cases, some stiffness or deformity of the affected limbs is noticed in infancy; but often nothing is observed by the mother until the child is old enough to stand and walk. She then notices that the child is backward in beginning to stand, awkward in movement, does not use the limb, or is deformed. Mental development, including speech, may also be delayed, and there is often emotional instability and defective bladder control.

On examination, certain groups of muscles are found to be abnormally strong, overcoming their antagonistic muscles and fixing the limbs in certain positions. At first these positions can be reversed by firm continuous manual pressure, under which the spastic muscles are felt to relax with a 'clasp-knife' sensation. Later, the muscles may become rigid in a different way, being permanently shortened by fibrous changes within them, so that they can no longer be stretched. The ligaments and other tissues around joints become adaptively changed, and finally the bones are also altered, making the deformity permanent. There is no disturbance of sensibility or of the electrical reactions of the muscles; but the tendon reflexes are exaggerated, and in paralysis of the leg the plantar reflex results in extension instead of the normal flexion of the great toe.

In paraplegia, the commonest positions of the limbs are adduction of the hips (sometimes to such a degree that the limbs are crossed), flexion of the knees, and plantar flexion of the feet (talipes equinus). If the child can walk at all, he does so on his toes and is unable to make the heels touch the ground.

In hemiplegia, the arm is almost always more affected than the leg. The position of the arm is usually one of slight abduction at the shoulder, flexion of the elbow, pronation of the forearm, and flexion of the wrist and fingers. Usually the child does not use the arm or is awkward with it. The leg is in the same state as in paraplegia.

The worst cases are those with diplegia, in which all four limbs are affected, and there is sometimes also disturbance of the muscles of the head and neck and deformity of the back. In these cases, especially, the mental development and the bladder and rectal control are often defective. But it is noteworthy that the mental state tends to improve when the physical condition is benefited by treatment and that the child can often be taught bladder and rectal control.

TREATMENT.—Formerly, spastic paralysis was treated by attempts to stretch the contracted muscles, either by repeated manipulation or by means of splints. This was rarely helpful, because a spastic muscle is only made worse by stretching. A child may to some extent be taught to control the limbs by exercises; but in cases with more than slight muscular rigidity and deformity, such training must be preceded by operations, the aim of which is to obtain a better balance of the muscle groups and to correct deformity. Massage and electrical stimulation are probably actually harmful when applied to spastic muscles; but they have a place in strengthening the stretched and weakened antagonistic muscles after operation on the rigid groups.

The power of the spastic muscles may be diminished by an operation to remove part of their nerve-supply or to lengthen their tendons. An operation on the nerves (neurectomy) is chiefly used for the adductor

muscles of the thigh, the flexors of the knee, and the calf muscles. The nerves are exposed where they enter the muscles, stimulated with the faradic current to make sure that they are motor in function, and a length of each is cut away. In the upper limb the effect of neurectomy is not so good as in the lower limb; but the nerves to the flexors of the wrist and fingers and the pronator teres are sometimes excised. More often, the operation done to relieve flexion contracture of the wrist and fingers is transplantation of the flexor into the extensor tendons at the back of the wrist.

Tendon-lengthening is done either to weaken a spastic muscle or because the muscle has become actually shortened. Thus it may be used either alternatively to neurectomy or to supplement it. The tendo Achillis should be lengthened by an open operation, after which the foot and leg are put up in plaster-of-Paris for six weeks. Other muscles are lengthened merely by dividing them subcutaneously with a tenotome or by cutting lengths of them away through an incision.

After these operations, measures to prevent recurrence of deformity and to obtain the utmost improvement of function are undertaken. The antagonistic muscles are strengthened by massage, faradic stimulation, and active exercise, and the child is taught the use of the limb by being made to do first simple movements and gradually more complicated movements. For the foot, a night splint is supplied; in applying this, the heel should be fixed well into the angle between the foot and leg pieces. Education is especially difficult in the upper limb, because the movements must be more exact and fine than those of the lower limb. The child may be given a game, such as Halma, or a jig-saw puzzle to do. Often

a child has grown so accustomed to using the sound arm that he will not try to use the affected arm even after operation. To overcome this, it is well to tie up the sound limb for part of the day so as to compel use of the other.

### ‘ COMPRESSION ’ PARAPLEGIA

Spastic paraplegia may be due to a lesion of the pyramidal tracts (upper neuron) of the spinal cord without affection of the brain. Occasionally in adults it is due to degeneration of these tracts (*lateral sclerosis*), and the orthopædic surgeon may have to deal with the contractures or uncontrolled painful muscular contractions which are manifestations of the disease. But the usual cause of spinal spastic paraplegia is localized pressure on the spinal cord, from which the term ‘compression’ paraplegia is derived. This pressure may be due to a number of lesions:—

1. Injuries or diseases of the spine causing collapse of vertebræ or severe deformity. By far the commonest of these are fracture and tuberculosis.
2. Tumours of the spinal cord, the meninges, or the spinal canal.
3. Chronic inflammation of the coverings of the cord (chronic meningitis).

Compression paraplegia differs from cerebral spastic paraplegia in that there is not only paralysis, but also loss of sensibility. This is because the pressure on the cord affects the sensory as well as the motor nerve tracts. The symptoms are therefore as follows:—

1. Localized and ‘girdle’ pain from pressure on the nerve-roots at the site of injury or disease.
2. Flaccid paralysis of the muscles supplied from the affected part of the cord.
3. Signs of interference with conduction in the long ascending and descending tracts of the cord:

- (i) Spastic paralysis of the muscles supplied by the nerves arising from the cord below the site of pressure ;
- (ii) Loss of sensibility below the level of pressure ;
- (iii) Interference with bladder and rectal function ;
- (iv) So-called ' trophic ' changes from the normal in the state of the skin and other tissues, including greater liability to damage from heat or injury.

TREATMENT.—The treatment is primarily that of the causal injury or disease. If the pressure on the cord is removed before the cord has been irreparably damaged, the symptoms gradually disappear and may do so completely. The nursing is difficult and most important. The patient is very liable to form bed-sores or to develop urinary infection, either of which gravely complicates the case and may prove fatal. The skin must be kept scrupulously clean, dry, and hardened by the use of soap and water, spirit, and zinc and starch powder, special attention being paid to bony points, such as the sacrum, tuber ischii, greater trochanters, and heels. The patient should lie between smooth sheets, if possible on a water-bed. A cradle should be placed over the lower limbs, high enough to permit full flexion of the knees. Hot-water bottles should not be used unless thickly covered. The patient's position should be changed frequently by lifting rather than dragging him. If a sore has formed, it is best to cover it with a piece of elastic-plaster bandage so as to prevent friction ; moist dressings should not be applied. If the bladder has to be catheterized, the most strict asepsis must be observed. Catheterization may have to be done every six hours to avoid over-distension ; but sometimes, after some weeks, retention is gradually replaced by automatic involuntary emptying of the bladder whenever a certain degree of distension of the organ is reached. If infection takes place, the bladder is irrigated several

times daily with an antiseptic solution and a urinary antiseptic mixture is given by mouth.

If the bowels fail to act, strong aperients and enema should be avoided, as they may cause damage to the rectal mucous membrane. Recourse should first be made to intramuscular injections of acetylcholine, prostigmin, or pituitrin, which may be given daily and repeated if necessary. A simple aperient, such as phenolphthalein, cascara, or senna, may be given also, if required, at night, and the bowel washed out with normal saline in the morning.

There is little place for physiotherapy in this condition, but gentle massage is helpful in maintaining the nutritional state of the skin, and voluntary movement should be encouraged. In such a serious state of physical disability, it is important to provide the patient with suitable mental interest and occupation, and to create for him an encouraging and hopeful outlook.

### **ACUTE ANTERIOR POLIOMYELITIS**

Acute anterior poliomyelitis, known briefly as 'poliomyelitis', or as 'infantile paralysis', is an acute inflammatory disease of the spinal cord. It is the cause of a large proportion of all cases of paralysis and consequent deformity.

The disease is due to an ultra-microscopic organism, which is thought to enter the body by the inspired air through the nasal mucous membrane. It is infectious through personal contact with a patient during the incubation period (four to fourteen days) and also during the first ten days of the acute stage of the disease. Young children are most liable to be attacked, but older children and adults are not immune. One attack usually confers immunity. Isolated cases occur occasionally, and sometimes there are epidemics, especially

in the summer months. Most persons are naturally immune, but may nevertheless become carriers; so that, when cases occur in an institution, they should be isolated, but contacts should not be sent away, because they may carry and disseminate the disease over a wide area.

The pathological changes are first inflammation and then degeneration of nerve-cells in the anterior horn of the spinal cord. Certain muscles are in this way deprived of their nerve-supply and thus paralysed. The paralysis is usually much more widespread at first than ultimately, because many nerve-cells may survive and resume their function. The muscles rapidly waste away. The bones of affected limbs are also changed, becoming slender and brittle and impaired in growth. The blood-vessels may be affected, causing the limbs to become cold and bluish, especially in cold weather. Indolent chilblains are apt to occur on exposed parts. The sensory nerves are not affected.

At the onset, there is a feverish state for a few hours or days, which may be quite trivial. There is nothing distinctive about this, except that there is often pain in the limbs and the child resents being moved or touched. Sometimes the fever is severe and fatal.

Paralysis of the flaccid kind is noticed as the fever subsides. Usually it comes on suddenly and may affect at first a large area of the body. But spontaneous recovery begins within the next six weeks, and proceeds until only one or two limbs, or merely certain muscles of the limbs, remain paralysed. Then follows gradual recovery of the remainder for about two years, after which no further recovery is to be expected. The extent of this recovery depends largely on the efficiency of treatment. It is seldom perfect; but partial recovery is the rule. The distribution of the residual paralysis varies and is characteristically erratic.



The lower limbs are the most commonly affected ; but any muscle or group of muscles of the limbs, abdomen, neck, or head may be paralysed, with or without accompanying paralysis of other parts of the body. Certain muscles are more often affected than

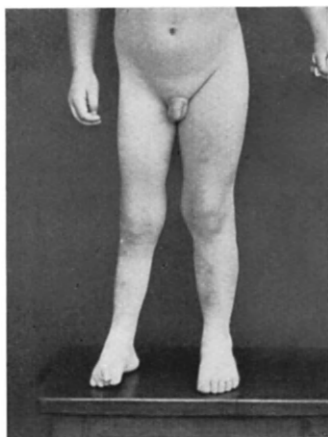

*Fig. 34.*—Severe irreducible scoliosis due to untreated poliomyelitis.

others ; for example, the glutei, quadriceps femoris, and tibialis anticus. Other muscles, such as the tensor fasciæ femoris, usually escape. .

Deformities are apt to develop, though they are entirely preventable, because of the paralysis and resulting loss of muscle balance and support of the joints against gravity. Lateral curvature of the spine (scoliosis) may develop rapidly when the muscles of

the back or abdominal wall are paralysed, and proceed to a severe and permanent state (*Fig. 34*). Partial or complete dislocation of joints, especially the hip and shoulder, may occur. The commonest deformities are seen in the lower limb in flexion of the hip and knee and in various kinds of talipes (*Fig. 35*). Thus, if the dorsiflexors of the foot are paralysed, talipes equinus



*Fig. 35.*—Poliomyelitis of right lower limb. Note wasting of the limb, genu valgum, and talipes equino-varus.

develops through the unbalanced contraction of the plantar-flexing muscles. Deformity may also result from shortening of a limb by impairment of growth of the bones; or from attempts of the body to compensate for a deformity due to paralysis, as is seen in lordosis of a normal back to compensate for flexion-contracture of the hips.

When a deformity first forms, it can be reduced without force. But soon it becomes fixed by stretching of the paralysed muscles and other soft tissues on one

aspect of the joint and shortening of the tissues and muscles on the opposite aspect (*Fig. 36*). Finally, adaptive changes take place in the bones, making the deformity permanent. When all the muscles controlling a joint are paralysed, a fixed deformity does not develop: the joint can be moved in all directions and is in a state known as 'flail-joint'.

The onset of the disease, when fever and acute inflammation of the spinal cord are present, is called the first stage, and lasts about two months. The



*Fig. 36.*—Paralytic talipes equinus. The foot is being held at its limit of dorsiflexion.

second or convalescent stage is that during which recovery from paralysis is occurring, and lasts two years. The third or chronic stage of residual paralysis lasts indefinitely. In this, further recovery of muscles sometimes takes place, but cannot be expected; deformities may progress or new deformities develop, unless prevented; retardation of growth may become more evident until adult age is reached.

#### TREATMENT.

**First Stage.**—In the first stage, while fever is present, treatment consists of rest in bed, administration of aperients, if necessary, and a fluid diet. Pain

is relieved by aspirin or other analgesic drugs. There is no specific remedy against the disease. Serum from convalescent patients or from immunized horses has been used, being given intramuscularly, intravenously, or into the spinal canal ; but there is no proof of its value.

As soon as paralysis is recognized, splints must be applied so as to relax the affected muscles. Massage, movements, and electrical stimulation at this stage are painful and harmful and should not be employed. When a single muscle or group is paralysed, a splint should be applied so as to relax the muscle or group. If opposing muscles or all the muscles controlling a joint are affected, the position of splinting is either the neutral, or else that which protects the most important muscle. Thus the foot is fixed at a right angle to the leg ; the knee straight ; the hip extended and slightly abducted and rotated neither in nor out ; the spine straight and hyper-extended ; the shoulder abducted to a right angle and externally rotated ; the elbow flexed to  $90^{\circ}$  ; the forearm midway between supination and pronation ; the wrist dorsiflexed ; and the fingers semiflexed at all joints. The splints used may be made either of plaster-of-Paris or of metal or other malleable material. If no plaster or splint is available, the positions can be maintained temporarily by sandbags or by pinning the clothing to the mattress. It is best to maintain the position uninterruptedly for two months. If at any time the splint has to be removed, care must be taken, in handling the limb, not to stretch the paralysed muscles by moving the joints.

**Second Stage.**—In this stage, the aim of treatment is to maintain the nutritional state of the muscles, to help them to regain power, and to prevent deformity. The patient is allowed to walk, but only with a supporting

appliance. A splint is provided also for use in bed, and thus the limb is kept constantly in a position protecting the weak muscles. The limb must be warmly clothed during the day, and kept warm at night by woollen stockings and hot-water bottles.



*Fig. 37.*—Poliomyelitis affecting the lower limbs. Walking instruments applied after correction of deformities.

Appliances are designed not only to prevent stretching of weak muscles, but also, in some cases, to assist the action of the muscles (*Fig. 37*); in other cases, they are made to fix or take the place of joints over which there is defective or absent muscular control. Such appliances are usually made of steel, and must be light and well-fitting. Night splints are made of plaster-of-Paris, tin, aluminium, duralumin, celluloid, leather, or wood. To compensate for a short lower limb, the sole of the boot is raised with leather or with cork.

In this stage, various means of physiotherapy are employed. Massage is valuable in promoting a better blood-supply to the muscles; but it must be only gentle friction and kneading, as rougher massage damages the muscles. The galvanic, faradic, and sinusoidal currents are used to exercise artificially muscles which cannot be contracted voluntarily. The most valuable treatment is voluntary exercise of the muscles, when possible, because not only are the muscles exercised in the natural way, but also the patient is educated to the use of his affected limb. Such contractions must be graduated to the strength of each weakened muscle, carefully controlled so that they are confined to that muscle and not extended to its strong antagonists, and must stop short of fatigue. For this reason, treatment by a trained masseuse is always better than exercises done at home by the patient alone or with the help of an untrained person.

If deformity has occurred, the surgeon corrects it before other treatment is begun, either by manipulation under anæsthesia, gradual stretching with a splint, or by operation. The operation consists either of division or lengthening of the tendons of the shortened muscles and joint capsule, sliding of shortened muscles distally at their attachments, or occasionally of division of bone (osteotomy).

**Third Stage.**—In the third stage the surgeon first determines the extent of residual paralysis, and decides whether he can do anything to balance the muscle power or to dispense with an appliance. To balance the power, transplantation of the tendons of healthy muscles to replace the paralysed muscles is sometimes done. In this operation, the tendon of the healthy muscle is cut at its insertion and moved to be fixed at a new point so that the muscle may act in the same way as the paralysed muscle did. The operation is not now

as popular as formerly, as there are only occasional cases in which success can be expected from it. More often operations are done either to abolish mobility at an imperfectly controlled joint (*arthrodesis*) or to make a new and more stable articulation. Both of these procedures are called 'stabilizing' operations. Arthrodesis cannot be done before the age of ten,

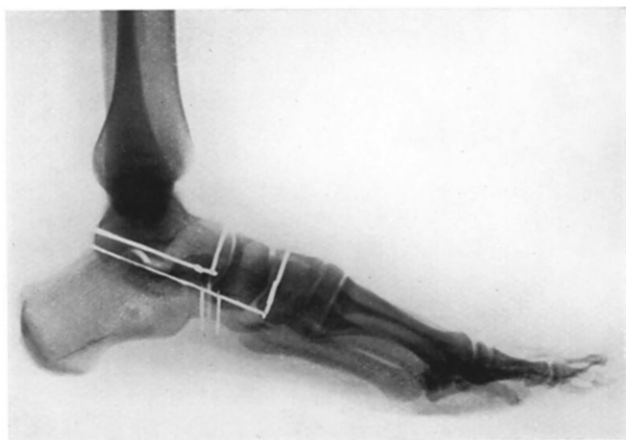

*Fig. 38.*—Showing parts excised (the scaphoid and the articular surfaces of the head of the astragalus, the proximal aspect of the cuneiforms, and the subastragaloid and calcaneo-cuboid joints) in Dunn's operation. The foot is then displaced backwards on the astragalus, and, on fusion of the raw surfaces, becomes a stable structure.

because the ends of the bones, which have to be cut away, are more cartilaginous than at a later age, so that growth is easily impaired. Over that age the operation is of proved value, and is chiefly done at the shoulder, knee, and mid-tarsal joints. For the last-mentioned joints, several methods of operation are practised, of which the most satisfactory is that devised by Naughton Dunn (*Fig. 38*). The other type

of stabilizing operation is illustrated by Whitman's operation on the foot. This consists of removal of the astragalus and displacement of the foot backwards. It can be performed at any age, and results in a useful and stable, though misshapen, foot. Operations to lengthen a short lower limb are also done, and can result in adding two to three inches to the length.

For intractable chilblains, removal of the sympathetic nerve-supply to the affected limb (by cervical or lumbar ganglionectomy) is advisable and permanently effective.

A patient with permanent paralysis from poliomyelitis requires supervision throughout life. Deformity must be prevented, appliances may need alteration or renewal, and operations may become necessary or advisable. Until growth ceases, the patient should be seen by the surgeon at intervals of three months or less ; thereafter, at intervals of six to twelve months.

### PERIPHERAL NEURITIS

Neuritis, meaning inflammation of a nerve, is a relatively uncommon disease, despite the popular tendency to ascribe most superficial pains to it or to neuralgia, which means literally pain along the course of a nerve. The majority of such pains are due to muscle, joint, bone, or blood-vessel affections, or are referred pains from visceral disease.

Neuritis may be caused by toxins from chronically infected teeth or other septic foci, or toxins of infectious diseases such as diphtheria, typhoid fever, and pneumonia. It may also be caused by chronic chemical poisoning by alcohol, lead, arsenic, copper, or mercury. It occurs in metabolic disorders such as gout and diabetes, and in the dietetic deficiency disease known as beri-beri. Chill may be the exciting cause in many cases of neuritis.



The change in the nerve is a mild inflammation of the supporting sheath and sometimes also of the nerve-fibres themselves, which may degenerate. Certain of the causal poisons tend to select certain nerves primarily: alcohol and arsenic affect the nerves of the legs, lead the musculospiral (radial) nerves of the arms, while the diphtheria toxin acts on the nerves of the soft palate and eye muscles.

The symptoms are due to interference with the function of the nerves. If the nerve contains motor

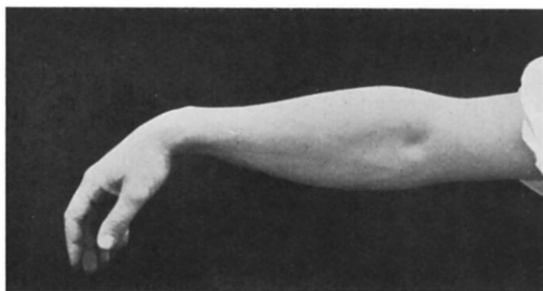

*Fig. 39.*—'Dropped-wrist' from paralysis of the musculospiral (radial) nerve.

fibres, there is partial or complete paralysis of the muscles it supplies, with wasting and loss of tendon reflexes, as in other lower neuron lesions. Deformities are likely to develop, unless prevented, by the action of gravity and the unopposed contraction of the unaffected groups of muscles. For example, in lead neuritis of the musculospiral nerve, dropping of the wrist occurs from paralysis of the extensors and the unopposed contraction of the flexors (*Fig. 39*). If the nerve contains sensory fibres, there are first signs of irritation of these—namely, shooting or aching pain along the course of the nerve, tingling sensations, and

a feeling of soreness (hyperæsthesia) on touching the area of skin supplied by the nerve ; later, there may be definite loss of sensibility (anæsthesia) of the skin, muscles, and joints, accompanied by inco-ordination in movement (ataxia).

**Bell's Palsy.**—Neuritis of the facial nerve, resulting in paralysis of the muscles of the same side of the face, is known as Bell's palsy. This may be due to inflammation of the middle ear, toxins from septic foci, or perhaps to exposure to cold alone. The mouth is drawn to the opposite side and the eye of the same side cannot be closed. At the onset there may be pain round the ear.

**Brachial Neuritis.**—In brachial neuritis, there is constant aching in the neck and shoulder and along the arm, aggravated by movement.

**Sciatic Neuritis.**—The pain in this affection usually begins in the buttock and spreads down the back of the thigh into the leg and sometimes the foot. It is made worse by any movement which puts the nerve on the stretch, such as stooping or flexing the hip with the knee kept straight. Probably to prevent stretching of the nerve, the spine is in some cases flexed laterally to the same side in standing ('sciatic' scoliosis—*Fig. 40*). The nerve is always tender on pressure along part or all of its course, and sometimes there is loss of the ankle-jerk and disturbance of sensation. In many cases of pain along the sciatic nerve (*sciatica*), the cause is not neuritis but pressure on the roots of the nerve in the pelvis or in the intervertebral foramina from disease of the pelvic organs or from malformation, injuries, or diseases of the vertebræ (*Fig. 41*).

**TREATMENT OF NEURITIS.**—The principles of treatment are : firstly, to remove the cause ; secondly, to

relieve pain by means of drugs and physical measures ; thirdly, to protect paralysed muscles and prevent deformity while the nerve is recovering. While pain is acute, it may be relieved by rest, drugs such as aspirin, analgesic liniments, or counter-irritation by



*Fig. 40.*—'Sciatic' scoliosis.

application of the constant current or exposure to ultra-violet light. When the pain is subsiding, but not before, infra-red or radiant heat lamps may be applied once or twice daily ; diathermy is inadvisable as it often aggravates the pain. When paralysis is present, splints should be applied to relax the affected muscles. For the face, the splint is a double-ended

vulcanite hook lifting the angle of the mouth upwards and backwards towards the ear. For the trunk and

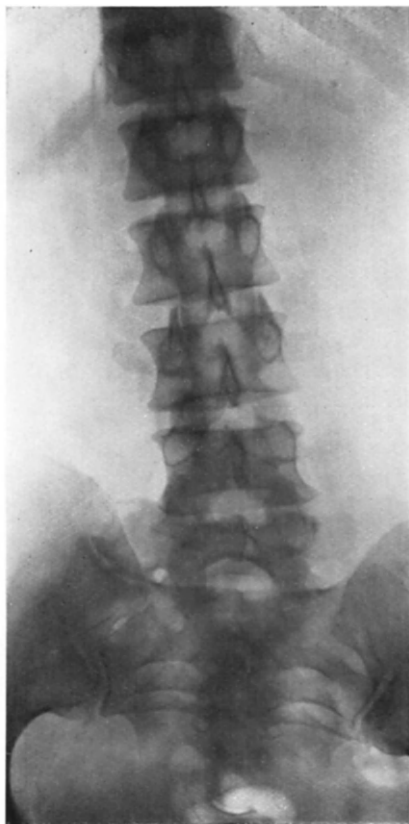

*Fig. 41.*—Partial sacralization of 5th lumbar vertebra with homolateral scoliosis. Sciatic pain was present on the same side.

limbs, the splints and positions of splinting are those employed for poliomyelitis (*see* p. 77). Massage and

galvanic and faradic stimulation of the muscles are too painful to be borne at any early stage, but may be given when the acute pain has subsided.

The prospect of recovery is good if the cause is found and removed early. If paralysed muscles are not properly cared for from the beginning, there may be irreparable loss of power and severe deformity, for which operative or other measures, as for poliomyelitis, are necessary to improve function. In some cases, after removal of the cause and subsidence of acute symptoms, there remain some persistent pain and limitation of movement, due to adhesions around the nerve or neighbouring joints. These symptoms may be relieved by manipulation under anæsthesia, followed by massage and exercises for several weeks; or by injection of normal saline solution around the roots or trunk of the nerve.

## CHAPTER VI

### RHEUMATIC DISEASES

THE term 'rheumatism' denotes certain painful and crippling affections of doubtful causation, which are not due to gross injury, specific bacteria, nervous lesions, or new growths. Care should be taken in ascribing vague pains to 'rheumatism,' because they may be really referred pains from visceral lesions, or may be due to disease of the nervous system, or to tuberculous, neoplastic, or other disease of bone or joint. The common rheumatic affections treated by orthopædic methods are *fibrositis*, *rheumatoid arthritis*, and *osteo-arthritis*.

#### FIBROSITIS

Fibrositis is a mild inflammation of the fibrous tissue of muscles, ligaments, nerve-sheaths, or subcutaneous connective tissue. It is one of the commonest and most disabling of ailments. According to the site affected, it is known as muscular or periarticular fibrositis or rheumatism, neuritis, or panniculitis. There are also many other vaguely descriptive names in use—including 'stiff-neck,' 'lumbago,' 'pleurodynia', and 'sciatica'—of states the cause of which is often fibrositis.

Fibrositis is probably caused by toxins derived from localized septic areas ('focal infection') at various sites in the body, or from disturbances of metabolism, that is, of the normal chemical changes which occur in the body tissues during life. When there is chronic infection of the teeth, tonsils, nasal sinuses,

gall-bladder, genito-urinary organs, or other parts, or inefficient emptying of the colon, toxins are absorbed into the blood and thus reach remote fibrous tissues, causing fibrositis. In the metabolic disorders gout and diabetes, fibrositis is probably caused by chemical substances which normally are rapidly destroyed or eliminated. Strain and exposure to cold are predisposing causes, lowering the resistance of a part of the body and so determining the site of the disease, as in the neck or the back.

The symptoms are pain and stiffness, which are usually sudden in onset and may move about from one site to another. In muscular fibrositis, stabbing pain is felt in the muscle on movement, and one or more points in the muscle are tender. In long-standing cases, tender thickenings may be felt in the muscle when relaxed. The muscles commonly affected are those of the lumbar, gluteal, neck, shoulder, and intercostal regions. Lumbar fibrositis is the commonest cause of pain in the back, but there are other more serious causes which must be eliminated before a diagnosis of fibrositis is made.

Fibrositis around joints causes stiffness and pain, which characteristically pass off with repeated movements, being thus worse after rest and at night, and passing off with exercise and during the day. When the disease has existed for some time, the fibrous tissue of the ligaments becomes contracted, limiting the mobility of the joint. This occurs especially at the shoulder.

Perineuritic fibrositis is a form of neuritis, which is described in the chapter on diseases of the nervous system (p. 83).

Panniculitis is seen chiefly in fat persons as soft, ill-defined, tender swellings in the subcutaneous tissues, accompanied by aching.

TREATMENT.—The general treatment consists of : (1) Elimination of toxæmia—for example, by extraction of septic teeth ; (2) Raising the bodily resistance by exposure to sun or ultra-violet light and general hygienic measures ; (3) The immediate relief of pain by drugs such as aspirin.

Local treatment consists of rest, surface heating, or counter-irritation while the pain is acute, and massage and movement later. A splint is necessary in perineuritis and periarticular fibrositis to provide rest and to prevent deformity. For heating, antiphlogistine, poulticing, vapour, water, or radiant-heat baths, mud packs, or diathermy may be used. Counter-irritation may be applied by high-frequency sparking, ultra-violet light, blistering, or mustard plaster. Massage should be either light stroking for its soothing effect, or deep localized kneading to get rid of thickenings ; the latter is painful at first, but soon brings relief. Active and passive movements are used to prevent stiffness and contracture of joints. In long-standing cases, after removal of causes of toxæmia, manipulation under anæsthesia may be necessary to restore normal mobility.

**Dupuytren's Contracture.**—This is a deformity of one or more fingers, caused by thickening and contracture of the palmar fascia, probably from a chronic form of fibrositis. Nearly always it is the fourth and fifth fingers which are affected, usually of both hands. The condition is most common in men, and after middle age. Pressure or irritation of a stick or hand-tool is sometimes a contributing cause.

The first sign is a puckering or nodular thickening in the palm near the base of one finger. Very slowly the finger becomes flexed at the metacarpo-phalangeal joint and then at the proximal inter-phalangeal joint, so that the finger is drawn into the palm (*Fig. 42*).



The usual complaint is of interference with the use of the hand ; but there may also be pain in the hand shooting up the forearm, and the thickening in the palm may be tender.

TREATMENT.—Apart from elimination of possible sources of toxæmia, the treatment of the contracture is operative. Splinting and stretching movements are ineffective in curing, but may delay progress of the contracture at an early stage. The operation consists

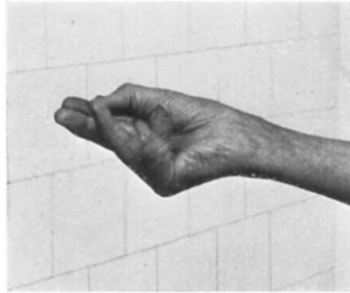

*Fig. 42.*—Dupuytren's contracture.

either of subcutaneous tenotomy of the thickened fascia at many points, or of complete removal of the affected area of fascia by open dissection. After operation, a malleable metal or plaster-of-Paris splint is applied and worn continuously until the wound is healed ; thereafter it should be worn day and night for several weeks, and then always at night. At the time of operation the finger is stretched out as much as possible, and massage and active and passive movements are begun as soon as the wound is healed. The result is good if the affected area of fascia is thoroughly excised and the after-treatment is carefully carried out.

**RHEUMATOID ARTHRITIS**

Rheumatoid arthritis is a chronic, painful, deforming disease of joints, probably caused by the action of bacterial toxins. It is more common in women than in men, and usually comes on between the ages of twenty and forty years. A similar condition—Still's disease—occurs in children and is accompanied by enlargement of the lymph-glands and spleen.



*Fig. 43.*—Rheumatoid arthritis of the hands.

The toxins may be derived from a number of sites in the body where localized infection may occur. The commonest are the teeth, tonsils, nasal sinuses, gall-bladder, appendix, colon, and genito-urinary tract. In certain persons with high resistance to disease focal infection may exist for a long time without accompanying changes in the joints, whilst in other persons such changes occur soon.

Many joints are usually affected, the smaller, such as those of the hands (*Fig. 43*), feet, and spine, more often than the larger. There are pain, limitation

of movement, swelling around or in the joints, and wasting of the muscles. The synovial membrane is thickened and adheres to the articular cartilage, which is eventually destroyed, so that union (ankylosis) by fibrous tissue, or rarely by bone, of the joint surfaces



*Fig. 44.*—Rheumatoid arthritis of wrist-joint and carpus.

may take place. The capsule is thickened, and the bones lose much of their lime salts. Suppuration and abscess formation never occur. X-ray examination shows the bones less dense than normal, and the joint

space diminished from loss of the articular cartilage (*Fig. 44*).

Severe deformities are apt to develop unless the affected joints are kept in splints while the disease is active. These deformities and the accompanying impairment of mobility are most disabling and may make the patient bedridden and helpless.

The disease presents itself in varied forms. One specially painful and crippling variety is 'spondylitis ligamentosa ossificans', or 'spondylose rhizomélique', affecting the spine, hip, and shoulder-joints of young adults. The ligaments of the spine become ossified so that the spine is converted into a rigid bony rod. Unless prevented by proper splinting, a total backward curve of the spine develops, and the hips also become fixed in flexion, resulting in a most severe and intractable deformity.

TREATMENT.—The aim of this is : (1) To eliminate toxæmia by treatment of focal infection ; (2) To raise the general resistance by hygienic measures, vaccines, drugs, and, in some cases, open air and sun exposure ; (3) To prevent deformity and loss of function while the disease is active ; (4) To restore or improve function, if necessary, when activity has ceased.

A thorough investigation of all possible foci of infection is necessary, followed by appropriate eliminative treatment. If there is bowel stasis, colon lavage may be ordered. For this, two pints of warm boiled water containing two drachms of salt and two drachms of sodium bicarbonate should be used. It should be introduced slowly into the rectum by means of a funnel and rectal tube at a pressure of one foot. The patient should lie on the left side and retain the fluid for a few minutes before evacuating it. The same amount of fluid should then be run in again, repeating the process. Such treatment is given on alternate

days for the first week and subsequently twice weekly for several weeks. Abdominal massage and exercises are also given.

To raise the general resistance, the patient should be given graduated exposure to sun or ultra-violet light, and, if confined to bed, nursed under open-air conditions. A vaccine or protein-shock treatment may be given by the physician. Drugs have not been found valuable, except to give temporary relief of pain. The therapeutic use of gold salts is at present on trial.

While the disease is active, as indicated by pain, fluid swelling, and tenderness, the joints must be kept at rest by splints. The means of splintage differs with the various joints, but it should allow the use of heat and gentle stroking and frictional massage, which relieve pain and reduce swelling. There is an optimum position for splinting each joint so as to preserve the greatest usefulness, should the joint lose its mobility; splints should always be applied with the affected joints in these positions. Thus the wrist and hand should be splinted in the position of the hand in holding a large tumbler. The forearm should be short of full supination, and the elbow extended slightly beyond the right angle. If both elbows are affected, the left should be held at  $60^\circ$  and the right at  $110^\circ$ . The shoulder should be held at  $60^\circ$  of abduction with slight forward flexion. The position of the ankle should be at a right angle to the leg, the foot being turned neither in nor outward. The knee should be a few degrees flexed, and the hip extended and slightly abducted. The spine should be splinted extended and straight. The head should be held without any rotation or bending to the side, and the neck should be extended.

If, when the disease is no longer active, the joints

are limited in movement or deformed, orthopædic treatment is directed to correcting deformity and improving the utility of the joints. Deformities in rheumatoid arthritis are usually corrected by gradual extension with weight and pulley, aided if necessary by a splint. For example, flexion deformity of the knee may be slowly corrected by weight-extension on the leg, the limb being supported on a Thomas knee-splint. Sometimes a deformity is forcibly corrected by manipulation under anæsthesia and plaster-of-Paris applied; or operative methods are required, such as division or lengthening of tendons, division of the capsule (capsulotomy), or osteotomy.

When the mobility of a joint is only slightly limited, it can often be restored to normal by putting the joint through the range of painless movement each day. By this means, adhesions are gradually stretched. It is not wise to repeat the movements more than once or twice, or to cause pain; but voluntary movements may be performed as often and freely as desired.

When the range of movement is rather more restricted, the surgeon may manipulate the joint forcibly under anæsthesia. This is never done while the disease is active, and it is apt to be followed by a general reaction with a rigor and rise of pulse-rate for some hours. After manipulation, the joint is kept for a time in a splint as before, while radiant heat or diathermy, active and passive movements, massage, and faradic exercise of the muscles are applied daily to restore strength and usefulness to the joint.

If a joint is severely damaged by the disease so that there is little mobility, the surgeon aims either at making the joint permanently stiff (ankylosis) in a good position for function, or in certain joints such as the jaw, where mobility is essential, at reconstructing the

joint. He may produce ankylosis merely by fixing the joint in plaster-of-Paris for several months. Fibrous union of the joint surfaces may occur in this way and be sufficient to keep the joint in the desired position so long as a supporting appliance is worn.

When bony ankylosis is desired, an operation ('arthrodesis') is necessary, but is not often performed in rheumatoid arthritis because the bones are slow to unite and may fail to do so. An operation to reconstruct the joint ('arthroplasty') is also not usual in this disease, as the changes limiting mobility are more in the soft tissues, which are not affected by the operation, than in the bones. In certain cases in which movement is obstructed mainly by great thickening and adhesion of the synovial membrane, removal of the membrane ('synovectomy') is done, especially at the knee-joint.

Some cases are best treated by appliances, which either check movement beyond the painless range, or relieve weight-bearing when the patient is feeble and the muscles weak. Such appliances are used chiefly for the spine, wrist, and knee.

### **OSTEO-ARTHRITIS**

Osteo-arthritis is a condition in which the articular cartilage of the surfaces of a joint is roughened and thinned and the ends of the articulating bones are expanded and deformed. The cartilage eventually disappears and the surfaces then consist of hardened 'eburnated' bone. At the edges of these surfaces, ridges and spikes of bone ('osteophytes') are formed. The capsule and synovial membrane are also thickened and the synovial fluid disappears. Suppuration never occurs. The joint surfaces never fuse, but mobility becomes diminished because of the deformation of

the bones, the absence of synovial fluid, and the thickening and contracture of the capsule.

The cause is uncertain, but is probably repeated slight injury to the joint by accident or abnormal stress. Thus the disease develops in joints after an injury to the cartilage or bone of the articulating surfaces, with resulting irregularity. Mal-union of a fracture, altering the line of weight-bearing, is followed by development of osteo-arthritis in the neighbouring joint. Persons who have led athletic lives often develop the disease in the knee or hip in middle life. In occupations in which there are abnormal stresses placed on certain joints, osteo-arthritis often occurs in these joints. Congenitally malformed joints usually become osteo-arthritic early in adult life.

It is doubtful whether osteo-arthritis can be caused by bacterial toxins. The disease affects chiefly persons in middle and old age and of the heavily built type, who otherwise have good health. Usually it affects only one or two of the larger joints. The onset is gradual without disturbance of the general state of health, and the course is slow. The early symptoms are stiffness and pain, and occasional swelling of the joint after exercise. Later, the range of movement is diminished, and there may be a feeling or sound of creaking or grating in the joint during movement. These symptoms slowly become worse until pain may be intolerable and mobility be entirely lost. The enlargement and deformation of the ends of the bones and the osteophytes may be felt in superficially placed joints such as the great-toe joint, or seen in an X-ray film together with diminution of the joint space (*Fig. 45*). Deforming contractures of the joint may or may not occur.

The joints most commonly affected are those of the spine and lower limbs. In the spine, the disease



is called 'spondylitis' or 'spondylosis deformans,' and is associated with degeneration, thinning, and loss of elasticity of the intervertebral discs. It is especially common in the lumbar region (*Fig. 46*); it is responsible for many cases of 'lumbago', and



*Fig. 45.*—Osteo arthritis of hip.

renders the back more liable to sprain than normally. The joints between the articular processes of the vertebræ are affected; their enlargement and the congestion of blood-vessels round them cause narrowing of the intervertebral foramina, of which the joints form the posterior walls. In this way the spinal nerve-roots passing through the foramina may be

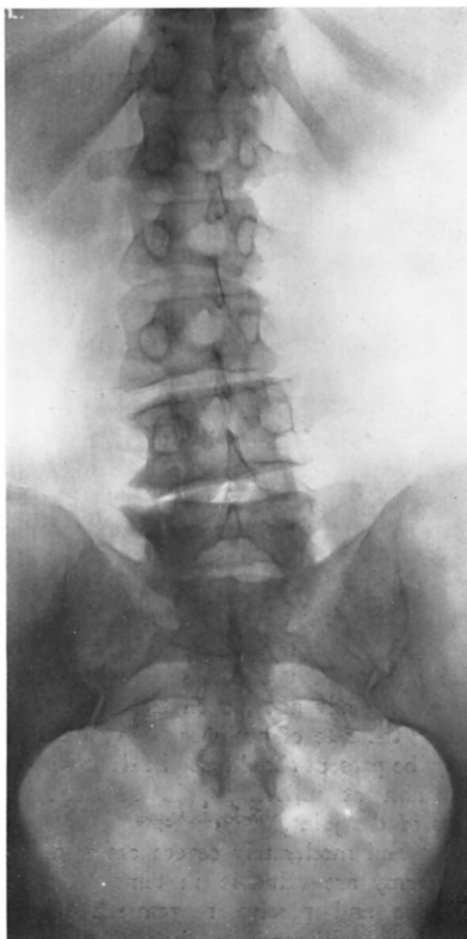

*Fig. 46.*—Spondylosis deformans of lumbar spine. Note the narrowing and thinning of the intervertebral discs and the deformation and osteophyte formation of the vertebral bodies. The surfaces of the joints between the articular processes are roughened and the joint spaces diminished.

compressed, giving rise to pain along the course of the nerves. This is the cause of pain in most cases of 'sciatica', and of many cases of pain in the limbs or trunk of doubtful origin.

Osteo-arthritis of the hip-joint is usually seen in persons past middle age, and hence was formerly known as 'morbus coxæ senilis'. One or both hips may be affected. Movement at the hip is gradually lost, and adduction deformity develops. The pain and disablement are often great.

Osteo-arthritis of the first metatarso-phalangeal joint is commonly called 'hallux rigidus'. Injury to the joint from persistent stubbing of the great toe in too short a shoe is probably a frequent cause. The joint is painful and cannot be dorsiflexed as normally. Enlargement of the ends of the articulating bones can be felt and seen. The patient avoids putting weight on the great toe in walking and thus tends to strain the foot. The toe may become permanently flexed, the deformity being known as 'hallux flexus'.

TREATMENT.—The development of the disease in a joint may be prevented by appropriate early treatment of any local cause of mechanical derangement or abnormal stress. If the disease is present and the changes not far advanced, such treatment is effective in lessening the rate of progress. Any focal infection which may be present should also be dealt with. Other measures aim at relieving pain or improving the usefulness of the joint.

In slight and moderately severe cases, radiant heat and diathermy are valuable in temporarily relieving pain. Active and passive movements through the painless range daily are also helpful. Manipulation under anæsthesia often entirely relieves pain for some months; it is especially valuable for affection of the hip-joint and of the lumbar region of the spine; when

sciatic pain is associated with the latter, it may be relieved in this way. An appliance to relieve weight-bearing or to abolish movement prevents pain and may be advisable in some cases. For the hip- and knee-joints, the appliance is a walking caliper with a ring or moulded steel and leather thigh-piece, to take the weight of the trunk from the tuber ischii to the ground. For the spine, a leather or poroplastic felt jacket, or a steel-and-stay spinal support, is employed. For hallux rigidus, strain is taken off the joint by providing shoes of proper length, to which is added a transverse leather 'metatarsal' bar built into the sole behind the line of the heads of the metatarsal bones; this bar transfers the body-weight on to the neck of the metatarsal and also raises the fulcrum of movement at the joint.

In advanced cases, pain is relievable only by an operation. This consists either of reconstruction of the joint (arthroplasty), fusion (arthrodesis), or alteration by osteotomy of the line of weight-bearing through the joint. In arthroplasty, sufficient of the end of one only of the articulating bones is removed to restore mobility, and the raw surface is rounded off with a file and either rubbed with aseptic wax or covered with a sheet of fascia. In arthrodesis, all the bony surfaces of the joint are denuded of cartilage or eburnated bone and brought together so that they may unite by bone. The choice between arthroplasty and arthrodesis depends on the joint affected: in the temporo-mandibular and great-toe joints it is essential to preserve mobility, while in the shoulder and lumbosacral joints it is better to abolish it. In the hip- and knee-joints, arthrodesis may be performed when only one joint is affected; but arthroplasty is essential when both hips or knees, or the hip and knee of one limb, are diseased.

Correction of deformity may be all that is required in cases in which pain is slight and the disability largely due to the deformity. It may be carried out by gradual stretching in a splint with weight-and-pulley traction. Or an operation to divide contracted muscles or capsule may be necessary. Especially at the hip, division of bone (osteotomy) near the joint so as to correct deformity and alter the line of weight-bearing through the joint may be performed, giving relief of pain and improving function.

*CHAPTER VII***TUBERCULOSIS OF BONES AND JOINTS**

TUBERCULOSIS is a disease caused by the tubercle bacillus. There are two kinds of tubercle bacillus affecting man, the human and the bovine. Both kinds cause disease of bones and joints. Infection may take place either by ingestion of milk or other food contaminated by the bacillus ; or by inhalation of infected dust or droplets of sputum in the breath of a person suffering from the pulmonary form of the disease. The bacilli pass by way of the tonsils and other lymph-nodes into the lymph-ducts and thence into the blood-stream, by which they reach their destination in the bones or the synovial membrane of joints.

Malnutrition and lack of fresh air and sunlight, and chronic septic infections, lower natural resistance and so predispose to the disease. Certain individuals have naturally less resistance than others, and this state may be inherited. Children are more liable to bone and joint tuberculosis than adults. A slight injury, which temporarily lowers local resistance, often precedes the onset of disease. Certain bones and joints are much more often affected than others, the commonest sites of disease being the spine, hip, and knee.

The disease usually begins in the bone close to the epiphysial line on the diaphysial side, whence it may spread to the neighbouring joint. It starts as a

localized area of softening of the bone ('caries'), which eventually collapses under the stress of body-weight or muscular contraction. Sometimes the



*Fig. 47.*—Active disease of 2nd and 3rd lumbar vertebræ with sequestrum.  
Healed disease of 4th and 5th lumbar vertebræ.

disease starts in the synovial membrane, which becomes thickened, softened, and ulcerated, and spreads over the articular cartilage, destroying it and extending

into the underlying bone (*Fig. 47*). In the destruction of the invaded tissues a soft cheesy 'caseous' material is formed, the process being known as 'caseation'. This material accumulates and is partly liquefied by serum; in this way, an abscess containing tuberculous pus is formed. If the abscess ruptures on to a free surface, a tuberculous ulcer or a sinus results.

The tuberculous process may end in death of the bacilli and disappearance of the area of disease, when the patient's resistance is high; or the focus may become walled off by fibrous tissue and lime salts deposited within it, though the bacilli may live and remain capable of fresh activity. If resistance is low or the virulence of the bacilli high, the disease gradually extends into new areas, with formation of abscesses, and may become generalized throughout the body.

The onset of tuberculous disease in bones and joints is slow and insidious. There is constant aching in the affected part, made worse by exercise. Examination shows limitation of movement and muscular spasm; in superficially placed parts, swelling and abnormal warmth on palpation are noticeable. After some weeks or months deformity develops. The patient may feel generally unwell and have slight rises of temperature; but the disease often begins in an apparently healthy person and may be unaccompanied by fever. An X-ray examination gives valuable information and is essential in all cases. Continued aching in a limb or the back, with limitation of movement, should always cause suspicion of tuberculous disease, and there should be no delay in proceeding to determine the diagnosis.

GENERAL PRINCIPLES OF TREATMENT.—Since in most cases there is more than one site of disease, treatment is based on the recognition that the whole



body must be considered and not merely the obvious areas of disease. The principles are : (1) To raise the general bodily resistance ; (2) To ensure rest to the affected areas, rest being the essential condition for local healing of the disease.

A general examination is first made to determine all localized areas of tuberculosis which may be present, and any other disease such as septic infection of the teeth or tonsils, and to estimate the power of resistance of the patient. This implies examination by a physician and other specialists as well as the orthopædic surgeon, and urine, blood, and other biochemical examinations.

The general resistance of the body is raised by : (1) Rest ; (2) Continuous living in fresh, open air ; (3) Natural or artificial sunlight ; (4) A sufficiency of good food, containing especially animal fat, calcium, phosphorus, iron, and vitamins A and D. The minerals are contained in milk and vegetables, and the vitamins in milk, cream, and butter ; but both the minerals and vitamins are often given separately to ensure a constant and adequate supply in the diet. Fruits, which contain vitamin C, and a preparation of vitamin B (such as marmite) are valuable additions to the diet.

The patient must be accustomed gradually and carefully to living in the open air and to sunlight. As a general rule, for the first few days after admission to hospital he should be kept at rest in bed indoors. Then he is taken for increasing periods out of doors, but kept in the shade, and his body exposed to the air in gradually increasing degrees of area. He should be accustomed to exposure to cool air, but nevertheless kept warm by sufficient clothing in cold weather. After a variable time, in summer, the surgeon orders exposure to the sun, which must be graduated both

as to the surface area of the body exposed and to the length of time of exposure. In this, each patient must be considered individually, since the sensitivity of his skin and his general reaction to exposure may differ from others. The Table below gives a rate of exposure (in England) which may be followed in

TABLE OF SUN EXPOSURE

PART EXPOSED	SUNNY DAYS						
	1	2	3	4	5	6	7
	min.	min.	min.	min.	min.	min.	min.
Trunk ..					15	30	45
Thighs ..			15	30	45	60	75
Legs ..		15	30	45	60	75	90
Feet ..	15	30	45	60	75	90	105

Apply similarly to back as well as front of body, if means of splintage allow.

After seventh day increase at same rate up to maximum of 3 hours daily of direct sun exposure.

The head is not exposed.

general. The head and neck should always be covered by a shade or large linen hat, and the clothing should be reduced to a cotton loin-slip, with a brassière also for women. Over-heating of the patient must be avoided, the best time of the day for exposure being in the morning before the sun becomes too hot. The temperature and pulse-rate must be kept regularly,

a rise of either being an indication to diminish the time and area of exposure. Headache, mental depression, and fatigue are also signs of over-exposure. The skin should not be so much exposed that it becomes more than slightly red. If more severe skin reaction occurs, blisters should be cut away and the area covered with calamine lotion.

The very young and old are more sensitive to sun-exposure than others. Fair and red-haired persons are more sensitive than dark. Patients who are weak or have sinuses or internal complications are more easily over-exposed than others. If a patient is reacting well to exposure, he feels better than formerly, and his skin becomes brown by deposit of pigment in its cells. The effect of cool air directly on the skin is as important as that of the sun, since it stimulates the functions of the skin and also the general bodily metabolism.

In winter and when natural sunlight is not available, so-called artificial sunlight is used in the same way. This is produced either by the carbon-arc, tungsten, or mercury-vapour quartz lamp. Exposure is usually made three times weekly.

Since treatment must be carried on for many months before arrest of the disease is possible, it is important to keep the patient occupied with some work or hobby. This prevents him from becoming mentally depressed, and is beneficial as well for his physical health. Occupations such as wood-carving, cardboard moulding, typewriting, clock-making, weaving, crochet, lace-making, painting, drawing, knitting, basket-making, and artificial flower-making, can all be carried out without interference with the necessary immobilization of the areas of disease.

Abscesses may subside spontaneously when treatment of the disease is efficiently carried out. When

they are large and approaching the surface, they should never be opened by incision, but their contents may be drawn out with an aspirating syringe. The syringe should be of 20-c.c. capacity or more, and be able to take a long wide-bore needle or a special trocar and cannula. The skin over and for several inches round the abscess must be carefully prepared, and asepsis strictly observed. The risk of a tuberculous abscess lies chiefly in the danger of its infection with septic bacteria, which adds greatly to the gravity of the disease. Such infection may occur through carelessness in the preparation of aspirating instruments, or other faults in the aseptic technique, and always follows when the abscess is allowed to burst through the skin spontaneously; it is difficult to prevent infection if the abscess is opened by incision, even though the wound is sutured.

Sinuses result from spontaneous or surgical opening of abscesses, and thus should not occur. They should be covered by dry antiseptic dressings except during exposure of the parts to sun or ultra-violet light, which directly stimulates their healing.

## TUBERCULOSIS OF THE SPINE

*(Pott's Disease)*

The disease may affect any part of the spine, but is most common in the lower thoracic region. Usually the body of one or of several adjacent vertebræ is attacked. The bone is softened and collapses under the body-weight, so that angulation of the affected and adjoining vertebræ takes place, producing a localized deformity of the back known as 'angular kyphosis' (*Fig. 48*). An abscess may form and track along muscle planes to appear at certain sites according to the part of the spine affected. Thus, in disease in the cervical region, an abscess may appear behind the

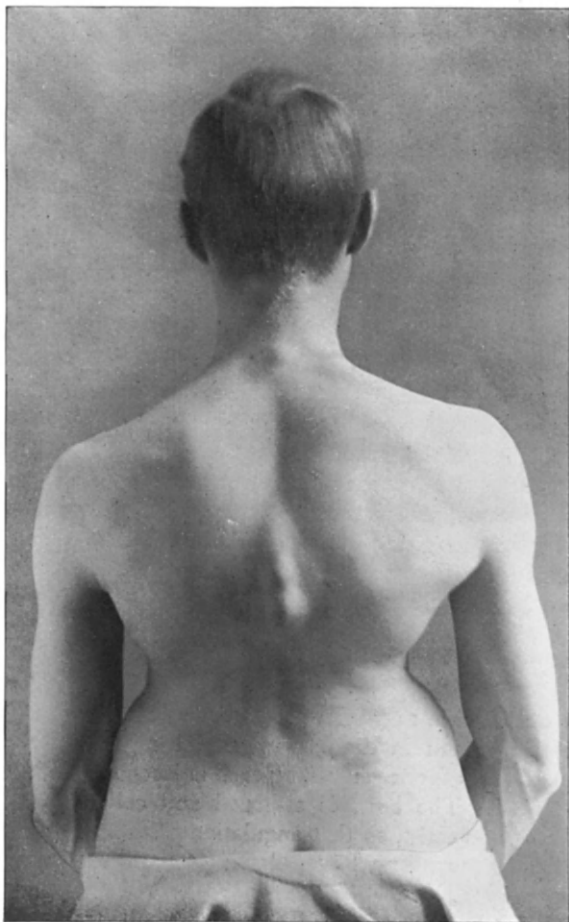

*Fig. 48.*—Angular curvature in thoracic region.

posterior wall of the pharynx or in the side of the neck. In disease in the thoracic region, the abscess forms round the front and sides of the vertebral bodies and may never reach the surface, being shown only in an X-ray film ; but sometimes the abscess comes to the surface in the back or along the course of a rib. In the lower thoracic and lumbar regions, an abscess tracks along the psoas muscle and can be felt or seen as a swelling in the abdomen, eventually filling the iliac fossa ; it is known as a *psoas abscess*. An abscess from the lumbar region of the spine may also present in the back (*lumbar abscess*).

When, in any region of the spine, the disease in the vertebral body extends backwards, the spinal cord or its nerve-roots may be affected by vascular congestion, pressure of an abscess, or, rarely, actual displacement of bone. This complication occurs most often in disease in the thoracic region. The functions of the spinal cord are interfered with, resulting in *compression paraplegia* (p. 70), in which there is spastic paralysis of the lower limbs with anæsthesia and retention or incontinence of urine.

The earliest symptom is constant aching in the affected part of the neck or back, which is increased by movement and relieved by rest. Such pain is apt to be wrongly ascribed to 'rheumatism'. The general state of health may be impaired. As the disease progresses and the bodies of the vertebræ begin to collapse, the nerves emerging through the intervertebral foramina are pressed upon and pain results in their areas of distribution. In this way pain is felt at a distance from the seat of disease, and may be ascribed to some other cause. Thus, in disease of the thoracic spine pain along the ribs or in the abdomen may be felt ; this is often bilateral, giving a girdle sensation. In lumbar disease, pain is felt down the legs and may

be attributed to 'sciatica'. In all cases of pain in the trunk or limbs without signs of disease at the site of pain, the origin is often in the spine, which should be examined.

Examination shows as the earliest sign limitation of movement in all directions of the part affected. The patient walks stiffly and avoids moving the spine in stooping. In cervical disease, the patient may support his chin with his hands, and turns his whole body to look around. In thoracic disease, he may grasp the furniture to take his weight in moving about a room. Deformity does not occur until the disease is well advanced. It is then seen as a localized backward bending (kyphosis) of the spine, which is more or less angular according to the number of vertebræ diseased.

In preparing a patient for examination, he should be completely stripped except for a loin slip. The movements of the spine in walking, stooping, sitting, and rising should be observed, and then passive movements made in the lying position; in this way, general or localized limitation of movement is determined. Any deformity or abscess should be noted, and a general examination made to discover any other sites of tuberculous disease or any non-tuberculous condition. An X-ray examination of the whole spine should be made.

TREATMENT.—The principles of treatment are: (1) To raise the general state of health so as to increase resistance to the disease (p. 106); (2) To keep the affected area of the spine at rest. Rest to the spine can only be fully provided with the patient in the horizontal position. In any suspected case, the patient should be kept flat on his back on a firm mattress with fracture boards beneath it. He should not be allowed to sit up or to turn himself; when turned,

he should be rolled over in one piece without flexing or rotating the spine, the shoulders being grasped with one hand and the hips with the other, and the head and legs supported and turned by assistants. If no special means of immobilization is available after the diagnosis of tuberculous disease has been made, the patient may continue to be nursed in this way. Firm pillows should be kept beneath the neck and the lumbar region to maintain the normal spinal curves. Care of the skin in the usual way must be taken to



*Fig. 49.*—Prone position of recumbency for tuberculosis of the lower thoracic spine. Note sunshade for head and wedge-shaped pillow under chest.

prevent sores. In disease of the cervical spine, immobilization is more efficient with traction on the head; a halter should be placed over the head and tied to a weight-and-pulley device, the head-end of the bed being raised on blocks to make the trunk and limbs act as a counter-extending force. A board should be placed across the lower end of the bed to support the feet, over which a cradle is placed. To keep the knees slightly flexed, a small beam is placed across the bed under the mattress. Children may be prevented from moving by means of webbing straps placed across the legs and buckled to the sides of the



cot, and a cloth corset round the chest and the pelvis with webbing straps similarly attached.



*Fig. 50.*—Position of recumbency in plaster bed for tuberculosis of the lower thoracic spine. Note slight flexion of the knees, and board to support the feet.



*Fig. 51.*—Showing immobilization in plaster bed for tuberculosis of the lower thoracic spine and right hip. Note slight flexion of knees, and board to support the feet.

The ventral position of recumbency may be used during part of the day for older children and adults

with disease in the thoracic or lumbar regions. In this the patient lies prone with a wedge-shaped firm pillow under the chest so as to produce hyper-extension of the spine (*Fig. 49*). This position not only affords a welcome change to the patient, but also provides beneficial activity for the muscles of the back.

Whenever possible, exact means of immobilization should be used. The means most commonly in use are the plaster bed, the Thomas splint, and the Bradford frame. The first is an accurate mould in plaster-of-Paris of the patient's back and head, and is made as described in *Appendix C* (p. 232). It is a satisfactory method, as the patient is completely fixed, nursing attention is easy, and the risk of pressure or friction sores is minimized (*Figs. 50, 51*). The Thomas double abduction splint (*Fig. 52*) is also satisfactory, though much more attention is required in applying it and in nursing than in either of the other methods. The Bradford frame is a stretcher, which can be made of gas-piping with canvas stretched between the side-bars. The frame is bent so that as the patient lies on the canvas the spine is hyper-extended. The patient is held in position by cloth corsets round the chest and pelvis tied by webbing straps to the side-bars of the frame, and a webbing strap is fixed across the forehead. More elaborate applications of the frame principle are in use in certain special hospitals.

With all these methods, the bed is made as usual with a long and short waterproof sheet and a draw-sheet. The other bedclothes should be light, but sufficient in cold weather for warmth. The clothing should be a shirt or night-dress open at the back in order that it may be removed from the front without moving the patient. Care must be taken in washing the patient to cause as little movement of the spine

as possible. To wash the back, which should be done twice weekly, the patient should be turned on to his face before the plaster bed, splint, or frame is removed. After washing, the back should be dried,

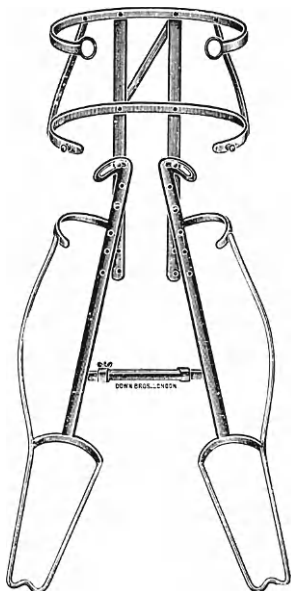

Fig. 52.—Thomas-Jones's double abduction splint (unpadded).

rubbed with spirit, and powdered, and the immobilizing apparatus reapplied, before the patient is turned back again. The details of these methods are best and most quickly learnt by experience, once the above principles are grasped.

Immobilization is carried out until all signs of disease have disappeared and an X-ray film shows re-consolidation and calcification of the diseased area

of bone. The patient is not allowed up on disappearance of clinical signs alone, as the X-ray film may still show that the disease is active. The usual period of immobilization required is two to three years.

When the patient may get up, support to the spine is provided either by a plaster-of-Paris jacket, changed as often as necessary, or by a removable celluloid, leather, or poroplastic felt jacket, or a steel-and-stay appliance. Such support is continued for one or more years until repeated clinical and X-ray examinations, at intervals of three to six months, show that the disease has remained healed and the back has recovered its strength. When there is severe deformity, a supporting appliance should be worn permanently. To prevent recurrence of disease in the spine or at new sites, every effort must be made to maintain a good general state of health. This may mean removal to a different place of living or a change of occupation.

To promote more rapid arrest of disease and to make the state of healing more secure, bone-grafting operations to fuse the affected area of the spine are performed. These are usually only done on adults, who are more able than children to stand a severe operation and for whom it is more important to shorten the period of recumbency. Several kinds of grafting are done, the aim of all being to fuse the diseased vertebræ to those immediately above and below, so as to abolish movement at the site of disease. The graft acts as an internal splint, and the operation is therefore merely supplementary to the other means of immobilization used and to the general treatment. The most common methods of spinal grafting are the Albee, Ollier, Hibbs, and the lateral graft. In the Albee method, a long massive piece of the tibia is cut and placed between the split spinous processes of the

vertebræ. In Ollier's method, the graft from the tibia consists of periosteum and a thin underlying

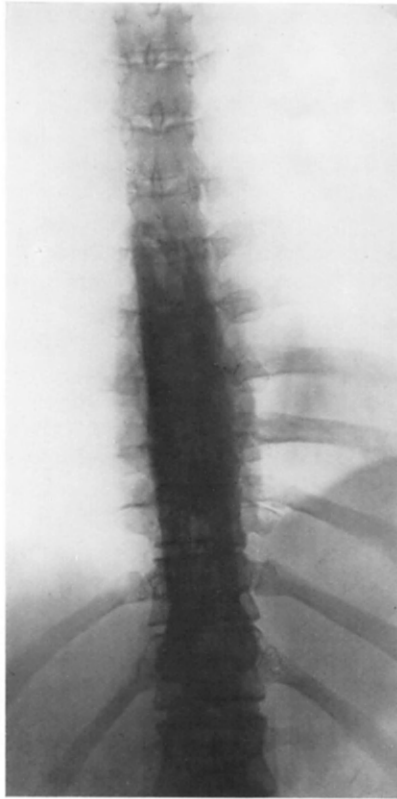

*Fig. 53.*—Spinal bone-grafting (two lateral grafts from the tibia) for tuberculosis of lower thoracic vertebræ.

shaving of bone, cut with an osteotome, and it is laid on the vertebral laminæ under the muscles. In the Hibbs method no graft is cut from the tibia, but the

spinous processes are split and bent to interlock, and layers of bone are raised from the laminæ and turned over on to adjoining laminæ. In the lateral graft method, a long massive graft from the tibia is placed on the laminæ on one or both sides of the spinous processes under the muscles (*Fig. 53*).

Before any of these operations are undertaken, a plaster bed is made and the patient fully accustomed to continuous lying in it. The patient comes to the theatre in the plaster bed, which is reapplied at the end of the operation. The skin of the whole back must be prepared for operation, and in all except the Hibbs method the skin of one leg from mid-thigh to toes also. The operation is a severe one and measures may be needed to treat shock. An intravenous transfusion of gum-saline or blood may be given in the theatre. On return to the ward, the foot of the bed should be raised on blocks, and artificial warmth provided by a radiant heat cradle or hot bottles. Rectal saline injection may be given. The patient is not turned out of the plaster bed for two weeks. The stitches from the back and leg wounds are then removed, the back cleaned, the plaster bed reapplied, and the patient turned back. From then on it is sufficient to turn him to clean the back once in two or three weeks. After three months the graft is usually well consolidated, and the patient may be allowed to lie in the prone position (in disease of the thoracic and lumbar regions) with a wedged pillow beneath his chest during the day. As when operation is not performed, the patient is kept recumbent until all clinical and X-ray signs of disease have gone. In favourable cases, this period is about half the time required for non-operative means of immobilization alone. When the patient gets up, a supporting appliance is provided and worn for a year or more.

### TUBERCULOSIS OF THE HIP

The disease may begin in the head or neck of the femur, the acetabulum, or the synovial membrane. Unless arrested, it progresses to soften and destroy usually the upper end of the femur and the upper and back part of the acetabulum. The amount of destruction is greatest when the patient continues to walk about, the body-weight acting to crush in the softened bone. With penetration of the capsule by disease, the head of the femur may be dislocated, and a tuberculous abscess extending from within the joint may appear on the outer side of the thigh, the gluteal region, the inner side of the thigh, or inside the pelvis. If the abscess is allowed to burst through the skin, sinuses are formed round the joint, resulting in secondary septic infection and increase in the severity of the disease in the adjoining bone.

The earliest symptoms are pain and limping. The pain is relieved at first by rest and may be slight, so that it may be neglected; it may be felt more in the knee than the hip. Limping is primarily due to the patient transferring his weight as soon as possible from the affected to the sound limb to avoid pain. Later, limping is largely due to shortening of the affected limb from deformity at the hip. As the disease progresses, so-called 'starting' pains in the joint also are felt. These are sharp pains felt suddenly while at rest, due to movement from momentary involuntary relaxation of the muscles. They may cause the patient to give a sudden cry during sleep.

Examination shows that the joint is held rigid by spasm of the muscles around it. It is held partly flexed and abducted. This may not be obvious, but is shown by compensatory lordosis and apparent shortening of the limb. If, when the patient is lying flat on his back, the sound limb is flexed on to the

abdomen, the flexion of the diseased hip is revealed. The position of the hip makes the limb appear shorter than the normal limb. Later, with destruction of bone in the joint, and especially if dislocation has occurred, there is real shortening of the limb, which is also adducted. If an abscess is present, it may be



Fig. 54.—Tuberculosis (osteo-arthritis) of the right hip.

felt as an ill-defined soft or fluctuant swelling in one of the situations mentioned above. An X-ray examination (*Fig. 54*) is necessary to determine the extent of the changes in the joint, and to assist in distinguishing tuberculosis from other diseases which may cause somewhat similar symptoms.

**TREATMENT.**—Apart from the general measures (p. 106) to raise the patient's resistance to disease, treatment consists of immobilizing the hip-joint.



Various means are used. At an early stage and while muscular spasm persists, it is important to maintain traction on the limb. This overcomes spasm, corrects deformity, and helps to immobilize the joint. A simple means of immobilization with traction is to apply a long Liston splint to the sound limb and the trunk so as to fix the pelvis while traction is applied



*Fig. 55.*—Pugh's method of traction in hip disease. The affected limb is tied to the foot of the bed, which is raised. The cloth corset round the chest and tied to the sides of the bed immobilizes the trunk. The knees are slightly flexed over a beam under the mattress.

to the affected limb by adhesive plaster or webbing attached to a stirrup, cord, and weight and pulley. Traction should be made first without attempting to alter the position of the hip, and gradually changed as the position is corrected, the limb being meanwhile supported on pillows or a suitable splint. The mattress of the bed must be firm and supported by fracture boards. The feet must be held at a right

angle to prevent development of equinus deformity. The knees are kept slightly flexed to prevent valgoid and backward deformity. The lower end of the bed is raised on blocks.

Another simple method (Pugh's), suitable for children, is to tie the cord attached to the adhesive plaster and stirrup to the lower end of the bed. This end is then raised high on blocks, thus making the body-weight act as the traction force (*Fig. 55*). There is no need for a long Liston splint in this method, because the weight of the sound limb is sufficient to prevent the pelvis from tilting.

The Thomas double abduction hip splint is also commonly used. This is a method of fixed traction in which counter-traction is made and the pelvis prevented from tilting by a perineal strap. Skill and careful attention are required to maintain the position and to prevent pressure sores. The method is best used in special orthopædic hospitals, in some of which the splint, or a modification of it, is mounted on a trolley so that the patient may be taken in and out of doors without disturbance.

Fixation of the hip by plaster-of-Paris is suitable for young children, for cases treated by one of the above methods after signs of active disease have gone, and for adults with well-advanced disease or after operation. The plaster should reach to the toes on the affected side, and either as high on the trunk as the nipple line or take in the opposite hip and thigh to above the knee. The affected hip should be fixed in extension, slight abduction, and without rotation in- or outwards; the knee on the same side in slight flexion; and the foot at a right angle at the ankle and neither in- nor out-turned. Felt or wadding should cover the parts beneath the plaster, which should be made to fit closely.

Immobilization by any of the above means is maintained until all clinical and X-ray signs of disease have disappeared. The patient is then allowed up in a plaster-of-Paris hip spica reaching only to the knee, or in a removable appliance of celluloid, leather, or steel. Such support is continued for a year or more until repeated examinations with the aid of X-ray



*Fig. 56.*—Tuberculosis of right hip after extra-articular arthrodesis. A graft has been taken from the fibula.

films at three-monthly intervals show that the disease is definitely arrested. At first, crutches and a patten under the boot of the sound limb are provided; later, the patient is allowed to walk on the affected limb.

If efficient treatment is begun early in children, full function of the hip without deformity may result. More often the result is fibrous union (ankylosis) of the joint surfaces, with loss of mobility and a tendency to gradual development of flexion-adduction deformity,

which may be prevented by wearing an appliance for some years. Once the deformity has developed, attempts to correct by forcible movement should not be made, as there is considerable risk of lighting up the disease. An operation (sub-trochanteric osteotomy) is required, after which the limb is fixed in plaster-of-Paris until the bone has re-united.

To accelerate arrest of the disease and to obviate recurrence or subsequent development of deformity after fibrous ankylosis, an operation to fuse the joint may be done. This consists of placing a bone-graft across from the greater trochanter to the ilium outside the capsule (extra-articular arthrodesis) (*Fig. 56*). The operation is most used in adult cases, and not often in children, for whom the duration of treatment is not important. After the operation, plaster-of-Paris is applied and treatment as for non-operative cases followed.

### TUBERCULOSIS OF THE KNEE

The disease begins in the synovial membrane or the bones. The earliest symptoms are persistent aching in the knee and limping. As with other superficially placed joints, signs of disease are more obvious than in the hip-joint and spine. These are swelling, increased warmth, muscular spasm and wasting, limitation of mobility, with pain on forcing. The joint is held partly flexed. As the disease advances, this position becomes fixed and backward displacement of the tibia occurs.

TREATMENT.—Apart from the usual general measures (p. 106), the local treatment is to put the joint at rest. This is done by a plaster-of-Paris casing reaching from the groin to the toes, or by a Thomas knee-splint. The plaster may be bivalved so that the front can be removed daily for exposure of the limb to sunlight

and air. The Thomas splint may be used either with fixed traction applied through the splint, or with mobile weight-and-pulley traction, the splint

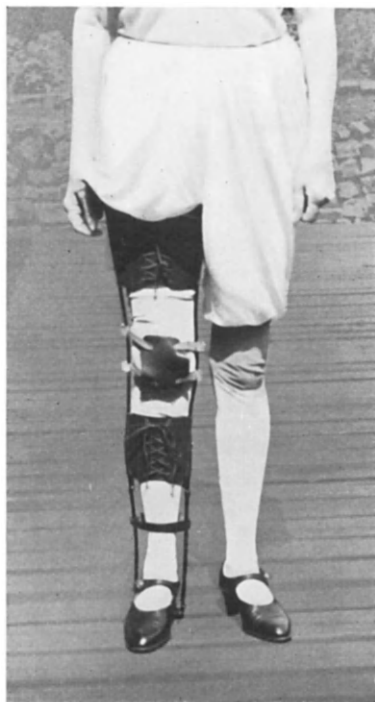

*Fig. 57.*—Caliper splint applied.

being used merely to support the limb. Hyper-extension and backward displacement of the tibia must be avoided and the foot supported at a right angle. A cradle is placed over the limb to take the weight of the bedclothes. The traction method

should always be used when there is any deformity, which can thus be gradually corrected.

When clinical and X-ray examination show arrest of the disease, the patient is allowed to begin walking after a caliper splint has been provided. This is the same as the Thomas knee-splint, except that the lower end fits into sockets in the heel of the boot (*Fig. 57*). The ring at the upper end must fit closely under the tuber ischii. The fit of the ring may be tested when the patient stands by attempting to force the finger between it and the tuber ischii. The patient should feel himself sitting on the ring with little or no weight going through the limb, there being thus relief of weight-bearing through the knee. The caliper and boot are worn during the day always, and at night a splint consisting of a posterior metal or plaster trough, reaching from the tuber ischii to the toes and bandaged to the limb, is worn.

In children, when efficient treatment is begun early, arrest of the disease without deformity or loss of function may be hoped for. In later cases and in adults fibrous ankylosis is the usual result of treatment, with flexion deformity also, unless prevented by wearing a caliper or encasing appliance of leather or celluloid for some years. The duration of treatment may be shortened and the need for an appliance avoided by an operation to remove the diseased synovial membrane and the articular cartilage of the joint so as to bring about bony ankylosis. For this operation the whole limb should be prepared, and a Thomas knee-splint or plaster-of-Paris bandages provided for subsequent fixation of the limb. The operation is done frequently in adults, but not in children, because it interferes with growth and is followed by gradual development of flexion deformity.

Tuberculosis of other joints and in the shaft of bones is not so common as at the above sites. Treatment is on the same lines of raising the general state of health and imposing local rest. Immobilization is best effected in most cases by plaster-of-Paris until the disease is arrested, and subsequently by removable celluloid or leather appliances. The joints should always be immobilized in the best position for use should ankylosis result. These positions are as stated in the chapter on RHEUMATIC DISEASES (p. 94).

*CHAPTER VIII***MISCELLANEOUS BONE AND JOINT  
DISEASES****OSTEOMYELITIS**

As generally used, the term 'osteomyelitis' means inflammation of all the tissues of a bone caused by pus-forming bacteria. Tuberculosis and other inflammatory diseases of bone are also forms of osteomyelitis; but for these the term is used only with a qualifying adjective.

The most common infecting organism is the staphylococcus; others are the streptococcus, colon bacillus, typhoid bacillus, pneumococcus, and gonococcus. In most cases the bacteria reach the bone by the bloodstream from some distant focus of infection, such as septic tonsils or a boil. Such blood-borne infection is most frequent in children, and is predisposed to by slight injury to an epiphysial junction and by general lowered resistance from unhygienic living conditions or other causes. Infection of a bone may also occur by direct extension from inflammation of the surrounding soft tissues, as from an ulcer or infected wound, or from an infected cavity such as a nasal sinus, the middle ear, or a joint. A third way in which osteomyelitis may occur is infection of an open wound involving a bone. Inflammation of the bone often develops in open fractures unless steps to prevent it are promptly taken. Operations on bones, unless performed with scrupulous aseptic technique by all concerned, and especially when metal or other foreign



materials are used to fix the bones, are very liable to be followed by osteomyelitis.

In blood-borne infection, the inflammation usually affects the femur, tibia, humerus, or other long bone, and begins at one end of the shaft. From there it spreads rapidly along the shaft, and sometimes also into the epiphysis and neighbouring joint. Pus is formed in the medullary cavity and beneath the periosteum, and death of the cortex occurs to a greater or less extent, the whole of the shaft being occasionally killed. The dead bone gradually becomes loose to form a *sequestrum*. The periosteum is raised and thickened to form a hard casing (*involucrum*), from which the shaft may be regenerated. The pus escapes by perforating the periosteum and making its way through the soft tissues to the surface. The tracks the pus makes between the bone and the surface of the skin are known as *sinuses*, and they continue to discharge so long as a sequestrum or a septic cavity remains in the bone. The extent to which the inflammation proceeds in the bone varies. Sometimes it remains localized to the end of the shaft and persists to form a chronic (Brodie's) abscess.

In infection of a bone by direct extension from wounds, in fracture, or after operation, usually only a localized area is affected; but diffuse inflammation with changes as in blood-borne infection may occur.

The onset of osteomyelitis is apt to be sudden, with severe throbbing or boring pain at the affected site. On deep pressure there is tenderness at this point, and, later, œdema, redness, and heat. These manifestations gradually become more widespread until they may affect the whole length of the bone. The temperature and pulse are raised, and there are signs of toxæmia, such as headache, and vomiting. In

children the disease may progress rapidly, leading to delirium, coma, and death within twenty-four hours. A blood examination shows high polymorph leucocytosis,



*Fig. 58.*—Chronic osteomyelitis of femur. Showing probes in sinuses, sequestra, and cavities in bone before operation.

and the causal bacteria may be grown in culture. X-ray examination does not give any information until about ten days after the onset, when irregular decrease in the density of the bone at the site of disease is

evident. If the patient survives and no operation is done, the pus may burst through to the surface after some days, when the symptoms may partly subside. The disease then becomes chronic, and does not tend to heal spontaneously, because sequestra usually cannot escape nor can cavities in the bone be obliterated. It may therefore persist for years, the patient suffering from intermittently discharging sinuses and toxæmia. In this chronic stage an X-ray film shows thickening and sclerosis of bone, cavities, and sequestra, the latter appearing as dense areas with well-defined edges (*Fig. 58*).

TREATMENT.—In treatment the surgeon takes into account that the disease is essentially a state of septicæmia with a localized manifestation in a bone. General measures, such as rest in bed under open-air conditions, abundant fluids, and a nourishing diet containing an adequate supply of vitamins, are therefore employed, and blood transfusions may be given.

The local condition is treated by establishing adequate drainage of the inflamed area of the bone, and rest to the whole limb. Usually an operation is done. A tourniquet is used; the soft tissues are laid open over the affected site, the periosteum is divided and separated, and the bone opened up by multiple drill holes, by a gouge, or by a hammer and chisel. The wound is left open, being packed with sterile vaseline gauze from the bottom to the surface. Over the packed wound is placed a large pad of sterile gamgee tissue, and then the whole limb is encased in plaster-of-Paris with the joints in the best functional position (*see p. 94*). The discharge from the wound escapes freely around the vaseline pack and soaks into the gamgee tissue and the plaster. After several weeks the dressing and plaster may need to be changed; but they are changed at as long intervals as possible until the wound

is healed. An alternative treatment of the wound is the Dakin-Carrel method, in which fine rubber tubes are placed in the wound, through which irrigation is carried out continuously or intermittently with Dakin's solution, the limb being immobilized on a suitable splint.

In the chronic state, treatment is on the same lines. An operation is needed to lay open the bone widely over the whole infected area, removing all sequestra, and converting cavities and the whole area into a wide-open trough. This and the wound in the soft tissues are then packed with sterile vaseline gauze, a thick covering of gamgee tissue is applied, and the limb encased in plaster-of-Paris (Winnett Orr method). Alternatively, the Dakin-Carrel method is used. A third method of treatment of the wound is to wipe it out with Bipp and then suture it, allowing temporary tube drainage. In this way the soft tissues fall into the troughed bone and thus obliterate the cavity ; the limb is immobilized during healing in a suitable splint.

### **ACUTE SUPPURATIVE ARTHRITIS**

Acute inflammation with formation of pus in a joint is a highly dangerous state, which may be fatal or result in permanent loss of mobility or usefulness of the joint. Infection by pus-forming organisms, such as staphylococci, streptococci, or gonococci, may be caused by a wound penetrating into the joint, by faulty aseptic technique at an operation on the joint, by spread of inflammation of neighbouring bone or soft tissues, or by transmission through the blood-stream from a distant septic focus in the tonsils, skin, or elsewhere.

The symptoms are those of a severe fever, together with pain, redness, heat, and swelling of the affected joint, which is held rigidly in the position of semi-flexion

with contraction of the muscles. Unless relieved by the surgeon, the signs of inflammation rapidly increase until pus ruptures through the capsule and overlying soft tissues and skin to establish sinuses.

The patient may die in a few hours from toxæmia, or in a few days from exhaustion, toxæmia, or pyæmia. If he survives the onset, he may eventually die from the effects of long-continued suppuration in and around the joint. Even if death does not occur and the inflammation subsides, the usual result is permanent stiffness (*ankylosis*) of the joint.

**TREATMENT.**—From consideration of the causes, it is obvious that much can be done to avoid infection of a joint. A wound extending into a joint demands immediate surgical attention, including cleansing and sterilization with an antiseptic. Operations on joints must be carried out with absolute asepsis. Inflammation of soft tissues near to joints should be treated efficiently without delay. Foci of sepsis anywhere in the body should not be allowed to persist.

When inflammation has begun in a joint, the limb is placed at rest on a suitable splint in the most useful position should ankylosis occur, and treatment for a general infection begun as in osteomyelitis (*see p. 132*). The surgeon may aspirate the joint to see if pus is present and to obtain fluid for bacteriological examination. If pus has not formed, the joint is washed out with normal saline, and a non-devitalizing antiseptic, such as flavine, is injected. If pus is present, an immediate operation is required to open and provide free drainage from the joint. Subsequently the joint is immobilized on a splint which allows constant or repeated irrigation by an antiseptic solution, such as Dakin's solution. In some cases treatment is preferably carried out by the vaseline gauze pack and plaster casing method, as for osteomyelitis (*see p. 132*).

### TUMOURS OF BONE

In accordance with the scheme of the American Registry of Bone Sarcoma, tumours of bone may be classified as follows :—

Primary tumours	Simple	Osteoma
		Chondroma
		Giant-cell tumour
Secondary tumours	Malignant	Periosteal fibrosarcoma
		Osteogenic sarcoma
		Ewing's sarcoma
		Myeloma
		Metastatic sarcoma
		Metastatic carcinoma

In the following description, only the salient features of each tumour can be given. For more detailed discussion, particularly of the pathology and differential diagnosis, larger works should be consulted.

**Osteoma.**—This is the commonest simple tumour of bone. Tumours of compact bone (*ivory exostosis*) occur in the bones of the skull, but are of no interest in orthopaedics. A cancellous bony tumour (*ossifying chondroma* or *spongy exostosis*) grows from the external surface of the end of the shaft of a long bone, close to the epiphysial cartilage, from an outlying part of which it is probably derived. It appears only during the period of growth of the bone, is usually pedunculated, and ceases to grow when the epiphysial cartilage becomes ossified. The lower end of the femur and upper end of the tibia are the commonest sites for the tumour, which may be single or multiple. It can be felt as a hard well-defined mass attached to the bone and with the soft tissues freely movable over it. With continued growth, it tends to move its position along the shaft away from the epiphysial cartilage (*Fig. 59*).

**TREATMENT.**—The tumour may escape notice unless

it causes disfigurement or interferes with the soft tissues, as, for example, by checking movement of tendons passing over the adjacent joint. In these circumstances it should be excised by operation, at which care must be taken to remove also the growing cap of cartilage over the summit of the tumour.



*Fig. 59.*—Cancellous osteoma of humerus. (Radiograph by Drs. Coldwell and Allchin.)

Multiple cancellous osteomas are sometimes seen affecting short and flat as well as long bones, and associated with stunting of growth. The condition is often familial and hereditary.

**Chondroma.**—This tumour is composed of cartilage, and grows either within or on the surface of a long bone. It may become large and undergo mucoid softening or be transformed into a sarcoma. Single chondroma usually occurs at one end of the femur

or humerus in a young adult. Multiple chondromas occur in children and young adults in the bones of the hands or feet, causing expansion and deformity of the bones. They grow slowly and painlessly;



*Fig. 60.*—Multiple chondromas of the bones of the hand. (Radiograph by Drs. Coldwell and Allchin.)

they are hard and not tender, and the soft tissues remain freely movable over them. In a radiograph (*Fig. 60*) they appear as well-defined areas, clear, or crossed by the shadows of coarse partitions (trabeculæ).

**TREATMENT.**—Operative removal is required when a tumour is causing disability, and must be thorough to avoid recurrence with stimulation of growth.



**Giant-cell Tumour.**—This growth contains, in addition to spindle-shaped cells and blood-vessels, characteristic large cells with many nuclei, the whole giving to the naked eye on being opened up an appearance of reddish jelly. It occurs in young adults at the



Fig. 61.—Giant-cell tumour of humerus. (Radiograph by Drs. Coldwell and Allchin.)

ends of long bones, or sometimes in the skull bones. The bone is gradually expanded by the growth, until it may become a mere shell and be liable to spontaneous fracture. A well-defined swelling is noticed at the site of the tumour; this may, when large, give a feeling

of egg-shell crackling on palpation. Tenderness and pain, of a constant gnawing kind, are frequent. In a radiogram is shown a sharply marked-out cystic area, divided by trabeculæ, in an expanded part of the bone, completely replacing the bone tissue (*Fig. 61*).

**TREATMENT.**—The tumour should be treated by a course of deep X rays or by operation. The latter should consist of thorough removal of the tumour tissue after opening the bony shell on one aspect. Incomplete removal is likely to be followed by recurrence, and malignant change may follow. In some situations it is possible and advisable to excise the whole affected section of bone, and to fill the gap, if necessary, with a bone-graft.

**Periosteal Fibrosarcoma.**—A rare malignant tumour, growing from the outer (fibrous) layer of the periosteum but not invading the bone. It affects most often the femur, and grows very slowly. It causes pain, and may eventually form a large, firm, clearly defined mass attached to the bone over a wide area. A radiogram shows around the bone a soft indistinct shadow through which the intact shaft is seen passing.

**TREATMENT.**—If the tumour is thoroughly excised and deep X-ray treatment given subsequently, the chance of recovery is good.

**Osteogenic Sarcoma.**—This is the most dangerous of malignant bone growths and the most common, though such growths are present in only about 1 in 100,000 of the general population. It occurs chiefly in adolescents and young adults in the lower limb, especially in the region of the knee. It is composed of many kinds of cells—spindle, mucoid, cartilage, and bone cells—and may begin under the periosteum or in the cancellous tissue beneath the cortex, whence it spreads both along the marrow and under the

periosteum. Eventually it breaks through the periosteum and invades the surrounding soft tissues. Growth occurs rapidly locally, and spread to the lungs and elsewhere is also rapid. A history of local injury a month or more before the onset of symptoms is often given. The first symptom is pain, at first intermittent, but becoming constant and felt especially at night. A constant severe pain at one end of a long bone in a young adult should always arouse suspicion of a sarcoma. The tumour appears as a firm, fixed, slightly tender swelling on one aspect of the bone. As it enlarges, the overlying skin shows dilated veins, and there may be a moderate effusion into the neighbouring joint. Spontaneous fracture is not usual. The general state of the patient remains good until exhaustion from pain and anæmia associated with secondary growths give a profoundly pale and haggard appearance. The X-ray signs are indefinite at an early stage. Later they vary with the cellular structure and the direction of growth of the tumour and the reaction of the invaded bone. Typically, there is seen an ill-defined spindle-shaped shadow through which the eroded shaft of the bone passes. At the ends of the shadow, the periosteum is seen to be raised and thickened in a wedge-shaped manner (*Fig. 62*). In about 18 per cent of cases there is an appearance in the radiogram of lines of ossification radiating at right angles to the bone.

The diagnosis of osteogenic sarcoma depends on a history of persistent intractable pain at the end of a bone, a firm fixed swelling at this site, and an X-ray appearance of an ill-defined shadow overlying eroded bone with elevation and some new bone formation of the periosteum at the limits of the shadow. As a last resort, an exploratory incision with removal of a piece of the tumour for pathological examination may be made.

TREATMENT.—The treatment of bone sarcoma is most unsatisfactory. Deep X-ray treatment may inhibit progress of the tumour, or may possibly cure. But if incorrectly given it may accelerate the growth.



*Fig. 62.*—Osteogenic sarcoma of lower end of femur.

Amputation of the whole affected bone and its surrounding muscles and fasciæ has been successful in a few recorded cases, but as a rule the growth recurs locally, or, more often, at a distance. Before operating, it should be determined that no metastases are present.

In advanced cases the limb may have to be amputated in any case for relief of pain.

**Ewing's Sarcoma.**—This tumour occurs in the same age-period as osteogenic sarcoma, but has distinctive

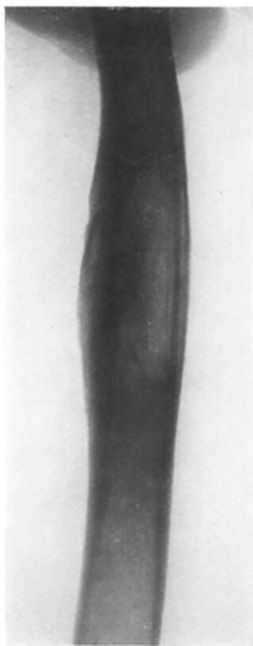

Fig. 63.—Ewing's sarcoma of femur. (Radiograph by Drs. Coldwell and Alchin.)

features. It begins in the centre rather than the ends of the shaft, and may appear simultaneously at several points of the same bone or in several bones. It may affect the small as well as the long bones of the limbs,

and also the skull. Metastases occur in the lymph-glands and in other bones rather than in the lungs or other viscera. The periosteum reacts to the growth in the bone by forming successive layers of new bone parallel to the shaft, which give a characteristic 'onion-layer' appearance in an X-ray film (*Fig. 63*).

A history of injury is common. Characteristically, attacks of pain with fever and moderate leucocytosis occur. After several attacks the tumour becomes evident, in some cases with local signs of inflammation. Pain eventually becomes constant. Metastases and death may be delayed for several years.

Both in its clinical and radiographic features, Ewing's tumour simulates osteomyelitis. It may be difficult to distinguish it except by pathological examination or by the effect of deep X-ray treatment, to which Ewing's tumour is sensitive.

**TREATMENT.**—Treatment should be by deep X rays. With this the tumour may disappear; but recurrence is frequent, and further radiation is not so effective. For local recurrence, amputation should be done. The ultimate result is invariably fatal.

**Myeloma.**—Myeloma is a rare malignant tumour, nearly always occurring at multiple sites, and favouring the mid-shafts of long bones, especially the humerus and femur, vertebræ, ribs, and flat bones of the skull. It is found chiefly in middle-aged men. Pain is felt later than in other bone sarcomas. Bence-Jones protein is present in the urine in many, but not in all, cases. The tumours are composed of several types of cells—plasmocytes, lymphocytes, myelocytes, and erythroblasts—in differing proportions. They erode and cause expansion of the bone, producing the appearance in a radiograph of multiple well-defined clear areas with thinning of the cortex (*Fig. 64*). Deformity or

fracture of the bone is common. Metastases occur in the liver, spleen, and lymph-glands.

TREATMENT.—The growths are susceptible to deep X rays, but death follows eventually from metastases.



Fig. 64.—Multiple myelomata of the ribs. (*Radiograph by Drs. Coldwell and Allchin.*)

**Metastatic Tumours.**—A secondary tumour in bone may arise from malignant cells conveyed in the blood from a primary sarcoma elsewhere, or by direct extension from a sarcoma or carcinoma in the soft tissues

over-lying the bone. But the commonest kind of metastatic growth is that due to dissemination of cells from a carcinoma of the breast, thyroid, prostate, kidney,

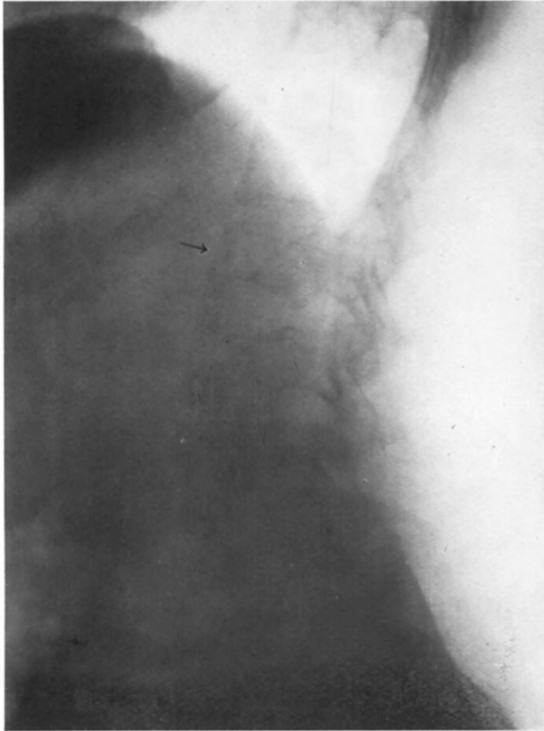
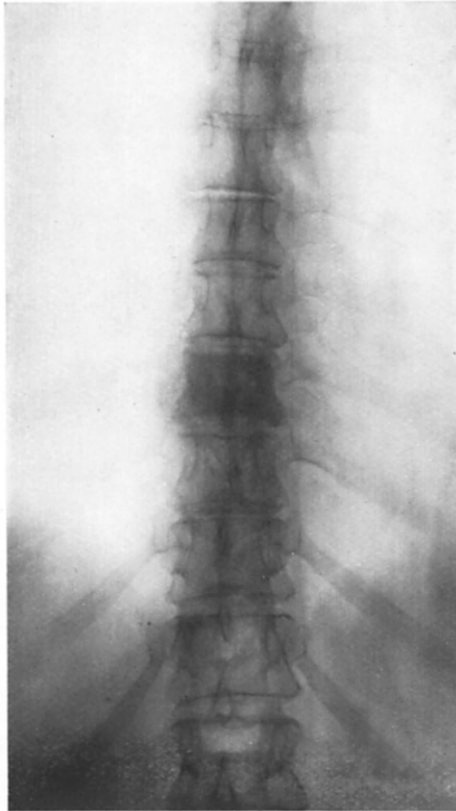

*Fig. 65.*—Secondary carcinoma of second lumbar vertebra.

stomach, or other organ. The most usual sites for metastatic growths are the vertebræ, femur (upper end), humerus (upper end), pelvis, ribs, and skull. The distal bones of the limbs are rarely affected.



The symptoms of a metastatic tumour in bone are pain and spontaneous fracture ; either of these may be



*Fig. 66.*—Secondary carcinoma of ninth thoracic vertebra.

the first sign of disease, and they may occur singly or together. A secondary growth may not become

evident until as much as fifteen years after the development or even the apparent cure, by operation or other means, of the primary growth. On the other hand, a secondary growth may manifest itself some months before any sign of the primary tumour appears. The patient may even die of metastases before a primary growth is discovered. For these reasons, serious errors in diagnosis are apt to be made unless an X-ray examination is done. Thus, sciatic or other pain due to a metastatic carcinoma of the spine may be for long ascribed to 'rheumatism' or some other cause. As a rule, continued pain in the back or limbs in a person who has had at any time a carcinoma removed from the breast or other organ should be thought due to a secondary tumour of bone until proved otherwise. The pain of a metastatic bone growth is usually not alleviable by immobilization or any means other than drugs. A spontaneous fracture may occur without warning, the true condition being shown only by X-ray examination. The X-ray appearance in metastatic carcinoma varies, the usual picture being of single or multiple clear areas in the bone, with indistinct margins, giving a 'moth-eaten' appearance. Alternatively, the affected area of bone appears increased in density, though the normal structure of bone is lost and the limits of the area are indistinct (*Figs. 65, 66*).

TREATMENT.—The prognosis is practically hopeless, but relief of pain and even re-organization of the bone is obtainable in some cases by X-ray treatment.

### **OSTEITIS FIBROSA CYSTICA**

Osteitis fibrosa is a disease in which the bone is replaced by vascular connective tissue, later changed into fibrous tissue or broken down by hæmorrhage and degeneration to form cavities or cysts. In this process the bone loses its calcium, probably by the

action of osteoblasts on the bone lamellæ. Giant cells are to be found in the fibrous tissue which lines the cyst wall. The cyst contains a clear fluid or a blood-stained amorphous mass.

The disease occurs in two forms, generalized and focal.

**Generalized Osteitis Fibrosa** is associated with enlargement from over-activity of one or more of the



*Fig. 67.*—Right femur and part of pelvis before removal of parathyroid tumour, showing multiple cystic cavities.

parathyroid glands, together with increase in the calcium content of the blood-serum (the normal content being 10 mg. in 100 c.c.), and in the urinary but not the faecal excretion of calcium. It occurs especially in women in the fourth decade of life, and is manifested by pain in the bones, followed by bending or spontaneous fractures. Many bones are affected to a wide extent. In radiograms, the bones show numerous circular or oval spaces with well-defined margins; the intervening bone is diminished in density from the normal, due to loss of calcium; there is no sign of new-bone-formation or of periosteal reaction (*Fig. 67*).

Generalized osteitis fibrosa may proceed in the course of some months or years to a state of severe deformity and disablement. Spontaneous recovery sometimes takes place, or death may occur from pneumonia or other infection if the patient becomes bedridden.

**TREATMENT.**—If the enlarged parathyroid gland is removed by operation, the disease is arrested, with relief of pain and more or less consolidation of bone. Meanwhile the limbs should be placed in splints to prevent fracture or bending and a high calcium diet and ultra-violet radiation given. Later, after arrest, any deformities which have developed and are causing disablement should be corrected by osteotomy.

**Focal Osteitis Fibrosa** ('solitary cyst') is more common than the generalized form, and occurs most frequently in adolescents. It is not associated with over-activity of the parathyroid glands and there is no disturbance of calcium metabolism. The long bones of the limbs are most often affected, especially at one end of the shaft close to the epiphysal cartilage. The changes in the bone are confined to the cyst, there being no general rarefaction of the bone as in generalized osteitis fibrosa. In a radiogram, a sharply

localized clear area is seen, perhaps with some expansion of the bone at the site. The appearance of symptoms is gradual. There may be some aching and localized swelling, or a spontaneous fracture may be the first indication of disease. If the bone reunites after fracture, the cyst may occasionally be obliterated.

TREATMENT.—This consists of opening and evacuating the cyst, with complete removal of any soft tissue in its wall. The cavity may then be filled with bone chips or allowed to close of its own accord.

### OSTEITIS DEFORMANS

(*Paget's Disease*)

Osteitis deformans is a chronic disease occurring in middle or old age, and manifested by general enlargement and deformity of the affected bones. The cause is unknown, but the condition is possibly due to a chronic state of toxæmia.

The disease may attack many bones, or be confined to one. The general health is not altered, but pain is usually felt in the affected bones. Such pain may be mild or severe, and may cause an error in diagnosis unless its origin in the disease in the bone is considered. The disease usually involves the whole length of the bone, which is increased both in circumference and in length, and also bowed (*Fig. 68*). The latter state is more marked in the lower than the upper limbs; thus the tibia and the femur are arched forward and outward, giving a bow-leg appearance, and the angle of the neck of the femur is also diminished (*coxa vara*). From this and from bending forward of the spine, when affected, the height of the patient is decreased. The underlying pathological changes consist of replacement of the normal osseous tissue by bone of more open and softer structure. The skull is also affected, especially the bones of the vault. These bones are greatly thickened,

but the cranial cavity is not lessened in size. Associated with the changes in the spine are often those of spondylosis deformans, namely, osteo-arthritis of the joints and degeneration of the intervertebral discs. From deformity and diminution of the size of the vertebral canal compression of the cord may occur.



*Fig. 68.*—Paget's disease of humerus, with forward bowing of the arm.

X-ray examination shows the increased size and deformity of affected bones. The normal view of the compact bone is replaced by that of a coarse, openwork structure with dense shadows in patches, giving a mottled or 'woolly' appearance (*Fig. 69*). Later the density of the bone shadow becomes greater.

The disease progresses very slowly and life may not be shortened. Spontaneous fractures may occur, but re-unite normally. Sarcoma has been observed as an occasional complication.

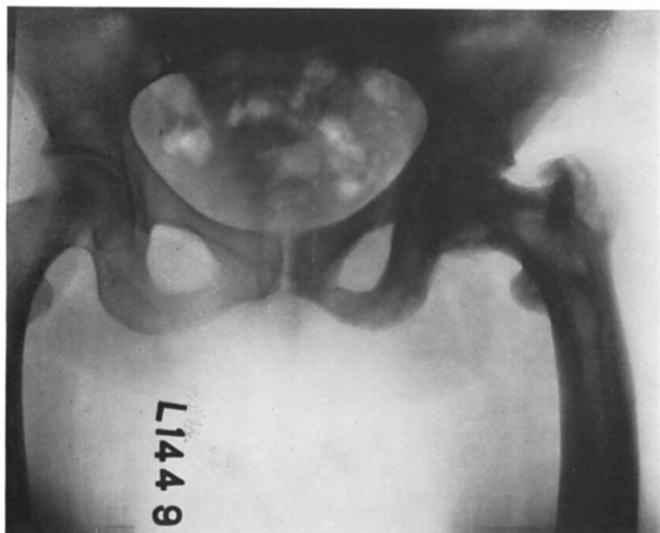

*Fig. 69.*—Osteitis deformans of the right femur. The bone is enlarged, bowed, and appears 'woolly' and increased in density.

**TREATMENT.**—There is no effectual treatment, but it is claimed that X-radiation and ultra-violet light give relief of pain in some cases.

### **OSTEOCHONDRITIS**

Osteochondritis is a disturbance of the epiphysis of growing bone, which is therefore seen only in children and adolescents. Its importance lies mainly in that from its symptoms it may be mistaken for tuberculosis ;

and that from the alteration it causes in the shape of bones it may cause deformity or development of osteoarthritis later in life.

The cause of osteochondritis is not known, but it is thought to be due either to mild infection or, more probably, to injury to the epiphysis. The disease may



*Fig. 70.*—Osteochondritis of hip (left).

affect many sites, the most common being the head of the femur (Calve's, Legg's, or Perthes' disease), the tubercle of the tibia (Osgood's or Schlatter's disease), and the tarsal scaphoid (Köhler's disease).

The symptoms at the onset are pain at the affected site, aggravated by movement, which may be limited by muscular spasm. A superficial epiphysis, such as the tibial tubercle, is tender on pressure. With affection of a lower limb epiphysis there is limping. The



diagnosis is made by X-ray examination, in which the epiphysis appears flattened and containing islands of dense bone with clear material around them ; later the islands fuse and the epiphysis presents a uniformly dense, flattened, and expanded appearance. These changes are seen especially well at the hip-joint, at which also shortening and broadening of the neck of the femur and lessening of the angle the neck makes with the shaft (coxa vara) are apparent (*Fig. 70*).

The disease pursues a course over some months or years. The symptoms gradually lessen and may entirely disappear, or in disease of the hip or spine some limitation of mobility or deformity may persist. Early in adult life, as has been stated, a joint such as the hip which has been affected with osteochondritis in childhood may become osteo-arthritic.

TREATMENT.—No treatment is of use in arresting the disease ; but pain is relieved and deformation of the epiphysis lessened by rest. The hip should be immobilized with extension in bed so long as pain and muscle spasm persist, and subsequently protected from weight-bearing for a year by the wearing of a caliper splint. In Osgood-Schlatter's disease, the child may be allowed to walk with a splint behind the knee to prevent movement. In Köhler's disease, a support for the longitudinal arch of the foot should be built into a strongly made shoe.

### SLIPPING OF EPIPHYSIS

Gradual slipping of an epiphysis without severe injury is seen occasionally at the upper end of the femur, causing symptoms which may be mistaken for tuberculosis, osteochondritis, or subacute septic arthritis. The head of the femur, like other epiphyses, may be displaced by the violence of an accident. But in the state of gradual slipping, the influence of injury

may be slight or absent ; it is therefore presumed that there is some disturbance of the epiphysis which makes it more liable than normally to displacement. The condition occurs nearly always in boys between the

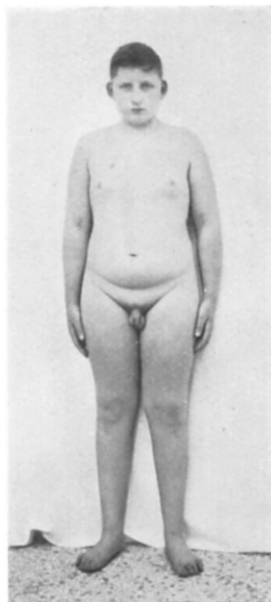

*Fig. 71.*—Slipping left upper femoral epiphysis. The patient is of the usual type suffering from hypopituitarism (Fröhlich's syndrome).

ages of 11 and 18 years, and of the heavy, obese, infantile type associated with deficient functioning of the pituitary gland (*Fig. 71*). The patient complains of pain at the hip, which may be sudden or gradual in onset, and limping, slight shortening, and limitation of abduction and internal rotation are noticeable. X-ray examination shows a degree of displacement

of the epiphysis downwards and backwards (*Fig. 72*). When this has become severe, the limb can be seen to be adducted at the hip, and the condition is known as 'epiphysial' or 'adolescent' coxa vara.



*Fig. 72.*—Slipping epiphysis of upper end of femur.

**TREATMENT.**—An attempt should be made to reduce the displacement. This may be done by forcible manipulation under anæsthesia followed by fixation of the hip for three months in plaster-of-Paris; or, preferably, reduction may be made gradually by abduction of both limbs supported in Thomas knee-splints

with weight-and-pulley traction. Obesity and pituitary disturbance if present should also be treated. When the patient begins walking again, he should do so only in a caliper to relieve weight-bearing through the hip. In unreduced cases in which the epiphysis has become fixed in the new position, the deformity at the hip may be corrected by subtrochanteric osteotomy. Osteo-arthritis may develop in adult life in unreduced cases.

## CHAPTER IX

**FRACTURES : GENERAL CONSIDERATIONS**

KNOWLEDGE of the principles of treatment of fractures is important to all who may be called upon to render first aid, to make preparations for treatment, or to maintain in an efficient state splints used for immobilizing a fractured bone. In cases treated in wards, constant attention on the part of the nurse is essential to success. With the better organization of fracture treatment in hospitals by segregation of cases in special wards and out-patient clinics, it is becoming easier for students and nurses to acquire a knowledge of fractures and to maintain interest in them.

A fracture is a break in the structure of a bone. It may be due to injury (*traumatic fracture*) or to disease (*pathological fracture*). In rare cases there is a congenital liability to fracture, a state known as *fragilitas ossium*, the cause of which is unknown. In certain nervous diseases—*tabes dorsalis* and *syringomyelia*—fractures are likely to occur. Cancerous deposits, other new growths, and fibrocystic disease of bone cause localized weakening which may result in fracture. In old age the bones are fragile ; in children they bend readily and so are more apt to crack and splinter lengthwise like a green stick than to break across completely.

Through injury, a bone may be fractured either by a blow (*direct violence*), or by force applied at a distance from the site of fracture (*indirect violence*), or by muscular action. The bone may be broken through completely or partially : the *green-stick* fracture of

children is a partial fracture. The line of fracture may be *transverse*, *longitudinal*, *oblique*, or *spiral*. If the fractured ends of the bone are driven into one another, the fracture is said to be *impacted*. If the ends are much broken up, the fracture is called *comminuted*. When a flat bone, as of the vault of the skull, is fractured and a part of the bone driven inwards, there is a *depressed* fracture. Finally, a fracture is *simple* or *closed* when there is no overlying wound opening on to the surface of the skin, or into a cavity such as the mouth. A fracture is *compound* or *open* when there is such a wound.

The symptoms of fracture are *pain* and *tenderness* localized to the site of fracture. Usually also there is *swelling* due to effusion of blood, and when the bones are displaced on one another there is *deformity*. If the bones are moved, a grating or crushing sound (*crepitus*) may be heard or felt ; but only the surgeon should attempt to elicit this. A fracture should be suspected whenever there is continued localized pain in a limb or in the back after an injury.

When a fracture occurs, the periosteum is torn and blood is spread around and between the ends of the bone. In a few hours, this blood clots and then is slowly 'organized' by growth of fine blood-vessels and fibrous tissue, which bind the ends of the bone together. In this bridging tissue lime salts are deposited, so that it becomes hard, forming *callus*. The callus is visible in an X-ray film and is gradually converted into bone. In this way the continuity of the bone is reconstituted. The time required for the process varies in different bones and at different sites in the same bone. Under ordinary conditions the following is the average time taken for certain common fractures to unite strongly : ankle, two months ; tibia, one to four months ; femur, three months ; upper

limb bones, three to six weeks ; vertebral bodies, three months.

Signs of union of a fracture are absence of pain during movement of the limb and on weight-bearing, absence of tenderness on deep pressure, and firmness on passive movement. In an X-ray film, a shadow is not shown by callus for about three weeks, and strong union must not be presumed until there is a solid and dense shadow between and around the fractured ends of the bone.

Union is delayed or prevented if the ends of the bone are not brought accurately together in reduction, and especially if muscle or other soft tissue is entangled between them ; also if the bones are not firmly held together after reduction. Septic inflammation of the wound of an open fracture causes osteomyelitis with destruction of bone, and thus leads to great delay in union. Union takes longer in adults, especially in old persons, than in children.

If the fractured ends join out of normal alinement, 'mal-union' is present. This is important, not only because it means an unsightly deformity, but also because it may interfere with the normal function of neighbouring joints and lead to development of osteo-arthritis in them.

### **GENERAL PRINCIPLES OF TREATMENT**

*The principles of treatment* are as follows :—

1. Before moving the patient from the place of the accident, immobilize the site of injury and dress any wound with an antiseptic dressing so as to prevent further injury and infection.
2. Reduce the fracture completely as soon as possible.
3. Immobilize continuously until union is present.
4. Maintain the muscles and other soft tissues in good condition while the bone is uniting.

5. Allow voluntary activity with use as soon as the means of immobilization and the amount of union will permit.

6. Prevent deformity during the early months of use after immobilization is discontinued, while the bony union is acquiring normal strength.

7. In open fractures, operate without delay to clear the wound of badly damaged soft tissue, dirt, and other foreign particles, disinfect, and close it; then reduce the fracture, and immobilize by external splintage.

8. In open fractures of more than twelve hours' duration or when inflammation is already present, leave the wound widely open to provide adequate drainage of discharge; reduce completely, and immobilize by external splintage.

The first aim of treatment is to save life, which may be endangered by shock, inflammation, pneumonia, or bed-sores. The second aim is to save the injured limb. The third aim is to obtain as perfect reduction and restoration of function as possible. Shock is often present, and is increased by imperfect immobilization during transport and by ineffectual efforts at reduction. Inflammation is usually preventable by early efficient treatment of the wound. Pneumonia and bed-sores may occur when the patient is kept recumbent for a long period and the back is not well cared for; they are uncommon with modern methods of treatment.

*The bed* on which the patient is nursed should be narrow, and have a firm mattress under which a board of the same extent should be placed. A mattress made in sections is in many cases advantageous. A hook with chain and handle over the head of the bed should be provided so that the patient may assist in raising himself.



*In reducing a fracture*, the surgeon attempts to place the distal in line with the proximal fragment, since the latter is held by the reflex contraction of muscles and only the distal fragment can be controlled. The way in which the fragments of the bone are displaced depends in the first place on the direction of the fracturing force; but other factors which increase or maintain the displacement are contraction of the muscles, injury of the soft tissues, effusion of blood, and the effect of gravity. In most fractures the fragments are displaced in several ways: they may overlap, so that the ends of the bone are side by side; they may form an angle with one another; or they may be rotated round their long axes from their normal position. All of these kinds of displacement must be overcome in reducing the fracture. Rotatory and angular displacement disappear when the distal is placed in the direction of the proximal fragment; longitudinal displacement (that is, shortening) goes when traction is applied, and then lateral displacement disappears by the pressure of the muscles around the bone or with external pressure.

In some fractures reduction is carried out immediately by manipulation; in others gradually by means of continuous traction. Another method of immediate reduction is by traction by means of special apparatus incorporating a screw. A fourth method is open operation, in which the fragments are exposed and levered together with instruments.

*An anæsthetic* is nearly always required in reduction, both to relieve pain and to relax the muscles. A general anæsthetic such as ether or chloroform may be used, or a local anæsthetic. The local anæsthetic (for example, 2 per cent novocain solution) is injected by a large syringe and needle through the skin into the blood effused around the fracture. The

anæsthetic quickly diffuses, pain disappears, and the muscles become relaxed in a few minutes. For this anæsthetic, sterile towels and gauze swabs, iodine, and collodion should be provided, as well as 50 c.c. sterilized local anæsthetic solution, a 20-c.c. syringe, and medium needles.

*An X-ray examination* is necessary before reduction to confirm the diagnosis and determine the exact position of the fragments. In some cases the fracture can be reduced with the aid of the fluorescent screen. After reduction, a further X-ray film is taken, and others during the period of immobilization, to ensure that a good position is maintained and to determine when sound union has occurred.

*The means of continuous immobilization* after reduction vary. With modern methods, few of the many special splints formerly in vogue are required. Wooden and other rigid splints which are not made to fit the injured part accurately should not be used. For fractures of the upper limb, the sling, the Thomas arm-splint, a shoulder abduction splint, and plaster-of-Paris suffice. For any fracture of the lower limb requiring traction, the Thomas knee and Hodgen splints are applicable. These are best used merely as a means of supporting the limb while the traction force is transmitted through them or independently of them to the limb. For this purpose, after pieces of flannel bandage have been fixed across them to support the limb, the splints should be slung with weights and pulleys to an overhead frame. The limb is thus held suspended, so that traction is more efficient and nursing is facilitated. An alternative to this suspension method is provided by Böhler's lower limb splint and by Hey Groves's cradle splint. With these the limb is supported on a raised frame resting on the bed and no overhead structure is needed. Plaster-of-Paris

is chiefly used for fractures of the spine, fractures in the region of joints which do not require traction, and for certain fractures of the shafts of the long bones, including partial fractures, fractures with no tendency to redisplacement after reduction, and fractures after operative reduction. When used for fractures, the plaster bandages are applied without padding directly on to the skin and closely moulded round bony prominences, so that no movement or displacement of the fragments within the plaster casing can take place. This method of application requires skill and care to prevent uneven pressure and interference with the circulation.

Means of traction are either fixed or mobile. In *fixed* traction, after the limb has been pulled upon until the fracture is reduced, it is held rigidly in that position by the splint, which must press upon some part of the body proximal to the level of fracture so as to maintain the necessary counter-traction. For example, when the Thomas knee-splint is used as originally designed, the leg is pulled on strongly and tied to the distal end of the splint; the ring at the proximal end presses against the tuber ischii and thus traction and counter-traction are maintained.

In *mobile* traction, the extending force is applied by a weight attached to the limb by a cord running over a pulley; counter-traction is provided by the weight of the rest of the body, aided by gravity when the foot of the bed is raised on blocks. This principle is applied, for example, when a suspended Hodgen or Thomas knee-splint, or a Böhler or Hey Groves splint, is used to support the leg, upon which a pull is made by a cord, weight, and pulley. The pull on the limb is taken either on the skin (skin traction), or by a direct grip on the distal fragment of the fractured bone (skeletal traction). In skin traction, a band

of adhesive material (zinc oxide plaster, strapping, or moleskin) is applied smoothly along either side of the limb from well above the level of the fracture, and fastened distally to a flat piece of wood to which is attached the cord passing over the pulley to the weight. The most even pull on the skin is obtained if the strapping is split on each side longitudinally into three pieces, which are fixed slightly diverging to the skin. No encircling pieces of strapping should be used, but a firm cotton bandage may be applied to cover the strapping. In skeletal traction, the distal fragment of the fractured bone is gripped by a steel caliper, by transfixion with a steel pin connected to a hoop, or by transfixion with a wire made taut during connection to a hoop; to the caliper or hoop is tied the cord passing over the pulley to the weight.

Skin traction is used mainly for children. Its disadvantage is that the adhesive material tends to slip and cause abrasions, and allows only a small weight (up to 10 lb.) to be used. This weight is usually enough for children, but not for adults. Skeletal traction is much more efficient: relatively less weight is required, but as much as 40 lb. may be used if necessary. The caliper, pin, or wire is usually applied with a local anæsthetic after a preliminary narcotic has been given. There must be strict asepsis, both in the application and the after-care.

*Open operations* on fractures must be carried out with the strictest aseptic technique by all concerned, because of the risk of infection, the results of which are disastrous. They are never done if the fracture can be reduced by other means, and should not be attempted except under completely satisfactory operating conditions. A minority of fractures are best treated by operation: fractures of the patella and olecranon usually; fractures of the shaft of the radius

or radius and ulna often ; most fractures if other methods have failed. After levering the fragments into accurate apposition, the surgeon may fix them by means of silk, catgut, or fascial sutures, or with plates, nails, or screws of steel or ivory. When plates or other foreign materials are used, the risk of infection is greater and union is delayed. Hence, many surgeons do not use these means of fixation, but operate merely to reduce the fracture or fix the fragments with a bone-graft. Whether or not some means of internal fixation of the fragments is employed, external splintage is necessary, as for fractures reduced by non-operative means ; usually plaster-of-Paris is used for this purpose.

*Massage and movements* require consideration here. Massage is not now regarded as so important in the treatment of fractures as formerly. The intention in treatment is to keep the fracture completely immobilized until there is sufficient union to prevent easy displacement. If, during that time, the means of immobilization allow of massage at the site of fracture and of movements of the neighbouring joints, these measures should be carried out, as they help to maintain a good circulation of blood through the limb and prevent joints from becoming stiff. Otherwise they are begun only when the fragments of the bone have united. Any movement should always be actively carried out by the patient, assisted, if necessary, by the hand of the masseuse or by apparatus. Forced so-called passive movements are harmful, and have no place in fracture treatment. In children, massage is not necessary, except effleurage to reduce marked swelling. More important than massage in all cases is active use of the limb. With modern methods of fixation of certain fractures, it is possible to allow a considerable amount of use of the limb

without risk of movement at the site of fracture. Thus, with a fracture of the wrist immobilized in plaster-of-Paris, the patient may and should do without a sling and use the hand freely for many purposes. With a fracture of the ankle, immobilized in plaster-of-Paris and with an iron walking heel applied, the patient should begin walking within a few days. In this way, the state of nutrition of the limb remains good, while union of the fracture is accelerated.

**Non-union.**—Permanent failure to unite is uncommon ; but delay in uniting from causes mentioned above is not infrequent. In the treatment of delayed union, local sepsis, if present, must be first eliminated. Then, if the fragments are in good position, active use of the limb in a supporting plaster or appliance usually results in union. But if the fragments are widely displaced, an operation is needed. In this the surgeon cuts away any intervening soft tissue and freshens the ends of the fragments, afterwards bringing them accurately together and fixing them with a bone-graft. After closing the wound, a plaster-of-Paris casing is applied, and, as soon as possible, active use of the limb permitted.

**Mal-union.**—Mal-union is nearly always avoidable by early and efficient treatment, but is sometimes inevitable from destruction of bone by the injury or by septic inflammation. When present, mal-union should usually be corrected by operation, either by re-making the fracture, levering the fragments into normal apposition, and fixing them ; or by simple osteotomy at a distance from the site of fracture and restoration of the normal general alinement of the limb. After either operation, the limb is encased in plaster-of-Paris until union has occurred in the corrected position.

*CHAPTER X***SPECIAL FRACTURES****THE SKULL**

IN fractures of the skull the most important factor is the usually associated injury to the brain and the blood-vessels of the meninges. Any part of the skull may be fractured ; but more often the base is injured than elsewhere. The fracture may occur either at the site where the skull was struck or at a point opposite to this. The brain and meninges may be injured either by the force of the blow which caused the fracture, by displacement of the fractured bone inwards, or by effusion of blood. A meningeal artery may be torn and bleed, causing a gradual accumulation of blood which presses on the brain.

Nearly always when the skull has been fractured the patient is unconscious for a period varying from a few seconds to several days. A fracture should be suspected if there is bleeding from the nose, mouth, or ear, or under the conjunctiva of the eye, and when there is a swelling over any part of the skull. It will be revealed, if present, by an X-ray examination. When a meningeal artery is torn, the patient may be unconscious for only a short time after receiving the injury ; but, as blood accumulates inside the skull, he becomes unconscious again and may die unless an immediate operation is done.

**TREATMENT.**—Any wound of the scalp should be covered by an antiseptic dressing and bandaged firmly to control bleeding until it can be explored and sutured

under proper conditions. The patient should be kept at rest in bed, warm, without a pillow, in a quiet, darkened room. The depth of unconsciousness, if present, should be ascertained by noting if the patient can be roused by questioning, or withdraws his arm or leg when the skin is pinched. Any subsequent change should be noted, and observation made also of the relative size of the pupils and the power and tone of the muscles of the face and limbs of both sides of the body. An hourly record should be kept of the temperature and the pulse and respiration rates for the first forty-eight hours, and subsequently a four-hourly record continued until recovery of consciousness. The presence of retention or incontinence of urine should be noted and reported. Progressive increase in the depth of unconsciousness, in the loss of tone in the muscles of one side of the body, in difference in the size of the pupils, or in slowing of the pulse, may indicate increasing pressure on the brain. To reduce the pressure, the surgeon may adopt measures such as lumbar puncture, administration per rectum of a solution of magnesium sulphate (3 oz. in 6 oz. of water), or intravenous injection of a hypertonic solution (50 per cent glucose). Or he may decide to perform an immediate operation, especially if he suspects continuing bleeding from a meningeal artery, or when there is a depressed fracture.

On recovery of consciousness, a patient may suffer from headache, giddiness, insomnia, and other cerebral symptoms. He should be kept strictly at rest while these symptoms persist and then be allowed only gradually to resume normal activity.

### THE JAWS

Fractures of the jaws are often compound into the mouth. Fracture of the lower jaw commonly occurs



through the ramus close to the angle ; it may be unilateral or bilateral, and is usually obvious.

TREATMENT.—For first aid, the fracture may be partly held by means of a four-tailed bandage, the centre piece of which is slit to fit over the chin and the tails are tied over the top and back of the head. Permanent immobilization is secured by a moulded external splint of plaster-of-Paris or poroplastic, or by an internal (inter-dental) splint of vulcanite. The fracture may also be immobilized by tying the upper and lower teeth together with wire ; or the fragments may be fixed together with silk or wire, or by a bone-graft. Whatever method is used, it is difficult, and special care is needed, to keep the mouth clean and free from accumulated food. The patient should be fed with liquids through a tube into the mouth, or through the nose, until the fracture has united.

### THE SPINE

The spine may be fractured in several ways. The body of a vertebra may be compressed vertically ('crush' fracture) without complete disruption ; or the vertebral body may be completely broken across, so that the fragments are much displaced (fracture-dislocation) ; or the laminæ or spinous processes may be fractured alone. In 'crush' fractures, the spinal cord is not injured, and there may be either no deformity or deformity only develops gradually later ; pain is felt radiating along the nerves which pass through the foramina at the site of fracture. This fracture (*Fig. 73*) is much more common than is generally realized, and is easily overlooked. In fracture-dislocation the spinal cord is very liable to be lacerated or crushed, so that paralysis and loss of sensibility in the area of the body below the level of the injury is usual, and there may be retention or incontinence of

urine (*see* p. 70). Whilst fractures of the vertebral bodies are caused by sudden forced flexion of the spine, fractures of the spinous processes and laminæ are usually due to a direct blow, and are, accordingly,

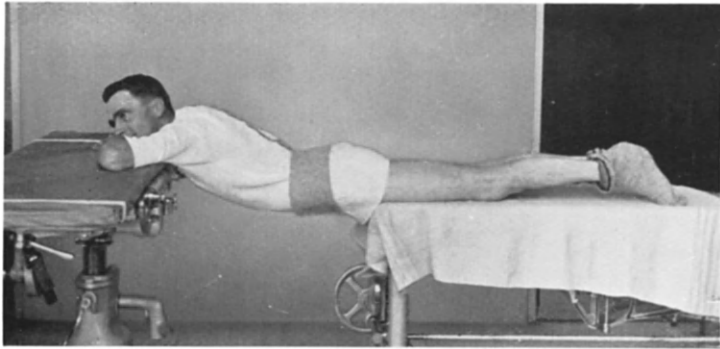

Fig. 73.—'Crush' fracture of the body of 1st lumbar vertebra (six weeks after injury).

often compound. The laminæ may be driven inwards, damaging the spinal cord and causing symptoms as in fracture-dislocation. In this case immediate operation is required to clean and suture the wound and to elevate the depressed fragments of bone.

TREATMENT.—The first-aid handling of a patient with a fracture of the body of a vertebra is most

important. Careless or improper handling may easily cause or increase damage to the cord, resulting perhaps in permanent paralysis or in death from later complications. In any case of apparent injury to the back or neck, the spine should be kept hyper-extended. In injury to the neck, the patient should be placed flat on his back with a small firm pillow behind the neck; in lifting him on to a stretcher or bed, one

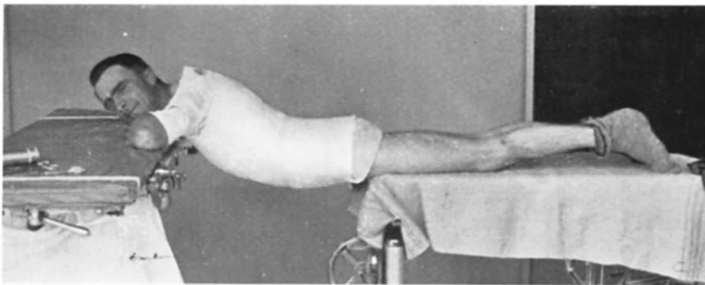

*Fig. 74.*—Fracture of spine in lower thoracic region. Patient suspended between higher and lower tables for application of plaster jacket over woollen vest. Note felt strips around pelvis and along midline of back.

person should grasp the head, maintaining a slight steady pull on it and holding the neck bent backwards. In injury below the level of the neck, the patient should be carefully rolled into the prone position, whereby the spine is extended; he should be lifted on to the stretcher in this position and kept thus during transport.

When the spine is held from the first hyper-extended, the shape of a crushed vertebra may be restored to normal or the displacement of a fracture-dislocation reduced. In treatment, the surgeon

reduces the fracture, whether or not there are signs of injury to the cord, by hyper-extending the spine, and then immobilizes it by applying plaster-of-Paris in the form of a jacket. In applying the jacket for fractures in the thoracic and lumbar regions, the patient is suspended prone between a high and a low table (*Fig. 74*). No anæsthetic is required, but a hypodermic injection of morphia and hyoscine may be given beforehand. The weight of the body provides



*Fig. 75.*—Fracture of spine in lower thoracic region. Plaster jacket applied, before trimming.

sufficient force to reduce the fracture. Without further moving the patient, plaster-of-Paris bandages are applied to form a casing reaching from the pelvis to the upper part of the chest (*Figs. 75, 76*). Under the plaster the patient should wear a close-fitting woollen or cotton vest, to which pieces of felt should be sewn over the crests of the ilia, the sacrum, and along the spine.

The plaster jacket is worn for three to six months. If there is no paralysis, the patient is allowed to walk as soon as the plaster is dry. Paralysed cases should be kept on a firm bed until the fracture has united, after which it may be possible to get them up in a

wheeled chair or on crutches. Special care is needed to prevent pressure sores, by frequently turning the



*Fig. 76.*—Fracture of the spine. Plaster jacket applied. (The woollen vest is still to be trimmed, turned up over the edge of the jacket, and fixed with plaster.)

patient into a new position and by scrupulous cleanliness of the skin. The lower limbs should be kept in splints to prevent deformities. If the bladder has to be catheterized, great care must be taken, as it is easy to introduce infection, the results of which may be fatal.

### THE RIBS

Fracture of a rib causes sharp localized pain, which is aggravated by breathing and coughing and if the chest is compressed from before backwards. The pleura or lung may be injured at the same time.

TREATMENT.—There is seldom any displacement of the fragments, so that it is sufficient to immobilize as much as possible the affected area of the chest by a broad band of adhesive strapping, applied during expiration round the half of the thorax on the injured side.

### THE PELVIS

Fracture of the pelvis is caused by a crushing injury, as by being run over by a wheel or caught between buffers. There is considerable risk of injury to the urethra, bladder, or rectum by displacement of the fragments. Evidence of such injury may be severe pain in the lower abdomen, passing of blood-stained urine, inability to urinate, or escape of urine into the subcutaneous or sub-fascial tissues ; it should not be overlooked, since immediate operation is required.

TREATMENT.—When there is no injury to the pelvic viscera and no clinical or X-ray signs of gross displacements of the fragments of the fracture, a firm binder is sufficient to immobilize ; or, to aid nursing, a broad sling may be placed round the pelvis and tied to an over-head beam. When the fragments are widely displaced, the surgeon may apply traction to the lower limb on the same side, as for fracture of the femur.

### THE CLAVICLE

Fracture of the clavicle occurs commonly at the junction of the middle and outer thirds of the shaft, or at the outer end. In the former, there is localized

pain and obvious deformity ; the shoulder is displaced downwards, forwards, and inwards, and the patient takes the weight of the limb by supporting the elbow in the opposite hand. In fracture of the outer end, the signs are not so evident, and, unless an X-ray examination is made, the injury to the bone may be overlooked.

TREATMENT.—The fracture is reduced by drawing the shoulder upwards, outwards, and forwards, and must be held thus for three weeks until the bones unite. The simplest method of immobilization is complete recumbency with a sandbag or small hard pillow between the shoulders. An ambulatory method is to tie a handkerchief round each shoulder and to draw the ends of the two together behind the back by joining them with a third handkerchief ; the forearm is supported with a sling. Alternatively a plaster-of-Paris yoke may be made to hold the shoulder in position ; or adhesive plaster may be used (Sayre's method). In children, in whom the fracture is usually of the 'greenstick' kind, a sling supporting the elbow is often all that is required.

### THE HUMERUS

**Fractures of the Upper End of the Humerus.**—These fractures are usually accompanied by considerable swelling, which obscures the deformity caused by displacement of the fragments. The presence of a fracture may thus be overlooked, the signs of injury being attributed to sprain or bruising unless an X-ray examination is made.

TREATMENT.—In children and young adults, after reduction, the fracture should be immobilized with the arm abducted to a right angle, forwardly flexed  $40^{\circ}$ , externally rotated, and with traction applied. The patient may be kept in bed with the arm supported

in a Thomas arm splint (*Fig. 77*) and traction applied by adhesive plaster to the arm or by a taut wire through the olecranon, connected to a weight and pulley on a standard; the elbow should be flexed and held by adhesive plaster on the forearm to a weight and pulley fixed to an overhead beam. If traction is not required, the arm may be supported on a metal shoulder abduction splint; or a plaster-of-Paris jacket may be applied, extended to include and hold the arm in the position of abduction, forward flexion, and external rotation as stated above.



*Fig. 77.*—Thomas's arm splint.

In older persons, it is best to immobilize the arm only by bandaging the arm to the side and supporting the forearm with a cuff and collar sling. From the first, massage of the arm and assisted active movements of the elbow and hand should be given. After two weeks, assisted movements of the shoulder-joint should be carried out. The bandage may be discarded after three and the sling after four weeks.

**Fractures of the Middle of the Shaft of the Humerus.**—Such fractures are liable to be complicated by injury to the radial nerve as it winds round the bone. The nerve injury is indicated by paralysis of the extensor muscles of the wrist and fingers, and demands a prompt reparative operation.

**TREATMENT.**—After reduction, the fracture may be immobilized by a plaster-of-Paris casing, reaching from the axilla and including the elbow. If traction



is required, a Thomas arm splint may be used, as for fractures of the upper end of the bone, the shoulder being held abducted and the elbow flexed.

### THE ELBOW

Fractures of the elbow-joint, unless adequately treated, often result in deformity and limitation of

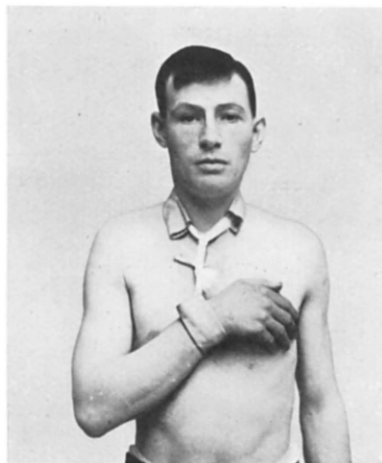

*Fig. 78.*—Cuff-and-collar sling.

movement. A common site of fracture, especially in children, is the lower end of the shaft of the humerus.

**TREATMENT.**—These fractures, after reduction, may be immobilized merely by flexing the elbow fully, but without tension, and applying a cuff-and-collar sling to hold the forearm (*Fig. 78*). It is an error to fix the flexed elbow with bandages, because the circulation of the blood may be thereby impeded, from

which in a short time irreparable damage to the muscles of the forearm may be done: the muscles become replaced partially or entirely by fibrous tissue, from contracture of which a claw-like deformity of the hand and wrist results. This disastrous state is known as Volkmann's ischæmic contracture, and is only partly improvable, if at all, by gradual stretching in splints, or by operation.

In some cases of injury to the elbow, the fracture involves the articular surfaces, pieces of which may be broken off and be loose in the joint. In these cases, an operation is usually required. Operation is also often needed for fracture of the head or neck of the radius and for fracture of the olecranon. In the latter, the fragments are fixed together by silk or wire, passed through drill holes, and the arm is subsequently immobilized, with the elbow extended, by a plaster-of-Paris or padded wooden splint.

### THE FOREARM

In fractures of the forearm either the radius or the ulna or both bones may be injured. There is often much displacement of the fragments with marked deformity.

TREATMENT.—Reduction by manipulation is difficult, so that operative reduction is frequently preferable. If traction is needed to maintain the position during immobilization, adhesive plaster is used, the limb being supported in a Thomas arm splint and the patient kept in bed. Otherwise, plaster-of-Paris is the best means of immobilization.

### THE WRIST

**Colles's Fracture.**—The commonest variety of fracture at the wrist is known as Colles's fracture. In this, the lower end of the radius is fractured and

displaced backwards and proximally; the styloid process of the ulna is sometimes also broken off. The hand and wrist are swung towards the radial side so that the lower end of the ulna is abnormally prominent. The deformity is usually obvious; but in some cases the displacement of the fragments is only slight, and until an X-ray examination is made the injury may be put down as a sprain. The result of this mistake may be serious, as ugly deformity may develop later.

TREATMENT.—It is important to reduce a Colles's fracture completely to prevent deformity and disablement. This may be done by manipulation, with the



Fig. 79.—Plaster casing for Colles's fracture.

aid of an orthopædic wedge in difficult cases. After reduction, the fracture may be immobilized by a light splint of plaster-of-Paris, applied directly to the skin on the dorsal aspect from the upper part of the forearm to just short of the knuckles (*Fig. 79*). This splint should be closely moulded round the borders of the forearm and hand. The patient should not be given a sling, but should be made to use the hand freely, since in this way any swelling rapidly subsides and the risk of stiffness of the joints of the hand and wrist is minimized. The plaster is retained for four to six weeks and then removed for assisted and active exercises of the wrist and forearm.

**Fracture of a Carpal Bone.**—Fracture of a carpal bone, commonly the *scaphoid*, is not rare, and may be mistaken for a sprain. Pain is felt on pressure over the injured bone and on dorsiflexing the wrist.

TREATMENT.—Treatment is by immobilization of the wrist in dorsiflexion by plaster-of-Paris for six weeks. Treatment by massage and movements from the first is actually harmful and prevents union of the fracture.

### THE METACARPALS AND PHALANGES

TREATMENT.—Fractures of the metacarpals and phalanges which do not require traction for fixation are treated by plaster-of-Paris or other moulded splints. When traction is needed, the pull on the fingers may be taken by adhesive plaster, or, better, by a fine steel wire introduced through the tip of the finger; this is attached to a wire hoop held by a plaster-of-Paris casing to the wrist and hand.

### THE FEMUR

**Fracture of the Neck of the Femur.**—Fracture of the middle of the neck of the femur (*intra-capsular fracture*) is relatively common in the aged, in whom it may occur from a trivial accident, such as tripping over a carpet. Formerly, it was thought that bony union of this fracture was not to be expected in old persons; accordingly little was done, and death from exhaustion, pneumonia, or toxæmia from bedsores often resulted. With modern methods, the fracture is reduced and bony union obtainable in the majority of cases, fibrous union being the result in the remainder. With careful nursing most patients remain well during treatment and survive this injury as well as any other.

Immediately the fracture has occurred, the position of the limb is characteristic, being shortened, adducted,

and everted (*Fig. 80*) ; the patient complains of pain in the hip and is unable to take weight on the limb. In some cases, in which the fragments are driven into one another (impacted), the symptoms are much less severe and the occurrence of fracture may not be recognized : this is a serious error, as deformity and disability may gradually develop.



*Fig. 80.*—Showing position of the limb in intracapsular fracture of the neck of the right femur.

**TREATMENT.**—The surgeon reduces the fracture by forcibly abducting, inverting, and extending the limb. This may be done by manipulation under general or local anæsthesia and the fracture then immobilized by applying a plaster-of-Paris casing, extending upwards on the trunk to the lower part of the chest and down the affected limb to beyond the toes (Whitman method) (*Fig. 81*). Or the reduction may be obtained gradually by weight extension applied to both lower limbs, which are supported in Thomas knee-splints, the degree of abduction being increased daily. A third method, the Anderson well-leg counter-traction method (*Fig. 82*), requires the use

of a special apparatus. It has the advantage that it enables the patient to sit up and go about in a



*Fig. 81.*—Showing plaster casing applied in Whitman abduction method of treating fracture of the neck of the femur.

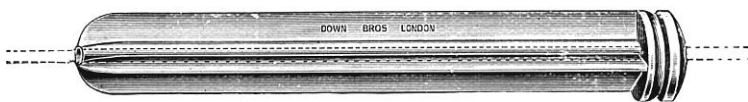

*Fig. 82.*—Fracture of neck of femur, left Anderson well-leg counter-traction apparatus applied.

wheeled chair without disturbing the fracture; but bony union does not occur so often as with the Whitman method. In the Anderson method, while

traction is maintained on the injured limb, the sound limb is used for countertraction and fixation.

Operative means of fixing the fracture are also employed: after reduction of the fracture by manipulation or through the operation wound, a bone-graft



*Fig. 83.*—Special 3-flanged rustless nail (Watson-Jones pattern) for fracture of neck of femur.

or a special flanged rustless pin (*Fig. 83*) is driven into a hole bored through the midline of the neck from the base of the greater trochanter across the line of fracture into the head of the femur (*Fig. 84*).

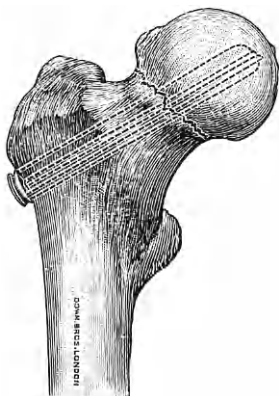

*Fig. 84.*—Showing nail in position for fracture of neck of femur.

Whatever method of treatment is used, the nursing must be constant and skilful. If the means of immobilization allow, as in the Whitman and Anderson methods, the patient should be turned over daily for

a time into the prone position. The skin of the back and buttocks must be kept clean and dry to prevent sores. The patient should be taught to breathe deeply frequently so as to prevent hypostatic congestion of the lungs.

Fracture of the base of the neck of the femur (*extra-capsular fracture*) may be treated by any of the above methods. Bony union nearly always occurs.

**Fracture of the Shaft of the Femur.—**

TREATMENT.—These fractures nearly always require strong continuous traction, both to reduce the displacement of the fragments gradually and to maintain

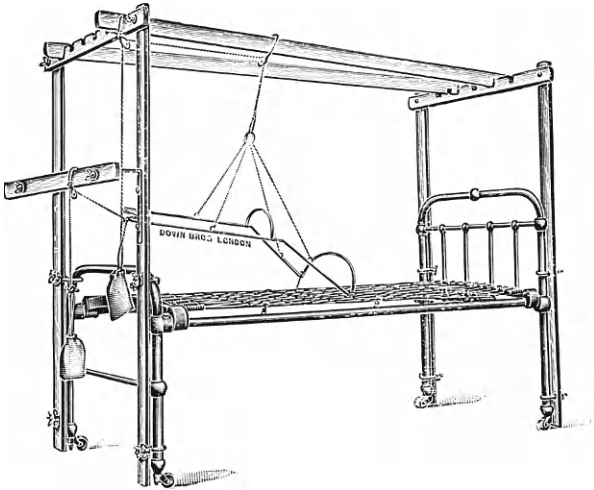
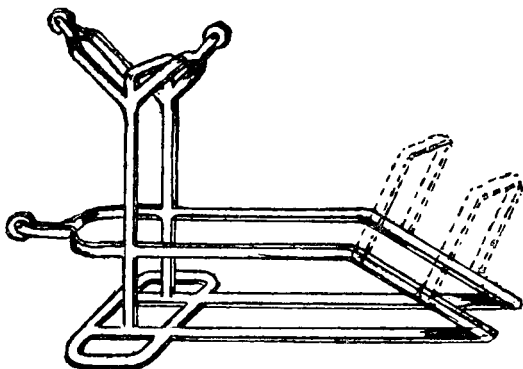

Fig. 85.—Overhead frame for traction and suspension.

them in good position. In young children, traction is taken by adhesive plaster and the limb tied vertically to a weight and pulley attached to an overhead bar ('gallows' method); the weight should be enough



to raise the buttocks slightly off the bed. In older children, adhesive plaster is also used, with either fixed traction by a Thomas knee-splint, or, preferably, mobile traction by weight and pulley, the limb being semi-flexed at the knee and slung to an overhead frame (*Fig. 85*). To support the limb, a towel beneath the knee (Hamilton Russell method), a Thomas knee-splint bent at the level of the knee, or a Hodgen splint may be used. Alternatively, the limb may be supported



*Fig. 86.*—Böhler's femur splint.

on Böhler's thigh splint (*Fig. 86*), which obviates the need for an overhead frame. In adults, skeletal traction is necessary, the grip being made on the lower end of the femur, either by ice-tong calipers, a steel pin and hoop, or a taut-wire apparatus; or on the tubercle of the tibia by a pin or taut wire. These appliances are connected to a weight and pulley, and the limb is slung in a bent Thomas knee-splint or Hodgen splint, or supported on a Böhler thigh splint. In any of these, adhesive plaster traction is made also on the leg below the knee, and the foot is supported by the same means at a right angle.

### THE PATELLA

TREATMENT.—Fracture of the patella is usually treated by operation, because there is often wide separation of the fragments which cannot be reduced by other means. If the fragments are not brought together accurately, the knee remains seriously disabled. At operation, which is performed after several days' preparation of the skin, the joint is irrigated with hot normal saline to wash away blood-clot, and the fragments are drilled and drawn together by silk or wire. Subsequently the limb is supported on a wooden or plaster back-splint. As soon as the wound is healed, faradic and active contractions of the quadriceps are given daily until active use of the limb is allowed.

### THE TIBIA AND FIBULA

TREATMENT.—Fracture of the shaft of the tibia and fibula usually requires strong traction for reduction. In children, the weight and pulley method is

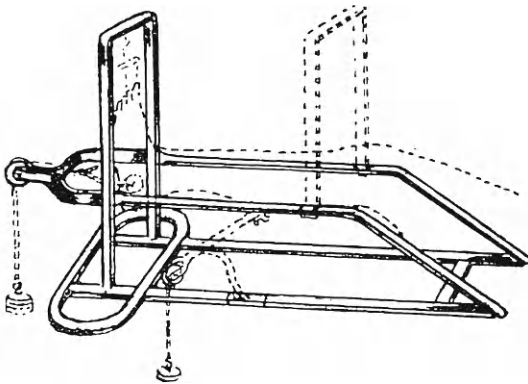

Fig. 87.—Böhler's leg splint. The leg is shown by a dotted line with metal pin traction through the os calcis and suspension of the foot.

used, adhesive plaster being applied to the skin and the limb supported on Böhler's leg splint or slung on a bent Thomas knee-splint. In adults, reduction may be made in a few minutes by a screw-traction



*Fig. 88.*—Walking plaster with Böhler's iron heel.

apparatus and an unpadded plaster-of-Paris casing can be applied immediately. Or the fracture may be gradually reduced by weight and pulley with skeletal traction, applied by a pin or taut wire through the

lower end of the tibia or the os calcis ; the limb is supported, as in children, on a Böhler leg splint (*Fig. 87*) or on a bent Thomas knee-splint, slung to an overhead frame. This fracture is often compound, because the front of the tibia is covered only by skin. When a wound is present, it must be at once cleaned and sterilized, and the fracture then dealt with as in simple fracture. In fractures without displacement of the fragments or without tendency to redisplacement after reduction, and in all fractures when early union has occurred, a plaster-of-Paris casing with an iron walking heel may be applied and walking allowed (*Fig. 88*).

### THE ANKLE

Several varieties of fracture occur at the ankle. In *Pott's fracture*, the fibula is broken a short distance above the external malleolus and either the internal malleolus is fractured at its base or the internal lateral ligament is torn ; in consequence, the foot is dislocated outwards and backwards. There is thus considerable deformity and also much swelling from effusion of blood.

TREATMENT.—Fractures at the ankle usually are reduced by manipulation and do not require traction to maintain them in position. After reduction, an unpadded plaster-of-Paris casing is applied with an iron heel so that the patient may walk from the first. If the fracture is not fully reduced, the resulting deformity may be unsightly and disabling and necessitate an operation to reconstruct the fracture and fix the bones in their normal position.

### THE OS CALCIS

Fracture of the os calcis occurs from falling from a height on to the feet. The bone is usually crushed and partly broken across the middle ; the break may

extend into the sub-astragaloid joint or upset the alinement of that joint. The common result of this fracture is severe and permanent disablement. In early cases, the presence of the fracture is easily overlooked unless an X-ray examination is made.

TREATMENT.—If there is no severe disruption of the bone, the treatment may consist of keeping the patient off his feet for six weeks, with or without immobilization of the injured foot in plaster-of-Paris. When the shape of the bone is much altered, it may be largely restored by the use of special traction and compression apparatus. In old cases, pain and disability may be relieved by arthrodesis of the sub-astragaloid joint.

### THE METATARSAL BONES

Fracture of a metatarsal bone may be caused by direct violence.

TREATMENT.—If there is no displacement of the fragments, a plaster-of-Paris casing, reaching from below the knee to beyond the toes and incorporating an iron heel, is applied and walking allowed. If there is displacement, traction is made on the metatarsal by a wire passed through the tip of the corresponding toe and fixed to a hoop, the ends of which are fixed in the plaster casing.

## CHAPTER XI

INJURIES TO NERVES, MUSCLES,  
TENDONS, AND JOINTS

## INJURIES TO NERVES

NERVES may be injured by accidental or operative wounds, by pressure, or by being stretched.

In *deep cuts, stabs, and gunshot wounds*, nerves are often partially or completely severed ; no such wound should be treated without first determining whether or not a nerve has been injured. Wounds of the wrist, especially, are frequently complicated in this way. Sometimes in *operations*, particularly on the neck, nerves are accidentally or unavoidably divided.

A nerve may be injured by *pressure* without damage to the skin and other overlying tissues. Such pressure may be applied momentarily, as when a limb is allowed to strike against the edge of an operating table while the patient is being fixed in position for operation. The continuous pressure of a tourniquet or a crutch, or of tightly applied splints, bandages, or strapping, may injure a nerve. In fractures, a nerve passing close to the site of fracture may be torn by the displaced ends of the bone or injured by pressure of newly-formed bone as the fracture unites. During healing of a wound, nerves may be caught up in and compressed by scar tissue.

Injury to a nerve by *stretching* is also easily and often caused. During operations, continuous holding of the limb in an exaggerated position may stretch nerves. In reduction of dislocations, nerves lying close to the joint may be similarly damaged. A

specially named variety of stretching nerve injury is 'obstetrical paralysis.' This is seen in newly-born infants, and is due to stretching of the roots of the brachial plexus during labour from pulling downwards or upwards on the arm or from excessive bending of the neck to one side. Commonly the upper



*Fig. 89.*—Erb's (birth) paralysis of upper limb.

roots of the plexus are injured, when the form known as 'Erb's paralysis' results, characterized by paralysis of the deltoid, biceps, brachialis, supinators of the forearm, and extensors of the wrist and fingers. The arm hangs by the side and is rotated inwards; the elbow is extended, the forearm pronated, and the wrist and fingers slightly flexed (*Fig. 89*). Rarely, the lowest root of the plexus is injured, resulting in paralysis of the intrinsic muscles of the hand and loss

of function of the cervical sympathetic nerves ; the hand becomes claw-shaped, and, on the same side, the pupil is contracted and the skin of the face, neck, and upper limb dry and flushed.

The injury to a nerve may cause complete or partial division (complete or incomplete anatomical interruption) ; or there may be no actual division of nerve fibres (complete or incomplete physiological interruption). In anatomical interruption, the continuity of the nerve fibres is broken ; in physiological interruption, only the power of conducting impulses along the nerve is lost. In the first, recovery is impossible without suture of the nerve ; in the second kind of interruption, spontaneous recovery may occur.

When a nerve is divided, it can only be regenerated from the proximal end. If the nerve is sutured, the nerve-fibres (axons) of the proximal part do not join again those of the distal part. The latter degenerate, leaving only the connective-tissue framework ; inside this the axons from the proximal part of the nerve grow gradually towards the periphery. If the nerve is not sutured, the distal part is converted into a fibrous cord, and the axons from the proximal end grow out irregularly and form a bulbous end to the nerve.

The symptoms of *complete interruption*, whether anatomical or physiological, are loss of feeling in the area of skin and loss of power in the muscles supplied by the nerve. The area of anaesthesia does not always correspond strictly to the area of skin to which the branches of the nerve are distributed, because nerve fields tend to overlap. Moreover, the area of loss of sensibility to light touch and tactile and thermal discrimination (epicritic sensibility) is always larger than the area of loss to pin-prick and large degrees of temperature (protopathic sensibility), which is



again larger than the area of loss to pressure. The nerve-fibres conducting feeling of pressure run mainly with the branches to muscles, and have widespread connections; feeling of this kind is therefore usually not lost except when a nerve-trunk is divided at a high level.

In addition to loss of voluntary power, the muscles cease to respond to stimulation by the interrupted faradic current after a few days, and their response to the galvanic current becomes altered, the anodal closing



*Fig. 90.*—Ulnar nerve paralysis. Note slight contracture of ring and little fingers.

contraction (A.C.C.) being greater than the kathodal closing contraction (K.C.C.), a stronger current than the normal being required, and the contraction being sluggish and wave-like. To these electrical phenomena the term 'reaction of degeneration' (R.D.) is applied. The muscles waste rapidly, and if their nerve connection is not re-established, they eventually become changed into fibro-fatty tissue. Unless prevented by splinting, the unparalysed antagonistic muscles gradually shorten and pull the limb into positions of deformity (*Fig. 90*).

In the area of anæsthesia, 'trophic' changes occur. The skin becomes wrinkled, pinkish-blue, dry, and

colder than normal. A slight injury, the pressure of a splint or the heat of a hot bottle, is likely to cause a blister, which ruptures to form an indolent ulcer. The nails lose their gloss and become ribbed, and the hair is lost.

In *incomplete interruption* of a nerve, sensibility may or may not be lost, or there may be an alteration in sensibility which the patient cannot define. The muscles are paralysed, but may remain responsive to the faradic current. In some cases a peculiar state known as 'causalgia' develops in a few days or weeks; there is pain, described as burning, in the area supplied by the nerve, and the skin is extremely tender to touch; the skin may be glossy and sweat profusely; blisters may form and ulcers follow.

TREATMENT.—When there is a wound and signs of nerve injury, the wound must be explored and the nerve sutured with fine catgut. If the wound is inflamed, suture of the nerve is postponed until the inflammation has subsided. The limb is placed in a splint in a position keeping the paralysed muscles relaxed and avoiding tension on the nerve. The muscles are exercised daily by stimulation with the surging galvanic current; later, when the nerve has re-established connection with the muscles, the faradic current is used also and active contractions are encouraged.

The length of time for regeneration of a divided nerve varies with different nerves, and depends also on the level and extent of division, whether the wound remains healthy or becomes inflamed, the time of suture after injury, and the age of the patient. The time is shortest in young patients, when immediate suture is carried out, and when there is no inflammation. In the absence of complications, sensory recovery begins in about six weeks, spreads gradually

towards the periphery, but is not complete for two or three years. Recovery takes place in the muscles similarly, but usually begins later and takes longer. Return of the normal response to the galvanic current is the first sign of recovery ; but usually the power of voluntary contraction returns a little before responsiveness to the faradic current. If there has been delay in suture, recovery both in sensibility and in the muscles is often slower and less complete.

When a nerve is injured by pressure or stretching and there is no external wound, an operation is not usually done immediately. A splint is applied with the paralysed muscles relaxed, and treatment by gentle kneading massage and electrical stimulation carried out. Often the muscles remain irritable to the faradic current and both sensibility and muscular power begin to return in a few weeks and are complete within six months. But if after two weeks the reaction of degeneration is present in the paralysed muscles, an operation on the nerve should be performed. The nerve may have to be freed from fibrous tissue, or trimmed and sutured, if rupture of its fibres has occurred.

Nerve injuries complicating fractures often need to be treated by operation to suture a torn nerve, to free it from scar tissue, or to relieve it from pressure or stretching by displaced bone. Sometimes the nerve is not affected until weeks or months after the fracture was sustained ; such cases nearly always require operation.

### **INJURIES TO MUSCLES**

A muscle may be injured by a direct blow or by the displacement of the bones in a fracture or dislocation ; or by indirect violence when it is suddenly stretched beyond its normal length. The fibres of

the muscle are torn and blood is effused between and around them. The rupture of the muscle is often only partial, but it may be complete. Sometimes the fibrous sheath of the muscle is torn while the muscle itself remains intact. In this way a hernia is caused; the muscle substance bulges through the gap in the sheath when the muscle is relaxed, and subsides when the muscle contracts or is put passively on the stretch. Partial rupture is a common injury, and is popularly called a 'strain' or 'pull'. Complete rupture is most common at the junction of the fleshy and tendinous parts of a muscle. In the healing of a partial or complete rupture the muscle fibres do not regenerate across the gap, which becomes filled with fibrous tissue.

The symptoms of muscle injury are pain at the site of rupture accentuated by attempts at active or passive movement, localized tenderness, and swelling. In complete rupture, the normal movement performed by contraction of the muscle cannot be made, and swelling is due not merely to blood effusion, but also to contraction and retraction of the ends of the muscle.

TREATMENT.—A partial rupture ('strain') is best treated by stroking and kneading massage, surging faradic contractions, and active and gentle passive movements. In this way the effused blood is rapidly absorbed and adhesions in and around the muscle are prevented. The treatment is carried out daily for about three weeks. If the case is not seen until some days after the injury was sustained, manipulation under anæsthesia may be necessary to break down adhesions before the above treatment is carried out.

Muscles which suffer repeated slight strain, such as the extensors of the wrist and fingers at their proximal attachment ('tennis elbow') or the adductors of the thigh in horse-riding, become persistently

painful during active contraction or when put on the stretch. This state of chronic strain is sometimes associated with toxæmia from focal sepsis in the teeth or other organs, which must be eliminated. The muscle is treated by kneading massage and surging faradism, which must sometimes be preceded by manipulation under anæsthesia.

In complete rupture, an operation should be done to suture the muscle without delay. A muscle hernia also requires operation to repair the torn sheath.

### INJURIES TO TENDONS

**Traumatic Tenosynovitis.**—In this state the synovial lining of the tendon-sheath is inflamed and there may be an effusion of synovial fluid into the sheath. During healing, adhesions may form between the sheath and the tendon. Pain and tenderness are felt along the line of the tendon. The pain is accentuated by movement, during which a creaking sensation may be present on palpation.

This condition may be due merely to over-use, when it may come on suddenly or develop gradually, as in certain occupations. In many cases there is an associated causal factor in toxæmia from remote focal infection.

**TREATMENT.**—This consists in elimination of toxæmia and avoidance of over-use. In acute tenosynovitis complete rest is advisable on a splint, while counter-irritation is applied, as by painting the skin with iodine. Chronic tenosynovitis may be the result of interference with the movement of the tendon by a mal-united fracture, which should be corrected. The tenosynovitis should be treated by passive movements to stretch adhesions and gradually increasing use.

It should be noted that tenosynovitis may be due to infection by pyogenic organisms or the gonococcus; or to tuberculosis or syphilis.

**Rupture of Tendons.**—A tendon may be severed in an accidental wound, as of the wrist or ankle from a fall through glass. No such wound should be treated without determining by inspection and movement whether or not a tendon has been injured. A cut tendon should be sutured with fine silk immediately. If the wound has become inflamed, suture of the tendon must be postponed. But in this case, or when a clean wound has been allowed to heal without repair of the tendon and has to be reopened, delayed suture is often difficult and the ultimate result unsatisfactory.

A tendon may also be ruptured by a sudden violent contraction of its muscle, the rupture taking place either at the junction of the muscle belly and the tendon, or at the attachment of the tendon to the bone: in the latter, a piece of bone may be torn off also. Tendons particularly liable to such injury are those of the tendo Achillis, the quadriceps femoris and ligamentum patellæ, the long head of the biceps brachii, and the supraspinatus. The extensor tendon of a finger at its attachment to the terminal phalanx may be ruptured by a sudden forced flexion of the phalanx; the terminal segment of the finger hangs semiflexed and cannot be voluntarily extended (*mallet finger*). Predisposing to rupture of a tendon in certain sites is weakening of the tendon, as from previous tenosynovitis or erosion in passing over a bony surface roughened by a mal-united fracture or osteo-arthritis.

The symptoms of tendon rupture are sudden acute pain, with a snap which may be felt or heard. There is immediate loss of power in the muscle, and later bruising is seen at the site of rupture. The gap in the tendon and a soft swelling formed by the retracted muscle may be felt.

**TREATMENT.**—If a ruptured tendon is promptly exposed by operation and sutured, the prospect of recovery of function is good. If there is delay, the muscle belly becomes shortened and the gap in the tendon filled with scar tissue. Repair is then difficult or impossible, but by various procedures, such as fascial grafting, plastic incisions, and fixation of the tendon in bone or joint stabilization, improvement in function is obtainable. In mallet finger, the extensor tendon may re-unite if the terminal joint of the finger is held hyper-extended by a plaster-of-Paris splint for six weeks. If this fails, and in neglected cases, the finger may be made more useful by operative fusion of the terminal joint.

**Dislocation of Tendons.**—A tendon may be dislocated during a sudden strong movement resulting in rupture of the ligamentous sheath which holds it in position. The tendons of the peronei, biceps brachii, and the thumb muscles are most often affected. Pain, loss of function, and swelling are experienced, and the tendon can be felt out of place.

**TREATMENT.**—The tendon should be at once replaced by manipulation, and a plaster-of-Paris splint or casing applied so as to prevent movement for six weeks. With imperfect fixation or for a shorter period, recurrence of dislocation is apt to occur repeatedly; if there is disability from this, a plastic operation to remake the tendon-sheath is required.

A ‘snapping joint’, when not caused by internal derangement, is often due to partial dislocation of a tendon from congenital laxity of its sheath or abnormality of the underlying bone.

**Trigger Finger.**—In this condition, which may affect also the thumb, a check occurs in flexing or extending the digit, followed by a snapping sound as

the check is overcome. Some pain may be felt, but the main complaint is of interference with use. The cause lies in impairment of the movement of the tendon in the tendon-sheath, either from narrowing of the sheath at one point or from enlargement of the tendon. This usually results from repeated slight injury, as may be caused by a tool or golf club; it may also be due to previous inflammation.

**TREATMENT.**—In many cases the symptoms disappear if the cause of the injury is stopped. In intractable cases an operation to widen the tendon-sheath by longitudinal incision may be done.

### INJURIES TO JOINTS

**Sprains.**—A sprain is a stretch or tear of the capsule, ligaments, or synovial membrane of a joint, and is caused by movement beyond the normal range of the joint. Blood from torn blood-vessels is at once effused at the site of injury. This may be outside or within the joint; or the joint may become filled with effusion of synovial fluid. During healing, the edges of the tear are joined by fibrous tissue, and, unless prevented, fibrous adhesions between the soft tissues in or around the joint may form.

When a sprain occurs, there is immediate sharp pain at the site of injury, which is aggravated by a passive movement to put the tissues at this point on the stretch. There is localized tenderness and swelling and the joint may become generally swollen. The pain often lessens as swelling occurs.

**TREATMENT.**—The complication to be avoided in a sprain is formation of adhesions. This is most likely to occur if the joint is kept at rest and an evaporating lotion applied, as was formerly customary. Adhesions are prevented by dispersing the swelling rapidly and putting the joint through its normal range



of movement once or twice each day. Stroking and frictional massage should be given, active movements encouraged, and a passive movement through the normal range gently but firmly carried out at each daily treatment. If there is much swelling outside the joint, radiant heat or diathermy should be applied. Effusion into the joint, if considerable, should be dealt with by aspiration. The muscles controlling the joint should be treated for fifteen minutes each day by surging faradic stimulation, so as to prevent wasting from disuse and formation of adhesions about their attachments. A splint may be necessary between treatments for a few days to relieve pain; but it should not be used for long. In the common sprain of the inner side of the knee, the inner side of the heel of the shoe should be raised to relieve strain on the internal lateral ligament. In sprain of the ankle or wrist, when there is only slight swelling and it is important for the patient not to be incapacitated, a close-fitting plaster-of-Paris casing may be applied and free use of the limb allowed. The wrist should be fixed in dorsiflexion; the ankle in the neutral position with an iron heel applied, so as to allow walking. By this method the pain is at once relieved, and, because free use is possible, effused blood is rapidly absorbed and adhesions often do not form.

**Chronic Sprain.**—Chronic sprain is the term used for the state in which adhesions exist after a sprain. This state is popularly called ‘weakness’ of the joint, and is common in the spinal, sacro-iliac, wrist, knee, and ankle joints. It is a common cause of aching in the lower part of the back.

The affected joint aches, especially after prolonged use. In superficially placed joints, recurrent swelling within or outside the joint is observable. There is tenderness on pressure at the site of the old injury,

and a movement which puts the tissues at this site on the stretch has less than the normal range and is painful; there is also an elastic feel when the limit of movement is reached. The presence of toxins in the blood from septic foci in the teeth or other organs is a contributory factor in the persistence of symptoms.

TREATMENT.—The treatment is to manipulate the joint after elimination of any source of toxæmia. By manipulation is meant putting the joint forcibly through its normal range of movement. A general anæsthetic is required to relax the muscles and because of pain. After manipulation treatment proceeds as for acute sprain, and is necessary daily for about three weeks. Heat and massage should be applied to reduce swelling, and the muscles should be exercised by surging faradism and active movements. In addition it is particularly important to put the joint through the normal range by one or two passive movements each day.

*Chronic Sprain of the Sacro-iliac Joint.*—This demands special mention, because it is a frequent cause of low backache, especially in women. It is common after pregnancy, during which the sacro-iliac joints are normally relaxed. If, for any reason, involution is delayed or the woman rises too soon after labour, the sacro-iliac joints may remain in a state of chronic sprain. They may also be sprained like other joints by sudden excessive movement, as in dancing. Aching is localized to the region of the posterior iliac spine, to the inner side of which there is tenderness on deep pressure. The patient complains of pain at this site on forward bending in the standing position and when, in lying on her back, the leg of the same side is passively raised to 60° or more with the knee extended.

TREATMENT.—Manipulation is ordinarily effective in relieving the symptoms ; but a few intractable cases require permanent wearing of an appliance or belt to immobilize the joint, or arthrodesis of the joint. Manipulation may be performed by the following movements, abruptly and forcibly made while the patient's muscles are relaxed under anæsthesia : (1) With the patient on her back, fully flex the legs on to the trunk, with the knees first flexed, then extended ; (2) With the patient prone, hyper-extend the legs at the hips, singly and together ; (3) With the patient on her side and the upper leg hanging over the edge of the couch, twist the trunk by thrusting against the uppermost shoulder with the hand of one arm while throwing weight through the elbow of the other arm on to the patient's uppermost hip.

**Dislocations.**—Dislocation of a joint may be congenital (p. 13), or result from destructive disease in the joint, or from paralysis of the controlling muscles. Dislocation through injury (traumatic dislocation) is caused by movement beyond the normal range, whereby the capsule is ruptured, allowing the escape of the end of one of the articulating bones. The muscles and other tissues, including the nerves and blood-vessels, around the joint may also be stretched or torn, and blood may be effused, causing swelling. If the dislocation is not reduced, the tissues react to form fibrous tissue around the displaced bone, so that the difficulty of reduction is rapidly increased and eventually, after several weeks, becomes impossible.

Dislocation may be *complete* or *partial* ('*subluxation*'). If there is no associated external wound, the dislocation is called *simple* or *closed*. If there is such a wound, the dislocation is *compound* or *open*.

As soon as dislocation has occurred, there is pain in the region of the joint, deformity, and inability to move the joint voluntarily or passively through the normal range. The displacement of the bone may be visible or palpable. Occasionally there are signs of injury to nerves or large blood-vessels, and it is important that these should not be overlooked. A fracture may also be present. An X-ray examination should always be made.

The most commonly dislocated joints are the shoulder, hip, and elbow.

*Dislocation of the Shoulder.*—The capsule is usually torn below. The head of the humerus passes out through the gap and is then directed forwards behind the subscapularis muscle to lie eventually below the coracoid process. The outer side of the shoulder is flattened, the displaced head of the humerus can be seen or felt, the elbow is held away from the side, and the hand cannot be placed on the opposite shoulder with the elbow at the same time in contact with the chest wall.

**TREATMENT.**—In reducing the dislocation, the surgeon brings the head of the humerus back to the gap in the capsule, through which it is made to pass into the joint. There are two methods of doing this. In Kocher's method, while an assistant steadies the trunk, the surgeon grasps the patient's elbow with one hand, and the wrist with the other; he first brings the elbow into the side and also forward a little, and then steadily rotates the arm outwards, using the forearm as a lever. In this way the gap in the capsule is opened and the head of the humerus pressed back towards the gap by the tension of the subscapularis muscle. Then, with a quick movement, the surgeon internally rotates the arm and brings the elbow forward and inward until the hand rests on the opposite shoulder and the

elbow is against the chest wall. In Miller's method, the surgeon grasps the elbow and wrist and abducts the shoulder to a right angle. He then pulls strongly and steadily on the arm, while counter-traction is exerted by an assistant on a broad towel placed round the patient's trunk. While applying traction, the surgeon steadily internally rotates the arm, using the forearm as a lever. By this manœuvre also the gap in the capsule is opened and the head of the humerus is drawn outwards and forced through the gap by the tension of the subscapularis muscle.

*Recurrent dislocation of the shoulder* : At this joint re-dislocation may take place some weeks or months after reduction, and recur often, being induced by comparatively slight force. The anatomical reason for this condition is not clear ; but it has been stated to be laxity of the capsule (Thomas), separation of the anterior part of the glenoid ligament (Bankart), or malformation of the head of the humerus (Tavernier). Of many operations devised to prevent re-dislocation, the best appears to be a modification of Nicola's : in this the tendon of the long head of the biceps is made adherent in its groove, which is extended a short distance on to the articular surface of the head of the humerus.

*Dislocation of the Hip*.—The capsule is torn inferiorly, allowing the head of the femur to escape ; thence the head passes beneath the muscles, commonly backward to rest on the dorsum ilii. Scarpa's triangle is unusually hollow, and the whole limb is markedly internally rotated ; abduction and external rotation are much limited or cannot be performed ; the head of the femur can be seen or felt beneath the glutei. Less often the head of the femur, after passing through the rent in the capsule, goes forwards beneath the proximal part of the adductors, where it can be felt ;

the limb is rotated outwards and internal rotation and adduction are limited.

**TREATMENT.**—In reducing this dislocation, the surgeon flexes the knee and hip, thus bringing the head of the femur below and behind the acetabulum. Then he swings the thigh outward (for posterior dislocation) or inward (for forward dislocation) until the head is opposite the gap in the capsule. Finally, with a pull in the line of the thigh he lifts the head over the margin of the acetabulum, which it can be heard to enter, and immediately extends the limb.

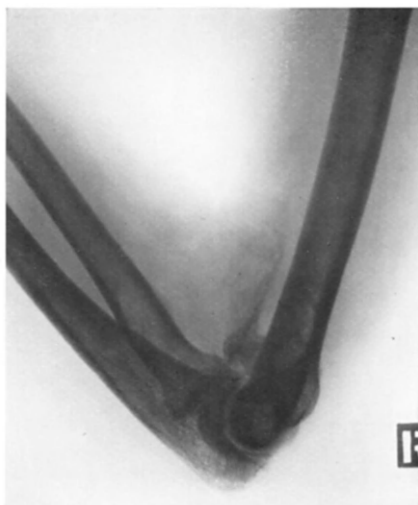

Fig. 91.—Myositis ossificans, following traumatic dislocation of the elbow.  
(Radiograph by Drs. Coldwell and Allchin.)

*Dislocation of the Elbow.*—This dislocation is often accompanied by a fracture of one or more of the articulating bones. The direction of dislocation may be backwards, forwards, or to one side.

TREATMENT.—Reduction of this and other dislocations is carried out on the same principle as at the hip and shoulder. In most cases an anæsthetic is required.

After reduction of a dislocation of the elbow, a mass of bone may form in front of the joint, limiting or abolishing mobility, the condition being known as *myositis ossificans* (*Fig. 91*). It is especially likely to occur if massage and movements, including passive movements, are too vigorously used. When it occurs, all physical treatment should cease and the joint be immobilized, if possible semiflexed, in plaster-of-Paris. During immobilization, the new bone may gradually disappear or consolidate into a well-defined mass which can be removed by operation so as to restore mobility.

AFTER-TREATMENT OF DISLOCATIONS.—After reduction of a dislocation, there is as a rule little tendency for the joint to re-dislocate unless it is moved far in the direction which brings the end of the bone opposite the gap in the capsule. This movement should be carefully controlled and increased; but all other movements may be carried out freely. Only assisted and voluntary movements should be done, passive movements being liable to do harm. The muscles round the joint should be gently kneaded each day and exercised with graduated surging faradism; some form of heating may be used, if there is much swelling.

If the above after-treatment is not properly carried out, adhesions may form in and around the joint, limiting movement and causing persistent pain and disability. This state is most likely to develop when there is toxæmia from any cause. The first step in treatment, therefore, must be to eliminate toxæmia. Then the joint is manipulated under anæsthesia to break down the adhesions, and the physical treatment as after reduction followed.

### INTERNAL DERANGEMENT OF JOINTS

The term 'internal derangement' is a convenient one meaning a disturbance inside a joint interfering with normal function. It is used to denote mechanical changes due to injury rather than disease. There are several varieties of such changes, all giving rise to symptoms of pain, effusion, and limitation of movement. A sprain is often the cause of internal derangement, because the synovial membrane may be torn as well as the capsule or external ligaments, and the injury be accompanied by effusion of serum or blood into the cavity of the joint and followed by formation of adhesions of the synovial membrane. Other kinds of injury are tearing or separation of an intra-articular ligament, laceration of the articular cartilage, fracture including the articular surface of one of the bones forming the joint, or tearing of an intra-articular cartilage.

Other causes of internal derangement exist. In rheumatoid arthritis and osteo-arthritis, an enlarged fold of synovial membrane may be nipped during a sudden movement, producing sudden sharp pain and subsequent effusion. When osteo-arthritis is beginning, sudden effusion into the joint with aching and slight limitation of movement may occur occasionally after unusual exercise. Similar symptoms may arise from slight sprains due to instability of a joint from weakness of the muscles or laxity of the ligaments, or from adhesions in the joint after a sprain. A 'loose body' may form in a joint, consisting of a fragment of cartilage or bone detached by injury, a nodule of cartilage formed in the synovial membrane and either pedunculated or free, or a seed-like mass of fibrin. There may be one or many loose bodies present. They may be palpable or visible in an X-ray film and give rise to recurrent attacks of momentary



pain in the joint, followed by swelling. Lastly, the symptoms of internal derangement may occur from bruising and subsequent enlargement by fibrosis of the folds of synovial membrane covering pads of fat, which normally fill up spaces between the bones at the edges of joints.

Although any joint may become deranged by these means, the knee is most often affected because it is the most liable to suffer from the stresses of modern work and sport. In this joint, sprains with tears of synovial membrane and subsequent adhesions or weakness of the quadriceps, and tearing of the internal or less often the external semilunar cartilage, occur frequently. Less common are lacerations of the articular cartilage, rupture of a cruciate ligament, bruising of the infra-patellar synovial fat pad, and fracture of the tibial spine. Since both rheumatoid arthritis and osteo-arthritis often affect this joint, the symptoms of internal derangement are sometimes due to these disorders. Loose bodies are also more often seen in the knee than in other joints.

TREATMENT.—The many causes of internal derangement are differentiated by consideration of the history and the symptoms and by X-ray examination. According to the cause, treatment may consist of physiotherapy, manipulation, operation, or an appliance.

## APPENDIX A

## PHYSIOTHERAPY

By physiotherapy is meant treatment by massage, active and passive movements, remedial exercises, the galvanic, faradic, or sinusoidal electric current, diathermy, radiant heat, infra-red rays, ultra-violet light, or baths (hydrotherapy). Knowledge and skill in the application of these methods is acquired by special training and experience. For details of the methods and of the apparatus employed, books devoted to the several branches of the subject should be consulted. Here only a brief statement of the scope and limitations of physiotherapy can be given. It should be emphasized that treatment by physical means is rarely sufficient by itself for any condition, but must be made to take its place in a scheme including other kinds of treatment. Otherwise it is liable to be abused or to fail and its real value is discredited.

**Massage.**—This consists of certain movements of the hand upon the patient's skin. *Effleurage*, or stroking, is a light frictional movement, the effects of which are to relieve pain, diminish muscular spasm, and improve reflexly the local circulation of blood; through the latter action, absorption of blood or serous effusion beneath the skin takes place. If the movement is deeper, it causes stronger friction and has a direct as well as a reflex effect on the circulation. In *pétrissage*, or kneading, the hand grasps the skin with even pressure of the palm and fingers and moves rhythmically the muscles and other deep tissues. The

effect of this is to loosen and dissipate fibrous tissue and adhesions, and also temporarily to increase the blood-supply to the area treated. *Tapotement*, or striking, consists of a series of staccato blows on the skin made with the ulnar border of the hands moving alternately. It has a strong stimulating effect on the circulation. *Vibration* is performed with the thumb pressing on one point, or, alternatively, with a knob connected to an electrically driven machine. It is useful in causing the disappearance of fibrous nodules and scar tissue in muscles and around joints, by increasing the blood-supply in the affected part.

The effects of massage are thus : (1) Relief of pain ; (2) Diminution of muscular spasm ; (3) Increase of blood-supply, whereby effusion and softening or disappearance of fibrous tissue takes place ; (4) Mechanical prevention of formation of adhesions in and around muscles and joints, or stretching of adhesions already present. Massage is often usefully preceded by heating, combined with baths, or applied for its soothing effect after passive movements or exercise.

**Active Movements and Exercises.**—An active movement is made by voluntary contraction of a certain group of muscles. Simultaneously, through nerve reflexes, lengthening of the opposing group takes place so that the movement is not resisted. Such movements repeated a number of times constitute an exercise. The purpose of exercises may be : (1) To restore the power of muscles weakened by local injury or disease, lack of use, or damage to their nerve-supply ; (2) To improve the voluntary control and co-ordination of muscles used inefficiently ; (3) To train the neuromuscular reflexes by which posture is maintained ; (4) To increase the range of movement of a joint by stretching the muscles on the contracted aspect and strengthening those on the opposite side.

Little progress can be made with exercises without the active mental as well as physical co-operation of the patient. The masseuse must from the beginning emphasize this truth and exert her personality so that the patient's interest and will may be stimulated. For this reason also, the purposive movements of physical work and of games should be used as exercises whenever possible. Boredom and fatigue are guarded against by such means, or by the use of music while the exercises are being done.

In considering exercises in the case of a stiffened joint after injury or from disease, the reasons for limitation of mobility must be first ascertained, as it may be useless or harmful to try to increase the range of movement. In postural training, it should be realized that exercises are merely a means of educating the patient to a sense of the normal posture. In cases of paralysis, care must be taken in giving exercises to plan them so that they are localized and do no harm to the weakened muscles, nor strengthen their healthy antagonists.

Exercises should always be graduated in strength. The gentlest exercise of a muscle is contraction without movement of the joint. Next in order is assisted exercise, in which the movement of the limb is aided by the hand of the masseuse or by apparatus. Stronger than this is active movement with the help of gravity, as when in standing the elbow is extended. When the action of gravity is resisted, the contraction of the muscle must be much stronger. Lastly, movement may be resisted by the masseuse or by apparatus.

Special apparatus is not essential for exercises, since, if the above principles are realized, movements, purposive work, or games can be easily devised and carried out. The elaborate exercising machines formerly in vogue are not now needed. If desired, the following

may be found useful : (1) Wall bars ; (2) A beam ; (3) High and low plinths ; (4) A rowing machine ; (5) Clubs and dumb-bells.

Examples of exercises for scoliosis, kypho-lordosis, and flat-foot are given in the chapter on postural deformities (Chapter III). Exercises for paralytic states must be planned according to the distribution of paralysis in each case. Strengthening and mobilizing exercises are simply the normal movements performed with gradually increasing resistance from gravity, the body-weight, or apparatus. For example, a series of exercises for the extensor muscles of the knee is as follows :—

1. Sitting, knees extended, on couch, contract and relax the quadriceps without moving the joint.
2. Lying on side, flex and extend the knee, with assistance.
3. Lying on side, flex and extend the knee, without assistance.
4. Sitting, flex and extend the knee slowly.
5. Sitting, flex and extend knee with weight tied to foot.
6. Standing, heels raise, knees bend.
7. Standing, place foot on step and slowly extend knee. Then slowly flex and extend knee several times, keeping other foot off ground.
8. Rowing in machine.

**Passive Movements.**—A passive movement is one in which the patient's muscles are relaxed while the joint is moved by the masseuse. The patient may be able to relax his muscles consciously, or relaxation may be brought about by slow gentle stroking massage. Passive movements may be required when there is no real limitation of mobility of a joint but a need to put the joint through its full range of movement daily to prevent such limitation. If it is thought right to overcome real limitation of mobility, *forced movement* is needed. Forced movement is apt to be painful and may do harm, and should never be performed by the masseuse without definite instruction. The aim is to

stretch contracted tissues and adhesions in muscles and joints. The movement should be made slowly and steadily rather than suddenly. To mobilize certain joints, movements which cannot be done actively are valuable, as, for example, side-to-side movements of the inter-phalangeal joints.

So-called *manipulation* of a joint is a form of forced movement. It is a movement performed once only in one or all directions of a joint, usually under anæsthesia, by the surgeon. It is used to break down adhesions in a previously sprained joint, and is valuable also in certain cases of rheumatoid arthritis and osteoarthritis. After manipulation, the range of movement obtained must be maintained by passive movements performed daily by the masseuse for several weeks.

**The Faradic, Galvanic, and Sinusoidal Currents.**—The *faradic* current is an electrical current interrupted at the rate of about fifty times a second. It is produced by induction from a primary to a secondary coil by a special apparatus, working either from batteries, as in the Smart-Bristow Coil, or from the electric mains. The current stimulates muscles only through their nerves, and produces a continuous (tetanic) contraction. It is used to exercise muscles artificially, for which purpose it is rhythmically interrupted by a metronome or with a surging apparatus.

The *galvanic* current is continuous, constant in strength, and unidirectional. It is obtained either from a battery of dry cells or from an electric main by means of a special earth-free machine, which reduces the strength of a direct-current mains supply or transforms an alternating-current supply. The galvanic current produces irritation of the skin where applied and also dilatation of the blood-vessels more deeply. By these means it exerts an effect as a counter-irritant

and in reducing swelling. When interrupted by a metronome or surger, it causes contraction of muscles, acting either on the nerves or the muscle fibres themselves. It is therefore used to exercise muscles when the nerve is injured or degenerated.

The *sinusoidal* current is one which evenly reverses its direction of flow about fifty to a hundred times a second. It is obtainable from an alternating current main through a machine which reduces the strength. It has the same action and uses as the faradic current.

**Diathermy.**—The diathermy current is alternating, reversing its direction about one million times a second. Owing to this extreme rapidity of alternation, neither nerves nor muscles are stimulated, and the only effect of the current is heating of the tissue through which it passes. It is produced by a special machine and has several applications. When the current is made to pass between large electrodes, such as may be placed on either side of a joint, *medical diathermy* is produced, by which is meant heating without destruction of tissues. Used in this way it is beneficial in many chronic traumatic or inflammatory states of joints and muscles. It is also used to raise temporarily the temperature of the whole body. It is the most efficient means known of applying heat, and is valuable in many diseases, including gonococcal inflammation. Care must be taken to avoid overheating of the skin beneath the electrodes, from which serious burns may result. Diathermy should not be given if there is loss of skin sensibility.

In surgery diathermy is used to destroy tissues—*surgical diathermy*—either by coagulation or by desiccation (fulguration). By reducing the size of one electrode to a needle point, small disc, or ball, the current is concentrated at the place of application of this electrode sufficiently to cause death of the tissues. In this way

moles, corns, warts, and other small growths can be destroyed. Another variety of diathermy is the cutting current, by which, with a needle electrode, operation wounds can be made with only very slight coagulation. This current is valuable in operating in malignant disease and in preventing bleeding in making large wounds.

**Radiant Heat.**—By this is meant the application of heat by means of carbon-filament lamps. These are mounted in a case ('bath') of varying size and shape, designed to cover a joint, a whole limb, the trunk, or the whole body excluding the head. Surface heating is produced, relieving pain from certain causes and bringing about sweating and dilatation of the superficial blood-vessels. The skin of the patient may be left bare or covered with a thin cloth.

**Infra-red Rays.**—This is another form of surface heating, for which greater penetrating power is claimed. The rays employed are ether vibrations of a wavelength longer than those which compose visible light. They are produced by a special generator, and have similar effects and uses to radiant heat.

Surface heating may also be produced by hot-water baths or bottles, hot fomentations, antiphlogistine, or mud-packs.

**Ultra-violet Light.**—The rationale and principles of application of sunlight are discussed in the section on tuberculosis of bones and joints (p. 106). Ultra-violet light ('artificial sunlight') is obtained from a carbon-arc, tungsten-arc, or mercury-vapour lamp, working from a direct-current main or from a transformed alternating-current main. General light baths of the whole body bring about improvement in the general health and are of value in surgical tuberculosis, rickets, and other states. Local light baths aid the



healing of wounds and sinuses and certain infective conditions. The length of exposure to the light must be carefully regulated to avoid serious harm. If the correct exposure is made, slight redness of the skin appears a few hours afterwards and fades in a day or two. Longer exposures produce more marked redness or blistering and may even be fatal. Exposures are made at a distance of two or three feet. The initial length of general exposure is determined by application of the light to a small area for two minutes, when the effect in reddening of the skin is noted. Exposures are given two or three times weekly and are gradually increased in length. Loss of appetite, irritability, vomiting, sleeplessness, and loss of weight are signs of excessive exposure.

**Hydrotherapy.**—Water treatments are given externally by means of baths, douches, or packs, or internally as irrigation of the colon. The latter has a place in orthopædics when colonic stasis or infection is associated with rheumatic affections, and is described on p. 93. Externally, the various kinds of water treatments have effects similar to those of other forms of physiotherapy. Hot baths and packs are means of relieving pain, relaxing muscles, stimulating the cutaneous glands, and improving the blood-supply at the site of application. Cold baths and packs also stimulate the glands and circulation of the skin. The circulation is especially improved by 'contrast' baths, the limb being placed alternately in hot and cold water. Douches and movements of the water, as in bubbling and whirlpool baths, act also as forms of massage, which is pain-relieving if gentle, and stimulating to the blood-vessels and muscles if strong. Remote effects are also produced by these measures on the general bodily metabolism and the cardiovascular system.

Like other means of applying heat, baths are valuable preliminaries to massage, movements, and electrical exercise of muscles. In a deep pool, passive movements are assisted by the relief of pain through the heat and movement of the water. Active exercises are also more easily performed in such a pool, especially of paralytic limbs, because the limbs are supported by the water.

Other baths and packs, as of mustard or brine, are valuable partly for their effects as counter-irritants, relieving pain and having reflex actions on the blood-supply of deep tissues.

*APPENDIX B***SPLINTS AND APPLIANCES**

A **SPLINT** is an apparatus for temporary use to hold a limb in a certain position or to aid gradual correction of a deformity. An appliance is for more or less permanent use as a mechanical support of a limb during activity.

**SPLINTS**

Formerly many kinds of splints were in use ; but in modern treatment only a few are required. The materials chiefly employed for splints are plaster-of-Paris and malleable metal (iron, tin, aluminium, or duralumin). With these readily adaptable materials, the first requirement of a splint, firm and even fitting, is obtainable in each case. They are used in two forms, the trough and the frame. The trough should be an accurate mould to the shape of the part, so that there can be no friction from movement or localized pressure, from either of which sores may result. The frame consists of metal bars on either side of the limb (or trunk), connected by a cross-piece or ring at each end ; between the bars are stretched bands of calico, upon which the limb rests. Padding may be required between a splint and the skin in order to relieve pressure, to prevent friction, or to help to retain a position ; if used, it should be spread evenly and may have to be adjusted frequently. The best materials for padding are piano felt, gamgee tissue, and dressmakers' wadding. As a further protection against sores, the skin should be cleaned frequently with soap and water, dried, washed

with spirit, and dusted with zinc and starch powder. If sores occur, they should be covered with a piece of elastic plaster and left alone. The nurse must attend at once to any complaint of discomfort, and frequently see that the splint is acting as intended. Consequently she must understand why and how the splint is applied.

In selecting a splint for any particular case, the surgeon has to decide first whether or not absolute immobilization is required, and if traction on the limb is necessary. Thus, for a fracture, complete fixation is essential; whereas for a wound of the soft tissues, such fixation may or may not be needed. In splinting a bone, correct alinement is the first consideration; but in a joint, the ultimate usefulness after treatment is the determining factor. If rigidity (ankylosis) is expected to result from the injury or disease, a joint must be splinted in the position which will be best for the ultimate function of the limb. But if the joint is expected to remain mobile, the position of fixation may be sometimes different. A joint should not be immobilized at the extreme limit of any one direction of its movement, as stiffness or deformity may follow. Thus the knee should be fixed always straight or slightly flexed, never hyperextended. The hand should not be splinted with the joints of the fingers and the metacarpo-phalangeal joints hyperextended, but rather slightly flexed.

When mobile traction is not required, a splint for almost any part of the body may be made from plaster-of-Paris (p. 230), which will have the advantages of accurate fitting and of needing little attention. If traction is necessary, a frame splint must be provided. For traction, taut-wire apparatus, a metal transfixion pin and hoop, or adhesive plaster, together with cord, pulleys, weights, and, in some cases, an

overhead wooden or metal suspension frame (*Fig. 85*) are required.

Suitable means of splintage for various parts are as follows :—

**Spine.**—Plaster-of-Paris bed (p. 232), or Thomas's double abduction frame.

**Shoulder.**—Plaster-of-Paris (bandages) for body casing, extending to arm and hand. Or metal shoulder abduction splint. The shoulder should be held abducted to a right angle, slightly flexed forward, and externally rotated.

**Arm.**—Plaster-of-Paris (bandages). Thomas's arm splint (*Fig. 77*). The latter is for use in bed, and must be supported at its distal end by a standard ; if the elbow is to be held flexed, an overhead frame is required.

**Elbow.**—Plaster-of-Paris (bandages). Leather cuff and collar sling (*Fig. 78*). Posterior angular splint, consisting of metal gutters for the arm and forearm, joined by a malleable rod.

**Forearm.**—Plaster-of-Paris (bandages). Thomas's arm splint. Metal trough splint.

**Wrist and Hand.**—Plaster-of-Paris (bandages). Metal cock-up splint, with short hand-piece for the wrist or long hand-piece if the fingers require support. Böhler's finger splints ; or small metal gutter finger splints.

**Hip.**—Plaster-of-Paris (bandages) for casing extending from the lower part of the chest to the toes on the affected side. Thomas's double abduction frame. To abduct the hip, the simplest method is to apply Thomas's knee splints to both limbs with mobile traction and suspension to an overhead frame.

**Thigh.**—Thomas's knee splint. Hodgen's splint. Böhler's thigh splint (*Fig. 86*).

**Knee.**—Plaster-of-Paris (bandages) for casing, or posterior gutter splint, reaching from the toes to the hip. To correct flexion-deformity, a Thomas knee splint may be used. With the patient in bed, the splint is applied bent to the existing angle of the knee and suspended to an overhead frame. Adhesive plaster and weight-and-pulley traction is arranged. The piece of calico across the splint behind the upper end of the tibia is kept taut, and another piece is fixed tightly across the front of the thigh just above the knee. As the deformity diminishes, the bend of the splint is made also less.

**Leg.**—Plaster-of-Paris (bandages). Böhler's leg splint (*Fig. 87*). Thomas's knee splint.

**Ankle and Foot.**—Plaster-of-Paris (bandages). Metal splint ('club-foot shoe' or 'tin-shoe'), consisting of a

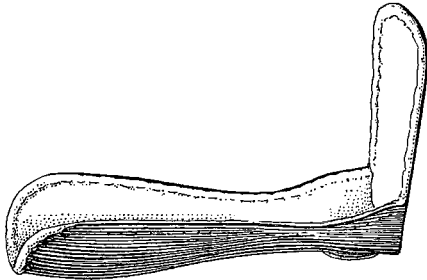

*Fig. 92.*—Metal (tin) shoe—night splint (Ernst).

gutter for the calf and a plate for the sole of the foot, connected by a bar set away from the back of the heel (*Fig. 92*).

### APPLIANCES

As an appliance is intended for use over a long period, it is usually made specially for each patient. Its purpose is to provide support while the limb is in active

use. It may be required to relieve the strain of weight-bearing through a limb, to hold a joint rigid, to limit movement, or to provide support at the sides of a lax joint. Two kinds of apparatus are in use: removable moulded casings of leather, celluloid, or poroplastic felt, and steel (or duralumin) frames. Examples of such appliances for various parts are as follows:—

**Spine.**—Either a moulded jacket of celluloid or other plastic material, or a steel-and-stay ‘spinal support’ (see *Fig. 31*). The latter is based on a metal band encircling the pelvis, and has attached to this an upright bar on either side of the trunk extending up to crutches under the arm-pits, and a third bar along the midline of the back; these are joined by other metal bands and by corseting.

**Shoulder.**—For immobilization, a moulded casing is used, enclosing the chest, shoulder, and arm. When movement at the shoulder is desired, the casing consists of trunk and arm parts with a metal joint between them.

**Elbow and Wrist.**—Moulded casings, jointed if necessary, as at the shoulder.

**Hip, Thigh, and Knee.**—The Thomas caliper (see *Fig. 57*) is used. This consists of two side-bars of steel, which extend along either side of the limb and fit into sockets in the heel of the boot. At their upper ends these lateral bars are joined to a padded metal ring, which fits closely round the top of the thigh, especially beneath the tuberosity of the ischium. In standing, the tuberosity should press down upon the ring, so that the patient feels that he is sitting on the ring and the body-weight is taken to the ground through the appliance instead of through the limb. To keep the knee straight, a leather ‘knee-cap’ is fixed across the front of the patella, and there may

be also leather bands behind the middle of the thigh and the calf.

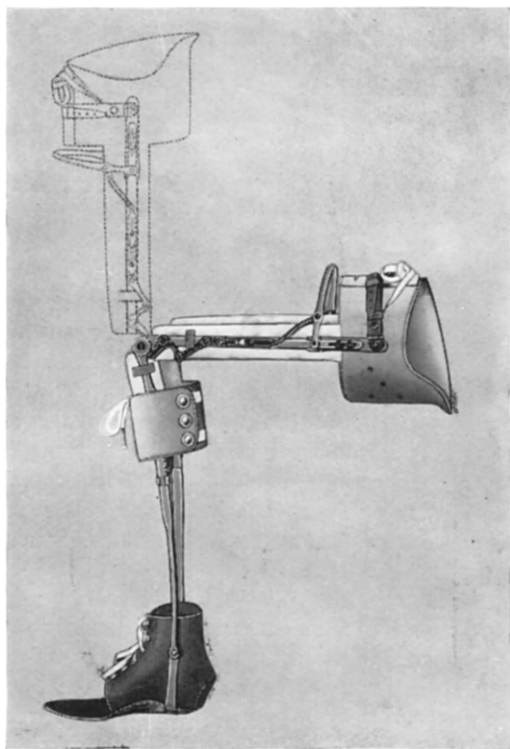

Fig. 93.—Weight-relieving walking apparatus (Ernst).

Modifications of this appliance (*Fig. 93*) are made for greater comfort in use or to serve other purposes. Instead of the ring, a steel and leather moulded thigh band is provided. To allow the limb to be bent in sitting, locking joints are inserted at the level of the knee,



and ankle-joints may also be added. The leather knee-cap may be made also to pull the knee outwards towards the outer side-bar in cases of genu valgum. Instead of the side-bars fitting into sockets in the heel of the boot, they may be made to end in a metal and leather sandal, over which the boot is drawn. If it is not necessary to relieve weight-bearing, the ring or thigh band need not reach quite to the tuberosity of the ischium. In this way, the appliance is used either to fix the knee in extension, as in paralysis of the quadriceps, or to prevent lateral mobility of a lax knee-joint while allowing, by means of a joint, flexion and extension.

**Ankle.**—A so-called 'walking appliance' or 'leg-iron' is used. This consists of a steel bar along one or both sides of the leg, fitting at its lower end into a socket in the heel of the boot, and joined at its upper end to a steel and leather band which encircles the leg a short distance below the knee. Opposite the ankle there may be put into the bar a joint, which may have a front or back stop to check dorsiflexion or plantar flexion. A single iron on the inner side of the leg is used to prevent or correct varus deformity of the foot (*see Fig. 5*). Its purpose is to hold a leather T-strap which is sewn to the opposite side of the boot and buckles round the ankle and iron. In this way the foot is everted. A single iron on the outer side acts with a T-strap fixed to the inner side of the boot to prevent or correct a valgus deformity by inverting the foot. A double iron with double T-straps is used in some cases. Metal springs to prevent equinus or calcaneus deformity are also sometimes required, and are fixed to the side-bars to act on the joints opposite the ankle.

*APPENDIX C***PLASTER-OF-PARIS TECHNIQUE**

PLASTER-OF-PARIS is a white powder derived from gypsum, a naturally occurring mineral which consists of calcium sulphate combined with water. The gypsum is burnt to expel the water, leaving a fine powder. On mixing the powder with water, a paste is formed which sets rapidly into a hard solid. Because of this property, the plaster is used extensively in orthopædics for making casts and splints. For this, fine Italian or dental plaster should be used. To prevent the plaster being spoilt by taking up moisture from the air before use, it should be kept in a galvanized iron bin with a close-fitting lid in a dry room.

The plaster is used either loose or enmeshed in bandage material.

When applied in loose form, it is made into a paste with cold or warm water in a basin with rounded bottom, the side of which should be smeared with vaseline or olive oil to facilitate cleaning after use. The basin is first filled about two-thirds with water, and then the plaster is sprinkled in spoonfuls rapidly and evenly into the water without stirring until it shows just beneath the surface ; the mixture is stirred with a spoon for about half a minute, when it becomes a smooth cream and is ready for use. It sets hard in a few minutes, more rapidly if warm water is employed or if salt is added. To clean the basin after use, it is only necessary to pour hot water on to the hardened plaster, which separates easily. Water containing used plaster should not be poured down a sink, which it would clog.

The best material for making plaster-of-Paris bandages is a book muslin of moderately open weave (40 strands to the inch). This is torn into strips six or eight inches wide and six feet long. Each strip is made into a roll and placed on a board or shallow tray with the tin of loose plaster alongside. A length of the roll is undone, and on it a thin layer of plaster is applied evenly and gently rubbed in with the hand. This part is then rolled and another length drawn out and spread with plaster in the same way, the process being repeated until the bandage is finished. It is important to apply plenty of plaster, to spread it evenly, and to roll the bandage firmly but not tightly. When the bandage is to be used, it is placed in a bowl of water, which should cover it by about an inch. The bandage should be left to soak without moving it until the air-bubbles have escaped, and then lifted out with two hands, which should grasp the ends and gently compress it lengthwise. If it is moved about in the water, or lifted or squeezed at the middle, some of the plaster is lost. It is preferable always to use freshly made bandages ; but if they are carefully packed in air-tight tins, they may be used several days or weeks later.

Another use of plaster in muslin is the 'folder'. This consists of several folds of a length of muslin, between which thick layers of plaster are spread. The folder is used to reinforce a plaster casing at special places. It is prepared, used, and stored in the same way as the bandage.

In the application of plaster by either method, a waterproof apron, canvas 'boots', a gown, and rubber gloves should be provided for the surgeon. A plain table, a basin, a large iron spoon, warm water, waterproof sheeting, and a scalpel are also required, and the floor may need to be covered with sheets or newspapers. In some cases the plaster cream or bandage

is applied directly to the skin ; in others, some kind of padding is used under the plaster. Padding may be tubular stockinet, semi-compressed felt, dress-makers' wadding (held on by a cotton bandage), lint, or woollen underwear.

**Plaster Casings.**—Before applying plaster, the surgeon places the limb in a certain desired position, which must be held by an assistant without movement until the plaster has set. The assistant must take care to hold with the flat of the hand, as depression of the plaster by the tips of the fingers may result in sores. Each plaster bandage should be applied evenly and firmly, but not tightly, and the resulting casing moulded accurately to the limb, especially around bony prominences. In this way also are avoided sores beneath the plaster, which are due either to uneven pressure or to friction from ill-fitting. Four to six layers of bandage are usually enough to make a strong casing, which may be reinforced at places likely to be subject to strain by means of 'folders'. As soon as the casing is lightly set, it should be trimmed where necessary by a sharp knife, which cuts readily at this stage. Windows to expose wounds are marked or cut out at this time easily rather than with difficulty later.

Drying of a plaster casing goes on for some hours after it has become rigid. During this time, it should be exposed to warm air under an electric cradle or hot-water bottles placed against it. In bed cases of body or leg plasters, fracture boards should be placed under the mattress and a waterproof sheet beneath the casing. A limb enclosed in plaster should be elevated for several hours, especially if an operation has been performed upon it. The risk of interference with the blood- or nerve-supply from a casing too tightly applied must be borne in mind. Severe pain in the limb, and swelling, blueness or pallor, tingling

or numbness, of the fingers or toes, or inability to move them, are signs of such interference and demand immediate attention. To relieve pressure, the casing should be split along one line in its whole length, or occasionally it may have to be removed. Bleeding into a casing after operation need cause no alarm if the above signs of excessive pressure are absent. If a sore forms under a casing the patient may complain of discomfort or pain at the site and a peculiar musty smell may be noticeable. If it is not desired to remove the casing, a window may be cut out and a dressing applied. The best dressing is a sterile vaseline-gauze



Fig. 94.—Plaster shears  
(Stille's).

pack which is covered with a gamgee pad and bandage and left untouched for several weeks; or, if superficial, the sore may be covered till healed with a piece of elastic plaster bandage.

Removal of a plaster casing is easier if it is split along one aspect immediately after application, as is possible in some situations. Otherwise, plaster shears (*Fig. 94*), a saw, or a knife is used. The casing is cut along one or two sides and then can be broken and removed with the hands. The plaster may be previously softened with acetic acid or hydrogen peroxide; but this is not necessary if shears or a saw is used.

The skin of a limb which has been in a plaster casing for some weeks is covered with partly cast-off epidermis. If this is removed rapidly by scrubbing and washing, the skin may become sore. It is better to use oil or vaseline and to take several days to get the skin clean. For this reason the skin cannot be prepared for any operation which may be necessary in less than a week.

**Plaster Splints.**—These have the merits that they can be made rapidly, fit accurately, and can be used

for any part of the body. Two methods of making such splints are employed. In both the limb is first covered with olive oil or vaseline to facilitate removal of the splint.

In the first method, a plaster bandage is taken, and after being soaked in water, is spread backwards and forwards on a glass or wooden surface until a slab of suitable width and length, and of four or five layers in thickness is made. This is placed on the limb, which is held in the desired position, and firmly moulded

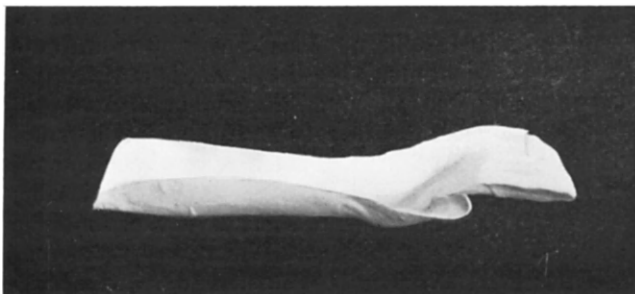

*Fig. 95.*—Plaster splint for the hand and wrist.

while it sets. While drying, the splint is trimmed by a scalpel or scissors. As soon as it is lightly set, it is slipped off the limb, trimming is completed, and the edges are rubbed smooth (*Fig. 95*). Additional pieces of plaster bandage may be added to strengthen weak parts and to fix on webbing straps, by which the splint is later held to the limb. It is then allowed to dry out thoroughly in a warm place, after which it may be lined with lint or felt, fixed on with starch paste or glue.

In the second method, plaster cream is made, into which are dipped pieces of muslin cut to the required size and shape. These are applied to the limb in

succession and carefully moulded while setting. Trimming, drying, and lining are carried out as in the first method.

*Plaster Bed.*—A splint for the back made in the way just described is known as a 'plaster bed'. In making this the patient is placed prone on a narrow table with the hands under the chin. The spine and head are placed straight or in the position desired by the surgeon. A rubber bathing cap is worn on the head, and the back is smeared with olive oil or vaseline. A large enamel bowl, an iron spoon, a jug containing 10 pints of warm water, and 14 lb. of loose plaster are required. Muslin of the correct weave is torn into pieces equal in length to the distance between the top of the patient's head and the middle of the thigh, and a little wider than the distance between the outer points of the shoulders. Twelve pairs of such pieces are needed. Two assistants are necessary in making the bed and a third should sit at the top of the table and steady the patient's head. When the preparations are complete, the water is poured into the bowl and the plaster sprinkled into it, the mixture being well stirred with the spoon. Each double piece of muslin is then in turn dipped into the bowl by an assistant, lightly squeezed by running through one hand as it is taken out of the cream, and handed to the surgeon, who with the help of the second assistant spreads it out and applies it to the patient's back and head. Each piece is carefully smoothed and moulded over the whole surface. After half the pieces have been applied, several reinforcing 'folders' should be placed along the neck, across the lower end of the bed, and also crosswise at the level of the shoulders, where an iron or wooden 'rest' is later fixed. Then the remainder of the pieces of muslin are applied (*Fig. 96*). As soon as the plaster has become firm, the bed is lifted off the patient's

back. It is at once trimmed with a knife to produce a broad edge, which is smoothed with the hand and bound with a narrow plaster bandage. At the level of the nipples and the hips, webbing straps with buckles are fixed to the outer side of the bed; by these straps the patient can be prevented from moving while lying in the bed. The lower end of the bed is cut away in a curve to the level of the upper end of the fold between the buttocks, to allow unimpeded use of the

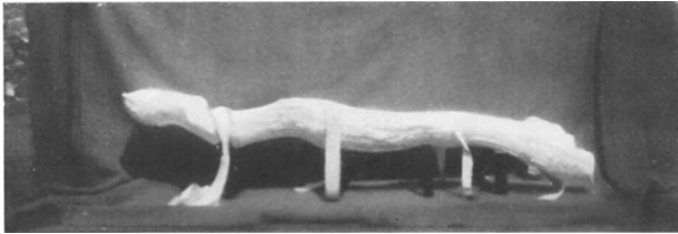

*Fig. 96.*—Making a plaster bed with leg extensions. Showing position of patient and cast before removal for trimming and finishing.

bed-pan. The bed is then put away for a day or two in a warm, dry place until it is quite dry, when the 'rest' is affixed by bolts. The 'rest' consists of a block of wood or a rectangular metal frame and is required to stabilize the plaster bed and to raise the upper end for the patient's comfort. The inner surface is rubbed smooth where necessary, and lined with felt or gamgee. When desired, a plaster bed may be extended in making so as to support the legs in troughs, and additional 'rests' can be affixed at lower levels (*Fig. 97*).



A patient lying in a plaster bed is firmly held and is unlikely to develop friction or pressure sores. After a few days he lies comfortably in it continuously, and need not be taken out more often than once in three or four weeks. In taking him out three nurses are required. He is lifted in the plaster to the edge of the bed and turned over on his face while being pressed closely against the plaster. Then the plaster is lifted off and the back can be washed or a wound dressed as required.



*Fig. 97.*—Plaster bed with leg extensions mounted on metal 'rests' and with webbing straps.

**Plaster Casts.**—These are used either for record purposes or to aid the making of appliances. In one method plaster cream only is used. The limb is smeared with oil or vaseline and pieces of string are placed along it on two aspects. The whole surface of the part is then covered with thick plaster cream. As soon as the plaster is set, the pieces of string, the ends of which have been left long, are pulled through it, thus dividing the cast into two sections. Each section is lifted off the limb and the two sections again fitted and bound together, thus forming a hollow mould (the negative). This is washed out with warm soapy water and filled with thin plaster cream. When this has set,



*Fig. 98.*—Plaster cast (negative)



*Fig. 99.*—Plaster cast (positive).

the mould is chipped away and the positive cast is revealed as an exact replica of the limb.

In another method, which is easier and more suitable for the making of appliances, plaster bandages are used. After the limb has been greased, a rubber or lead strip is laid along one aspect. While the limb is held in the desired position, a soaked plaster bandage is applied in the same way as in making a casing. Three or four layers only of bandage are applied, and are moulded closely to the whole surface, especially around bony points. Just as the plaster is lightly set, it is cut with a sharp scalpel along the line of the rubber strip. The cast (the negative) (*Fig. 98*) is then slipped off the limb and the edges at once brought together again and closed by another plaster bandage. The mould thus obtained is allowed to dry and is then filled with plaster cream. When this has set, the mould is cut away, leaving the positive cast (*Fig. 99*).

## INDEX

	PAGE		PAGE
<b>A</b> BSCCESS, chronic, of bones		Arthritis, acute suppurative	133
(Brodie's)	130	— — — cause of	133
— tuberculous	105	— — — treatment of	134
— — in hip disease	120	— osteo -	96
— — lumbar	111	— rheumatoid	91
— — psoas	111	Arthrodesis, extra-articular, for	
— — in spinal disease	109	tuberculosis of hip	125
— — treatment of	108	— in osteo-arthritis	101
Acute flat-foot	40	— poliomyelitis	80
Adductor strain	197	— rheumatoid arthritis	95
Adhesions after dislocation of		— of the sub-astragaloid joint in	
joints	205	fracture of the os calcis	190
— — sprain	202	— in tuberculosis of the knee	127
— — causing internal derangement		Arthroplasty in osteo-arthritis	101
of joints	209	— rheumatoid arthritis	95
Adolescent kyphosis	31	'Artificial sunlight'	108, 217
After-care of cripples	3	Ataxia in peripheral neuritis	83
Albee's operation	117	'Attitude of rest,' the	28
Anderson well-leg counter-trac-			
tion method	182	BACK, pain in	88
Angular kyphosis	31, 109	Backache due to chronic sprain	202
Ankle, sprain of	202	— — sacro-iliac sprain	203
Ankylosis	134	— — spondylitis deformans	98
— from acute suppurative arth-		Baths	218
ritis	134	— deep pool	219
— — rheumatoid arthritis	92	Bed-sores in fracture cases	161
— — tuberculosis of hip	124	— — of the spine	174
— — knee	127	— prevention and treatment of	
Anterior transverse metatarsal		with plaster casing	229
arch, flattening of	37, 42	Bell's palsy	83
'Anterior reposition' of congeni-		— treatment of	84
tal dislocation of the hip	19	Bence-Jones proteinuria in	
Appliances	223	myeloma	143
— bow-leg splints	64	Bipp, use of in osteomyelitis	133
— for ankle	226	Birth injury of brachial plexus	192
— elbow and wrist	224	— — of sternomastoid muscle-	192
— exercises	213	— — spastic paralysis as a	
— hip, thigh, and knee	224	cause of	66
— knock-knee splint	36	Bodily types	26
— leg-iron	226	Böhler's iron walking heel	188
— night splints	223	— leg splint	163, 186
— in osteo-arthritis	101	— thigh splint	163, 186
— poliomyelitis	78	Bone-grafting after excision of	
— purpose of	223	giant-cell tumour	139
— in rheumatoid arthritis	96	— for fracture of neck of femur	182
— for shoulder	224	— tuberculosis of hip	125
— spine	224	— — spine	117
— sole plates	12	Bow-leg due to rickets	62
— spinal support	59	— in osteitis deformans	64
— tin shoes	223	— — operation for	64
— T-strap	226	— — — splintage for	64
— in tuberculosis of the hip	124	Brachial neuritis	83
— — spine	117	Bradford frame	115
— varus instrument and boot	9, 226	Brodie's abscess	130
— walking caliper for tuber-		Bunions	47
culosis of the knee	127		

	PAGE		PAGE
CALCIUM metabolism in osteitis fibrosa - - - - -	149	Congenital torticollis, treatment of	21
Caliper splint, Thomas - - - - -	224	' Contrast baths ' - - - - -	218
Callosities - - - - -	50	Corns - - - - -	50
Callus - - - - -	159	— treatment of - - - - -	50
Calve's disease - - - - -	153	— with flat-foot - - - - -	38
Capsulotomy in rheumatoid arthritis - - - - -	95	Counter-irritation by baths - - - - -	219
' Caries ' - - - - -	104	— with galvanic current - - - - -	215
Cascation - - - - -	105	Coxa vara - - - - -	64
' Causalgia ' - - - - -	195	— ' adolescent ' - - - - -	156
Cerebral paralysis of childhood - - - - -	66	— — causes of - - - - -	64
— — — causes of - - - - -	66	— — due to rickets - 63, 64, 65	65
— — — treatment of - - - - -	68	— — slipping epiphyses - - - - -	156
Cervical rib - - - - -	22	— — ' epiphyseal ' - - - - -	156
— — treatment of - - - - -	23	— — in osteitis deformans - - - - -	150
Chondroma - - - - -	136	— — osteochondritis - - - - -	154
— multiple - - - - -	137	Crepitus - - - - -	159
— ossifying - - - - -	135	Cripples, after-care - - - - -	3
— treatment of - - - - -	137	— definition of - - - - -	1
' Clasp-knife ' sensation in spastic paralysis - - - - -	67	— discovery of - - - - -	2
Claw-foot - - - - -	6	— education of - - - - -	3
Club-foot - - - - -	6	— employment of - - - - -	3
— shoe for - - - - -	10, 223	— occupation of during treatment - - - - -	3
Cod-liver oil in treatment of rickets - - - - -	63	— prevention of - - - - -	2
Colon lavage - - - - -	93	— psychology of - - - - -	4
Compression paraplegia - - - - -	66, 70	— responsibility of public authorities for - - - - -	2
— — nursing of - - - - -	71	— vocational training of - - - - -	3
— — in spine, fracture of - - - - -	170	— welfare work, organization of - - - - -	1
— — tuberculosis of - - - - -	111	Cruciate ligaments, rupture of - - - - -	210
— — treatment of - - - - -	71	Crush fracture of the spine - - - - -	170
Congenital absence of bones - - - - -	5	DAKIN-CARREL'S method in osteomyelitis - - - - -	133
— — a limb - - - - -	5	Diabetes in fibrositis - - - - -	88
— — muscles - - - - -	5	Diathermy - - - - -	216
— — deformities, cause of - - - - -	5	— for corns, callosities, and warts - - - - -	50
— — varieties of - - - - -	5	— medical - - - - -	216
— — dislocation of the hip - - - - -	13	— surgical - - - - -	216
— — — ' anterior reposition ' of - - - - -	19	Diplegia - - - - -	66, 68
— — — cause of - - - - -	13	Discovery of cripples - - - - -	2
— — — Lorenz bifurcation osteotomy for - - - - -	20	Dislocation, causes of - - - - -	204
— — — nursing of - - - - -	18	— congenital - - - - -	5
— — — open operation for - - - - -	20	— paralytic - - - - -	75
— — — prognosis in - - - - -	15	— pathological - - - - -	120
— — — Schanz sub-trochanteric osteotomy for - - - - -	20	— traumatic - - - - -	204
— — — ' shelf ' operation for - - - - -	20	— — adhesions following - - - - -	208
— — — telescoping in - - - - -	14	— — — manipulation for - - - - -	208
— — — treatment of - - - - -	15	— — — after-treatment of - - - - -	208
— — — by manipulation (Lorenz method) - - - - -	17	— — — of elbow - - - - -	207
— — joints - - - - -	5	— — — hip - - - - -	206
— — talipes - - - - -	5	— — — treatment of - - - - -	207
— — calcaneo-valgus - - - - -	10	— — — injuries to nerves in - - - - -	205
— — — treatment of - - - - -	10	— — — of shoulder - - - - -	205
— — equino-varus - - - - -	6	— — — recurrent - - - - -	206
— — — corrective exercises for - - - - -	10	— — — treatment of - - - - -	205
— — — special boot and instrument for - - - - -	9	— — — subluxation - - - - -	204
— — — treatment of - - - - -	7	Dropped foot - - - - -	5
— — torticollis - - - - -	5	— wrist - - - - -	82
— — — causes of - - - - -	21	Dunn, Naughton, operation in poliomyelitis - - - - -	80
— — — tenotomy of sternomastoid - - - - -	22	Dupuytren's contracture - - - - -	89
		— — causes of - - - - -	89
		— — treatment of - - - - -	90

	PAGE		PAGE
EBURNATION - - - -	96	Focal infection with osteo-	
Education of cripples - - -	3	arthritis - - - -	97, 100
Effluage - - - -	211	— osteomyelitis - - - -	129
Employment of cripples - - -	3	— peripheral neuritis - - -	81
Epicritic sensibility - - - -	193	— rheumatoid arthritis - -	91
Erb's paralysis - - - -	192	— stiffness of joints after	
Ewing's sarcoma - - - -	142	dislocation - - - -	208
— simulating osteomyelitis	143	tenosynovitis - - - -	198
— treatment of - - - -	143	tuberculosis of bones	
Exercises, remedial - - - -	212	and joints - - - -	103
— apparatus for - - - -	213	Foot, correct use of - - - -	43
— for flat-foot - - - -	44	— function of - - - -	37
— genu valgum - - - -	35	— natural shape of - - - -	37
— knee - - - -	214	Foot-strain - - - -	37, 40
— kypho-lordosis - - - -	30, 31	Fractures - - - -	158
— principles of - - - -	213	— anæsthesia in - - - -	162
— purpose of - - - -	212	— of ankle - - - -	189
— for scoliosis - - - -	56	— carpus - - - -	181
— use of deep pool baths with	219	— causes of - - - -	158
Exostosis, ivory - - - -	135	— of clavicle - - - -	175
— spongy - - - -	135	— treatment of - - - -	176
— with hallux valgus - - - -	47	— Colles' - - - -	179
Extensor hallucis longus, trans-		— treatment of - - - -	180
plantation of for pes cavus	13	— comminuted - - - -	159
— tendons, tenotomy of for re-		— complications of - - - -	161
traction of toes - - - -	13	— compound or open - - - -	159
		— delayed union of - - - -	110
		— treatment of - - - -	167
		— depressed - - - -	159
		— of elbow - - - -	178
		— head of the radius - - - -	179
		— olecranon - - - -	179
		— radius and ulna - - - -	179
		— treatment of - - - -	178
		— Volkman's ischæmic con-	
		tracture in - - - -	179
		— femur, neck of - - - -	181
		— Anderson well-leg coun-	
		ter-traction method	
		for - - - -	182
		— extra-capsular fracture	158
		— intra-capsular fracture	181
		— treatment of - - - -	182
		— nursing in - - - -	184
		— operative fixation in - -	184
		— Whitman method in - - -	182
		— shaft of - - - -	185
		— Hamilton-Russell meth-	
		od - - - -	186
		— methods of immobili-	
		zation for - - - -	185
		— fixed traction in - - - -	164
		— general considerations - -	158
		— principles of treatment -	160
		— green-stick - - - -	158
		— of humerus, shaft of - - -	176
		— upper end of - - - -	176
		— immobilization of - - - -	163
		— impacted - - - -	159
		— injuries to nerves in - - -	177
		— of jaws - - - -	160
		— treatment of - - - -	170
		— mal-union of - - - -	160
		— osteo-arthritis secondary to	97
		— tendon rupture with - - -	199
FARADIC current - - - -	216		
Fibrosarcoma, periosteal - - -	139		
Fibrositis - - - -	87		
— causes of - - - -	87		
— manipulation for - - - -	89		
— muscular - - - -	88		
— periarticular - - - -	88		
— perineuritic - - - -	88		
— subcutaneous - - - -	88		
— treatment of - - - -	89		
First aid in fracture of the spine	171		
Flaccid paralysis - - - -	66		
Flail-joint in poliomyelitis - -	76		
Flat-back - - - -	33		
Flat-foot - - - -	37		
— acute - - - -	40		
— causes of - - - -	38		
— congenital - - - -	10		
— infantile - - - -	39		
— inflammatory - - - -	38		
— postural - - - -	29		
— causes of - - - -	38		
— definition of - - - -	37		
— exercises for - - - -	44		
— manipulation for - - - -	44		
— re-education - - - -	44		
— treatment of - - - -	43		
— rigid - - - -	41		
— traumatic - - - -	38		
— varieties of - - - -	37		
— with peroneal spasm - - - -	41		
Focal infection with acute sup-			
purative arthritis - - - -	133		
— chronic sprain - - - -	202		
— fibrositis - - - -	87		
— injuries to muscles - - - -	198		
— tendons - - - -	198		

	PAGE		PAGE
Fractures, mal-union of, teno-		GALLOWES method of immobiliza-	
synovitis due to - - -	198	tion of fracture of the	
— treatment of - - -	167	femur - - - - -	185
— massage and movements in -	166	Galvanic current - - - - -	216
— of metacarpals - - - - -	181	Ganglionectomy, sympathetic, in	
— metatarsals - - - - -	190	poliomyelitis - - - - -	81
— non-union of - - - - -	160	Genu valgum - - - - -	34
— cause of - - - - -	160	— appliances for - - - - -	36
— treatment of - - - - -	167	— causes of - - - - -	34
— nursing in - - - - -	161	— compensatory - - - - -	34
— open operations on - - - - -	165	due to injury or disease -	34
— open or compound - - - - -	159	— rickets - - - - -	63
— risk of osteomyelitis in -	129	— exercises for - - - - -	35
— of os calcis - - - - -	189	— measurement of - - - - -	34
— osteomyelitis complicating		— operative correction of -	37
open fractures - - - - -	129	— paralytic - - - - -	34
of patella - - - - -	187	— postural - - - - -	29, 34
pathological - - - - -	158	— treatment of - - - - -	35
— in osteitis fibrosa cystica	158	— varum - - - - -	64
— syringo-myelia - - - - -	158	Giant-cell tumour - - - - -	138
— tabes dorsalis - - - - -	158	— treatment of - - - - -	139
— of pelvis - - - - -	175	'Girdle' pain - - - - -	70, 111
— phalanges - - - - -	181	Gold salts in rheumatoid arthritis	94
— Pott's - - - - -	189	Gout, arthritic, with hallux valgus	47
— mal-union of - - - - -	189	— with fibrositis - - - - -	88
— of radius and ulna - - - - -	179	— peripheral neuritis - - - -	66
— reduction of - - - - -	162	G.V. strap with knock-knee	
— of ribs - - - - -	175	appliance - - - - -	37
— screw traction in - - - - -	162	Gypsum - - - - -	227
— signs of union - - - - -	160		
— simple or closed - - - - -	159	HALIBUT liver oil in treatment	
— skeletal traction - - - - -	164	of rickets - - - - -	63
— skin traction - - - - -	164	Hallux flexus - - - - -	100
— of skull - - - - -	168	— rigidus - - - - -	100
— after-effects of - - - - -	169	— treatment of - - - - -	101
— injury to brain from - - - -	168	— valgus - - - - -	46
— meningeal hæmorrhage in	168	— causes of - - - - -	46
— nursing in - - - - -	169	— congenital - - - - -	46
— treatment of - - - - -	168	— exercises for - - - - -	47
— spine - - - - -	170	— operations for - - - - -	47
— "crush" fracture - - - - -	170	— postural - - - - -	29, 46
— first aid in - - - - -	171	— treatment of - - - - -	47
— fracture-dislocation - - - -	170	Hammer-toe - - - - -	29, 48
— of laminae or spinal pro-		— acquired - - - - -	48
cesses - - - - -	171	— congenital - - - - -	48
— nursing in - - - - -	173	— treatment of - - - - -	49
— spinal cord injury in - - - -	170	Hamstrings, shortening of, with	
— treatment of - - - - -	171	kyphosis and flat-back - - -	33
— spontaneous - - - - -	158	Harrison's sulcus - - - - -	61
— causes of - - - - -	158	Hemiplegia - - - - -	66, 68
— from giant-cell tumour -	138	Hernia of muscle - - - - -	197
— in metastatic tumours - - - -	147	Hibb's operation - - - - -	117
— myeloma - - - - -	144	Hollow back - - - - -	32
— osteitis deformans - - - - -	152	— foot - - - - -	6
— fibrosa cystica - - - - -	158	Hydrotherapy - - - - -	218
— osteogenic sarcoma - - - - -	140	— effects of - - - - -	218
— of tibia and fibula - - - - -	187	— varieties of - - - - -	218
— tibial spine - - - - -	210	Hyperæsthesia in peripheral	
— traction in - - - - -	164	neuritis - - - - -	83
— traumatic - - - - -	158		
— treatment of - - - - -	160	INFANTILE flat-foot - - - - -	39
— varieties of - - - - -	158	— paralysis - - - - -	72
— X-ray examination of - - - -	163	Inflammatory flat-foot - - - -	38
Fragilitas ossium - - - - -	158		
Fulguration - - - - -	216		





	PAGE		PAGE
Muscle sliding in Steindler's operation - - -	12	OCCUPATION during treatment	
Muscles, injuries to - - -	196	of cripples - - -	3
— adductor strain - - -	197	— — tuberculosis of bones and joints - - -	108
— — causes of - - -	196	Ollier's operation - - -	117
— — focal infection associated with - - -	198	Onychogryphosis - - -	50
— — manipulation in - - -	197	Open-air treatment in osteomyelitis - - -	132
— — muscle hernia - - -	197	— — rickets - - -	63
— — physiotherapy in - - -	197	— — tuberculosis - - -	106
— — rupture of - - -	197	Organization of cripple welfare work - - -	I
— — strained and pulled - - -	197	Orr's, Winnett, method in osteomyelitis - - -	I33
— — tennis elbow - - -	197	Orthopaedic surgery, definition of - - -	I
— — treatment of - - -	197	— — scope of - - -	I
Music, use of in re-educative and mobilizing exercises - - -	213	— wedge - - -	8
Myeloma - - -	143	— wrench - - -	8
— treatment of - - -	144	Osgood's disease - - -	153
Myositis ossificans - - -	208	Osteitis deformans - - -	150
		— — cause of - - -	150
NÉLATON's line - - -	14	— — treatment of - - -	152
Nerve injury - - -	191	— fibrosa cystica - - -	147
— — causalgia - - -	195	— — focal - - -	149
— — causes of - - -	191	— — treatment of - - -	150
— — in fracture of the shaft of the humerus - - -	177	— — generalized - - -	148
— — obstetrical (Erb's) paralysis - - -	192	— — treatment of - - -	149
— — peripheral - - -	66	Osteo-arthritis - - -	96
— — physiotherapy in - - -	195, 196	— cause of - - -	97
— — reaction of degeneration - - -	194	— causing internal derangement - - -	209
— — regeneration of nerve - - -	193, 195	— correction of deformity in - - -	102
— — treatment of - - -	195	— of first metatarso-phalangeal joint - - -	100
— — trophic changes in - - -	194	— following osteo-chondritis - - -	154
— — with dislocation - - -	205	— — slipped epiphysis - - -	157
Nervous system, diseases of - - -	66	— of hip-joint - - -	100
Neuralgia - - -	81	— predisposing to tendon rupture - - -	199
Neurectomy in spastic paralysis - - -	68	— of the spine - - -	97
Neuritis, brachial - - -	83	— with hallux valgus - - -	47
— peripheral - - -	66, 81	Osteochondritis - - -	152
— — causes of - - -	81	— cause of - - -	153
— — deformities in - - -	82	— treatment of - - -	154
— — prevention of - - -	84	Osteoclasia for bow-leg - - -	64
— — treatment of - - -	86	Osteogenic sarcoma - - -	139
— — physiotherapy in - - -	84	— — treatment of - - -	141
— — sciatic - - -	83	Osteoma - - -	135
— — splintage - - -	84, 85	— multiple cancellous - - -	136
— — treatment of - - -	83	— treatment of - - -	135
Nicola's operation for recurrent dislocation of shoulder - - -	206	Osteomyelitis - - -	129
Night splints - - -	223	— causes of - - -	129
Normal bodily type - - -	26	— Ewing's sarcoma simulating - - -	143
— erect posture - - -	26	— treatment of - - -	132
Nursing in compression paraplegia - - -	71	Osteophytes - - -	96
— congenital dislocation of the hip - - -	18	Osteotomy for bow-leg - - -	64
— fractures - - -	161	— congenital dislocation of the hip - - -	20
— — of the neck of the femur - - -	184	— genu valgum - - -	37
— — skull - - -	169	— — varum - - -	64
— — spine - - -	173	— osteo-arthritis - - -	101
— — of patients in plaster casings - - -	229	— poliomyelitis - - -	79
— — bed - - -	234	— rheumatoid arthritis - - -	95
— — in tuberculosis of the hip - - -	122	— sub-trochanteric, for coxa-vara - - -	65
— — spine - - -	115, 119	— — healed tuberculosis of the hip with deformity - - -	125
		Out-patient clinics - - -	3

	PAGE		PAGE
PAGET'S disease - - -	150	Plantar warts - - -	50
Panniculitis - - -	88	Plaster bed - - -	232
Paralysis, cerebral, of childhood	66, 68	— — in operative treatment of	
— flaccid - - -	66	scoliosis - - -	60
— infantile - - -	72	— — treatment of spinal tuber-	
— musculospiral - - -	82	culosis - - -	115
— obstetrical (Erb's) - - -	192	Plaster-of-Paris - - -	227
— spastic - - -	66	— bed, method of making - - -	232
— — electrical reactions - - -	67	— casings - - -	229
— — treatment of - - -	68	— padding under - - -	229
Paraplegia - - -	66, 67	— — nursing of patients in - - -	229
— compression - - -	66, 70	— — removal of - - -	230
— causes of - - -	70	— — signs of interference with	
— symptoms of - - -	70	vessels or nerves from - - -	229
— treatment of - - -	71	— — sores under, prevention of - - -	229
— — in tuberculosis of spine - - -	111	— casts - - -	234
— spinal spastic - - -	70	— methods of use - - -	227
Parathyroid, over-activity of,		— muslin - - -	228
causing osteitis fibrosa - - -	148	— preparation of bandages - - -	228
Pelvic rest - - -	17	— splints - - -	230
Periosteal fibrosarcoma - - -	139	— storage of bandages - - -	228
— — treatment of - - -	139	— use in fracture of the spine - - -	173
Peroneal spasm with flat-foot - - -	41	— — treatment of fractures - - -	163
Perthe's disease - - -	153	— — tuberculosis of hip - - -	123
Pes cavus - - -	5, 11	— — knee - - -	125
— — causes of - - -	11	— Whitman method for fracture	
— — treatment of - - -	12	of the neck of the femur - - -	182
— — plano-valgus - - -	40	Pleurodynia - - -	87
— — congenital - - -	39	Poliomyelitis - - -	66
— — postural - - -	37, 40	— acute anterior - - -	72
— — planus - - -	41	— after-care in - - -	81
— — congenital - - -	6	— appliances for - - -	78
— — postural - - -	41	— arthrodesis in - - -	80
— — valgus, postural - - -	37, 39	— cause of - - -	72
Pétrissage - - -	211	— deformities in - - -	74
Phasic contraction - - -	24	— — correction of - - -	79
Physiotherapy - - -	211	— — prevention of - - -	77
— in after-treatment of dis-		— Dunn's (Naughton) operation	
locations - - -	208	in - - -	80
— artificial sunlight - - -	217	— incubation period - - -	72
— baths - - -	218	— isolation of cases in - - -	73
— in compression paraplegia - - -	72	— splintage in - - -	77
— diathermy - - -	216	— stabilizing operations in - - -	80
— exercises - - -	212	— sympathectomy in - - -	81
— faradic current - - -	215	— tendon transplantation in - - -	79
— in fibrositis - - -	89	— treatment of - - -	76
— fracture - - -	166	— use of serum in - - -	77
— galvanic current - - -	215	— Whitman's operation in - - -	81
— infra-red rays - - -	217	Postural contraction of muscles	
— in injuries to muscles - - -	197	— deficiency, generalized - - -	28
— — nerves - - -	195, 196	— — exercises for - - -	30
— — massage - - -	211	— — deformities, causes of - - -	25
— in neuritis - - -	84	— — flat-foot - - -	29
— osteo-arthritis - - -	100	— — generalized postural defi-	
— peripheral neuritis - - -	84	ciency - - -	28
— poliomyelitis - - -	77, 79	— — genu valgum - - -	29
— radiant heat - - -	217	— — hammer-toe - - -	29
— in rheumatoid arthritis - - -	94, 95	— — hallux valgus - - -	29
— sinusoidal electric current - - -	211	— — kypho-lordosis - - -	28, 31
— for spastic paralysis - - -	68, 69	— — lateral curvature (scolio-	
— in sprains - - -	202	sis) - - -	29
— tuberculosis of bones and joints	108	— — treatment of - - -	29
— — ultra-violet light - - -	217	— reflexes - - -	25
Pigeon breast - - -	61	— training - - -	29
Plantar fascia, division of - - -	8, 12	Posture, maintenance of - - -	24

	PAGE		PAGE
Posture, normal erect - - -	26	Rounded kyphosis - - -	31
Pott's disease - - -	109	Russell-Hamilton method of immobilization - - -	186
Prevention of crippling - - -	2	Sacro-iliac sprain - - -	203
Protein shock in rheumatoid arthritis - - -	94	Saline solution injection in peripheral neuritis - - -	86
Protopathic sensibility - - -	193	Sarcoma of bone - - -	139
Psoas abscess - - -	111	— — osteogenic - - -	139
Psychology of the cripple - - -	4	— — periosteal fibrosarcoma - - -	139
Public authorities, responsibility of for prevention and treatment of crippling - - -	2	Schanz sub-trochanteric osteotomy for congenital dislocation of the hip - - -	20
Pugh's method of traction in tuberculosis of hip - - -	123	Schlatter's disease - - -	153
RADIANT heat - - -	217	Sciatic neuritis - - -	83
— — baths - - -	219	— — pain, causes of - - -	83
Reaction of degeneration (R.D.) - - -	194	— — due to malformation of lumbar spine - - -	83
Recurrent dislocation of the shoulder - - -	206	— — tumours of spine - - -	147
Re-education in postural deformity - - -	29	— — in metastatic carcinoma of the spine - - -	147
— — spastic paralysis - - -	69	— — spinal osteo-arthritis - - -	100
Re-educative exercises for generalized postural deficiency - - -	30	— — tuberculosis - - -	111
— — genu valgum - - -	35	— — scoliosis - - -	83
— — postural flat-foot - - -	44	Sciatica - - -	87
— — — kypho-lordosis - - -	30	— — causes of - - -	83
— — — scoliosis - - -	56	— — in metastatic carcinoma of the spine - - -	147
Regeneration of nerves - - -	193, 195	— — osteo-arthritis - - -	100
Relaxed attitude, the - - -	28	— — spinal tuberculosis - - -	111
Retention of urine in compression paraplegia - - -	71	— — with spondylitis deformans - - -	100
Retracted toes, treatment of - - -	13	Scoliosis - - -	51
— — with flattening of the transverse arch - - -	43	— — causes of - - -	51
— — — pes cavus - - -	13	— — compensatory - - -	51
Rheumatism - - -	87	— — congenital - - -	51
— — definition of - - -	87	— — paralytic - - -	51
Rheumatoid arthritis - - -	91	— — pathological - - -	51
— — ankylosis in - - -	92, 95	— — in poliomyelitis - - -	74
— — causing internal derangement - - -	209	— — postural - - -	29
— — correction of deformity in deformities in - - -	95, 93	— — corrective plaster jackets for - - -	58
— — manipulation in - - -	95	— — etiology of - - -	51
— — operation for - - -	95	— — examination of - - -	52
— — physiotherapy in - - -	94, 95	— — immobilizing exercises for - - -	57
— — prevention of deformity in - - -	94	— — irreducible - - -	54
— — splintage in - - -	94	— — operation for - - -	60
— — treatment of - - -	93	— — reducible - - -	55
— — with hallux valgus - - -	47	— — re-education in - - -	56
Rickets - - -	61	— — re-educative exercises for - - -	56
— — as a cause of crippling - - -	2	— — 'structural' - - -	55
— — cause of - - -	61	— — in rickets - - -	62
— — deformities in - - -	62	— — sciatic - - -	83
— — prevention of - - -	63	— — due to short lower limb - - -	60
— — production of - - -	62	Scope of orthopaedic surgery - - -	1
— — varieties of - - -	62	Semilunar cartilages of knee, injury to - - -	210
— — prevention of - - -	63	Senile kyphosis - - -	31
— — treatment of - - -	63	Sequestrum in osteomyelitis - - -	130
Rickety rosary - - -	61	Shelf operation for congenital dislocation of the hip - - -	20
Rigid flat-foot - - -	41	Shoes, correctly made - - -	43
Round shoulders - - -	28, 32	— — special - - -	46
		Shortening of a limb, congenital - - -	51, 60
		— — in poliomyelitis - - -	75

	PAGE		PAGE
Shortening of limb in poliomyelitis, operation for	81	Splint, Thomas double abduction	
Sinus in osteomyelitis	130	tuberculosis of hip	123
— tuberculosis	105	— — Thomas knee	163, 164
Sinusoidal electric current	216	— — uses of	220
Slender bodily type	26	— — for wrist	222
Slipping of epiphysis of head of femur	154	Spondylitis deformans	98
— — — cause of	154	— — ligamentosa ossificans	93
— — — coxa vara due to	156	Spondylolysis deformans	98
— — — — pituitary disturbance in	155	— — treatment of	100
— — — — treatment of	156	— — with osteitis deformans	151
Smart-Bristow coil	215	Sprain, acute	200
Snapping joint	200	— — chronic	202
Sole plate for correction of retracted toes	13	— — of ankle	202
— — pes cavus	12	— — knee	202
Solitary cyst	149	— — sacro-iliac joint	204
Sores, bed	161	— — wrist	202
— splint	220	Stabilizing operation in poliomyelitis	80
Spastic paralysis	66	Starting pains in tuberculosis of hip	120
— — treatment of	68	Steindler's operation	12
Spinal spastic paraplegia	70	Sthenic bodily type	26
— support	59	Stiff joints, principles of exercises for	213
Spine, deformity due to rickets	62, 65	— neck	87
— — malformation of	83	— Still's disease	91
— — sciatic pain due to	83	Subluxation, congenital, of hip	15
— — tuberculosis of	109	— — traumatic	204
Splints	220	Sun exposure in rickets	63
— — Anderson well-leg counter-traction apparatus	182	— — signs of over-exposure	107
— — for ankle	223	— — in tuberculosis of bones and joints	107
— — arm	222	Supernumerary fingers and toes	5
— — Böhler's femur	163, 186	Sympathetic ganglionectomy in poliomyelitis	81
— — iron heel	188	Synovectomy in rheumatoid arthritis	95
— — leg	163, 187		
— — Bradford frame	115	TALIPES, calcaneo-cavo-valgus	6
— — cuff and collar sling	178	— — calcaneo-plano-valgus	6
— — for elbow	222	— — calcaneus	5
— — foot	223	— — equino-valgus	6
— — forearm	222	— — equinus	5
— — hand	222	— — in poliomyelitis	75
— — Hey-Groves cradle	163	— — spastic paralysis	67
— — for hip	222	— — valgus	6
— — Hodgen's	163	— — varus	6
— — for knee	223	Tapotement	212
— — leg	223	Tendon lengthening in poliomyelitis	79
— — long Liston, use of in tuberculosis of hip	123	— — rheumatoid arthritis	95
— — malleable	220	— — spastic paralysis	69
— — materials for	220	— — transplantation of extensor hallucis longus	13
— — overhead frame	185	— — in poliomyelitis	79
— — padding for	220	— — spastic paralysis	69
— — plaster-of-Paris	230	Tendons, injuries to	198
— — prevention and treatment of sores due to	220	— — dislocation of	200
— — principles of splintage	221	— — — snapping joint due to	200
— — for shoulder	222	— — — mallet finger	199, 200
— — shoulder abduction	177, 222	— — — rupture of	199
— — for spine	222	— — — traumatic tenosynovitis	198
— — thigh	222	— — — treatment of	200
— — Thomas arm	163		
— — double abduction splint	115		

	PAGE		PAGE
Tendons, injuries to, trigger		Tuberculosis of spine, examin-	
— finger - - - - -	200	ation of - - - - -	112
— wound of - - - - -	199	— — nursing in - - - - -	115, 119
Tennis elbow - - - - -	197	— — operation for - - - - -	117
Tenosynovitis, traumatic - - -	198	— — sciatic pain in - - - - -	111
— — causes of - - - - -	198	— — splintage for - - - - -	113
— — focal infection with - - -	198	— — symptoms of - - - - -	111
— — infective - - - - -	198	— — treatment of - - - - -	112
— — treatment of - - - - -	198	— — with paraplegia - - - - -	111
— — with mal-united fracture	198	Tumours of bone - - - - -	135
Tenotomy for congenital torti-		— — chondroma - - - - -	135
collis - - - - -	22	— — Ewing's sarcoma - - - - -	142
— poliomyelitis - - - - -	79	— — giant-cell tumour - - - - -	138
— retraction of toes - - - - -	13	— — metastatic carcinoma - - -	144
— rheumatoid arthritis - - - -	95	— — — sarcoma - - - - -	144
— spastic paralysis - - - - -	69	— — myeloma - - - - -	143
Thomas's arm splint - - - - -	177	— — osteogenic sarcoma - - - - -	139
— caliper splint - - - - -	224	— — osteoma - - - - -	135
— double abduction splint - - -	115	— — periosteal fibrosarcoma - - -	139
— knee splint for use in genu		— — of spine, with paraplegia	
valgum - - - - -	223	— — varieties of - - - - -	66, 70 135
Tibial spine, fracture of - - - -	210	ULCER, tuberculous - - - - -	105
Tin shoe - - - - -	223	Ultra-violet light - - - - -	217
Torticollis - - - - -	21	— — application of - - - - -	218
— acquired - - - - -	21	— — in rheumatic affections	89, 94
— congenital - - - - -	21	— — sources of - - - - -	217
Transverse metatarsal bar - - -	12	— — in tuberculosis of bones	
Traumatic flat-foot - - - - -	38	and joints - - - - -	108
Trigger finger - - - - -	200	— — uses of - - - - -	217
Trophic changes in compression		VALGUS ankle - - - - -	39
paraplegia - - - - -	71	— pad or support - - - - -	46
— — nerve injury - - - - -	194	— wedge - - - - -	46
T-strap - - - - -	226	Vibration massage - - - - -	212
Tuberculosis of bones and joints	103	Visceroptosis - - - - -	26
— — as a cause of crippling - - -	2	Vitamins in rickets - - - - -	11
— — cause of - - - - -	103	— treatment of tuberculosis - - -	106
— — focal infection in - - - - -	103	Vocational training of cripples - -	3
— — — occupation during		Volkman's ischaemic contracture	179
treatment - - - - -	108	WARTS - - - - -	50
— — — simulation by osteo-		Wasting of the muscles of the	
chondritis - - - - -	152	hand associated with cer-	
— — — treatment in - - - - -	105	vical rib - - - - -	23
— — — general principles of	105	Weak ankle - - - - -	39
— — — open-air - - - - -	106	Whitman's operation in polio-	
— — — sun - - - - -	106	myelitis - - - - -	81
— — hip - - - - -	120	— plaster abduction method for	
— — abscess in - - - - -	120	fracture of the neck of	
— — nursing in - - - - -	122	femur - - - - -	182
— — operative treatment of - - -	125	Wrist, sprain of - - - - -	202
— — splintage for - - - - -	102	Wry neck - - - - -	21
— — treatment of - - - - -	121		
— — knee - - - - -	125		
— — operative treatment of - - -	127		
— — treatment of - - - - -	125		
— — spine - - - - -	109		
— — abscess in - - - - -	109		
— — deformity due to - - - - -	112		