

LONDON SCHOOL OF ECONOMICS MONOGRAPHS ON SOCIAL ANTHROPOLOGY

Managing Editor: Charles Stafford

The Monographs on Social Anthropology were established in 1940 and aim to publish results of modern anthropological research of primary interest to specialists.

The continuation of the series was made possible by a grant in aid from the Wenner-Gren Foundation for Anthropological Research, and more recently by a further grant from the Governors of the London School of Economics and Political Science. Income from sales is returned to a revolving fund to assist further publications.

The Monographs are under the direction of an Editorial Board associated with the Department of Anthropology of the London School of Economics and Political Science.

# SOCIAL AND ECONOMIC ORGANIZATION OF THE ROWANDUZ KURDS

E. R. LEACH

LONDON SCHOOL OF ECONOMICS MONOGRAPHS ON SOCIAL ANTHROPOLOGY

Volume 3

 **BERG**

Oxford • New York



03B-2008-193

Reprinted in 2006 by

**Berg**

Editorial Offices:

1st Floor, Angel Court, 81 St Clements Street, Oxford OX4 1AW, UK  
175 Fifth Avenue, New York, NY 10010, USA

Previously published in 1940 by

The London School of Economics and Political Science  
London, UK

All rights reserved.

No part of this publication may be reproduced in any form  
or by any means without the written permission of Berg.

Berg is an imprint of Oxford International Publishers Ltd.

ISBN 1 84520 019 5 (Cloth)

[www.bergpublishers.com](http://www.bergpublishers.com)

CONTENTS.

CHAPTER 1.	DEFINITION OF THE PROBLEM.	Page 1
	Introduction - Note on Kurdish names - The Field of Investigation - Method of Analysis - The External Administration.	
CHAPTER 2.	SOCIAL ORGANISATION.	Page 13
	Political Structure - Definition of Units - Inheritance of Land Tenure - The Clan Agha - The Tribal Agha - Kinship Structure - Marriage of Commoners - Marriage of Aghas - Comparison with observations made by Hay - Points of Analysis calling for further study - Areas other than the Balik - The Nomads.	
CHAPTER 3.	ECONOMIC ORGANISATION.	Page 28
	The Guest House - The Expenditure of the Agha - Economic Balance of the Village Community - Effects of an increase in Tobacco Cultivation - Economic Relations within the Village - Crafts - Traders - Tobacco Marketing - Marriage - Death - The Mulla.	
CHAPTER 4.	SOCIAL AND ECONOMIC ASPECTS OF KURDISH TECHNIQUES.	Page 47
	The Relevance of Technology in a Social Study - Land Scarcity, House Construction and Kinship - Ploughing - Threshing - Land Utilisation - Rice - The Mill - Weaving.	
CHAPTER 5.	FACTORS OF MINOR ECONOMIC SIGNIFICANCE.	Page 55
	1) WARFARE 2) RELIGION	
	Warfare - The Feud - Religious Organisation - The Mulla - The Mosque.	
CHAPTER 6.	CONCLUSION.	Page 61
	Limitations of Foregoing Material - Positive Contribution.	
APPENDIX.	Table of Kinship Terms.	Page 63
TECHNICAL DIAGRAMS.	A. Kurdish Loom.	" 65
	B. Kurdish Mill.	" 69
MAPS.	1. Erbil liwa	" 71
	2. Rowanduz district.	" 72
	3. Walash Village.	" 73
PHOTOGRAPHS.		" 74

CHAPTER 1

Introductory

The following account is based upon a five weeks field survey carried out during the summer of 1938. It was intended to follow this up with an intensive study of one locality over a period of twelve months. Political developments in Europe made this project impracticable at the time and the scheme has now been abandoned.

For the facilities afforded me in Iraq I am particularly indebted to Mr.C.J.Edmonds, Adviser to the Iraq Government, Captain Vyvyan Holt, Oriental Secretary at the British Embassy Baghdad, and His Excellency Ahmad Beg i Taufiq Beg, Mutasarrif of Erbil, in whose province this research was carried out.

The justification for publishing the somewhat superficial data contained in this monograph lies in the absence of any strictly comparable material elsewhere. The general form of Kurdish social organisation as here described is probably fairly typical of that of a large number of Mohammedan peoples scattered throughout the mountainous areas of western Asia. Concerning such peoples there is at present available very little ethnographic material of any kind and the postulate that the Kurdish form of society is typical is put forward as an hypothesis open to correction in the light of further study.

Of more immediate relevance is the close correlation that undoubtedly exists between Kurdish social forms and those of Arabia in general. This fact is of interest since linguistically the Kurds are of "aryan" rather than "semitic" stock. Concerning the "manners and customs" of various Bedouin and Semitic groups there is of course an enormous mass of literature available, some of it of the highest scientific quality, but the emphasis in every case has been to make an historical record of ethnographic fact rather than to study any particular group as a society in functioning existence at the present time. The work of\*Jaussen, Musil, Lane, Drower and Murray to name but a few, though admirably detailed, is by modern standards somewhat lifeless, since it describes the pattern of various cultural norms without, as a rule, showing their social significance or demonstrating the fundamental interrelationship between them. The earlier studies of Robertson-Smith, Frazer and Westermarck were entirely synthetic in character and gave no true picture of the functioning of any single

\* A. Jaussen - Les Coutumes des Arabes au Pays de Moab  
A. Musil - Manners and Customs of the Rwala Bedouins  
E.W.Lane - Manners and Customs of the Modern Egyptians  
E.S.Drower - The Mandaeans of Iraq and Iran  
G.W.Murray - Sons of Ishmael

society. Nevertheless these works continue to be of fundamental importance as contributions to anthropological theory. There have been important studies of particular aspects of semitic culture, notably that of Mrs. Seligman on Kinship and Granqvist on Marriage, the latter being at the present time unique in its wealth of documentary detail concerning the actual position of women in a Mohammedan society, but we still lack a coordinated study for any single area. Owing to the lack of adequate empirical data the present monograph does not effectively fill that gap, but it does provide for the first time an indication of the practical organisation of a settled group whose kinship affiliations are of the typical semitic pattern. The details of my account will it is hoped be filled in and elaborated by further research.

The existing documentary material concerning Kurdistan and the Kurds is somewhat meagre in quality. Most of it consists of highly romanticised travel stories of which the title of Millingen's *Wild Life among the Koords* (1870) gives a fair indication of the contents. The romantic tradition is incidentally still maintained, as evidence G.J.Mueller's *Einbruch in verschlossene Kurdistan* published only in 1937

For the Southern Kurdish area in general little serious ethnographic material is available, though Hellmut Christoff's *Kurden und Armenier* dealing with the Turkish area to the north has some relevance. V.F.Minorsky's *Kurds: Notes and Observations* published in Russian in 1915 refers, I believe, in part to the area under discussion but this has not been accessible to me.

Concerning the Rowanduz area itself there are only two books generally accessible. A.M.Hamilton's *Road through Kurdistan* which is a light hearted though highly interesting account of the construction of the strategic motor road up to Rowanduz and on to the frontier, and W.R.Hay's *Two Years in Kurdistan*. The latter deals precisely with the same area and the same individuals as are the subject of this monograph; I shall refer to it frequently both in criticism and as providing supporting evidence. Further local colour may be obtained from W.A.Wigram's *Cradle of Mankind*, which deals with a neighbouring area slightly to the North West; the author's religious prejudices in favour of the Assyrian (Christian) community however give a marked bias to many of his judgements.

Of my own study I repeat that further research will doubtless correct my analysis on many points of detail. Nevertheless I believe the general correlation of the elements of social organisation to be

\* B.Z.Seligman - *Studies in Semitic Kinship* (Bulletin of the School of Oriental Studies Vol.iii)  
H.N.Granqvist - *Marriage Conditions in a Palestine Village*

valid, and I would draw the readers attention to the seemingly very close interdependence of kinship, political and economic factors in the groups studied.

#### Preliminary note on Kurdish names

The ordinary Kurd has a single name given to him at birth of which the following are typical - Jelal, Ali, Mustafa, Hamid (Mohammad), Amin, Kharim. If it is necessary to be more specific he will give the name of his village also; thus we find that sophisticated detribalised Kurds often use the name of their village as a surname - my interpreter called himself Kharim Bakhani - Bakhani being his village of origin. Among the tribes such usage is unnecessary.

The title Agha will be discussed in detail later - it is usually translated "chief" and is carried by the landlords of villages and their immediate male relatives. As a title it follows the name:- thus Ali Agha, Hamid Amin Agha. To be more specific the name of the village is added:- thus Hamid Amin Agha i Naupurdan.

Analogous to this is the title Beg. Strictly speaking it is a turkish title but is used by some Kurds. Thus the Sorani people of Dergala call themselves Begzawada, by virtue of the fact that their leaders claim descent from the former princes of Rowanduz, who established an independent principality in the 17th/18th Century.\* The use of Beg among the Sorani seems to be identical to Agha elsewhere, so to avoid confusion I refer to the chief of Dergala, Mir Hamid Amin, as Agha and not Miran or Beg as he is usually called.

Mir (prince) is similarly a turkish title which is carried by certain notables. The Agha of Rust for instance is Mir Sadik Agha and the title appears several times in the ancestry of the chiefs of Walsh.

The title Sheikh does not, as in Arabia, imply tribal leadership. Normally it is reserved for religious leaders:- e.g. Sheikh Alauddin of Khalan, a leader of the Nakhshwandi sect of mystics. The name is however sometimes carried as an ordinary name. Thus Sheikh Mohammad Agha of Walsh is not himself a religious leader. He was given the personal name Sheikh Mohammad at birth after a relative who had been a real sheikh.

The Mulla is the village priest, his precise functions are discussed later. As a title it comes before the name:- thus Mulla Mahmoud.

Hajji is the Mohammedan title for those who have visited Mecca. As few Kurds achieve this, the bearer of such a title likes to be

\* See C.J.Edmonds - *A Bibliography of Southern Kurdish* (Journal of the Royal Central Asian Society, Vol.XXIV, 487).

addressed by it. Ali Agha of Rayat's full title is Hajji Ali Agha and he is sometimes addressed simply as Hajji. The nephew of Hamid Amin of Naupurdan had also made the pilgrimage and I never heard him called anything but Hajji.

The title Sayyid implies a descendant of the Prophet and carries with it the right to wear a green turban. The descent is probably in most cases mythical; anyway the Sayyids whom I met had every appearance of being pure bred Kurds. In the Balik area the only persons claiming this honour are the two Sheikhs of Khalan and Zinu - Alauddin and his uncle Obaidullah.

The turkish term Effendi is frequently applied to town notables who have no tribal linkage and thus cannot be called Aghas:- thus Mustapha Effendi, the leading notable of Rowanduz. Similarly it is a title applied to scholars - my interpreter was known everywhere as Kharim Effendi.

Hakim (arabic 'doctor') is applied only to foreigners. I acquired this title myself after resolutely refusing to be either a 'Lord' or a 'Major'.

#### The field of investigation

The field of investigation is shown on the two maps at the end of this volume. It has been found impossible in a single colour line drawing to show the contour features of the country at all adequately and altitudes are merely indicated in figures. The area is covered by sections I 38 and J 38 of the International Map of the World (Scale 1: 1,000,000) while the Rowanduz area appears on section 1. D on the 4 miles to 1 inch War Office map of Iraq, Persia and Turkey in Asia.

Map 1 which shows the whole of the Erbil liwa of Iraqi-Kurdistan is divided into three areas A, B and C having both geographic and ethnographic significance.

A. Rowanduz. This area, the main field of study, is shown in enlarged scale on Map 2. Prior to the construction of the motor road some ten years ago, this area was extremely inaccessible. Practically the only way of reaching the region was by way of a bandit infested mule track that led along the edge of the precipitous \*Rowanduz Gorge. The area is extremely mountainous. Rowanduz itself is some 3,000 feet above sea level and the peaks on the Persian border reach above 12,000 feet. Cool and well watered it presents a tremendous contrast to the arid plains of Mesopotamia. Comparitively little land is suitable for cultivation, and the steep inclines preclude the adoption

\* For photographs see Hay pp. 200, 222.

of modern methods of agriculture. The villages as will be seen from Map 2 are situated mostly in the valleys. East of Dergala village practically the whole area is snow bound throughout the winter. Before the war, though the area was nominally under Turkish domination, the local Kurdish leaders maintained practical independence. After the war the area came within the area of the Iraq mandate. The policy adopted by the British administration and the immediate political consequences are described by Hay. Crudely summarised it may be said that after some initial mistakes in which the government unfortunately "backed the wrong man" the administration eventually achieved a relative tranquility by paying all the important leaders a substantial salary provided they behaved themselves. The economic consequences of this will be referred to later. Following the abandonment of the mandate, or perhaps earlier, it was decided by the Baghdad authorities to adopt a more positive policy of "pacification". \*A strategic road was built through the mountains from Erbil to Rowanduz and continued on to the Persian border; a large military barracks was established at Rowanduz with subsidiary police posts at Rayat and Gelala. The economic and political consequences of the building of this road have been very great and will be discussed in greater detail later.

To sum up then, the distinguishing characteristics of area A are the poverty of the soil resources; the severity of the winter; the extreme difficulty, until very recently, of any intercommunication between the various valleys; and the fact that such "tribal dis-integration" as is now found is all of fairly recent origin dating for the most part from the construction of the road and the establishment of permanent police authority in the Rayat valley.

B. Foothill Area. This area corresponding approximately to the administrative district of Shaqlawa is separated from area A by an almost impassable range of mountains. On the South side on the other hand it merges quite gradually into the plains area C. Geographical considerations therefore are mainly responsible for the fact that the inhabitants of area B, though presumably of identical cultural origins to those of area A, have for many years been in much closer contact with the Arab world and western "sophisticated" influences generally. At the present time the tribes of this area no longer function as political entities, and the whole region is in a very real sense "directly administered" by the police. Hay's account (1920) makes it appear that conditions were very similar even in his time though the process of disintegration has doubtless been intensified in the interval. The potential economic resources of the district are probably much greater than for area A both on account of the milder climate and the greater area of cultivable land.

\* An account of the construction of this road is given by A.M.Hamilton - Road through Kurdistan.

The migrations and shiftings of the Assyrian (Christian) population consequent upon the various massacres and persecutions that have taken place since the War have had important repercussions on the economics of the area. The Assyrian groups were formerly widely distributed among the Kurdish villages, mostly in a region North West from area A. Despite special pleading by Wigram and others it would appear that, apart from the religious differentiation, there was formerly little ethnic or cultural difference between Assyrian and Kurd. Under present conditions the differentiation is much more marked. Persecution and the patronage of over-sympathetic European Christians has had the double effect that those Assyrians who are now left in the region are on the one hand congregated into tightly isolated colonies, and on the other are rapidly adopting a high degree of western sophistication with its accompanying technical advantages. One such Assyrian colony exists at Batas, and appears to be achieving considerable prosperity through the scientific development of tobacco cultivation. This success is likely to have consequences for neighbouring Kurdish groups.

We distinguish area B therefore by the mildness of its climate; its comparative fertility; and the looseness of the tribal organisation as now existing.

C. Plains area. Geographically this area differs completely from the other two. Largely flat, completely treeless, with a minimal rainfall, and scorched cinder dry for four or five months of every year, it would seem to be no place for the hillsman. But the soil is one of the richest in the world. It forms part of the great "fertile crescent" so beloved of archaeological historians, and has yielded a vast annual crop of wheat and barley for literally thousands of years. Historically the area formed part of the great Assyrian and Hittite empires and the number of archaeological remains is sufficient evidence of its economic and political importance in ancient times. Today the population consists of two distinct cultural groups; nomadic and semi-settled Arabs intrusive from the South and permanently settled Kurds with distinct Turkish and Armenian groups in the towns. According to Hay (p. 77) the penetration of the Kurds southwards into the Erbil plain is a comparatively recent historical event. He holds that the area was formerly occupied by nomadic Arab groups who have been ousted by the recent expansion of the Dizai tribe. The evidence for this view seems to me doubtful. In any case, whatever the historical facts, the techniques and economic arrangements of the plains Kurds now differ so markedly from the hill groups that in most respects they must be treated as a separate culture group. Politically also they differ from the hill Kurds in that the present village chiefs (Aghas) are mostly of quite different lineage to their followers, so that the organisation tends to be feudal rather than tribal. I had supposed at first that this must be a very recent development but similar conditions are described by Hay writing in 1920.

The Nomads. In addition to the permanent settled inhabitants of the three areas here discussed there are certain nomadic groups who move seasonally from one area to another and even out of the district altogether. These nomads are again in many respects a distinct cultural group; their economy is based exclusively on pastoralism as opposed to the pastoral-agriculturalism of the settled peoples. The largest of the nomad tribes are the Herki. They are normally resident in Persia near the southernmost end of Lake Urmia. These high altitudes cannot provide sufficient fodder for their herds throughout the year and during the late autumn the bulk of the tribe migrates down the Rowanduz river and spreads out through the foothills (Area B) and the northern fringe of the plains. They return to Persia with the melting of the snows in the late spring. I have no first hand evidence concerning these people and the second hand evidence appears to be both fabulous and contradictory. There is reason to think that their tribal organisation at the present time functions more perfectly than that of the settled groups, presumably owing to less government interference. They possess definite grazing rights in certain areas, even in districts nominally under the control of settled groups\* though in other areas they pay some sort of rental for the right to herd their flocks. Their migration is linked with important trade activities. They bring salt with them from Persia to Iraq, and take back wheat and barley. Wool is disposed of on the Erbil market as well as large numbers of their livestock. The duty-free import of salt is of course strictly illegal but is winked at by the authorities. It was reported in the summer of 1938 that the Persian authorities intended to compel the Herki to adopt a settled habitat. It is thus unlikely that it will ever be possible to determine the precise position of this group in the political and economic organisation of the Kurdish area as a whole.

In my field work I stayed nearly all the time in villages occupied by members of the Soran and Balik tribes (see Map 2).

\*The Iraq government authorities are able to carry on all negotiations with the Herki through the agency of a single paramount Agha, this despite the fact that the tribe itself scatters into small family groups throughout a very wide area; this seems to imply a high degree of tribal integration. During the summer of 1938 a law case was proceeding between the Agha paramount of the Herki and Jemil Agha of Bahrika (Gerdi tribe) as to whether the former need pay any rent to the latter for the grazing rights of what appeared to be Gerdi land. Jemil Agha complained to me bitterly that the Herki seemed likely to win their case owing to their greater wealth and resources for corruption. The case however establishes the point that they might claim traditional grazing rights in land seemingly within the sphere of influence of permanently settled groups.

Accordingly the description which follows applies primarily to Area A of the foregoing description. Prior to the opening of the road it might indeed have been possible to treat this district as a single culture area, virtually self contained. Under present conditions however economic factors and the external political authority link the three regions, A, B and C, closely together. I will attempt to make clear as I proceed the degree to which generalisations derived primarily from a study of the Balik and Dergala tribes can be regarded as generally applicable to the whole region. I will conclude this section with a rather more detailed description of the groups inhabiting Area A. Map 2.

The Soran group whose full tribal name is Sorani Begzawada (i.e. "descendants of the Begs of Soran") are few in number. The group is a single unit (taifa), the paramount of which is the Agha of Dergala - Mir Hamid Amin Beg.

The Balik tribe is a very much larger group and is subdivided into three clans, usually named Mullasherifi, Shevdini and Sukri, of which Mullasherifi is much the largest. The Shevdini group centred around Rayat has a considerable degree of cohesion and accepts the Agha of Rayat - Ali Agha - as paramount. The Mullasherifi on the other hand though nominally owing allegiance to the Agha of Walash - Sheikh Mohammad Agha - appear in practice to be split into three groups centred on Walash, Rust and Gelala. The Sukri are a small group about which I know nothing. Sheikh Mohammad Agha by virtue of his position as head of the largest clan is considered by the government to be Agha paramount of all the Balik; at the present time however his authority is nominal outside the immediate sphere of influence of his own village of Walash.

The two villages of Khalan and Zhimu i Sheikh require special mention. (See Hay pp. 255 and 257 where Khalan is called Dar ul Aman). The heads of these two villages, \*Sheikh Alauddin and Sheikh Obaidullah, are leaders of the mystic sect known as Nakhschwandi, which has its basis in Bokhara. The villages are really hospices belonging to this order. Apart from the adherents of the religious community the population is very mixed, traders predominating. The marked prosperity of the community is not hard to understand. At least two large armed convoys of smugglers passed over the border even during the course of my three day visit. They even offered to take me with them, but discretion unfortunately prevented my acceptance.

\* These two individuals described as 'cousins' by Hay are really nephew and uncle respectively although nearly the same age. It is the nephew, Alauddin, who has the greater reputation and influence.

Apart from these two non-tribal villages, all the groups in the Balik and Dergala areas are at least 95% pure Kurdish. The intrusive element is provided by a few Jews and Assyrian Christians who as a rule carry on some special trade such as weaving or carpentry and are thus tolerated as useful members of the community.

#### Method of Analysis.

As is clear from what has already been said, the tribal organisation of the various groups throughout the area under review have all to a greater or less degree been effected by contact with, and interference by the external administrative authority. If we go so far as to assume that at one time there was a form of social organisation which could be regarded as the typical norm for all the hill tribes of this region, it is certain that such a norm can nowhere now be found functioning in its complete state. Kurdish society as it exists today is a society undergoing extremely rapid and at times violent social change. As we shall see there are powerful and perhaps irresistible forces at work tending not so much to the modification as to the total destruction and disintegration of existing forms of tribal organisation. In such circumstances, in order to make the description intelligible at all, some degree of idealisation seems essential. In the main therefore I shall seek to describe Kurdish society as if it were a functioning whole and then show up existing circumstances as variations from this idealised norm. I am aware that such a method makes the resulting description to some extent subjective and that on many points I have not the empirical data to check the validity of my hypothetical norm. In the circumstances however it appears to be the most reasonable procedure to adopt.

#### The External Administration

The precise form of the external administration has no very direct bearing on the Kurdish social system as described in this monograph. But at various points in the argument especially in the section dealing with economic problems reference will have to be made to elements in the administrative organisation, and it seems desirable therefore to give first a brief description of the functions and relationships of the various members of this external organisation.

The administrative system of Iraq has been developed out of that of the old Ottoman Empire. The terminology remains in many respects unaltered. The whole of the Kurdish area here under

discussion lies within the Province (liwa) of Erbil. \*The civil head of the liwa is Mutasarrif who is directly responsible for the police administration and the magistracy and indirectly for such social services as Health, Education, Agricultural Reform etc. The tax organisation is closely associated with the police and also comes under the administration of the Mutasarrif. Outside his control however are the military and the judiciary.

Within the field of our discussion the social services of the government are very limited, though the education system is worthy of note. There are primary and secondary schools at Erbil and a primary school at Rowanduz. There was for a while a secondary school also at Rowanduz but this was closed following a nationalist strike by the students who demanded to be taught in the Kurdish language instead of Arabic. For obvious economic reasons these schools effect only a very small stratum of society - the sons of important Aghas and town merchants. Some of the larger villages have in addition a paid government teacher. Though the intention is good, the practice is less so. The wages offered and the facilities for advancement are so poor that only the very poorest type of indolent scholar offers himself for such posts. In the Balik area anyway the experience of government education has so far proved unfortunate. The current opinion seemed to be that all government education officers are moral perverts. Two examples serve to show the basis for such an attitude. The only schoolmaster among the Balik at the time of my visit was attached to the village of Rayat. Formerly he had been attached to the village of Rust where he had married one of the Agha's daughters; this lady he had now divorced or rather deserted and the Agha of Rust was suing him in the courts for maintenance. In Rayat he had seduced the daughter of the Mulla and to avoid scandal had now married her, but this in itself was a scandalous proceeding since the Mulla and the schoolmaster are regarded as enemies by nature - (since from the traditional viewpoint education is the Mulla's chief function). In another case which is described more fully later the Agricultural Adviser of Walash was murdered,

\* At the time of my visit the post of Mutasarrif of Erbil was held by Ahmad Beg i Taufiq Beg, a Kurd from the relatively sophisticated district of Sulaimani, a man of great intelligence and personal integrity. I am directly indebted to him for the facilities and assistance which enabled me to carry out this piece of field work, the more especially since his own political position at the time was somewhat delicate. Being related by marriage to the chiefs of the Pizdah tribes, at that time in revolt, he was regarded with a certain amount of suspicion by some of the Arab elements in the Baghdad government. This fact, coupled with a mild reputation for being pro-British - by no means a desirable sentiment in modern Iraq, - made my request for travel facilities a decided inconvenience. In the circumstances his help was deeply appreciated.

probably at the instigation of the Agha, because he was held to have corrupted the morals of the youth.

Health services need not concern us. In the area studied there is no resident doctor outside the city of Erbil.

The Government have made various experiments in agricultural reform chiefly with a view to improving the breed of livestock and the quality of valuable crops such as tobacco. The Government's interest in the improvement of the tobacco crop is especially relevant to the area here described. Details will be discussed later but it may be pointed out that Government assistance of this kind is not a philanthropic enterprise. The heavy excise duty levied on all saleable tobacco much more than repays any expenses incurred.

The independent judiciary functions through its court in Erbil. In practice however it is in the nature of appeal court, since in the first instance cases come before the Mudir (sub-district magistrate) and then before the Qa'im Maqam (district magistrate) before being referred to the court. I am not clear as to the rules governing "appeal" of this sort, nor as to the limits of sentence that can be imposed by the magistrates' courts. So far as I know, only serious cases such as homicide automatically go before the court at Erbil.

During time of peace the military are stationed only at Erbil and Rowanduz. There appears to be a general attitude of suspicion and conflict as between the civil and the military authorities. In this area the civil service is staffed mainly by Kurds and Turks and is thus in general inclination Kurdo-phil. The army on the other hand is staffed mainly by Iraqi-Arabs whose hatred and fear of the "barbarous Kurd" can be taken for granted.

The liwa is divided into several districts (khaza) each presided over by a district magistrate (Qa'im Maqam). Area A, Map 1 with which this account is mainly concerned lies wholly within the khaza of Rowanduz. The Qa'im Maqam is responsible for his district in much the same way as the Mutasarrif is responsible for his liwa.

The khaza in turn is subdivided into several sub-districts (nahiya) over which presides a Mudir. The Balik tribe all reside within the nahiya Balik - the administrative district in this case coinciding with the tribal one. Dergala on the other hand is administered from Rowanduz.

The Mudir has in his direct control a number of policemen who provide the direct liaison between the external authority and the tribe. It is the venality of these junior officials which is the worst feature of the system, and which is the real source of



Government unpopularity among the tribes. Hay describes the gendarmerie of his time as "hardened ruffians without training and without principles; they used their authority to commit innumerable extortions". It does not appear that the position is much changed today.

\*Below the Mudir there should be in each village a Mukhtar, his functions being basically those of registrar and tax collector. Among the hill Kurds the Mukhtar is invariably the Agha of the village concerned and the term is little used.

This summarises briefly the normal functions of the various elements of Government within the area under discussion. A more dynamic view of the interaction between Government and tribe will emerge in the course of what follows.

\* Iraq has had conscription since Turkish times and nominally all Kurds are liable for military service. It is part of the duties of the Mukhtar to record births and report to the Mudir the names of those liable for service. Until very recently however no real records have been kept, so to avoid military service it was merely necessary to produce suitable presents for the right people at the right moment. Contrarywise military service provides the Agha with a convenient means of getting rid of undesirable characters. That at least summarises the position as outlined to me by my interpreter. But I obtained no figures as to the actual numbers conscripted.

## CHAPTER 2

## Political Structure

## Definition of Units

The Kurdish term which in the foregoing pages I have crudely described as tribe is **Ashiret**. \*The name of the Ashiret describes at once the people and the land they occupy. Thus it is sensible to speak of 'Balik country' as a district on the map while the individual tribesman will describe himself as 'a Balik'.

An ashiret may consist of one or more patrilineal clans called **taifa**, the fundamental difference between the two being that whereas **ashiret** is essentially descriptive of a political group, **taifa** is descriptive of a kinship group. Thus in Balik there are three **taifa** usually known as Mullasherifi, Shevdini (or Shuizuri) and Sukri; in "Soran" on the other hand there is just the one **taifa** of Sorani Begzawada. The dual title of the Shevdini depends upon the context of reference. Shevdin is the name of the ancestor from whom all members of the Shevdini **taifa** nominally trace their descent, he was the 'founder' of the **taifa**; Shuizur on the other hand is the name of the district he came from. The Mullasherifi similarly all claim descent from a certain Mulla Sherif said to have been a member of the Galali tribe of Sulaimani district. In general the tendency seems to be to take the group name from the ancestor rather than the place. Ali Agha of Rayat in giving me his genealogy claimed that Shevdin had lived eight generations ago and that in those days his family had belonged to the Surchi tribe west of the Great Zab, and that they migrated to the east in search of better land.† It was interesting to note that Ali Agha was reluctant to admit that his **taifa** formed part of the Balik **ashiret**. With the loosening of the political ties that linked the three clans of the tribe he hoped soon to establish that the Shevdini were an **ashiret** in their own right.

\* The same is not strictly true of the Sorani centred on Dergala. During the latter part of the 18th Century the name Soran was applied to a territory approximately corresponding to areas A and B of Map 1 over which the princes of Rowanduz had established a titular suzerainty. Hamid Amin Beg the Agha of Dergala claims direct descent from these former princes and he and his immediate kin call themselves the Sorani Begzawada - "the descendants of the Begs of Soran". The term Soran has no direct territorial significance today, but on Map 2 the area so marked is that controlled by Hamid Amin Beg of Dergala.

† For comparison one may note that Sheikh Mohammad Agha of Walash, Agha paramount of the Balik and of the Mullasherifi **taifa** was also able to trace back his descent for eight generations but did not reach the name of Mulla Sherif in the process.

The taifa in turn is frequently divided into subsections called tira (branch), though in many contexts the two terms appear to be interchangeable. The Mullasherifi taifa referred to before are for instance subdivided into three tira each group claiming descent from one of the sons of Mulla Sherif. These sons (I did not obtain their names) are supposed to have settled respectively in Merga, Gelala and Rust, and these villages remain the centres of their respective tira to the present day. Thus the Agha of Rust is overlord of a number of villages by virtue of the fact that he is head of his tira. The Shevdini taifa is similarly subdivided into three tira, the names being given to me as Hadr Agha, Kaka Hasani and Hamadi Babakhr Agha - these being presumably the names of the ancestral founders of the lineage. On the other hand some persons at least did not seem to be clearly aware of this subdivision and on being asked the name of their tira would reply "Shevdin". Moreover I was assured by one informant that there is no difference between taifa and tira, but that the one is bigger than the other. This is I think an accurate description. Tira is a type of kinship group fairly frequently encountered by anthropologists. Usually termed lineage, but more aptly described by Firth as ramage, it differs only from the clan group in scale and political cohesion. With the loosening of political ties the distinction between the two types of grouping tends to disappear. The Agha of Rust for instance claimed to me that he was head of his own taifa and as such of equal rank to Sheikh Mohammad Agha of Walash. Sheikh Mohammad of course did not admit this claim but maintained that Mir Sadik, Agha of Rust was his subject.

From this description and the examples quoted it is clear that the terms ashiret, taifa and tira fall into the normal anthropological classifications of tribe, clan and lineage (ramage), with the single abnormality that the clans are in this case endogamous, or largely so.

#### Inheritance of Land Tenure

The settlements for the most part consist of small villages (gund) scattered along the valleys. The term gund really includes both the houses and the cultivation surrounding them and may at times prove confusing. The gund of Naupurdan for instance contains two houses only, that of Dergala has over a hundred. Every gund is the 'property' of a landlord (Agha). If the Agha owns only one gund as in the case of Hamid Amin Agha of Naupurdan he will live in it himself; if

\*See C. Daryll Forde - Fission and Accretion in the Patrilineal Clans of a semi-Bantu community in Southern Nigeria J.R.A.I. Vol. 68; 314,

R. Firth - We, the Tikopia; 370, 371.

Note however that owing to the rule of ortho-cousin marriage, Kurdish taifa and tira tend to be endogamous rather than exogamous.

he owns several as in the case of Sheikh Mohammad Agha of Walash or Hamid Amin Beg of Dergala, he will live in one himself and appoint headmen (kokha) as his agents in the other villages. In theory the Agha is the absolute owner of all the land in the gund,\*the villagers occupy and cultivate the land in the capacity of tenants and in return pay him, in theory at any rate, the seemingly staggering rental of 50% of the yield of the land. Again in theory the Agha has absolute discretion to evict any tenant he disapproves of, and similarly the tenant is free to leave whenever he chooses; the only property that the tenant possesses in his own right are ordinary household belongings, the roof beams of his house, and his personal livestock. Practise probably differs markedly from theory. So far as I could judge in the Balik country at any rate at least 90% of the population of any gund were not only Balik tribesmen but also members of the Agha's own taifa, many of them being his near kinsmen. It would seem then that the Agha's right of eviction remains theoretical except under extreme provocation. In practise the right of tenancy is hereditary. This latter point was confirmed to me by Sheikh Mohammad Agha of Walash; the way he put it was that when a tenant died he, the Agha, could do whatever he liked with the land, but that "as a rule" he gave it to the deceased's son or brother whichever was the most suitable. It may be noted that such a procedure would tend to prevent the land being split up into a vast number of small holdings by the process of inheritance, and would also provide an economic bond between the members of the smaller extended family groups.

The tribal custom here is not, as might at first sight appear, at variance with Mohammedan law. According to the Koranic rule a man's testamentary rights are limited and most of his "property" (mulk) is passed on in defined proportions to certain specific relatives. Land however is for the most part excluded in the term mulk. The actual legal position as it applies to land tenure in Iraq is somewhat involved and the interested reader should refer direct to Sir E. Dowson's "An Inquiry into Land Tenure and Related Questions" (Iraq Government 1932). The following account summarises the position.

The legal situation regarding the inheritance of land tenure is defined by the Ottoman Land Code of 1858, and certain subsidiary enactments of the old Turkish Empire. This recognises five classes of

\*I have no data to show what rental is really paid. I was assured on several different occasions and in different contexts at Naupurdan, Walash and Dergala that the normal arrangement is for the Agha to receive half the gross yield of the land if the tenant provides his own cattle, implements, seed, etc., but two thirds of the gross yield if the Agha provides the seed, implements, etc. According to Hay (p. 68) the figure is only 10% of the yield. But as I shall show presently a 50% rental is probably not as excessive as it sounds.

land tenure *Mulk*, *Miri*, *Waqf*, *Matruka* and *Mewat*. These categories however do not apply accurately to present day Iraq conditions, the term *miri* in particular being in practice used in a different sense to that implied by the Land Code. The effective categories appear to be three in number

- 1) *Mulk* (property) - undiluted ownership; owners rights and inheritance being dictated by the Koranic sacred law.
- 2) *Tapu* - state land, the legal possession of which is granted out on the registered tenure laid down in Book 1 of the Land Code. Inheritance of this land is entailed to the direct descendants of the original holders, though actual ownership continues to be vested in the state.
- 3) *Miri* - state land, retained in full legal ownership and possession of the state which may be exploited directly or indirectly at its discretion subject to due recognition of established occupancy rights. In effect *miri* land simply represents the overwhelming residue of the country not held in *mulk* or *tapu* tenure.

So far as the area of this study is concerned very little if any agricultural land is held in *mulk* tenure and this category applies, I think, only to town property. Most of area C is held in *tapu* tenure and some portions of area B also. Area A is exclusively *miri* land so that in legal theory the tribes are here tenants of the state

Such subtle distinctions are not clearly understood by the Kurdish tridesmen, and as Dowson's study shows the position is in fact confused and provides many opportunities for corruption. In the *Balik* area there seemed to be a movement on foot to get the tribal land made *tapu* in the name of the clan leaders. Ali Agha of Rayat for instance was anxious to have the Shevdini territory "registered" in his name and seemed to think that it was merely a question of bribing the right people. Such a development would be strongly resisted by Sheikh Mohammad Agha of *Walash* since it would infringe his nominal overlordship over the whole *Balik* territory.

So far as the question of inheritance is concerned the position is legally clear. None of the Kurdish land is *mulk* and accordingly none of it is subject to the Koranic stipulations. The attitude of the Aghas however is not very clear. Sheikh Mohammad Agha for example was very insistent that all the land of the *Balik* was his personal property, which was somewhat inconsistent since he certainly did not mean to imply that the territory would be divided up among his relatives when he died. It is quite definite in fact that where land is concerned the various claims to "ownership" are not correlated with any principle of Koranic inheritance.

## The Clan Agha

The gund Aghas' relations to their tenants has now been defined; they in turn owe allegiance to the Agha of the *taifa*. This individual also may glibly claim to own all the land of all the gunds under his suzerainty, but his ownership is of a much more nominal variety than that of the gund Agha. The *taifa* Agha does not levy any specific charge upon his underlings but rather receives from them gifts in proportion to his usefulness. Thus Hamid Amin Agha of *Naupurdan*, even though he belonged to the same *tira* as Sheikh Mohammad Agha of *Walash* head of the *Mullasherifi* and nominal paramount of all the *Balik*, did not admit that the latter was in any general sense his superior; though Sheikh Mohammad for his part claimed that Hamid Amin was his vassal. This discrepancy I think is only partly due to the recent loosening of political ties. In general it would appear that prior to the coming of the external administration the function of the *taifa* Agha was roughly that of arbitrator and court of appeal rather than dominating overlord. He seems to have been called in to arbitrate in small scale feuds, settle disputes between neighbouring villages over grazing rights and water, settle divorce disputes and so forth. For these services he would be suitably recompensed by the parties to the dispute.

This system of justice was doubtless exceedingly corrupt by European standards, but probably worked tolerably well. It is not clear what sanctions could be employed to enforce judiciary decisions of this sort. Today the clansman is encouraged to short-circuit the traditional machinery of the Aghas' courts and appeal for justice direct to the police. To some extent the two systems continue to operate side by side but with the continual lessening of the Aghas' authority litigation tends more and more to be a matter for the external administration only. I tried to obtain some opinions as to the relative efficiency of the old system and the new. The results were interesting. It was admitted that the decisions of the Agha in the old days were somewhat arbitrary, being based on considerations of wealth and nepotism rather than moral right, but at least a decision was arrived at quickly. The modern procedure on the other hand though plainly well intentioned is considered in practice to be slow, complicated and costly, and since the wealthier litigant can nearly always manage to appeal to a higher court if the first decision goes against him, the "justice" is nearly as one sided as before. Moreover it was argued that the police were just as corrupt as the Aghas with the disadvantage that, whereas formerly the Aghas were to some extent limited in their decisions by kinship obligations, the police had no interest at all except to sell justice to the highest bidder. Though this is certainly an overstatement of the case, many of the Iraqi police do appear to be exceedingly corrupt. So much so in fact that the new *Qa'im Maqam* of *Rowanduz*, chief magistrate of the district, was generally acclaimed by all as the almost unique example of a sincere

and honest administrator. The venality of the junior police officers has probably an important effect upon the economic status, and hence the influence of the Aghas. The position was put to me thus by Hamid Amin Agha of Dergala. "In the old days" he said "all my followers gave me presents; nowadays few can afford to, they must keep in well with the police and then they have nothing left for me".

In earlier times the taifa Agha was probably in a position to organise small scale military activities; even today this would appear to be partly true. I was told for instance that in 1936 Ali Agha of Rayat, head of the Shevdini, had led his men across the border and sacked a Persian police post in reprisal for the latter having impounded some of his clansmen's cattle. Naturally such incidents are strongly disapproved of by the authorities.

#### The Tribal Agha

\*In the case of the Balik, as we have seen, the Agha of the largest taifa, Mullasherifi, is also Agha paramount of the whole tribe, and this is doubtless the normal rule. His function as tribal Agha does not ever seem to have amounted to very much except in time of war, in which case he automatically became leader of the whole group and doubtless received economic benefits accordingly. In time of peace he only receives small token payments, such as gifts of fruit and the like, from his more remote subordinates.

The evidence concerning the actual behaviour of the Balik during the disturbed times of 1914-1920 is contradictory. Sheikh Mohammad asserts that he led his people to a victorious massacre of the invading Russian army; Hamid Amin of Naupurdan on the other hand says that Sheikh Mohammad ran away and that it was he Hamid Amin who saved the remnants of the Balik from annihilation and finally routed the Russians. Whatever really happened, it seems clear that Sheikh Mohammad as head of the Mullasherifi ought to have led the Balik to war, whether he actually did so or not.

The first effect of contact with the external administration was certainly to increase the influence of the tribal Agha at the expense of his fellows. Thus Hay ingenuously remarks (p. 67) "The tribal chief has many obligations towards his tenants and tribesmen, the most important of which is that he will become their spokesman in all matters which concern the Government". The British

\*Hay (p. 68) states that it is the custom to present the paramount chief with a pregnant ewe from every considerable flock at the beginning of the year. Hay however makes no distinction between tribes and clans and the obligation may be towards the Agha of the taifa rather than the ashiret.

Administration moreover adopted the Turkish expedient of paying the tribal Aghas an annual salary provided they kept their tribe in order. This procedure undoubtedly gave the tribal Agha an altogether disproportionate economic influence, and has had various repercussions which will be discussed further in the next chapter.

The salary awarded to Sheikh Mohammad of Walash was stopped some years ago and, as might be expected, his influence as tribal leader declined rapidly. As is evidenced by the rival claims of the Aghas of Rayat and Rust noted above, the Balik has scarcely any functioning unity as a tribe at the present time, though Sheikh Mohammad with a wide sweep of his arm, still declares that all the land belongs to him and that the taifas of Shevdin and Sukr are only there on sufferance. At the present moment (1938) his prestige is probably on the upgrade since he has recently been appointed a "member of Parliament" and regularly attends the legislative assemblies in Baghdad. The appointment carries with it a small salary, but its real importance so far as the tribes are concerned is that it demonstrates that the holder is in favour with the Mutasarrif and with the Baghdad Authorities.

#### Kinship Structure

While I have here sketched out the superficial political structure of the community the real nature of the relationship between the various Aghas and their followers can only be understood in terms of kinship.

The essentially conditional nature of the Aghas' authority was only vaguely understood by the earlier British Administrators. Hay for instance remarks (p. 67) "The Aghas are very oppressive to their tenants, more especially where the Government is close at hand and can assert its authority. In the mountain districts the tribesmen are exceedingly poor, they have little to fear from the Government, and their chief finds it difficult to coerce them. A rival chief would probably soon appear if he did". This statement brings out the fact, already well known from examples in the African field, that Government support for "the Chief" frequently gives that individual a tyrannical authority quite foreign to the ordinary tribal system of government, but it does not explain the Aghas' normal relationship to his followers.

#### Marriage of Commoners

As we have seen already the taifa is essentially a patrilineal clan. It is moreover largely endogamous by virtue of the system of ortho-cousin marriage common to most Mohammedan societies. Reference to the tables of Kinship Terminology at the end of this book

will show that the various cousins are known by the following terms

Father's Brother's children - amoza  
 Father's Sister's children - purrza  
 Mother's Brother's children - khaloza  
 Mother's Sister's children - purrza

My knowledge of the Kurdish language was not sufficient to verify the exact use of these terms, and to some extent my informants were contradictory. It would appear however that some of these terms are "classificatory" at least so far as all members of Ego's own tira are concerned. Thus to quote an example Hamid Amin i Naupurdan considers himself amoza to Sheikh Mohammad i Walash. Hamid Amin is actually great-great-grandson of Mir Mahmal Agha and Sheikh Mohammad is great-grandson of the same man. Again I was told of the Dizai tribe, a group widely scattered in Area C that "they all call one another amoza" - (implying that they were all one tira)

According to my informants the order of preferred marriages is:-

- 1st Amoza
- 2nd Purrza (Father's sister's daughter)
- 3rd Khaloza
- 4th Purrza (Mother's sister's daughter)

This statement seems consistent with the customs recorded for other Mohammadan areas (See Seligman B.Z. op.cit 268) but I was unable to check the frequency of particular types of marriage. It should be noted that Father's Brother's Daughter (amoza) and Mother's Sister's Daughter (purrza) may frequently be the same individual, and similarly Mother's Brother's Daughter (Khaloza) may coincide with Father's sister's Daughter (purrza). Amoza and khaloza could however only coincide if both were used in a classificatory sense. I did not actually encounter any classificatory use of the term khaloza and this probably refers only to the immediate children of the mother's brother (khalo). It would appear that until very recently not only was marriage between amoza the preferred norm, it was also a definite right. Hay (p. 71) even records the gruesome murder of a girl who refused to abide by this ruling. Today though marriage restrictions are to some extent relaxed it is probable that the great majority of commoners still take their wives from within the patrilineal group. There is in fact very little choice in the matter. In the Balik country at any rate the proportion of 'strangers' - e.g. Jews, Assyrian Christians, traders, Kurds from other tribes and so forth, is very small; nearly everyone within the group belongs to one of the three patrilineal clans. These clans moreover are themselves more or less segregated each by itself. Within any single gund nearly everyone is of the same clan as the Agha.

In the ideal, the Kurdish family which maintains ortho-cousin marriage and does not require the wife to change her place of residence on marriage forms what may be termed a "fratrilocal" group. Brothers are close neighbours or even share the same house. They frequently work their landholdings jointly, perhaps even in cooperation with their cousins. The marriage of ortho-cousins clearly serves to simplify and perpetuate such cooperation. Moreover in such a case the bride-price, whatever its nominal amount - and the Kurds are keen to flatter their wives by asserting that they have paid a quite fabulous price for them, - is in practice nothing but a sort of book entry, a transfer of assets from the right hand to the left. Even where the marriage to father's brother's daughter does not take place, there is still a strong tendency for a man to marry a girl from his own village - i.e. a classificatory "ortho-cousin" - if for no other reason than that the Agha must approve of all marriages and he has an obvious interest in keeping the group as closely unified as possible. Besides, a man of the commoner class would normally have comparatively few opportunities of either meeting or bargaining for a girl from another village, still less for a girl of another clan or tribe. Startling romances and elopements do take place, but they are the exception and are usually followed by a long and bloody trail of vengeance. For the commoner the general rule of marriage within the taifa is fairly well maintained. In this connection the building of the road will probably have important consequences for the Balik in the near future, since the ordinary tribesman can now much more readily make contact with groups other than his own immediate kinsfolk.

#### Marriage of Aghas

The foregoing applies however only to the marriage arrangements of commoner families (kurmanj). Quite different are the conditions that govern the marriage of the son of an Agha. Mohammadan law permits a man to have four wives at a time, and to effect divorce simply by the pronouncement of the word talaq three times. In practice scarcely any of the commoners among the Balik can afford more than one wife, and polygyny is the almost exclusive prerogative of the Aghas. The marriage to father's brother's daughter serves to simplify and concentrate the inheritance of cattle, implements and other items of 'capital' equipment within the economic working unit of the group household and to avoid friction over the inheritance of tenancy rights. But the Agha is not swayed by considerations of inheritance since, in the limited sense already described, he 'owns' all the available land anyway and there is no question of splitting up the territory at death. His aim rather is to gain prestige and live at peace with his neighbours. We find therefore that the marriages of Aghas tend to take the form of political alliances, rather after the style of the royal marriages of mediaeval Europe. Sheikh Mohammad Agha of Walash for instance, who in the course of a long life has had 9 wives and 15 surviving children, appears to be related either by marriage or

through the marriage of his sons to nearly every important leader, tribal, religious, or townsman, within fifty miles radius. More humble Aghas are content with one or two alliances with neighbouring notables, while the rest of their offspring are married off to members of their own community, thus further strengthening the bonds of kinship between the Agha and his followers. It is interesting to examine the effect of this in greater detail.

Sheikh Mohammad of Walash was one of 9 surviving brothers; he himself has had nine wives and has six surviving sons, and several daughters

Mir Hamid Amin of Dergala has had 6 wives and 24 children of which there survive 9 sons and 5 daughters.

If we consider the male side of the tree only, it would appear that the average reproduction rate of a 'princely' Agha is of the order of 8 surviving sons. If we assume that the total population of the villages remains very roughly stationary we must reach the conclusion that the effective birthrate is very heavily loaded in favour of the Aghas. The effect of this would seem to be that in many of the smaller villages the Agha is not only of the same clan as nearly everyone but actually quite closely related to about half the population. I was unable to make any accurate census of a village but my observations at \*Walash were I think reasonably accurate, and tend to confirm this calculation.

There appeared to be twelve separate households, of which four are accounted for by the Agha's fortress and the establishments of his third and fourth married sons and of a brother. (The two eldest sons have been established as Aghas in their own right over neighbouring villages). The population I estimated at ninety, in the proportion twenty five men, thirty women, thirty five children. The Aghas household appeared to consist of about twenty persons including his younger children and personal servants; while the households of his married sons and his brother contained about eight persons each. In this case therefore quite half the population of the gund was in immediate kinship or economic relationship with the Agha. The case may be exceptional, but serves to explain why a rental of 50% of the yield of the land does not in practice prove entirely extortionate.

#### Comparison of these observations and those of Hay

The foregoing account shows the interrelationship of the political and kinship organisation among the Balik Kurds. As a commentary upon sociological method it is interesting to note what

\*This village would appear to be fairly average so far as size is concerned, though centres such as Dergala and Merga are vastly larger. Walash however is in some respects the private fortress of Sheikh Mohammad and its kinship organisation may not be typical.

happens when the same empirical facts are considered without an adequate appreciation of the sociological significance of kinship. The following quotations illustrate the position of the Agha as understood by Hay.

The first is reasonable enough:-

(p. 65) A tribe is a community or federation of communities which exists for the protection of its members against external aggression and for the maintenance of the old racial customs and standards of life. Some tribes have no recognised chiefs some have many.

The second is more hypothetical:-

(p. 65/66) The position of the chief varies greatly in different tribes. In the remoter mountains, though granted the most ungrudging obedience, he is distinctly one of the tribesmen, the leading member of a family which has won its headship through military prowess. Lower down he often belongs to an entirely separate caste, and comes from a different stock to the tribesmen. The large tribes are divided into sections, and in different tribes we find many sections with the same names. This points to the fact that the sections represent the original owners of the soil, while the present chiefs belong to powerful families who have invaded their domains and siezed their lands. This is notably the case with the Dizai where nearly all the land belongs to one powerful family, against which a few old tribal Aghas and headmen still maintain an unequal struggle. Here the chief is a landlord, and the system that prevails is feudal rather than tribal.

The statement that in the foothill and plains area the Aghas are frequently of different stock to their villagers is valid and has already been commented upon in Chapter 1. The idea that the *taifas* "represent the original owners of the soil", while the paramount tribal Aghas are conquering overlords is mere fantasy; while as for the Dizai the facts seem to be that the tribe itself is "all one family" (*taifa*) while the land is mostly held by town dwelling landlords who have no kinship affiliations with the Dizai at all. While this lineage distinction between Agha and tenant is valid for the plains area, it does not apply to the tribal districts. The following for instance is quite absurd:-

(Hay, p. 42) In the bigger tribes the Aghas, whose families have for many generations been entirely disassociated from manual labour, are of a far finer type than the peasants.

Such generalisations may lead to some startling sociological conclusions:-

(p. 221) This village (Merga; Map 2) lies just below Sheikh Mohammad Agha's residence (Walash) in the Balik country, and its inhabitants, some fifty families in number, are nearly all his relations. Being of 'chiefly' descent they consider it beneath their dignity to cultivate the soil; they have therefore only two means of livelihood, sponging on Sheikh Mohammad Agha who pays them most of his salary to keep them quiet, and looting and taking toll from the caravans that pass along the Persian Road.

This paragraph I consider most illuminating. For it is precisely on the basis of such evidence that the British policy of 'military pacification' is carried out on all the outlying frontiers of Empire. The tribesmen just beyond the border are always, it seems, "desperate bandits and brigands" intent on plundering the innocent peasantry within the jurisdiction of the British raj. Hay of course does not intentionally deceive. He had only seen Merga from afar and was merely recording the position as outlined to him by Sheikh Mohammad. In giving this account however Sheikh Mohammad was fairly obviously black-mailing the British Administrator for more money, and was probably himself responsible for the particular piece of brigandage complained of. Merga today has one of the most extensive cultivations of the whole district, and is considered a prosperous village. There seems no reason to suppose that the position was radically different in 1920, even though the ravages of war had temporarily disorganised the agricultural arrangements of the whole area.

This is not special pleading on behalf of the villagers of Merga or of the Kurds in general, but it is time that their nefarious activities were seen in proper proportion. It must be admitted that prior to the establishment of an external Authority most Kurdish tribes freely resorted to brigandage on every possible occasion. It was a socially approved aspect of inter-tribal life and one upon which the Kurds themselves lay great emphasis in folk tale and tradition. But it is this very emphasis that has led to the fabulous distortions that appear in all accounts of Kurdish life either lay or official. To read the literature one must suppose that in former times the majority of Kurdish communities lived solely on the proceeds of plunder and ransom; and while the Government continues its present policy of cultural suppression such fallacies are obviously convenient. But the unbiased observer cannot avoid the conclusion that most of the more spectacular exploits of Kurdish brigandage are products of the Kurds' own imagination. Seen in their proper scale these warlike activities can never have been more than an exciting gloss upon the normal balanced cycle of agricultural economics.

### Points of Analysis calling for Further Study

The foregoing analysis has thrown emphasis on the fact that the Agha is of the same kinship group as the majority of his followers and very closely related to many of them. It was interesting to note that in conversation Mir Hamid Amin of Dergala differentiated between "Khezma khoimana" (my relatives) and "kurmanj" (peasantry), but I doubt whether there is any precise dividing line between the two classifications. I noted that he included in the former term at least some of his second cousins. The practical distinction seemed to be that his khezma were allowed to sit in his guest house by right while the kurmanj could only do so by special invitation. Linguistically there appeared to be a confusion between the terms kurmanj and muskeyn both of which were translated to me as arabic fellahin (peasant). In this area however there is considerable overlapping between the two Kurdish dialects of Kirmanji and Kurdi and the confusion is probably only due to my linguistic incompetence.

Another point that requires further examination is the precise inheritance of the title Agha. We have seen that from the point of view of political organisation each gund has at any time one, and only one, Agha, in the sense of landlord. The succession however does not necessarily follow the rule of primogeniture. As it happens both Sheikh Mohammad Agha of Walash and Ali Agha of Rayat have living with them in the same village brothers who are older than themselves. In the former case the elder brother leads a retired life and takes no part in village affairs; in the latter Abdullah Agha who lives in Ali Agha's house in Rayat throughout the winter moves off into the mountains in the summer with the sheep and goats and a few of the villagers and establishes his own hoba (settlement of black tents). But though Abdullah is the elder brother there is never any suggestion that anyone but Ali Agha is head of the group. On the other hand though the Agha of Rayat is quite definitely Ali Agha the title is much more widely distributed as a form of address. Thus in Rayat the old chief Ali, his brother, his two nephews Kharim and Ali and presumably his adult son also (who was away during my visit) are all given the title Agha in ordinary speech. And this seems to be the normal usage, thus Hamid Amin's brother in Naupurdan is known as Rasul Agha though he does not function as a landlord, and Sheikh Mohammad Agha's four eldest sons all carry the title. What is not clear is how the title is inherited as the lineage spreads, for instance will the sons of Kharim, who will in their time presumably be second cousins of the reigning Agha of Rayat also carry the title? Probably there is no definite rule.

In the remainder of this book where I refer to the Agha or the Aghas of a particular group I shall imply only those individuals who fulfil the sociological function of the Agha, and not any sons or near relatives who happen to bear the same title. The sociological function of the gund Agha can be quite clearly defined. He is the

landlord of the soil - by which title he receives rent, and he supports the village Guest House. As we shall see later these two functions are closely interrelated.

### Social Organisation Areas other than Balik

As explained earlier my information for groups other than the Balik must be treated with reserve. The following notes may however prove of value to further students of the area.

Area B. It would appear that the tribes of this area such as the Surchi and the Khushnao were originally organised on much the same lines as described above but that owing to their relatively long period of contact with an external administration the social forms have now become blurred. The general tendency seems to be for the land to become the property of absentee landlords having no kinship relation with their tenants. The villages moreover lack the clan homogeneity noticeable among the Balik.

Area C. Mention has already been made of the principle settled tribes of this area, the Dizai and the Girdi. With the Dizai as recorded by Hay the organisation is feudal rather than tribal, since the village Aghas are not of the same kin group as their tenants. I was told that "all the Dizai call each other amoza" implying, if true, that the whole tribe consists of one taifa only. With the Girdi the position appears to be somewhat different. Jemil Agha, their paramount chief, is himself a Girdi but is a townsman in habit and holds himself very much aloof from his followers.

In its technological aspects the plains culture differs markedly from that of the hills, especially as regards housebuilding and agricultural equipment. An important sociological difference is that, owing to the limited water supply, the position of the village sites is determined and limited by the occurrence of water holes, and the villages in consequence are larger than those found in the hills. From the size of the surrounding cemetery and from archaeological considerations it would appear that some such sites (Bahrika for instance) have been in continuous occupation for several thousand years.

### The Nomads

Though my information is extremely scanty the indications are that the social organisation of tribes such as the Herki differs in many respects from that of the settled tribes. In terminology the term *kabila* appears to correspond to *ashiret* and *khel* to *taifa* but the identity may not be exact. The term *hoba* corresponds to *gund* and implies a small settlement of tents in one location. This last term is also used by the settled peoples. Thus among the Shevdini

of Balik the people leave their villages during the hot months of the summer and live in tents instead. This was the case when I visited Ali Agha of Rayat. Rayat on this occasion had as a matter of fact divided into two separate *hoba* one under Ali Agha himself and the other under his brother, both were located within a mile or so of the deserted village. Among the nomads, I was told, the *hobas* are small in size, each group consisting merely of a single extended family (e.g. Father, brothers, sons and dependants). Although in the course of their annual migration the Herki spread out over a wide area the whole group of "more than 2000 tents" are directly controlled by a single paramount chief, Fattah Agha i Herki. According to my informants the Herki own over a million sheep and some 20,000 cattle; but the Kurds are notoriously fond of large figures. A notable characteristic of the Herki appears to be their extreme hardiness. They live in their black tents throughout the winter and I was told numerous improbable tales of the astonishing rigours and privations they are said to put up with. They appeared in fact to have an almost legendary quality even for the settled peoples through whose land they pass.



## The Guest House

So far we have been mainly concerned with describing the relative social positions of the different individuals that go to make up the Kurdish tribal community. It is now necessary to consider these same relationships on an institutional plane and to examine more specifically the economic context in which they operate.

I have defined the position of the village Agha in functional terms as (a) the individual who 'owns' the land and who receives rent by virtue of that title and (b) the individual responsible for the upkeep of the Guest House. We must now examine this definition more carefully.

It is a cardinal feature of Kurdish custom that the stranger, whatever his rank and position, is entitled to free board and lodging at the expense of the Agha. The more lavish the Agha's hospitality the greater the esteem of his fellows; so much so that the prestige a man gains by virtue of being a good and generous host may in terms of reputation fully discount disadvantages of birth. Hamid Amin Agha of Naupurdan for example though only a poor man and a fairly distant cousin of the ruling chief of his clan has a tremendous reputation throughout the district simply on account of his hospitality. On all sides it was maintained that he was much more of a man (piao - the Kurdish idiom is the same as our own) than his nominal overlord Sheikh Mohammad Agha of Walsh. If Hamid Amin was not so generous, it was argued, he also would be rich and powerful; \*Sheikh Mohammad was miserly and an old woman. It must be admitted that a mere reputation for generosity may not bring with it any particular tangible reward in the form of economic advantage or practical influence. But the pattern of the society is such that this form of reputation is esteemed above all others, and it is in the light of this set of values that the institution of the Guest House must be considered.

† In the Balik country the Guest House is seldom actually a house. Winter travellers are few and can be accommodated if necessary somewhere in the Agha's own residence; during the summer on the other hand a shady pergola is erected somewhere close to the Agha's house and furnished with carpets, seats and cushions. It is here that the traveller is expected to take his meals and sleep.

\* This incidentally seems to have been Sheikh Mohammad's reputation throughout his life; see Hay p. 253.

† In the plains villages however the great heat of the summer and the greater frequency of winter travellers necessitates a permanent building for the Guest House. For description see Hay 47 - 49.

Among semi-nomadic groups such as the Shevdini who spend their summer in black tents the 'Guest House' is a portion of the Agha's tent specially partitioned off for the purpose. This corresponds to Arab bedouin usage. The Agha himself spends much of his day in and about the Guest House and directly supervises the ordering of the meals which he suitably adjusts according to the dignity of his visitor. The actual preparation of the meals is in the hands of the womenfolk, but properly speaking these should never themselves appear in the Guest House. If the visitor has any social eminence the Agha will either sleep in the Guest House himself as a kind of protection, or else depute one of his sons to do so.

But what concerns us here is not so much the description of the Guest House as such, but rather its economic and social significance.

The hospitality offered is free and theoretically unlimited, but in practice any individual of low rank who overstayed his welcome would soon be made conscious of the fact. For those of higher status custom dictates that the visitor should offer his host a substantial gift immediately after the preliminary introductions. I have no information as to the scale of such presents in normal Kurdish usage. In my own case since I was anxious to establish my good name with all concerned, both gifts and hospitality received were probably on an exaggerated scale. I had to rely upon the advice of my interpreter for the quality and quantity of the goods I offered. In kind they included sugar, tea, coffee, cloth, matches, soap and cigarette paper, much the most important item being sugar. The quantities varied according to the length of my intended stay and the eminence of my host. Thus Sheikh Mohammad of Walsh received proportionately more than his nominal vassal Hamid Amin of Naupurdan. On average my board and lodging together with that of my interpreter cost me a sack of sugar (36 Kilos) a week.

## The Expenditure of the Agha

The procedure raises the interesting question as to whether or not it is profitable to run a Guest House. From the Kurdish viewpoint the Guest House represents an enormous drain upon the Agha's resources, but this attitude is to be expected since the more the Agha can persuade his neighbours that he is being made bankrupt by the lavishness of his hospitality the greater will be his reputation. Sheikh Mohammad Agha of Walsh for instance was particularly insistent that his Guest House was bringing him to the edge of ruin, and I questioned him closely on the matter. I noted that while he included under Guest House expenditure a variety of items that were purely personal; in reckoning income he took no account at all of gifts received. To take an example he complained that for the upkeep of his Guest House he was having to feed thirty people and kill at least a kid a day. On trying to discover how he had arrived at this figure

of thirty persons I reached the conclusion that it was made up as follows:-

1	The Agha himself	} Mostly kinsfolk of some sort
1	Wife	
3	Sons	
4	Daughters	
7	Maidservants	
4	Menservants	
1	Mulla	
1	Brother	
5	Guests	
3	By exaggeration	

30

In fact it became quite clear that he lumped together all household expenditure as "the expense of the Guest House", though in fact his expenditure on the guests represented only a small fraction of the total.

Moreover the really expensive item in Guest House upkeep is not the killing of a kid a day, but the cost of sugar, tea and coffee; especially sugar. During the last fifty years or so the Russian style of tea drinking has become fashionable throughout Kurdistan. The tea is brewed very strong over samovars and served with enormous quantities of lump sugar. The samovar is brought into operation as soon as the guest arrives and tea is served at persistent intervals until he goes away again. Owing to the high import duties and costs of transport, sugar costs about 45/- a bag (of 36 Kilos); and I was told that a bag would last a Guest House such as that of Dergala about a month provided there were no special occasions such as weddings and funerals to be allowed for. If this figure is anywhere near accurate it implies an expenditure of some £27 per annum on sugar alone, which, considering the limited facilities available for obtaining ready cash, is a very substantial sum indeed. Actually the situation must be radically effected by the fact that, as noted above, the guest gives presents to his host. As might be expected the gifts that are most acceptable and mostly frequently given are the luxury imports already mentioned - sugar, tea and coffee. I cannot then be certain whether, prestige considerations apart, it is an economic advantage or disadvantage for an Agha to have a large number of guests. Even funerals which involve a long period of polite 'social calls' continuing for over a month, and which certainly involve the Agha in heavy outgoings of rice and meat, may yet, it would appear, prove to be profitable in the long run.

On the other hand whatever may be the immediate relationship, between the Guest House and the Aghas net income, the importance of Guest House expenditure in the economics of the group as a whole must

not be underestimated. The consumption of sugar, tea and coffee is to a large extent confined to the Guest House and it is important to recognise that these are the principle items of ordinary consumption that have to be paid for in cash. \*In the simple foods, wheat, rice, meat, fruits, etc. each small community can be largely self supporting; it is only the luxury foodstuffs associated with the Guest House which have to be paid for in cash. The effect of this upon the general economic organisation will be discussed presently.

Meanwhile it should be noted again how closely linked from the Kurdish viewpoint is the upkeep of the Guest House and the upkeep of the Aghas household in general. This attitude is not so inconsistent as at first appears. Although the womenfolk never appear in the Guest House, it is they who do all the work connected with it. It is the women who milk the goats and prepare the *mast* (a milk product similar to yaghourt), it is the women who make the bread and do all the cooking - and all this is work for several pairs of hands. In the commoner's house one wife alone can readily enough accomplish all the work required of her, but the hospitality undertaken by an Agha in his Guest House involves the work of a number of women, and this is consistent with the fact that the Agha's household is normally the only polygynous group in the community.

A further point to be noted in this connection is that not only does the Agha's household include an abnormal proportion of women, but that the upkeep of these women is much more expensive than the average. In the Balik area nearly all the males have their clothes made from locally woven cloth; even the Aghas and their sons, though employing better quality materials than the commoner, stick mainly to Kurdish cloth and eschew the fancy clothing adopted by townfolk and the Aghas of the plain. This appears to be due to their severely puritan tastes rather than to economic necessity. A nephew of the Agha of Rayat was seen wearing a suit of ordinary Kurdish style but made of obviously expensive imported cloth in plain bright colours, - this was much admired; but at the same time a trader from Rowanduz, who was wearing a rig out of the cheap gaudily striped Japanese cloth typical of Near Eastern Bazaars, was held up to ridicule as a man of no taste. Anyway, as the conventions are at present, neither the commoner nor the Agha incurs much cash expenditure in connection with his own clothes; but for the womenfolk it is different. In the old days they too were well satisfied with the simple cloths produced on the local looms, but now more and more they are becoming eager for "frills and furbelows" - Japanese cotton prints for the commoners, Indian silks for the wives of Aghas. In part this is the inevitable result of the greater facilities for trading contact brought about by 'pacification' and the building of the road, but the tendency was undoubtedly accelerated by

\* The more important Aghas often import extra supplies of rice so as to avoid giving their guests the inferior rice substitute *saua* (see later).

the policy of the Administration after the Great War.

Formerly the village communities were, within the limits of a somewhat meagre standard of living, virtually self supporting. Trade and currency circulation were both minimal. \*The British Administration's policy of buying the loyalty of the tribal chiefs by means of a cash salary resulted in there being available within the community substantial amounts of currency for which there was no immediate outlet except in the purchase of luxuries. Moreover this wealth was not distributed evenly throughout the community but concentrated into the hands of a few leading Aghas. The result has many analogies with similar phenomena observed in Africa. The preliminary expenditure creates a sudden taste for luxuries within a small segment of the community. These new wants develop both in scope and intensity out of all proportion to the ability of the community to satisfy them, with the inevitable result that the economic balance of the community is upset and the originally wealthy group, by developing expensive tastes, becomes eventually an economic drain upon the community. The process can indeed be expressed in general economic terms applicable even to the conditions of our own society.

Expenditure by the Government can for a time create a new large effective demand, but when this expenditure ceases and the income of the community drops the newly created wants remain unsatisfied. The result is not a reversion to the original situation but an adaptation of it, in which the available income is allocated to new ends in an attempt to give partial satisfaction to the newly created wants.

There can be no doubt that in the Balik country, under the influence of the Government subsidy, the tastes of the more important Aghas and their households developed a high degree of sophistication without any corresponding improvement in the productivity of the community as a whole. With the establishment of effective police authority in the Rowanduz valley the subsidy to the tribal leaders was suspended as being unnecessary. The consequences were inevitable. The foreign clothing and house furnishings which had formerly been mere luxuries had by this time developed into essential necessities. Today the more sophisticated Aghas such as Sheikh Mohammad of Walsh and Hamid Amin of Dergala are feeling the pinch severely. They will tell you that times are hard and that they can no longer afford to maintain the standard they were accustomed to in the days of their youth, but the truth rather would seem to be that they are vainly trying to maintain a much "higher" standard than was ever thought of

\* It is difficult to obtain from Kurdish sources reliable information of the sums involved. Sheikh Mohammad's son assured me that at one time his father possessed over £3,000 in gold and specie. At the present time he appears to be in debt to merchants and moneylenders.

in olden times, and that the economy of the village will not stand the strain.

Much point is lent to this by the fact that Ali Agha of Rayat (head of the Shevdini), who being a nominal subordinate of Sheikh Mohammad received no Government subsidy, has remained a simple tribesman with few tendencies towards sophistication. Moreover, far from lamenting the new order he seems to find the present times extremely prosperous and is eagerly pressing his claims with the Government to have the Shevdini land registered in his own name, so that he can establish his people's claim to be an *ashiret* in their own right instead of merely a *taifa* of the Balik. It seems significant too that the Shevdini, who alone have never had to undergo the economic shock of temporary Government support, appear to be today much the most integrated group in the sociological sense.

One further generalisation emerges from this analysis. We noted earlier that of the food consumed by the village, the only items that must be purchased by cash are sugar, tea, coffee and in some cases rice. We noted further that practically the whole of this expenditure was incurred by the Agha in connection with the maintenance of the Guest House and his own household. Now from our analysis of other forms of cash expenditure we see that these too fall almost exclusively on the Agha rather than the commoner. The Agha's expenditure thus differs from that of the commoner not only in volume but also very largely in kind. This distortion has important bearings for our further analysis.

#### Economic Balance of the Village Community

Of the various village groups in the area here described it is scarcely possible to select any single community as typical, so far as agricultural production is concerned. While all the groups are interested in approximately the same range of products, what might be called the 'emphasis of production' varies considerably. One village may specialise in fruit growing, another in wheat, another in tobacco and so on. This differentiation arises partly from geographical considerations - such as altitude, water supply, soil fertility - and partly from the conservative prejudices of the Aghas concerned. Owing to the increased trading contacts opened up since the coming of the road, and the need to satisfy newly developed wants for imported "luxury" goods the whole structure of the economic organisation of these hill people is undergoing very rapid change and readjustment. The individual variations as between different villages at the present time depend in the main upon the degree to which this readjustment to changed external circumstances has already taken place. It should be borne in mind therefore that the synthetic account of this process of change in the following few pages, though valid in general terms if applied to the district as a whole, is not necessarily applicable to

any single village community.

The basis of the ordinary Kurdish menu is unleavened bread, baked in thin slabs (nan), and a sour milk product of the yaghourt type (mast); in addition by a rather elaborate process of boiling the whole wheat grain and then crushing it, a sort of imitation boiled rice (saua) is produced, which is eaten just as ordinary pilaf would be with stewed vegetables or mutton. The fundamentals of the food supply are thus wheat and goats. And in fact by far the greater proportion of arable land is devoted to wheat cultivation. Such land is normally worked on an alternate system - one year crop, one year fallow and this rotation is apparently sufficient to maintain the soil in fertility. The supplementary acreage devoted to vegetables such as marrows, tomatoes, gherkins, brinjal, lentils, etc. is very approximately one sixth of the wheat land. For the most part the vegetable acreage requires irrigation.

Though wheat has the largest acreage, rice would everywhere be the preferred crop if it could be extensively cultivated. The rice yield in volume is roughly thirty times greater than that of wheat for equal areas of cultivation, and the Kurd is well aware of the advantages to be gained by increasing his rice acreage at the expense of the wheat. He would willingly substitute cooked rice (p'lau) for the saua if it could be managed. I discussed this matter in some detail with Sheikh Mohammad of Walsh and it was clear that he was firmly under the impression that the acreage devoted to rice in Walsh was the maximum the irrigation system would stand, and this was probably the case, though the irrigation was in fact very unintelligently arranged.

A third cereal grown only in small quantities is millet.

As things are at present, the cereal production is barely adequate for the needs of the local community and there can certainly be no exports. In fact most of the Aghas purchase additional supplies of rice from outside so as to be able always to serve p'lau to their guests instead of saua.

In former times this bare self sufficiency in primary products set no great strain on the economics of the community. Few commodities had to be imported; clothing was almost entirely locally produced, and trade requirements were limited to a small range of metal goods and certain luxuries such as tea and sugar. But as has

\* In the villages around Dergala there is an exceptional acreage devoted to the cultivation of mash, which appears to be a kind of lentils, but the proportion of wheat land is here correspondingly reduced. In this case presumably most of the mash crop is traded.

been pointed out in a previous section the events of the last thirty years have served to create a steadily increasing demand for a range of imports which, if they might previously have been classed as luxuries, are now regarded by the Kurds themselves as essential necessities. Whatever the immediate nature of the cash or credit transactions by which such goods are purchased, they must ultimately be paid for by the 'exports' of the community as a whole, and the problem arises as to how this can be done in a community which, on the face of it, can only produce a bare self-sufficiency of primary products. The following table shows approximately the categories of goods that go to make up the 'balance of trade' for the tribes of the Balik area.

#### Imports

First Quality Rice for Aghas (brinj sadri - chiefly from Persia), Sugar, Tea, Coffee, Matches, Metalware, Clothing, Kerosene, Dyes. Of these the most important are rice, sugar, tea and clothing.

#### Exports

Tobacco, Lentils, Walnuts, Gallnuts, Honey.  
Fruits:- Apricots, Apples, Pears, Grapes, Raisins, Almonds.  
Wool and Goatskins.  
Of these by far the most important is tobacco.

In addition there are certain cash transactions that must be taken into account which are independent of the process of trade. On the debit side certain sales - taxes and legal dues have to be paid in cash to the Government, and there is an excise duty on tobacco. This latter is nominally due only on tobacco actually traded but in practice it appears to be charged on the private supplies of the cultivator also. The Agha again incurs certain cash expenditure in educating his children. He also incurs very substantial expenditure in 'purchasing' his own wives and those of his sons, but since the majority of such marriages take place within the group these exchanges do not necessarily effect the economy of the community as a whole. On the credit side one must allow for the fact that a small number of tribes-people are earning wages either in Rowanduz or down on the plain, and that such people may send home part of their earnings in cash.

In general however it is fairly true to say that all the goods imported by the groups of the Balik area must ultimately be paid for by the proceeds of surplus fruit and tobacco. Large scale fruit production is limited to the villages around Rust, and I will therefore consider only the problem as it affects tobacco production, this crop having a much more general relevance.

## Effects of an Increase in Tobacco Cultivation

The Kurds are inveterate smokers and have cultivated their own varieties of tobacco for several centuries. Though these particular varieties are still the preferred smoke for the Kurds themselves, they have little or no trade value owing to the crumbly nature of the leaf. In recent years however a number of modern cigarette factories have been started in and around Baghdad, thus creating a good market for a better class leaf. In the main this market is satisfied by the more sophisticated Kurdish areas such as Sulaimani, but the tribesmen of the Rowanduz district are also slowly beginning to adapt their production to the new conditions. In this they receive encouragement from the Government and the factory owners who supply free seed and instruction to those who want it; this service by the Government is of course more than recouped by the ultimate excise on the resulting product.

Under these new conditions the improved tobacco leaf has a cash value proportionately vastly in excess of that of wheat or rice. In terms of a money economics it would be sensible to increase the area of land devoted to the production of tobacco at the expense of that devoted to wheat and rice.

Furthermore since, other things being equal, the area of tobacco cultivation would again only be limited by the supply of irrigation water available, the logical thing to do would be to abolish the rice cultivation altogether and substitute tobacco, both on the rice land itself and also on much of the wheat land - (tobacco requiring less water than rice). This development has actually taken place in certain of the lowland villages, notably in the Assyrian community round Batas, and the resulting financial advantage has been very marked; but in the Balik area the increase in tobacco acreage seems so far to have been very slight. In the highest villages such as Khalan and Rayat climatic conditions are probably unfavourable, but lower down in the valleys around Merga and Dergala where tobacco and rice are at present grown side by side there seems to be no immediate technical reason why the former crop should not be expanded. There would of course be certain difficulties in connection with the re-organisation of the water courses, and there is the problem of specialist training in tobacco cultivation but in the main it would appear that the problems involved are social rather than technical. If it were possible for every individual tenant to grow tobacco in equal quantities the transition to a modern cash economy might be simple. But in practice the existing tenancy rights are such that any extension of the tobacco cultivation must affect unequally different sections of the community - those whose land is converted to the new cultivation benefiting at the expense of the rest. We may analyse the problem in economic form in terms of the factors of production involved.

**Land.** The land potentially available for tobacco cultivation

is roughly speaking all the arable land that can be effectively irrigated; - its extent being limited both by the configuration of the land and the available water supply. Here immediately there are complications. The irrigation system as at present arranged may serve a number of purposes

1. Irrigation of rice cultivation - which in most villages appear to be a personal plot pertaining to the Agha alone and not a tenant's holding in the ordinary sense.
2. Periodic irrigation of the vegetable gardens. In any re-organisation this would have to be maintained.
3. Periodic irrigation of existing tobacco areas.
4. In some villages (e.g. Dergala) for driving the mill, which is owned either by the Agha himself or a near relative.

Any reorganisation of such a system would affect a number of different individuals whose immediate interests may be directly conflicting. The Agha for instance is hardly likely to abandon his rice plot which is his personal property merely to provide his tenants with more water to grow tobacco; but on the other hand if he reserves the whole of the tobacco cultivation for himself the tenants whose land is interfered with will have a justifiable grievance. It might well be found in fact that in any particular village the rearrangement of the water supply so as to provide a greater tobacco acreage would in practice involve a completely new allocation of land holdings to all the inhabitants, a reform which would certainly be very difficult to carry out. It may be significant that at Batas where such a re-organisation of cultivation has in fact been brought about the Assyrian tenants were new arrivals in the district and there was no old established system of tenancy rights supported by an ancestral tradition.

A further question of interest is the problem of "marginal" land. It is true that the land configuration, somewhat similar to that of the Alpine villages of the Bernese Oberland, sets a definite limit to the area that can be cultivated, but on the other hand there seem to be a number of small marginal areas, at present under scrub, which might be brought into cultivation if the available water were more efficiently utilised and the cash incentive were sufficient to repay the extra labour involved. The 'rights' over such uncleared land rest at present exclusively with the Agha.

**Labour.** The labour available is the labour of the tenant occupiers and their families; it would seem that the substitution of tobacco for cereals would affect the balance rather than the volume of work required. Under the present system the wheat harvest comes in

late June and threshing proceeds steadily from July to October. The much smaller rice harvest comes about the end of September. With less wheat and no rice, threshing could be finished by mid-september leaving labour free for the main work of the tobacco harvest. On the other hand the tobacco plant requires a good deal of finicky attention during the early stages of its growth which coincide with the wheat harvest. It is possible therefore that any radical increase in the tobacco cultivation is dependent upon the introduction of improved methods of threshing. A much greater difficulty arises from the fact that the change in labour requirements would not be equally distributed as between different households. Whereas at present each household has approximately the same programme of work, the situation would be greatly complicated if one man's land was devoted to tobacco and his neighbour's only to wheat. The difficulty could be avoided if all the tobacco cultivation were 'owned' by the Agha; - the commoner being under obligation to work for his Agha but not for a fellow commoner. Such a development would never be countenanced by the Government however since the system would be regarded as "exploitation" of the tribesman by his chief.\*

**Capital.** The additional capital required for tobacco as opposed to cereal cultivation is not very significant. The Government is prepared to supply seed and expert advice; so far as I know the process of drying does not require any special technical apparatus. The re-organisation of the irrigation system would of course be an initial 'capital' expenditure for the community concerned.

**Technique.** On the other hand the mere statement that Government is prepared to offer expert advice rather oversimplifies the social aspects of the technical problem. I have already mentioned that the native Kurdish tobacco cured in the traditional manner results in a powdery substance that is quite useless for the purposes of a modern factory. In order to produce a marketable product, the farmer has to be taught entirely new methods. The reformer is here up against several types of difficulty. Firstly there is a simple conservative resistance, the dislike of new methods, not simply because they are new but because the practitioner in the old methods thinks he knows best. But there are other difficulties of a much more intricate kind. Here is an example.

The Government are prepared to supply approved villages with a trained expert to supervise the growing and harvesting of tobacco. Such a man was supplied to the village of Walsh. He was a Kurd, but a townsman from the plains and by mountain standards a man of low moral

\* In Batas, where in functional terms the Assyrian Bishop takes the place of the Agha, the tobacco crop is owned by the Church, and difficulties over individual labour requirements thus avoided. But then a Christian Bishop is obviously not the same thing as a tribal Agha!

character; it was alleged that he corrupted the villagers with alcohol and gambling and attempted to seduce their daughters, in particular the Mulla's daughter, in fact he was altogether a scoundrel. In due course he was found in the high road with two bullets through his body. The police took action. Two harmless looking nomads from another tribe were brought before the courts and on the basis of somewhat elaborate circumstantial evidence convicted of murder. Sentence however was never carried out since the "criminals" curiously disappeared a few days after the trial. Whatever was the truth of this matter, local rumour had no doubts on the subject. The bullet wounds, the arrest and conviction of the nomads were all a frame up by the police, who had the sense not to fish in troubled waters. The murdered man had really died of strangulation - hanged in the Guest House of Sheikh Mohammad, Agha of Walsh and chief of the Balik.

This story was told me by Hamid Amin of Naupurdan who was always eager to cast a slur on his cousin Sheikh Mohammad. It appeared however to have some general currency since, when I was discussing the misdemeanours of the local schoolmaster with the Agha of Rayat, he referred to the Walsh story. "These small Government servants! What do you expect? They're all scoundrels".

Whether the story is true or not is irrelevant, its effect among the Balik is the same as if it had been true. Even though Sheikh Mohammad's prestige is not so great as formerly, the fact, or even the rumour, that he had to hang his first and only agricultural adviser is a sufficient deterrent for any lesser Aghas who may be contemplating agricultural reform within their own communities. This example brings out well how a problem which on the surface is purely economic may in practice be effected by a maze of seemingly irrelevant considerations in the field of ethics, tribal law, politics and religion.

To sum up then. We have seen how the necessity for developing an export trade implies the necessity for increasing the tobacco acreage at the expense of cereal acreage, and I have tried to analyse out the forces of resistance which serve to prevent any immediate response to this incentive. Nevertheless the incentive is clearly very great. I was told for instance in Batas that whereas in the old days the crops of the entire village had been worth barely £50 in cash, the tobacco sales in 1937 alone totalled £2,500. I believe therefore that in the hills also some radical alteration in the emphasis of agriculture must take place in the near future.

But it must be recognised that any such development must bring about fundamental changes both in the ideology of the people and of their social organisation. As things are, the hill country farmer sets out first of all to grow sufficient food for himself and his family. Only when he is assured of that does he turn his attention to the cultivation of luxury products such as tobacco. In short he aims at

being self sufficient in his production, trading only that which is surplus to his requirements. Under the new conditions the local production of cereals will be inadequate and the difference will have to be made up by trading tobacco for wheat. Thus for the first time the ordinary commoner will be forced to evaluate his basic foodstuffs in terms of a cash economy - and this may have serious consequences. Under present conditions tobacco is so enormously valuable (in terms of cash) compared with any other Kurdish production that some well favoured villages may come to rely on this crop to the exclusion of all others, thus making the welfare of the community dependent upon fluctuations in the price of tobacco on the Baghdad market, - hardly a desirable development.

The social consequences of an increase in tobacco cultivation may be equally drastic. Consider for instance the matter of rents. In a previous section I have suggested that the commoner normally pays his Agha 50% of the yield of his land; and this is evidently no great hardship since the commoner family lives satisfactorily on the remaining 50%. Moreover in terms of cash the rental does not represent very much - at 1938 prices, a ton of wheat would purchase locally only just over 50 kilos of sugar. But under the new system not only will the commoner be unable to satisfy his own food requirements without resort to trade, but a 50% rental would, relatively speaking, be worth its weight in gold, - with the added exasperation that the commoner who trades tobacco will for the first time find himself under a direct tax obligation to the Government. There is little doubt that in such circumstances 'rents' would be reduced. In my view the general levelling up of financial status as between commoner and Agha which would result from this process would be entirely fatal to the existing tribal organisation.

On the analogy with the lowland areas the ultimate line of evolution is indeed clear. The Agha finds it increasingly difficult to maintain his obligations of kinship and hospitality; he falls into debt and eventually by some trick of the law the tribal land is mortgaged to pay the bill;\* thereafter the new Agha is merely a landlord with no personal ties with the community - the process of tribal dissolution may to all intents and purposes be regarded as complete.

From the Government's point of view such a development is not entirely undesirable. A completely detribalised community is in many respects easier to administer than a tribal one, at least in the short term view. And there are still wider factors effecting the situation. The labour for the Kirkuk oil fields is largely supplied

\* This is theoretically impossible, since by Iraq definition tribal land is miri land. Nevertheless the process of alienation has in the past clearly taken place in the plains and foothill areas.

by detribalised Kurds from the Sulaimani area. Similar industrial developments further north would provide a labour market for the Kurds of the Erbil liwa. Notoriously the cheapest labour is that which is least organised. Once again the analogy with South African developments is very close.

### Economic relations within the Village

The previous section dealt primarily with the economic relationships between the village group and the outside world, and the way in which changes in the form of this external contact may be expected to effect the basis economic organisation of village life. It is now necessary to consider the same set of phenomena from the point of view of the individual rather than of the village group as a whole.

In general the motives for exchange within the village group are to be regarded as social rather than economic. The system of cultivation by family groups rather than individuals ensures that there is no great differentiation of economic status as between different commoners, and trading contacts within the group are scarcely necessary.

### Crafts

An exception to this is the case of the weaver who occupies a specialist position by virtue of his trade. It should be noted that carding and spinning are not specialist occupations. For the most part the wool is prepared and spun independently by the women of each household. The material is then worked up into cloth by the weaver in return for payment either in cash or kind.\*

Another individual sometimes occupying a specialist position is the herdsman. Both in Walash and Dergala the whole flock of goats and sheep was in charge of a single individual who apparently lived permanently in the open with his charges. It was explained to me that the goatherd was not a member of the village but a stranger, the various families whose flocks he tended contributing jointly to his support. Though the flocks are thus herded together there is no suggestion of 'joint ownership', each man knows his own stock; this fact being amply demonstrated at milking time every morning and evening when the womenfolk go out to the grazing and pick out their own particular property. In other villages conditions are rather different. For instance the Shevdini of Rayat have large herds, and as stated already part of the community separates off during the summer to form an independent hoba, which tends to the cattle exclusively. I have no

\* This idealises the existing conditions. It is valid for Dergala but some of the other villagers now have no weaver of their own. The men still nearly all wear Kurdish cloth, but the spinning and weaving is largely concentrated in Rowanduz and Erbil.

information as to how many individuals go with the cattle or what is their relationship with those that stay behind to get in the harvest.

There are few other specialist occupations. Rug making is a specialist accomplishment of some of the women but the quantities produced are of no economic importance. Other crafts are chiefly in the hands of travelling experts who wander from village to village equipped with the tools of their craft and work up the materials offered to them by their clients. One may name for instance the felt maker, the carpenter, the tinker and the builder. It must be emphasised that these people are not dealers but craftsmen. The felt maker works up the wool provided by the villager; the villager must provide the wood before the carpenter can make a fork for him. The capital of such craftsmen can therefore be very small and the return for their work is little more than their keep and travelling expenses.

#### Traders

Quite distinct from these are the various traders who provide the contact between the village and the outside world. These are best classified by their Kurdish names - *miaoafusch*, *atar* and *bazargan*. The *miaoafusch* are primarily travelling fruit dealers, their trade is of a local nature and entirely on a barter basis. They provide contact as between one part of the tribal area and another. Thus when I was in Walsh a dealer arrived with fruit from Rust which he traded for small quantities of wheat and tobacco.

The *atar* may best be described as a travelling pedlar. He deals in such items as matches, needles, cigarette papers, spices, kerosene, thread, sugar, tea and coffee - in fact he fulfils the functions of the general village store. His terms are partly barter and partly cash. He can however only deal in small quantities - an Agha such as Sheikh Mohammad would always send in direct to Rowanduz for his sugar rather than purchase it through an *atar*. Occasionally the *atar* is permanently established in a single village. A shopkeeper of this sort is known as *dukandar*; among the villages I visited, shops of this sort only existed in the smuggling centre of Khalan.

The *bazargan* maintain permanent shops in the towns such as Rowanduz and Erbil and only send travellers out to the villages. They deal only in the superior categories of goods, - cloth, calico, tea, coffee, sugar, - so that their principal clients are the Aghas. For the most part they are Jews or Armenians. They do not trade for barter but gain their trade by offering elastic terms of credit. It is worth noting that usury seems to be excluded; a debt of £5 incurred today is still a debt of £5 if settled in 3 years time. Presumably to allow for this, the prices are quite extortionate. The development of this system of credit trading is, I think, quite new for this part of Kurdistan. It seems likely in due course to lead to the bankruptcy

of either the Aghas or the traders, - it is hard to judge which is the most vulnerable. Thus, Said, son of Sheikh Mohammad of Walsh, assured me that he personally was in debt to the tune of £300 and wanted me to get him a job with the oil company in Kirkuk so that he could work off his indebtedness; on the other hand in Dergala I met a rather pathetic little Rowanduz trader who complained that he had £150 out at credit, some of it for over three years, and though he had just been round to dun all his clients he had only managed to collect £3!

#### Tobacco Marketing

In a previous section I emphasised the growing importance of tobacco for the economy of this part of Kurdistan. It is now necessary to consider how this tobacco crop is actually marketed. My enquiries on this subject led to somewhat contradictory results and the matter needs further investigation; in general I think the divergence of view was primarily due to the rapidly changing conditions in the tobacco trade. My notes reveal three distinct methods of marketing. The first is that now generally practiced in the sophisticated areas of Kurdistan around Sulaimani and in the lowland districts of the Erbil liwa. This method does not at present apply to the Rowanduz area but may be expected to do so as the tobacco crop is increased.

**Marketing procedure 1.** The big tobacco factories of Baghdad have their own agents in Kurdistan, who contract with the Aghas for the whole saleable surplus of the village crop. If required the Agha can obtain a substantial cash advance at the time of sowing the crop. Seed and technical advice is often provided by the merchant's agents who presumably work in cooperation with the Government departments concerned. 50% of the crop is the Agha's own by virtue of his land title, the other 50% belongs to individual cultivators. Since however the buyers' agent deals only with the Agha, the latter is in a position to take a substantial commission on the cultivators' share as well. On the other hand the individual cultivator need not sell his crop through the Agha if he does not think he is getting a fair price. But his only alternative is to trade with the *atar*, who as a middleman, can only offer a much lower price than the buyers' agent offers the Agha. The tobacco is transported from village to town at the buyers' expense in each case.

The second method was described to me as that practiced in the old days before the coming of the Baghdad cigarette factories. My informant in this case was a Sulaimani man and I am uncertain to what extent this procedure was ever relevant for the Rowanduz area.

**Marketing procedure 2.** Trade was on a more individual basis. The tobacco merchants or their agents, with the Agha's consent, made advance contracts with individual cultivators. These advances had the



effect of greatly reducing the ultimate return for the producer. Thus a cultivator who sold his crop for a cash advance at the time of sowing would only get about 60% of the market value of his ultimate crop. Merchants would pay substantial gifts - either in cash or kind - to the Agha for the right to trade and in return the Agha would in effect guarantee the contract. Thus if an individual cultivator failed to meet his contract the Agha could force him to sell his personal goods to meet the bond, though for reasons of kinship it seems likely that the Agha would in many cases prefer to meet the liability himself.

**Marketing procedure 3.** Detailed enquiries in Walash revealed that the tobacco surplus for that village is fairly small and is disposed of either through individual tobacco dealers operating from Erbil or else through the ordinary *atar*; terms of trade are for cash only, and there is no system of advances. From Dergala, where the tobacco cultivation is much more extensive, I unfortunately obtained no information concerning marketing methods.

Having dealt with the various individual contacts between members of the village and those outside it, there remain for examination those forms of exchange within the group itself which have an essentially social rather than an economic basis. Owing to lack of empirical data I can do little more than point out what are the principal occasions for these exchanges.

**Marriage.** A bride price is payable by the bridegroom to the bride's father. I was told that if the wife ran away or otherwise misbehaved herself the husband could claim back part of the bride price, but the information was not specific. \* In the event of a divorce the husband is responsible for the maintenance of his former wife at any rate during her pregnancy and frequently longer. It is difficult to obtain reliable figures concerning the amount of bride price paid. Hay quotes the figure of £500 for a wealthy Agha. There is a natural tendency to exaggerate the figures both as flattery for the lady and to create an air of affluence about the informant. When I pointed out that in the case of the marriage of ortho-cousins living as close neighbours in the same village the payment of bride price, whatever its amount, could be little more than a nominal transaction, this was admitted; nevertheless, it was argued, every girl's self

\* Hay (p. 44) says the husband is responsible only for three months after divorce or during pregnancy whichever is the longer and this is good Mohammedan law. According to my interpreter important Aghas wishing to increase the number of their household will sometimes divorce one of their wives merely in order to marry a fifth; in such a case the divorced wife would remain a member of the Agha's household indefinitely, though whether her position would be that of concubine was not made clear. The situation however is hypothetical as I obtained no concrete examples.

esteem demands that her price should be a high one. It would need a very intimate knowledge of all concerned to find out what real transactions take place within the village on the occasion of a marriage. Where the marriage is to someone outside the village the position is more clear, especially in the case of the Aghas, though here again there is a tendency to exaggerate the figures involved. A point of some interest is the frequency with which Aghas or their sons marry the daughters of townspeople. For instance a son of Sheikh Mohammad of Walash was married to a daughter of Mustafa Effendi, the leading notable of Rowanduz, and one of the wives of Mir Hamid Amin of Dergala was also a townswoman. Such marriages are socially approved of as it is considered that townswomen bring with them an air of culture and sophistication. The reciprocal marriage of Aghas daughter to townsman's son is however most unusual, mainly because the townsman considers the tribal girl raw and uncivilised. The one sided nature of the transaction thus represents a further periodic cash loss to the tribal group without any compensating return.\* It is not to be supposed that the bride price payment is the only economic transaction taking place on the occasion of a marriage. Near relatives on both sides send presents to the bridegroom; these may be in kind or cash and in the case of marriages between important Agha families may amount to substantial sums.

**Death.** Compared with normal Moslem usage the mourning ceremonies of the Kurds, at any rate for Aghas, are unusually prolonged. While I was staying at Walash the wife of Mustafa Agha, second son of Sheikh Mohammad, died. As Mustafa was the Agha of a neighbouring village I did not see the ceremonies involved. I was told that the proceedings consisted principally of the bereaved sitting at home in his Guest House and providing food and drink for all those friends and relatives who may think fit to come and condole with him. This would go on for a month. Moreover it was reckoned that as Mustafa had only a small Guest House all his less immediate kin would have to be accommodated at Walash. I gathered that the mourners would bring with them gifts which would at least approximately compensate for the cost of entertaining them, but the immediate economic strain occasioned by a death such as this may be considerable. As soon as Sheikh Mohammad heard the news he sent off riders to Rowanduz to fetch four sacks of sugar (36 kilos each), two bags of rice and a big roll

\* Formerly it appears it was quite customary for commoners to sell their unwanted girl children to townsfolk. The girls were known as *Kurdiya*. During adolescence she was a slave servant of the purchaser but might be married off quite respectably when she grew up. The system appears to have much in common with the *mai tsai* system of South China.

of cigarette papers. The scale of entertainment naturally varies greatly with the status of the deceased; moreover the death of a male is in every case far more serious than the death of a female. So far as I am aware the ceremonial commiseration is similar in the case of commoner families though on a smaller scale.\*

#### The Mulla

The Mulla has his part to play in the ritual both on occasions of marriage and death, and gains some appropriate reward. His interest in the marriage ritual is on the decline. Government regulations now require that marriages must be registered with the police, and the marriage is legal without any religious ceremony. The tendency is therefore to give presents to the police rather than the Mulla.

\* The above remarks do not apply at all to nomad tribes; I was told that among the Herki the whole ceremonial is concluded in one day. The procedure was said to contain much ritual of non-Moslem type.

#### The Relevance of Technology in a Social Study

The earlier type of ethnographic monograph which sought only to record as historical facts the manners and customs of peculiar peoples was painstakingly elaborate in its description of technological detail. In contrast to this many of the latest anthropological works with their wholehearted sociological emphasis have ignored technological detail altogether. In a science that seeks to establish general laws for human behaviour it is desirable in the first place to emphasise the similarities rather than the peculiarities of different cultures, and from this point of view the demonstration of general sociological and economic principles is of greater importance than the cautious elaboration of the local variants of a particular technique. Nevertheless the techniques of a people are not merely of historical significance. They too have a flexibility depending upon their immediate function.

Social anthropologists tacitly admit the existence of some inter-relationship between the social forms of a culture and its visible material aspects, but the nature of this relationship is seldom specifically examined. The interest tends to be so exclusively on the abstract concept of social structure, that the co-existence of a formal material structure is sometimes forgotten. But the social form and the material form are surely equally significant aspects of human adjustment to the given facts of climate and environment? The tendency in the past has been to use material facts merely as a rigid stage upon which to demonstrate the interlocking unity of social norms. For my part I have purposely left all material description to the last since by so doing it is more easy to demonstrate the close correlation that exists between the social and the material norms and to show that variation in the one implies immediate and interdependent variation in the other. The recognition of this correlation is especially important where the situation is one of culture change. In so far as the Anthropologist's aim becomes one of predicting the trend and development of change, his method must be to detect and evaluate the forces of conservatism and resistance in different aspects of the culture as he sees it. It is part of my argument that any such evaluation based on a consideration of social trends alone is necessarily distorted. In some cases it is true, social forces must be treated as of paramount importance, but in others it is technical factors which provide the ultimate determining factor as to which direction a new social development will take. Conservatism in its final analysis is a highly complex amalgam of social obligations, psychological reluctance, and actual technical inability to effect change. A direct correlation between the social and the material aspects of a Kurdish hill village should therefore be of interest.

### Land Scarcity, House Construction and Kinship

The indications are that land resources are for the most part as fully utilised as present technical equipment permits; the amount of marginal land that could be brought into cultivation merely by an increase in economic inducement is small. Except on the moorland country above Khalan where conditions are too severe, wheat is cultivated wherever the land is sufficiently level to work a plough, and where shelter permits subsidiary cultivations such as vines are carried far up onto the steep hill face. Since there is clear evidence that the food supplies grown are only barely adequate for the needs of the community it may be postulated that the existing population approximates to the maximum that can be supported by the present economic system.

Land scarcity anyway seems the most plausible explanation for the very curious form of architecture adopted in this region. The villages are always constructed on a steep hill which could have no possible agricultural utility. They are not constructed at the top of the hill as defence considerations might seem to suggest but on the side of it immediately above the level plough land at the bottom of the valley. Sometimes as at Walash and at Rayat the houses are clustered together in an almost solid block; elsewhere they are grouped into a number of individual clusters, the cohesion of these visible structures seeming to bear some correlation with the degree of kinship unity within the village. As can be seen from photograph No. 3 the houses in a particular cluster are frequently built one above the other in a series of terraces so that the roof of one house forms the front porch of the one below. The house block shown in the photograph was occupied by two brothers and their families. These occupied the two top buildings. The bottom building though also originally a dwelling house was at the time of my visit being used as a store house for both families. And this is no exceptional case; a single block of buildings such as this is usually found to be occupied by a group of near relatives functioning for the most part as a joint economic group. In view of the obvious inconveniences of such close proximity it could hardly be otherwise. If however economic developments of the future tend to accentuate the rights of the individual as opposed to those of the kinship group we may expect the complementary development of a more individualistic style of architecture. On the other hand the existing type of joint dwelling house is a factor which complicates any effort on the part of the Agha to reorganise the system of land tenure and cultivation on lines of greater efficiency.

One may remark perhaps that in the plains where the whole agricultural emphasis is upon wheat production and where the limitations of water supply radically affect the whole economic organisation of the community, not only the arrangement of the villages but the actual technological construction of the houses is totally different from that of the hill districts. What follows applies only to the villages of the

Romanduz area, and approximately also to area B of Map 1. It does not apply at all to area C.

The technological peculiarities of the buildings may be summarised as follows:

The shape is rectangular but there is no consistency in size or plan. As a rule the main door faces downhill and leads out onto the roof of the house immediately below but this practice varies. The walls are usually of rough cut stone set in a mud plaster about two feet thick, but the modern tendency is to substitute sun-dried mud brick for the stone and plaster. Some houses are two stories high but this is rather unusual; in such cases the upper storey is reached by an outside ladder. All rooms have windows in the outside wall but, except in the Agha's houses, there are very rarely any shutters. The fire is set in a small floor pit; there is sometimes a proper smoke vent in the roof but more usually the only escape for smoke is through the window. The roof is flat, sloping downwards slightly towards the front; the main roof beams run horizontally, parallel to the hill contours, while over them is laid a thick layer of thin branches about the thickness of pea-sticks. This is given a top dressing several inches thick of a slurry made from lime, ashes and rubble. In dry weather this sets hard and provides a perfectly rigid floor, but it is not a true cement. Under rain, it quickly goes soft and must be kept constantly rolled if leaks are to be avoided. The furnishings of a Kurdish house are extremely meagre. A variety of cooking utensils are the chief items. There is seldom a chair or a table. Bedding consists of felt quilts, perhaps a rug or two, and blankets. During the daytime these are rolled up in a corner and pushed out of the way. It may be mentioned that the most valuable parts of the house are the roof beams. Straight baulks of timber of adequate length are hard to obtain, and only Aghas can afford anything really substantial. If for any reason a peasant decides to build a new house, he dismantles the roof of his old one and uses the materials for his new house. A village site that has been abandoned thus reverts almost immediately to common scrub. The limitations of this type of architecture are chiefly defined by the deficiency of materials. This is demonstrated in the houses of the wealthier Aghas and Sheikhs where by adding refinements such as wooden floors, glass windows and hinged doors extremely comfortable houses can be created from a design essentially similar to that of the ordinary peasant's house. With any levelling up of the general economic status of the community similar modifications of the peasant architecture may also be expected. Building is nowadays a specialist craft; an expert is usually called in from the town, the client supplying the materials. The employment of town experts is probably correlated with the adoption of mudbrick instead of stone and plaster noted above.

## Ploughing

The technical equipment available for land cultivation is extremely rudimentary. The principal implement the plough (see photographs) is of the simplest possible type, though small details of design vary from village to village. The example illustrated comes from the Rayat district. Its great advantage from the cultivator's point of view is its extreme lightness; it can be dismantled easily in a few moments and carried about by one man. This is of great importance where in order to reach some of the plots to be cultivated it may be necessary to ford a stream or climb half way up a mountain. Thus despite its crudity of construction it is doubtful whether any more modern implement could fulfil the special requirements of the environment equally well. In the plains things are different. There in the big wheat areas capital expenditure on large scale mechanical equipment would be well worth while,\* but in the hills the individual plots of cultivation are so small and the inclines so steep that a small portable implement is essential.

The disadvantage of the existing hill country plough is its appalling slowness. The chief reason for this is that instrument makes a straight furrow and has no curved plough share to turn the soil over as in the European instrument. Each furrow is thus less than half as wide as that of an instrument which turns the soil over. But here again any immediate modification is difficult. To use the European instrument efficiently the land must be divided up into long rectangular strips so that the ploughman can go up one side and down the other. With a primitive straight furrow plough, such as the Kurdish, the ploughman returns on his own track so that it does not much matter how short is each individual furrow. The typical smallholdings resulting from the use of these different instruments are thus of different shape - with the European plough the typical smallholder's cultivation plot becomes as in France or Germany a long narrow strip; with the primitive instrument the typical plot is nearly square. Even if the existing Kurdish plough were to be improved so as to carry a curved blade, it probably could not usefully be employed without a considerable redistribution of existing land holdings. Thus though educated Kurds, when lamenting the backwardness of their people, tend to deplore most of all the primitive inefficiency of their equipment, it seems to me most

\* It is of interest to note that the manufacturers of harvesting machinery seem to be unaware of the existence of Iraq. I discussed the matter with the landlord Agha of Saadowa, a village some twenty miles west of Erbil. He was a rich man with advanced ideas. He said that he was quite prepared to invest several thousand pounds in ploughs and harvesting machinery but that as far as he could discover there was only one firm of machinery makers with agents in Baghdad and they carried no spare parts.

unlikely that there will be any serious modification of the existing type of plough, at any rate in the hill country.

## Threshing

For threshing the hill people use no instrument at all; the cattle are merely walked round and round on the piled straw until the whole is reduced to a fine chaff and the straw then winnowed with a fork in a light wind (see photographs). The process of threshing takes an immense time, often lasting from July to late October; any drastic change in the economic programme of the village - such as a switch over from rice to tobacco - must as I have shown be dependent on the extent to which this process of threshing can be speeded up.

A circumstance that I find very puzzling is that throughout the plains area, - where the wheat harvest is very large - use is made of a relatively advanced 'threshing machine'. This consists of a horse drawn sled (see photograph) to the underside of which is attached a rotating set of metal blades for mincing up the chaff. The apparatus is very simple and not, one would have thought, unduly expensive. But the curious fact remains that this device is not found in the hill country around Rowanduz at all, though its advantages must be well known to all.

The only explanation I could get was that in the hill country the wheat production was not great enough to make the more efficient method worth while; the argument seemed to be that as long as the threshing got finished before the rains came in November it was good enough. Whatever the real reason it seems likely that there must be some modification of existing threshing methods if there is ever any radical extension of the tobacco cultivation.

## Land Utilisation

The actual lay-out of the cultivation is primarily determined by the topography of each individual village. Rice, tobacco, fruit and vegetable cultivations are permanently sited, their position being determined by the lay-out of the irrigation system. The wheat on the other hand is worked on a two year cycle as noted already. The diagram map shows roughly the lay-out of cultivation in Walsh at the time of my visit. It will be noted that all the fallow lies on one side of the stream and all the (1938) wheat crop on the other. Nothing corresponding to this neat symmetry could be observed in the other villages I visited. It emphasises the fact however that the holdings of individual cultivators are not necessarily all in one place; - in Walsh obviously each working group must have approximately an equal area of land on either side of the stream. I thought at first that there might be some system of reallothing land to different individual cultivators in successive years but my informants

denied this. My information however on the actual topographical arrangement of individual holdings is definitely unsatisfactory. From the evidence it would appear that each working group of commoners must hold in separate plots at least the following:- one patch of vegetable garden, one patch of tobacco cultivation, one patch of wheat and one patch of fallow. But my informants never formulated the position to me in this manner. The problem is linked up with the question of inheritance concerning which my first hand evidence is very slight. As I have shown, it appears that so far as land is concerned the injunctions of the Koran have scarcely even a nominal relevance. Granted however that the Agha as landlord has a nominal right to determine absolutely the inheritance of land tenure among his tenants, it is still far from clear how this works out in practice.

### Rice

The rice cultivation seems usually to be the personal property of the Agha - this being true at least for Walash, Rayat and Dergala. I did not discover what particular individuals are conscripted to work this cultivation or how they are recompensed. It is extremely hard to understand why in a village such as Walash this cultivation is not turned over to tobacco. Sheikh Mohammad actually complained to me that one of the reasons he was so badly off compared with his enemy the Mir of Dergala was that the latter owing to better water supplies was also to grow so much more tobacco. Possible political reasons for this conservatism have been suggested in a previous section; another reason is psychological - from the Kurdish point of view it just is not sense to go short of food and rely on the proceeds of a cash crop to make up deficiencies. In this perhaps the Aghas show remarkable intuitive foresight.

### The Mill

An institution which I have so far neglected but which is of more than merely technological significance is the mill. There is a mill associated with nearly all the larger villages. There are mills at Dergala, Rayat and Merga. Walash has none but there is one at Naupurdan. All are worked on the same principle which technologically speaking is very advanced. As may be seen from the diagram and photographs the machine is worked as a horizontal turbine and thus uses the 'velocity' head of the water instead of the weight as in the more usual types of water wheel. This has various technical advantages - for instance it disposes of the necessity for any gearing - and if the apparatus were 'precision made' there is no reason why it should not be highly efficient. Actually the crudity of the workmanship makes it impossible to work the machine at any great speed and the output is limited to about  $\frac{1}{4}$  ton of flour in 24 hours, working continuously. The operation of the machine is quite automatic and once started it requires only the minimum of attention.

Where possible the driving water is obtained by diverting some main stream. This is done at Naupurdan, Rayat and Merga and the operation of the mill then has no effect upon the irrigation system of the village. In Dergala however water supplies are less adequate. If the stream is diverted through the irrigation channels there is insufficient to drive the mill. A compromise has therefore been reached. The water is passed through the cultivation on average six hours per day and to the mill for the remaining eighteen. Some friction arises on this account and while I was in Dergala a young man got a good kicking from the Agha for cutting the dyke during the night so as to get an extra supply of water for his tobacco seedlings. Here again then is an obstacle that might prove confusing to any hastily thought out scheme of agricultural reform.

The owner of the mill is probably in most cases a near relative of the Agha. In Naupurdan it is the Agha himself, in Dergala a father-in-law of the Agha. The terms are in effect that the owner of the wheat hires the mill at a fixed charge for each sack of corn ground. The man who owns the wheat himself operates the machinery. There is no suggestion of selling the corn to the miller. The millowner merely obtains a rental for the use of his apparatus. In this he is in competition with up-to-date apparatus in the towns, the latter being of course much quicker and producing a smoother and cleaner flour. In general however the trouble involved in carrying the wheat to Rowanduz and bringing the flour back again is sufficient to ensure that the business remains with the local mill provided the price charged is not too high. In outlying districts at any rate then the mill seems likely to remain a permanent institution.

### Weaving

\*The only other piece of technical equipment I intend to discuss in this study is the cloth loom. The design of the apparatus is indicated in the diagram. It is nearly identical to the loom used elsewhere in Iraq, with the difference that the latter has the "beater in" suspended from a rigid rectangular framework instead of freely hung from the roof as in the Kurdish example. This improvement permits the widening of the warp. Thus while the Kurdish loom has a maximum warp of about  $10\frac{1}{2}$  inches, an apparatus which I saw in Baghdad could carry a warp nearly three times as wide. Kurdish weavers do not apparently ever attempt complicated patterns, they always use a plain weave. Stripes are sometimes introduced by means of coloured threads in the warp. Qualities of cloth produced differ mainly in the thickness and density of the threads. Thus from specimens in my possession, the coarse brown cloth, normally used for the trouserings of commoners, has Warp 19; Weft 22 threads

\*The rug loom is quite a different piece of apparatus; it is not considered here since its social relevance seems insignificant.

per inch; while a good quality coloured cloth such as worn by Aghas has Warp 44; Weft 28 threads per inch.

As mentioned already the village weaver, where there is one, now has to face serious competition not only from the cloth dealers of the town but also from certain large scale weaving concerns in Rowanduz and Erbil. The latter still use the ordinary Kurdish looms but seem to be able to produce a better quality product than the village craftsman. The difference may be due to the fact that the town craftsman uses a mechanically spun thread, whereas the village weaver in the main works with a hand spun article. But there is no definite tradition that the town made material is superior. The clothes worn by the Mir while I was in Dergala had been made from local cloth, his son Jelal, on the other hand, had purchased the stuff for his new blue trousers in Rowanduz. My impression is however that with the ever increasing facilities for contact with traders from the town the functions of the village weaver will soon become superfluous and the community will become completely dependent upon outside sources in yet one further respect.

### Warfare

Under present conditions large scale warlike activities on the part of the tribes are a complete impossibility, but that does not justify us in dismissing the topic of warfare altogether as being of no relevance to the present social situation. Historically speaking the traditional forms of Kurdish social organisation are associated with an ideology of raids and counter raids, war, pillage and feud. Earlier writers have undoubtedly greatly exaggerated the extent to which the average Kurd in former times did in fact devote himself to murder, violence and loot, but in describing this preoccupation they were, after all, only accepting the Kurd at his own valuation. The Kurdish ideal of manly behaviour does correspond very closely with the typical English concept of a "Brigand". His folk tales are gory in the extreme; his conversation hardly less so. And this has relevance to the existing situation. The Agha likes to think of himself as a military leader rather than as a landlord; he habitually classes all his neighbours into 'friends' and 'enemies'. The consequences of this attitude are highly subtle and cannot be examined here, but at least two divergent trends can be noted. On the one hand the sharp antagonism between neighbouring groups is even today a force of social cohesion; the members of the clan or the tribe are aware of their unity largely in terms of their common enmity to some other group. On the other hand increasing economic contacts and the constant harmonising efforts of the Police and the Administration, in so far as they are successful in lessening intergroup suspicion, do at the same time serve to lessen the social cohesion of the groups concerned.

While organised raiding or warfare is now impossible the private feud continues and may be examined further.

### The Feud

The motif of the blood feud may be summarised by the phrase that "a man's wrongs must be avenged by his kinsfolk and his descendants", and we may note at once that a system of small patrilocal, nearly endogamous groups is peculiarly suited to perpetuate antagonisms of this kind. The individual's near kinsfolk are also his near neighbours, and since his wife's kinsfolk are probably identical with his own he is bound by no ties of loyalty to any group outside his own village. Within the village all are bound together to resist the aggressor, beyond it everyone is a potential enemy, the identity of interest between the family and the village is complete.

Quarrels between villages may arise from a variety of causes, chiefly economic. Water and grazing rights are always ill-defined and may lead to serious friction in times of scarcity, and this may

lead to one side burning the other's crops or stealing their cattle. Until bloodshed has occurred nothing is serious and a good clan Agha will see to it that the parties submit to arbitration before the affair reaches a crisis. More serious are affairs in which women are involved; an insult to honour can only be wiped out by death and the discovery of adultery can have only one possible sequel. Such cases however need not necessarily lead to feud; if the guilty lover belongs to the same village as the injured husband a single murder is considered to settle the matter. If the parties are from different groups however the affair is much more serious and several assassinations may take place before settlement can be reached. Eventually, provided it is the honour of commoners rather than of Aghas that is at stake, the Aghas concerned will arrange *fasl* through the mediation of the tribal chiefs. According to Hay "A blood feud is usually settled by the payment of blood-money; every condition of man or woman has his or her price, and even the parts of the body are catalogued. A Kurmanji or middle class Kurdish farmer is valued at £90, one of his women at £45, and his leg or arm at say £20. Such payment is often made in kind, some cattle or a horse, or so much wheat being handed over to the aggrieved party. It is very common for a girl to be given away in marriage in payment of blood money. Thus if £90 were owing, the price of the blood of one man the debt might be paid by the delivery of one girl, three cows and a donkey". I have no comparable information, though I think the general principle is accurately described. In Hay's time the Government could seldom apprehend a murderer. He says "For the murdered man's relations to take their revenge is quite in order, but an execution at the hands of that monster, the Government, is an entirely different matter. The culprit therefore is carefully concealed until he can make good his escape to the hills". The position today is somewhat different and I fancy the murderer is usually caught. This however does not end the feud; blood feud murders are punishable only by two years imprisonment and the war starts again when the culprit gets free.\*

As has been explained the feuds of commoners and the less important Aghas are settled in the end by tribal arbitration. Moreover

\* The Administration makes a distinction between feud murders justified by tribal custom and ordinary murders which are not. The former come under a special code for which the maximum penalty is two years imprisonment; the latter come under the ordinary Iraq criminal code for which the penalty is much more severe (? death). This has had an interesting repercussion. In the old days by tribal custom an affair of honour was adequately settled if the man only was killed, the woman in the case being merely driven out of her own community to fend for herself. Today it is necessary for the avenging husband to prove to the Authorities that it is really an affair of honour and not just a cold blooded murder. The custom now therefore is to kill both the guilty parties.

nowadays the Government takes an active interest in the proceedings and by threat of dire and awful penalties is usually able to settle the affair near the start. Much more serious is a feud in which important tribal leaders are involved; here settlement is extremely difficult and assassinations may apparently continue for generations. One such major feud splits the Rowanduz district at the present time and has become so widespread that the contestants have assumed the scale and significance of political parties. Practically everyone I met seemed to be involved on one side or the other, some as active assassins, others, the majority, merely as intriguers. The term "my enemies" was clearly highly elastic; - as far as I could judge there was no particular distinction between mere political opponents and those one was prepared to assassinate. The allegiance of the more remote contestants is doubtless largely determined by kinship considerations, but this is not always obvious. A nephew of Hamid Amin of Dergala who had been shot in the back a year before was quite closely related to both of the principal contestant families; and there seemed to be no obvious reason why he should be campaigning on one side rather than the other.

When this particular feud started is not clear, but it was already well established in 1918 and Hay mentions it a number of times; the most recent murder of the sequence occurred the day after I left Rowanduz. The murderer had come out of prison three days before, having been gaoled two years previously on account of an earlier assassination. My records on the subject are certainly very incomplete but even so they show a considerable casualty record:-

Descendants and Relatives of Bawil Agha - 5 dead, 2 wounded,  
2 in prison.

Descendants and Relatives of Abdulla Pasha - 4 dead.

Today the affair has become entangled with all sorts of wider issues - Kurdish Nationalism in particular. Accusations of being pro-British, or pro-Arab, or anti-Kurd were levelled at all and sundry, and in the limited time available I had no chance to unravel all the complex of personal antagonisms and rival interests involved. Iraqi-Kurdistan however is now a part of Iraq and it was highly interesting to see how in this new political situation the old antagonisms were being realigned to cope with wider issues on a more impersonal front.

#### Religious Organisation

Religion is not a subject that the investigator can gain much information on in his first preliminary survey, and my own studies in this field were particularly slender.

\*Cf. the feud between the Husseinis and the Nahashibis in Palestine today.

All that I can do therefore is to describe in superficial terms the social position of the Mulla in his function as village priest, and give some description of the mosque as the visible evidence of the religious life of the community. I cannot make any attempt to examine beliefs or ritual practices in detail.

### The Mulla

Most of the larger villages have a resident Mulla. The functions and social position of this individual are by no means easy to define. His accomplishments are a supposed ability to read and write the Arabic language and an extensive knowledge of the Koran. This mental equipment is acquired during a long period of training as a student, during which time he is parasitic upon the village in which he lives, begging his keep and avoiding all serious manual labour. Most Mullas have one or two such pupils, some may have a dozen or more. They are not usually members of the local kinship group, but individuals who through some social maladjustment have left their own group and are thus without normal means of support. The student must I believe achieve a certain standard before he 'graduates' as a Mulla, but how this is defined is not clear, it certainly cannot be very high. The intellectual attainments of the Mulla vary greatly. Some have a real understanding of Arabic and Persian and of the written literature of their own language; others merely learn the Koran by rote and recite portions of it on suitable occasions without any clear understanding of the meaning. Knowledge of the Koran does not even necessarily imply an ability to read - the Mulla student in Rayat was quite blind but was gradually memorising the whole book. In general however the Mulla may be regarded as the most sophisticated member of the community. None of the ordinary commoners are literate; most of the Aghas would claim the distinction but I doubt their real ability - Ali Agha of Rayat for instance called in the Mulla both to read and write his letters, and Hamid Amin of Dergala though he could certainly read was scarcely fluent. In earlier times one of the Mulla's definite functions was to be scribe and general secretary to the Agha; conditions in this respect are changing rapidly owing to the fact that most Aghas sons are now quite well educated. Apart from such personal services to the Agha the Mulla's services to the community are roughly those of village priest. He leads the prayers in the mosque, and on the Sabbath (Friday) supplements this with a brief sermon in Arabic, which is entirely unintelligible to his audience. He officiates at weddings and funerals and recites suitable verses from the Koran. It was hinted further that he is frequently called in to cure sickness - chiefly by means of prayers and charms and exorcism. I have no information at all as to the magical procedure involved, but the wide distribution of amulets and Koranic charms, especially among the women and the smaller children suggests that there is a field here for investigation.

In return for these services he receives from the Agha a

free house and cultivation and from the commoners gifts in accordance with particular services rendered. He usually marries into the community concerned and his heirs will become ordinary kurmanj of the village.

It is difficult to assess what, in the norm, is his social position vis-a-vis the chief. He is one of those who has the run of the Agha's Guest House, a right otherwise reserved for strangers and near relatives (khezem), and he is always greeted with formal respect. But beyond that it is difficult to generalise. Ideally no doubt he should use his religious influence to back up the prestige and authority of his patron the Agha, but the facts seem at variance. The Mulla in Rayat was clearly the close confidant and right hand man of the Agha, he dined every evening in the Guest House and was present at all discussions. In Walash on the other hand the Mulla though frequently in the Guest House was treated as a person of small importance and I never saw him in conversation with the Agha. In Dergala again, the Mulla though admittedly a person of importance never came to the Guest House at all during the week of my stay and considerable precautions seemed to be taken that I should not meet him myself independently. In this case there was some definite source of friction between the Agha and the Mulla, though I do not know its nature.

To sum up then it is clear that though the Mulla holds his land and his position as a direct fief from the Agha, his functions are such that he may yet gain considerable independent wealth and influence. In the old days it must have been necessary for the efficient working of the gund that the Mulla and the Agha should be in harmony and work in close collaboration. Under present conditions the attitude of the Mulla appears to be of less significance for the community as a whole.

On the other hand it may well be that in the plains where the Agha is frequently an absentee landlord, the social influence of the Mulla is much greater than is at present the case among the hills. Hay for instance attaches much greater weight to the Mulla's influence than seems justifiable on my own evidence.

### The Mosque

In Arabic the word *masjid* simply signifies a place of prayer. The essential constituents are an open courtyard where the faithful may assemble and a place for ritual ablutions. Historically the covered courtyards, the domes and the minarets are later accretions to the simpler form. In the cool of the hills the open courtyard has been maintained. In most of the villages the mosque is simple paved courtyard of slatestone, surrounded by stone seats with a spring or a fountain in the middle. The slatestone courtyard has the same sanctity as the floor of an ordinary mosque and the visitor must remove



his shoes before stepping onto the stone. Here the Mulla recites prayers five times a day and those who feel like it join in. The average commoner is very casual about his prayers; many do not pray at all, those who do mostly pray only at sunset. The Aghas on the other hand are frequently excessively sanctimonious; of my acquaintances Hamid Amin of Dergala in particular made a tremendous fuss about his prayers and ritual washings. It was interesting to note that he would often break off in the middle, give orders to his servants, and then go on again where he left off. While one can have no insight into his real religious feelings, I got the impression that it was largely done for show. There is a definite prestige value attached to being a devout Mohammedan - it is the characteristic of a gentleman. In the same way the Aghas consistently make a show of being very strict about the seclusion and veiling of their womenfolk when strangers are present while commoners, if they bother at all, are lax and casual.

A man need not of course go to the mosque to pray. Each man's prayer mat is in effect his own mosque. The actual practice varies in different villages depending I fancy upon the example set by the Agha. Anyway I noticed that there was always a much higher attendance at prayers when the Agha was there in person. The conventions seem to be analogous to those of English churchgoing, there is a much bigger attendance on the Sabbath. The devout Hamid Amin of Dergala for instance said his prayers at home all the week but on Fridays attended at the mosque, and most of the village went too.

Some villages have a supplementary roofed building which is used as a mosque during the winter, but this is not invariable. In the foothills area and on the plain the mosque is normally a roofed building with minaret attached. In this case prayers are held either within the covered courtyard or on the roof.

### The Limitations of the Foregoing Material

The reader may have noted a serious defect in the samples of evidence offered to support my generalisations. In nearly every case the authority quoted is either an Agha or a near relative of an Agha. It may reasonably be queried whether, - if all my informants had been commoners, - the same general picture of the social organisation would have emerged.

The reasons for limiting my enquiry to Agha sources were strictly practical ones. I was the first Englishman for some years to approach the district without some form of military protection, and since it was assumed that I must necessarily be a secret agent of the former mandatory power I was naturally the object of considerable curiosity and suspicion. The high policy that caused Britain to establish Iraq as an independent state is incomprehensible to the Kurdish tribesman, and it is assumed that Kurdistan is somehow an important bone of contention between the English and the Arabs. Accordingly though I travelled with an official pass from the Ministry of the Interior, it was generally assumed that in some mysterious way I was plotting against the Government; my curiosity concerning the intimate details of Kurdish life was regarded as a cloak with which to hide my subtler designs. This put my Agha hosts in an awkward position. Obligations of hospitality compelled them to treat me as an honoured guest, and if my coming implied, as was rumoured, 'that the English were coming back', then certainly they would be well advised to treat me well. On the other hand if I was really an enemy of the Arabs, my undue familiarity with me would surely lead to a relentless grilling at the hands of the police as soon as I had left. And there were further complications - Hamid Amin of Dergala assured my interpreter that he had not slept a wink throughout my stay. As he saw it, I was in mortal danger. This was a golden chance for his enemies - they had only to bump me off and it would be he that would get in disgrace with the Government! Accordingly four armed sentries were posted round my bed every night.

In this complex web of intrigue and distrust it is understandable that the Aghas, though willing enough that I should discuss village affairs with them personally, were extremely suspicious of anything that I might attempt to discover without their knowledge. Accordingly, since I believed at the time that I would be returning to the area later for more intensive study, I made little attempt to confirm the Agha's description of affairs by means of check interviews with commoners. This fact must be borne in mind by anyone using this monograph as a basis for further research. Even where the facts as described by me seem to be confirmed by further enquiry, it will be necessary to round the statement off by an analysis of the position as seen from the commoner's point of view.

## The Positive Contribution

On the other hand on the positive side I have attempted to avoid dry generalisations of the form "the Kurds marry their first cousins". My aim definitely has not been to record the "manners and customs" of the Kurds. Rather I have tried to throw some light on the contrasting factors of conflict and cohesion that affect the lives of the small group of people inhabiting this Rowanduz area. If there is any moral in the story it is to emphasise once again the futility of attaching psychological labels to cultural groups. Again and again the Kurds as a group have been labelled treacherous, bloodthirsty, lazy, virile, stupid and a dozen things besides; this study at least should show that there can be no such easy classification. It is true that the structural pattern of a society does impose upon individuals some interests of different individuals in widely different ways and their resulting reactions differ accordingly. There can never be absolute conformity to the cultural norm, indeed the norm itself exists only as a stress of conflicting interests and divergent attitudes. All cultural groups, no matter how stable they appear in the light of history, are within themselves at any given time in a constant state of flux and potential change, the balance is always precarious.

Thus the changes, often violent and disintegrative, that arise under conditions of Culture Contact differ only in degree and not in kind from smaller incipient changes that take place all the time even when the culture group is functioning under "natural" conditions, however those may be defined. The mechanism of culture change is to be found in the reaction of individuals to their differential economic and political interests. Viewed in this light the problems even of a small and obscure Kurdish tribe may have a wide and general relevance, extending even to the conditions of our own society. The study of processes of change and development is a cardinal problem for sociologists. As an anthropologist I would argue that these processes can best be studied in the microcosmic conditions of a small and relatively isolated group, where the limits of individual interest can be clearly recognised; but the problem is one of general application.

In conclusion, so far as the Kurds are concerned, I will merely express the hope that this analysis is soon put out of date by more intensive research.

## KINSHIP TERMS

TABLE I. FATHER'S RELATIVES

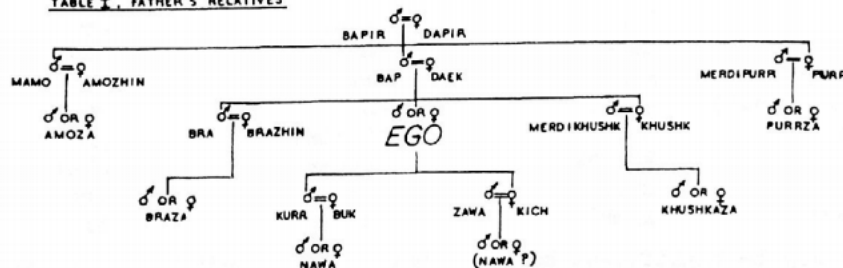

TABLE II. MOTHER'S RELATIVES

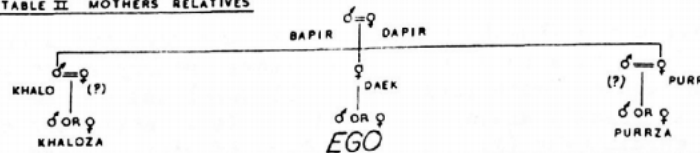

TABLE IIIA. HUSBAND'S RELATIVES

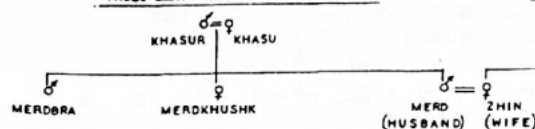
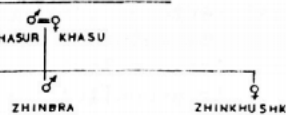

TABLE IIIB. WIFE'S RELATIVES



## APPENDIX.

## Note on Table of Kinship Terms

General. The Kurdish language spoken in the Rowanduz area has much in common with old Persian, but contains far fewer Arabic importations than does modern Persian. In both languages the kinship terms show a blending of Indo-European and Semitic roots but there is no close correspondence. Thus:-

	Kurdish	Persian	Arabic
Grandfather	bapir	jadd	jidd
Father	bap	pidar	abu
Mother	daek	madar	umm
Uncle (paternal)	mamo	'amm	'amm
" (maternal)	khalo	khal	khal
Brother	bra	biradar	akh
Sister	khushk	khahar	ukht
Son	kurr	pisar	ibn
Daughter	kich	dukhtar	bint

It may be significant however that in both Kurdish and Persian Semitic words are used to describe the two types of Uncle.

Table 1. As explained elsewhere in the text, the term *amoza* (father's brother's child) appears to be used in a classificatory sense to include all members of Ego's *tira*. The colloquial use of the English word 'cousin' is closely analogous to this. It is not clear whether terms such as *merdikhushk* (literally 'husband of sister') are merely descriptive in the sense of 'my sister's husband', or whether they are actual terms of colloquial reference such as 'brother in law'.  
 Buk - 'daughter in law' - literally means 'bride'  
 Zawa - 'son in law' - " " " 'bridegroom'  
 Nawa - 'grandchild' - seems to have an extended meaning in the sense of 'descendants'.

Table 2. Note that in a system of ortho-cousin marriage, 'mother's brother' may frequently be married to 'father's sister', so that the 'khaloza' may also be members of Ego's own *tira*.

Table 3. *Zhin* - 'wife' - and *merd* - 'husband' - mean literally simply 'woman' and 'man' respectively.

It is not clear how any of these tables are affected in a situation of Polygyny. Thus Jelal Beg, eighth son of the Mir of Dergala told me that he had only one brother - i.e. by his own mother. He said he addressed his step-mothers as *daek*, but if he wanted to be more specific would add a name; thus *daek Fatim* - 'mother Fatima'. I do not know whether any distinction is made between uncles who are full brothers of Ego's father and those who are only half brothers.

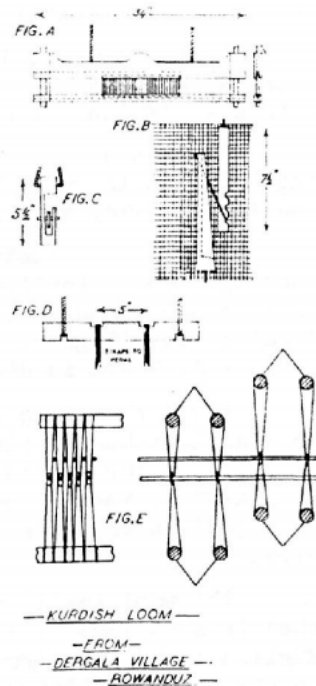
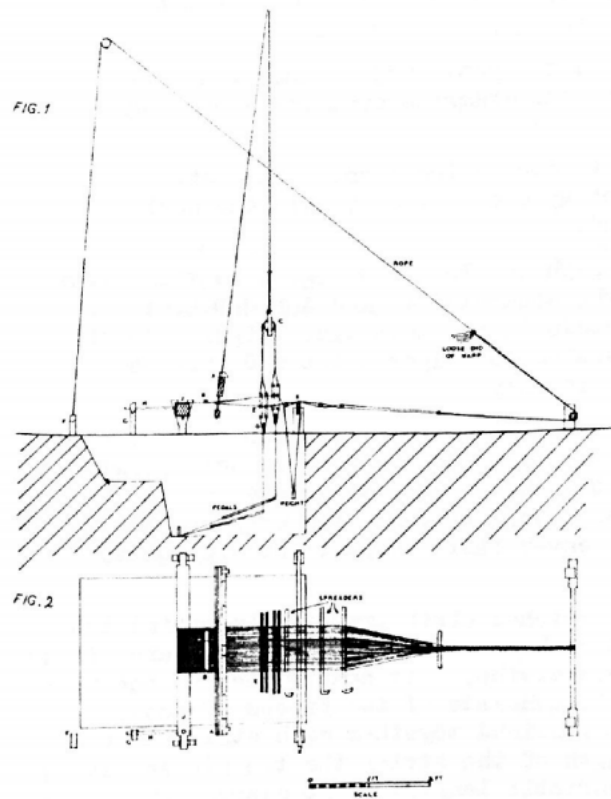

## The Kurdish Loom

The Kurdish Loom illustrated on the opposite page has not, so far as I can discover, been described in detail before. \*Ling Roth mentions the Hindu Pit Treadle Loom as a variation of the Horizontal Narrow Band Treadle Loom but does not describe it. The Kurdish Pit Treadle Loom, here shown, is similar to that used in Central Mesopotamia except that the latter has the sley slung from a rigid rectangular framework thus allowing of a wider warp.

Taken in conjunction with the photographs (unfortunately blurred owing to overexposure) the diagrams opposite should be more or less self explanatory.

The weaver sits in a pit beneath the loom. He operates the heddle mechanism with his feet by means of a treadle and works the shuttle and sley with his hands.

Fig. 1 is a section through the loom and Fig. 2 is the corresponding plan. Portions of the apparatus marked A.B.C.D.E. in small letters are shown in larger scale in the subsidiary figures to the right of the diagram. The scales for figures A.B.C.D. are as indicated; Fig.E is diagrammatic only.

Fig.A shows the sley (reed, beater in). As can be seen it can be readily taken to pieces. The comb of the reed is not rigidly attached to the batten frame but runs freely in grooved slots indicated by the dotted lines. This prevents the warp being 'dragged' on one side if the weaver fails to pull the sley quite straight.

The woof (weft) on the finished cloth immediately behind the shed is kept taut by the device shown in Fig.B. I am unaware of the English technical term for this device. It can be seen in position in one of the photographs. It consists of two pieces of wood, each with a steel needle at one end, joined together with string at the other. By adjusting the length of the string the two pieces can be made to form a rigid bar of variable length. The diagram shows the pieces in position on the cloth before locking one inside the other.

Fig.C shows one of the two pulley blocks supporting the heddle rocker.

Fig.D shows one of the bars from which the pedal straps are suspended; it appears in cross section in figure 1 at the point D.

Fig.E shows (diagrammatically) the way the warp threads are threaded through the leashes of the heddle. Note from figure 1 that both heddle and counter-heddle are double, the odd threads passing through both sets of leashes on one side of the rocker and the even threads through those of the other. I did not obtain precise details of how the leash strings are knotted and looped.

\*H. Ling Roth - Studies in Primitive Looms

The finished cloth is rolled on the square sectioned breast beam (J). This is held in position by the rod H which fits into one of four holes in the sides of J and is hooked under the fixed ground peg F. To adjust the warp the rope is freed at F, and H and J can then be adjusted at will. It should be noted that for convenience F.G.H. have been shown in Fig.1 as well as in Fig.2 though they are positioned on the weavers right hand side as indicated in the plan.

There are three spreaders (laze rods), the front one of which is in front of the raddle beam K. This last is held down by the weight shown in figure 1; this prevents the spreader slipping forward into the heddle mechanism and prevents the warp 'bouncing' on K. Without this device the rear spreaders would require constant adjustment.

The raddle beam K is slightly grooved on the top face so as to keep the threads in place; it serves the same function as the spreaders - that of keeping the warp threads taut and spread out. Its occurrence is unusual in primitive loom designs.

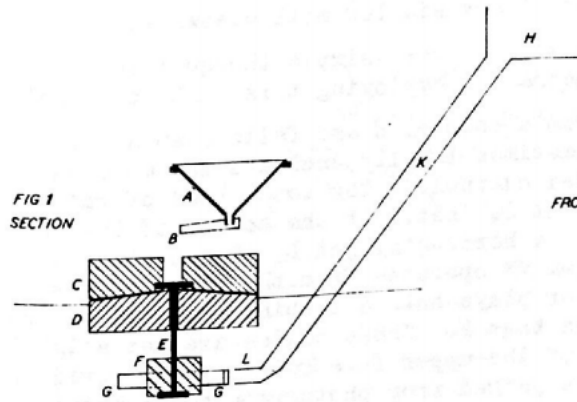

FIG 1  
SECTION

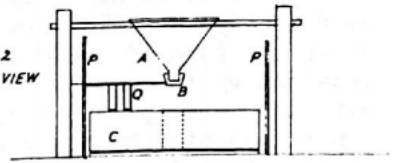

FIG 2  
FRONT VIEW

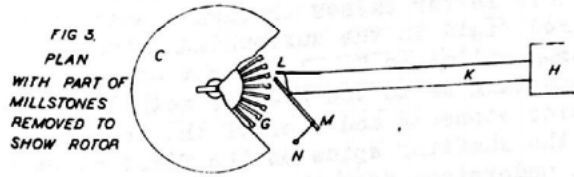

FIG 3  
PLAN  
WITH PART OF  
MILLSTONES  
REMOVED TO  
SHOW ROTOR

— DIAGRAMS TO SHOW WORKING —

— PRINCIPLE OF A KURDISH MILL —

— APPROX. SCALE: MILLSTONE DIA. 3 1/4 FT. —

## The Kurdish Water Mill - Hill Country, Turbine Type

The diagrams opposite should be read in conjunction with the photographs at the end. The type of mill illustrated is found all over the Rowanduz area (Map 1. Area A) and probably has a wide distribution, it is not found however in the plains districts where an entirely different type of water wheel is in use. I have so far failed to trace a description of any similar mill elsewhere.

The operation of the mill is very simple though I know of no other example of primitive mechanism employing this turbine principle.

Water is supplied from a channel H and falls down a steep shoot or feed pipe K. This is sometimes totally enclosed but more usually takes the form of a deep sided channel. The total head of water obtained by this means is about 20 feet. At the bottom of the feed pipe the water passes through a horizontal jet L, the aperture of which can be adjusted by a mechanism MN operated from the floor of the mill-house. From the jet the water plays onto a turbine rotor of wooden blades G set in a heavy stone boss F. These blades are set slightly on the skew and have a portion of the upper face cut away to provide a cup. The extent of the skew can be judged from photograph No.15 where a spare rotor block can be seen on the left of the picture. There is no bottom bearing and the whole rotor mechanism hangs freely from above, supported only by the steel shafting E. This latter passes through a hole in the lower millstone D, (which is fixed rigid in the surrounding masonry) and is slotted into the upper rotating millstone C. I did not see the apparatus dismantled so I am uncertain as to the precise method of keying the shafting into the rotor stones F and C or of the form of the bearing where the upper end of the shafting spins on the fixed stone D. The corn feed mechanism is best understood from the photograph. The corn passes from the bin A, into the dripfeed B. The dripfeed is attached to the device Q which is joggled by the rotation of the millstone. This causes the feed B to vibrate and drop the corn grains into the central hole of the millstone. The rate of feed is adjusted by varying the incline of the feed B. The screen P is erected round the back and sides of the millstone so as to prevent the flour flying out in all directions.

The following additional explanation refers to the diagrams only. In Fig.1 the structure supporting the corn bin and the screen P and also the mechanism for adjusting and vibrating the feed B are omitted. It should be understood that the lower stone D is set rigid in the ground, while the rotor mechanism FG hangs freely in a cavernous space underground. In Fig.3 the rotor and jet setting is oversimplified, and the skew setting of the rotor blades ignored. The jet L is actually slightly above the rotor blades and the direction of the water flow slightly downwards. The blades are thus struck in the centre at an incline of about 30 degrees rather than at the ends horizontally as the diagrams would seem to indicate. In actual operation the machine works remarkably smoothly at slow speeds, but as might be expected a violent vibration develops if any attempt is made to drive the apparatus hard.

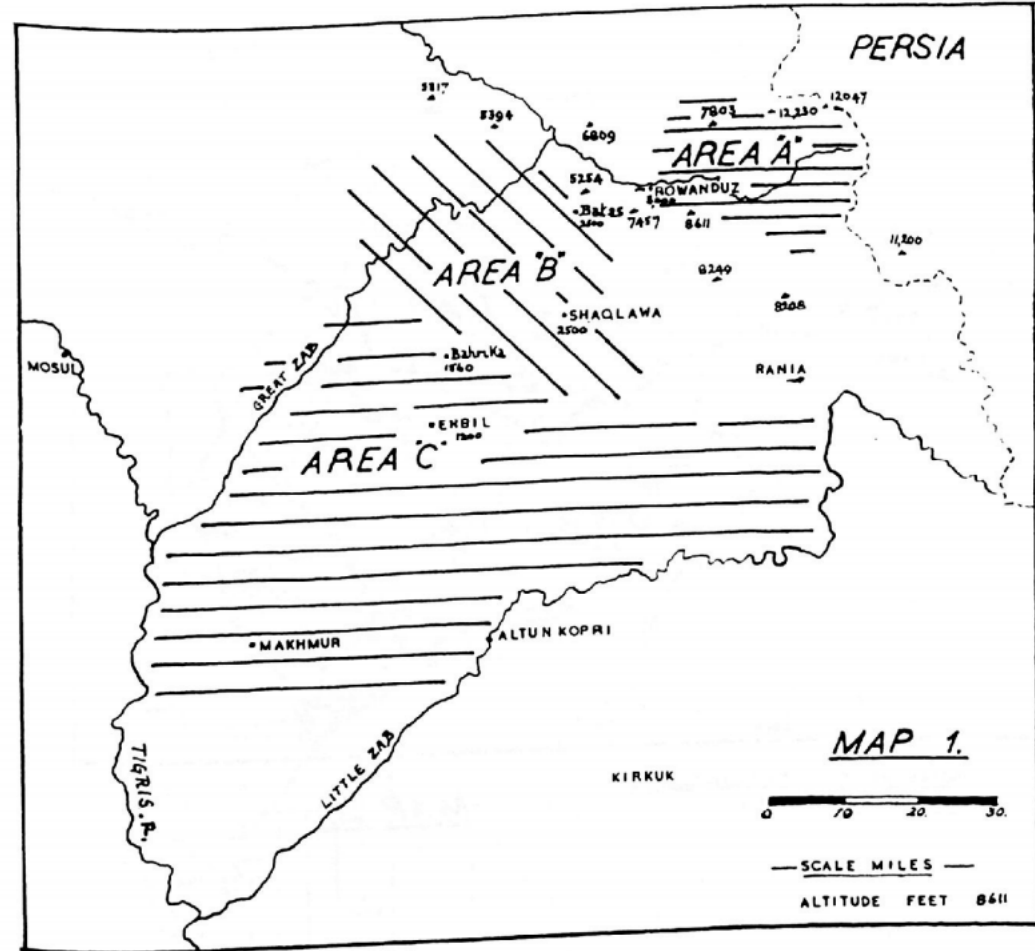

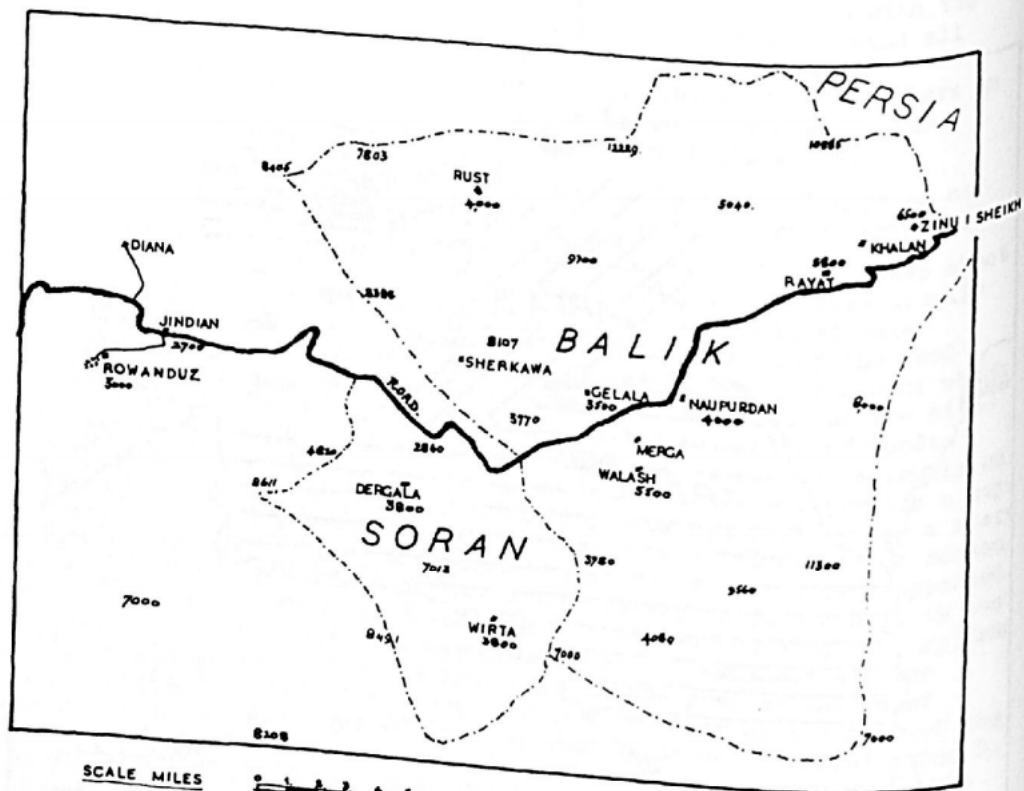

SCALE MILES  
ALTITUDE FEET

— MAP 2. —

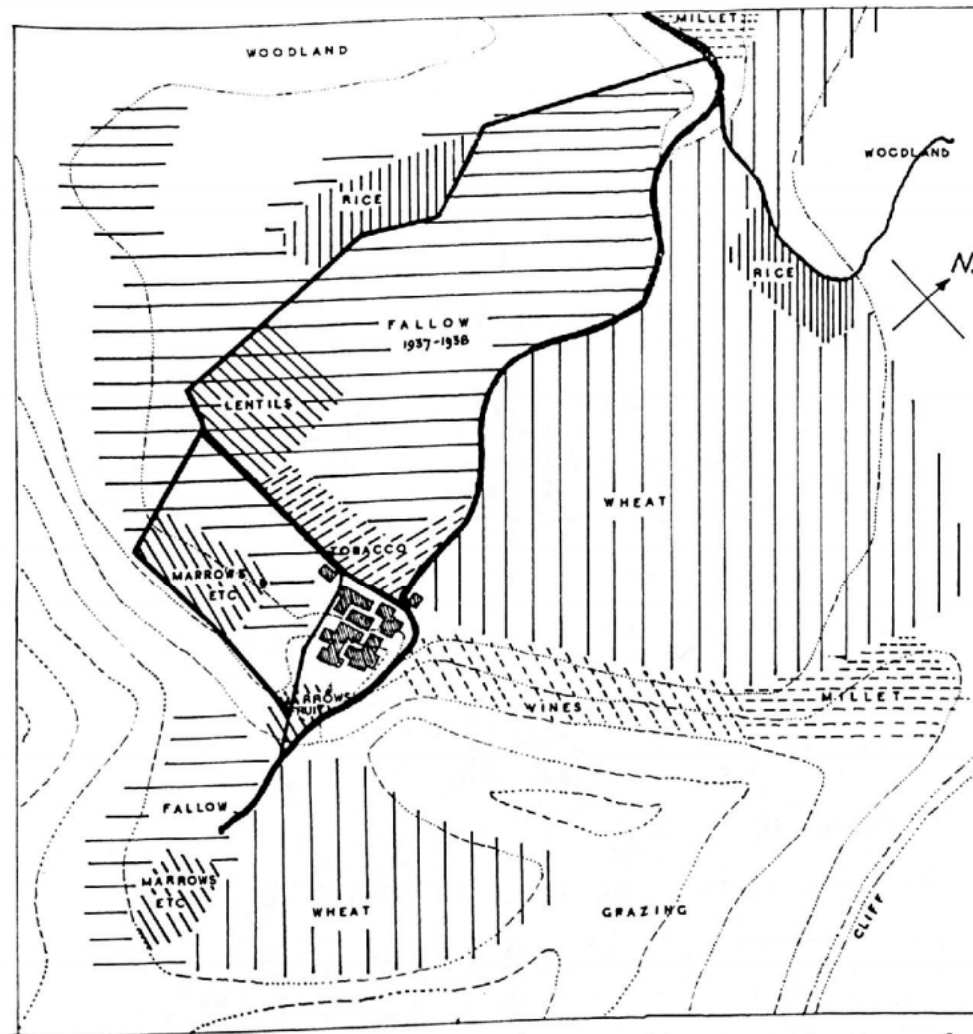

CONTOUR INTERVALS APPROX 50 FT

SCALE > TOTAL WIDTH OF MAP  $\frac{3}{4}$  MILE

NATURAL WATERCOURSE

ARTIFICIAL "

BUILDINGS

— LAND UTILISATION —

— WALASH VILLAGE SUMMER 1938 —

## List of Photographs

1. People. Young Kurdish Agha; - a nephew of Ali Agha of Rayat.
2. " Hamid Amin Agha of Naupurdan, his elder brother, and a visiting Mulla.
3. Dwellings. Typical house construction, Dergala.
4. " Ali Agha's "Black Tent" at Rayat. The open section at the near end is the "Guest House".
5. Food. Girl churning mast, an operation normally carried out at early dawn.
6. " A visitor takes his meal. The food consists of thin bread (nan); rice soup; saua pilaw, ghee, and, as drink, mastao (watered down mast). Note that shoes have been removed before sitting down to eat. Note also the bowl of lump sugar beside the teacups in the background.
7. Plough - Rayat Village.
8. Plough - detail. Note the simplicity with which the apparatus can be dismantled.
9. Threshing - Hill country style; Walash Village.
10. " - Plains style. (See comments in text).
11. Winnowing - Rayat Village.
12. The travelling carpenter makes a winnowing fork.
13. Loom - (For comparison with diagrams)
14. " ( " " " )
15. Turbine Water Mill - (For comparison with diagrams; especially Fig.2).
16. " " " - Rotor blades.

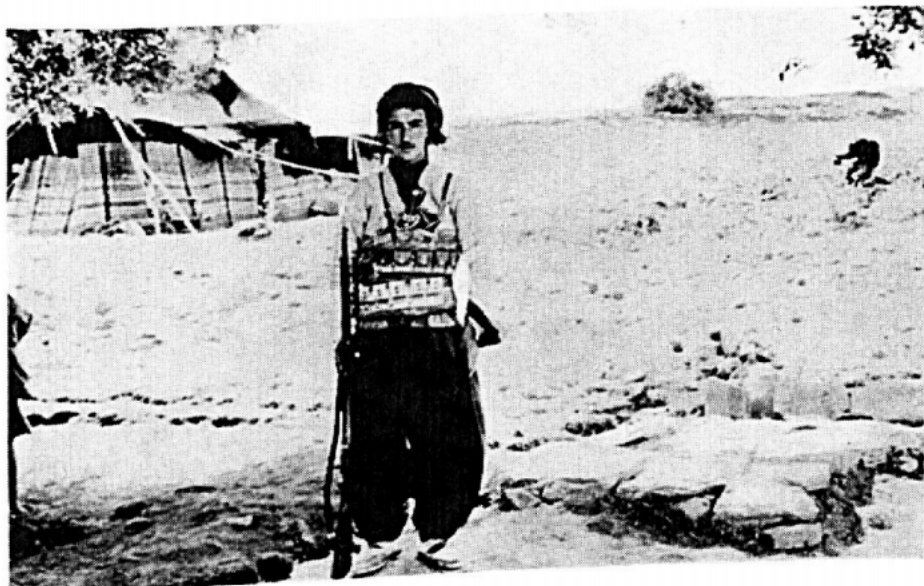

Plate 1.  
People. Young Kurdish Agha—a nephew of Ali Agha of Rayat.



Plate 2.  
People. Hamid Amin Agha of Naupurdan, his elder brother, and a visiting Mulla.



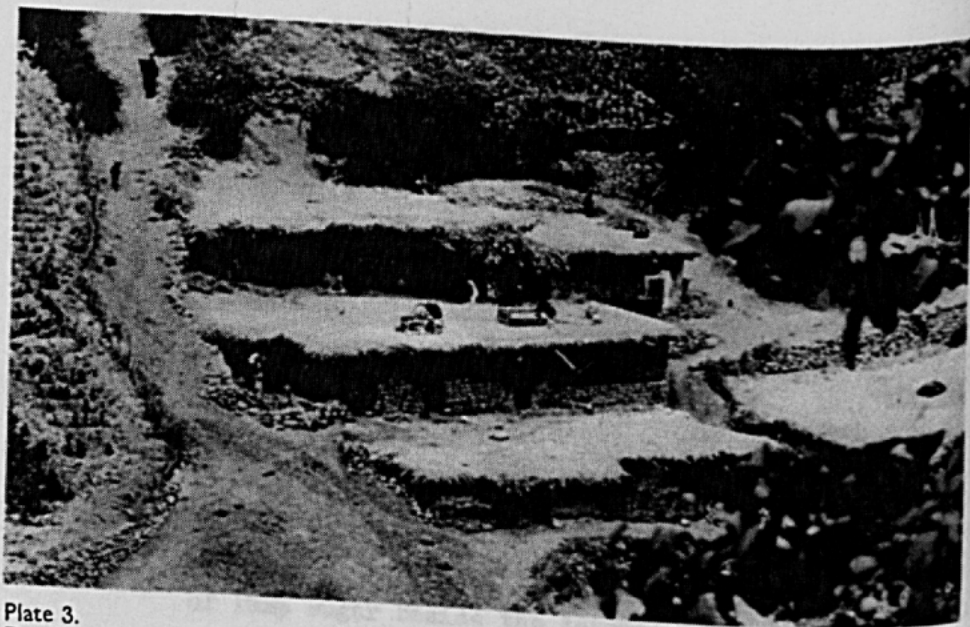

Plate 3.  
Dwellings. Typical house construction, Dergala.

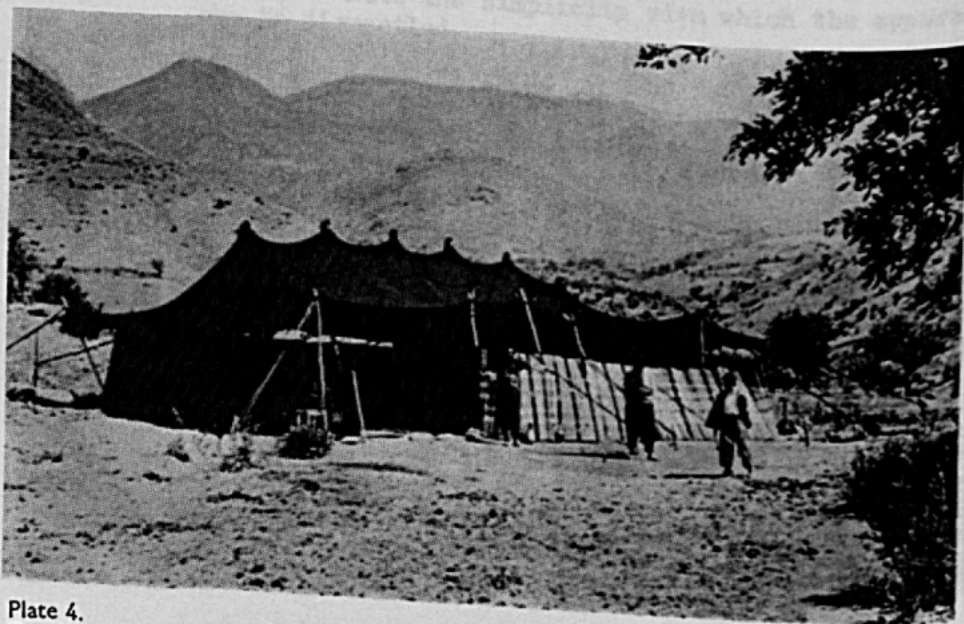

Plate 4.  
Dwellings. Ali Agha's "Black Tent," at Rayat. The open section at the near end is the "Guest House."



Plate 5.  
Food. Girl churning mast, an operation normally carried out at early dawn.



Plate 6.  
Food. A visitor takes his meal. The food consists of thin bread (nan); rice soup; saua pilaw; ghee, and, as drink, mastao (watered-down mast). Note that shoes have been removed before sitting down to eat. Note also the bowl of lump sugar beside the teacups in the background.

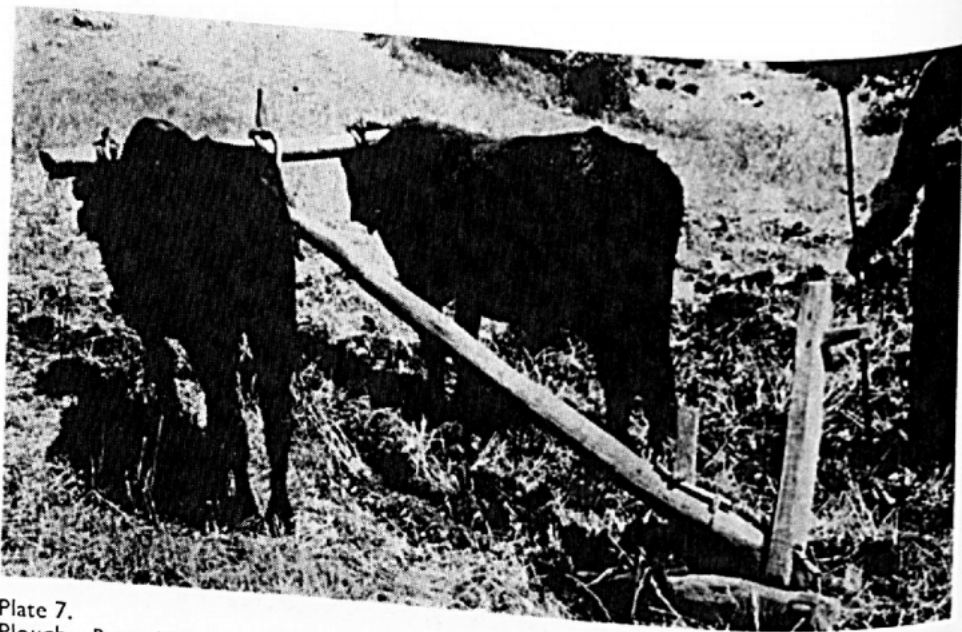

Plate 7.  
Plough. Rayat Village.



Plate 8.  
Plough. Detail. Note the simplicity with which the apparatus can be dismantled.



Plate 9.  
Threshing. Hill country style; Walsh Village.

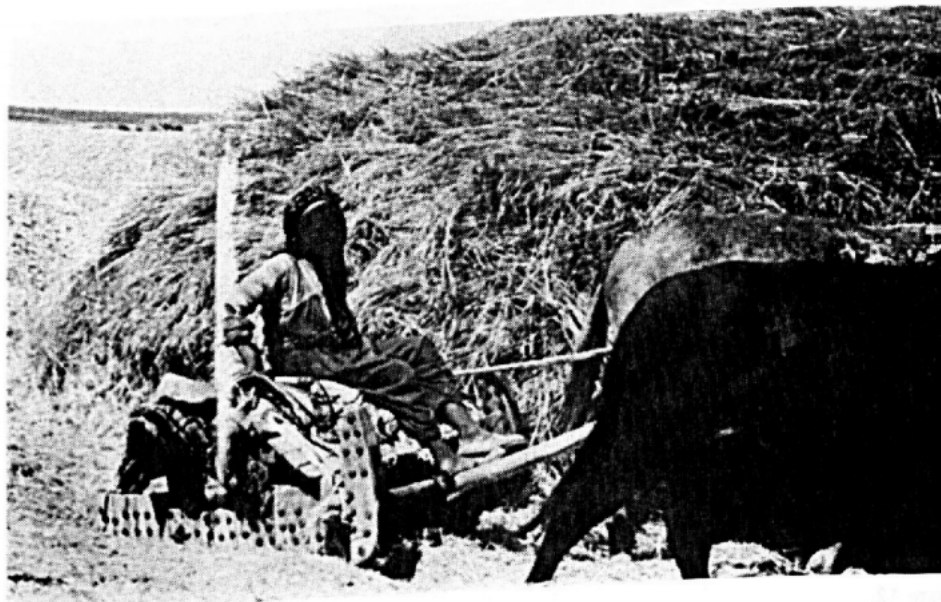

Plate 10.  
Threshing. Plains style. (See comments in text.)



Plate 11.  
Winnowing. Rayat Village.

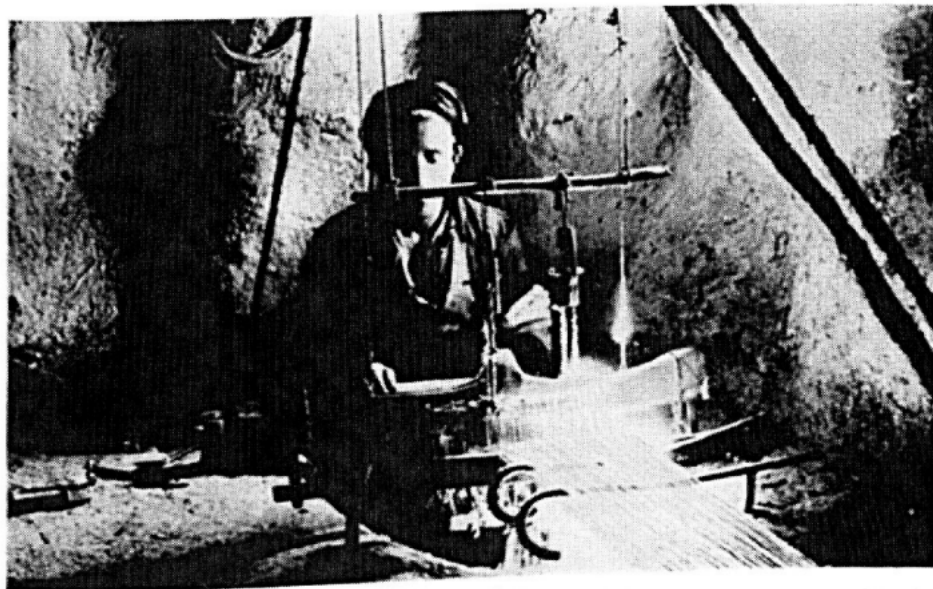

Plate 13.  
Loom. (For comparison with diagrams.)



Plate 12.  
The travelling carpenter makes a winnowing fork.

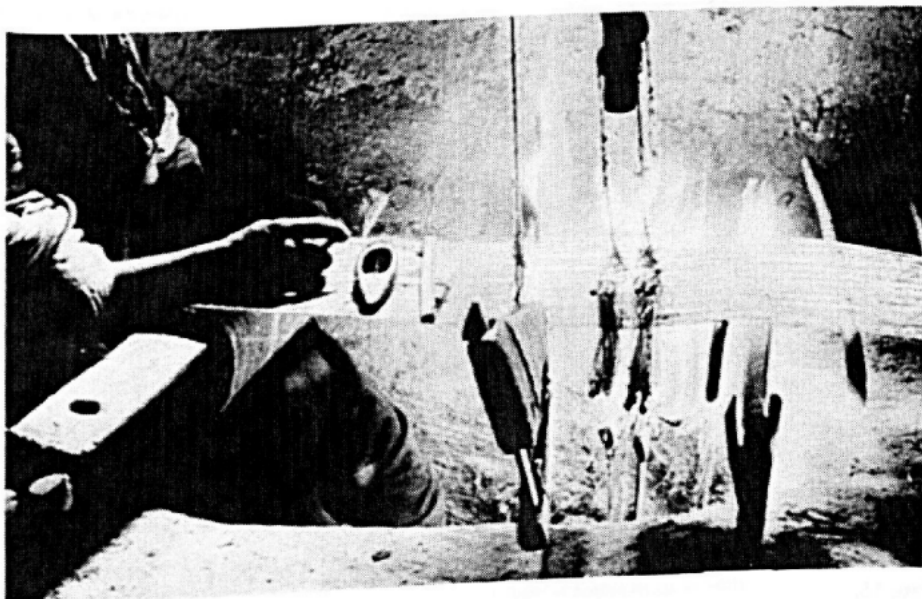

Plate 14.  
Loom. (For comparison with diagrams.)

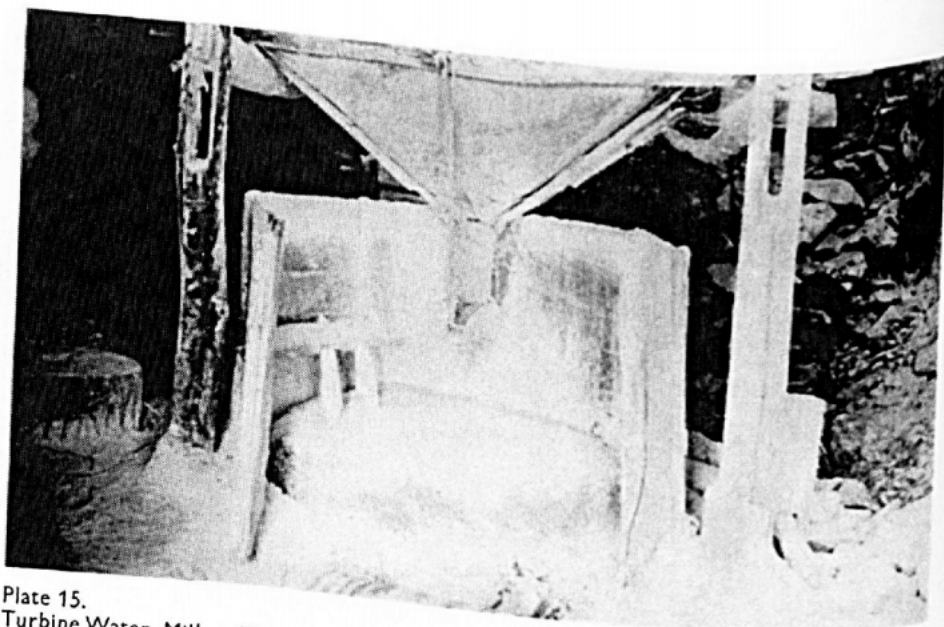

Plate 15.  
Turbine Water Mill. (For comparison with diagrams;  
especially Fig. 2.)



Plate 16.  
Turbine Water Mill. Rotor blades.

**London School of Economics Monographs on Social Anthropology series**

*Series Editor: Charles Stafford*

*With over 70 volumes published since 1949, including classic work by Gell, Barth, Leach and Firth, the LSE Monographs now form one of the most prestigious series in the discipline of Anthropology. Presenting scholarly work from all branches of Social Anthropology the series continues to build on its history with both theoretical and ethnographic studies of the contemporary world*

74. **Between China and Europe**  
Person, Culture and Emotion in Macao  
*Joao de Pina-Cabral*
73. **The Earth Shakers of Madagascar**  
An Anthropological Study of Authority, Fertility and Creation  
*Oliver Woolley*
72. **Chinese Sociologies**  
An Anthropological Account of Alienation and Social Reproduction  
*P. Steven Sangren*
71. **The Performance of Gender**  
An Anthropology of Everyday Life in a South Indian Fishing Village  
*Cecilia Busby*
70. **Arguments with Ethnography**  
Comparative Approaches to History, Politics and Religion  
*Ioan M. Lewis*
69. **Those Who Play with Fire**  
Gender, Fertility and Transformation in East and Southern Africa  
*Henrietta L. Moore, Todd Sanders and Bwire Kaare*
68. **Conceiving Persons**  
Ethnographies of Procreation, Fertility and Growth  
*Edited by Peter Z. Loizos and P. Heady*
67. **The Art of Anthropology**  
Essays and Diagrams  
*Alfred Gell (Edited by Eric Hirsch)*
66. **Leadership and Change in the Western Pacific**  
*Edited by Richard Feinberg and Karen Ann Watson-Gegeo*
65. **Hierarchy and Egalitarianism**  
Castle, Class and Power in Sinhalese Peasant Society  
*Tamara Gunasekera*
64. **The Harambee Movement in Kenya**  
Self-help, Development and Education among the Kamba of Kitui District  
*Martin J. D. Hill*
63. **Society and Politics in India**  
Essays in a Comparative Perspective  
*Andre Beteille*
62. **The Power of Love**  
The Moral Use of Knowledge amongst the Amuesha of Central Peru  
*Fernando Santos-Granero*
61. **Making Sense of Hierarchy**  
Cognition as Social Process in Fiji  
*Christina Toren*
60. **The Social Practice of Symbolization**  
An Anthropological Analysis  
*Ivo Strecker*
59. **Gods on Earth**  
The Management of Religious Experience and Identity in a North Indian Pilgrimage Centre  
*Peter van der Veer*
58. **Ritual, History and Power**  
Selected Papers in Anthropology  
*Maurice Bloch*
57. **Sacrifice and Sharing in the Philippine Highlands**  
Religion and Society among the Buid of Mindoro  
*Thomas P. Gibson*
56. **Communication, Social Structure and Development in Rural Malaysia**  
A Study of Kampung Kuala Bera  
*William D. Wilder*
55. **Forest Traders**  
A Socio-Economic Study of the Hill Pandaram  
*Brian Morris*
54. **Ma' Betisek Concepts of Living Things**  
*Wazir-Jahan Karim*
53. **White Nile Arabs**  
Political Leadership and Economic Change  
*Abbas Ahmed Mohamed*
52. **Knowledge of Illness in Sepik Society**  
A Study of the Gnau, New Guinea  
*Gilbert Lewis*
51. **Metamorphosis of the Cassowaries**  
Umeda Society, Language and Ritual  
*Alfred Gell*
50. **Choice and Change**  
*Edited by John Davis*
49. **Beyond the Village**  
Local Politics in Madang, Papua New Guinea  
*Louise Morauta*
48. **Land and Family in Pistieci**  
*J. Davis*
47. **West Indian Migration**  
The Montserrat Case  
*Stuart B. Philpott*
46. **Uncertainties in Peasant Farming**  
A Colombian Case  
*Sutti Ortiz*
45. **Pioneers in the Tropics**  
The Political Organization of Japanese in an Immigrant Community in Brazil  
*Philip Staniford*
44. **Political Systems of Highland Burma**  
A Study of Kachin Social Structure  
*E. R. Leach*