

The background of the book cover is dark. A large, vibrant rainbow arc curves across the middle of the cover, starting from the bottom left and moving towards the top right. In the bottom right corner, there is a partial view of a CD-ROM, showing its reflective surface and the center hole.

# The ART of SOFTWARE TESTING

SECOND EDITION

**GLENFORD J. MYERS**

Revised and updated by Tom Badgett and Todd M. Thomas  
with Corey Sandler

# The Art of Software Testing

*Second Edition*

**Glenford J. Myers**

Revised and Updated by

**Tom Badgett and Todd M. Thomas  
with Corey Sandler**



John Wiley & Sons, Inc.



# **The Art of Software Testing**



# The Art of Software Testing

*Second Edition*

**Glenford J. Myers**

Revised and Updated by

**Tom Badgett and Todd M. Thomas  
with Corey Sandler**



John Wiley & Sons, Inc.

Copyright © 2004 by Word Association, Inc. All rights reserved.

Published by John Wiley & Sons, Inc., Hoboken, New Jersey.

Published simultaneously in Canada.

No part of this publication may be reproduced, stored in a retrieval system, or transmitted in any form or by any means, electronic, mechanical, photocopying, recording, scanning, or otherwise, except as permitted under Section 107 or 108 of the 1976 United States Copyright Act, without either the prior written permission of the Publisher, or authorization through payment of the appropriate per-copy fee to the Copyright Clearance Center, Inc., 222 Rosewood Drive, Danvers, MA 01923, (978) 750-8400, fax (978) 646-8600, or on the web at [www.copyright.com](http://www.copyright.com). Requests to the Publisher for permission should be addressed to the Permissions Department, John Wiley & Sons, Inc., 111 River Street, Hoboken, NJ 07030, (201) 748-6011, fax (201) 748-6008.

**Limit of Liability/Disclaimer of Warranty:** While the publisher and author have used their best efforts in preparing this book, they make no representations or warranties with respect to the accuracy or completeness of the contents of this book and specifically disclaim any implied warranties of merchantability or fitness for a particular purpose. No warranty may be created or extended by sales representatives or written sales materials. The advice and strategies contained herein may not be suitable for your situation. The publisher is not engaged in rendering professional services, and you should consult a professional where appropriate. Neither the publisher nor author shall be liable for any loss of profit or any other commercial damages, including but not limited to special, incidental, consequential, or other damages.

For general information on our other products and services please contact our Customer Care Department within the United States at (800) 762-2974, outside the United States at (317) 572-3993 or fax (317) 572-4002.

Wiley also publishes its books in a variety of electronic formats. Some content that appears in print may not be available in electronic books. For more information about Wiley products, visit our web site at [www.Wiley.com](http://www.Wiley.com).

Library of Congress Cataloging-in-Publication Data:

Myers, Glenford J.

The art of software testing / Glenford J. Myers ; Revised and updated by Tom Badgett and Todd Thomas, with Corey Sandler.—2nd ed.

p. cm.

ISBN 0-471-46912-2

1. Computer software—Testing. 2. Debugging in computer science. I. Badgett, Tom. II. Thomas, Todd M. III. Sandler, Corey, 1950– IV. Title.

QA76.6.M888 2004

005.1'4—dc22 2004002227

Printed in the United States of America

10 9 8 7 6 5 4 3 2 1

# CONTENTS

List of Figures and Tables	ix
Preface	xi
Introduction	xiii
<b>Chapter 1 A Self-Assessment Test</b>	<b>1</b>
<b>Chapter 2 The Psychology and Economics of Program Testing</b>	<b>5</b>
The Psychology of Testing	5
The Economics of Testing	9
Black-Box Testing	9
White-Box Testing	11
Software Testing Principles	14
Summary	20
<b>Chapter 3 Program Inspections, Walkthroughs, and Reviews</b>	<b>21</b>
Inspections and Walkthroughs	22
Code Inspections	24
An Error Checklist for Inspections	27
Data Reference Errors	27
Data-Declaration Errors	29
Computation Errors	30
Comparison Errors	31
Control-Flow Errors	32
Interface Errors	34
Input/Output Errors	35
Other Checks	38



Walkthroughs	38
Desk Checking	40
Peer Ratings	40
Summary	42
<b>Chapter 4 Test-Case Design</b>	<b>43</b>
White-Box Testing	44
Logic-Coverage Testing	44
Equivalence Partitioning	52
An Example	56
Boundary-Value Analysis	59
Cause-Effect Graphing	65
Error Guessing	88
The Strategy	90
<b>Chapter 5 Module (Unit) Testing</b>	<b>91</b>
Test-Case Design	92
Incremental Testing	105
Top-down versus Bottom-up Testing	109
Top-down Testing	110
Bottom-up Testing	116
A Comparison	118
Performing the Test	120
<b>Chapter 6 Higher-Order Testing</b>	<b>123</b>
Function Testing	129
System Testing	130
Facility Testing	133
Volume Testing	133
Stress Testing	134
Usability Testing	135
Security Testing	137
Performance Testing	137
Storage Testing	138
Configuration Testing	138

Compatibility/Configuration/Conversion Testing	138
Installability Testing	139
Reliability Testing	139
Recovery Testing	141
Serviceability Testing	142
Documentation Testing	142
Procedure Testing	142
Performing the System Test	143
Acceptance Testing	144
Installation Testing	144
Test Planning and Control	145
Test Completion Criteria	148
The Independent Test Agency	155
<b>Chapter 7 Debugging</b>	<b>157</b>
Debugging by Brute Force	158
Debugging by Induction	160
Debugging by Deduction	164
Debugging by Backtracking	168
Debugging by Testing	169
Debugging Principles	170
Error-Locating Principles	170
Error-Repairing Techniques	171
Error Analysis	173
<b>Chapter 8 Extreme Testing</b>	<b>177</b>
Extreme Programming Basics	178
Extreme Testing: The Concepts	183
Extreme Unit Testing	183
Acceptance Testing	185
Extreme Testing Applied	186
Test-Case Design	186
Test Driver and Application	189
Summary	191

<b>Chapter 9 Testing Internet Applications</b>	<b>193</b>
Basic E-commerce Architecture	194
Testing Challenges	196
Testing Strategies	200
Presentation Layer Testing	202
Business Layer Testing	205
Data Layer Testing	208
Appendix A Sample Extreme Testing Application	213
Appendix B Prime Numbers Less Than 1,000	221
Glossary	223
Index	227

# LIST OF FIGURES AND TABLES

Figure 2.1	Control-Flow Graph of a Small Program	12
Table 2.1	Vital Program Testing Guidelines	15
Figure 2.2	The Surprising Errors Remaining/ Errors Found Relationship	20
Table 3.1	Inspection Error Checklist Summary, Part I	36
Table 3.2	Inspection Error Checklist Summary, Part II	37
Figure 4.1	A Small Program to Be Tested	47
Figure 4.2	Machine Code for the Program in Figure 4.1	50
Figure 4.3	A Form for Enumerating Equivalence Classes	54
Table 4.1	Equivalence Classes	57
Figure 4.4	Input to the MTEST Program	62
Figure 4.5	Basic Cause-Effect Graph Symbols	68
Figure 4.6	Sample Cause-Effect Graph	69
Figure 4.7	Logic Diagram Equivalent to Figure 4.6	69
Figure 4.8	Constraint Symbols	70
Figure 4.9	Symbol for “Masks” Constraint	71
Figure 4.10	Sample Cause-Effect Graph with “Exclusive” Constraint	71
Figure 4.11	Syntax of the DISPLAY Command	72
Figure 4.12	Beginning of the Graph for the DISPLAY Command	76
Figure 4.13	Full Cause-Effect Graph without Constraints	77
Figure 4.14	Complete Cause-Effect Graph of the DISPLAY Command	78
Figure 4.15	Considerations Used When Tracing the Graph	80
Figure 4.16	Sample Graph to Illustrate the Tracing Considerations	81
Figure 4.17	First Half of the Resultant Decision Table	82
Figure 4.18	Second Half of the Resultant Decision Table	84
Figure 5.1	Input Tables to Module BONUS	93
Figure 5.2	Module BONUS	94
Table 5.1	Situations Corresponding to the Decision Outcomes	96

Figure 5.3	Test Cases to Satisfy the Decision–Coverage Criterion	97
Table 5.2	Situations Corresponding to the Condition Outcomes	98
Figure 5.4	Test Cases to Satisfy the Condition–Coverage Criterion	99
Figure 5.5	Test Cases to Satisfy the Multicondition–Coverage Criterion	100
Figure 5.6	Supplemental Boundary–Value–Analysis Test Cases for BONUS	104
Figure 5.7	Sample Six–Module Program	106
Figure 5.8	Sample 12–Module Program	111
Figure 5.9	Second Step in the Top–down Test	113
Figure 5.10	Intermediate State in the Top–down Test	115
Figure 5.11	Intermediate State in the Bottom–up Test	118
Table 5.3	Comparison of Top–down and Bottom–up Testing	119
Figure 6.1	The Software Development Process	124
Figure 6.2	The Development Process with Intermediate Verification Steps	126
Figure 6.3	The Correspondence between Development and Testing Processes	127
Figure 6.4	The System Test	131
Table 6.1	Hours per Year for Various Uptime Requirements	141
Table 6.2	Hypothetical Estimate of When the Errors Might Be Found	151
Figure 6.5	Estimating Completion by Plotting Errors Detected by Unit Time	153
Figure 6.6	Postmortem Study of the Testing Processes of a Large Project	154
Figure 7.1	The Inductive Debugging Process	161
Figure 7.2	A Method for Structuring the Clues	162
Figure 7.3	An Example of Clue Structuring	163
Figure 7.4	The Deductive Debugging Process	165
Figure 7.5	Test Case Results from the DISPLAY Command	166
Table 8.1	The 12 Practices of Extreme Programming	180
Table 8.2	Test Case Descriptions for check4Prime.java	187
Table 8.3	Test Driver Methods	189
Figure 9.1	Typical Architecture of an E–Commerce Site	195
Table 9.1	Examples of Presentation, Business, and Data Tier Testing	199
Figure 9.2	Detailed View of Internet Application Architecture	202
Table 9.2	Items to Test in Each Tier	203

## PREFACE

**I**n 1979, Glenford Myers published a book that turned out to be a classic. Myers's original *The Art of Software Testing* stood the test of time, 25 years on the publisher's list of available books. This fact alone is a testament to the solid, basic, and valuable nature of his work.

During that same time, the current authors of the updated version of this book published collectively more than 120 books, most of them on computer software topics. Some of these books sold very well, going through multiple versions. (Corey Sandler's *Fix Your Own PC* is in its seventh edition as this book is written, and Tom Badgett's books on Microsoft PowerPoint and other Office titles went through four or more editions, for example.) Nevertheless, none of the current authors' books remained current more than a few years.

What is the difference? These newer books cover more transient topics: operating systems, applications software, security, communications technology, and hardware configurations. Rapid changes in computer hardware and software technology during the 1980s and 1990s necessitated frequent changes and updates to these topics.

During that period dozens—perhaps even hundreds—of books also were published about software testing. They, too, took a more transient approach to the topic.

Myers's *The Art of Software Testing*, on the other hand, gave the industry a long-lasting, foundational guide to one of the most important computer topics: How do you ensure that all of the software you produce does what it was designed to do and, just as important, does not do what it isn't supposed to do?

The version you are reading today retains that same foundational philosophy. We have updated the examples to include more current programming languages, and we have addressed topics that no one knew about when Myers wrote the first edition: Web programming, e-commerce, and Extreme Programming and Testing.

But we didn't forget that a new classic must be true to its roots, so this version also offers you a software testing philosophy that is all Glenford Myers, a philosophy and a process that work across current and unforeseeable future hardware and software platforms. Hopefully this, too, is a book that will span a generation of software designers and developers.

# INTRODUCTION

**A**t the time this book was first published, in 1979, it was a well-known rule of thumb that in a typical programming project approximately 50 percent of the elapsed time and more than 50 percent of the total cost were expended in testing the program or system being developed.

Today, a quarter of the century later, the same is still true. There are new development systems, languages with built-in tools, and programmers who are used to developing more on the fly. But testing still plays an important part in any software development project.

Given these facts, you might expect that by this time program testing would have been refined into an exact science. This is far from true. In fact, less seems to be known about software testing than about any other aspect of software development. Furthermore, testing has been an out-of-vogue subject—it was true when this book was first published and, unfortunately, it is still true today. Today there are more books and articles about software testing, meaning that, at least, the topic has more visibility than it did when this book was first published. But testing remains among the “dark arts” of software development.

This would be more than enough reason to update this book on the art of software testing, but there are additional motivations. At various times, we have heard professors and teaching assistants say, “Our students graduate and move into industry without any substantial knowledge of how to go about testing a program. Moreover, we rarely have any advice to provide in our introductory courses on how a student should go about testing and debugging his or her exercises.”



So, the purpose of this updated edition of *The Art of Software Testing* is the same as it was in 1979: to fill these knowledge gaps for the professional programmer and the student of computer science. As the title implies, the book is a practical, rather than theoretical, discussion of the subject, complete with updated language and process discussions. Although it is possible to discuss program testing in a theoretical vein, this book is intended to be a practical, “both feet on the ground” handbook. Hence, many subjects related to program testing, such as the idea of mathematically proving the correctness of a program, were purposefully excluded.

Chapter 1 is a short self-assessment test that every reader should take before reading further. It turns out that the most important practical information that you must understand about program testing is a set of philosophical and economic issues; these are discussed in Chapter 2. Chapter 3 discusses the important concept of non-computer-based code walk-throughs or inspections. Rather than focus attention on the procedural or managerial aspects of this concept, as most discussions do, Chapter 3 discusses it from a technical, how-to-find-errors point of view.

The knowledgeable reader will realize that the most important component in the bag of tricks of a program tester is the knowledge of how to write effective test cases; this is the subject of Chapter 4. Chapters 5 and 6 discuss, respectively, the testing of individual modules or subroutines and the testing of larger entities, with Chapter 7 presenting some practical advice on program debugging. Chapter 8 discusses the concepts of extreme programming and extreme testing, while Chapter 9 shows how to use other features of program testing detailed elsewhere in this book with Web programming, including e-commerce systems.

This book has three major audiences. Although we hope that not everything in this book will be new information to the professional programmer, it should add to the professional’s knowledge of testing techniques. If the material allows you to detect just one more bug in one program, the price of the book will have been recovered many times over. The second audience is the project manager, since the book contains new, practical information on the management of the

testing process. The third audience is the programming or computer science student; the goal here is to expose the student to the problems of program testing and to provide a set of effective techniques. It is suggested that the book be used as a supplement in programming courses such that the student is exposed to the subject of software testing at an early time in his or her education.

**GLENFORD J. MYERS**

**TOM BADGETT**

**TODD M. THOMAS**

**COREY SANDLER**



# **The Art of Software Testing**



## CHAPTER 1

# A SELF-ASSESSMENT TEST

**S**ince this book was first published 25 years ago, software testing has become both easier and more difficult than ever.

Software testing is more difficult because of the vast array of programming languages, operating systems, and hardware platforms that have evolved. And, while relatively few people used computers in the 1970s, today virtually anyone in business or education could hardly complete a day's work without using a computer. Furthermore, the machines themselves are hundreds of times more powerful than those early devices.

Therefore, the software we write today potentially touches millions of people, enabling them to do their jobs effectively and efficiently—or causing them untold frustration and the cost of lost work or lost business. This is not to say that software is more important today than it was when the first edition of this book was published, but it is safe to say that computers—and the software that drives them—certainly affect more people and more businesses today.

Software testing is easier, in some ways, because the array of software and operating systems is much more sophisticated than ever, providing intrinsic well-tested routines that can be incorporated into applications without the need for a programmer to develop them from scratch. Graphical user interfaces (GUIs), for example, can be built from a development language's libraries, and, since they are pre-programmed objects that have been debugged and tested previously, the need for testing them as part of a custom application is much reduced.

Software testing is a process, or a series of processes, designed to make sure computer code does what it was designed to do and that it

does not do anything unintended. Software should be predictable and consistent, offering no surprises to users. In this book we will look at many approaches to achieving this goal.

Now, before we start the book, we'd like you to take a short exam.

We want you to write a set of test cases—specific sets of data—to properly test a relatively simple program. Create a set of test data for the program—data the program must handle correctly to be considered a successful program. Here's a description of the program:

The program reads three integer values from an input dialog. The three values represent the lengths of the sides of a triangle. The program displays a message that states whether the triangle is scalene, isosceles, or equilateral.

Remember that a scalene triangle is one where no two sides are equal, whereas an isosceles triangle has two equal sides, and an equilateral triangle has three sides of equal length. Moreover, the angles opposite the equal sides in an isosceles triangle also are equal (it also follows that the sides opposite equal angles in a triangle are equal), and all angles in an equilateral triangle are equal.

Evaluate your set of test cases by using it to answer the following questions. Give yourself one point for each “yes” answer.

1. Do you have a test case that represents a *valid* scalene triangle? (Note that test cases such as 1,2,3 and 2,5,10 do not warrant a “yes” answer because there does not exist a triangle having these dimensions.)
2. Do you have a test case that represents a valid equilateral triangle?
3. Do you have a test case that represents a valid isosceles triangle? (Note that a test case representing 2,2,4 would not count because it is not a valid triangle.)
4. Do you have at least three test cases that represent valid isosceles triangles such that you have tried all three permutations of two equal sides (such as, 3,3,4; 3,4,3; and 4,3,3)?
5. Do you have a test case in which one side has a zero value?

6. Do you have a test case in which one side has a negative value?
7. Do you have a test case with three integers greater than zero such that the sum of two of the numbers is equal to the third? (That is, if the program said that 1,2,3 represents a scalene triangle, it would contain a bug.)
8. Do you have at least three test cases in category 7 such that you have tried all three permutations where the length of one side is equal to the sum of the lengths of the other two sides (for example, 1,2,3; 1,3,2; and 3,1,2)?
9. Do you have a test case with three integers greater than zero such that the sum of two of the numbers is less than the third (such as 1,2,4 or 12,15,30)?
10. Do you have at least three test cases in category 9 such that you have tried all three permutations (for example, 1,2,4; 1,4,2; and 4,1,2)?
11. Do you have a test case in which all sides are zero (0,0,0)?
12. Do you have at least one test case specifying noninteger values (such as 2.5,3.5,5.5)?
13. Do you have at least one test case specifying the wrong number of values (two rather than three integers, for example)?
14. For each test case did you specify the expected output from the program in addition to the input values?

Of course, a set of test cases that satisfies these conditions does not guarantee that all possible errors would be found, but since questions 1 through 13 represent errors that actually have occurred in different versions of this program, an adequate test of this program should expose at least these errors.

Now, before you become concerned about your own score, consider this: In our experience, highly qualified professional programmers score, on the average, only 7.8 out of a possible 14. If you've done better, congratulations; if not, we'll try to help.

The point of the exercise is to illustrate that the testing of even a trivial program such as this is not an easy task. And if this is true, consider the difficulty of testing a 100,000-statement air traffic control



system, a compiler, or even a mundane payroll program. Testing also becomes more difficult with the object-oriented languages such as Java and C++. For example, your test cases for applications built with these languages must expose errors associated with object instantiation and memory management.

It might seem, from working with this example, that thoroughly testing a complex, real-world program would be impossible. Not so! Although the task can be daunting, adequate program testing is a very necessary—and achievable—part of software development, as you will learn in this book.

## CHAPTER 2

# THE PSYCHOLOGY AND ECONOMICS OF PROGRAM TESTING

**S**oftware testing is a technical task, but it also involves some important considerations of economics and human psychology.

In an ideal world, we would want to test every possible permutation of a program. In most cases, however, this simply is not possible. Even a seemingly simple program can have hundreds or thousands of possible input and output combinations. Creating test cases for all of these possibilities is impractical. Complete testing of a complex application would take too long and require too many human resources to be economically feasible.

In addition, the software tester needs the proper attitude (perhaps “vision” is a better word) to successfully test a software application. In some cases, the tester’s attitude may be more important than the actual process itself. Therefore, we will start our discussion of software testing with these issues before we delve into the more technical nature of the topic.

## THE PSYCHOLOGY OF TESTING

One of the primary causes of poor program testing is the fact that most programmers begin with a false definition of the term. They might say:

- “Testing is the process of demonstrating that errors are not present.”

or

- “The purpose of testing is to show that a program performs its intended functions correctly.”

or

- “Testing is the process of establishing confidence that a program does what it is supposed to do.”

These definitions are upside-down.

When you test a program, you want to add some value to it. Adding value through testing means raising the quality or reliability of the program. Raising the reliability of the program means finding and removing errors.

Therefore, don’t test a program to show that it works; rather, you should start with the assumption that the program contains errors (a valid assumption for almost any program) and then test the program to find as many of the errors as possible.

Thus, a more appropriate definition is this:

***Testing is the process of executing a program  
with the intent of finding errors.***

Although this may sound like a game of subtle semantics, it’s really an important distinction. Understanding the true definition of software testing can make a profound difference in the success of your efforts.

Human beings tend to be highly goal-oriented, and establishing the proper goal has an important psychological effect. If our goal is to demonstrate that a program has no errors, then we will subconsciously be steered toward this goal; that is, we tend to select test data that have a low probability of causing the program to fail. On the other hand, if our goal is to demonstrate that a program has errors, our test data will have a higher probability of finding errors. The latter approach will add more value to the program than the former.

This definition of testing has myriad implications, many of which are scattered throughout this book. For instance, it implies that testing is a destructive process, even a sadistic process, which explains

why most people find it difficult. That may go against our grain; with good fortune, most of us have a constructive, rather than a destructive, outlook on life. Most people are inclined toward making objects rather than ripping them apart. The definition also has implications for how test cases (test data) should be designed and who should and who should not test a given program.

Another way of reinforcing the proper definition of testing is to analyze the use of the words “successful” and “unsuccessful”—in particular, their use by project managers in categorizing the results of test cases. Most project managers call a test case that did not find an error a “successful test run,” whereas a test that discovers a new error is usually called “unsuccessful.”

Once again, this is upside-down. “Unsuccessful” denotes something undesirable or disappointing. To our way of thinking, a well-constructed and -executed test of a piece of software is successful when it finds errors that can be fixed. And that same test is also successful when it eventually establishes that there are no more errors to be found. The only unsuccessful test is one that does not properly examine the software and, in the majority of cases, a test that found no errors would likely be considered unsuccessful, since the concept of a program without errors is basically unrealistic.

A test case that finds a new error can hardly be considered unsuccessful; rather, it has proven to be a valuable investment. An unsuccessful test case is one that causes a program to produce the correct result without finding any errors.

Consider the analogy of a person visiting a doctor because of an overall feeling of malaise. If the doctor runs some laboratory tests that do not locate the problem, we do not call the laboratory tests “successful”; they were unsuccessful tests in that the patient’s net worth has been reduced by the expensive laboratory fees, the patient is still ill, and the patient may question the doctor’s ability as a diagnostician. However, if a laboratory test determines that the patient has a peptic ulcer, the test is successful because the doctor can now begin the appropriate treatment. Hence, the medical profession seems to use these words in the proper sense. The analogy, of course, is that we should think of the program, as we begin testing it, as the sick patient.

A second problem with such definitions as “testing is the process of demonstrating that errors are not present” is that such a goal is impossible to achieve for virtually all programs, even trivial programs.

Again, psychological studies tell us that people perform poorly when they set out on a task that they know to be infeasible or impossible. For instance, if you were instructed to solve the crossword puzzle in the Sunday *New York Times* in 15 minutes, we would probably observe little, if any, progress after 10 minutes because most of us would be resigned to the fact that the task seems impossible. If you were asked for a solution in four hours, however, we could reasonably expect to see more progress in the initial 10 minutes. Defining program testing as the process of uncovering errors in a program makes it a feasible task, thus overcoming this psychological problem.

A third problem with the common definitions such as “testing is the process of demonstrating that a program does what it is supposed to do” is that programs that do what they are supposed to do still can contain errors. That is, an error is clearly present if a program does not do what it is supposed to do, but errors are also present *if a program does what it is not supposed to do*. Consider the triangle program of Chapter 1. Even if we could demonstrate that the program correctly distinguishes among all scalene, isosceles, and equilateral triangles, the program still would be in error if it does something it is not supposed to do (such as representing 1,2,3 as a scalene triangle or saying that 0,0,0 represents an equilateral triangle). We are more likely to discover the latter class of errors if we view program testing as the process of finding errors than if we view it as the process of showing that a program does what it is supposed to do.

To summarize, program testing is more properly viewed as the destructive process of trying to find the errors (whose presence is assumed) in a program. A successful test case is one that furthers progress in this direction by causing the program to fail. Of course, you eventually want to use program testing to establish some degree of confidence that a program does what it is supposed to do and does not do what it is not supposed to do, but this purpose is best achieved by a diligent exploration for errors.

Consider someone approaching you with the claim that “my program is perfect” (error free). The best way to establish some confidence in this claim is to try to refute it, that is, to try to find imperfections rather than just confirm that the program works correctly for some set of input data.

## THE ECONOMICS OF TESTING

Given this definition of program testing, an appropriate next step is the determination of whether it is possible to test a program to find *all* of its errors. We will show you that the answer is negative, even for trivial programs. In general, it is impractical, often impossible, to find all the errors in a program. This fundamental problem will, in turn, have implications for the economics of testing, assumptions that the tester will have to make about the program, and the manner in which test cases are designed.

To combat the challenges associated with testing economics, you should establish some strategies before beginning. Two of the most prevalent strategies include black-box testing and white-box testing, which we will explore in the next two sections.

### **Black-Box Testing**

One important testing strategy is *black-box*, *data-driven*, or *input/output-driven* testing. To use this method, view the program as a black box. Your goal is to be completely unconcerned about the internal behavior and structure of the program. Instead, concentrate on finding circumstances in which the program does not behave according to its specifications.

In this approach, test data are derived solely from the specifications (i.e., without taking advantage of knowledge of the internal structure of the program).

If you want to use this approach to find all errors in the program, the criterion is *exhaustive input testing*, making use of every possible input condition as a test case. Why? If you tried three equilateral-

triangle test cases for the triangle program, that in no way guarantees the correct detection of all equilateral triangles. The program could contain a special check for values 3842,3842,3842 and denote such a triangle as a scalene triangle. Since the program is a black box, the only way to be sure of detecting the presence of such a statement is by trying every input condition.

To test the triangle program exhaustively, you would have to create test cases for all valid triangles up to the maximum integer size of the development language. This in itself is an astronomical number of test cases, but it is in no way exhaustive; it would find errors where the program said that  $-3,4,5$  is a scalene triangle and that  $2,A,2$  is an isosceles triangle. To be sure of finding all such errors, you have to test using not only all *valid* inputs, but all *possible* inputs. Hence, to test the triangle program exhaustively, you would have to produce virtually an infinite number of test cases, which, of course, is not possible.

If this sounds difficult, exhaustive input testing of larger programs is even more of a problem. Consider attempting an exhaustive black-box test of a C++ compiler. Not only would you have to create test cases representing all valid C++ programs (again, virtually an infinite number), but you would have to create test cases for all invalid C++ programs (an infinite number) to ensure that the compiler detects them as being invalid. That is, the compiler has to be tested to ensure that it does not do what it is not supposed to do—for example, successfully compile a syntactically incorrect program.

The problem is even worse for programs having a memory, such as operating systems or database applications. For example, in a database application such as an airline reservation system, the execution of a transaction (such as a database query, a reservation for a plane flight) is dependent upon what happened in previous transactions. Hence, not only would you have to try all unique valid and invalid transactions, but also all possible sequences of transactions.

This discussion shows that exhaustive input testing is impossible. Two implications of this are that (1) you cannot test a program to guarantee that it is error free and (2) a fundamental consideration in program testing is one of economics. That is, since exhaustive testing is out of the question, the objective should be to maximize the yield

on the testing investment by maximizing the number of errors found by a finite number of test cases. Doing so will involve, among other things, being able to peer inside the program and making certain reasonable, but not airtight, assumptions about the program (for example, if the triangle program detects 2,2,2 as an equilateral triangle, it seems reasonable that it will do the same for 3,3,3). This will form part of the test-case-design strategy in Chapter 4.

### White-Box Testing

Another testing strategy, *white-box* or *logic-driven* testing, permits you to examine the internal structure of the program. This strategy derives test data from an examination of the program's logic (and often, unfortunately, at the neglect of the specification).

The goal at this point is to establish, for this strategy, the analog to exhaustive input testing in the black-box approach. Causing every statement in the program to execute at least once might appear to be the answer, but it is not difficult to show that this is highly inadequate. Without belaboring the point, since this matter is discussed in more depth in Chapter 4, the analog is usually considered to be *exhaustive path testing*. That is, if you execute, via test cases, all possible paths of control flow through the program, then possibly the program has been completely tested.

There are two flaws in this statement, however. One is that the number of unique logic paths through a program could be astronomically large. To see this, consider the trivial program represented in Figure 2.1. The diagram is a control-flow graph. Each node or circle represents a segment of statements that execute sequentially, possibly terminating with a branching statement. Each edge or arc represents a transfer of control (branch) between segments. The diagram, then, depicts a 10- to 20-statement program consisting of a `DO` loop that iterates up to 20 times. Within the body of the `DO` loop is a set of nested `IF` statements. Determining the number of unique logic paths is the same as determining the total number of unique ways of moving from point *a* to point *b* (assuming that all decisions in the program are independent from one another). This number is approx-



imately  $10^{14}$ , or 100 trillion. It is computed from  $5^{20} + 5^{19} + \dots + 5^1$ , where 5 is the number of paths through the loop body. Since most people have a difficult time visualizing such a number, consider it this way: If you could write, execute, and verify a test case every five minutes, it would take approximately one billion years to try every path. If you were 300 times faster, completing a test once per second, you could complete the job in 3.2 million years, give or take a few leap years and centuries.

**Figure 2.1**  
**Control-flow graph of a small program.**

---

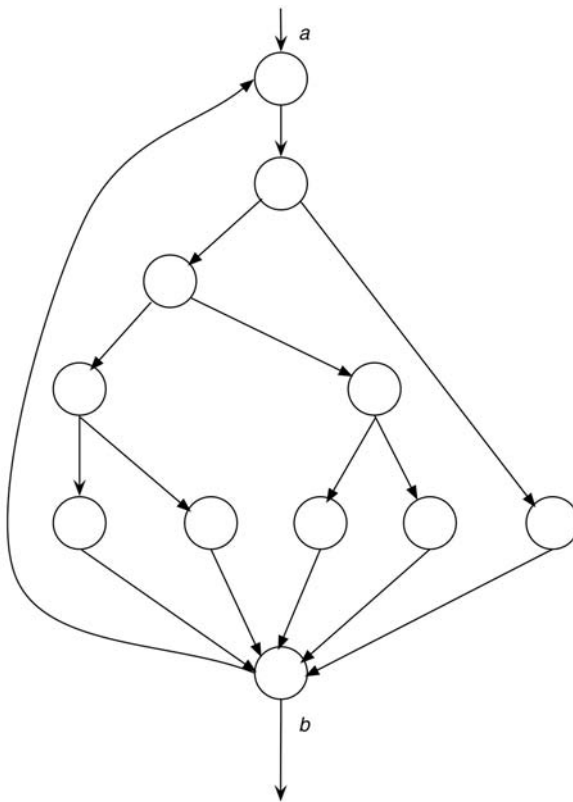

Of course, in actual programs every decision is not independent from every other decision, meaning that the number of possible execution paths would be somewhat less. On the other hand, actual programs are much larger than the simple program depicted in Figure 2.1. Hence, exhaustive path testing, like exhaustive input testing, appears to be impractical, if not impossible.

The second flaw in the statement “exhaustive path testing means a complete test” is that every path in a program could be tested, yet the program might still be loaded with errors. There are three explanations for this.

The first is that an exhaustive path test in no way guarantees that a program matches its specification. For example, if you were asked to write an ascending-order sorting routine but mistakenly produced a descending-order sorting routine, exhaustive path testing would be of little value; the program still has one bug: It is the wrong program, as it does not meet the specification.

Second, a program may be incorrect because of *missing paths*. Exhaustive path testing, of course, would not detect the absence of necessary paths.

Third, an exhaustive path test might not uncover *data-sensitivity* errors. There are many examples of such errors, but a simple example should suffice. Suppose that in a program you have to compare two numbers for convergence, that is, to see if the difference between the two numbers is less than some predetermined value. For example, you might write a Java IF statement as

```
if (a-b < c)
    System.out.println("a-b < c");
```

Of course, the statement contains an error because it should compare  $c$  to the absolute value of  $a-b$ . Detection of this error, however, is dependent upon the values used for  $a$  and  $b$  and would not necessarily be detected by just executing every path through the program.

In conclusion, although exhaustive input testing is superior to exhaustive path testing, neither proves to be useful because both are

infeasible. Perhaps, then, there are ways of combining elements of black-box and white-box testing to derive a reasonable, but not airtight, testing strategy. This matter is pursued further in Chapter 4.

## SOFTWARE TESTING PRINCIPLES

Continuing with the major premise of this chapter, that the most important considerations in software testing are issues of psychology, we can identify a set of vital testing principles or guidelines. Most of these principles may seem obvious, yet they are all too often overlooked. Table 2.1 summarizes these important principles, and each is discussed in more detail in the paragraphs that follow.

***Principle 1: A necessary part of a test case is a definition of the expected output or result.***

This obvious principle is one of the most frequent mistakes in program testing. Again, it is something that is based on human psychology. If the expected result of a test case has not been predefined, chances are that a plausible, but erroneous, result will be interpreted as a correct result because of the phenomenon of “the eye seeing what it wants to see.” In other words, in spite of the proper destructive definition of testing, there is still a subconscious desire to see the correct result. One way of combating this is to encourage a detailed examination of all output by precisely spelling out, in advance, the expected output of the program. Therefore, a test case must consist of two components:

1. A description of the input data to the program.
2. A precise description of the correct output of the program for that set of input data.

**Table 2.1**  
**Vital Program Testing Guidelines**

<i>Principle Number</i>	<i>Principle</i>
1	A necessary part of a test case is a definition of the expected output or result.
2	A programmer should avoid attempting to test his or her own program.
3	A programming organization should not test its own programs.
4	Thoroughly inspect the results of each test.
5	Test cases must be written for input conditions that are invalid and unexpected, as well as for those that are valid and expected.
6	Examining a program to see if it does not do what it is supposed to do is only half the battle; the other half is seeing whether the program does what it is not supposed to do.
7	Avoid throwaway test cases unless the program is truly a throwaway program.
8	Do not plan a testing effort under the tacit assumption that no errors will be found.
9	The probability of the existence of more errors in a section of a program is proportional to the number of errors already found in that section.
10	Testing is an extremely creative and intellectually challenging task.

A problem may be characterized as a fact or group of facts for which we have no acceptable explanation, that seem unusual, or that fail to fit in with our expectations or preconceptions. It should be obvious that some prior beliefs are required if anything is to appear problematic. If there are no expectations, there can be no surprises.

***Principle 2: A programmer should avoid attempting to test his or her own program.***

Any writer knows—or should know—that it’s a bad idea to attempt to edit or proofread his or her own work. You know what the piece is *supposed* to say and may not recognize when it says otherwise. And you really don’t want to find errors in your own work. The same applies to software authors.

Another problem arises with a change in focus on a software project. After a programmer has *constructively* designed and coded a program, it is extremely difficult to suddenly change perspective to look at the program with a *destructive* eye.

As many homeowners know, removing wallpaper (a destructive process) is not easy, but it is almost unbearably depressing if it was your hands that hung the paper in the first place. Similarly, most programmers cannot effectively test their own programs because they cannot bring themselves to shift mental gears to attempt to expose errors. In addition, a programmer may subconsciously avoid finding errors for fear of retribution from peers or from a supervisor, a client, or the owner of the program or system being developed.

In addition to these psychological issues, there is a second significant problem: The program may contain errors due to the programmer’s misunderstanding of the problem statement or specification. If this is the case, it is likely that the programmer will carry the same misunderstanding into tests of his or her own program.

This does not mean that it is impossible for a programmer to test his or her own program. Rather, it implies that testing is more effective and successful if someone else does it.

Note that this argument does not apply to debugging (correcting known errors); debugging is more efficiently performed by the original programmer.

***Principle 3: A programming organization should not test its own programs.***

The argument here is similar to the previous argument. A project or programming organization is, in many senses, a living organization with psychological problems similar to those of individual programmers. Furthermore, in most environments, a programming organization or a project manager is largely measured on the ability to produce a program by a given date and for a certain cost. One reason for this is that it is easy to measure time and cost objectives, but it is extremely difficult to quantify the reliability of a program. Therefore, it is difficult for a programming organization to be objective in testing its own programs, because the testing process, if approached with the proper definition, may be viewed as decreasing the probability of meeting the schedule and the cost objectives.

Again, this does not say that it is *impossible* for a programming organization to find some of its errors, because organizations do accomplish this with some degree of success. Rather, it implies that it is more economical for testing to be performed by an objective, independent party.

***Principle 4: Thoroughly inspect the results of each test.***

This is probably the most obvious principle, but again it is something that is often overlooked. We've seen numerous experiments that show many subjects failed to detect certain errors, even when symptoms of those errors were clearly observable on the output listings. Put another way, errors that are found on later tests are often missed in the results from earlier tests.

***Principle 5: Test cases must be written for input conditions that are invalid and unexpected, as well as for those that are valid and expected.***

There is a natural tendency when testing a program to concentrate on the valid and expected input conditions, at the neglect of the invalid and unexpected conditions. For instance, this tendency frequently appears in the testing of the triangle program in Chapter 1.

Few people, for instance, feed the program the numbers 1,2,5 to make sure that the program does not erroneously interpret this as a scalene triangle instead of an invalid triangle. Also, many errors that are suddenly discovered in production programs turn up when the program is used in some new or unexpected way. Therefore, test cases representing unexpected and invalid input conditions seem to have a higher error-detection yield than do test cases for valid input conditions.

***Principle 6: Examining a program to see if it does not do what it is supposed to do is only half the battle; the other half is seeing whether the program does what it is not supposed to do.***

This is a corollary to the previous principle. Programs must be examined for unwanted side effects. For instance, a payroll program that produces the correct paychecks is still an erroneous program if it also produces extra checks for nonexistent employees or if it overwrites the first record of the personnel file.

***Principle 7: Avoid throwaway test cases unless the program is truly a throwaway program.***

This problem is seen most often with interactive systems to test programs. A common practice is to sit at a terminal and invent test cases on the fly, and then send these test cases through the program. The major problem is that test cases represent a valuable investment that, in this environment, disappears after the testing has been completed. Whenever the program has to be tested again (for example, after correcting an error or making an improvement), the test cases must be reinvented. More often than not, since this reinvention requires a considerable amount of work, people tend to avoid it. Therefore, the retest of the program is rarely as rigorous as the original test, meaning that if the modification causes a previously functional part of the program to fail, this error often goes undetected. Saving test cases and running them again after changes to other components of the program is known as *regression testing*.

***Principle 8: Do not plan a testing effort under the tacit assumption that no errors will be found.***

This is a mistake project managers often make and is a sign of the use of the incorrect definition of testing—that is, the assumption that testing is the process of showing that the program functions correctly. Once again, the definition of testing is the process of executing a program with the intent of finding errors.

***Principle 9: The probability of the existence of more errors in a section of a program is proportional to the number of errors already found in that section.***

This phenomenon is illustrated in Figure 2.2. At first glance it makes little sense, but it is a phenomenon present in many programs. For instance, if a program consists of two modules, classes, or sub-routines A and B, and five errors have been found in module A and only one error has been found in module B, and if module A has not been purposely subjected to a more rigorous test, then this principle tells us that the likelihood of more errors in module A is greater than the likelihood of more errors in module B.

Another way of stating this principle is to say that errors tend to come in clusters and that, in the typical program, some sections seem to be much more prone to errors than other sections, although nobody has supplied a good explanation of why this occurs. The phenomenon is useful in that it gives us insight or feedback in the testing process. If a particular section of a program seems to be much more prone to errors than other sections, then this phenomenon tells us that, in terms of yield on our testing investment, additional testing efforts are best focused against this error-prone section.

***Principle 10: Testing is an extremely creative and intellectually challenging task.***

It is probably true that the creativity required in testing a large program exceeds the creativity required in designing that program. We



**Figure 2.2**  
**The Surprising Errors Remaining/Errors Found Relationship.**

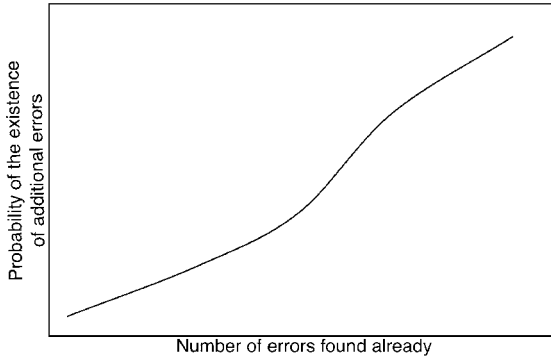

already have seen that it is impossible to test a program sufficiently to guarantee the absence of all errors. Methodologies discussed later in this book let you develop a reasonable set of test cases for a program, but these methodologies still require a significant amount of creativity.

## SUMMARY

As you proceed through this book, keep in mind these three important principles of testing:

- Testing is the process of executing a program with the intent of finding errors.
- A good test case is one that has a high probability of detecting an as yet undiscovered error.
- A successful test case is one that detects an as yet undiscovered error.

## CHAPTER 3

# PROGRAM INSPECTIONS, WALKTHROUGHS, AND REVIEWS

**F**or many years, most of us in the programming community worked under the assumptions that programs are written solely for machine execution and are not intended for people to read, and that the only way to test a program is to execute it on a machine. This attitude began to change in the early 1970s through the efforts of program developers who first saw the value in reading code as part of a comprehensive testing and debugging regimen.

Today, not all testers of software applications read code, but the concept of studying program code as part of a testing effort certainly is widely accepted. Several factors may affect the likelihood that a given testing and debugging effort will include people actually reading program code: the size or complexity of the application, the size of the development team, the timeline for application development (whether the schedule is relaxed or intense, for example), and, of course, the background and culture of the programming team.

For these reasons, we will discuss the process of non-computer-based testing (“human testing”), before we delve into the more traditional computer-based testing techniques. Human testing techniques are quite effective in finding errors—so much so that every programming project should use one or more of these techniques. You should apply these methods between the time the program is coded and the time when computer-based testing begins. You also can develop and apply analogous methods at earlier stages in the programming process

(such as at the end of each design stage), but these are outside the scope of this book.

But before we begin the discussion of human testing techniques, here's an important note: Because the involvement of humans results in less formal methods than mathematical proofs conducted by a computer, you may feel skeptical that something so simple and informal can be useful. Just the opposite is true. These informal techniques don't get in the way of successful testing; rather, they substantially contribute to productivity and reliability in two major ways.

First, it is generally recognized that the earlier errors are found, the lower the costs of correcting the errors and the higher the probability of correcting the errors correctly. Second, programmers seem to experience a psychological change when computer-based testing commences. Internally induced pressures seem to build rapidly and there is a tendency to want to "fix this darn bug as soon as possible." Because of these pressures, programmers tend to make more mistakes when correcting an error found during computer-based testing than they make when correcting an error found earlier.

## INSPECTIONS AND WALKTHROUGHS

The two primary human testing methods are code inspections and walkthroughs. Since the two methods have a lot in common, we will discuss their similarities together here. Their differences are discussed in subsequent sections.

Inspections and walkthroughs involve a team of people reading or visually inspecting a program. With either method, participants must conduct some preparatory work. The climax is a "meeting of the minds," at a participant conference. The objective of the meeting is to find errors but not to find solutions to the errors. That is, to test, not debug.

Code inspections and walkthroughs have been widely used for some time. In our opinion, the reason for their success is related to some of the principles in Chapter 2.

In a walkthrough, a group of developers—with three or four being an optimal number—performs the review. Only one of the participants is the author of the program. Therefore, the majority of program testing is conducted by people other than the author, which follows the testing principle stating that an individual is usually ineffective in testing his or her own program.

An inspection or walkthrough is an improvement over the older desk-checking process (the process of a programmer reading his or her own program before testing it). Inspections and walkthroughs are more effective, again because people other than the program's author are involved in the process.

Another advantage of walkthroughs, resulting in lower debugging (error-correction) costs, is the fact that when an error is found it is usually precisely located in the code. In addition, this process frequently exposes a batch of errors, allowing the errors to be corrected later en masse. Computer-based testing, on the other hand, normally exposes only a symptom of the error (the program does not terminate or the program prints a meaningless result), and errors are usually detected and corrected one by one.

These methods generally are effective in finding from 30 to 70 percent of the logic-design and coding errors in typical programs. They are not effective, however, in detecting high-level design errors, such as errors made in the requirements-analysis process. Note that a success rate of 30 to 70 percent doesn't mean that up to 70 percent of all errors might be found. Remember that Chapter 2 tells us we can never know the total number of errors in a program. Rather, this means these methods are effective in finding up to 70 percent of all errors found by the end of the testing process.

Of course, a possible criticism of these statistics is that the human processes find only the “easy” errors (those that would be trivial to find with computer-based testing) and that the difficult, obscure, or tricky errors can be found only by computer-based testing. However, some testers using these techniques have found that the human processes tend to be *more* effective than the computer-based testing processes in finding *certain* types of errors, *while the opposite is true for other types of errors*. The implication is that inspections/walkthroughs

and computer-based testing are complementary; error-detection efficiency will suffer if one or the other is not present.

Finally, although these processes are invaluable for testing new programs, they are of equal, or even higher, value in testing modifications to programs. In our experience, modifying an existing program is a process that is more error prone (in terms of errors per statement written) than writing a new program. Therefore, program modifications also should be subjected to these testing processes as well as regression testing techniques.

## CODE INSPECTIONS

A code inspection is a set of procedures and error-detection techniques for group code reading. Most discussions of code inspections focus on the procedures, forms to be filled out, and so on; here, after a short summary of the general procedure, we will focus on the actual error-detection techniques.

An inspection team usually consists of four people. One of the four people plays the role of moderator. The moderator is expected to be a competent programmer, but he or she is not the author of the program and need not be acquainted with the details of the program. The duties of the moderator include

- Distributing materials for, and scheduling, the inspection session
- Leading the session
- Recording all errors found
- Ensuring that the errors are subsequently corrected

The moderator is like a quality-control engineer. The second team member is the programmer. The remaining team members usually are the program's designer (if different from the programmer) and a test specialist.

The moderator distributes the program's listing and design specifi-

cation to the other participants several days in advance of the inspection session. The participants are expected to familiarize themselves with the material prior to the session. During the session, two activities occur:

1. The programmer narrates, statement by statement, the logic of the program. During the discourse, other participants should raise questions, and they should be pursued to determine whether errors exist. It is likely that the programmer rather than the other team members will find many of the errors found during this narration. In other words, the simple act of reading aloud a program to an audience seems to be a remarkably effective error-detection technique.
2. The program is analyzed with respect to a checklist of historically common programming errors (such a checklist is discussed in the next section).

The moderator is responsible for ensuring that the discussions proceed along productive lines and that the participants focus their attention on finding errors, not correcting them. (The programmer corrects errors after the inspection session.)

After the session, the programmer is given a list of the errors found. If more than a few errors were found, or if any of the errors requires a substantial correction, the moderator might make arrangements to reinspect the program after the errors are corrected. This list of errors is also analyzed, categorized, and used to refine the error checklist to improve the effectiveness of future inspections.

As stated, this inspection process usually concentrates on discovering errors, not correcting them. However, some teams may find that when a minor problem is discovered, two or three people, including the programmer responsible for the code, then propose obvious patches to the design to handle this special case. The discussion of this minor problem may, in turn, focus the group's attention on that particular area of the design. During the discussion of the best way to patch the design to handle this minor problem, someone may notice

a second problem. Now that the group has seen two problems related to the same aspect of the design, comments likely will come thick and fast, with interruptions every few sentences. In a few minutes, this whole area of the design could be thoroughly explored, and any problems would be obvious.

The time and location of the inspection should be planned to avoid all outside interruptions. The optimal amount of time for the inspection session appears to be from 90 to 120 minutes. Since the session is a mentally taxing experience, longer sessions tend to be less productive. Most inspections proceed at a rate of approximately 150 program statements per hour. For that reason, large programs should be examined in multiple inspections, each inspection dealing with one or several modules or subroutines.

Note that for the inspection process to be effective, the appropriate attitude must be established. If the programmer views the inspection as an attack on his or her character and adopts a defensive posture, the process will be ineffective. Rather, the programmer must approach the process with an egoless attitude and must place the process in a positive and constructive light: The objective of the inspection is to find errors in the program, thus improving the quality of the work. For this reason, most people recommend that the results of an inspection be a confidential matter, shared only among the participants. In particular, if managers somehow make use of the inspection results, the purpose of the process can be defeated.

The inspection process also has several beneficial side effects in addition to its main effect of finding errors. For one thing, the programmer usually receives feedback concerning programming style, choice of algorithms, and programming techniques. The other participants gain in a similar way by being exposed to another programmer's errors and programming style. Finally, the inspection process is a way of identifying early the most error-prone sections of the program, helping to focus more attention on these sections during the computer-based testing processes (one of the testing principles of Chapter 2).

## AN ERROR CHECKLIST FOR INSPECTIONS

An important part of the inspection process is the use of a checklist to examine the program for common errors. Unfortunately, some checklists concentrate more on issues of style than on errors (for example, “Are comments accurate and meaningful?” and “Are `if-else`, code blocks, and `do-while` groups aligned?”), and the error checks are too nebulous to be useful (such as “Does the code meet the design requirements?”). The checklist in this section was compiled after many years of study of software errors. The checklist is largely language independent, meaning that most of the errors can occur with any programming language. You may wish to supplement this list with errors peculiar to your programming language and with errors detected after using the inspection process.

### Data Reference Errors

1. Does a referenced variable have a value that is unset or uninitialized? This probably is the most frequent programming error; it occurs in a wide variety of circumstances. For each reference to a data item (variable, array element, field in a structure), attempt to “prove” informally that the item has a value at that point.
2. For all array references, is each subscript value within the defined bounds of the corresponding dimension?
3. For all array references, does each subscript have an integer value? This is not necessarily an error in all languages, but it is a dangerous practice.
4. For all references through pointer or reference variables, is the referenced memory currently allocated? This is known as the “dangling reference” problem. It occurs in situations where the lifetime of a pointer is greater than the lifetime of the referenced memory. One situation occurs where a pointer references a local variable within a procedure, the pointer value is assigned to an output parameter or a global variable, the procedure returns (freeing the referenced loca-



tion), and later the program attempts to use the pointer value. In a manner similar to checking for the prior errors, try to prove informally that, in each reference using a pointer variable, the reference memory exists.

5. When a memory area has alias names with differing attributes, does the data value in this area have the correct attributes when referenced via one of these names? Situations to look for are the use of the `EQUIVALENCE` statement in FORTRAN, and the `REDEFINES` clause in COBOL. As an example, a FORTRAN program contains a real variable `A` and an integer variable `B`; both are made aliases for the same memory area by using an `EQUIVALENCE` statement. If the program stores a value into `A` and then references variable `B`, an error is likely present since the machine would use the floating-point bit representation in the memory area as an integer.
6. Does a variable's value have a type or attribute other than what the compiler expects? This situation might occur where a C, C++, or COBOL program reads a record into memory and references it by using a structure, but the physical representation of the record differs from the structure definition.
7. Are there any explicit or implicit addressing problems if, on the machine being used, the units of memory allocation are smaller than the units of memory addressability? For instance, in some environments, fixed-length bit strings do not necessarily begin on byte boundaries, but addresses only point to byte boundaries. If a program computes the address of a bit string and later refers to the string through this address, the wrong memory location may be referenced. This situation also could occur when passing a bit-string argument to a subroutine.
8. If pointer or reference variables are used, does the referenced memory location have the attributes the compiler expects? An example of such an error is where a C++ pointer upon which a data structure is based is assigned the address of a different data structure.

9. If a data structure is referenced in multiple procedures or subroutines, is the structure defined identically in each procedure?
10. When indexing into a string, are the limits of the string off-by-one errors in indexing operations or in subscript references to arrays?
11. For object-oriented languages, are all inheritance requirements met in the implementing class?

### **Data-Declaration Errors**

1. Have all variables been explicitly declared? A failure to do so is not necessarily an error, but it is a common source of trouble. For instance, if a program subroutine receives an array parameter, and fails to define the parameter as an array (as in a DIMENSION statement, for example), a reference to the array (such as `C=A (I)`) is interpreted as a function call, leading to the machine's attempting to execute the array as a program. Also, if a variable is not explicitly declared in an inner procedure or block, is it understood that the variable is shared with the enclosing block?
2. If all attributes of a variable are not explicitly stated in the declaration, are the defaults well understood? For instance, the default attributes received in Java are often a source of surprise.
3. Where a variable is initialized in a declarative statement, is it properly initialized? In many languages, initialization of arrays and strings is somewhat complicated and, hence, error prone.
4. Is each variable assigned the correct length and datatype?
5. Is the initialization of a variable consistent with its memory type? For instance, if a variable in a FORTRAN subroutine needs to be reinitialized each time the subroutine is called, it must be initialized with an assignment statement rather than a DATA statement.

6. Are there any variables with similar names (VOLT and VOLTS, for example)? This is not necessarily an error, but it should be seen as a warning that the names may have been confused somewhere within the program.

## Computation Errors

1. Are there any computations using variables having inconsistent (such as nonarithmetic) datatypes?
2. Are there any mixed-mode computations? An example is the addition of a floating-point variable to an integer variable. Such occurrences are not necessarily errors, but they should be explored carefully to ensure that the language's conversion rules are understood. Consider the following Java snippet showing the rounding error that can occur when working with integers:

```
int x = 1;
int y = 2;
int z = 0;
z = x/y;
System.out.println ("z = " + z);
```

OUTPUT:

```
z = 0
```

3. Are there any computations using variables having the same datatype but different lengths?
4. Is the datatype of the target variable of an assignment smaller than the datatype or result of the right-hand expression?
5. Is an overflow or underflow expression possible during the computation of an expression? That is, the end result may appear to have valid value, but an intermediate result might be too big or too small for the programming language's datatypes.
6. Is it possible for the divisor in a division operation to be zero?

7. If the underlying machine represents variables in base-2 form, are there any sequences of the resulting inaccuracy? That is,  $10 \times 0.1$  is rarely equal to 1.0 on a binary machine.
8. Where applicable, can the value of a variable go outside the meaningful range? For example, statements assigning a value to the variable `PROBABILITY` might be checked to ensure that the assigned value will always be positive and not greater than 1.0.
9. For expressions containing more than one operator, are the assumptions about the order of evaluation and precedence of operators correct?
10. Are there any invalid uses of integer arithmetic, particularly divisions? For instance, if `i` is an integer variable, whether the expression  $2*i/2 == i$  depends on whether `i` has an odd or an even value and whether the multiplication or division is performed first.

## Comparison Errors

1. Are there any comparisons between variables having different datatypes, such as comparing a character string to an address, date, or number?
2. Are there any mixed-mode comparisons or comparisons between variables of different lengths? If so, ensure that the conversion rules are well understood.
3. Are the comparison operators correct? Programmers frequently confuse such relations as *at most*, *at least*, *greater than*, *not less than*, *less than or equal*.
4. Does each Boolean expression state what it is supposed to state? Programmers often make mistakes when writing logical expressions involving *and*, *or*, and *not*.
5. Are the operands of a Boolean operator Boolean? Have comparison and Boolean operators been erroneously mixed together? This represents another frequent class of mistakes. Examples of a few typical mistakes are illustrated here. If you want to determine whether `i` is between 2 and 10, the

expression `2<i<10` is incorrect; instead, it should be `(2<i) && (i<10)`. If you want to determine whether `i` is greater than `x` or `y`, `i>x||y` is incorrect; instead, it should be `(i>x)||(i>y)`. If you want to compare three numbers for equality, `if(a==b==c)` does something quite different. If you want to test the mathematical relation `x>y>z`, the correct expression is `(x>y)&&(y>z)`.

6. Are there any comparisons between fractional or floating-point numbers that are represented in base-2 by the underlying machine? This is an occasional source of errors because of truncation and base-2 approximations of base-10 numbers.
7. For expressions containing more than one Boolean operator, are the assumptions about the order of evaluation and the precedence of operators correct? That is, if you see an expression such as `if((a==2) && (b==2) || (c==3))`, is it well understood whether the *and* or the *or* is performed first?
8. Does the way in which the compiler evaluates Boolean expressions affect the program? For instance, the statement

```
if((x==0 && (x/y)>z)
```

may be acceptable for compilers that end the test as soon as one side of an *and* is false, but may cause a division-by-zero error with other compilers.

## Control-Flow Errors

1. If the program contains a multiway branch such as a computed `GO TO`, can the index variable ever exceed the number of branch possibilities? For example, in the statement

```
GO TO (200,300,400), i
```

will `i` always have the value of 1, 2, or 3?

2. Will every loop eventually terminate? Devise an informal proof or argument showing that each loop will terminate.

3. Will the program, module, or subroutine eventually terminate?
4. Is it possible that, because of the conditions upon entry, a loop will never execute? If so, does this represent an oversight? For instance, if you had the following loops headed by the following statements:

```

for (i==x ; i<=z; i++) {
...
}
while (NOTFOUND) {
...
}

```

what happens if NOTFOUND is initially false or if  $x$  is greater than  $z$ ?

5. For a loop controlled by both iteration and a Boolean condition (a searching loop, for example) what are the consequences of loop fall-through? For example, for the psuedo-code loop headed by

```
DO I=1 to TABLESIZE WHILE (NOTFOUND)
```

what happens if NOTFOUND never becomes false?

6. Are there any off-by-one errors, such as one too many or too few iterations? This is a common error in zero-based loops. You will often forget to count “0” as a number. For example, if you want to create Java code for a loop that counted to 10, the following would be wrong, as it counts to 11:

```

for (int i=0; i<=10;i++) {
    System.out.println(i);
}

```

Correct, the loop is iterated 10 times:

```

for (int i=0; i <=9;i++) {
    System.out.println(i);
}

```

7. If the language contains a concept of statement groups or code blocks (e.g., `do-while` or `{...}`), is there an explicit `while` for each group and do the `do`'s correspond to their appropriate groups? Or is there a closing bracket for each open bracket? Most modern compilers will complain of such mismatches.
8. Are there any nonexhaustive decisions? For instance, if an input parameter's expected values are 1, 2, or 3, does the logic assume that it must be 3 if it is not 1 or 2? If so, is the assumption valid?

## Interface Errors

1. Does the number of parameters received by this module equal the number of arguments sent by each of the calling modules? Also, is the order correct?
2. Do the attributes (e.g., datatype and size) of each parameter match the attributes of each corresponding argument?
3. Does the units system of each parameter match the units system of each corresponding argument? For example, is the parameter expressed in degrees but the argument expressed in radians?
4. Does the number of arguments transmitted by this module to another module equal the number of parameters expected by that module?
5. Do the attributes of each argument transmitted to another module match the attributes of the corresponding parameter in that module?
6. Does the units system of each argument transmitted to another module match the units system of the corresponding parameter in that module?
7. If built-in functions are invoked, are the number, attributes, and order of the arguments correct?
8. If a module or class has multiple entry points, is a parameter ever referenced that is not associated with the current point of entry? Such an error exists in the second assignment statement in the following PL/1 program:

```
A:  PROCEDURE(W,X);  
    W=X+1;  
    RETURN  
B:  ENTRY (Y,Z);  
    Y=X+Z;  
    END;
```

9. Does a subroutine alter a parameter that is intended to be only an input value?
10. If global variables are present, do they have the same definition and attributes in all modules that reference them?
11. Are constants ever passed as arguments? In some FORTRAN implementations a statement such as

```
CALL SUBX(J,3)
```

is dangerous, since if the subroutine `SUBX` assigns a value to its second parameter, the value of the constant 3 will be altered.

## Input/Output Errors

1. If files are explicitly declared, are their attributes correct?
2. Are the attributes on the file's `OPEN` statement correct?
3. Does the format specification agree with the information in the I/O statement? For instance, in FORTRAN, does each `FORMAT` statement agree (in terms of the number and attributes of the items) with the corresponding `READ` or `WRITE` statement?
4. Is there sufficient memory available to hold the file your program will read?
5. Have all files been opened before use?
6. Have all files been closed after use?
7. Are end-of-file conditions detected and handled correctly?
8. Are I/O error conditions handled correctly?
9. Are there spelling or grammatical errors in any text that is printed or displayed by the program?



**Table 3.1**  
**Inspection Error Checklist Summary, Part I**

<i>Data Reference</i>	<i>Computation</i>
1. Unset variable used?	1. Computations on nonarithmetic variables?
2. Subscripts within bounds?	2. Mixed-mode computations?
3. Non integer subscripts?	3. Computations on variables of different lengths?
4. Dangling references?	4. Target size less than size of assigned value?
5. Correct attributes when aliasing?	5. Intermediate result overflow or underflow?
6. Record and structure attributes match?	6. Division by zero?
7. Computing addresses of bit strings? Passing bit-string arguments?	7. Base-2 inaccuracies?
8. Based storage attributes correct?	8. Variable's value outside of meaningful range?
9. Structure definitions match across procedures?	9. Operator precedence understood?
10. Off-by-one errors in indexing or subscripting operations?	10. Integer divisions correct?
11. Are inheritance requirements met?	
<i>Data Declaration</i>	<i>Comparison</i>
1. All variables declared?	1. Comparisons between inconsistent variables?
2. Default attributes understood?	2. Mixed-mode comparisons?
3. Arrays and strings initialized properly?	3. Comparison relationships correct?
4. Correct lengths, types, and storage classes assigned?	4. Boolean expressions correct?
5. Initialization consistent with storage class?	5. Comparison and Boolean expressions mixed?
6. Any variables with similar names?	6. Comparisons of base-2 fractional values?
	7. Operator precedence understood?
	8. Compiler evaluation of Boolean expressions understood?

**Table 3.2**  
**Inspection Error Checklist Summary, Part II**

<i>Control Flow</i>	<i>Input/Output</i>
1. Multiway branches exceeded?	1. File attributes correct?
2. Will each loop terminate?	2. OPEN statements correct?
3. Will program terminate?	3. Format specification matches I/O statement?
4. Any loop bypasses because of entry conditions?	4. Buffer size matches record size?
5. Are possible loop fall-throughs correct?	5. Files opened before use?
6. Off-by-one iteration errors?	6. Files closed after use?
7. DO/END statements match?	7. End-of-file conditions handled?
8. Any nonexhaustive decisions?	8. I/O errors handled?
9. Any textual or grammatical errors in output information?	
<i>Interfaces</i>	<i>Other Checks</i>
1. Number of input parameters equal to number of arguments?	1. Any unreferenced variables in cross-reference listing?
2. Parameter and argument attributes match?	2. Attribute list what was expected?
3. Parameter and argument units system match?	3. Any warning or informational messages?
4. Number of arguments transmitted to called modules equal to number of parameters?	4. Input checked for validity?
5. Attributes of arguments transmitted to called modules equal to attributes of parameters?	5. Missing function?
6. Units system of arguments transmitted to called modules equal to units system of parameters?	
7. Number, attributes, and order of arguments to built-in functions correct?	
8. Any references to parameters not associated with current point of entry?	
9. Input-only arguments altered?	
10. Global variable definitions consistent across modules?	
11. Constants passed as arguments?	

## Other Checks

1. If the compiler produces a cross-reference listing of identifiers, examine it for variables that are never referenced or are referenced only once.
2. If the compiler produces an attribute listing, check the attributes of each variable to ensure that no unexpected default attributes have been assigned.
3. If the program compiled successfully, but the computer produced one or more “warning” or “informational” messages, check each one carefully. Warning messages are indications that the compiler suspects that you are doing something of questionable validity; all of these suspicions should be reviewed. Informational messages may list undeclared variables or language uses that impede code optimization.
4. Is the program or module sufficiently robust? That is, does it check its input for validity?
5. Is there a function missing from the program?

This checklist is summarized in Tables 3.1 and 3.2 on pages 36–37.

## WALKTHROUGHS

The code walkthrough, like the inspection, is a set of procedures and error-detection techniques for group code reading. It shares much in common with the inspection process, but the procedures are slightly different, and a different error-detection technique is employed.

Like the inspection, the walkthrough is an uninterrupted meeting of one to two hours in duration. The walkthrough team consists of three to five people. One of these people plays a role similar to that of the moderator in the inspection process, another person plays the role of a secretary (a person who records all errors found), and a third person plays the role of a tester. Suggestions as to who the three to five

people should be vary. Of course, the programmer is one of those people. Suggestions for the other participants include (1) a highly experienced programmer, (2) a programming-language expert, (3) a new programmer (to give a fresh, unbiased outlook), (4) the person who will eventually maintain the program, (5) someone from a different project, and (6) someone from the same programming team as the programmer.

The initial procedure is identical to that of the inspection process: The participants are given the materials several days in advance to allow them to bone up on the program. However, the procedure in the meeting is different. Rather than simply reading the program or using error checklists, the participants “play computer.” The person designated as the tester comes to the meeting armed with a small set of paper test cases—representative sets of inputs (and expected outputs) for the program or module. During the meeting, each test case is mentally executed. That is, the test data are walked through the logic of the program. The state of the program (i.e., the values of the variables) is monitored on paper or whiteboard.

Of course, the test cases must be simple in nature and few in number, because people execute programs at a rate that is many orders of magnitude slower than a machine. Hence, the test cases themselves do not play a critical role; rather, they serve as a vehicle for getting started and for questioning the programmer about his or her logic and assumptions. In most walkthroughs, more errors are found during the process of questioning the programmer than are found directly by the test cases themselves.

As in the inspection, the attitude of the participants is critical. Comments should be directed toward the program rather than the programmer. In other words, errors are not viewed as weaknesses in the person who committed them. Rather, they are viewed as being inherent in the difficulty of the program development.

The walkthrough should have a follow-up process similar to that described for the inspection process. Also, the side effects observed from inspections (identification of error-prone sections and education in errors, style, and techniques) also apply to the walkthrough process.

## DESK CHECKING

A third human error-detection process is the older practice of desk checking. A desk check can be viewed as a one-person inspection or walkthrough: A person reads a program, checks it with respect to an error list, and/or walks test data through it.

For most people, desk checking is relatively unproductive. One reason is that it is a completely undisciplined process. A second, and more important, reason is that it runs counter to a testing principle of Chapter 2—the principal that people are generally ineffective in testing their own programs. For this reason, you could deduce that desk checking is best performed by a person other than the author of the program (e.g., two programmers might swap programs rather than desk check their own programs), but even this is less effective than the walkthrough or inspection process. The reason is the synergistic effect of the walkthrough or inspection team. The team session fosters a healthy environment of competition; people like to show off by finding errors. In a desk-checking process, since there is no one to whom you can show off, this apparently valuable effect is missing. In short, desk checking may be more valuable than doing nothing at all, but it is much less effective than the inspection or walkthrough.

## PEER RATINGS

The last human review process is not associated with program testing (i.e., its objective is not to find errors). This process is included here, however, because it is related to the idea of code reading.

Peer rating is a technique of evaluating anonymous programs in terms of their overall quality, maintainability, extensibility, usability, and clarity. The purpose of the technique is to provide programmer self-evaluation.

A programmer is selected to serve as an administrator of the process. The administrator, in turn, selects approximately 6 to 20 participants (6 is the minimum to preserve anonymity). The participants

are expected to have similar backgrounds (you shouldn't group Java application programmers with assembly language system programmers, for example). Each participant is asked to select two of his or her own programs to be reviewed. One program should be representative of what the participant considers to be his or her finest work; the other should be a program that the programmer considers to be poorer in quality.

Once the programs have been collected, they are randomly distributed to the participants. Each participant is given four programs to review. Two of the programs are the "finest" programs and two are "poorer" programs, but the reviewer is not told which is which. Each participant spends 30 minutes with each program and then completes an evaluation form after reviewing the program. After reviewing all four programs, each participant rates the relative quality of the four programs. The evaluation form asks the reviewer to answer, on a scale from 1 to 7 (1 meaning definitely "yes," 7 meaning definitely "no"), such questions as these:

- Was the program easy to understand?
- Was the high-level design visible and reasonable?
- Was the low-level design visible and reasonable?
- Would it be easy for you to modify this program?
- Would you be proud to have written this program?

The reviewer also is asked for general comments and suggested improvements.

After the review, the participants are given the anonymous evaluation forms for their two contributed programs. The participants also are given a statistical summary showing the overall and detailed ranking of their original programs across the entire set of programs, as well as an analysis of how their ratings of other programs compared with those ratings of other reviewers of the same program. The purpose of the process is to allow programmers to self-assess their programming skills. As such, the process appears to be useful in both industrial and classroom environments.

## SUMMARY

This chapter discussed a form of testing that developers do not often consider—human testing. Most people assume that because programs are written for machine execution machines should test programs as well. This assumption is invalid. Human testing techniques are very effective at revealing errors. In fact, most programming projects should include the following human testing techniques:

- Code inspections using checklists
- Group walkthroughs
- Desk checking
- Peer reviews

## CHAPTER 4

# TEST-CASE DESIGN

**M**oving beyond the psychological issues discussed in Chapter 2, the most important consideration in program testing is the design and creation of effective test cases.

Testing, however creative and seemingly complete, cannot guarantee the absence of all errors. Test-case design is so important because complete testing is impossible; a test of any program must be necessarily incomplete. The obvious strategy, then, is to try to make tests as complete as possible.

Given constraints on time and cost, the key issue of testing becomes

*What subset of all possible test cases has the highest probability of detecting the most errors?*

The study of test-case-design methodologies supplies answers to this question.

In general, the least effective methodology of all is random-input testing—the process of testing a program by selecting, at random, some subset of all possible input values. In terms of the likelihood of detecting the most errors, a randomly selected collection of test cases has little chance of being an optimal, or close to optimal, subset. In this chapter we want to develop a set of thought processes that let you select test data more intelligently.

Chapter 2 showed that exhaustive black-box and white-box testing are, in general, impossible, but suggested that a reasonable testing strategy might be elements of both. This is the strategy developed in this chapter. You can develop a reasonably rigorous test by using certain black-box-oriented test-case-design methodologies and then



supplementing these test cases by examining the logic of the program, using white-box methods.

The methodologies discussed in this chapter are listed as follows.

***Black Box***

Equivalence partitioning  
Boundary-value analysis  
Cause-effect graphing  
Error guessing

***White Box***

Statement coverage  
Decision coverage  
Condition coverage  
Decision-condition coverage  
Multiple-condition coverage

Although the methods will be discussed separately, we recommend that you use a combination of most, if not all, of the methods to design a rigorous test of a program, since each method has distinct strengths and weaknesses. One method may find errors another method overlooks, for example.

Nobody ever promised that software testing would be easy. To quote an old sage, “If you thought designing and coding that program was hard, you ain’t seen nothing yet.”

The recommended procedure is to develop test cases using the black-box methods and then develop supplementary test cases as necessary with white-box methods. We’ll discuss the more widely known white-box methods first.

## WHITE-BOX TESTING

### **Logic-Coverage Testing**

White-box testing is concerned with the degree to which test cases exercise or cover the logic (source code) of the program. As we saw in Chapter 2, the ultimate white-box test is the execution of every path in the program, but complete path testing is not a realistic goal for a program with loops.

If you back completely away from path testing, it may seem that a worthy goal would be to execute every statement in the program at least once. Unfortunately, this is a weak criterion for a reasonable

white-box test. This concept is illustrated in Figure 4.1. Assume that Figure 4.1 represents a small program to be tested. The equivalent Java code snippet follows:

```
public void foo(int a, int b, int x) {
    if (a>1 && b==0) {
        x=x/a;
    }
    if (a==2 || x>1) {
        x=x+1;
    }
}
```

You could execute every statement by writing a single test case that traverses path *ace*. That is, by setting  $A=2$ ,  $B=0$ , and  $X=3$  at point *a*, every statement would be executed once (actually,  $X$  could be assigned any value).

Unfortunately, this criterion is a rather poor one. For instance, perhaps the first decision should be an *or* rather than an *and*. If so, this error would go undetected. Perhaps the second decision should have stated  $X>0$ ; this error would not be detected. Also, there is a path through the program in which  $X$  goes unchanged (the path *abd*). If this were an error, it would go undetected. In other words, the statement-coverage criterion is so weak that it generally is useless.

A stronger logic-coverage criterion is known as *decision coverage* or *branch coverage*. This criterion states that you must write enough test cases that each decision has a *true* and a *false* outcome at least once. In other words, each branch direction must be traversed at least once. Examples of branch or decision statements are *switch*, *do-while*, and *if-else* statements. Multiway *GOTO* statements qualify in some programming languages such as *FORTRAN*.

Decision coverage usually can satisfy statement coverage. Since every statement is on some subpath emanating either from a branch statement or from the entry point of the program, every statement must be executed if every branch direction is executed. However, there are at least three exceptions:

- Programs with no decisions.
- Programs or subroutines/methods with multiple entry points. A given statement might be executed only if the program is entered at a particular entry point.
- Statements within ON-units. Traversing every branch direction will not necessarily cause all ON-units to be executed.

Since we have deemed statement coverage to be a necessary condition, decision coverage, a seemingly better criterion, should be defined to include statement coverage. Hence, decision coverage requires that each decision have a *true* and a *false* outcome, *and* that each statement be executed at least once. An alternative and easier way of expressing it is that each decision has a *true* and a *false* outcome, and that each point of entry (including ON-units) be invoked at least once.

This discussion considers only two-way decisions or branches and has to be modified for programs that contain multiway decisions. Examples are Java programs containing `select (case)` statements, FORTRAN programs containing arithmetic (three-way) `IF` statements or computed or arithmetic `GOTO` statements, and COBOL programs containing altered `GOTO` statements or `GO-TO-DEPENDING-ON` statements. For such programs, the criterion is exercising each possible outcome of all decisions at least once and invoking each point of entry to the program or subroutine at least once.

In Figure 4.1, decision coverage can be met by two test cases covering paths *ace* and *abd* or, alternatively, *acd* and *abe*. If we choose the latter alternative, the two test-case inputs are  $A = 3, B = 0, X = 3$  and  $A = 2, B = 1, X = 1$ .

Decision coverage is a stronger criterion than statement coverage, but it still is rather weak. For instance, there is only a 50 percent chance that we would explore the path where  $X$  is not changed (i.e., only if we chose the former alternative). If the second decision were in error (if it should have said  $X < 1$  instead of  $X > 1$ ), the mistake would not be detected by the two test cases in the previous example.

A criterion that is sometimes stronger than decision coverage is *condition coverage*. In this case, you write enough test cases to ensure that each condition in a decision takes on all possible outcomes at

**Figure 4.1**  
**A small program to be tested.**

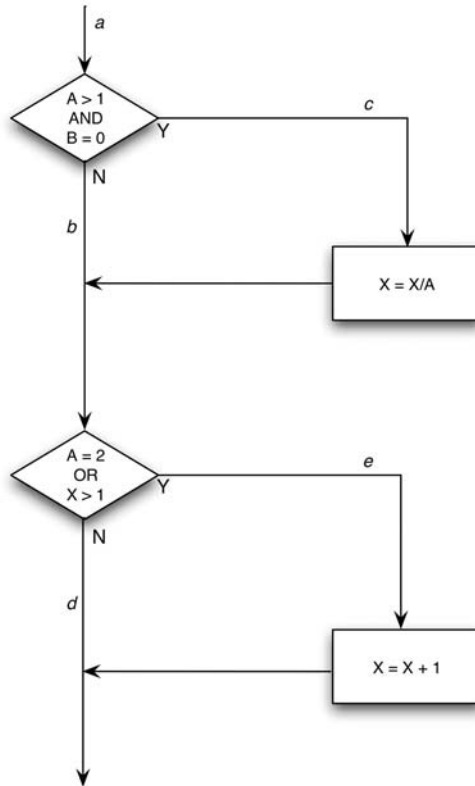

least once. Since, as with decision coverage, this does not always lead to the execution of each statement, an addition to the criterion is that each point of entry to the program or subroutine, as well as ON-units, be invoked at least once. For instance, the branching statement

```
DO K=0 to 50 WHILE (J+K<QUEST)
```

contains two conditions: is  $K$  less than or equal to 50, and is  $J+K$  less than  $QUEST$ ? Hence, test cases would be required for the situations

$K \leq 50$ ,  $K > 50$  (to reach the last iteration of the loop),  $J + K < \text{QUEST}$ , and  $J + K \geq \text{QUEST}$ .

Figure 4.1 has four conditions:  $A > 1$ ,  $B = 0$ ,  $A = 2$ , and  $X > 1$ . Hence, enough test cases are needed to force the situations where  $A > 1$ ,  $A \leq 1$ ,  $B = 0$ , and  $B > 0$  are present at point *a* and where  $A = 2$ ,  $A < 2$ ,  $X > 1$ , and  $X \leq 1$  are present at point *b*. A sufficient number of test cases satisfying the criterion, and the paths traversed by each, are

1.  $A = 2$ ,  $B = 0$ ,  $X = 4$      *ace*
2.  $A = 1$ ,  $B = 1$ ,  $X = 1$      *adb*

Note that, although the same number of test cases was generated for this example, condition coverage usually is superior to decision coverage in that it *may* (but does not always) cause every individual condition in a decision to be executed with both outcomes, whereas decision coverage does not. For instance, in the same branching statement

```
DO K=0 to 50 WHILE (J+K<QUEST)
```

is a two-way branch (execute the loop body or skip it). If you are using decision testing, the criterion can be satisfied by letting the loop run from  $K = 0$  to 51, *without ever exploring the circumstance where the WHILE clause becomes false*. With the condition criterion, however, a test case would be needed to generate a *false* outcome for the conditions  $J + K < \text{QUEST}$ .

Although the condition-coverage criterion appears, at first glance, to satisfy the decision-coverage criterion, it does not always do so. If the decision `IF (A&B)` is being tested, the condition-coverage criterion would let you write two test cases—*A is true, B is false*, and *A is false, B is true*—but this would not cause the `THEN` clause of the `IF` to execute. The condition-coverage tests for the earlier example cov-

ered all decision outcomes, but this was only by chance. For instance, two alternative test cases

1. A=1, B=0, X=3
2. A=2, B=1, X=1

cover all condition outcomes, but they cover only two of the four decision outcomes (both of them cover path *abe* and, hence, do not exercise the *true* outcome of the first decision and the *false* outcome of the second decision).

The obvious way out of this dilemma is a criterion called *decision/condition coverage*. It requires sufficient test cases that each condition in a decision takes on all possible outcomes at least once, each decision takes on all possible outcomes at least once, and each point of entry is invoked at least once.

A weakness with decision/condition coverage is that, although it may appear to exercise all outcomes of all conditions, it frequently does not because certain conditions mask other conditions. To see this, examine Figure 4.2. The flowchart in Figure 4.2 is the way a compiler would generate machine code for the program in Figure 4.1. The multicondition decisions in the source program have been broken into individual decisions and branches because most machines do not have a single instruction that makes multicondition decisions. A more thorough test coverage, then, appears to be the exercising of all possible outcomes of each primitive decision. The two previous decision-coverage test cases do not accomplish this; they fail to exercise the *false* outcome of decision H and the *true* outcome of decision K.

The reason, as shown in Figure 4.2, is that results of conditions in *and* and *or* expressions can mask or block the evaluation of other conditions. For instance, if an *and* condition is false, none of the subsequent conditions in the expression need be evaluated. Likewise if an *or* condition is true, none of the subsequent conditions need be evaluated. Hence, errors in logical expressions are not necessarily revealed by the condition-coverage and decision/condition-coverage criteria.

A criterion that covers this problem, and then some, is *multiple-*

**Figure 4.2**  
**Machine code for the program in Figure 4.1.**

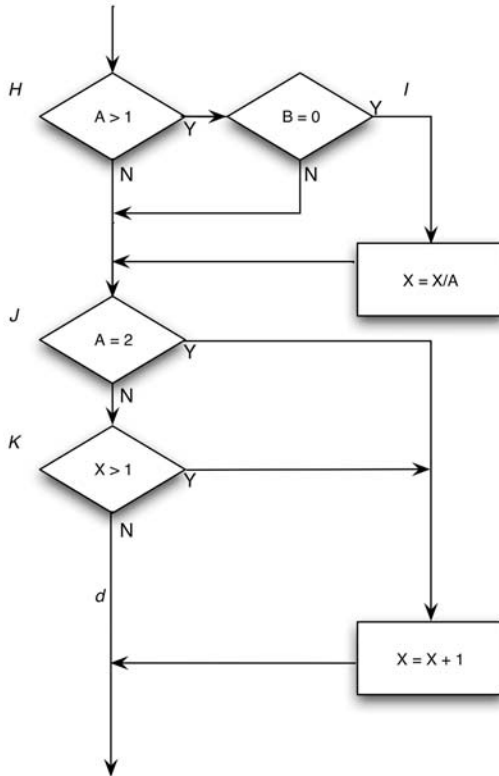

*condition coverage*. This criterion requires that you write sufficient test cases that all possible combinations of condition outcomes in each decision, and all points of entry, are invoked at least once. For instance, consider the following sequence of pseudocode.

```

NOTFOUND=TRUE;
DO I=1 to TABSIZE WHILE (NOTFOUND); /*SEARCH TABLE*/
    ...searching logic...;
END
  
```

The four situations to be tested are:

1.  $I \leq \text{TABSIZE}$  and NOTFOUND is true.
2.  $I \leq \text{TABSIZE}$  and NOTFOUND is false (finding the entry before hitting the end of the table).
3.  $I > \text{TABSIZE}$  and NOTFOUND is true (hitting the end of the table without finding the entry).
4.  $I > \text{TABSIZE}$  and NOTFOUND is false (the entry is the last one in the table).

It should be easy to see that a set of test cases satisfying the multiple-condition criterion also satisfies the decision-coverage, condition-coverage, and decision/condition-coverage criteria.

Returning to Figure 4.1, test cases must cover eight combinations:

- |                        |                        |
|------------------------|------------------------|
| 1. $A > 1, B = 0$      | 5. $A = 2, X > 1$      |
| 2. $A > 1, B < > 0$    | 6. $A = 2, X \leq 1$   |
| 3. $A \leq 1, B = 0$   | 7. $A < > 2, X > 1$    |
| 4. $A \leq 1, B < > 0$ | 8. $A < > 2, X \leq 1$ |

Note, as was the case earlier, that cases 5 through 8 express values at the point of the second *if* statement. Since *x* may be altered above this *if* statement, the values needed at this *if* statement must be backed up through the logic to find the corresponding input values.

These combinations to be tested do not necessarily imply that eight test cases are needed. In fact, they can be covered by four test cases. The test-case input values, and the combinations they cover, are as follows:

- |                       |             |
|-----------------------|-------------|
| $A = 2, B = 0, X = 4$ | Covers 1, 5 |
| $A = 2, B = 1, X = 1$ | Covers 2, 6 |
| $A = 1, B = 0, X = 2$ | Covers 3, 7 |
| $A = 1, B = 1, X = 1$ | Covers 4, 8 |

The fact that there are four test cases and four distinct paths in Figure 4.1 is just coincidence. In fact, these four test cases do not cover every



path; they miss the path *acd*. For instance, you would need eight test cases for the following decision:

```
if(x==y && length(z)==0 && FLAG) {  
    j=1;  
else  
    i=1;  
}
```

although it contains only two paths. In the case of loops, the number of test cases required by the multiple-condition criterion is normally much less than the number of paths.

In summary, for programs containing only one condition per decision, a minimum test criterion is a sufficient number of test cases to (1) evoke all outcomes of each decision at least once and (2) invoke each point of entry (such as entry point or ON-unit) at least once, to ensure that all statements are executed at least once. For programs containing decisions having multiple conditions, the minimum criterion is a sufficient number of test cases to evoke all possible combinations of condition outcomes in each decision, and all points of entry to the program, at least once. (The word “possible” is inserted because some combinations may be found to be impossible to create.)

## Equivalence Partitioning

Chapter 2 described a good test case as one that has a reasonable probability of finding an error, and it also discussed the fact that an exhaustive-input test of a program is impossible. Hence, in testing a program, you are limited to trying a small subset of all possible inputs. Of course, then, you want to select the right subset, the subset with the highest probability of finding the most errors.

One way of locating this subset is to realize that a well-selected test case also should have two other properties:

1. It reduces, by more than a count of one, the number of other test cases that must be developed to achieve some predefined goal of “reasonable” testing.

2. It covers a large set of other possible test cases. That is, it tells us something about the presence or absence of errors over and above this specific set of input values.

These two properties, although they appear to be similar, describe two distinct considerations. The first implies that each test case should invoke as many different input considerations as possible to minimize the total number of test cases necessary. The second implies that you should try to partition the input domain of a program into a finite number of *equivalence classes* such that you can reasonably assume (but, of course, not be absolutely sure) that a test of a representative value of each class is equivalent to a test of any other value. That is, if one test case in an equivalence class detects an error, all other test cases in the equivalence class would be expected to find the same error. Conversely, if a test case did not detect an error, we would expect that no other test cases in the equivalence class would fall within another equivalence class, since equivalence classes may overlap one another.

These two considerations form a black-box methodology known as *equivalence partitioning*. The second consideration is used to develop a set of “interesting” conditions to be tested. The first consideration is then used to develop a minimal set of test cases covering these conditions.

An example of an equivalence class in the triangle program of Chapter 1 is the set “three equal-valued numbers having integer values greater than zero.” By identifying this as an equivalence class, we are stating that if no error is found by a test of one element of the set, it is unlikely that an error would be found by a test of another element of the set. In other words, our testing time is best spent elsewhere (in different equivalence classes).

Test-case design by equivalence partitioning proceeds in two steps: (1) identifying the equivalence classes and (2) defining the test cases.

### ***Identifying the Equivalence Classes***

The equivalence classes are identified by taking each input condition (usually a sentence or phrase in the specification) and partitioning it into two or more groups. You can use the table in Figure 4.3 to do

**Figure 4.3**  
**A form for enumerating equivalence classes.**

---

External condition	Valid equivalence classes	Invalid equivalence classes

---

this. Notice that two types of equivalence classes are identified: *valid equivalence* classes represent valid inputs to the program, and *invalid equivalence* classes represent all other possible states of the condition (i.e., erroneous input values). Thus, we are adhering to the principle discussed in Chapter 2 that stated that you must focus attention on invalid or unexpected conditions.

Given an input or external condition, identifying the equivalence classes is largely a heuristic process. A set of guidelines is as follows:

1. If an input condition specifies a range of values (for example, “the item count can be from 1 to 999”), identify one valid equivalence class ( $1 < \text{item count} < 999$ ) and two invalid equivalence classes ( $\text{item count} < 1$  and  $\text{item count} > 999$ ).
2. If an input condition specifies the number of values (for example, “one through six owners can be listed for the automobile”), identify one valid equivalence class and two invalid equivalence classes (no owners and more than six owners).
3. If an input condition specifies a set of input values and there

is reason to believe that the program handles each differently (“type of vehicle must be BUS, TRUCK, TAXICAB, PASSENGER, or MOTORCYCLE”), identify a valid equivalence class for each and one invalid equivalence class (“TRAILER,” for example).

4. If an input condition specifies a “must be” situation, such as “first character of the identifier must be a letter,” identify one valid equivalence class (it is a letter) and one invalid equivalence class (it is not a letter).

If there is any reason to believe that the program does not handle elements in an equivalence class identically, split the equivalence class into smaller equivalence classes. An example of this process will be illustrated shortly.

### *Identifying the Test Cases*

The second step is the use of equivalence classes to identify the test cases. The process is as follows:

1. Assign a unique number to each equivalence class.
2. Until all valid equivalence classes have been covered by (incorporated into) test cases, write a new test case covering as many of the uncovered valid equivalence classes as possible.
3. Until your test cases have covered all invalid equivalence classes, write a test case that covers one, and only one, of the uncovered invalid equivalence classes.

The reason that individual test cases cover invalid cases is that certain erroneous-input checks mask or supersede other erroneous-input checks. For instance, if the specification states “enter book type (HARDCOVER, SOFTCOVER, or LOOSE) and amount (1–999),” the test case, XYZ 0, expressing two error conditions (invalid book type and amount) will probably not exercise the check for the amount, since the program may say “XYZ IS UNKNOWN BOOK TYPE” and not bother to examine the remainder of the input.

## An Example

As an example, assume that we are developing a compiler for a subset of the FORTRAN language, and we wish to test the syntax checking of the `DIMENSION` statement. The specification is listed below. (This is not the full FORTRAN `DIMENSION` statement; it has been cut down considerably to make it a textbook-sized example. Do not be deluded into thinking that the testing of actual programs is as easy as the examples in this book.) In the specification, items in italics indicate syntactic units for which specific entities must be substituted in actual statements, brackets are used to indicate option items, and an ellipsis indicates that the preceding item may appear multiple times in succession.

A `DIMENSION` statement is used to specify the dimensions of arrays. The form of the `DIMENSION` statement is

```
DIMENSION ad[,ad]. . .
```

where *ad* is an array descriptor of the form

```
n(d[ ,d]. . .)
```

where *n* is the symbolic name of the array and *d* is a dimension declarator. Symbolic names can be one to six letters or digits, the first of which must be a letter. The minimum and maximum numbers of dimension declarations that can be specified for an array are one and seven, respectively. The form of a dimension declarator is

```
[lb: ]ub
```

where *lb* and *ub* are the lower and upper dimension bounds.

A bound may be a constant in the range  $-65534$  to  $65535$  or the name of an integer variable (but not an array element name).

If *lb* is not specified, it is assumed to be one. The value of *ub* must be greater than or equal to *lb*. If *lb* is specified, its value may be negative, zero, or positive. As for all statements, the `DIMENSION` statement may be continued over multiple lines. (End of specification.)

The first step is to identify the input conditions and, from these, locate the equivalence classes. These are tabulated in Table 4.1. The numbers in the table are unique identifiers of the equivalence classes.

**Table 4.1**  
**Equivalence Classes**

<i>Input Condition</i>	<i>Valid Equivalence Classes</i>	<i>Invalid Equivalence Classes</i>
Number of array descriptors	one (1), > one (2)	none (3)
Size of array name	1–6 (4)	0 (5), > 6 (6)
Array name	has letters (7), has digits (8)	has something else (9)
Array name starts with letter	yes (10)	no (11)
Number of dimensions	1–7 (12)	0 (13), > 7 (14)
Upper bound is	constant (15), integer variable (16)	array element name (17), something else (18)
Integer variable name	has letter (19), has digits (20)	has something else (21)
Integer variable starts with letter	yes (22)	no (23)
Constant	–65534–65535 (24)	≤65534 (25), >65535 (26)
Lower bound specified	yes (27), no (28)	
Upper bound to lower bound	greater than (29), equal (30)	less than (31)
Specified lower bound	negative (32), zero (33), > 0 (34)	
Lower bound is	constant (35), integer variable (36)	array element name (37), something else (38)
Multiple lines	yes (39), no (40)	

The next step is to write a test case covering one or more valid equivalence classes. For instance, the test case

DIMENSION A(2)

covers classes 1, 4, 7, 10, 12, 15, 24, 28, 29, and 40. The next step is to devise one or more test cases covering the remaining valid equivalence classes. One test case of the form

DIMENSION A 12345 (I,9,J4XXXX,65535,1,KLM,  
X 100), BBB(-65534:100,0:1000,10:10, I:65535)

covers the remaining classes. The invalid-input equivalence classes, and a test case representing each, are

- (3): DIMENSION
- (5): DIMENSION (10)
- (6): DIMENSION A234567(2)
- (9): DIMENSION A.1(2)
- (11): DIMENSION 1A(10)
- (13): DIMENSION B
- (14): DIMENSION B(4,4,4,4,4,4,4,4)
- (17): DIMENSION B(4,A(2))
- (18): DIMENSION B(4,,7)
- (21): DIMENSION C(I.,10)
- (23): DIMENSION C(10,1J)
- (25): DIMENSION D(-65535:1)
- (26): DIMENSION D(65536)
- (31): DIMENSION D(4:3)
- (37): DIMENSION D(A(2):4)
- (38): D(.:4)

Hence, the equivalence classes have been covered by 18 test cases. You may want to consider how these test cases would compare to a set of test cases derived in an ad hoc manner.

Although equivalence partitioning is vastly superior to a random selection of test cases, it still has deficiencies. It overlooks certain types of high-yield test cases, for example. The next two methodologies, boundary-value analysis and cause-effect graphing, cover many of these deficiencies.

## Boundary-Value Analysis

Experience shows that test cases that explore *boundary conditions* have a higher payoff than test cases that do not. Boundary conditions are those situations directly on, above, and beneath the edges of input equivalence classes and output equivalence classes. Boundary-value analysis differs from equivalence partitioning in two respects:

1. Rather than selecting any element in an equivalence class as being representative, boundary-value analysis requires that one or more elements be selected such that each edge of the equivalence class is the subject of a test.
2. Rather than just focusing attention on the input conditions (input space), test cases are also derived by considering the *result space* (output equivalence classes).

It is difficult to present a “cookbook” for boundary-value analysis, since it requires a degree of creativity and a certain amount of specialization toward the problem at hand. (Hence, like many other aspects of testing, it is more a state of mind than anything else.) However, a few general guidelines are as follows:

1. If an input condition specifies a range of values, write test cases for the ends of the range, and invalid-input test cases for situations just beyond the ends. For instance, if the valid domain of an input value is  $-1.0$ – $+1.0$ , write test cases for the situations  $-1.0$ ,  $1.0$ ,  $-1.001$ , and  $1.001$ .
2. If an input condition specifies a number of values, write test cases for the minimum and maximum number of values and



- one beneath and beyond these values. For instance, if an input file can contain 1–255 records, write test cases for 0, 1, 255, and 256 records.
3. Use guideline 1 for each output condition. For instance, if a program computes the monthly FICA deduction and if the minimum is \$0.00 and the maximum is \$1,165.25, write test cases that cause \$0.00 and \$1,165.25 to be deducted. Also, see if it is possible to invent test cases that might cause a negative deduction or a deduction of more than \$1,165.25. Note that it is important to examine the boundaries of the result space because it is not always the case that the boundaries of the input domains represent the same set of circumstances as the boundaries of the output ranges (e.g., consider a sine subroutine). Also, it is not always possible to generate a result outside of the output range, but it is worth considering the possibility, nonetheless.
  4. Use guideline 2 for each output condition. If an information-retrieval system displays the most relevant abstracts based on an input request, but never more than four abstracts, write test cases such that the program displays zero, one, and four abstracts, and write a test case that might cause the program to erroneously display five abstracts.
  5. If the input or output of a program is an ordered set (a sequential file, for example, or a linear list or a table), focus attention on the first and last elements of the set.
  6. In addition, use your ingenuity to search for other boundary conditions.

The triangle analysis program of Chapter 1 can illustrate the need for boundary-value analysis. For the input values to represent a triangle, they must be integers greater than 0 where the sum of any two is greater than the third. If you were defining equivalent partitions, you might define one where this condition is met and another where the sum of two of the integers is not greater than the third. Hence, two possible test cases might be 3–4–5 and 1–2–4. However, we have missed a likely error. That is, if an expression in the program were

coded as  $A+B \geq C$  instead of  $A+B > C$ , the program would erroneously tell us that 1-2-3 represents a valid scalene triangle. Hence, the important difference between boundary-value analysis and equivalence partitioning is that boundary-value analysis explores situations *on and around the edges of the equivalence partitions*.

As an example of a boundary-value analysis, consider the following program specification:

MTEST is a program that grades multiple-choice examinations. The input is a data file named OCR, with multiple records that are 80 characters long. Per the file specification, the first record is a title used as a title on each output report. The next set of records describes the correct answers on the exam. These records contain a “2” as the last character. In the first record of this set, the number of questions is listed in columns 1–3 (a value of 1–999). Columns 10–59 contain the correct answers for questions 1–50 (any character is valid as an answer). Subsequent records contain, in columns 10–59, the correct answers for questions 51–100, 100–150, and so on.

The third set of records describes the answers of each student; each of these records contains a “3” in column 80. For each student, the first record contains the student’s name or number in columns 1–9 (any characters); columns 10–59 contain the student’s answers for questions 1–50. If the test has more than 50 questions, subsequent records for the student contain answers 51–100, 101–150, and so on, in columns 10–59. The maximum number of students is 200. The input data are illustrated in Figure 4.4. The four output records are

1. A report, sorted by student identifier, showing each student’s grade (percentage of answers correct) and rank.
2. A similar report, but sorted by grade.
3. A report indicating the mean, median, and standard deviation of the grades.
4. A report, ordered by question number, showing the percentage of students answering each question correctly.

(End of specification.)

**Figure 4.4**  
**Input to the MTEST program.**

---

Title				
1				80

No. of questions		Correct answers 1–50		2
1	3 4	9 10	59 60	79 80

	Correct answers 51–100		2
1	9 10	59 60	79 80

Student identifier	Correct answers 1–50		3
1	9 10	59 60	79 80

	Correct answers 51–100		3
1	9 10	59 60	79 80

Student identifier	Correct answers 1–50		3
1	9 10	59 60	79 80

---

We can begin by methodically reading the specification, looking for input conditions. The first boundary input condition is an empty input file. The second input condition is the title record; boundary conditions are a missing title record and the shortest and longest possible titles. The next input conditions are the presence of correct-answer records and the number-of-questions field on the first answer

record. The equivalence class for the number of questions is not 1–999, since something special happens at each multiple of 50 (i.e., multiple records are needed). A reasonable partitioning of this into equivalence classes is 1–50 and 51–999. Hence, we need test cases where the number-of-questions field is set to 0, 1, 50, 51, and 999. This covers most of the boundary conditions for the number of correct-answer records; however, three more interesting situations are the absence of answer records and having one too many and one too few answer records (for example, the number of questions is 60, but there are three answer records in one case and one answer record in the other case). The test cases identified so far are

1. Empty input file.
2. Missing title record.
3. 1-character title.
4. 80-character title.
5. 1-question exam.
6. 50-question exam.
7. 51-question exam.
8. 999-question exam.
9. 0-question exam.
10. Number-of-questions field has nonnumeric value.
11. No correct-answer records after title record.
12. One too many correct-answer records.
13. One too few correct-answer records.

The next input conditions are related to the students' answers. The boundary-value test cases here appear to be

14. 0 students.
15. 1 student.
16. 200 students.
17. 201 students.
18. A student has one answer record, but there are two correct-answer records.
19. The above student is the first student in the file.

20. The above student is the last student in the file.
21. A student has two answer records, but there is just one correct-answer record.
22. The above student is the first student in the file.
23. The above student is the last student in the file.

You also can derive a useful set of test cases by examining the output boundaries, although some of the output boundaries (e.g., empty report 1) are covered by the existing test cases. The boundary conditions of reports 1 and 2 are

- 0 students (same as test 14).
- 1 student (same as test 15).
- 200 students (same as test 16).
24. All students receive the same grade.
25. All students receive a different grade.
26. Some, but not all, students receive the same grade (to see if ranks are computed correctly).
27. A student receives a grade of 0.
28. A student receives a grade of 100.
29. A student has the lowest possible identifier value (to check the sort).
30. A student has the highest possible identifier value.
31. The number of students is such that the report is just large enough to fit on one page (to see if an extraneous page is printed).
32. The number of students is such that all students but one fit on one page.

The boundary conditions from report 3 (mean, median, and standard deviation) are

33. The mean is at its maximum (all students have a perfect score).
34. The mean is 0 (all students receive a grade of 0).

35. The standard deviation is at its maximum (one student receives a 0 and the other receives a 100).
36. The standard deviation is 0 (all students receive the same grade).

Tests 33 and 34 also cover the boundaries of the median. Another useful test case is the situation where there are 0 students (looking for a division by 0 in computing the mean), but this is identical to test case 14.

An examination of report 4 yields the following boundary-value tests:

37. All students answer question 1 correctly.
38. All students answer question 1 incorrectly.
39. All students answer the last question correctly.
40. All students answer the last question incorrectly.
41. The number of questions is such that the report is just large enough to fit on one page.
42. The number of questions is such that all questions but one fit on one page.

An experienced programmer would probably agree at this point that many of these 42 test cases represent common errors that might have been made in developing this program, yet most of these errors probably would go undetected if a random or ad hoc test-case-generation method were used. Boundary-value analysis, if practiced correctly, is one of the most useful test-case-design methods. However, it often is used ineffectively because the technique, on the surface, sounds simple. You should understand that boundary conditions may be very subtle and, hence, identification of them requires a lot of thought.

## Cause-Effect Graphing

One weakness of boundary-value analysis and equivalence partitioning is that they do not explore *combinations* of input circumstances. For

instance, perhaps the MTEST program of the previous section fails if the product of the number of questions and the number of students exceeds some limit (the program runs out of memory, for example). Boundary-value testing would not necessarily detect such an error.

The testing of input combinations is not a simple task because even if you equivalence-partition the input conditions, the number of combinations usually is astronomical. If you have no systematic way of selecting a subset of input conditions, you'll probably select an arbitrary subset of conditions, which could lead to an ineffective test.

Cause-effect graphing aids in selecting, in a systematic way, a high-yield set of test cases. It has a beneficial side effect in pointing out incompleteness and ambiguities in the specification.

A cause-effect graph is a formal language into which a natural-language specification is translated. The graph actually is a digital-logic circuit (a combinatorial logic network), but instead of standard electronics notation, a somewhat simpler notation is used. No knowledge of electronics is necessary other than an understanding of Boolean logic (understanding the logic operators *and*, *or*, and *not*).

The following process is used to derive test cases:

1. The specification is divided into workable pieces. This is necessary because cause-effect graphing becomes unwieldy when used on large specifications. For instance, when testing an e-commerce system, a "workable piece" might be the specification for choosing and verifying a single item placed in a shopping cart. When testing a Web page design, you might test a single menu tree or even a less complex navigation sequence.
2. The causes and effects in the specification are identified. A cause is a distinct input condition or an equivalence class of input conditions. An effect is an output condition or a system transformation (a lingering effect that an input has on the state of the program or system). For instance, if a transaction causes a file or database record to be updated, the alteration is a system transformation; a confirmation message

- would be an output condition. You identify causes and effects by reading the specification word by word and underlining words or phrases that describe causes and effects. Once identified, each cause and effect is assigned a unique number.
3. The semantic content of the specification is analyzed and transformed into a Boolean graph linking the causes and effects. This is the cause-effect graph.
  4. The graph is annotated with constraints describing combinations of causes and/or effects that are impossible because of syntactic or environmental constraints.
  5. By methodically tracing state conditions in the graph, you convert the graph into a limited-entry decision table. Each column in the table represents a test case.
  6. The columns in the decision table are converted into test cases.

The basic notation for the graph is shown in Figure 4.5. Think of each node as having the value 0 or 1; 0 represents the “absent” state and 1 represents the “present” state. The *identity* function states that if  $a$  is 1,  $b$  is 1; else  $b$  is 0. The *not* function states that if  $a$  is 1,  $b$  is 0, else  $b$  is 1. The *or* function states that if  $a$  or  $b$  or  $c$  is 1,  $d$  is 1; else  $d$  is 0. The *and* function states that if both  $a$  and  $b$  are 1,  $c$  is 1; else  $c$  is 0. The latter two functions (*or* and *and*) are allowed to have any number of inputs.

To illustrate a small graph, consider the following specification:

The character in column 1 must be an “A” or a “B.” The character in column 2 must be a digit. In this situation, the file update is made. If the first character is incorrect, message X12 is issued. If the second character is not a digit, message X13 is issued.

The causes are

- 1—character in column 1 is “A”
- 2—character in column 1 is “B”
- 3—character in column 2 is a digit



**Figure 4.5**  
**Basic cause-effect graph symbols.**

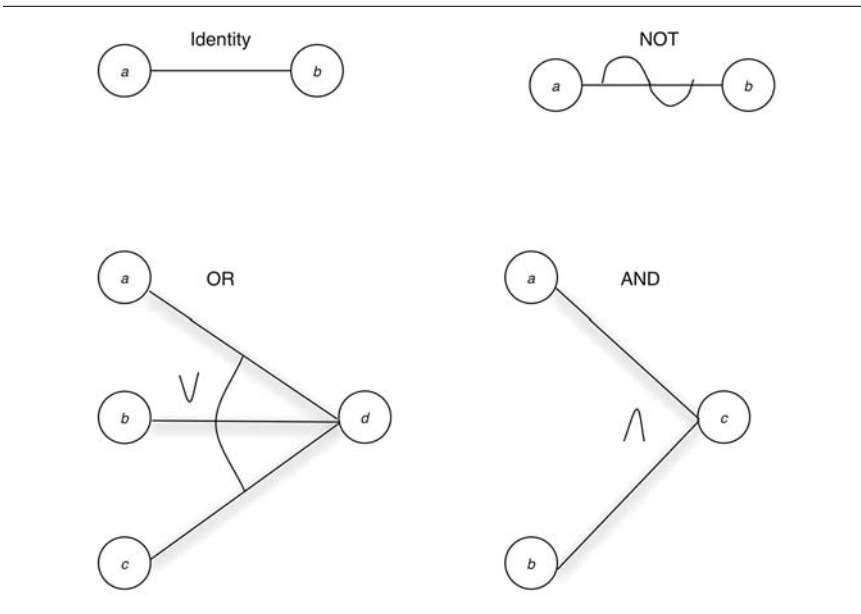

and the effects are

- 70—update made
- 71—message X12 is issued
- 72—message X13 is issued

The cause-effect graph is shown in Figure 4.6. Notice the intermediate node 11 that was created. You should confirm that the graph represents the specification by setting all possible states of the causes and seeing that the effects are set to the correct values. For readers familiar with logic diagrams, Figure 4.7 is the equivalent logic circuit.

Although the graph in Figure 4.6 represents the specification, it does contain an impossible combination of causes—it is impossible for both causes 1 and 2 to be set to 1 simultaneously. In most pro-

**Figure 4.6**  
**Sample cause-effect graph.**

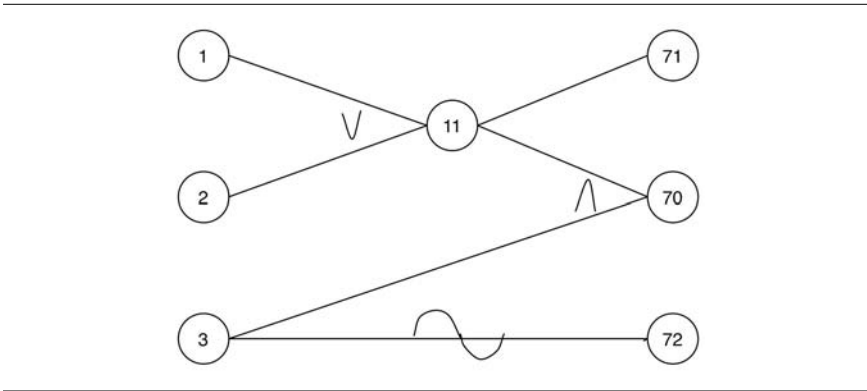

grams, certain combinations of causes are impossible because of syntactic or environmental considerations (a character cannot be an “A” and a “B” simultaneously). To account for these, the notation in Figure 4.8 is used. The E constraint states that it must always be true that, at most, one of *a* and *b* can be 1 (*a* and *b* cannot be 1 simulta-

**Figure 4.7**  
**Logic diagram equivalent to Figure 4.6.**

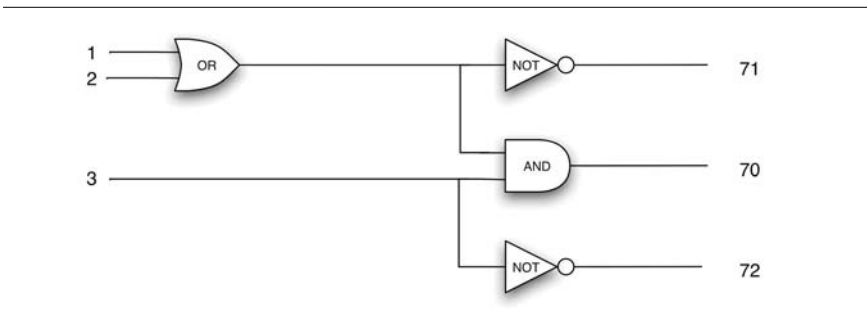

**Figure 4.8**  
**Constraint symbols.**

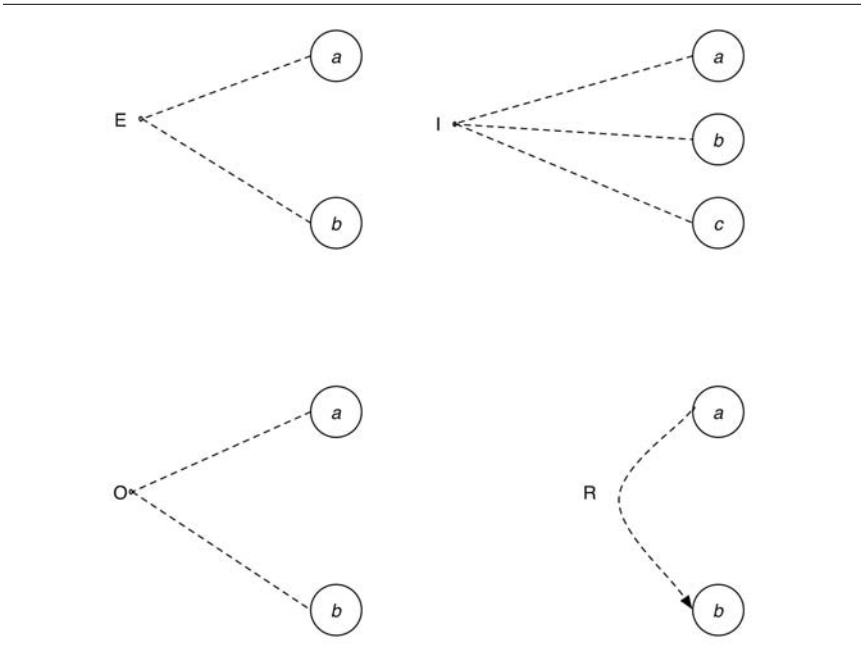

neously). The I constraint states that at least one of  $a, b$ , and  $c$  must always be 1 ( $a, b$ , and  $c$  cannot be 0 simultaneously). The O constraint states that one, and only one, of  $a$  and  $b$  must be 1. The R constraint states that for  $a$  to be 1,  $b$  must be 1 (i.e., it is impossible for  $a$  to be 1 and  $b$  to be 0).

There frequently is a need for a constraint among effects. The M constraint in Figure 4.9 states that if effect  $a$  is 1, effect  $b$  is forced to 0.

Returning to the preceding simple example, we see that it is physically impossible for causes 1 and 2 to be present simultaneously, but it is possible for neither to be present. Hence, they are linked with the E constraint, as shown in Figure 4.10.

**Figure 4.9**  
**Symbol for “masks” constraint.**

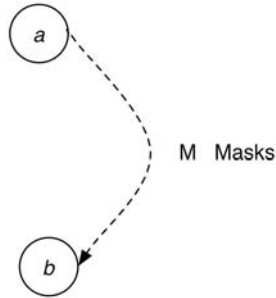

To illustrate how cause-effect graphing is used to derive test cases, the specification in the following paragraphs will be used. The specification is for a debugging command in an interactive system.

The DISPLAY command is used to view from a terminal window the contents of memory locations. The command syntax is shown in

**Figure 4.10**  
**Sample cause-effect graph with “exclusive” constraint.**

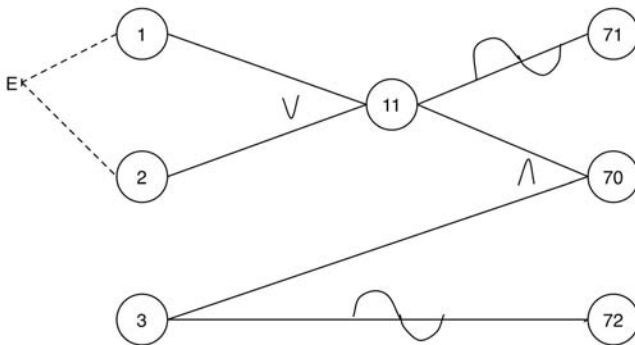
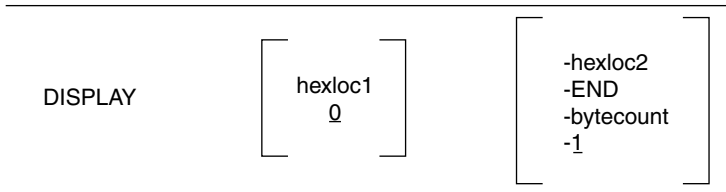

Figure 4.11. Brackets represent alternative optional operands. Capital letters represent operand keywords; lowercase letters represent operand values (i.e., actual values are to be substituted). Underlined operands represent the default values (i.e., the value used when the operand is omitted).

The first operand (*hexloc1*) specifies the address of the first byte whose contents are to be displayed. The address may be one to six hexadecimal digits (0–9, A–F) in length. If it is not specified, the address 0 is assumed. The address must be within the actual memory range of the machine.

The second operand specifies the amount of memory to be displayed. If *hexloc2* is specified, it defines the address of the last byte in the range of locations to be displayed. It may be one to six hexadecimal digits in length. The address must be greater than or equal to the starting address (*hexloc1*). Also, *hexloc2* must be within the actual memory range of the machine. If *END* is specified, memory is displayed up through the last actual byte in the machine. If *bytecount* is specified, it defines the number of bytes of memory to be displayed (starting with the location specified in *hexloc1*). The operand *bytecount* is a hexadecimal integer (one to six digits). The sum of *bytecount* and *hexloc1* must not exceed the actual memory size plus 1, and *bytecount* must have a value of at least 1.

**Figure 4.11**  
**Syntax of the DISPLAY command.**



When memory contents are displayed, the output format on the screen is one or more lines of the format

```
xxxxxx = word1 word2 word3 word4
```

where `xxxxxx` is the hexadecimal address of *word1*. An integral number of words (four-byte sequences, where the address of the first byte in the word is a multiple of four) is always displayed, regardless of the value of *hexloc1* or the amount of memory to be displayed. All output lines will always contain four words (16 bytes). The first byte of the displayed range will fall within the first word.

The error messages that can be produced are

- M1 invalid command syntax
- M2 memory requested is beyond actual memory limit
- M3 memory requested is a zero or negative range

As examples,

```
DISPLAY
```

displays the first four words in memory (default starting address of 0, default byte count of 1),

```
DISPLAY 77F
```

displays the word containing the byte at address 77F and the three subsequent words,

```
DISPLAY 77F-407A
```

displays the words containing the bytes in the address range 775-407A,

```
DISPLAY 77F.6
```

displays the words containing the six bytes starting at location 77E, and

DISPLAY 50FF-END

displays the words containing the bytes in the address range 50FF to the end of memory.

The first step is a careful analysis of the specification to identify the causes and effects. The causes are as follows:

1. First operand is present.
2. The *hexloc1* operand contains only hexadecimal digits.
3. The *hexloc1* operand contains one to six characters.
4. The *hexloc1* operand is within the actual memory range of the machine.
5. Second operand is *END*.
6. Second operand is *hexloc2*.
7. Second operand is *bytecount*.
8. Second operand is omitted.
9. The *hexloc2* operand contains only hexadecimal digits.
10. The *hexloc2* operand contains one to six characters.
11. The *hexloc2* operand is within the actual memory range of the machine.
12. The *hexloc2* operand is greater than or equal to the *hexloc1* operand.
13. The *bytecount* operand contains only hexadecimal digits.
14. The *bytecount* operand contains one to six characters.
15.  $bytecount + hexloc1 \leq \text{memory size} + 1$ .
16.  $bytecount \geq 1$ .
17. Specified range is large enough to require multiple output lines.
18. Start of range does not fall on a word boundary.

Each cause has been given an arbitrary unique number. Notice that four causes (5 through 8) are necessary for the second operand because the second operand could be (1) *END*, (2) *hexloc2*, (3) *byte-*

count, (4) absent, and (5) none of the above. The effects are as follows:

91. Message M1 is displayed.
92. Message M2 is displayed.
93. Message M3 is displayed.
94. Memory is displayed on one line.
95. Memory is displayed on multiple lines.
96. First byte of displayed range falls on a word boundary.
97. First byte of displayed range does not fall on a word boundary.

The next step is the development of the graph. The cause nodes are listed vertically on the left side of the sheet of paper; the effect nodes are listed vertically on the right side. The semantic content of the specification is carefully analyzed to interconnect the causes and effects (i.e., to show under what conditions an effect is present).

Figure 4.12 shows an initial version of the graph. Intermediate node 32 represents a syntactically valid first operand; node 35 represents a syntactically valid second operand. Node 36 represents a syntactically valid command. If node 36 is 1, effect 91 (the error message) does not appear. If node 36 is 0, effect 91 is present.

The full graph is shown in Figure 4.13. You should explore the graph carefully to convince yourself that it accurately reflects the specification.

If Figure 4.13 were used to derive the test cases, many impossible-to-create test cases would be derived. The reason is that certain combinations of causes are impossible because of syntactic constraints. For instance, causes 2 and 3 cannot be present unless cause 1 is present. Cause 4 cannot be present unless both causes 2 and 3 are present. Figure 4.14 contains the complete graph with the constraint conditions. Notice that, at most, one of the causes 5, 6, 7, and 8 can be present. All other cause constraints are the *requires* condition. Notice that cause 17 (multiple output lines) requires the *not* of cause 8 (second operand is omitted); cause 17 can be present only when cause 8 is absent. Again, you should explore the constraint conditions carefully.



**Figure 4.12**  
**Beginning of the graph for the DISPLAY Command.**

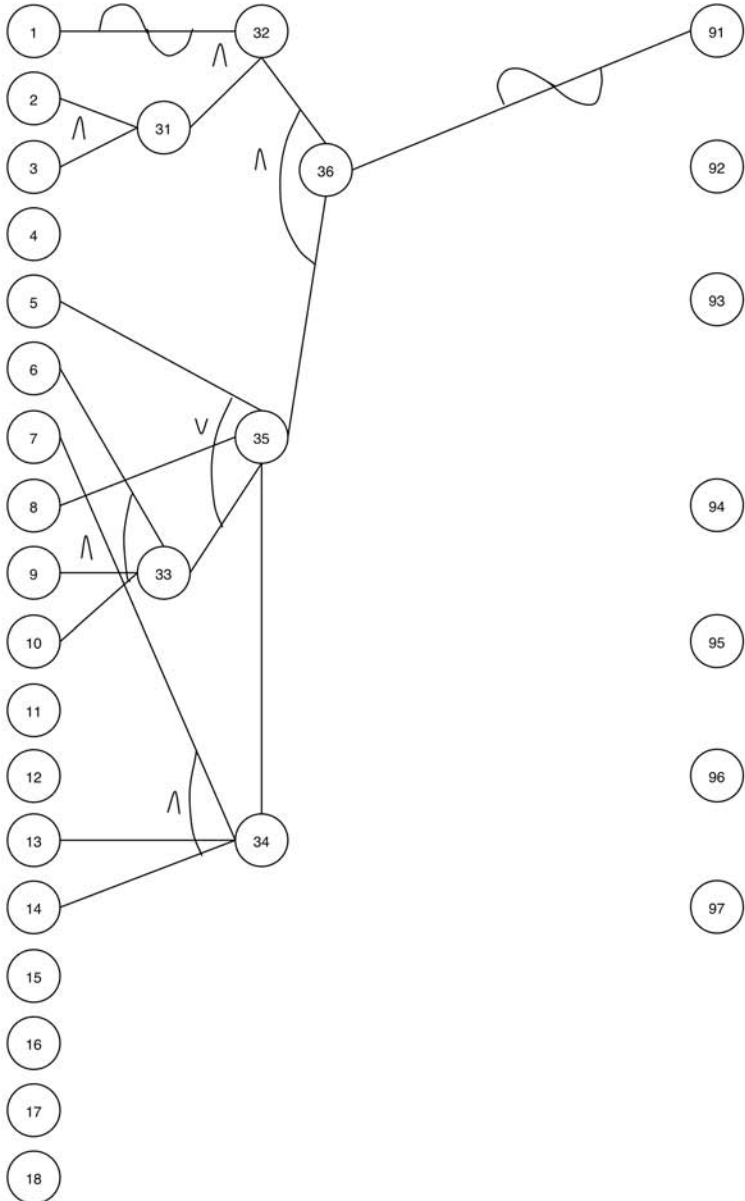

**Figure 4.13**  
**Full cause-effect graph without constraints.**

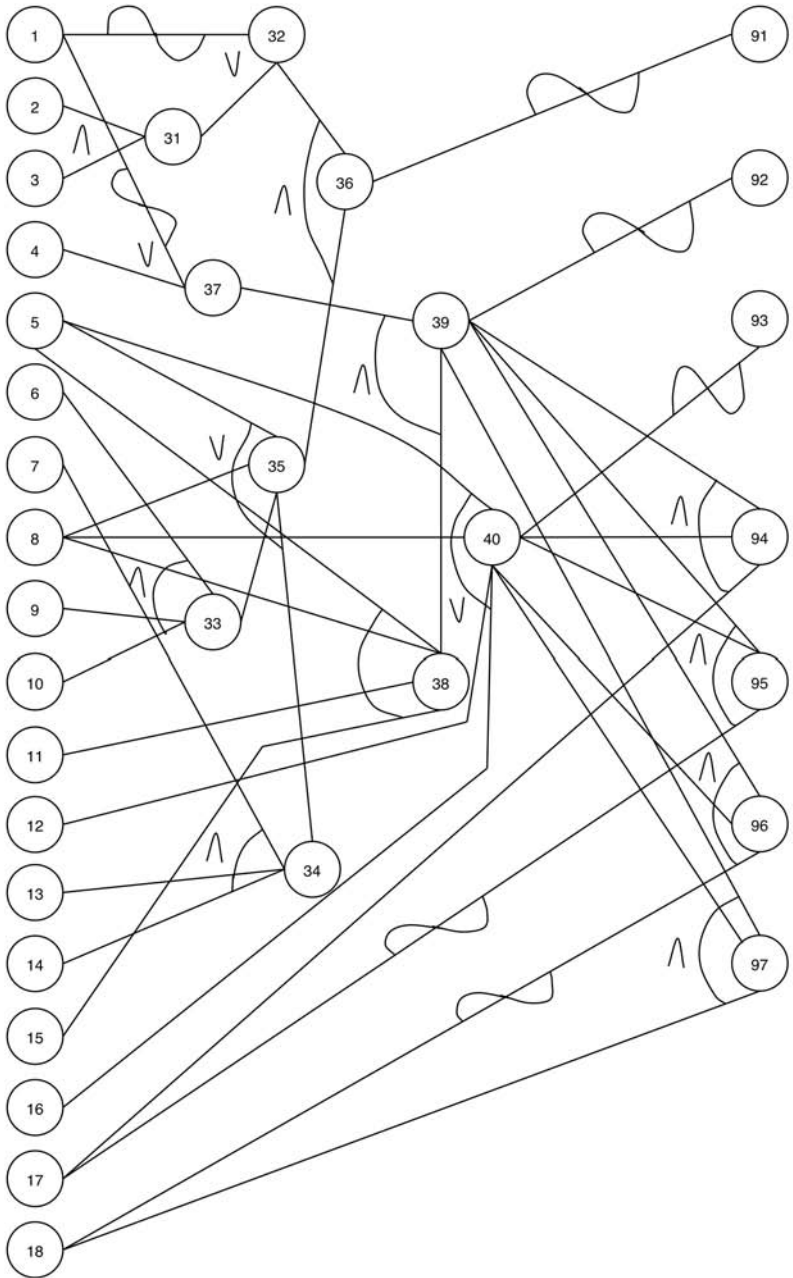

**Figure 4.14**  
**Complete cause-effect graph of the DISPLAY Command.**

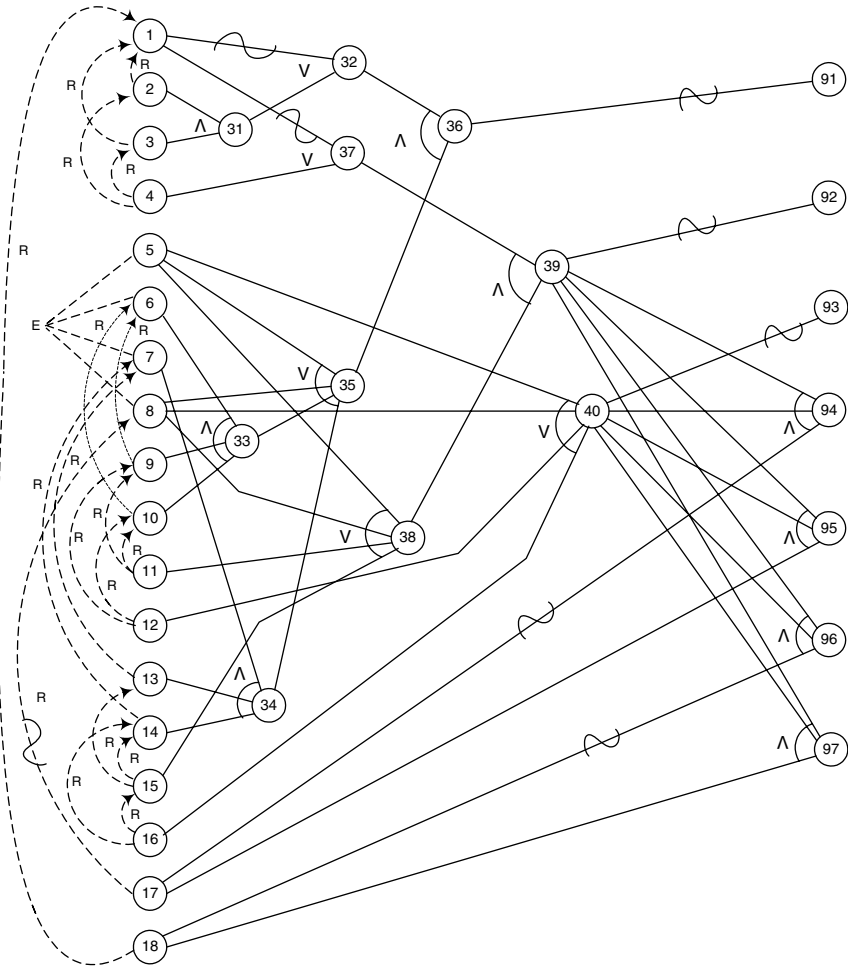

The next step is the generation of a limited-entry decision table. For readers familiar with decision tables, the causes are the conditions and the effects are the actions. The procedure used is as follows:

1. Select an effect to be the present (1) state.
2. Tracing back through the graph, find all combinations of causes (subject to the constraints) that will set this effect to 1.
3. Create a column in the decision table for each combination of causes.
4. For each combination, determine the states of all other effects and place these in each column.

In performing step 2, the considerations are as follows:

1. When tracing back through an *or* node whose output should be 1, never set more than one input to the *or* to 1 simultaneously. This is called *path sensitizing*. Its objective is to prevent the failure to detect certain errors because of one cause masking another cause.
2. When tracing back through an *and* node whose output should be 0, all combinations of inputs leading to 0 output must, of course, be enumerated. However, if you are exploring the situation where one input is 0 and one or more of the others are 1, it is not necessary to enumerate all conditions under which the other inputs can be 1.
3. When tracing back through an *and* node whose output should be 0, only one condition where all inputs are zero need be enumerated. (If the *and* is in the middle of the graph such that its inputs come from other intermediate nodes, there may be an excessively large number of situations under which all of its inputs are 0.)

These complicated considerations are summarized in Figure 4.15. Figure 4.16 is used as an example.

Assume that we want to locate all input conditions that cause the output state to be 0. Consideration 3 states that we should list only

**Figure 4.15**  
**Considerations used when tracing the graph.**

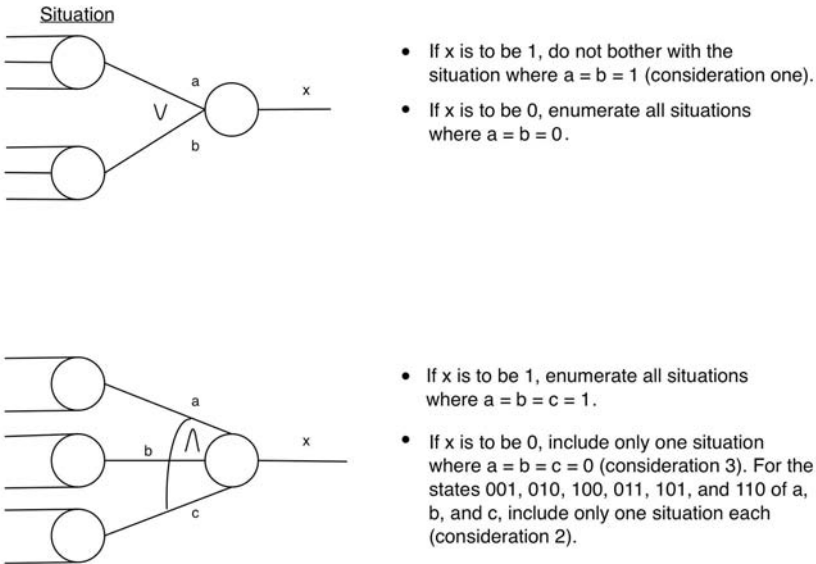

one circumstance where nodes 5 and 6 are 0. Consideration 2 states that, for the state where node 5 is 1 and node 6 is 0, we should list only one circumstance where node 5 is 1, rather than enumerating all possible ways that node 5 can be 1. Likewise, for the state where node 5 is 0 and node 6 is 1, we should list only one circumstance where node 6 is 1 (although there is only one in this example). Consideration 1 states that where node 5 should be set to 1, we should not set nodes 1 and 2 to 1 simultaneously. Hence, we would arrive at five states of nodes 1 through 4, for example, the values

0	0	0	0	(5=0, 6=0)
1	0	0	0	(5=1, 6=0)
1	0	0	1	(5=1, 6=1)
1	0	1	0	(5=1, 6=0)
0	0	1	1	(5=0, 6=1)

**Figure 4.16**  
**Sample graph to illustrate the tracing considerations.**

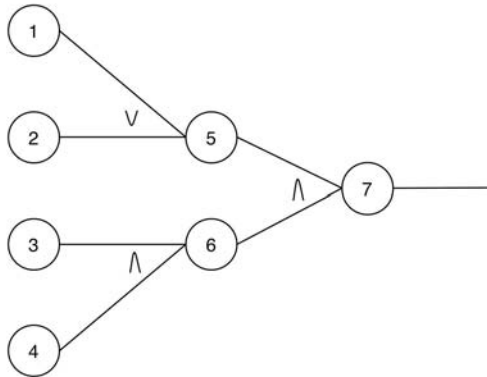

rather than the 13 possible states of nodes 1 through 4 that lead to a 0 output state.

These considerations may appear to be capricious, but they have an important purpose: to lessen the combined effects of the graph. They eliminate situations that tend to be low-yield test cases. If low-yield test cases are not eliminated, a large cause-effect graph will produce an astronomical number of test cases. If the number of test cases is too large to be practical, you will select some subset, but there is no guarantee that the low-yield test cases will be the ones eliminated. Hence, it is better to eliminate them during the analysis of the graph.

The cause-effect graph in Figure 4.14 will now be converted into the decision table. Effect 91 will be selected first. Effect 91 is present if node 36 is 0. Node 36 is 0 if nodes 32 and 35 are 0,0; 0,1; or 1,0; and considerations 2 and 3 apply here. By tracing back to the causes and considering the constraints among causes, you can find the combinations of causes that lead to effect 91 being present, although doing so is a laborious process.

The resultant decision table under the condition that effect 91 is present is shown in Figure 4.17 (columns 1 through 11). Columns

**Figure 4.17**  
**First half of the resultant decision table.**

	1	2	3	4	5	6	7	8	9	10	11	12	13	14	15	16	17
1	1	1	1	1	1	1	1	1	1	1	1	1	1	1	1	1	1
2	1	0	0	1	1	1	1	1	1	1	1	1	1	1	1	1	1
3	0	1	0	1	1	1	1	1	1	1	0	1	1	1	1	1	1
4												1	1	0	0	1	1
5				0										1			
6	1	1	1	0	1	1	1				1	1			1	1	
7				0				1	1	1			1				1
8				0													
9	1	1	1		1	0	0				0	1			1	1	
10	1	1	1		0	1	0				1	1			1	1	
11												0			0	1	
12																0	
13								1	0	0			1				1
14								0	1	0			1				1
15													0				
16																	0
17																	
18																	
91	1	1	1	1	1	1	1	1	1	1	1	0	0	0	0	0	0
92	0	0	0	0	0	0	0	0	0	0	1	1	1	1	1	0	0
93	0	0	0	0	0	0	0	0	0	0	0	0	0	0	0	1	1
94	0	0	0	0	0	0	0	0	0	0	0	0	0	0	0	0	0
95	0	0	0	0	0	0	0	0	0	0	0	0	0	0	0	0	0
96	0	0	0	0	0	0	0	0	0	0	0	0	0	0	0	0	0
97	0	0	0	0	0	0	0	0	0	0	0	0	0	0	0	0	0

(tests) 1 through 3 represent the conditions where node 32 is 0 and node 35 is 1. Columns 4 through 10 represent the conditions where node 32 is 1 and node 35 is 0. Using consideration 3, only one situation (column 11) out of a possible 21 situations where nodes 32 and 35 are 0 is identified. Blanks in the table represent “don’t care” situations (i.e., the state of the cause is irrelevant) or indicate that the state of a cause is obvious because of the states of other dependent causes (e.g., in column 1, we know that causes 5, 7, and 8 must be 0 because they exist in an “at most one” situation with cause 6).

Columns 12 through 15 represent the situations where effect 92 is present. Columns 16 and 17 represent the situations where effect 93 is present. Figure 4.18 represents the remainder of the decision table.

The last step is to convert the decision table into 38 test cases. A set of 38 test cases is listed here. The number or numbers beside each test case designate the effects that are expected to be present. Assume that the last location in memory on the machine being used is 7FFF.

1	DISPLAY 234AF74-123	(91)
2	DISPLAY 2ZX4-3000	(91)
3	DISPLAY HHHHHHHH-2000	(91)
4	DISPLAY 200 200	(91)
5	DISPLAY 0-22222222	(91)
6	DISPLAY 1-2X	(91)
7	DISPLAY 2-ABCDEFGHI	(91)
8	DISPLAY 3.1111111	(91)
9	DISPLAY 44.\$42	(91)
10	DISPLAY 100.\$\$\$\$\$\$	(91)
11	DISPLAY 10000000-M	(91)
12	DISPLAY FF-8000	(92)
13	DISPLAY FFE7001	(92)
14	DISPLAY 8000-END	(92)
15	DISPLAY 8000-8001	(92)
16	DISPLAY AA-A9	(93)
17	DISPLAY 7000.0	(93)
18	DISPLAY 7FF9-END	(94, 97)
19	DISPLAY 1	(94, 97)



**Figure 4.18**  
**Second half of the resultant decision table.**

	18	19	20	21	22	23	24	25	26	27	28	29	30	31	32	33	34	35	36	37	38
1	1	1	1	1	0	0	0	0	1	1	1	1	1	1	1	0	0	0	1	1	1
2	1	1	1	1					1	1	1	1	1	1	1				1	1	1
3	1	1	1	1					1	1	1	1	1	1	1				1	1	1
4	1	1	1	1					1	1	1	1	1	1	1				1	1	1
5	1				1				1				1			1			1		
6			1				1				1			1			1			1	
7				1				1				1			1			1			1
8		1				1				1											
9			1				1				1			1			1			1	
10			1				1				1			1			1			1	
11			1				1				1			1			1			1	
12			1				1				1			1			1			1	
13				1				1				1			1			1			1
14				1				1				1			1			1			1
15				1				1				1			1			1			1
16				1				1				1			1			1			1
17	0	0	0	0	0	0	0	0	0	0	0	0	0	1	1	1	1	1	1	1	1
18	1	1	1	1	0	0	0	0	0	0	0	0	0	1	1	1	0	0	0	0	0
91	0	0	0	0	0	0	0	0	0	0	0	0	0	0	0	0	0	0	0	0	0
92	0	0	0	0	0	0	0	0	0	0	0	0	0	0	0	0	0	0	0	0	0
93	0	0	0	0	0	0	0	0	0	0	0	0	0	0	0	0	0	0	0	0	0
94	1	1	1	1	1	1	1	1	1	1	1	1	0	0	0	0	0	0	0	0	0
95	0	0	0	0	0	0	0	0	0	0	0	0	1	1	1	1	1	1	1	1	1
96	0	0	0	0	1	1	1	1	1	1	1	1	0	0	0	1	1	1	1	1	1
97	1	1	1	1	0	0	0	0	0	0	0	0	1	1	1	0	0	0	0	0	0

20	DISPLAY 21-29	(94, 97)
21	DISPLAY 4021.A	(94, 97)
22	DISPLAY -END	(94, 96)
23	DISPLAY	(94, 96)
24	DISPLAY -F	(94, 96)
25	DISPLAY .E	(94, 96)
26	DISPLAY 7FF8-END	(94, 96)
27	DISPLAY 6000	(94, 96)
28	DISPLAY A0-A4	(94, 96)
29	DISPLAY 20.8	(94, 96)
30	DISPLAY 7001-END	(95, 97)
31	DISPLAY 5-15	(95, 97)
32 <sub>w</sub>	DISPLAY 4FF.100	(95, 97)
33	DISPLAY -END	(95, 96)
34	DISPLAY -20	(95, 96)
35	DISPLAY .11	(95, 96)
36	DISPLAY 7000-END	(95, 96)
37	DISPLAY 4-14	(95, 96)
38	DISPLAY 500.11	(95, 96)

Note that where two or more different test cases invoked, for the most part, the same set of causes, different values for the causes were selected to slightly improve the yield of the test cases. Also note that, because of the actual storage size, test case 22 is impossible (it will yield effect 95 instead of 94, as noted in test case 33). Hence, 37 test cases have been identified.

### **Remarks**

Cause-effect graphing is a systematic method of generating test cases representing combinations of conditions. The alternative would be an ad hoc selection of combinations, but, in doing so, it is likely that you would overlook many of the “interesting” test cases identified by the cause-effect graph.

Since cause-effect graphing requires the translation of a specification into a Boolean logic network, it gives you a different perspective

on, and additional insight into, the specification. In fact, the development of a cause-effect graph is a good way to uncover ambiguities and incompleteness in specifications. For instance, the astute reader may have noticed that this process has uncovered a problem in the specification of the `DISPLAY` command. The specification states that all output lines contain four words. This cannot be true in all cases; it cannot occur for test cases 18 and 26 since the starting address is less than 16 bytes away from the end of memory.

Although cause-effect graphing does produce a set of useful test cases, it normally does not produce *all* of the useful test cases that might be identified. For instance, in the example we said nothing about verifying that the displayed memory values are identical to the values in memory and determining whether the program can display every possible value in a memory location. Also, the cause-effect graph does not adequately explore boundary conditions. Of course, you could attempt to cover boundary conditions during the process. For instance, instead of identifying the single cause

$$hexloc2 \geq hexloc1$$

you could identify two causes:

$$hexloc2 = hexloc1$$

$$hexloc2 > hexloc1$$

The problem in doing this, however, is that it complicates the graph tremendously and leads to an excessively large number of test cases. For this reason it is best to consider a separate boundary-value analysis. For instance, the following boundary conditions can be identified for the `DISPLAY` specification:

1. *hexloc1* has one digit.
2. *hexloc1* has six digits.
3. *hexloc1* has seven digits.
4. *hexloc1* = 0.

5.  $hexloc1 = 7FFF$ .
6.  $hexloc1 = 8000$ .
7.  $hexloc2$  has one digit.
8.  $hexloc2$  has six digits.
9.  $hexloc2$  has seven digits.
10.  $hexloc2 = 0$ .
11.  $hexloc2 = 7FFF$ .
12.  $hexloc2 = 8000$ .
13.  $hexloc2 = hexloc1$ .
14.  $hexloc2 = hexloc1 + 1$ .
15.  $hexloc2 = hexloc1 - 1$ .
16.  $bytecount$  has one digit.
17.  $bytecount$  has six digits.
18.  $bytecount$  has seven digits.
19.  $bytecount = 1$ .
20.  $hexloc1 + bytecount = 8000$ .
21.  $hexloc1 + bytecount = 8001$ .
22.  $display$  16 bytes (one line).
23.  $display$  17 bytes (two lines).

Note that this does not imply that you would write 60 ( $37 + 23$ ) test cases. Since the cause-effect graph gives us leeway in selecting specific values for operands, the boundary conditions could be blended into the test cases derived from the cause-effect graph. In this example, by rewriting some of the original 37 test cases, all 23 boundary conditions could be covered without any additional test cases. Thus, we arrive at a small but potent set of test cases that satisfy both objectives.

Note that cause-effect graphing is consistent with several of the testing principles in Chapter 2. Identifying the expected output of each test case is an inherent part of the technique (each column in the decision table indicates the expected effects). Also note that it encourages us to look for unwanted side effects. For instance, column (test) 1 specifies that you should expect effect 91 to be present and that effects 92 through 97 should be absent.

The most difficult aspect of the technique is the conversion of the graph into the decision table. This process is algorithmic, implying that you could automate it by writing a program; several commercial programs exist to help with the conversion.

## ERROR GUESSING

It has often been noted that some people seem to be naturally adept at program testing. Without using any particular methodology such as boundary-value analysis or cause-effect graphing, these people seem to have a knack for sniffing out errors.

One explanation of this is that these people are practicing, subconsciously more often than not, a test-case-design technique that could be termed *error guessing*. Given a particular program, they surmise, both by intuition and experience, certain probable types of errors and then write test cases to expose those errors.

It is difficult to give a procedure for the error-guessing technique since it is largely an intuitive and ad hoc process. The basic idea is to enumerate a list of possible errors or error-prone situations and then write test cases based on the list. For instance, the presence of the value 0 in a program's input is an error-prone situation. Therefore, you might write test cases for which particular input values have a 0 value and for which particular output values are forced to 0. Also, where a variable number of inputs or outputs can be present (e.g., the number of entries in a list to be searched), the cases of "none" and "one" (e.g., empty list, list containing just one entry) are error-prone situations. Another idea is to identify test cases associated with assumptions that the programmer might have made when reading the specification (i.e., things that were omitted from the specification, either by accident or because the writer felt them to be obvious).

Since a procedure cannot be given, the next-best alternative is to discuss the spirit of error guessing, and the best way to do this is by presenting examples. If you are testing a sorting subroutine, the following are situations to explore:

- The input list is empty.
- The input list contains one entry.
- All entries in the input list have the same value.
- The input list is already sorted.

In other words, you enumerate those special cases that may have been overlooked when the program was designed. If you are testing a binary-search subroutine, you might try the situations where (1) there is only one entry in the table being searched, (2) the table size is a power of two (e.g., 16), and (3) the table size is one less than and one greater than a power of two (e.g., 15 or 17).

Consider the MTEST program in the section on boundary-value analysis. The following additional tests come to mind when using the error-guessing technique:

- Does the program accept “blank” as an answer?
- A type-2 (answer) record appears in the set of type-3 (student) records.
- A record without a 2 or 3 in the last column appears as other than the initial (title) record.
- Two students have the same name or number.
- Since a median is computed differently depending on whether there is an odd or an even number of items, test the program for an even number of students and an odd number of students.
- The number-of-questions field has a negative value.

Error-guessing tests that come to mind for the DISPLAY command of the previous section are as follows:

- DISPLAY 100- (partial second operand)
- DISPLAY 100. (partial second operand)
- DISPLAY 100-10A 42 (extra operand)
- DISPLAY 000-0000FF (leading zeros)

## THE STRATEGY

The test-case-design methodologies discussed in this chapter can be combined into an overall strategy. The reason for combining them should be obvious by now: Each contributes a particular set of useful test cases, but none of them by itself contributes a thorough set of test cases. A reasonable strategy is as follows:

1. If the specification contains combinations of input conditions, start with cause-effect graphing.
2. In any event, use boundary-value analysis. Remember that this is an analysis of input and output boundaries. The boundary-value analysis yields a set of supplemental test conditions, but, as noted in the section on cause-effect graphing, many or all of these can be incorporated into the cause-effect tests.
3. Identify the valid and invalid equivalence classes for the input and output, and supplement the test cases identified above if necessary.
4. Use the error-guessing technique to add additional test cases.
5. Examine the program's logic with regard to the set of test cases. Use the decision-coverage, condition-coverage, decision/condition-coverage, or multiple-condition-coverage criterion (the last being the most complete). If the coverage criterion has not been met by the test cases identified in the prior four steps, and if meeting the criterion is not impossible (i.e., certain combinations of conditions may be impossible to create because of the nature of the program), add sufficient test cases to cause the criterion to be satisfied.

Again, the use of this strategy will not guarantee that all errors will be found, but it has been found to represent a reasonable compromise. Also, it represents a considerable amount of hard work, but no one has ever claimed that program testing is easy.

## CHAPTER 5

# MODULE (UNIT) TESTING

**U**p to this point we have largely ignored the mechanics of testing and the size of the program being tested. However, large programs (say, programs of 500 statements or more) require special testing treatment. In this chapter we consider an initial step in structuring the testing of a large program: module testing. Chapter 6 discusses the remaining steps.

Module testing (or unit testing) is a process of testing the individual subprograms, subroutines, or procedures in a program. That is, rather than initially testing the program as a whole, testing is first focused on the smaller building blocks of the program. The motivations for doing this are threefold. First, module testing is a way of managing the combined elements of testing, since attention is focused initially on smaller units of the program. Second, module testing eases the task of debugging (the process of pinpointing and correcting a discovered error), since, when an error is found, it is known to exist in a particular module. Finally, module testing introduces parallelism into the program testing process by presenting us with the opportunity to test multiple modules simultaneously.

The purpose of module testing is to compare the function of a module to some functional or interface specification defining the module. To reemphasize the goal of all testing processes, the goal here is not to show that the module meets its specification, but to show that the module contradicts the specification. In this chapter we discuss module testing from three points of view:

1. The manner in which test cases are designed.
2. The order in which modules should be tested and integrated.
3. Advice about performing the test.



## TEST-CASE DESIGN

You need two types of information when designing test cases for a module test: a specification for the module and the module's source code. The specification typically defines the module's input and output parameters and its function.

Module testing is largely white-box oriented. One reason is that as you test larger entities such as entire programs (which will be the case for subsequent testing processes), white-box testing becomes less feasible. A second reason is that the subsequent testing processes are oriented toward finding different types of errors (for example, errors not necessarily associated with the program's logic, such as the program's failing to meet its users' requirements). Hence, the test-case-design procedure for a module test is the following: Analyze the module's logic using one or more of the white-box methods, and then supplement these test cases by applying black-box methods to the module's specification.

Since the test-case-design methods to be used have already been defined in Chapter 4, their use in a module test is illustrated here through an example. Assume that we wish to test a module named `BONUS`, and its function is to add \$2,000 to the salary of all employees in the department or departments having the largest sales amount. However, if an eligible employee's current salary is \$150,000 or more, or if the employee is a manager, the salary is increased by only \$1,000.

The inputs to the module are the tables shown in Figure 5.1. If the module performs its function correctly, it returns an error code of 0. If either the employee or the department table contains no entries, it returns an error code of 1. If it finds no employees in an eligible department, it returns an error code of 2.

The module's source code is shown in Figure 5.2. Input parameters `ESIZE` and `DSIZE` contain the number of entries in the employee and department tables. The module is written in PL/1, but the following discussion is largely language independent; the techniques are applicable to programs coded in other languages. Also, since the

**Figure 5.1**  
**Input tables to module BONUS.**

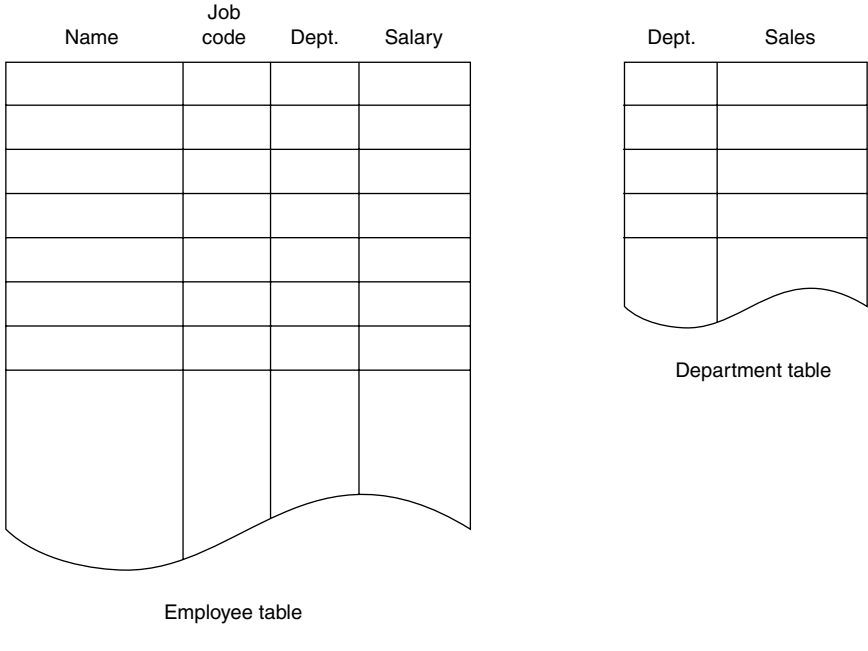

PL/1 logic in the module is fairly simple, virtually any reader, even those not familiar with PL/1, should be able to understand it.

Regardless of which of the logic-coverage techniques you use, the first step is to list the conditional decisions in the program. Candidates in this program are all IF and DO statements. By inspecting the program, we can see that all of the DO statements are simple iterations, each iteration limit will be equal to or greater than the initial value (meaning that each loop body always will execute at least once), and the only way of exiting each loop is via the DO statement. Thus, the DO statements in this program need no special attention, since any test case that causes a DO statement to execute will eventually cause it to

**Figure 5.2**  
**Module BONUS.**

---

```
BONUS : PROCEDURE(EMPTAB,DEPTTAB,ESIZE,DSIZE,ERRCODE);
DECLARE 1  EMPTAB (*),
        2  NAME CHAR(6),
        2  CODE CHAR(1),
        2  DEPT CHAR(3),
        2  SALARY FIXED DECIMAL(7,2);
DECLARE 1  DEPTTAB (*),
        2  DEPT CHAR(3),
        2  SALES FIXED DECIMAL(8,2);
DECLARE (ESIZE,DSIZE) FIXED BINARY;
DECLARE  ERRCODE FIXED DECIMAL(1);
DECLARE  MAXSALES FIXED DECIMAL(8,2) INIT(0); /*MAX. SALES IN DEPTTAB*/
DECLARE  (I,J,K) FIXED BINARY;             /*COUNTERS*/
DECLARE  FOUND BIT(1); /*TRUE IF ELIGIBLE DEPT. HAS EMPLOYEES*/
DECLARE  SINC FIXED DECIMAL(7,2) INIT(200.00); /*STANDARD INCREMENT*/
DECLARE  LINC FIXED DECIMAL(7,2) INIT(100.00); /*LOWER INCREMENT*/
DECLARE  LSALARY FIXED DECIMAL(7,2) INIT(15000.00); /*SALARY BOUNDARY*/
DECLARE  MGR CHAR(1) INIT('M');

1  ERRCODE=0;
2  IF(ESIZE<=0)|(DSIZE<=0)
3     THEN ERRCODE=1;             /*EMPTAB OR DEPTTAB ARE EMPTY*/
4     ELSE DO;
5         DO I = 1 TO DSIZE;             /*FIND MAXSALES AND MAXDEPTS*/
6             IF(SALES(I)>=MAXSALES) THEN MAXSALES=SALES(I);
7         END;
8         DO J = 1 TO DSIZE;
9             IF(SALES(J)=MAXSALES)     /*ELIGIBLE DEPARTMENT*/
10                THEN DO;
11                 FOUND='0'B;
12                 DO K = 1 TO ESIZE;
13                     IF(EMPTAB.DEPT(K)=DEPTTAB.DEPT(J))
```

```

14             THEN DO;
15                 FOUND='1'B;
16                 IF (SALARY(K)>=LSALARY) | CODE(K)=MGR)
17                     THEN SALARY(K)=SALARY(K)+LINC;
18                     ELSE SALARY(K)=SALARY(K)+SINC;
19             END;
20         END;
21     IF (-FOUND) THEN ERRCODE=2;
22 END;
23 END;
24 END;
25 END;

```

---

branch in both directions (i.e., enter the loop body and skip the loop body). Therefore, the statements that must be analyzed are

```

2 IF (ESIZE<=0) | (DSIZE<=0)
6 IF (SALES(I) >= MAXSALES)
9 IF (SALES(J) = MAXSALES)
13 IF (EMPTAB.DEPT(K) = DEPTTAB.DEPT(J))
16 IF (SALARY(K) >= LSALARY) | (CODE(K) =MGR)
21 IF (-FOUND) THEN ERRCODE=2

```

Given the small number of decisions, we probably should opt for multicondition coverage, but we shall examine all the logic-coverage criteria (except statement coverage, which always is too limited to be of use) to see their effects.

To satisfy the decision-coverage criterion, we need sufficient test cases to evoke both outcomes of each of the six decisions. The required input situations to evoke all decision outcomes are listed in Table 5.1. Since two of the outcomes will always occur, there are 10 situations that need to be forced by test cases. Note that to construct

Table 5.1, decision–outcome circumstances had to be traced back through the logic of the program to determine the proper corresponding input circumstances. For instance, decision 16 is not evoked by any employee meeting the conditions; the employee must be in an eligible department.

The 10 situations of interest in Table 5.1 could be evoked by the two test cases shown in Figure 5.3. Note that each test case includes a definition of the expected output, in adherence to the principles discussed in Chapter 2.

Although these two test cases meet the decision–coverage criterion, it should be obvious that there could be many types of errors in the module that are not detected by these two test cases. For instance, the test cases do not explore the circumstances where the error code is 0, an employee is a manager, or the department table is empty ( $DSIZE \leq 0$ ).

A more satisfactory test can be obtained by using the condition–coverage criterion. Here we need sufficient test cases to evoke both

**Table 5.1**  
**Situations Corresponding to the Decision Outcomes**

<i>Decision</i>	<i>True Outcome</i>	<i>False Outcome</i>
2	$ESIZE$ or $DSIZE \leq 0$ .	$ESIZE$ and $DSIZE > 0$ .
6	Will always occur at least once.	Order $DEPTTAB$ so that a department with lower sales occurs after a department with higher sales.
9	Will always occur at least once.	All departments do not have the same sales.
13	There is an employee in an eligible department.	There is an employee who is not in an eligible department.
16	An eligible employee is either a manager or earns $LSALARY$ or more.	An eligible employee is not a manager and earns less than $LSALARY$ .
21	All eligible departments contain no employees.	An eligible department contains at least one employee.

**Figure 5.3**  
**Test cases to satisfy the decision-coverage criterion.**

Test case	Input	Expected output																																										
1	<p style="text-align: center;">ESIZE = 0 All other inputs are irrelevant</p>	<p style="text-align: center;">ERRCODE = 1 ESIZE, DSIZE, EMPTAB, and DEPTTAB are unchanged</p>																																										
2	<p>ESIZE = DSIZE = 3</p> <table style="width: 100%; border-collapse: collapse;"> <tr> <td style="width: 50%; border: none;"> <table border="1" style="width: 100%; border-collapse: collapse;"> <tr><td colspan="4" style="text-align: center;">EMPTAB</td></tr> <tr><td style="text-align: center;">JONES</td><td style="text-align: center;">E</td><td style="text-align: center;">D42</td><td style="text-align: right;">21,000.00</td></tr> <tr><td style="text-align: center;">SMITH</td><td style="text-align: center;">E</td><td style="text-align: center;">D32</td><td style="text-align: right;">14,000.00</td></tr> <tr><td style="text-align: center;">LORIN</td><td style="text-align: center;">E</td><td style="text-align: center;">D42</td><td style="text-align: right;">10,000.00</td></tr> </table> </td> <td style="width: 50%; border: none;"> <table border="1" style="width: 100%; border-collapse: collapse;"> <tr><td colspan="2" style="text-align: center;">DEPTTAB</td></tr> <tr><td style="text-align: center;">D42</td><td style="text-align: right;">10,000.00</td></tr> <tr><td style="text-align: center;">D32</td><td style="text-align: right;">8,000.00</td></tr> <tr><td style="text-align: center;">D95</td><td style="text-align: right;">10,000.00</td></tr> </table> </td> </tr> </table>	<table border="1" style="width: 100%; border-collapse: collapse;"> <tr><td colspan="4" style="text-align: center;">EMPTAB</td></tr> <tr><td style="text-align: center;">JONES</td><td style="text-align: center;">E</td><td style="text-align: center;">D42</td><td style="text-align: right;">21,000.00</td></tr> <tr><td style="text-align: center;">SMITH</td><td style="text-align: center;">E</td><td style="text-align: center;">D32</td><td style="text-align: right;">14,000.00</td></tr> <tr><td style="text-align: center;">LORIN</td><td style="text-align: center;">E</td><td style="text-align: center;">D42</td><td style="text-align: right;">10,000.00</td></tr> </table>	EMPTAB				JONES	E	D42	21,000.00	SMITH	E	D32	14,000.00	LORIN	E	D42	10,000.00	<table border="1" style="width: 100%; border-collapse: collapse;"> <tr><td colspan="2" style="text-align: center;">DEPTTAB</td></tr> <tr><td style="text-align: center;">D42</td><td style="text-align: right;">10,000.00</td></tr> <tr><td style="text-align: center;">D32</td><td style="text-align: right;">8,000.00</td></tr> <tr><td style="text-align: center;">D95</td><td style="text-align: right;">10,000.00</td></tr> </table>	DEPTTAB		D42	10,000.00	D32	8,000.00	D95	10,000.00	<p>ERRCODE = 2 ESIZE, DSIZE, and DEPTTAB are unchanged</p> <table border="1" style="width: 100%; border-collapse: collapse;"> <tr><td colspan="4" style="text-align: center;">EMPTAB</td></tr> <tr><td style="text-align: center;">JONES</td><td style="text-align: center;">E</td><td style="text-align: center;">D42</td><td style="text-align: right;">21,100.00</td></tr> <tr><td style="text-align: center;">SMITH</td><td style="text-align: center;">E</td><td style="text-align: center;">D32</td><td style="text-align: right;">14,000.00</td></tr> <tr><td style="text-align: center;">LORIN</td><td style="text-align: center;">E</td><td style="text-align: center;">D42</td><td style="text-align: right;">10,200.00</td></tr> </table>	EMPTAB				JONES	E	D42	21,100.00	SMITH	E	D32	14,000.00	LORIN	E	D42	10,200.00
<table border="1" style="width: 100%; border-collapse: collapse;"> <tr><td colspan="4" style="text-align: center;">EMPTAB</td></tr> <tr><td style="text-align: center;">JONES</td><td style="text-align: center;">E</td><td style="text-align: center;">D42</td><td style="text-align: right;">21,000.00</td></tr> <tr><td style="text-align: center;">SMITH</td><td style="text-align: center;">E</td><td style="text-align: center;">D32</td><td style="text-align: right;">14,000.00</td></tr> <tr><td style="text-align: center;">LORIN</td><td style="text-align: center;">E</td><td style="text-align: center;">D42</td><td style="text-align: right;">10,000.00</td></tr> </table>	EMPTAB				JONES	E	D42	21,000.00	SMITH	E	D32	14,000.00	LORIN	E	D42	10,000.00	<table border="1" style="width: 100%; border-collapse: collapse;"> <tr><td colspan="2" style="text-align: center;">DEPTTAB</td></tr> <tr><td style="text-align: center;">D42</td><td style="text-align: right;">10,000.00</td></tr> <tr><td style="text-align: center;">D32</td><td style="text-align: right;">8,000.00</td></tr> <tr><td style="text-align: center;">D95</td><td style="text-align: right;">10,000.00</td></tr> </table>	DEPTTAB		D42	10,000.00	D32	8,000.00	D95	10,000.00																			
EMPTAB																																												
JONES	E	D42	21,000.00																																									
SMITH	E	D32	14,000.00																																									
LORIN	E	D42	10,000.00																																									
DEPTTAB																																												
D42	10,000.00																																											
D32	8,000.00																																											
D95	10,000.00																																											
EMPTAB																																												
JONES	E	D42	21,100.00																																									
SMITH	E	D32	14,000.00																																									
LORIN	E	D42	10,200.00																																									

outcomes of each condition in the decisions. The conditions and required input situations to evoke all outcomes are listed in Table 5.2. Since two of the outcomes will always occur, there are 14 situations that must be forced by test cases. Again, these situations can be evoked by only two test cases, as shown in Figure 5.4.

The test cases in Figure 5.4 were designed to illustrate a problem. Since they do evoke all the outcomes in Table 5.2, they satisfy the condition-coverage criterion, but they are probably a poorer set of test cases than those in Figure 5.3 in terms of satisfying the decision-coverage criterion. The reason is that they do not execute every statement. For example, statement 18 is never executed. Moreover, they do not accomplish much more than the test cases in Figure 5.3. They do not cause the output situation `ERRORCODE=0`. If statement 2 had erroneously said `(ESIZE=0)` and `(DSIZE=0)`, this error would go undetected. Of course, an alternative set of test cases might solve these problems, but the fact remains that the two test cases in Figure 5.4 do satisfy the condition-coverage criterion.

**Table 5.2**  
**Situations Corresponding to the Condition Outcomes**

<i>Decision</i>	<i>Condition</i>	<i>True Outcome</i>	<i>False Outcome</i>
2	$ESIZE \leq 0$	$ESIZE \leq 0$	$ESIZE > 0$
2	$DSIZE \leq 0$	$DSIZE \leq 0$	$DSIZE > 0$
6	$SALES(I) \geq$ MAXSALES	Will always occur at least once.	Order DEPTTAB so that a depart- ment with lower sales occurs after a department with higher sales.
9	$SALES(J) =$ MAXSALES	Will always occur at least once.	All departments do not have the same sales.
13	$EMPTAB.DEPT(K) =$ $DEPTTAB.DEPT(J)$	There is an employee in an eligible department.	There is an employee who is not in an eligible department.
16	$SALARY(K) \geq$ LSALARY	An eligible employee earns LSALARY or more.	An eligible employee earns less than LSALARY.
16	$CODE(K) = MGR$	An eligible employee is a manager.	An eligible employee is not a manager.
21	-FOUND	An eligible department contains no employees.	An eligible depart- ment contains at least one employee.

**Figure 5.4**  
**Test cases to satisfy the condition-coverage criterion.**

Test case	Input	Expected output																																
1	<p style="text-align: center;">ESIZE = DSIZE = 0  All other inputs are irrelevant</p>	<p style="text-align: center;">ERRCODE = 1  ESIZE, DSIZE, EMPTAB, and  DEPTTAB are unchanged</p>																																
2	<p>ESIZE = DSIZE = 3</p> <table style="width: 100%; border-collapse: collapse;"> <tr> <td style="width: 50%; border: none;"> <p>EMPTAB</p> <table border="1" style="width: 100%; border-collapse: collapse;"> <tr> <td>JONES</td> <td>E</td> <td>D42</td> <td>21,000.00</td> </tr> <tr> <td>SMITH</td> <td>E</td> <td>D32</td> <td>14,000.00</td> </tr> <tr> <td>LORIN</td> <td>M</td> <td>D42</td> <td>10,000.00</td> </tr> </table> </td> <td style="width: 50%; border: none;"> <p>DEPTTAB</p> <table border="1" style="width: 100%; border-collapse: collapse;"> <tr> <td>D42</td> <td>10,000.00</td> </tr> <tr> <td>D32</td> <td>8,000.00</td> </tr> <tr> <td>D95</td> <td>10,000.00</td> </tr> </table> </td> </tr> </table>	<p>EMPTAB</p> <table border="1" style="width: 100%; border-collapse: collapse;"> <tr> <td>JONES</td> <td>E</td> <td>D42</td> <td>21,000.00</td> </tr> <tr> <td>SMITH</td> <td>E</td> <td>D32</td> <td>14,000.00</td> </tr> <tr> <td>LORIN</td> <td>M</td> <td>D42</td> <td>10,000.00</td> </tr> </table>	JONES	E	D42	21,000.00	SMITH	E	D32	14,000.00	LORIN	M	D42	10,000.00	<p>DEPTTAB</p> <table border="1" style="width: 100%; border-collapse: collapse;"> <tr> <td>D42</td> <td>10,000.00</td> </tr> <tr> <td>D32</td> <td>8,000.00</td> </tr> <tr> <td>D95</td> <td>10,000.00</td> </tr> </table>	D42	10,000.00	D32	8,000.00	D95	10,000.00	<p>ERRCODE = 2  ESIZE, DSIZE, and DEPTTAB are  unchanged</p> <p>EMPTAB</p> <table border="1" style="width: 100%; border-collapse: collapse;"> <tr> <td>JONES</td> <td>E</td> <td>D42</td> <td>21,000.00</td> </tr> <tr> <td>SMITH</td> <td>E</td> <td>D32</td> <td>14,000.00</td> </tr> <tr> <td>LORIN</td> <td>M</td> <td>D42</td> <td>10,100.00</td> </tr> </table>	JONES	E	D42	21,000.00	SMITH	E	D32	14,000.00	LORIN	M	D42	10,100.00
<p>EMPTAB</p> <table border="1" style="width: 100%; border-collapse: collapse;"> <tr> <td>JONES</td> <td>E</td> <td>D42</td> <td>21,000.00</td> </tr> <tr> <td>SMITH</td> <td>E</td> <td>D32</td> <td>14,000.00</td> </tr> <tr> <td>LORIN</td> <td>M</td> <td>D42</td> <td>10,000.00</td> </tr> </table>	JONES	E	D42	21,000.00	SMITH	E	D32	14,000.00	LORIN	M	D42	10,000.00	<p>DEPTTAB</p> <table border="1" style="width: 100%; border-collapse: collapse;"> <tr> <td>D42</td> <td>10,000.00</td> </tr> <tr> <td>D32</td> <td>8,000.00</td> </tr> <tr> <td>D95</td> <td>10,000.00</td> </tr> </table>	D42	10,000.00	D32	8,000.00	D95	10,000.00															
JONES	E	D42	21,000.00																															
SMITH	E	D32	14,000.00																															
LORIN	M	D42	10,000.00																															
D42	10,000.00																																	
D32	8,000.00																																	
D95	10,000.00																																	
JONES	E	D42	21,000.00																															
SMITH	E	D32	14,000.00																															
LORIN	M	D42	10,100.00																															

Using the decision/condition-coverage criterion would eliminate the big weakness in the test cases in Figure 5.4. Here we would provide sufficient test cases such that all outcomes of all conditions *and* decisions were evoked at least once. Making Jones a manager and making Lorin a nonmanager could accomplish this. This would have the result of generating both outcomes of decision 16, thus causing us to execute statement 18.

One problem with this, however, is that it is essentially no better than the test cases in Figure 5.3. If the compiler being used stops evaluating an *or* expression as soon as it determines that one operand is *true*, this modification would result in the expression `CODE(K)=MGR` in statement 16 never having a *true* outcome. Hence, if this expression were coded incorrectly, the test cases would not detect the error.

The last criterion to explore is multicondition coverage. This criterion requires sufficient test cases that all possible combinations of conditions in each decision are evoked at least once. This can be accomplished by working from Table 5.2. Decisions 6, 9, 13, and 21



have two combinations each; decisions 2 and 16 have four combinations each. The methodology to design the test cases is to select one that covers as many of the combinations as possible, select another that covers as many of the remaining combinations as possible, and so on. A set of test cases satisfying the multicondition-coverage criterion is shown in Figure 5.5. The set is more comprehensive than the previous sets of test cases, implying that we should have selected this criterion at the beginning.

It is important to realize that module BONUS could have a large number of errors that would not be detected by even the tests satisfy-

**Figure 5.5**

**Test cases to satisfy the multicondition-coverage criterion.**

Test case	Input	Expected output																																																
1	ESIZE = 0 DSIZE = 0 All other inputs are irrelevant	ERRCODE = 1 ESIZE, DSIZE, EMPTAB, and DEPTTAB are unchanged																																																
2	ESIZE = 0 DSIZE > 0 All other inputs are irrelevant	Same as above																																																
3	ESIZE > 0 DSIZE = 0 All other inputs are irrelevant	Same as above																																																
4	ESIZE = 5 DSIZE = 4  EMPTAB <table border="1" style="display: inline-table; vertical-align: top;"> <tr><td>JONES</td><td>M</td><td>D42</td><td>21,000.00</td></tr> <tr><td>WARNS</td><td>M</td><td>D95</td><td>12,000.00</td></tr> <tr><td>LORIN</td><td>E</td><td>D42</td><td>10,000.00</td></tr> <tr><td>TOY</td><td>E</td><td>D95</td><td>16,000.00</td></tr> <tr><td>SMITH</td><td>E</td><td>D32</td><td>14,000.00</td></tr> </table> DEPTTAB <table border="1" style="display: inline-table; vertical-align: top;"> <tr><td>D42</td><td>10,000.00</td></tr> <tr><td>D32</td><td>8,000.00</td></tr> <tr><td>D95</td><td>10,000.00</td></tr> <tr><td>D44</td><td>10,000.00</td></tr> </table>	JONES	M	D42	21,000.00	WARNS	M	D95	12,000.00	LORIN	E	D42	10,000.00	TOY	E	D95	16,000.00	SMITH	E	D32	14,000.00	D42	10,000.00	D32	8,000.00	D95	10,000.00	D44	10,000.00	ERRCODE = 2 ESIZE, DSIZE, and DEPTTAB are unchanged  EMPTAB <table border="1" style="display: inline-table; vertical-align: top;"> <tr><td>JONES</td><td>M</td><td>D42</td><td>21,100.00</td></tr> <tr><td>WARNS</td><td>M</td><td>D95</td><td>12,100.00</td></tr> <tr><td>LORIN</td><td>E</td><td>D42</td><td>10,200.00</td></tr> <tr><td>TOY</td><td>E</td><td>D95</td><td>16,100.00</td></tr> <tr><td>SMITH</td><td>E</td><td>D32</td><td>14,000.00</td></tr> </table>	JONES	M	D42	21,100.00	WARNS	M	D95	12,100.00	LORIN	E	D42	10,200.00	TOY	E	D95	16,100.00	SMITH	E	D32	14,000.00
JONES	M	D42	21,000.00																																															
WARNS	M	D95	12,000.00																																															
LORIN	E	D42	10,000.00																																															
TOY	E	D95	16,000.00																																															
SMITH	E	D32	14,000.00																																															
D42	10,000.00																																																	
D32	8,000.00																																																	
D95	10,000.00																																																	
D44	10,000.00																																																	
JONES	M	D42	21,100.00																																															
WARNS	M	D95	12,100.00																																															
LORIN	E	D42	10,200.00																																															
TOY	E	D95	16,100.00																																															
SMITH	E	D32	14,000.00																																															

ing the multicondition-coverage criterion. For instance, no test cases generate the situation where `ERRORCODE` is returned with a value of 0; thus, if statement 1 were missing, the error would go undetected. If `LSALARY` were erroneously initialized to \$150,000.01, the mistake would go unnoticed. If statement 16 stated `SALARY(K)>LSALARY` instead of `SALARY(K)>=LSALARY`, this error would not be found. Also, whether a variety of off-by-one errors (such as not handling the last entry in `DEPTTAB` or `EMPTAB` correctly) would be detected would depend largely on chance.

Two points should be apparent now: the multicondition-criterion is superior to the other criteria, and any logic-coverage criterion is not good enough to serve as the only means of deriving module tests. Hence, the next step is to supplement the tests in Figure 5.5 with a set of black-box tests. To do so, the interface specifications of `BONUS` are shown in the following:

`BONUS`, a PL/1 module, receives five parameters, symbolically referred to here as `EMPTAB`, `DEPTTAB`, `ESIZE`, `DSIZE`, and `ERRORCODE`. The attributes of these parameters are

```

DECLARE 1 EMPTAB(*),      /*INPUT AND OUTPUT*/
        2 NAME CHARACTER(6),
        2 CODE CHARACTER(1),
        2 DEPT CHARACTER(3),
        2 SALARY FIXED DECIMAL(7,2);
DECLARE 1 DEPTTAB(*),    /*INPUT*/
        2 DEPT CHARACTER(3),
        2 SALES FIXED DECIMAL(8,2);
DECLARE (ESIZE, DSIZE) FIXED BINARY;      /*INPUT*/
DECLARE ERRCODE FIXED DECIMAL(1);        /*OUTPUT*/

```

The module assumes that the transmitted arguments have these attributes. `ESIZE` and `DSIZE` indicate the number of entries in `EMPTAB` and `DEPTTAB`, respectively. No assumptions should be made about the order of entries in `EMPTAB` and `DEPTTAB`. The function of the

module is to increment the salary (`EMPTAB.SALARY`) of those employees in the department or departments having the largest sales amount (`DEPTTAB.SALES`). If an eligible employee's current salary is \$150,000 or more, or if the employee is a manager (`EMPTAB.CODE='M'`), the increment is \$1,000; if not, the increment for the eligible employee is \$2,000. The module assumes that the incremented salary will fit into field `EMPTAB.SALARY`. If `ESIZE` and `DSIZE` are not greater than 0, `ERRCODE` is set to 1 and no further action is taken. In all other cases, the function is completely performed. However, if a maximum-sales department is found to have no employee, processing continues, but `ERRCODE` will have the value 2; otherwise, it is set to 0.

This specification is not suited to cause-effect graphing (there is not a discernable set of input conditions whose combinations should be explored); thus, boundary-value analysis will be used. The input boundaries identified are as follows:

1. `EMPTAB` has 1 entry.
2. `EMPTAB` has the maximum number of entries (65,535).
3. `EMPTAB` has 0 entries.
4. `DEPTTAB` has 1 entry.
5. `DEPTTAB` has 65,535 entries.
6. `DEPTTAB` has 0 entries.
7. A maximum-sales department has 1 employee.
8. A maximum-sales department has 65,535 employees.
9. A maximum-sales department has no employees.
10. All departments in `DEPTTAB` have the same sales.
11. The maximum-sales department is the first entry in `DEPTTAB`.
12. The maximum-sales department is the last entry in `DEPTTAB`.
13. An eligible employee is the first entry in `EMPTAB`.
14. An eligible employee is the last entry in `EMPTAB`.
15. An eligible employee is a manager.
16. An eligible employee is not a manager.
17. An eligible employee who is not a manager has a salary of \$149,999.99.

18. An eligible employee who is not a manager has a salary of \$150,000.
19. An eligible employee who is not a manager has a salary of \$150,000.01.

The output boundaries are as follows:

20. `ERRCODE=0`.
21. `ERRCODE=1`.
22. `ERRCODE=2`.
23. The incremented salary of an eligible employee is \$299,999.99.

A further test condition based on the error-guessing technique is as follows:

24. A maximum-sales department with no employees is followed in `DEPTTAB` with another maximum-sales department having employees.

This is used to determine whether the module erroneously terminates processing of the input when it encounters an `ERRCODE=2` situation.

Reviewing these 24 conditions, conditions 2, 5, and 8 seem like impractical test cases. Since they also represent conditions that will never occur (usually a dangerous assumption to make when testing, but seemingly safe here), they are excluded. The next step is to compare the remaining 21 conditions to the current set of test cases (Figure 5.5) to determine which boundary conditions are not already covered. Doing so, we see that conditions 1, 4, 7, 10, 14, 17, 18, 19, 20, 23, and 24 require test cases beyond those in Figure 5.5.

The next step is to design additional test cases to cover the 11 boundary conditions. One approach is to merge these conditions into the existing test cases (i.e., by modifying test case 4 in Figure 5.5), but this is not recommended because doing so could inadvertently upset the complete multicondition coverage of the existing test cases. Hence, the safest approach is to add test cases to those of

**Figure 5.6**  
**Supplemental boundary-value-analysis**  
**test cases for BONUS.**

Test case	Input	Expected output																												
5	ESIZE = 3 DSIZE = 2  EMPTAB <table border="1" style="display: inline-table; margin-right: 20px;"> <tr><td>ALLY</td><td>E</td><td>D36</td><td>14,999.99</td></tr> <tr><td>BEST</td><td>E</td><td>D33</td><td>15,000.00</td></tr> <tr><td>CELTO</td><td>E</td><td>D33</td><td>15,000.01</td></tr> </table> DEPTTAB <table border="1" style="display: inline-table;"> <tr><td>D33</td><td>55,400.01</td></tr> <tr><td>D36</td><td>55,400.01</td></tr> </table>	ALLY	E	D36	14,999.99	BEST	E	D33	15,000.00	CELTO	E	D33	15,000.01	D33	55,400.01	D36	55,400.01	ERRCODE = 0  ESIZE, DSIZE, and DEPTTAB are unchanged  EMPTAB <table border="1" style="display: inline-table;"> <tr><td>ALLY</td><td>E</td><td>D36</td><td>15,199.99</td></tr> <tr><td>BEST</td><td>E</td><td>D33</td><td>15,100.00</td></tr> <tr><td>CELTO</td><td>E</td><td>D33</td><td>15,100.01</td></tr> </table>	ALLY	E	D36	15,199.99	BEST	E	D33	15,100.00	CELTO	E	D33	15,100.01
ALLY	E	D36	14,999.99																											
BEST	E	D33	15,000.00																											
CELTO	E	D33	15,000.01																											
D33	55,400.01																													
D36	55,400.01																													
ALLY	E	D36	15,199.99																											
BEST	E	D33	15,100.00																											
CELTO	E	D33	15,100.01																											
6	ESIZE = 1 DSIZE = 1  EMPTAB <table border="1" style="display: inline-table; margin-right: 20px;"> <tr><td>CHIEF</td><td>M</td><td>D99</td><td>99,899.99</td></tr> </table> DEPTTAB <table border="1" style="display: inline-table;"> <tr><td>D99</td><td>99,000.00</td></tr> </table>	CHIEF	M	D99	99,899.99	D99	99,000.00	ERRCODE = 0  ESIZE, DSIZE, and DEPTTAB are unchanged  EMPTAB <table border="1" style="display: inline-table;"> <tr><td>CHIEF</td><td>M</td><td>D99</td><td>99,999.99</td></tr> </table>	CHIEF	M	D99	99,999.99																		
CHIEF	M	D99	99,899.99																											
D99	99,000.00																													
CHIEF	M	D99	99,999.99																											
7	ESIZE = 2 DSIZE = 2  EMPTAB <table border="1" style="display: inline-table; margin-right: 20px;"> <tr><td>DOLE</td><td>E</td><td>D67</td><td>10,000.00</td></tr> <tr><td>FORD</td><td>E</td><td>D22</td><td>33,333.33</td></tr> </table> DEPTTAB <table border="1" style="display: inline-table;"> <tr><td>D66</td><td>20,000.00</td></tr> <tr><td>D67</td><td>20,000.00</td></tr> </table>	DOLE	E	D67	10,000.00	FORD	E	D22	33,333.33	D66	20,000.00	D67	20,000.00	ERRCODE = 2  ESIZE, DSIZE, and DEPTTAB are unchanged  EMPTAB <table border="1" style="display: inline-table;"> <tr><td>DOLE</td><td>E</td><td>D67</td><td>10,000.00</td></tr> <tr><td>FORD</td><td>E</td><td>D22</td><td>33,333.33</td></tr> </table>	DOLE	E	D67	10,000.00	FORD	E	D22	33,333.33								
DOLE	E	D67	10,000.00																											
FORD	E	D22	33,333.33																											
D66	20,000.00																													
D67	20,000.00																													
DOLE	E	D67	10,000.00																											
FORD	E	D22	33,333.33																											

Figure 5.5. In doing this, the goal is to design the smallest number of test cases necessary to cover the boundary conditions. The three test cases in Figure 5.6 accomplish this. Test case 5 covers conditions 7, 10, 14, 17, 18, 19, and 20; test case 6 covers conditions 1, 4, and 23; and test case 7 covers condition 24.

The premise here is that the logic-coverage, or white-box, test cases in Figure 5.6 form a reasonable module test for procedure BONUS.

## INCREMENTAL TESTING

In performing the process of module testing, there are two key considerations: the design of an effective set of test cases, which was discussed in the previous section, and the manner in which the modules are combined to form a working program. The second consideration is important because it has implications for the form in which module test cases are written, the types of test tools that might be used, the order in which modules are coded and tested, the cost of generating test cases, and the cost of debugging (locating and repairing detected errors). In short, then, it is a consideration of substantial importance. In this section, two approaches, incremental and nonincremental testing, are discussed. In the next section, two incremental approaches, top-down and bottom-up development or testing, are explored.

The question pondered here is the following: Should you test a program by testing each module independently and then combining the modules to form the program, or should you combine the next module to be tested with the set of previously tested modules before it is tested? The first approach is called *nonincremental* or “big-bang” testing or integration; the second approach is known as *incremental* testing or integration.

The program in Figure 5.7 is used as an example. The rectangles represent the six modules (subroutines or procedures) in the program. The lines connecting the modules represent the control hierarchy of the program; that is, module A calls modules B, C, and D; module B

**Figure 5.7**  
**Sample six-module program.**

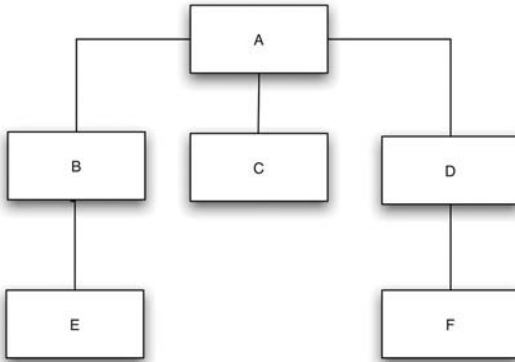

calls module E; and so on. Nonincremental testing, the traditional approach, is performed in the following manner. First, a module test is performed on each of the six modules, testing each module as a stand-alone entity. The modules might be tested at the same time or in succession, depending on the environment (e.g., interactive versus batch-processing computing facilities) and the number of people involved. Finally, the modules are combined or integrated (e.g., “link edited”) to form the program.

The testing of each module requires a special *driver* module and one or more *stub modules*. For instance, to test module B, test cases are first designed and then fed to module B by passing it input arguments from a driver module, a small module that must be coded to “drive,” or transmit, test cases through the module under test. (Alternatively, a test tool could be used.) The driver module must also display, to the tester, the results produced by B. In addition, since module B calls module E, something must be present to receive control when B calls E. A stub module, a special module given the name “E” that must be coded to simulate the function of module E, accomplishes this.

When the module testing of all six modules has been completed, the modules are combined to form the program.

The alternative approach is incremental testing. Rather than testing each module in isolation, the next module to be tested is first combined with the set of modules that have already been tested.

It is premature to give a procedure for incrementally testing the program in Figure 5.7, because there are a large number of possible incremental approaches. A key issue is whether we should begin at the top or bottom of the program. However, since this issue is discussed in the next section, let us assume for the moment that we are beginning from the bottom. The first step is to test modules E, C, and F, either in parallel (by three people) or serially. Notice that we must prepare a driver for each module, but not a stub. The next step is the testing of B and D, but rather than testing them in isolation, they are combined with modules E and F, respectively. In other words, to test module B, a driver is written, incorporating the test cases, and the pair B-E is tested. The incremental process, adding the next module to the set or subset of previously tested modules, is continued until the last module (Module A in this case) is tested. Note that this procedure could have alternatively progressed from the top to the bottom.

Several observations should be apparent at this point.

1. Nonincremental testing requires more work. For the program in Figure 5.7, five drivers and five stubs must be prepared (assuming we do not need a driver module for the top module). The bottom-up incremental test would require five drivers but no stubs. A top-down incremental test would require five stubs but no drivers. Less work is required because previously tested modules are used instead of the driver modules (if you start from the top) or stub modules (if you start from the bottom) needed in the nonincremental approach.
2. Programming errors related to mismatching interfaces or incorrect assumptions among modules will be detected earlier if incremental testing is used. The reason is that combina-



tions of modules are tested together at an early point in time. However, if nonincremental testing is used, modules do not “see one another” until the end of the process.

3. As a result, debugging should be easier if incremental testing is used. If we assume that errors related to intermodule interfaces and assumptions do exist (a good assumption from experience), then, if nonincremental testing has been used, the errors will not surface until the entire program has been combined. At this time, we may have difficulty pinpointing the error, since it could be anywhere within the program. Conversely, if incremental testing is used, an error of this type should be easier to pinpoint, because it is likely that the error is associated with the most recently added module.
4. Incremental testing might result in more thorough testing. If you are testing module B, either module E or A (depending on whether you started from the bottom or the top) is executed as a result. Although E or A should have been thoroughly tested previously, perhaps executing it as a result of B’s module test will evoke a new condition, perhaps one that represents a deficiency in the original test of E or A. On the other hand, if nonincremental testing is used, the testing of B will affect only module B. In other words, incremental testing substitutes previously tested modules for the stubs or drivers needed in the nonincremental test. As a result, the actual modules receive more exposure by the completion of the last module test.
5. The nonincremental approach appears to use less machine time. If module A of Figure 5.7 is being tested using the bottom-up approach, modules B, C, D, E, and F probably execute during the execution of A. In a nonincremental test of A, only stubs for B, C, and E are executed. The same is true for a top-down incremental test. If module F is being tested, modules A, B, C, D, and E may be executed during the test of F; in the nonincremental test of F, only the driver for F, plus F itself, executes. Hence, the number of machine instructions executed during a test run using the incremental

approach is apparently greater than that for the nonincremental approach. However, offsetting this is the fact that the nonincremental test requires more drivers and stubs than the incremental test; machine time is needed to develop the drivers and stubs.

6. At the beginning of the module-testing phase, there is more opportunity for parallel activities if nonincremental testing is used (that is, all the modules can be tested simultaneously). This might be of significance in a large project (many modules and people), since the head count of a project is usually at its peak at the start of the module-test phase.

In summary, observations 1 through 4 are advantages of incremental testing, and observations 5 through 6 are disadvantages. Given current trends in the computing industry (hardware costs have been decreasing and seem destined to continue to do so while hardware capability increases, and labor costs and the consequences of software errors are increasing), and given the fact that the earlier an error is found, the lower the cost of repairing it, you can see that observations 1 through 4 are increasing in importance while observation 5 is becoming less important. Observation 6 seems to be a weak disadvantage, if one at all. This leads to the conclusion that incremental testing is superior.

## TOP-DOWN VERSUS BOTTOM-UP TESTING

Given the conclusion of the previous section—that incremental testing is superior to nonincremental testing—two incremental strategies are explored: top-down and bottom-up testing. Before discussing them, however, several misconceptions should be clarified. First, the terms “top-down testing,” “bottom-down development,” and “top-down design” are often used as synonyms. Top-down testing and top-down development are synonyms (they represent a strategy of ordering the coding and testing of modules), but top-down design is something quite different and independent. A program that was

designed in top-down fashion can be incrementally tested in either a top-down or a bottom-up fashion.

Second, bottom-up testing (or bottom-up development) is often mistakenly equated with nonincremental testing. The reason is that bottom-up testing begins in a manner that is identical to a nonincremental test (i.e., when the bottom, or terminal, modules are tested), but as we saw in the previous section, bottom-up testing is an incremental strategy. Finally, since both strategies are incremental, the advantages of incremental testing are not repeated here; only the differences between top-down and bottom-up testing are discussed.

### **Top-down Testing**

The top-down strategy starts with the top, or initial, module in the program. After this, there is no single right procedure for selecting the next module to be incrementally tested; the only rule is that to be eligible to be the next module, at least one of the module's subordinate (calling) modules must have been tested previously.

Figure 5.8 is used to illustrate this strategy. A through L are the 12 modules in the program. Assume that module J contains the program's I/O read operations and module I contains the write operations.

The first step is the testing of Module A. To accomplish this, stub modules representing B, C, and D must be written. Unfortunately, the production of stub modules is often misunderstood; as evidence, you may often see such statements as “a stub module need only write a message stating ‘we got this far,’ ” and “in many cases, the dummy module (stub) simply exits—without doing any work at all.” In most situations, these statements are false. Since module A calls module B, A is expecting B to perform some work; this work most likely is some result (output arguments) returned to A. If the stub simply returns control or writes an error message without returning a meaningful result, module A will fail, not because of an error in A, but because of a failure of the stub to simulate the corresponding module. Moreover, returning a “wired-in” output from a stub module is often insufficient. For instance, consider the task of writing a stub representing a square-root routine, a database table-search routine, an

**Figure 5.8**  
**Sample 12-module program.**

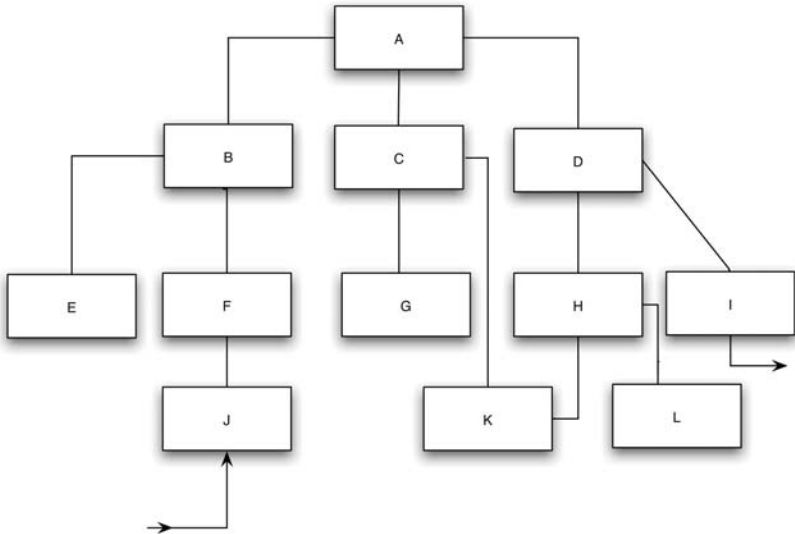

“obtain corresponding master-file record” routine, or the like. If the stub returns a fixed wired-in output, but, not having the particular value expected by the calling module during this invocation, the calling module may fail or produce a confusing result. Hence, the production of stubs is not a trivial task.

Another consideration is the form in which test cases are presented to the program, an important consideration that is not even mentioned in most discussions of top-down testing. In our example, the question is: How do you feed test cases to module A? Since the top module in typical programs neither receives input arguments nor performs input/output operations, the answer is not immediately obvious. The answer is that the test data are fed to the module (module A in this situation) from one or more of its stubs. To illustrate, assume that the functions of B, C, and D are as follows:

- B—Obtain summary of transaction file.
- C—Determine whether weekly status meets quota.
- D—Produce weekly summary report.

A test case for A, then, is a transaction summary returned from stub B. Stub D might contain statements to write its input data to a printer, allowing the results of each test to be examined.

In this program, another problem exists. Since module A presumably calls module B only once, the problem is how you feed more than one test case to A. One solution is to develop multiple versions of stub B, each with a different wired-in set of test data to be returned to A. To execute the test cases, the program is executed multiple times, each time with a different version of stub B. Another alternative is to place test data on external files and have stub B read the test data and return them to A. In either case, and because of the previous discussion, you should see that the development of stub modules is more difficult than it is often made out to be. Furthermore, it often is necessary, because of the characteristics of the program, to represent a test case across multiple stubs beneath the module under test (i.e., where the module receives data to be acted upon by calling multiple modules).

After A has been tested, an actual module replaces one of the stubs, and the stubs required by that module are added. For instance, Figure 5.9 might represent the next version of the program.

After testing the top module, numerous sequences are possible. For instance, if we are performing all the testing sequences, four examples of the many possible sequences of modules are

1. A    B    C    D    E    F    G    H    I    J    K    L
2. A    B    E    F    J    C    G    K    D    H    L    I
3. A    D    H    I    K    L    C    G    B    F    J    E
4. A    B    F    J    D    I    E    C    G    K    H    L

If parallel testing occurs, other alternatives are possible. For instance, after module A has been tested, one programmer could take module A and test the combination A-B, another programmer could

**Figure 5.9**  
**Second step in the top-down test.**

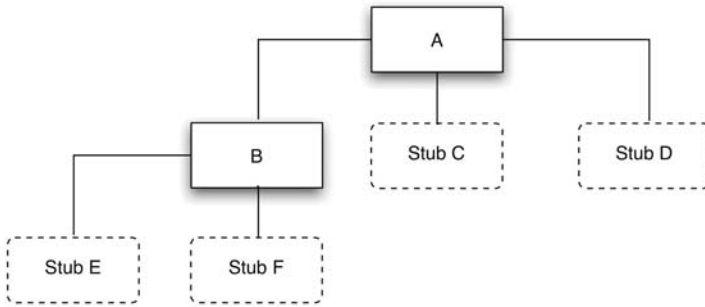

test A-C, and a third could test A-D. In general, there is no best sequence, but here are two guidelines to consider:

1. If there are critical sections of the program (perhaps module G), design the sequence such that these sections are added as early as possible. A “critical section” might be a complex module, a module with a new algorithm, or a module suspected to be error prone.
2. Design the sequence such that the I/O modules are added as early as possible.

The motivation for the first should be obvious, but the motivation for the second deserves further discussion. Recall that a problem with stubs was that some of them must contain the test cases and others must write their input to a printer or display. However, as soon as the module accepting the program’s input is added, the representation of test cases is considerably simplified; their form is identical to the input accepted by the final program (e.g., from a transaction file or a terminal). Likewise, once the module performing the program’s output

function is added, the placement of code in stub modules to write results of test cases might no longer be necessary. Thus, if modules J and I are the I/O modules and if module G performs some critical function, the incremental sequence might be

A B F J D I C G E K H L

and the form of the program after the sixth increment would be that shown in Figure 5.10.

Once the intermediate state in Figure 5.10 has been reached, the representation of test cases and the inspection of results are simplified. It has another advantage in that you have a working skeletal version of the program, that is, a version that performs actual input and output operations. However, stubs are still simulating some of the “insides.” This early skeletal version

- Allows you to find human-factor errors and problems
- Allows the program to be demonstrated to the eventual user
- Serves as evidence that the overall design of the program is sound
- Serves as a morale booster

These points represent the major advantage of the top-down strategy.

On the other hand, the top-down approach has some serious shortcomings. Assume that our current state of testing is that of Figure 5.10 and that our next step is to replace stub H with module H. What we should do at this point (or earlier) is use the methods described earlier in this chapter to design a set of test cases for H. Note, however, that the test cases are in the form of actual program inputs to module J. This presents several problems. First, because of the intervening modules between J and H (F, B, A, and D), we might find it impossible to represent certain test cases to module J that test every predefined situation in H. For instance, if H is the BONUS module of Figure 5.2, it might be impossible, because of the nature of intervening module D, to create some of the seven test cases of Figures 5.5 and 5.6.

**Figure 5.10**  
**Intermediate state in the top-down test.**

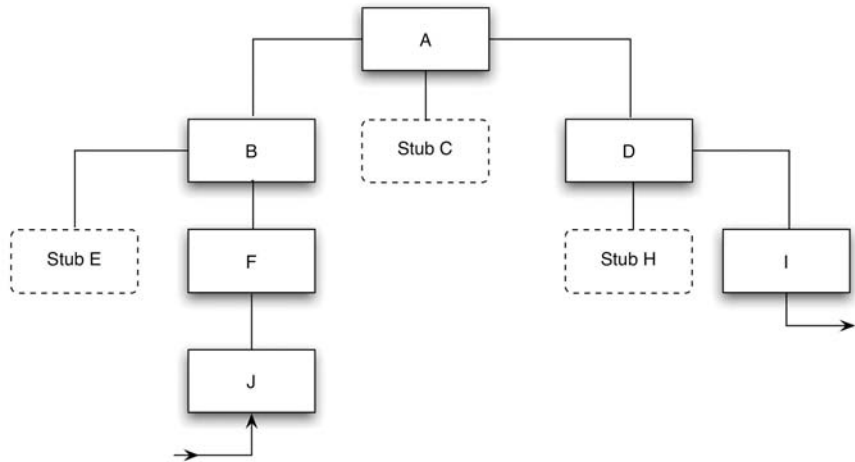

Second, because of the “distance” between H and the point at which the test data enter the program, even if it were possible to test every situation, determining what data to feed to J to test these situations in H is often a difficult mental task.

Third, because the displayed output of a test might come from a module that is a large distance away from the module being tested, correlating the displayed output to what went on in the module may be difficult or impossible. Consider adding module E to Figure 5.10. The results of each test case are determined by examining the output written by module I, but because of the intervening modules, it may be difficult to deduce the actual output of E (that is, the data returned to B).

The top-down strategy, depending on how it is approached, may have two further problems. People occasionally feel that it can be overlapped with the program’s design phase. For instance, if you are in the process of designing the program in Figure 5.8, you might



believe that after the first two levels are designed, modules A through D can be coded and tested while the design of the lower levels progresses. As we have emphasized elsewhere, this is usually an unwise decision. Program design is an iterative process, meaning that when we are designing the lower levels of a program's structure, we may discover desirable changes or improvements to the upper levels. If the upper levels have already been coded and tested, the desirable improvements will most likely be discarded, an unwise decision in the long run.

A final problem that often arises in practice is not completely testing a module before proceeding to another module. This arises for two reasons: because of the difficulty of embedding test data in stub modules, and because the upper levels of a program usually provide resources to lower levels. In Figure 5.8 we saw that testing module A might require multiple versions of the stub for module B. In practice, there is a tendency to say, "Because this represents a lot of work, I won't execute all of A's test cases now. I'll wait until I place module J in the program, at which time the representation of test cases is easier, and remember at this point to finish testing module A." Of course, the problem here is that we may forget to test the remainder of module A at this later point in time. Also, because upper levels often provide resources for use by lower levels (e.g., opening of files), it is difficult sometimes to determine whether the resources have been provided correctly (e.g., if a file has been opened with the proper attributes) until the lower modules that use them are tested.

### **Bottom-up Testing**

The next step is to examine the bottom-up incremental testing strategy. For the most part, bottom-up testing is the opposite of top-down testing; the advantages of top-down testing become the disadvantages of bottom-up testing, and the disadvantages of top-down testing become the advantages of bottom-up testing. Because of this, the discussion of bottom-up testing is shorter.

The bottom-up strategy begins with the terminal modules in the program (the modules that do not call other modules). After these

modules have been tested, again there is no best procedure for selecting the next module to be incrementally tested; the only rule is that, to be eligible to be the next module, all of the module's subordinate modules (the modules it calls) must have been tested previously.

Returning to Figure 5.8, the first step is to test some or all of modules E, J, G, K, L, and I, either serially or in parallel. To do so, each module needs a special driver module: a module that contains wired-in test inputs, calls the module being tested, and displays the outputs (or compares the actual outputs with the expected outputs). Unlike the situation with stubs, multiple versions of a driver are not needed, since the driver module can iteratively call the module being tested. In most cases, driver modules are easier to produce than stub modules.

As was the case earlier, a factor influencing the sequence of testing is the critical nature of the modules. If we decide that modules D and F are most critical, an intermediate state of the bottom-up incremental test might be that of Figure 5.11. The next steps might be to test E and then test B, combining B with the previously tested modules E, F, and J.

A drawback of the bottom-up strategy is that there is no concept of an early skeletal program. In fact, the working program does not exist until the last module (module A) is added, and this working program is the complete program. Although the I/O functions can be tested before the whole program has been integrated (the I/O modules are being used in Figure 5.11), the advantages of the early skeletal program are not present.

The problems associated with the impossibility or difficulty of creating all test situations in the top-down approach do not exist here. If you think of a driver module as a test probe, the probe is being placed directly on the module being tested; there are no intervening modules to worry about. Examining other problems associated with the top-down approach, you can't make the unwise decision to overlap design and testing, since the bottom-up test cannot begin until the bottom of the program has been designed. Also, the problem of not completing the test of a module before starting another, because of the difficulty of encoding test data in versions of a stub, does not exist when using bottom-up testing.

**Figure 5.11**  
**Intermediate state in the bottom-up test.**

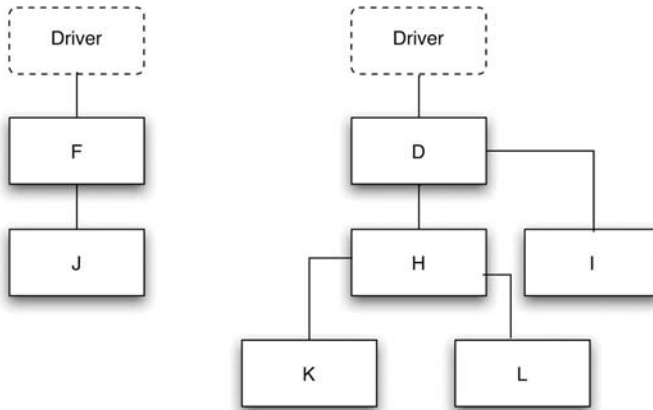

## A Comparison

It would be convenient if the top-down versus bottom-up issue were as clear-cut as the incremental versus nonincremental issue, but unfortunately it is not. Table 5.3 summarizes their relative advantages and disadvantages (excluding the previously discussed advantages shared by both—the advantages of incremental testing). The first advantage of each approach might appear to be the deciding factor, but there is no evidence showing that major flaws occur more often at the top or bottom levels of the typical program. The safest way to make a decision is to weigh the factors in Table 5.3 with respect to the particular program being tested. Lacking such a program here, the serious consequences of the fourth disadvantage of top-down testing and the availability of test tools that eliminate the need for drivers but not stubs seem to give the bottom-up strategy the edge.

In addition, it may be apparent that top-down and bottom-up testing are not the only possible incremental strategies.

**Table 5.3**  
**Comparison of Top-down and Bottom-up Testing**

Top-down Testing	
<i>Advantages</i>	<i>Disadvantages</i>
<ol style="list-style-type: none"> <li>1. This is advantageous if major flaws occur toward the top of the program.</li> <li>2. Once the I/O functions are added, representation of test cases is easier.</li> <li>3. Early skeletal program allows demonstrations and boosts morale.</li> </ol>	<ol style="list-style-type: none"> <li>1. Stub modules must be produced.</li> <li>2. Stub modules are often more complicated than they first appear to be.</li> <li>3. Before the I/O functions are added, the representation of test cases in stubs can be difficult.</li> <li>4. Test conditions may be impossible, or very difficult, to create.</li> <li>5. Observation of test output is more difficult.</li> <li>6. It allows one to think that design and testing can be overlapped.</li> <li>7. It induces one to defer completion of the testing of certain modules.</li> </ol>
Bottom-up Testing	
<i>Advantages</i>	<i>Disadvantages</i>
<ol style="list-style-type: none"> <li>1. This is advantageous if major flaws occur toward the bottom of the program.</li> <li>2. Test conditions are easier to create.</li> <li>3. Observation of test results is easier.</li> </ol>	<ol style="list-style-type: none"> <li>1. Driver modules must be produced.</li> <li>2. The program as an entity does not exist until the last module is added.</li> </ol>

## PERFORMING THE TEST

The remaining part of the module test is the act of actually carrying out the test. A set of hints and guidelines for doing this are described here.

When a test case produces a situation where the module's actual results do not match the expected results, there are two possible explanations: either the module contains an error or the expected results are incorrect (the test case is incorrect). To minimize this confusion, the set of test cases should be reviewed or inspected before the test is performed (that is, the test cases should be tested).

The use of automated test tools can minimize part of the drudgery of the testing process. For instance, there exist test tools that eliminate the need for driver modules. Flow-analysis tools enumerate the paths through a program, find statements that can never be executed ("unreachable" code), and find instances where a variable is used before it is assigned a value.

It is helpful, when preparing for a module test, to review the psychological and economic principles discussed in Chapter 2. As was the practice earlier in this chapter, remember that a definition of the expected result is a necessary part of a test case. When executing a test, remember to look for side effects (instances where a module does something it is not supposed to do). In general, these situations are difficult to detect, but some instances may be found by checking, after execution of the test case, the inputs to the module that are not supposed to be altered. For instance, test case 7 in Figure 5.6 states that, as part of the expected result, `ESIZE`, `DSIZE`, and `DEPTTAB` should be unchanged. When running this test case, not only is the output examined for the correct result, but `ESIZE`, `DSIZE`, and `DEPTTAB` should be examined to determine whether they were erroneously altered.

The psychological problems associated with a person attempting to test his or her own programs apply to module testing. Rather than testing their own modules, programmers might swap modules; the programmer of the calling module is always a good candidate to test the called module. Note that this applies only to testing; the debugging of a module always should be performed by the original pro-

grammer. Avoid throwaway test cases; represent them in such a form that they can be reused in the future. Recall the counterintuitive phenomenon in Figure 2.2. If an abnormally high number of errors are found in a subset of the modules, it is likely that these modules contain even more, as yet undetected, errors. Such modules should be subjected to further module testing, and possibly an additional code walkthrough or inspection. Finally, remember that the purpose of a module test is not to demonstrate that the module functions correctly, but to demonstrate the presence of errors in the module.



## CHAPTER 6

# HIGHER-ORDER TESTING

**W**hen you finish module-testing a program, you have really only just begun the testing process. This is especially true of large or complex programs. Consider this important concept:

*A software error occurs when the program does not do what its end user reasonably expects it to do.*

Applying this definition, even if you could perform an absolutely perfect module test, you still couldn't guarantee that you have found all software errors.

To complete testing, then, some form of further testing is necessary. We call this new form *higher-order* testing.

Software development is largely a process of communicating information about the eventual program and translating this information from one form to another. For that reason, the vast majority of software errors can be attributed to breakdowns, mistakes, and noise during the communication and translation of information.

This view of software development is illustrated in Figure 6.1, a model of the development cycle for a software product. The flow of the process can be summarized in seven steps:

1. The program user's needs are translated into a set of written requirements. These are the goals for the product.
2. The requirements are translated into specific objectives by assessing feasibility and cost, resolving conflicting requirements, and establishing priorities and trade-offs.



**Figure 6.1**  
**The software development process.**

---

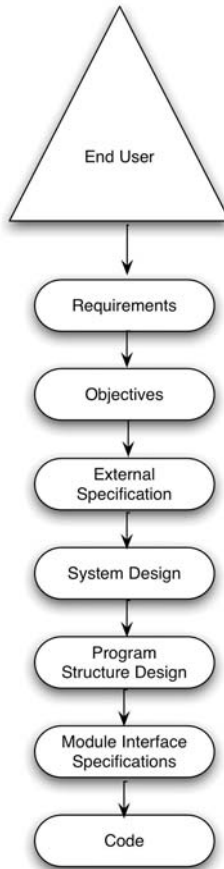

3. The objectives are translated into a precise product specification, viewing the product as a black box and considering only its interfaces and interactions with the end user. This description is called the *external specification*.
4. If the product is a system such as an operating system, flight-control system, database management system, or

employee personnel system, rather than a program (compiler, payroll program, word processor), the next process is system design. This step partitions the system into individual programs, components, or subsystems, and defines their interfaces.

5. The structure of the program or programs is designed by specifying the function of each module, the hierarchical structure of the modules, and the interfaces between modules.
6. A precise specification is developed that defines the interface to, and function of, each module.
7. Through one or more substeps, the module interface specification is translated into the source-code algorithm of each module.

Here's another way of looking at these forms of documentation:

- Requirements specify why the program is needed.
- Objectives specify what the program should do and how well the program should do it.
- External specifications define the exact representation of the program to users.
- Documentation associated with the subsequent processes specifies, in increasing levels of detail, how the program is constructed.

Given the premise that the seven steps of the development cycle involve communication, comprehension, and translation of information, and the premise that most software errors stem from breakdowns in information handling, there are three complementary approaches to prevent and/or detect these errors. First, we can introduce more precision into the development process to prevent many of the errors. Second, we can introduce, at the end of each process, a separate verification step to locate as many errors as possible before proceeding to the next process. This approach is illustrated in Figure 6.2. For instance, the external specification is verified by comparing

**Figure 6.2**  
**The development process with**  
**intermediate verification steps.**

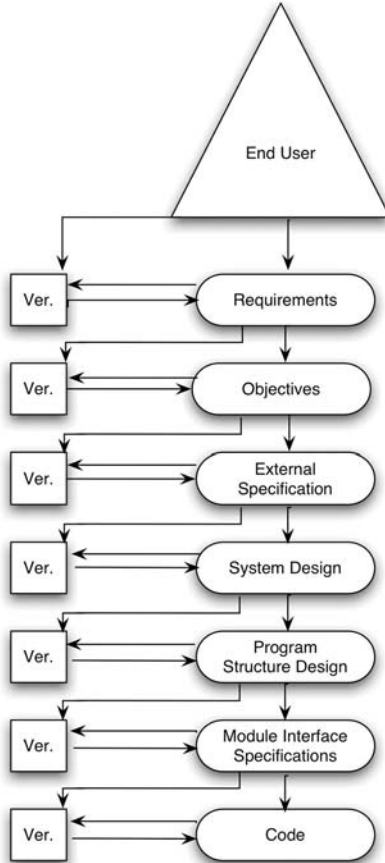

it to the output of the prior stage (the statement of objectives) and feeding back any discovered mistakes to the external-specification process. Use the code inspection and walkthrough methods discussed in Chapter 3 in the verification step at the end of the seventh process.

The third approach is to orient distinct testing processes toward distinct development processes. That is, focus each testing process on a particular translation step, thus focusing it on a particular class of errors. This approach is illustrated in Figure 6.3. The testing cycle has been structured to model the development cycle. In other words, you

**Figure 6.3**  
**The correspondence between development and testing processes.**

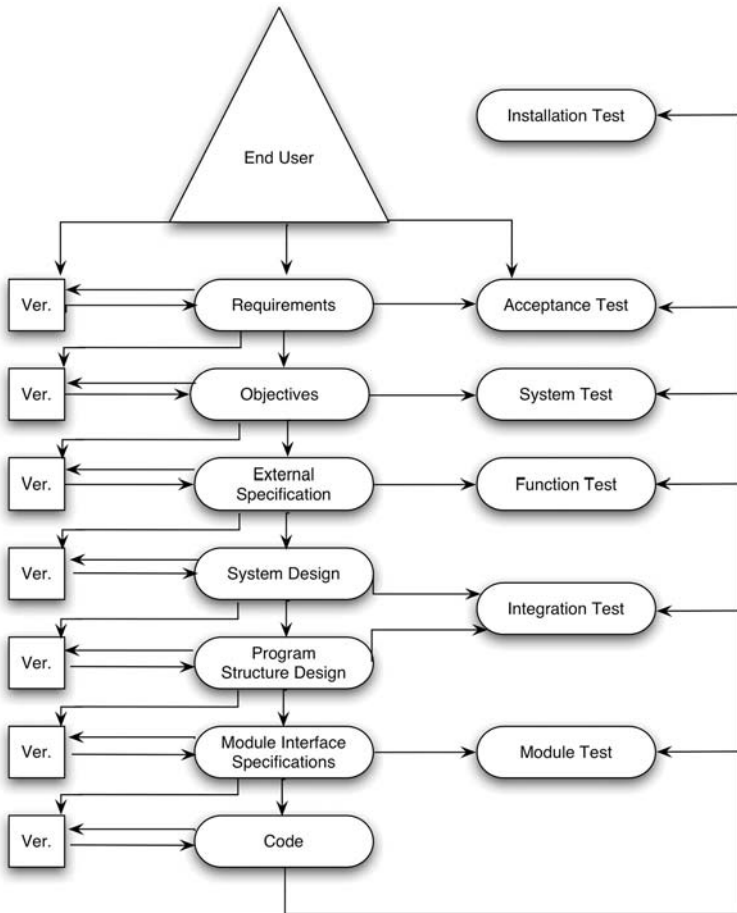

should be able to establish a one-to-one correspondence between development and testing processes. For instance:

- The purpose of a *module test* is to find discrepancies between the program's modules and their interface specifications.
- The purpose of a *function test* is to show that a program does not match its external specifications.
- The purpose of a *system test* is to show that the product is inconsistent with its original objectives.

The advantages of this structure are that it avoids unproductive redundant testing and prevents you from overlooking large classes of errors. For instance, rather than simply labeling system testing as “the testing of the whole system” and possibly repeating earlier tests, system testing is oriented toward a distinct class of errors (those made during the translation of the objectives to the external specification) and measured with respect to a distinct type of documentation in the development process.

The higher-order testing methods shown in Figure 6.3 are most applicable to software products (programs written as a result of a contract or programs intended for wide usage, as opposed to experimental programs or programs written for use only by the program's author). Programs not written as products often do not have formal requirements and objectives; for such programs, the function test might be the only higher-order test. Also, the need for higher-order testing increases as the size of the program increases. The reason is that the ratio of design errors (errors made in the earlier development processes) to coding errors is considerably higher in large programs than in small programs.

Note that the sequence of testing processes in Figure 6.3 does not necessarily imply a time sequence. For instance, since system testing is *not* defined as “the kind of testing you do after function testing,” but instead is defined as a distinct type of testing focused on a distinct class of errors, it could very well be partially overlapped in time with other testing processes.

In this chapter, we discuss the processes of function, system, acceptance, and installation testing. Integration testing is omitted because it

is often not regarded as a separate testing step and, when incremental module testing is used, it is an implicit part of the module test.

The discussions of these testing processes will be brief, general, and, for the most part, without examples because specific techniques used in these higher-order tests are highly dependent on the specific program being tested. For instance, the characteristics of a system test (the types of test cases, the manner in which test cases are designed, the test tools used) for an operating system will differ considerably from a system test of a compiler, a program controlling a nuclear reactor, or a database application program.

The last few sections in this chapter discuss planning and organizational issues and the important question of determining when to stop testing.

## FUNCTION TESTING

As indicated in Figure 6.3, function testing is a process of attempting to find discrepancies between the program and the external specification. An external specification is a precise description of the program's behavior from the point of view of the end user.

Except when used on small programs, function testing is normally a black-box activity. That is, you rely on the earlier module-testing process to achieve the desired white-box logic-coverage criteria.

To perform a function test, the specification is analyzed to derive a set of test cases. The equivalence-partitioning, boundary-value analysis, cause-effect graphing, and error-guessing methods described in Chapter 4 are especially pertinent to function testing. In fact, the examples in Chapter 4 are examples of function tests. The descriptions of the FORTRAN DIMENSION statement, the examination-scoring program, and the DISPLAY command actually are examples of external specifications. (Note, however, that they are not completely realistic examples; for instance, a real external specification for the scoring program would include a precise description of the format of the reports.) Hence, no examples of function tests are presented in this section.

Many of the guidelines of Chapter 2 also are particularly pertinent to function testing. Keep track of which functions have exhibited the greatest number of errors; this information is valuable because it tells us that these functions probably also contain the preponderance of as yet undetected errors. Remember to focus a sufficient amount of attention on invalid and unexpected input conditions. Recall that the definition of the expected result is a vital part of a test case. Finally, as always, remember that the purpose of the function test is to expose errors and discrepancies with the specification, not to demonstrate that the program matches its external specification.

## SYSTEM TESTING

System testing is the most misunderstood and most difficult testing process. System testing is not a process of testing the functions of the complete system or program, because this would be redundant with the process of function testing. As shown in Figure 6.3, system testing has a particular purpose: to compare the system or program to its original objectives. Given this purpose, two implications are as follows:

1. System testing is not limited to systems. If the product is a program, system testing is the process of attempting to demonstrate how the program, as a whole, does not meet its objectives.
2. System testing, by definition, is impossible if there is no set of written, measurable objectives for the product.

In looking for discrepancies between the program and its objectives, focus on translation errors made during the process of designing the external specification. This makes the system test a vital test process, because in terms of the product, the number of errors made, and the severity of those errors, this step in the development cycle usually is the most error prone.

It also implies that, unlike the function test, the external specifica-

tion cannot be used as the basis for deriving the system test cases, since this would subvert the purpose of the system test. On the other hand, the objectives document cannot be used, by itself, to formulate test cases, since it does not, by definition, contain precise descriptions of the program's external interfaces. We solve this dilemma by using the program's user documentation or publications. Design the system test by analyzing the objectives; formulate test cases by analyzing the user documentation. This has the useful side effect of comparing the program to its objectives and to the user documentation, as well as comparing the user documentation to the objectives, as shown in Figure 6.4

Figure 6.4 illustrates why system testing is the most difficult testing process. The leftmost arrow in the figure, comparing the program to

**Figure 6.4**  
**The system test.**

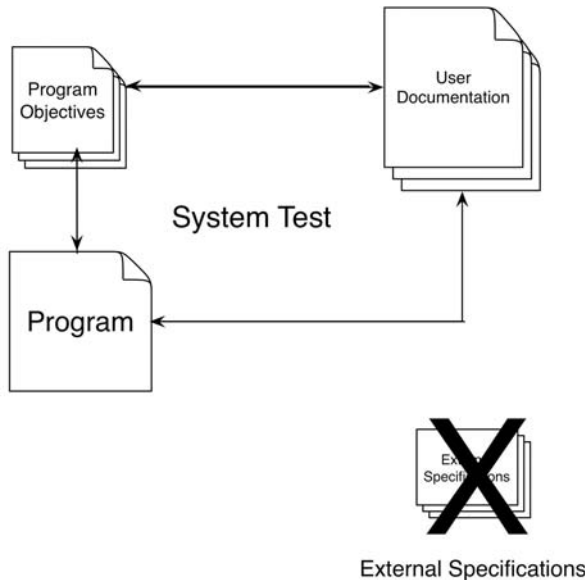



its objectives, is the central purpose of the system test, but there are no known test-case-design methodologies. The reason for this is that objectives state what a program should do and how well the program should do it, but they do not state the representation of the program's functions. For instance, the objectives for the `DISPLAY` command specified in Chapter 4 might have read as follows:

A command will be provided to view, from a terminal, the contents of main-storage locations. Its syntax should be consistent with the syntax of all other system commands. The user should be able to specify a range of locations, via an address range or an address and a count. Sensible defaults should be provided for command operands.

Output should be displayed as multiple lines of multiple words (in hexadecimal), with spacing between the words. Each line should contain the address of the first word of that line. The command is a "trivial" command, meaning that under reasonable system loads, it should begin displaying output within two seconds, and there should be no observable delay time between output lines. A programming error in the command processor should, at the worst, cause the command to fail; the system and the user's session must not be affected. The command processor should have no more than one user-detected error after the system is put into production.

Given the statement of objectives, there is no identifiable methodology that would yield a set of test cases, other than the vague but useful guideline of writing test cases to attempt to show that the program is inconsistent with each sentence in the objectives statement. Hence, a different approach to test-case design is taken here; rather than describing a methodology, distinct categories of system test cases are discussed. Because of the absence of a methodology, system testing requires a substantial amount of creativity; in fact, the design of good system test cases requires more creativity, intelligence, and experience than are required to design the system or program.

The 15 categories of test cases are discussed here. We don't claim that all 15 categories will be applicable to every program, but, to

avoid overlooking something, all 15 categories should be explored when designing test cases.

## Facility Testing

The most obvious type of system testing is the determination of whether each facility (or function, but the word “function” is not used here to avoid confusing this with function testing) mentioned in the objectives was actually implemented. The procedure is to scan the objectives sentence by sentence and, when a sentence specifies a *what* (for example, “syntax should be consistent . . .,” “user should be able to specify a range of locations . . .”), determine that the program satisfies the “what.” This type of testing often can be performed without a computer; a mental comparison of the objectives with the user documentation is sometimes sufficient. Nonetheless, a checklist is helpful to ensure that you mentally check the same objectives the next time you perform the test.

## Volume Testing

A second type of system testing is subjecting the program to heavy volumes of data. For instance, a compiler would be fed an absurdly large source program to compile. A linkage editor might be fed a program containing thousands of modules. An electronic circuit simulator would be given a circuit containing thousands of components. An operating system’s job queue would be filled to capacity. If a program is supposed to handle files spanning multiple volumes, enough data is created to cause the program to switch from one volume to another. In other words, the purpose of volume testing is to show that the program cannot handle the volume of data specified in its objectives.

Since volume testing obviously can require significant resources, in terms of machine and people time, you can’t go overboard. However, every program must be exposed to at least a few volume tests.

## Stress Testing

Stress testing subjects the program to heavy loads or stresses. This should not be confused with volume testing; a heavy stress is a peak volume of data, or activity, encountered *over a short span of time*. An analogy would be evaluating a typist. A volume test would determine whether the typist could cope with a draft of a large report; a stress test would determine whether the typist could type at a rate of 50 words per minute.

Because stress testing involves an element of time, it is not applicable to many programs, for example, a compiler or a batch-processing payroll program. It is applicable, however, to programs that operate under varying loads, or interactive, real-time, and process control programs. If an air traffic control system is supposed to keep track of up to 200 planes in its sector, you could stress-test it by simulating the existence of 200 planes. Since there is nothing to physically keep a 201st plane from entering the sector, a further stress test would explore the system's reaction to this unexpected plane. An additional stress test might simulate the *simultaneous* entry of a large number of planes into the sector.

If an operating system is supposed to support a maximum of 15 multiprogrammed jobs, the system could be stressed by attempting to run 15 jobs simultaneously. Stress a pilot training aircraft simulator by determining the system's reaction to the trainee's forcing the rudder left, pulling back on the throttle, lowering the flaps, lifting the nose, lowering the landing gear, turning on the landing lights, and banking left, all at the same time. (Such test cases might require a four-handed pilot or, realistically, two test specialists in the cockpit.) You might stress-test a process control system by causing all of the monitored processes to generate signals simultaneously. A telephone switching system is stressed by routing to it a large number of simultaneous phone calls.

One of the common recipients of stress testing is Web-based applications. Here you want to ensure that your application, and hardware, can handle some volume of concurrent users. You could argue that you may have millions of people accessing the site at one time,

but that is not realistic. You need to understand your audience, then design a stress test to represent the maximum number of users you think will use your site. Chapter 9 provides more information on testing Web-based applications.

Although many stress tests do represent conditions that the program likely will experience during its operation, other stress tests may truly represent “never will occur” situations, but this does not imply that these tests are not useful. If these impossible conditions detect errors, the test is valuable because it is likely that the same errors might also occur in realistic, less stressful situations.

## **Usability Testing**

Another important category of system test cases is an attempt to find human-factor, or usability, problems. When the first edition of this book was published, the computing industry had given very little attention to studying and defining good human-factor considerations of programming systems. Today’s software systems—particularly those designed for a mass, commercial market—generally have undergone extensive human-factor studies, and modern programs, of course, benefit from the thousands of programs and systems that have gone before. Nevertheless, an analysis of human factors is still a highly subjective matter. Here’s our list of considerations that might be tested:

1. Has each user interface been tailored to the intelligence, educational background, and environmental pressures of the end user?
2. Are the outputs of the program meaningful, nonabusive, and devoid of computer gibberish?
3. Are the error diagnostics, such as error messages, straightforward, or does the user need a PhD in computer science to comprehend them? For instance, does the program produce such messages as “IEK022A OPEN ERROR ON FILE ‘SYSIN’ ABEND CODE=102?” Messages such as these weren’t all that uncommon in software systems of the 1970s

and 1980s. Mass-market systems do better today, but you still will encounter unhelpful messages such as “An unknown error has occurred” or “This program has encountered an error and must be restarted.” Programs you design yourself are under your control and should not be plagued with such useless messages. Even if you didn’t design the program, if you are on the testing team you can push for improvements in this area of the human interface.

4. Does the total set of user interfaces exhibit considerable conceptual integrity, an underlying consistency, and uniformity of syntax, conventions, semantics, format, style, and abbreviations?
5. Where accuracy is vital, such as in an online banking system, is sufficient redundancy present in the input? For example, such a system should ask for an account number, a customer name, and a PIN (personal identification number) to verify that the proper person is accessing account information.
6. Does the system contain an excessive number of options, or options that are unlikely to be used? One trend in modern software is to present to the user only those menu choices they are most likely to use, based on software testing and design considerations. Then a well-designed program can learn from the user and begin to present those menu items that individual users frequently access. Even with such an intelligent menu system, successful programs still must be designed so that accessing the various options is logical and intuitive.
7. Does the system return some type of immediate acknowledgment to all inputs? Where a mouse click is the input, for example, the chosen item can change color or a button object can depress or be presented in a raised format. If the user is expected to choose from a list, the selected number should be presented on the screen when the choice is made. Moreover, if the selected action requires some processing time—which is frequently the case if the software is accessing a remote system—then a message should be displayed informing the user of what is going on.

8. Is the program easy to use? For example, is the input case sensitive without making this fact clear to the user? Also, if a program requires navigation through a series of menus or options, is it clear how to return to the main menu? Can the user easily move up or down one level?

## **Security Testing**

Because of society's increasing concern about privacy, many programs have specific security objectives. Security testing is the process of attempting to devise test cases that subvert the program's security checks. For example, you could try to formulate test cases that get around an operating system's memory protection mechanism. You can try to subvert a database management system's data security mechanisms. One way to devise such test cases is to study known security problems in similar systems and generate test cases that attempt to demonstrate similar problems in the system you are testing. For example, published sources in magazines, chat rooms, or newsgroups frequently cover known bugs in operating systems or other software systems. By searching for security holes in existing programs that provide services similar to the one you are testing, you can devise test cases to determine whether your program suffers from similar problems.

Web-based applications often need a higher level of security testing than do most applications. This is especially true of e-commerce sites. Although sufficient technology, namely encryption, exists to allow customers to complete transactions securely over the Internet, you should not rely on the mere application of technology to ensure safety. In addition, you will need to convince your customer base that your application is safe, or you risk losing customers. Again, Chapter 9 provides more information on security testing in Internet-based applications.

## **Performance Testing**

Many programs have specific performance or efficiency objectives, stating such properties as response times and throughput rates under

certain workload and configuration conditions. Again, since the purpose of a system test is to demonstrate that the program does not meet its objectives, test cases must be designed to show that the program does not satisfy its performance objectives.

### **Storage Testing**

Similarly, programs occasionally have storage objectives that state, for example, the amount of main and secondary memory the program uses and the size of temporary or spill files. You should design test cases to show that these storage objectives have not been met.

### **Configuration Testing**

Programs such as operating systems, database management systems, and message-switching programs support a variety of hardware configurations, including various types and numbers of I/O devices and communications lines, or different memory sizes. Often the number of possible configurations is too large to test each one, but at the least, you should test the program with each type of hardware device and with the minimum and maximum configuration. If the program itself can be configured to omit program components, or if the program can run on different computers, each possible configuration of the program should be tested.

Today, many programs are designed for multiple operating systems, for example, so if you are testing such a program, you should test it with all of the operating systems for which it was designed. Programs designed to execute within a Web browser require special attention, since there are numerous Web browsers available and they don't all function the same way. In addition, the same Web browser will operate differently on different operating systems.

### **Compatibility/Configuration/Conversion Testing**

Most programs that are developed are not completely new; they often are replacements for some deficient system. As such, programs often

have specific objectives concerning their compatibility with, and conversion procedures from, the existing system. Again, in testing the program to these objectives, the orientation of the test cases is to demonstrate that the compatibility objectives have not been met and that the conversion procedures do not work. Here you try to generate errors while moving data from one system to another. An example would be upgrading a database management system. You want to ensure that your existing data fit inside the new system. Various methods exist to test this process; however, they are highly dependent on the database system you employ.

### **Installability Testing**

Some types of software systems have complicated installation procedures. Testing the installation procedure is an important part of the system testing process. This is particularly true of an automated installation system that is part of the program package. A malfunctioning installation program could prevent the user from ever having a successful experience with the main system you are charged with testing. A user's first experience is when he or she installs the application. If this phase performs poorly, then the user/customer may find another product or have little confidence in the application's validity.

### **Reliability Testing**

Of course, the goal of all types of testing is the improvement of the program reliability, but if the program's objectives contain specific statements about reliability, specific reliability tests might be devised. Testing reliability objectives can be difficult. For example, a modern online system such as a corporate wide area network (WAN) or an Internet service provider (ISP) generally has a targeted uptime of 99.97 percent over the life of the system. There is no known way that you could test this objective with a test period of months or even years. Today's critical software systems have even higher reliability standards, and today's hardware conceivably could be expected to support these objectives. Programs or systems with more modest



mean time between failures (MTBF) objectives or reasonable (in terms of testing) operational error objectives can potentially be tested.

An MTBF of no more than 20 hours or an objective that a program should experience no more than 12 unique errors after it is placed into production, for example, presents testing possibilities, particularly for statistical, program-proving, or model-based testing methodologies. These methods are beyond the scope of this book, but the technical literature (online and otherwise) offers ample guidance in this area.

For example, if this area of program testing is of interest to you, research the concept of inductive assertions. The goal of this method is the development of a set of theorems about the program in question, the proof of which guarantees the absence of errors in the program. The method begins by writing assertions about the program's input conditions and correct results. The assertions are expressed symbolically in a formal logic system, usually the first-order predicate calculus. You then locate each loop in the program and, for each loop, write an assertion stating the invariant (always true) conditions at an arbitrary point in the loop. The program now has been partitioned into a fixed number of fixed-length paths (all possible paths between a pair of assertions). For each path, you then take the semantics of the intervening program statements to modify the assertion, and eventually reach the end of the path. At this point, two assertions exist at the end of the path: the original one and the one derived from the assertion at the opposite end. You then write a theorem stating that the original assertion implies the derived assertion, and attempt to prove the theorem. If the theorems can be proved, you could assume the program is error free—as long as the program eventually terminates. A separate proof is required to show that the program will always eventually terminate.

As complex as this sort of software proving or prediction sounds, reliability testing and, indeed, the concept of software reliability engineering (SRE) are with us today and are increasingly important for systems that must maintain very high uptimes. To illustrate this

point, examine Table 6.1 to see the number of hours per year a system must be up to support various uptime requirements. These values should indicate the need for SRE.

## Recovery Testing

Programs such as operating systems, database management systems, and teleprocessing programs often have recovery objectives that state how the system is to recover from programming errors, hardware failures, and data errors. One objective of the system test is to show that these recovery functions do not work correctly. Programming errors can be purposely injected into a system to determine whether it can recover from them. Hardware failures such as memory parity errors or I/O device errors can be simulated. Data errors such as noise on a communications line or an invalid pointer in a database can be created purposely or simulated to analyze the system's reaction.

One design goal of such systems is to minimize the mean time to recovery (MTTR). Downtime often causes a company to lose revenue because the system is inoperable. One testing objective is to show that the system fails to meet the service-level agreement for

**Table 6.1**  
**Hours per Year for Various Uptime Requirements**

<i>Uptime Percent Requirements</i>	<i>Operational Hours per Year</i>
100	8760.0
99.9	8751.2
98	8584.8
97	8497.2
96	8409.6
95	8322.0

MTTR. Often, the MTTR will have an upper and lower boundary, so your test cases should reflect these bounds.

### **Serviceability Testing**

The program also may have objectives for its serviceability or maintainability characteristics. All objectives of this sort must be tested. Such objectives might define the service aids to be provided with the system, including storage dump programs or diagnostics, the mean time to debug an apparent problem, the maintenance procedures, and the quality of internal logic documentation.

### **Documentation Testing**

As we illustrated in Figure 6.4, the system test also is concerned with the accuracy of the user documentation. The principle way of accomplishing this is to use the documentation to determine the representation of the prior system test cases. That is, once a particular stress case is devised, you would use the documentation as a guide for writing the actual test case. Also, the user documentation should be the subject of an inspection (similar to the concept of the code inspection in Chapter 3), checking it for accuracy and clarity. Any examples illustrated in the documentation should be encoded into test cases and fed to the program.

### **Procedure Testing**

Finally, many programs are parts of larger, not completely automated systems involving procedures people perform. Any prescribed human procedures, such as procedures for the system operator, database administrator, or end user, should be tested during the system test.

For example, a database administrator should document procedures for backing up and recovering the database system. If possible, a person not associated with the administration of the database should test the procedures. However, a company must create the

resources needed to adequately test the procedures. These resources often include hardware and additional software licensing.

## **Performing the System Test**

One of the most vital considerations in implementing the system test is determining who should do it. To answer this in a negative way, (1) programmers shouldn't perform a system test, and (2) of all the testing phases, this is the one that the organization responsible for developing the programs definitely should not perform.

The first point stems from the fact that a person performing a system test must be capable of thinking like an end user, which implies a thorough understanding of the attitudes and environment of the end user and of how the program will be used. Obviously, then, if feasible, a good testing candidate is one or more end users. However, because the typical end user will not have the ability or expertise to perform many of the categories of tests described earlier, an ideal system test team might be composed of a few professional system test experts (people who spend their lives performing system tests), a representative end user or two, a human-factors engineer, and the key original analysts or designers of the program. Including the original designers does not violate the earlier principle recommending against testing your own program, since the program has probably passed through many hands since it was conceived. Therefore, the original designers do not have the troublesome psychological ties to the program that motivated this principle.

The second point stems from the fact that a system test is an "anything goes, no holds barred" activity. Again, the development organization has psychological ties to the program that are counter to this type of activity. Also, most development organizations are most interested in having the system test proceed as smoothly as possible and on schedule, and are not truly motivated to demonstrate that the program does not meet its objectives. At the least, the system test should be performed by an independent group of people with few, if any, ties to the development organization. Perhaps the most economical

way of conducting a system test (economical in terms of finding the most errors with a given amount of money, or spending less money to find the same number of errors), is to subcontract the test to a separate company. This is discussed further in the last section of this chapter.

## ACCEPTANCE TESTING

Returning to the overall model of the development process shown in Figure 6.3 on page 127, you can see that acceptance testing is the process of comparing the program to its initial requirements and the current needs of its end users. It is an unusual type of test in that it usually is performed by the program's customer or end user and normally is not considered the responsibility of the development organization. In the case of a contracted program, the contracting (user) organization performs the acceptance test by comparing the program's operation to the original contract. As is the case for other types of testing, the best way to do this is to devise test cases that attempt to show that the program does not meet the contract; if these test cases are unsuccessful, the program is accepted. In the case of a program product, such as a computer manufacturer's operating system or compiler, or a software company's database management system, the sensible customer first performs an acceptance test to determine whether the product satisfies its needs.

## INSTALLATION TESTING

The remaining testing process in Figure 6.3 is the installation test. Its position in Figure 6.3 is a bit unusual, since it is not related, as all of the other testing processes are, to specific phases in the design process. It is an unusual type of testing because its purpose is not to find software errors but to find errors that occur during the installation process.

Many events occur when installing software systems. A short list of examples includes the following:

- User must select a variety of options.
- Files and libraries must be allocated and loaded.
- Valid hardware configurations must be present.
- Programs may need network connectivity to connect to other programs.

Installation tests should be developed by the organization that produced the system, delivered as part of the system, and run after the system is installed. Among other things, the test cases might check to ensure that a compatible set of options has been selected, that all parts of the system exist, that all files have been created and have the necessary contents, and that the hardware configuration is appropriate.

## TEST PLANNING AND CONTROL

If you consider that the testing of a large system could entail writing, executing, and verifying tens of thousands of test cases, handling thousands of modules, repairing thousands of errors, and employing hundreds of people over a time span of a year or more, it is apparent that you are faced with an immense project management challenge in planning, monitoring, and controlling the testing process. In fact, the problem is so enormous that we could devote an entire book to just the management of software testing. The intent of this section is to summarize some of these considerations.

As mentioned in Chapter 2, the major mistake most often made in planning a testing process is the tacit assumption that no errors will be found. The obvious result of this mistake is that the planned resources (people, calendar time, and computer time) will be grossly underestimated, a notorious problem in the computing industry. Compounding the problem is the fact that the testing process falls at the end of the development cycle, meaning that resource changes are

difficult. A second, perhaps more significant problem is that the wrong definition of testing is being used, since it is difficult to see how someone using the correct definition of testing (the goal being to find errors) would plan a test using the assumption that no errors will be found.

As is the case for most undertakings, the plan is the crucial part of the management of the testing process. The components of a good test plan are as follows:

1. *Objectives.* The objectives of each testing phase must be defined.
2. *Completion criteria.* Criteria must be designed to specify when each testing phase will be judged to be complete. This matter is discussed in the next section.
3. *Schedules.* Calendar time schedules are needed for each phase. They should indicate when test cases will be designed, written, and executed. Some software methodologies such as Extreme Programming (discussed in Chapter 8) require that you design the test cases and unit tests before application coding begins.
4. *Responsibilities.* For each phase, the people who will design, write, execute, and verify test cases, and the people who will repair discovered errors, should be identified. Since in large projects disputes unfortunately arise over whether particular test results represent errors, an arbitrator should be identified.
5. *Test case libraries and standards.* In a large project, systematic methods of identifying, writing, and storing test cases are necessary.
6. *Tools.* The required test tools must be identified, including a plan for who will develop or acquire them, how they will be used, and when they are needed.
7. *Computer time.* This is a plan for the amount of computer time needed for each testing phase. This would include servers used for compiling applications, if required; desktop machines required for installation testing; Web servers for Web-based applications; networked devices, if required; and so forth.

8. *Hardware configuration.* If special hardware configurations or devices are needed, a plan is required that describes the requirements, how they will be met, and when they are needed.
9. *Integration.* Part of the test plan is a definition of how the program will be pieced together (for example, incremental top-down testing). A system containing major subsystems or programs might be pieced together incrementally, using the top-down or bottom-up approach, for instance, but where the building blocks are programs or subsystems, rather than modules. If this is the case, a system integration plan is necessary. The system integration plan defines the order of integration, the functional capability of each version of the system, and responsibilities for producing “scaffolding,” code that simulates the function of nonexistent components.
10. *Tracking procedures.* Means must be identified to track various aspects of the testing progress, including the location of error-prone modules and estimation of progress with respect to the schedule, resources, and completion criteria.
11. *Debugging procedures.* Mechanisms must be defined for reporting detected errors, tracking the progress of corrections, and adding the corrections to the system. Schedules, responsibilities, tools, and computer time/resources also must be part of the debugging plan.
12. *Regression testing.* Regression testing is performed after making a functional improvement or repair to the program. Its purpose is to determine whether the change has regressed other aspects of the program. It usually is performed by rerunning some subset of the program’s test cases. Regression testing is important because changes and error corrections tend to be much more error prone than the original program code (in much the same way that most typographical errors in newspapers are the result of last-minute editorial changes, rather than changes in the original copy). A plan for regression testing—who, how, when—also is necessary.



## TEST COMPLETION CRITERIA

One of the most difficult questions to answer when testing a program is determining when to stop, since there is no way of knowing if the error just detected is the last remaining error. In fact, in anything but a small program, it is unreasonable to expect that all errors will eventually be detected. Given this dilemma, and given the fact that economics dictate that testing must eventually terminate, you might wonder if the question has to be answered in a purely arbitrary way, or if there are some useful stopping criteria.

The completion criteria typically used in practice are both meaningless and counterproductive. The two most common criteria are these:

1. Stop when the scheduled time for testing expires.
2. Stop when all the test cases execute without detecting errors; that is, stop when the test cases are unsuccessful.

The first criterion is useless because you can satisfy it by doing absolutely nothing. It does not measure the quality of the testing. The second criterion is equally useless because it also is independent of the quality of the test cases. Furthermore, it is counterproductive because it subconsciously encourages you to write test cases that have a low probability of detecting errors.

As discussed in Chapter 2, humans are highly goal oriented. If you are told that you have finished a task when the test cases are unsuccessful, you will subconsciously write test cases that lead to this goal, avoiding the useful, high-yield, destructive test cases.

There are three categories of more useful criteria. The first category, but not the best, is to base completion on the use of specific test-case-design methodologies. For instance, you might define the completion of module testing as the following:

*The test cases are derived from (1) satisfying the multicondition-coverage criterion, and (2) a boundary-value analysis of the module interface specification, and all resultant test cases are eventually unsuccessful.*

You might define the function test as being complete when the following conditions are satisfied:

*The test cases are derived from (1) cause-effect graphing, (2) boundary-value analysis, and (3) error guessing, and all resultant test cases are eventually unsuccessful.*

Although this type of criterion is superior to the two mentioned earlier, it has three problems. First, it is not helpful in a test phase in which specific methodologies are not available, such as the system test phase. Second, it is a subjective measurement, since there is no way to guarantee that a person has used a particular methodology, such as boundary-value analysis, properly and rigorously. Third, rather than setting a goal and then letting the tester choose the best way of achieving it, it does the opposite; test-case-design methodologies are dictated, but no goal is given. Hence, this type of criterion is useful sometimes for some testing phases, but it should be applied only when the tester has proven his or her abilities in the past in applying the test-case-design methodologies successfully.

The second category of criteria—perhaps the most valuable one—is to state the completion requirements in positive terms. Since the goal of testing is to find errors, why not make the completion criterion the detection of some predefined number of errors? For instance, you might state that a module test of a particular module is not complete until three errors are discovered. Perhaps the completion criterion for a system test should be defined as the detection and repair of 70 errors or an elapsed time of three months, whichever comes later.

Notice that, although this type of criterion reinforces the definition of testing, it does have two problems, both of which are surmountable. One problem is determining how to obtain the number of errors to be detected. Obtaining this number requires the following three estimates:

1. An estimate of the total number of errors in the program.
2. An estimate of what percentage of these errors can feasibly be found through testing.

3. An estimate of what fraction of the errors originated in particular design processes, and during what testing phases these errors are likely to be detected.

You can get a rough estimate of the total number of errors in several ways. One method is to obtain them through experience with previous programs. Also, a variety of predictive modules exist. Some of these require you to test the program for some period of time, record the elapsed times between the detection of successive errors, and insert these times into parameters in a formula. Other modules involve the seeding of known, but unpublicized, errors into the program, testing the program for a while, and then examining the ratio of detected seeded errors to detected unseeded errors. Another model employs two independent test teams who test for a while, examine the errors found by each and the errors detected in common by both teams, and use these parameters to estimate the total number of errors. Another gross method to obtain this estimate is to use industry-wide averages. For instance, the number of errors that exist in typical programs at the time that coding is completed (before a code walkthrough or inspection is employed) is approximately four to eight errors per 100 program statements.

The second estimate from the preceding list (the percentage of errors that can be feasibly found through testing) involves a somewhat arbitrary guess, taking into consideration the nature of the program and the consequences of undetected errors.

Given the current paucity of information about how and when errors are made, the third estimate is the most difficult. The data that exist indicate that, in large programs, approximately 40 percent of the errors are coding and logic-design mistakes, and the remainder are generated in the earlier design processes.

To use this criterion, you must develop your own estimates that are pertinent to the program at hand. A simple example is presented here. Assume we are about to begin testing a 10,000-statement program, the number of errors remaining after code inspections are performed is estimated at 5 per 100 statements, and we establish, as an objective, the detection of 98 percent of the coding and logic-design errors and

95 percent of the design errors. The total number of errors is thus estimated at 500. Of the 500 errors, we assume that 200 are coding and logic-design errors, and 300 are design flaws. Hence, the goal is to find 196 coding and logic-design errors and 285 design errors. A plausible estimate of when the errors are likely to be detected is shown in Table 6.2.

If we have scheduled four months for function testing and three months for system testing, the following three completion criteria might be established:

1. Module testing is complete when 130 errors are found and corrected (65 percent of the estimated 200 coding and logic-design errors).
2. Function testing is complete when 240 errors (30 percent of 200 plus 60 percent of 300) are found and corrected, or when four months of function testing have been completed, whichever occurs later. The reason for the second clause is that if we find 240 errors quickly, this is probably an indication that we have underestimated the total number of errors and thus should not stop function testing early.
3. System testing is complete when 111 errors are found and corrected, or when three months of system testing have been completed, whichever occurs later.

**Table 6.2**  
**Hypothetical Estimate of**  
**When the Errors Might Be Found**

	<i>Coding and Logic-Design Errors</i>	<i>Design Errors</i>
Module test	65%	0%
Function test	30%	60%
System test	3%	35%
<b>Total</b>	98%	95%

The other obvious problem with this type of criterion is one of overestimation. What if, in the preceding example, there are less than 240 errors remaining when function testing starts? Based on the criterion, we could never complete the function-test phase.

There is a strange problem if you think about it. Our problem is that we do not have enough errors; the program is too good. You could label it a nonproblem because it is the kind of problem a lot of people would love to have. If it does occur, a bit of common sense can solve it. If we cannot find 240 errors in four months, the project manager can employ an outsider to analyze the test cases to judge whether the problem is (1) inadequate test cases or (2) excellent test cases but a lack of errors to detect.

The third type of completion criterion is an easy one on the surface, but it involves a lot of judgment and intuition. It requires you to plot the number of errors found per unit time during the test phase. By examining the shape of the curve, you can often determine whether to continue the test phase or end it and begin the next test phase.

Suppose a program is being function-tested and the number of errors found per week is being plotted. If, in the seventh week, the curve is the top one of Figure 6.5, it would be imprudent to stop the function test, even if we had reached our criterion for the number of errors to be found. Since, in the seventh week, we still seem to be in high gear (finding many errors), the wisest decision (remembering that our goal is to find errors) is to continue function testing, designing additional test cases if necessary.

On the other hand, suppose the curve is the bottom one in Figure 6.5. The error-detection efficiency has dropped significantly, implying that we have perhaps picked the function-test bone clean and that perhaps the best move is to terminate function testing and begin a new type of testing (a system test, perhaps). Of course, we must also consider other factors such as whether the drop in error-detection efficiency was due to a lack of computer time or exhaustion of the available test cases.

**Figure 6.5**  
**Estimating completion by plotting errors**  
**detected by unit time.**

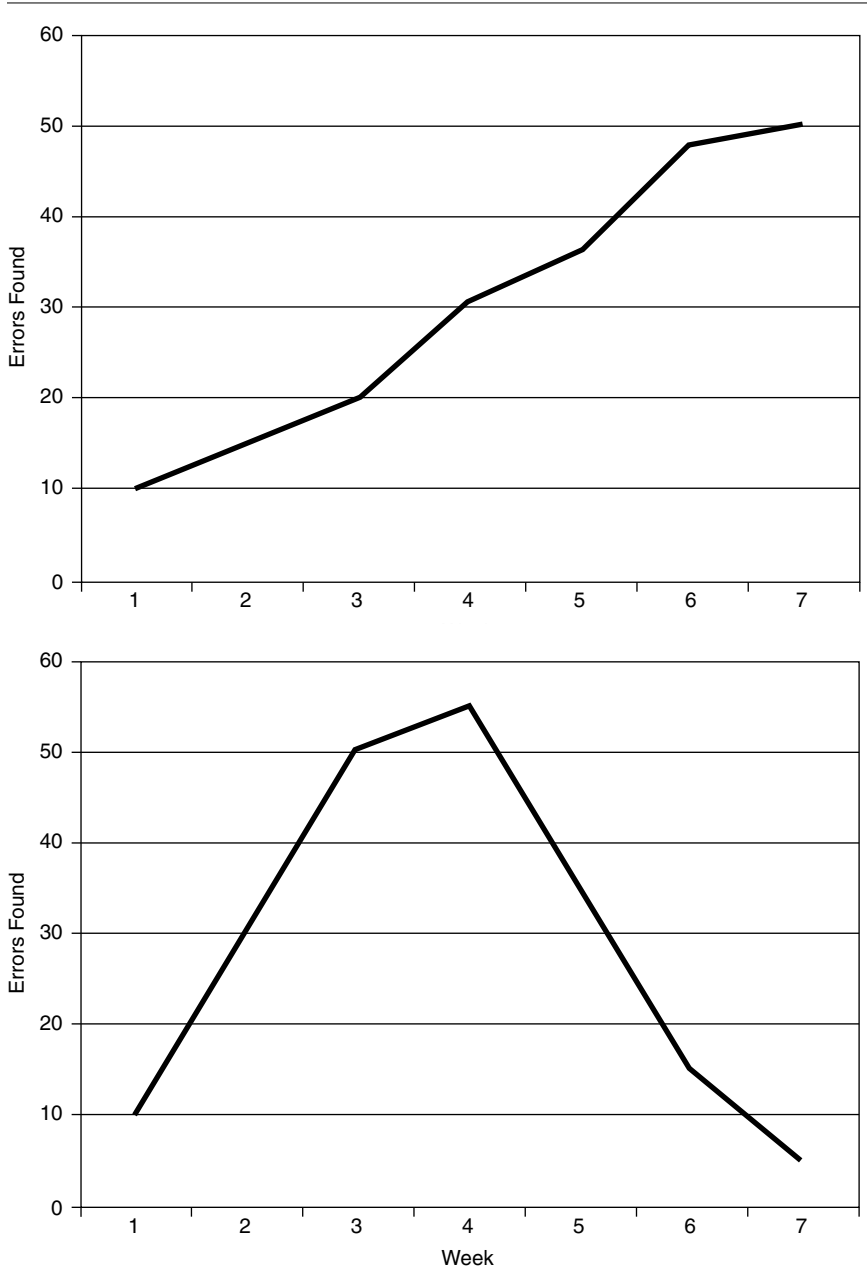

**Figure 6.6**  
**Postmortem study of the testing processes**  
**of a large project.**

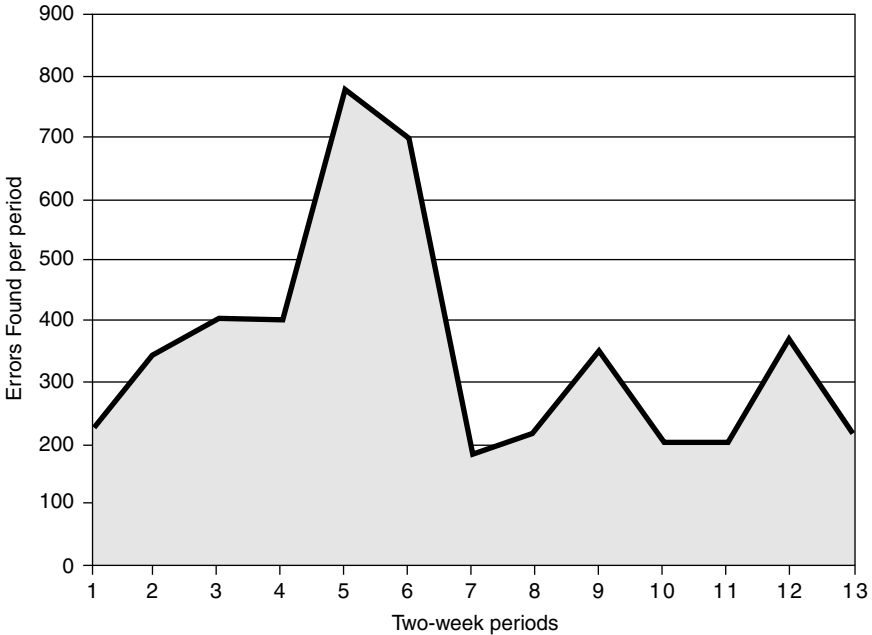

Figure 6.6 is an illustration of what happens when you fail to plot the number of errors being detected. The graph represents three testing phases of an extremely large software system. An obvious conclusion is that the project should not have switched to a different testing phase after period 6. During period 6, the error-detection rate was good (to a tester, the higher the rate, the better), but switching to a second phase at this point caused the error-detection rate to drop significantly.

The best completion criterion is probably a combination of the three types just discussed. For the module test, particularly because most projects do not formally track detected errors during this phase, the best completion criterion is probably the first. You should request

that a particular set of test-case-design methodologies be used. For the function- and system-test phases, the completion rule might be to stop when a predefined number of errors is detected or when the scheduled time has elapsed, whichever comes later, but provided that an analysis of the errors versus time graph indicates that the test has become unproductive.

## THE INDEPENDENT TEST AGENCY

Earlier in this chapter and in Chapter 2, we emphasized that an organization should avoid attempting to test its own programs. The reasoning was that the organization responsible for developing a program has difficulty in objectively testing the same program. The test organization should be as far removed as possible, in terms of the structure of the company, from the development organization. In fact, it is desirable that the test organization not be part of the same company, for if it is, it is still influenced by the same management pressures influencing the development organization.

One way to avoid this conflict is to hire a separate company for software testing. This is a good idea, whether the company that designed the system and will use it developed the system or whether a third-party developer produced the system. The advantages usually noted are increased motivation in the testing process, a healthy competition with the development organization, removal of the testing process from under the management control of the development organization, and the advantages of specialized knowledge that the independent test agency brings to bear on the problem.





## CHAPTER 7

# DEBUGGING

**I**n brief, debugging is what you do after you have executed a successful test case. Remember that a successful test case is one that shows that a program does not do what it was designed to do. Debugging is a two-step process that begins when you find an error as a result of a successful test case. Step 1 is the determination of the exact nature and location of the suspected error within the program. Step 2 consists of fixing the error.

As necessary and as integral as debugging is to program testing, this seems to be the one part of the software production process that programmers enjoy the least. These seem to be the main reasons:

- *Your ego may get in the way.* Like it or not, debugging confirms that programmers are not perfect, committing errors in either the design or the coding of the program.
- *You may run out of steam.* Of all the software development activities, debugging is the most mentally taxing activity. Moreover, debugging usually is performed under a tremendous amount of organizational or self-induced pressure to fix the problem as quickly as possible.
- *You may lose your way.* Debugging is mentally taxing because the error you've found could occur in virtually any statement within the program. That is, without examining the program first, you can't be absolutely sure that, for example, a numerical error in a paycheck produced by a payroll program is not produced in a subroutine that asks the operator to load a particular form into the printer. Contrast this with the debugging of a physical system, such as an automobile. If a car

stalls when moving up an incline (the symptom), then you can immediately and validly eliminate as the cause of the problem certain parts of the system—the AM/FM radio, for example, or the speedometer or the truck lock. The problem must be in the engine, and, based on our overall knowledge of automotive engines, we can even rule out certain engine components such as the water pump and the oil filter.

- *You may be on your own.* Compared to other software development activities, comparatively little research, literature, and formal instruction exist on the process of debugging.

Although this is a book about software testing, not debugging, the two processes are obviously related. Of the two aspects of debugging, locating the error and correcting it, locating the error represents perhaps 95 percent of the problem. Hence, this chapter concentrates on the process of finding the location of an error, given that a successful test case has found one.

## DEBUGGING BY BRUTE FORCE

The most common scheme for debugging a program is the “brute force” method. It is popular because it requires little thought and is the least mentally taxing of the methods, but it is inefficient and generally unsuccessful.

Brute force methods can be partitioned into at least three categories:

1. Debugging with a storage dump.
2. Debugging according to the common suggestion to “scatter print statements throughout your program.”
3. Debugging with automated debugging tools.

The first, debugging with a storage dump (usually a crude display of all storage locations in hexadecimal or octal format) is the most inefficient of the brute force methods. Here’s why:

- It is difficult to establish a correspondence between memory locations and the variables in a source program.
- With any program of reasonable complexity, such a memory dump will produce a massive amount of data, most of which is irrelevant.
- A memory dump is a static picture of the program, showing the state of the program at only one instant in time; to find errors, you have to study the dynamics of a program (state changes over time).
- A memory dump is rarely produced at the exact point of the error, so it doesn't show the program's state at the point of the error. Program actions between the time of the dump and the time of the error can mask the clues you need to find the error.
- There aren't adequate methodologies for finding errors by analyzing a memory dump (so many programmers stare, with glazed eyes, wistfully expecting the error to expose itself magically from the program dump).

Scattering statements throughout a failing program to display variable values isn't much better. It may be better than a memory dump because it shows the dynamics of a program and lets you examine information that is easier to relate to the source program, but this method, too, has many shortcomings:

- Rather than encouraging you to think about the problem, it is largely a hit-or-miss method.
- It produces a massive amount of data to be analyzed.
- It requires you to change the program; such changes can mask the error, alter critical timing relationships, or introduce new errors.
- It may work on small programs, but the cost of using it in large programs is quite large. Furthermore, it often is not even feasible on certain types of programs such as operating systems or process control programs.

Automated debugging tools work similarly to inserting print statements within the program, but rather than making changes to the program, you analyze the dynamics of the program with the debugging features of the programming language or special interactive debugging tools. Typical language features that might be used are facilities that produce printed traces of statement executions, subroutine calls, and/or alterations of specified variables. A common function of debugging tools is the ability to set breakpoints that cause the program to be suspended when a particular statement is executed or when a particular variable is altered, and then the programmer can examine the current state of the program. Again, this method is largely hit or miss and often results in an excessive amount of irrelevant data.

The general problem with these brute force methods is that they ignore the process of *thinking*. You can draw an analogy between program debugging and solving a homicide. In virtually all murder mystery novels, the mystery is solved by careful analysis of the clues and by piecing together seemingly insignificant details. This is not a brute force method; roadblocks or property searches would be.

There also is some evidence to indicate that whether the debugging teams are experienced programmers or students, people who use their brains rather than a set of aids work faster and more accurately in finding program errors. Therefore, we could recommend brute force methods only (1) when all other methods fail or (2) as a supplement to, not a substitute for, the thought processes we'll describe next.

## DEBUGGING BY INDUCTION

It should be obvious that careful thought will find most errors without the debugger even going near the computer. One particular thought process is induction, where you move from the particulars of a situation to the whole. That is, start with the clues (the symptoms of the error, possibly the results of one or more test cases) and look

**Figure 7.1**  
**The inductive debugging process.**

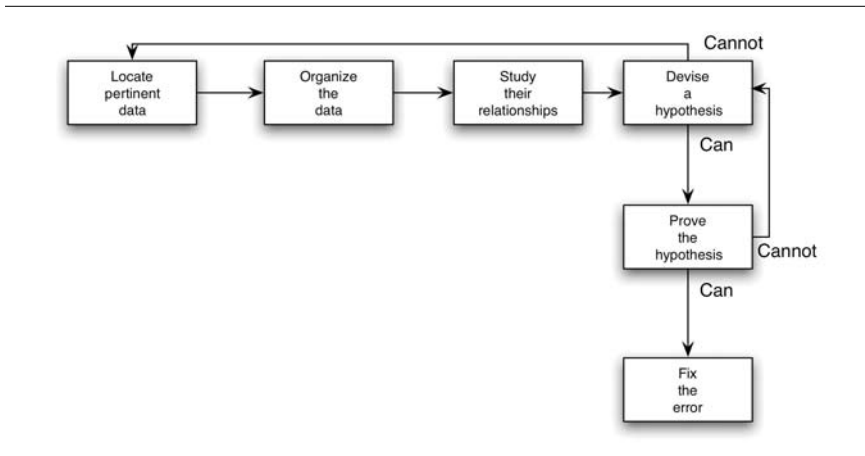

for relationships among the clues. The induction process is illustrated in Figure 7.1.

The steps are as follows:

1. *Locate the pertinent data.* A major mistake debuggers make is failing to take account of all available data or symptoms about the problem. The first step is the enumeration of all you know about what the program did correctly and what it did incorrectly—the symptoms that led you to believe there was an error. Additional valuable clues are provided by similar, but different, test cases that *do not* cause the symptoms to appear.
2. *Organize the data.* Remember that induction implies that you're processing from the particulars to the general, so the second step is to structure the pertinent data to let you observe the patterns. Of particular importance is the search for contradictions, events such as that the error occurs only when the customer has no outstanding balance in his or her margin account. You can use a form such as the one shown

**Figure 7.2**  
**A method for structuring the clues.**

---

?	Is	Is not
What		
Where		
When		
To what extent		

---

in Figure 7.2 to structure the available data. The “what” boxes list the general symptoms, the “where” boxes describe where the symptoms were observed, the “when” boxes list anything that you know about the times that the symptoms occur, and the “to what extent” boxes describe the scope and magnitude of the symptoms. Notice the “is” and “is not” columns; they describe the contradictions that may eventually lead to a hypothesis about the error.

3. *Devise a hypothesis.* Next, study the relationships among the clues and devise, using the patterns that might be visible in the structure of the clues, one or more hypotheses about the cause of the error. If you can’t devise a theory, more data are needed, perhaps from new test cases. If multiple theories seem possible, select the more probable one first.
4. *Prove the hypothesis.* A major mistake at this point, given the pressures under which debugging usually is performed, is skipping this step and jumping to conclusions to fix the

problem. However, it is vital to prove the reasonableness of the hypothesis before you proceed. If you skip this step, you'll probably succeed in correcting only the problem symptom, not the problem itself. Prove the hypothesis by comparing it to the original clues or data, making sure that this hypothesis *completely* explains the existence of the clues. If it does not, either the hypothesis is invalid, the hypothesis is incomplete, or multiple errors are present.

As a simple example, assume that an apparent error has been reported in the examination grading program described in Chapter 4. The apparent error is that the median grade seems incorrect in some, but not all, instances. In a particular test case, 51 students were graded. The mean score was correctly printed as 73.2, but the median printed was 26 instead of the expected value of 82. By examining the results of this test case and a few other test cases, the clues are organized as shown in Figure 7.3.

**Figure 7.3**  
**An example of clue structuring.**

---

?	Is	Is not
What	The median printed in report 3 is incorrect.	The calculation of the mean or standard deviation.
Where	Only on report 3.	On the other reports. The students' grades seem to be calculated correctly.
When	Occurred in a test run using 51 students.	Did not occur in the test runs for 2 and 200 students.
To what extent	The median printed was 26. It also occurred in the test run using one student; the median printed in this case was 1!	

---



The next step is to derive a hypothesis about the error by looking for patterns and contradictions. One contradiction we see is that the error seems to occur only in test cases that use an *odd* number of students. This might be a coincidence, but it seems significant, since you compute a median differently for sets of odd and even numbers. There's another strange pattern: In some test cases, the calculated median always is less than or equal to the number of students ( $26 \leq 51$  and  $1 \leq 1$ ). One possible avenue at this point is to run the 51-student test case again, giving the students different grades from before to see how this affects the median calculation. If we do so, the median is still 26, so the "is not—to what extent" box could be filled in with "the median seems to be independent of the actual grades." Although this result provides a valuable clue, we might have been able to surmise the error without it. From available data, the calculated median appears to equal half of the number of students, rounded up to the next integer. In other words, if you think of the grades as being stored in a sorted table, the program is printing the entry number of the middle student rather than his or her grade. Hence, we have a firm hypothesis about the precise nature of the error. Next, prove the hypothesis by examining the code or by running a few extra test cases.

## DEBUGGING BY DEDUCTION

The process of deduction proceeds from some general theories or premises, using the processes of elimination and refinement, to arrive at a conclusion (the location of the error). See Figure 7.4.

As opposed to the process of induction in a murder case, for example, where you induce a suspect from the clues, you start with a set of suspects and, by the process of elimination (the gardener has a valid alibi) and refinement (it must be someone with red hair), decide that the butler must have done it. The steps are as follows:

1. *Enumerate the possible causes or hypotheses.* The first step is to develop a list of all conceivable causes of the error. They

**Figure 7.4**  
**The deductive debugging process.**

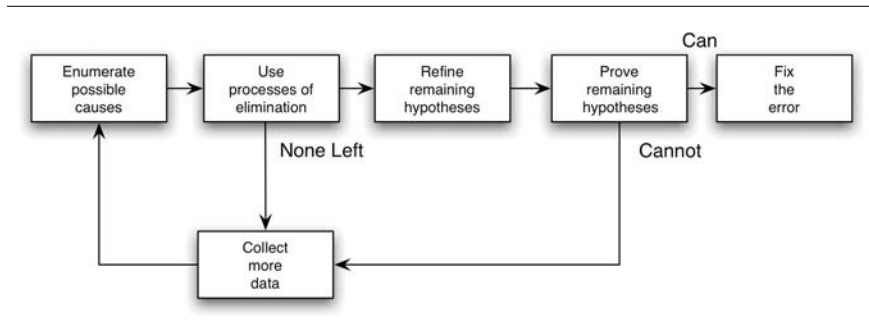

don't have to be complete explanations; they are merely theories to help you structure and analyze the available data.

2. *Use the data to eliminate possible causes.* Carefully examine all of the data, particularly by looking for contradictions (Figure 7.2 could be used here), and try to eliminate all but one of the possible causes. If all are eliminated, you need more data through additional test cases to devise new theories. If more than one possible cause remains, select the most probable cause—the prime hypothesis—first.
3. *Refine the remaining hypothesis.* The possible cause at this point might be correct, but it is unlikely to be specific enough to pinpoint the error. Hence, the next step is to use the available clues to refine the theory. For example, you might start with the idea that “there is an error in handling the last transaction in the file” and refine it to “the last transaction in the buffer is overlaid with the end-of-file indicator.”
4. *Prove the remaining hypothesis.* This vital step is identical to step 4 in the induction method.

As an example, assume that we are commencing the function testing of the `DISPLAY` command discussed in Chapter 4. Of the 38 test

cases identified by the process of cause-effect graphing, we start by running four test cases. As part of the process of establishing input conditions, we will initialize memory that the first, fifth, ninth, . . . , words have the value 000; the second, sixth, . . . , words have the value 4444; the third, seventh, . . . , words have the value 8888; and the fourth, eighth, . . . , words have the value CCCC. That is, each memory word is initialized to the low-order hexadecimal digit in the address of the first byte of the word (the values of locations 23FC, 23FD, 23FE, and 23FF are C).

The test cases, their expected output, and the actual output after the test are shown in Figure 7.5.

Obviously, we have some problems, since none of the test cases apparently produced the expected results (all were successful), but let's start by debugging the error associated with the first test case. The command indicates that, starting at location 0 (the default), E locations (14 in decimal) are to be displayed. (Recall that the specification stated that all output will contain four words or 16 bytes per line.)

**Figure 7.5**

**Test case results from the DISPLAY command.**

Test case input	Expected output	Actual Output
DISPLAY.E	000000 = 0000 4444 8888 CCCC	M1 INVALID COMMAND SYNTAX
DISPLAY 21 v- 29	0000020 = 0000 4444 8888 CCCC	000020 = 4444 8888 CCCC 0000
DISPLAY .11	000000 = 0000 4444 8888 CCCC 000010 = 0000 4444 8888 CCCC	000000 = 0000 4444 8888 CCCC
DISPLAY 8000 - END	M2 STORAGE REQUESTED IS BEYOND ACTUAL MEMORY LIMITS	008000 = 0000 4444 8888 CCCC

Enumerating the possible causes for the unexpected error message, we might get

1. The program does not accept the word `DISPLAY`.
2. The program does not accept the period.
3. The program does not allow a default as a first operand; it expects a storage address to precede the period.
4. The program does not allow an `E` as a valid byte count.

The next step is to try to eliminate the causes. If all are eliminated, we must retreat and expand the list. If more than one remain, we might want to examine additional test cases to arrive at a single error hypothesis, or proceed with the most probable cause. Since we have other test cases at hand, we see that the second test case in Figure 7.5 seems to eliminate the first hypothesis, and the third test case, although it produced an incorrect result, seems to eliminate the second and third hypotheses.

The next step is to refine the fourth hypothesis. It seems specific enough, but intuition might tell us that there is more to it than meets the eye; it sounds like an instance of a more general error. We might contend, then, that the program does not recognize the special hexadecimal characters `A–F`. This absence of such characters in the other test cases makes this sound like a viable explanation.

Rather than jumping to a conclusion, however, we should first consider *all* of the available information. The fourth test case might represent a totally different error, or it might provide a clue about the current error. Given that the highest valid address in our system is `7FFF`, how could the fourth test case be displaying an area that appears to be nonexistent? The fact that the displayed values are our initialized values and not garbage might lead to the supposition that this command is somehow displaying something in the range `0–7FFF`. One idea that may arise is that this could occur if the program is treating the operands in the command as *decimal* values rather than hexadecimal as stated in the specification. This is borne out by the third test case; rather than displaying 32 bytes of memory, the next increment above 11 in hexadecimal (17 in base 10), it displays 16 bytes of memory,

which is consistent with our hypothesis that the “11” is being treated as a base-10 value. Hence, the refined hypothesis is that the program is treating the byte count as storage address operands, and the storage addresses on the output listing as decimal values.

The last step is to prove this hypothesis. Looking at the fourth test case, if 8000 is interpreted as a decimal number, the corresponding base-16 value is 1F40, which would lead to the output shown. As further proof, examine the second test case. The output is incorrect, but if 21 and 29 are treated as decimal numbers, the locations of storage addresses 15–1D would be displayed; this is consistent with the erroneous result of the test case. Hence, we have almost certainly located the error; the program is assuming that the operands are decimal values and is printing the memory addresses as decimal values, which is inconsistent with the specification. Moreover, this error seems to be the cause of the erroneous results of all four test cases. A little thought has led to the error, and it also solved three other problems that, at first glance, appear to be unrelated.

Note that the error probably manifests itself at two locations in the program: the part that interprets the input command and the part that prints memory addresses on the output listing.

As an aside, this error, likely caused by a misunderstanding of the specification, reinforces the suggestion that a programmer should not attempt to test his or her own program. If the programmer who created this error is also designing the test cases, he or she likely will make the same mistake while writing the test cases. In other words, the programmer’s expected outputs would not be those of Figure 7.5; they would be the outputs calculated under the assumption that the operands are decimal values. Therefore, this fundamental error probably would go unnoticed.

## DEBUGGING BY BACKTRACKING

An effective method for locating errors in small programs is to backtrack the incorrect results through the logic of the program until you

find the point where the logic went astray. In other words, start at the point where the program gives the incorrect result—such as where incorrect data were printed. At this point you deduce from the observed output what the values of the program’s variables must have been. By performing a mental reverse execution of the program from this point and repeatedly using the process of “if this was the state of the program at this point, then this must have been the state of the program up here,” you can quickly pinpoint the error. With this process you’re looking for the location in the program between the point where the state of the program was what was expected and the first point where the state of the program was what was not expected.

## DEBUGGING BY TESTING

The last “thinking type” debugging method is the use of test cases. This probably sounds a bit peculiar since the beginning of this chapter distinguishes debugging from testing. However, consider two types of test cases: test cases for testing, where the purpose of the test cases is to expose a previously undetected error, and test cases for debugging, where the purpose is to provide information useful in locating a suspected error. The difference between the two is that test cases for testing tend to be “fat” because you are trying to cover many conditions in a small number of test cases. Test cases for debugging, on the other hand, are “slim” since you want to cover only a single condition or a few conditions in each test case.

In other words, after a symptom of a suspected error is discovered, you write variants of the original test case to attempt to pinpoint the error. Actually, this method is not an entirely separate method; it often is used in conjunction with the induction method to obtain information needed to generate a hypothesis and/or to prove a hypothesis. It also is used with the deduction method to eliminate suspected causes, refine the remaining hypothesis, and/or prove a hypothesis.

## DEBUGGING PRINCIPLES

In this section, we want to discuss a set of debugging principles that are psychological in nature. As was the case for the testing principles in Chapter 2, many of these debugging principles are intuitively obvious, yet they are often forgotten or overlooked. Since debugging is a two-part process—locating an error and then repairing it—two sets of principles are discussed.

### **Error-Locating Principles**

#### *Think*

As implied in the previous section, debugging is a problem-solving process. The most effective method of debugging is a mental analysis of the information associated with the error's symptoms. An efficient program debugger should be able to pinpoint most errors without going near a computer.

#### *If You Reach an Impasse, Sleep on It*

The human subconscious is a potent problem solver. What we often refer to as inspiration is simply the subconscious mind working on a problem when the conscious mind is working on something else such as eating, walking, or watching a movie. If you cannot locate an error in a reasonable amount of time (perhaps 30 minutes for a small program, several hours for a larger one), drop it and work on something else, since your thinking efficiency is about to collapse anyway. After forgetting about the problem for a while, your subconscious mind will have solved the problem, or your conscious mind will be clear for a fresh examination of the symptoms.

#### *If You Reach an Impasse, Describe the Problem to Someone Else*

Talking about the problem with someone else may help you discover something new. In fact, often simply by describing the problem to a

good listener, you will suddenly see the solution without any assistance from the listener.

### ***Use Debugging Tools Only as a Second Resort***

Use debugging tools after you've tried other methods, and then only as an adjunct to, not a substitute for, thinking. As noted earlier in this chapter, debugging tools, such as dumps and traces, represent a haphazard approach to debugging. Experiments show that people who shun such tools, even when they are debugging programs that are unfamiliar to them, are more successful than people who use the tools.

### ***Avoid Experimentation—Use It Only as a Last Resort***

The most common mistake novice debuggers make is trying to solve a problem by making experimental changes to the program. You might say, "I know what is wrong, so I'll change this DO statement and see what happens." This totally haphazard approach cannot even be considered debugging; it represents an act of blind hope. Not only does it have a minuscule chance of success, but it often compounds the problem by adding new errors to the program.

## **Error-Repairing Techniques**

### ***Where There Is One Bug, There Is Likely to Be Another***

This is a restatement of the principle in Chapter 2 that states when you find an error in a section of a program, the probability of the existence of another error in that same section is higher than if you hadn't already found one error. In other words, errors tend to cluster. When repairing an error, examine its immediate vicinity for anything else that looks suspicious.

### ***Fix the Error, Not Just a Symptom of It***

Another common failing is repairing the symptoms of the error, or just one instance of the error, rather than the error itself. If the pro-



posed correction does not match all the clues about the error, you may be fixing only a part of the error.

***The Probability of the Fix Being Correct  
Is Not 100 Percent***

Tell this to someone and, of course, he would agree, but tell it to someone in the process of correcting an error and you may get a different answer. (“Yes, in most cases, but this correction is so minor that it just has to work.”) You can never assume that code added to a program to fix an error is correct. Statement for statement, corrections are much more error prone than the original code in the program. One implication is that error corrections must be tested, perhaps more rigorously than the original program. A solid regression testing plan can help ensure that correcting an error does not induce another error somewhere else in the application.

***The Probability of the Fix Being Correct Drops  
as the Size of the Program Increases***

Stating it differently, in our experience the ratio of errors due to incorrect fixes versus original errors increases in large programs. In one widely used large program, one of every six new errors discovered is an error in a prior correction to the program.

***Beware of the Possibility That an Error Correction  
Creates a New Error***

Not only do you have to worry about incorrect corrections, but also you have to worry about a seemingly valid correction having an undesirable side effect, thus introducing a new error. Not only is there a probability that a fix will be invalid, but there also is a probability that a fix will introduce a new error. One implication is that not only does the error situation have to be tested after the correction is made, but you must also perform regression testing to determine whether a new error has been introduced.

### ***The Process of Error Repair Should Put You Temporarily Back into the Design Phase***

You should realize that error correction is a form of program design. Given the error-prone nature of corrections, common sense says that whatever procedures, methodologies, and formalism were used in the design process should also apply to the error-correction process. For instance, if the project rationalized that code inspections were desirable, then it must be doubly important that they be used after correcting an error.

### ***Change the Source Code, Not the Object Code***

When debugging large systems, particularly a system written in an assembly language, occasionally there is the tendency to correct an error by making an immediate change to the object code with the intention of changing the source program later. Two problems associated with this approach are (1) it usually is a sign that “debugging by experimentation” is being practiced, and (2) the object code and source program are now out of synchronization, meaning that the error could easily surface again when the program is recompiled or reassembled. This practice is an indication of a sloppy, unprofessional approach to debugging.

## **ERROR ANALYSIS**

The last thing to realize about program debugging is that, in addition to its value in removing an error from the program, it can have another valuable effect: It can tell us something about the nature of software errors, something we still know too little about. Information about the nature of software errors can provide valuable feedback in terms of improving future design, coding, and testing processes.

Every programmer and programming organization could improve immensely by performing a detailed analysis of the detected errors, or at least a subset of them. It is a difficult and time-consuming task,

for it implies much more than a superficial grouping such as “*x* percent of the errors are logic–design errors,” or “*x* percent of the errors occur in IF statements.” A careful analysis might include the following studies:

- *Where was the error made?* This question is the most difficult one to answer, because it requires a backward search through the documentation and history of the project, but it also is the most valuable question. It requires that you pinpoint the original source and time of the error. For example, the *original* source of the error might be an ambiguous statement in a specification, a correction to a prior error, or a misunderstanding of an end-user requirement.
- *Who made the error?* Wouldn't it be useful to discover that 60 percent of the design errors were created by one of the 10 analysts, or that programmer X makes three times as many mistakes as the other programmers? (Not for the purposes of punishment but for the purposes of education.)
- *What was done incorrectly?* It is not sufficient to determine when and by whom each error was made; the missing link is a determination of exactly why the error occurred. Was it caused by someone's inability to write clearly? Someone's lack of education in the programming language? A typing mistake? An invalid assumption? A failure to consider valid input?
- *How could the error have been prevented?* What can be done differently in the next project to prevent this type of error? The answer to this question constitutes much of the valuable feedback or learning for which we are searching.
- *Why wasn't the error detected earlier?* If the error is detected during a test phase, you should study why the error was not detected during earlier testing phases, code inspections, and design reviews.
- *How could the error have been detected earlier?* The answer to this is another piece of valuable feedback. How can the review and testing processes be improved to find this type of error earlier in future projects? Providing that we are not analyzing an error

found by an end user (that is, the error was found by a test case), we should realize that something valuable has happened: We have written a successful test case. Why was this test case successful? Can we learn something from it that will result in additional successful test cases, either for this program or for future programs?

Again, this analysis process is difficult, but the answers discovered can be invaluable in improving subsequent programming efforts. It is alarming that the vast majority of programmers and programming organizations do not employ it.



## CHAPTER 8

# EXTREME TESTING

**I**n the 1990s a new software development methodology termed *Extreme Programming* (XP) was born. A project manager named Kent Beck is credited with conceiving the lightweight, agile development process, first testing it while working on a project at Daimler-Chrysler in 1996. Although several other agile software development processes have since been created, XP is by far the most popular. In fact, numerous open-source tools exist to support it, which verifies XP's popularity among developers and project managers.

XP was likely developed to support the adoption of programming languages such as Java, Visual Basic, and C#. These object-based languages allow developers to create large, complex applications much more quickly than with traditional languages such as C, C++, FORTRAN, or COBOL. Developing with these languages often requires building general-purpose libraries to support your efforts. Methods for common tasks such as printing, sorting, networking, and statistical analysis are not standard components. Languages such as C# and Java ship with full-featured application programming interfaces (APIs) that eliminate or reduce the need for custom library creation.

However, with the benefits of rapid application development languages come liabilities. Although developers were creating applications much more quickly, the quality was not guaranteed. If the application worked, it often failed to meet the program specification. The purpose of the XP development methodology is to create quality programs in short time frames. Classical software processes still work, but often take too much time, which equates to lost income in the competitive arena of software development.

The XP model relies heavily on unit and acceptance testing of modules. In general, you must run unit tests for every incremental code change, no matter how small, to ensure that the code base still meets its specification. In fact, testing is of such importance in XP that the process requires that you create the unit (module) and acceptance tests first, then create your code base. This form of testing is called, appropriately, *Extreme Testing* (XT).

## EXTREME PROGRAMMING BASICS

As previously mentioned, XP is a relatively new software development process that enables developers to rapidly create high-quality code. In this instance, you may define “quality” as a code base that meets its specification. XP focuses on implementing simple designs, communicating between developers and customers, constantly testing your code base, refactoring to accommodate specification changes, and seeking customer feedback. XP tends to work well for small to medium-size development efforts in environments that have frequent specification changes and where near-instant communication is possible.

XP differs from traditional development processes in a several ways. First, it avoids the large-scale project syndrome in which the customer and the programming team meet to design every detail of the application before coding begins. Project managers know this approach has its drawbacks because customer specifications and requirements constantly change to reflect new business rules or marketplace conditions. For example, the finance department may want payroll reports sorted by processed date instead of check numbers, or the marketing department may determine that consumers will not buy product XYZ if it doesn't send e-mail. XP planning sessions focus on collecting application requirements, not designing the application.

Another difference with the XP methodology is that it avoids coding unneeded functionality. If your customer thinks the feature is needed but not required, it generally is left out of the release. Thus, you can focus on the task at hand, adding value to a software prod-

uct. Focusing only on the required functionality helps create quality software in short time frames.

However, the primary difference of the XP methodology is that it focuses on testing. After an all-inclusive design phase, traditional software development models suggest you code first, then create testing interfaces later. In XP, you *must* create the unit tests first, then you create the code to pass the tests. You design unit tests in an XP environment by following the concepts discussed in Chapter 5.

The XP development model has 12 core practices that drive the process. Table 8.1 summarizes the practices. In a nutshell, you can group the 12 core XP practices into four concepts:

1. Listening to the customer and other programmers.
2. Collaborating with the customer to develop the application's specification and test cases.
3. Coding with a programming partner.
4. Testing the code base.

Most of the comments provided by each practice listed in Table 8.1 are self-explanatory. However, a couple of the more important principles, namely planning and testing, warrant further discussion. A successful planning phase provides the foundation for the XP process. The planning phase in XP differs from that in traditional development models, which often combine requirements gathering and application design. Planning in XP focuses on identifying your customer's application requirements and designing user stories (or case stories) that meet them. You gain a significant insight into the application's purpose and requirements when creating user stories. In addition, the customer employs the user stories when performing acceptance tests at the end of a release cycle. Finally, an intangible benefit of the planning phase is that the customer gains ownership and confidence in the application by heavily participating in it.

Continuous testing is central to the success of an XP-based effort. Although acceptance testing falls under this principle, unit testing occupies the bulk of the effort. You want to ensure that any code changes improve the application and do not introduce bugs. The



**Table 8.1**  
**The 12 Practices of Extreme Programming**

<i>Practice</i>	<i>Comment</i>
1. Planning and requirements	<ul style="list-style-type: none"> <li>• Marketing and business development personnel gathering work together to identify the maximum business value of each software feature.</li> <li>• Each major software feature is rewritten as a user story.</li> <li>• Programmers provide time estimates to complete each user story.</li> <li>• The customer chooses the software features based on time estimates and business value.</li> </ul>
2. Small, incremental releases	<ul style="list-style-type: none"> <li>• Strive to add small, tangible, value-added features and release a new code base often.</li> </ul>
3. System metaphors	<ul style="list-style-type: none"> <li>• Your programming team identifies an organizing metaphor to help with naming conventions and program flow.</li> </ul>
4. Simple designs	<ul style="list-style-type: none"> <li>• Implement the simplest design that allows your code to pass its unit tests. Assume change will come, so don't spend a lot of time designing; just implement.</li> </ul>
5. Continuous testing	<ul style="list-style-type: none"> <li>• Write unit tests before writing their code module. Each unit is not complete until it passes its unit test. In addition, the program is not complete until it passes all unit tests and acceptance tests are complete.</li> </ul>
6. Refactoring	<ul style="list-style-type: none"> <li>• Clean up and streamline your code base. Unit tests help ensure that you do not destroy the functionality in the process. You must rerun all unit tests after any refactoring.</li> </ul>

<i>Practice</i>	<i>Comment</i>
7. Pair programming	<ul style="list-style-type: none"><li>• You and another programmer work together, at the same machine, to create your code base. This allows for real-time code review, which dramatically increases bug detection and resolution.</li></ul>
8. Collective ownership of the code	<ul style="list-style-type: none"><li>• All code is owned by all programmers. No single base programmer is dedicated to a specific code base.</li></ul>
9. Continuous integration	<ul style="list-style-type: none"><li>• Every day, integrate all changes, after it passes the unit tests, back into the code base.</li></ul>
10. 40-hour work week	<ul style="list-style-type: none"><li>• No overtime is allowed. If you work with dedication for 40 hours per week, then overtime will not be needed. The exception is the week before a major release.</li></ul>
11. On-site customer	<ul style="list-style-type: none"><li>• You and your programming team have unlimited access to the customer so you may resolve questions quickly and decisively, which keeps the development process from stalling.</li></ul>
12. Coding standards	<ul style="list-style-type: none"><li>• All code should look the same. Developing a system metaphor helps meet this principle.</li></ul>

continuous testing principle also supports refactoring efforts used to optimize and streamline the code base. Constant testing also leads to an intangible benefit: confidence. The programming team gains confidence in the code base because you constantly validate it with unit tests. In addition, your customers' confidence in their investment soars because they know the code base passes unit tests every day.

Now that we've presented the 12 practices of the XP process, how does a typical XP project flow? Here is a quick example of what you might find if you worked on an XP-based project:

1. Programmers meet *with* the customer to determine the product requirements and build user stories.
2. Programmers meet *without* the customer to break the requirements into independent tasks and estimate the time to complete each task.
3. Programmers present the customer with the task list and with time estimates, and have them create a priority list of features.
4. The programming team assigns tasks to pairs of programmers based on their skill sets.
5. Each pair creates unit tests for their programming task using the application's specification.
6. The pair works on their task with the goal of creating a code base that passes the unit tests.
7. Each pair fixes/retests their code until all unit tests are passed.
8. All pairs gather and integrate their code base every day.
9. The team releases a preproduction version of the application.
10. Customers run acceptance tests and either approve the application or create a report identifying the bugs/deficiencies.
11. Programmers release a version into production upon successful acceptance tests.
12. Programmers update time estimates based on latest experience.

Although glamorous, XP is not for every project or every organization. Proponents of XP concluded that if a programming team fully implements the 12 practices, then the chances of successful application development increase dramatically. Detractors say that because XP is a process, you must do all or nothing. If you skip a practice, then you are not properly implementing XP and your program quality may suffer. In addition, detractors claim that the cost of changing a program in the future to add more features is more than the cost of initially anticipating and coding the requirement. Finally,

some programmers find working in pairs very cumbersome and invasive; therefore, they do not embrace the XP philosophy.

Whatever your views, you should consider XP as a software methodology for your project. Carefully weigh its pros and cons along with the attributes of your project and make the best decision you can.

## EXTREME TESTING: THE CONCEPTS

To meet the pace and philosophy of XP, developers use extreme testing, which focuses on constant testing. As mentioned earlier in the chapter, two forms of testing make up the bulk of XT: unit testing and acceptance testing. The theory used when writing the tests does not vary significantly from the theory presented in Chapter 5. However, the stage in the development process in which you create the tests does differ. Nonetheless, XT and traditional testing still have the same goal: to identify errors in a program.

The rest of this section provides more information on unit testing and acceptance testing, from an Extreme Programming perspective.

### **Extreme Unit Testing**

Unit testing is the primary testing approach used in Extreme Testing and has two simple rules: All code modules must have unit tests before coding begins, and all code modules must pass unit tests before being released into production. At first glance this may not seem so extreme. However, the big difference between unit testing, as previously described, and XT is that the unit tests must be defined and created before coding the module.

Initially, you may wonder why you should, or how you can, create test drivers for code you haven't even written. You may also think that you do not have time to create the tests because the application must meet a deadline. These are valid concerns, but they are easily addressed. The following list identifies some benefits associated with writing unit tests before you start coding the application.

- You gain confidence that your code will meet its specification.
- You express the end result of your code before you start coding.
- You better understand the application's specification and requirements.
- You may initially implement simple designs and confidently refactor the code later to improve performance without worrying about breaking the specification.

Of these benefits, the insight and understanding you gain of the application's specification and requirements cannot be underestimated. For example, you may not fully understand the acceptable data types and boundaries for the input values of an application if you start coding first. So how can you write a unit test to perform boundary analysis without understanding the acceptable inputs? Can the application accept only numbers, only characters, or both? If you create the unit tests first, you *must* understand the specification. The practice of creating unit tests first is the shining point of the XP methodology, as it forces you to understand the specification to resolve ambiguities *before* you begin coding.

As mentioned in Chapter 5, you determine the unit's scope. Given that today's popular programming languages such as Java, C#, and Visual Basic are mostly object oriented, modules are often classes or even individual class methods. You may sometimes define a module as a group of classes or methods that represent some functionality. Only you, as the programmer, know the architecture of the application and how best to build the unit tests for it.

Manually running unit tests, even for the smallest application, can be a daunting task. As the application grows, you may generate hundreds or thousands of unit tests. Therefore, you typically use an automated software testing suite to ease the burden of constantly running unit tests. With these suites you script the tests and then run all or part of them. In addition, testing suites typically allow you to create reports and classify the bugs that frequently occur in your application. This information may help you proactively eliminate bugs in the future.

Interestingly enough, once you create and validate your unit tests, the "testing" code base becomes as valuable as the software application

you are trying to create. As a result, you should keep the tests in a code repository for protection. In addition, you should ensure that adequate backups occur, as well as that the needed security is in place.

## **Acceptance Testing**

Acceptance testing represents the second, and an equally important, type of XT that occurs in the XP methodology. The purpose of acceptance testing is to determine whether the application meets other requirements such as functionality and usability. You and the customer create the acceptance tests during the design/planning phases.

Unlike the other forms of testing discussed thus far, customers, not you or your programming partners, conduct the acceptance tests. In this manner, customers provide the unbiased verification that the application meets their needs. Customers create the acceptance tests from user stories. The ratio of user stories to acceptance tests is usually one to many. That is, more than one acceptance test may be needed for each user story.

Acceptance tests in XT may or may not be automated. For example, an unautomated test is required when the customer must validate that a user-input screen meets its specification with respect to color and screen layout. An example of an automated test is when the application must calculate payroll values using data input via some data source such as a flat file to simulate production values.

With acceptance tests, the customer validates an expected result from the application. A deviation from the expected result is considered a bug and is reported to the development team. If customers discover several bugs, then they must prioritize them before passing the list to your development group. After you correct the bugs, or after any change, the customers rerun the acceptance tests. In this manner, the acceptance tests also become a form of regression testing.

An important note is that a program can pass all unit tests but fail the acceptance tests. Why? Because a unit test validates whether a program unit meets some specification such as calculating payroll deductions correctly, not some defined functionality or aesthetics. For a commercial application, the look and feel is a very important

component. Understanding the specification, but not the functionality, generally creates this scenario.

## EXTREME TESTING APPLIED

In this section we create a small Java application and employ JUnit, a Java-based open-source unit testing suite, to illustrate the concepts of Extreme Testing. The example itself is trivial; however, the concepts apply to most any programming situation.

Our example is a command-line application that simply determines whether an input value is a prime number. For brevity, the source code, `check4Prime.java`, and its test harness, `check4PrimeTest.java`, are listed in Appendix A. In this section we provide snippets from the application to illustrate the main points.

The specification of this program is as follows:

Develop a command-line application that accepts any positive integer,  $n$ , where  $0 \leq n \leq 1,000$ , and determine whether it is a prime number. If  $n$  is a prime number, then the application should return a message stating it is a prime number. If  $n$  is not a prime number, then the application should return a message stating it is not a prime number. If  $n$  is not a valid input, then the application should display a help message.

Following the XP methodology and the principles listed in Chapter 5, we begin the application by designing unit tests. With this application, we can identify two discrete tasks: validating inputs and determining prime numbers. We could use black-box and white-box testing approaches, boundary-value analysis, and the decision-coverage criterion, respectively. However, the XT practice mandates a hands-off black-box approach to eliminate any bias.

### Test-Case Design

We begin designing test cases by identifying a testing approach. In this instance we will use boundary analysis to validate the inputs

because this application can only accept positive integers within a certain range. All other input values, including character datatypes and negative numbers, should raise an error and not be used. Of course, you could certainly make the case that input validation could fall under the decision-coverage criterion, as the application must decide whether the input is valid. The important concept is to identify, and commit, to a testing approach when designing your tests.

With the testing approach identified, develop a list of test cases based on possible inputs and expected outcome. Table 8.2 shows the

**Table 8.2**  
**Test Case Descriptions for check4Prime.java**

<i>Case Number</i>	<i>Input</i>	<i>Expected Output</i>	<i>Comments</i>
1	$n = 3$	Affirm $n$ is a prime number.	<ul style="list-style-type: none"> <li>• Tests for a valid prime number</li> <li>• Tests input between boundaries</li> </ul>
2	$n = 1,000$	Affirm $n$ is not a prime number.	<ul style="list-style-type: none"> <li>• Tests input equal to upper bounds</li> <li>• Tests if <math>n</math> is an invalid prime</li> </ul>
3	$n = 0$	Affirm $n$ is not a prime number.	<ul style="list-style-type: none"> <li>• Tests input equal to lower bounds</li> </ul>
4	$n = -1$	Print help message.	<ul style="list-style-type: none"> <li>• Tests input below lower bounds</li> </ul>
5	$n = 1,001$	Print help message.	<ul style="list-style-type: none"> <li>• Tests input greater than the upper bounds</li> </ul>
6	2 or more inputs	Print help message.	<ul style="list-style-type: none"> <li>• Tests for correct number of input values</li> </ul>
7	$n = \text{"a"}$	Print help message.	<ul style="list-style-type: none"> <li>• Tests input is an integer and not a character datatype</li> </ul>
8	$n$ is empty (blank)	Print help message.	<ul style="list-style-type: none"> <li>• Tests if an input value is supplied</li> </ul>



eight test cases identified. (Note: We are using a very simple example to illustrate the basics of Extreme Testing. In practice you would have a much more detailed program specification that may include items such as user-interface requirements and output verbiage. As a result, the list of test cases would increase substantially.)

Test case 1 from Table 8.2 combines two test scenarios. It checks whether the input is a valid prime and how the application behaves with a valid input value. You may use any valid prime in this test. Appendix B provides a list of the prime numbers less than 1,000 that could be used.

We also test two scenarios with test case 2: What happens when the input value is equal to the upper bounds and when the input is not a prime number? This case could have been broken out into two unit tests, but one goal of software testing in general is to minimize the number of test cases while still adequately checking for error conditions. Test case 3 checks the lower boundary of valid inputs as well as testing for invalid primes. The second part of the check is not needed because test case 2 handles this scenario. However, it is included by

JUnit is a freely available open-source tool used to automate unit tests of Java applications in Extreme Programming environments. The creators, Kent Beck and Erich Gamma, developed JUnit to support the significant unit testing that occurs in the Extreme Programming environment. JUnit is very small, but very flexible and feature rich. You can create individual tests or a suite of tests. You can automatically generate reports detailing the errors.

Before using JUnit, or any testing suite, you must fully understand how to use it. JUnit is powerful but only after you master its API. However, whether or not you adopt an XP methodology, JUnit is a useful tool to provide sanity checks for your own code.

Check out [www.junit.org](http://www.junit.org) for more information and to download the test suite. In addition, there is a wealth of information on XP and XT at this Website.

default because 0 is not a prime number. Test cases 4 and 5 ensure that the inputs are within the defined range, which is greater than 0 and less than, or equal to, 1,000.

Case 6 tests whether the application properly handles character input values. Because we are doing a calculation, it is obvious that the application should reject character datatypes. The assumption with this test case is that Java will handle the datatype check. This application must handle the exception raised when an invalid datatype is supplied. This test will ensure that the exception is thrown. Last, tests 7 and 8 check for the correct number of input values; any number other than 1 should fail.

## Test Driver and Application

Now that we have designed both test cases, we can create the test driver class, `check4PrimeTest`. Table 8.3 maps the JUnit methods in `check4PrimeTest` to the test cases covered.

Note that the `testCheckPrime_false()` method tests two conditions because the boundary values are not prime numbers. Therefore, we can check for boundary-value errors and for invalid primes with one test method. Examining this method in detail will reveal that the two tests actually do occur within it. Here is the complete JUnit method from the `check4JavaTest` class listed in Appendix A.

**Table 8.3**  
**Test Driver Methods**

<i>Methods</i>	<i>Test Case Examined</i>
<code>testCheckPrime_true()</code>	1
<code>testCheckPrime_false()</code>	2, 3
<code>testCheck4Prime_checkArgs_char_input()</code>	7
<code>testCheck4Prime_checkArgs_above_upper_bound()</code>	5
<code>testCheck4Prime_checkArgs_neg_input()</code>	4
<code>testCheck4Prime_checkArgs_2_inputs()</code>	6
<code>testCheck4Prime_checkArgs_0_inputs()</code>	8

```
public void testCheckPrime_false(){
    assertFalse(check4prime.primeCheck(0));
    assertFalse(check4prime.primeCheck(10000));
}
```

Notice that the JUnit method, `assertFalse()`, checks to see whether the parameter supplied to it is false. The parameter must be a Boolean datatype, or a function that returns a Boolean value. If false is returned, then the test is considered a success.

The snippet also provides an example of a benefit of creating test cases and test harnesses first. You may notice that the parameter in the `assertFalse()` methods is a method, `check4prime.primeCheck(n)`. This method will reside in a class of the application. Creating the test harness first forced us to think about the structure of the application. In some respects, the application is designed to support the test harness. Here we will need a method to check whether the input is a prime number, so we included it in the application.

With the test harness complete, application coding can begin. Based on the program specification, test cases, and the test harness, the resultant Java application will consist of a single class, `check4Prime`, with the following definition:

```
public class check4Prime {
    public static void main (String [] args)
    public void checkArgs(String [] args) throws Exception
    public boolean primeCheck (int num)
}
```

Briefly, per Java requirements, the `main()` procedure provides the entry point into the application. The `checkArgs()` method asserts that the input value is a positive,  $n$ , where  $0 \leq n \leq 1,000$ . The `primeCheck()` procedure checks the input value against a calculated list of prime numbers. We implemented the sieve of Eratosthenes to quickly calculate the prime numbers. This approach is acceptable because of the small number of prime numbers involved.

## SUMMARY

With the increased competitiveness of software products, there is a need to introduce the products very quickly into the marketplace. As a result, the Extreme Programming model was developed to support rapid application development. This lightweight development process focuses on communication, planning, and testing.

The testing aspect of Extreme Programming is termed Extreme Testing. It focuses on unit and acceptance tests. You run unit tests whenever a change to the code base occurs. The customer runs the acceptance tests at major release points.

Extreme Testing also requires you to create the test harness, based on the program specification, before you start coding your application. In this manner, you design your application to pass the unit tests, thus increasing the probability that it will meet the specification.



## CHAPTER 9

# TESTING INTERNET APPLICATIONS

**J**ust a few years ago, Internet-based applications seemed to be the wave of the future; today, the wave has arrived onshore, and customers, employees, and business partners expect companies to have a Web presence.

Generally, small to medium-size businesses have simple Web pages they use to tout their products and services. Larger enterprises often build full-fledged e-commerce applications to sell their wares, from cookies to cars and from consulting services to entire virtual companies that exist only on the Internet.

Internet applications are essentially client-server applications in which the client is a Web browser and the server is a Web or application server. Although conceptually simple, the complexity of these applications varies wildly. Some companies have applications built for business-to-consumer uses such as banking services or retail stores, while others have business-to-business applications such as supply chain management. Development and user presentation/user interface strategies vary for these different types of Websites, and, as you might imagine, the testing approach varies for the different types of sites as well.

The goal of testing Internet-based applications is no different from that of traditional applications. You need to uncover errors in the application before deploying it to the Internet. And, given the complexity of these applications and the interdependency of the components, you likely will succeed in finding plenty of errors.

The importance of rooting out the errors in an Internet application cannot be understated. As a result of the openness and accessi-

bility of the Internet, competition in the business-to-consumer arena is intense. Thus, the Internet has created a buyer's market for goods and services. Consumers have developed high expectations, and if your site does not load quickly, respond immediately, and provide intuitive navigation features, chances are that the user will find another site with which to conduct business.

It would seem that consumers have higher quality expectations for Internet applications than they do for shrink-wrapped applications. When people buy products in a box and install them on their computers, as long as the quality is "average," they will continue to use them. One reason for this behavior is that they have paid for the application and it must be a product they perceive as useful or desirable. Even a less-than-satisfactory program can't be corrected easily, so if the application at least satisfies the users' basic needs, they likely will retain the program. On the Internet, an average-quality application will likely cause your customer to use a competitor's site. Not only will the customer leave your site if it exhibits poor quality, your corporate image becomes tarnished as well. After all, who feels comfortable buying a car from a company that cannot build a suitable Website? Like it or not, your Website has become the new first impression for business. In general, consumers don't pay to access your Website, so there is little incentive to remain loyal in the face of mediocre Website design or performance.

This chapter covers some of the basics of testing Internet applications. This subject is large and complex, and many references exist that explore its details. However, you will find that the techniques explained in early chapters apply to Internet testing as well. Nevertheless, because there are, indeed, functional and design differences between Web applications and conventional applications, we wanted to point out some of the particulars of Web-based application testing.

## BASIC E-COMMERCE ARCHITECTURE

Before diving into testing Internet-based applications, we will provide an overview of the three-tier client-server (C/S) architecture

used in a typical Internet-based e-commerce application. Conceptually, each tier is treated as a black box with well-defined interfaces. This model allows you to change the internals of each tier without worrying about breaking another tier. Figure 9.1 illustrates each tier and the associated components used by most e-commerce sites.

Although not an official tier in the architecture, the client side and its relevance are worth discussing. Most of the access to your applications occurs from a Web browser running on a computer, although many devices, such as cell phones, refrigerators, pagers, and automobiles, are being developed that can connect to the Internet. Browsers vary dramatically in how they render content from a Website. As we discuss later in this chapter, testing for browser compatibility is one challenge associated with testing Internet applications. Vendors loosely follow published standards to help make browsers behave consistently, but they also build in proprietary enhancements that cause inconsistent behavior. The remainder of the clients employ custom applications that use the Internet as a pipeline to a particular site. In this scenario, the application mimics a standard client-server application you might find on a company's local area network.

**Figure 9.1**  
**Typical architecture of an e-commerce site.**

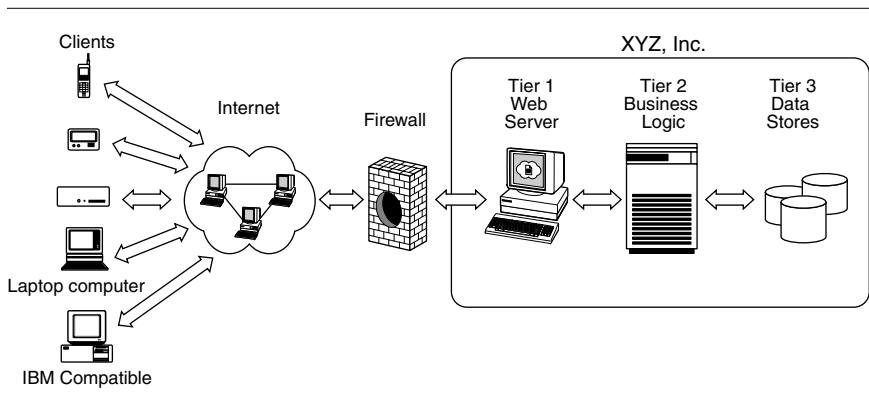



The Web server represents the first tier in the three-tier architecture and houses the Website. The look and feel of an Internet application comes from the first tier. Thus, another term for this tier is the *Presentation tier* or *layer*, so dubbed because it provides the visual content to the end user. The Web server can use static HyperText Markup Language (HTML) pages or Common Gateway Interface (CGI) scripts to create dynamic HTML, but most likely it uses a combination of static and dynamic pages.

Tier 2, or the *Business layer*, houses the application server. Here you run the software that models your business processes. The following lists some of the functionality associated with the business layer:

- Transaction processing
- User authentication
- Data validation
- Application logging

The third tier focuses on storing and retrieving data from a data source, typically a relational database management system (RDBMS). Another term for Tier 3 is the *Data layer*. This tier consists of a database infrastructure to communicate with the second tier. The interface into the Data layer is defined by the data model, which describes how you want to store data. Sometimes several database servers make up this tier. You typically tune database systems in this layer to handle the high transaction rates encountered in an e-commerce site. In addition to a database server, some e-commerce sites may place an authentication server in this layer. Most often, you use an LDAP (Lightweight Directory Application Protocol) server for this function.

## TESTING CHALLENGES

You will face many challenges when designing and testing Internet-based applications due to the large number of elements you cannot control and the number of interdependent components. Adequately

testing your application requires that you make some assumptions about the environment that your customers use and how they use the site.

An Internet-based application has many failure points that you should consider when designing a testing approach. The following list provides some examples of the challenges associated with testing Internet-based applications:

- *Large and varied user base.* The users of your Website possess different skill sets, employ a variety of browsers, and use different operating systems or devices. You can also expect your customers to access your Website using a wide range of connection speeds. Not everyone has T1 or broadband Internet access.
- *Business environment.* If you operate an e-commerce site, then you must consider issues such as calculating taxes, determining shipping costs, completing financial transactions, and tracking customer profiles.
- *Locales.* Users may reside in other countries, in which case you will have internationalization issues such as language translation, time zone considerations, and currency conversion.
- *Testing environments.* To properly test your application, you will need to duplicate the production environment. This means you should use Web servers, application servers, and database servers that are identical to the production equipment. For the most accurate testing results, the network infrastructure will have to be duplicated as well. This includes routers, switches, and firewalls.
- *Security.* Because your site is open to the world, you must protect it from hackers. They can bring your Website to a grinding halt with denial-of-service (DoS) attacks or rip off your customers' credit card information.

Even from this list, which could be expanded considerably as we include viewpoints from a wide variety of developers and businesses, you can see that configuring a testing environment provides one of

the most challenging aspects of e-commerce development. Testing applications that process financial transactions requires the most effort and expense. You must replicate all the components, both hardware and software, used for the application to produce valid test results. Configuring such an environment is a costly endeavor. You will incur not only equipment costs, but labor costs as well. Most companies fail to include these expenses when creating a budget for their applications. Those that do include it generally underestimate the time and monetary requirements. In addition, the testing environment needs a maintenance plan to support application upgrade efforts.

Another significant testing challenge you face is testing browser compatibility. There are several different browsers on the market today, and each behaves differently. Although standards exist for browser operation, most vendors enhance their browsers to try and attract a loyal user base. Unfortunately, this causes the browsers to operate in a nonstandard way. We cover this topic in greater detail later in this chapter.

Although many challenges exist when testing Internet-based applications, you should narrow your testing efforts to specific areas. Table 9.1 identifies some of the most important testing areas that can help ensure that users have a positive experience on your Website.

Because the first impression is the most important impression, some of your testing will focus on usability and human-factor concerns. This area concentrates on the look and feel of your application. Items such as fonts, colors, and graphics play a major role in whether users accept or reject your application.

System performance also influences a customer's first impression. As mentioned earlier, Internet users want instant gratification. They will not wait long for pages to load or transactions to complete. Literally, a few seconds' delay can cause your customer to try another site. Poor performance may also cause customers to doubt the reliability of your site. Therefore, you should set performance goals and design tests that reveal problems that cause your site to miss the goals.

Users demand that the transaction occur rapidly and accurately when purchasing products or services from your site. They do not,

**Table 9.1**  
**Examples of Presentation, Business, and Data Tier Testing**

<i>Presentation Tier</i>	<i>Business Tier</i>	<i>Data Tier</i>
<ul style="list-style-type: none"> <li>• Ensure fonts are the same across browsers.</li> <li>• Check to make sure all links point to valid files or Websites.</li> <li>• Check graphics to ensure they are the correct resolution and size.</li> <li>• Spell-check each page.</li> <li>• Allow a copy editor to check grammar and style.</li> <li>• Check cursor positioning when page loads to ensure it is in the correct text box.</li> <li>• Check to ensure default button is selected when the page loads.</li> </ul>	<ul style="list-style-type: none"> <li>• Check for proper calculation of sales tax and shipping charges.</li> <li>• Ensure documented performance rates are met for response times and throughput rates.</li> <li>• Verify that transactions complete properly.</li> <li>• Ensure failed transactions roll back correctly.</li> <li>• Ensure data are collected correctly.</li> </ul>	<ul style="list-style-type: none"> <li>• Ensure database operations meet performance goals.</li> <li>• Verify data are stored correctly and accurately.</li> <li>• Verify that you can recover using current backups.</li> <li>• Test failover or redundancy operations.</li> </ul>

and should not, tolerate inaccurate billings or shipping errors. Probably worse than losing a customer is finding yourself liable for more than the transaction amount if your application does not process financial transactions correctly.

Your application will likely collect data to complete tasks such as purchases or e-mail registrations. Therefore, you should ensure that the data you collect are valid. For example, make sure that phone numbers, ID numbers, currencies, e-mail addresses, and credit card

numbers are the correct length and are properly formatted. In addition, you should check the integrity of your data. Localization issues can easily cause data corruption via truncation due to character-set issues.

In the Internet environment, it is critical to keep the Website available for customer use. This requires that you develop and implement maintenance guidelines for all the supporting applications and servers. Items such as the Web server and RDBMS require a high level of management. You must monitor logs, system resources, and backups to ensure that these critical items do not fail. As described in Chapter 6, you want to maximize the mean time between failures (MTBF) and minimize the mean time to recovery (MTTR) for these systems.

Finally, network connectivity provides another area in which to focus your testing efforts. At some point, you can count on network connectivity going down. The source of the failure might be the Internet itself, your service provider, or your internal network. Therefore, you need to create contingency plans for your application and infrastructure to respond gracefully when an outage occurs. Keeping with the theme of testing, you should design your tests to break your contingency plans.

## TESTING STRATEGIES

Developing a testing strategy for Internet-based applications requires a solid understanding of each of the hardware and software components that make up the application. As is critical to successful testing of standard applications, a specification document is needed to describe the expected functionality and performance of your Website. Without this document, you cannot design the appropriate tests.

You need to test components developed internally and those purchased from a third party. For the components developed in-house you should employ the tactics presented in earlier chapters. This includes creating unit/module tests and performing code reviews.

You should integrate the components into your system only after verifying that they meet the design specifications and functionality outlined in the specification document.

If you purchase components, then you need to develop a series of system tests to validate that the items perform correctly independently of your application. Do not rely on the vendor's quality-control program to detect errors in its components. Ideally, you should complete this task independently of your application testing. Integrate these components only once you determine that they perform acceptably. Including a nonfunctional third-party component in your architecture makes it difficult to interpret test results and identify the source of errors. Generally, you will use black-box approaches for third-party components because you rarely have access to the component internals.

Testing Internet-based applications is best tackled with a divide-and-conquer approach. Fortunately, the architecture of Internet applications allows you to identify discrete areas to target testing. Figure 9.1 presented the basic architecture of Internet applications. Figure 9.2 provides a more detailed view of each tier.

As mentioned earlier in this chapter, Internet applications are considered three-tier client-server applications. Each tier, or layer, from Figure 9.2 is defined as follows:

- *Presentation layer.* The layer of an Internet application that provides the GUI (graphical user interface).
- *Business Logic layer.* The layer that models your business processes such as user authentication and transactions.
- *Data Access layer.* The layer that houses data used by the application or that is collected from the end user.

Each tier has its own characteristics that encourage test segmentation. Testing each tier independently allows you to more easily identify bugs and errors before complete system testing begins. If you rely only on system testing, then you may have a difficult time locating the specific components that are creating the problem.

**Figure 9.2**  
**Detailed view of Internet application architecture.**

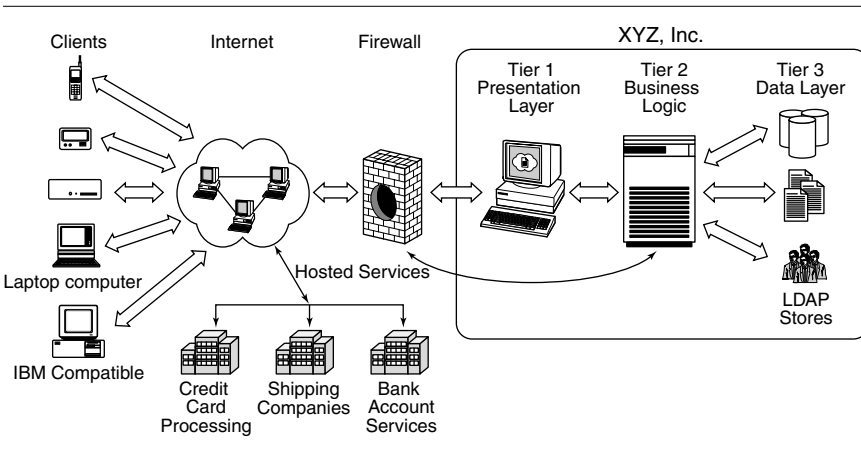

Table 9.2 lists items that you should test in each tier. The list is not complete, but provides a starting point to develop your own testing criteria. In the remainder of this chapter we provide more details on how to test each tier.

## Presentation Layer Testing

Testing the presentation layer consists of finding errors in the GUI, or front end, of your application. This important layer provides the curb appeal of your site, so detecting and correcting errors in this layer are critical to presenting a quality, robust Website. If your customers encounter errors in this layer, they may not return. They may conclude that if your company creates Web pages with misspelled words, it cannot be trusted to successfully execute a credit card transaction.

In a nutshell, presentation layer testing is very labor intensive. However, just as you can segment the testing of an Internet application into discrete entities, you can do the same when testing the pres-

**Table 9.2**  
**Items to Test in Each Tier**

<i>Test Area</i>	<i>Comments</i>
Usability/human factors	<ul style="list-style-type: none"> <li>• Review overall look and feel.</li> <li>• Fonts, colors, and graphics play a major role in the application aesthetics.</li> </ul>
Performance	<ul style="list-style-type: none"> <li>• Check for fast-loading pages.</li> <li>• Check for quick transactions.</li> <li>• Poor performance often creates a bad impression.</li> </ul>
Business rules	<ul style="list-style-type: none"> <li>• Check for accurate representation of business process.</li> <li>• Consider business environment for target user groups.</li> </ul>
Transaction accuracy	<ul style="list-style-type: none"> <li>• Ensure transactions complete accurately.</li> <li>• Ensure cancelled transactions roll back correctly.</li> </ul>
Data validity and integrity	<ul style="list-style-type: none"> <li>• Check for valid formats of phone number, e-mail addresses, and currency amounts.</li> <li>• Ensure proper character sets.</li> </ul>
System reliability	<ul style="list-style-type: none"> <li>• Test the failover capabilities of your Web, application, and database servers.</li> <li>• Maximize MTBF and minimize MTTR.</li> </ul>
Network architecture	<ul style="list-style-type: none"> <li>• Test connectivity redundancy.</li> <li>• Test application behavior during network outages.</li> </ul>

entation layer. The following identifies the three major areas of presentation layer testing:

1. *Content testing.* Overall aesthetics, fonts, color, spelling, content accuracy, default values.
2. *Website architecture.* Broken links or graphics.
3. *User environment.* Web browser versions and operating system configuration.



Content testing involves checking the human-interface element of a Website. You need to search for errors in font type, screen layout, colors, graphic resolutions, and other features that directly affect the end-user experience. In addition, you should check the accuracy of the information on your Website. Providing grammatically correct, but inaccurate, information harms your company's credibility as much as any other GUI bug. Inaccurate information may also create legal problems for your company.

Test the Website architecture by trying to find navigational and structural errors. You should search for broken links, missing pages, wrong files, or anything that sends the user to the wrong area of the site. These errors can occur very easily, especially for dynamic Websites and during development or upgrade phases. All a project team member needs to do is rename a file, and its hyperlink becomes invalid. If a graphic element is renamed or moved, then a hole will exist in your Web page because the file cannot be found. You can validate your Website's architecture by creating a unit test that checks each page for architectural problems. As a best practice, you should migrate architecture testing into the regression-testing process as well. Numerous tools exist that can automate the process of verifying links and checking for missing files.

White-box testing techniques are useful when testing Website architecture. Just as program units have decision points and execution paths, so do Web pages. Users may click on links and buttons in any order, which will navigate to another page. For large sites, there exist many combinations of navigation events that can occur. Review Chapter 4 for more information on white-box testing and logic-coverage theory.

As mentioned earlier, testing the end-user environment, also known as *browser-compatibility testing*, is often the most challenging aspect of testing Internet-based applications. The combination of browsers and an operating system (OS) is very large. Not only should you test each browser configuration, but different versions of the same browser as well. Vendors often improve some feature of their browser with each release, which may or may not be compatible with older versions.

User environment testing becomes more convoluted when your application relies heavily on client-side script processing. Every browser has a different scripting engine or virtual machine to run scripts and code on the client's computer. Pay particular attention to browser-compatibility issues if you use any of the following:

- ActiveX controls
- JavaScript
- VBScript
- Java applets

You can overcome most of the challenges associated with browser-compatibility testing by creating well-defined functional requirements. For example, during the requirements-gathering phase, your marketing department may decide that the application should be certified to work only with certain browsers. This requirement eliminates a significant amount of testing because you have a well-defined target platform to test against.

## **Business Layer Testing**

Business layer testing focuses on finding errors in the business logic of your Internet application. You will find this layer very similar to testing stand-alone applications in that you can employ both white- and black-box techniques. You will want to create test plans and procedures that detect errors in the application's performance requirements, data acquisition, and transaction processing.

You should employ white-box approaches for components developed in-house because you have access to the program logic. However, black-box testing techniques are your primary testing approach for this layer. You will start by developing test drivers to unit-test the individual components. Next, you can perform a system test to determine whether all the components work together correctly. When conducting a system test for this layer, you need to mimic the steps a user performs when purchasing a product or service. For example, for

an e-commerce site you may need to build a test driver that searches inventory, fills a shopping cart, and checks out. Pragmatically modeling these steps can prove challenging.

The technologies that you use to build the business logic dictate how you build and conduct your tests. There are numerous technologies and techniques you may use to build this layer, which makes it impossible to suggest a cookie-cutter testing method. For instance, you might architect your solution using a dedicated application server such as JBoss. Or you could have stand-alone CGI modules written in C or Perl.

Regardless of your approach, there exist certain characteristics of your application that you should always test. These areas include the following:

- *Performance.* Test to see whether the application meets documented performance specifications (generally specified in response times and throughput rates).
- *Data validity.* Test to detect errors in data collected from customers.
- *Transactions.* Test to uncover errors in transaction processing, which may include items such as credit card processing, e-mailing verifications, and calculating sales tax.

### ***Performance Testing***

A poorly performing Internet application creates doubt about its robustness in your user's mind and often turns the person away. Lengthy page loads and slow transactions are typical examples. To help achieve adequate performance levels, you need to ensure that operational specifications are written during the requirements-gathering phase. Without written specifications or goals, you do not know whether your application performs acceptably. Operational specifications are often stated in terms of response times or throughput rates. For instance, a page should load in  $x$  seconds, or the application server will complete  $y$  credit card transactions per minute.

A common approach you may use when conducting performance tests is stress testing. Often, system performance degrades to the point of being unusable when the system becomes overloaded with requests. This might cause time-sensitive transactional components to fail. If you perform financial transactions, then component failures could cause you or your customer to lose money. The concepts on stress testing presented in Chapter 6 apply to testing business layer performance.

As a quick review, stress testing involves blasting the application with multiple logins and simulating transactions to the point of failure so you can determine whether your application meets its performance objectives. Of course, you need to model a typical user visit for valid results. Just loading the homepage does not equate to the overhead of filling a shopping cart and processing a transaction. You should fully tax the system to uncover processing errors.

Stress-testing the application also allows you to investigate the robustness and scalability of your network infrastructure. You may think that your application has bottlenecks that allow only  $x$  transactions per second. But further investigation shows that a misconfigured router, server, or firewall is throttling bandwidth. Therefore, you should ensure that your supporting infrastructure components are in order before beginning stress testing. Not doing so may lead to erroneous results.

### ***Data Validation***

An important function of the business layer is to ensure that data you collect from users are valid. If your system operates with invalid information, such as erroneous credit card numbers or malformed addresses, then significant errors may occur. If you are unlucky, the errors could have financial implications to both you and your customers. You should test for data collection errors much like you search for user-input or parameter errors when testing stand-alone applications. Refer to Chapter 5 for more information on designing tests of this nature.

### ***Transactional Testing***

Your e-commerce site must process transactions correctly 100 percent of the time. No exceptions. Customers will not tolerate failed transactions. Besides a tarnished reputation and lost customers, you may also incur legal liabilities associated with failed transactions.

You can consider transactional testing as system testing of the business layer. In other words, you test the business layer from start to finish, trying to uncover errors. Once again, you should have a written document specifying exactly what constitutes a transaction. Does it include a user searching a site and filling a shopping cart, or does it only consist of processing the purchase?

For a typical Internet application, a transaction component is more than completing a financial transaction (such as processing credit cards). Typical events that a customer performs in a transaction include the following:

- Searching inventory
- Collecting items the user wants to purchase
- Purchasing items, which may involve calculating sales tax and shipping costs as well as processing financial transactions
- Notifying the user of the completed transaction, usually via e-mail

In addition to testing internal transaction processes, you must test the external services, such as credit card validation, banking, and address verification. You typically use third-party components and well-defined interfaces to communicate with financial institutions when conducting financial transactions. Don't assume these items work correctly. You must test and validate that you can communicate with the external services and that you receive correct data back from them.

### **Data Layer Testing**

Once your site is up and running, the data you collect become very valuable. Credit card numbers, payment information, and user pro-

files are examples of the types of data you may collect while running your e-commerce site. Losing this information could prove disastrous and crippling to your business. Therefore, you should develop a set of procedures to protect your data storage systems.

Testing of the data layer consists primarily of testing the database management system that your application uses to store and retrieve information. Smaller sites may store data in text files, but larger, more complex sites use full-featured enterprise-level databases. Depending upon your needs, you may use both approaches.

One of the biggest challenges associated with testing this layer is duplicating the production environment. You must use equivalent hardware platforms and software versions to conduct valid tests. In addition, once you obtain the resources, both financial and labor, you must develop a methodology for keeping production and test environments synchronized.

As with the other tiers, you should search for errors in certain areas when testing the data layer. These include the following:

- *Response time.* Quantifying completion times for Data Manipulation Language (DML) (Structured Query Language [SQL] INSERTs, UPDATEs, and DELETEs), queries (SELECTs), and transactions.
- *Data integrity.* Verifying that the data are stored correctly and accurately.
- *Fault tolerance and recoverability.* Maximize the MTBF and minimize the MTTR.

### ***Response Time***

Slow e-commerce applications cause unhappy customers. Thus, it is in your interest to ensure that your Website responds in a timely manner to user requests and actions. Response-time testing in this layer does not include timing page loads, but focuses on identifying database operations that do not meet performance objectives. When testing the data-tier response time, you want to ensure that individual database operations occur quickly so as not to bottleneck other operations.

However, before you can measure database operations, you should understand what constitutes one. For this discussion, a database operation involves inserting, deleting, updating, or querying of data from the RDBMS. Measuring the response time simply consists of determining how long each operation takes. You are not interested in measuring transactional times, as that may involve multiple database operations. Profiling transaction speeds occurs while testing the business layer.

Because you want to isolate problem database operations, you do not want to measure the speed of a complete transaction when testing data layer response times. Too many factors may skew the test results if you test the whole transaction. For example, if it takes a long time when users try to retrieve their profiles, you should determine where the bottleneck for that operation resides. Is it the SQL statement, Web server, or firewall? Testing the database operation independently allows you to identify the problem. With this example, if the SQL statement is poorly written, it will reveal itself when you test response time.

Data layer response-time testing is plagued with challenges. You must have a test environment that matches what you use in production; otherwise, you may get invalid test results. Also, you must have a thorough understanding of your database system to make certain that it is set up correctly and operating efficiently. You may find that a database operation is performing poorly because the RDBMS is configured incorrectly.

Generally speaking, though, you perform most response-time testing using black-box methods. All you are interested in is the elapsed time for a database transaction(s). Many tools exist to help with these efforts, or you may write your own.

### ***Data Integrity***

Data-integrity testing is the process of finding inaccurate data in your database tables. This test differs from data validation, which you conduct while testing the business layer. Data validation testing tries to

find errors in data collection. Data integrity testing strives to find errors in how you store data.

Many factors can affect how the database stores data. The datatype and length can cause data truncation or loss of precision. For date and time fields, time zone issues come into play. For instance, do you store time based on the location of the client, the Web server, the application server, or the RDBMS? Internationalization and character sets can also affect data integrity. For example, multibyte character sets can double the amount of storage required, plus they can cause queries to return padded data.

You should also investigate the accuracy of the lookup/reference tables used by your application, such as sales tax, zip codes, and time zone information. Not only must you ensure that this information is accurate, you must keep it up to date.

### ***Fault Tolerance and Recoverability***

If your e-commerce site relies on an RDBMS, then the system must stay up and running. There is very little, if any, time available for downtime in this scenario. Thus, you must test the fault tolerance and recoverability of your database system.

One goal of database operations, in general, is to maximize MTBF and minimize MTTR. You should find these values specified in the system requirements documentation for your e-commerce site. Your goal when testing the database system robustness is to try to exceed these numbers.

Maximizing MTBF depends on the fault-tolerance level of your database system. You might have a failover architecture that allows active transactions to switch to a new database when the primary system fails. In this case, your customers might experience a small service disruption, but the system should remain usable. Another scenario is that you build fault tolerance into your application so that a downed database affects the system very little. The types of tests you run depend on the architecture.



You should also consider database recovery as equally important. The objective of recoverability testing is to create a scenario in which you cannot recover that database. At some point, your database will crash, so you should have procedures in place to recover it very quickly. The planning for recovery begins in obtaining valid backups. If you cannot recover the database during recoverability testing, then you need to modify your backup plan.

## APPENDIX A

# SAMPLE EXTREME TESTING APPLICATION

### 1. check4Prime.java

To compile:

```
&> javac check4Prime.java
```

To run:

```
&> java -cp check4Prime 5  
Yippee... 5 is a prime number!
```

```
&> java -cp check4Prime 10  
Bummer.... 10 is NOT a prime number!
```

```
&> java -cp check4Prime A  
Usage: check4Prime x  
    -- where 0<=x<=1000
```

Source code:

```
//check4Prime.java  
//Imports  
import java.lang.*;  
  
public class check4Prime {  
  
    static final int max = 1000; // Set upper bounds.  
    static final int min = 0; // Set lower bounds.  
    static int input =0; // Initialize input variable.
```

```

public static void main (String [] args) {

    //Initialize class object to work with
    check4Prime check = new check4Prime();

    try{
        //Check arguments and assign value to input variable
        check.checkArgs(args);

        //Check for Exception and display help
    }catch (Exception e) {
        System.out.println("Usage: check4Prime x");
        System.out.println("      -- where 0<=x<=1000");
        System.exit(1);
    }

    //Check if input is a prime number
    if (check.primeCheck(input))
        System.out.println("Yippeee... " + input + " is a prime number!");
    else
        System.out.println("Bummer... " + input + " is NOT a prime number!");

} //End main

//Calculates prime numbers and compares it to the input
public boolean primeCheck (int num) {

    double sqroot = Math.sqrt(max);    // Find square root of n

    //Initialize array to hold prime numbers
    boolean primeBucket [] = new boolean [max+1];

    //Initialize all elements to true, then set non-primes to false
    for (int i=2; i<=max; i++) {
        primeBucket[i]=true;
    }
}

```

```

//Do all multiples of 2 first
int j=2;
for (int i=j+j; i<=max; i=i+j) { //start with 2j as 2 is prime
    primeBucket[i]=false; //set all multiples to false
}

for (j=3; j<=sqrt; j=j+2) { // do up to sqrt of n
    if (primeBucket[j]==true) { // only do if j is a prime
        for (int i=j+j; i<=max; i=i+j) { // start with 2j as j is prime
            primeBucket[i]=false; // set all multiples to false
        }
    }
}

//Check input against prime array
if (primeBucket[num] == true) {
    return true;
}else{
    return false;
}

} //end primeCheck()

//Method to validate input
public void checkArgs(String [] args) throws Exception{
    //Check arguments for correct number of parameters
    if (args.length != 1) {
        throw new Exception();
    }else{
        //Get integer from character
        Integer num = Integer.valueOf(args[0]);
        input = num.intValue();
    }
}

```

```
//If less than zero
if (input < 0)           //If less than lower bounds
    throw new Exception();
else if (input > max)   //If greater than upper bounds
    throw new Exception();
}
}

} //End check4Prime
```

## 2. check4PrimeTest.java

Requires the JUnit API, junit.jar

To compile:

```
&> javac -classpath .:junit.jar check4PrimeTest.java
```

To run:

```
&> java -cp .:junit.jar check4PrimeTest
```

Examples:

Starting test...

.....

Time: 0.01

OK (7 tests)

Test finished...

## Source code:

```
//check4PrimeTest.java
//Imports
import junit.framework.*;

public class check4PrimeTest extends TestCase{

    //Initialize a class to work with.
    private check4Prime check4prime = new check4Prime();

    //constructor
    public check4PrimeTest (String name) {
        super(name);
    }

    //Main entry point
    public static void main(String[] args) {
        System.out.println("Starting test...");
        junit.textui.TestRunner.run(suite());
        System.out.println("Test finished...");
    } // end main()

    //Test case 1
    public void testCheckPrime_true() {
        assertTrue(check4prime.primeCheck(3));
    }

    //Test cases 2,3
    public void testCheckPrime_false() {
        assertFalse(check4prime.primeCheck(0));
        assertFalse(check4prime.primeCheck(1000));
    }
}
```

```
//Test case 7
public void testCheck4Prime_checkArgs_char_input() {
    try {
        String [] args= new String[1];
        args[0]="r";
        check4prime.checkArgs(args);
        fail("Should raise an Exception.");
    } catch (Exception success) {
        //successful test
    }
} //end testCheck4Prime_checkArgs_char_input()

//Test case 5
public void testCheck4Prime_checkArgs_above_upper_bound() {
    try {
        String [] args= new String[1];
        args[0]="10001";
        check4prime.checkArgs(args);
        fail("Should raise an Exception.");
    } catch (Exception success) {
        //successful test
    }
} // end testCheck4Prime_checkArgs_upper_bound()

//Test case 4
public void testCheck4Prime_checkArgs_neg_input() {
    try {
        String [] args= new String[1];
        args[0]="-1";
        check4prime.checkArgs(args);
        fail("Should raise an Exception.");
    } catch (Exception success) {
        //successful test
    }
} // end testCheck4Prime_checkArgs_neg_input()
```

```
//Test case 6
public void testCheck4Prime_checkArgs_2_inputs() {
    try {
        String [] args= new String[2];
        args[0]="5";
        args[1]="99";
        check4prime.checkArgs(args);
        fail("Should raise an Exception.");
    } catch (Exception success) {
        //successful test
    }
} // end testCheck4Prime_checkArgs_2_inputs

//Test case 8
public void testCheck4Prime_checkArgs_0_inputs() {
    try {
        String [] args= new String[0];
        check4prime.checkArgs(args);
        fail("Should raise an Exception.");
    } catch (Exception success) {
        //successful test
    }
} // end testCheck4Prime_checkArgs_0_inputs

//JUnit required method.
public static Test suite() {
    TestSuite suite = new TestSuite(check4PrimeTest.class);
    return suite;
} //end suite()

} //end check4PrimeTest
```





## APPENDIX B

### PRIME NUMBERS LESS THAN 1,000

2	3	5	7	11	13	17	19	23	29
31	37	41	43	47	53	59	61	67	71
73	79	83	89	97	101	103	107	109	113
127	131	137	139	149	151	157	163	167	173
179	181	191	193	197	199	211	223	227	229
233	239	241	251	257	263	269	271	277	281
283	293	307	311	313	317	331	337	347	349
353	359	367	373	379	383	389	397	401	409
419	421	431	433	439	443	449	457	461	463
467	479	487	491	499	503	509	521	523	541
547	557	563	569	571	577	587	593	599	601
607	613	617	619	631	641	643	647	653	659
661	673	677	683	691	701	709	719	727	733
739	743	751	757	761	769	773	787	797	809
811	821	823	827	829	839	853	857	859	863
877	881	883	887	907	911	919	929	937	941
947	953	967	971	977	983	991	997		



## GLOSSARY

- black-box testing.*** A testing approach whereby the program is considered as a complete entity and the internal structure is ignored. Test data are derived solely from the application's specification.
- bottom-up testing.*** A form of incremental module testing in which the terminal module is tested first, then its calling module, and so on.
- boundary-value analysis.*** A black-box testing methodology that focuses on the boundary areas of a program's input domain.
- branch coverage.*** See *decision coverage*.
- cause-effect graphing.*** A technique that aids in identifying a set of high-yield test cases by using a simplified digital-logic circuit (combinatorial logic network) graph.
- code inspection.*** A set of procedures and error-detection techniques used for group code readings that is often used as part of the testing cycle to detect errors. Usually a checklist of common errors is used to compare the code against.
- condition coverage.*** A white-box criterion in which one writes enough test cases that each condition in a decision takes on all possible outcomes at least once.
- data-driven testing.*** See *black-box testing*.
- decision/condition coverage.*** A white-box testing criterion that requires sufficient test cases that each condition in a decision takes on all possible outcomes at least once, each decision takes on all possible outcomes at least once, and each point of entry is invoked at least once.

**decision coverage.** A criterion used in white-box testing in which you write enough test cases that each decision has a true and a false outcome at least once.

**desk checking.** A combination of code inspection and walk-through techniques that the program performs at the user's desk.

**equivalence partitioning.** A black-box methodology in which each test case should invoke as many different input conditions as possible in order to minimize the total number of test cases; you should try to *partition* the input domain of a program into equivalent classes such that the test result for an input in a class is representative of the test results for all inputs of the same class.

**exhaustive input testing.** A criterion used in black-box testing in which one tries to find all errors in a program by using every possible input condition as a test case.

**external specification.** A precise description of a program's behavior from the viewpoint of the user of a dependent system component.

**facility testing.** A form of system testing in which you determine if each facility (a.k.a. function) stated in the objectives is implemented. Do not confuse facility testing with function testing.

**function testing.** The process of finding discrepancies between the program and its external specification.

**incremental testing.** A form of module testing whereby the module to be tested is combined with already-tested modules.

**input/output testing.** See *black-box testing*.

**JVM.** Acronym for Java Virtual Machine.

**LDAP.** Acronym for Lightweight Directory Application Protocol.

**logic-driven testing.** See *white-box testing*.

**multiple-condition coverage.** A white-box criterion in which one writes enough test cases that all possible combinations of condition outcomes in each decision, and all points of entry, are invoked at least once.

**nonincremental testing.** A form of module testing whereby each module is tested independently.

**performance testing.** A system test in which you try to demonstrate that an application does not meet certain criteria, such as

response time and throughput rates, under certain workloads or configurations.

**random-input testing.** The processes of testing a program by randomly selecting a subset of all possible input values.

**security testing.** A form of system testing whereby you try to compromise the security mechanisms of an application or system.

**stress testing.** A form of system testing whereby you subject the program to heavy loads or stresses. Heavy stresses are considered peak volumes of data or activity over a short time span. Internet applications where large numbers of concurrent users can access the applications typically require stress testing.

**system testing.** A form of higher-order testing that compares the system or program to the original objectives. To complete system testing, you must have a written set of measurable objectives.

**testing.** The process of executing a program, or a discrete program unit, with the intent of finding errors.

**top-down testing.** A form of incremental module testing in which the initial module is tested first, then the next subordinate module, and so on.

**usability testing.** A form of system testing in which the human-factor elements of an application are tested. Components generally checked include screen layout, screen colors, output formats, input fields, program flow, spellings, and so on.

**volume testing.** A type of system testing of the application with large volumes of data to determine whether the application can handle the volume of data specified in its objectives. Volume testing is not the same as stress testing.

**walkthrough.** A set of procedures and error-detection techniques for group code readings that is often used as part of the testing cycle to detect errors. Usually a group of people act as a “computer” to process a small set of test cases.

**white-box testing.** A type of testing in which you examine the internal structure of a program.



# INDEX

## A

Acceptance testing, 128, 144  
    with Extreme Programming,  
    179, 185  
Application programming inter-  
    face (API), 177  
Application server, 196  
Architecture testing, 204  
Automated debugging tools,  
    158, 160  
Automated testing  
Automated test tools, 120

## B

Backtrack debugging, 168  
Basic e-commerce architecture,  
    194  
Beck, Kent, 188  
Big-bang testing, 105  
Black-box testing, 9–11, 44,  
    205. *See also* Equivalence  
    partitioning  
    methodologies of, 52  
    vs. white-box testing, 114  
BONUS module, 94, 101  
    boundary value analysis of,  
    102  
Boolean logic network, 85

Bottom-up testing, 116–119  
    disadvantages, 117  
    vs. top-down testing, 109  
Boundary conditions, 59  
Boundary-value analysis, 44, 59,  
    196  
    compared to equivalence class  
    testing, 59  
    input boundaries for, 102  
    program example, 60, 61  
    weakness of, 65  
Branch coverage, 45  
Branch decision testing, excep-  
    tions to successful testing, 46  
Branching statement, Java code  
    sample, 47, 48  
Browser compatibility testing,  
    198, 204  
Brute force debugging, 158  
    problems with, 160  
Business layer, 196, 201  
    business layer testing, 199,  
    205–208  
Business tier, 196

## C

C++ compiler testing, 10  
Case stories, 179



- Cause-effect graph:
    - converting to decision table, 81
    - definition, 66
    - symbols, 68
    - used to derive test cases, 71
  - Cause-effect graphing, 44, 65–88, 149
    - described, 85
    - for program specification analysis, 86
  - Check4Prime.java, 186, 213
  - Check4PrimeTest.java, 186, 216
  - Checklists, 27–38
    - comparison errors, 31
    - computation errors, 30
    - control flow errors, 32
    - data-declaration errors, 29
    - data reference errors, 27
    - input/output errors, 35
    - inspection error, 36
    - interface errors, 34
  - Client-server applications, 193
  - Client-server architecture, 194–196, 201
  - Code inspection, 22, 24–26
    - benefits, 26
    - checklist for, 27
    - process, 26
    - time required, 26
  - Code walkthrough, 38
  - Comparison errors, 31
  - Compatibility/configuration/
    - conversion testing, 138
  - Compiler testing, 10
  - Computation errors, 30
  - Condition coverage, 44, 46, 97
  - Configuration testing, 138
  - Content testing, 204
  - Continuous testing, 179
  - Control-flow errors, 32
  - Control-flow graph, 11
- D**
- Data access layer, 196, 201
    - data access layer testing, 199, 208–212
  - Data checking, 23
  - Data-declaration errors, 29
  - Data-driven testing, 9
  - Data integrity, 210
  - Data reference errors, 27
  - Data-sensitivity errors, 13
  - Data tier, 196
  - Data validation, 207
  - Debugging, 157–175
    - by backtracking, 168–169
    - brute force method, 158–160
    - by changing the program, 159
    - cost of, 23
    - by deduction, 164–168
    - error analysis and, 173
    - by induction, 160–164
    - principles of, 170–173
    - procedures for, 147
    - by testing, 169
  - Decision/condition-coverage
    - testing, 49, 99
    - and/or masking, 49
  - Decision coverage, 44, 45
  - Decision coverage testing, definition, 47

- Decision table, 79
  - from cause-effect graph, 81
- Deductive debugging, 164
  - test cases, 166
- Desk checking, 40
- Development vs. testing, 127
- Documentation testing, 142
- Driver module, 106
- E**
- E-commerce architecture, 194–196
- Economics of program testing, 9
- End-user test, 144
- Equivalence classes:
  - compared to boundary-value analysis, 59
  - identifying, 53, 54
  - program example, 56
  - splitting, 55
- Equivalence partitioning, 44, 52
  - steps to complete, 53
  - weakness of, 65
- Eratosthenes, sieve of, 190
- Erroneous input checks, 55
- Error analysis debugging, 173
- Error guessing, 44, 88
  - example, 89
- Error-locating debugging
  - principles, 170
- Error-repairing debugging
  - principles, 171
- Errors:
  - checklists for, 27–35
  - comparison, 31
  - computation, 30
  - control-flow, 32
  - data-declaration, 29
  - data reference, 27
  - input/output, 35
  - interface, 34
- Errors found/errors remaining
  - relationship, 20
- Exhaustive input testing, 9, 10, 13
- Exhaustive path testing, 11, 13
- External specification, 124, 125
- Extreme Programming (XP), 177
  - acceptance testing with, 178–183, 185
  - basics of, 178
  - case stories with, 179
  - continuous testing with, 179
- Extreme Testing with, 183
  - practices, 179–181
  - project example, 182
  - refactoring with, 180
  - strengths and weaknesses, 182
  - unit testing with, 179, 183–185
- Extreme Testing (XT), 177, 178, 183–190
  - applied, 186
  - concepts of, 183
  - program sample, 213
  - test case design, 186
  - test driver for, 189
  - test harness with, 190
- Extreme unit testing, 183

**F**

- Facility testing, 133
- Fault tolerance and recoverability, 211
- Flow-control graph, 12
- FORTTRAN DISPLAY command:
  - objectives for, 132
  - test cases for, 133
- Function test, purpose of, 128, 130
- Function testing, 129–130
  - completion criteria for, 149, 151

**G**

- Gamma, Erich, 188
- Graphical user interface (GUI), 1
- Guidelines for program testing, 15

**H**

- Higher-order testing, 123–155
  - defined, 123
- Human factors, 135
- Human testing, 21
  - procedures of, 142
  - See also* Code inspection, Desk checking, Peer ratings, Walkthrough

**I**

- Identifying test cases, 55
- Incremental testing: 105–109
  - compared to nonincremental testing, 107
  - See also* Bottom-up testing, Top-down testing

- Independent test agency, 155
- Induction debugging, 160
  - example, 163
  - steps to follow, 161
- Inductive assertions, 140
- Input checks, erroneous, 55
- Input/output-driven testing, 9
- Input/output errors, 35
- Inspection error checklist, 36
- Inspections, 21
  - checklist for, 27–40
  - and walkthroughs, 22
- Inspection team, 24
  - duties, 25
  - members, 25
- Installability testing, 139
- Installation testing, 128, 144
  - test cases for, 145
- Integration testing, 105
- Interface errors, 34
- Internet applications:
  - architecture testing with, 204
  - Business layer testing, 205–208
  - challenges, 197
  - client-server architecture, 194–196
  - content testing with, 204
  - data integrity with, 210
  - Data layer testing with, 208
  - data validation of, 207
  - fault tolerance with, 211
  - performance goals for, 198
  - performance testing of, 206
  - Presentation layer testing, 202
  - recoverability with, 211
  - response time testing with, 209

- stress testing with, 207
- testing strategies for, 200
- transactional testing of, 208

Internet application testing,  
193–212

- challenges with, 196

Isosceles triangle, 2

## J

Java code sample, branching  
statement, 47, 48

Java program sample, 186, 213,  
216

JUnit, 188

## L

Logic coverage testing, 44. *See*  
also White-box testing

Logic-driven testing, 11

Loop testing, 33

## M

Mean time between failures  
(MTBF), 140, 200

- maximizing, 211

Mean time to recovery  
(MTTR), 141, 142, 200

Memory dump, 159

Missing path errors, 13

Module testing, 91–121, 151

- with automated tools, 120
- completion criteria for, 148
- performing the test, 120
- purpose of, 128,
- test case design, 92

MTBF. *See* Mean time between  
failures (MTBF)

MTEST, 61, 63

- error guessing with, 89
- output boundaries for, 64
- test cases for, 63

MTTR. *See* Mean time to  
recovery

Multicondition coverage crite-  
rion, 101

Multiple-condition coverage,  
44

Multiple condition testing,  
49–50

## N

Network connectivity, 200

Non-computer-based testing,  
21

Nonincremental testing, 105,  
106

## O

Off-by-one errors, 33

## P

Path testing, 45

Peer ratings, 40

Performance testing, 137, 206

PL/1, 92, 101

Presentation layer, 196, 201

- presentation layer testing, 199,  
202–205

Presentation tier, 196

Preventing software errors,  
125

Prime numbers:  
calculation, 190

- list, 221

Print statement debugging, 159

Procedure testing, 142

Program:

- control-flow graph, 11, 12
- debugging, 16
- inspections, 21
- reviews, 21
- walkthroughs, 21

Program errors:

- checklist for inspections, 27
- comparison, 31
- computation, 30
- control-flow, 32
- data-declaration, 29
- data-sensitivity, 13
- determining number of, 149
- input/output, 35
- interface, 34
- missing path, 13
- probability, 19

Program testing:

- as destructive process, 8
- assumption, 6
- black-box, 9
- definition, 5, 6
- economics of, 9
- example, 56
- guidelines, 14, 15
- human factor considerations, 135
- principles of, 14
- strategies, 9
- success, 7
- white-box, 11
- who should test, 16

## R

Random-input testing, 43

Rapid application development, 177

RDBMS. *See* Relational database management system (RDBMS)

Recovery testing, 141

Refactoring, 180

Regression testing, 18, 147

Relational database, 196

Relational database management system (RDBMS), 196

Reliability testing, 139

Response-time testing, 209

## S

Scalene triangle, 2

Security testing, 137

Serviceability testing, 142

Sieve of Eratosthenes, 190

Software development, vs. testing, 127

Software development cycle, 123, 124

Software documentation, 125

Software errors:

- causes, 124, 125
- preventing, 125

Software objectives, external specification, 124

Software prediction, 140

Software proving, 140

Software reliability engineering (SRE), 140

Software requirements, 125

- Software testing:
    - vs. development, 127
    - human factor consideration, 135
    - principles of, 14–20
    - summarized, 15
  - Software test plan, 146
  - SRE. *See* Software reliability engineering (SRE)
  - Statement coverage, 44
  - Storage dump debugging, 158
  - Storage testing, 138
  - Stress testing, 134, 207
  - Stub module, 106, 110
  - System testing, 130–144, 151
    - fifteen categories of, 133–142
    - performing, 143
    - purpose of, 128
    - stress testing, 134, 207
- T**
- Test-based debugging, 169
  - Test case design, 43–90. *See also*
    - Black-box testing, White-box testing
    - with Extreme Testing, 186–189
    - information required, 92
    - module testing, 92
    - multiple-condition criteria, 51
    - properties of, 52
    - strategy, 90
    - subset definition, 52
  - Test case program, 2
  - Test cases, 17
    - deductive debugging, 166
    - identifying, 55
    - steps to derive, 66
    - user documentation for, 131
  - Test completion criteria, 148–155
  - Test driver and application, 189
  - Test harness, 190
  - Testing. *See also specific test types*
    - of browser compatibility, 198
    - vs. development, 127
    - of Internet applications, 193
    - of large programs, 91
    - psychology of, 5
    - successful vs. unsuccessful, 7
  - Testing strategies, for Internet applications, 200
  - Test management, 146
  - Test plan, components of, 146–147
  - Test planning and control, 145
  - Three-tier architecture, 196. *See also* Business layer, Data access layer, Presentation layer
  - Top-down testing, 110–116
    - advantages and disadvantages, 114–115
    - vs. bottom-up testing, 109
    - guidelines, 113
  - Tracking procedures, 147
  - Transactional testing, 208
  - Twelve practices of Extreme Programming, 180–181
- U**
- Unit testing, 91, 183–187
    - test case design, 92

Unit testing (*Continued*)  
  with JUnit, 188  
  with Extreme Programming,  
    179, 183  
Usability testing, 135  
User documentation, forming  
  test cases with, 131  
User environment testing, 205  
User stories, 179

## V

Volume testing, 133

## W

Walkthroughs, 22–24, 38  
  team members, 39  
Web-based applications  
  configuration testing with, 138

  security testing with, 137  
  stress testing with, 134  
Web browsers:  
  compatibility among,  
    198  
  content delivery, 195  
Web server, 196  
White-box testing, 11–13, 44  
  logic coverage testing, 44  
  module test, 92, 204  
  module testing, 92  
  vs. black-box testing,  
    114

## X

XP. *See* Extreme Programming  
  (XP)  
XT. *See* Extreme Testing (XT)