

ELECTRICITY AND MAGNETISM

By
SILVANUS P. THOMPSON
D.Sc., B.A., FRAS.





L. Ellsworth Dodd.

ca. 1904 (?)

Handwritten scribbles and faint markings across the middle of the page.

ELEMENTARY LESSONS

IN

ELECTRICITY AND MAGNETISM

ELEMENTARY LESSONS

ELECTRICITY AND MAGNETISM

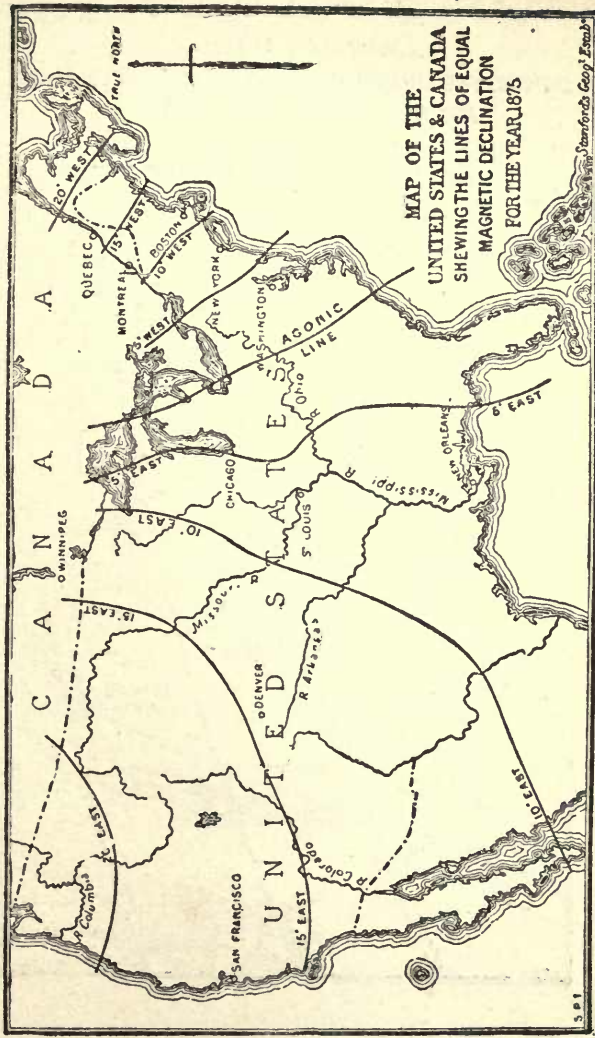

MAP OF THE
 UNITED STATES & CANADA
 SHEWING THE LINES OF EQUAL
 MAGNETIC DECLINATION
 FOR THE YEAR 1875

Stanford's Geop. Esmb.

A MAP OF ENGLAND,
SHEWING THE LINES OF EQUAL MAGNETIC DECLINATION
AND THOSE OF EQUAL DIP & INTENSITY.
FOR THE YEAR, 1888



ELEMENTARY LESSONS IN
ELECTRICITY
and Magnetism

By SILVANUS P. THOMPSON, D.Sc., B.A., F.R.A.S.

PRINCIPAL OF AND PROFESSOR OF PHYSICS IN THE CITY AND GUILDS OF LONDON
TECHNICAL COLLEGE, FINSBURY; LATE PROFESSOR OF EXPERIMENTAL PHYSICS IN
UNIVERSITY COLLEGE, BRISTOL : : : : : : : : : : : : : : : :



R. F. FENNO AND COMPANY
NINE AND ELEVEN EAST SIXTEENTH STREET
NEW YORK CITY

PREFACE.

These Lessons in Electricity and Magnetism are intended to afford to beginners a clear and accurate knowledge of the experiments upon which the Sciences of Electricity and Magnetism are based, and of the exact laws which have been thereby discovered. The difficulties which beginners find in studying many modern text-books arise partly from the very wide range of the subject, and partly from want of familiarity with the simple fundamental experiments. We have, at the outset, three distinct sets of phenomena to observe, viz.—those of Frictional Electricity, of Current Electricity, and of Magnetism; and yet it is impossible to study any one of these rightly without knowing something of them all. Accordingly, the first three chapters of this work are devoted to a simple exposition of the prominent experimental *facts* of these three branches of the subject, reserving until the later chapters the points of connection between them, and such parts of electrical theory as are admissible in a strictly elementary work. No knowledge of algebra beyond simple equations, or of geometry beyond the first book of Euclid, is assumed.

A series of Exercises and Problems has been added at the end of the book in order that students, who so desire, may test their power of applying thought to what they read, and of ascertaining, by answering the questions or working the problems, how far they have digested what they have read and made it their own.

Wherever it has been necessary to state electrical

quantities numerically, the practical system of electrical units (employing the *volt*, the *ohm*, and the *ampere*, as units of electromotive-force, resistance and current, respectively) has been resorted to in preference to any other system. The author has adopted this course purposely, because he has found by experience that these units gradually acquire, in the minds of students of electricity, a concreteness and reality not possessed by any mere abstract units, and because it is hoped that the lessons will be thereby rendered more useful to young telegraphists to whom these units are already familiar, and who may desire to learn something of the Science of Electricity beyond the narrow limits of their own practical work.

Students should remember that this little work is but the introduction to a very widely-extended science, and those who desire not to stop short at the first step should consult the larger treatises of Faraday, Maxwell, Thomson, Wiedemann, and Mascart, as well as the more special works which deal with the various technical Applications of the Science of Electricity to the Arts and Manufactures. Though the Author does not think it well in an elementary text-book to emphasize particular theories on the nature of Electricity upon which the highest authorities are not yet agreed, he believes that it will add to a clear understanding of the matter if he states his own views on the subject.

The theory of electricity adopted throughout these Lessons is, that Electricity, whatever its true nature, is *one*, not *two*: that this Electricity, whatever it may prove to be, is not *matter*, and is not *energy*; that it

resembles both matter and energy in one respect, however, in that it can neither be created nor destroyed. The doctrine of the *Conservation of Matter*, established a century ago by Lavoisier, teaches us that we can neither destroy nor create matter, though we can alter its distribution, and its forms and combinations, in innumerable ways. The doctrine of the *Conservation of Energy*, which has been built up during the past half-century by Helmholtz, Thomson, Joule, and Mayer, teaches us that we can neither create nor destroy energy, though we may change it from one form to another, causing it to appear as the energy of moving bodies, or as the energy of heat, or as the static energy of a body which has been lifted against gravity, or some other attracting force, into a position whence it can run down, and where it has the potentiality of doing work. So also the doctrine of the *Conservation of Electricity*, now growing into shape,¹ but here first enunciated under this name, teaches us that we can neither create nor destroy Electricity though we may alter its distribution,—may cause *more* to appear at one place and *less* at another,—may change it from the condition of rest to that of motion, or may cause it to spin round in whirlpools or vortices, which themselves can attract or repel other vortices. According to this view all our electrical machines and batteries are merely instruments for altering the *distribution* of Electricity by moving some of it

¹ This is undoubtedly the outcome of the ideas of Maxwell and of Faraday as to the nature of Electricity. Since the above was written an elegant analytical statement of the "Doctrine of the Conservation of Electricity" has been published by Mons. G. Lippmann, who had independently, and at an earlier date, arrived at the same view.

from one place to another, or for causing Electricity, when accumulated or heaped together in one place, to do work in returning to its former level distribution. Throughout these lessons the attempt has been made to state the facts of the Science in language consonant with this view, but at the same time rather to lead the student to this as the result of his study than to insist upon it dogmatically at the outset.

PREFACE
TO FORTY-THIRD THOUSAND.

Since the last revision when Chapter V. on Electromagnetics was rewritten, few alterations have been made; but very brief notices have been added of two most important researches of the year 1888, namely those of Professor Oliver Lodge on lightning conductors, and those of Professor H. Hertz on the propagation in space of electromagnetic waves.

S. P. T.

CITY AND GUILDS TECHNICAL COLLEGE,
FINSBURY, *November*, 1888.

CONTENTS.

Part First.

CHAPTER I.

FRICTIONAL ELECTRICITY.

LESSON	PAGE
I. Electrical Attraction and Repulsion	I
II. Electroscopes	11
III. Electrification by Induction	18
IV. Conduction and Distribution of Electricity	28
V. Electrical Machines	40
VI. The Leyden Jar and other Accumulators	53
VII. Other Sources of Electricity	62

CHAPTER II.

MAGNETISM.

VIII. Magnetic Attraction and Repulsion	72
IX. Methods of Making Magnets	82
X. Distribution of Magnetism	87
XI. Laws of Magnetic Force	95
Note on Ways of Reckoning Angles and Solid-Angles	108
Table of Natural Sines and Tangents	111
XII. Terrestrial Magnetism	112

CHAPTER III.

CURRENT ELECTRICITY.

LESSON	PAGE
XIII. Simple Voltaic Cells	122
XIV. Chemical Actions in the Cell	131
XV. Voltaic Batteries	137
XVI. Magnetic Actions of the Current	150
XVII. Galvanometers	161
XVIII. Chemical Actions of the Current. Voltmeters	171
XIX. Physical and Physiological Effects of the Current	180

Part Second.

CHAPTER IV.

ELECTROSTATICS.

XX. Theory of Potential	190
Note on Fundamental and Derived Units	208
XXI. Electrometers	211
XXII. Specific Inductive Capacity, etc.	220
XXIII. Phenomena of Discharge	235
XXIV. Atmospheric Electricity	253

CHAPTER V.

ELECTROMAGNETICS.

XXV. Theory of Magnetic Potential	265
Note on Magnetic and Electromagnetic Units	281
Note on Measurement of Earth's Magnetic Force in Absolute Units	284
Note on Index Notation	285
XXVI. Electromagnets	286
XXVII. Electrodynamics	298
XXVIII. Diamagnetism	306 <i>d</i>

CHAPTER VI.

MEASUREMENT OF CURRENTS, ETC.

LESSON	PAGE
XXIX. Ohm's Law and its Consequences	307
XXX. Electrical Measurements	316
Note on the Ratio of the Electrostatic to the Electro-magnetic Units	326

CHAPTER VII.

HEAT, LIGHT, AND WORK, FROM ELECTRIC CURRENTS.

XXXI. Heating effects of Currents	328
XXXII. The Electric Light	333
XXXIII. Electromotors (Electromagnetic Engines) .	340

CHAPTER VIII.

THERMO-ELECTRICITY.

XXXIV. Thermo-Electric Currents	346
---	-----

CHAPTER IX.

ELECTRO-OPTICS.

XXXV. General Relations between Light and Electricity	353
--	-----

CHAPTER X.

INDUCTION CURRENTS (MAGNETO-ELECTRICITY).

LESSON	PAGE
XXXVI. Currents produced by Induction	361
XXXVII. Magneto-electric and Dynamo Electric Generators	375

CHAPTER XI.

ELECTRO-CHEMISTRY.

XXXVIII. Electrolysis and Electrometallurgy	387
---	-----

CHAPTER XII.

TELEGRAPHS AND TELEPHONES.

XXXIX. Electric Telegraphs	401
XL. Electric Bells, Clocks, and Telephones	411

APPENDIX.

PROBLEMS AND EXERCISES	421
INDEX	443
MAGNETIC MAP OF ENGLAND AND WALES	<i>Frontispiece.</i>
MAGNETIC MAP OF THE UNITED STATES AND CANADA	"

ELEMENTARY LESSONS
ON
ELECTRICITY & MAGNETISM.

Part First.

CHAPTER I.

FRICTIONAL ELECTRICITY.

LESSON I.—*Electrical Attraction and Repulsion.*

1. **Electrical Attraction.**—If you take a piece of sealing-wax, or of resin, or a glass rod, and rub it upon a piece of flannel or silk, it will be found to have acquired a property which it did not previously possess: namely, the power of attracting to itself such light bodies as chaff, or dust, or bits of paper (Fig. 1). This curious power was originally discovered to be a property of amber, or, as the Greeks called it, *ἤλεκτρον*, which is mentioned by Thales of Miletus (B.C. 600), and by Theophrastus in his treatise on Gems, as attracting light bodies when rubbed. Although an enormous number of substances possess this property, amber and jet were the only two in which its existence had been recognised by the ancients, or even down to so late a date as the time of Queen Elizabeth. About the year 1600, Dr. Gilbert of Colchester discovered by experiment that not only

amber and jet, but a very large number of substances, such as diamond, sapphire, rock-crystal, glass, sulphur, sealing-wax, resin, etc., which he styled *electrics*,¹ possess the same property. Ever since his time the name *electricity* has been employed to denote the agency at work in producing these phenomena. Gilbert also remarked that these experiments are spoiled by the presence of moisture.

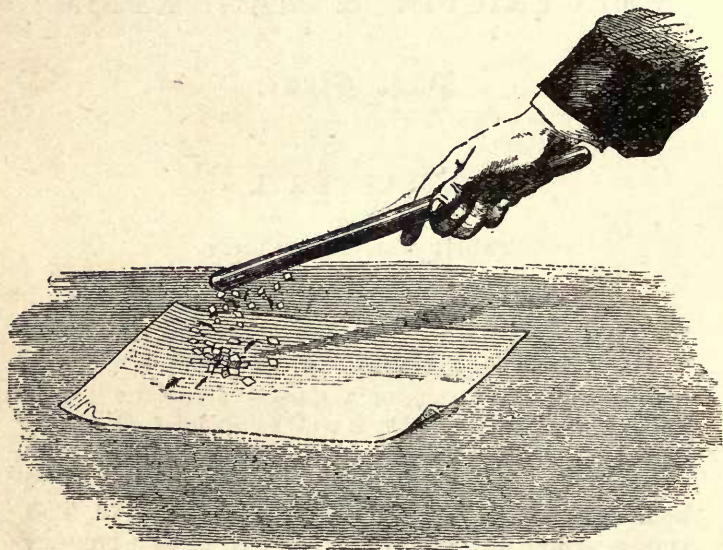

Fig. 1.

2. A better way of observing the attracting force is to employ a small ball of elder pith, or of cork, hung by a fine thread from a support, as shown in Fig. 2. A dry warm glass tube, excited by rubbing it briskly with a silk handkerchief, will attract the pith ball strongly, showing that it is highly electrified. The most suitable rubber, if a stick of sealing-wax is used, will be found to

¹ "*Electrica* ; quæ attrahunt eadem ratione ut electrum."—(Gilbert).

be flannel, woollen cloth, or, best of all, fur discovered that an electrified body is itself attracted by one that has not been electrified. This may be verified (see Fig. 3) by rubbing a stick of sealing-wax, or a glass rod, and hanging it in a wire loop at the end of a *silk* thread. If, then, the hand be held out towards the suspended electrified body, it will turn round and approach the hand. So, again, a piece of silk ribbon, if rubbed with warm

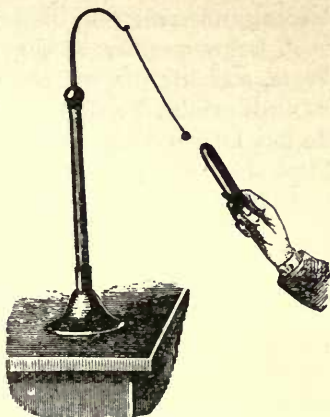

Fig. 2

indiarubber, or even if drawn between two pieces of warm flannel, and then held up by one end, will be found to be attracted by objects presented to it. If held near the wall of the room it will fly to it and stick to it. With proper precautions it can be shown that *both* the rubber and the thing rubbed are in an electrified state, for both will attract light bodies; but to show this, care must be taken not to

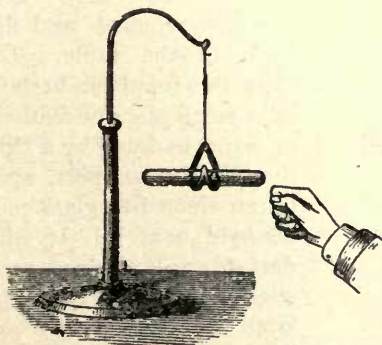

Fig. 3.

handle the rubber too much. Thus, if it is desired to show that when a piece of rabbit's fur is rubbed upon sealing-wax, the fur becomes also electrified, it is better not to take the fur in the hand, but to fasten it to the

end of a glass rod as a handle. The reason of this precaution will be explained toward the close of this lesson, and more fully in Lesson IV.

A large number of substances, including iron, gold, brass, and all the metals, when held in the hand and rubbed, exhibit no sign of electrification,—that is to say, do not attract light bodies as rubbed amber and rubbed glass do. Gilbert mentions also pearls, marble, agate, and the lodestone, as substances not excited electrically by rubbing them. Such bodies were, on that account, formerly termed *non-electrics*; but the term is erroneous, for if they are fastened to glass handles and then rubbed with silk or fur, they behave as electrics.

3. Electrical Repulsion.—When experimenting, as in Fig. 1, with a rubbed glass rod and bits of chopped paper, or straw, or bran, it will be noticed that these

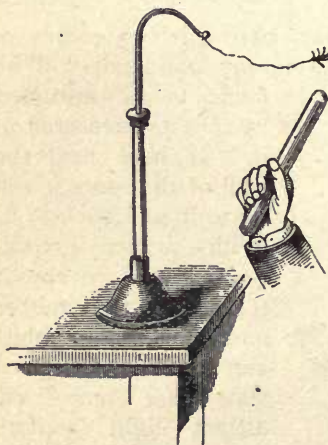

Fig. 4.

little bits are first attracted and fly up towards the excited rod, but that, having touched it, they are speedily repelled and fly back to the table. To show this repulsion better, let a small piece of feather or down be hung by a silk thread to a support, and let an electrified glass rod be held near it. It will dart towards the rod and stick to it, and a moment later will dart away from it, repelled by an invisible force (Fig. 4), nor will it

again dart towards the rod. If the experiment be repeated with another feather and a stick of sealing-wax rubbed on flannel the same effects will occur. But, if now the hand be held towards the feather, it will rush

toward the hand, as the rubbed body in Fig. 3 did. This proves that the feather, though it has not itself been rubbed, possesses the property originally imparted to the rod by rubbing it. In fact, it has become electrified, by having touched an electrified body which has given part of its electricity to it. It would appear then that two bodies electrified with the same electricity repel one another. This may be confirmed by a further experiment. A rubbed glass rod, hung up as in Fig. 3, is repelled by a similar rubbed glass rod; while a rubbed stick of sealing-wax is repelled by a second rubbed stick of sealing-wax. Another way of showing the repulsion between two similarly electrified bodies is to hang a couple of small pith-balls, by thin linen threads to a glass support, as in Fig. 5, and then touch them both with a rubbed glass rod. They repel one another and fly apart, instead of hanging down side by side, while the near presence of the glass rod will make them open out still wider, for now it repels them both. The self-repulsion of the parts of an electrified body is beautifully illustrated by the experiment of electrifying a soap-bubble, which *expands* when electrified.

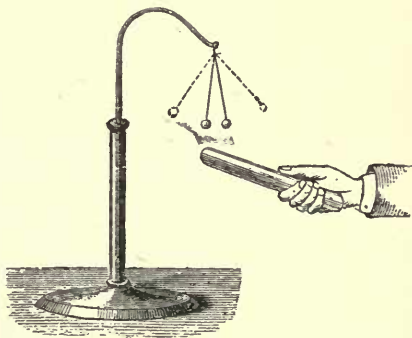

Fig. 5.

4. **Two kinds of Electrification.**—Electrified bodies do not, however, always repel one another. The feather which (see Fig. 4) has been touched by a rubbed glass rod, and which in consequence is repelled from the rubbed glass, will be *attracted* if a stick of rubbed sealing-wax be presented to it; and conversely, if the

feather has been first electrified by touching it with the rubbed sealing-wax, it will be attracted to a rubbed glass rod, though repelled by the rubbed wax. So, again, a rubbed glass rod suspended as in Fig. 3 will be attracted by a rubbed piece of sealing-wax, or resin, or amber, though repelled by a rubbed piece of glass. The two pith-balls touched (as in Fig. 5) with a rubbed glass rod fly from one another by repulsion, and, as we have seen, fly wider asunder when the excited glass rod is held near them; yet they fall nearer together when a rubbed piece of sealing-wax is held under them, being attracted by it. Symmer first observed such phenomena as these, and they were independently discovered by Du Fay, who suggested in explanation of them that there were two different kinds of electricity which attracted one another while each repelled itself. The electricity produced on glass by rubbing it with silk he called *vitreous* electricity, supposing, though erroneously, that glass could yield no other kind; and the electricity excited in such substances as sealing-wax, resin, shellac, indiarubber, and amber, by rubbing them on wool or flannel, he termed *resinous* electricity. The kind of electricity produced is, however, found to depend not only on the thing rubbed but on the rubber also; for glass yields "resinous" electricity when rubbed with a cat's skin, and resin yields "vitreous" electricity if rubbed with a soft amalgam of tin and mercury spread on leather. Hence these names have been abandoned in favour of the more appropriate terms introduced by Franklin, who called the electricity excited upon glass by rubbing it with silk *positive* electricity, and that produced on resinous bodies by friction with wool or fur, *negative* electricity. The observations of Symmer and Du Fay may therefore be stated as follows:—Two positively electrified bodies repel one another: two negatively electrified bodies repel one another: but a positively electrified body and a negatively electrified body attract one another.

5. **Simultaneous production of both Electrical States.**—Neither kind of electrification is produced alone; there is always an equal quantity of both kinds produced; one kind appearing on the thing rubbed and an equal amount of the other kind on the rubber. The clearest proof that these amounts are *equal* can be given in some cases. For it is found that if both the - electricity of the rubber and the + electricity of the thing rubbed be imparted to a third body, that third body will show *no electrification at all*, the two equal and opposite electrifications having exactly neutralised each other.

In the following list the bodies are arranged in such an order that if any two be rubbed together the one which stands earlier in the series becomes positively electrified, and the one that stands later negatively electrified:—*Fur, wool, ivory, glass, silk, metals, sulphur, indiarubber, guttapercha, collodion.*

6. **Theories of Electricity.**—Several theories, have been advanced to account for these phenomena, but all are more or less unsatisfactory. Symmer proposed a "two-fluid" theory, according to which there are two imponderable electric fluids of opposite kinds, which neutralise one another when they combine, and which exist combined in equal quantities in all bodies until their condition is disturbed by friction. A modification of this theory was made by Franklin, who proposed instead a "one-fluid" theory, according to which there is a single electric fluid distributed usually uniformly in all bodies, but which, when they are subjected to friction, distributes itself unequally between the rubber and the thing rubbed, one having more of the fluid. the other less, than the average. Hence the terms *positive* and *negative*, which are still retained: that body which is supposed to have an excess being said to be charged with positive electricity (usually denoted by the *plus* sign +), while that which is supposed to have less is said to be charged with negative electricity (and is denoted by

the *minus* sign -). These terms are, however, purely arbitrary, for in the present state of science we do not know which of these two states really means more and which means less. It is, however, quite certain that *electricity is not a material fluid*, whatever else it may be. For while it resembles a fluid in its property of apparently flowing from one point to another, it differs from every known fluid in almost every other respect. It possesses no weight; it repels itself. -It is, moreover, quite impossible to conceive of two fluids whose properties should in every respect be the precise opposites of one another. For these reasons it is clearly misleading to speak of an electric fluid or fluids, however convenient the term may seem to be. Another theory, usually known as the **molecular theory** of electricity, and first distinctly upheld by Faraday, supposes that electrical states are the result of certain peculiar conditions of the molecules of the bodies that have been rubbed, or of the "æther" which is believed to surround the molecules. There is much to be said in favour of this hypothesis, but it has not yet been proven. In these lessons, therefore, we shall avoid as far as possible all theories, and shall be content to use the term **electricity**.

7. **Charge**.—The quantity of electrification of either kind produced by friction or other means upon the surface of a body is spoken of as a **charge**, and a body when electrified is said to be *charged*. It is clear that there may be charges of different values as well as of either kind. When the charge of electricity is removed from a charged body it is said to be *discharged*. Good conductors of electricity are instantaneously discharged if touched by the hand or by any conductor in contact with the ground, the charge thus finding a means of escaping to earth. A body that is not a good conductor may be readily discharged by passing it rapidly through the flame of a spirit-lamp or a candle; for the flame instantly carries off the electricity and dissipates it in the air.

Electricity may either reside upon the surface of bodies as a *charge*, or flow through their substance as a *current*. That branch of the science which treats of the laws of the charges upon the surface of bodies is termed *electrostatics*, and is dealt with in Chapter IV. The branch of the subject which treats of the flow of electricity in currents is dealt with in Chapter III., and other later portions of this book.

8. Conductors and Insulators.—The term “conductors,” used above, is applied to those bodies which readily allow electricity to flow through them. Roughly speaking bodies may be divided into two classes—those which conduct and those which do not; though very many substances are partial conductors, and cannot well be classed in either category. All the metals conduct well; the human body conducts, and so does water. On the other hand glass, sealing-wax, silk, shellac, gutta-percha, indiarubber, resin, fatty substances generally, and the air, are “non-conductors.” On this account these substances are used to make supports and handles for electrical apparatus where it is important that the electricity should not leak away; hence they are sometimes called *insulators* or *isolators*. Faraday termed them *dielectrics*. We have remarked above that Gilbert gave the name of *non-electrics* to those substances which, like the metals, yield no sign of electrification when held in the hand and rubbed. We now know the reason why they show no electrification; for, being good conductors, the electricity flows away as fast as it is generated. The observation of Gilbert that electrical experiments fail in damp weather is also explained by the knowledge that water is a conductor, the film of moisture on the surface of damp bodies causing the electricity produced by friction to leak away as fast as it is generated.

9. Other electrical effects.—The production of electricity by friction is attested by other effects than those of attraction and repulsion, which hitherto we have

assumed to be the test of the presence of electricity. Otto von Guericke first observed that sparks and flashes of light could be obtained from highly electrified bodies at the moment when they were discharged. Such sparks are usually accompanied by a snapping sound, suggesting on a small scale the thunder accompanying the lightning spark, as was remarked by Newton and other early observers. Pale flashes of light are also produced by the discharge of electricity through tubes partially exhausted of air by the air-pump. Other effects will be noticed in due course.

10. Other Sources of Electrification.—The student must be reminded that *friction* is by no means the only source of electricity. The other sources, percussion, compression, heat, chemical action, physiological action, contact of metals, etc., will be treated of in Lesson VII. We will simply remark here that friction between two different substances *always* produces electrical separation, no matter what the substances may be. Symmer observed the production of electricity when a silk stocking was drawn over a woollen one, though woollen rubbed upon woollen, or silk rubbed upon silk, produces no electrical effect. If, however, a piece of rough glass be rubbed on a piece of smooth glass, electrification is observed; and indeed the conditions of the surface play a very important part in the production of electricity by friction. In general, of two bodies thus rubbed together, that one becomes negatively electrical whose particles are the more easily removed by friction. Differences of temperature also affect the electrical conditions of bodies, a warm body being usually negative when rubbed on a cold piece of the same substance. Péclet found the degree of electrification produced by rubbing two substances together to be independent of the pressure and of the size of the surfaces in contact, but depended on the materials and on the velocity with which they moved over one another. Rolling friction and sliding friction produced equal effects. The quantity

of electrification produced is, however, not proportional to the amount of the actual mechanical friction; hence it appears doubtful whether friction is truly the cause of the electrification. Indeed, it is probable that the true cause is the *contact* of dissimilar substances (see Art. 73), and that when on contact two particles have assumed opposite electrical states, one being + the other -, it is necessary to draw them apart before their respective electrifications can be observed. Electrical machines are therefore machines for bringing dissimilar substances into intimate contact, and then drawing apart the particles that have touched one another and become electrical.

LESSON II.—*Electroscopes.*

11. Simple Electroscopes.—An instrument for detecting whether a body is electrified or not, and whether the electrification is positive or negative, is termed an **Electroscope**. The feather which was attracted or repelled, and the two pith balls which flew apart, as we found in Lesson I., are in reality simple electroscopes. There are, however, a number of pieces of apparatus better adapted for this particular purpose, some of which we will describe.

12. Straw-Needle Electroscope.—The earliest electroscope was that devised by Dr. Gilbert, and shown in Fig. 6, which consists of a stiff straw balanced lightly

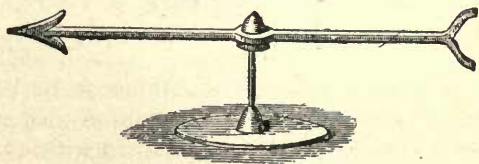

Fig. 6.

upon a sharp point. A thin strip of brass or wood, or even a goose quill, balanced upon a sewing needle, will

serve equally well. When an electrified body is held near the electroscope it is attracted and turned round, and will thus indicate the presence of quantities of electricity far too small to attract bits of paper from a table.

13. Gold-Leaf Electroscope.—A still more sensitive instrument is the **Gold-Leaf Electroscope** invented by Bennet, and shown in Fig. 7. We have seen how two pith-balls when similarly electrified repel one another and stand apart, the force of gravity being partly overcome by the force of the electric repulsion.

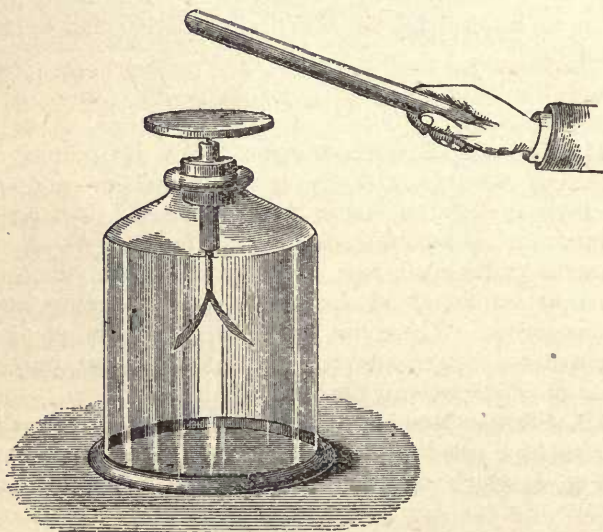

Fig. 7.

A couple of narrow strips of the thinnest tissue paper, hung upon a support, will behave similarly when electrified. But the best results are obtained with two strips of gold-leaf, which, being excessively thin, is much lighter than the thinnest paper. The Gold-Leaf Electroscope is conveniently made by suspending the two leaves within a wide-mouthed glass jar, which both serves to

protect them from draughts of air and to support them from contact with the ground. Through the cork, which should be varnished with shellac or with paraffin wax, is pushed a bit of glass tube, also varnished. Through this passes a stiff brass wire, the lower end of which is bent at a right angle to receive the two strips of gold-leaf, while the upper supports a flat plate of metal, or may be furnished with a brass knob. When kept dry and free from dust it will indicate excessively small quantities of electricity. A rubbed glass rod, even while two or three feet from the instrument, will cause the leaves to repel one another. The chips produced by sharpening a pencil, falling on the electroscope top, are seen to be electrified. If the knob be even brushed with a small camel's hair brush, the slight friction produces a perceptible effect. With this instrument all kinds of friction can be shown to produce electrification. Let a person, standing upon an insulating support,—such as a stool with glass legs, or a board supported on four glass tumblers,—be briskly struck with a silk handkerchief, or with a fox's tail, or even brushed with a clothes' brush, he will be electrified, as will be indicated by the electroscope if he place one hand on the knob at the top of it. The Gold-Leaf Electroscope can further be used to indicate the *kind* of electricity on an excited body. Thus, suppose we rubbed a piece of brown paper with a piece of indiarubber and desired to find out whether the electrification excited on the paper was + or - , we should proceed as follows :— First charge the gold leaves of the electroscope by touching the knob with a glass rod rubbed on silk. The leaves diverge. being electrified with + electrification. When they are thus charged the approach of a body which is positively electrified will cause them to diverge still more widely ; while, on the approach of one negatively electrified, they will tend to close together. If now the brown paper be brought near the electroscope, the leaves will be seen to diverge more, proving the

electrification of the paper to be of the same kind as that with which the electroscope is charged, or positive.

The Gold-Leaf Electroscope will also indicate roughly the amount of electricity on a body placed in contact with it, for the gold leaves open out more widely when the quantity of electricity thus imparted to them is greater. For exact measurement, however, of the amounts of electricity thus present, recourse must be had to the instruments known as Electrometers, described in Lesson XXI.

In another form of electroscope (Bohnenberger's) a single gold leaf is used, and is suspended between two metallic plates, one of which can be positively, the other negatively electrified, by placing them in communication with the poles of a "dry pile" (Art. 182). If the gold leaf be charged positively or negatively it will be attracted to one side and repelled from the other, according to the law of attraction and repulsion mentioned in Art. 4.

14. Henley's Quadrant Electroscope. — The Quadrant Electroscope is sometimes employed as an indicator for large charges of electricity. It consists of

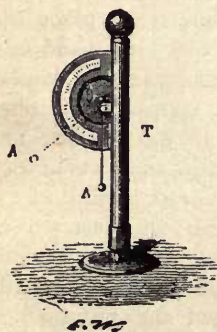

Fig. 8.

a pith ball at the end of a light arm fixed on a pivot to an upright. When the whole is electrified the pith-ball is repelled from the upright and flies out at an angle, indicated on a graduated scale or quadrant behind it. Its usual form is shown in Fig. 8. This little electroscope, which is seldom used except to show whether an electric machine or a Leyden battery is charged, must on no account be confused with the deli-

cate "Quadrant Electrometer" described in Lesson XXI., whose object is to *measure* very small charges of electricity—not to *indicate* large ones.

15. The Torsion Balance.—Although more properly an *Electrometer* than a mere *Electroscope*, it will be most convenient to describe here the instrument known as the Torsion Balance. (Fig. 9.) This instrument serves to measure the force of the repulsion between two similarly electrified bodies, by balancing the force of this repulsion against the force exerted by a fine wire in untwisting itself after it has been twisted. The torsion balance consists of a light arm or lever of shellac suspended within a cylindrical glass case

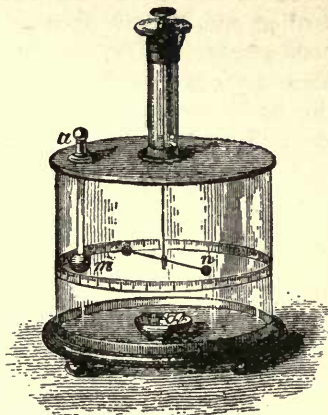

Fig. 9.

by means of a fine silver wire. At one end this lever is furnished with a gilt pith-ball, *n*. The upper end of the silver wire is fastened to a brass top, upon which a circle, divided into degrees, is cut. This top can be turned round in the tube which supports it, and is known as the torsion-head. Through an aperture in the cover there can be introduced a second gilt pith-ball *m*, fixed to the end of a vertical glass rod *a*. Round the glass case, at the level of the pith-balls, a circle is drawn, and divided also into degrees.

In using the torsion balance to measure the amount of a charge of electricity, the following method is adopted:—First, the torsion-head is turned round until the two pith-balls *m* and *n* just touch one another. Then the glass rod *a* is taken out, and the charge of electricity to be measured is imparted to the ball *m*, which is then replaced in the balance. As soon as *m* and *n* touch one another, part of the charge passes from

m to n , and they repel one another because they are then similarly electrified. The ball n , therefore, is driven round and twists the wire up to a certain extent. The force of repulsion becomes less and less as n gets farther and farther from m ; but the force of the twist gets greater and greater the more the wire is twisted. Hence these two forces will balance one another when the balls are separated by a certain distance, and it is clear that a large charge of electricity will repel the ball n with a greater force than a lesser charge would. The distance through which the ball is repelled is read off not in inches but in angular degrees of the scale. When a wire is twisted, the force with which it tends to untwist is precisely proportional to the amount of the twist. The force required to twist the wire ten degrees is just ten times as great as the force required to twist it one degree. In other words, *the force of torsion is proportional to the angle of torsion*. The angular distance between the two balls is, when they are not very widely separated, very nearly proportional to the actual straight distance between them, and represents the force exerted between electrified balls *at that distance* apart. The student must, however, carefully distinguish between the measurement of the force and the measurement of the actual quantity of electricity with which the instrument is charged. For the force exerted between the electrified balls will vary at different distances according to a particular law known as the "law of inverse squares," which requires to be carefully explained.

16. The Law of Inverse Squares.—Coulomb proved, by means of the Torsion Balance, that the force exerted between two small electrified bodies varies inversely as the square of the distance between them when the distance is varied. Thus, suppose two electrified bodies one inch apart repel one another with a certain force, at a distance of two inches the force will

be found to be only one quarter as great as the force at one inch; and at ten inches it will be only $\frac{1}{100}$ th part as great as at one inch. This law is proved by the following experiment with the torsion balance. The two scales were adjusted to 0° , and a certain charge was then imparted to the balls. The ball *n* was repelled round to a distance of 36° . The twist on the wire between its upper and lower ends was also 36° , or the force of the repulsion was thirty-six times as great as the force required to twist the wire by 1° . The torsion-head was now turned round so as to twist the thread at the top and force the ball *n* nearer to *m*, and was turned round until the distance between *n* and *m* was halved. To bring down this distance from 36° to 18° , it was found needful to twist the torsion-head through 126° . The total twist between the upper and lower ends of the wire was now $126^\circ + 18^\circ$, or 144° ; and the force was 144 times as great as that force which would twist the wire 1° . But 144 is four times as great as 36; hence we see that while the distance had been reduced to one *half*, the force between the balls had become *four times* as great. Had we reduced the distance to *one quarter*, or 9° , the total torsion would have been found to be 576° , or *sixteen times* as great; proving the force to vary *inversely as the square of the distance*.

In practice it requires great experience and skill to obtain results as exact as this, for there are many sources of inaccuracy in the instrument. The balls must be very small, in proportion to the distances between them. The charges of electricity on the balls are found, moreover, to become gradually less and less, as if the electricity leaked away into the air. This loss is less if the apparatus be quite dry. It is therefore usual to dry the interior by placing inside the case a cup containing either chloride of calcium, or pumice stone soaked with strong sulphuric acid, to absorb the moisture,

Before leaving the subject of electric forces, it may be well to mention that the force of *attraction* between two oppositely electrified bodies varies also inversely as the square of the distance between them. And in every case, whether of attraction or repulsion, the force at any given distance is proportional to the product of the two quantities of electricity on the bodies. Thus, if we had separately given a charge of 2 to the ball *m* and a charge of 3 to the ball *n*, the force between them will be $3 \times 2 = 6$ times as great as if each had had a charge of 1 given to it.

17. Unit quantity of Electricity.—In consequence of these laws of attraction and repulsion, it is found most convenient to adopt the following definition for that quantity of electricity which we take for a **unit** or standard by which to measure other quantities of electricity. *One Unit of Electricity is that quantity which, when placed at a distance of one centimetre in air from a similar and equal quantity, repels it with a force of one dyne.* Further information about the measurement of electrical quantities is given in Lessons XX. and XXI

LESSON III.—*Electrification by Induction.*

18. We have now learned how two charged bodies may attract or repel one another. It is sometimes said that it is the electricities in the bodies which attract or repel one another; but as electricity is not known to exist except in or on material bodies, the proof that it is the electricities themselves which are attracted is only indirect. Nevertheless there are certain matters which support this view, one of these being the electric influence exerted by an electrified body upon one not electrified.

Suppose we rub a ball of glass with silk to electrify it,

and hold it near to a body that has not been electrified, what will occur? We take for this experiment the apparatus shown in Fig. 10, consisting of a long sausage-shaped piece of metal, either hollow or solid, held upon a glass support. This "conductor," so called because it is made of metal which permits electricity to pass freely through it or over its surface, is supported on glass to prevent the escape of electricity to the earth, glass being a non-conductor. The presence of the positive electricity of the glass ball near this conductor is found to *induce* electricity on the conductor, which,

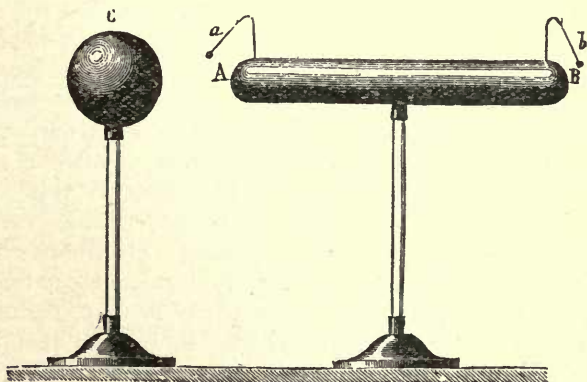

Fig. 10.

although it has not been rubbed itself, will be found to behave at its two ends as an electrified body. The ends of the conductor will attract little bits of paper; and if pith-balls be hung to the ends they are found to be repelled. It will, however, be found that the middle region of the long-shaped conductor will give no sign of any electrification. Further examination will show that the two electrifications on the ends of the conductor are of opposite kinds, that nearest the excited glass ball being a negative charge, and that at the farthest end being an equal charge, but of positive

sign. It appears then that a positive charge attracts negative and repels positive, and that this influence can be exerted at a distance from a body. If we had begun with a charge of negative electrification upon a stick of sealing-wax, the presence of the negative charge near the conductor would have induced a positive charge on the near end, and negative on the far end. This action, discovered in 1753 by John Canton, is spoken of as electric induction, or influence. It will take place across a considerable distance. Even if a large sheet of glass be placed between, the same effect will be produced. When the electrified body is removed both the charges disappear and leave no trace behind, and the glass ball is found to be just as much electrified as before ; it has parted with none of its own charge. It will be remembered that on one theory a body charged positively is regarded as having *more* electricity than the things round it, while one with a negative charge is regarded as having *less*. According to this view it would appear that when a body (such as the + electrified glass ball) having more electricity than things around it is placed near an insulated conductor, the uniform distribution of electricity in that conductor is disturbed, the electricity flowing away from that end which is near the + body, leaving less than usual at that end, and producing more than usual at the other end. This view of things will account for the disappearance of all signs of electrification when the electrified body is removed, for then the conductor returns to its former condition ; and being neither more nor less electrified than all the objects around on the surface of the earth, will show neither positive nor negative charge.

19. If the conductor be made in two parts, so that while under the inductive influence of the electrified body they can be separated, then on the removal of the electrified body the two charges can no longer return to neutralise one another, but remain each on their own

portion of the conductor, and may be examined at leisure.

If the conductor be not insulated on glass supports, but placed in contact with the ground, that end only which is nearest the electrified body will be found to be electrified. The repelled electricity is indeed repelled as far as possible—into the earth. One kind of electrification only is under these circumstances to be found, namely, the opposite kind to that of the excited body, whichever this may be. The same effect occurs in this case as if an electrified body had the power of attracting up the opposite kind of charge out of the earth, though the former way of regarding matters is more correct.

The quantity of the two charges thus separated by induction on such a conductor in the presence of a charge of electricity, depends upon the amount of the charge, and upon the distance of the charged body from the conductor. A highly electrified glass rod will produce a greater inductive effect than a less highly electrified one; and it produces a greater effect as it is brought nearer and nearer. The utmost it can do will be to induce on the near end a negative charge equal in amount to its own positive charge, and a similar amount of positive electricity at the far end; but usually, before the electrified body can be brought so near as to do this, something else occurs which entirely alters the condition of things. As the electrified body is brought nearer and nearer, the charges of opposite sign on the two opposed surfaces attract one another more and more strongly and accumulate more and more densely, until, as the electrified body approaches very near, a spark is seen to dart across, the two charges thus rushing together to neutralise one another, leaving the induced charge of positive electricity, which was formerly repelled to the other end of the conductor, as a permanent charge after the electrified body has been removed.

20. We are now able to apply the principle of

induction to explain why an electrified body should attract things that have not been electrified at all. Let a light ball be suspended by a silk thread (Fig. 11), and a rubbed glass rod held near it. The positive charge of the glass will induce a negative charge on the near side,

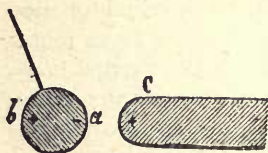

Fig. 11.

and an equal amount of positive electrification on the farther side, of the ball. The nearer half of the ball will therefore be attracted, and the farther half repelled; but the attraction will be stronger than the repulsion, because the attracted elec-

tricity is nearer than the repelled. Hence on the whole the ball will be attracted. It can easily be observed that if a ball of non-conducting substance, such as wax, be employed, it is not attracted so much as a ball of conducting material. This in itself *proves* that induction really precedes attraction.

21. Inductive capacity.—We have assumed up to this point that electricity could act at a distance, and could produce these effects of induction without any intervening means of communication. This, however, is not the case, for Faraday discovered that the air in between the electrified body and the conductor played a very important part in the production of these actions. Had some other substance, such as paraffin oil, or solid sulphur, occupied the intervening space, the effect produced by the presence of the electrified body at the same distance would have been greater. The power of a body thus to allow the inductive influence of an electrified body to act across it is called its **inductive capacity** (see Article 49 and Lesson XXII.)

22. The Electrophorus.—We are now prepared to explain the operation of a simple and ingenious instrument, devised by Volta in 1775, for the purpose of procuring, by the principle of induction, an unlimited,

number of charges of electricity from one single charge. This instrument is the **Electrophorus** (Fig. 12). It consists of two parts, a round cake of resinous material cast in a metal dish or "sole," about 12 inches in diameter, and a round disc of slightly smaller diameter made of metal, or of wood covered with tinfoil, and



Fig. 12

provided with a glass handle. Shellac, or sealing-wax, or a mixture of resin, shellac, and Venice turpentine, may be used to make the cake. A slab of sulphur will also answer, but it is liable to crack. Sheets of hard ebonised indiarubber are excellent; but the surface of this substance requires occasional washing with ammonia and rubbing with paraffin oil, as the sulphur contained

in it is liable to oxidise and to attract moisture. To use the electrophorus the resinous cake must be beaten or rubbed with a warm piece of woollen cloth, or, better still, with a cat's skin. The disc or "cover" is then placed upon the cake, touched momentarily with the finger, then removed by taking it up by the glass handle, when it is found to be powerfully electrified with a positive charge, so much so indeed as to yield a spark when the knuckle is presented to it. The "cover" may be replaced, touched, and once more removed, and will thus yield any number of sparks, the original charge on the resinous plate meanwhile remaining practically as strong as before.

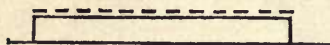

Fig. 13.

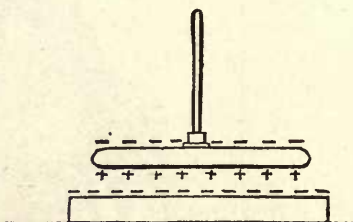

Fig. 14.

The theory of the electrophorus is very simple, provided the student has clearly grasped the principle of induction explained above. When the resinous cake is first beaten with the cat's skin its surface is negatively electrified, as indicated in Fig. 13. When the metal disc is placed down upon it, it rests really only on three or four points of the surface, and may be regarded as an insulated conductor in the presence of an electrified body. The negative electrification of the cake therefore acts inductively on the metallic disc or "cover," attracting a positive charge to its under side, and repelling a negative charge to its upper surface. This state of things is shown in Fig. 14. If now the cover be touched for an instant with the finger, the negative charge of the upper surface (which is upon the upper

surface being repelled by the negative charge on the cake) will be neutralised by electricity flowing in from the earth through the hand and body of the experimenter. The attracted positive charge will, however, remain, being bound as it were by its attraction towards the negative charge on the cake. Fig. 15 shows the condition of things after the cover has been touched. If, finally, the cover be lifted by its handle, the remaining positive charge will be no longer "bound" on the lower surface by attraction, but will distribute itself on both sides of

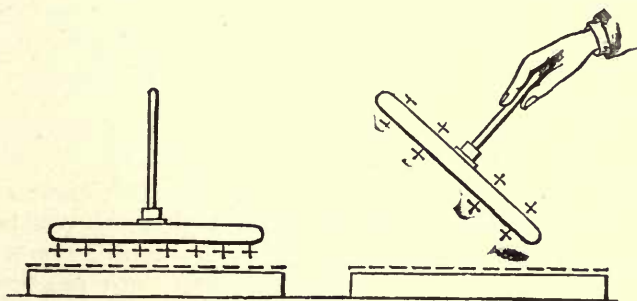

Fig. 15.

Fig. 16.

the cover, and may be used to give a spark, as already said. It is clear that no part of the original charge has been consumed in the process, which may be repeated as often as desired. As a matter of fact, the charge on the cake slowly dissipates—especially if the air be damp. Hence it is needful sometimes to renew the original charge by afresh beating the cake with the cat's skin. The labour of touching the cover with the finger at each operation may be saved by having a pin of brass or a strip of tinfoil projecting from the metallic "sole" on to the top of the cake, so that it touches the plate each time, and thus neutralises the negative charge by allowing electricity to flow in from the earth.

Since the electricity thus yielded by the electrophorus

is not obtained at the expense of any part of the original charge, it is a matter of some interest to inquire what the source is from which the energy of this apparently unlimited supply is drawn; for it cannot be called into existence without the expenditure of some other form of energy, any more than a steam-engine can work without fuel. As a matter of fact it is found that it is a little harder work to lift up the cover when it is charged with the + electricity than if it were not charged; for, when charged, there is the force of the electric attraction to be overcome as well as the force of gravity. Slightly harder work is done at the expense of the muscular energies of the operator; and this is the real origin of the energy stored up in the separate charges.

23. Continuous Electrophori.—The purely mechanical actions of putting down the disc on to the cake, touching it, and lifting it up, can be performed automatically by suitable mechanical arrangements, which render the production of these inductive charges practically continuous. The earliest of such continuous electrophori was Bennet's "Doubler," the latest is Wimshurst's machine, described in Lesson V.

24. "Free" and "Bound" Electricity.—We have spoken of a charge of electricity on the surface of a conductor, as being "bound" when it is attracted by the presence of a neighbouring charge of the opposite kind. The converse term "free" is sometimes applied to the ordinary state of electricity upon a charged conductor, not in the presence of a charge of an opposite kind. A "free" charge upon an insulated conductor flows away instantaneously to the earth, if a conducting channel be provided, as will be explained in the next lesson. It is immaterial what point of the conductor be touched. Thus, in the case represented in Fig. 10, wherein a + electrified body induces - electrification at the near end, and + electrification at the far end of an

insulated conductor, the $-$ charge is "bound," being attracted, while the $+$ charge at the other end, being repelled, is "free"; and if the insulated conductor be touched by a person standing on the ground, the "free" electricity will flow away to the earth through his body, while the "bound" electricity will remain, no matter whether he touch the conductor at the far end, or at the near end, or at the middle.

25. Inductive method of charging the Gold-leaf Electroscope.—The student will now be prepared to understand the method by which a Gold-Leaf Electroscope can be charged with the opposite kind of charge to that of the electrified body used to charge it. In Lesson II. it was assumed that the way to charge an electroscope was to place the excited body in contact with the knob, and thus permit, as it were, a small portion of the charge to flow into the gold leaves. A rod of glass rubbed on silk being $+$ would thus obviously impart $+$ electrification to the gold leaves.

Suppose, however, the rubbed glass rod to be held a few inches above the knob of the electroscope, as is indeed shown in Fig. 7. Even at this distance the gold leaves diverge, and the effect is due to induction. The gold leaves, and the brass wire and knob, form one continuous conductor, insulated from the ground by the glass jar. The presence of the $+$ electricity of the glass acts inductively on this "insulated conductor," inducing $-$ electrification on the near end or knob, and inducing $+$ at the far end, *i.e.*, on the gold leaves, which diverge. Of these two induced charges, the $-$ on the knob is "bound," while the $+$ on the leaves is "free." If now, while the excited rod is still held above the electroscope, the knob be touched by a person standing on the ground, one of these two induced charges flows to the ground, namely the free charge—not that on the knob itself, for it was "bound," but that on the gold leaves which was "free"—and the gold leaves

instantly drop down straight. There now remains only the - charge on the knob, "bound" so long as the + charge of the glass rod is near to attract it. But if, finally, the glass rod be taken right away, the - charge is no longer "bound" on the knob, but is "free" to flow into the leaves, which once more diverge—but this time with a *negative* electrification.

26. "The Return-Shock."—It is sometimes noticed that, when a charged conductor is suddenly discharged, a discharge is felt by persons standing near, or may even affect electroscopes, or yield sparks. This action, known as the "return-shock," is due to induction. For in the presence of a charged conductor a charge of opposite sign will be induced in neighbouring bodies, and on the discharge of the conductor these neighbouring bodies may also suddenly discharge their induced charge into the earth, or into other conducting bodies. A "return-shock" is sometimes felt by persons standing on the ground at the moment when a flash of lightning has struck an object some distance away.

LESSON IV.—*Conduction and Distribution of Electricity.*

27. **Conduction.**—Toward the close of Lesson I. we explained how certain bodies, such as the metals, conduct electricity, while others are non-conductors or insulators. This discovery is due to Stephen Gray; who, in 1729, found that a cork, inserted into the end of a rubbed glass tube, and even a rod of wood stuck into the cork, possessed the power of attracting light bodies. He found, similarly, that metallic wire and pack-thread conducted electricity, while silk did not.

We may repeat these experiments by taking (as in Fig. 17) a glass rod, fitted with a cork and a piece of wood. If a bullet or a brass knob be hung to the end of this by a linen thread or a wire, it is found that when the

glass tube is rubbed the bullet acquires the property of attracting light bodies. If a dry silk thread is used, however, no electricity will flow down to the bullet.

Gray even succeeded in transmitting a charge of electricity through a hempen thread over 700 feet long, suspended on silken loops. A little later Du Fay succeeded in sending electricity to no less a distance than 1256 feet through a moistened thread, thus proving the conducting power of moisture. From that time the classification of bodies into conductors and insulators has been observed.

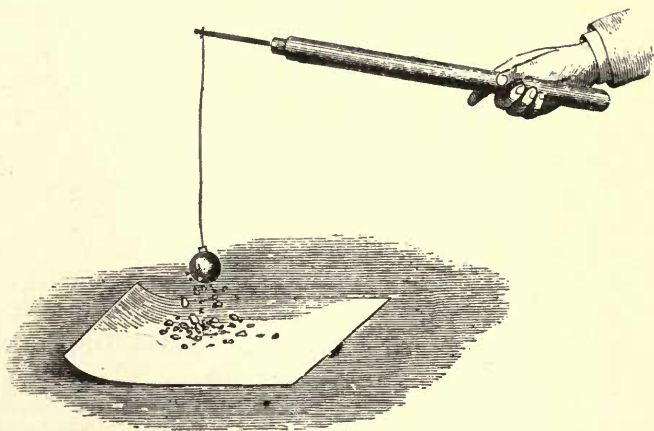

Fig. 17

This distinction cannot, however, be entirely maintained, as a large class of substances occupy an intermediate ground as partial conductors. For example, dry wood is a bad conductor and also a bad insulator; it is a good enough conductor to conduct away the high-potential electricity obtained by friction; but it is a bad conductor for the relatively low-potential electricity of small voltaic batteries. Substances that are very bad conductors are said to offer a great **resistance** to the

flow of electricity through them. There is indeed no substance so good a conductor as to be devoid of resistance. There is no substance of so high a resistance as not to conduct a little. Even silver, which conducts best of all known substances, resists the flow of electricity to a small extent ; and, on the other hand, such a non-conducting substance as glass, though its resistance is many million times greater than any metal, does allow a very small quantity of electricity to pass through it. In the following list, the substances named are placed in order, each conducting better than those lower down on the list.

Silver . . .	} Good Conductors.
Copper . . .	
Other metals . . .	
Charcoal . . .	
Water . . .	
The body . . .	} Partial Conductors.
Cotton . . .	
Dry Wood . . .	
Marble . . .	
Paper . . .	} Non-Conductors or Insulators.
Oils . . .	
Porcelain . . .	
Wool . . .	
Silk . . .	
Resin . . .	
Guttapercha . . .	
Shellac . . .	
Ebonite . . .	
Paraffin . . .	
Glass . . .	
Dry air . . .	

A simple way of observing experimentally whether a body is a conductor or not, is to take a charged gold-leaf electroscope, and, holding the substance to be examined in the hand, touch the knob of the electroscope with it. If the substance is a conductor the electricity will flow away through it and through the body to the earth, and the electroscope will be discharged. Through good conductors the rapidity of the flow is so

great that the discharge is practically instantaneous. Further information on this question is given in Lesson XXIII.

28. Distribution of Electricity on Bodies.—If electricity is produced at one part of a non-conducting body, it remains at that point and does not flow over the surface, or at most flows over it excessively slowly. Thus if a glass tube is rubbed at one end, only that one end is electrified. If a warm cake of resin be rubbed at one part with a piece of cloth, only the portion rubbed will attract light bodies. The case is, however, wholly different when a charge of electricity is imparted to any part of a conducting body placed on an insulating support, for it *instantly* distributes itself all over the surface, though in general not uniformly over all points of the surface.

29. The Charge resides on the surface.—A charge of electricity resides only on the surface of conducting bodies. This is proved by the fact that it is found to be immaterial to the distribution what the interior of a conductor is made of; it may be solid metal, or hollow, or even consist of wood covered with tinfoil or gilt, but, if the shape be the same, the charge will distribute itself precisely in the same manner over the surface. There are also several ways of proving by direct experiment this very important fact. Let a hollow metal ball, having an aperture at the top, be taken (as in Fig. 18), and set upon an insulating stem, and charged by sending into it a few sparks from an electrophorus. The absence of any charge in the interior may be shown as follows:—In order to observe the nature of the electricity of a charged body, it is convenient to have some means of removing a small quantity of the charge as a sample for examination. To obtain such a sample, a little instrument known as a **proof-plane** is employed. It consists of a little disc of sheet copper or of gilt paper fixed at the end of a small glass rod. If this disc is laid

on the surface of an electrified body at any point, part of the electricity flows into it, and it may be then removed, and the sample thus obtained may be examined with a Gold-leaf Electroscope in the ordinary way. For some purposes a metallic bead, fastened to the end of a glass rod, is more convenient than a flat disc. If such

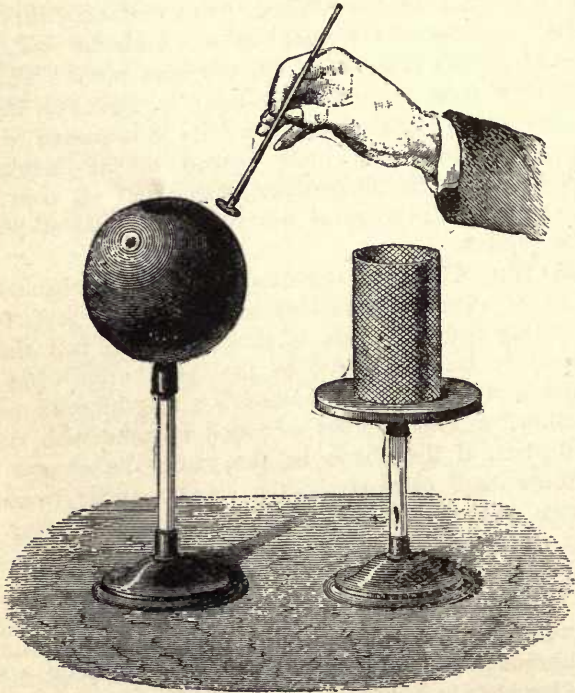

Fig. 18.

a proof-plane be applied to the outside of our electrified hollow ball, and then touched on the knob of an electroscope, the gold leaves will diverge, showing the presence of a charge. But if the proof-plane be carefully inserted through the opening, and touched against the *inside* of

the globe and then withdrawn, it will be found that the inside is destitute of electricity. An electrified pewter mug will show a similar result, and so will even a cylinder of gauze wire.

30. Biot's experiment.—Biot proved the same fact in another way. A copper ball was electrified and insulated. Two hollow hemispheres of copper, of a larger size, and furnished with glass handles, were then placed together outside it (Fig. 19). So long as they did not come into contact the charge remained on the

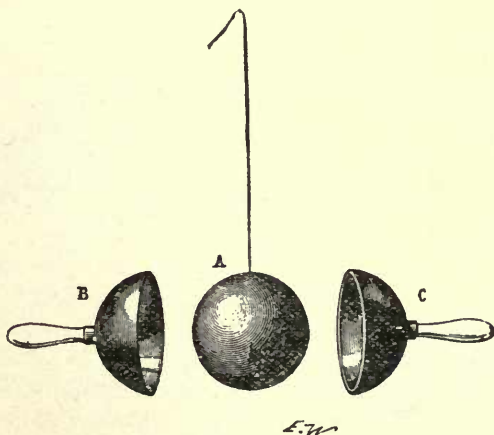

Fig. 19.

inner sphere; but if the outer shell touched the inner sphere for but an instant, the whole of the electricity passed to the exterior; and when the hemispheres were separated and removed the inner globe was found to be completely discharged.

31. Further explanation.—Doubtless the explanation of this behaviour of electricity is to be found in the property previously noticed as possessed by either kind of electricity, namely, that of repelling itself; hence it retreats as far as can be from the centre and remains

upon the surface. An important proposition concerning the absence of electric force within a closed conductor is proved in Lesson XX. , meanwhile it must be noted that the proofs, so far, are directed to demonstrate the absence of a free charge of electricity in the interior of hollow conductors. Many other experiments have been devised in proof. Thus, Terquem showed that a pair of gold leaves hung inside a wire cage could not be made to diverge when the cage was electrified. Faraday constructed a conical bag of linen-

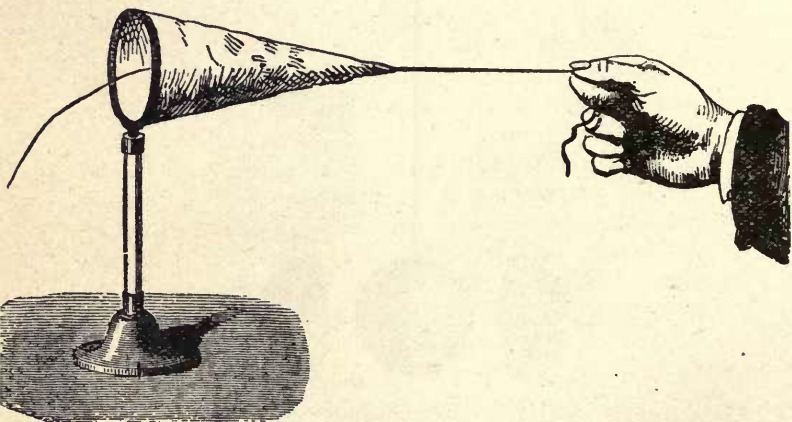

Fig. 20.

gauze, supported as in Fig. 20, upon an insulating stand, and to which silk strings were attached, by which it could be turned inside out. It was charged, and the charge was shown by the proof-plane and electro-scope to be on the outside of the bag. On turning it inside out the electricity was once more found *outside*. Faraday's most striking experiment was made with a hollow cube, measuring 12 feet each way, built of wood, covered with tinfoil, insulated, and charged with a powerful machine, so that large sparks and brushes

were darting off from every part of its outer surface. Into this cube Faraday took his most delicate electroscopes; but once within he failed to detect the least influence upon them.

32. Applications.—Advantage is taken of this in the construction of delicate electrometers and other instruments, which can be effectually screened from the influence of electrified bodies by enclosing them in a thin metal cover, closed all round, except where apertures must be made for purposes of observation. It has also been proposed by the late Prof. Clerk Maxwell to protect buildings from lightning by covering them on the exterior with a network of wires.

33. Apparent Exceptions.—There are two apparent exceptions to the law that electricity resides only on the outside of conductors. (1) If there are electrified insulated bodies actually placed inside the hollow conductor, the presence of these electrified bodies acts inductively and attracts the opposite kind of electricity to the inner side of the hollow conductor. (2) When electricity flows in a current, it flows through the substance of the conductor. The law is limited therefore to electricity at rest,—that is, to *statical* charges.

34. Faraday's "Ice-pail" Experiment.—One experiment of Faraday deserves notice, as showing the part played by induction in these phenomena. He gradually lowered a charged metallic ball into a hollow conductor connected by a wire to a gold-leaf electroscope (Fig. 21), and watched the effect. A pewter ice-pail being convenient for his purpose, this experiment is continually referred to by this name, though any other hollow conductor—a tin canister or a silver mug, placed on a glass support—would of course answer equally well. The following effects are observed:—Suppose the ball to have a + charge: as it is lowered into the hollow conductor the gold leaves begin to diverge, for the presence of the charge acts inductively, and attracts

a $-$ charge into the interior and repels a $+$ charge to the exterior. The gold leaves diverge more and more until the ball is right within the hollow conductor, after which no greater divergence is obtained. On letting the ball touch the inside the gold leaves still remain diverging as before, and if now the ball is pulled out it is found to have lost all its electricity.

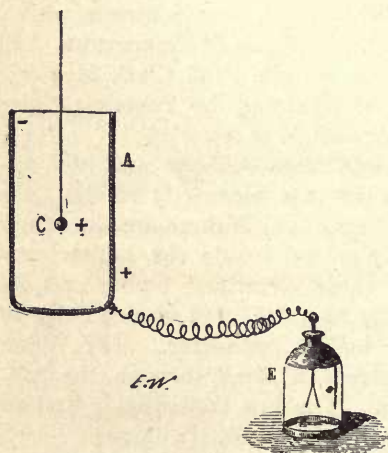

Fig. 21.

The fact that the gold leaves diverge no wider after the ball touched than they did just before, proves that when the charged ball is right inside the hollow conductor the induced charges are each of them precisely equal in amount to its own charge, and the interior negative charge exactly neutralises the charge on the ball at the moment when they touch, leaving the equal exterior charge unchanged. An *electric*

cage, such as this ice-pail, when connected with an electroscope or electrometer, affords an excellent means of examining the charge on a body small enough to be hung inside it. For without using up any of the charge of the body (which we are obliged to do when applying the method of the proof-plane) we can examine the induced charge repelled to the outside of the cage, which is equal in amount and of the same sign.

35. Distribution of Charge.—A charge of electricity is not usually distributed uniformly over the surfaces of bodies. Experiment shows that there is more electricity on the edges and corners of bodies than

upon their flatter parts. This distribution can be deduced from the theory laid down in Lesson XX., but meantime we will give some of the chief cases as they can be shown to exist. The term **Electric Density** is used to signify the amount of electricity at any point of a surface; *the electric density at a point is the number of units of electricity per unit of area (i.e. per square inch, or per square centimetre), the distribution being supposed uniform over this small surface.*

(a) **Sphere.**—The distribution of a charge over an insulated sphere of conducting material is uniform, provided the sphere is remote from the presence of all other conductors and all other electrified bodies; or, in

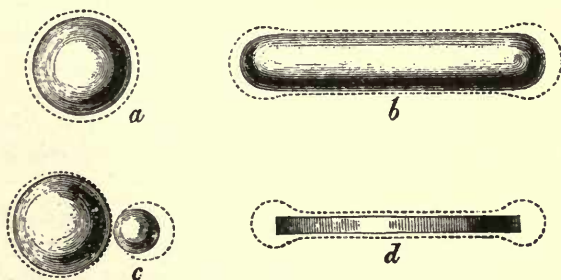

Fig. 22.

other words, the density is uniform all over it. This is symbolised by the dotted line round the sphere in Fig. 22, *a*, which is at an equal distance from the sphere all round, suggesting an equal thickness of electricity at every point of the surface. It must be remembered that the charge is not really of any perceptible thickness at all; it resides on or at the surface, but cannot be said to form a stratum upon it.

(b) **Cylinder with rounded ends.**—Upon an elongated conductor, such as is frequently employed in electrical apparatus, the density is greatest at the ends where the curvature of the surface is the greatest.

(c) **Two Spheres in contact.**—If two spheres in contact with each other are insulated and charged, it is found that the density is greatest at the parts farthest from the point of contact, and least in the crevice between them. If the spheres are of unequal sizes the density is greater on the smaller sphere, which has the surface more curved. On an egg-shaped or pear-shaped conductor the density is greatest at the small end. On a cone the density is greatest at the apex; and if the cone terminate in a sharp point the density there is very much greater than at any other point. At a point, indeed, the density of the collected electricity may be so great as to electrify the neighbouring particles of air, which then are repelled, thus producing a continual loss of charge. For this reason points and sharp edges are always avoided on electrical apparatus, except where it is specially desired to set up a discharge.

(d) **Flat Disc.**—The density of a charge upon a flat disc is greater, as we should expect, at the edges than on the flat surfaces; but over the flat surfaces the distribution is fairly uniform.

These various facts are ascertained by applying a small proof-plane successively at various points of the electrified bodies and examining the amount taken up by the proof-plane by means of an electroscope or electrometer. Coulomb, who investigated mathematically as well as experimentally many of the important cases of distribution, employed the torsion balance to verify his calculations. He investigated thus the case of the ellipsoid of revolution, and found the densities of the charges at the extremities of the axis to be proportional to the lengths of those axes. He also showed that the density of the charge at any other point of the surface of the ellipsoid was proportional to the length of the perpendicular drawn from the centre to the tangent at that point. Riess also investigated several interesting cases of distribution. He found the density at the middle of

the edges of a cube to be nearly two and a half times as great as the density at the middle of a face; while the density at a corner of the cube was more than four times as great.

36. Redistribution of Charge.—If any portion of the charge of an insulated conductor be removed, the remainder of the charge will immediately redistribute itself over the surface in the same manner as the original charge, provided it be also *isolated*, *i.e.*, that no other conductors or charged bodies be near to perturb the distribution by complicated effects of induction.

If a conductor be charged with any quantity of electricity, and another conductor of the same size and shape (but uncharged) be brought into contact with it for an instant and then separated, it will be found that the charge has divided itself equally between them. In the same way a charge may be divided equally into three or more parts by being distributed simultaneously over three or more equal and similar conductors brought into contact.

If two equal metal balls, suspended by silk strings, charged with unequal quantities of electricity, are brought for an instant into contact and then separated, it will be found that the charge has redistributed itself fairly, half the sum of the two charges being now the charge of each. This may even be extended to the case of charges of opposite signs. Thus, suppose two similar conductors to be electrified, one with a positive charge of 5 units and the other with 3 units of negative charge, when these are made to touch and separated, each will have a positive charge of 1 unit; for the algebraic sum of + 5 and - 3 is + 2, which, shared between the two equal conductors, leaves + 1 for each.

37. Capacity of Conductors.—If the conductors be unequal in size, or unlike in form, the shares taken by each in this redistribution will not be equal, but will be proportional to the electric *capacities* of the conductors. The definition of *capacity* in its relation

to electric quantities is given in Lesson XX., Art. 246. We may, however, make the remark, that two insulated conductors of the same form, but of different sizes, differ in their electrical *capacity*; for the larger one must have a larger amount of electricity imparted to it in order to electrify its surface to the same degree. The term *potential* is employed in this connection, in the following way:—A given quantity of electricity will electrify an isolated body up to a certain “potential” (or power of doing electric work) depending on its capacity. A large *quantity* of electricity imparted to a conductor of small *capacity* will electrify it up to a very high *potential*; just as a large quantity of water poured into a vessel of narrow capacity will raise the surface of the water to a high level in the vessel. The exact definition of Potential, in terms of energy spent against the electrical forces, is given in the Lesson on Electrostatics (Art. 237).

It will be found convenient to refer to a positively electrified body as one electrified to a *positive or high potential*; while a negatively electrified body may be looked upon as one electrified to a *low or negative potential*. And just as we take the level of the sea as a zero level, and measure the heights of mountains above it, and the depths of mines below it, using the sea level as a convenient point of reference for differences of level, so we take the potential of the earth's surface (for the surface of the earth is always electrified to a certain degree) as *zero potential*, and use it as a convenient point of reference from which to measure differences of electric potential.

LESSON V.—*Electrical Machines.*

38. For the purpose of procuring larger supplies of electricity than can be obtained by the rubbing of a rod of glass or shellac. electrical machines have been

devised. All electrical machines consist of two parts, one for producing, the other for collecting, the electricity. Experience has shown that the quantities of + and - electrification developed by friction upon the two surfaces rubbed against one another depend on the amount of friction, upon the extent of the surfaces rubbed, and also upon the nature of the substances used. If the two substances employed are near together on the list of electrics given in Art. 5, the electrical effect of rubbing them together will not be so great as if two substances widely separated in the series are chosen. To obtain the highest effect, the most positive and the most negative of the substances convenient for the construction of a machine should be taken, and the greatest available surface of them should be subjected to friction, the moving parts having a sufficient pressure against one another compatible with the required velocity.

The earliest form of electrical machine was devised by Otto von Guericke of Magdeburg, and consisted of a globe of sulphur fixed upon a spindle, and pressed with the dry surface of the hands while being made to rotate; with this he discovered the existence of electric sparks and the repulsion of similarly electrified bodies. Sir Isaac Newton replaced Von Guericke's globe of sulphur by a globe of glass. A little later the form of the machine was improved by various German electricians; Von Bose added a collector or "prime conductor," in the shape of an iron tube, supported by a person standing on cakes of resin to insulate him, or suspended by silken strings; Winckler of Leipzig substituted a leathern cushion for the hand as a rubber; and Gordon of Erfurth rendered the machine more easy of construction by using a glass cylinder instead of a glass globe. The electricity was led from the excited cylinder or globe to the prime conductor by a metallic chain which hung over against the globe. A pointed collector was not employed until after Franklin's famous

researches on the action of points. About 1760 De la Fond, Planta, Ramsden, and Cuthbertson, constructed machines having glass plates instead of cylinders. The only important modifications introduced since their time are the substitution of ebonite for glass, and the invention of machines depending on the principles of induction and convection.

39. The Cylinder Electrical Machine.—The Cylinder Electrical Machine, as usually constructed, consists of a glass cylinder mounted on a horizontal axis capable of being turned by a handle. Against it is pressed from behind a cushion of leather stuffed with horsehair, the surface of which is covered with a powdered amalgam of zinc or tin. A flap of silk attached to the cushion passes over the cylinder, covering its

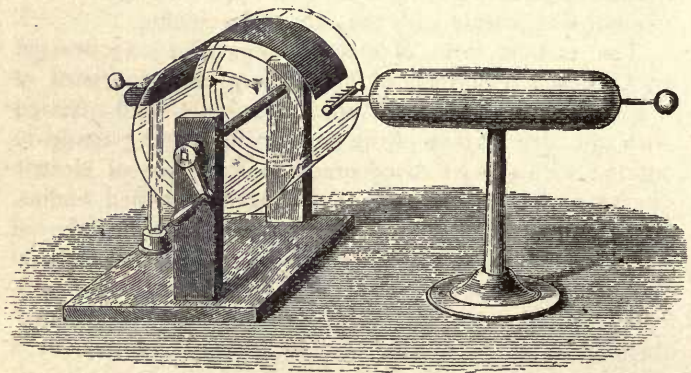

Fig. 23.

upper half. In front of the cylinder stands the "prime conductor," which is made of metal, and usually of the form of an elongated cylinder with hemispherical ends, mounted upon a glass stand. At the end of the prime conductor nearest the cylinder is fixed a rod bearing a row of fine metallic spikes, resembling in form a rake; the other end usually carries a rod terminated in a brass

ball or knob. The general aspect of the machine is shown in Fig. 23. When the handle is turned the friction between the glass and the amalgam-coated surface of the rubber produces a copious electrical action, electricity appearing as a + charge on the glass, leaving the rubber with a - charge. The prime conductor collects this charge by the following process:—The + charge being carried round on the glass acts inductively on the long insulated conductor, repelling a + charge to the far end; leaving the nearer end - ly charged. The effect of the row of points is to drive off in a continuous discharge - ly electrified air towards the attracting + charge upon the glass, which is neutralised thereby; the glass thus arriving at the rubber in a neutral condition ready to be again excited. This action of the points is sometimes described, though less correctly, by saying that the points collect the + electricity from the glass. If it is desired to collect also the - charge of the rubber, the cushion must be supported on an insulating stem and provided at the back with a metallic knob. This device, permitting either kind of charge to be used at will, is due to Nairne. It is, however, more usual to use only the + charge, and to connect the rubber by a chain to "earth," so allowing the - charge to be neutralised.

40. The Plate Electrical Machine.—The Plate Machine, as its name implies, is constructed with a circular plate of glass or of ebonite, and is usually provided with two pairs of rubbers formed of double cushions, pressing the plate between them, placed at its highest and lowest point, and provided with silk flaps, each extending over a quadrant of the circle. The prime conductor is either double or curved round to meet the plate at the two ends of its horizontal diameter, and is furnished with two sets of spikes, for the same purpose as the row of points in the cylinder machine. A common form of plate machine is shown in Fig. 24.

The action of the machine is, in all points of theoretical interest, the same as that of the cylinder machine. Its advantages are that a large glass plate is more easy to construct than a large glass cylinder of perfect form, and that the length along the surface of the glass between the

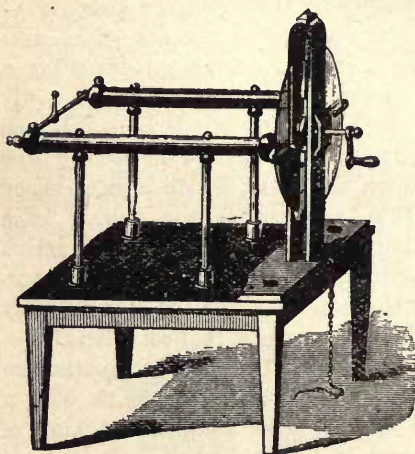

Fig. 24.

collecting row of points and the edge of the rubber cushions is greater in the plate than in the cylinder for the same amount of surface exposed to friction; for, be it remarked, when the two electricities thus separated have collected to a certain extent, a discharge will take place along this surface, the length of which limits therefore the power of the machine. In a more modern form,

due to Le Roy, and modified by Winter, there is but one rubber and flap, occupying a little over a quadrant of the plate, and one collector or double row of points. In Winter's machine the prime conductor consists of a ring-shaped body, for which the advantage is claimed of collecting larger quantities of electricity than the more usual sausage-shaped conductor. Whatever advantage the form may have is probably due to the curvature of its surface being on the whole greater than that of the commoner form.

41. Electrical Amalgam.—Canton, finding glass to be highly electrified when dipped into dry mercury, suggested the employment of an amalgam of tin with mercury as a suitable substance wherewith to cover the

surface of the rubbers. An amalgam of zinc is also effective; though still better is Kienmayer's amalgam, consisting of equal parts of tin and zinc, mixed while molten with twice their weight of mercury. Bisulphide of tin ("mosaic gold") may also be used. These amalgams are applied to the cushions with a little stiff grease. They serve the double purpose of conducting away the negative charge separated upon the rubber during the action of the machine, and of affording as a rubber a substance which is more powerfully negative (see list in Art. 5) than the leather or the silk of the cushion itself. Powdered graphite is also good.

42. Precautions in using Electrical Machines.

—Several precautions must be observed in the use of electrical machines. Damp and dust must be scrupulously avoided. The surface of glass is hygroscopic, hence, except in the driest climates, it is necessary to warm the glass surfaces and rubbers to dissipate the film of moisture which collects. Glass stems for insulation may be varnished with a thin coat of shellac varnish, or with paraffin (solid). A few drops of anhydrous paraffin (obtained by dropping a lump of sodium into a bottle of paraffin oil), applied with a bit of flannel to the previously warmed surfaces, hinders the deposit of moisture. An electrical machine which has not been used for some months will require a fresh coat of amalgam on its rubbers. These should be cleaned and warmed, a thin uniform layer of tallow or other stiff grease is spread upon them, and the amalgam, previously reduced to a fine powder, is sifted over the surface.

All points should be avoided in apparatus for frictional electricity except where they are desired, like the "collecting" spikes on the prime conductor, to let off a charge of electricity. All the rods, etc., in frictional apparatus are therefore made with knobs, so as to avoid sharp edges and points.

43. Experiments with the Electrical Machine.

—With the abundant supply of electricity afforded by the electrical machine, many pleasing and instructive experiments are possible. The phenomena of *attraction and repulsion* can be shown upon a large scale.

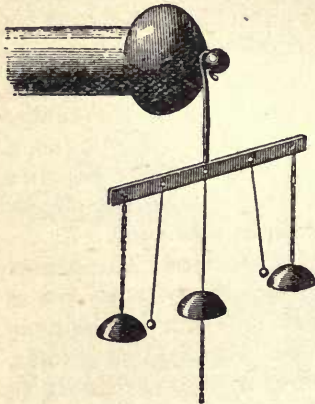

Fig. 25.

The phenomena of *attraction and repulsion* can be shown upon a large scale. Fig. 25 represents a device known as the **electric chimes**,¹ in which two small brass balls hung by silk strings are set in motion and strike against the bells between which they are hung. The two outer bells are hung by metallic wires or chains to the knob of the machine. The third bell is hung by a silk thread, but communicates with the ground by a brass chain. The balls are

first attracted to the electrified outer bells, then repelled, and, having discharged themselves against the uninsulated central bell, are again attracted, and so vibrate to and fro.

By another arrangement small figures or dolls cut out of pith can be made to dance up and down between a metal plate hung horizontally from the knob of the machine, and another flat plate an inch or two lower and communicating with "earth."

The *effect of points* in discharging electricity from the surface of a conductor may be readily proved by numerous experiments. If the machine be in good working order, and capable of giving, say, sparks four inches long when the knuckle is presented to the knob, it will be found that, on fastening a fine pointed needle

¹ Invented in 1752 by Franklin, for the purpose of warning him of the presence of atmospheric electricity, drawn from the air above his house by a pointed iron rod.

to the conductor, it discharges the electricity so effectually at its point that only the shortest sparks can be

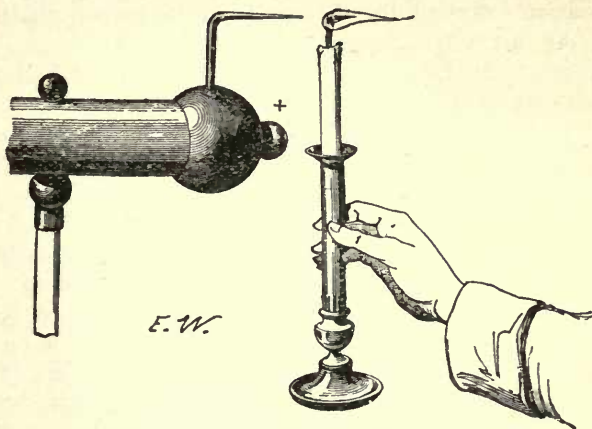

Fig. 26.

drawn at the knob, while a fine jet or brush of pale blue light will appear at the point. If a lighted taper be held in front of the point, the flame will be visibly blown aside (Fig. 26) by the streams of electrified air repelled from the point. These air-currents can be felt with the hand. They are due to a mutual repulsion between the electrified air-particles near the point and the electricity collected on the point itself. That this mutual *reaction* exists is proved by the electric fly or electric reaction-mill of Hamilton (Fig. 27), which consists of a light cross of brass or straw, suspended on a pivot,

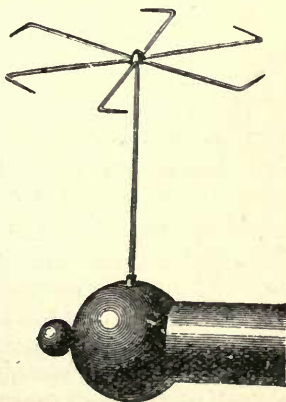

Fig. 27.

and having the pointed ends bent round at right angles. When placed on the prime conductor of the machine, or joined to it by a chain, the force of repulsion between the electricity of the points and that on the air immediately in front of them drives the mill round in the direction opposite to that in which the points are bent.

Another favourite way of exhibiting electric repulsion is by means of a doll with long hair placed on the machine; the individual hairs stand on end when the machine is worked, being repelled from the head, and from one another. A paper tassel will behave similarly if hung to the prime conductor. The most striking way of showing this phenomenon is to place a person upon a glass-legged stool, making him touch the knob of the machine; when the machine is worked, his hair, if dry, will stand on end. Sparks will pass freely between a person thus electrified and one standing upon the ground.

The sparks from the machine may be made to kindle spirits of wine or ether, placed in a metallic spoon, connected by a wire, with the nearest metallic conductor that runs into the ground. A gas jet may be lit by passing a spark to the burner from the finger of the person standing, as just described, upon an insulating stool.

44. Armstrong's Hydro-Electrical Machine.—

The friction of a jet of steam issuing from a boiler, through a wooden nozzle, generates electricity. In reality it is the particles of condensed water in the jet which are directly concerned. Sir W. Armstrong, who investigated this source of electricity, constructed a powerful apparatus, known as the **hydro-electrical machine** (Fig. 28), capable of producing enormous quantities of electricity, and yielding sparks five or six feet long. The collector consisted of a row of spikes, placed in the path of the steam jets issuing from the nozzles, and was supported, together with a brass ball

which served as prime-conductor, upon a glass pillar. The nozzles were made of wood, perforated with a crooked passage in order to increase the friction of the jet against the sides.

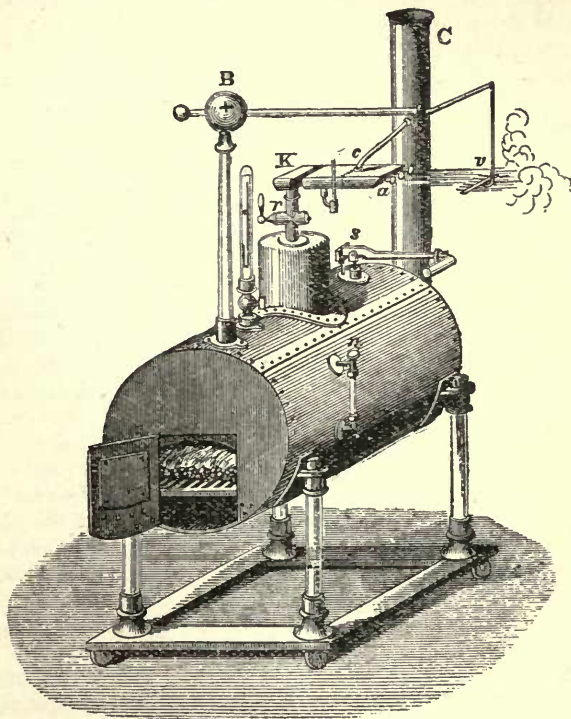

Fig. 28.

45. Convection-Induction Machines.—There is another class of electrical machine, differing entirely from those we have been describing, and depending upon the employment of a small initial charge which, acting *inductively*, produces other charges, which are then *conveyed* by the moving parts of the machine to some other point where they can increase the initial charge, or furnish a supply of electricity to a suitable collector. Of such instruments the oldest is the **Electrophorus** of Volta, explained fully in Lesson III. Bennet, Nicholson, Darwin, and others,

devised pieces of apparatus for accomplishing by mechanism that which the electrophorus accomplishes by hand. Nicholson's revolving doubler consists of a revolving apparatus, in which an insulated carrier can be brought into the presence of an electrified body, there touched for an instant to remove its repelled electricity, then carried forward with its acquired charge towards another body, to which it imparts its charge, and which in turn acts inductively on it, giving it an opposite charge which it can convey to the first body, thus increasing its initial charge at every rotation. Similar instruments have been contrived by Varley, Sir W. Thomson (the "replenisher"), Töpler, Carré, and Holtz. The two latter are perfectly continuous in their action, and have been well described as *continuous electrophori*. The machine of Holtz has come into such general use as to deserve explanation.

46. **Holtz's Influence Machine.**—The action of this machine is not altogether easy to grasp, though in reality simple enough when carefully explained. The machine in its latest form consists (see Fig. 29) of two plates, one, A, fixed by its edges, the other, B, mounted on an axis, and requiring to be rotated at a high speed by a band and driving pulley. There are two holes or windows, P and P', cut at opposite points of the fixed plate. Two pieces varnished paper, f and f' , are fastened to the plate above the window on the left and below the one on the right. These pieces of paper or *armatures* are upon the side of the fixed plate away from the movable disc, or, as we may say, upon the back of the plate. They are provided with narrow tongues which project forward through the windows towards the movable disc, which they nearly touch with their protruding points. The disc must rotate in the opposite direction to that in which these tongues point. On the front side of the moving disc, and opposite the forward edges of the two armatures, stands an oblique metal conductor, D, which need not be insulated. It has metal *combs* or spikes projecting towards the disc. On the right and left, supported on insulating holders, are two horizontal metal combs, joined to two metal rods terminated with brass balls, m , n , which in this form of machine merely constitute a discharging apparatus and are not concerned in the action of the machine. In some forms of Holtz machine there is no diagonal conductor D; and as the discharging apparatus has then to serve both functions, the balls m , n , must in these forms of machine touch one another before the machine

will charge itself. To work the machine a small initial charge must be given by an electrophorus, or by a rubbed glass rod, to one of the two armatures. The disc is then rapidly rotated ;

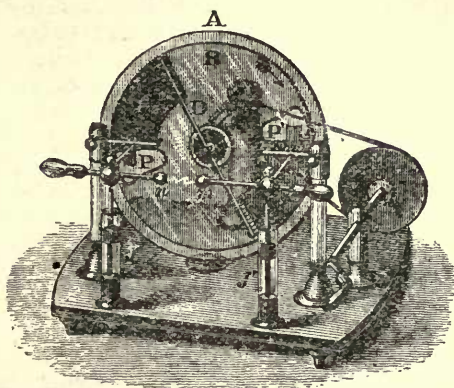

Fig. 29.

and it is found that after a few turns the exertion required to keep up the rotation increases greatly: at the same moment pale blue brushes of light are seen to issue from the points, and, on separating the brass balls, a torrent of brilliant sparks darts across the intervening space. The action of the machine is as follows. Sup-

pose a small + charge to be imparted at the outset to the right armature f' ; this charge acts inductively across the intervening glass and air upon the comb at the lower end of the diagonal conductor D, repels electricity through D, leaving the lower points negatively electrified. These discharge negatively electrified air upon the front surface of the movable disc, while the repelled + charge passes up along D, and is discharged through the upper comb upon the front face of the movable disc. Here it acts inductively upon the paper armature f , causing that part which is opposite the comb to be negatively charged, and repelling a + charge into its farthest part, viz. into the tongue, which slowly discharges a + charge upon the back of the moving disc. If now the disc be turned round, this + charge on the back comes over, in the direction indicated by the arrow, from the left to the right side; and, when it gets opposite the right tongue, is discharged into the armature f' , increasing its charge, and thereby helps that armature to act still more strongly than before. Meantime the - charge, which we saw had been induced in the left armature f , has in turn reacted on the upper comb, causing it to emit more powerfully than before a + charge from its points, and drawing electricity through the diagonal rod. The combs at the two ends of this rod therefore

both emit electrified streams of air, the upper one charging the upper portion of the front of the rotating disc positively, the lower one charging the lower portion of the disc negatively. The back of the rotating disc is at the same time similarly charged; and the charges carried round on the back surface serve to increase the charges on the two armatures. Hence a very small initial charge is speedily raised to a maximum, the

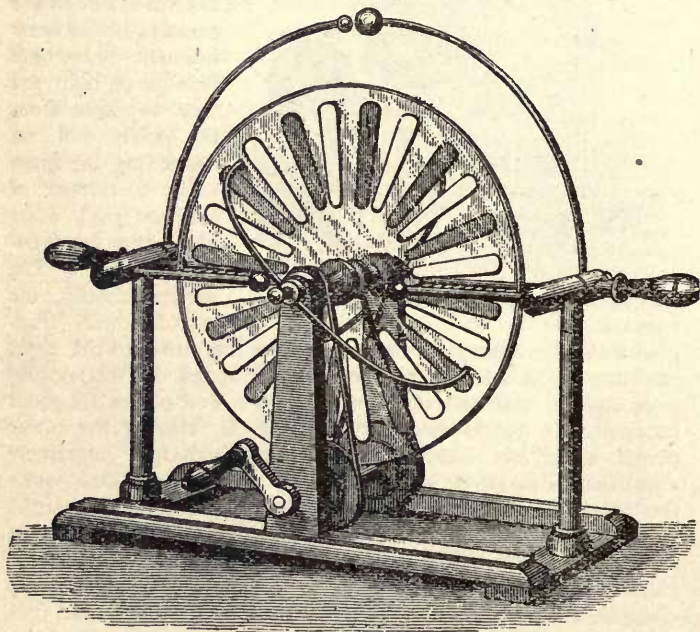

Fig. 29a.

limit being reached when the electrification of the armatures is so great that the leakage of electricity at their surface equals the gain by induction and convection. The charges let off by the spikes of the diagonal conductor upon the front surface of the moving disc are carried round and discharged into the right and left conductors of the discharging apparatus, by means of the horizontal combs which collect the charges exactly as explained on p. 43. Two small Leyden jars are usually added to increase the density of the sparks that pass between *m* and *n*.

In some recent Holtz machines, a number of rotating discs fixed upon one common axis are employed, and the whole is enclosed in a glass case to prevent access of damp. A small disc of ebonite is now usually fixed to the axis, and provided with a rubber in order to keep up the initial charge. Holtz has lately constructed a machine with thirty-two plates.

Mascart has shown the interesting fact that the Holtz machine is *reversible* in its action; that is to say, that if a continuous supply of the two electricities (furnished by another machine) be communicated to the armatures, the movable plate will be thereby set in rotation, and will turn in an opposite sense.

Rigli has shown that a Holtz machine can yield a continuous current like a voltaic battery, the strength of the current being nearly proportional to the velocity of rotation. It was found that the electromotive force of a machine was equal to that of 52,000 Daniell's cells, or nearly 53,000 volts, at all speeds. The resistance, when the machine made 120 revolutions per minute, was 2180 million ohms; but only 646 million ohms when making 450 revolutions per minute.

Voss has lately constructed a simple machine very like Fig. 29, but on Töpler's plan, having small metallic buttons affixed to the front of the rotating plate, these buttons being lightly touched, while rotating, by small metal brushes fixed upon the combs, thus providing by friction a minute initial charge. In this machine there are no windows, but small metal arms attached to the paper armatures and furnished with small brushes of metal foil are brought round to the front of the rotating plate, and touch the buttons as they pass. The buttons therefore act as carriers of charges that are induced in them by their being touched whilst under inductive influence.

46 (*bis*). Wimshurst's Influence Machine.—Still more recent is the machine of Wimshurst (Fig. 29a) in which the two plates rotate in opposite directions. Each plate has a series of small slips of thin metal foil upon it, which serve both as carriers and as armatures. There are two uninsulated diagonal conductors at the front and back; and two insulated collecting combs at the right and left, connected with a discharging apparatus. Each little carrier is touched by an uninsulated brush as it passes opposite the charged carrier of the other disc, and each thereby has a charge induced in it which it carries over to the collecting comb on the right or left.

LESSON VI.—*The Leyden Jar and other condensers.*

47. It was shown in previous lessons that the opposite charges of electricity attract one another; that electricity cannot flow through glass; and that yet electricity can *act across* glass by induction. Two suspended pith-balls, one electrified positively and the other negatively, will attract one another across the intervening air. If a plate of glass be put between them they will still

attract one another, though neither they themselves nor the electric charges on them can pass through the glass. If a pith-ball electrified with a - charge be hung inside a dry glass bottle, and a rubbed glass rod be held outside, the pith-ball will rush to the side of the bottle nearest to the glass rod, being attracted by the + charge thus brought near it. If a pane of glass be taken, and a piece of tinfoil be stuck upon the middle of each face of the pane, and one piece of tinfoil be charged positively, and the other negatively, the two charges will attract one another across the glass, and will no longer be found to be free. If the pane is set up on edge, so that neither piece of tinfoil touches the table, it will be found that hardly any electricity can be got by merely touching either of the foils, for the charges are "bound," so to speak, by each other's attractions; each charge is inducing the other. In fact it will be found that these two pieces of tinfoil may be, in this manner, charged a great deal more strongly than either of them could possibly be if it were stuck to a piece of glass alone, and then electrified. In other words, *the capacity of a conductor is greatly increased when it is placed near to a conductor electrified with the opposite kind of charge.* If its capacity is increased, a greater quantity of electricity may be put into it before it is charged to a high degree of potential. Hence, such an arrangement for holding a large quantity of electricity may be called a **condenser** or accumulator of electricity.

48. **Condensers.**—Next, suppose that we have two brass discs, A and B (Fig. 30), set upon insulating stems, and that a glass plate is placed between them. Let B be connected by a wire to the knob of an electrical machine, and let A be joined by a wire to "earth." The + charge upon B will act inductively across the glass plate on A, and will repel electricity into the earth, leaving the nearest face of A negatively electrified. This - charge on A will attract the + charge of

B to the side nearest the glass, and a fresh supply of electricity will come from the machine. Thus this arrangement will become an accumulator or condenser. If the two brass discs are pushed up close to the glass plate there will be a still stronger attraction between the + and - charges, because they are now nearer one another, and the inductive action will be greater; hence a still larger quantity can be accumulated in the plates. We see then that the capacity of an accumulator is increased by bringing the plates near together. If now, while the discs are strongly charged, the wires are removed and the discs are drawn backwards from one another, the two charges will not hold one another bound so strongly, and there will be more *free* electrification than before over their surfaces. This would be rendered evident to the experimenter by the little pith-ball electroscopes fixed to them (see the Fig.), which would fly out as the brass discs were moved apart.

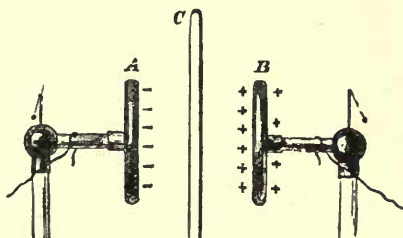

Fig. 30.

We have put no further charge on the disc B, and yet, from the indications of the electroscope, we should conclude that by moving it away from disc A it has become electrified to a higher degree. The fact is, that while the conductor B was near the - charge of A the *capacity* of B was greatly increased, but on moving it away from A its capacity has diminished, and hence the same quantity of electricity now electrifies it to a higher degree than before. The presence, therefore, of an earth-connected plate near an insulated conductor increases its capacity, and permits it to accumulate a greater charge by attracting and *condensing* the elec-

tricity upon the face nearest the earth-plate, the surface-density on this face being therefore very great. Such an arrangement is sometimes called a **condenser**, sometimes an **accumulator**. We shall call such an arrangement a condenser when the object of the earth-connected plate is to increase the surface-density of the charge upon one face of the insulated conductor. The term *accumulator* is now more often applied to batteries for storing the energy of electric currents (Art. 415).

The stratum of *air* between the two discs will suffice to insulate the two charges one from the other. The brass discs thus separated by a stratum of air constitute an **air-condenser**. Such condensers were first devised by Wilke and Aepinus.

49. Dielectrics.—In these experiments the sheet of glass or layer of air plays an important part by permitting the inductive electric influences to act across or through them. On account of this property these substances were termed by Faraday **dielectrics**. All dielectrics are insulators, but equally good insulators are not necessarily equally good dielectrics. Air and glass are far better insulators than ebonite or paraffin in the sense of being much worse conductors. But induction takes place better across a slab of glass than across a slab of ebonite or paraffin of equal thickness, and better still across these than across a layer of air. In other words, glass is a better **dielectric** than ebonite, or paraffin, or air. Those substances which are good dielectrics are said to possess a high *inductive capacity*.

50. Capacity of a Condenser.—It appears, therefore, that the capacity of a condenser will depend upon—

- (1) The size and form of the metal plates or coatings.
- (2) The thinness of the stratum of dielectric between them; and
- (3) The inductive capacity of the dielectric.

51. The Leyden Jar.—The Leyden Jar, called after

the city where it was invented, is a convenient form of condenser. It usually consists (Fig. 31) of a glass jar coated up to a certain height on the inside and outside with tinfoil. A brass knob fixed on the end of a stout brass wire passes downward through a lid or top of dry well-varnished wood, and communicates by a loose bit of brass chain with the inner coating of foil. To charge the jar the knob is held to the prime conductor of an electrical machine, the outer coating being either held in

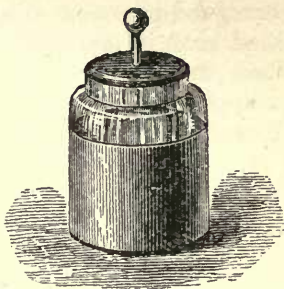

Fig. 31

the hand or connected to "earth" by a wire or chain. When a + charge of electricity is imparted thus to the inner coating, it acts inductively on the outer coating, attracting a - charge into the face of the outer coating nearest the glass, and repelling a + charge to the outside of the outer coating, and thence through the hand or wire to earth. After a few moments the jar will have acquired its full charge, the outer coating being - and the inner +. If the jar is of good glass, and dry, and free from dust, it will retain its charge for many hours or days. But if a path be provided by which the two mutually attracting electricities can flow to one another, they will do so, and the jar will be instantaneously discharged. If the outer coating be grasped with one hand, and the knuckle of the other



Fig. 32.

hand be presented to the knob of the jar, a bright spark will pass between the knob and the knuckle with a sharp report, and at the same moment a convulsive

“shock” will be communicated to the muscles of the wrists, elbows, and shoulders. A safer means of discharging the jar is afforded by the **discharging tongs** or **discharger** (Fig. 32), which consists of a jointed brass rod provided with brass knobs and a glass handle. One knob is laid against the outer coating, the other is then brought near the knob of the jar, and a bright snapping spark leaping from knob to knob announces that the two accumulated charges have flowed together, completing the discharge.

52. Discovery of the Leyden Jar.—The discovery of the Leyden jar arose from the attempt of Musschenbroek and his pupil Cuneus¹ to collect the supposed electric “fluid” in a bottle half filled with water, which was held in the hand and was provided with a nail to lead the “fluid” down through the cork to the water from the electric machine. Here the water served as an inner coating and the hand as an outer coating to the jar. Cuneus on touching the nail received a shock. This accidental discovery created the greatest excitement in Europe and America.

53. Residual Charges.—If a Leyden jar be charged and discharged and then left for a little time to itself, it will be found on again discharging that a small second spark can be obtained. There is in fact a residual charge which seems to have soaked into the glass or been absorbed. The return of the residual charge is hastened by tapping the jar. The amount of the residual charge varies with the time that the jar has been left charged; it also depends on the kind of the glass of which the jar is made. There is no residual charge discoverable in an air-condenser after it has once been discharged.

54. Batteries of Leyden Jars.—A large Leyden jar will give a more powerful shock than a small one,

¹ The honour of the invention of the jar is also claimed for Kleist, Bishop of Pomerania.

for a larger charge can be put into it: its capacity is greater. A Leyden jar made of *thin* glass has a greater capacity as an accumulator than a thick one of the same size; but if it is too thin it will be destroyed when powerfully charged by a spark actually piercing the glass. "Toughened" glass is less easily pierced than ordinary glass, and hence Leyden jars made

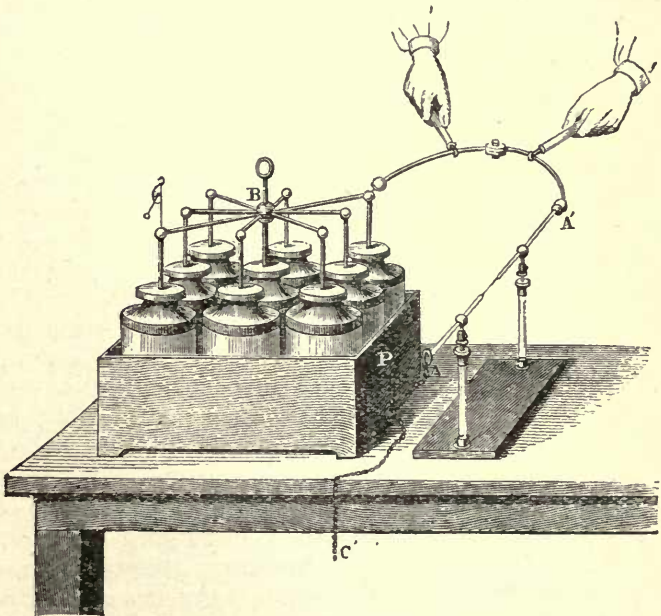

Fig. 33.

of it may be made thinner, and so will hold a greater charge.

If, however, it is desired to accumulate a very great charge of electricity, a number of jars must be employed, all their inner coatings being connected together, and all their outer coatings being united. This arrangement is called a **Battery of Leyden jars**, or Leyden

battery; Fig. 33. As it has a large capacity it will require a large quantity of electricity to charge it fully. When charged it produces very powerful effects; its spark will pierce glass readily, and every care must be taken to avoid a shock from it passing through the person, as it might be fatal. The "Universal Discharger" as employed with the Leyden battery is shown in the figure.

55. Seat of the charge. — Benjamin Franklin

discovered that the charges of the Leyden jar really resided on the surface of the glass, not on the metallic coatings. This he proved by means of a jar whose coatings could be removed, Fig. 34. The jar was charged and placed upon an insulating stand. The inner coating was then lifted out, and the glass jar was then taken out of the outer coating. Neither coating was found to be electrified to any extent; but on again putting the jar together it was found to be highly charged. The charges had all the time remained upon the inner and outer surfaces of the glass dielectric.

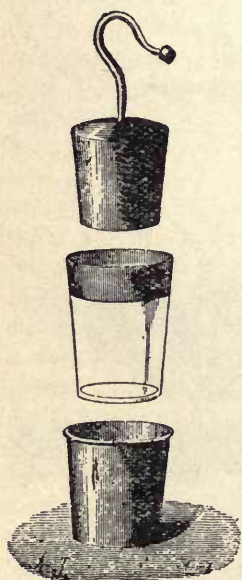

Fig. 34.

56. Dielectric Strain.—Faraday proved that the medium across which induction takes place really plays an important part in the phenomena. It is now known

that all dielectrics across which inductive actions are at work are thereby *strained*.¹ Inasmuch as a good vacuum is a good dielectric, it is clear that it is not

¹ In the exact sciences a *strain* means an alteration of form or volume due to the application of a stress. A *stress* is the force, pressure, or other agency which produces a strain.

necessarily the material particles of the dielectric substance that are thus affected ; hence it is believed that electrical phenomena are due to stresses and strains in the so-called "æther," the thin medium pervading all matter and all space, whose highly elastic constitution enables it to convey to us the vibrations of light though it is millions of times less dense than the air. As the particles of bodies are intimately surrounded by "æther," the strains of the "æther" are also communicated to the particles of bodies, and they too suffer a strain. The glass between the two coatings of tinfoil in the Leyden jar is actually strained or squeezed between the attracting charges of electricity. When an insulated charged ball is hung up in a room an equal amount of the opposite kind of electricity is attracted to the inside of the walls, and the air between the ball and the walls is strained (electrically) like the glass of the Leyden jar. If a Leyden jar is made of thin glass it may give way under the stress ; and when a Leyden jar is discharged the layer of air between the knob of the jar and the knob of the discharging tongs is more and more strained as they are approached towards one another, till at last the stress becomes too great, and the layer of air gives way, and is "perforated" by the spark that discharges itself across. The existence of such stresses enables us to understand the residual charge of Leyden jars in which the glass does not recover itself all at once, by reason of its viscosity, from the strain to which it has been subjected. This hypothesis, that electric force acts across space in consequence of the transmission of stresses and strains in the medium with which space is filled, is now entirely superseding the old theory of action-at-a-distance, which was logically unthinkable, and which, moreover, failed to account for the facts of observation.

LESSON VII.—*Other Sources of Electricity.*

57. It was remarked at the close of Lesson I. (p. 10), that friction was by no means the only source of electricity. Some of the other sources will now be named.

58. **Percussion.**—A violent blow struck by one substance upon another produces opposite electrical states on the two surfaces. It is possible indeed to draw up a list resembling that of Art. 5, in such an order that each substance will take a + charge on being struck with one lower on the list. Erman, who drew up such a list for a number of metals, remarked that the order was the same as that of the thermo-electric series given in Article 381.

59. **Vibration.**—Volpicelli showed that vibrations set up within a rod of metal coated with sulphur or other insulating substance, produced a separation of electricities at the surface separating the metal from the non-conductor.

60. **Disruption and Cleavage.**—If a card be torn asunder in the dark, sparks are seen, and the separated portions, when tested with an electroscope, will be found to be electrical. The linen faced with paper used in making strong envelopes and for paper collars, shows this very well. Lumps of sugar, crunched in the dark between the teeth, exhibit pale flashes of light. The sudden cleavage of a sheet of mica also produces sparks, and both laminae are found to be electrified.

61. **Crystallisation and Solidification.**—Many substances, after passing from the liquid to the solid state, exhibit electrical conditions. Sulphur fused in a glass dish and allowed to cool is violently electrified, as may be seen by lifting out the crystalline mass with a glass rod. Chocolate also becomes electrical during solidification. When arsenic acid crystallises out from its solution in

hydrochloric acid, the formation of each crystal is accompanied by a flash of light, doubtless due to an electrical discharge. A curious case occurs when the sulphate of copper and potassium is fused in a crucible. It solidifies without becoming electrical, but on cooling a little further the crystalline mass begins to fly to powder with an instant evolution of electricity.

62. Combustion.—Volta showed that combustion generated electricity. A piece of burning charcoal, or a burning pastille, such as is used for fumigation, placed in connection with the knob of a gold-leaf electroscope, will cause the leaves to diverge.

63. Evaporation.—The evaporation of liquids is often accompanied by electrification, the liquid and the vapour assuming opposite states. A few drops of a solution of sulphate of copper thrown into a hot platinum crucible produce violent electrification as they evaporate.

64. Atmospheric Electricity.—Closely connected with the electricity of evaporation is the atmospheric electricity always present in the air, and due, in part at least, to evaporation going on over the oceans. The subject of atmospheric electricity is treated of separately in Lesson XXIV.

65. Pressure.—A large number of substances when compressed exhibit electrification on their surface. Thus cork becomes + when pressed against amber, gutta-percha, and metals; while it takes a - charge when pressed against spars and animal substances. Abbe Haüy found that a crystal of calcspar pressed between the dry fingers, so as to compress it along the blunt edges of the crystal, became electrical, and that it retained its electricity for some days. He even proposed to employ a squeezed suspended crystal as an electroscope. A similar property is alleged of mica, topaz, and flourspar. Pressure also produces opposite kinds of electrification at opposite ends of a crystal of tourmaline

and of other crystals mentioned in the next paragraph.

66. Pyro-electricity.—There are certain crystals which, while being heated or cooled, exhibit electrical charges at certain regions or poles. Crystals thus electrified by heating or cooling are said to be **pyro-electric**. Chief of these is the **Tourmaline**, whose power of attracting light bodies to its ends after being heated has been known for some centuries. It is alluded to by Theophrastus and Pliny under the name of *Lapis Lyncurius*. The tourmaline is a hard mineral, semi-transparent when cut into thin slices, and of a dark green or brown colour, but looking perfectly black and opaque in its natural condition, and possessing the power of polarising light. It is usually found in slightly irregular three-sided prisms which, when perfect, are pointed at both ends. It belongs to the "hexagonal" system of crystals, but is only hemihedral, that is to say, has the alternate faces only developed. Its form is given in Fig. 35, where a general view is first shown, the two ends A and B being depicted in separate plans. It will be noticed that these two ends are slightly different from each other. Each is made up of three sloping faces terminating in a point. But at A the edges between these faces run down to the corners of the prism, while in B the edges between the terminal faces run down to the middle points of the long faces of the prism. The end A is known as the **analogous pole**, and B as the **antilogous pole**. While the crystal is rising in temperature A exhibits + electrification, B -; but if, after having been heated, it is allowed to cool, the polarity is reversed; for during the time that the temperature is falling B is + and A is -. If the temperature is steady no such electrical effects are observed either at high or low temperatures; and the phenomena cease if the crystal be warmed above 150° C. This is not, however, due, as Gauguain declared, to

the crystal becoming a conductor at that temperature; for its resistance at even higher temperatures is still so great as to make it practically a non-conductor. A heated crystal of tourmaline suspended by a silk fibre may be attracted and repelled by electrified bodies, or by a second heated tourmaline; the two similar poles repelling one another, while the two poles of opposite form attract one another. If a crystal be broken up, each fragment is found to possess also an analogous and an antilogous pole.

67. Many other crystals beside the tourmaline are more or less pyro-electric. Amongst these are silicate of

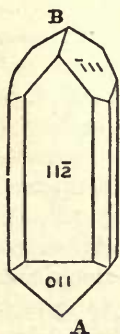

Fig. 35.

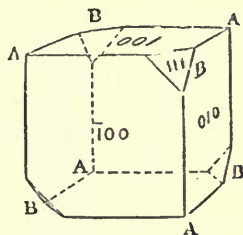
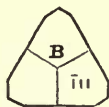

Fig. 36.

zinc ("electric calamine"), boracite, cane-sugar, quartz, tartrate of potash, sulphate of quinine, and several others. *Boracite* crystallises in the form shown in Fig. 36, which represents a cube having four alternate corners truncated. The corners not truncated behave as analogous poles, the truncated ones as antilogous. This peculiar skew-symmetry or hemihedry is exhibited by all the crystals enumerated above, and is doubtless due to the same molecular peculiarity which determines their singular electric property, and which also, in many cases, determines the optical behaviour of the crystal in polarised light.

68. **Animal Electricity.**—Several species of creatures inhabiting the water have the power of producing electric discharges by certain portions of their organism. The best known of these are the *Torpedo*, the *Gymnotus*, and the *Silurus*, found in the Nile and the Niger. The *Raia Torpedo*,¹ or electric ray, of which



Fig. 37.

there are three species inhabiting the Mediterranean and Atlantic, is provided with an electric organ on the back of its head, as shown in Fig. 37. This organ consists of laminæ composed of polygonal cells to the number of 800 or 1000, or more, supplied with four large bundles of nerve fibres; the under surface of the fish is -, the upper +. In the *Gymnotus electricus*, or Surinam eel (Fig. 38), the electric organ goes the whole length of the body along both sides. It is able to give a most terrible shock, and is a formidable antagonist when it has attained its full length of 5 or 6 feet. Humboldt gives a lively account of the combats between the electric eels and the wild horses, driven by the natives into the swamps inhabited by the *Gymnotus*.

Nobili, Matteucci, and others, have shown that nerve-

¹ It is a curious point that the Arabian name for the torpedo, *ra-ad*, signifies *lightning*. This is perhaps not so curious as that the *Electra* of the Homeric legends should possess certain qualities that would tend to suggest that she is a personification of the *lightning*. The resemblance between the names *electra* and *electron* (amber) cannot be accidental.

excitations and muscular contractions of human beings also give rise to feeble discharges of electricity.

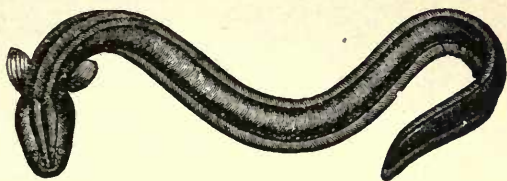

Fig. 38.

69. Electricity of Vegetables.—Buff thought he detected electrification produced by plant life; the roots and juicy parts being negatively, and the leaves positively, electrified. The subject has, however, been little investigated.

70. Thermo-electricity.—*Heat* applied at the junction of two dissimilar metals produces a flow of electricity across the junction. This subject is discussed in Lesson XXXIV. on *Thermo-electric Currents*.

71. Contact of dissimilar Metals.—Volta showed that the contact of two dissimilar metals produced opposite kinds of electricity on the two surfaces, one becoming positively, and the other negatively, electrified. This he proved in several ways, one of the most conclusive proofs being that afforded by his *condensing electroscope*. This consisted of a gold-leaf electroscope combined with a small condenser. A metallic plate formed the top of the electroscope, and on this was placed a second metallic plate furnished with a handle, and insulated from the lower one by being well varnished at the surface (Fig. 68). As the capacity of such a condenser is considerable, a very feeble source may supply a quantity of electricity to the condenser without materially raising its potential, or causing the gold leaves to diverge. But if the upper plate be lifted, the capacity of the lower plate diminishes enormously, and

the potential of its charge rises as shown by the divergence of the gold leaves. To prove by the condensing electroscope that contact of dissimilar metals does produce electrification, a small compound bar made of two dissimilar metals—say zinc and copper—soldered together, is held in the hand, and one end of it is touched against the lower plate, the upper plate being placed in contact with the ground or touched with the finger. When the two opposing charges have thus collected in the condenser the upper plate is removed, and the diverging of the gold leaves shows the presence of a free charge, which can afterwards be examined to see whether it be + or -. For a long time the existence of this electricity of contact was denied, or rather it was declared to be due (when occurring in voltaic combinations such as are described in Lesson XIII.) to chemical actions going on; whereas the real truth is that the electricity of contact and the chemical action are both due to molecular conditions of the substances which come into contact with one another, though we do not yet know the precise nature of the molecular conditions which give rise to these two effects. Later experiments, especially those made with the delicate electrometers of Sir W. Thomson (Fig. 101), put beyond doubt the reality of Volta's discovery. One simple experiment explains the

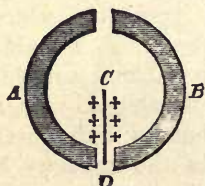

Fig 39.

method adopted. A thin strip or needle of metal is suspended so as to turn about a point C. It is electrified from a known source. Under it are placed (Fig. 39) two semicircular discs, or half-rings of dissimilar metals. Neither attracts or repels the electrified needle until the two are brought into contact, or connected by

a third piece of metal, when the needle immediately turns, being attracted by the one that is oppositely electrified, and repelled by the one that is similarly electrified with itself.

72. Volta found, moreover, that the differences of electric potential between the different pairs of metals were not all equal. Thus, while zinc and lead were respectively + and - to a slight degree, he found zinc and silver to be respectively + and - to a much greater degree. He was able to arrange the metals in a series such that each one enumerated became positively electrified when placed in contact with one below it in the series. Those in italics are added from observations made since Volta's time—

CONTACT-SERIES OF METALS (IN AIR).

+ *Sodium.*

Magnesium.

Zinc.

Lead.

Tin.

Iron.

Copper.

Silver.

Gold.

Platinum.

- *Graphite* (Carbon).

Though Volta gave rough approximations, the actual numerical values of the differences of potential for different pairs of metals have only lately been measured by Ayrton and Perry, a few of whose results are tabulated here—

				Difference of Potential (in volts)
Zinc	}	.	.	.210
Lead				
Tin	}	.	.	.313
Iron				
Copper	}	.	.	.146
Platinum				
Carbon	}	.	.	.113

The difference of potential between zinc and carbon is the same as that obtained by adding the successive differences, or 1.09 volts.¹ Volta's observations may therefore be stated in the following generalised form, known as **Volta's Law**. *The difference of potential between any two metals is equal to the sum of the differences of potentials between the intervening metals in the contact-series.*

It is most important to notice that the order of the metals in the contact-series *in air* is almost identical with that of the metals arranged according to their electro-chemical power, as calculated from their chemical equivalents and their heat of combination with oxygen (see Table, Art. 422 (*bis*)). From this it would appear that the difference of potentials between a metal and the air that surrounds it measures the tendency of that metal to become oxidised by the air. If this is so, and if (as is the case) the air is a bad conductor while the metals are good conductors, it ought to follow that when two different metals touch they equalise their own potentials by conduction but leave the films of air that surround them at different potentials. All the exact experiments yet made have measured the difference of potentials not between the metals themselves, but between the air near one metal and that near another metal. All this is most important in the theory of the voltaic cells. Mr. James Brown has lately demonstrated the existence on freshly-cleaned metal surfaces of *films* of liquid or condensed gases, and has shown that polished zinc and copper when brought so near that their films touch will act as a battery.

73. A difference of potential is also produced by the contact of *two dissimilar liquids* with one another.

A *liquid and a metal* in contact with one another also exhibit a difference of potential.

¹ For the definition of the *volt*, or unit of difference of potential, see Art 323.

A *hot* metal placed in contact with a *cold* piece of the same metal also produces a difference of potential, electrical separation taking place across the surface of contact.

Lastly, it has been shown by Prof. J. J. Thomson that the surface of contact between two non-conducting substances, such as sealing-wax and glass, is the seat of a permanent difference of potentials.

74. Magneto-electricity.—Electricity, in the form of currents flowing along in wires, can be obtained from magnets by moving closed conducting circuits in their neighbourhood. As this source of electricity yields currents rather than statical charges of electricity, the account of it is deferred to Lesson XXXVI.

75. Summary.—We have seen in the preceding paragraphs how almost all conceivable agencies may produce electrification in bodies. The most important of these are friction, heat, chemical action, magnetism, and the contact of dissimilar substances. We noted that the production of electricity by friction depended largely upon the molecular condition of the surfaces. We may here add that the difference of potentials produced by contact of dissimilar substances also varies with the temperature and with the nature of the medium (air, vacuum, etc.) in which the experiments are made. Doubtless this source also depends upon the molecular conditions of dissimilar substances being different; the particles at the surfaces being of different sizes and shapes, and vibrating with different velocities and with different forces. There are (see Art. 10) good reasons for thinking that the electricity of friction is really due to electricity of contact, excited at successive portions of the surfaces as they are moved over one another. But of the molecular conditions of bodies which determine the production of electricity where they come into contact, little or nothing is yet known.

CHAPTER II

MAGNETISM.

LESSON VIII.—*Magnetic Attraction and Repulsion.*

76. Natural Magnets or Lodestones.—The name Magnet (*Magnes Lapis*) was given by the ancients to certain hard black stones found in various parts of the world, notably at *Magnesia* in Asia Minor, which possessed the property of attracting to them small pieces of iron or steel. This magic property, as they deemed it, made the magnet-stone famous; but it was not until the tenth or twelfth century that such stones were discovered to have the still more remarkable property of pointing north and south when hung up by a thread. This property was turned to advantage in navigation, and from that time the magnet received the name of Lodestone¹ (or “leading-stone”). The natural magnet or lodestone is an ore of iron, known to mineralogists as *magnetite* and having the chemical composition Fe_3O_4 . This ore is found in quantities in Sweden, Spain, Arkansas, the Isle of Elba, and other parts of the world, though not always in the magnetic condition. It frequently occurs in crystals; the usual form being the regular octahedron.

77. Artificial Magnets.—If a piece of iron, or, better still, a piece of hard steel, be rubbed with a lodestone, it will be found to have also acquired the properties characteristic of the magnet; it will attract light bits of

¹ The common spelling *loadstone* is due to misapprehension.

iron, and, if hung up by a thread it will point north and south. Figures 40 and 41 represent a natural lodestone and an artificial magnet of steel, each of which has been dipped into iron-filings; the filings are attracted and adhere in tufts.

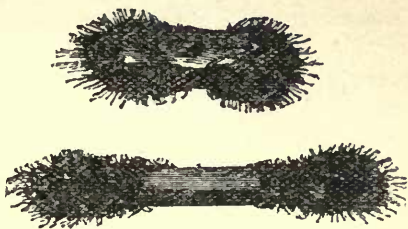

Figs. 40 and 41..

78. Discoveries of Dr. Gilbert.—This was all, or nearly all, that was known of the magnet until 1600, when Dr. Gilbert published a large number of magnetic discoveries in his famous work "*De Magnete.*" He observed that the attractive power of a magnet appears to reside at two regions, and in a long-shaped magnet these regions, or poles, are usually at the ends (see Figs. 40 and 41). The portion of the magnet which lies between the two poles is apparently less magnetic, and does not attract iron-filings so strongly; and all round the magnet, halfway between the poles, there is no attraction at all. This region Gilbert called the equator of the magnet, and the imaginary line joining the poles he termed the axis.

79. Magnetic Needle.—To investigate more fully the magnetic forces a magnetic needle is employed. This consists (Fig. 42) of a light needle cut out of steel, and fitted with a little cap of brass, glass, or agate, by means of which it can be hung upon a sharp point, so as to turn with very little friction. It is made into a magnet by being rubbed upon a magnet; and when thus magnetised will turn into the north-and-south position, or, as we should say, will set itself in the "magnetic meridian" (Art. 136). The *compass* sold by opticians consists of such a needle balanced above a card marked with the "points of the compass."

80. Magnetic Attractions and Repulsions.—

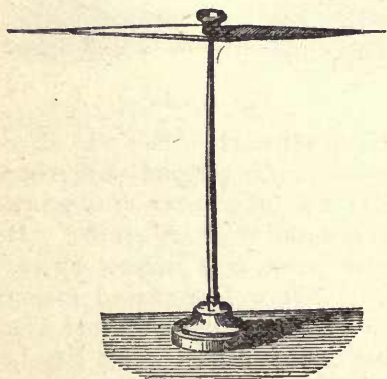

Fig. 42.

If we take a magnet (either natural or artificial) in our hand and present the two "poles" of it successively to the north-pointing end of a magnetic needle, we shall observe that one pole of the magnet *attracts* it, while the other *repels* it. (Fig. 43.) If we repeat the experiment on the south-pointing end of the magnetic needle, we shall find that it is *repelled* by one pole and *attracted* by

the other; and that the same pole which attracts the north-pointing end of the needle repels the south-pointing end.

If we try a similar experiment on the magnetic needle, using for a magnet a second magnetised needle which has previously been sus-

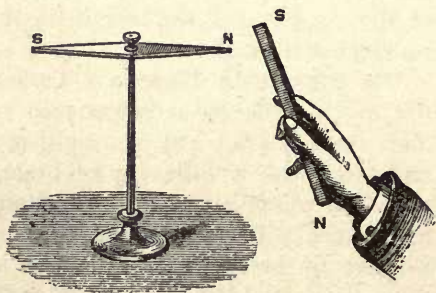

Fig. 43.

suspended, and which has its north-pointing end *marked* to distinguish it from the south-pointing end, we shall discover that the N.-pointing pole repels the N.-pointing

pole, and that the S.-pointing pole repels the S.-pointing pole ; but that a N.-pointing pole attracts and is attracted by a S.-pointing pole.

81. Two kinds of Magnetic Poles.—There would therefore appear to be two opposite kinds of magnetism, or at any rate two opposite kinds of magnetic poles, which attract or repel one another in very much the same fashion as the two opposite kinds of electricity do ; and one of these kinds of magnetism appears to have a tendency to move toward the north and the other to move toward the south. It has been proposed to call these two kinds of magnetism “north-seeking magnetism” and “south-seeking magnetism,” but for our purpose it is sufficient to distinguish between the two kinds of poles. In common parlance the poles of a magnet are called the “North Pole” and “South Pole” respectively, and it is usual for the makers of magnets to mark the N.-pointing pole with a letter N. It is therefore sometimes called the “marked” pole, to distinguish it from the S.-pointing or “unmarked” pole. We shall, to avoid any doubt,¹ call that pole of a magnet which would, if the magnet were suspended, tend to turn to the

¹ It is necessary to be precise on this point, as there is some confusion in the existing text-books. The cause of the confusion is this :—If the north-pointing pole of a needle is *attracted* by magnetism residing near the North Pole of the earth, the law of attraction (that *unlike poles attract*), shows us that these two poles are really magnetically of opposite kinds. Which are we then to call north magnetism? That which is at the N. pole of the earth? If so, we must say that the N.-pointing pole of the needle contains south magnetism. And if we call that north magnetism which points to the north, then we must suppose the magnetic pole at the north pole of the earth to have south magnetism in it. In either case there is then a difficulty. The Chinese and the French call the N.-pointing pole of the needle a south pole, and the S.-pointing pole a north pole. Sir Wm. Thomson also calls the N.-pointing pole a “True South” pole. But common practice goes the other way, and calls the N.-pointing pole of a magnet its “North” pole. For experimental purposes it is usual to paint the two poles of a magnet of different colours, the N.-seeking pole being coloured *red* and the S.-seeking pole *blue*; but here again, strangely enough, authorities differ, for in the collections of apparatus at the Royal Institution and Royal School of Mines, the colours are used in exactly the opposite way to this, which is due to Sir G. Airy.

north, the "North-seeking" pole, and the other the "South-seeking" pole.

We may therefore sum up our observations in the concise statement: *Like magnetic poles repel one another; unlike poles attract one another.* This we may call the first law of magnetism.

82. The two Poles inseparable.—It is impossible to obtain a magnet with only one pole. If we magnetise a piece of steel wire, or watch spring, by rubbing it with one pole of a magnet, we shall find that still it has two poles—one N.-seeking, the other S.-seeking. And if we break it into two parts, each part will still have two poles of opposite kinds.

83. Magnetic Force.—The force with which a magnet attracts or repels another magnet, or any piece of iron or steel, we shall call *magnetic force*.¹ The force exerted by a magnet upon a bit of iron or on another magnet is not the same at all distances, the force being greater when the magnet is nearer, and less when the magnet is farther off. In fact the attraction due to a magnet-pole falls off inversely as the square of the distance from the pole. (See Art. 117.)

Whenever a force acts thus between two bodies, it acts on both of them, tending to move both. A magnet will attract a piece of iron, and a piece of iron will attract a magnet. This was shown by Sir Isaac Newton, who fixed a magnet upon a piece of cork and floated it in a basin of water (Fig. 44), and found that it moved across the basin when a piece of iron was held near. A compass

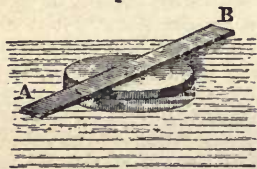

Fig. 44.

needle thus floated turns round and points north and south; but it does not rush towards the north as a whole, nor towards the south. The reason of this will be explained later, in Art. 117.

¹ See footnote on "Force," Art. 155.

Gilbert suggested that the force of a magnet might be measured by making it attract a piece of iron hung to one arm of a balance, weights being placed in the scalepan hanging to the other arm; and he found, by hanging the *magnet* to the balance and placing the *iron* beneath it, that the effect produced was the same. The action and reaction are then equal for magnetic forces.

84. Attraction across bodies.—If a sheet of glass, or wood, or paper, be interposed between a magnet and the piece of iron or steel it is attracting, it will still attract it as if nothing were interposed. A magnet sealed up in a glass tube still acts as a magnet. Lucretius found a magnet put into a brass vase attracted iron filings through the brass. Gilbert surrounded a magnet by a ring of flames, and found it still to be subject to magnetic attraction from without. Across water, vacuum, and all known substances, the magnetic forces will act; with the single exception, however, that magnetic force will not act across a *screen of iron* or other magnetic material. If a small magnet is suspended inside a hollow ball made of iron, no outside magnet will affect it. A hollow shell of iron will therefore act as a *magnetic cage*, and screen the space inside it from magnetic influences.

85. Magnetic Substances.—A distinction was drawn by Gilbert between *magnets* and *magnetic substances*. A magnet attracts only at its poles, and they possess opposite properties. But a lump of iron will attract either pole of the magnet, no matter what part of the lump be presented to the magnet. It has no distinguishable fixed "poles," and no magnetic "equator." A true magnet has poles, one of which is *repelled* by the pole of another magnet.

86. Other Magnetic Metals.—Later experimenters have extended the list of substances which are attracted by a magnet. In addition to iron (and steel) the following metals are recognised as magnetic:—

Nickel.
Cobalt.

Chromium.
Cerium.

Manganese,

and a few others. But only nickel and cobalt are at all comparable with iron and steel in magnetic power, and even they are very far inferior. Other bodies, sundry salts of iron and other metals, paper, porcelain, and oxygen gas, are also very feebly attracted by a powerful magnet.

87. Diamagnetism.—A number of bodies, notably bismuth, antimony, phosphorus, and copper, are repelled from the poles of a magnet. Such bodies are called *diamagnetic bodies*; a fuller account of them will be found in Lesson XXVIII.

88. The Earth a Magnet.—The greatest of Gilbert's discoveries was that of the inherent magnetism of the earth. *The earth is itself a great magnet*, whose "poles" coincide nearly, but not quite, with the geographical north and south poles, and therefore it causes a freely-suspended magnet to turn into a north and south position. The subject of *Terrestrial Magnetism* is treated of in Lesson XII. It is evident from the first law of magnetism that the magnetic condition of the northern regions of the earth must be the opposite to that of the north-seeking pole of a magnetised needle. Hence arises the difficulty alluded to on page 75.

89. Magnetic Induction.—Magnetism may be communicated to a piece of iron, without actual contact with a magnet. If a short, thin unmagnetised bar of iron, be placed near some iron filings, and a magnet be brought near to the bar, the presence of the magnet will *induce* magnetism in the iron bar, and it will now attract the iron filings (Fig. 45). This inductive action is very similar to that observed in Lesson III. to take place when an electrified body was brought near a non-electrified one. The analogy, indeed, goes farther than this, for it is found that the iron bar thus magnetised by induction will have two poles; the pole nearest to the

pole of the inducing magnet being of the opposite kind, while the pole at the farther end of the bar is of the same kind as the inducing pole. Magnetism can, however, only be induced in those bodies which we have enumerated as magnetic bodies; and those bodies in which a magnetising force produces a high degree of magnetisation are said to possess a high *co-efficient of magnetisation*. It will be shown presently that magnetic induction takes place along certain directions called *lines of magnetic induction*, or *lines of magnetic force*, which may pass either through iron and other magnetic media, or through air, vacuum,

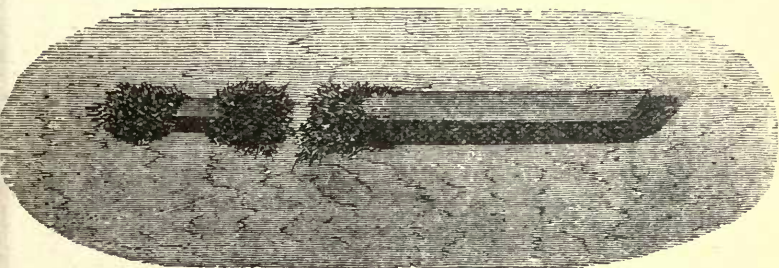

Fig. 45.

glass, or other non-magnetic media: and, since induction goes on most freely in bodies of high magnetic susceptibility, those lines of force are sometimes (though not too accurately) said to “pass by preference through magnetic matter,” or, that “magnetic matter conducts the lines of force.”

Although magnetic induction takes place at a distance across an intervening layer of air, glass, or vacuum, there is no doubt that the intervening medium is directly concerned in the transmission of the magnetic force, though probably the true medium is the “æther” of space surrounding the molecules of matter, not the molecules themselves.

We now can see why a magnet should attract a not-previously-magnetised piece of iron; it first magnetises it by induction and then attracts it: for the nearest end will have the opposite kind of magnetism induced in it, and will be attracted with a force exceeding that with which the more distant end is repelled. But *induction precedes attraction*.

90. Retention of Magnetisation.—Not all magnetic substances can become magnets permanently. Lodestone, steel, and nickel, retain permanently the greater part of the magnetism imparted to them. Cast iron and many impure qualities of wrought iron also retain magnetism imperfectly. Pure soft iron is, however, only temporarily magnetic.

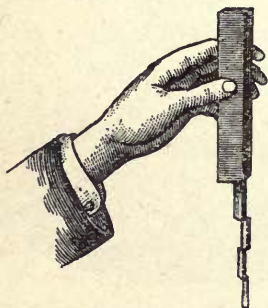

Fig. 46.

The following experiment illustrates the matter:—Let a few pieces of iron rod, or a few soft iron nails be taken. If one of these (see Fig. 46) be placed in contact with the pole of a permanent steel magnet, it is attracted to it, and becomes itself a temporary magnet. Another bit of iron may then be hung to it, and another, until a chain of four or five pieces is built up. But if the steel magnet be removed from the top of the chain, all the rest drop off, and are found to be no longer magnetic. A similar chain of steel needles may be formed, but they will retain their magnetism permanently.

It will be found, however, that a steel needle is more difficult to magnetise than an iron needle of the same dimensions. It is harder to get the magnetism *into* steel than into iron, and it is harder to get the magnetism *out* of steel than out of iron; for the steel retains the magnetism, once put into it. This power of resisting magnetisation or demagnetisation, is sometimes called

coercive force; a much better term, due to Lamont, is *retentivity*. The retentivity of hard-tempered steel is great; that of soft wrought iron is very small. The harder the steel, the greater its retentivity.

91. Theories of Magnetism.—The student will not have failed to observe the striking analogies between the phenomena of attraction, repulsion, induction, etc., of magnetism and those of electricity. Yet the two sets of phenomena are quite distinct. A positively electrified body does not attract either the North-pointing or the South-pointing pole of the magnet as such; in fact, it attracts either pole quite irrespective of its magnetism, just as it will attract any other body. There does exist, indeed, a direct relation between magnets and *currents* of electricity, as will be later explained. There is none known, however, between magnets and stationary *charges* of electricity.

No theory as to the nature of magnetism has yet been placed before the reader, who has thus been told the fundamental *facts* without bias. In many treatises it is the fashion to speak of a *magnetic fluid* or fluids; it is, however, *absolutely certain that magnetism is not a fluid*, whatever else it may be. The term, which is a relic of bygone times, is only tolerated because, under certain circumstances, magnetism distributes itself in magnetic bodies in the same manner as an elastic fluid would do. Yet the reasons against its being a fluid are even more conclusive than in the case of electricity. An electrified body when touched against another conductor, electrifies the conductor by giving up a part of its electricity to it. But a magnet when rubbed upon a piece of steel magnetises it *without giving up or losing any of its own magnetism*. A fluid cannot possibly propagate itself indefinitely without loss. The arguments to be derived from the behaviour of a magnet on breaking, and from other experiments narrated in Lesson X., are even stronger. No theory

of magnetism will therefore be propounded until these facts have been placed before the student.

LESSON IX.—*Methods of Making Magnets.*

92. Magnetisation by Single Touch.—It has been so far assumed that bars or needles of steel were to be magnetised by simply touching them, or stroking them from end to end with the pole of a permanent magnet of lodestone or steel. In this case the last touched point of the bar will be a pole of opposite kind to that used to touch it; and a more certain effect is produced if one pole of the magnet be rubbed on one end of the steel needle, and the other pole upon the other end. There are, however, better ways of magnetising a bar or needle.

93. Magnetisation by Divided Touch.—In this method the bar to be magnetised is laid down horizontally; two bar magnets are then placed down upon it, their opposite poles being together. They are then drawn asunder from the middle of the bar towards its

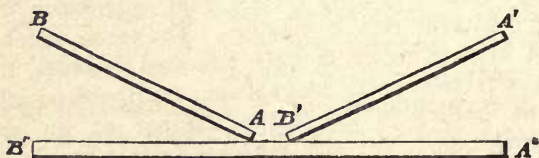

Fig. 47.

ends, and back, several times. The bar is then turned over, and the operation repeated, taking care to leave off at the middle (see Fig. 47). The process is more effectual if the ends of the bar are meantime supported on the poles of other bar magnets, the poles being of the same names as those of the two magnets above them used for stroking the steel bar.

94. Magnetisation by Double Touch.—Another

method, known as *double touch*, differs slightly from that last described. A piece of wood or cork is interposed between the ends of the two bar magnets employed, and they are then both moved backwards and forwards along the bar that is to be magnetised. By none of these methods, however, can a steel bar be magnetised beyond a certain degree of intensity.

95. Laminated Magnets.—It is found that long thin steel magnets are more powerful in proportion to their weight than thicker ones. Hence it was proposed by Scoresby¹ to construct compound magnets, consisting of thin laminae of steel separately magnetised, and afterwards bound together in bundles. These laminated magnets are more powerful than simple bars of steel.

96. Magnetisation derived from the Earth.—The magnetism of the earth may be utilised, where no other permanent magnet is available, to magnetise a bar of steel. Gilbert states that iron bars set upright for a long time, acquire magnetism from the earth. If a steel poker be held in the magnetic meridian, with the north end dipping down, and in this position be struck with a wooden mallet, it will be found to have acquired magnetic properties. Wires of steel subjected to torsion, while in the magnetic meridian, are also found to be thereby magnetised.

97. Magnetisation after Heating.—Gilbert discovered also that if a bar of steel be heated to redness, and cooled, either slowly or suddenly, while lying in the magnetic meridian, it acquires magnetic polarity. No such property is acquired if it is cooled while lying east-and-west. It has been proposed to make powerful magnets by placing hot bars of steel to cool between the poles of very powerful electro-magnets; and Carré has recently produced strong magnets of iron cast in moulds lying in an intense magnetic field.

¹ A similar suggestion was made by Geuns of Venlo in 1768. Similar magnets have been constructed recently by Jamin.

98. Magnetisation by Currents of Electricity. A strong current of electricity carried in a spiral wire around a bar of iron or steel, magnetises it more powerfully than in any of the preceding operations. In the case of a soft iron bar, it is only a magnet while the current continues to flow. Such a combination is termed an **Electro-magnet**; it is fully described in Lesson XXVI. Elias of Haarlem proposed to magnetise steel bars by passing them through a wire coiled up into a ring of many turns, through which a strong current was sent by a voltaic battery. Tommasi claims to have magnetised steel bars by passing a current of hot steam round them in a spiral tube: but the matter needs further evidence.

99. Destruction of Magnetism.—A steel magnet loses its magnetism partially or wholly if subjected to rough usage, or if purposely hit or knocked about. It also loses its magnetism, as Gilbert showed, on being raised to a red-heat.

100. Effects of Heat on Magnetisation.—If a permanent steel magnet be warmed by placing it in hot or boiling water, its strength will be thereby lessened, though it recovers partially on cooling. Chilling a magnet increases its strength. Cast iron ceases to be attracted by a magnet at a bright red-heat, or at a temperature of about 700° C. Cobalt retains its magnetism at the highest temperatures. Chromium ceases to be magnetic at about 500° C, and Nickel at 350° C. Manganese exhibits magnetic attraction only when cooled to -20° C. It has therefore been surmised that other metals would also become magnetic if cooled to a low enough temperature; but a very severe cooling to 100° below zero destroys the magnetism of steel magnets. The magnetic metals at high temperatures do not become diamagnetic, but are still feebly magnetic.

101. Forms of Magnets.—Natural Magnets are usually of irregular form, though they are sometimes

reduced to regular shapes by cutting or grinding. Formerly it was the fashion to mount them with soft iron cheeks or "armatures" to serve as pole-pieces.

For scientific experiments *bar magnets* of hardened steel are commonly used; but for many purposes the *horse-shoe* shape is preferred. In the horse shoe magnet the poles are bent round so as to approach one another, the advantage here being that so both poles can attract one piece of iron. The "armature," or "keeper," as the piece of soft iron placed across the poles is named, is itself rendered a magnet by induction when placed across the poles; hence, when *both* poles magnetise it, the force with which it is attracted to the magnet is the greater.

102. Magnetic Saturation.—A magnet to which as powerful a degree of magnetisation as it can attain to has been given is said to be "*saturated*." Many of the methods of magnetisation described will excite in a magnet a higher degree of magnetism than it is able to retain permanently. A recently magnetised magnet will occasionally appear to be *supersaturated*, even after the application of the magnetising force has ceased. Thus a horse-shoe-shaped steel magnet will support a greater weight immediately after being magnetised than it will do after its armature has been once removed from its poles. Even soft iron after being magnetised retains a small amount of magnetism when its *temporary magnetism* has disappeared. This small remaining magnetic charge is spoken of as *residual magnetism*.

Strength of a Magnet.—The "*strength*" of a magnet is not the same thing as its "*lifting-power*." The "*strength*" of a magnet is the "*strength*" of its poles. The "*strength*" of a magnet pole must be measured by the magnetic force which it exerts. Thus, suppose there are two magnets, A and B, whose strengths we compare by making them each act upon the N. pole of a third magnet C. If the N. pole of A repels C with twice as much force as that with which the N. pole of B placed

at the same distance would repel C, then we should say that the "strength" of A was twice that of B. Another way of putting the matter is to say that the "strength" of a pole is the amount of free magnetism at that pole. By adopting the unit of strength of magnet poles as defined in Art. 125, we can express the strength of any pole in numbers as so many "units" of strength.

103. Lifting Power.—The lifting power of a magnet (also called its "*portative force*") depends both upon the form of the magnet and on its magnetic strength. A horse-shoe magnet will lift a load three or four times as great as a bar magnet of the same weight will lift. The lifting power is greater if the area of contact between the poles and the armature is increased. Also the lifting power of a magnet grows in a very curious and unexplained way by gradually increasing the load on its armature day by day until it bears a load which at the outset it could not have done. Nevertheless, if the load is so increased that the armature is torn off, the power of the magnet falls at once to its original value. The attraction between a powerful electro-magnet and its armature may amount to 200 lbs. per square inch, or 14,000 grammes per square centimetre. Small magnets lift a greater load in proportion to their own weight than large ones.¹ A good steel horse-shoe magnet weighing itself one pound ought to lift twenty pounds' weight. Sir Isaac Newton is *said* to have possessed a little lodestone mounted in a signet ring which would lift a piece of iron 200 times its own weight.

¹ Bernoulli gave the following rule for finding the lifting-power p of a magnet whose weight was w :—

$$p = a \sqrt{\frac{3}{2} w};$$

where a is a constant depending on the goodness of the steel and the method of magnetising it. In the best steel magnets made at Haarlem by V. Wetteren this coefficient was from 19.5 to 23. In Breguet's magnets, made from Alleverd steel, the value is equally high.

LESSON X.—*Distribution of Magnetism.*

104. **Normal Distribution.**—In an ordinary bar magnet the poles are not quite at the ends of the bar, but a little way from it; and it can be shown that this is a result of the way in which the magnetism is distributed in the bar. A very long, thin, uniformly magnetised bar has its poles at the ends; but in ordinary thick magnets the “pole” occupies a considerable region, the “free magnetism” falling off gradually from the ends of the bar. In each region, however, a point can be determined at which the resultant magnetic forces act, and which may for most purposes be considered as the pole. In certain cases of irregular magnetisation it is possible to have one or more poles between those at the ends. Such poles are called *consequent poles* (see Fig. 51).

105. **Magnetic Field.**—The space all round a magnet pervaded by the magnetic forces is termed the “*field*” of that magnet. It is most intense near the pole of the magnet, and is weaker and weaker at greater distances away from it. At every point in a magnetic field the force has a particular strength, and the magnetic induction acts in a particular direction or line. In the horse-shoe magnet the field is most intense between the two poles, and the lines of magnetic induction are curves which pass from one pole to the other across the field. A practical way of investigating the distribution of the lines of induction in a field is given in Art. 108, under the title “Magnetic Figures.” When the armature is placed upon the poles of a horse-shoe magnet, the force of the magnet on all the external regions is weakened, for the induction now goes on through the iron of the keeper, not through the surrounding space. In fact a *closed system* of magnets—such as that made by placing four bar magnets along the sides of a square, the N. pole of one touching the S. pole of the next—has no external field of force. A *ring* of steel may thus be magnetised

so as to have neither external field nor poles; or rather any point in it may be regarded as a N. pole and a S. pole, so close together that they neutralise one another's forces.

That poles of opposite name do neutralise one another may be shown by the well-known experiment of hanging a small object—a steel ring or a key—to the N. pole of a bar magnet. If now the S. pole of another bar magnet be made to touch the first the two poles will neutralise each other's actions, and the ring or key will drop down.

106. **Breaking a Magnet.**—We have already stated that when a magnet is broken into two or more parts, each is a complete magnet, possessing poles, and each is nearly as strongly magnetised as the original magnet. Fig. 48 shows this. If the broken parts be closely joined



Fig. 48.

these adjacent poles neutralise one another and disappear, leaving only the poles at the ends as before. If a magnet be ground to powder each fragment will still act as a little magnet and exhibit polarity. A magnet may therefore be regarded as composed of many little magnets

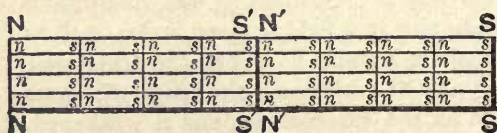

Fig. 49.

put together, so that their like poles all face one way. Such an arrangement is indicated in Fig. 49, from which it will be seen that if the magnet be broken asunder across any part, one face of the fracture will present only N.

poles, the other only S. poles. This would be true no matter how small the individual particles.

If the intrinsic magnetisation of the steel at every part of a magnet were equal, the free poles would be found only at the ends; but the fact that the free magnetism is not at the ends merely, but diminishes from the ends towards the middle, shows that the intensity of the intrinsic magnetisation must be less towards and at the ends than it is at the middle of the bar.

107. Lamellar Distribution of Magnetism.

Magnetic Shells.—Up to this point the ordinary distribution of magnetism along a bar has been the only distribution considered. But it is possible to have magnetism distributed over a thin sheet so that the whole of one face of the sheet shall have one kind of magnetism, and the other face the other kind of magnetism. If an immense number of little magnets were placed together side by side, like the cells in a honey comb, all with their N.-seeking ends upwards, and S.-seeking ends downwards, the whole of one face of the slab would be one large flat N.-seeking pole, and the other face S.-seeking. Such a distribution as this over a surface or sheet is termed a **lamellar** distribution, to distinguish it from the ordinary distribution along a line or bar, which is termed, for distinction, the **solenoidal** distribution. A lamellarly magnetised magnet is sometimes spoken of as a **magnetic shell**. The properties of magnetic shells are extremely important on account of their analogy with those of closed voltaic circuits.

108. Magnetic Figures.—Gilbert showed¹ that if a sheet of paper or card be placed over a magnet, and iron-filings are dusted over the paper, they settle down in curving lines, forming a *magnetic figure*, the general form of which is shown in Fig. 50. The filings should be fine, and sifted through a bit of muslin; to facilitate their settling in the lines, the sheet of paper should be

¹ The magnetic figures were known to Lucretius.

lightly tapped. The figures thus obtained can be fixed permanently by several processes. The best of these consists in employing a sheet of glass which has been previously gummed and dried, instead of the sheet of paper; after this has been placed above the magnet the filings are sifted evenly over the surface, and then the glass is tapped; then a jet of steam is caused to play gently above the sheet, softening the surface of the gum, which, as it hardens, fixes the filings in their places. In-

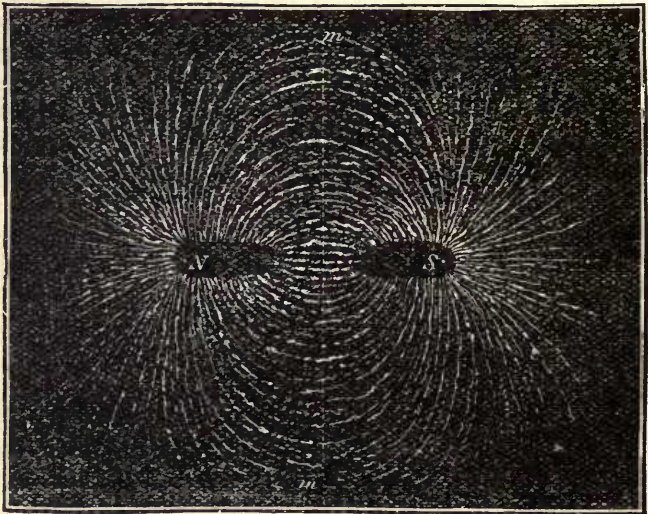

Fig. 50.

spection of the figure will show that the lines diverge nearly radially from each pole, and curve round to meet these from the opposite pole. Faraday, who made a great use of this method of investigating the distribution of magnetism in various "fields," gave to the lines the name of **lines of force**. They represent, as shown by the action on little magnetic particles which set themselves thus in obedience to the attractions and repulsions

in the field, the resultant direction of the forces at every point; for each particle tends to assume the direction of the magnetic induction due to the simultaneous action of both poles: hence they may be taken to represent the *lines of magnetic induction*.¹ Faraday pointed out that these "lines of force" map out the magnetic field, showing by their position the direction of the magnetic force, and by their number its intensity. If a small N.-seeking pole could be obtained alone, and put down on any one of these lines of force, it would tend to move along that line from N. to S.; a single S.-seeking pole would tend to move along the line in an opposite direction. Faraday also assigned to these lines of force certain physical properties (which are, however, only true of them in a secondary sense), viz., that they tend to shorten themselves from end to end, and that they repel one another as they lie side by side. The modern view, which holds that magnetism results from certain properties of the "æther" of space, is content to say that in every magnetic field there are certain stresses, which produce a tension along the lines of force, and a pressure across them.

109. This method may be applied to ascertain the presence of "*consequent poles*" in a bar of steel, the figure obtained resembling that depicted in Fig. 51. Such a state of things is produced when a strip of very hard steel is purposely irregularly magnetised by touching it with strong magnets at certain points. A strip thus magnetised virtually consists of several magnets put end to end, but in reverse directions, N.-S., S.-N., etc.

110. The forces producing attraction between unlike poles, and repulsion between like poles, are beautifully illustrated by the magnetic figures obtained in the fields between the poles in the two cases, as given in Figs.

¹ Or rather the component part of the magnetic induction resolved into the plane of the figure; which is not quite the same thing, for above the poles the filings stand up nearly vertically to this plane.

52 and 53. In Fig. 52 the poles are of opposite kinds, and the lines of force curve across out of one pole into the other; while in Fig. 53, which represents the action



Fig. 51.

of two similar poles, the lines of force curve away as if repelling one another, and turn aside at right angles. Musschenbroek first pointed out the essential difference between these two figures.

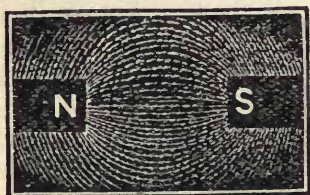

Fig. 52.



Fig. 53.

111. Magnetic Writing.—Another kind of magnetic figures was discovered by De Haldat, who wrote with the pole of a magnet upon a thin steel plate (such as a saw-blade), and then sprinkled filings over it. The writing, which is quite invisible in itself, comes out in the lines of filings that stick to the magnetised parts; this magic writing will continue in a steel plate many months. The author of these Lessons has produced similar figures in

iron filings by writing upon a steel plate with the wires coming from a powerful voltaic battery.

112. Surface Magnetisation.—In many cases the magnetism imparted to magnets is confined chiefly to the outer layers of steel. If a steel magnet be put into acid so that the outer layers are dissolved away, it is found that it has lost its magnetism when only a thin film has been thus removed. Magnets which have been magnetised very thoroughly, however, exhibit some magnetism in the interior. A hollow steel tube when magnetised is nearly as strong a magnet as a solid rod of the same size. If a bundle of steel plates are magnetised while bound together, it will be found that only the outer ones are strongly magnetised. The inner ones may even exhibit a reversed magnetisation.

113. Mechanical effects of Magnetisation.—When a steel or iron bar is powerfully magnetised it grows a little longer than before; and, since its volume is the same as before, it at the same time contracts in thickness. Joule found an iron bar to increase by $\frac{1}{71000}$ of its length when magnetised to its maximum. This phenomenon is believed to be due to the magnetisation of the individual particles, which, when magnetised, tend to set themselves parallel to the length of the bar. This supposition is confirmed by the observation of Page, that at the moment when a bar is magnetised or demagnetised, a faint metallic clink is heard in the bar. Sir W. Grove showed that when a tube containing water rendered muddy by stirring up in it finely divided magnetic oxide of iron was magnetised, the liquid became clearer in the direction of magnetisation, the particles apparently setting themselves end-on, and allowing more light to pass between them. A twisted iron wire tends to untwist itself when magnetised. A piece of iron, when powerfully magnetised and demagnetised in rapid succession, grows hot, as if magnetisation were accompanied by internal friction.

114. Action of Magnetism on Light.—Faraday

discovered that a ray of polarised light passing through certain substances in a powerful magnetic field has the direction of its vibrations changed. This phenomenon, which is sometimes called "The Magnetisation of Light," is better described as "The Rotation of the Plane of Polarisation of Light by Magnetism." The amount of rotation differs in different media, and varies with the magnetising force. More recently Kerr has shown that a ray of polarised light is also rotated by reflection at the end or side of a powerful magnet. Further mention is made of these discoveries in the Chapter on Electro-optics, Lesson XXXV.

115. **Physical Theory of Magnetism.**—All these various phenomena point to a theory of magnetism very different from the old notion of fluids. It appears that every particle of a magnet is itself a magnet, and that the magnet only becomes a magnet as a whole by the particles being so turned as to point one way. This conclusion is supported by the observation that if a glass tube full of iron filings is magnetised, the filings can be seen to set themselves endways, and that, when thus once set, they act as a magnet until shaken up. It appears to be harder to turn the individual molecules of solid steel, but, when once so set, they remain end-on unless violently struck or heated. It follows from this theory that when all the particles were turned end-on the limits of possible magnetisation would have been attained. Some careful experiments of Beetz on iron deposited by electrolysis entirely confirm this conclusion, and add weight to the theory. The optical phenomena led Clerk Maxwell to the further conclusion that these longitudinally-set molecules are rotating round their long axes, and that in the "æther" of space there is also a vortical motion along the lines of magnetic induction; this motion, if occurring in a perfect medium (as the "æther" may be considered), producing tensions along the lines and pressures at right angles to them, would afford a satisfactory explanation of the magnetic attractions and repulsions which apparently act across empty space. Hughes has lately shown that the magnetism of iron and steel is intimately connected with the molecular rigidity of the material. His researches with the "induction balance" (Art. 438) and "magnetic balance" (Art. 439) tend to prove that each molecule of a magnetic metal has an absolutely constant inherent magnetic polarity; and that when a piece of iron or steel is apparently neutral, its molecules are internally arranged so as to satisfy each other's polarity, forming closed magnetic circuits amongst

themselves. On this view magnetising a piece of iron simply causes the molecules to rotate into new and symmetrical positions.

LESSON XI.—*Laws of Magnetic Force.*

116. Laws of Magnetic Force.

FIRST LAW.—*Like magnetic poles repel one another; unlike magnetic poles attract one another.*

SECOND LAW.—*The force exerted between two magnetic poles is proportional to the product of their strengths, and is inversely proportional to the square of the distance between them.*

117. The Law of Inverse Squares.—The second of the above laws is commonly known as the law of inverse squares. The similar law of electrical attraction has already been explained and illustrated (Art. 16). This law furnishes the explanation of a fact mentioned in an earlier Lesson, Art. 77, that small pieces of iron are drawn bodily up to a magnet pole. If a small piece of iron wire, *a b* (Fig. 54), be suspended by a thread, and the N.-pointing pole A of a magnet be brought near it, the iron is thereby inductively magnetised; it turns round and points towards the mag-

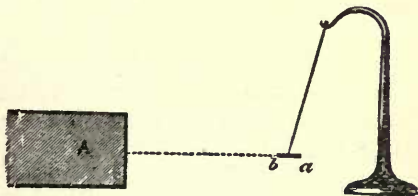

Fig. 54.

net pole, setting itself as nearly as possible along a line of force, its near end *b* becoming a S.-seeking pole, and its further end *a* becoming a N.-seeking pole. Now the pole *b* will be attracted and the pole *a* will be repelled. But these two forces do not exactly equal one another, since the distances are unequal. The repulsion will

(by the law of inverse squares) be proportional to $\frac{1}{(A a)^2}$; and the attraction will be proportional to $\frac{1}{(A b)^2}$. Hence the bit of iron $a b$ will experience a pair of forces, turning it into a certain direction, and also a total force drawing it bodily toward A. Only those bodies are attracted by magnets in which magnetism can thus be induced; and they are attracted only because of the magnetism induced in them.

We mentioned, Art. 83, that a magnet needle floating freely on a bit of cork on the surface of a liquid, is acted upon by forces that give it a certain direction, but that, unlike the last case, it does not tend to rush as a whole either to the north or to the south. It experiences a rotation, because the attraction and repulsion of the magnetic poles of the earth act in a certain direction; but since the magnetic poles of the earth are at a distance enormously great as compared with the length from one pole of the floating magnet to the other, we may say that, for all practical purposes, the poles of the magnet are at the same distance from the N. pole of the earth. The attracting force on the N.-pointing pole of the needle is therefore practically no greater than the repelling force acting on the S.-pointing pole, hence there is no motion of translation given to the floating needle as a whole.

118. Measurement of Magnetic Forces.—The truth of the law of inverse squares can be demonstrated by measuring the attraction between two magnet poles at known distances. But this implies that we have some means of measuring accurately the amount of the magnetic forces of attraction or repulsion. Magnetic force may be measured in any one of the four following ways: (1) by balancing it against the torsion of an elastic thread; (2) by observing the time of swing of a magnetic needle oscillating under the influence of the force; (3) by observing the deflection it produces upon a

magnetic needle which is already attracted into a different direction by a force of known intensity ; (4) by balancing it against the force of gravity as brought into play in attempting to deflect a magnet hung by two parallel strings (called the *bifilar* suspension), for these strings cannot be twisted out of their parallel position without raising the centre of gravity of the magnet. The first three of these methods must be further explained.

119. The Torsion Balance.—Coulomb also applied the Torsion Balance to the measurement of magnetic

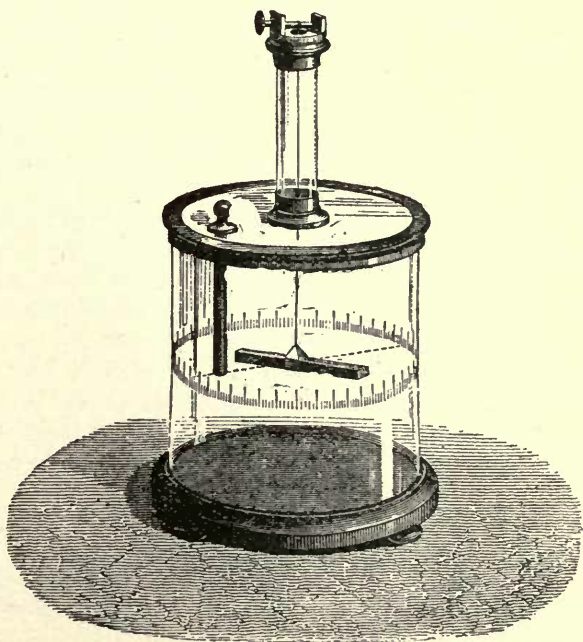

Fig. 55.

forces. The main principles of this instrument (as used to measure electrostatic forces of repulsion) were described on p. 15. Fig. 55 shows how it is arranged for

measuring magnetic repulsions. By means of the torsion balance we may prove the law of inverse squares. We may also, assuming this law proved, employ the balance to measure the strengths of magnet poles by measuring the forces they exert at known distances.

To prove the law of inverse squares, Coulomb made the following experiment:—The instrument was first adjusted so that a magnetic needle, hung in a copper stirrup to the fine silver thread, lay in the magnetic meridian without the wire being twisted. This was done by first putting in the magnet and adjusting roughly, then replacing it by a copper bar of equal weight, and once more adjusting, thus diminishing the error by repeated trials. The next step was to ascertain through what number of degrees the torsion-head at the top of the thread must be twisted in order to drag the needle 1° out of the magnetic meridian. In the particular experiment cited it was found that 35° of torsion corresponded to the 1° of deviation of the magnet; then a magnet was introduced, that pole being downwards which repelled the pole of the suspended needle. It was found (in this particular experiment) to repel the pole of the needle through 24° . From the preliminary trial we know that this directive force corresponds to $24^\circ \times 35^\circ$ of the torsion-head, and to this we must add the actual torsion on the wire, viz., the 24° , making a total of 864° , which we will call the "torsion equivalent" of the repelling force when the poles are thus 24° apart. Finally, the torsion-head was turned round so as to twist the suspended magnet round, and force it nearer to the fixed pole, until the distance between the repelling poles was reduced to half what it was at first. It was found that the torsion-head had to be turned round 8 complete rotations to bring the poles to 12° apart. These 8 rotations were an actual twist of $8^\circ \times 360^\circ$, or 2880° . But the bottom of the torsion thread was still twisted 12° as compared with the top, the force pro

ducing this twist corresponding to 12×35 (or 420°) of torsion; and to these the actual torsion of 12° must be added, making a total of $2880^\circ + 420^\circ + 12^\circ = 3312$. The result then of halving the distance between the magnet poles was to increase the force *fourfold*, for 3312 is very nearly four times 864. Had the distance between the poles been reduced to one-third the force would have been nine times as great.

120. Method of Oscillations.¹—If a magnet suspended by a fine thread, or poised upon a point, be pushed aside from its position of rest, it will vibrate backwards and forwards, performing oscillations which, although they gradually decrease in amplitude, are executed in *very nearly* equal times. In fact, they follow a law similar to that of the oscillations executed by a pendulum swinging under the influence of gravity. The law of pendular vibrations is, that *the square of the number of oscillations executed in a given time is proportional to the force*. Hence we can measure magnetic forces by counting the oscillations made in a minute by a magnet. It must be remembered, however, that the actual number of oscillations made by any given magnet will depend on the weight, length, and form of the magnet, as well as upon the strength of its poles, and of the "field" in which it may be placed.

121. We can use this method to compare the intensity of the force of the earth's magnetism² at any place with that at any other place on the earth's surface, by oscillating a magnet at one place and then taking it to the other place and oscillating it there. If, at the first, it makes *a* oscillations in one minute, and at the second, *b* oscillations a minute, then the magnetic forces at the

¹ It is possible, also, to measure *electrical* forces by a "method of oscillations;" a small charged ball at the end of a horizontally-suspended arm being caused to oscillate under the attracting force of a charged conductor near it, whose "force" at that distance is proportional to the square of the number of oscillations in a given time.

² Or, more strictly, of its *horizontal component*.

two places will be to one another in the ratio of a^2 to b^2 .

Again, we may use the method to compare the force exerted at any point by a magnet near it with the force of the earth's magnetism at that point. For, if we swing a small magnetic needle there, and find that it makes m oscillations a minute under the joint action¹ of the earth's magnetism, and that of the neighbouring magnet, and that, when the magnet is removed, it makes n oscillations a minute under the influence of the earth's magnetism alone, then m^2 will be proportional to the joint forces, n^2 to the force due to the earth's magnetism, and the difference of these, or $m^2 - n^2$ will be proportional to the force due to the neighbouring magnet.

122. We will now apply the method of oscillations to measure the relative quantities of free magnetism at different points along a bar magnet. The magnet to be examined is set up vertically (Fig. 56). A small magnet, capable of swinging horizontally, is brought near it and set at a short distance away from its extremity, and then oscillated, while the rate of its oscillations is counted. Suppose the needle were such that, when exposed to the earth's magnetism alone, it would perform 3 complete oscillations a minute, and that, when vibrating at its place near the end of the vertical magnet it oscillated 14 times a minute, then the force due to the magnet will be proportional to $14^2 - 3^2 = 196 - 9 = 187$. Nextly, let the oscillating magnet be brought to an equal distance opposite a point a little away from

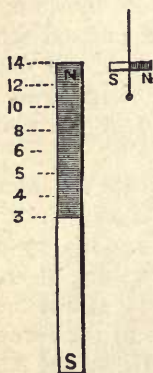

Fig. 56.

the end of the vertical magnet. If, here, it oscillated

¹ We are here assuming that the magnet is so placed that its force is in a line with that of the earth's magnetism at the point, and that the other pole of the magnet is so far away as not to affect the oscillating needle.

12 times a minute, we know that the force will be proportional to $12^2 - 3^2 = 144 - 9 = 135$. So we shall find that as the force falls off the oscillations will be fewer, until, when we put the oscillating magnet opposite the middle of the vertical magnet, we shall find that the number of oscillations is 3 per minute, or that the earth's force is the only force affecting the oscillations. In Fig. 57 we have indicated the number of oscillations at successive points, as 14, 12, 10, 8, 6, 5, 4, and 3. If we square these numbers and subtract 9 from each, we shall get for the forces at the various points the following:—187, 135, 91, 55, 27, 16, 7, and 0. These forces may be taken to represent the strength of the free magnetism at the various points, and it is convenient to plot them out graphically in the manner shown in

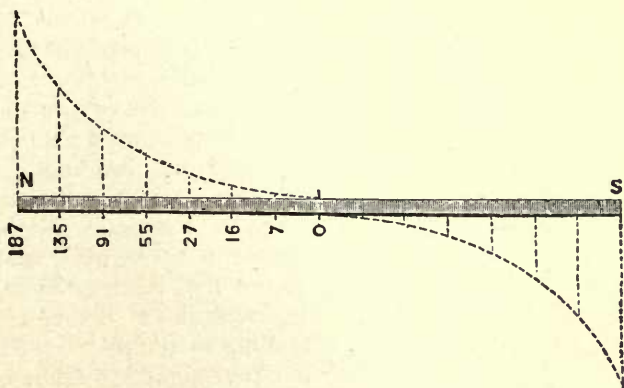

Fig. 57.

Fig. 57, where the heights of the dotted lines are chosen to a scale to represent proportionally the forces. The curve which joins the tops of these "ordinates" shows graphically how the force, which is greatest at the end, falls off toward the middle. On a distant magnet pole these forces, thus represented by this curvilinear triangle, would act as if concentrated at a point in the magnet

opposite the "centre of gravity" of this triangle; or, in other words, the "pole," which is the centre of the resultant forces, is not at the end of the magnet. In thin bars of magnetised steel it is at about $\frac{1}{7}$ of the magnet's length from the end.

123. Method of Deflections.—There are a number of ways in which the deflection of a magnet by another magnet may be made use of to measure magnetic forces.¹ We cannot here give more than a glance at first principles. When two equal and opposite forces act on the ends of a rigid bar they simply tend to turn it round. Such a

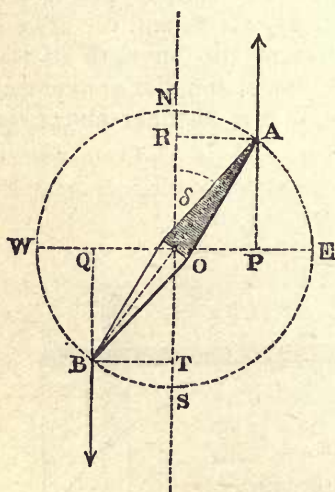

Fig. 58.

pair of forces form what is called a "couple," and the effective power or "moment" of the couple is obtained by multiplying one of the two forces by the perpendicular distance between the directions of the forces. Such a couple tends to produce a motion of rotation, but not a motion of translation. Now, a magnetic needle placed in a magnetic field across the lines of force, experiences a "couple," tending to rotate it round into the magnetic meridian,

for the N.-seeking pole is urged northwards, and the S.-seeking pole is urged southwards, with an equal and opposite force. The force acting on each pole is the product of the strength of the pole and the intensity of the "field," that is to say, of the horizontal component of the force of the earth's magnetism at the

¹ The student desirous of mastering these methods of measuring magnetic forces should consult Sir G. Airy's *Treatise on Magnetism*.

place. We will call the strength of the N.-seeking pole m ; and we will use the symbol H to represent the force exerted in a horizontal direction by the earth's magnetism. (The value of H is different at different regions of the globe.) The force on the pole A (see Fig. 58) will be then $m \times H$ or $m H$, and that on pole B will be equal and opposite. We take $N S$ as the direction of the magnetic meridian, and the forces will be parallel to this direction. Now, the needle $A B$ lies obliquely in the field, and the magnetic force acting on A is in the direction of the line $P A$, and that on B in the direction $Q B$, as shown by the arrows. $P Q$ is the perpendicular distance between these forces; hence the "moment" of the couple will be got by multiplying the length $P Q$ by the force exerted on one of the poles. Using the symbol G for the moment of the couple we may write

$$G = P Q \times m \cdot H.$$

But $P Q$ is equal to the length of the magnet multiplied by the sine¹ of the angle $A O R$, which is the angle of deflection, and which we will call δ . Hence, using l for the length between the poles of the magnet, we may write the expression for the moment of the couple.

$$G = m l H \cdot \sin \delta.$$

In words this is: the "moment of the couple" acting on the needle is proportional to its "magnetic moment," ($m \times l$) to the horizontal force of the earth's magnetism, and to the sine of the angle of deflection.

The reader will not have failed to notice that if the needle were turned more obliquely, the distance $P Q$ would be longer, and would be greatest if the needle were turned round east-and-west, or in the direction $E W$. Also the "moment" of the couple tending to rotate the magnet will be less and less as the needle is turned more nearly into the direction $N S$.

¹ If any reader is unacquainted with trigonometrical terms he should consult the note at the end of this Lesson, on "Ways of reckoning Angles."

124. Now, let us suppose that the deflection δ were produced by a magnetic force applied at right angles to the magnetic meridian, and tending to draw the pole A in the direction R A. The length of the line R T multiplied by the new force will be the "moment" of the new couple tending to twist the magnet into the direction E W. Now, if the needle has come to rest in equilibrium between these two forces, it is clear that the two opposing twists are just equal and opposite in power, or that the moment of one couple is equal to the moment of the other couple. Hence, the force in the direction W E will be to the force in the direction S N in the same ratio as P Q is to R T, or as P O is to R O.

Or, calling this force f ,

$$f : H = P O : R O$$

Or $f = H \frac{P O}{R O}$

But P O = A R and $\frac{A R}{R O} = \tan \delta$ hence

$$f = H \tan \delta ;$$

or, in other words, *the magnetic force which, acting at right angles to the meridian, produces on a magnetic needle the deflection δ , is equal to the horizontal force of the earth's magnetism at that point, multiplied by the tangent of the angle of deflection.* Hence, also, two different magnetic forces acting at right angles to the meridian would severally deflect the needle through angles whose tangents are proportional to the forces.

This very important theorem is applied in the construction of certain galvanometers (see Art. 199).

The name **Magnetometer** is given to any magnet specially arranged as an instrument for the purpose of measuring magnetic forces by the deflections they produce. The methods of observing the *absolute* values of magnetic forces in *dynes* or other abstract units of force will be explained in the Note at the end of

Lesson XXV. See also Sir George Airy's *Treatise on Magnetism*.

125. Unit Strength of Pole.—We found in Coulomb's torsion-balance a convenient means of comparing the strengths of poles of different magnets; for the force which a pole exerts is proportional to the strength of the pole. The Second Law of Magnetic Force (see Art. 116) stated that the force exerted between two poles was proportional to the product of their strengths, and was inversely proportional to the square of the distance between them. It is possible to choose such a strength of pole that this proportionality shall become numerically an equality. In order that this may be so, we must adopt the following as our unit of strength of a pole, or unit magnetic pole: *A Unit Magnetic Pole is one of such a strength that, when placed at a distance of one centimetre from a similar pole of equal strength it repels it with a force of one dyne* (see Art. 255). If we adopt this definition we may express the second law of magnetic force in the following equation:—

$$f = \frac{m \times m'}{d^2}$$

where f is the force (in dynes), m and m' the strengths of the two poles, and d the distance between them (in centimetres). This subject is resumed in Lesson XXV., Art. 310, on the Theory of Magnetic Potential.

126. Theory of Magnetic Curves.—We saw (Art. 108) that magnetic figures are produced by iron-filings setting themselves in certain directions in the field of force around a magnet. We can now apply the law of inverse squares to aid us in determining the direction in which a filing will set itself at any point in the field. Let N S (Fig. 59) be a long thin magnet, and P any point in the field due to its magnetism. If the N-seeking pole of a small magnet be put at P, it will be attracted by S and repelled by N; the directions of these two forces will be along the lines P S and P N. The

amounts of the forces may be represented by certain lengths marked out along these lines. Suppose the distance $P N$ is twice as great as $P S$, the repelling force along $P N$ will be $\frac{1}{4}$ as strong as the attracting force along $P S$. So measure a distance out, $P A$ towards S four times as long as the length $P B$ measured along $P N$ away from N . Find the resultant force¹ in the usual way of compounding mechanical forces, by completing the parallelogram $P A R B$, and the diagonal $P R$ represents by its length and direction the magnitude and the

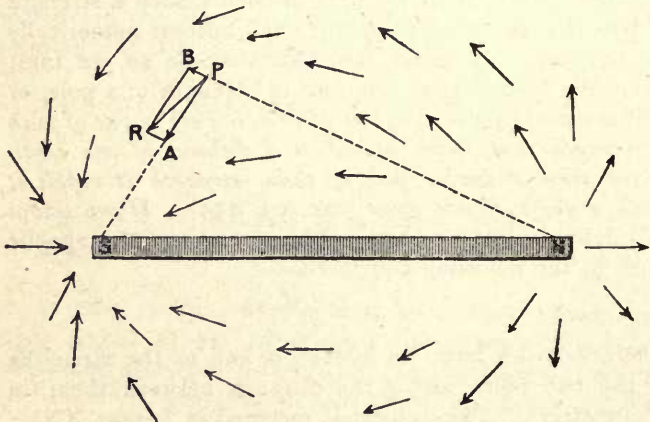

Fig. 59.

direction of the resultant magnetic force at the point P . In fact the line $P R$ represents the line along which a small magnet or an iron filing would set itself. In a similar way we might ascertain the direction of the lines of force at any point of the field. The little arrows in Fig. 59 show how the lines of force start out from the N . pole and curve round to meet in the S . pole. The student should compare this figure with the lines of filings of Fig. 50.

¹ See Balfour Stewart's *Lessons in Elementary Physics*, page 26; or Todhunter's *Natural Philosophy for Beginners*, page 55.

127. **Force due to a Magnetic Shell.**—A magnetic shell (Art. 107) exerts a magnetic force upon a magnet pole placed at a point in its neighbourhood. If the shell be flat and very great, as compared with the distance of the point considered, this force will be independent of that distance, will be normal to the shell in direction, and will depend only upon the amount of magnetism on the shell; and will be numerically equal to 2π times the quantity of magnetism per square centimetre¹ (*i.e.* to $2\pi\sigma$ when σ is the "surface density" of magnetism on the face of the shell).

If the shell is bounded, however, by a limiting area, the force exerted by a shell upon a point outside it will be greater near to the shell than at a distance away. In this case it is most convenient to measure not the force but the *potential* due to the shell. The definition of "magnetic potential" is given in Art. 310; meantime we may content ourselves with stating that *the potential due to a magnetic shell at a point near it, is equal to the strength of the shell multiplied by the solid angle,*² subtended by the shell at that point.

128. **A Magnetic Paradox.**—If the N.-seeking pole of a strong magnet be held at some distance from the N.-seeking pole of a weak magnet, it will repel it; but if it is pushed up quite close it will be found now to *attract* it. This paradoxical experiment is explained by the fact that the magnetism induced in the weak magnet by the powerful one will be of the opposite kind, and will be attracted; and, when the powerful magnet is near, this induced magnetism may overpower and mask the original magnetism of the weak magnet. The student must be cautioned that in most of the experiments on magnet poles similar perturbing causes are at work. The magnetism in a magnet is not quite *fixed*,

¹ The proof of this proposition is similar to that given at end of Lesson XX., for the analogous proposition concerning the force due to a flat plate charged with electricity.

² See Note on "Ways of Reckoning Angles," at the end of this Lesson.

but is liable to be disturbed in its distribution by the near presence of other magnet poles, for no steel is so hard as not to be temporarily affected by magnetic induction. The law of inverse squares is only true when the distance between the poles is so great that the displacement of their magnetism due to mutual induction is so small that it may be neglected.

NOTE ON WAYS OF RECKONING ANGLES AND SOLID-ANGLES.

129. Reckoning in Degrees.—When two straight lines cross one another they form an *angle* between them; and this angle may be defined as the amount of rotation which one of the lines has performed round a fixed point in the other line. Thus we may suppose the line CP in Fig. 60 to have originally lain along CO , and then turned round to its present position. The amount by which it has been rotated is clearly a certain fraction of the whole way round; and the amount of rotation round C we call “the angle which PC makes with OC ,” or more simply “the angle PCO .” But there are a number of different ways of *reckoning* this angle.

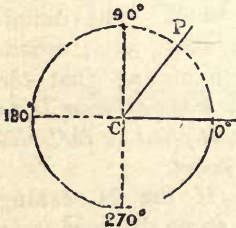

Fig. 60.

The common way is to reckon the angle by “degrees” of arc. Thus, suppose a circle to be drawn round C , if the circumference of the circle were divided into 360 parts each part would be called “one degree” (1°), and the angle would be reckoned by naming the number of such degrees along the curved arc OP . In the figure the arc is about $57\frac{1}{4}^\circ$, or $\frac{57\frac{1}{4}}{360}$ of the whole way round, no matter what size the circle is drawn.

130. Reckoning in Radians.—A more sensible but less usual way to express an angle is to reckon it by the ratio between the length of the curved arc that “subtends” the angle and the length of the radius of the circle. Suppose we have drawn round the centre C a circle whose *radius* is *one* centimetre, the *diameter* will be *two* centimetres. The length of the circumference all round is known to be about $3\frac{1}{2}$ times the length of the diameter, or more exactly $3\cdot14159 \dots$. This number is so awkward that, for convenience, we always

use for it the Greek letter π . Hence the length of the circumference of our circle, whose radius is one centimetre, will be $6.28318 \dots$ centimetres, or 2π centimetres. We can then reckon any angle by naming the length of arc that subtends it on a circle one centimetre in radius. If we choose the angle PCO , such that the curved arc OP shall be just one centimetre long, this will be the angle *one*, or unit of angular measure, or, as it is sometimes called, the angle PCO will be *one "radian."*

In degree-measure one radian = $\frac{360^\circ}{2\pi} = 57^\circ 17'$ nearly. All the way round the circle will be 2π radians. A right-angle will be $\frac{\pi}{2}$ radians.

131. Reckoning by Sines or Cosines.—In trigonometry other ways of reckoning angles are used, in which, however, the angles themselves are not reckoned, but certain "functions" of them called "sines," "cosines," "tangents," etc. For readers not accustomed to these we will briefly explain the geometrical nature of these "functions." Suppose we draw (Fig. 61)

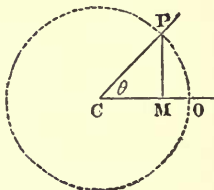

Fig. 61.

our circle as before round centre C, and then drop down a plumb-line PM , on to the line CO ; we will, instead of reckoning the angle by the curved arc, reckon it by the length of the line PM . It is clear that if the angle is small PM will be short; but as the angle opens out towards a right angle, PM will get longer and longer (Fig. 62).

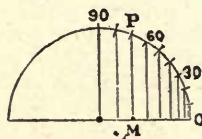

Fig. 62.

The ratio between the length of this line and the radius of the circle is called the "*sine*" of the angle, and if the radius is 1 the length of PM will be the value of the sine. It can never be greater than 1, though it may have all values between 1 and -1. The length of the line CM will also depend upon the amount of the angle. If the angle is small CM will be nearly as long as CO ; if the angle open out to nearly a right angle CM will be very short. The length of CM (when the radius is 1) is called the "*cosine*" of the angle. If the angle be called θ , then we may for shortness write these functions:

$$\text{Sin } \theta = \frac{\text{PM}}{\text{CP}}$$

$$\text{Cos } \theta = \frac{\text{CM}}{\text{CP}}$$

132. Reckoning by Tangents.—Suppose we draw our circle,

as before (Fig. 63),

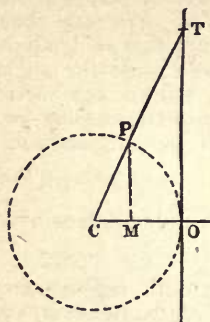

Fig. 63.

but at the point O draw a straight line touching the circle, the *tangent line* at O; let us also prolong CP until it meets the tangent line at T. We may measure the angle between OC and OP in terms of the length of the tangent OT as compared with the length of the radius. Since our radius is 1, this ratio is numerically the length of OT, and we may therefore call the length of OT the "*tangent*" of the angle OCP. It is clear that smaller angles will have smaller tangents, but that larger angles may have very large tangents; in fact, the length of the tangent when PC was moved round to a right angle would be infinitely great. It can be shown that the ratio between the lengths of the sine and

of the cosine of the angle is the same as the ratio between the length of the tangent and that of the radius; or the tangent of an angle is equal to its sine divided by its cosine. The formula for the tangent may be written :

$$\tan \theta = \frac{TO}{OC} = \frac{PM}{MC}.$$

133. **Solid Angles.**—When three or more surfaces intersect at a point they form a *solid angle*: there is a solid angle, for example, at the top of a pyramid, or of a cone, and one at every corner of a diamond that has been cut. If a surface of any given shape be near a point, it is said to subtend a certain solid angle at that point, the solid angle being mapped out by drawing lines from all points of the edge of this surface to the point P (Fig. 64.) An irregular cone will thus be generated whose solid angle is the solid angle subtended at P by the surface EF. To reckon this

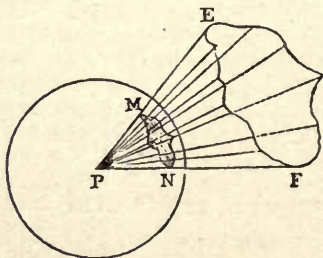

Fig. 64.

solid angle we adopt an expedient similar to that adopted when we wished to reckon a plane angle in radians. About the point P, with radius of 1 centimetre, describe a *sphere*, which will intercept the cone over an area MN: the area thus intercepted measures the solid angle. If the sphere have the radius 1, its total surface is 4π . The solid angle subtended at the centre by a hemisphere would be 2π .

TABLE OF NATURAL SINES AND TANGENTS.

Arc.	Sine.	Tangent.	
0°	0·000	0·000	90°
1	·017	·017	89
2	·035	·035	88
3	·052	·052	87
4	·070	·070	86
5	·087	·087	85
6	·105	·105	84
7	·122	·123	83
8	·139	·141	82
9	·156	·158	81
10	·174	·176	80
15	·259	·268	75
20	·342	·364	70
25	·423	·466	65
30	·500	·577	60
35	·574	·700	55
40	·643	·839	50
45	·707	1·000	45
50	·766	1·192	40
55	·819	1·428	35
60	·866	1·732	30
65	·906	2·145	25
70	·940	2·747	20
75	·966	3·732	15
80	·985	5·671	10
81	·988	6·314	9
82	·990	7·115	8
83	·993	8·144	7
84	·995	9·514	6
85	·996	11·43	5
86	·998	14·30	4
87	·999	19·08	3
88	·999	28·64	2
89	·999	57·29	1
90	1·000	Infìn.	0
	Co-sine.	Co-tangent.	Arc.

LESSON XII.—*Terrestrial Magnetism.*

134. **The Mariner's Compass.**—It was mentioned in Art. 79 that the compass sold by opticians consists of a magnetised steel needle balanced on a fine point above a card marked out N, S, E, W, etc. The **Mariner's Compass** is, however, somewhat differently arranged.

In Fig. 65 one of the forms of a Mariner's Compass, used for nautical observations, is shown. Here the

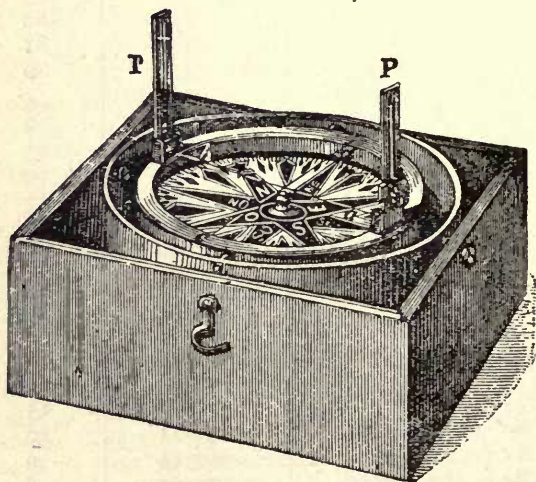

Fig. 65.

card, divided out into the 32 "points of the Compass," is itself attached to the needle, and swings round with it so that the point marked N *on the card* always points to the north. In the newest and best ships' compasses several magnetised needles are placed side by side, as it is found that the indications of such a compound needle are more reliable. The iron fittings of wooden vessels, and, in the case of iron vessels, the ships themselves,

affect the compass, which has therefore to be corrected by placing compensating masses of iron near it, or by fixing it high upon a mast.

135. The Earth a Magnet.—Gilbert made the great discovery that the compass needle points north and south because the earth is itself also a great magnet. The magnetic poles of the earth are, however, not exactly at the geographical north and south poles. The magnetic north pole of the earth is more than 1000 miles away from the actual pole, being in lat. $70^{\circ} 5' N.$, and long. $96^{\circ} 46' W.$ In 1831, it was found by Sir J. C. Ross to be situated in Boothia Felix, just within the Arctic Circle. The south magnetic pole of the earth has never been reached; and by reason of irregularities in the distribution of the magnetism there appear to be two south magnetic polar regions.

136. Declination.—In consequence of this natural distribution the compass-needle does not at all points of the earth's surface point truly north and south. Thus, in 1881, the compass-needle at London points at an angle of about $18^{\circ} 33'$ west of the true north. This angle between the "magnetic meridian"¹ and the geographical meridian of a place is called the magnetic Declination of that place. The existence of this declination was discovered by Columbus in 1492, though it appears to have been previously known to the Chinese, and is said to have been noticed in Europe in the early part of the 13th century by Peter Pellegrinus. The discovery is also claimed, though on doubtful authority, for Sebastian Cabot of Bristol. The fact that the declination differs at different points of the earth's surface, is the undisputed discovery of Columbus.

In order that ships may steer by the compass, mag-

¹ The *Magnetic Meridian* of any place is an imaginary plane drawn through the zenith, and passing through the magnetic north point and magnetic south point of the horizon, as observed at that place by the pointing of a horizontally-suspended compass-needle.

netic charts (Art. 139) must be prepared, and the declination at different places accurately measured. The upright pieces P P', on the "azimuth compass" drawn in Fig. 65, are for the purpose of sighting a star whose position may be known from astronomical tables, and thus affording a comparison between the magnetic meridian of the place and the geographical meridian, and of measuring the angle between them.

137. Inclination or Dip.—Norman, an instrument-maker, discovered in 1576 that a balanced needle, when magnetised, tends to dip downwards toward the

north. He therefore constructed a **Dipping-Needle**, capable of turning in a vertical plane about a horizontal axis, with which he found the "dip" to be (at London) an angle of $71^{\circ} 50'$. A simple form of Dipping-needle is shown in Fig. 66. The dip-circles used in the magnetic observatory at Kew are much more exact and delicate instruments. It was,

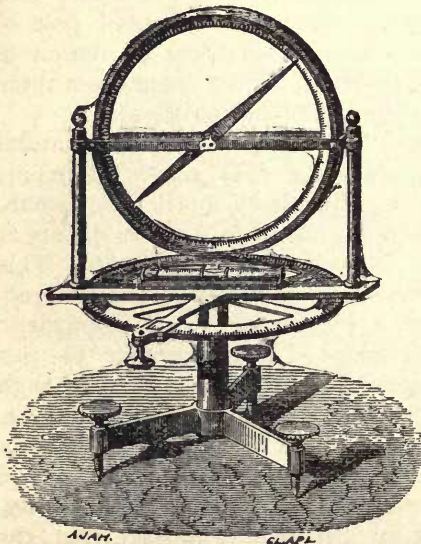

Fig. 66.

however, found that the dip, like the declination, differs at different parts of the earth's surface, and that it also undergoes changes from year to year. The "dip" in London for the year 1881 is $67^{\circ} 39'$. At the north magnetic pole the needle dips straight down. The following table gives particulars of the Declination,

Inclination, and total magnetic force at a number of important places, the values being approximately true for the year 1880.

TABLE OF MAGNETIC DECLINATION AND INCLINATION
(for Year 1880.)

	Declination.	Inclination.	Total force (in C. G. S. units).
Boothia Felix	(None.)	90° N	·65
London	18° 40' W	67° 40' N	·47
St. Petersburg	0° 40' W	70° N	·48
Berlin	11° 30' W	64° N	·48
Paris	16° 45' W	66° N	·47
Rome	11° 30' W	60° N	·45
New York	7° 57' W	72° 12' N	·61
Mexico	7° 55' E	45° ? N	·48
Quito	7° 40' E	25° ? N	·35
St. Helena	26° 25' W	28° S	·31
Cape Town	30° 2' W	56° 30' S	·36
Sydney	9° 30' E	62° 45' S	·57
Hobarton	8° 49' E	71° 5' S	·64
Tokio	4° 5' W	50° N	·45

138. Intensity.—Three things must be known in order to specify exactly the magnetism at any place; these three elements are :

- The Declination ;
- The Inclination, and
- The Intensity of the Magnetic Force.

The magnetic force is measured by one of the methods mentioned in the preceding Lesson. Its direction is in the line of the dipping-needle, which, like every magnet, tends to set itself along the lines-of-force. It is, however, more convenient to measure the force not in its total intensity in the line of the dip, but to measure the horizontal component of the force,—that is to say, the force in the direction of the horizontal compass-needle, from which the total force can be

calculated if the dip is known. Or if the horizontal and vertical components of the force are known, the total force and the angle of the dip can both be calculated.¹ The horizontal component of the force, or "horizontal intensity," can be ascertained either by the method of Vibrations or by the method of Deflexions. The mean horizontal force of the earth's magnetism at London in 1880 was .18 dyne-units, the total force (in the line of dip) is .47 dyne-units. The distribution of the magnetic force at different points of the earth's surface is irregular, and varies in different latitudes according to an approximate law, which, as given by Biot, is that the force is proportional to $\sqrt{1 + 3 \sin^2 l}$, where l is the magnetic latitude.

139. **Magnetic Maps.**—For purposes of convenience it is usual to construct magnetic maps, on which such data as these given in the Table on p. 115 can be marked down. Such maps may be constructed in several ways. Thus, it would be possible to take a map of England, or of the world, and mark it over with lines such as to represent by their direction the actual direction in which the compass points; in fact to draw the lines of force. A more useful way of marking the map is to find out those places at which the declination is the same, and to join these places by a line. The Magnetic Map of England which forms the Frontispiece to these Lessons is constructed on this plan. At Bristol the compass-needle in 1888 will point 19° to the west of the geographical north. The declination at Torquay, at Stafford, at Leeds, and at Hartlepool, will in that year be the same as at Bristol. Hence a line joining these towns may be called a *line of equal declination*, or an *Isogonic line*. It will be seen from this map that the declination is greater in the north-west of England than

¹ For if H = Horizontal Component of Force and I = Total Force, and θ = angle of dip, $I = H \div \cos \theta$.

² For $H^2 + V^2 = I^2$, where V = Vertical Component of Force.

in the south-east. We might similarly construct a magnetic map, marking it with lines joining places where the *dip* was equal; such lines would be called *isoclinic lines*. In England they run across the map from west-south-west to east-north-east. On the globe

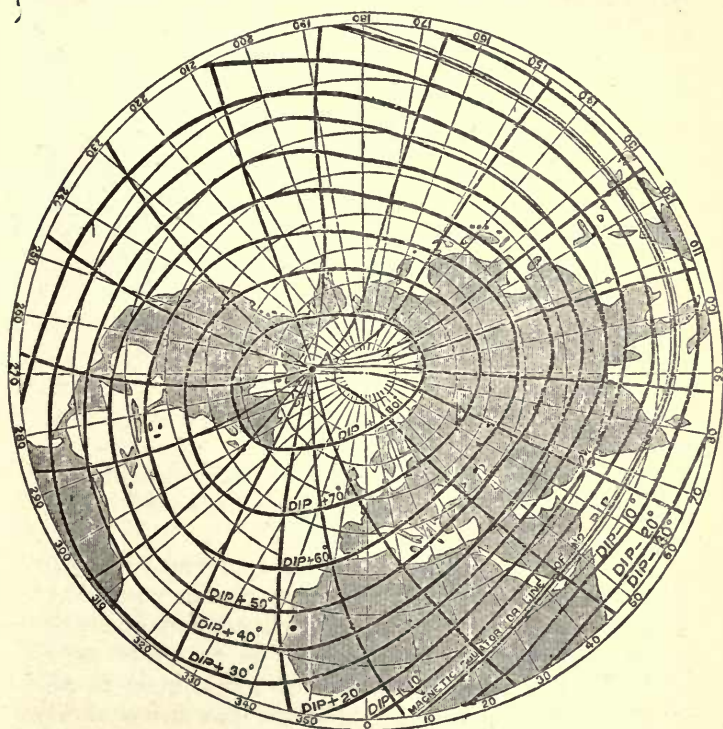

Fig. 67.

the isogonic lines run for the most part from the north magnetic pole to the south magnetic polar region, but, owing to the irregularities of distribution of the earth's magnetism, their forms are not simple. The isoclinic lines of the globe run round the earth like the parallels

of latitude, but are irregular in form. Thus the line joining places where the north-seeking pole of the needle dips down 70° runs across England and Wales, passes the south of Ireland, then crosses the Atlantic in a south-westerly direction, traverses the United States, swerving northwards, and just crosses the southern tip of Alaska. It drops somewhat southward again as it crosses China, but again curves northwards as it enters Russian territory. Finally it crosses the southern part of the Baltic, and reaches England across the German Ocean. The chart of the world, given in Fig. 67, shows the isoclinic lines of the Northern Hemisphere, and also a system of "terrestrial magnetic meridians" meeting one another in the North Magnetic pole at A. It was prepared by the Astronomer-Royal, Sir George Airy, for his *Treatise on Magnetism*.

140. Variations of Earth's Magnetism.—We have already mentioned that both the declination and the inclination are subject to changes; some of these changes take place very slowly, others occur every year, and others again every day.

141. Secular Changes.—Those changes which require many years to run their course are called *secular changes*.

The variations of the *declination* previous to 1580 are not recorded; the compass at London then pointed 11° east of true north. This easterly declination gradually decreased, until in 1657 the compass pointed true north. It then moved westward, attaining a maximum of $24^\circ 27'$ about the year 1816, from which time it has slowly diminished to its present value of $18^\circ 33'$; it diminishes (in England) at about the rate of $7'$ per year. At about the year 1976 it will again point truly north, making a complete cycle of changes in about 320 years.

The *Inclination* in 1576 was $71^\circ 50'$, and it slowly increased till 1720, when the angle of dip reached the maximum value of $74^\circ 42'$. It has since steadily

diminished to its present value of $67^{\circ} 39'$. The period in which the cycle is completed is not known, but the rate of variation of the dip is less at the present time than it was fifty years ago. In all parts of the earth both declination and inclination are changing similarly. The following table gives the data of the secular changes at London.

TABLE OF SECULAR MAGNETIC VARIATIONS.

Year.	Declination.	Inclination.
1576		$71^{\circ} 50'$
1580	$11^{\circ} 17' \text{ E.}$	
1600		$72^{\circ} 0'$
1622	$6^{\circ} 12'$	
1634	$4^{\circ} 0'$	
1657	$0^{\circ} 0' \text{ min.}$	
1676	$3^{\circ} 0' \text{ W.}$	$73^{\circ} 30'$
1705	$9^{\circ} 0'$	
1720	$13^{\circ} 0'$	$74^{\circ} 42' \text{ max.}$
1760	$19^{\circ} 30'$	
1780		$72^{\circ} 8'$
1800	$24^{\circ} 6'$	$70^{\circ} 35'$
1816	$24^{\circ} 30' \text{ max.}$	
1830	$24^{\circ} 2'$	$69^{\circ} 3'$
1855	$23^{\circ} 0'$	
1868	$20^{\circ} 33'$	$68^{\circ} 2'$
1878	$19^{\circ} 14'$	$67^{\circ} 43'$
1880	$18^{\circ} 40'$	$67^{\circ} 40'$
1888	$17^{\circ} 40'$	$67^{\circ} 25' (i)$

The *Total Magnetic force*, or "Intensity," also slowly changes in value. As measured near London it was equal to $\cdot 4791$ dyne-units in 1848, $\cdot 4740$ in 1866, and at the beginning of 1880, $\cdot 4736$ dyne-units.¹ Owing to the steady decrease of the angle at which the needle dips, the horizontal component of this force (*i.e.* the "Horizontal Intensity") is slightly increasing. It was $\cdot 1716$ dyne-units in 1848, and $\cdot 1797$ dyne-units at the beginning of 1880.

¹ That is to say, a north magnet pole of unit strength is urged in the line of dip, with a mechanical force of a little less than half a dyne

142. Daily Variations.—Both compass and dipping-needle, if minutely observed, exhibit slight daily motions. About 7 a.m. the compass needle begins to travel westward with a motion which lasts till about 1 p.m.; during the afternoon and evening the needle slowly travels back eastward, until about 10 p.m.; after this it rests quiet; but in summer-time the needle begins to move again slightly to the west at about midnight, and returns again eastward before 7 a.m.. These delicate variations—never more than 10' of arc—appear to be connected with the position of the sun; and the moon also exercises a minute influence upon the position of the needle.

143. Annual Variations.—There is also an annual variation corresponding with the movement of the earth around the sun. In the British Islands the total force is greatest in June and least in February, but in the Southern Hemisphere, in Tasmania, the reverse is the case. The dip also differs with the season of the year, the angle of dip being (in England) less during the four summer months than in the rest of the year.

144. Eleven-Year Period.—General Sabine discovered that there is a larger amount of variation of the declination occurring about once every eleven years. Schwabe noticed that the recurrence of these periods coincided with the eleven-year periods at which there is a maximum of *spots* on the sun. Professor Balfour Stewart and others have endeavoured to trace a similar periodicity in the recurrence of auroræ¹ and of other phenomena.

145. Magnetic Storms.—It is sometimes observed that a sudden (though very minute) irregular disturbance will affect the whole of the compass needles over a considerable region of the globe. Such occurrences are known as magnetic storms; they frequently occur at the time when an aurora is visible.

146. Self-recording Magnetic Apparatus.—At

¹ See Lesson XXIV., on Atmospheric Electricity.

Kew and other magnetic observatories the daily and hourly variations of the magnet are recorded on a continuous register. The means employed consists in throwing a beam of light from a lamp on to a light mirror attached to the magnet whose motion is to be observed. A spot of light is thus reflected upon a ribbon of photographic paper prepared so as to be sensitive to light. The paper is moved continuously forward by a clock-work train ; and if the magnet be at rest the dark trace on the paper will be simply a straight line. If, however, the magnet moves aside, the spot of light reflected from the mirror will be displaced, and the photographed line will be curved or crooked. Comparison of such records, or "*magnetographs*," from stations widely apart on the earth's surface, promises to afford much light upon the *cause* of the earth's magnetism and of its changes, of which hitherto no reliable origin has been with certainty assigned.

The phenomenon of earth-currents (Art. 403) appears to be connected with that of the changes in the earth's magnetism, and can be observed whenever there is a display of aurora, and during a magnetic storm ; but it is not yet determined whether these currents are due to the variations in the magnetism of the earth, or whether these variations are due to the currents. It is known that the evaporation (see Art. 63) always going on in the tropics causes the ascending currents of heated air to be electrified positively relatively to the earth. These air-currents travel northward and southward toward the colder polar regions, where they descend. These streams of electrified air will act (see Art. 337) like true electric currents, and as the earth rotates within them it will be acted upon magnetically. Whether this will account for the gradual growth of the earth's magnetism is an open question. The action of the sun and moon in raising tides in the atmosphere might also account for the variations mentioned in Art. 142. It is important to note that in all magnetic storms the intensity of the perturbations is greatest in the regions nearest the poles ; also, that the magnetic poles coincide very nearly with the regions of greatest cold ; that the region where auroræ (Art. 309) are seen in greatest abundance is a region lying nearly symmetrically round the magnetic pole. It may be added that the general direction of the feeble daily earth-currents (Art. 403) is from the pole toward the equator

CHAPTER III.

CURRENT ELECTRICITY.

LESSON XIII.—*Simple Voltaic Cells.*

147. It has been already mentioned, in Lesson IV, now electricity flows away from a charged body through any conducting substance, such as a wire or a wetted string. If, by any arrangement, electricity could be supplied to the body just as fast as it flowed away, a continuous current would be produced. Such a current always flows through a conducting wire, if the ends are kept at different electric potentials. In like manner, a current of heat flows through a rod of metal if the ends are kept at different temperatures, the flow being always from the high temperature to the lower. It is convenient to regard electricity as flowing from positive to negative ; or, in other words, the direction of an electric current is from the high potential to the low. It is obvious that such a flow tends to bring both to one level of potential. The "current" has sometimes been regarded as a double transfer of positive electricity in one direction, and of negative electricity in the opposite direction. The only evidence to support this very unnecessary supposition is the fact that, in the decomposition of liquids by the current, some of the elements are liberated at the point where the potential is highest, others at the point where it is lowest.

Continuous currents of electricity, such as we have described, are usually produced by *voltaic cells*, or *batteries* of such cells, though there are other sources of currents hereafter to be mentioned.

148. Discoveries of Galvani and of Volta.—The discovery of electric currents originated with *Galvani*, a physician of Bologna, who, about the year 1786, made a series of curious and important observations upon the convulsive motions produced by the “return-shock” (Art. 26) and other electric discharges upon a frog’s leg. He was led by this to the discovery that it was not necessary to use an electric machine to produce these effects, but that a similar convulsive kick was produced in the frog’s leg when two dissimilar metals, iron and copper, for example, were placed in contact with a nerve and a muscle respectively, and then brought into contact with each other. Galvani imagined this action to be due to electricity generated by the frog’s leg itself. It was, however, proved by *Volta*, Professor in the University of Pavia, that the electricity arose not from the muscle or nerve, but from the contact of the dissimilar metals. When two metals both in contact with the air or other oxidising medium are placed in contact with one another, the surface of one becomes positive and of the other negative, as stated on p. 67. Though the charges are very feeble, Volta proved their reality by two different methods.

149. Contact Electricity: Proof by the Condensing Electroscope.—The first method of proof devised by Volta involved the use of the *Condensing Electroscope*, alluded to in Art. 71. It can be used in the following way to show the production of electrification. A small bar made of two dissimilar metals, zinc and copper soldered together, is held in the hand, and one end is touched against the lower plate, the upper plate being at the same time joined to “earth” or touched with the hand (Fig. 68). During the contact electrical separation has taken place at the point

where the dissimilar metals touched one another, and

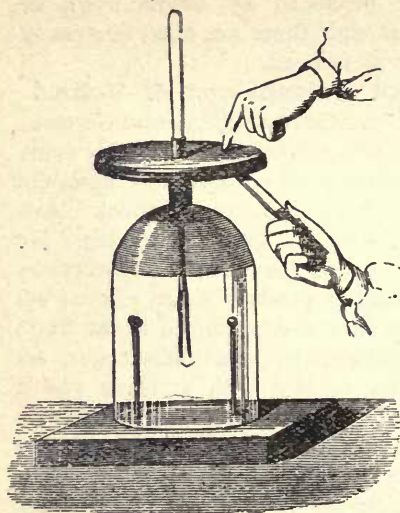

Fig 68.

upon the plates of the condenser the opposite charges have accumulated. When the upper plate is lifted off the lower one, the capacity of the condenser diminishes enormously, and the small quantity of electricity is now able to raise the potential of the plates to a higher degree, and the gold leaves accordingly expand.¹

150. The Voltaic Pile.—The second of Volta's proofs was less

direct, but even more convincing; and consisted in showing that when a number of such contacts of dissimilar metals could be arranged so as to add their electrical effects together, those effects were more powerful in proportion to the number of the contacts. With this view he constructed the apparatus known (in honour of the discoverer) as the **Voltaic Pile** (Fig. 69). It is made by placing a pair of discs of zinc and copper in contact with one another, then laying on the copper disc a piece of flannel or blotting-paper moistened with brine, then another pair of discs of zinc and copper, and so on, each pair of discs in the pile being separated

¹ Formerly, this action was accounted for by saying that the electricity which was "bound" when the plates of the condenser were close together, becomes "free" when the top plate is lifted up; the above is, however, a more scientific and more accurate way of saying the same thing. The student who is unable to reconcile these two ways of stating the matter should read again Articles 47, 48, on pp. 53 to 55.

by a moist conductor. Such a *pile*, if composed of a number of such pairs of discs, will produce electricity enough to give quite a perceptible shock, if the top and bottom discs, or wires connected with them, be touched simultaneously with the moist fingers. When a single pair of metals are placed in contact, one becomes + ly electrical to a certain small extent, and the other - ly electrical, or in other words there is a certain difference of electric potential (see p. 40) between them. But when a number are thus set in series with moist conductors between the successive pairs, the difference of potential between the first zinc and the last copper disc is increased in proportion to the number of pairs; for now all the successive small differences of potential are added together.

151. **The Crown of Cups.**—Another combination devised by Volta was his *Couronne de Tasses* or *Crown of Cups*. It consisted of a number of cups (Fig. 70),

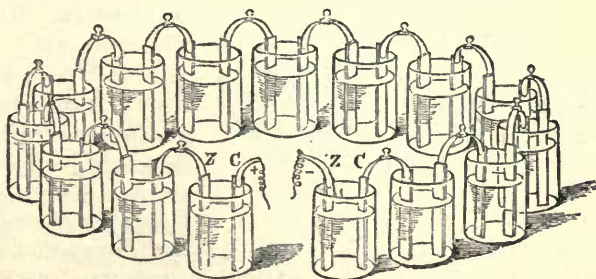

Fig. 70.

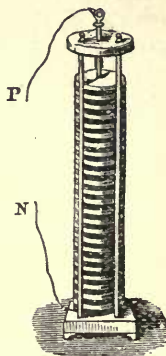

Fig. 69.

filled either with brine or dilute acid, into which dipped a number of compound strips, half zinc half copper, the zinc portion of one strip dipping into one cup, while

the copper portion dipped into the other cup. The difference of potential between the first and last cups is again proportional to the number of pairs of metal strips. This arrangement, though badly adapted for such a purpose, is powerful enough to ring an electric bell, the wires of which are joined to the first zinc and the last copper strip. The electrical action of these combinations is, however, best understood by studying the phenomena of one single cup or *cell*.

152. Simple Voltaic Cell:—Place in a glass jar some water having a little sulphuric acid or any other oxidising acid added to it (Fig. 71). Place in it separately two

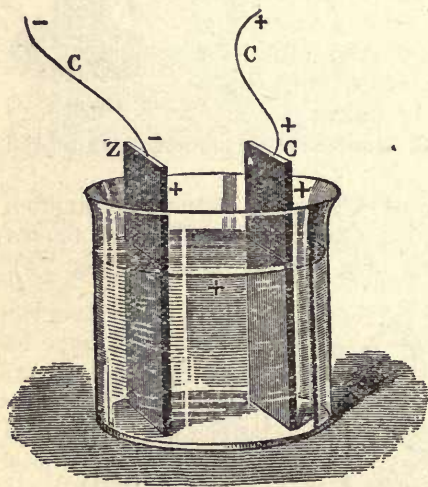

Fig. 71.

clean strips, one of zinc Z, and one of copper C. This cell is capable of supplying a continuous flow of electricity through a wire whose ends are brought into connection with the two strips. When the current flows the zinc strip is observed to waste away; its consumption in fact furnishes the energy required to drive the current through the cell

and the connecting wire. The cell may therefore be regarded as a sort of chemical furnace in which the fuel is zinc. Before the strips are connected by a wire no appreciable difference of potential between the copper and the zinc will be observed by an electrometer; because the electrometer only measures the potential at

a point in the air or oxidising medium outside the zinc or the copper, not the potentials of the metals themselves. The zinc itself is at about 1.86 volts lower potential than the surrounding oxidising media (see Art. 422 *bis*); while the copper is at only about .81 volts lower, having a less tendency to become oxidised. There is then a latent difference of potential of about 1.05 volts between the copper and the zinc: but this produces no current as long as there is no metallic contact. If the strips are made to touch, or are joined by a pair of metal wires, immediately there is a rush of electricity through the metal from the copper to the zinc, and a small portion of the zinc is at the same time dissolved away; the zinc parting with its latent energy as its atoms combine with the acid. This energy is expended in forcing a discharge of electricity through the acid to the copper strip, and thence through the wire circuit back to the zinc strip. The copper strip, whence the current starts on its journey through the external circuit, is called the *positive pole*, and the zinc strip is called the *negative pole*. If two copper wires are united to the tops of the two strips, though no current flows so long as the wires are kept separate, the wire attached to the zinc will be found to be negative, and that attached to the copper positive, there being still a *tendency* for the zinc to oxidise and drive electricity through the cell from zinc to copper. This state of things is represented in Fig. 71; and this distribution of potentials led some to consider the junction of the zinc with the copper wire as the starting point of the current. But the real starting point is in the cell at the surface of the zinc where the chemical action is furnishing energy; for from this point there are propagated through the liquid certain electro-chemical actions (more fully explained in chap. xi.) which have the result of constantly renewing the difference of potential and supplying electricity to the + pole just as fast as that electricity leaks away through

the wire to the - pole. At the same time it will be noticed that a few bubbles of hydrogen gas appear on the surface of the copper plate. Both these actions go on as long as the wires are joined to form a complete circuit.

153. Effects produced by Current.—The current itself cannot be *seen* to flow through the wire circuit; hence to prove that any particular cell or combination produces a current requires a knowledge of some of the *effects* which currents can produce. These are of various kinds. A current flowing through a thin wire will heat it; flowing near a magnetic needle it will cause it to turn; flowing through water and other liquids it decomposes them; and, lastly, flowing through the living body or any sensitive portion of it, it produces certain sensations. These effects, thermal, magnetic, chemical, and physiological, will be considered in special Lessons.

154. Voltaic Battery.—If a number of such simple cells are united in series, the zinc plate of one joined to the copper plate of the next, and so on, a greater difference of potentials will be produced between the copper "pole" at one end of the series and the zinc "pole" at the other end. Hence, when the two poles are joined by a wire there will be a more powerful flow of electricity than one cell would cause. Such a combination of Voltaic Cells is called a Voltaic Battery.¹

155. Electromotive-Force.—The term "*electromotive-force*" is employed to denote that which moves or tends to move electricity from one place to another.²

¹ By some writers the name *Galvanic Battery* is given in honour of Galvani; but the honour is certainly Volta's. The electricity that flows thus in currents is sometimes called *Voltaic Electricity*, or *Galvanic Electricity*, or sometimes even *Galvanism* (!), but, as we shall see, it differs only in degree from Frictional or any other Electricity, and both can flow through wires, and magnetise iron, and decompose chemical compounds.

² The beginner must not confuse "*Electromotive-force*," or that which tends to move electricity, with *Electric "force,"* or that force with which electricity tends to move matter. Newton has virtually defined "force," once for all, as that which moves or tends to move matter. What

For brevity we sometimes write it E.M.F. In this particular case it is obviously the result of the difference of potential, and proportional to it. Just as in water-pipes a *difference of level* produces a *pressure*, and the pressure produces a *flow* so soon as the tap is turned on, so *difference of potential* produces *electromotive-force*, and electromotive-force sets up a *current* so soon as a circuit is completed for the electricity to flow through. Electromotive-force, therefore, may often be conveniently expressed as a difference of potential, and *vice versâ*; but the student must not forget the distinction.

156. Volta's Laws.—Volta showed (Art. 71) that the difference of potential between two metals in contact depended merely on what metals they were, not on their size, nor on the amount of surface in contact. He also showed that when a number of metals touch one another the difference of potential between the first and last of the row is the same as if they touched one another directly. A quantitative illustration from the researches of Ayrton and Perry was given in Art. 72. But the case of a series of cells is different from that of a mere row of metals, for, as we have seen, when two metals are immersed in a conducting liquid they are thereby equalised, or nearly equalised, in potential. Hence, if in the row of cells the zincs and coppers are all arranged in one order, so that all of them set up electromotive-forces in the same direction, *the total electromotive-force of the series will be equal to the electromotive-force of one cell multiplied by the number of cells.*

157. Hitherto we have spoken only of zinc and copper as the materials for a battery; but batteries may be made of any two metals. That battery will have the

matter is moved by a magnet we speak rightly of *magnetic force*; when electricity moves matter we may speak of *electric force*. But E.M.F. is quite a different thing, not "force" at all, for it acts not on matter but on electricity, and tends to move it.

greatest electromotive-force, or be the most "intense," in which those materials are used which give the greatest difference of potentials on contact, or which are widest apart on the "contact-series" given in Art. 72. Zinc and copper are very convenient in this respect; and zinc and silver would be better but for the expense. For more powerful batteries a zinc-platinum or a zinc-carbon combination is preferable.

158. Resistance.—The same electromotive-force does not, however, always produce a current of the same *strength*. The strength of the current depends not only on the force tending to drive the electricity round the circuit, but also on the **resistance** which it has to encounter and overcome in its flow. If the cells be partly choked with sand or sawdust (as is sometimes done in so-called "Sawdust Batteries" to prevent spilling), or, if the wire provided to complete the circuit be very long or very thin, the action will be partly stopped, and the current will be weaker, although the E.M.F. may be unchanged. The analogy of the water-pipes will again help us. The pressure which forces the water through pipes depends upon the difference of level between the cistern from which the water flows and the tap to which it flows; but the amount of water that runs through will depend not on the pressure alone, but on the resistance it meets with; for, if the pipe be a very thin one, or choked with sand or sawdust, the water will only run slowly through.

Now the metals in general conduct well: their resistance is small; but metal wires must not be too thin or too long, or they will resist too much, and permit only a feeble current to pass through them. The liquids in the battery do not conduct nearly so well as the metals, and different liquids have different resistances. Pure water will hardly conduct at all, and is for the feeble electricity of the voltaic battery almost a perfect insulator, though for the high-potential electricity of the

frictional machines it is, as we have seen, a fair conductor. Salt and saltpetre dissolved in water are good conductors, and so are dilute acids, though strong sulphuric acid is a bad conductor. The resistance of the liquid in the cells may be reduced, if desired, by using larger plates of metal and putting them nearer together. Gases are bad conductors; hence the bubbles of hydrogen gas which are given off at the copper plate during the action of the cell, and which stick to the surface of the copper plate, increase the internal resistance of the cell by diminishing the effective surface of the plates.

LESSON XIV.—*Chemical Actions in the Cell.*

159. The production of a current of electricity in a voltaic cell is *always* accompanied by chemical actions in the cell. One of the metals at least must be readily oxidisable, and the liquid must be one capable of acting on the metal. As a matter of fact, it is found that zinc and the other metals which stand at the electropositive end of the contact-series (see Art. 72) are oxidisable; whilst the electronegative substances—copper, silver, gold, platinum, and graphite—are less oxidisable, and the last three resist the action of every single acid. There is no proof that their electrical behaviour is due to their chemical behaviour; nor is their chemical behaviour due to their electrical. Probably both result from a common cause. (See Article 422 (*bis*), and also p. 71.)

160. A piece of quite pure zinc when dipped alone into dilute sulphuric acid is not attacked by the liquid. But the ordinary commercial zinc is not pure, and when plunged into dilute sulphuric acid dissolves away, a large quantity of bubbles of hydrogen gas being given off from the surface of the metal. Sulphuric acid is a complex substance, in which every molecule is made up of a group of atoms,—2 of Hydrogen, 1 of Sulphur, and 4 of

Oxygen ; or, in symbols, H_2SO_4 . The chemical reaction by which the zinc enters into combination with the radical of the acid, turning out the hydrogen, is expressed in the following equation :—

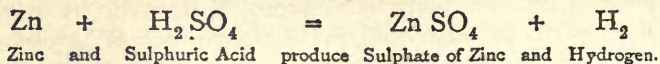

The sulphate of zinc produced in this reaction remains in solution in the liquid.

Now, when a plate of pure zinc and a plate of some less-easily oxidisable metal—copper or platinum, or, best of all, carbon (the hard carbon from the gas retorts)—are put side by side into the cell containing acid, no appreciable chemical action takes place until the circuit is completed by joining the two plates with a wire, or by making them touch one another. Directly the circuit is completed a current flows and the chemical actions begin, the zinc dissolving in the acid, and the acid giving up its hydrogen in streams of bubbles. But it will be noticed that these bubbles of hydrogen are evolved *not* at the zinc plate, nor yet throughout the liquid, but *at the surface of the copper plate* (or the carbon plate if carbon is employed). This apparent transfer of the hydrogen gas through the liquid from the surface of the zinc plate to the surface of the copper plate where it appears is very remarkable. The ingenious theory framed by Grotthuss to account for it, is explained in Lesson XXXVIII. on Electro-Chemistry.

These chemical actions go on as long as the current passes. The quantity of zinc used up in each cell is proportional to the amount of electricity which flows round the circuit while the battery is at work ; or, in other words, is proportional to the strength of the current. The quantity of hydrogen gas evolved is also proportional to the amount of zinc consumed, and also to the strength of the current. After the acid has thus dissolved zinc in it, it will no longer act as a corrosive

solvent; it has been "killed," as workmen say, for it has been turned into sulphate of zinc. The battery will cease to act, therefore, either when the zinc has all dissolved away, or when the acid has become exhausted, that is to say, when it is all turned into sulphate of zinc. Stout zinc plates will last a long time, but the acids require to be renewed frequently, the spent liquor being emptied out.

161. Local Action.—When the circuit is not closed the current cannot flow, and there should be no chemical action so long as the battery is producing no current. The impure zinc of commerce, however, does not remain quiescent in the acid, but is continually dissolving and giving off hydrogen bubbles. This local action, as it is termed, is explained in the following manner:—The impurities in the zinc consist of particles of iron, arsenic, and other metals. Suppose a particle of iron to be on the surface anywhere and in contact with the acid. It will behave like the copper plate of a battery towards the zinc particles in its neighbourhood, for a local difference of potential will be set up at the point where there is metallic contact, causing a local current to run from the particles of zinc through the acid to the particle of iron, and so there will be a constant wasting of the zinc, both when the battery circuit is closed and when it is open.

162. Amalgamation of Zinc.—We see now why a piece of ordinary commercial zinc is attacked on being placed in acid. There is local action set up all over its surface in consequence of the metallic impurities in it. To do away with this local action, and abolish the wasting of the zinc while the battery is at rest, it is usual to amalgamate the surface of the zinc plates with mercury. The surface to be amalgamated should be cleaned by dipping into acid, and then a few drops of mercury should be poured over the surface and rubbed into it with a bit of linen rag tied to a stick. The mercury unites with the zinc at the surface, forming a

pasty amalgam. The iron particles do not dissolve in the mercury, but float up to the surface, whence the hydrogen bubbles which may form speedily carry them off. As the zinc in this pasty amalgam dissolves into the acid the film of mercury unites with fresh portions of zinc, and so presents always a clean bright surface to the liquid.

A newer and better process is to add about 4 per cent of mercury to the molten zinc before casting into plates or rods. If the zinc plates of a battery are well amalgamated there should be no evolution of hydrogen bubbles when the circuit is open. Nevertheless there is still always a little wasteful local action during the action of the battery. Jacobi found that while one part of hydrogen was evolved at the positive pole, 33.6 parts of zinc were dissolved at the negative pole, instead of the 32.5 parts which are the chemical equivalent of the hydrogen.

163. Polarisation.—The bubbles of hydrogen gas liberated at the surface of the copper plate stick to it in great numbers, and form a film over its surface; hence the effective amount of surface of the copper plate is very seriously reduced in a short time. When a simple cell, or battery of such cells, is set to produce a current, it is found that the strength of the current after a few minutes, or even seconds, falls off very greatly, and may even be almost stopped. This immediate falling off in the strength of the current, which can be observed with any galvanometer and a pair of zinc and copper plates dipping into acid, is almost entirely due to the film of hydrogen bubbles sticking to the copper pole. A battery which is in this condition is said to be "polarised."

164. Effects of polarisation.—The film of hydrogen bubbles affects the strength of the current of the cell in two ways.

Firstly, It weakens the current by the increased *resistance* which it offers to the flow, for bubbles of gas are bad conductors; and,

Secondly, It weakens the current by setting up an

opposing *electromotive-force*; for hydrogen is almost as oxidisable a substance as zinc, especially when freshly deposited (or in a "nascent" state), and is electropositive, standing high in the series on p. 69. Hence the hydrogen itself produces a difference of potential, which would tend to start a current in the opposite direction to the true zinc-to-copper current.

It is therefore a very important matter to abolish this polarisation, otherwise the currents furnished by batteries would not be constant.

165. Remedies against Internal Polarisation.

—Various remedies have been practised to reduce or prevent the polarisation of cells. These may be classed as mechanical, chemical, and electro-chemical.

1. *Mechanical Means*.—If the hydrogen bubbles be simply brushed away from the surface of the positive pole, the resistance they caused will be diminished. If air be blown into the acid solution through a tube, or if the liquid be agitated or kept in constant circulation by siphons, the resistance is also diminished. If the surface be rough or covered with points, the bubbles collect more freely at the points and are quickly carried up to the surface, and so got rid of. This remedy was applied in **Smee's Cell**, which consisted of a zinc and a platinised silver plate dipping into dilute sulphuric acid; the silver plate, having its surface thus covered with a rough coating of finely divided platinum, gave up the hydrogen bubbles freely; nevertheless, in a battery of Smee Cells the current falls off greatly after a few minutes.

2. *Chemical Means*.—If a highly-oxidising substance be added to the acid it will destroy the hydrogen bubbles whilst they are still in the nascent state, and thus will prevent both the increased internal resistance and the opposing electromotive-force. Such substances are bichromate of potash, nitric acid, and bleaching powder (so-called chloride of lime). These substances, however, would attack the copper in a zinc-copper cell. Hence

they can only be made use of in zinc-carbon or zinc-platinum cells. Nitric acid also attacks zinc when the circuit is open. Hence it cannot be employed in the same single cell with the zinc plate. In the **Bichromate Battery**, invented by Poggendorf, bichromate

of potash is added to the sulphuric acid. This cell is most conveniently made up as a "bottle battery" (Fig. 72), in which a plate of zinc is the - pole, and a pair of carbon plates, one on each side of the zinc, are joined together at the top as a + pole. As this solution acts on the metal zinc when the circuit is open, the zinc plate is fixed to a rod by which it can be drawn up out of the solution

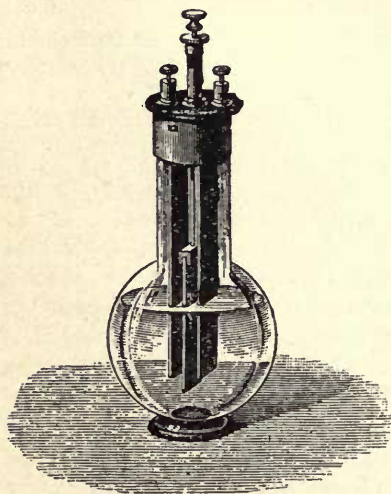

Fig. 72.

when the cell is not being worked. Other cases of chemical prevention of polarisation are mentioned in describing other forms of battery.

3. *Electro-chemical Means.*—It is possible by employing double cells, as explained in the next Lesson, to so arrange matters that some solid metal, such as *copper*, shall be liberated instead of hydrogen bubbles, at the point where the current leaves the liquid. This electro-chemical exchange entirely obviates polarisation.

166. **Simple Laws of Chemical Action in the Cell.**—We will conclude this section by enumerating the two simple laws of chemical action in the cell.

1. *The amount of chemical action in the cell is propor-*

tional, to the quantity of electricity that passes through it, —that is to say, is proportional to the strength of the current while it passes.

One coulomb¹ of electricity in passing through the cell liberates $\frac{1}{96800}$ (or .000010352) of a gramme of hydrogen, and causes $\frac{32.5}{96800}$ (or .00033644) of a gramme of zinc to dissolve in the acid.

II. *The amount of chemical action is equal in each cell of a battery consisting of cells joined in series.*

The first of these laws was thought by Faraday, who discovered it, to disprove Volta's contact theory. He foresaw that the principle of the conservation of energy would preclude a mere contact force from furnishing a continuous supply of current, and hence ascribed the current to the chemical actions which were proportional in quantity to it. How the views of Volta and Faraday are to be harmonised has been indicated in the last paragraph of Art. 72.

LESSON XV.—*Voltaic Batteries.*

167. A good Voltaic Battery should fulfil all or most of the following conditions:—

1. Its electromotive-force should be high and constant.
2. Its internal resistance should be small.
3. It should give a constant current, and therefore must be free from polarisation, and not liable to rapid exhaustion, requiring frequent renewal of the acid.
4. It should be perfectly quiescent when the circuit is open.
5. It should be cheap and of durable materials.
6. It should be manageable, and if possible, should not emit corrosive fumes.

¹ For the definition of the *coulomb*, or practical unit of quantity of electricity, see Art. 323.

168. No single battery fulfils all these conditions, however, and some batteries are better for one purpose and some for another. Thus, for telegraphing through a long line of wire a considerable internal resistance in the battery is no great disadvantage; while, for producing an electric light, much internal resistance is absolutely fatal. The electromotive-force of a battery depends on the materials of the cell, and on the number of cells linked together, and a high E.M.F. can therefore be gained by choosing the right substances and by taking a large number of cells. The resistance within the cell can be diminished by increasing the size of the plates, by bringing them near together, so that the thickness of the liquid between them may be as small as possible, and by choosing liquids that are good conductors. Of the innumerable forms of battery that have been invented, only those of first importance can be described. Batteries may be classified into two groups, according as they contain one or two fluids, or electrolytes,

SINGLE-FLUID CELLS.

169. The simple cell of Volta, with its zinc and copper plates, has been already described. Cruickshank suggested to place the plates vertically in a trough, producing a more powerful combination. Dr. Wollaston proposed to use a plate of copper of double size, bent round so as to approach the zinc on both sides, thus diminishing the resistance. Smee, as we have seen, replaced the copper plate by platinised silver, and Walker suggested the use of plates of hard carbon instead of copper or silver, thereby saving cost, and at the same time increasing the electromotive-force. The simple bichromate cell (Fig. 72) is almost the only single-fluid cell free from polarisation, and even in this form the strength of the current falls off after a few minutes' working, owing to the chemical reduction of the liquid. Pabst uses an iron-carbon cell with perchloride of iron as the exciting liquid. The iron dissolves and chlorine is at first evolved; but without polarisation; the liquid regenerating itself.

by absorbing oxygen from the air. It is very constant, but of low E.M.F. Complete depolarisation is usually obtained by two-fluid cells, or by cells in which in addition to the one fluid there is a depolarising solid body, such as oxide of manganese, oxide of copper, or peroxide of lead, in contact with the carbon pole. Such cells do not really belong to the class of single-fluid cells, and they are considered in the next group in which there are two electrolytes.

TWO-FLUID CELLS.

170. Daniell's Battery.—Each cell or “element” of Daniell's Battery consists of an inner and an outer cell, divided by a porous partition to keep the separate liquids in the two cells from mixing. The

outer cell (Fig. 73) is usually of copper, and serves also as a copper plate. Within it is placed a cylindrical cell of unglazed porous porcelain (a cell of parchment, or even of brown paper, will answer), and in this is a rod of amalgamated zinc for the negative pole. The liquid in the inner cell is dilute sulphuric acid;

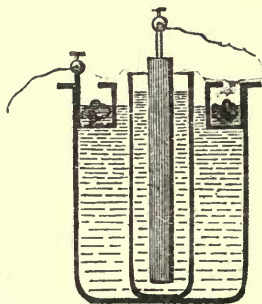
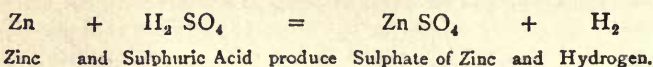

Fig. 73.

that in the outer cell is a saturated solution of sulphate of copper (“blue vitriol”), some spare crystals of the same substance being contained in a perforated shelf at the top of the cell, in order that they may dissolve and replace that which is used up while the battery is in action.

When the circuit is closed the zinc dissolves in the dilute acid, forming sulphate of zinc, and liberating hydrogen gas; but this gas does *not* appear in bubbles on the surface of the copper cell, for, since the inner cell is porous, the molecular actions (by which the freed atoms of hydrogen are, as explained by Fig. 155, handed on through the acid) traverse the pores of the inner cell, and there, in the solution of sulphate of copper, the

hydrogen atoms are exchanged for copper atoms, the result being that pure copper, and not hydrogen gas, is deposited on the outer copper plate. Chemically these actions may be represented as taking place in two stages.



And then

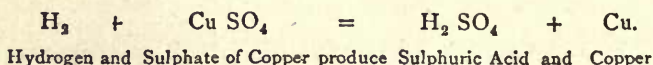

The hydrogen is, as it were, translated electro-chemically into copper during the round of changes, and so while the zinc dissolves away the copper grows, the dilute sulphuric acid gradually changing into sulphate of zinc, and the sulphate of copper into sulphuric acid. There is therefore no polarisation so long as the copper solution is saturated; and the battery is very constant, though not so constant in all cases as Clark's standard cell described in Art. 177, owing to slight variations in the electromotive-force as the composition of the other fluid varies. When sulphuric acid diluted with twelve parts of water is used the E.M.F. is 1.181 (legal) volts. The E.M.F. is 1.047 volts when concentrated zinc sulphate is used; 1.07 volts when a half-concentrated solution of zinc sulphate is used; and, in the common cells made up with water or dilute acid, 1.028 volts or less. Owing to its constancy, this battery, made up in a convenient flat form (Fig. 77), has been much used in telegraphy.

171. Grove's Battery.—Sir Wm. Grove devised a form of battery having both greater E.M.F. and smaller internal resistance than Daniell's Cell. In Grove's element there is an outer cell of glazed ware or of ebonite, containing the amalgamated zinc plate and dilute sulphuric acid. In the inner porous cell a piece of platinum foil serves as the negative pole, and it dips into the strongest nitric acid. There is no polarisation in this cell, for the hydrogen liberated by the solution of the zinc in dilute sulphuric acid, in passing through the

nitric acid in order to appear at the platinum pole, decomposes the nitric acid and is itself oxidized, producing water and the red fumes of nitric peroxide gas. This gas does not, however, produce polarisation, for as it is very soluble in nitric acid it does not form a film upon the face of the platinum plate, nor does it, like hydrogen, set up an opposing electromotive-force with the zinc. The Grove cells may be made of a flat shape, the zinc being bent up so as to embrace the flat porous cell on both sides. This reduces the internal resistance, which is already small on account of the good conducting powers of nitric acid. Hence the Grove's cell will furnish for three or four hours continuously a powerful current. The E.M.F. of one cell is about 1.9 volts. A single cell will readily raise to a bright red heat two or three inches of thin platinum wire, or drive a small electro-magnetic engine. For producing larger effects a number of cells must be joined up "in series," the platinum of one cell being clamped to the zinc of the next to it. Fifty such cells, each holding about a quart of liquid, amply suffice to produce an electric light, as will be explained in Lesson XXXII.

172. Bunsen's Battery.—The battery which bears Bunsen's name is a modification of that of Grove, and was indeed originally suggested by him. In the Bunsen cell the expensive¹ platinum foil is replaced by a rod or slab of hard gas carbon. The difficulty of cutting this into thin slabs causes a cylindrical form of battery, with a rod of carbon, as shown in Fig. 74, to be preferred to the flat form. The difference of potentials for a zinc-carbon combination is a little higher than for a zinc-platinum one, which is an advantage; but the Bunsen cell is troublesome to keep in order, and there is some difficulty in making a good contact between the rough

¹ Platinum costs about 30 shillings an ounce—nearly half as much as gold; while a hundredweight of the gas carbon may be had for a mere trifle, often for nothing more than the cost of carrying it from the gasworks.

surface of the carbon and the copper strap which connects the carbon of one cell to the zinc of the next.

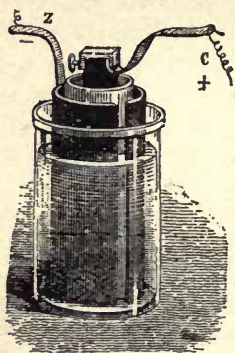

Fig. 74.

Fig. 75 shows the usual way of coupling up a series of five such cells. The Bunsen's battery will continue to furnish a current for a longer time than the flat Grove's cells, on account of the larger quantity of acid contained by the cylindrical pots.¹

173. **Leclanché's Battery: Niaudet's Battery.**—For working electric bells and telephones, and also to a limited extent in telegraphy, a zinc-carbon cell is employed, invented by Mons.

Leclanché, in which the exciting liquid is not dilute acid, but a solution of salammoniac. In this the zinc dissolves, forming a double chloride of zinc and ammonia, while ammonia gas and hydrogen are liberated

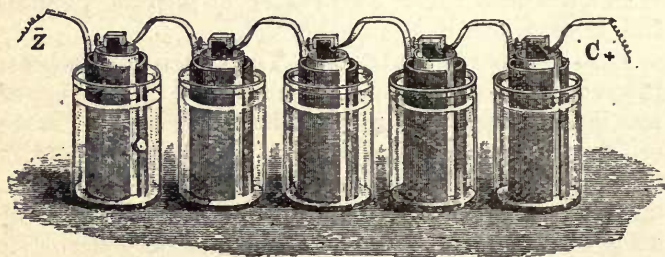

Fig. 75.

at the carbon pole. To prevent polarisation the carbon plate is packed inside a porous pot along with frag-

¹ Callan constructed a large battery in which *cast-iron* formed the positive pole, being immersed in strong nitric acid, the zincs dipping into dilute acid. The iron under these circumstances is not acted upon by the acid, but assumes a so-called "passive state." In this condition its surface appears to be impregnated with a film of magnetic peroxide, or of oxygen.

ments of carbon and powdered binoxide of manganese, a substance which slowly yields up oxygen and destroys the hydrogen bubbles. If used to give a continuous current for many minutes together, the power of the cell falls off owing to the accumulation of the hydrogen bubbles; but if left to itself for a time the cell recovers itself, the binoxide gradually destroying the polarisation. As the cell is in other respects perfectly constant, and does not require renewing for months or years, it is well adapted for domestic purposes. Three Leclanché cells are shown joined in series, in Fig. 76.

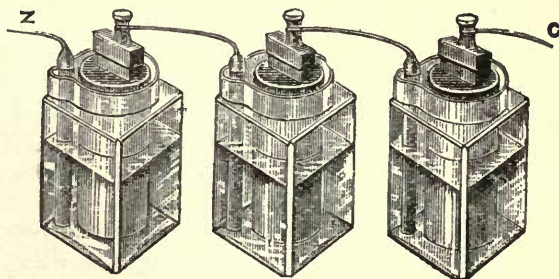

Fig. 76.

In more recent forms the binoxide of manganese is applied in a conglomerate attached to the face of the carbon, thus avoiding the necessity of using a porous inner cell.

Mons. Niaudet has also constructed a zinc-carbon cell in which the zinc is placed in a solution of common salt (chloride of sodium), and the carbon is surrounded by the so-called chloride-of-lime (or bleaching-powder), which readily gives up chlorine and oxygen, both of which substances will destroy the hydrogen bubbles and prevent polarisation. This cell has a higher E.M.F. and a less resistance than the Leclanché. De Lalande and Chaperon propose a cell in which oxide of copper is used as a solid depolariser in a solution of caustic potash.

174. **De la Rue's Battery.**—Mr. De la Rue has constructed a perfectly constant cell in which zinc and

silver are the two metals, the zinc being immersed in chloride of zinc, and the silver embedded in a stick of fused chloride of silver. As the zinc dissolves away, metallic silver is deposited upon the + pole, just as the copper is in the Daniell's cell. Mr. De la Rue has constructed an enormous battery of over 11,000 little cells. The difference of potential between the first zinc and last silver of this gigantic battery was over 11,000 volts, yet even so no spark would jump from the + to the - pole until they were brought to within less than a quarter of an inch of one another. With 8040 cells the length of spark was only 0.08 of an inch.

175. *Marié Davy's Battery.*—In this cell the zinc dips into sulphate of zinc, while a carbon plate dips into a pasty solution of mercurous sulphate. When the cell is in action mercury is deposited on the surface of the carbon, so that the cell is virtually a zinc-mercury cell. It was largely used for telegraphy in France before the introduction of the Leclanché cell.

176. *Gravitation Batteries.*—Instead of employing a porous cell to keep the two liquids separate, it is possible, where one of the liquids is heavier than the other, to arrange that the heavier liquid shall form a stratum at the bottom of the cell, the lighter floating upon it. Such arrangements are called *gravitation batteries*; but the separation is never perfect, the heavy liquid slowly diffusing upwards. Daniell's cells arranged as gravitation batteries have been contrived by Meidinger, Minotto, Callaud, and Sir. W. Thomson. In Siemens' modification of Daniell's cell paper-pulp is used to separate the two liquids. The "Sawdust Battery" of Sir W. Thomson is a Daniell's battery, having the cells filled with sawdust, to prevent spilling and make them portable.

177. *Latimer Clark's Standard Cell.*—A standard cell whose E.M.F. is even more constant than that of the Daniell was suggested by Latimer Clark. This

battery is composed of pure mercury, on which floats a paste of mercurous sulphate, a plate of zinc resting on the paste. Contact with the mercury, which acts as the positive pole, is made with a platinum wire. The E.M.F. is 1.436 legal volts.

178. The following table gives the electromotive-forces of the various batteries enumerated :—

Name of Battery, etc.	E.M.F. in (legal) Volts.
<i>Single-Fluid Cells.</i>	
Volta (Wollaston, etc.) .	1.036—0.81
Smee	0.64 ?
Poggendorff (Grenet, Trouvé, etc.)	2.27—1.77
Pabst	0.78
<i>Two-Fluid Cells.</i>	
Daniell (Meidinger, Minotto, Thomson, etc.)	1.122—1.07—1.047—1.028
Grove	1.934—1.76
Bunsen	1.942—1.73
Leclanché	1.59—1.46—1.402
Niäudet	1.63
Lalande and Chaperon	0.66
De la Rue	1.046
Marié Davy	1.50
Latimer Clark (Standard)	1.436
<i>Secondary Batteries.</i>	
Ritter	2.22—1.47
Planté (Faure, Sellon, etc.)	2.22—1.96

179. **Strength of Current.**—The student must not mistake the figures given in the above table for the strength of current which the various batteries will yield; *that* depends, as was said in Lesson XIII., on the internal *resistance* of the cells as well as on their E.M.F. The E.M.F. of a cell is independent of its size, and is determined solely by the materials chosen and their condition. The resistance depends on the

size of the cell, the conducting qualities of the liquid, the thickness of the liquid which the current must traverse, etc.

The exact definition of the strength of a current is as follows: *The strength of a current is the quantity of electricity which flows past any point of the circuit in one second.*¹ Suppose that during 10 seconds 25 coulombs of electricity flow through a circuit, then the average strength of that strong current during that time has been $2\frac{1}{2}$ coulombs per second, or $2\frac{1}{2}$ amperes. The usual strength of currents used in telegraphing over main lines is only from five to ten thousandths of an ampère.

If in t seconds a quantity of electricity Q has flowed through the circuit, then the strength C of the current during that time is represented by the equation:

$$C = \frac{Q}{t}.$$

Moreover, if C represents the strength of the current, the total quantity of electricity that has passed through the circuit in a given time, t is found by multiplying the strength of the current by the time; or

$$Q = Ct.$$

For the quantity of electricity that is thus transferred will be proportional to the strength of the flow, and to the time that it continues.

The laws which determine the strength of a current in a circuit were first enunciated by Dr. G. S. Ohm, who stated them in the following law:

180. Ohm's Law.—*The strength of the current varies directly as the electromotive-force, and inversely*

¹ The terms "strong," "great," and "intense," as applied to currents, mean precisely the same thing. Formerly, before Ohm's Law was properly understood, electricians used to talk about "quantity currents," and "intensity currents," meaning by the former term a current flowing through a circuit in which there is very *small resistance* inside the battery or out; and by the latter expression they designated a current due to a *high electromotive-force*. The terms were convenient, but should be avoided as misleading.

as the resistance of the circuit; or, in other words, anything that makes the E.M.F. of the cell greater will increase the strength of the current, while anything that increases the resistance (either the internal resistance in the cells themselves or the resistance of the external wires of the circuit) will diminish the strength of the current. (See further concerning Ohm's Law in Lesson XXIX.)

Now the internal resistances of the cells we have named differ very greatly, and differ with their size. Roughly speaking we may say that the resistance in a Daniell's cell is about five times that in a Grove's cell of equal size. The Grove's cell has therefore both a higher E.M.F. and less internal resistance. It would in fact send a current about eight times as strong as the Daniell's cell of equal size through a short stout wire.

181. We may then increase the strength of a battery in two ways:—

(1) by increasing its E.M.F

(2) by diminishing its internal resistance.

The electromotive-force of a cell being determined by the materials of which it is made, the only way to

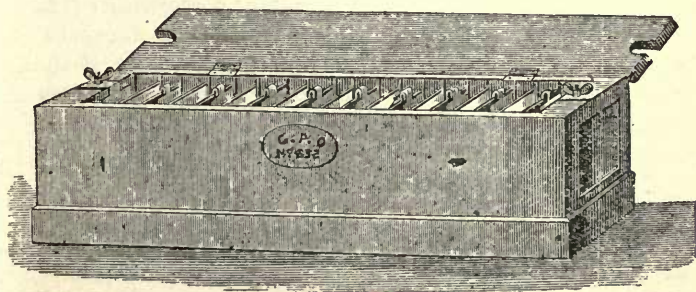

Fig. 77.

increase the total E.M.F. of a battery of given materials, is to increase the number of cells joined in series. It is

frequent in the telegraph service to link thus together two or three hundred of the flat Daniell's cells; and they are usually made up in trough-like boxes, containing a series of 10 cells, as shown in Fig. 77.

To diminish the internal resistance of a cell the following expedients may be resorted to:—

(1.) The plates may be brought nearer together, so that the current shall not have to traverse so thick a stratum of liquid.

(2.) The size of the plates may be increased, as this affords the current, as it were, a greater number of possible paths through the stratum of liquid.

(3.) The zincs of several cells may be joined together, to form, as it were, one large zinc plate, the coppers being also joined to form one large copper plate. Cells thus joined are said to be united "in parallel circuit," or "for quantity," to distinguish this method of joining from the joining in simple series. Suppose four similar cells thus joined, the current has four times the available number of paths by which it can traverse the liquid from zinc to copper; hence the internal resistance of the whole will be only $\frac{1}{4}$ of that of a single cell. But the E.M.F. of them will be no greater thus than that of one cell.

It is most important for the student to remember that the strength of the current is also affected by the resistances of the wires of the *external* circuit; and if the external resistance be already great, as in telegraphing through a long line, it is little use to diminish the internal resistance if this is already much smaller than the resistance of the line wire.

The E.M.F. of the single-fluid cells of Volta and Smee is marked as doubtful, for the opposing E.M.F. of polarisation sets in almost before the true E.M.F. of the cell can be measured. The different values assigned to other cells are accounted for by the different degrees of concentration of the liquids. Thus in the Daniell's cells

used in telegraphy, *water* only is supplied at first in the cells containing the zincs ; and the E.M.F. of these is less than if acid or sulphate of zinc were added to the water.

182.—Other Batteries.—Numerous other forms of battery have been suggested by different electricians. There are three, of theoretical interest only, in which the electromotive-force is due, not to differences of potential at the contact of dissimilar *metals*, but to differences of potential at the contact of a metal or metals with *liquids*. The first of these was invented by the Emperor Napoleon III. Both plates were of copper, dipping respectively into solutions of dilute sulphuric acid and of caustic soda, separated by a porous cell. The second of these combinations, due to Wöhler, employs plates of aluminium only, dipping respectively into strong nitric acid and a solution of caustic soda. In the third, invented by Dr. Fleming, the two liquids do not even touch one another, being joined together by a second metal. In this case the liquids chosen are sodium persulphide and nitric acid, and the two metals copper and lead. A similar battery might be made with copper and zinc, using solutions of ordinary sodium sulphide, and dilute sulphuric acid in alternate cells, a bent zinc plate dipping into the first and second cells, a bent copper plate dipping into second and third, and so on ; for the electromotive-force of a copper-sodium sulphide-zinc combination is in the reverse direction to that of a copper-sulphuric acid-zinc combination.

Bennett has lately described a cheap and most efficient battery, in which the metals are iron and zinc, and the exciting liquid a strong solution of caustic soda. Old meat-canisters packed with iron filings answer well for the positive element, and serve to contain the solution. Scrap zinc thrown into mercury in a shallow inner cup of porcelain forms the negative pole.

Skrivanoff has modified the zinc-carbon cell of Latimer Clark, by employing a stiff paste made of ammonio-mercuric chloride and common salt, thereby rendering the cells dry and portable.

Jablochkoff has described a battery in which plates of carbon and iron are placed in fused nitre ; the carbon is here the electro-positive element, being rapidly consumed in the liquid.

Planté's and Faure's *Secondary Batteries*, and Grove's *Gas Battery*, are described in Arts. 415, 416.

The so-called *Dry Pile* of Zamboni deserves notice. It consists of a number of paper discs, coated with zinc

foil on one side and with binoxide of manganese on the other, piled upon one another, to the number of some thousands, in a glass tube. Its internal resistance is enormous, as the internal conductor is the moisture of the paper, and this is slight; but its electromotive-force is very great, and a good dry pile will yield sparks. Many years may elapse before the zinc is completely oxidised or the manganese exhausted. In the Clarendon Laboratory at Oxford there is a dry pile, the poles of which are two metal bells: between them is hung a small brass ball, which, by oscillating to and fro, slowly discharges the electricity. It has now been continuously ringing the bells for over forty years.

183. **Effect of Heat on Batteries.**—If a cell be warmed it yields a stronger current than when cold. This is chiefly due to the fact that the liquids conduct better when warm, the internal resistance being thereby reduced. A slight change is also observed in the E.M.F. on heating; thus the E.M.F. of a Daniell's cell is about $1\frac{1}{2}$ per cent higher when warmed to the temperature of boiling water, while that of a bichromate battery falls off nearly 2 per cent under similar circumstances.

LESSON XVI.—*Magnetic Actions of the Current.*

184. About the year 1802 Romagnosi, of Trente, discovered that a voltaic pile affects a magnetised needle, and causes it to turn aside from its usual position. The discovery, however, dropped into oblivion, having never been published. A connection of some kind between magnetism and electricity had long been suspected. Lightning had been known to magnetise knives and other objects of steel; but almost all attempts to imitate these effects by powerful charges of electricity, or by sending currents of electricity through

steel bars, had failed.¹ The true connection between magnetism and electricity remained to be discovered.

In 1819, Oerstedt, of Copenhagen, showed that a magnet tends to set itself at right-angles to a wire carrying an electric current. He also found that the way in which the needle turns, whether to the right or the left of its usual position, depends upon the position of the wire that carries the current—whether it is above or below the needle,—and on the direction in which the current flows through the wire.

185. Oerstedt's Experiment.—Very simple apparatus suffices to repeat the fundamental experiment. Let a magnetic needle be suspended on a pointed pivot, as in Fig. 78. Above it, and parallel to it, is held a stout

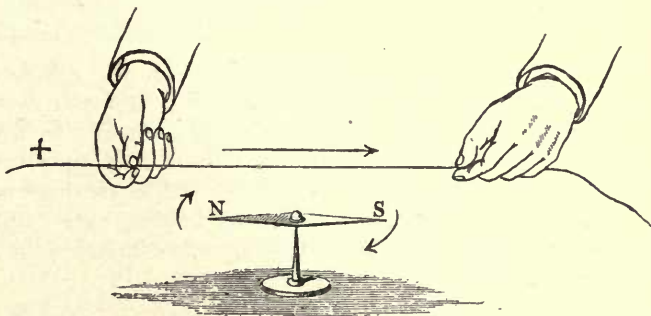

Fig. 78.

copper wire, one end of which is joined to one pole of a battery of one or two cells. The other end of the wire is then brought into contact with the other pole of the battery. As soon as the circuit is completed the current flows through the wire and the needle turns briskly aside. If the current be flowing along the wire *above* the needle

¹ Down to this point in these lessons there has been no connection between magnetism and electricity, though something has been said about each. The student who cannot remember whether a *charge* of electricity does or does not affect a magnet, should turn back to what was said in Art. 91.

in the direction from north to south, it will cause the N.-seeking end of the needle to turn eastwards: if the current flows from south to north in the wire the N.-seeking end of the needle will be deflected westwards. If the wire is, however, *below* the needle, the motions will be reversed, and a current flowing from north to south will cause the N.-seeking pole to turn westwards.

186. Ampère's Rule.—To keep these movements in memory, Ampère suggested the following fanciful but useful rule. *Suppose a man swimming in the wire with the current, and that he turns so as to face the needle, then the N.-seeking pole of the needle will be deflected towards his left hand.* In other words, the deflection of the N.-seeking pole of a magnetic needle, as viewed from the conductor, is towards the left of the current.

For certain particular cases in which a *fixed* magnet pole acts on a *movable* circuit, the following *converse to Ampère's Rule* will be found convenient. Suppose a man swimming in the wire with the current, and that he turns so as to look along the direction of the lines of force of the pole (*i.e.* as the lines of force run, *from* the pole if it be N.-seeking, *towards* the pole if it be S.-seeking), then he and the conducting wire with him will be urged *toward his left*.

187. A little consideration will show that if a current

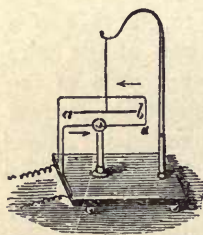

Fig. 79.

be carried *below* a needle in one direction, and then back in the opposite direction *above* the needle, by bending the wire round, as in Fig. 79, the forces exerted on the needle by both portions of the current will be in the same direction. For let *a* be the N.-seeking, and *b* the S.-seeking, pole of the suspended needle, then the tendency of the current in the lower part of the wire will be to turn the needle so that *a* comes towards the observer, while *b*

retreats; while the current flowing above, which also deflects the N.-seeking pole to its left, will equally urge a towards the observer, and b from him. The needle will not stand out completely at right-angles to the direction of the wire conductor, but will take an oblique position. The directive forces of the earth's magnetism are tending to make the needle point north-and-south. The electric current is acting on the needle, tending to make it set itself west-and-east. The resultant force will be in an oblique direction between these, and will depend upon the relative strength of the two conflicting forces. If the current is very strong the needle will turn widely round; but could only turn completely to a right-angle if the current were infinitely strong. If, however, the current is feeble in comparison with the directive magnetic force, the needle will turn very little.

188. This arrangement will, therefore, serve roughly as a **Galvanoscope** or indicator of currents; for the movement of the needle shows the direction of the current, and indicates whether it is a strong or a weak one. This apparatus is too rough to detect very delicate currents. To obtain a more sensitive instrument there are two possible courses: (*i.*) Increase the effective action of the current by carrying the wire more than once round the needle: (*ii.*) Decrease the opposing directive force of the earth's magnetism by some compensating contrivance.

189. **Schweigger's Multiplier.**—The first of the above suggestions was carried out by Schweigger, who constructed a *multiplier* of many turns of wire. A suitable frame of wood, brass, or ebonite, is prepared to receive the wire, which must be "insulated," or covered with silk, or cotton, or guttapercha, to prevent the separate turns of the coil from coming into contact with each other. Within this frame, which may be circular, elliptical, or more usually rectangular, as in Fig. 80, the needle is suspended, the frame being placed so that the

wires lie in the magnetic meridian. The greater the

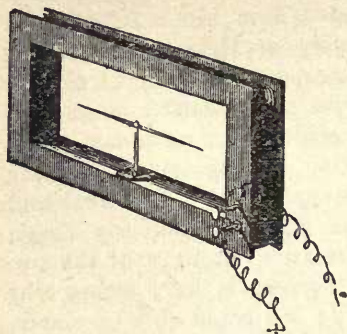

Fig. 80.

number of turns the more powerful will be the magnetic deflection produced by the passage of equal quantities of current. But if the wire is thin, or the number of turns of wire numerous, the resistance thereby offered to the flow of electricity may very greatly reduce the strength of the current. The student will grasp the importance

of this observation when he has read the chapter on Ohm's Law.

190. Astatic Combinations.—The directive force exercised by the earth's magnetism on a magnetic needle may be reduced or obviated by one of two methods:—

(a.) By employing a *compensating magnet*. An ordinary long bar magnet laid in the magnetic meridian, but with its N.-seeking pole directed towards the north, will, if placed horizontally above or below a suspended magnetic needle, tend to make the needle set itself with its S.-seeking pole northwards. If near the needle it may overpower the directive force of the earth, and cause the needle to reverse its usual position. If it is far away, all it can do is to lessen the directive force of the earth. At a certain distance the magnet will just compensate this force, and the needle will be neutral. This arrangement for reducing the earth's directive force is applied in the reflecting galvanometer shown in Fig. 91, in which the magnet at the top, curved in form and capable of adjustment to any height, affords a means of adjusting the instrument to the desired degree of sensitiveness by raising or lowering it.

(b.) By using an *astatic pair* of magnetic needles.

If two magnetised needles of equal strength and size are bound together by a light wire of brass, or aluminium, in reversed positions, as shown in Fig. 81, the force urging one to set itself in the magnetic meridian is exactly counterbalanced by the force that acts on the other. Consequently this pair of needles will remain in any position in which it is set, and is independent of the earth's magnetism. Such a combination is known as an **astatic pair**.

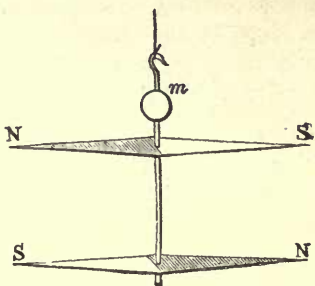

Fig. 81.

It is, however, difficult in practice to obtain a perfectly astatic pair, since it is not easy to magnetise two needles exactly to equal strength, nor is it easy to fix them perfectly parallel to one another.

Such an astatic pair is, however, readily deflected by a current flowing in a wire coiled around one of the needles; for, as shown in Fig. 82, the current which flows above one needle and below the other will urge both in the same direction, because they are already in reversed positions. It is even possible to go farther, and to carry the wire round both needles, winding the coil around the upper in

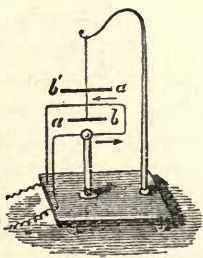

Fig. 82.

the opposite sense to that in which the coil is wound round the lower needle.

Nobili applied the astatic arrangement of needles to the multiplying coils of Schwëigger, and thus constructed a very sensitive instrument, the *Astatic Galvanometer*, Shown in Fig. 88. The special forms of galvanometer adapted for the measurement of currents are described in the next Lesson.

191. **Magnetic field due to Current.** — Arago found that if a current be passed through a piece of copper wire it becomes capable of attracting iron filings to it so long as the current flows. These filings set themselves at right angles to the wire, and cling around it, but drop off when the circuit is broken. There is, then, a magnetic "field," around the wire which carries the current; and it is important to know how the lines of force are distributed in this field.

Let the central spot in Fig. 83 represent an imaginary cross-section of the wire, and let us suppose the current to be flowing in through the paper at that point. Then by Ampère's rule a magnet needle placed below will tend to set itself in the position shown, with its N. pole pointing to the left.¹ The current will urge a needle above the wire into the reverse position. A needle on the right of the current will set itself at right angles to the current (*i.e.* in the plane of the paper), and with its



Fig. 83.

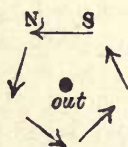

Fig. 84.

N. pole pointing *down*, while the N. pole of a needle on the left would be urged *up*. In fact the tendency would be to urge the N. pole round the conductor in the same

way as the hands of a watch move; while the S. pole would be urged in the opposite cyclic direction to that of the hands of a watch. If the current is reversed, and is regarded as flowing towards the reader, *i.e.* coming up *out* of the plane of the paper, as in the diagram of Fig.

¹ If the student has any difficulty in applying Ampère's rule to this case and the others which succeed, he should carefully follow out the following mental operation. Consider the spot marked "in" as a hole in the ground into which the current is flowing, and into which he dives head-foremost. While in the hole he must turn round so as to face each of the magnets in succession, and remember that in each case the N.-seeking pole will be urged to *his* left. In diagram 84 he must conceive himself as coming up *out* of the hole in the ground where the current is flowing out.

84, then the motions would be just in the reverse sense. It would seem from this as if a N.-seeking pole of a magnet ought to revolve continuously round and round a current; but as we cannot obtain a magnet with one pole only, and as the S.-seeking pole is urged in an opposite direction, all that occurs is that the needle sets itself as a tangent to a circular curve surrounding the conductor. This is what Oerstedt meant when he described the electric current as acting "in a revolving manner," upon the magnetic needle. The field of force with its circular lines surrounding a current flowing in a straight conductor, can be examined experimentally with iron filings in the following way: A card is placed horizontally and a stout copper wire is passed vertically through a hole in it (Fig. 85). Iron filings are sifted over the card (as described in Art. 108), and a strong current from three or four large cells is passed through the wire. On tapping the card gently the filings near the wire set themselves in concentric circles round it.

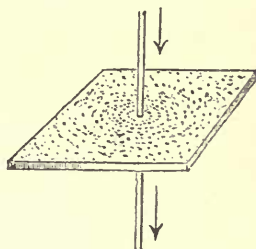

Fig. 85.

192. Equivalent Magnetic Shell: Ampère's Theorem.—For many purposes the following way of regarding the magnetic action of electric currents is more convenient than the preceding. Suppose we take a battery and connect its terminals by a circuit of wire, and that a portion of the circuit be twisted, as in Fig. 86, into a looped curve, it will be found that the entire space enclosed by the loop possesses magnetic properties. In our figure the current is supposed to be flowing round the loop, as viewed from above, in the same direction as the hands of a clock move round; an imaginary man swimming round the circuit and always facing towards the centre would have his left side down. By Ampère's

rule, then, a N. pole would be urged downwards through the loop, while a S. pole would be urged upwards. In fact the space enclosed by the loop of the circuit behaves

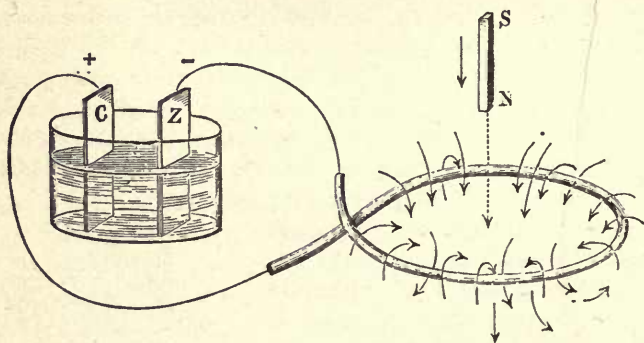

Fig. 86.

like a *magnetic shell* (see Art. 107), having its upper face of S.-seeking magnetism, and its lower face of N.-seeking magnetism. It can be shown in every case that a *closed voltaic circuit is equivalent to a magnetic shell whose edges coincide in position with the circuit*, the shell being of such a strength that the number of its lines of force is the same as that of the lines of force due to the current in the circuit. The circuit acts on a magnet attracting or repelling it, and being attracted or repelled by it, just exactly as its equivalent magnetic shell would do. Also, the circuit itself, when placed in a magnetic field, experiences the same force as its equivalent magnetic shell would do.

193. Maxwell's Rule.—Professor Clerk Maxwell, who developed this method of treating the subject, has given the following elegant rule for determining the mutual action of a circuit and a magnet placed near it. *Every portion of the circuit is acted upon by a force urging it in such a direction as to make it enclose within its embrace the greatest possible number of lines of*

force. If the circuit is fixed and the magnet movable, then the force acting on the magnet will also be such as to tend to make the number of lines of force that pass through the circuit a maximum (see also Art. 317).

194. **De la Rive's Floating Battery.**—The preceding remarks may be illustrated experimentally by the aid of a little floating battery. A plate of zinc and one of copper (see Fig. 87) are fixed side by side in a large

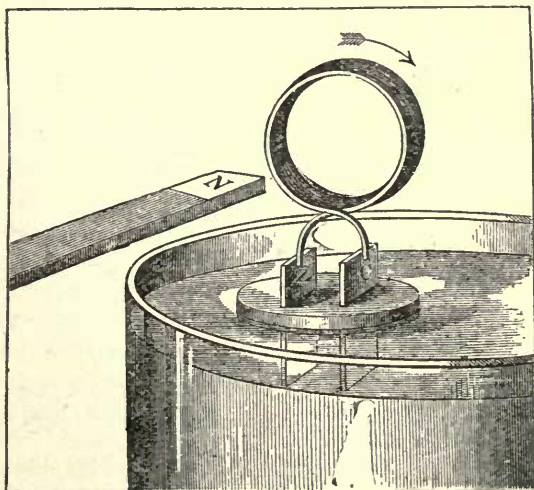

Fig. 87.

cork, and connected above by a coil of covered copper wire bent into a ring. This is floated upon a dish containing dilute sulphuric acid. If one pole of a bar magnet be held towards the ring it will be attracted or repelled according to the pole employed. The floating circuit will behave like the floating magnet in Fig. 44, except that here we have what is equivalent to a floating magnetic shell. If the S. pole of the magnet be presented to that face of the ring which acts as a S.-seeking pole (viz. that face round which the current is flowing

in a clockwise direction), it will repel it. If the pole be thrust right into the ring, and then held still, the battery will be strongly repelled, will draw itself off, float away, turn round so as to present toward the S. pole of the magnet its N.-seeking face, will then be attracted up, and will thread itself on to the magnet up to the middle, in which position as many magnetic lines of force as possible cross the area of the ring.

It can be shown also that two circuits traversed by currents attract and repel one another just as two magnetic shells would do.

It will be explained in Lesson XXVI. on Electromagnets how a piece of iron, or steel can be magnetised by causing a current to flow in a spiral wire round it.

195. Strength of the Current in Magnetic Measure.—When a current thus acts on a magnet pole near it, the force f which it exerts will be proportional to the strength i of the current, and proportional also to the strength m of the magnet pole, and to the length l of the wire employed: it will also vary inversely as the square of the distance r from the circuit to the magnet pole. Or, $f = \frac{i.l.m}{r^2}$ dynes. Suppose the wire looped up into a circle round the magnet pole, then $l = 2\pi r$, and $f = \frac{2\pi i}{r} m$ dynes. Suppose also that the circle is of *one* centimetre radius, and that the magnet pole is of strength of *one* unit (see Art. 125), then the force exerted by the current of strength i will be $\frac{2\pi i}{1} \times 1$, or $2\pi i$ dynes. In order, therefore, that a current of strength i should exert a force of i dynes on the unit pole, one must consider the current as travelling round only $\frac{1}{2\pi}$ part of the circle, or round a portion of the circumference equal in length to the radius.

196. Unit of Current Strength.—A current is said to have a strength of one “absolute” unit when it

is such that if one centimetre length of the circuit is bent into an arc of one centimetre radius, the current in it exerts a force of one dyne on a magnet-pole of unit strength placed at the centre of the arc. The practical unit of "one *ampère*" is only $\frac{1}{10}$ of this theoretical unit. (See also Art. 323.)

LESSON XVII.—*Galvanometers.*

197. The term **Galvanometer** is applied to an instrument for measuring the strength of electric currents by means of the deflection of a magnetic needle, round which the current is caused to flow through a coil of wire. The simple arrangement described in Art. 188 was termed a "Galvanoscope," or current *indicator*, but it could not rightly be termed a "galvanometer"¹ or current *measurer*, because its indications were only qualitative, not quantitative. The indications of the needle did not afford accurate knowledge as to the exact strength of current flowing through the instrument. A good galvanometer must fulfil the essential condition that its readings shall really *measure* the strength of the current in some certain way. It should also be sufficiently sensitive for the currents that are to be measured to affect it. The galvanometer adapted for measuring very small currents (say a current of only one or two millionth parts of an *ampère*) will not be suitable for measuring very strong currents, such as are used in producing an electric light. Moreover, if the current to be measured has already passed through a circuit of great resistance (as, for example, some miles of telegraph wire), a galvanometer whose coil is a short one, consist-

¹ The terms "*Rheoscope*" and "*Rheometer*" are still occasionally applied to these instruments. A current interrupter is sometimes called a "*Rheotom*," and the Commutator or Current Reverser, shown in Fig. 149, is in some books called a "*Rheotrope*"; but these terms are dropping out of use.

ing only of a few turns of wire, will be of no use, and a long-coil galvanometer must be employed with many turns of wire round the needle. The reason of this is explained hereafter (Art. 352). Hence it will be seen that different styles of instrument are needed for different kinds of work; but of all the requisites are that they should afford quantitative measurements, and that they should be sufficiently sensitive for the current that is to be measured.

198. Nobili's Astatic Galvanometer. — The instrument constructed by Nobili, consisting of an astatic pair of needles delicately hung, so that the lower one lay

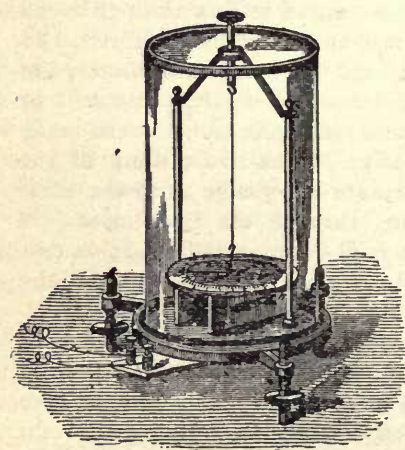

Fig. 88.

within a coil of wire wound upon an ivory frame (Fig. 88), was for long the favourite form of sensitive galvanometer. The needles of this instrument, being independent of the earth's magnetism, take their position in obedience to the torsion of the fibre by which they are hung. The frame on which the coil is wound must be set carefully parallel to

the needles; and three screw feet serve to adjust the base of the instrument level. Protection against currents of air is afforded by a glass shade. When a current is sent through the wire coils the needles move to right or left over a graduated circle. When the deflections are *small* (*i.e.* less than 10° or 15°), they are very nearly proportional to the strength of the currents that produce them. Thus, if a current produces a

deflection of 6° it is known to be approximately three times as strong as a current which only turns the needle through 2° . But this approximate proportion ceases to be true if the deflection is more than 15° or 20° ; for then the needle is not acted upon so advantageously by the current, since the poles are no longer within the coils, but are protruding at the side, and, moreover, the needle being oblique to the force acting on it, part only of the force is turning it against the directive force of the fibre; the other part of the force is uselessly pulling or pushing the needle along its length. It is, however, possible to "*calibrate*" the galvanometer,—that is, to ascertain by special measurements, or by comparison with a standard instrument, to what strengths of current particular amounts of deflection correspond. Thus, suppose it once known that a deflection of 32° on a particular galvanometer is produced by a current of $\frac{1}{10}$ of an ampère, then a current of that strength will *always* produce on that instrument the same deflection, unless from any accident the torsion force or the intensity of the magnetic field is altered.

199. The Tangent Galvanometer.—It is not—for the reasons mentioned above—possible to construct a galvanometer in which the *angle* (as measured in degrees of arc) through which the needle is deflected is proportional throughout its whole range to the strength of the current. But it is possible to construct a very simple galvanometer in which the *tangent*¹ of the angle of deflection shall be accurately proportional to the strength of the current. Fig. 89 shows a frequent form of **Tangent Galvanometer**. The coil of this instrument consists of a simple circle of stout copper wire from ten to fifteen inches in diameter. At the centre is delicately suspended a magnetised steel needle not exceeding one inch in length, and usually furnished with a light index of aluminium. The instrument is adjusted

¹ See note on Ways of Reckoning Angles, p. 109.

by setting the coil in the magnetic meridian, the small needle lying then in the plane of the coil. One essential feature of this arrangement is, that while the coil is very large, the needle is relatively very small. The "field"

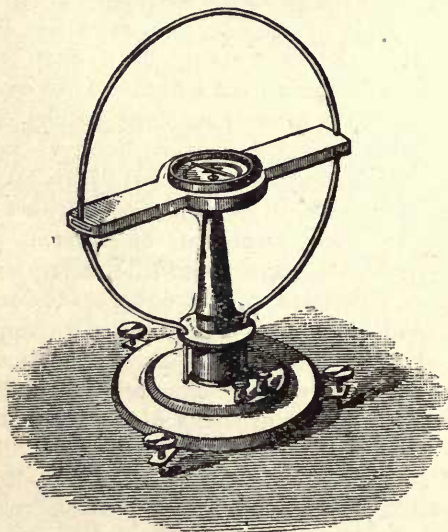

Fig. 89.

due to a current passing round the circle is very uniform at and near the centre, and the lines of force are there truly normal to the plane of the coil.¹ This is not true of other parts of the space inside the ring, the force being neither uniform nor normal in direction, except *in* the plane of the coil and *at* its centre. The needle being

¹ In order to ensure uniformity of field, Gauguain proposed to hang the needle at a point on the axis of the coil distant from its centre by a distance equal to half the radius of the coils. Helmholtz's arrangement of *two* parallel coils, symmetrically set on either side of the needle, is better; and a *three-coil* galvanometer having the central coil larger than the others, so that all three may lie in the surface of a sphere having the small needle at its centre, is the best arrangement of all for ensuring that the field at the centre is uniform.

small its poles are never far from the centre, and hence never protrude into the regions where the magnetic force is irregular. Whatever magnetic force the current in the coil can exert on the needle is exerted normally to the plane of the ring, and therefore at right angles to the magnetic meridian. Now, it was proved in Art. 124 that the magnetic force which, acting at right angles to the meridian, produces on a magnetic needle the deflection δ is equal to the horizontal force of the earth's magnetism at that place multiplied by the *tangent* of the angle of deflection. Hence a current flowing in the coil will turn the needle aside through an angle such that *the tangent of the angle of deflection is proportional to the strength of the current.*

EXAMPLE.—Suppose a certain battery gave a deflection of 15° on a tangent galvanometer, and another battery yielding a stronger current gave a deflection of 30° . The strengths currents are *not* in the proportion of 15 : 30, but in the proportion of $\tan 15^\circ$ to $\tan 30^\circ$. These values must be obtained from a Table of natural tangents like that given on p. 111, from which it will be seen that the ratio between the strengths of the currents is .268 : .577, or about 10 : 22.

Or, more generally, if current C produces deflection δ , and current C' deflection δ' , then

$$C : C' = \tan \delta : \tan \delta'$$

To obviate reference to a table of figures, the circular scale of the instrument is sometimes graduated into tangent values instead of being divided into equal degrees of arc. Let a tangent O T be drawn to the circle, as in Fig. 90, and along this line let any number of equal divisions be set off, beginning at O. From these points draw back to the centre. The circle will thus be divided into a number of pieces, of which those near O are nearly equal, but which get smaller and smaller away from O. These unequal pieces correspond

to equal increments of the tangent. If the scale were divided thus, the readings would be proportional to the tangents. It is, however, harder to divide an arc

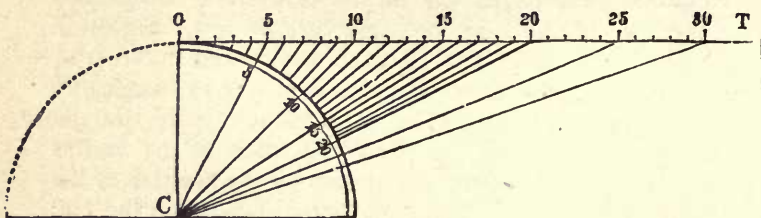

Fig. 90.

into tangent-lines with accuracy than to divide it into equal degrees; hence this graduation, though convenient, is not used where great accuracy is needed.

200. Absolute Measure of Current by Tangent Galvanometer.—The strength of a current may be determined in “absolute” units by the aid of the tangent galvanometer if the “constants” of the instrument are known. The tangent of the angle of deflection represents (*see* Art. 124) the ratio between the magnetic force due to the current and the horizontal component of the earth’s magnetic force. Both these forces act on the needle, and depend *equally* upon the magnetic moment of the needle, which, therefore, we need not know for this purpose. We know that the force exerted by the current at centre of the coil is proportional to the horizontal force of the earth’s magnetism multiplied by the tangent of the angle of deflection. These two quantities can be found from the tables, and from them we calculate the absolute value of the current, as follows:—Let r represent the radius of the galvanometer coil (measured in centimetres); its total length (if of one turn only) is $2\pi r$. The distance from the centre to all parts of the coil is of course r . From our definition of the unit of strength of current (Art. 196),

it follows that $i \times \frac{2\pi r}{r^2} = \text{force (in dynes) at centre,}$

$$\text{or } i \times \frac{2\pi}{r} = H \cdot \tan \delta;$$

$$\text{hence } i = \frac{r}{2\pi} \cdot H \cdot \tan \delta.$$

The quantity $\frac{r}{2\pi}$ is called the "constant" of the galvanometer.

Hence we obtain the value of the current in absolute (electromagnetic) units¹ by multiplying together the galvanometer constant, the horizontal magnetic force at the place, and the tangent of the angle of deflection. Tangent galvanometers are often made with more than one turn of wire. In this case the "constant" is $\frac{r}{2\pi n}$ where n is the number of turns in the coil.

200 (bis). Am-meter.—Professors Ayrton and Perry have lately designed some galvanometers for electric-light work, intended to show by a pointer attached to the magnetic needle the strength of the current in *ampères* (Art. 323). In these instruments, which are portable, and "dead-beat" in action, the needle is placed between the poles of a powerful permanent magnet to control its direction and make it independent of the earth's magnetism. By a peculiar shaping of the pole-pieces, needle, and coils, the angular deflections are proportional to the strength of the deflecting current. The coils are in ten sections, which can be grouped either "in series" or "in parallel" at will, by turning an appropriate commutator, thus enabling the scale-readings to be verified by using one ordinary cell. These *Am-meters* are made with short-coils of very low resistance and few turns of wire. Ayrton and Perry have also arranged *Voltmeters* (see Art. 360 *d*), with long-coils of high resistance, in a similar way.

201. Sine Galvanometer.—The disadvantage of the tangent galvanometer just described is that it is not very sensitive, because the coil is necessarily very large as compared with the needle, and therefore far away from it. A galvanometer with a smaller coil or a larger needle could not be used as a tangent galvanometer, though it would be more sensitive. Any sensitive galvanometer in which the needle is directed by the earth's magnetism can, however, be used as a **Sine Galvanometer**, provided the frame on which the coils are wound is capable of being turned round a central axis. When the instrument is so constructed, the following method of measuring currents is adopted. The coils are first set parallel to the needle (*i.e.* in the magnetic meridian); the current is then sent through it, producing a deflection; the coil itself is rotated round in the same sense, and, if turned round through a wide

¹ The student will learn (Art. 196 and 323) that the practical unit of current which we call "one *ampère*" is only $\frac{1}{10}$ of one "absolute" unit of the centimetre-gramme-second system.

enough angle, will overtake the needle, which will once more lie parallel to the coil. In this position two forces are acting on the needle: the directive force of the earth's magnetism acting along the magnetic meridian, and the force due to the current passing in the coil, which tends to thrust the poles of the needle out at right angles; in fact there is a "couple" which exactly balances the "couple" due to terrestrial magnetism. Now it was shown in the Lesson on the Laws of Magnetic Force (Art. 123), that when a needle is deflected the "moment" of the couple is proportional to the sine of the angle of deflection. Hence in the sine galvanometer, when the coil has been turned round so that the needle once more lies along it, *the strength of the current in the coil is proportional to the sine of the angle through which the coil has been turned.*¹

202. The Mirror Galvanometer.—When a galvanometer of great delicacy is needed, the moving parts must be made very light and small. To watch the movements of a very small needle an *index* of some kind must be used; indeed, in the tangent galvanometer it is usual to fasten to the short stout needle a delicate stiff pointer of aluminium. A far better method is to fasten to the needle a very light mirror of silvered glass, by means of which a beam of light can be reflected on to a scale, so that every slightest motion of the needle is magnified and made apparent. The *mirror galvano-*

¹ Again the student who desires to compare the strength of two currents will require the help of a Table of natural sines, like that given on page 111. Suppose that with current C the coils had to be turned through an angle of θ degrees; and that with a different current C' the coils had to be turned through θ' degrees, then

$$C : C' = \sin \theta : \sin \theta'.$$

It is of course assumed that the instrument is provided with a scale of degrees on which to read off the angle through which the coils have been turned. It is possible here also, for rough purposes, to graduate the circle not in degrees of arc but in portions corresponding to equal additional values of the sine. The student should try this way of dividing a circle after reading the note On Ways of Reckoning Angles, p. 109.

meters devised by Sir. W. Thomson for signalling through submarine cables, are admirable examples of this class of instrument. In Fig. 91 the general arrangements of this instrument are shown. The body of the galvanometer is supported on three screw feet by which it can be adjusted. The magnet consists of one or more small pieces of steel watch-spring attached to the back

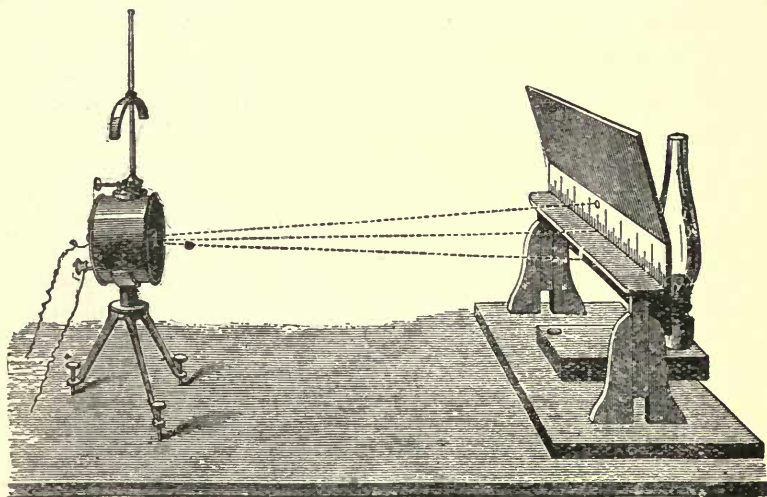

Fig. 91

of a light concave silvered glass mirror about as large as a threepenny piece. This mirror is hung by a single fibre of cocoon silk within the coil, and a curved magnet, which serves to counteract the magnetism of the earth, or to direct the needle, is carried upon a vertical support above. Opposite the galvanometer is placed the scale. A beam of light from a paraffin lamp passes through a narrow aperture under the scale and falls on the mirror, which reflects it back on to the scale. The mirror is slightly concave, and gives a well defined spot of light if the scale is adjusted to suit the focus of the

mirror.¹ The adjusting magnet enables the operator to bring the reflected spot of light to the zero point at the middle of the scale. The feeblest current passing through the galvanometer will cause the spot of light to shift to right or left. The tiny current generated by dipping into a drop of salt water the tip of a brass pin and a steel needle (connected by wires to the terminals of the galvanometer) will send the spot of light swinging right across the scale. If a powerful lime-light is used, the movement of the needle can be shown to a thousand persons at once. For still more delicate work an astatic pair of needles can be used, each being surrounded by its coil, and having the mirror rigidly attached to one of the needles.

Strong currents must not be passed through very sensitive galvanometers, for, even if they are not spoiled, the deflections of the needle will be too large to give accurate measurements. In such cases the galvanometer is used with a *shunt*, or coil of wire arranged so that the greater part of the current shall flow through it, and pass the galvanometer by, only a small portion of the current actually traversing the coils of the instrument. The resistance of the shunt must bear a known ratio to the resistance of the instrument, according to the principle laid down in Art. 353 about branched circuits.

203. Differential Galvanometer.—For the purpose of comparing two currents a galvanometer is sometimes employed, in which the coil consists of *two* separate wires wound side by side. If two equal currents are sent in opposite directions through these wires, the needle will not move. If the currents are, however, unequal, then the needle will be moved by the stronger

¹ As concave mirrors are expensive, a plain mirror behind a lens of suitable focus may be substituted. The thin discs of glass used in mounting objects for the microscope form, when silvered, excellent light mirrors. Where great accuracy is desired a fine wire is placed in the aperture traversed by the beam of light, and the image of this appears when focused on the screen as a dark line crossing the spot of light.

of them, with an intensity corresponding to the *difference* of the strengths of the two currents

204. Ballistic Galvanometer.—In order to measure the strength of currents which last only a very short time, galvanometers are employed in which the needle takes a relatively long time to swing. This is the case with long or heavy needles; or the needles may be weighted by enclosing them in leaden cases. As the needle swings slowly round, it adds up, as it were, the varying impulses received during the passage of a transient current. *The sine of half the angle of the first swing is proportional to the quantity of electricity that has flowed through the coil.* The charge of a condenser may thus be measured by discharging it through a ballistic galvanometer.

LESSON XVIII.—*Chemical Actions of the Current* :—

Voltameters.

205. In addition to the chemical actions inside the cells of the battery, which always accompany the production of a current, there are also chemical actions produced outside the battery when the current is caused to pass through certain liquids. Liquids may be divided into three classes—(1) *those which do not conduct at all*, such as turpentine and many oils, particularly petroleum; (2) *those which conduct without decomposition*, viz. mercury and other molten metals, which conduct just as solid metals do; (3) *those which are decomposed when they conduct a current*, viz. the dilute acids, solutions of metallic salts, and certain fused solid compounds.

206. Decomposition of Water.—In the year 1800 Carlisle and Nicholson discovered that the voltaic current could be passed through water, and that in passing through it decomposed a portion of the liquid into its constituent gases. These gases appeared in bubbles on the ends of the wires which led the current into and out of the liquid; bubbles of *oxygen* gas appearing at the point

where the current entered the liquid, and *hydrogen* bubbles where it left the liquid. It was soon found that a great many other liquids, particularly dilute acids and solutions of metallic salts, could be similarly decomposed by passing a current through them.

207. Electrolysis.—To this process of decomposing a liquid by means of an electric current Faraday gave the name of **electrolysis** (*i.e.* electric analysis); and those substances which are capable of being thus decomposed or “electrolysed” he termed **electrolytes**.

The ends of the wires leading from and to the battery are called **electrodes**; and to distinguish them, that by which the current enters is called the **anode**, that by which it leaves the **kathode**. The vessel in which a liquid is placed for electrolysis is termed an *electrolytic cell*.

208. Electrolysis of Water.—Returning to the decomposition of water, we may remark that perfectly pure water appears not to conduct, but its resistance is greatly reduced by the addition of a few drops of sulphuric or of hydrochloric acid. The apparatus shown in Fig. 92 is suitable for this purpose. Here a battery of two cells (those shown are circular Bunsen’s batteries) is seen with its poles connected to two strips of metallic platinum as electrodes, which project up into a vessel containing the acidulated water. Two tubes closed at one end, which have been previously filled with water and inverted, receive the gases evolved at the electrodes. Platinum is preferred to other metals such as copper or iron for electrodes, since it is less oxidisable and resists every acid. It is found that there is almost exactly *twice* as much hydrogen gas (by volume) evolved at the kathode as there is of oxygen at the anode. This fact corresponds with the known chemical composition of water, which is produced by combining together these two gases in the proportion of two volumes of the former to one of the latter. The proportions of gases evolved, however, are not *exactly* two to one, for at first a

very small quantity of the hydrogen is absorbed or "occluded" by the platinum surface, while a more considerable proportion of the oxygen—about 1 per cent—

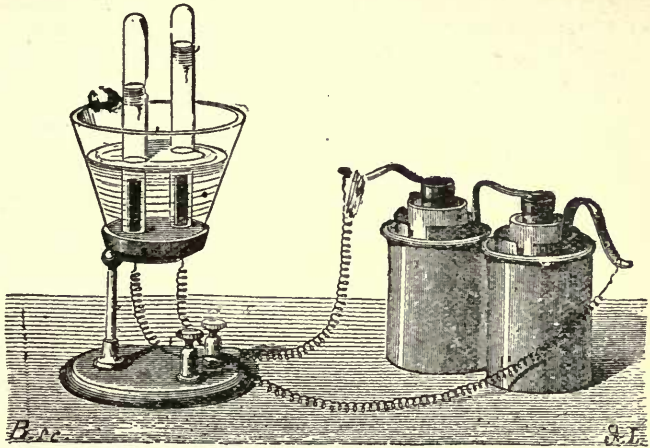
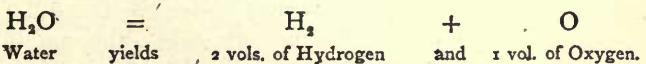

Fig. 92.

is given off in the denser allotropic form of *ozone*, which occupies less space and is also slightly soluble in the water. When a sufficient amount of the gases has been evolved and collected they may be tested; the hydrogen by showing that it will burn, the oxygen by its causing a glowing spark on the end of a splinter of wood to burst into flame. If the two gases are collected together in a common receiver, the mixed gas will be found to possess the well known explosive property of mixed hydrogen and oxygen gases. The chemical decomposition is expressed in the following equation:



209. Electrolysis of Sulphate of Copper.—We will take as another case the electrolysis of a solution of the well-known "blue vitriol" or sulphate of copper. If

a few crystals of this substance are dissolved in water a blue liquid is obtained, which is easily electrolysed between two electrodes of platinum foil, by the current from a single cell of any ordinary battery. The chemical formula for sulphate of copper is CuSO_4 . The result of the electrolysis is to split it up into metallic copper, which is deposited in a film upon the kathode, and "Sulphion" an easily decomposed compound of sulphur and oxygen, which is immediately acted upon by the water forming sulphuric acid and oxygen. This oxygen is liberated in bubbles at the anode. The chemical changes are thus expressed :

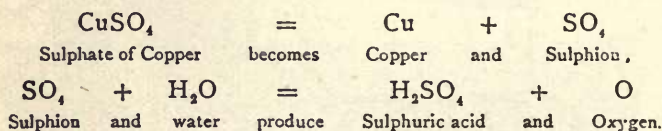

In this way, as the current continues to flow, copper is continually withdrawn from the liquid and deposited on the kathode, and the liquid gets more and more acid. If copper electrodes are used, instead of platinum, no oxygen is given off at the anode, but the copper anode itself dissolves away into the liquid at exactly the same rate as the copper of the liquid is deposited on the kathode.

210. Anions and Kathions.—The atoms which thus are severed from one another and carried invisibly by the current to the electrodes, and there deposited, are obviously of two classes: one set go to the anode, the other to the kathode. Faraday gave the name of **ions** to these wandering atoms; those going to the anode being **anions**, and those going to the kathode being **kathions**. Anions are sometimes regarded as "electro-negative" because they move as if attracted toward the + pole of the battery, while the kathions are regarded as "electro-positive." Hydrogen and the metals are kathions, moving apparently *with* the direction assumed as that of the current, and are deposited where

the current leaves the electrolytic cell. The anions are oxygen, chlorine, etc. When, for example, chloride of tin is electrolysed, metallic tin is deposited on the cathode, and chlorine gas is evolved at the anode.

211. Quantitative Laws of Electrolysis.

(i.) *The amount of chemical action is equal at all points of a circuit.* If two or more electrolytic cells are placed at different points of a circuit the amount of chemical action will be the same in all, for the same quantity of electricity flows past every point of the circuit in the same time. If all these cells contain acidulated water, the quantity, for example, of hydrogen set free in each will be the same; or, if they contain a solution of sulphate of copper, identical quantities of copper will be deposited in each: If some of the cells contain acidulated water, and others contain sulphate of copper, the weights of hydrogen and of copper will not be equal, but will be in chemically equivalent quantities.

(ii.) *The amount of an ion liberated at an electrode in a given time is proportional to the strength of the current.* A current of 2 ampères will cause just twice the quantity of chemical decomposition to take place as a current of 1 ampère would do in the same time.

(iii.) *The amount of an ion liberated at an electrode in one second is equal to the strength of the current multiplied by the "electro-chemical equivalent" of the ion.* It has been found by experiment that the passage of one coulomb of electricity through water liberates 000010352 gramme¹ of hydrogen. Hence, a current the strength of which is C (ampères) will liberate $C \times 000010352$ grammes of hydrogen per second. The quantity 000010352 is called the *electro-chemical equivalent* of hydrogen. The "electro-chemical equivalents" of other elements can be easily calculated if their chemical "equivalent" is known. Thus the chemical

¹ Lord Rayleigh says 000010352; Mascart, 000010415; F. and W. Kohlrausch, 000010354.

“equivalent”¹ of copper is 31·5; multiplying this by ·000010352 we get as the electro-chemical equivalent of copper the value ·0003261 (gramme).

212. TABLE OF ELECTRO-CHEMICAL EQUIVALENTS. ETC.

	Atomic Weight.	Valency.	Chemical Equivalent.	Electro-chemical Equivalent (grammes per coulomb).
<i>Electropositive—</i>				
Hydrogen	1	1	1	·000010352
Potassium	39·1	1	39·1	·0004047
Sodium	23	1	23	·0002381
Gold	196·6	3	65·5	·0006780
Silver	108	1	108	·0011180
Copper (Cupric)	63	2	31·5	·0003261
„ (Cuprose)	63	1	63	·0006522
Mercury (Mercuric)	200	2	100	·0010351
„ (Mercurose)	200	1	200	·0020702
Tin (Stannic)	118	4	29·5	·0003054
„ (Stannose)	118	2	59	·0006108
Iron (Ferric)	56	3	18·6	0·0001932
„ (Ferrose)	56	2	28	·0002898
Nickel	59	2	29·5	·0003054
Zinc	65	2	32·5	·0003364
Lead	207	2	103·5	·0010684
<i>Electronegative—</i>				
Oxygen	16	2	8	·0000828
Chlorine	35·5	1	35·5	·0003675
Iodine	127	1	127	·0013147
Bromine	80	1	80	·0008282
Nitrogen	14	3	4·3	·0000445

¹ The chemical “equivalent” must not be confounded with the “atomic weight.” The atomic weight of copper is 63, that is to say, its atoms are 63 times as heavy as atoms of hydrogen. But in chemical combinations one atom of copper replaces, or is “worth,” two atoms of hydrogen; hence the weight of copper equivalent to 1 of hydrogen is $\frac{63}{2} = 31\frac{1}{2}$. In all cases the chemical “equivalent” is the quotient $\frac{\text{atomic weight.}}{\text{valency}}$. The above Table gives full statistical information.

213. The following equation embodies the rule for finding the weight of any given ion disengaged from an electrolytic solution during a known time by a current whose strength is known. Let C be the strength of the current (reckoned in *ampères*), t the time (in seconds), z the electro-chemical equivalent, and w the weight (in grammes) of the element liberated; then

$$w = zCt,$$

or, in words, *the weight (in grammes) of an element deposited by electrolysis is found by multiplying its electro-chemical equivalent by the strength of the current (reckoned in ampères), and by the time (in seconds), during which the current continues to flow.*

EXAMPLE.—A current from five Daniell's cells was passed through two electrolytic cells, one containing a solution of silver, the other acidulated water, for ten minutes. A tangent galvanometer in the circuit showed the strength of the current to be $\cdot 5$ *ampères*. The weight of silver deposited will be $\cdot 0011180 \times \cdot 5 \times 10 \times 60 = \cdot 3354$ gramme. The weight of hydrogen evolved in the second cell will be $\cdot 000010352 \times \cdot 5 \times 10 \times 60 = \cdot 0031056$ gramme.

214. **Voltameters.**—The second of the above laws, that the amount of an ion liberated in a given time is proportional to the strength of the current, is sometimes known as *Faraday's Law*, from its discoverer. Faraday pointed out that it affords a chemical means of measuring the strength of currents. He gave the name of *voltmeter* to an electrolytic cell arranged for the purpose of measuring the strength of the current by the amount of chemical action it effects.

215. **Water-Voltmeter.**—The apparatus shown in Fig. 92 might be appropriately termed a *Water-Voltmeter*, provided the tubes to collect the gases be graduated, so as to measure the quantities evolved;

The weight of each measured cubic centimetre of hydrogen (at the standard temperature of 0° C, and pressure of 760 millims.) is known to be $\cdot 0000896$ grammes. Hence, if the number of cubic centimetres liberated during a given time by a current of unknown strength be ascertained, the strength of the current can be calculated by first reducing the volume to weight, and then dividing by the electro-chemical equivalent, and by the time. Each *coulomb* of electricity liberates in its flow $\cdot 1157$ cubic centimetres of hydrogen, and $\cdot 0579$ c. c. of oxygen. If these gases are collected together in a *mixed-gas voltameter* there will be $\cdot 1736$ c. c. of the mixed gases evolved for every *coulomb* of electricity which passes. To decompose 9 grammes of water, liberating 1 gramme of H and 8 grammes of O, requires 96,600 *coulombs*.

216. Copper and Silver Voltameters.—As mentioned above, if sulphate of copper is electrolysed between two electrodes of copper, the anode is slowly dissolved, and the kathode receives an equal quantity of copper as a deposit on its surface. One *coulomb* of electricity will cause $\cdot 0003261$ gramme to be deposited; and to deposit one gramme weight requires a total quantity of 3066 *coulombs* to flow through the electrodes. A current of one *ampère* deposits in one hour 1'174 grammes of copper, or 4'025 grammes of silver.

By weighing one of the electrodes before and after the passage of a current, the gain (or loss) will be proportional to the quantity of electricity that has passed. In 1879 Edison, the inventor, proposed to apply this method for measuring the quantity of electricity supplied to houses for electric lights in them; a small copper Voltameter being placed in a branch of the circuit which supplied the house, to serve as a meter. Various other kinds of *Coulombmeters* have been proposed, having clockwork counters, rolling integrating discs, and other mechanical devices to add up the total quantity of electricity conveyed by the current.

217. Comparison of Voltameters with Galvanometers.—It will be seen that both *Galvanometers* and *Voltameters* are intended to measure the strength of currents, one by magnetic, the other by chemical means. Faraday demonstrated that the magnetic and the chemical actions of a current are proportional to one another

The galvanometer shows, however, the strength of the current at any moment, and its variations in strength from one moment to another, by the position of the needle. In the Voltmeter, a varying current may liberate the bubbles of gas or the atoms of copper rapidly at one moment, and slowly the next, but all the varying quantities will be simply added together in the total yield. In fact, the voltmeter gives us the "time integral" of the current. It tells us *what quantity of electricity* has flowed through it during the experiment, rather than *how strong the current was* at any one moment.

218. Chemical Test for Weak Currents. — A very feeble current suffices to produce a perceptible amount of change in certain chemical substances. If a few crystals of the white salt *iodide of potassium* are dissolved in water, and then a little starch paste is added, a very sensitive electrolyte is obtained, which turns to an indigo blue colour at the anode when a very weak current passes through it. The decomposition of the salt liberates iodine at the anode, which, acting on the starch, forms a coloured compound. White blotting-paper, dipped into the prepared liquid, and then laid on the kathode and touched by the anode, affords a convenient way of examining the discoloration due to a current. A solution of Ferrocyanide of Potassium affords similarly on electrolysis the well-known tint of Prussian Blue. Bain proposed to utilise this in a Chemical Writing Telegraph, the short and long currents transmitted along the line from a battery being thus recorded in blue marks on a strip of prepared paper, drawn along by clockwork under the terminal of the positive wire. Faraday showed that chemical discoloration of paper moistened with starch and iodide of potassium was produced by the passage of all different kinds of electricity—frictional, voltaic, thermo-electric, and magneto-electric, —even by that evolved by the Torpedo and the

Gymnotus. In fact, he relied on this chemical test as one proof of the identity of the different kinds.

219. Internal and External Actions.—In an earlier Lesson it was shown that the quantity of chemical action inside the cells of the battery was proportional to the strength of the current. Hence, Law (i.) of Art. 211, applies both to the portion of the circuit within the battery and to that without it.

Suppose 3 Daniell's cells are being employed to decompose water in a voltameter. Then while 1 gramme weight (11,200 cub. centims.) of hydrogen and 8 grammes (5,600 c. c.) of oxygen are set free in the voltameter, 31.5 grammes of copper will be deposited in each cell of the battery, and (neglecting loss by local action), 32.5 grammes of zinc will be dissolved in each cell.

220. It will therefore be evident that the electrolytic cell is the *converse* of the voltaic cell. The chemical work done in the voltaic cell furnishes the energy of the current which that cell sets up in the circuit. In the electrolytic cell chemical work is performed, the necessary energy being furnished by the current of electricity which is sent into the cell from an independent battery or other source.

A theory of electrolysis, and some examples of its application, are given in Chapter XXXVIII. on Electrochemistry.

LESSON XIX.—*Physical and Physiological Effects of the Current.*

221. Molecular Actions.—Metal conductors, when subjected to the prolonged action of currents, undergo slow molecular changes. Wires of copper and brass gradually become brittle under its influence. During the passage of the current through metallic wires their

cohesion is temporarily lessened, and there also appears to be a decrease in their coefficient of elasticity. It was thought by Edlund that a definite elongation could be observed in strained wires when a current was passed through them; but it has not yet been satisfactorily shown that this elongation is independent of the elongation due to the heating of the wire owing to the resistance it opposes to the current.

222. Electric Osmose.—Porret observed that if a strong current is led into certain liquids, as if to electrolyse them, a porous partition being placed between the electrodes, the current mechanically carries part of the liquid through the porous diaphragm, so that the liquid is forced up to a higher level on one side than on the other. This phenomenon, known as *electric osmose*, is most manifest when badly conducting liquids, such as alcohol and bisulphide of carbon, are used. The transfer through the diaphragm takes place in the direction of the current; that is to say, the liquid is higher about the kathode than round the anode.

223. Electric Distillation.—Closely connected with the preceding phenomenon is that of the *electric distillation* of liquids. It was noticed by Beccaria that an electrified liquid evaporated more rapidly than one not electrified. Gernez has recently shown that in a bent closed tube, containing two portions of liquid, one of which is made highly + and the other highly -, the liquid passes over from + to -. This apparent distillation is not due to difference of temperature, nor does it depend on the extent of surface exposed, but is effected by a slow creeping of the liquid along the interior surface of the glass tubes. Bad conductors, such as turpentine, do not thus pass over.

224. Diaphragm Currents.—Professor Quincke discovered that a current is set up in a liquid when it is forced by pressure through a porous diaphragm. This phenomenon may be regarded as the converse of electric

osmose. The E.M.F. of the current varies with the pressure and with the nature of the diaphragm. When water was forced at a pressure of one atmosphere through sulphur, the difference of potential was over 9 volts. With diaphragms of porcelain and bladder the differences were only $\cdot 35$ and $\cdot 01$ volts respectively.

225. Electro-Capillary Phenomena.—If a horizontal glass tube, turned up at the ends, be filled with dilute acid, and a single drop of mercury be placed at about the middle of the tube, the passage of a current through the tube will cause the drop to move along towards the negative pole. It is believed that the liberation of very small quantities of gas by electrolysis at the surface where the mercury and acid meet alters the surface-tension very considerably, and thus a movement results from the capillary forces. Lippmann, Dewar, and others, have constructed upon this principle *capillary electrometers*, in which the pressure of a column of liquid is made to balance the electro-capillary force exerted at the surface of contact of mercury and dilute acid, the electro-capillary force being nearly proportional to the electromotive-force when this does not exceed one volt. Fig. 93 shows the capillary electrometer of Dewar. A glass tube rests horizontally between two glass dishes in which holes have been bored to receive the ends of

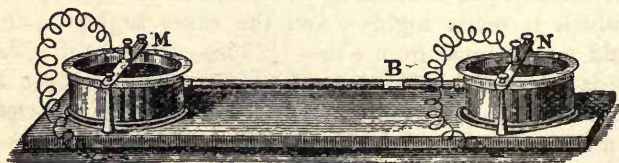

Fig. 93.

the tube. It is filled with mercury, and a single drop of dilute acid is placed in the tube. Platinum wires to serve as electrodes dip into the mercury in the dishes. An E.M.F. of only $\frac{1}{10}$ volt suffices to produce a measure-

able displacement of the drop. The direction of the displacement varies with that of the current.

226. **Physiological Actions.**—Currents of electricity passed through the limbs affect the nerves with certain painful sensations, and cause the muscles to undergo involuntary contractions. The sudden rush of even a small charge of electricity from a Leyden jar charged to a high potential, or from an induction coil (see Fig. 148), gives a sharp and painful *shock* to the system. The current from a few strong Grove's cells, conveyed through the body by grasping the terminals with moistened hands, gives a very different kind of sensation, not at all agreeable, of a prickling in the joints of the arms and shoulders, but not producing any spasmodic contractions, except it be in nervous or weakly persons, at the sudden making or breaking of the circuit. The difference between the two cases lies in the fact that the tissues of the body offer a very considerable resistance, and that the difference of potential in the former case may be many thousands of volts; hence, though the actual quantity stored up in the Leyden jar is very small, its very high E.M.F. enables it at once to overcome the resistance. The battery, although it might, when working through a good conductor, afford in one second a thousand times as much electricity, cannot, when working through the high resistance of the body, transmit more than a small fraction, owing to its limited E.M.F.

After the discovery of the *shock* of the Leyden jar by Cunæus in 1745 many experiments were tried. Louis XV. of France caused an electric shock from a battery of Leyden jars to be administered to 700 Carthusian monks joined hand in hand, with prodigious effect. Franklin killed a turkey by a shock from a Leyden jar.

227. In 1752 Sulzer remarked that "if you join two pieces of lead and silver, and then lay them upon the tongue, you will notice a certain *taste* resembling that of

green vitriol, while each piece apart produces no such sensation." This galvanic taste, not then suspected to have any connection with electricity, may be experienced by placing a silver coin on the tongue and a steel pen under it, the edges of them being then brought into metallic contact. The same taste is noticed if the two wires from the poles of a voltaic cell are placed in contact with the tongue.

228. Ritter discovered that a feeble current transmitted through the eyeball produces the sensation as of a bright *flash of light* by its sudden stimulation of the optic nerve. A stronger current transmitted by means of moistened conductors attached to the battery terminals gave a sensation of blue and green *colours* in flowing between the forehead and the hand. Helmholtz, repeating this experiment, observed only a wild rush of colour. Dr. Hunter saw flashes of light when a piece of metal placed under the tongue was touched against another which touched the moist tissues of the eye. Volta and Ritter heard musical sounds when a current was passed through the ears; and Humboldt found a sensation to be produced in the organs of smell when a current was passed from the nostril to the soft palate. Each of the specialised senses can be stimulated into activity by the current. Man possesses no specialised sense for the perception of electrical forces, as he does for light and for sound; but there is no reason for denying the possibility that some of the lower creatures may be endowed with a special electrical sense.

The following experiment shows the effect of feeble currents on cold-blooded creatures. If a copper (or silver) coin be laid on a piece of sheet zinc, and a common garden snail be set to crawl over the zinc, directly it comes into contact with the copper it will suddenly pull in its horns, and shrink in its body. If it is set to crawl over two copper wires, which are then placed in contact with a feeble voltaic cell, it immediately an-

nounces the establishment of a current by a similar contraction.¹

229. Muscular Contractions.—In 1678 Swammerdam showed to the Grand Duke of Tuscany that when a portion of muscle of a frog's leg hanging by a thread of nerve bound with silver wire was held over a copper support, so that both nerve and wire touched the copper, the muscle immediately contracted. More than a cen-

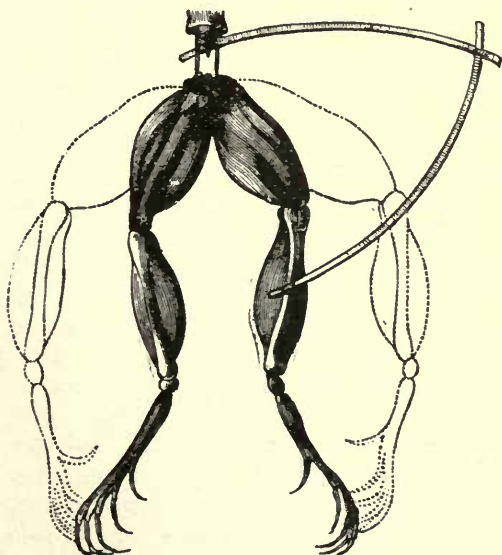

Fig. 94.

ture later Galvani's attention was drawn to the subject by his observation of spasmodic contractions in the legs of freshly-killed frogs under the influence of the "return-shock" experienced every time a neighbouring electric machine was discharged. Unaware of Swammerdam's experiment, he discovered in 1786 the fact (alluded to in

¹ It will scarcely be credited that a certain Jules Alix once seriously proposed a system of telegraphy based on this physiological phenomenon.

Art. 148 as leading ultimately to the discovery of the Voltaic Pile) that when nerve and muscle touch two dissimilar metals in contact with one another a contraction of the muscle takes place. The limbs of the frog, prepared as directed by Galvani, are shown in Fig. 94. After the animal has been killed the hind limbs are detached and skinned; the crural nerves and their attachments to the lumbar vertebræ remaining. For some hours after death the limbs retain their contractile power. The frog's limbs thus prepared form an excessively delicate galvanoscope: with them, for example, the excessively delicate induction-currents of the telephone (Lesson XL.) can be shown, though the most sensitive galvanometers barely detect them. Galvani and Aldini proved that other creatures undergo like effects. With a pile of 100 pairs Aldini experimented on newly killed sheep, oxen, and rabbits, and found them to suffer spasmodic muscular contractions. Humboldt proved the same on fishes; and Zanotti, by sending a current through a newly killed grasshopper, caused it to emit its familiar chirp. Aldini, and later Dr. Ure of Glasgow, experimented on the bodies of executed criminals, with a success terrible to behold. The facial muscles underwent horrible contortions, and the chest heaved with the contraction of the diaphragm. This has suggested the employment of electric currents as an adjunct in reviving persons who have been drowned, the contraction of the muscles of the chest serving to start respiration into activity. The small muscles attached to the roots of the hairs of the head appear to be markedly sensitive to electrical conditions from the readiness with which electrification causes the hair to stand on end.

230. Conditions of Muscular Contraction.—To produce muscular contraction the current must traverse a portion of the nerve longitudinally. In a freshly prepared frog the current causes a contraction only momen-

tarily when the circuit is made or broken. A rapidly interrupted current will induce a second contraction before the first has had time to pass off, and the muscle may exhibit thus a continuous contraction resembling *tetanus*. The prepared frog after a short time becomes less sensitive, and a "direct" current (that is to say, one passing along the nerve in the direction from the brain to the muscle) only produces an effect when circuit is made, while an "inverse" current only produces an effect when the circuit is broken. Matteucci, who observed this, also discovered by experiments on living animals that there is a distinction between the conductivity of sensory and motor nerves,—a "direct" current affecting the motor nerves on making the circuit, and the sensory nerves on breaking it; while an "inverse" current produced inverse results. Little is, however, yet known of the conditions of conductivity of the matter of the nerves; they conduct better than muscular tissue, cartilage, or bone; but of all substances in the body the blood conducts best. Powerful currents doubtless electrolyse the blood to some extent, coagulating it and the albumin it contains. The power of *contracting* under the influence of the current appears to be a distinguishing property of *protoplasm* wherever it occurs. The *amœba*, the most structureless of organisms, suffers contractions. Ritter discovered that the *sensitive plant* shuts up when electrified, and Burdon Sanderson has shown that this property extends to other vegetables, being exhibited by the *carnivorous plant*, the *Dionæa* or Venus' Fly Trap.

231. Animal Electricity.—Although, in his later writings at least, Galvani admitted that the electricity thus operating arose from the metals employed, he insisted on the existence of an *animal electricity* resident in the muscular and nervous structures. He showed that contractions could be produced without using any metals at all by merely touching a nerve at two different

points along its length with a morsel of muscle cut from a living frog; and that a conductor of one metal when joining a nerve to a muscle also sufficed to cause contraction in the latter. Galvani and Aldini regarded these facts as a disproof of Volta's contact-theory. Volta regarded them as proving that the contact between nerve and muscle itself produced (as in the case of two dissimilar metals) opposite electrical conditions. Nobili, later, showed that when the nerve and the muscle of the frog were respectively connected by a water-contact with the terminals of a delicate galvanometer, a *current* is produced which lasts several hours: he even arranged a number of frogs' legs in series, like the cells of a battery, and thus increased the current. Matteucci showed that through the muscle alone there is an electromotive-force. Du Bois Reymond has shown that if the end of a muscle be cut across, the *ends* of the muscular fibres of the transverse section are negative, and the *sides* of the muscular fibres are positive, and that this difference of potential will produce a current even while the muscle is at rest. To demonstrate this he employed a fine astatic galvanometer with 20,000 turns of wire in its coils; and to obviate errors arising from the contact of the ends of the wires with the tissues *unpolarisable electrodes* were used, made by plunging terminal zinc points into a saturated solution of sulphate of zinc, contained in a fine glass tube, the end of which was stopped with a porous plug of moistened china clay. The contraction of muscles also produces currents. These Du Bois Reymond obtained from his own muscles by dipping the tips of his fore-fingers into two cups of salt water communicating with the galvanometer terminals. A sudden contraction of the muscles of either arm produced a current from the contracted toward the uncontracted muscles. Dewar has shown that when light falls upon the retina of the eye an electric current is set up in the optic nerve.

232. Medical Applications.—Electric currents have been successfully employed as an adjunct in restoring persons rescued from drowning; the contraction of the diaphragm and chest muscles serving to start respiration. Since the discovery of the Leyden jar many attempts have been made to establish an electrical medical treatment. Discontinuous currents, particularly those furnished by small induction-coils and magneto-electric machines, are employed by practitioners to stimulate the nerves in paralysis and other affections. Electric currents should not be used at all except with great care, and under the direction of regularly trained surgeons.¹

¹ It is not out of place to enter an earnest caution on this head against the numerous quack doctors who deceive the unwary with magnetic and galvanic "appliances." In many cases these much-advertised shams have done incalculable harm: in the very few cases where some fancied good has accrued the curative agent is probably not magnetism, but flannel!

Part Second.

CHAPTER IV.

ELECTROSTATICS.

LESSON XX.—*Theory of Potential.*

233. By the Lessons in Chapter I. the student will have obtained some elementary notions upon the existence and measurement of definite quantities of electricity. In the present Lesson, which is both one of the hardest and one of the most important to the beginner, and which he must therefore study the more carefully, the laws which concern the magnitude of electrical quantities and their measurement are more fully explained. In no branch of knowledge is it more true than in electricity, that "science is measurement." That part of the science of electricity which deals with the measurement of charges of electricity is called **Electrostatics**. We shall begin by discussing first the simple laws of electric force, which were brought to light in Chapter I. by simple experimental means.

234. **First Law of Electrostatics.**—*Electric charges of similar sign repel one another, but electric charges of opposite signs attract one another.* The fundamental facts expressed in this Law were fully explained in Lesson I. Though familiar to the student, and apparently simple, these facts require for their complete explanation the aid of advanced mathematical analysis. They will here be treated as simple facts of observation.

235. Second Law of Electrostatics.—*The force exerted between two charges of electricity (supposing them to be collected at points or on two small spheres), is directly proportional to their product, and inversely proportional to the square of the distance between them.* This law, discovered by Coulomb, and called Coulomb's Law, was briefly alluded to (on page 16) in the account of experiments made with the torsion-balance; and examples were there given in illustration of both parts of the law. We saw, too, that a similar law held good for the forces exerted between two magnet poles. Coulomb applied also the method of oscillations to verify the indications of the torsion-balance and found the results entirely confirmed. We may express the two clauses of Coulomb's law, in the following symbolic manner. Let f stand for the force, q for the quantity of electricity in one of the two charges, and q' for that of the other charge, and let d stand for the distance between them. Then,

$$(1.) f \text{ is proportional to } q \times q',$$

and $(2.) f \text{ is proportional to } \frac{1}{d^2}$

These two expressions may be combined into one; and it is most convenient so to choose our units or standards of measurement that we may write our symbols as an equation:—

$$f = \frac{q \times q'}{d^2}$$

236. Unit of Electric Quantity.—If we are, however, to write this as an equality, it is clear that we must choose our unit of electricity in accordance with the units already fixed for measuring force and distance. All electricians are now virtually agreed in adopting a system which is based upon three fundamental units: viz., the Centimetre for a unit of *length*; the Gramme for a unit of *mass*, the Second for a unit of *time*. All

other units can be derived from these, as is explained in the Note at the end of this Lesson. Now, amongst the derived units of this system is the unit of *force*, named the **Dyne**, which is that force which, acting for one second on a mass of one gramme, imparts to it a velocity of one centimetre per second. Taking the dyne then as the unit of force, and the centimetre as the unit of length (or distance), we must find a unit of electric quantity to agree with these in our equation. It is quite clear that if q , q' , and d were each made equal to 1 (that is, if we took two charges of value 1 each, and placed them one centimetre apart), the value of $\frac{q \times q'}{d^2}$ would be $\frac{1 \times 1}{1 \times 1}$, which is equal to 1. Hence we adopt, as our **Definition** of a *Unit of Electricity*, the following, which we briefly gave at the end of Lesson II. *One Unit of Electricity is that quantity which, when placed at a distance of one centimetre (in air) from a similar and equal quantity, repels it with a force of one dyne.*

An example will aid the student to understand the application of Coulomb's law.

EXAMPLE.—Two small spheres, charged respectively with 6 units and 8 units of + electricity, are placed 4 centimetres apart; find what force they exert on one another. By the formula, $f = \frac{q \times q'}{d^2}$, we find $f = \frac{6 \times 8}{4^2} = \frac{48}{16} = 3$ dynes. Examples for the student are given in the Questions at the end of the Book.

The force in the above example would clearly be a force of repulsion. Had one of these charges been negative, the product $q \times q'$ would have had a - value, and the answer would have come out as *minus* 3 dynes. The presence of the negative sign, therefore, prefixed to a force, will indicate that it is a force of *attraction*, whilst the + sign would signify a force of *repulsion*.

237. Potential.—We must next define the term *potential*, as applied to electric forces; but to make

the meaning plain a little preliminary explanation is necessary. Suppose we had a charge of + electricity on a small insulated sphere A (See Fig. 95), placed by itself and far removed from all other electrical charges and electrical conductors. If we were to bring another body B near it, charged also with + electricity, A would repel B. But the repelling force would depend on the *quantity* of the new charge, and on the *distance* at which it was placed. Suppose the new charge thus brought



Fig. 95.

near to be one unit of + electricity ; when B was a long way off it would be repelled with a very slight force, and very little work need be expended in bringing it up nearer against the repelling forces exerted by A ; but as B was brought nearer and nearer to A, the repelling force would grow greater and greater, and more and more work would have to be done against these opposing forces in bringing up B. Suppose that we had begun at an infinite distance away, and that we pushed up our little test charge B from B' to B'' and then to Q, and so finally moved it up to the point P, against the opposing forces exerted by A, we should have had to spend a certain amount of *work* ; that work represents the *potential*¹ at the point P due to A. For the following is the *definition* of electrostatic potential :—*The potential at any point is the work that must be spent*

¹ In its widest meaning the term "*potential*" must be understood as "power to do work." For if we have to do a certain quantity of work against the repelling force of a charge in bringing up a unit of electricity from an infinite distance, just so much work has the charge power to do, for it will spend an exactly equal amount of work in pushing the unit of electricity back to an infinite distance. If we lift a pound five feet high against the force of gravity, the weight of the pound can in turn do five foot-pounds of work in falling back to the ground. See the Lesson on *Energy* in Professor Balfour Stewart's *Lessons in Elementary Physics*.

upon a unit of positive electricity in bringing it up to that point from an infinite distance. Had the charge on A been a - charge, the force would have been one of attraction, in which case we should have theoretically to measure the potential at P, either by the opposite process of placing there a + unit, and then removing it to an infinite distance against the attractive forces, or else by measuring the amount of work which would be done by a + unit in being attracted up to P from an infinite distance.

It can be shown that where there are more electrified bodies than one to be considered, the potential due to them at any point is the sum of the potentials (at that point) of each one taken separately.

238. It can also be shown that the potential at a point P, near an electrified particle A, is equal to the quantity of electricity at A divided by the distance between A and P. Or, if the quantity be called q , and the distance r , the potential is $\frac{q}{r}$.* If there are a number of electrified particles at different distances from P, the separate values of the potential $\frac{q}{r}$ due to each electrified particle separately can be found, and therefore *the potential at P can be found by dividing the quantity of each charge by its distance from the point P, and then adding up together the separate amounts so obtained.* The symbol V is generally used to represent potential. The potential at point P we will call V_P , then

$$V_P = \frac{q'}{r'} + \frac{q''}{r''} + \frac{q'''}{r'''} + \dots \text{etc.}$$

$$\text{or } V_P = \sum \frac{q}{r}.$$

This expression $\sum \frac{q}{r}$ represents the work done on a unit

* The complete proof would require an elementary application of the integral calculus, but an easy geometrical demonstration, sufficient for present purposes, is given below.

by a unit of + electricity when moved up to the given point P from an infinite distance, according as the potential at P is positive or negative.

Proof.—*First determine* the difference of potential between point P and point Q due to a charge of electricity q on a small sphere at A.

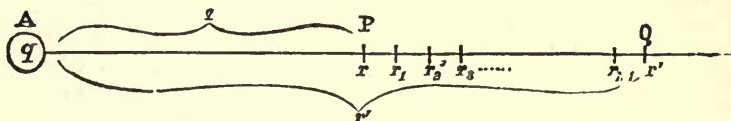

Fig. 96.

Call distance $AP = r$, and $AQ = r'$. Then $PQ = r' - r$. The difference of potential between Q and P is the work done in moving a + unit from Q to P against the force; and since

work = (average) force \times distance through which it is overcome

$$V_P - V_Q = f (r' - r).$$

The force at P exerted by q on a + unit = $\frac{q}{r^2}$,

and the force at Q exerted by q on a + unit = $\frac{q}{r'^2}$.

Suppose now that the distance PQ be divided into any number (n) of equal parts $rr_1, r_1r_2, r_2r_3, \dots, r_{n-1}r_n$.

The force at $r = \frac{q}{r^2}$.

„ „ $r_1 = \frac{q}{r_1^2} \dots$ etc.

Now since r_1 may be made as close to r as we choose, if we only take n a large enough number, we shall commit no serious error in supposing that $r \times r_1$ is a fair mean between r^2 and r_1^2 ; hence we may assume the average force over the short

length from r to r_1 to be $\frac{q}{rr_1}$.

Hence the work done in passing from r_1 to r will be

$$\begin{aligned} &= \frac{q}{rr_1} (r_1 - r) \\ &= q \left(\frac{1}{r} - \frac{1}{r_1} \right) \end{aligned}$$

On a similar assumption, the work done in passing from r_2 to r_1 , will be

$$\begin{aligned} &= q \left(\frac{1}{r_1} - \frac{1}{r_2} \right), \text{ and that done from } r_3 \text{ to } r_2 \text{ will be} \\ &= q \left(\frac{1}{r_2} - \frac{1}{r_3} \right), \text{ etc., giving us } n \text{ equations, of which} \end{aligned}$$

the last will be the work done in passing from r' to r_{n-1}

$$= q \left(\frac{1}{r_{n-1}} - \frac{1}{r'} \right).$$

Adding up all these portions of the work, the intermediate values of r cancel out, and we get for the work done in passing from Q to P

$$V_P - V_Q = q \left(\frac{1}{r} - \frac{1}{r'} \right)$$

Next suppose Q to be an infinite distance from A. Here $r' = \text{infinity}$, and $\frac{1}{r'} = 0$. In that case the equation becomes

$$V_P = \frac{q}{r}$$

If instead of one quantity of electricity q , there were a number of electrified particles having charges $q', q'', q''' \dots$ etc., at distances of $r', r'', r''' \dots$ etc., respectively from P, then

$$V_P = \frac{q'}{r'} + \frac{q''}{r''} + \frac{q'''}{r'''} + \dots \dots \dots \text{ etc}$$

$$V_P = \Sigma \frac{q}{r}, \quad \text{which was to be proved.}$$

239. Zero Potential.—At a place infinitely distant from all electrified bodies there would be no electric forces and the potential would be zero. For purposes of convenience it is, however, usual to consider the potential of the earth for the time being as an arbitrary

zero, just as it is convenient to consider "sea-level" as a zero from which to measure heights or depths.

240. Difference of Potentials.—Since potential represents the work that must be done on a + unit in bringing it up from an infinite distance, the *difference of potential* between two points is *the work to be done on or by a + unit of electricity in carrying it from one point to the other*. Thus if V_P represents the potential at P, and V_Q the potential at another point Q, the difference of potentials $V_P - V_Q$ denotes the work done in moving up the + unit from Q to P. It is to be noted that since this value depends only on the values of the potential at P and at Q, and not on the values of the potential at intermediate points, the work done will be the same, whatever the path along which the particle moves from Q to P. In the same way it is true that the expenditure of energy in lifting a pound against the earth's attraction from one point, to another on a higher level, will be the same whatever the path along which the pound is lifted.

241. Electric Force.—The definition of "work" is the product of the force overcome into the distance through which the force is overcome, or **work = force \times distance** through which it is overcome.

Hence, if the difference of potential between two points is the work done in moving up our + unit from one point to the other, it follows that the average *electric force* between those points will be found by dividing the work so done by the distance between the points: or $\frac{V_P - V_Q}{PQ} = f$ (the average electric force along the line PQ). The (average) electric force is therefore the rate of change of potential per unit of length. If P and Q are near together the force will be practically uniform between P and Q.

242. Equipotential Surfaces.—A charge of electricity collected on a small sphere acts on external bodies as if the charge were all collected into one point.

at its centre.¹ We have seen that the force exerted by such a charge falls off at a distance from the ball, the force becoming less and less as the square of the distance increases. But the force is the same in amount at all points equally distant from the small charged sphere. And the potential is the same at all points that are equally distant from the charged sphere. If, in Fig. 96, the point A represents the sphere charged with q units of electricity, then the potential at P, which we will call V_P , will be equal to $\frac{q}{r}$, where r is the distance from A to P. But if we take any other point at the same distance from A its potential will also be $\frac{q}{r}$. Now all the points that are the same distance from A as P is, will be found to lie upon the surface of a sphere whose centre is at A, and which is represented by the circle drawn through P, in Fig. 97. All round this circle the potential will have equal values; hence this circle represents an equipotential surface. The work to be done in bringing up a + unit from an infinite distance will be the same, no matter what point of this equipotential surface it is brought to, and to move it about from one point to another in the equipotential surface requires no further overcoming of the electrical forces, and involves therefore no further expenditure of work. At another distance, say at the point Q, the potential will have another value, and through this point Q another equipotential surface may be drawn. Suppose we chose Q so far from P that to push up a unit of + electricity against the repelling force of A required the expenditure of just one *erg* of work (for the definition

¹ The student must be warned that this ceases to be true if other charges are brought very near to the sphere, for then the electricity will no longer be distributed *uniformly* over its surface. It is for this reason that we have said, in describing the measurement of electrical forces with the torsion balance, that "the balls must be very small in proportion to the distances between them."

of one *erg* see the Note on Units at the end of this lesson); there will be then *unit difference of potential*

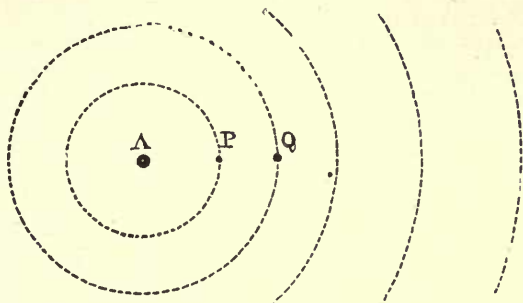

Fig. 97.

between the surface drawn through Q and that drawn through P, and it will require one *erg* of work to carry a + unit from any point on the one surface to any point on the other. In like manner we might construct a whole *system* of equipotential surfaces about the point A, choosing them at such distances that there should be unit difference of potential between each one and the next. The widths between them would get wider and wider, for, since the force falls off as you go further from A, you must, in doing one *erg* of work, bring up the + unit through a longer distance against the weaker opposing force.

The form of the equipotential surfaces about two small electrified bodies placed near to one another would not be spherical; and around a number of electrified bodies placed near to one another the equipotential surfaces would be highly irregular in form.

243. Lines of Force.—The electric force, whether of attraction or repulsion, always acts across the equipotential surfaces in a direction normal to the surface. The lines which mark the direction of the resultant electric forces are sometimes called Lines of Electric

Induction. In the case of the single electrified sphere the lines of force would be straight lines, radii of the system of equipotential spheres. In general, however, lines of force are curved; in this case the resultant force at any point would be in the direction of the tangent to the curve at that point. Two lines of force cannot cut one another, for it is impossible; the resultant force at a point cannot act in two directions at once. The positive direction along a line of force is that direction in which a small body charged with + electricity would be impelled by the electric force, if free to move. A space bounded by a number of lines of force is sometimes spoken of as a *tube of force*. All the space, for example, round a small insulated electrified sphere may be regarded as mapped out into a number of conical tubes, each having their apex at the centre of the sphere. The total electric force exerted across any section of a tube of force is constant wherever the section be taken.

244. Potential within a Closed Conductor.—

The experiments related in Arts. 29 to 32 prove most convincingly that there is *no electric force inside a closed conductor*. Now we have shown above that electric force is the rate of change of potential per unit of length. If there is no electric force there is no change of potential. The potential within a closed conductor (for example a hollow sphere) is therefore the same all over the interior; the same as the potential of the surface. *The surface of a closed conductor is therefore necessarily an equipotential surface.* If it were not at one potential there would be a flow of electricity from the higher potential to the lower, which would instantaneously establish equilibrium and reduce the whole to one potential. The power of an electric system to do work does not depend upon the accidental surface-density at any one point. We know, for instance, that when an electrified body is placed near an insulated conductor the nearer and farther portions of that con.

ductor exhibit induced charges of opposite kinds. The explanation of the paradox is that in the space round the charged body the potential is not uniform. Suppose the body to have a $+$ charge, the potential near it is higher than in the space farther away. The end of the insulated conductor nearest to the charge is in a region of high potential, while its farther end is in a region of lower potential. It will, as a whole, take a mean potential, which will, relatively to the potential of the surrounding medium, appear negative at the near end, positive at the far end.

245. Law of Inverse Squares.—An important consequence follows from the absence of electric force inside a closed conductor; this fact enables us to demonstrate the necessary truth of the “law of inverse squares” which was first experimentally, though roughly, proved by Coulomb with the torsion balance. Suppose a point P anywhere inside a hollow sphere charged with electricity (Fig. 98). The charge is uniform all over,

and the quantity of electricity on any small portion of its surface will be proportional to the area of that portion. Consider a small portion of the surface AB . The charge on AB would repel a $+$ unit placed at P with a certain force. Now draw the lines AD and BC through P , and regard these as mapping out a small conical surface of two sheets, having its apex at P ;

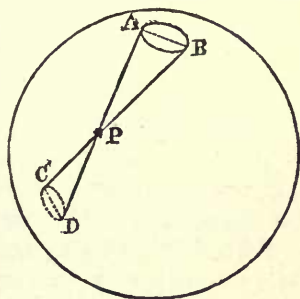

Fig. 98.

the small area CD will represent the end of the opposed cone, and the electricity on CD will also act on the $+$ unit placed at P , and repel it. Now these surfaces AB and CD , and the charges on them, will be directly proportional to the *squares* of their respective distances from P . If, then

the forces which they exercise on P exactly neutralise one another (as experiment shows they do), it is clear that the electric force must fall off *inversely as the squares of the distances*; for the whole surface of the sphere can be mapped out similarly by imaginary cones drawn through P. The reasoning can be extended also to hollow conductors of any form.

246. Capacity.—In Lesson IV. the student was given some elementary notions on the subject of the Capacity of conductors. We are now ready to give the precise definition. The **Electrostatic Capacity** of a conductor is measured by *the quantity of electricity which must be imparted to it in order to raise its potential from zero to unity*. A small conductor, such as an insulated sphere of the size of a pea, will not want so much as one unit of electricity to raise its potential from 0 to 1; it is therefore of small capacity—while a large sphere will require a large quantity to raise its potential to the same degree, and would therefore be said to be of large capacity. If C stand for capacity, and Q for a quantity of electricity,

$$C = \frac{Q}{V} \quad \text{and} \quad CV = Q.$$

This is equivalent to saying in words that the quantity of electricity necessary to charge a given conductor to a given potential, is numerically equal to the product of the capacity into the potential through which it is raised.

247. Unit of Capacity.—A conductor that required only one unit of electricity to raise its potential from 0 to 1, would be said to possess *unit capacity*. A sphere one centimetre in radius possesses unit capacity; for if it be charged with a quantity of one unit, this charge will act as if it were collected at its centre. At the surface, which is one centimetre away from the centre, the potential, which is measured as $\frac{q}{r}$, will be 1. Hence, as 1 unit of quantity raises it to unit 1 of potential, the

sphere possesses unit capacity. *The capacities of spheres are proportional to their radii.* Thus, a sphere of one metre radius has a capacity of 100. The earth has a capacity of about 630 millions (in electrostatic units). It is almost impossible to calculate the capacities of conductors of other shapes. It must be noted that the capacity of a sphere, as given above, means its capacity when far removed from other conductors or charges of electricity. The capacity of a conductor is increased by bringing near it a charge of an opposite kind; for the potential at the surface of the conductor is the sum of the potential due to its own charge, and of the potential of opposite sign due to the neighbouring charge. Hence, to bring up the resultant potential to unity, a larger quantity of electricity must be given to it; or, in other words, its capacity is greater. This is the true way of regarding the action of Leyden jars and other accumulators, and must be remembered by the student when he advances to the consideration of the theory of accumulators, in Lesson XXII.

248. *Surface-density.*¹—Coulomb applied this term to denote the amount of electricity per unit of area at any point of a surface. It was mentioned in Lesson IV. that a charge of electricity was never distributed uniformly over a conductor, except in the case of an insulated sphere. Where the distribution is unequal, the density at any point of the surface may be expressed by considering the quantity of electricity which exists upon a small unit of area at that point. If Q be the quantity of electricity on the small surface, and S be the area of

¹ The word Tension is sometimes used for that which is here precisely defined as Coulomb defined it. The term tension is, however, unfortunate; and it is so often misapplied in text-books to mean not only surface-density but also potential, and even electric force (*i.e.*, the mechanical force exerted upon a material body by electricity), that we avoid its use altogether. The term would be invaluable if we might adopt it to denote only the mechanical stress across a dielectric, due to accumulated charges; but so long as the above confusion lasts, it is better to drop the term entirely, and the student will have one thing fewer to learn—and to unlearn.

that small surface, then the surface density (denoted by the Greek letter ρ) will be given by the equation,

$$\rho = \frac{Q}{S}$$

In dry air, the limit to the possible electrification is reached when the density reaches the value of about 20 units of electricity per square centimetre. If charged to a higher degree than this, the electricity escapes in "sparks" and "brushes" into the air. In the case of *uniform* distribution over a surface (as with the sphere, and as approximately obtained on a flat disc by a particular device known as a guard-ring), the density is found by dividing the whole quantity of the charge by the whole surface.

249 Surface-Density on a Sphere.—The surface of a sphere whose radius is r , is $4\pi r^2$. Hence, if a charge Q be imparted to a sphere of radius r , the surface-density all over will be $\rho = \frac{Q}{4\pi r^2}$; or, if we know the surface-density, the quantity of the charge will be $Q = 4\pi r^2\rho$.

The surface-density on *two spheres* joined by a thin wire is an important case. If the spheres are unequal, they will share the charge in proportion to their capacities (see Art. 37), that is, in proportion to their radii. If the spheres are of radii 2 and 1, the ratio of their charges will also be as 2 to 1. But their respective densities will be found by dividing the quantities of electricity on each by their respective surfaces. But the surfaces are proportional to the squares of the radii, *i.e.*, as 4 : 1; hence, the densities will be as 1 : 2, or *inversely as the radii*. Now, if one of these spheres be very small—no bigger than a point—the density on it will be relatively immensely great, so great that the air particles in contact with it will rapidly carry off the charge by convection. This explains the *action of points* in discharging conductors, noticed in Chapter I. Arts. 35 c, 42 and 43.

250. **Electric Images.**—It can be shown mathematically that if $+q$ units of electricity are placed at a point near a non-electrified conducting sphere of radius r , at a distance d from its centre, the negative induced charge will be equal to $-\frac{r}{d}q$, and will be distributed over the nearest part of the surface of the sphere with a surface-density inversely proportional to the cube of the distance from that point. Sir W. Thomson pointed out that, so far as all external points are concerned, the potential due to this peculiar distribution on the surface would be exactly the same as if this negative charge were all collected at an internal point at a distance of $r - \frac{r^2}{d}$ behind the surface. Such a point may be regarded as a *virtual image* of the external point, in the same way as in optics we regard certain points behind mirrors as the virtual images of the external points from which the rays proceed. Clerk Maxwell has given the following definition of an Electric Image:—*An electric image is an electrified point, or system of points, on one side of a surface, which would produce on the other side of that surface the same electrical action which the actual electrification of that surface really does produce.* A charge of $+$ electricity placed one inch from a flat metallic plate induces on it a negative charge distributed over the neighbouring region of the plate (with a density varying inversely as the cube of the distance from the point); but the electrical action of this distribution would be precisely represented by its “image,” namely, by an equal quantity of negative electricity placed at a point one inch *behind* the plate. Many beautiful mathematical applications of this method have been made, enabling the distribution to be calculated in difficult cases, as, for example, the distribution of the charge on the inner surface of a hollow bowl.

251. **Electric Force exerted by a Charged**

Sphere at a point near to it.—It was shown above that the quantity of electricity Q upon a sphere charged until its surface-density was ρ , was

$$Q = 4 \pi r^2 \rho.$$

The problem is to find the force exercised by this charge upon a + unit of electricity, placed at a point infinitely near the surface of the sphere. The charge on the sphere acts as if at its centre. The distance between the two quantities is therefore r . By Coulomb's law the

$$\text{force } f = \frac{Q \times 1}{r^2} = \frac{4 \pi r^2 \rho}{r^2} = 4 \pi \rho.$$

This important result may be stated in words as follows:—*The force (in dynes) exerted by a charged sphere upon a unit of electricity placed infinitely near to its surface, is numerically equal to 4π times the surface-density of the charge.*

252. Electric Force exerted by a charged plate of indefinite extent on a point near it.—Suppose a plate of indefinite extent to be charged so that it has a surface-density ρ . This surface-density will be uniform, for the edges of the plate are supposed to be so far off as to exercise no influence. It can be shown that *the force exerted by such a plate upon a + unit anywhere near it, will be expressed (in dynes) numerically as $2\pi\rho$.* This will be of opposite signs on opposite sides of the plate, being $+2\pi\rho$ on one side, and $-2\pi\rho$ on the other side, since in one case the force tends to move the unit from right to left, in the other from left to right. It is to be observed, therefore, that the force changes its value by the amount of $4\pi\rho$ as the point passes through the surface. The same was true of the charged sphere, where the force outside was $4\pi\rho$, and inside was zero. The same is true of all charged surfaces. These two propositions are of the utmost importance in the theory of Electrostatics.

253. The elementary geometrical proof of the latter theorem is as follows:—

Required the Electric Force at point at any distance from a plane of infinite extent charged to surface-density ρ .

Let P be the point, and PX or a the normal to the plane. Take any small cone having its apex at P. Let the solid-angle of this cone be ω ; let its length be r ; and θ the angle its axis makes with a . The cone meets the surface of the plane obliquely, and if an orthogonal section be made where it meets the plane, the angle between these sections will be $= \theta$.

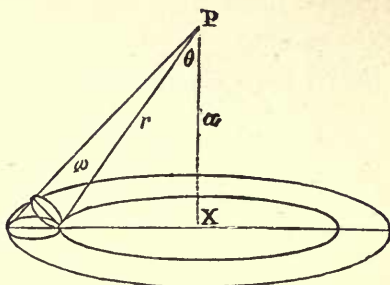

Fig. 99.

Now solid-angle ω is by definition = $\frac{\text{orthogonal area of section}}{r^2}$

Hence, area of oblique section = $r^2 \omega \times \frac{1}{\cos \theta}$

charge on oblique section = $\frac{r^2 \omega \rho}{\cos \theta}$

Hence if a + unit of electricity were placed at P, the force exerted on this by this small charge = $\frac{r^2 \omega \rho}{\cos \theta} \times 1 \div r^2$

$$\text{or} = \frac{\omega \rho}{\cos \theta}$$

Resolve this force into two parts, one acting along the plane, the other along a , normal to the plane. The normal component along a is $\cos \theta \times \frac{\omega \rho}{\cos \theta} = \omega \rho$

But the whole surface of the plane may be similarly mapped out into small surfaces, all forming small cones, with their summits at P. If we take an infinite number of such small cones meeting every part, and resolve their forces in a similar way, we shall find that the components along the plane will neutralise one another all round, while the normal components, or the resolved forces along a , will be equal to the sum of all their solid-angles multiplied by the surface-density; or

$$\text{Total resultant force along } a = \Sigma \omega \rho.$$

But the total solid-angle subtended by an infinite plane at a point is 2π , for it subtends a whole hemisphere.

$$\therefore \text{Total resultant force} = 2\pi\rho.$$

NOTE ON FUNDAMENTAL AND DERIVED UNITS.

254. Fundamental Units.—All physical quantities, such as force, velocity, etc., can be expressed in terms of the three fundamental quantities: *length*, *mass*, and *time*. Each of these quantities must be measured in terms of its own units.

The system of units, adopted by almost universal consent, and used throughout these Lessons, is the so-called "Centimetre-Gramme-Second" system, in which the fundamental units are:—

The *Centimetre* as a unit of *length* ;

The *Gramme* as a unit of *mass* ;

The *Second* as a unit of *time*.

The *Centimetre* is equal to 0·3937 inch in length, and nominally represents one thousand-millionth part, or $\frac{1}{1,000,000,000}$ of a quadrant of the earth.

The *Metre* is 100 centimetres, or 39·37 inches.

The *Kilometre* is 1000 metres, or about 1093·6 yards.

The *Millimetre* is the tenth part of a centimetre, or 0·03937 inch.

The *Gramme* is equal to 15·432 grains, and represents the mass of a cubic centimetre of water at 4° C : the *Kilogramme* is 1000 grammes or 2·2 pounds.

255. Derived Units.—

Area.—The unit of area is the *square centimetre*.

Volume.—The unit of volume is the *cubic centimetre*.

Velocity.—The unit of velocity is the velocity of a body which moves through unit distance in unit time, or the *velocity of one centimetre per second*.

Acceleration.—The unit of acceleration is that acceleration which imparts unit velocity to a body in unit time, or an acceleration of one centimetre-per-second per second. The acceleration due to gravity imparts in one second a velocity considerably greater than this, for the velocity it imparts to falling bodies is about 981 centimetres per

second (or about 32.2 feet per second). The value differs slightly in different latitudes. At Bristol the value of the acceleration of gravity is $g = 981.1$; at the Equator $g = 978.1$; at the North Pole $g = 983.1$.

Force. The unit of force is that force which, acting for one second on a mass of one gramme, gives to it a velocity of one centimetre per second. It is called one *Dyne*. The force with which the earth attracts any mass is usually called the "weight" of that mass, and its value obviously differs at different points of the earth's surface. The force with which a body gravitates, *i.e.* its weight (in dynes), is found by multiplying its mass (in grammes) by the value of g at the particular place where the force is exerted.

Work.—The unit of work is the work done in overcoming unit force through unit distance, *i.e.* in pushing a body through a distance of one centimetre against a force of one dyne. It is called one *Erg*. Since the "weight" of one gramme is 1×981 or 981 dynes, the work of raising one gramme through the height of one centimetre against the force of gravity is 981 ergs.

Energy.—The unit of energy is also the *erg*; for the energy of a body is measured by the work it can do.

Heat.—The unit of heat (sometimes called a *calorie*) is the amount of heat required to warm one gramme mass of water from 0° to 1° (C); and the dynamical equivalent of this amount of heat is 42 million *ergs*, which is the value of Joule's equivalent, as expressed in absolute (C.G.S.) measure. (*See also* Art. 367.)

These units are sometimes called "absolute" units; the term *absolute*, introduced by Gauss, meaning that they are independent of the size of any particular instrument, or of the value of gravity at any particular place, or of any other arbitrary quantities than the three standards of length, mass, and time. It is, however, preferable to refer to them by the more appropriate name of "C.G.S. units," as being derived from the centimetre, the gramme, and the second.

256. **Electrical Units.**—There are two systems of electrical units derived from the fundamental "C.G.S." units, one set being based upon the force exerted between two quantities of electricity, and the other upon the force exerted between two magnet poles. The former set are termed *electrostatic* units, the latter *electromagnetic* units. The important relation between the two sets is explained in the note at the end of Lesson XXX.

257. **Electrostatic Units.**—No special *names* have been assigned to the electrostatic units of Quantity, Potential, Capacity, etc. The reasons for adopting the following values as units are given either in Chapter I. or in the present Chapter.

Unit of Quantity.—The unit of quantity is that quantity of electricity which, when placed at a distance of one centimetre (in air) from a similar and equal quantity, repels it with a force of one *dyne* (Art. 236).

Potential.—Potential being measured by *work* done in moving a unit of + electricity against the electric forces, the unit of potential will be measured by the unit of work, the *erg*.

Unit Difference of Potential.—Unit difference of potential exists between two points, when it requires the expenditure of one *erg* of work to bring a unit of + electricity from one point to the other against the electric force (Art. 242).

Unit of Capacity.—That conductor possesses unit capacity which requires a charge of one unit of electricity to bring it up to unit potential. A sphere of one centimetre radius possesses unit capacity (Art. 247).

Specific Inductive Capacity is defined in Art. 268 as the ratio between two quantities of electricity. The specific inductive capacity of the air is taken as unity.

258. **Dimensions of Units.**—It has been assumed above that a velocity can be expressed in centimetres per second; for velocity is rate of change of place, and it is clear that if change of place may be measured as a length in centimetres, the *rate* of change of place will be measured by the number of centimetres through which the body moves in unit of time. It is impossible, indeed, to express a velocity without regarding it as the quotient of a certain number of units of length divided by a certain number of units of time. In other words, a velocity

$= \frac{\text{a length}}{\text{a time}}$; or, adopting L as a symbol for length, and T as a symbol for time, $V = \frac{L}{T}$, which is still more conveniently written

$V = L \times T^{-1}$. in a similar way *acceleration* being rate of change of velocity, we have $A = \frac{V}{T} = \frac{L}{T \times T} = \frac{L}{T^2} = L \times T^{-2}$.

Now these physical quantities, “velocity,” and “acceleration,” are respectively *always* quantities of the same nature, no matter whether the centimetre, or the inch. or the mile, be taken as the **unit** of length, or the second or any other interval be taken as

the unit of time. Hence we say that these abstract equations express the “*dimensions*” of those quantities with respect to the fundamental quantities length and time. A little consideration will show the student that the following will therefore be the dimensions of the various units mentioned above :—

	UNITS.	DIMENSIONS.
<i>(Fundamental.)</i>		
<i>l</i>	Length	L
<i>m</i>	Mass	M
<i>t</i>	Time	T
<i>(Derived.)</i>		
	Area = L × L =	L ²
	Volume = L × L × L =	L ³
<i>v</i>	Velocity = L ÷ T =	LT ⁻¹
<i>a</i>	Acceleration = velocity ÷ time =	LT ⁻²
<i>f</i>	Force = mass × acceleration =	MLT ⁻²
	Work = force × length =	ML ² T ⁻²
<i>(Electrostatic.)</i>		
<i>q</i>	Quantity = $\sqrt{\text{force} \times (\text{distance})^2}$ =	M ^½ L ^½ T ⁻¹
<i>i</i>	Current = quantity ÷ time =	M ^½ L ^½ T ⁻²
V	Potential = work ÷ quantity =	M ^½ L ^½ T ⁻¹
R	Resistance = potential ÷ current =	L ⁻¹ T ¹
C	Capacity = quantity ÷ potential =	L
<i>k</i>	Sp. Ind. Capacity = quantity ÷ another quantity	a numeral
	Electromotive Intensity = force ÷ quantity =	M ^½ L ^½ T ⁻¹

The dimensions of magnetic units are given in the note on Magnetic Units, Art. 324.

LESSON XXI.—*Electrometers.*

259. In Lesson II. we described a number of *electroscopes* or instruments for indicating the presence and

sign of a charge of electricity ; some of these also served to indicate roughly the amount of these charges, but none of them save the torsion balance could be regarded as affording an accurate means of measuring either the *quantity* or the *potential* of a given charge. *An instrument for measuring differences of electrostatic potential is termed an Electrometer.* Such instruments can also be used to measure electric *quantity* indirectly, for the quantity of a charge can be ascertained by measuring the potential to which it can raise a conductor of known capacity. The earliest electrometers attempted to measure the quantities directly. Lane and Snow Harris constructed "Unit Jars" or small Leyden jars, which, when it was desired to measure out a certain quantity of electricity, were charged and discharged a certain number of times. The discharging gold-leaf electroscope of Gaugain was invented with a similar idea.

260. Repulsion Electrometers. — The torsion balance, described in Art. 15, measures quantities by measuring the forces exerted by the charges given to the fixed and movable balls. It can only be applied to the measurement of repelling forces, for the equilibrium is unstable in the case of a force of attraction.

There are, besides the gold-leaf electroscope and the Lane's electroscope, described in Lesson II., a number of finer electrometers based upon the principle of repulsion, some of which resemble the torsion balance in having a movable arm turning about a central axis. Amongst these are the electrometers of Dellmann and of Peltier ; the latter of these is shown in Fig. 111, in the Lesson on Atmospheric Electricity. In this apparatus a light arm of aluminium, balanced upon a point, carries also a small magnet to direct it in the magnetic meridian. A fixed arm, in metallic contact with the movable one, also lies in the magnetic meridian. A charge imparted to this instrument produces a repulsion between the fixed and movable arms, causing an angular deviation. Here,

however, the force is measured not by being pitted against the torsion of an elastic fibre, or against gravitation, but against the directive magnetic force of the earth acting on the small needle. Now this depends on the intensity of the horizontal component of the earth's magnetism at the place, on the magnetic moment of the needle, and on the sine of the angle of its deviation. Moreover, the repulsion here is not between two charges collected on small spheres, but between the fixed arm and the movable one. Hence, to obtain quantitative values for the readings of this electrometer, it is necessary to make preliminary experiments and to "calibrate" the degree-readings of the angular deviation to an exact scale.

261. **Attracted - Disc Electrometers.** — Snow Harris was the first to construct an electrometer for measuring the attraction between an electrified and a non-electrified disc; and the instrument he devised may be roughly described as a balance for *weighing* a charge of electricity. More accurately speaking, it was an instrument resembling a balance in form, carrying at one end a light scale pan; at the other a disc was hung above a fixed insulated disc, to which the charge to be measured was imparted. The disadvantages of this instrument were manifold, the chief objection being due to the irregular distribution of the charge on the disc. The force exerted by an electrified point falls off inversely as the *square* of the distance, since the lines of force emanate in radial lines. But in the case of a uniformly electrified plane surface, the lines of force are normal to the surface, and parallel to one another; and the force is independent of the distance. The distribution over a small sphere nearly fulfils the first of these conditions. The distribution over a flat disc would nearly fulfil the latter condition, were it not for the perturbing effect of the edges of the disc where the surface-density is much greater (see Art. 35); for this reason Snow Harris's electrometer was very imperfect.

Sir W. Thomson has introduced several very important modifications into the construction of attracted-disc electrometers, the chief of these being the employment of the "guard-plate" and the providing of means for working with a definite standard of potential. It would be beyond the scope of these lessons to give a complete description of all the various forms of attracted-disc electrometer; but the main principles of them all can be readily explained.

The disc, C, whose attraction is to be measured, is suspended (Fig. 100) within a fixed guard-plate, B, which

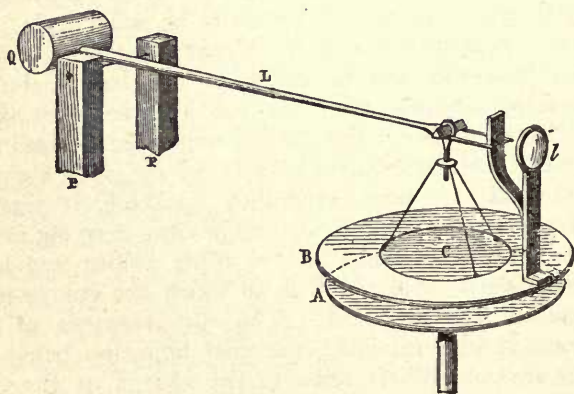

Fig. 100.

surrounds it without touching it, and which is placed in metallic contact with it by a fine wire. A lever, L, supports the disc, and is furnished with a counterpoise; whilst the aluminium wire which serves as a fulcrum may be also employed to produce a torsion force. In order to know whether the disc is precisely level with the lower surface of the guard-plate a little gauge or index is fixed above, and provided with a lens, Z, to observe its indications. Beneath the disc and guard-plate is

a second disc, A, supported on an insulating stand. This lower disc can be raised or lowered at will by a micrometer screw, great care being taken in the mechanical arrangements that it shall always be parallel to the plane of the guard-plate. Now, since the disc and guard-plate are in metallic connection with one another, they form virtually part of one surface, and as the irregularities of distribution occur at the edges of the surface, the distribution over the surface of the disc is practically uniform. Any attraction of the lower plate upon the disc *might* be balanced either by increasing the weight of the counterpoise, or by putting a torsion on the wire; but in practice it is found most convenient to obtain a balance by altering the distance of the lower plate until the electric force of attraction exactly balances the forces (whether of torsion or of gravity acting on the counterpoise) which tend to lift the disc above the level of the guard-plate.

The theory of the instrument is simple also. The force F just outside a charged conductor is $4\pi\rho$ (Art. 252); and since electric force is the same thing as the rate of change of potential per unit of length (Art. 241), it will be equal to $\frac{V}{D}$, where V is the difference of potentials between the upper and lower plates, and D the distance between them: hence $\rho = \frac{V}{4\pi D}$. If the surface of the movable disc be S , the quantity of the charge on it will be $S\rho$. Now, let us suppose that the electricity on the lower plate has an equal density but of opposite sign, as will be the case if either plate is connected to "earth." Since its density is $-\rho$ it will exercise a force of $-2\pi\rho$ on a $+$ unit placed near the disc; (but as this force is a force exerted from the upper side of the plate we must change its sign again and call it $+2\pi\rho$, where the $+$ sign signifies a force tending to move a $+$ unit downwards.) Now on the disc there are

$S\rho$ units of electricity; hence the total force of attraction on the disc will be $F = 2\pi\rho \times S\rho$.

$$= 2\pi S\rho^2.$$

$$= 2\pi S \frac{V^2}{16\pi^2 D^2}.$$

or
$$F = \frac{S}{8\pi} \frac{V^2}{D^2},$$

whence
$$V = D \sqrt{\frac{8\pi F}{S}}.$$

From this we gather that, if the force F remain the same throughout the experiments, *the difference of potentials between the discs will be simply proportional to the distance between them* when the disc is in level equilibrium. And the quantity $\sqrt{\frac{8\pi F}{S}}$ may be determined once for all as a "constant" of the instrument;

In the more elaborate forms of the instrument, such as the "absolute electrometer," and the "portable electrometer," the disc and guard-plate are covered with a metallic cage, and are together placed in communication with a condenser to keep them at a known potential. This obviates having to make measurements with zero readings, for the *differences of potential* will now be proportional to *differences of micrometer readings*,

or,
$$V_1 - V_2 = (D_1 - D_2) \sqrt{\frac{8\pi F}{S}}.$$

The condenser is provided in these instruments with a *gauge*, itself an attracted-disc; to indicate when it is charged to the right potential, and with a *replenisher* to increase or decrease the charge, the replenisher being a little convection-induction machine (see Art. 45).

262. The Quadrant Electrometer.—The Quadrant Electrometer of Sir W. Thomson is an example of a different class of electrometers, in which use is made of an auxiliary charge of electricity previously imparted to the needle of the instrument. The needle, which con-

sists of a thin flat piece of metal hung horizontally by a fibre or thin wire, thus charged with, say, + electricity, will be attracted by a - charge, but repelled by a + charge; and such attraction or repulsion will be stronger in proportion to these charges, and in proportion to the charge on the needle. Four quadrant-pieces of brass are fixed horizontally below the needle without touching it or one another. Opposite quadrants are joined with fine wires.

Fig. 101 shows a very simple form of the Quadrant Electrometer, as arranged for qualitative experiments.

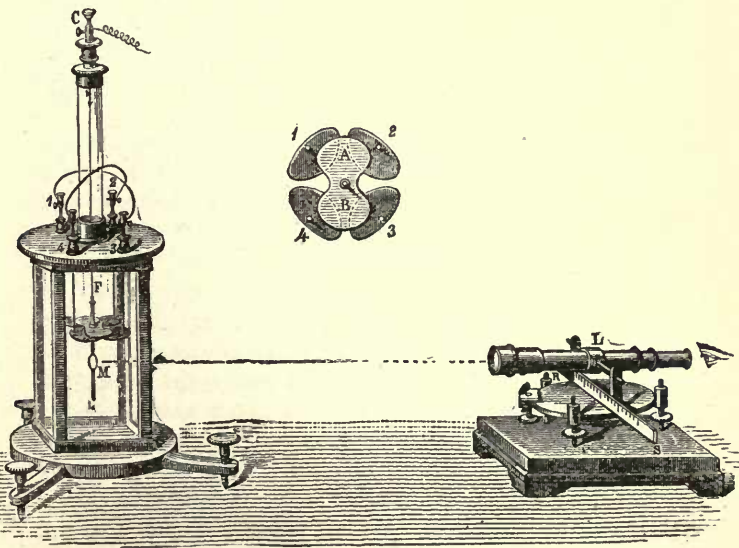

Fig. 101.

The four quadrants are enclosed within a glass case, and the needle, which carries a light mirror, M, below it, is suspended from a torsion head, C, by a very thin metallic wire, F. It is electrified to a certain potential by being connected, through a wire attached to C, with a charged

Leyden jar or other condenser. In order to observe the minutest motions of the needle, a reading-telescope and scale are so placed that the observer looking through the telescope sees an image of the zero of the scale reflected in the little mirror. The wires connecting quadrants 1 and 3, 2 and 4, are seen above the top of the case. The needle and quadrants are shown in plan separately above. If there is the slightest difference of potential between the pairs of quadrants, the needle, which is held in its zero position by the elasticity of the wire, will turn, and so indicate the difference of potential. When these deflections are small, the scale readings will be very nearly proportional to the difference of potential. The instrument is sufficiently delicate to show a difference of potential between the quadrants as small as the $\frac{1}{4}$ that of the Daniell's cell.

For very exact measurements many additional refinements are introduced into the instrument. Two sets of quadrants are employed, an upper and a lower, having the needle between them. The torsion wire is replaced by a delicate bifilar suspension (Art. 118). To keep up the charge of the Leyden jar a "Replenisher" is added; and an "attracted-disc," like that of the Absolute Electrometer, is employed in order to act as a gauge to indicate when the jar is charged to the right potential. In these forms the jar consists of a glass vessel placed below the quadrants, coated externally with strips of tin-foil, and containing strong sulphuric acid which serves the double function of keeping the apparatus dry by absorbing the moisture and of acting as an internal coating for the jar. It is also more usual to throw a spot of light from a lamp upon a scale by means of the little mirror (as described in the case of the Mirror Galvanometer, in Art. 202), than to adopt the subjective method with the telescope, which only one person at a time can use. When the instrument is provided with replenisher and gauge, the measurements can be made in

terms of absolute units, provided the "constant" of the particular instrument (depending on the suspension of the needle, size and position of needle and quadrants, potential of the gauge, etc.) is once ascertained.

263. An example will illustrate the mode of using the instrument. It is known that when the two ends of a thin wire are kept at two different potentials a current flows through the wire, and that if the potential is measured at different points along the wire, it is found to fall off in a perfectly uniform manner from the end that is at a high potential down to that at the low potential. At a point one quarter along the potential will have fallen off one quarter of the whole difference. This could be proved by joining the two ends of the wire through which the current was flowing to the terminals of the Quadrant Electrometer, when one pair of quadrants would be at the high potential and the other at the low potential. The needle would turn and indicate a certain deflection. Now, disconnect one of the pairs of quadrants from the low potential end of the wire, and place them in communication with a point one quarter along the wire from the high potential end. The needle will at once indicate that the difference of potential is but one quarter of what it was before.

Often the Quadrant Electrometer is employed simply as a very delicate *electroscope* in systems of measurement in which a difference of electric potential is measured by being balanced against an equal and opposite difference of potential, exact balance being indicated by there being *no* deflection of the Electrometer needle. Such methods of experimenting are known as "*Null Methods*," or "*Zero Methods*."

264. *Dry-Pile Electrometer*.—The principle of symmetry observed in the Quadrant Electrometer was previously employed in the *Electroscope of Bohnenberger*—a much less accurate instrument—in which the charge to be examined was imparted to a single gold leaf, placed symmetrically between the poles of a dry-pile (Art. 182), toward one or other pole of which the leaf was attracted. Fechner modified the instrument by connecting the + pole of the dry-pile with a gold leaf hanging between two metal discs, from the more + of which it was re-

pelled. The inconstancy of dry-piles as sources of electrification led Hankel to substitute a battery of a very large number of small Daniell's cells.

265. **Capillary Electrometers.**—The Capillary Electrometer of Lippmann, as modified by Dewar, was described in Art. 225.

LESSON XXII.—*Specific Inductive Capacity, etc.*

266. In Lesson VI. it was shown that the capacity of a Leyden jar or other condenser depended upon the size of the conducting coatings or surfaces, the thinness of the glass or other dielectric between them, and upon the particular "*inductive capacity*" of the dielectric used. We will now examine the subject in a more rigorous way. In Art. 246 it was laid down that the capacity of a conductor was measured by the quantity of electricity required to raise its potential to unity; or if a quantity of electricity Q raise the potential from V to V' then its capacity is

$$C = \frac{Q}{V' - V}$$

Now, a Leyden jar or other condenser may be regarded as a conductor, in which (owing to the particular device of bringing near together the two oppositely-charged surfaces) the conducting surface can be made to hold a very large quantity of electricity without its potential (whether + or -) rising very high. The capacity of a condenser, like that of a simple conductor, will be measured by the quantity of electricity required to produce unit rise of potential.

267. **Theory of Spherical Air-Condenser.**—Suppose a Leyden jar made of two concentric metal spheres, one inside the other, the space between them being filled by air. The inner one, A , will represent the interior coating of tinfoil, and the outer sphere, B (Fig.

102), will represent the exterior coating. Let the radii of these spheres be r and r' respectively. Suppose a charge of Q units to be imparted to A; it will induce on the inner side of B an equal negative charge $-Q$, and to the outer side of B a charge $+Q$ will be repelled. This latter is removed by contact with "earth," and need be no further considered. The potential¹ at the centre M, calculated by the rule given in Art. 238, will be

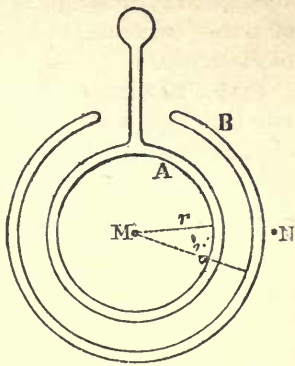

Fig. 102.

$$V_M = \frac{Q}{r} - \frac{Q}{r'}$$

At a point N, outside the outer sphere and quite near to it, the potential will be the same as if these two charges, $+Q$ and $-Q$, were both concentrated at M. Hence

$$V_N = \frac{+Q - Q}{r'} = 0.$$

So then the difference of potentials will be

$$V_M - V_N = \frac{Q}{r} - \frac{Q}{r'} = Q \left(\frac{r' - r}{rr'} \right);$$

whence $\frac{Q}{V_M - V_N} = \frac{rr'}{r' - r}$.

But, by the preceding Article, the capacity $C = \frac{Q}{V - V'}$, therefore $C = \frac{rr'}{r' - r}$.

We see from this formula that the capacity of the condenser is proportional to the size of the metal globes, and that if the insulating layer is very thin,—that is, if r be very nearly as great as r' , $r' - r$ will become very

¹ The student must remember that as there is no electric force within a closed conductor the potential at the middle is just the same as at any other point inside; so that it is somewhat a stretch of language to talk of the middle point M as having a potential.

small, and the value of the expression $\frac{r_2'}{r_2' - r}$ will become very great; which proves the statement that the capacity of a condenser depends upon the *thinness* of the layer of dielectric.

268. Specific Inductive Capacity.—Cavendish was the first to discover that the capacity of a condenser depended not on its actual dimensions only, but upon the *inductive power* of the material used as the dielectric between the two surfaces. If two condensers (of any of the forms to be described) are made of exactly the same size, and in one of them the dielectric be a layer of air, and in the other a layer of some other insulating substance, it is found that equal quantities of electricity imparted to them do not produce equal differences-of-potentials; or, in other words, it is found that they have not the same capacity. If the dielectric be sulphur, for example, it is found that the capacity is about three times as great; for sulphur possesses a high inductive power and allows the transmission across it of electrostatic influence three times as well as air does. The name **specific inductive capacity**¹ was assigned by Faraday to the ratio between the capacities of two condensers equal in size, one of them being an air-condenser, the other filled with the specified dielectric. The specific inductive capacity of dry air at the temperature 0° C, and pressure 76 centims., is taken as the standard and reckoned as unity.

Cavendish, about the year 1775, measured the specific inductive capacity of glass, bees-wax, and other substances, by forming them into condensers between two circular metal plates, the capacity of these condensers being compared with that of an air condenser (resembling Fig. 30) and with other condensers which he

¹ The name is not a very happy one,—*specific inductivity* would have been better, and is the analogous term, for dielectrics, to the term “specific conductivity” used for conductors. The term *dielectric capacity* is also used by some modern writers.

called "trial-plates." He even went so far as to compare the capacities of these "trial-plates" with that of a sphere of $12\frac{1}{2}$ inches diameter hung up in the middle of a room.

269. **Faraday's Experiments.**—In 1837 Faraday, who did not know of the then unpublished researches of Cavendish, independently discovered specific inductive capacity, and measured its value for several substances; using for this purpose two condensers of the form shown in Fig. 103. Each consisted of a brass ball A, enclosed inside a hollow sphere of brass B, and insulated by a long plug of shellac, up which passed a wire terminating in a ball *a*. The outer sphere consisted of two parts which could be separated from each other in order to fill the hollow space with any desired material: the experimental process then was to compare their capacities when one was filled with the substance to be examined, the other containing only dry air. The method of experimenting was simple. One of the condensers was charged with electricity. It was then made to share its charge with the other condenser, by putting the two inner coatings into metallic communication with one another, the outer coatings also being in communication with one another. If their capacities were equal they would share the charge equally, and the potential after contact would be just half what it was in the charged condenser before con-

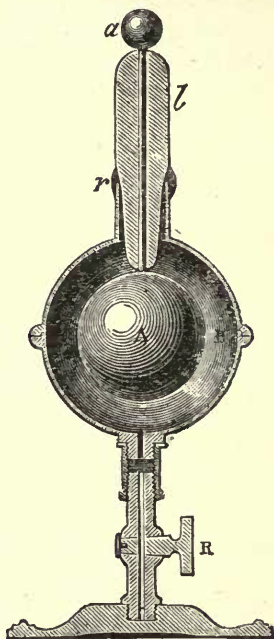

Fig. 103.

tact. If the capacity of one was greater than the other the final potential would not be exactly half the original potential, because they would not share the charge equally, but in proportion to their capacities. The potentials of the charges were measured before and after contact by means of a torsion balance.¹ Faraday's results showed the following values:—Sulphur, 2.26; shellac, 2.0; glass, 1.76 or more.

270. Recent Researches.—Since 1870 large additions to our knowledge of this subject have been made. Gibson and Barclay measured the inductive capacity of paraffin by comparing the capacity of an air condenser with one of paraffin by means of a sliding condenser, and a divided condenser called a "platymeter," using a quadrant electrometer as a sensitive electroscope to adjust the capacity of the condensers exactly to equality. Wüllner, Boltzmann, and others, have also examined the inductive capacity of solid bodies by several methods. Hopkinson has examined that of glass of various kinds, using a constant battery to produce the required difference of potentials, and a condenser provided with a guard-ring for a purpose similar to that of the guard-ring in absolute electrometers. Gordon has still more recently made a large number of observations, using a delicate apparatus known as a statical "induction balance," which is a complicated condenser, so arranged in connection with a quadrant electrometer that when the capacities of the separate parts are adjusted to equality there shall be no deflection in the electrometer, whatever be the amount or sign of the actual electrifi-

¹ The value of the specific inductive capacity k could then be calculated as follows:—

$$Q = VC = V'C + V'k$$

(where C is the capacity of the first apparatus and V its potential, and V' the potential after communication with the second apparatus, whose capacity is Ck):

$$\text{hence } V = V'(1 + k)$$

$$\text{and } k = \frac{V - V'}{V'}$$

cation employed for the moment. This arrangement, when employed in conjunction with an induction coil (Fig. 148) and a rapid commutator, admits of the inductive capacity being measured when the duration of the actual charge is only very small, the electrification being reversed 12,000 times per second. Such an instrument, therefore, overcomes one great difficulty besetting these measurements, namely, that owing to the apparent absorption of part of the charge by the dielectric (as mentioned in Art. 53), the capacity of the substance, when measured slowly, is different from its "instantaneous capacity." This electric absorption is discussed further in Art. 272. The amount of the absorbed charge is found to depend upon the time that the charge has been accumulated. For this reason the values assigned by different observers for the inductive capacity of various substances differ to a most perplexing degree, especially in the case of the less perfect insulators. The following Table summarises Gordon's observations :

Air	1'00	
Glass	3'013	to 3'258
Ebonite	2'284	
Guttapercha	2'462	
Indiarubber	2'220	to 2'497
Paraffin (solid)	1'9936	
Shellac	2'74	
Sulphur	2'58	

Gordon's values would probably have been more reliable had the plates of the induction balance been provided with guard-rings (Art. 248). Hopkinson, whose method was a "slow" one, found for glass much higher inductive capacities, ranging from 6·5 to 10·1, the denser kinds having higher capacities. Rowland has lately examined the inductive capacity of plates of quartz cut from a homogeneous crystal, and finds it perfectly devoid of electric absorption. Cavendish observed that the apparent capacity of glass

became much greater at those temperatures at which it begins to conduct electricity. Boltzmann has announced that in the case of two crystalline substances, Iceland spar and sulphur, the inductive capacity is different in different directions, according to their position with respect to the axes of crystallisation.

271. Specific Inductive Capacity of Liquids and Gases.—The inductive capacity of liquids also has specific values. The following table is taken from the data of Silow and of Gordon :—

Turpentine	2·16
Petroleum	2·03 to 2·07
Bisulphide of Carbon	1·81

Faraday examined the inductive capacity of several gases by means of his apparatus (Fig. 103), one of the condensers being filled with air, the other with the gas which was let in through the tap below the sphere after exhaustion by an air pump. The method was too rough, however, to enable him to detect any difference between them, although many experiments were made with different pairs of gases at different temperatures and under varying pressures. More recently Boltzmann, and independently Ayrton and Perry, have measured the specific inductive capacities of different gases by very exact methods ; and their results agree very fairly.

	Boltzmann.	Ayrton and Perry.
Air	(1)	(1)
Vacuum	(0·999410)	(0·9985)
Hydrogen	0·999674	0·9998
Carbonic Acid	1·000356	1·0008
Olefiant Gas	1·000722	
Sulphur Dioxide		1·0037

272. Mechanical Effects of Dielectric Stress.

—That different insulating substances have specific

inductive power sufficiently disproves the idea that induction is merely an "action at a distance," for it is evident that the dielectric medium is itself concerned in the propagation of induction, and that some media allow induction to take place across them better than others. The existence of a residual charge (Art. 53) can be explained either on the supposition that the dielectric is composed of heterogenous particles which have unequal conducting powers, as Maxwell has suggested, or on the hypothesis that the molecules are actually subjected to a strain from which, especially if the stress be long-continued, they do not recover all at once. Kohlrausch and others have pointed out the analogy between this phenomenon and that of the "elastic recovery" of solid bodies after being subjected to a bending or a twisting strain. A fibre of glass, for example, twisted by a certain force, flies back when released to *almost* its original position, a slight sub-permanent set remains, from which, however, it slowly recovers itself, the rate of its recovery depending upon the amount and duration of the original twisting strain. Hopkinson has shown that it is possible to superpose several residual charges, even charges of opposite signs, which apparently "soak out" as the strained material gradually recovers itself. Perry and Ayrton have also investigated the question, and have shown that the polarisation charges in voltmeters exhibit a similar recovery.¹ Air condensers exhibit no residual charges.

When a condenser is discharged a sound is often heard. This was noticed by Sir W. Thomson in the case of air condensers; and Varley even constructed a telephone in which the rapid charge and discharge of a condenser gave rise to distinct tones.

¹ It would appear, therefore, probable that Maxwell's suggestion of heterogeneity of structure, as leading to residual electrification at the bounding surface of the particles whose electric conductivities differ, is the true explanation of the "residual" charge. The phenomenon of elastic recovery may itself be due to heterogeneity of structure.

As to the precise nature of the molecular or mechanical operations in the dielectric when thus subjected to the stress of electrostatic induction, nothing is known. One pregnant experiment of Faraday is of great importance, by showing that induction is, as he expressed it, "an action of contiguous particles." In a glass trough (Fig.

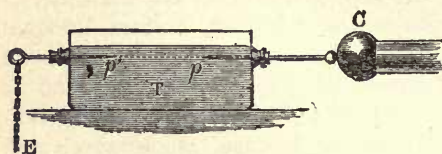

Fig. 104.

104), is placed some oil of turpentine, in which are put some fibres of dry silk cut into small bits. Two wires pass into

the liquid, one of which is joined to earth, the other being put into connection with the collector of an electrical machine. The bits of silk come from all parts of the liquid and form a chain of particles from wire to wire. On touching them with a glass rod they resist being pushed aside, though they at once disperse if the supply of electricity is stopped. Faraday regarded this as typical of the internal actions in every case of induction across a dielectric, the particles of which he supposed to be "polarised," that is, to be turned into definite positions, each particle having a positive and a negative end. The student will perceive an obvious analogy, therefore, between the condition of the particles of a dielectric across which electrostatic induction is taking place, and the molecules of a piece of iron or steel when subjected to magnetic induction.

Siemens has shown that the glass of a Leyden jar is sensibly warmed after being several times rapidly charged and discharged. This obviously implies that molecular movement accompanies the changes of dielectric stress.

273. Electric Expansion.—Fontana noticed that the internal volume of a Leyden jar increased when it was charged. Volta sought to explain this by suggesting that the attraction between the two charged surfaces

compressed the glass and caused it to expand laterally. This idea had previously occurred to Priestley. Duter showed that the amount of apparent expansion was inversely proportional to the thickness of the glass, and varied as the square of the potential difference. Quincke has recently shown that though glass and some other insulators exhibit electrical expansion, an apparent contraction is shown by resins and oily bodies under electrostatic stress. He connects with these properties the production of optical strain and of double refraction discovered by Kerr. (See Lesson on Electro-optics, Art. 386.)

274. Submarine Cables as Condensers.—A submarine telegraph cable may act as a condenser, the ocean forming the outer coating, the internal wire the inner coating, while the insulating layers of guttapercha correspond to the glass of the Leyden jar. When one end of a submerged cable is connected to, say, the + pole of a powerful battery, + electricity flows into it. Before any signal can be received at the other end, enough electricity must flow in to charge the cable to a considerable potential, an operation which may in the case of long cables require some seconds. Faraday predicted that this retardation would occur. It is, in actual fact, a serious obstacle to signalling with speed through the Atlantic cables and others. Professor Fleeming Jenkin has given the following experimental demonstration of the matter. Let a mile of insulated cable wire be coiled up in a tub of water (Fig. 105), one end, N, being insulated. The other end is joined up through a long-coil galvanometer, G, to the + pole of a large battery, whose - pole is joined by a wire to the water in the tub. Directly this is done, the needle of the galvanometer will show a violent deflection, + electricity rushing through it into the interior of the cable; and a - charge being accumulated on the outside of it where the water touches the guttapercha. For perhaps an hour the flow will go

on, though diminishing, until the cable is fully charged. Now remove the battery, and instead join up *a* and *b* by a wire; the charge in the cable will rush out through the

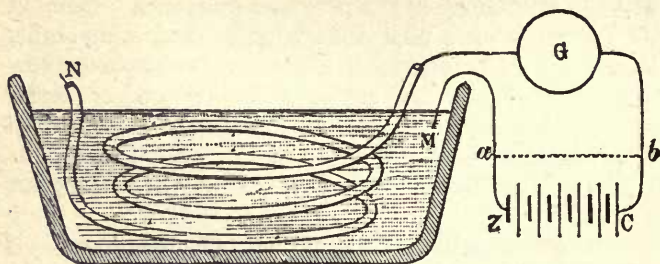

Fig. 105.

galvanometer, which will show an opposite deflection, and the residual charge will continue "soaking out" for a long time.

Since the speed of signalling, and therefore the economical working through a cable, depends upon its "capacity" as a condenser,¹ and since its capacity depends upon the specific inductive power of the insulating substance used, Hooper's compound, which has an inductive capacity of only 1.7, and is cheap, is preferred to gutta-percha, which is expensive, and has a specific inductive capacity as high as 2.46.

275. Use of Condensers.—To avoid this retardation and increase the speed of signalling in cables several devices are adopted. Very delicate receiving instruments are used, requiring only a feeble current; for with the feebler batteries the actual charge given to the cable is less. In some cases a key is employed which, after every signal, immediately sends into the cable a charge of opposite sign, to sweep out, as it were, the charge left behind. In duplex signalling (Lesson XXXIX.) the

¹ The capacity of the "Direct" Atlantic cable from Ballinskelligs (Ireland) to Nova Scotia is 992 microfarads.

resistance and electrostatic capacity of the cable have to be met by balancing against them an "artificial cable" consisting of a wire of equal resistance, and a condenser of equal capacity. Messrs. Muirhead constructed for duplexing the Atlantic Cable a condenser containing 100,000 square feet (over two acres of surface) of tinfoil. Such condensers are also occasionally used on telegraph lines in single working to avoid earth currents. They are constructed by placing sheets of tinfoil between sheets of mica or of paraffined paper, alternate sheets of foil being connected together. Small condensers of similar construction are used in connection with induction coils (Fig. 148).

276. Practical Unit of Capacity.—Electricians adopt a *unit of capacity*, termed one farad, based on the system of electromagnetic units. A condenser of one farad capacity would be raised to a potential of one volt by a charge of one coulomb of electricity.¹ In practice such a condenser would be too enormous to be constructed. As a *practical unit* of capacity is therefore chosen the **microfarad**, or one millionth of a farad; a capacity about equal to that of three miles of an Atlantic cable. Microfarad condensers are made containing about 3600 square inches of tinfoil. Their general form is shown in Fig. 106, which represents a $\frac{1}{2}$ microfarad condenser. The two brass pieces upon the ebonite top are connected respectively with the two series of alternate sheets of tinfoil. The plug between them serves to keep the condenser discharged when not in use.

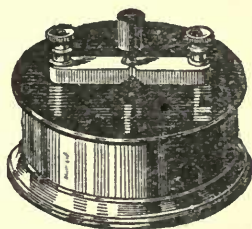

Fig. 106.

Methods of measuring the capacity of a condenser are given in Art. 362.

277. Formulæ for Capacities of Conductors and Condensers.—The following formulæ give the

¹ See Note on Electromagnetic Units, Art. 321.]

capacity of condensers of all ordinary forms, in electrostatic units:—

Sphere: (radius = r . See Art. 247).

$$C = r.$$

Two Concentric Spheres: (radii r and r' , specific inductive capacity of the dielectric = k).

$$C = k \frac{rr'}{r' - r}$$

Cylinder: (length = l , radius = r).

$$C = \frac{l}{2 \log_e \frac{l}{r}}$$

Two Concentric Cylinders: (length = l , specific inductive capacity of dielectric = k , internal radius = r , external radius = r').

$$C = k \frac{l}{2 \log_e \frac{r'}{r}}$$

Circular Disc: (radius = r , thickness negligible).

$$C = \frac{2r}{\pi}$$

Two Circular Discs: (like air condenser, Art. 48, radii = r , surface = S , thickness of dielectric = b , its specific inductive capacity = k).

$$C = k \frac{r^2}{4b}$$

$$\text{or } C = k \frac{S}{4\pi b}$$

(The latter formula applies to any two parallel discs of surface S , whether circular or otherwise, provided they are *large* as compared with the distance b between them.)

278. *Energy of Discharge of Leyden Jar or Condenser*.—It follows from the definition of potential, given in Art. 237, that in bringing up one + unit of

electricity to the potential V , the work done is V *ergs*. This assumes, however, that the total potential V is not thereby raised, and on this assumption the work done in bringing up Q units would be QV . If, however, the potential is nothing to begin with and is raised to V by the charge Q , the average potential during the operation is only $\frac{1}{2}V$; hence the total work done in bringing up the charge Q from zero potential to potential V is $\frac{1}{2}QV$ *ergs*. Now, according to the principle of the conservation of energy, the work done in charging a jar or condenser with electricity is equal to the work which could be done by that quantity of electricity when the jar is discharged. Hence a $\frac{1}{2}QV$ represents also the energy of the discharge, where V stands for the difference of potential between the two coatings.

Since $Q = VC$, it follows that we may write $\frac{1}{2}QV$ in the form $\frac{1}{2}\frac{Q^2}{C}$. That is to say, if a condenser of capacity C is charged by having a quantity Q of electricity imparted to it, the energy of the charge is proportional directly to the square of the quantity, and inversely to the capacity of the condenser.

If two equal Leyden jars are charged to the same potential, and then their inside and outside coatings are respectively joined, their united charge will be the same as that of a jar of equal thickness, but having twice the amount of surface.

If a charged Leyden jar is placed—similarly in communication with an uncharged jar of equal capacity, the charge will be shared equally between the two jars, and the passage of electricity from one to the other will be evidenced by the production of a spark when the respective coatings are put into communication. Here, however, half the energy of the charge is lost in the operation of sharing the charge, for each jar will have only $\frac{1}{2}Q$ for its charge and $\frac{1}{2}V$ for its potential; hence the energy of the charge of each being half the product of charge and potential will only be one quarter of the

original energy. The spark which passes in the operation of dividing the charge is, indeed, evidence of the loss of energy; it is about half as powerful as the spark would have been if the first jar had been simply discharged, and it is just twice as powerful as the small sparks yielded finally by the discharge of each jar after the charge has been shared between them.

The energy of a charge of the jar manifests itself, as stated above, by the production of a spark at discharge; the sound, light, and heat produced being the equivalent of the energy stored up. If discharge is effected slowly through a long thin wire of high resistance the air spark may be feeble, but the wire may be perceptibly heated. A wet string being a feeble conductor affords a slow and almost silent discharge; here probably the electrolytic conduction of the moisture is accompanied by an action resembling that of secondary batteries (Lesson XXXVIII.) tending to prolong the duration of the discharge.

279. Charge of Jars arranged in Cascade.—Franklin suggested that a series of jars might be arranged, the outer coating of one being connected with the inner one of the next, the outer coating of the last being connected to earth. The object of this arrangement was that the second jar might be charged with the electricity repelled from the outer coating of the first, the third from that of the second, and so on. This "cascade" arrangement, however, is of no advantage, the whole charge accumulated in the series being only equal to that of one single jar. For if the inner coating of the first jar be raised to V , that of the outer coating of the last jar remaining at zero in contact with earth, the difference of potential between the outer and inner coating of any one jar will be only $\frac{1}{n} V$, where n is number of jars. And as the charge in each jar is equal to its capacity C , multiplied by its potential, the charge in each will only be $\frac{1}{n} CV$, and in the whole n jars the

total charge will be $n \frac{1}{n} CV$, or CV , or equals the charge of one jar of capacity C raised to the same potential V .

LESSON XXIII.—*Phenomena of Discharge.*

280. An electrified conductor may be discharged in at least three different ways, depending on the medium through which the discharge is effected, and varying with the circumstances of the discharge.

281. **Disruptive Discharge.**—In the preceding Lesson it has been shown that induction across a non-conducting medium is always accompanied by a mechanical stress upon the medium. If this stress is very great the non-conducting medium will suddenly give way and a *spark* will burst across it. Such a discharge is called a “**disruptive**” discharge.

A very simple experiment, carefully considered, will set the matter in a clear light. Suppose a brass ball charged with + electricity to be hung by a silk string above a metal plate lying on the ground. If we lower down the suspended ball a spark will pass between it and the plate when they come very near together, and the ball will then be found to have lost all its previous charge. It was charged with a certain quantity of electricity, and as it had, when suspended out of the range of other conductors, a certain capacity (numerically equal to its radius in centimetres), the electricity on it would be at a certain potential (namely $= \frac{Q}{C}$), and the charge would be distributed with a certain surface density all over it. The plate lying on the earth would be all the while at zero potential. But when the suspended ball was lowered down towards the plate the previous state of things was altered. In the presence of the + charge of the ball the potential¹ of the plate

¹ The student must remember that, by the definition of potential in Art. 237, the potential at a point is the sum of all the separate quantities of electricity near it, divided each by its distance from the point.

would rise, were it not that, by the action termed induction, just enough negative electrification appears on it to keep its potential still the same as that of the earth. The presence of the induced negative electricity on the plate will attract the + electricity of the ball downwards, and alter the distribution of the electricity on the ball, the surface-density becoming greater at the under surface, and less on the upper. The capacity of the ball will be increased, and therefore its potential will fall correspondingly. The layer of air between the ball and the plate is acting like the glass of a Leyden jar. The more the ball is lowered down the greater is the accumulation of the opposite kinds of electricity on each side of the layer of air, and the stress across the layer becomes greater and greater, until the limit of the dielectric strength is reached; the air suddenly gives way and the spark tears a path across. The greater the difference of potential between the two bodies, the thicker will be the layer which can thus be pierced, and the longer will be the spark.

282. Conductive Discharge.—If the discharge takes place by the passage of a continuous *current*, as when electricity flows through a thin wire from the collector of a machine back to the rubbers, or from the positive pole of a battery to the negative pole, the operation is termed a “**conductive**” discharge. The laws of the conductive discharge are explained in Lessons XXIX. and XXX.

283. Convective Discharge.—A third kind of discharge, differing from either of those above mentioned, may take place, and occurs chiefly when electricity of a high potential discharges itself at a pointed conductor by accumulating there with so great a density as to electrify the neighbouring particles of air; these particles then flying off by repulsion, conveying away part of the charge with them. Such *convective discharges* may occur either in gases or in liquids, but are best mani-

fested in air and other gases at a low pressure, in tubes exhausted by an air pump.

The discharge of a quantity of electricity in any of the above ways is always accompanied by a transformation of its energy into energy of some other kind,—sound, light, heat, chemical actions, and other phenomena being produced. These effects must be treated in detail.

284. Mechanical Effects.—Chief amongst the mechanical effects of the disruptive spark discharge is the shattering and piercing of glass and other insulators. The dielectric strength of glass, though much greater than that of air, is not infinitely great. A slab of glass 3 inches thick has been pierced by the discharge of a powerful induction-coil. The so-called “toughened” glass has a greater dielectric strength than ordinary glass, and is more difficult to pierce. A sheet of glass may be readily pierced by a spark from a large Leyden jar or battery of jars, by taking the following precautions :—The glass to be pierced is laid upon a block of glass or resin, through which a wire is led by a suitable hole, one end of the wire being connected with the outer coating of the jar, the other being cut off flush with the surface. Upon the upper surface of the sheet of glass that is to be pierced another wire is fixed upright, its end being exactly opposite the lower wire, the other extremity of this wire being armed with a metal knob to receive the spark from the knob of the jar or discharger. To ensure good insulation a few drops of paraffin oil, or of olive oil, are placed upon the glass round the points where the wires touch it. A piece of dry wood similarly treated is split by a powerful spark.

If a spark is led through a tightly corked glass tube containing water, the tube will be shattered into small pointed fragments by the sudden expansion of the liquid.

The mechanical action of the brush discharge at

points is mentioned in Art. 43, and the mechanical effects of a current of electricity were described in Lesson XIX.

285. Lullin's Experiment.—If a piece of cardboard be perforated by a spark between two metal points, two curious facts are observed. *Firstly*, there is a slight burr raised on each side, as if the hole had been pierced from the middle outwards. *Secondly*, if the two points are not exactly opposite one another the hole is found to be nearer the *negative* point. But if the experiment is tried under the air pump in a vacuum, there is no such displacement of the hole; it is then midway exactly.

286. Chemical Effects.—The chemical actions produced by currents of electricity have been described in Lessons XIV. and XVIII. Similar actions can be produced by the electric spark, and by the silent glow discharge (see Art. 290). Faraday showed, indeed, that all kinds of electricity from different sources produced the same kinds of chemical actions, and he relied upon this as one proof of the essential identity of the electricity produced in different ways. If sparks from an electric machine are received upon a piece of white blotting-paper moistened with a solution of iodide of potassium, brown patches are noticed where the spark has effected a chemical decomposition and liberated the iodine.

When a stream of sparks is passed through moist air in a vessel, the air is found to have acquired the property of changing to a red colour a piece of paper stained blue with litmus. This, Cavendish showed, was due to the presence of nitric acid, produced by the chemical union of the nitrogen and oxygen of the air. The effect is best shown with the stream of sparks yielded by a small induction coil (Fig. 148), in a vessel in which the air has been compressed beyond the usual atmospheric pressure.

The spark will decompose ammonia gas, and olefiant

gas, and it will also cause chemical combination to take place with explosion, when passed through detonating mixtures of gases. Thus equal volumes of chlorine and hydrogen are exploded by the spark. So are oxygen and hydrogen gases, when mixed in the proportion of two volumes of the latter to one of the former. Even the explosive mixture of common coal gas mixed with from four to ten times its own volume of common air, can be thus detonated. A common experiment with the so-called *electric pistol* consists in filling a small brass vessel with detonating gases and then exploding them by a spark. The spark discharge is sometimes applied to the firing of blasts and mines in military operations, a small quantity of fulminating powder being placed in the path of the spark to kindle the larger charge of gunpowder or other explosive. (See also Art. 370.)

287. Physiological Effects.—The physiological effects of the current have been described in Lesson XIX. Those produced by the spark discharge are more sudden in character, but of the same general nature. The bodies of persons killed by the lightning spark frequently exhibit markings of a reddish tint where the discharge in passing through the tissues has lacerated or destroyed them. Sometimes these markings present a singular ramified appearance, as though the discharge had spread in streams over the surface at its entry.

288. Calorific Effects.—The flow of electricity through a resisting medium is in every case accompanied by an evolution of heat. The laws of heating due to currents are given in Art. 367. The disruptive discharge is a transfer of electricity through a medium of great resistance and accompanied by an evolution of heat. A few drops of ether in a metallic spoon are easily kindled by an electric spark. The spark from an electric machine, or even from a rubbed glass rod, is hot enough to kindle an ordinary gas-jet. In certain districts of America, during the driest season of the year, the mere

rubbing of a person's shoes against the carpet, as he shuffles across the floor, generates sufficient electricity to enable sparks to be drawn from his body, and he may light the gas by a single spark from his outstretched finger. Gunpowder can be fired by the discharge of a Leyden jar, but the spark should be retarded by being passed through a wet thread, otherwise the powder will simply be scattered by the spark.

The *Electric Air-Thermometer*, invented by Kinnersley,¹ serves to investigate the heating powers of the discharge. It consists of a glass vessel enclosing air, and communicating with a tube partly filled with water or other liquid, in order to observe changes of volume or of pressure. Into this vessel are led two metal rods, between which is suspended a thin wire, or a filament of gilt paper; or a spark can be allowed simply to cross between them. When the discharge passes the enclosed air is heated, expands, and causes a movement of the indicating column of liquid. Mascart has further developed the instrument by making it self-registering. The results of observation with these instruments are as follows:—The heating effect produced by a given charge in a wire of given length is inversely proportional to the square of the area of the cross section of the wire. The heating effect is greater, the slower the discharge. The total heat evolved is jointly proportional to the charge, and to the potential through which it falls. In fact, if the entire energy of the discharge is expended in producing heat, and in doing no other kind of work, then the heat developed will be the thermal equivalent of $\frac{1}{2} QV$, or will be $\frac{QV}{2J}$ units of heat, where J represents the mechanical equivalent of heat; ($J = 42$ million;

¹ This instrument differs in no essential respect from that devised ninety years later by Riess, to whom the instrument is often accredited. Riess, however, deduced quantitative laws, while Kinnersley contented himself with qualitative observations. Snow Harris also anticipated Riess in several points of his researches.

since 42×10^6 ergs = 1 gramme-water-degree of heat), and Q and V are expressed in C. G. S. units.

When a powerful discharge takes place through very thin wires, they may be heated to redness, and even fused by the heat evolved. Van Marum thus once heated 70 feet of wire by a powerful discharge. A narrow strip of tinfoil is readily fused by the charge of a large Leyden jar, or battery of jars. A piece of gold leaf is in like manner volatilised under the sudden heating of a powerful discharge; and Franklin utilised this property for a rude process of multiplying *portraits* or other patterns, which, being first cut out in card, were reproduced in a silhouette of metallic particles on a second card, by the device of laying above them a film of gold or silver leaf covered again with a piece of card or paper, and then transmitting the charge of a Leyden battery through the leaf between the knobs of a universal discharger.

289. Luminous Effects.—The luminous effects of the discharge exhibit many beautiful and interesting variations under different conditions. The *spark* of the disruptive discharge is usually a thin brilliant streak of light. When it takes place between two metallic balls, separated only by a short interval, it usually appears as a single thin and brilliant line. If, however, the distance be as much as a few centimetres, the spark takes an irregular zig-zag form. In any case its path is along the line of least resistance, the presence of minute motes of dust floating in the air being quite sufficient to determine the zig-zag character. In many cases the spark exhibits curious ramifications and forkings, of which an illustration is given in Fig. 107, which is drawn of one eighth of the actual size of the spark obtained from a Cuthbertson's electrical machine. The discharge from a Leyden jar affords a much brighter, shorter, noisier spark than the spark drawn direct from the collector of a machine. The length (see Art. 291)

depends upon the potential, and upon the pressure and temperature of the air in which the discharge takes place. The brilliance depends chiefly upon the quantity

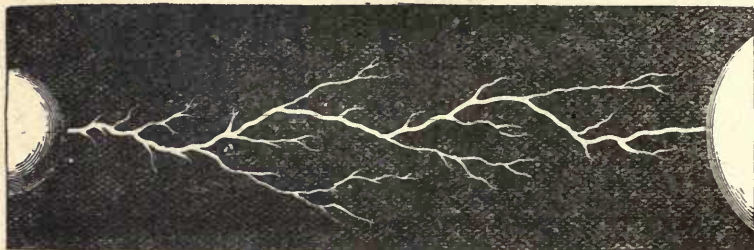

Fig. 107.

of electricity discharged. The colour of the spark varies with the nature of the metal surfaces between which the discharge takes place. Between copper or silver terminals the spark takes a green tint, while between iron knobs, it is of a reddish hue. Examination with the spectroscope reveals the presence in the spark of the rays characteristic of the incandescent vapours of the several metals; for the spark tears away in its passage small portions of the metal surfaces, and volatilises them.

290. Brush Discharge: Glow Discharge.—If an electric machine is vigorously worked, but no sparks be drawn from its collector, a fine diverging *brush* of pale blue light can be seen (in a dark room) streaming from the brass ball at the end of it farthest from the collecting comb: a hissing or crackling sound always accompanies this kind of discharge. The brush discharge consists of innumerable fine twig-like ramifications, presenting a form of which Fig. 108 gives a fine example. The brightness and size of the *brush* is increased by holding a flat plate of metal a little way from it. With a smaller ball, or with a bluntly pointed wire, the brush

appears smaller, but is more distinct and continuous. The brush discharge is larger and more ramified when a positive charge is escaping. than when the electrification

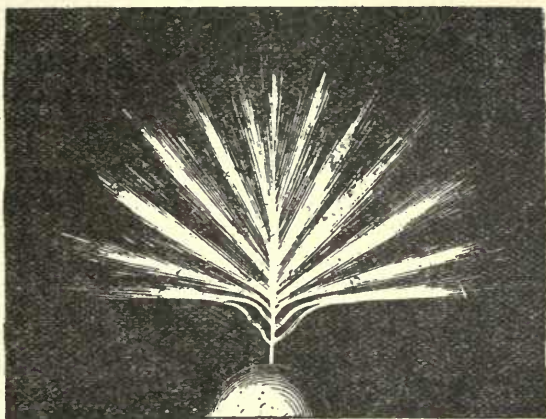

Fig. 108.

is negative. Wheatstone found by using his rotating mirror that the brush discharge is really a series of successive partial sparks at rapid intervals.

If the blunt or rounded conductor be replaced by a pointed one, the brush disappears and gives place to a quiet and continuous *glow* where the electrified particles of air are streaming away at the point. If these convection-streams are impeded the glow may once more give place to the brush. Where a negative charge is being discharged at a point, the glow often appears to be separated from the surface of the conductor by a dark space, where the air, without becoming luminous, still conveys the electricity. This phenomenon, to which Faraday gave the name of the "*dark*" discharge, is very well seen when electricity is discharged through rarefied air and other gases in vacuum tubes.

291. Length of Sparks.—Roughly speaking, the

length of spark between two conductors increases with the difference between their potentials. It is also found to increase when the pressure of the air is diminished. Riess found the distance to increase in a proportion a little exceeding that of the difference of potentials. Sir W. Thomson measured by means of an "absolute electrometer" (Art. 261) the difference of potential necessary to produce a spark discharge between two parallel plates at different distances. His precise experiments confirm Riess's observation. Thus, to produce a spark at .1 of a millimetre distance, the difference of potential must be 2.7 (arbitrary) units; at .5 millim. 7.3 units; at 1 millim. 12.6 units; and at 1.5 millims. 17.3 units. De la Rue and Müller have found with their great battery (Art. 174) that with a difference of potential of 1000 volts the striking distance of the spark was only .0127 centimetres (or about $\frac{1}{77}$ of an inch), and with a difference of 10,000 volts only 1.369. Their 11,000 silver cells gave a spark of 1.59 centim. (about $\frac{2}{3}$ of an inch) long. To produce a spark one mile long, through air at the ordinary pressure, would therefore require a difference of potential exceeding that furnished by 1,000,000,000 Daniell's cells!

The length of the spark differs in different gases, being nearly twice as long in hydrogen as in air at the same density, and longer in air than in carbonic acid gas.

In rarefied air the spark is longer. Snow Harris stated that the length of spark was inversely proportional to the pressure, but this law is not quite correct, being approximately true only for pressures between that of eleven inches of mercury and that of 30 inches (one atmosphere). At lower pressures, as Gordon has lately shown, a greater difference of potential must be used to produce a spark than that which would accord with Harris's law. From this it would appear that thin layers of air oppose a proportionally greater resistance to the piercing power of the spark than thick layers, and possess greater dielectric strength.

A perfect vacuum is a perfect insulator—no spark will cross it. It is possible to exhaust a tube so perfectly that none of our electric machines or appliances can send a spark through the vacuous space even over so short a distance as one centimetre.

On the other hand a great increase of pressure also increases the dielectric strength of air, and causes it to resist the passage of a spark. Cailletet compressed dry air at 40 to 50 atmospheres' pressure, and found that even the spark of a powerful induction coil failed to cross a space of .05 centimetre wide. The length of the spark (in air), is also affected by temperature, sparks being longer and straighter through hot air than through cold.

Flames and currents of very hot air, such as those rising from a red-hot piece of iron, are extremely good conductors of electricity, and act even better than metallic points in discharging a charged conductor. Gilbert showed that an electrified body placed near a flame lost its charge; and the very readiest way to rid the surface of a charged body of low conducting power of a charge imparted to it by friction or otherwise, is to pass it through the flame of a spirit-lamp. Faraday found negative electrification to be thus more easily discharged than positive. Flames powerfully negatively electrified are repelled from conductors, though not so when positively electrified. Sir W. Grove has shown that a current is set up in a platinum wire, one end of which touches the tip, and the other the base, of a flame.

292. Discharges in Partial Vacua.—If the discharge take place in glass tubes or vessels from which the air has been partially exhausted, many remarkable and beautiful luminous phenomena are produced. A common form of vessel is the "electric egg" (Fig. 150), a sort of oval bottle that can be screwed to an air-pump, and furnished with brass knobs to lead in the sparks. More often "vacuum tubes," such as those manufactured by

the celebrated Geissler, are employed. These are merely tubes of thin glass blown into bulbous or spiral forms, provided with two electrodes of platinum wire fused into the glass, and sealed off after being partially exhausted of air by a mercurial air-pump. Of these Geissler tubes the most useful consist of two bulbs joined by a very narrow tube, the luminous effects being usually more intense in the contracted portion. Such tubes are readily illuminated by a spark from an electrophorus or electric machine; but it is more common to work them with the spark of an induction coil (Fig. 148).

Through such tubes, before exhaustion, the spark passes without any unusual phenomena being produced. As the air is exhausted the sparks become less sharply defined, and widen out to occupy the whole tube, becoming pale in tint and nebulous in form. The negative electrode exhibits a beautiful bluish or violet glow, separated from the conductor by a narrow dark interval, while at the positive electrode a single small bright star of light is all that remains. Frequently the light breaks up into a set of *striae*, or patches of light of a cup-like form, which vibrate to and fro between darker spaces. In nitrogen gas the violet aureole glowing around the negative pole is very bright, the rest of the light being rosy in tint. In oxygen the difference is not so marked. In hydrogen gas the tint of the discharge is bluish, except where the tube is narrow, where a beautiful crimson may be seen. With carbonic acid gas the light is remarkably white. Particles of metal are torn off from the negative electrode, and projected from its surface. The negative electrode is also usually the hotter when made of similar dimensions to the positive electrode. It is also observed that the light of these discharges in vacuo is rich in those rays which produce phosphorescence and fluorescence. Many beautiful effects are therefore produced by blowing tubes in uranium glass, which fluoresces with a fine green light,

and by placing solutions of quinine or other fluorescent liquids in outer tubes of glass.

293. Phenomena in High Vacua.—Crookes has found that when exhaustion is carried to a very high degree, the dark space separating the negative glow from the negative pole increases in width; and that across this space electrified molecules are projected in parallel paths normally to the surface of the electrode. The chief point relied upon for this theory is, that if exhaustion be carried to such a high degree that the dark space fills the entire tube or bulb, and bodies (whether opaque or transparent) be then interposed in front of the electrode, sharply defined shadows of these bodies are projected upon the opposite wall of the vessel, as if they stopped the way for some of the flying molecules, and prevented them from striking the opposite wall. Lightly-poised vanes are also driven round if placed in the path of the discharge. Holtz has more recently produced "electric shadows," by means of discharges in air at ordinary pressure, between the poles of his well-known machine (Fig. 29), the discharge taking place between a point and a disc covered with silk, on which the shadows are thrown.

294. Striæ.—The *striæ* or *stratifications* have been examined very carefully by Gassiot, by Spottiswoode, and by De la Rue. The principal facts hitherto gleaned are as follow:—The *striæ* originate at the positive electrode at a certain pressure, and become more numerous, as the exhaustion proceeds, up to a certain point, when they become thicker and diminish in number, until exhaustion is carried to such a point that no discharge will pass. The *striæ* are hotter than the spaces between them. The number and position of the *striæ* vary, not only with the exhaustion but with the difference of potentials of the electrodes. When *striæ* are produced by the intermittent discharges of the induction coil, examination of them in a rotating mirror reveals that they move forward from the positive electrode towards the negative.

Schuster has recently shown that the discharge of electricity through gases is a process resembling that of electrolysis (Art. 418), being accompanied by breaking up of the gaseous mole-

cules and incessant interchanges of atoms between them. The production of ozone (Art. 208) and the phenomena noticed at the negative electrode (Art. 292) certainly give support to this view.

The discharges in vacuum tubes are affected by the *magnet* at all degrees of exhaustion, behaving like flexible conductors. Under certain conditions also, the discharge is *sensitive* to the presence of a conductor on the exterior of the tube, retreating from the side where it is touched. This sensitive state appears to be due to a periodic intermittence in the discharge; an intermittence or partial intermittence in the flow would also probably account for the production of striæ.

295. Electric Oscillations.—Feddersen examined the spark of a Leyden jar by means of a rotating mirror, and found that instead of being a single instantaneous discharge, it exhibited¹ certain definite fluctuations. With very small resistances in the circuit, there was a true oscillation of the electricity backward and forward for a brief time, these alternate partial discharges being probably due to the self-induction of the circuit. With a certain higher resistance the discharge became continuous but not instantaneous. With a still higher resistance, the discharge consisted of a series of partial intermittent discharges, following one another in the same direction. Such sparks when viewed in the rotating mirror showed a series of separate images at nearly equal distances apart. The period of the oscillations was found to be proportional to the square root of the capacity of the condenser.

296. Velocity of Propagation of Discharge.—The earliest use of the rotating mirror to analyse phenomena of short duration was made by Wheatstone, who attempted by this means to measure “the velocity of electricity” in conducting wires. What he succeeded in measuring was not, however, *the velocity of electricity*, but the time taken by a certain quantity of electricity to flow through a conductor of considerable resistance and capacity. Viewed in a rotating mirror, a spark of

¹ This phenomenon of oscillation was *predicted* from purely theoretical considerations, arising out of the equations of self-induction, by Sir W. Thomson

definite duration would appear to be drawn out into an elongated streak. Such an elongation was found to be visible when a Leyden jar was discharged through a copper wire half a mile long; and when the circuit was interrupted at three points, one in the middle and one at each end of this wire, three sparks were obtained, which, viewed in the mirror, showed a lateral displacement, indicating (with the particular rate of rotation employed) that the middle spark took place $\frac{1}{1,162,000}$ of a second later than those at the ends. Wheatstone argued from this a velocity of 288,000 miles per second. But Faraday showed that the apparent rate of propagation of a quantity of electricity must be affected by the capacity of the conductor; and he even predicted that since a submerged insulated cable acts like a Leyden jar (see Art. 274), and has to be charged before the potential at the distant end can rise, it *retards* the apparent flow of electricity through it. Professor Fleeming Jenkin says of one of the Atlantic cables, that, after contact with the battery is made at one end, no effect can be detected at the other for two-tenths of a second, and that then the received current gradually increases, until about three seconds afterwards it reaches its maximum, and then dies away. This retardation is proportional to the square of the length of the cable as well as to its capacity and to its resistance; hence it becomes very serious on long cables, as it reduces the speed of signalling. There is in fact no definite assignable "velocity of electricity."

A very simple experiment will enable the student to realise the excessively short duration of the spark of a Leyden jar. Let a round disc of cardboard painted with black and white sectors be rotated very rapidly so as to look by ordinary light like a mere gray surface. When this is illuminated by the spark of a Leyden jar it appears to be standing absolutely still, however rapidly it may be turning. A flash of lightning is equally in-

stantaneous: it is utterly impossible to determine at which end the flash begins.¹

297. Electric Dust-figures.—Electricity may creep slowly over the surface of bad conductors. Lichtenberg devised an ingenious way of investigating the distribution of electricity by means of certain dust-figures. The experiment is very easy. Take a charged Leyden jar and write with the knob of it upon a cake of shellac or a dry sheet of glass. Then sift, through a bit of

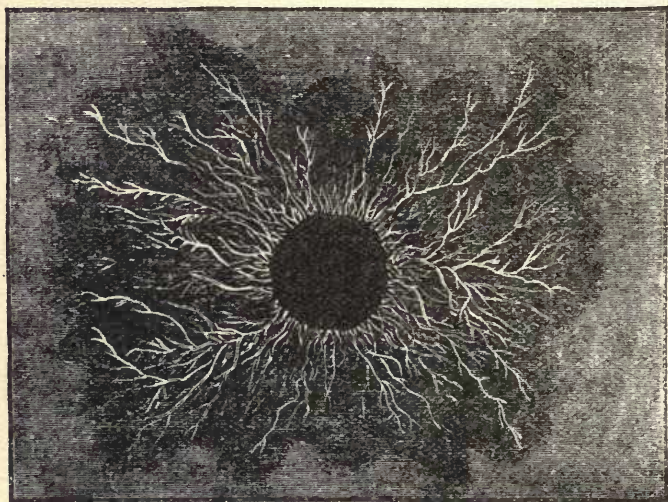

Fig. 109.

muslin, over the cake of shellac a mixture of powdered red lead and sulphur (vermilion and lycopodium powder answer equally well). The powders in this process rub against one another, the red lead becoming +, the sulphur -. Hence the sulphur will be attracted to those parts where there is + electrification on the disc, and settles down in curious branching yellow streaks like

¹ Sometimes the flash seems to strike downwards from the clouds sometimes upwards from the earth. This is an optical illusion, resulting from the unequal sensitiveness to light of different portions of the retina of the eye.

those shown in Fig. 109. The red lead settles down in little red heaps and patches where the electrification is negative. Fig. 110 shows the general appearance of the *Lichtenberg's figure* produced by holding the knob of

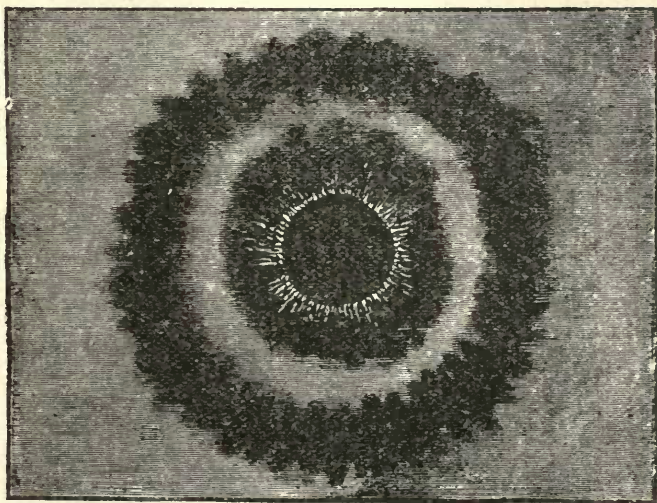

Fig. 110.

the Leyden jar at the centre of a shellac plate that has previously been rubbed with flannel, the negative electrification being attracted upon all sides toward the central positive charge.

Powdered tourmaline, warmed and then sifted over a sheet of glass previously electrified irregularly, will show similar figures, though not so well defined.

Breath-figures can be made by electrifying a coin or other piece of metal laid upon a sheet of dry glass, and then breathing upon the glass where the coin lay, revealing a faint image of it on the surface of the glass.

298. Production of Ozone.—Whenever an electric machine is worked a peculiar odour is perceived. [This was formerly thought to be evidence of the existence

of an electric "effluvium" or fluid; it is now known to be due to the presence of ozone, a modified form of oxygen gas, which differs from oxygen in being denser, more active chemically, and in having a characteristic smell. The discharge of the Holtz-machine and that of the induction coil are particularly favourable to the production of this substance.

299. Dissipation of Charge.—However well insulated a charged conductor may be, and however dry the surrounding air, it nevertheless slowly loses its charge, and in a few days will be found to be completely discharged. The rate of loss of charge is, however, not uniform. It is approximately proportional to the difference of potential between the body and the earth. Hence the rate of loss is greater at first than afterwards, and is greater for highly charged bodies than for those feebly charged. The law of dissipation of charge therefore resembles Newton's law of cooling, according to which the rate of cooling of a hot body is proportional to the difference of temperature between it and the surrounding objects. If the potential of the body be measured at equal intervals of time it will be found to have diminished in a decreasing geometric series; or the logarithms of the potentials at equal intervals of time will differ by equal amounts.

This may be represented by the following equation :

$$V_t = V_0 e^{-pt},$$

where V_0 represents the original potential and V_t the potential after an interval t . Here e stands for the number 2.71828... (the base of the natural logarithms), and p stands for the "coefficient of leakage," which depends upon the temperature, pressure, and humidity of the air.

The rate of loss is, however, greater at negatively electrified surfaces than at positive.

300. Positive and Negative Electrification.—The student will not have failed to notice throughout

this Lesson frequent differences between the behaviour of positive and negative electrification. The striking dissimilarity in the Lichtenberg's figures, the displacement of the perforation-point in Lullin's experiment, the unequal tendency to dissipation at surfaces, the remarkable differences in the various forms of brush and glow discharge, are all points that claim attention. Gassiot described the appearance in vacuum tubes as of a force emanating from the negative pole. Crookes's experiments in high vacua show molecules to be violently discharged from the negative electrode, the vanes of a little fly enclosed in such tubes being moved from the side struck by the negative discharge. Holtz found that when funnel-like partitions were fixed in a vacuum tube the resistance is much less when the open mouths of the funnels face the negative electrode. These matters are yet quite unaccounted for by any existing theory of electricity.

The author of these Lessons is disposed to take the following view on this point:—If electricity be really *one* and not *two*, either the so-called *positive* or the *negative* electrification must be a state in which there is *more* electricity than in the surrounding space, and the other must be a state in which there is *less*. The student was told, in Art. 6, that in the present state of the science we do not know for certain whether "positive" electrification is really an *excess* of electricity or a *defect*. Now some of the phenomena alluded to in this Article seem to indicate that the so-called "negative" electrification really is the state of excess. In particular, the fact that the rate of dissipation of charge is greater for negative electrification than for positive, points this way; because the law of loss of charge is the exact counterpart of the law of the loss of heat, in which it is quite certain that, for equal differences of temperature between a body and its surroundings, the rate of loss of heat is greater at higher temperatures than at lower; or the body that is really hotter loses its heat fastest.

LESSON XXIV.—*Atmospheric Electricity.*

301. The phenomena of atmospheric electricity are of two kinds. There are the well-known electrical phenomena of thunderstorms; and there are the phenomena

of continual slight electrification in the air, best observed when the weather is fine. The phenomena of the Aurora constitute a third branch of the subject.

302. The Thunderstorm an Electrical Phenomenon.—The detonating sparks drawn from electrical machines and from Leyden jars did not fail to suggest to the early experimenters, Hawkesbee, Newton, Wall, Nollet, and Gray, that the lightning flash and the thunderclap were due to electric discharges. In 1749, Benjamin Franklin, observing lightning to possess almost all the properties observable in electric sparks,¹ suggested that the electric action of points (Art. 43), which was discovered by him, might be tried on thunderclouds, and so draw from them a charge of electricity. He proposed, therefore, to fix a pointed iron rod to a high tower. Before he could carry his proposal into effect, Dalibard, at Marly-la-ville, near Paris, taking up Franklin's hint, erected an iron rod 40 feet high, by which, in 1752, he succeeded in drawing sparks from a passing cloud. Franklin shortly after succeeded in another way. He sent up a kite during the passing of a storm, and found the wetted string to conduct electricity to the earth, and to yield abundance of sparks. These he drew from a key tied to the string, a silk ribbon being interposed between his hand and the key for safety. Leyden jars could be charged, and all other electrical effects produced, by the sparks furnished from the clouds. The proof of the identity was complete. The kite experiment was repeated by Romas, who drew from a metallic

¹ Franklin enumerates specifically an agreement between electricity and lightning in the following respects:—Giving light; colour of the light; crooked direction; swift motion; being conducted by metals; noise in exploding; conductivity in water and ice; rending imperfect conductors; destroying animals; melting metals; firing inflammable substances; sulphureous smell (due to *ozone*, as we now know); and he had previously found that needles could be magnetised both by lightning and by the electric spark. He also drew attention to the similarity between the pale-blue flame seen during thundery weather playing at the tips of the masts of ships (called by sailors *St. Elmo's Fire*), and the "glow" discharge at points.

string sparks 9 feet long, and by Cavallo, who made many important observations on atmospheric electricity. In 1753 Richmann, of St. Petersburg, who was experimenting with an apparatus resembling that of Dalibard, was struck by a sudden discharge and killed.

303. Theory of Thunderstorms.— Solids and liquids cannot be charged throughout their substance; if charged at all the electricity is upon their surface (see Art. 29). But gases and vapours, being composed of myriads of separate particles, can receive a bodily charge. The air in a room in which an electric machine is worked is found afterwards to be charged. The clouds are usually charged more or less with electricity, derived, probably, from evaporation¹ going on at the earth's surface. The minute particles of water floating in the air being better conductors than the air itself become more highly charged. As they fall by gravitation and unite together, the strength of their charges increases. Suppose eight small drops to join into one. That one will have eight times the quantity of electricity distributed over the surface of a single sphere of twice the radius (and, therefore, of twice the capacity, by Art. 247) of the original drops; and its electrical potential will therefore be four times as great. Now a mass of cloud may consist of such charged spheroids, and its potential may gradually rise, therefore, by the coalescence of the drops, and the electrification at the lower surface of the cloud will become greater and greater, the surface of the earth beneath acting as a condensing plate and becoming inductively charged with the opposite kind of electrification. Presently the difference of potential becomes so great that the intervening strata of air give way under the strain, and a disruptive discharge takes place at the point where the air offers least resistance. This lightning spark, which may be more than a mile in length, discharges only the electricity that has been accumulat-

¹ See Art. 63.

ing at the surface of the cloud, and the other parts of the cloud will now react upon the discharged portion, producing internal attractions and internal discharges. The internal actions thus set up will account for the usual appearance of a thundercloud, that it is a well-defined flat-bottomed mass of cloud which appears at the top to be boiling or heaving up with continual movements.

304. **Lightning and Thunder.**—Three kinds of lightning have been distinguished by Arago: (i.) The *Zig-zag flash* or "*Forked lightning*," of ordinary occurrence. The zig-zag form is probably due either to the presence of solid particles in the air or to local electrification at certain points, making the crooked path the one of least resistance. (ii.) *Sheet lightning*, in which whole surfaces are lit up at once, is probably only the reflection on the clouds of a flash taking place at some other part of the sky. It is often seen on the horizon at night, reflected from a storm too far away to produce audible thunder, and is then known as "summer lightning." (iii.) *Globular lightning*, in the form of *balls of fire*, which move slowly along and then burst with a sudden explosion. This form is very rare, but must be admitted as a real phenomenon, though some of the accounts of it are greatly exaggerated. Similar phenomena on a small scale have been produced (though usually accidentally) with electrical apparatus. Cavallo gives an account of a *fireball* slowly creeping up the brass wire of a large highly charged Leyden jar, and then exploding as it descended; and Planté has recently observed similar but smaller globular discharges from his "rheostatic machine" charged by powerful secondary batteries.

The sound of the thunder may vary with the conditions of the lightning spark. The spark heats the air in its path, causing sudden expansion and compression all round, followed by as sudden a rush of air into the

partial vacuum thus produced. If the spark be straight and short, the observer will hear but one short sharp *clap*. If its path be a long one and not straight, he will hear the successive sounds one after the other, with a characteristic *rattle*, and the echoes from other clouds will come *rolling* in long afterwards. The lightning-flash itself never lasts more than $\frac{1}{100000}$ of a second.

The damage done by a lightning-flash when it strikes an imperfect conductor appears sometimes as a disruptive mechanical disintegration, as when the masonry of a chimney-stack or church-spire is overthrown, and sometimes as an effect of heat, as when bell-wires and objects of metal in the path of the lightning-current are fused. The physiological effects of sudden discharges are discussed in Art. 226. The remedy against disaster by lightning is to provide an efficient conductor communicating with a conducting stratum in the earth.

The "return-stroke" experienced by persons in the neighbourhood of a flash is explained in Art. 26.

305. Lightning Conductors.—The first suggestion to protect property from destruction by lightning was made by Franklin in 1749, in the following words :

"May not the knowledge of this power of points be of use to mankind, in preserving houses, churches, ships, etc., from the stroke of lightning, by directing us to fix on the highest parts of those edifices upright rods of iron made sharp as a needle, and gilt to prevent rusting, and from the foot of those rods a wire down the outside of the building into the ground, or round one of the shrouds of a ship, and down her side till it reaches the water? Would not these pointed rods probably draw the electrical fire silently out of a cloud before it came nigh enough to strike, and thereby secure us from that most sudden and terrible mischief."

The four essential points of a good lightning-conductor are—(1) that its apex be a fine point elevated above the highest point of the building ; (2) that its lower end passes either into a stream or into wet stratum of ground ; (3)

that the conductor between the apex and the ground be perfectly continuous and of sufficient conducting power ; (4) that the leads and any iron work or metal work about the roofs or chimneys be connected by stout wires with the main conductor. Too great importance cannot be attached to the second and third of these essentials. Maxwell has proposed to cover houses with a network of conducting wires, without any main conductor, the idea being that then the interior of the building will, like Faraday's hollow cube (Art. 31), be completely protected from electric force. Much controversy has arisen of late respecting lightning-rods, Professor Oliver Lodge maintaining that a lightning flash to be of the nature of an electric oscillation (Art. 295) rather than a current. If so, the conductor of least resistance is not necessarily the best lightning-rod. Professor Lodge and the author independently, and for different reasons, recommend iron in preference to copper for lightning-rods.

306. Atmospheric Electricity.—In 1752 Lemonnier observed that the atmosphere usually was in an electrical condition. Cavallo, Beccaria, Ceca, and others, added to our knowledge of the subject, and more recently Quetelet and Sir W. Thomson have generalised from more careful observations. The main result is that the air above the surface of the earth is usually, during fine weather, positively electrified, or at least that it is positive with respect to the earth's surface, the earth's surface being relatively negative. The so-called measurements of "atmospheric electricity" are really measurements of difference of potential between a point of the earth's surface, and a point somewhere in the air above it. In the upper regions of the atmosphere the air is highly rarefied, and conducts electricity as do the rarefied gases in Geissler's tubes (Art. 292). The lower air is, when dry, a non-conductor. The upper stratum is believed to be charged with + electricity, while the earth's surface is itself negatively charged ;

the stratum of denser air between acting like the glass of a Leyden jar in keeping the opposite charges separate. If we could measure the electric potential at different points within the thickness of the glass of a Leyden jar, we should find that the values of the potential changed in regular order from a + value at one side to a - value at the other, there being a point of zero potential about half way between the two. Now, the air in fine weather always gives + indications, and the potential of it is higher the higher we go to measure it. Cavallo found more electricity in the air just outside the cupola of St. Paul's Cathedral than at a lower point of the building. Sir W. Thomson found the potential in the island of Arran to increase from 23 to 46 volts for a rise of one foot in level; but the difference of potential was sometimes eight or ten times as much for the same difference of level, and changed rapidly, as the east wind blew masses of cloud charged with + or - electricity across the sky. Joule and Thomson, at Aberdeen, found the rise of potential to be equal to 40 volts per foot, or 1.3 volts per centimetre rise of level

During fine weather a negative electrification of the air is extremely rare. Beccaria only observed it six times in fifteen years, and then with accompanying winds. But in broken weather and during rain it is more often - than +, and exhibits great fluctuations, changing from - to +, and back, several times in half an hour. A definite change in the electrical conditions usually accompanies a change of weather. "If, when the rain has ceased (said Ceca), a strong excessive (+) electricity obtains, it is a sign that the weather will continue fair for several days."

307. Methods of Observation. — The older observers were content to affix to an electroscope (with gold leaves or pith-balls) an insulated pointed rod stretching out into the air above the ground, or to fly a

kite, or (as Becquerel did) to shoot into the air an arrow communicating with an electroscope by a fine wire, which was removed before it fell. Gay Lussac and Biot lowered a wire from a balloon, and found a difference of potential between the upper and lower strata of the air. None of these methods is quite satisfactory, for they do not indicate the potential at any *one* point. To bring the tip of a rod to the same potential as the surrounding air, it is necessary that material particles should be discharged from that point for a short time, each particle as it breaks away carrying with it a + or a - charge until the potentials are equalised between the rod and the air at that point. Volta did this by means of a small flame at the end of an exploring rod. Sir W. Thomson has employed a "water-dropper," an insulated cistern provided with a nozzle protruding into the air, from which drops issue to equalise the potentials: in winter he uses a small roll of smouldering touch-paper. Dellmann adopted another method, exposing a sphere to induction by the air, and then insulating it, and bringing it within doors to examine its charge. Peltier adopted the kindred expedient of placing, on or near the ground, an electrometer of the form shown in Fig. 111, which during exposure was connected to the ground, then insulated, then removed in-doors for examination. This process really amounted to charging the electrometer *by induction* with electricity of opposite sign to that of the air. The principle of this particular electrometer was explained in Art. 260. Of recent years the more exact electrometers of Sir W. Thomson, particularly the "quadrant" electrometer, described in Art. 262, the "divided-ring" electrometer, and a "portable" electrometer on the same general principle, have been used for observations on atmospheric electricity. These electrometers have the double advantage of giving quantitative readings, and of being readily adapted to automatic registration, by recording photographically the

movements of a spot of light reflected from a small mirror attached to their needle. Using a water-dropping collector and a Thomson electrometer, Everett made

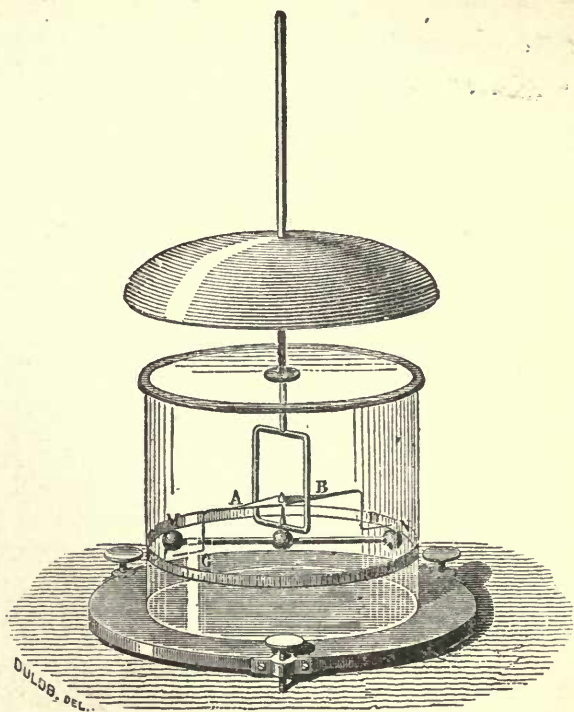

Fig. 111.

a series of observations in Nova Scotia, and found the highest + electrification in frosty weather, with a dry wind charged with particles of ice.

308. **Diurnal Variations.**—Quetelet found that at Brussels the daily indications (during fine weather) showed two *maxima* occurring in summer at 8 *a.m.* and 9 *p.m.*, and in winter at 10 *a.m.* and 6 *p.m.* respectively,

and two *minima* which in summer were at the hours of 3 *p.m.* and about midnight. He also found that in January the electricity was about thirteen times as strong as in June. Observations made by Prof. B. Stewart at Kew show a maximum at 8 *a.m.* in summer at 10 *a.m.* in winter, and a second minimum at 10 *p.m.* in summer and 7 *p.m.* in winter. The *maxima* correspond fairly with hours of changing temperature, the *minima* with those of constant temperature. In Paris, M. Mascart finds but one maximum just before midnight: at sunrise the electricity diminishes until about 3 *p.m.*, when it has reached a minimum, whence it rises till nightfall.

Our knowledge of this important subject is still very imperfect. We do not even know whether all the changes of the earth's electrification relatively to the air are due to causes operating above or below the earth's surface. Simultaneous observations at different places and at different levels are greatly wanted.

309. The *Aurora*.—In all the northern regions of the earth the *Aurora borealis*, or "Northern Lights," is an occasional phenomenon; and within and near the Arctic circle is of almost nightly occurrence. Similar lights are seen in the south polar regions of the earth, and are denominated *Aurora australis*. As seen in European latitudes, the usual form assumed by the aurora is that of a number of ill-defined streaks or streamers of a pale tint (sometimes tinged with red and other colours), either radiating in a fan-like form from the horizon in the direction of the (magnetic) north, or forming a sort of arch across that region of the sky, of the general form shown in Fig. 112. A certain flickering or streaming motion is often discernible in the streaks. Under very favourable circumstances the aurora extends over the entire sky. The appearance of an aurora is usually accompanied by a *magnetic storm* (Art. 145), affecting the compass-needles over whole regions of the globe. This fact, and the position of the

auroral 'arches' and streamers with respect to the magnetic meridian, directly suggest an electric origin for the light,—a conjecture which is confirmed by the many analogies found between auroral phenomena and

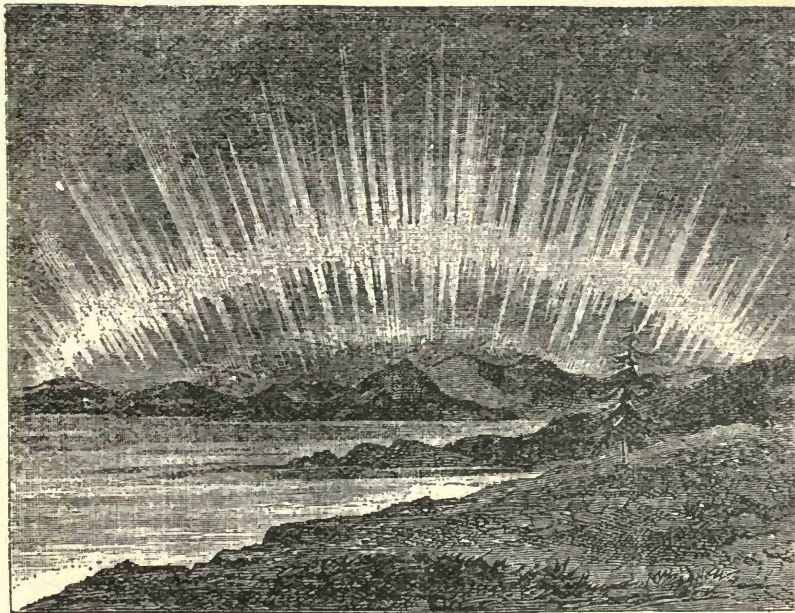

Fig. 112.

those of discharge in rarefied air (Arts. 292 and 294). Yet the presence of an aurora does not, at least in our latitudes, affect the electrical conditions of the lower regions of the atmosphere. On September 1, 1859, a severe magnetic storm occurred, and auroræ were observed almost all over the globe; at the same time a remarkable outburst of energy took place in the photosphere of the sun; but no simultaneous development of atmospheric electricity was recorded. Auroræ appear in greater frequency in periods of about $11\frac{1}{2}$

years, which agrees pretty well with the cycles of maximum of magnetic storms (see Art. 144) and of sun-spots.

The spectroscope shows the auroral light to be due to gaseous matter, its spectrum consisting of a few bright lines not referable with certainty to any known terrestrial substance, but having a general resemblance to those seen in the spectrum of the electric discharge through rarefied dry air.

The most probable theory of the aurora is that originally due to Franklin, namely, that it is due to electric discharges in the upper air, in consequence of the differing electrical conditions between the cold air of the polar regions and the warmer streams of air and vapour raised from the level of the ocean in tropical regions by the heat of the sun. For evaporation of water containing saline matter is a source of electrification (see Art. 63), the escaping vapour becoming positively electrified.

According to Nordenskiöld the terrestrial globe is perpetually surrounded at the poles with a ring or crown of light, single or double, to which he gives the name of the "aurora-glory." The outer edge of this ring he estimates to be at 120 miles above the earth's surface, and its diameter about 1250 miles. The centre of the aurora-glory is not quite at the magnetic pole, being in lat. 81° N., long. 80° E. This aurora-glory usually appears as a pale arc of light across the sky, and is destitute of the radiating streaks shewn in Fig. 112, except during magnetic and auroral storms.

An artificial aurora has been produced by Lemström, who erected on a mountain in Lapland a network of wires presenting many points to the sky. By insulating this apparatus and connecting it by a telegraph wire with a galvanometer at the bottom of the mountain, he was able to observe actual currents of electricity when the auroral beam rose above the mountain

CHAPTER V.

ELECTROMAGNETICS.

LESSON XXV.—*Theory of Magnetic Potential.*

310. That branch of the science of electricity which treats of the relation between electric currents and magnetism is termed **Electromagnetics**. In Art. 117 the law of inverse squares as applied to magnets was explained, and the definition of "unit magnetic pole" was given in Art. 125. The student also learned to express the strength of poles of magnets in terms of the unit pole, and to apply the law to the measurement of magnetic forces. It is, however, much more convenient, for the purpose of study, to express the interaction of magnetic and electromagnetic systems in terms not of "force" but of "*potential*"; *i.e.* in terms of their power to do work. In Art. 237 the student was shown how the electric potential due to a quantity of electricity may be evaluated in terms of the work done in bringing up as a test charge a unit of + electricity from an infinite distance. **Magnetic potential** can be measured similarly by the ideal process of bringing up a unit magnetic pole (N.-seeking) from an infinite distance, and ascertaining the amount of work done in the operation. Hence a large number of the points proved in Lesson XX. concerning electric potential will also hold true for magnetic potential. The student may compare the following propositions with the corresponding ones in Articles 237 to 243:—

- (a) *The magnetic potential at any point is the work that must be spent upon a unit magnetic (N.-seeking) pole in bringing it up to that point from an infinite distance.*
- (b) *The magnetic potential at any point due to a system of magnetic poles is the sum of the separate magnetic potentials due to the separate poles.*

The student must here remember that the potentials due to S.-seeking poles will be of opposite sign to those due to N.-seeking poles, and must be reckoned as negative.

- (c) *The (magnetic) potential at any point due to a system of magnetic poles may be calculated (compare with Art. 238) by summing up the strengths of the separate poles divided each by its own distance from that point. Thus, if poles of strengths m' , m'' , m''' , etc., be respectively at distances of r' , r'' , r''' , (centimetres) from a point P, then the following equation gives the potential at P:—*

$$V_P = \frac{m'}{r'} + \frac{m''}{r''} + \frac{m'''}{r'''} + \dots$$

$$\text{or } V_P = \sum \frac{m}{r}.$$

- (d) *The difference of (magnetic) potential between two points is the work to be done on or by a unit (N.-seeking) pole in moving it from one point to the other.*
- (e) *Magnetic force is the rate of change of (magnetic) potential per unit of length.*
- (f) *Equipotential surfaces are those (imaginary) surfaces surrounding a magnetic pole or system of poles, over which the (magnetic) potential has equal values. Thus, around a single magnetic pole, supposing all the magnetism to be collected at a point far removed from all other poles, the potential would be equal all round at equal*

distances; and the equipotential surfaces would be a system of concentric spheres at such distances apart that it would require the expenditure of one *erg* of work to move a unit pole up from a point on the surface of one sphere to any point on the next (see Fig. 97). Around any real magnet possessing two polar regions the equipotential surfaces would be much more complicated. *Magnetic force, whether of attraction or repulsion, always acts across the equipotential surfaces in a direction normal to the surface; the magnetic lines of force are everywhere perpendicular to the equipotential surfaces.*

311. Tubes of Force.—The following proposition is also important:—From a single magnetic pole (supposed to be a point far removed from all other poles) the lines of force diverge radially in all directions. The space around may be conceived as thus divided up into a number of conical regions, each having their apex at that pole; and through each cone, as through a tube, a certain number of lines of force will pass. Such a conical space may be called a “tube of force.” No matter where you cut across a tube of force the cross-section will cut through all the enclosed lines of force, though they diverge more widely as the tube widens. Hence,

(g) *The total magnetic force exerted across any section of a tube of force is constant wherever the section be taken.*

In case the magnetism is not concentrated at one point, but distributed over a surface, we shall have to speak of the “amount of magnetism” rather than of the “strength of pole,” and in such a case the

(h) *Magnetic density is the amount of free magnetism per unit of surface.* In the case of a simple magnetic shell over the face of which the magnetism is distributed with uniform density,

the "strength" of the shell will be equal to the thickness of the shell multiplied by the surface-density.

312. Intensity of Field.—We have seen (Art. 105) that every magnet is surrounded by a certain "field," within which magnetic force is observable. We may completely specify the properties of the field at any point by measuring the *strength* and the *direction* of that force,—that is, by measuring the "intensity of the field" and the direction of the lines of force. *The "intensity of the field" at any point is measured by the force with which it acts on a unit magnetic pole placed at that point.* Hence, *unit intensity of field is that intensity of field which acts on a unit pole with a force of one dyne.* There is therefore a field of unit intensity at a point one centimetre distant from the pole of a magnet of unit strength. Suppose a magnet pole, whose strength is m , placed in a field at a point where the intensity is H , then the force will be m times as great as if the pole were of unit strength, and

$$f = m \times H.$$

We may also take as a measure of the intensity of the field at any point the number of lines of force that pass through a square centimetre of surface placed across the field at that point. *It follows that a unit magnetic pole will have 4π lines of force proceeding from it:* for there is unit field at unit distance away, or one line of force per square centimetre; and there are 4π square centimetres of surface on a sphere of unit radius drawn round the pole. A magnet, whose pole-strength is m , has $4\pi m$ lines of force running through the steel, and diverging at its pole.

313. Intensity of Magnetisation: Magnetic Susceptibility and Magnetic Permeability.—When a piece of magnetic metal is placed in a magnetic

field, some of the lines of magnetic force run through it and magnetise it. The intensity of its magnetisation will depend upon the intensity of the field into which it is put and upon the metal itself. There are two ways of looking at the matter, each of which has its advantages. We may think of the magnetism of the iron or other metal as something resident on the polar surfaces, and expressed therefore in units of magnetism: or we may think about the internal condition of the piece of metal, and of the number of magnetic lines that are running through it and emerging from it into the surrounding space. This is the more modern way. The fact that soft iron placed in the magnetic field becomes highly magnetic may then be expressed in the following two ways:—(1) iron when placed in the magnetic field develops strong poles on its end surfaces, being highly *susceptible* to magnetisation; (2) when iron is placed in the magnetic field, the magnetic lines gather themselves up and run in greater quantities through the space now occupied by iron, for iron is very *permeable* to the lines of magnetic induction, being a good conductor of the magnetic lines. Each of these ideas may be rendered exact by the introduction of appropriate coefficients.

The coefficient of magnetisation, or susceptibility, is based on unit of pole strength. Suppose a magnet to have m units of magnetism on each pole; then if the length between its poles is l , the product $m \times l$ is called its *magnetic moment*, and the magnetic moment divided by its volume is called its *intensity of magnetisation*; this term being intended, though based on surface-unit of pole strength, to convey an idea as to the internal magnetic state. Seeing that volume is the product of sectional area into length, it follows that if any piece of iron or steel of uniform section had its surface magnetism situated on its ends only, its intensity of magnetisation would be equal to the strength of pole

divided by the area of end surface. Writing I for the intensity of magnetisation we should have

$$I = \frac{\text{mag. moment}}{\text{volume}} = \frac{m \times l}{s \times l} = \frac{m}{s}.$$

Now, supposing this intensity of magnetisation were due to the iron having been put into a magnetic field of intensity H , we find that the ratio between the resulting intensity of magnetisation I and the magnetising force H producing it is expressible by a numerical coefficient of magnetisation, or *susceptibility*, k . We may write :

$$I = k H$$

or

$$k = \frac{I}{H}$$

This may be looked at as saying that for every magnetic line in the field there will be k units of magnetism on the end surface.

In magnetic substances such as iron, steel, nickel, etc., the susceptibility k has positive values ; but there are many substances such as bismuth, copper, mercury, etc., which possess feeble negative coefficients. These latter are termed "diamagnetic" bodies (Art. 339) and are repelled by the poles of magnets. The values of k vary very much in iron, not only in the different qualities of iron, but vary in every specimen with the stage of magnetisation. When a piece of iron has become well magnetised it is no longer as susceptible to magnetisation as it was at first: it is becoming "saturated." Barlow found the value of k for iron to be 32.8, Thalen found it from 32 to 44, Archibald Smith 80 to 90, Stoletow 21 to 174 ; Rowland found Norwegian iron to go as high as 366 ; Ewing found *thin* soft iron wires go up to 1300 or 1400. Stoletow showed that iron in a weak magnetic field showed a small susceptibility, which greatly increased as the magnetising force in the field was strengthened, but again fell off with still greater forces as the iron got saturated. When very intense

magnetising forces are used, so that the intensity of magnetisation is very great, the susceptibility (and permeability) is practically reduced to zero. It appears that the maximum intensity of magnetisation that can be given to iron and steel is about 1500 (units, per square centimetre of cross section). According to Rowland the maximum for cobalt is 800, for nickel 494. Steel does not retain all the magnetisation that can be temporarily induced in it, its maximum intensity being, according to Weber 400, according to Von Waltenhofen 470, according to Rowland 785, according to Hopkinson 878. Everett has calculated (from Gauss's observations) that the intensity of magnetisation of the earth is only 0.0790, or only $\frac{1}{17800}$ of what it would be if the globe were wholly iron. In weak magnetic fields the susceptibility of nickel exceeds by about five times that of iron; but in strong fields iron is more susceptible.

The coefficient of magnetic induction, or permeability, is based on the lines of magnetic induction. The number of magnetic lines that run through unit area of cross section, at any point, is called "the magnetic induction" at that point: it is denoted by the letter B. The ratio between the magnetic induction and the magnetising force producing it is expressed by a numerical coefficient of induction, or permeability, μ . We therefore write

$$B = \mu H$$

or

$$\mu = \frac{B}{H}$$

This coefficient is always positive: for empty space it is 1, for air it is practically 1; for magnetic materials it is greater than 1, for diamagnetic materials it is slightly less than 1. The student may think of it in the following way: Suppose a certain magnetising force to act in a certain direction, there would naturally result from its action induction along a certain number of lines of in-

duction (or so-called lines of force), and in a vacuum the number of lines would numerically represent the magnetising force. But if the space considered were occupied by iron the same magnetising force would induce many more lines. The iron has a sort of multiplying power or specific inductive capacity, or conductivity for the magnetic lines. This permeability is easily calculated from the susceptibility. It was shown at end of Art. 312 that there are 4π magnetic lines proceeding from each unit of pole magnetism. Hence if, as shown above, each line of force of the magnetising field produces k units of magnetism there will be $4\pi k$ lines added by the iron to each 1 line in the field, or the multiplying power of the iron μ is equal to $1 + 4\pi k$. The values of the permeability, like those of susceptibility, decrease as the magnetisation of the iron gets increased towards saturation. In the following Table two sets of values are given from the researches of Stolew, and the more recent ones of Bidwell.

H	k	I	μ	B
OBSERVATIONS OF STOLETOW.				
0.43	21.5	9.24	275.6	118.5
0.44	30.5	13.45	390.5	171.8
3.20	174.0	556.6	2222.	7113
30.6	39.4	1206.	504.2	15427.
OBSERVATIONS OF BIDWELL.				
3.9	151.0	587	1899.1	7390
10.3	89.1	918	1121.4	11550
40.	30.7	1226	386.4	15460.
115.	11.9	1370	150.7	17330
208.	7.0	1452	88.8	18470
427.	3.5	1504	45.3	19330
585.	2.6	1530	33.9	19820

According to Hopkinson the induction B for cast iron is about 11,000, in a field H of 220: the residual induction being about 5000. Bosanquet finds maximum induction B for charcoal iron and wrought iron from 16,800 to about 19,000; but has succeeded in magnetising a wrought iron bar so that the induction in the middle bit of the bar reached 29,388. Steel containing 12 per cent of manganese is curiously non-magnetic. Hopkinson found its maximum induction only 310.

314. Potential due to a (Solenoidal) Magnet.

—A long thin uniformly magnetised magnet exhibits free magnetism only at the two ends, and acts on external objects just as if there were two equal quantities of opposite kinds of magnetism collected at these two points. Such a magnet is sometimes called a *solenoid* to distinguish it from a magnetic *shell* (Art. 107). Ordinary straight and horse-shoe shaped magnets are imperfect solenoids. The magnetic potential due to a solenoid, and all its magnetic effects, depend only on the position of its two poles, and on their strength, and not on the form of the bar between them, whether straight or curved. In Art. 310 (*c*) was given the rule for finding the potential due to a system of poles. Suppose the two poles of a solenoid have strengths $+m$ and $-m$ (taking S.-seeking pole as of negative value), and that the respective distances of these poles from an external point P , are r_1 and r_2 : then the potential at P will be,

$$V_P = m \left(\frac{1}{r_1} - \frac{1}{r_2} \right).$$

Suppose a magnet curled round until its N. and S. poles touch one another: it will not act as a magnet on an external object, and will have no "field" (Art. 105); for if the two poles are in contact, their distances r_1 and r_2 , to an external point P will be equal, and

$$\left(\frac{1}{r_1} - \frac{1}{r_2} \right) \text{ will be } =$$

315. Potential due to a Magnetic Shell.—

Gauss demonstrated that *the potential due to a magnetic*

shell at a point near it is equal to the strength of the shell multiplied by the solid-angle subtended by the shell at that point; the "strength" of a magnetic shell being the product of its thickness into its surface-density of magnetisation.

If ω represents the solid-angle subtended at the point P, and i the strength of the shell, then

$$V_P = \omega i.$$

Proof.—To establish this proposition would require an easy application of the integral calculus. But the following geometrical demonstration, though incomplete, must here suffice.

Let us consider the shell as composed, like that drawn, of a series of small elements of thickness t , and having each an area of surface s . The whole solid-angle subtended at P by the shell may likewise be conceived as made up of a number of elementary small cones, each of solid-angle ω : Let r_1 and r_2 be the distances from P to the two faces of the element: Let

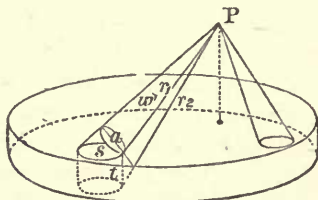

Fig. 113.

a section be made across the small cone orthogonally, or at right angles to r_1 , and call the area of this section a : Let the angle between the surfaces s and a be called angle β : then

$s = \frac{a}{\cos \beta}$. Let i be the "strength" of the shell (*i.e.* = its

surface-density of magnetisation \times its thickness); then $\frac{i}{t} =$

surface-density of magnetisation, and $s \frac{i}{t} =$ strength of either pole of the little magnet = m .

Now solid angle $\omega = \frac{\text{area of its orthogonal section}}{r^2}$

$$= \frac{a}{r^2};$$

therefore

$$a = \omega r^2,$$

and

$$s = \frac{\omega r^2}{\cos \beta}$$

Hence

$$\omega i \frac{r^2}{t \cos \beta} = m.$$

But the potential at P of the magnet whose pole is m , will be

$$v = m \left(\frac{1}{r_1} - \frac{1}{r_2} \right)$$

$$= \omega i \frac{r^2}{t \cos \beta} \left(\frac{1}{r_1} - \frac{1}{r_2} \right)$$

but $\frac{1}{r_1} - \frac{1}{r_2} = \frac{r_1 - r_2}{r_1 r_2}$ which we may write $\frac{r_1 - r_2}{r^2}$
 because r_1 and r_2 may be made as nearly equal as we please.
 And since $r_1 - r_2 = t \cos \beta$

$$v = \omega i \frac{r^2}{t \cos \beta} \left(\frac{t \cos \beta}{r^2} \right)$$

$$v = \omega i$$

or the potential due to the element of the shell = the strength of the shell \times the solid-angle subtended by the element of the shell. Hence, if V be the sum of all the values of v for all the different elements, and if ω be the whole solid-angle (the sum of all the small solid-angles such as ω),

$$V_P = \omega i$$

or, the potential due to a magnetic shell at a point is equal to the strength of the shell multiplied by the solid-angle subtended by the whole of the shell at that point.

Hence ωi represents the work that would have to be done on or by a unit-pole, to bring it up from an infinite distance to the point P, where the shell subtends the solid-angle ω . At a point Q where the solid-angle subtended by the shell is different, the potential will be different, the difference of potential between P and Q being

$$V_Q - V_P = i (\omega_Q - \omega_P).$$

If a magnet-pole whose strength is m were brought up to P, m times the work would have to be done, or the mutual potential would be $= m\omega i$.

316. Potential of a Magnet-pole on a Shell.—

It is evident that if the shell of strength i is to be placed where it subtends a solid-angle ω at the pole m , it would require the expenditure of the same amount of work to bring up the shell from an infinite distance on the one hand, as to bring up the magnet-pole from

an infinite distance on the other; hence mwi represents both the potential of the pole on the shell and the potential of the shell on the pole. Now the lines of force from a pole may be regarded as proportional in number to the strength of the pole, and from a single pole they would radiate out in all directions equally. Therefore, if a magnet-pole was placed at P, at the apex of the solid-angle of a cone, the number of lines of force which would pass through the solid-angle would be proportional to that solid-angle. It is therefore convenient to regard $m\omega$ as representing the number of lines of force of the pole which pass through the shell, and we may call the number so intercepted N. Hence *the potential of a magnet-pole on a magnetic shell is equal to the strength of the shell multiplied by the number of lines of force (due to the magnet-pole) which pass through the shell; or $V = Ni$.* If either the shell or the pole were moved to a point where a different number of lines of force were cut, then the difference of potential would be,

$$V_Q - V_P = \pm i (N_Q - N_P).$$

This formula is of great importance: but the student must be specially cautioned as to the *signs* to be attributed in applying it to the various quantities. A magnet has two poles (N.-seeking and S.-seeking), whose strengths are $+m$ and $-m$, and the two faces of a magnetic shell are of opposite sign. To bring up a N.-seeking (or $+$) pole against the repelling force of the N.-seeking face of a magnetic shell requires a positive amount of work to be done; and their mutual reaction would enable work to be done afterwards by virtue of their position: in this case then the potential is $+$. But in moving a N.-seeking pole up to the S.-seeking face of a shell work will be done *by* the pole, for it is attracted up; and as work done *by* the pole may be regarded as our doing *negative* work, the potential here will have a negative value.

Again, suppose we could bring up a unit N.-seeking pole against the repulsion of the N.-seeking face of a shell of strength i , and should push it right up to the shell; when it actually reached the plane of the shell the shell would occupy a whole horizon, or half the whole space around the pole, the solid-angle it subtended being therefore 2π ,¹ and the potential will be $+2\pi i$. If we had begun at the S.-seeking face, the potential at that face would be $-2\pi i$. It appears then that *the potential alters its value by $4\pi i$ on passing from one side of the shell to the other.*

317. Reaction between a Pole and a Magnetic Shell.—Again, Figs. 52 and 53 will show graphically that lines of force from two poles of opposite kind run into one another, whilst those from similar poles turn aside as if mutually repellent. If a N.-seeking pole be brought up to the N.-seeking face of a shell few or none of the lines of force of the magnet will cut the shell; whereas if a N.-seeking pole be brought up to the S.-seeking face of a shell, large numbers of the lines will be cut by the shell and the pole, as a matter of fact, will be attracted up to the shell, where as many lines of force as possible are cut by the shell. We may formulate this action by saying that *a magnetic shell and a magnet-pole react on one another and urge one another in such a direction as to make the number of lines of force that are cut by the shell a maximum.* (Maxwell's Rule, Art. 193). Outside the attracting face of the shell the potential is $-wi$, and the pole moves so as to make this negative quantity as great as possible, or to make the potential a minimum. Which is but another way of putting the matter as a particular case of the general proposition that bodies tend to move so that the energy they possess in virtue of their position tends to run down to a minimum.

318. Magnetic Potential due to Current.—The propositions concerning magnetic shells given in the

¹ See note on Ways of Reckoning Angles, Art. 133.

preceding paragraphs derive their great importance because of the fact laid down in Art. 192 that circuits, traversed by currents of electricity, behave like magnetic shells. And for the purpose of calculating the magnetic effects due to currents by applying these theorems, it is necessary to adopt the electromagnetic unit of the strength of current explained in Art. 196. If we adopt such a unit we may at once go back to Art. 315, and take the theorems about magnetic shells as being also true of closed voltaic circuits.

(a.) Potential due to closed circuit (compare Art. 315).

The potential V due to a closed voltaic circuit (traversed by a current) at a point P near it, is equal to the strength of the current multiplied by the solid-angle ω subtended by the circuit at that point. If i be the strength of the current in electromagnetic units, then

$$V_P = - \omega i.$$

The reason for adopting the negative sign is the following:—

The potential (*i.e.* the work done on a unit N.-seeking pole) is reckoned positive where the work is done against repulsion. Now, if a N.-seeking pole is to be brought up to a point opposite the *repelling* face of a circuit, it must (see Fig. 115) be brought up to that face round which the electricity is flowing in the counter-clock-wise or negative direction, or round which the current must be considered as having strength = $-i$. The student may be helped to understand this convention about signs by remembering (see Fig. 115) that when he is looking at the S.-pole of an electromagnet he is looking along the magnetic lines of force in their positive direction, and that the current is running clock-wise round the coil. Or, the positive direction of lines of force through the circuit is associated with a (positive) rotation round the circuit, as is the *forward* thrust with the *right-handed* rotation in the operation of driving an ordinary right-handed screw.

(b.) At a point Q , where the solid-angle subtended by

the circuit is ω_Q instead of ω_P , the potential will have a different value, the difference of potential being,

$$V_Q - V_P = -i(\omega_Q - \omega_P).$$

319. (c.) *Mutual Potential of a Magnet-pole and a Circuit.*—If a magnet-pole of strength m were brought up to P, where the circuit subtends a solid-angle ω , from an infinite distance against the magnetic forces exercised by the current, m times as much work will be done as if the magnet-pole had been of unit strength, and the work would be just as great whether the pole m were brought up to the circuit, or the circuit up to the pole. Hence, the *mutual potential* will be

$$- m\omega i.$$

But, as in Art. 316, we may regard $m\omega$ as representing the number of lines of force of the pole which are intercepted by and pass through the circuit, and we may write N for that number, and say

$$V = -iN,$$

or *the mutual potential of a magnet-pole and a circuit is equal to the strength of the current multiplied by the number of the magnet-pole's lines of force that are intercepted by the circuit, taken with reversed sign.*

(d.) As in the case of the magnetic shell, so with the circuit, the value of the potential changes by $4\pi i$ from a point on one side of the circuit to a point just on the other side; that is to say, being $-2\pi i$ on one side and $+2\pi i$ on the other side, work equal to $4\pi i$ must be done in carrying a unit-pole from one side to the other round the outside of the circuit. The work done in thus threading the circuit along a path looped n times round it would be $4n\pi i$.

320. (e.) *Mutual Potential of two Circuits.*—Two closed circuits will have a mutual potential, depending on the strengths of their respective currents, on their distance apart, and on their form and position. If their currents

be respectively i and i' , and if the distance between two elements ds and ds' of the circuits be called r , and ϵ the angle between the elements, it can be shown that their *mutual potential* is $= -ii \iint \frac{\cos \epsilon}{r} ds ds'$. This expression represents the work that would have to be done to bring up either of the circuits from an infinite distance to its present position near the other, and is a negative quantity if they attract one another. Now, suppose the strength of current in each circuit to be unity; their mutual potential will in that case be $\iint \frac{\cos \epsilon}{r} ds ds'$, a quantity which depends purely upon the geometrical form and position of the circuits, and for which we may substitute the single symbol M , which we will call the "*coefficient of mutual potential*:" we may now write the mutual potential of the two circuits when the currents are i and i' as $= -i'iM$.

But we have seen in the case of a single circuit that we may represent the potential between a circuit and a unit-pole as the product of the strength of the current $-i$ into the number N of the magnet-pole's lines of force intercepted by the circuit. Hence the symbol M must represent the number of each other's lines of force mutually intercepted by both circuits, if each carried unit current. If we call the two circuits A and B , then, when each carries unit current, A intercepts M lines of force belonging to B , and B intercepts M lines of force belonging to A .

Now suppose both currents to run in the same (clock-wise) direction; the front or S.-seeking face of one circuit will be opposite to the back or N.-seeking face of the other circuit, and they will attract one another, and will actually *do* work as they approach one another, or (as the negative sign shows) negative work will be done in bringing up one to the other. When they have attracted one another up as much as possible the circuits will coincide in direction and position as nearly as can

ever be. Their potential energy will have run down to its lowest minimum, their mutual potential being a negative maximum, and their coefficient of mutual potential M , having its greatest possible value. *Two circuits, then, are urged so that their coefficient of mutual potential M shall have the greatest possible value.* This justifies Maxwell's Rule (Art. 193), because M represents the number of lines of force mutually intercepted by both circuits. And since in this position each circuit *induces* as many lines of magnetic force as possible through the other, the *coefficient of mutual potential M* is also called the *coefficient of mutual induction*.

NOTE ON MAGNETIC AND ELECTRO- MAGNETIC UNITS.

§21. Magnetic Units.—All magnetic quantities, strength of poles, intensity of magnetisation, etc., are expressed in terms of special units derived from the fundamental units of *length, mass, and time*, explained in the *Note on Fundamental and Derived Units* (Art. 254). Most of the following units have been directly explained in the preceding Lesson, or in Lesson XI.; the others follow from them.

Unit Strength of Magnetic Pole.—The unit magnetic pole is one of such a strength, that when placed at a distance of one centimetre (in air) from a similar pole of equal strength, repels it with a force of one dyne (Art. 125).

Magnetic Potential.—Magnetic potential being measured by *work* done in moving a unit magnetic pole against the magnetic forces, the unit of magnetic potential will be measured by the unit of work, the *erg*.

Unit Difference of Magnetic Potential.—Unit difference of magnetic potential exists between two points when it requires the expenditure of one *erg* of work to bring a (N.-seeking) unit magnetic pole from one point to the other against the magnetic forces.

Intensity of Magnetic Field is measured by the *force* it exerts upon a unit magnetic pole: hence,

Unit Intensity of Field is that intensity of field which acts on a unit (N.-seeking) pole with a force of one dyne.

322. **Electromagnetic Units.**—The preceding magnetic units give rise to the following set of electrical units, in which the strength of currents, etc., are expressed *in magnetic measure*. The relation of this “electromagnetic” set of units to the “electrostatic” set of units of Art. 257 is explained in Art. 365.

Unit Strength of Current.—A current has unit strength when one centimetre length of its circuit bent into an arc of one centimetre radius (so as to be always one centimetre away from the magnet-pole) exerts a force of one dyne on a unit magnet-pole placed at the centre (Art. 196).

Unit of Quantity of Electricity is that quantity which is conveyed by unit current in one second.

Unit of Difference of Potential (or of *Electromotive-force*). Potential is work done on a unit of electricity; hence unit difference of potential exists between two points when it requires the expenditure of one *erg* of work to bring a unit of +electricity from one point to the other against the electric force.

Unit of Resistance.—A conductor possesses unit resistance when unit difference of potential between its ends causes a current of unit strength (*i.e.* one unit of quantity per second) to flow through it.

323. **Practical Units**—Several of the above “absolute” units would be inconveniently large and others inconveniently small for practical use. The following are therefore chosen instead, as electromagnetic units:—

Electromotive-force.—The **Volt**, = 10^8 absolute units (being a little less than the E.M.F. of one Daniell’s cell).

Resistance.—The **Ohm**, = 10^9 absolute units of resistance (and theoretically the resistance represented by the velocity of one earth-quadrant per second). (*See* Art. 364.)

Current.—As a practical unit of current, that furnished by a potential of one *volt* though one *ohm* is taken, being 10^{-1} of an absolute (electro-magnetic) unit of current, and is known as one **Ampère** (formerly one “weber”).

Quantity.—The **Coulomb**, = 10^{-1} absolute units of quantity of the electromagnetic system.

Capacity.—The **Farad**, = 10^{-9} (or one one-thousand-millionth) of absolute unit of capacity.

Seeing, however, that quantities a million times as great as some of these, and a million times as small as some, have to be measured by electricians, the prefixes *mega-* and *micro-* are sometimes used to signify respectively "one million" and "one-millionth part." Thus a *megohm* is a resistance of one million ohms, a *microfarad* a capacity of $\frac{1}{1,000,000}$ of a farad, etc. The prefix *milli-* is frequently used for "one-thousandth part;" thus a *milli-ampère* is the thousandth part of one ampère.

This system of "practical" units was devised by a committee of the British Association, who also determined the value of the "ohm" by experiment, and constructed standard resistance coils of german-silver, called "B. A. Units" or "ohms." The "practical" system may be regarded as a system of units derived not from the fundamental units of *centimetre*, *gramme*, and *second*, but from a system in which, while the unit of time remains the second, the units of length and mass are respectively the earth-quadrant and 10^{-11} gramme.

324. Dimensions of Magnetic and Electromagnetic Units.

—The fundamental idea of "dimensions" is explained in Art. 258. A little consideration will enable the student to deduce for himself the following table—

	UNITS.	DIMENSIONS.
	(<i>Magnetic.</i>)	
<i>m</i>	{ Strength of pole Quantity of magnetism } = $\sqrt{\text{force} \times (\text{distance})^2}$ =	$M^{\frac{1}{2}} L^{\frac{3}{2}} T^{-1}$
<i>V</i>	Magnetic Potential = work \div strength of pole =	$M^{\frac{1}{2}} L^{\frac{1}{2}} T^{-1}$
<i>H</i>	Intensity of Field = force \div strength of pole =	$M^{\frac{1}{2}} L^{-\frac{1}{2}} T^{-1}$
	(<i>Electro-magnetic.</i>)	
<i>i</i>	Current (strength) = intensity of field \times length =	$M^{\frac{1}{2}} L^{\frac{1}{2}} T^{-1}$
<i>Q</i>	Quantity = current \times time =	$M^{\frac{1}{2}} L$
<i>V</i>	Potential	$M^{\frac{1}{2}} L^{\frac{3}{2}} T^{-2}$
<i>E</i>	Electromotive-Force } = work \div quantity =	
<i>R</i>	Resistance = E.M.F. \div current =	$L T^{-1}$
<i>C</i>	Capacity = quantity \div potential =	$L^{-1} T^2$

NOTE ON MEASUREMENT OF EARTH'S MAGNETIC FORCE IN ABSOLUTE UNITS.

325a. The intensity of the earth's magnetic force at any place is the force with which a magnet-pole of unit strength is attracted. As explained in Art. 138, it is usual to measure the horizontal component H of this force, and from this and the cosine of the angle of dip to calculate the total force I , as the direct determination of the total force is surrounded with difficulties. To determine H in *absolute* (or C.G.S.) *units*, it is necessary to make two observations with a magnet of magnetic moment M ; (the magnetic moment being, as mentioned in Art. 313, the product of its length into the strength of one of its poles). In one of these observations the product MH is determined by a *method of oscillations*; in the second the quotient $\frac{M}{H}$ is determined by a particular *method of deflection*. The square root of the quantity obtained by dividing the former by the latter will, of course, give H .

(i.) *Determination of MH.*—The time t of a complete oscillation to-and-fro of a magnetic bar is

$$t = 2\pi \sqrt{\frac{K}{HM}},$$

where K is the "moment of inertia" of the magnet. This formula is, however, only true for very small arcs of vibration. By simple algebra it follows that

$$HM = \frac{4\pi^2 K}{t^2}.$$

Of these quantities t is ascertained by a direct observation of the time of oscillation of the magnet hung by a torsionless fibre; and K can be either determined experimentally or by one of the following formulæ:—

$$\text{For a round bar } K = w \left(\frac{l^2}{12} + \frac{a^2}{4} \right),$$

$$\text{For a rectangular bar } K = w \left(\frac{l^2 + b^2}{12} \right);$$

where w is the mass of the bar in grammes, l its length, a

its radius (if round), b its breadth, measured horizontally (if rectangular).

(ii.) *Determination of $\frac{M}{H}$.*—The magnet is next caused to deflect a small magnetic needle in the following manner, “broadside on.” The magnet is laid horizontally at right angles to the magnetic meridian, and so that its middle point is (magnetically) due south or due north of the small needle, and at a distance r from its centre. Lying thus broadside to the small needle its N.-pole will repel, and its S.-pole attract, the N.-pole of the needle, and will exercise contrary actions on the S.-pole of the needle. The total action of the magnet upon the needle will be to deflect the latter through an angle δ , whose tangent is directly proportional to $\frac{M}{H}$, and inversely proportional to the *cube* of the distance r ; or

$$\frac{M}{H} = r^3 \tan \delta.$$

Dividing the former equation by this, and taking the square root, we get,

$$H = \frac{2\pi}{t} \sqrt{\frac{K}{r^3 \tan \delta}}.$$

NOTE ON INDEX NOTATION.

325b. Seeing that electricians have to deal with quantities requiring in some cases very large numbers, and in other cases very small numbers, to express them, a system of *index notation* is adopted, in order to obviate the use of long rows of cyphers. In this system the significant figures only of a quantity are put down, the cyphers at the end, or (in the case of a long decimal) at the beginning, being indicated by an index written above. Accordingly, we may write a thousand ($= 10 \times 10 \times 10$) as 10^3 , and the quantity 42,000 may be written 42×10^3 . The British National Debt of £770,000,000 may be written $£77 \times 10^7$. Fractional quantities will have negative indices when written as exponents. Thus $\frac{1}{100}$ ($= 0.01$), $= 1 \div 10 \div 10 = 10^{-2}$. And so the decimal 0.00028 will be written 28×10^{-5} (being $= 28 \times .00001$). The convenience of this method will be seen by an example or two on electricity. The electrostatic capacity of the earth is 630,000,000 times

that of a sphere of one centimetre radius, $= 63 \times 10^7$ (electrostatic) units. The magnetic moment of the earth is, according to Gauss, no less than 85,000,000,000,000,000,000,000,000 times that of a magnet of unit strength and centim. length, *i.e.* its magnetic moment is 85×10^{24} units. The resistance of selenium is about 40,000,000,000, or 4×10^{10} times as great as that of copper; that of *air* is about 10^{26} , or

100,000,000,000,000,000,000,000,000

times as great. The velocity of light is about 30,000,000,000 centimetres per second, or 3×10^{10} . As a final example we may state that the number of atoms in the universe, as far as the nearest fixed star, can be shown to be certainly fewer than 7×10^{91}

LESSON XXVI.—*Electromagnets.*

326. **Electromagnets.**—In 1820, almost immediately after Oerstedt's discovery of the action of the electric current on a magnet needle, Arago and Davy independently discovered how to magnetise iron and steel by causing currents of electricity to circulate round them in spiral coils of wire. The method is shown in the

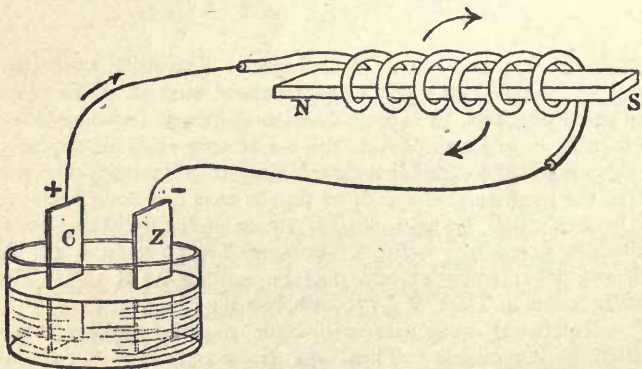

Fig. 114.

simple diagram of Fig. 114, where a current from a single cell is passed through a spiral coil of wire, in the

hollow of which is placed a bar of iron or steel, which is thereby magnetised. The separate turns of the coil must not touch one another or the central bar, otherwise the current will take the shortest road open to it and will not traverse the whole of the coils. To prevent such short-circuiting by contact the wire of the coil should be overspun with silk or cotton (in the latter case insulation is improved by steeping the cotton covering in melted paraffin wax) or covered with a layer of gutta-percha. If the bar be of iron it will be a magnet only so long as the current flows; and an iron bar thus surrounded with a coil of wire for the purpose of magnetising it by an electric current is called an **Electromagnet**. Sturgeon, who gave this name, applied the discoveries of Davy and Arago to the construction of electromagnets far more powerful than any magnets previously made. It was first shown by Henry that when electromagnets are required to work at distant end of a long line they must be wound with many turns of fine wire.

By applying Ampère's Rule (Art. 186), we can find which end of an electromagnet will be the N.-seeking pole; for, imagining ourselves to be swimming in the current (Fig. 114), and to face towards the centre where the iron bar is, the N.-seeking pole will be on the left. It is convenient to remember this relation by the following rules:—*Looking at the S.-seeking pole of an electromagnet, the magnetising currents are circulating round it in the same cyclic direction as the hands of a clock move; and, looking at the N.-seeking pole of an electromagnet, the magnetising currents are circulating round it in the opposite cyclic direction to that of the hands of a clock.* Fig. 115 shows this graphically. These rules are true, no matter whether the beginning of the coils is at the end near the observer, or at the farther

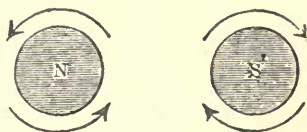

Fig. 115.

end from him, *i.e.* whether the spiral be a right-handed screw, or (as in Fig. 114) a left-handed screw. It will be just the same thing, so far as the magnetising power is concerned, if the coils begin at one end and run to the other and back to where they began; or they may begin half-way along the bar and run to one end and then back to the other: the one important thing to know is which way the current flows round the bar when you look at it end-on.

327. Construction of Electromagnets.—The most useful form of electromagnet is that in which the iron core is bent into the form of a horse-shoe, so that both poles may be applied to one iron armature. In this case it is usual to divide the coils into two parts wound on bobbins, as in Figs. 116 and 117. The electromagnet depicted in Fig. 117 is of a form adapted for laboratory experiments, and has movable coils which are slipped on over the iron cores.

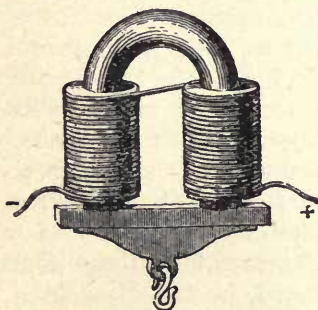

Fig. 116.

A special form of electromagnet devised by Ruhmkorff for experiments on diamagnetism is shown in Fig. 127. The great usefulness of the electromagnet in its application to electric bells and telegraphic instruments lies in the fact that *its magnetism is under the control of the current*; when circuit is "made" it becomes a magnet, when circuit is "broken" it ceases to act as a magnet.

Many special forms of electromagnet have been devised for special purposes. To give a very powerful attraction at very short distances, a short cylindrical electromagnet surrounded by an outer iron tube, united at the bottom by iron to the iron core, is found best. To give a gentle pull over a long range a solenoid (Art.

329), having a long movable iron core is used. For giving a very quick-acting magnet the coils should not be wound all along the iron, but only round the poles. As a rule the iron parts, including the yoke and arma-

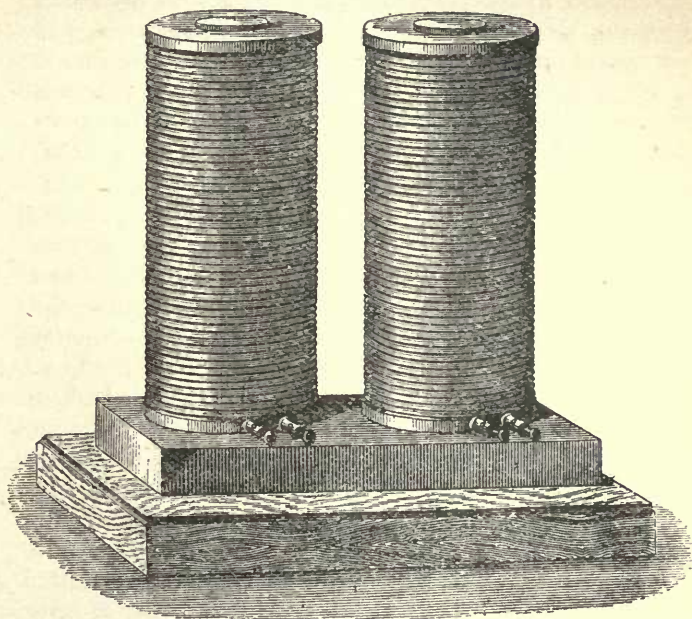

Fig. 117.

ture, should form as nearly as possible a closed magnetic circuit. The cross-sections of yokes should be thicker than those of the cores.

328. Lifting-power of Electromagnets.—The lifting-power of an electromagnet depends not only on its “magnetic strength,” but also upon its form, and on the shape of its poles, and on the form of the soft iron armature which it attracts. It should be so arranged that as many lines of force as possible should run through the armature, and the armature itself should contain a

sufficient mass of iron. Joule designed a powerful electromagnet, capable of supporting over a ton. The maximum attraction he could produce between an electromagnet and its armature was 200 lbs. per square inch, or about 13,800,000 dynes per square centimetre. Bidwell has found the attraction to go up to 226.3 lbs. per square inch when the wrought iron core was saturated up to 19,820 magnetic lines to the square centimetre. It can be shown that, when the iron is far from saturation, *the attraction of an armature of soft iron is proportional to the square of the "magnetic strength" of the electromagnet*; for, suppose an electromagnet to have its strength doubled, it will induce the opposite kind of magnetisation twice as strongly as before in the iron armature, and the resulting force (which is proportional to the product of the two strengths) will be four times as great as at first.

329. Solenoid.—Without any central bar of iron or steel a spiral coil of wire traversed by a current acts as an electromagnet (though not so powerfully as when an iron core is placed in it). Such a coil is sometimes termed a solenoid. A solenoid has two poles and a

neutral equatorial region. Ampère found that it will attract magnets and be attracted by magnets. It will attract another solenoid; it has a magnetic field resembling generally that of a bar

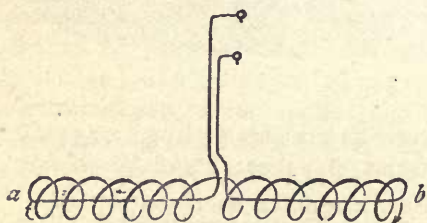

Fig. 1

magnet. If so arranged that it can turn round a vertical axis, it will set itself in a North and South direction along the magnetic meridian. Fig. 118 shows a solenoid arranged with pivots, by which it can be suspended to a "table," like that shown in Fig. 121.

Reference to Fig. 86 and to Art. 192 will recall how a single loop of a circuit acts as a magnetic shell of equivalent form and strength. A solenoid may be regarded as made up of a series of such magnetic shells placed upon one another, all their N.-seeking faces being turned the same way. Since the same quantity of electricity flows round each loop of the spiral coil the loops will be of equal magnetic strength, and the total magnetic strength of the solenoid will be just in proportion to the number of turns in the coil; and if there be n turns, the number of magnetic lines of force running through the solenoid will be n times as great as the number due to one single turn. The use of the iron core is by its greater magnetic induction to concentrate and increase the available number of lines of force at definite poles. The student has been told (Art. 191) that the lines of force due to a current flowing in a wire are closed curves, approximately circles (see Fig. 85), round the wire. If there were no iron core many of these little circular lines of force would simply remain as small closed curves around their own wire; but, since iron has a high coefficient of magnetic induction, where the wire passes near an iron core the lines of force alter their shape, and instead of being little circles around the separate wires, run through the iron core from end to end, and round outside from one pole back to the other, as in a steel magnet. A few of the lines of force do this when there is no iron; almost all of them do this when there is iron. Hence the electromagnet *with* its iron core has enormously stronger poles than the spiral coils of the circuit would have alone.

In a long straight solenoid without an iron core it is easy to calculate approximately the intensity of the magnetic field produced by the current. For, as we have seen in Art. 319, the work done on a unit magnetic pole in moving it (against the magnetic forces) along a path which threads through the circuit n times is equal to $4\pi ni$

bergs, where the current i is expressed in absolute units (Art. 196). But since the work done on a unit pole measures the magnetic potential (Art. 310), we may say that the difference of magnetic potential between one end and the other of the long solenoid is equal to $4\pi ni$. But when the magnetic potential changes as you go along a line, the rate of change of potential per unit of length is a measure of the magnetic force (Art. 310, e). If l be the length of the solenoid in centimetres then $4\pi ni \div l$ will be the intensity of the magnetic force inside the solenoid. And since the intensity of the magnetic force is the same thing as the intensity of the magnetic field at that point, we may say that this number represents the number of lines of magnetic force per square centimetre of the cross-section of the solenoid. If H stands for the intensity of the field thus produced inside the solenoid, and if the radius of the spirals be r , and the whole number of magnetic lines N running through the solenoid from end to end will be equal $H \times \pi r^2$. Hence we have—

$$H \text{ (inside solenoid)} = \frac{4\pi ni}{l},$$

$$N \text{ (through solenoid)} = \pi r^2 \times \frac{4\pi ni}{l};$$

and since (see Art. 312) 4π magnetic lines go to one unit of magnetism, the solenoid will act as if it had at its ends as the amount of magnetism m in its poles—

$$m = \frac{\pi r^2 ni}{l}.$$

If the current is expressed in ampères—for which we may use the letter C —we must remember that ten ampères equal one absolute unit (Art. 196), and therefore $C \div 10 = i$. The formulæ will then become—

$$H = \frac{4\pi}{10l} Cn,$$

$$N = \frac{4\pi^2 r^2}{10l} Cn,$$

$$m = \frac{\pi r^2}{10l} Cn.$$

It will be noticed that for any solenoid of given length and radius the three magnetic quantities H (interior magnetic force), N (total magnetic lines), and m (strength of poles) are proportional to the *ampères* of current and to the number of *turns* in the coil. The product Cn which thus comes into all solenoid formulæ is often referred to as the number of *ampère-turns*.

330. The Laws of the Electromagnet.—The exact laws governing the electromagnet are somewhat complicated; but it is easy to give certain rules which are approximately true. The current circulating in the coils exercises a magnetising force, and this magnetising force produces in the iron core a certain amount of magnetism. But the amount of magnetism produced in the core depends on many other things beside the intensity of the magnetising force; for instance, it depends on the quality of the iron, on its sectional area, and on its length and form. The data respecting magnetic permeability and saturation of iron in Art. 313 are all-important. Every electromagnet

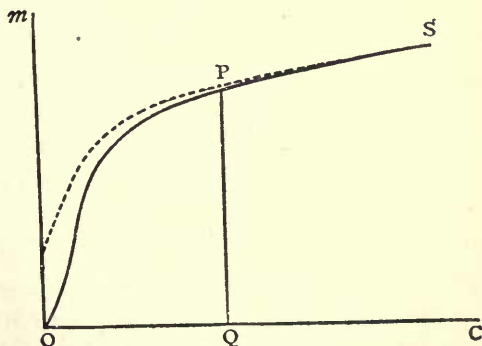

Fig. 118 (bis).

shows the same general set of facts—that with small exciting currents there is little magnetism produced, with larger exciting power there is more magnetism, and that

with very great exciting power the iron becomes practically saturated and will take up very little additional magnetism. The curve given in Fig. 118 (*bis*) is characteristic of the relation between exciting power and the resulting magnetism. The numbers of ampères of current C (or, if preferred, the number of ampère-turns Cn) are plotted out horizontally to scale, and the corresponding amount of magnetism m vertically. For example, when the exciting current has the value indicated to scale by the length of the line OQ , the amount of magnetism was found to be such, on its scale, as to be represented by the length QP . The point P is a point on the curve. It begins at O , no magnetism when there is no current; then it rises steeply and obliquely for some time, then bends over and at S becomes nearly horizontal, the iron being nearly saturated. The dotted curve corresponds to the values of magnetism found when the exciting current is gradually decreased. It will be noted that when the current is reduced to zero there is still some magnetism left. Many attempts have been made to represent by algebraic formulæ the facts that are thus graphically exhibited. Some of these deserve mention.

Formula of Lenz and Jacobi.—According to Lenz and Jacobi the magnetism of an electromagnet is proportional to the current and to the number of turns of wire in the coil—in other words, is proportional to the ampère-turns. Or in symbols—

$$m = a n C,$$

where a is a constant depending on the quantity, quality, and form of iron. This rule is, however, only true when the iron core is still far from being “saturated.” If the iron is already strongly magnetised—as at P in the Fig.—a current twice as strong will not double the magnetisation in the iron. Joule in 1847 showed this tendency to depart from a simple proportion.

Formula of Müller.—Müller gave the following approximate rule:—*The strength of an electromagnet is proportional to the angle whose tangent is the strength of the magnetising current; or*

$$m = A \tan^{-1} C,$$

where C is the magnetising current, and A a constant depending on the construction of the particular magnet. If the student will look at Fig. 90 and imagine the divisions of the horizontal tangent line OT to represent strengths of current, and the number of degrees of arc intercepted by the oblique lines to represent strengths of magnetism, he will see that even if OT be made infinitely long, the intercepted angle can never exceed 90° .

Formula of Lamont and Frölich.—A simpler expression, and one more easy for algebraic calculation has lately come into use, and forms the basis of Frölich's calculations about dynamo-electric machines. We may write it thus:—

$$m = M \frac{C}{1 + bC};$$

where M and b are constants depending on the form, quality, and quantity of the iron, and on the winding of the coil. The constant b is the reciprocal of that number of ampères which would make m equal to half possible maximum of magnetism. Another form of this equation is—

$$m = B \frac{nC}{1 + \sigma nC},$$

wherein B is a constant depending on the construction and the quality of the iron, and σ another constant (a small fraction) depending on the quality and quantity of the iron, and equal to the reciprocal of that number of ampère-turns which would bring the magnetism up to half-saturation.

Yet another form of this equation is of use to express

the number of magnetic lines N proceeding from the pole of the electromagnet—

$$N = Y \frac{C}{C + C'}$$

where Y represents the maximum number of magnetic lines that there would be if the magnetising current were indefinitely increased and the iron core saturated, and C' stands for that number of ampères which would bring the magnetism up to half-saturation.

Hopkinson's Formula.—Hopkinson has shown that it is possible to calculate N by a process resembling the calculations made according to Ohm's law for electric circuits. We may look upon the iron cores and the armature of an electromagnet as constituting, together with the spaces between, a sort of magnetic circuit traversed by the magnetic lines. Just as we can calculate in an electric circuit the amount of current when we know the electromotive-force and the electric resistance round the circuit, so in a magnetic circuit we can calculate N if we know the magnetomotive-force (or the line-integral of the magnetising forces acting round the circuit) and the several resistances of the different parts of the circuit. Now the magnetomotive-force is equal to (see Arts. 319, *d*, and 329) $4\pi Cn \div 10$. The magnetic resistance of any magnetic conductor is proportional to its length, and inversely proportional to its sectional area and to its permeability. Suppose then we have a magnetic circuit made up of three parts—a curved iron core of length l_1 , section s_1 , and permeability μ_1 ; an armature of length l_2 , section s_2 , and permeability μ_2 ; two air-gaps between them, of length (from iron to iron) of l_3 , section (equal to area of polar surface) s_3 , and of unit permeability (for air, $\mu = 1$); then the resistances of these three parts will be respectively

Then dividing the magnetomotive-force by the total magnetic resistance we get—

$$N = \frac{4\pi Cn}{10 \left\{ \frac{l_1}{s_1 \mu_1} + \frac{l_2}{s_2 \mu_2} + \frac{2 l_3}{s_3} \right\}},$$

giving the number of magnetic lines of the magnet in terms of the ampère-turns of excitation. It is necessary, however, to know the values of μ of the various pieces of iron at the various stages of excitation. Hopkinson has applied this formula with great success in calculations about dynamo-electric machines. Analogous formulæ have been used by Rowland and by Kapp.

It may be noted that when electromagnets are wound with many turns of fine wire, these coils will add to the electric resistance of the circuit, and will tend to diminish the current. This has an important bearing on the construction of telegraphic and other instruments; for while electromagnets with "long coils," consisting of many turns of fine wire, must be used on long circuits where there is great resistance, such an instrument would be of no service in a circuit of very small resistance, for the resistance of a long thin coil would be disproportionately great: here a short coil of few turns of stout wire would be appropriate. (See Art. 352.)

As the magnetism of the magnet depends on the number of ampère-turns, it should make no matter whether the coils are bigger than the core or whether they enwrap it quite closely. If there were no magnetic leakage this would be true in one sense: but it wastes more battery power to drive the current round coils of larger diameter, because of the greater resistance of the greater length of wire. Hence in well-constructed electromagnets the coils are all wound as closely to the iron core as is consistent with good insulation. Also the iron is chosen as thick as possible, as permeable as

possible, and forming as compact a magnetic circuit as possible. so that the magnetic resistance may be reduced to its utmost, giving the greatest amount of magnetism for the number of ampère-turns of excitation. This is why horse-shoe-shaped electromagnets are more powerful than straight electromagnets of equal weight.

It requires time to magnetise an iron core. This is partly due to the fact that a current, when the circuit is first made, does not instantly attain its full strength, being retarded by the self-induced counter-electromotive-force (Art. 404); it is partly due to the presence of transient reverse induction currents (Art. 393) in the iron itself. Faraday's large electromagnet at the Royal Institution takes about two seconds to attain its maximum strength. The electromagnets of large dynamo machines often take ten minutes or more to rise to their working stage of magnetisation.

LESSON XXVII.—*Electrodynamics.*

331. Electrodynamics.—In 1821, almost immediately after Oerstedt's discovery of the action of a current on a magnet, Ampère discovered that a current acts upon another current, attracting it¹ or repelling it according to certain definite laws. These actions he investigated by experiment, and from the experiments he built up a theory of the force exerted by one current on another. That part of the science which is concerned with the force which one current exerts upon another he termed **Electrodynamics**.

332. Laws of Parallel and Oblique Circuits.—The following are the laws discovered by Ampère :—

¹ It would be more correct to speak of the force as acting on *conductors carrying currents*, than as acting on the currents themselves. It is disputed whether the current *in* the conductor is attracted; we know only with certainty that the conductor itself experiences a force. See, however, Art. 337.

(i.) *Two parallel portions of a circuit attract one another if the currents in them are flowing in the same direction, and repel one another if the currents flow in opposite directions.*

This law is true whether the parallel wires be parts of two different circuits or parts of the same circuit. The separate turns of a spiral coil, like Fig. 118, for example, when traversed by a current attract one another because the current moves in the same direction in adjacent parts of the circuit; such a coil, therefore, shortens when a current is sent through it.

(ii.) *Two portions of circuits crossing one another obliquely attract one another if both the currents run either towards or from the point of crossing, and repel one another if one runs to and the other from that point.*

Fig. 119 gives three cases of attraction and two of repulsion that occur in these laws.

(iii.) *When an element of a circuit exerts a force on another element of a circuit, that force always tends to urge the latter in a direction at right angles to its own direction. Thus, in the case of two parallel circuits, the force of attraction or repulsion acts at right-angles to the currents themselves.*

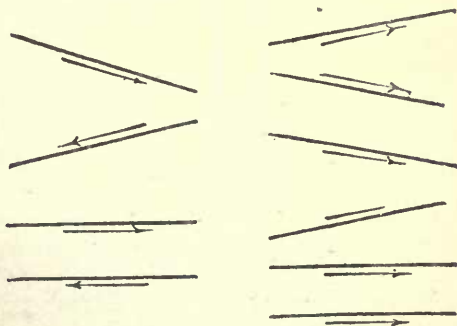

Fig. 119.

An example of laws ii. and iii. is afforded by the case shown in Fig. 120. Here two currents *ab*

and cd are movable round O as a centre. There will be *repulsion* between a and d and between c and b , while in the other quadrants there will be *attraction*, a attracting c , and b attracting d .

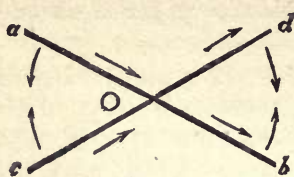

Fig. 120.

The foregoing laws may be summed up in one, by saying that two portions of circuits, however situated, experience a mutual force tending to set them so that their currents flow as nearly in the same path as possible.

(iv.) *The force exerted between two parallel portions of circuits is proportional to the product of the strengths of the two currents, to the length of the portions, and inversely proportional to the distance between them.*

333. Ampère's Table.—In order to observe these

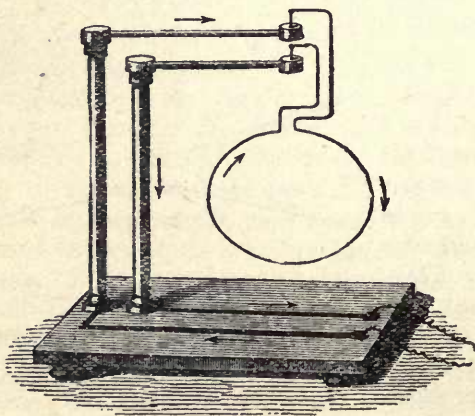

Fig. 121.

attractions and repulsions, Ampère devised the piece of apparatus known as *Ampère's Table*, shown in Fig. 121,

consisting of a double supporting stand, upon which conductors formed of wire, shaped in different ways, can be hung in such a way as to be capable of rotation. In the figure a simple loop is shown as hung upon the supports. The ends of the wires of the movable portion dip into two mercury cups so as to ensure good contact. The solenoid, Fig. 118, is intended to be hung upon the same stand.

By the aid of this piece of apparatus Ampère further demonstrated the following points:—

- (a) A circuit doubled back upon itself, so that the current flows back along a path close to itself, exerts no force upon external points.
- (b) A circuit bent into zig-zags or sinuosities, produces the same magnetic effects on a neighbouring piece of circuit as if it were straight.
- (c) There is in no case any force tending to move a conductor in the direction of its own length.
- (d) The force between two conductors of any form is the same, whatever the linear size of the system, provided the distances be increased in the same proportion, and that the currents remain the same in strength.

The particular case, given in Fig. 122, will show the value of these experiments: Let AB and CD represent two wires carrying currents, lying neither parallel nor in the same plane. It follows from (b), that if we replace the portion PQ by the crooked wire PRSQ, the force will remain the same. The portion PR is drawn vertically downwards, and, as it can, by (c), experience no force in the direction of its length, this portion will neither be attracted nor repelled by CD. In the portion RS the current runs at right angles to CD, and this portion is neither attracted nor repelled by CD. In the portion SQ the current runs parallel to CD, and in the same direction, and will therefore be attracted down-

wards. On the whole, therefore, PQ will be urged towards CD. The portions PR and RS will experience forces of rotation however, P being urged round R as a

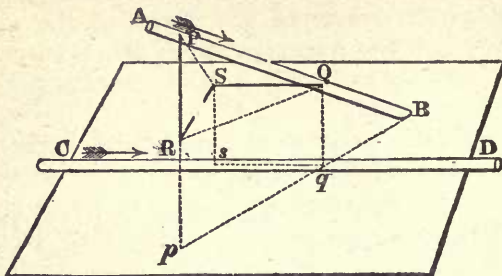

Fig 122.

centre towards C, and R being urged horizontally round S towards C. These actions would tend to make AB parallel with CD.

334. Ampère's Theory.—From the four preceding experimental data, Ampère built up an elaborate mathematical theory, assuming that, in the case of these forces acting apparently at a distance across empty space, the action took place in straight lines between two points, the total attraction being calculated as the sum of the separate attractions on all the different parts. The researches of Faraday have, however, led to other views, and we now regard the mutual attractions and repulsions of currents as being due to actions taking place in the medium which fills the space around and between the conductors. That space we regard rather as being full of curving "lines of force." Every wire carrying a current has a magnetic field, like that of Fig. 85, surrounding it; and every closed circuit acts as a magnetic shell. Hence all these electrodynamic actions are capable of being regarded as magnetic actions, and they can be predicted beforehand for any particular case on that supposition. Thus, the author of these Lessons

has shown¹ that in the case of two parallel concurrent circuits the "lines of force" due to the two systems run into one another, embracing both circuits, while in the case of two parallel and non-concurrent circuits the "lines of force" due to the two currents indicate mutual repulsion. The theory of Maxwell, that a voltaic circuit acts like a magnetic shell (a direct deduction from Faraday's work), is in practice a more fruitful conception than that of Ampère. On Maxwell's theory two circuits will tend, like two magnetic shells, to move so as to include as many of one another's "lines of force" as possible (Art. 193 and 320). This will be the case when they coincide as nearly as possible; *i.e.*, when the two wires are parallel in every part, and when the currents run round in the same direction. In fact, all the electrodynamic laws of parallel and oblique circuits can be deduced from Maxwell's theory in the simplest manner.

An interesting experiment, showing an apparent mutual self-repulsion between contiguous portions of the circuit, was devised by Ampère. A trough divided by a partition into two parts, and made of non-conducting materials, is filled with mercury. Upon it floats a

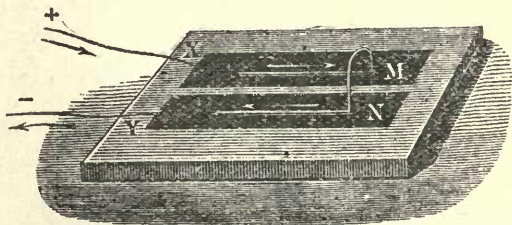

Fig. 123.

metallic bridge formed of a bent wire, of the form shown in Fig. 123, or consisting of a glass tube filled siphon-wise with mercury. When a current is sent through the floating conductor from X over MN, and out at

¹ *Philosophical Magazine*, November 1878, p. 348.

Y, the floating bridge is observed to move so as to increase the length of the circuit. But Maxwell has shown that the true explanation depends upon the self-induction (Art. 404) of the two parallel portions of the floating conductor, and that the force would be diminished indefinitely if the two parallel parts could be made to lie quite close to one another.

335. Electromagnetic Rotations.—Continuous rotation can be produced between a magnet and a circuit, or between two parts of one circuit, provided that one part of the circuit can move while another part remains fixed, or that the current in one part can be reversed. The latter device is adopted in the construction of the *electromagnetic engines* described in Art. 375; the former alternative is applied in a good many interesting pieces of apparatus for showing rotations, a sliding-contact being made between one part of the circuit and another. Several different forms of rotation-apparatus were devised by Faraday and by Ampère. One of the simplest of these is shown in Fig. 124, in which a

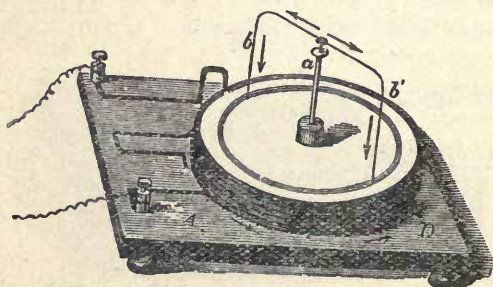

Fig. 124.

current rising through *a* and passing through the lightly pivoted wire *b b'* in either direction, passes down into a circular trough containing mercury. The trough is made of copper, and is connected with a wire which is also wound in a coil round the outside of the trough,

and which forms part of the circuit. The arrows show the direction of the currents. The currents in the circular coils constitute a magnetic shell, whose N.-seeking face is uppermost. The lines of force due to this shell therefore run vertically in an upward direction. According to the converse to Ampère's Rule (Art. 186), a man swimming in one of the horizontal branches from the centre *a* outwards, and looking along the lines of force, *i.e.* turned on to his back, so as to look upwards, will be carried, along with the conductor, toward his left hand. And the pivoted conductor as seen from above will rotate continuously in the same sense as the hands of a clock around the centre *a*. A pole of a magnet can also be made to rotate round a current; and if a vertical magnet be pivoted so as to turn around its own axis it will rotate when a current is led into its middle region and out at either end. If the current is led in at one end and out at the other there will be no rotation, since the two poles will thus be urged to rotate in opposite ways, which is impossible. Liquid conductors too can exhibit electromagnetic rotations. Let a cylindrical metallic vessel connected to one pole of a battery be filled with mercury or dilute acid, and let a wire from the other pole dip into its middle, so that a current may flow radially from the centre to the circumference, or *vice versa*; then, if this be placed upon the pole of a powerful magnet, or if a magnet be held vertically over it, the liquid may be seen to rotate.

336. Electrodynamometer.—Weber devised an instrument known as an *electrodynamometer* for measuring the strength of currents by means of the electrodynamic action of one part of the circuit upon another part. It is in fact a sort of galvanometer, in which, instead of a needle, there is a small coil suspended. One form of this instrument, in which both the large outer and small inner coils consist of two parallel coils of many turns, is

shown in Fig. 125. The inner coil CD is suspended with its axis at right angles to that of the outer coils AA, BB, and is supported *bifilarly* (see Art. 118) by two fine metal wires.

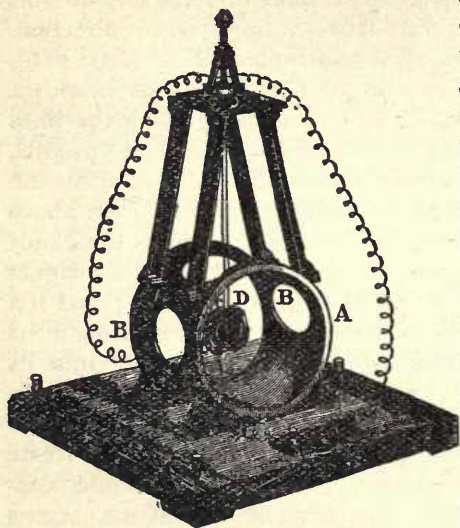

Fig. 125.

If one current flows round *both* coils in *either* direction the inner bobbin tends to turn and set its coils parallel to the outer coils; the sine of the angle through which the suspending wires are twisted being proportional to the square of the strength of the current. The chief advantage of this instrument over a galvanometer is,

that it may be used for induction-currents in which there are very rapid alternations,—a current in one direction being followed by a reverse current, perhaps thousands of times in a minute. Such currents hardly affect a galvanometer needle at all, because of the slowness of its swing.

Siemens employs an electro-dynamometer with coils made of very thick wire for the absolute measurement of strong currents, such as are used in producing electric light. It is possible also to use an electro-dynamometer as a "Power-meter" to measure the electric horse power evolved by a battery or consumed in an electric lamp or machine. In this case the whole current is sent through a fixed coil of thick wire, while the movable coil, made of many turns of thin wire, is

connected as a shunt across the terminals of the lamp or machine being thus traversed by a current proportional to the difference of potential between those points (*see* Art. 360 *d*). The sine of the angle of deflection will be proportional to the product of the two currents, and therefore, to the product of the whole current into the difference of potential (*see* Art. 378 *bis*).

337. Electromagnetic Actions of Convection Currents.—According to Faraday a stream of particles charged with electricity acts magnetically like a true conduction-current. This was first proved in 1876 by Rowland, who found a charged disc rotated rapidly to act upon a magnet as a feeble circular current would do. Convection currents, consisting of streams of electrified particles, are also acted upon by magnets. The convective discharges in vacuum-tubes (Art. 292) can be drawn aside by a magnet, or caused to rotate around a magnet-pole. The “brush” discharge when taking place in a strong magnetic field is twisted. The voltaic arc (Art. 371) also behaves like a flexible conductor, and can be attracted or repelled by a magnet. Two stationary positively electrified particles repel one another, but two parallel currents attract one another (Art. 332), and if electrified particles flowing along act like currents, there should be an (electromagnetic) attraction between two electrified particles moving along side by side through space. According to Maxwell’s theory (Art. 390) the electrostatic repulsion will be just equal to the electromagnetic attraction when the particles move with a velocity equal to the velocity of light.

Quite recently Hall has discovered that when a powerful magnet is made to act upon a current flowing along in a strip of very thin metal, the equipotential lines are no longer at right-angles to the lines of flow of the current in the strip. This action appears to be connected with the magnetic rotation of polarized light (Art. 387), the co-efficient of this transverse thrust of

the magnetic field on the current being feebly + in gold, strongly + in bismuth, and - in iron, and immensely strong negatively in tellurium. It was shown by the author, and about the same time by Righi, that those metals which manifest the Hall effect undergo a change in their electric resistance when placed in the magnetic field.

338. Ampère's Theory of Magnetism.—Ampère, finding that solenoids (such as Fig. 118) act precisely as magnets, conceived that all magnets are simply collections of currents, or that, around every individual molecule of a magnet an electric current is ceaselessly circulating. We know that such currents could not flow perpetually if there were any resistance to them, and we know that there is resistance when electricity flows from one molecule to another. As we know nothing about the interior of molecules themselves, we cannot assert that Ampère's supposition is impossible. Since a whirlpool of electricity acts like a magnet, there seems indeed reason to think that magnets may be merely made up of rotating portions of electrified matter.

LESSON XXVIII.—*Diamagnetism.*

339. Diamagnetic Experiments. — In 1778 Brugmans of Leyden observed that when a lump of bismuth was held near either pole of a magnet needle it repelled it. In 1827 Le Baillif and Becquerel observed that the metal antimony also could repel and be repelled by the pole of a magnet. In 1845 Faraday, using powerful electromagnets, examined the magnetic properties of a large number of substances, and found that whilst a great many are, like iron, attracted to a magnet, others are feebly repelled. To distinguish between these two classes of bodies, he termed those which are attracted **paramagnetic**,¹ and those which are repelled **diamagnetic**. The property of being thus repelled from a magnet he termed **diamagnetism**.

Faraday's method of experiment consisted in suspending a small bar of the substance in a powerful magnetic

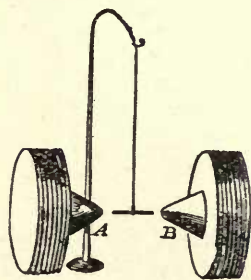

Fig. 126.

field between the two poles of an electromagnet, and observing whether the small bar was attracted into an **axial** position, as in Fig. 126, with its length along the line joining the two poles, or whether it was repelled into an **equatorial** position, at right angles to the line joining the poles, across the lines of force of the field, as is shown by the position of the small bar in Fig 127, sus-

suspended between the poles of an electromagnet constructed on Ruhmkorff's pattern.

¹ Or simply "magnetic." Some authorities use the term "ferromagnetic." *Sidero-magnetic* would be less objectionable than this hybrid word.

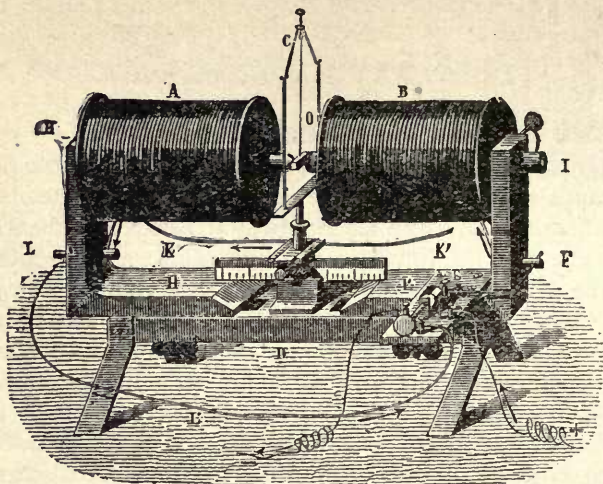

Fig. 127.

The following are the principal substances examined by the method :—

Paramagnetic.	Diamagnetic.
Iron.	Bismuth.
Nickel.	Phosphorus
Cobalt.	Antimony.
Manganese.	Zinc.
Chromium.	Mercury.
Cerium.	Lead.
Titanium.	Silver.
Platinum. ¹	Copper.
Many ores and salts containing the above metals.	Gold.
Oxygen gas.	Water.
	Alcohol.
	Tellurium.
	Selenium.
	Sulphur.
	Thallium.
	Hydrogen gas.
	Air.

¹ Chemically pure Platinum is *diamagnetic*, according to Wiedemann.

Liquids were placed in glass vessels and suspended between the poles of the electromagnet. Almost all liquids are diamagnetic, except solutions of salts of the magnetic metals, some of which are feebly magnetic; but blood is diamagnetic though it contains iron. To examine gases bubbles are blown with them, and watched as to whether they were drawn into or pushed out of the field. Oxygen gas was found to be magnetic; ozone has recently been found to be still more strongly so.

340. Quantitative Results.—The diamagnetic properties of substances may be numerically expressed in terms of their *susceptibility* or their *permeability* (Art. 313). For diamagnetic bodies the susceptibility k is negative, and therefore the permeability ($\mu = 1 + 4\pi k$) is less than unity. For bismuth the value of k is -0.0000025 according to Maxwell. The repulsion of bismuth is immensely feebler than the attraction of iron. Plücker compared the magnetic powers of equal weights of substances, and reckoning that of iron as one million, he found the following values for the “specific magnetism” of bodies:—

Iron	+	1,000,000
Lodestone Ore	+	402,270
Ferric Sulphate	+	1,110
Ferrose Sulphate	+	780
Water	-	7.8
Bismuth	-	23.6

341. Apparent Diamagnetism due to surrounding Medium.—It is found that feebly magnetic bodies behave as if they were diamagnetic when suspended in a more highly magnetic fluid. A small glass tube filled with a weak solution of ferric chloride, when suspended in air between the poles of an electromagnet points axially, or is paramagnetic; but if it be surrounded by a stronger (and therefore more magnetic) solution of the same substance, it points equatorially, and is apparently repelled like diamagnetic bodies. All that

the equatorial pointing of a body proves then is, that it is less magnetic than the medium that fills the surrounding space. A balloon, though it possesses mass and weight, rises through the air in obedience to the law of gravity, because the medium surrounding it is more attracted than it is. But it is found that diamagnetic repulsion takes place even in a vacuum: hence it would appear that space itself¹ is more magnetic than the substances classed as diamagnetic.

342. Diamagnetic Polarity.—At one time Faraday thought that diamagnetic repulsion could be explained on the supposition that there existed a “diamagnetic polarity” the reverse of the ordinary magnetic polarity. According to this view, which, however, Faraday himself quite abandoned, a magnet, when its N. pole is presented to the end of a bar of bismuth, induces in that end a N. pole (the reverse of what it would induce in a bar of iron or other magnetic metal), and therefore repels it. Weber adopted this view, and Tyndall warmly advocated it, especially after discovering that the repelling diamagnetic force varies as the *square* of the magnetic power employed, a law which is the counterpart of the law (Art. 328) of attraction due to induction. Many experiments have been made to establish this view; and some have even imagined that when a diamagnetic bar lies equatorially across a field of force, its east and west poles possess different properties. The experiments named in the preceding paragraph suggest, however, an explanation less difficult to reconcile with the facts. There can be no doubt that the phenomenon is due to magnetic induction: and it has been pointed out (Art. 89) that the amount of induction which goes on in a medium depends upon the magnetic inductive capacity (or “permeability”) of that medium. Now, permeability expresses the number of magnetic lines induced in the medium for every line of magnetising force

¹ Or, possibly, the “æther” filling all space.

applied. A certain magnetising force applied to a space containing air or vacuum would induce a certain number of magnetic lines through it. If, however, the space considered were occupied by bismuth, the same magnetising-force would induce in the bismuth *fewer* "lines of induction" than in vacuum. But those lines which were induced would still run in the same general *direction* as in the vacuum; *not in the opposite direction*, as Weber and Tyndall maintain. The result of there being a less induction through diamagnetic substances can be shown to be that such substances will be urged from places where the magnetic force is strong, to places where it is weaker. This is why a ball of bismuth moves away from a magnet, and why a little bar of bismuth between the conical poles of the electro-magnet (Fig. 127) turns equatorially so as to put its ends into the regions that are magnetically weaker. There is no reason to doubt that in a magnetic field of *uniform* strength a bar of bismuth would point along the lines of induction.

343. Magne - Crystalline Action. — In 1822 Poisson predicted that a body possessing crystalline structure would, if magnetic at all, have different magnetic powers in different directions. In 1847 Plücker discovered that a piece of tourmaline, which is itself feebly paramagnetic, behaved as a diamagnetic body, when so hung that the axis of the crystal was horizontal. Faraday, repeating the experiment with a crystal of bismuth, found that it tended to point with its axis of crystallisation along the lines of the field axially. The magnetic force acting thus upon crystals by virtue of their possessing a certain structure he named *magne-crystalline force*. Plücker endeavoured to connect the magne-crystalline behaviour of crystals with their optical behaviour, giving the following law: there will be either repulsion *or* attraction of the optic axis (or, in the case of bi-axial crystals, of *both* optic axes) by the poles of a magnet; and if the crystal is a

“negative” one (*i.e.* optically negative, having an extraordinary index of refraction *less* than its ordinary index), there will be repulsion, if a “positive” one, there will be attraction. Tyndall has endeavoured to show that this law is insufficient in not taking into account the paramagnetic or diamagnetic powers of the substance as a whole. He finds that the magne-crystallic axis of bodies is in general *an axis of greatest density, and that if the mass itself be paramagnetic this axis will point axially; if diamagnetic, equatorially.* In bodies which, like slate and many crystals, possess cleavage, the planes of cleavage are usually at right angles to the magne-crystallic axis.

344. Diamagnetism of Flames.—In 1847 Bancalari discovered that flames are repelled from the axial line joining the poles of an electromagnet. Faraday showed that all kinds of flames, as well as ascending streams of hot air and of smoke, are acted on by the magnet and tend to move from places where the magnetic forces are strong to those where they are weaker. Gases (except oxygen and ozone), and hot gases especially, are feebly diamagnetic. But the active repulsion and turning aside of flames may possibly be in part due to an electromagnetic action like that which the magnet exercises on the convection-current of the voltaic arc and on other convection-currents. The electric properties of flame are mentioned in Arts. 7 and 291.

CHAPTER VI.

MEASUREMENT OF CURRENTS, ETC.

LESSON XXIX.—*Ohm's Law and its Consequences.*

345. In Art. 180 the important law of Ohm was stated in the following terms:—*The strength of the current varies directly as the electromotive-force, and inversely as the (total) resistance of the circuit.*

Using the units adopted by practical electricians, and explained in Art. 323, we may now restate Ohm's law in the following definite manner:—*The number of ampères of current flowing through a circuit is equal to the number of volts of electromotive-force divided by the number of ohms of resistance in the entire circuit.* Or,

$$\text{Current} = \frac{\text{Electromotive-force}}{\text{Resistance}},$$

$$C = \frac{E}{R}.$$

In practice, however, the matter is not quite so simple, for if a number of cells are used and the circuit be made up of a number of different parts through all of which the current must flow, we have to take into account not only the electromotive-forces of the cells, but their resistances, and the resistance of all the parts of the circuit. For example, the current may flow from the zinc plate of the first cell through the liquid to the copper (or carbon)

plate; then through a connecting wire or screw to the next cell, through its liquid, through the connecting screws and liquids of the rest of the cells, then through a wire to a galvanometer, then through the coils of the galvanometer, then perhaps through an electrolytic cell, and finally through a return wire to the zinc pole of the battery. In this case there are a number of separate electromotive-forces all tending to produce a flow, and a number of different resistances, each impeding the flow and adding to the total resistance. If in such a case we knew the separate values of all the different electromotive-forces and all the different resistances we could calculate what the current would be, for it would have the value,

$$C = \frac{e' + e'' + e''' + e^{iv} + \dots}{r' + r'' + r''' + r^{iv} + \dots}$$

$$= \frac{\text{Total electromotive-force}}{\text{Total resistance}}$$

If any one of the cells were set wrong way-round its electromotive-force would oppose that of the other cells; an opposing electromotive-force must therefore be subtracted, or reckoned as negative in the algebraic sum. The "polarisation" (Arts. 163 and 413) which occurs in battery cells and in electrolytic cells after working for some time is an opposing electromotive-force, and diminishes the total of the electromotive-forces in the circuit. So, also, the induced back-current which is set up when a current from a battery drives a magneto-electric engine (Art. 377) reduces the strength of the working current.

346. Conductivity and Resistance.—The term *conductivity* is sometimes used as the inverse of resistance; and the reciprocal $\frac{1}{r}$ represents the conductivity of a conductor whose resistance is r ohms. In practice, however, it is more usual to speak of the *resistances* of conductors than of their *conductivities*.

347. Laws of Resistance.—Resistances in a circuit may be of two kinds—*first*, the resistances of the conductors themselves; *second*, the resistances due to imperfect contact at points. The latter kind of resistance is affected by pressure, for when the surfaces of two conductors are brought into more intimate contact with one another, the current passes more freely from one conductor to the other. The contact-resistance of two copper conductors may vary from infinity down to a small fraction of an ohm, according to the pressure. The variation of resistance at a point of imperfect contact is utilised in Telephone Transmitters (Arts. 434, 436). The following are the laws of the resistance of conductors:—

- i. *The resistance of a conducting wire is proportional to its length.* If the resistance of a mile of telegraph wire be 13 ohms, that of fifty miles will be $50 \times 13 = 650$ ohms.
- ii. *The resistance of a conducting wire is inversely proportional to the area of its cross section, and therefore in the usual round wires is inversely proportional to the square of its diameter.* Ordinary telegraph wire is about $\frac{1}{4}$ th of an inch thick; a wire twice as thick would conduct four times as well, having four times the area of cross section: hence an equal length of it would have only $\frac{1}{4}$ th the resistance.
- iii. *The resistance of a conducting wire of given length and thickness depends upon the material of which it is made,—that is to say, upon the specific resistance of the material.*

348. Specific Resistance.—The specific resistance of a substance is best stated as the resistance in “absolute” C.G.S. units (*i.e.* in thousand millionths of an ohm) of a centimetre cube of the substance. The following Table also gives the relative conductivity when that of silver is taken as 100.

TABLE OF SPECIFIC RESISTANCE.

Substance.	Specific Resistance.	Relative Conductivity.
<i>Metals.</i>		
Silver	1,609	100
Copper	1,642	96
Gold	2,154	74
Iron (soft)	9,827	16
Lead	19,847	8
German Silver	21,170	7.5
Mercury (liquid)	96,146	1.6
Selenium (annealed)	6×10^{13}	$\frac{1}{40,000,000,000}$
<i>Liquids.</i>		
Pure Water } at 22°C }	7.18×10^{10}	less than <i>one</i> <i>millionth</i> part.
Dilute H_2SO_4 } ($\frac{1}{2}$ acid) }	$.332 \times 10^{10}$	
Dilute H_2SO_4 } ($\frac{1}{3}$ acid) }	$.126 \times 10^{10}$	
<i>Insulators.</i>		
Glass (at 200°C)	2.27×10^{16}	less than <i>one</i> <i>billionth</i> .
Guttapercha (at 20°C)	3.5×10^{23}	

It is found that those substances that possess a high conducting power for electricity are also the best conductors of heat. Liquids are worse conductors than the metals, and gases are perfect non-conductors, except when so rarefied as to admit of discharge by convection through them (Art. 283).

349. **Effects of Heat on Resistance.**—Changes of temperature affect temporarily the conducting power of metals. Forbes found the resistance of iron to increase considerably as the temperature is raised. The resistances of copper and lead also increase, while that

of carbon appears on the other hand to diminish on heating. German-silver and other alloys do not show so much change, hence they are used in making standard resistance-coils. Those liquids which only conduct by being electrolysed (Art. 205), conduct better as the temperature rises. The effect of *light* in varying the resistance of selenium is stated in Art. 389.

350. Typical Circuit.—Let us consider the typical case of the circuit shown in Fig. 128, in which a battery, ZC, is joined up in circuit with a galvanometer by means of wires whose resistance is R. The total electromotive-force of the battery we will call E, and the total internal resistance of the liquids in the cells r. The resistance of the galvanometer coils may be called G. Then, by Ohm's law:—

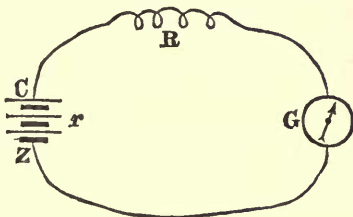

Fig. 128.

$$C = \frac{E}{R + r + G}$$

The *internal resistance* r of the liquids of the battery bears a very important relation to the *external resistance* of the circuit (including R and G), for on this relation depends the best way of arranging the battery cells for any particular purpose. Suppose, for example, that we have a battery of 50 small Daniell's cells at our disposal, of which we may reckon the electromotive-force as one volt (or more accurately, 1.079 volt) each, and each having an internal resistance of two ohms. If we have to use these cells on a circuit where there is already of necessity a high resistance, we should couple them up "in simple series" rather than in parallel branches of a compound circuit. For, supposing we have to send our current through a line of telegraph 100 miles long, the external resistance R will

be (reckoning 13 ohms to the mile of wire) at least 1300 ohms. Through this resistance a single such cell would give a current of less than one milli-ampère, for here $E = 1$, $R = 1300$, $r = 2$, and therefore

$C = \frac{E}{R + r} = \frac{1}{1300 + 2} = \frac{1}{1302}$ of an ampère, a current far too weak to work a telegraph instrument.

With fifty such cells in series we should have $E = 50$, $r = 100$, and then

$C = \frac{50}{1300 + 100} = \frac{50}{1400} = \frac{1}{28}$ of an ampère, or over 35 milli-ampères. In telegraph work, where the instruments require a current of 5 to 10 milli-ampères to work them, it is usual to reckon an additional Daniell's cell for every 5 miles of line, each instrument in the circuit being counted as having as great a resistance as 10 miles of wire.

If, however, the resistance of the external circuit be small, such arrangements must be made as will keep the total internal resistance of the battery small. Suppose, for example, we wish merely to heat a small piece of platinum wire to redness, and have stout copper wires to connect it with the battery. Here the external resistance may possibly not be as much as one ohm. In that case a single cell would give a current of $\frac{1}{3}$ of an ampère (or 333 milli-ampères) through the wire, for here $E = 1$, $R = 1$, and $r = 2$. But ten cells would only give half as much again, or 476 milli-ampères, and fifty cells only 495 milli-ampères, and with an infinite number of such cells *in series* the current could not possibly be more than 500 milli-ampères, because every cell, though it adds 1 to E , adds 2 to R . It is clear then that though linking many cells in series is of advantage where there is the resistance of a long line of wire to be overcome, yet where the external resistance is small the practical advantage of adding cells in series soon reaches a limit.

But suppose in this second case, where the external resistance of the circuit is small, we reduce also the

internal resistance of our battery by linking cells together in parallel branches of a compound circuit, joining several zincs of several cells together, and joining also their copper poles together (as suggested in Art. 181), a different and better result is attained. Suppose we thus join up four cells. Their electromotive-force will be no more, it is true, than that of one cell, but their resistance will be but $\frac{1}{4}$ of one such cell, or $\frac{1}{2}$ an ohm. These four cells would give a current of 666 milli-ampères through an external resistance of 1 ohm, for if $E = 1$, $R = 1$, and the internal resistance be $\frac{1}{4}$ of r , or $= \frac{1}{2}$, then

$$C = \frac{E}{R + r} = \frac{2}{3} \text{ of an ampère, or 666 milli-ampères.}$$

351. Best Grouping of Cells.—It is at once evident that if we arrange the cells of a battery in n files of m cells in series in each file (there being $m \times n$ similar cells altogether), the electromotive-force of each file will be m times the electromotive-force E of each cell, or mE ; and the resistance of each file will be m times the resistance r of each cell, or mr . But there being n files in parallel branches the whole internal resistance will be only $\frac{1}{n}$ of the resistance of any one file, or will be $\frac{m}{n}r$, hence, by Ohm's law, such a battery would give as its current

$$C = \frac{mE}{\frac{m}{n}r + R}.$$

It can be shown mathematically that, for a given battery of cells, the most effective way of grouping them when they are required to work through a given external resistance R , is so to choose m and n , that the internal resistance ($\frac{m}{n}r$) shall equal the external resistance. The student should verify this rule by taking examples and working them out for different groupings of the cells. Although this arrangement gives the strongest current it is not the most economical; for if the internal and external resistances be equal to one another, the useful work in the outer circuit and the useless work done in heating the cells will be equal also, half the energy being wasted. The greatest economy is attained when the external resistance is very great as compared with the internal resistance; only, in this case, the materials of the battery will be consumed slowly, and the current will not be drawn off at its greatest possible strength.

352. Long and Short Coil Instruments.—The student will also now have no difficulty in perceiving why a “long-coil” galvanometer, or a “long-coil” electromagnet, or instrument of any kind in which the conductor is a long thin wire of high resistance, must not be employed on circuits where both R and r are already small. He will also understand why, on circuits of great length, or where there is of necessity a high resistance and a battery of great electromotive force is employed, “short-coil” instruments are of little service, for though they add little to the resistances their few turns of wire are not enough with the small currents that circulate in high-resistance circuits; and why “long-coil” instruments are here appropriate as multiplying the effects of the currents by their many turns, their resistance, though perhaps large, not being a serious addition to the existing resistances of the circuit. A galvanometer with a “long-coil” of high resistance, if placed as a shunt across two points of a circuit, will draw therefrom a current proportional to the difference of potential between those points. Hence such an instrument may be used as a *voltmeter* (Art. 360 *d*.)

353. Divided Circuits.—If a circuit divides, as in Fig. 129, into two branches at A, uniting together again at B, the current will also be divided, part flowing through one branch part through the other. *The relative strengths of current in the two branches will be proportional to their conductivities, i.e., inversely proportional to*

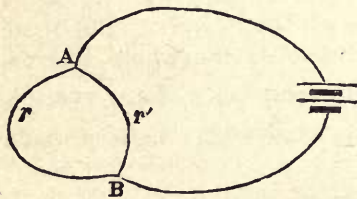

Fig. 129.

their resistances. Thus, if r be a wire of 2 ohms resistance and r' 3 ohms, then current in r : current in r' = $r' : r$

$$= 3 : 2,$$

or, $\frac{3}{5}$ of the whole current will flow through r , and $\frac{2}{5}$ of the whole current through r' .

The *joint resistance* of the divided circuit between A and B will be less than the resistance of either branch singly, because the current has now choice of either path. In fact, the joint conductivity will be the sum of the two

separate conductivities. And if we call the joint resistance R , it follows that

$$\frac{1}{R} = \frac{1}{r} + \frac{1}{r'} = \frac{r' + r}{rr'},$$

whence $R = \frac{rr'}{r' + r}$, or, in words, *the joint resistance of a divided conductor is equal to the product of the two separate resistances divided by their sum.*

Kirchhoff has given the following important laws, both of them deducible from Ohm's law.

- (i.) *In any branching network of wires the algebraic sum of the currents in all the wires that meet in any point is zero.*
- (ii.) *When there are several electromotive-forces acting at different points of a circuit, the total electromotive-force round the circuit is equal to the sum of the resistances of its separate parts multiplied each into the strength of the current that flows through it.*

354. Current Sheets.—When a current enters a solid conductor it no longer flows in one line but spreads out and flows through the mass of the conductor. When a current is led into a thin plate of conducting matter it spreads out into a "current sheet" and flows through the plate in directions that depend upon the form of the plate and the position of the pole by which it returns to the battery. Thus, if wires from the two poles of a battery are brought into contact with two neighbouring points A and B in the middle of a very large flat sheet of tinfoil, the current flows through the foil not in one straight line from A to B, but in curving "lines of flow," which start out in all directions from A, and curl round to meet in B, in curves very like those of the "lines of force" that run from the N.-pole to the S.-pole of a magnet (Fig. 50). When the earth is used as a return wire to conduct the telegraph currents (Fig. 160), a similar spreading of the currents into current sheets occurs.

LESSON XXX.—*Electrical Measurements.*

355. The practical electrician has to measure electrical resistances, electromotive-forces, and the capacities of condensers. Each of these several quantities is measured by comparison with ascertained standards, the particular methods of comparison varying, however, to meet the circumstances of the case. Only a few simple cases can be here explained.

356. *Measurement of Resistance.*—Resistance is that which stops the flow of electricity. Ohm's law shows us that the strength of a current due to an electromotive force falls off in proportion as the resistance in the circuit increases.

(a) It is therefore possible to compare two resistances with one another by finding out in what proportion each of them will cause the current of a constant battery to fall off. Thus, suppose in Fig. 128 we have a standard battery of a few Daniell's cells, joined up in circuit with a wire of an unknown resistance R , and with a galvanometer, we shall obtain a current of a certain strength, as indicated by the galvanometer needle experiencing a certain deflection. If we remove the wire R , and substitute in its place in the circuit wires whose resistances we *know*, we may, by trying, find one which, when interposed in the path of the current, gives the same deflection on the galvanometer. Hence we shall know that this wire and the one we called R offer equal resistance to the current. Such a process of comparison, which we may call a *method of substitution* of equivalent resistances, was further developed by Wheatstone, Jacobi, and others, when they proposed to employ as a standard resistance a long thin wire coiled upon a wooden cylinder, so that any desired length of the standard wire might be thrown into the circuit by unwinding the proper number of turns of wire off the cylinder, or by making contact at some point at any desired distance from the end of the wire.

Such an instrument was known as a **Rheostat**, but it is now superseded by the resistance coils explained below.

(*b*) The method explained above can be used with any galvanometer of sufficient sensitiveness, but if a tangent galvanometer is available the process may be shortened by calculation. Suppose the tangent galvanometer and an unknown resistance R to be included in the circuit, as in Fig. 128, and that the current is strong enough to produce a deflection of δ degrees: Now substitute for R any known resistance R' , which will alter the deflection to δ' ; then (provided the other resistances of the circuit be negligibly small) it is clear that since the strengths of the currents are proportional to $\tan \delta$ and $\tan \delta'$ respectively, the resistance R can be calculated by the inverse proportion.

$$\tan \delta : \tan \delta' = R' : R.$$

(*c*) With a differential galvanometer (Art. 203), and a set of standard resistance coils, it is easy to measure the resistance of a conductor. Let the circuit divide into two branches, so that part of the current flows through the unknown resistance and round one set of coils of the galvanometer, the other part of the current being made to flow through the known resistances and then round the other set of coils in the opposing direction. When we have succeeded in matching the unknown resistance by one equal to it from amongst the known resistances, the currents in the two branches will be equal, and the needle of the differential galvanometer will show *no* deflection. With an accurate instrument this null method is very reliable.

(*d*) The best of all the ways of measuring resistances is, however, with a set of standard resistance coils and the important instrument known as **Wheatstone's Bridge**, described below in Art. 358.

(*e*) To measure very high resistances the plan may be adopted of charging a condenser from a standard battery for a definite period through the resistance, and then

ascertaining the accumulated charge by discharging it through a ballistic galvanometer (Art. 204).

357. Fall of Potential along a Wire.—To understand the principle of Wheatstone's Bridge we must explain a preliminary point. If the electric potential of different points of a circuit be examined by means of an electrometer, as explained in Art. 263, it is found to decrease all the way round the circuit from the + pole of the battery, where it is highest, down to - pole, where it is lowest. If the circuit consist of one wire of uniform thickness, which offers, consequently, a uniform resistance to the current, it is found that the potential falls uniformly; if however, part of the circuit resists more than another, it is found that the potential falls most rapidly along the conductor of greatest resistance. But in every case the fall of potential between any two points is proportional to the resistance between those two points; and we know, for example, that when we have gone round the circuit to a point where the potential has fallen through half its value, the current has at that point gone through half the resistances. The difference of potential e between the poles of a battery (of electromotive-force E and internal resistance r) in a circuit of which the total resistance is $R + r$, may be written in the following ways as:

$$e = E \frac{R}{R+r} = E - rC = RC.$$

358. Wheatstone's Bridge.—This instrument, invented by Christie, and applied by Wheatstone to measure resistances, consists of a system of conductors shown in diagram in Fig. 130. The circuit of a constant battery is made to branch at P into two parts, which re-unite at Q, so that part of the current flows through the point M, the other part through the point N. The four conductors D, C, B, A, are spoken of as the "arms" of the "balance" or "bridge;" it is by the proportion subsisting between their resistances that the resistance of one of them can be calculated when the resistances of the other three are known. When the current which starts from C at the battery arrives at P, the potential will have fallen to a certain value. The potential of the current in the upper branch falls again to M, and continues to fall to Q. The potential of the lower

branch falls to N, and again falls till it reaches the value at Q. Now if N be the same proportionate distance

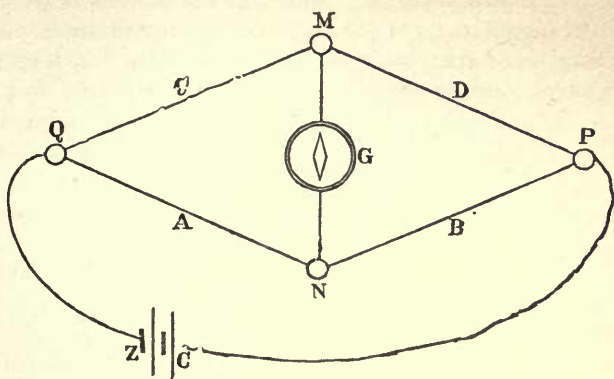

Fig. 130.

along the resistances between P and Q, as M is along the resistances of the upper line between P and Q, the potential will have fallen at N to the same value as it has fallen to at M; or, in other words, if the ratio of the resistance C to the resistance D be equal to the ratio between the resistance A and the resistance B, then M and N will be at equal potentials. To find out whether they are at equal potentials a sensitive galvanometer is placed in a branch wire between M and N; it will show *no* deflexion when M and N are at equal potentials; or when the four resistances of the arms "balance" one another by being in proportion, thus:—

$$A : C :: B : D.$$

If, then, we know what A, B, and C are, we can calculate D, which will be

$$D = \frac{B \times C}{A}$$

EXAMPLE.—Thus if A and C are (as in Fig. 133) 10 *ohms* and 100 *ohms* respectively, and B be 15 *ohms*, D will be $15 \times 100 \div 10 = 150$ *ohms*.

359. **Resistance Coils.**—Wires of standard resistance are now sold by instrument makers under the name of **Resistance Coils**. They consist of coils of german-silver (see Art. 349) (or sometimes silver-iridium alloy), wound with great care, and adjusted to such a length as to have resistances of a definite number of *ohms*. In order

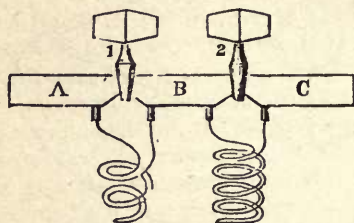

Fig. 131.

to avoid self-induction, and the consequent sparks (see Art. 404) at the opening or closing of the circuit, they are wound in the peculiar manner indicated in Fig. 131, each wire (covered with silk or paraffined-cotton) being doubled on itself

before being coiled up. Each end of a coil is soldered to a solid brass piece, as coil 1 to A and B, coil 2 to B and C; the brass pieces being themselves fixed to a block of ebonite (forming the top of the "resistance box"), with sufficient room between them to admit of the insertion of stout well-fitting plugs of brass. Fig. 132 shows a complete resistance-box, as fitted up for

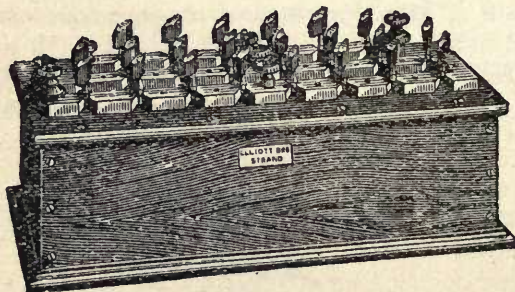

Fig. 132.

electrical testing, with the plugs in their places. So long as the plugs remain in, the current flows through.

the solid brass pieces and plugs without encountering any serious resistance; but when any plug is removed, the current can only pass from the one brass piece to the other by traversing the coil thus thrown into circuit. The series of coils chosen is usually of the following numbers of *ohms*' resistance—1, 2, 2, 5; 10, 20, 20, 50; 100, 200, 200, 500; up to 10,000 *ohms*. By pulling out one plug any one of these can be thrown into the circuit, and any desired whole number, up to 20,000, can be made up by pulling out more plugs; thus a resistance of 263 *ohms* will be made up as $200 + 50 + 10 + 2 + 1$.

It is usual to construct Wheatstone's bridges with some resistance coils in the arms A and C, as well as with a complete set in the arm B. The advantage of this

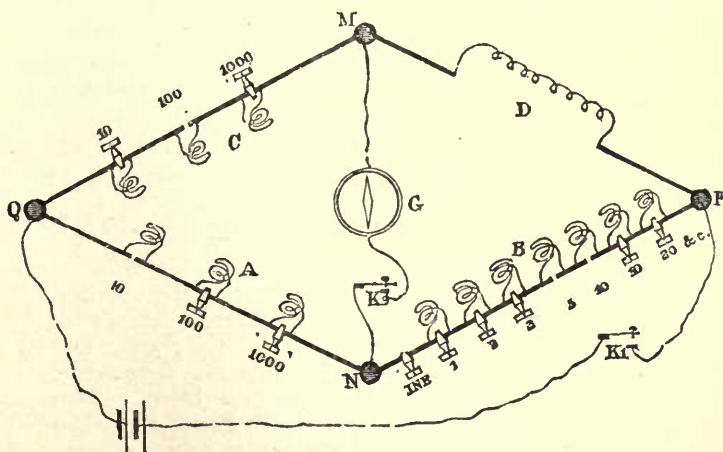

Fig. 133.

arrangement is that by adjusting A and C we determine the proportionality between B and D, and can, in certain cases, measure to fractions of an *ohm*. Fig. 133 shows a more complete scheme, in which resistances of 10, 100, and 1000 *ohms* are included in the arms A and C.

EXAMPLE.—Suppose we had a wire, whose resistance we knew to be between 46 and 47 *ohms*, and wished to measure the fraction of an *ohm*, we should insert it at D, and make A 100 *ohms* and C 10 *ohms*; in that case D would be balanced by a resistance in B 10 times as great as the wire D. If, on trial, this be found to be 464 *ohms* we know that $D = 464 \times 10 \div 100 = 46.4 \text{ ohms}$.

In practice the bridge is seldom or never made in the lozenge-shape of the diagrams. The resistance-box of Fig. 132 is, in itself, a complete “bridge,” the appropriate connections being made by screws at various points. In using the bridge the battery circuit should always be completed by depressing the key K_1 before the key K_2 of the galvanometer circuit is depressed, in order to avoid the sudden violent “throw” of the galvanometer needle, which occurs on closing circuit in consequence of self-induction (Art. 404).

360. Measurement of Electromotive-Force.—There being no easy absolute method of measuring electromotive-forces, they are usually measured *relatively*, by comparison with the electromotive-force of a standard cell, such as that of Daniell (Art. 170), or better still that of Latimer Clark (Art. 177). The methods of comparison are various; only four can here be mentioned.

(a) Call E the electromotive-force of the battery to be measured, and E' that of a standard battery. Join E with a galvanometer, and let it produce a deflection of δ_1 degrees through the resistances of the circuit; then add enough resistance r to bring down the deflection to δ_2 degrees—say 10 degrees less than before. Now substitute the standard battery in the circuit and adjust the resistances till the deflection is δ_1 as before, and then add enough resistance r' , to bring down the deflection to δ_2 . Then

$$r' : r = E' : E,$$

since the resistances that will reduce the strength of the current equally will be proportional to the electromotive-forces

- (b) If the poles of a standard battery are joined by a long thin wire, the potential will fall uniformly from the + to the - pole. Hence, by making contacts at one pole and at a point any desired distance along the wire, any desired proportional part of the whole electromotive-force can be taken. This proportional part may be balanced against the electromotive-force of any other battery, or used to compare the difference between the electromotive-forces of two different cells.
- (c) The electromotive-force of a battery may be measured directly as a difference of potentials by a quadrant electrometer. In this case the circuit is never closed, and no current flows.
- (d) If a galvanometer be constructed so that the resistance of its coils is several thousand ohms, in comparison with which the internal resistance of a battery or dynamo machine is insignificant, such a galvanometer will serve to measure electromotive-forces; for, by Ohm's law, the strength of current which such a battery or dynamo can send through it will depend only on the electromotive-force between the ends of the coil. Such a galvanometer, suitably graduated, is sometimes called a "*Volt-meter*" or "*Potential galvanometer*." It can be used to determine the difference of potential between any two points of a circuit by connecting its terminals as a shunt to the circuit between these two points.

361. Measurement of Internal Resistance of Battery.—This may be done in three ways.

- (a) Note by a tangent galvanometer the strength of the current, first, when the resistance of the external circuit is small; and secondly, when a larger known external resistance is introduced. From this the proportion between the internal resistance and the introduced external resistance can be calculated.
- (b) (*Method of Opposition*).—Take two similar cells and join them in opposition to one another, so that they send no current of their own. Then measure their united resistance just as the resistance of a wire is measured. The resistance of one cell will be half that of the two.
- (c) (*Mance's Method*).—Place the cell itself in one arm of the Wheatstone's bridge, and put a *key* where the battery usually is, adjust the resistances till the permanent galvano-

meter deflection is the same whether the key be depressed or not. When this condition of things is attained the battery resistance is balanced by those of the other three arms. (*Not a reliable method.*)

362. Measurement of Capacity of a Condenser.—The capacity of a condenser may be measured by comparing it with the capacity of a standard condenser—such as the $\frac{1}{3}$ microfarad condenser shown in Fig. 106,—in one of the following ways:—

(a) Charge the condenser of unknown capacity to a certain potential; then make it share its charge with the condenser of known capacity, and measure the potential to which the charge sinks; then calculate the original capacity, which will bear the same ratio to the joint capacity of the two as the final potential bears to the original potential.

(b) Charge each condenser to equal differences of potential, and then discharge each successively through a ballistic galvanometer (Art. 204), when the sine of half the angle of the first swing of the needle will be proportional in each case to the charge, and therefore to the capacity.

(c) Charge the two condensers simultaneously from one pole of the same battery, interposing high resistances in each branch, and adjusted so that the potential rises at an equal rate in both; then the capacities are inversely proportional to the resistances through which they are respectively being charged.

(d) Another method, requiring no standard condenser, is as follows:—Allow the condenser, whose capacity is to be measured, to discharge itself slowly through a wire of very high resistance. The time taken by the potential to fall to any given fraction of its original value is proportional to the resistance, to the capacity, and to the logarithm of the given fraction.

363. Resistance Expressed as a Velocity.—It will be seen, on reference to the table of “Dimensions” of electromagnetic units (Art. 324), that the dimensions of resistance are

given as LT^{-1} , which are the same dimensions (see Art. 258) as those of a velocity. Every resistance is capable of being expressed as a velocity. The following considerations may assist the student in forming a physical conception of this:— Suppose we have a circuit composed of two horizontal rails

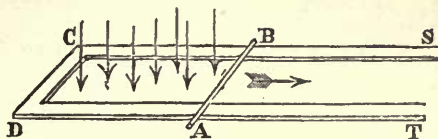

Fig. 134.

(Fig. 134), CS and DT, 1 centim. apart, joined at CD, and completed by means of a sliding piece AB. Let this variable circuit be placed in a uniform magnetic field of unit intensity, the lines of force being directed vertically downwards through the circuit. If, now, the slider be moved along towards ST with a velocity of n centimetres per second, the number of additional lines of force embraced by the circuit will increase at the rate n per second; or, in other words, there will be an *induced* electromotive-force (Art. 394) impressed upon the circuit, which will cause a current to flow through the slider from A to B. Let the rails have no resistance, then the strength of the current will depend on the resistance of AB. Now let AB move at such a rate that the current shall be of unit strength. If its resistance be one "absolute" (electromagnetic) unit it need only move at the rate of 1 centim. per second. If its resistance be greater it must move with a proportionately greater velocity; the velocity at which it must move to keep up a current of unit strength being numerically equal to its resistance. *The resistance known as "one ohm" is intended to be 10^9 absolute electromagnetic units, and therefore is represented by a velocity of 10^9 centimetres, or ten million metres (one earth-quadrant) per second.*

361. Evaluation of the Ohm.—The value of the ohm in absolute measure was determined by a Committee of the British Association in London in 1863. It being impracticable to give to a horizontal sliding-piece so high a velocity as was necessitated, the velocity which corresponded to the resistance of a wire was measured in the following way:—A ring of wire (of many turns), pivoted about a vertical axis, as in Fig. 135, was made to rotate very rapidly and uniformly. Such a ring in rotating cuts the lines of force of the earth's magnetism. The northern half of the ring, in moving from west toward east,

will have (see Rule Art. 395) an upward current induced in it, while the southern half, in crossing from east toward west, will have a downward current induced in it. Hence the rotating ring will, as it spins, act as its own galvanometer if a small magnet be hung at its middle; the magnetic effect due to the rotating coil being proportional directly to the horizontal component of the earth's magnetism, to the velocity of rotation, and to the number of turns of wire in the coil, and inversely proportional to the resistance of the wire of the coils. Hence, all the other data being known, the resistance can be calculated and measured as a velocity. The

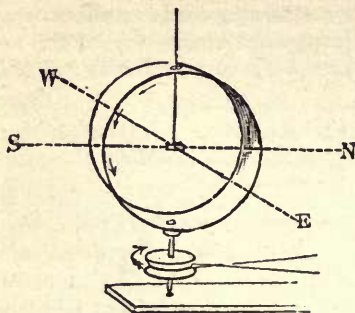

Fig. 135.

existing *ohms* or *B.A. units* were constructed by comparison with this rotating coil; but there being some doubt as to whether the B.A. unit really represented 10^9 centims. per second, a redetermination of the ohm was suggested in 1880 by the British Association Committee.

364 (bis). *The Legal Ohm*—At the International Congress of Electricians in Paris 1881 the project for a redetermination of the ohm was endorsed, and it was also agreed that the practical standards should no longer be constructed in German silver wire, but that they should be made upon the plan originally suggested by Siemens, by defining the *practical ohm* as the resistance of a column of pure mercury of a certain length, and of one millimetre of cross-section. The original "Siemens' unit" was a column of mercury one metre in length, and one square millimetre in section, and was rather less than an ohm (0.9415 B.A. unit). Acting on measurements made by the best physicists of Europe, the Paris Congress of 1884 decided that the mercury column representing the *legal ohm* shall be 106 centimetres in length. [Lord Rayleigh's determination gave 106.21 centimetres of mercury, as representing the true theoretical ohm (= 10^9 absolute units).] Our old B.A. ohm is only 0.9887 of the new *legal ohm*; and our old volt is 0.9887 of the *legal volt*.

NOTE ON THE RATIO OF THE ELECTROSTATIC TO THE ELECTROMAGNETIC UNITS.

365. If the student will compare the Table of Dimensions of Electrostatic Units of Art. 258 with that of the Dimensions of Electromagnetic Units of Art. 324, he will observe that the dimensions assigned to similar units are different in the two systems. Thus, the dimensions of "Quantity" in *electrostatic* measure are $M^{\frac{1}{2}} L^{\frac{3}{2}} T^{-1}$, and in *electromagnetic* measure are $M^{\frac{1}{2}} L^{\frac{1}{2}}$. Dividing the former by the latter we get LT^{-1} , a quantity which

we at once see is of the nature of a *velocity*. This velocity occurs in every case in the ratio of the electrostatic to the electromagnetic measure of every unit. It is a definite concrete velocity, and represents that velocity at which two electrified particles must travel along side by side in order that their mutual electromagnetic attraction (considered as equivalent in moving to two parallel currents) shall just equal their mutual electrostatic repulsion, see Art. 337. This velocity, "*v*," which is of enormous importance in the *electromagnetic theory of light* (Art. 390), has been measured in several ways.

UNIT.	ELECTROSTATIC.	ELECTROMAGNETIC.	RATIO
Quantity .	$M^{\frac{1}{2}} L^{\frac{3}{2}} T^{-1}$	$M^{\frac{1}{2}} L^{\frac{1}{2}}$	$LT^{-1} = v$
Potential .	$M^{\frac{1}{2}} L^{\frac{1}{2}} T^{-1}$	$M^{\frac{1}{2}} L^{\frac{3}{2}} T^{-2}$	$L^{-1} T = \frac{1}{v}$
Capacity .	L	$L^{-1} T^2$	$L^2 T^{-2} = v^2$
Resistance .	$L^{-1} T$	LT^{-1}	$L^{-2} T^2 = \frac{1}{v^2}$

(a) Weber and Kohlrausch measured the electrostatic unit of quantity and compared it with the electromagnetic unit of quantity, and found the ratio *v* to be = $3 \cdot 1074 \times 10^{10}$ centims. per second.

(b) Sir W. Thomson compared the two units of potential and found

$$v = 2 \cdot 825 \times 10^{10},$$

and later,

$$= 2 \cdot 93 \times 10^{10}.$$

(c) Professor Clerk Maxwell balanced a force of electrostatic attraction against one of electromagnetic repulsion, and found

$$v = 2 \cdot 88 \times 10^{10}.$$

(d) Professors Ayrton and Perry measured the capacity of a condenser electromagnetically by discharging it into a ballistic galvanometer, and electrostatically by calculations from its size, and found

$$v = 2 \cdot 980 \times 10^{10}.$$

(e) Professor Joseph J. Thomson compared the capacity of a condenser as measured electrostatically by calculation and as measured electromagnetically on a Wheatstone's bridge, and deduced

$$v = 2 \cdot 963 \times 10^{10}.$$

The *velocity of light* is believed to be = $2 \cdot 9992 \times 10^{10}$;
 or, according to G. Forbes's latest determination,
 the velocity of *red light* is $2 \cdot 9826 \times 10^{10}.$

Assuming as a mean value 3×10^{10} , and comparing with Arts. 257 and 323, we get :—

- 1 coulomb = 3×10^9 electrostatic (C.G.S.) units of quantity ;
- 1 volt = $\frac{1}{3} \times 10^{-9}$ electrostatic (C.G.S.) units of potential ;
- 1 farad = 9×10^{11} electrostatic (C.G.S.) units of capacity ;
- 1 ohm = $\frac{1}{3} \times 10^{-11}$ electrostatic (C.G.S.) units of resistance.

CHAPTER VII.

HEAT, LIGHT, AND WORK, FROM ELECTRIC CURRENTS.

LESSON XXXI.—*Heating Effects of Currents.*

366. Heat and Resistance.—A current may do work of various kinds, chemical, magnetic, mechanical, and thermal. In every case where a current does work that work is done by the expenditure of part of the energy of the current. We have seen that, by the law of Ohm, the current produced by a given battery is diminished in strength by anything that increases the external resistance. But the strength of the current may be diminished, in certain cases, by another cause, namely, the setting up of an opposing electromotive force at some point of the circuit. Thus, in passing a current through a voltameter (Art. 214) there is a diminution due to the resistance of the voltameter itself, and a further diminution due to the opposing electromotive-force (commonly referred to as "polarisation") which is generated while the chemical work is being done. So, again, when a current is used to drive an electromagnetic motor (Art. 375), the rotation of the motor will itself generate a back-current, which will diminish the strength of the current. Whatever current is, however, not expended in this way in external work, is *frittered down into heat*, either in the battery or in some part of the circuit, or in both. Suppose a quantity of electricity to be set flowing round a closed circuit. If there were no resistance to stop it it would

circulate for ever; just as a waggon set rolling along a circular railway should go round for ever if it were not stopped by friction. When matter in motion is stopped by friction the energy of its motion is frittered down by the friction into heat. When electricity in motion is stopped by resistance the energy of its flow is frittered down by the resistance into heat. Heat, in fact, appears wherever the circuit offers a resistance to the current. If the terminals of a battery be joined by a short thick wire of small resistance, most of the heat will be developed in the battery; whereas, if a thin wire of considerable resistance be interposed in the outer circuit, it will grow hot, while the battery itself will remain comparatively cool.

367. Laws of Development of Heat: Joule's

Law.—To investigate the development of heat by a current, Joule and Lenz used instruments on the principle of Fig. 136, in which a thin wire joined to two stout conductors is enclosed within a glass vessel containing alcohol, into which also a thermometer dips. The resistance of the wire being known, its relation to the other resistances can be calculated. Joule found

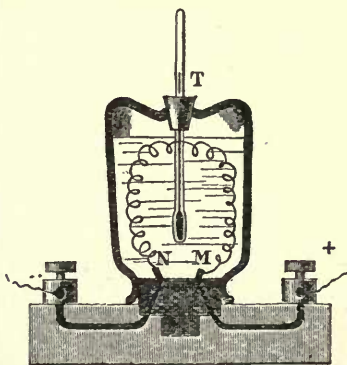

Fig. 136.

that *the number of units of heat developed in a conductor is proportional—*

- (i.) to its resistance;
- (ii.) to the square of the strength of the current;
- and
- (iii.) to the time that the current lasts.

The equation expressing these relations is known as Joule's Law, and is—

$$H = C^2Rt \times 0.24$$

where C is the current in ampères, R the resistance in ohms, t the time in seconds, and H the heat in the usual unit of heat-quantities, viz. the amount of heat that will raise 1 gramme of water through 1°C of temperature (Art. 255).

Joule's law may be arrived at by the following calculation. The work W done by a current in moving Q units of electricity through a difference of potential $V_2 - V_1$ is—

$$W = Q(V_2 - V_1);$$

and since $Q = Ct$, and $V_2 - V_1 = E$, and $W = JH$, (where J is Joule's equivalent $= 4.2 \times 10^7$, and H the heat in water-gramme-centigrade degree units), we have—

$$JH = CtE \quad (\text{and } E = CR).$$

$$= C^2Rt$$

$$\text{whence } H = \frac{C^2Rt}{J}.$$

But as C and R are here in "absolute" units, they must be multiplied by $10^{-2} \times 10^9 = 10^7$, to reduce to the ordinary case of ampères and ohms; whence—

$$H = C^2Rt \div 4.2 \\ = C^2Rt \times 0.24.$$

This is equivalent to the statement that *a current of one ampère flowing through a resistance of one ohm develops therein 0.24 heat-units per second.*

Dr. Siemens proposes to call this quantity of heat (or its mechanical equivalent in work) by the name of one *joule*. If this suggestion be adopted, the electric unit of heat, the *joule*, will be only 0.24 of an ordinary heat-unit or *calorie* (Art. 255), and 1 *calorie* will be equal to 4.2 *joules*.

The second of the above laws, that the heat is, *ceteris paribus*, proportional to the square of the strength of the current, often puzzles young students, who expect the heat to be proportional to the current simply. Such may remember that the consumption of zinc is, *ceteris paribus*, also proportional to the square of the current; for, suppose that in working through a high resistance (so as to get all the heat developed outside the battery) we double the current by doubling the number of battery cells, there will be twice as much zinc consumed as before in *each* cell, and as there are twice as many cells as at first the consumption of zinc is *four times* as great as before.

368. Favre's Experiments.—Favre made a series of most important experiments on the relation of the energy of a current

to the heat it develops. He ascertained that the number of heat-units evolved when 33 grammes (1 equivalent) of zinc are dissolved in dilute sulphuric acid (from which it causes hydrogen to be given off) to be 18,682. This figure was arrived at by conducting the operation in a vessel placed in a cavity of his calorimeter, an instrument resembling a gigantic thermometer filled with mercury, the expansion of which was proportional to the heat imparted to it. When a Smee's cell was introduced into the same instrument, the solution of the same amount of zinc was observed to be accompanied by the evolution of 18,674 units of heat (*i.e.* an amount almost identical with that observed before), and this amount was the same whether the evolution took place in the battery-cell when the circuit was closed with a short thick wire, or whether it took place in a long thin wire placed in the external circuit. He then arranged 5 Smee's cells in series, in cavities of the calorimeter, and sent their current round a small electromagnetic engine. The amount of heat evolved during the solution of 33 grammes of zinc was then observed in three cases ; (i.) when the engine was at rest ; (ii.) when the engine was running round and doing no work beyond overcoming the friction of its pivots ; (iii.) when the engine was employed in doing 13,124,000 gramme-centimetres ($= 12,874 \times 10^6$ ergs) of work, by raising a weight by a cord running over a pulley. The amounts of heat evolved in the circuit in the three cases were respectively, 18,667, 18,657, and 18,374 units. In the last case the work done accounts for the diminution in the heat frittered down in the circuit. If we add the heat-equivalent of the work done to the heat evolved in the latter case, we ought to get the same value as before. Dividing the $12,874 \times 10^6$ ergs of work by Joule's equivalent, expressed in "absolute" measure (42×10^6), we get as the heat-equivalent of the work done 306 heat units. Now $18,374 + 306 = 18,680$, a quantity which is almost identical with that of the first observation, and quite within the limits of unavoidable experimental error.

369. Rise of Temperature.—The elevation of temperature in a resisting wire depends on the *nature* of the resistance. A very short length of a very thin wire may resist just as much as a long length of stout wire. Each will cause the same number of units of heat to be evolved, but in the former case, as the heat is spent in warming a

short thin wire of small mass. it will get very hot, whereas in the latter case it will perhaps only warm to an imperceptible degree the mass of the long thick wire. If the wire weigh w grammes, and have a specific capacity for heat s , then $H = s\omega\theta$, where θ is the rise of temperature in degrees (Centigrade). Hence

$$\theta = 0.24 \times \frac{C^2 R l}{sw}$$

Since the resistance of metals increases as they rise in temperature, a thin wire heated by the current will resist more, and grow hotter and hotter until its rate of loss of heat by conduction and radiation into the surrounding air equals the rate at which heat is supplied by the current.

The following pretty experiment illustrates the laws of heating. The current from a few cells is sent through a chain made of alternate links of silver and platinum wires. The platinum links glow red-hot while the silver links remain comparatively cool. The explanation is that the specific resistance of platinum is about six times that of silver, and its capacity for heat about half as great; hence the rise of temperature in wires of equal thickness traversed by the same current is roughly twelve times as great for platinum as for silver.

Thin wires heat much more rapidly than thick, the rise of temperature in different parts of the same wire (carrying the same current), being, for different thicknesses, inversely proportional to the fourth power of the diameters.

Thus, suppose a wire at any point to become reduced to *half* its diameter, the cross-section will have an area $\frac{1}{4}$ as great as in the thicker part. The resistance here will be 4 times as great, and the number of heat units developed will be 4 times as great as in an equal length of the thicker wire. But 4 times the amount of heat spent on $\frac{1}{4}$ the amount of metal will warm it to a degree 16 times as great, and $16 = 2^4$.

For surgical purposes a thin platinum wire, heated red-hot by a current, is sometimes used instead of a

knife, as, for example, in the operation of amputating the tongue for cancer. Platinum is chosen on account of its infusibility, but even platinum wires are fused by the current if too strong. Carbon alone, of conductors, resists fusion.

370. Blasting by Electricity.—In consequence of these heating effects, electricity can be applied to fire blasts and mines, stout conducting wires being carried from an appropriate battery at a distance to a special *fuze*, in which a very thin platinum wire is joined in the circuit. This wire gets hot when the current flows, and being laid amidst an easily combustible substance to serve as a priming, ignites this and sets fire to the charge of gunpowder. Torpedoes can thus be exploded beneath the water, and at any desired distance from the battery.

The special use of heat developed or abstracted by a current passing through a junction of dissimilar metals, known as Peltier's effect, is mentioned in Art. 380.

LESSON XXXII.—*The Electric Light.*

371. The Voltaic Arc.—If two pointed pieces of carbon are joined by wires to the terminals of a powerful voltaic battery or other generator of electric currents, and are brought into contact for a moment and then drawn apart to a short distance, a kind of electric flame called the **voltaic arc** is produced between the points of carbon, and a brilliant light is emitted by the white hot points of the carbon electrodes. This phenomenon was first noticed by Humphry Davy in 1800, and its explanation appears to be the following:—Before contact the difference of potential between the points is insufficient to permit a spark to leap across even $\frac{1}{10000}$ of an inch of air-space, but when the carbons are made to touch, a current is established. On separating the carbons the momentary extra-current due to self-induction of the

circuit (Art. 404), which possesses a high electromotive-force, can leap the short distance, and in doing so volatilises a small quantity of carbon between the points. Carbon vapour being a partial conductor allows the current to continue to flow across the gap, provided it be not too wide ; but as the carbon vapour has a very high

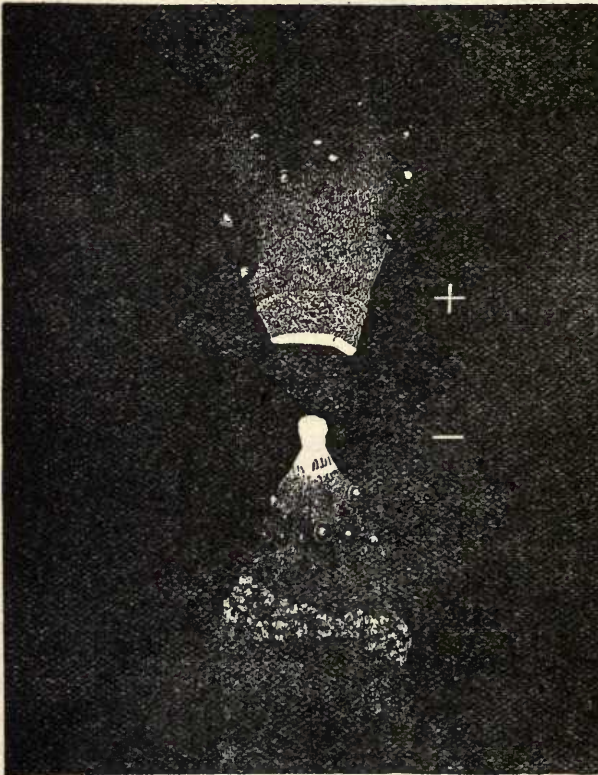

Fig. 137.

resistance it becomes intensely heated by the passage of the current, and the carbon points also grow hot. Since, however, solid matter is a better radiator than gaseous matter, the carbon points emit far more light

than the arc itself, though they are not so hot. In the arc the most infusible substances, such as flint and diamond, melt; and metals such as gold and platinum are even vapourised readily in its intense heat. When the arc is produced in the air the carbons slowly burn away by oxidisation. It is observed, also, that particles of carbon are torn away from the + electrode, which becomes hollowed out to a cup-shape, and some of these are deposited on the - electrode, which assumes a pointed form, as shown in Fig. 137. The resistance of the arc may vary, according to circumstances, from 0.5 ohm to nearly 100 ohms. It is also found that the arc exerts an opposing electromotive-force of its own of about 39 volts when the arc is quiet, or 15 volts when hissing.

To produce an electric light satisfactorily a minimum electromotive-force of 40-50 *volts* is necessary; and as the current must be at least from 5 to 10 or more *ampères*, it is clear that the internal resistance of the battery or generator must be kept small. With weaker currents or smaller electromotive-forces it is impracticable to maintain a steady arc. The internal resistance of the ordinary Daniell's or Leclanché's cells (as used in telegraphy) is too great to render them serviceable for producing electric lights. A battery of 40-60 Grove's cells (Art. 171) is efficient, but will not last more than 2 or 3 hours. A dynamo-electric machine (such as described in Art. 407 to 411), worked by a steam-engine, is the best generator of currents for practical electric lighting. The quantity of light emitted by an electric lamp is disproportionate to the strength of the current; and is, within certain limits, proportional to the square of the heat developed, or to the fourth power of the strength of the current.

372. Electric Arc Lamps.—Davy employed wood charcoal for electrodes to obtain the arc light. Pencils of hard gas-carbon were later introduced by Foucault. In all the more recent arc lamps, pencils of a more

dense and homogeneous artificial coke-carbon are used. These consume away more regularly, and less rapidly, but still some contrivance is necessary to push the points of the carbons forward as fast as needed. It is requisite that the mechanism should start the arc by causing the pencils to touch and then separate them to the requisite distance for the production of a steady arc; the mechanism should also cause the carbons not only to be fed into the arc as fast as they consume, but also to approach or recede automatically in case the arc becomes too long or too short; it should further bring the carbons together for an instant to start the arc again if by any chance the arc goes out. *Electric Arc Lamps*

or *Regulators*, fulfilling these conditions, have been invented by a number of persons. These may be classified as follows:—

(a) *Clockwork Lamps*.—Fig. 138 shows the regulator of Foucault as constructed by Duboscq; in this lamp the carbon-holders are propelled by a train of clockwork wheels actuated by a spring. An electromagnet at the base, through which the current runs, attracts an armature and governs the clockwork. If the current is too

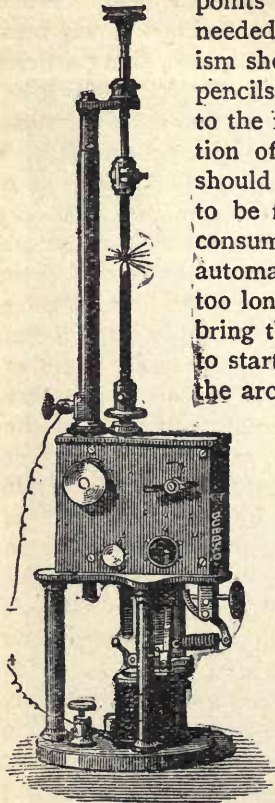

Fig. 138.

strong the armature is drawn down, and the clockwork draws the carbons further apart. If the current is weakened by the resistance of the arc, the armature is drawn upwards by a spring, and a second train of wheels comes into play and moves the carbons nearer together.

Clockwork arc lamps have also been devised by Serrin and by Crompton, in which the weight of the carbon-holders drive the clockwork mechanism.

(b) *Break-wheel Lamps*.—Jaspar and Crompton have devised mechanism for regulating the rate of feeding the carbon into the arc by adding to the train of wheels a break-wheel; the break which stops the wheel being actuated by a small electromagnet which allows the wheel to run forward a little when the resistance of the arc increases beyond its normal amount.

(c) *Solenoid Lamps*.—In this class of arc lamp one of the carbons is attached to an iron plunger capable of sliding vertically up or down inside a hollow coil or solenoid, which, being traversed by the current, regulated the position of the carbons and the length of the arc. Siemens employed two solenoids acting against one another differentially, one being a main-circuit coil, the other being a shunt-circuit. If the resistance of the arc became too great, more of the current flowed past the lamp through the shunt-circuit, and caused the carbon-holders to bring the carbons nearer together. Shunt-circuits to regulate the arc have also been used by Lontin, Brush, Lever, and others.

(d) *Clutch Lamps*.—A somewhat simpler device is that of employing a clutch to pick up the upper carbon holder, the lower carbon remaining fixed. In this kind of lamp the clutch is worked by an electromagnet, through which the current passes. If the lamp goes out the magnet releases the clutch, and the upper carbon falls by its own weight and touches the lower carbon. Instantly the current starts round the electromagnet, causes it to act on the clutch which grips the carbon-holder and raises it to the requisite distance. Should the arc grow too long the lessening attraction on the clutch permits the carbon-holder to advance a little. Hart, Brush, Weston, and Lever employ clutch lamps.

373. *Electric Candles*.—To obviate the expense

and complication of such regulators, electric *candles* have been suggested by Jablochkoff, Wilde, and others. Fig. 139 depicts *Jablochkoff's candle*, consisting of two parallel pencils of hard carbon separated by a thin layer of plaster of Paris and supported in an upright holder. The arc plays across the summit between the two carbon wicks. In order that both carbons may consume at equal rates, rapidly alternating currents must be employed, which is disadvantageous from an economical point of view.

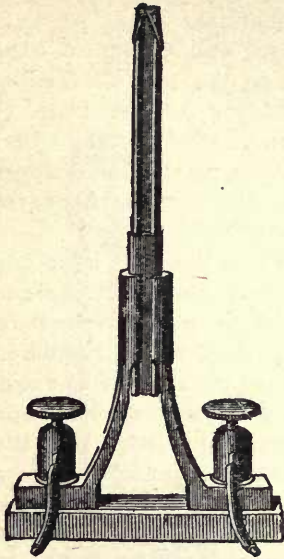

Fig. 139.

374. **Incandescent Electric Lamps.**—Voltaic arcs of an illuminating power of less than 100 candles cannot be maintained steady in practice, and are uneconomical. For

small lights it is both simpler and cheaper to employ a thin continuous wire or filament of some infusible conductor, heated to whiteness by passing a current through it. Thin wires of platinum have repeatedly been suggested for this purpose, but they cannot be kept from risk of fusing. Iridium wires and thin strips of carbon have also been suggested by many inventors. Edison in 1878 devised a lamp consisting of a platinum spiral combined with a short-circuiting switch to divert the current from the lamp in case it became overheated. More recently thin filaments of carbon have been employed by Swan, Edison, Lane-Fox, Maxim, Crookes, and others for the construction of little *incandescent lamps*. In these lamps the carbon filament is mounted upon conducting wires, usually of platinum, which pass into a glass bulb, into

which they are sealed, the bulbs being afterwards exhausted of air and other gases, the vacuum being made very perfect by the employment of special mercurial air-pumps. Carbon is better for this purpose than platinum or any other metal, partly because of its superior infusibility and higher resistance, and partly because of the remarkable property of carbon of offering a lower resistance when hot than when cold. This property, which is the reverse of that observed in metals, renders it less

liable to become overheated. The forms of several incandescent lamps are shown in Fig. 140. Swan (1) prepares his filament from cotton thread parchmented in sulphuric acid and afterwards carbonised; such a filament becoming remarkably elastic and

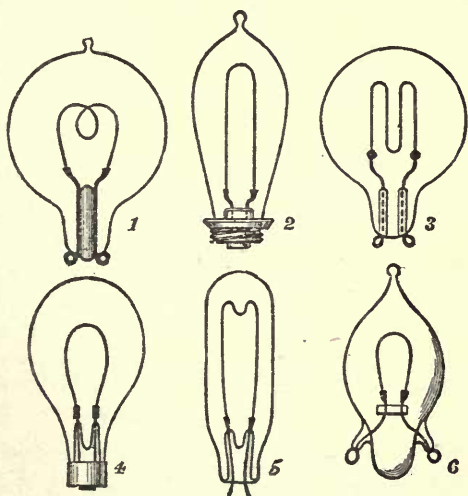

Fig. 140

metal-like in the process. Edison (2) now uses a thin flat strip of carbonised bamboo instead of a filament. Maxim (3) uses a preparation of paper. Lane-Fox (4) and Akester (6) use prepared and carbonised vegetable fibres. Crookes (5) employs a filament made from animal or vegetable matter parchmented by treatment with cuprammonic chloride. The resistance of such lamps varies according to size and length of the filament from 3 to 200 *ohms*. The current necessary to heat the

filaments white-hot is usually from 1 to 1.3 *ampère*. To produce this current the electromotive force that must be applied is dependent on the resistance of the lamp. Suppose a lamp the resistance of which is 60 *ohms* when cold and 40 *ohms* when hot: the requisite current will be obtained by applying an electromotive force of about 50 *volts*, because $50 \div 40 = 1.25$ *ampère*. The best economy is obtained with very thin cylindrical filaments of high resistance. Flat strips of carbon which expose a disproportionate amount of surface, and thick filaments in which the mass of carbon is considerable, are open to objection. Well-made lamps, if not overheated, will last 1000 to 1200 hours before the filament disintegrates. It is usual to group these lamps in parallel arc between the leading main conductor and the return main, so that each lamp is independent of the others if the electromotive force of the supply is constant. The light emitted varies according to the size of lamp from 2 to 50 candles. There appears to be some difficulty in obtaining durable filaments that will bear being made incandescent to a higher candle power.

LESSON XXXIII.—*Electromotors (Electromagnetic Engines)*.

375. Electromotors.—Electromagnetic engines, or electromotors, are machines in which the motive power is derived from electric currents by means of electromagnets. In 1821 Faraday showed a simple case of rotation produced between a magnet and a current of electricity. In 1831 Henry, and in 1833 Ritchie, constructed electromagnetic engines producing rotation by electromagnetic means. Fig. 141 shows a modification of Ritchie's electromotor. An electromagnet DC, is poised upon a vertical axis between the poles of a fixed magnet (or electromagnet) SN. A current, generated by a suitable battery, is carried by wires which terminate

in two mercury-cups, A, B, into which dip the ends of the coil of the movable electromagnet CD. When a current traverses the coil of CD it turns so as to set itself in the line between the poles NS, but as it swings round, the wires that dip into the mercury-cups pass from one cup to the opposite, so that, at the moment when C approaches S, the current in CD is reversed, and C is repelled from S and attracted round to N, the current through CD being thus reversed every half turn. In larger electromotors, the mercury-cup arrangement is replaced by a commutator, consisting of a brass ring, slit into two or more parts, and touched at opposite points by a pair of metallic springs or "contact brushes."

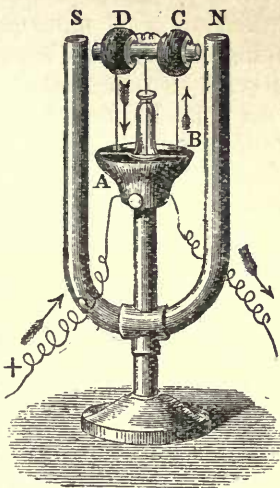

Fig. 141.

In another form of electromotor, devised by Froment, bars of iron fixed upon the circumference of a rotating cylinder are attracted up towards an electromagnet, in which the current is automatically broken at the instant when each bar has come close up to its poles. In a third kind, an electromagnet is made to attract a piece of soft iron alternately up and down, with a motion like the piston of a steam-engine, which is converted by a crank into a rotatory motion. In these cases the difficulty occurs that, as the attraction of an electromagnet falls off nearly in inverse proportion to the square of the distance from its poles, the attracting force can only produce effective motion through very small distances.

The dynamo-electric machines of Gramme, Siemens, and others, described in Arts. 407 to 411, will also work

as electromotors, and, indeed, are the most efficient of electromagnetic engines.

In 1839 Jacobi propelled a boat along the river Neva at the rate of $2\frac{1}{4}$ miles per hour with an electromagnetic engine of about one horse-power, worked by a battery of 64 large Grove's cells.

In 1882 an iron screw-boat capable of carrying 12 persons, and driven by two Siemens' dynamos, with a power of about 3 horse-power, the electricity being furnished by 45 accumulators of the Sellon-Volckmar type, has been worked upon the Thames at a speed of 8 miles per hour.

Electric railways on which trains are propelled by power furnished by dynamo-electric generators stationed at some fixed point, and communicating with the electromagnetic machinery of the train either by the rails or by a special conductor, have been constructed by Siemens in Berlin, and by Edison in Menlo Park.

376. Electric Transmission of Power to a distance.—The increasing use of dynamo-electric machines for electric lighting has revived the problem of transmitting power to a distance by electrical means, and so utilising waste water-power. A mountain stream may be made to turn a water-wheel or turbine, and drive a dynamo-electric machine, thereby generating currents which can be conveyed by wires to an electromotor at a distant point, and there reconverted into mechanical power. Whether such transmission is profitable or not depends on the *efficiency* of the machines employed.

377. Theory of Efficiency of Electromotors.—If a galvanometer be included in a circuit with a battery and an electromotor, it is found that the current is *weaker* when the electromotor is working than when the electromotor is standing still, and that the faster the electromotor runs the weaker does the battery current become. This is due to electromagnetic induction (Art. 391) between the

moving and fixed parts of the electromotor, which, as it spins round, generates a back-current. The electromotive-force due to this inductive action increases with the speed of the electromotor, so that the back-current is strongest when it runs fastest. If the motor be loaded so as to do work by moving slowly against considerable forces, the back-current will be small, and only a small proportion of the energy of the current will be turned into useful work. If it be set to run very quickly, so as to generate a considerable back-current, it will utilise a larger proportion of the energy of the direct current, but can only run fast enough to do this if its load be very light. Jacobi calculated that the practical efficiency lay between these two extremes, and that an electromotor would turn the energy of a battery into work in the most effective way when it was allowed to do its work at such a speed that the battery current was thereby reduced to *half* its strength. This is indeed true if it be desired to do the work at the quickest possible rate. But where economy in working is desired, and when it is not needful to get through the work as rapidly as possible, or to consume materials in the battery at a great rate, then a higher economic efficiency will be attained by making the electromotor do lighter work and spin at a greater speed; for if the electromotive-force of the battery be E volts, and the counter electromotive-force of the motor while running be e volts, then the efficiency of the motor (that is to say, the ratio which the work it takes up from the current bears to the whole energy of the current) will be equal to $\frac{e}{E}$. Now if the motor be allowed to run more quickly e will increase proportionately, and if it runs very quickly e may become very nearly equal to E ; that is to say, the motor will utilise very nearly all the energy of the current. But since, by Ohm's law, the current is $= \frac{E - e}{R}$, it follows that if e is very nearly as great as E , the current will be reduced to a small fraction of its original strength. The materials of the battery will be

more slowly used, and it will take a longer time to do the total amount of the work, but the *percentage* of energy of the current turned into work will be higher. A good modern dynamo-electric machine (Art. 408) used as a motor can attain an efficiency of over 90 per cent.

378. Cost of Working.—The cost of working electromotors by batteries is great. A pound of zinc contains only about $\frac{1}{6}$ as much potential energy as a pound of coal, and it costs more than twenty times as much: the relative cost for equal amounts of energy is therefore about 120:1. But, as shown above, an electromagnetic engine will turn 85 per cent of the electric energy into work, while even good steam-engines only turn about 10 to 20 per cent of the energy of their fuel into work, small steam-engines being even less efficient. But, reckoning electromagnetic engines as being 5 times as “efficient” as steam-engines of equal power, the necessary zinc is still 24 times as dear as the equivalent amount of coal. This calculation does not take into account the cost of acids of the batteries. In fact, where strong currents are wanted, batteries are abandoned in favour of dynamo-electric machines, worked by steam or water power, or by gas-engines.

In the case of transmission of power, as in the preceding paragraph, the expense may be far smaller if the original water-power costs little. The dynamo-machine may turn 90 per cent of the mechanical power into the energy of electric currents, and the electromotor may convert back 85 per cent of the current energy (or 75 per cent of the original power) into work.

378. (bis) Calculation of Electric Power.—The *mechanical work* of a current may be calculated as follows: A current whose strength is C conveys through the circuit in t seconds a quantity of electricity = Ct . But the number of *ergs* of work W , done by a current is equal to the product of the quantity of electricity into the difference of potentials E through which it is trans-

ferred (Art. 367), provided these latter are expressed in "absolute" C.G.S. units; or

$$CtE = W$$

Now if W *ergs* of work are done in t seconds, the rate of working is got by dividing W by t ; whence

$$CE = \frac{W}{t}$$

If C and E are expressed in *ampères* and *volts* respectively, and it is desired to give the rate of working in horse-power, it must be remembered that 1 *ampère* = 10^{-1} C.G.S. units of current; that 1 *volt* = 10^8 C.G.S. units of E.M.F.; and that 1 *horse-power* (as defined by Watt) = 550 foot-pounds per second = 76 kilogramme-metres per second = 76×10^5 gramme-centimetres per second = 746×10^7 *ergs* per second, whence

$$\frac{C \text{ ampères} \times E \text{ volts}}{746} = \text{rate of doing work in H.-P.}$$

For example, to find the rate at which actual work is consumed in an electric lamp: measure the whole current in *ampères*; measure the difference of potential between the terminals of the lamp in *volts*; multiply them together and divide by 746; the result will be the number of horse-power used up in the lamp: or the rule may be written thus:—

$$\text{H.-P} = CE \times 0.00134.$$

A convenient "*electric power-meter*" may be made of an electro-dynamometer (Art. 336) having the fixed coil of thick wire to receive the whole current, and having the movable coil of many turns of thin wire arranged as a shunt to the lamp or dynamo whose power is to be measured.

It has been proposed by Preece and by Siemens to call the unit of electric power (*i.e.* one *ampère* working through one *volt*) a *watt*. One horse-power will equal 746 *watts*.

CHAPTER VIII.

THERMO-ELECTRICITY.

LESSON XXXIV.—*Thermo-Electric Currents.*

379. In 1822 Seebeck discovered that a current may be produced in a closed circuit by heating a point of contact of two dissimilar metals. Thus, if a piece of bismuth and a piece of antimony be soldered together, and their free ends be connected with a short-coil galvanometer, it is found that if the junction be warmed to a temperature higher than that of the rest of the circuit, a current flows whose direction across the heated point is from bismuth to antimony, the strength of the current being proportional to the excess of temperature. If the junction is cooled below the temperature of the rest of the circuit a current in the opposite direction is generated. The electromotive-force thus set up will maintain a constant current so long as the excess of temperature of the heated point is kept up, heat being all the while absorbed in order to maintain the energy of the current. Such currents are called *Thermo-electric currents*, and the electromotive-force producing them is known as *Thermo-electromotive-force*.

380. Peltier Effect. — In 1834 Peltier discovered a phenomenon which is the converse of that discovered by Seebeck. He found that if a current of electricity from a battery be passed through a junction of dissimilar metals the junction is either heated or cooled, according

to the direction of the current. Thus a current which passes through a bismuth-antimony pair in the direction from bismuth to antimony absorbs heat in passing the junction of these metals, and cools it; whereas, if the current flow from antimony to bismuth across the junction it evolves heat, and the junction rises in temperature.

This phenomenon of heating (or cooling) by a current, where it crosses the junction of two dissimilar metals (known as the "Peltier effect," to distinguish it from the ordinary heating of a circuit where it offers a resistance to the current, which is sometimes called the "Joule effect"), is utterly different from the evolution of heat in a conductor of high resistance, for (a) the Peltier effect is *reversible*, the current heating or cooling the junction according to its direction, whereas a current meeting with resistance in a thin wire heats it in whichever direction it moves; and (b) the amount of heat evolved or absorbed in the Peltier effect is proportional simply to the strength of the current, not to the *square* of that strength as the heat of resistance is.

The complete law of the heat developed in a circuit will therefore require to take into account any Peltier effects which may exist at metal junctions in the circuit. If the letter P stand for the difference of potential due to the heating of the junction, expressed as a fraction of a volt, then the complete law of heat is

$$H = 0.24 \times (C^2R \pm PC)$$

which the student should compare with Joule's law in Art. 367. The quantity called P is also known as *the coefficient of the Peltier effect*; it has different values for different pairs of metals, and is numerically equal to the number of *ergs* of work which are the dynamical equivalent of the heat evolved at a junction of the particular metals by the passage of one *ampère* of electricity through the junction.

381. Thermo-electric Laws.—The thermo-electric properties of a circuit are best studied by reference to the simple circuit of Fig. 142, which represents a

bismuth-antimony pair united by a copper wire. Volta's law (Art. 72) concerning the difference of potentials due to contact would tell us that when all are at one

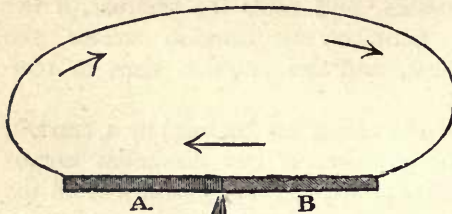

Fig. 142.

temperature the difference of potentials between bismuth and copper in one direction is equal to the sum of the differences between bismuth and antimony, and between antimony and copper in the

other direction, and that hence there would be equilibrium between the opposing and equal electromotive-forces. But when a junction is heated this equilibrium no longer exists and Volta's law ceases to be true. The new electromotive-force set up at the heated junction is found to obey the following laws:—

- (i.) *The thermo-electromotive-force is, for the same pair of metals, proportional (even through considerable ranges of temperature) to the excess of temperature of the junction over the rest of the circuit.*
- (ii.) *The total thermo-electromotive-force in a circuit is the sum of all the separate thermo-electromotive-forces at the various junctions.*

It follows from this law that the various metals can be arranged, as Seebeck found, in a series, according to their thermo-electric power, each one in the series being thermo-electrically positive (as bismuth is to antimony) toward one lower down. The following is the thermo-electric series of metals, together with the differences of potentials (in microvolts) which they exhibit with a difference of temperature of 1°C , lead being regarded as the standard zero metal.

+ Bismuth	89 to 97
German-silver	11·75
Lead	0
Platinum	-- 0·9
Zinc	-- 3·7
Copper	-- 3·8
Iron	-- 17·5
- Antimony	-- 22·6 to -- 26·4

A very small amount of impurity may make a great difference in the thermo-electric power of a metal, and some alloys, and some of the metallic sulphides, as galena, exhibit extreme thermo-electric power.

The electromotive-forces due to heating single pairs of metals are very small indeed. If the junction of a copper-iron pair be raised 1°C above the rest of the circuit its electromotive-force is only 13·7 millionths of a volt (*i.e.* 13·7 microvolts). That of the more powerful bismuth-antimony pair is for 1°C , about 117 microvolts.

382. Thermo-electric Inversion.—Cumming discovered that in the case of iron and other metals an inversion of their thermo-electric properties may take place at a high temperature. In the case of the copper-iron pair the temperature of 280° is a neutral point; below that temperature the current flows through the hotter junction from the copper to the iron; but when the circuit is above that temperature iron is thermo-electrically positive to copper.

383. Thermo-electric Diagram.—The facts of thermo-electricity are best studied by means of the diagram (Fig. 143) suggested by Sir W. Thomson and constructed by Professor Tait. The horizontal divisions represent temperatures, the vertical distances differences of potential divided by absolute temperatures, on a scale of millionths of volts per degree. These differences are measured with respect to the metal lead, which is taken as the standard of zero at all temperatures, because, while with other metals there appears to be a difference of potentials between the metal hot and the same metal

cold, hot lead brought into contact with cold lead shows no perceptible difference of potential.

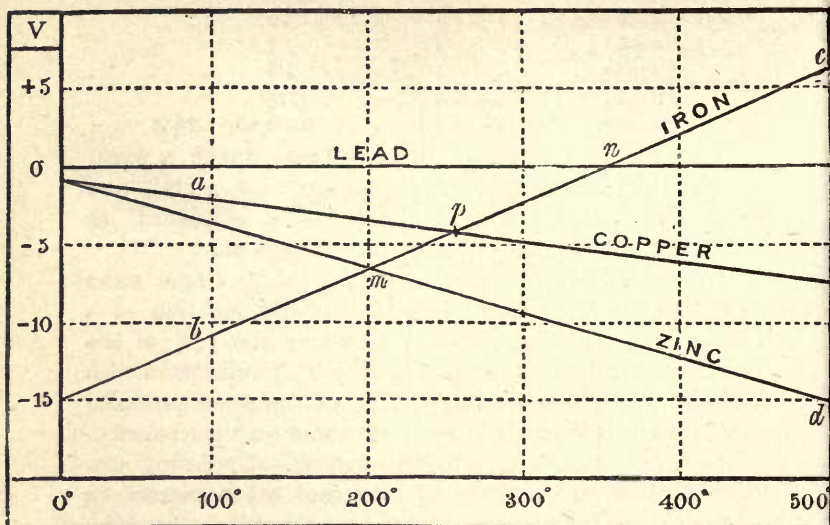

Fig. 143.

An example will illustrate the usefulness of the diagram. Let a circuit be made by uniting at both ends a piece of iron and a piece of copper; and let the two junctions be kept at 0° and 100° respectively by melting ice and boiling water. Then the total electromotive-force round the circuit is represented by the area $a, o, -15, b$. The slope of the lines for the various metals represents the property referred to above, of an electromotive-force between differently heated portions of the same metal accompanied by an absorption or evolution of heat when the current flows from a hotter to a colder portion of the same metal. This effect, known as the Thomson effect from its discoverer Sir W. Thomson, is opposite in iron to what it is in copper or zinc. In copper, when a current of electricity flows from a hot to a cold point, it evolves heat in the copper, and it absorbs heat when it flows from a cold point to a hot point in the copper. In iron a current flowing from a hot point to a cold point absorbs heat.

384. Thermo-electric Piles.—In order to increase.

the electromotive-force of thermo-electric pairs it is usual to join a number of pairs of metals (preferably bismuth and antimony) in series, but so bent that the *alternate* junctions can be heated as shown in Fig. 144 at B B B,

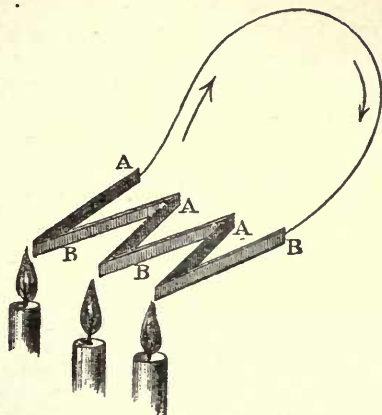

Fig. 144.

whilst the other set A A A are kept cool. The various electromotive-forces then all act in the same direction, and the current is increased in proportion to the number of pairs of junctions. Powerful thermo-electric batteries have been made by Clamond,—an iron-galena battery of 120 pairs affording a strong current; but it is extremely difficult to maintain them in effective action for long, as they fail after continued use, probably owing to a permanent molecular change at the junctions. In the hands of Melloni the thermo-electric pile or **thermopile**, constructed of many small pairs of antimony and bismuth united in a compact form, proved an excellent electrical thermometer when used in conjunction with a sensitive short-coil astatic galvanometer like that of Fig. 88. For the detection of excessively small differences of temperature the thermopile is an invaluable instrument, the currents being proportional to the differ-

ence of temperature between the hotter set of junctions on one face of the thermopile and the cooler set on the other face. The arrangement of the thermopile and galvanometer for this purpose is shown in Fig. 145.

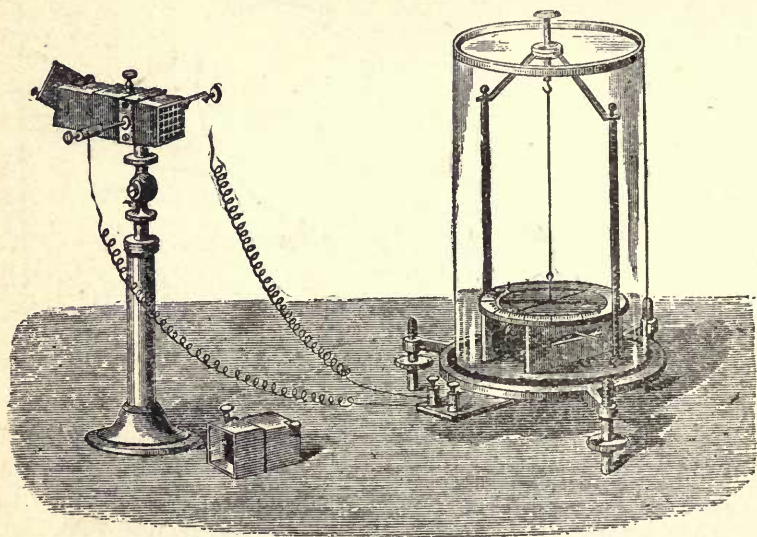

Fig. 145

CHAPTER IX.

ELECTRO-OPTICS.

LESSON XXXV.—*General Relations between Light and Electricity.*

385. Of late years several important relations have been observed between electricity and light. These relations may be classified under the following heads:—

- (i.) Production of double refraction by dielectric stress.
- (ii.) Rotation of plane of polarisation of a ray of light on traversing a transparent medium placed in a magnetic field, or by reflection at the surface of a magnet.
- (iii.) Change of electric resistance, exhibited by selenium and other bodies during exposure to light.
- (iv.) Relation between refractive index and dielectric capacity of transparent bodies.

It was announced by Mrs. Somerville; by Zantedeschi, and others, that steel needles could be magnetised by exposing portions of them to the action of violet and ultra-violet rays of light; the observations were, however, erroneous.

386. *Electrostatic Optical Stress.*—In 1875 Dr. Kerr of Glasgow discovered that glass when subjected to a severe electrostatic stress undergoes an actual strain, which can be observed by the aid of a beam of polarised light. In the original experiment two wires were fixed into holes drilled in a slab of glass, but not quite meeting,

so that when these were placed in connection with the terminals of an induction coil or of a Holtz machine the accumulating charges on the wires subjected the intervening dielectric to an electrostatic stress. The slab when placed between two Nicol prisms as polariser and analyser¹ exhibited double refraction. The behaviour of the glass was as if it had been subjected to a pull along the direction of the electric force, *i.e.*, as if it had expanded along the lines of electrostatic induction. Later, he found that bisulphide of carbon and other insulating liquids exhibit similar phenomena, but that of these the fatty oils of animal and vegetable origin exhibited an action in the negative direction, as if they had contracted along the lines of induction. It is found that *the quantity of optical effect (i.e., the difference of retardation between the ordinary and extraordinary rays) per unit thickness of the dielectric is proportional to the square of the resultant electric force.* The axis of double refraction is along the line of the electric force. Quincke has pointed out that these phenomena can be explained by the existence of electrostatic expansions and contractions, stated in Art. 273.

387. Magneto-optic Rotation of the Plane of Polarisation of a Ray of Light.—A ray of light is said to be *polarised* if the vibrations take place in one plane. Ordinary light can be reduced to this condition by passing it through a suitable polarising apparatus (such as a Nicol prism, a thin slice of tourmaline crystal, etc.) In 1845 Faraday discovered that a ray polarised in a certain plane can be twisted round by the action of a magnet, so that the vibrations are executed in a different plane. The plane in which a ray is polarised can be detected by observing it through a second Nicol prism (or tourmaline), for each such polariser is opaque to rays polarised in a plane at right angles to that plane

¹ The student is referred to Prof. Balfour Stewart's *Lessons on Elementary Physics* for further information concerning the properties of polarised light.

in which it would itself polarise light. Faraday caused a polarised ray to pass through a piece of a certain "heavy glass" (consisting chiefly of borate of lead), lying in a powerful magnetic field, between the poles of a large electromagnet, through the coils of which a current could be sent at pleasure. The emerging ray traversed a second Nicol prism which had been turned round until all the light was extinguished. In this position its own plane of symmetry was at right angles to the plane of polarisation of the ray. On completing the circuit, light was at once seen through the analysing Nicol prism, proving that the ray had been twisted round into a new position, in which its plane of polarisation was no longer at right angles to the plane of symmetry of the analyser. But if the analysing Nicol prism was itself turned round, a new position could be found (at right angles to the plane of polarisation of the ray) at which the light was once more extinguished. *The direction of the magneto-optic rotation of the plane of polarisation is the same (for diamagnetic media) as that in which the current flows which produces the magnetism.* Verdet, who repeated Faraday's experiments, using powerful electromagnets of the form shown in Fig. 127, discovered the important law that, with a given material, *the amount of rotation is proportional to the strength of the magnetic force H.* In case the rays do not pass straight along the direction of the lines of force (which is the direction of maximum effect), the amount of rotation is proportional to the cosine of the angle β between the direction of the ray and the lines of force. It is also proportional to the length l of the material through which the rays pass. These laws are combined in the equation for the rotation θ ;

$$\theta = w \cdot H \cdot \cos \beta \cdot l,$$

where w is a coefficient which represents the specific magnetic rotatory power of the given substance, and is known as "*Verdet's constant.*" Now, $H \cdot \cos \beta$ is the

resolved part of the magnetic force in the direction of the ray; and $H \cdot \cos \beta \cdot l$ is the difference of magnetic potential¹ between the point A where the ray enters and B where it leaves the medium. Hence w , the coefficient of specific magnetic rotatory power, is found by dividing the observed angular rotation by the difference of magnetic potential between the points where the ray enters and leaves the medium; or

$$w = \frac{\theta}{V_B - V_A}.$$

Different substances possess different magnetic rotatory powers. For diamagnetic substances the coefficient is usually positive; but in the case of many magnetic substances, such as solutions of ferric chloride, has a negative value; (*i.e.* in these substances the rotation is in the opposite direction to that in which the magnetising current flows). The phenomenon discovered by Hall (Art. 337) appears to be intimately related to the phenomenon of magneto-optic rotation.

	Coefficient of Specific Magnetic Rotation, (Verdet's Constant in C. G. S.)	Magnetic Rotatory Power.
Bisulphide of Carbon	1.5235×10^{-5}	1.000
Water	$.4693 \times 10^{-5}$.308
Heavy glass	2.665×10^{-5}	1.422

It is convenient, for purposes of reference, to take the rotatory power of bisulphide of carbon as unity. Careful measurements executed by J. E. H. Gordon have shown that the rotatory power of bisulphide of carbon, thus assumed as a standard, must be multiplied by 1.5235×10^{-5} to reduce it to C. G. S. measure; for he finds that

¹ For *force* \times *length* = *work*; and the work done in bringing a unit magnetic pole from A to B against the magnetic force measures the difference of magnetic potential. See Art. 310 (*e*).

this is the number of radians through which a polarised ray of green light (of thallium flame) will be rotated by traversing unit difference of potential. For rays of different colours the rotation is not equal, but varies (very nearly) inversely as the square of the wave-length; the rotation by bisulphide of carbon of red, green, and blue light (rays "C," "E," and "G"), being respectively as .60, 1.00, and 1.65. H. Becquerel, who gave this law, also found that for substances of similar nature the rotation depends on the refractive index, but in rather a complicated relation, being proportional to $\mu^2 (\mu^2 - 1)$; where μ is the refractive index.

Gases also rotate the plane of polarisation of light in a magnetic field with varying amounts; coal-gas and carbonic acid being more powerful than air or hydrogen; oxygen and ozone being negative. The rotation is in all cases very slight, and varies for any gas in proportion to the density—that is to the quantity of gas traversed. H. Becquerel has lately shown that the plane of the natural polarisation of the sky does not coincide with the plane of the sun, but is rotated by the influence of the earth's magnetism through an angle which, however, only reached 59' of arc at a maximum on the magnetic meridian.

388. **Photo-magnetic Properties of Iron.**—Dr. Kerr showed in 1877 that a ray of polarised light is also rotated when *reflected at the surface of a magnet* or electromagnet. When the light is reflected at a pole the plane of polarisation is turned in a direction contrary to that in which the magnetising current flows. If the light is reflected at a point on the side of the magnet it is found that when the plane of polarisation is parallel to the plane of incidence the rotation is in the same direction as that of the magnetising current; but that, when the plane of polarisation is perpendicular to the plane of incidence, the rotation is in the same direction as that of the magnetising current only when the incidence exceeds 75°.

Kundt showed in 1884 that a film of metallic iron so thin as to be transparent, placed across the lines of force of the magnetic field, rotates the plane of polarisation of transmitted light strongly in the direction in which the magnetising current flow

389. Photo-voltaic Properties of Selenium.—

In 1875 Willoughby Smith discovered that the metal *selenium* possesses the abnormal property of changing its electric resistance under the influence of light. Ordinary fused or vitreous selenium is a very bad conductor; its resistance being nearly forty-thousand-million (3.8×10^{10}) times as great as that of copper. When carefully annealed (by keeping for some hours at a temperature of about 220°C , just below its fusing point, and subsequent slow cooling), it assumes a crystalline condition, in which its electric resistance is considerably reduced. In the latter condition, especially, it is sensitive to light. Prof. W. G. Adams found that greenish-yellow rays were the most effective. He also showed that *the change of electric resistance varies directly as the square root of the illumination*, and that the resistance is less with a high electromotive-force than a low one. Lately, Prof. Graham Bell and Mr. Sumner Tainter have devised forms of "selenium cells," in which the selenium is formed into narrow strips between the edges of broad conducting plates of brass, thus securing both a reduction of the transverse resistance and a large amount of surface-exposure to light. Thus a cell, whose resistance in the dark was 300 ohms, when exposed to sunlight had a resistance of but 150 ohms. This property of selenium the latter experimenters have applied in the construction of the **Photophone**, an instrument which transmits sounds to a distance by means of a beam of light reflected to a distant spot from a thin mirror thrown into vibrations by the voice; the beam falling, consequently, with varying intensity upon a receiver of selenium connected in circuit with a small battery and a Bell telephone (Art. 435) in which the sounds are reproduced by the variations of the current.

Similar properties are possessed, to a smaller degree, by *tellurium*. Carbon is also sensitive to light.

About the middle of the present century Becquerel showed that when two plates of silver, coated with

freshly deposited chloride of silver, are placed in a cell with water and connected with a galvanometer, a current is observed to pass when light falls upon one of the two plates, the exposed plate acting as a negative pole.

390. Electromagnetic Theory of Light.—Clerk Maxwell proposed a theory of the relation between electromagnetic phenomena and the phenomena of light, based upon the assumption that each of these are due to certain modes of motion in the all-pervading "*æther*" of space, the phenomena of electric currents and magnets being due to streams and whirls, or other bodily movements in the substance of the *æther*, while light is due to vibrations to and fro in it.

We have seen (Arts. 115, 338, and 387) what evidence there is for thinking that magnetism is a phenomenon of rotation, there being a rotation of *something* around an axis lying in the direction of the magnetisation. Such a theory would explain the rotation of the plane of polarisation of a ray passing through a magnetic field. For a ray of plane-polarised light may be conceived of as consisting of a pair of (oppositely) circularly-polarised waves, in which the right-handed rotation in one ray is periodically counteracted by an equal left-handed rotation in the other ray; and if such a motion were imparted to a medium in which there were superposed a rotation (such as we conceive to take place in every magnetic field) about the same direction, one of these circularly-polarised rays would be accelerated and the other retarded, so that, when they were again compounded into a single plane-polarised ray, this plane would not coincide with the original plane of polarisation, but would be apparently turned round through an angle proportional to the superposed rotation.

It was pointed out (Art. 337) that an electric displacement produces a magnetic force at right angles to itself; it also produces (by the peculiar action known as induction) an electric force which is propagated at right angles both to the electric displacement and to the magnetic force. Now it is known that in the propagation of light the actual displacements or vibrations which constitute the so-called ray of light are executed in directions at right angles to the direction of propagation. This

analogy is an important point in the theory, and immediately suggests the question whether the respective rates of propagation are the same. Now the velocity of propagation of electromagnetic induction is that velocity " v " which was shown (Art. 365) to represent the ratio between the electrostatic and the electromagnetic units, and which (in air) is believed to be

$$2.9857 \times 10^{10} \text{ centimetres per second.}$$

And the velocity of light (in air) has been repeatedly measured (by Fizeau, Cornu, Michelson, and others) giving as the approximate value

$$2.9992 \times 10^{10} \text{ centimetres per second.}$$

The close agreement of these figures is at least remarkable. Amongst other mathematical deductions from the theory may be mentioned the following: (i.) all true conductors of electricity must be opaque¹ to light; (ii.) for transparent media the specific inductive capacity ought to be equal to the square of the index of refraction. Experiments by Gordon, Boltzmann, and others, show this to be approximately true for waves of very great wave-length. The values are shown below. For gases the agreement is even closer.

	K.	μ^2 .
Flint Glass .	3.162	2.796
Bisulphide of Carbon	1.812	2.606
Sulphur (mean)	4.151	4.024
Paraffin .	2.32	2.33

¹ The author of these Lessons has found that in some crystalline bodies which conduct electricity better in one direction than in another, the opacity to light differs correspondingly. Coloured crystals of *Tourmaline* conduct electricity better *across* the long axis of the crystal than *along* that axis. Such crystals are much more opaque to light passing *along* the axis than to light passing *across* it. And, in the case of rays traversing the crystal *across* the axis, the vibrations *across* the axis are more completely absorbed than those *parallel* to the axis: whence it follows that the transmitted light will be polarized.

Prof. H. Hertz has shown (1888) that invisible electric undulations are propagated across space just as light-waves are; for he has been able to produce the phenomena of interference between two sets of them.

CHAPTER X.

INDUCTION CURRENTS (Magneto-Electricity).

LESSON XXXVI.—*Currents produced by Induction.*

391. In 1831 Faraday discovered that currents can be induced in a closed circuit by moving magnets near it, or by moving the circuit across the magnetic field, and he followed up this discovery by finding that a current whose strength is changing may induce a secondary current in a closed circuit near it. Such currents, whether produced by magnets or by other currents, are known as **Induction Currents**. And the action of a magnet or current in producing such induced currents is termed **electromagnetic induction**.¹

392. **Induction Currents produced by a Magnet.**—If a coil of insulated wire be connected in circuit with a delicate (long-coil) galvanometer, and a magnet be inserted rapidly into the hollow of the coil (as in Fig.

¹ The student must not confuse this electromagnetic induction with the phenomenon of the electrostatic induction of one *charge* of electricity by another *charge*, as explained in Lesson III., and which has nothing to do with *currents*. Formerly, before the identity of the electricity derived from different sources was understood (Art. 218), electricity derived thus from the motion of magnets was termed *magneto-electricity*. For most purposes the adjectives *magneto-electric* and *electro-magnetic* are synonymous. The production of electricity from magnetism, and of magnetism from electricity, are, it is true, two distinct operations; but both are included in the branch of science denominated *Electromagnetics*.

146), a momentary current is observed to flow round the circuit while the magnet is being moved into the coil. So long as the magnet lies motionless in the coil it induces no currents. But if it be rapidly pulled out of

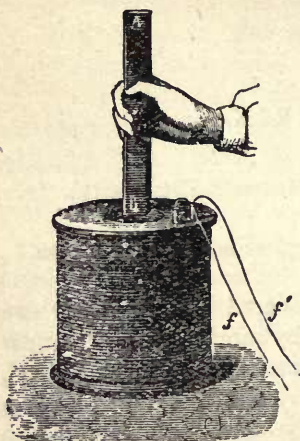

Fig. 146.

the coil another momentary current will be observed to flow, and in the opposite direction to the former. The induced current caused by inserting the magnet is an *inverse current*, or is in the opposite direction to that which would magnetise the magnet with its existing polarity. The induced current caused by withdrawing the magnet is a *direct current*.

Precisely the same effect is produced if the coil be moved towards the magnet as if the magnet were moved toward

the coil. The more rapid the motion is, the stronger are the induced currents.

393. Induction Currents produced by Currents.—Faraday also showed that the approach or recession of a current might induce a current in a closed circuit near it. This may be conveniently shown as an experiment by the apparatus of Fig. 147.

A coil is joined up to a sensitive galvanometer as before. A smaller coil of stout wire is connected to the poles of a battery (a single Bunsen's cell in Fig. 147), so as to be traversed by a current. On approaching or inserting the smaller or "*primary*" coil into the larger or "*secondary*" coil, a momentary inverse current is produced; and on removing it a momentary direct current (*i.e.*, one which runs the same way round the outer secondary coil as the primary current which

circulates in the inner coil) is observed. *Breaking* the battery circuit while the primary coil lies still within the

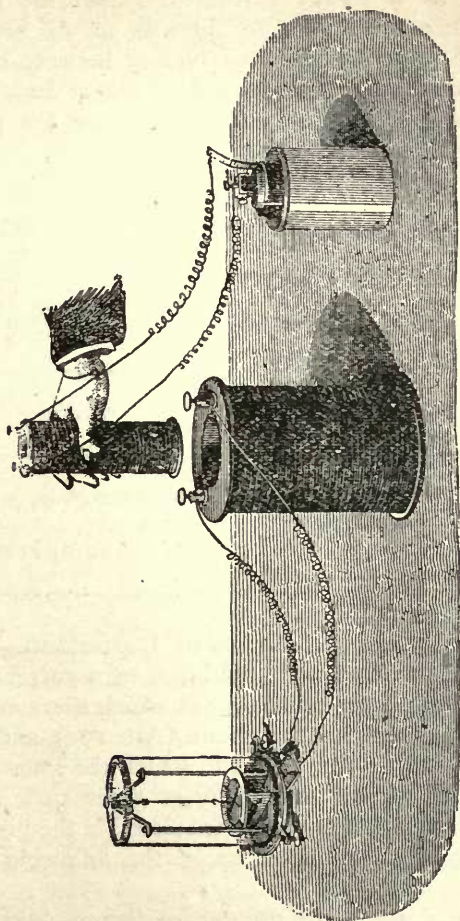

.Fig. 147.

secondary outer coil produces the same effect as if the primary coil were suddenly removed to an infinite distance. *Making* the battery circuit while the primary

coil lies within the secondary produces the same effect as plunging it suddenly into the coil.

So long as a steady current traverses the primary circuit there are no induced currents in the secondary circuit, unless there is *relative motion* between the two circuits: but moving the secondary circuit towards the primary has just the same effect as moving the primary circuit towards the secondary, and *vice versa*.

We may tabulate these results as follows:—

By means of	Momentary Inverse currents are induced in the secondary circuit	Momentary Direct currents are induced in the secondary circuit
Magnet	while <i>approaching</i> .	while <i>receding</i> .
Current	while <i>approaching</i> , or <i>beginning</i> , or <i>increasing</i> in strength.	while <i>receding</i> , or <i>ending</i> , or <i>decreasing</i> in strength.

394. Fundamental Laws of Induction.—When we reflect that every circuit traversed by a current has a field of magnetic force of its own in which there are lines-of-force running through the circuit (Art. 192), and that a coil of many turns has a field in which the lines-of-force are distributed almost identically as those of a magnet are, we shall see that the facts tabulated in the preceding paragraph may be summed up in the following fundamental laws:—

- (i.) *A decrease in the number of lines-of-force which pass through a circuit produces a current round the circuit in the positive direction (i.e., produces a "direct" current); while an increase in the number of lines-of-force which pass through the*

circuit produces a current in the negative direction round the circuit.

Here we suppose the *positive* direction along lines-of-force to be the direction along which a free N.-pole would tend to move, and positive direction round the circuit to be the same as the direction in which the hands of a clock move. (See also p. 275.)

(ii.) *The total induced electromotive-force acting round a closed circuit is equal to the rate of decrease in the number of lines-of-force which pass through the circuit.*

Suppose at first the number of lines-of-force passing through the circuit to be N_1 , and that after a very short interval of time, t , they are N_2 , then the total induced electromotive-force E is

$$E = \frac{N_1 - N_2}{t} :$$

By Ohm's law, $C = E \div R$, therefore

$$C = \frac{N_1 - N_2}{R t} :$$

If N_2 is greater than N_1 , and there is an *increase* in the number of lines-of-force, then $N_1 - N_2$ will be a negative quantity, and C will have a negative sign, showing that the current is an *inverse* one.

A reference to Fig. 134 will make this important law clearer. Suppose ABCD to be a wire circuit of which the piece AB can slide along DA and CB towards S and T. Let the vertical arrows represent vertical lines of force in a uniform magnetic field, and show (as is the case with the vertical components of the earth's lines-of-force in the northern hemisphere) the direction in which a N.-pointing pole would move if free. The positive direction of these lines of force is therefore vertically downwards through the circuit. Now if AB slide towards ST with a uniform velocity it will cut a certain number of lines-of-force every second, and a certain number will be added during every second of time to the total number passing through the circuit. If N_1 be the number at the beginning, and N_2 that at the end of a circuit, $N_1 - N_2$ will be a negative quantity, and there will be an electromotive-force round the circuit whose direction through the sliding piece is from A towards B.

395. The following adaptation of Ampère's rule to the case of induction may be useful: *Suppose a figure swimming in any conductor to turn so as to look along the (positive direction of the)*

lines-of-force, then if he and the conductor be moved towards his right hand he will be swimming with the current induced by this motion; if he be moved towards his left hand, the current will be against him.

396. Lenz's Law.—In Art. 320 it was laid down that a circuit traversed by a current experiences a force tending to move it so as to include the greatest possible number of lines-of-force in the embrace of the circuit. But if the number of lines-of-force be increased, during the increase there will be an opposing (or negative) electromotive-force set up, which will tend to stop the original current, and therefore tend to stop the motion. • If there be no current to begin with, the motion will generate one, which being in a negative direction will tend to diminish the number of lines-of-force passing through the circuit, and so stop the motion. Lenz, in 1834, summed up the matter by saying that *in all cases of electromagnetic induction the induced currents have such a direction that their reaction tends to stop the motion which produces them.* This is known as Lenz's Law.

397. Mutual Induction of Two Circuits.—In Art. 320 it was shown that when two circuits, in which currents of unit strength are flowing, are placed near together, they have a mutual potential whose value we called M . This symbol M , upon investigation, was found to represent the number of lines-of-force which each circuit induced through the other circuit, or was "the number of each other's lines-of-force mutually intercepted by both circuits when each carries unit current." This number depended upon the form and position of the circuits, and was greatest when they were brought as near together as possible. Hence we may regard this quantity M as the "coefficient of mutual induction" of the two circuits; and any movement of either circuit which alters the number of lines-of-force passing mutually through them, will be accompanied by the production of induced currents in each. It can be shown mathematically that, in the case of two simple circular circuits of equal size, enclosing area S , the greatest number of lines-of-force

each can induce through the other, when each carries unit current, is $4\pi S$. which is the maximum value of M . If the circuits are not simple, but have respectively m turns and n turns, then the value of M will be $4\pi S \times mn$. when the circuits coincide with each other.

398. The Induction Coil.—Induced currents have in general enormously high electromotive-forces, and are able to spark across spaces that ordinary battery currents cannot possibly cross. In order to observe these effects a piece of apparatus invented by Mason, and improved by Ruhmkorff, and termed the **Induction Coil** or **Inductorium** (Fig. 148), is used. The induction coil consists of a cylindrical bobbin having a central iron core

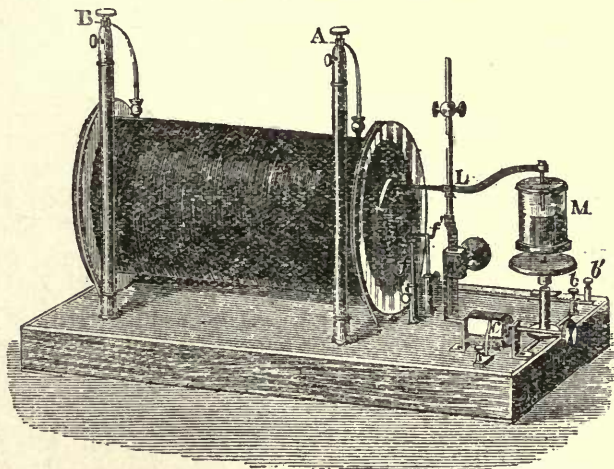

Fig. 148.

surrounded by a short inner or "primary" coil of stout wire, and by an outer "secondary" coil consisting of many thousand turns of very fine wire, very carefully insulated between its different parts. The primary circuit is joined to the terminals of a few powerful Grove's or Bunsen's cells, and in it are also included an interruptor, and a commutator or key. The object of the interruptor is

to make and break the primary circuit in rapid succession. The result of this is at every "make" to induce in the outer "secondary" circuit a momentary inverse current, and at every "break" a powerful momentary direct current. The currents at "make" are suppressed, as explained below: the currents at "break" manifest themselves as a brilliant torrent of sparks between the ends of the secondary wires when brought near enough together. The primary coil is made of stout wire, that it may carry strong currents, and produce a powerful magnetic field at the centre, and is made of few turns to keep the resistance low, and to avoid self-induction of the primary current on itself. The central iron core is for the purpose of increasing, by its great coefficient of magnetic induction, the number of lines-of-force that pass through the coils: it is usually made of a bundle of fine wires to avoid the induction currents, which if it were a solid bar would be set circulating in it, and which would retard its rapidity of magnetisation or demagnetisation. The secondary coil is made with many turns, in order that the coefficient of mutual induction may be large; and as the electromotive-force of the induced currents will be thousands of volts, its resistance will be immaterial, and it may be made of the thinnest wire that can conveniently be wound. In Mr. Spottiswoode's giant Induction Coil (which yields a spark of $42\frac{1}{2}$ inches' length in air, when worked with 30 Grove's cells), the secondary coil contains 280 miles of wire, wound in 340,000 turns, and has a resistance of over 100,000 ohms.

The interruptors of induction coils are usually self-acting. That of Foucault, shown with the coil in Fig. 148, consists of an arm of brass L, which dips a platinum wire into a cup of mercury M, from which it draws the point out, so breaking circuit, in consequence of its other end being attracted toward the core of the coil whenever it is magnetised; the arm being drawn back

again by a spring when, on the breaking of the circuit, the core ceases to be a magnet. A more common interruptor on small coils is a "break," consisting of a piece of thin steel which makes contact with a platinum point, and which is drawn back by the attraction of the core on the passing of a current; and so makes and breaks circuit by vibrating backwards and forwards just as does the hammer of an ordinary electric bell.

Associated with the primary circuit of a coil is usually a small *condenser*, made of alternate layers of tinfoil and paraffined paper, into which the current flows whenever circuit is broken. The object of the condenser is, firstly, to make the break of circuit more sudden by preventing the spark of the "extra-current" (due to self-induction in the primary circuit) (Art. 404) from leaping across the interruptor; and, secondly, to store up the electricity of this self-induced extra-current at break for a brief instant, and then discharge it back through the primary coil so as to hasten demagnetisation and so augment the induced direct electromotive-force in the secondary coil.

399. Ruhmkorff's Commutator.—In order to cut off or reverse the direction of the battery current at will, Ruhmkorff invented the *commutator* or *current-reverser*, shown in Fig. 149. In this instrument the battery poles are connected through the ends of the axis of a small ivory or ebonite cylinder to two cheeks of brass V and V', which can be turned so as to place them either way in contact with two vertical springs B and C, which are joined to the ends of the primary coil. Many other forms of commutator have been devised; one, much used as a key for telegraphic signalling, is drawn in Fig. 159.

400. Luminous Effects of Induction Sparks.—The induction coil furnishes a rapid succession of sparks with which all the effects of disruptive discharge may be studied. These sparks differ only in degree from those

furnished by friction machines and by Leyden jars (*see* Lesson XXIII. on Phenomena of Discharge).

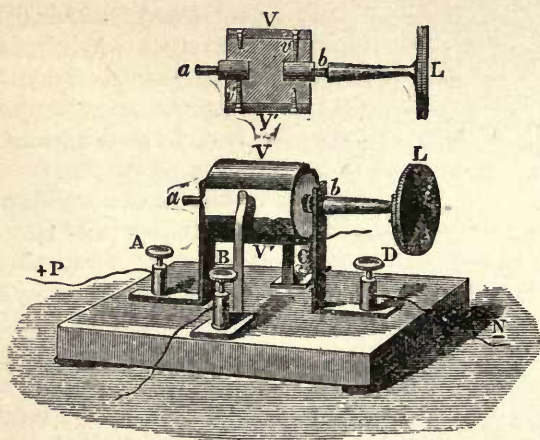

Fig. 149.

For studying discharge through glass vessels and tubes from which the air has been partially exhausted, the coil is very useful. Fig. 150 illustrates one of the many beautiful effects which can be obtained, the spark expanding in the rarefied gas into flickering sheets of light, exhibiting striæ and other complicated phenomena.

401. Currents Induced in Masses of Metal.—

A magnet moved near a solid mass or plate of metal induces in it currents, which, in flowing through it from one point to another, have their energy eventually frittered down into heat, and which, while they last, produce (in accordance with Lenz's law) electromagnetic forces tending to stop the motion. Several curious instances of this are known. Arago discovered that when a disc of copper is rotated in its own plane under a magnetic needle the needle turns round and follows the disc: and if a magnet is rotated beneath a balanced metal disc the disc follows the magnet. Attempts were made to account for these phenomena—known as

Arago's rotations—by supposing there to be a sort of magnetism of rotation, until Faraday proved them to be due to induction. A magnetic needle set swinging on its pivot comes to rest sooner if a copper disc lies beneath it, the induced currents stopping it. If a cube or disc of good conducting metal be set spinning between the poles of such an electromagnet as that drawn in Fig. 127, and the current be suddenly turned on, the spinning metal stops suddenly. If, by sheer force, a disc be kept spinning between the poles of a powerful electromagnet it will get hot in consequence of the induced currents flowing through it. In fact, any conductor moved forcibly across the lines-of-force of a magnetic field experiences a mechanical resistance due to the induced currents which oppose its motion.

402. Induction - currents from Earth's Magnetism.—It is easy to obtain induced currents from the earth's magnetism.

A coil of fine wire joined to a long-coil galvanometer, when suddenly inverted, cuts the lines-of-force of the earth's magnetism, and is traversed accordingly by a current.

Faraday, indeed, applied this method to investigate

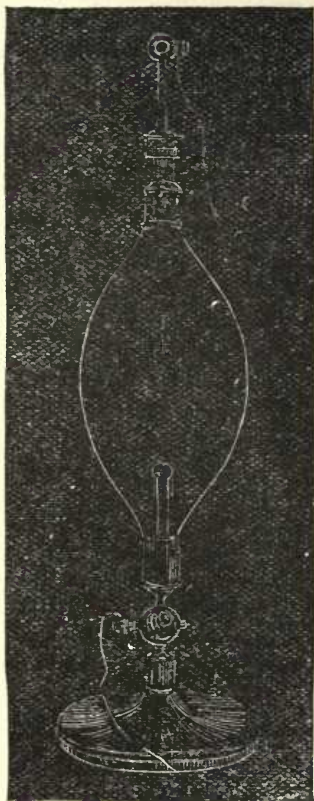

Fig. 150.

the direction and number of lines-of force. If a small wire coil be joined in circuit with a long coil galvanometer having a heavy needle, and the little coil be suddenly inverted while in a magnetic field, it will cut all the lines-of-force that pass through its own area, and the sine of half the angle of the first swing (see Art. 204) will be proportional to the number of lines of force cut; for with a slow-moving needle, the total quantity of electricity that flows through the coils will be the integral whole of all the separate quantities conveyed by the induced currents, strong or weak, which flow round the circuit during the rapid process of cutting the lines-of-force; and the little coil acts therefore as a *magnetic proof-plane*.

If the circuit be moved parallel to itself across a uniform magnetic field there will be no induction currents, for just as many lines-of-force will be cut in moving ahead in front as are left behind. There will be no current in a wire moved parallel to itself along a line-of-force; nor if it lie along such a line while a current is sent through it will it experience any mechanical force.

403. Earth Currents.—The variations of the earth's magnetism, mentioned in Lesson XII., alter the number of lines-of-force which pass through the telegraphic circuits, and hence induce in them disturbances which are known as "earth currents." During magnetic storms the earth currents on the British lines of telegraph have been known to attain a strength of 40 milli-ampères, which is stronger than the usual working currents. Feeble earth currents are observed every day, and are more or less periodic in character.

404. Self-Induction: Extra Currents.—In Art. 397 the induction of one circuit upon another was explained, and was shown to depend upon the number of lines-of-force due to one circuit which passed through the other, the coefficient of mutual induction M being the number of mutual lines-of-force embraced by both

circuits when each carried unit current. Now, if two such circuits approach one another so as actually to coincide, the *mutual* induction becomes a *self-induction* of the circuit on itself. For every circuit there is a *coefficient of self-induction*, whose value depends upon the form of the circuit, and which will be greater if the circuit be coiled up into many turns, so that one loop of the circuit can induce lines-of-force through another loop of the same. Let L represent the coefficient of self-induction of one circuit, and L' that of a second circuit equal to the first. When these two circuits coincide with one another their coefficient of mutual induction (*i.e.*, the number of lines-of-force running through both circuits, each carrying unit current) M will be equal to $L + L'$; or, $L = \frac{1}{2} M$. Now for two coincident circuits having n turns each, and each of area S (by Art. 397),

$$M = 4\pi S n^2;$$

hence the coefficient of self-induction for one circuit of n turns coiled up in one plane,

$$L = 4\pi S n^2.$$

The existence of self-induction in a circuit is attested by the so-called *extra-current*, which makes its appearance as a bright spark at the moment of breaking circuit. If the circuit be a simple one, and consist of a straight wire and a parallel return wire, there will be little or no self-induction; but if the circuit be coiled up, especially if it be coiled round an iron bar, as in an electromagnet, then on breaking circuit there will be a brilliant spark, and a person holding the two ends of the wires between which the circuit is broken may receive a slight shock, owing to the high electromotive-force of this self-induced extra current. The extra-current due to self-induction on "making" circuit is an inverse current, and gives no spark. but it prevents the battery current from rising at once to its full value. The extra-current on breaking circuit is a direct current, and therefore increases the strength of the current just at the moment when it ceases altogether.

405. Helmholtz's Equation—Helmholtz, who investigated mathematically the effect of self-induction upon the strength of a current, deduced the following important equations to express the relation between the self-induction of a circuit and the time required to establish the current at full strength :—

The current of self-induction at any moment will be proportional to the rate at which the current is increasing in strength. Let τ represent a very short interval of time, and let the current increase during that short interval from C to $C + c$. The actual increase during the interval is c , and the rate of increase in strength is $\frac{c}{\tau}$. Hence, if the coefficient of self-induction be L , the electromotive-force of self-induction will be $-L\frac{c}{\tau}$, and, if the whole resistance of the circuit be R , the strength of the opposing extra-current will be $-\frac{L}{R} \cdot \frac{c}{\tau}$ during the short interval τ ; and hence the actual strength of current flowing in the circuit during that short interval instead of being (as by Ohm's Law it would be if the current were steady) $C = E \div R$, will be

$$C = \frac{E}{R} - \frac{L}{R} \cdot \frac{c}{\tau}$$

To find out the strength at which the current will have arrived after a time t made up of a number of such small intervals added together requires an application of the integral calculus, which at once gives the following result :—

$$C = \frac{E}{R} \left(1 - e^{-\frac{R}{L}t} \right),$$

(where e is the base of the natural logarithms).

Put into words, this expression amounts to saying that after a lapse of t seconds *the self-induction in a circuit on making contact has the effect of diminishing the strength of the current by a quantity, the logarithm of whose reciprocal is inversely proportional to the coefficient of self-induction, and directly proportional to the resistance of the circuit and to the time that has elapsed since making circuit.*

A very brief consideration will show that in those cases where the circuit is so arranged that the coefficient of self-induction, L , is small as compared with the resistance R , the fraction $\frac{R}{L}$ will have a high value, and the term $\left(e^{-\frac{R}{L}t} \right)$ will vanish from the equation for all appreciable values of t ,

Where, however, L is large as compared with R , as in long coils, long lines of telegraph cable, etc., the value of this term, which stands for the *retardation due to self-induction*, may become considerable.

406. Induced Currents of Higher Orders.—Professor Henry discovered that the variations in the strength of the secondary current could induce tertiary currents in a third closed circuit, and that variations in the tertiary currents might induce currents of a fourth order, and so on. A single sudden primary current produces therefore two secondary currents (one inverse and one direct), each of these produces two tertiary currents, or four tertiary currents in all. But where the primary current simply varies in strength in a periodic rise and fall,—as when a musical note is transmitted by a microphone or telephone (Art. 435),—there will be the same number of secondary and tertiary fluctuations as of primary, each separate induction involving, however, a retardation of a quarter of the full period.

406 (bi.). Transformers.—Of late years a new use has been found for induction-coils for the distribution of rapidly alternating currents (see Art. 411 *d*) for electric lighting. Such induction-coils, known as transformers, usually consist of a core of thin plates or wires of iron, interlaced with two sets of copper-wire coils, a primary consisting of many turns of thin wire, to receive the incoming small currents at high potential, and a secondary consisting of a few turns of thick wire, to deliver the large currents which go out at low potential to the lamps. The number of watts given out by the secondary is, in a well-constructed transformer, equal, within a very small percentage to the number of watts supplied to the primary coil; whilst the volts of the secondary are to the volts at the primary in proportion to the respective number of turns in the two coils.

LESSON XXXVII.—*Magneto-electric and Dynamo-electric Generators.*

407. Faraday's discovery of the induction of currents in wires by moving them across a magnetic field suggested the construction of **magneto-electric machines**

to generate currents in place of voltaic batteries. In the early attempts of Pixii (1833), Saxton, and Clarke, bobbins of insulated wire were fixed to an axis and spun rapidly in front of the poles of strong steel magnets. But, since the currents thus generated were alternately inverse and direct currents, a *commutator* (which rotated with the coils) was fixed to the axis to turn the successive currents all into the same direction. The little magneto-electric machines, still sold by opticians, are on this principle. Holmes and Van Malderen constructed more powerful machines, the latter getting a nearer approach to a continuous current by combining around one axis sixty-four separate coils rotating between the poles of forty powerful magnets.

In 1856 Siemens devised an improved armature, in which the coils of wire were wound *lengthways* along a spindle of peculiar form, thereby gaining the advantage of being able to cut a greater number of lines-of-force when rotated in the powerful "field" between the poles of a series of adjacent steel magnets. The next improvement, due to Wilde, was the employment of electromagnets instead of steel magnets for producing the "field" in which the armature revolved; these electromagnets being excited by currents furnished by a small auxiliary magneto-electric machine, also kept in rotation.

408. Dynamo-electric Machines.—In 1867 the suggestion was made simultaneously, but independently, by Siemens and by Wheatstone, that a coil rotating between the poles of an electromagnet might from the feeble residual magnetism induce a small current, which, when transmitted through the coils of the electromagnet, might exalt its magnetism, and so prepare it to induce still stronger currents. Magneto-electric machines constructed on this principle, the coils of their field-magnets being placed in circuit with the coils of the rotating armature, so as to be traversed by the whole or by a portion of the induced currents, are known as **dynamo-**

electric machines or generators, to distinguish them from the generators in which permanent steel magnets are employed. In either case the current is due to magneto-electric induction; and in either case also the energy of the currents so induced is derived from the dynamical power of the steam-engine or other motor which performs the work of moving the rotating coils of wire in the magnetic field. Of the many modern machines on this principle the most famous are those of Siemens, Gramme, Brush, and Edison. They differ chiefly in the means adopted for obtaining practical continuity in the current. In all of them the electromotive-force generated is proportional to the number of turns of wire in the rotating armature, and (within certain limits) to the speed of revolution. When currents of small electromotive-force, but of considerable strength, are required, as for electroplating, the rotating armatures of a generator must be made with small internal resistance, and therefore of a few turns of stout wire or ribbon of sheet copper. For producing currents of high electromotive-force for the purpose of electric lighting, the armature must be driven very fast, and must consist of *many* turns of wire, or, where very small resistance is necessary (as in a system of lamps arranged in parallel arc), of rods of copper suitably connected.

There are several ways of arranging the coils upon the rotating armature, and the methods adopted may be classified as follows:—

1. *Drum* Armatures, in which the coils are wound longitudinally upon the surface of a cylinder or drum. Examples: the Siemens (Altneck) and Edison machines.
2. *Ring* Armatures, in which the coils are wound around a ring. Examples: the Pacinotti, Gramme, Brush, Gülcher, and Bürgin machines.
3. *Pole* Armatures, in which the coils are arranged radially with their poles pointing outwards. Example: Lontin machine.
4. *Disc* Armatures, having coils arranged in or on a disc. Examples: Niaudet, Wallace, Hopkinson, and Gordon. In an early machine by Faraday a simple copper disc rotating between the poles of a magnet generated a continuous current.

There are also several ways of arranging the coils of the field-magnets, giving rise to following classification:—

1. *Series-Dynamo*, wherein the coils of the field-magnets are in series with those of the armature and the external circuit.
2. *Shunt-Dynamo*, in which the coils of the field-magnets form a shunt or shunts to the main circuit; and being made of many turns of thinner wire, draw off only a fraction of the whole current.
3. *Separately-excited Dynamo*: one in which the currents used to excite the field-magnets are derived from a separate machine.
4. *Compound-Dynamo*: partly excited by shunt coils, partly by series coils.

All these varieties have their appropriate uses according to the conditions under which they are applied.

409. Siemens' Machine.—The dynamo-electric generator, invented by Siemens and Von Hefner Alteneck, usually called the **Siemens' machine**, is shown in Fig. 151. Upon a stout frame are fixed four powerful flat electromagnets, the right pair having their N.-poles facing one another and united by arched pieces or cheeks of iron. The two S.-poles of the left pair are similarly united. In the space between the right and left cheeks, which is, therefore, a very intense magnetic field, lies a horizontal axis, upon which rotates an armature consisting of fifty-six separate longitudinal coils, each end of each coil being connected with a copper bar forming one segment of the *collector* or *commutator* at the anterior end of the axis. This armature differs from the earlier simple longitudinal armature of Siemens only in the multiplication and arrangement of its parts, the division into so many paths giving a current which is practically continuous. The collector, made up, as said, of copper bars or segments fixed upon a cylinder of insulating material, may be regarded as a split-tube. The current cannot pass from one segment to the next without traversing one of the fifty-six coils of the armature; and, as the end of one coil and the beginning of the next are both connected to the same commutator bar, there is a continuous communication round the whole armature. Against the

commutator press a pair of metallic brushes or springs, as contact pieces, which touch opposite sides at points

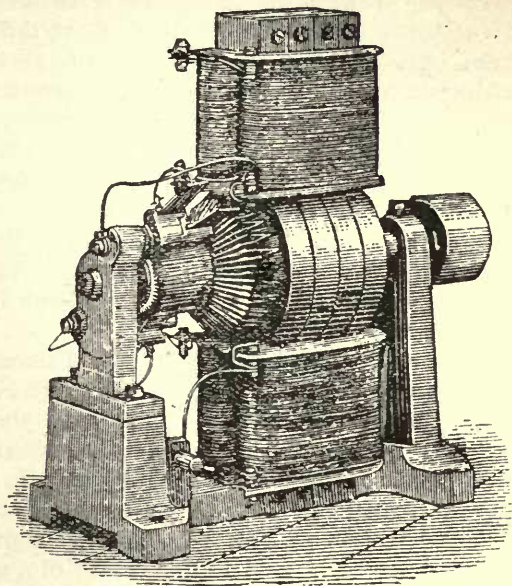

Fig. 151.

above and below, and so lead away into the circuit the current generated in the coils of the rotating armature. Suppose the lines-of-force in the field to run from right to left,¹ and the armature to rotate left-handedly, as seen in Fig. 151, then, by the rule given in Art. 395, in all

¹ Their direction is not exactly thus when the generator is working, as the magnetic force due to the currents in the coils, which is nearly horizontal in direction, changes the resultant magnetic force to an oblique direction across the field. It is for this reason that the commutator "brushes" have to be displaced with a certain angular "lead." A similar displacement of the brushes occurs in the Gramme and all other dynamo-electric generators, the degree of displacement to get maximum strength of current varying with the resistances in the external circuit and with the work done by the current.

the separate wires of the coils, moving upwards on the right, there will be currents induced in a direction from the back toward the front. In all the separate wires of the coils moving downwards on the left of the axis, the induced currents will be in a direction from the front toward the back. Hence, if the coils are joined as described to the commutator bars all the currents thus generated in one half of the coils will be flowing *into* the external circuit at one of the commutator brushes; and all the reverse currents of the other half of the coils will be flowing *out* of the other brush. The terminal screws connected by wires to the commutator brushes correspond to the + and - poles of a galvanic battery, the coils of the field-magnets being included in the external circuit.

410. Gramme's Machine.—In 1864 Pacinotti invented a magneto-electric machine, its armature being a toothed *ring of iron* with coils wound between the projections. In 1870 Gramme invented a dynamo-electric machine having a *ring* armature differing only in being completely overwound with coils of insulated copper wires. The principle of this generator is shown in diagram in Fig. 152. The ring itself, made of a bundle of annealed iron wires, is wound in separate sections, the ends of each coil being joined to strips of copper which are insulated from each other, and fixed symmetrically as a commutator around the axis, like a split tube. Their actual arrangement is shown again in Fig. 153. The coils of the separate sections of the ring are connected together in series, each strip of the commutator being united to one end of each of two adjacent coils. Against the split-tube collector press metallic brushes to receive the current. When this ring is rotated the action is as follows:—Suppose (in Fig. 152) the ring to rotate in the opposite direction to the hands of a clock in the magnetic field between the N and S-poles of a magnet (or electro-magnet), and that the positive direc-

tion of the lines of force is from N to S. As a matter of fact the lines will not be straight across from N to S, because the greater part of them will pass into the ring near N and traverse the iron of the ring to near S, where they emerge; the space within the ring being almost entirely destitute of them. Consider one single coil of the wire wrapped round the ring at E'' which is ascending

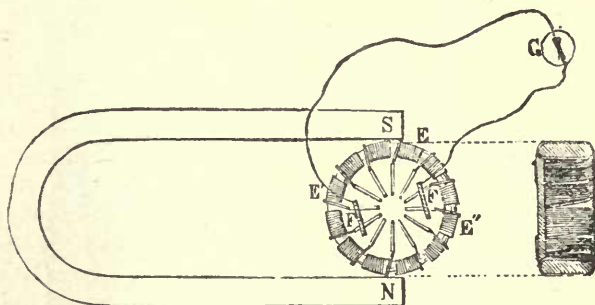

Fig. 152.

toward S; the greatest number of lines-of-force will pass through its plane when it lies near E'', at right angles to the line NS. As it rises toward S and comes to E the number of lines-of-force that traverse it will be steadily diminishing, and will reach zero when it comes close to S and lies in the line NS, edgewise to the lines-of-force. As it moves on toward E' it will again enclose lines-of-force, which will, however, pass in the negative direction through its plane, and at E' the number of such negative lines-of-force becomes a maximum. Hence, through all its journey from E'' to E' the number of (positive) lines-of-force embraced by a strand of the coils has been diminishing; during its journey round the other half from E' to E'' again, the number will be increasing. Therefore, by the rule given in Art. 395, in all the coils moving round the upper half of the ring direct currents are being

generated, while in the coils of the lower half of the ring *inverse* currents are being generated. Hence there is a constant tendency for electricity to flow from the left side at E' both ways round towards the right side at E'' , and E'' will be at a higher potential than E' . A continuous

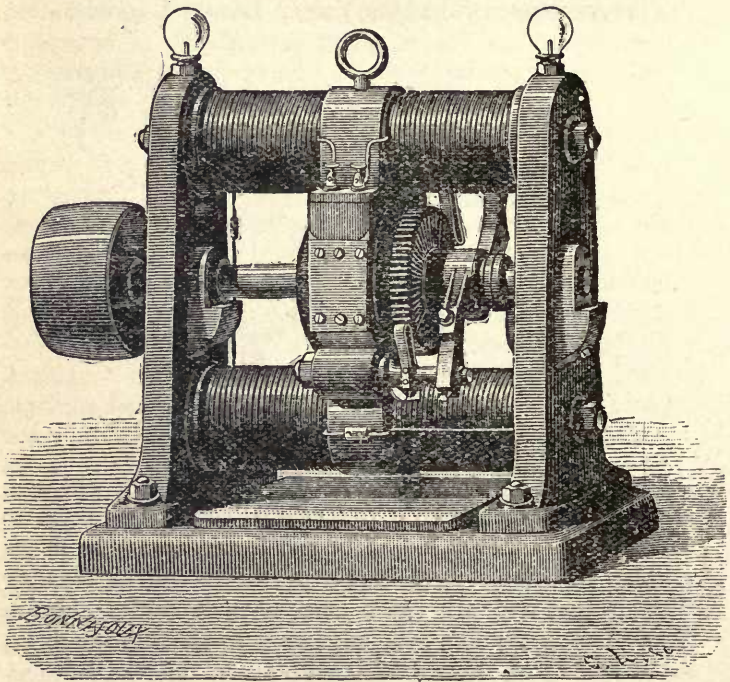

Fig. 153.

current will therefore be generated in an external wire, making contact at F and F' by means of brushes, for as each successive coil moves up towards the brushes the induced current in it increases in strength, because the coils on each side of this position are sending their induced currents also toward that point. Fig. 153 shows the little Gramme machine, 21 inches high, suitable for

producing an electric arc light when driven by a $2\frac{1}{2}$ horse-power engine. Above and below are opposite pairs of powerful electro-magnets, whose iron pole-pieces project forwards and almost embrace the central ring-armature, which, with the commutator, is fixed to the horizontal spindle.

411. (a) **Brush's Machine.**—In Brush's dynamo-electric generator, a ring-armature is also used, identical in form with that invented by Pacinotti, the iron ring being enlarged with protruding cheeks, with spaces between, in which the coils are wound, the coils themselves being also somewhat differently joined, each coil being united with that diametrically opposite to it, and having for the pair a commutator consisting of a collar slit into two parts. For each pair of coils there is a similar collar, the separate collars being grouped together and communicating to two or more pairs of brushes that rub against them the currents which they collect in rotating. The electromotive-force of these machines is very high, hence they are able to drive a current through a long row of arc lamps connected in one series. The largest Brush machines capable of maintaining 65 arc lights have an electromotive-force exceeding 3000 volts. In Gülcher's and Schuckert's machines the ring-armature takes the form of a flattened disk. In Crompton's dynamo the armature is wound on a hollow cylindrical core built up of flat thin iron rings.

Siemens and others have devised another class of dynamo-electric machines, differing entirely from any of the preceding, in which a coil or other movable conductor slides round one pole of a magnet and cuts the lines of force in a continuous manner without any reversals in the direction of the induced currents. Such machines, sometimes called "uni-polar" machines, have, however, very low electromotive-force.

411. (b) **Edison's Machine.**—Some very large dynamo-electric generators have been constructed by Edison for his system of electric lighting. This machine (as shown in Fig. 154) is built upon the same bed-plate as the steam engine (of 120 H-P) which drives it, and is called by its designer the *steam-dynamo*. The field-magnets are placed horizontally, and consist of 12 cylindrical iron bars overwound with wire, united to solid-iron pole-pieces weighing many tons. Between the upper and lower pole-pieces rotates the armature, which is a modification of the drum-armature of Siemens, and is made up of 98

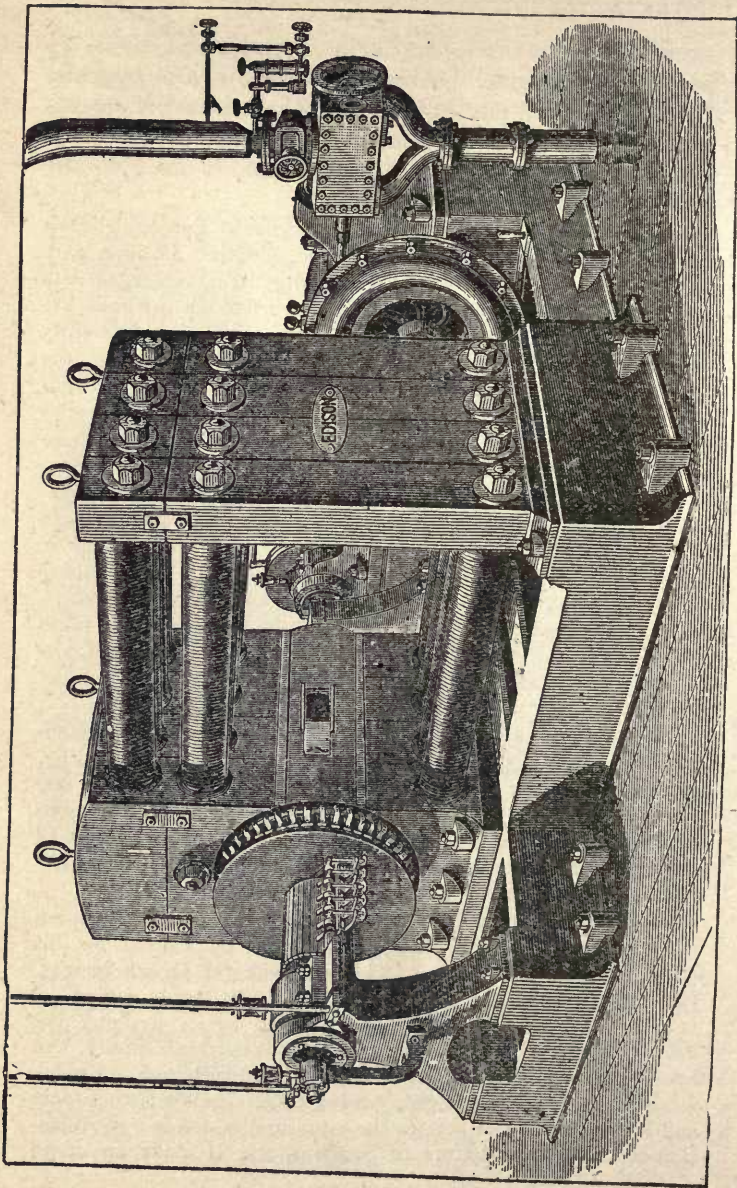

Fig. 154.

long rods of copper connected by copper discs at the ends instead of coils of wire. The commutator or collector consists of 49 parallel bars of copper, like the split-tube commutator of the other machines. The circuit of the armature runs from one bar of the commutator along one of the copper rods into a copper disc at the far end, crosses by this disc to the opposite rod, along which it comes back to the front end to another copper disc connected to the next bar of the commutator, and so on all round. This arrangement greatly reduces the wasteful resistance of the armature, and adds to the efficiency of the machine. The interior of the armature is made up of thin discs of iron strung upon the axis to intensify the magnetic action while avoiding the currents which would be generated wastefully (see Art. 401) in the mass of the metal were the iron core solid. There are also 5 pairs of brushes at the commutator to diminish sparking. This machine has a very high efficiency, and turns 90 per cent of the mechanical power into electrical power. It is capable of maintaining 1300 of Edison's incandescent lamps (Art. 374) alight at one time. When driven at 300 revolutions per minute the current generated is about 900 ampères, and the electromotive-force 105 volts.

411. (c) Theory of Continuous-Current Dynamo. — The electromotive-force of a dynamo depends (*i*) on the number of magnetic lines N which the field-magnet forces through the armature core, passing into it from the north-pole of the field-magnet on one side, and out of it into the south-pole of the field-magnet on the other; (*ii*) on the number of conducting wires or bars wound upon the armature; (*iii*) on the speed of rotation. If we use the symbol C for the number of armature conductors counted all round the periphery, and n for the number of revolutions per second, then the electromotive-force of the dynamo (in absolute units) will be given by the rule

$$E = nCN;$$

but since one volt is taken as 10^8 absolute C.G.S. units (see Art. 323), the electromotive-force as expressed in volts will be

$$E \text{ (volts)} = nCN \div 10^8.$$

The number N of magnetic lines through the armature can be calculated by the rule for the magnetic circuit, given on p. 297, proper allowance being made for inevitable leakage of some of the magnetic lines.

All and any of the continuous-current magneto-electric and dynamo-electric machines can be used as electromotors, the

armature rotating and exerting power when a current from an independent source is led into the machine.

411. (*d*) **Alternate-Current Machines.**—In some dynamo-electric machines the alternately-directed currents generated by the successive approach and recession of the coils to and from the fixed magnet-poles are never commuted, but pass direct to the circuit. In a typical machine of this class invented by Wilde, the armature consists of a series of bobbins arranged upon the periphery of a disk which rotates between two sets of fixed electromagnets arranged upon circular frames, and presenting N and S-poles alternately inward. The alternate-current machine of Siemens is similar in design. Such machines cannot excite their own field-magnets with a constant polarity, and require a small auxiliary direct-current dynamo to excite their magnets. In another machine, devised by De Meritens, a ring-armature, resembling those of Pacinotti and Brush, moves in front of permanent steel magnets. In this machine the current induced in the circuit in one direction while the coils approach one set of poles is immediately followed by a current in the other direction as the coils recede from this set of poles and approach the set of poles of contrary sign. Alternate-current machines have also been devised by Lontin, Gramme, and others, for use in particular systems of electric lighting; as, for example, the Jablochhoff candle (Art. 374). In Lontin's machine, as in the more recent and much larger disk-dynamo of Gordon, the field-magnet coils rotate between two great rings of fixed coils in which the currents are induced. A recent form of alternate-current machine, designed by Ferranti, differs from the machines of Wilde and Siemens in the substitution of copper strips wound in zig-zag, for the set of rotating bobbins in the armature. In Mordey's alternator the field-magnet which rotates presents two crowns of opposing poles on either side of a stationary armature.

411. (*e*) **Compound-Wound Machines.**—The field-magnets of a dynamo-electric machine are sometimes wound with two sets of coils, so that it can be used as a combined shunt-and-series machine (see Art. 408). Such machines, when run at a certain "critical" speed, may be made to yield their current, at a constant electromotive-force whatever the resistances in circuit.

CHAPTER XI.

ELECTRO-CHEMISTRY.

LESSON XXXVIII.—*Electrolysis and Electrometallurgy.*

412. In Lessons XIV. and XVIII. it was explained that a definite amount of chemical action in a cell evolves a current and transfers a certain quantity of electricity through the circuit, and that, conversely, a definite quantity of electricity, in passing through an electrolytic cell, will perform there a definite amount of chemical work. The relation between the current and the chemical work performed by it is laid down in the following paragraphs.

413. **Electromotive - force of Polarisation.**—Whenever an electrolyte is decomposed by a current, the resolved ions have a tendency to reunite, that tendency being commonly termed “chemical affinity.” Thus, when zinc sulphate ($ZnSO_4$) is split up into Zn and SO_4 , the zinc tends to dissolve again into the solution by reason of its “affinity” for oxygen and for sulphuric acid. But zinc dissolving into sulphuric acid sets up an electromotive-force of definite amount; and to tear the zinc away from the sulphuric acid requires an electromotive-force at least as great as this, and in an opposite direction to it. So, again, when acidulated water is decomposed in a voltameter, the separated hydrogen

and oxygen tend to reunite and set up an opposing electromotive-force of no less than 1.47 volts. This opposing electromotive-force, which is in fact the measure of their "chemical affinity," is termed the electromotive-force of polarisation. It can be observed in any water-voltmeter (Art. 208) by simply disconnecting the wires from the battery and joining them to a galvanometer, when a current will be observed flowing back through the voltmeter from the hydrogen electrode toward the oxygen electrode. The polarisation in a voltaic cell (Art. 163) produces an opposing electromotive-force in a perfectly similar way.

Now, since the affinity of hydrogen for oxygen is represented by an electromotive-force of 1.47 volts, it is clear that no cell or battery can decompose water unless it has an electromotive-force *at least* of 1.47 volts. With every electrolyte there is a similar minimum electromotive-force necessary to produce complete, continuous decomposition.

414. Theory of Electrolysis.—Suppose a current to convey a quantity of electricity Q through a circuit in which there is an opposing electromotive-force E : the work done in moving Q units of electricity against this electromotive-force will be equal to $E \times Q$. (If E and Q are expressed in "absolute" C.G.S. units, $E \cdot Q$ will be in *ergs.*) The total energy of the current, as available for producing heat or mechanical motion, will be diminished by this quantity, which represents the work done against the electromotive-force in question.

But we can arrive in another way at an expression for this same quantity of work. For the quantity of electricity in passing through the cell will deposit a certain amount of metal: this amount of metal could be burned, or dissolved again in acid, giving up its potential energy as heat, and, the mechanical equivalent of heat being known, the equivalent quantity of work can be calculated. Q units of electricity will cause the depo-

sition of Qz grammes of an ion whose absolute electrochemical equivalent is z . [For example, z for hydrogen is $\cdot 00010352$ gramme, being ten times the amount (see table in Art. 212) deposited by one coulomb, for the coulomb is $\frac{1}{10}$ of the absolute C.G.S. unit of quantity.] If H represent the number of heat units evolved by one gramme of the substance, when it enters into the combination in question, then QzH represents the value (in heat units) of the chemical work done by the flow of the Q units; and this value can immediately be translated into *ergs* of work by multiplying by Joule's equivalent J ($= 42 \times 10^6$). [See Table on page 400.]

We have therefore the following equality:—

$$EQ = QzHJ; \text{ whence it follows that}$$

$E = zHJ$; or, in words, *the electromotive-force of any chemical reaction is equal to the product of the electro-chemical equivalent of the separated ion into its heat of combination, expressed in dynamical units.*

EXAMPLES.—(1) *Electromotive-force of Hydrogen tending to unite with Oxygen.* For Hydrogen $z = \cdot 00010352$; H (heat of combination of one gramme) = 34,000 gramme-degree-units; $J = 42 \times 10^6$.

$\cdot 00010352 \times 34,000 \times 42 \times 10^6 = 1\cdot47 \times 10^8$ "absolute" units of electromotive-force, or = 1'47 volts.

(2) *Electromotive-force of Zinc dissolving into Sulphuric Acid.* $z = \cdot 003364$; $H = 1670$ (according to Julius Thomsen); $J = 42 \times 10^6$.

$\cdot 003364 \times 1670 \times 42 \times 10^6 = 2\cdot359 \times 10^8$
or = 2'359 volts.

(3) *Electromotive-force of Copper dissolving into Sulphuric Acid.* $z = \cdot 003261$; $H = 909\cdot5$; $J = 42 \times 10^6$.

$\cdot 003261 \times 909\cdot5 \times 42 \times 10^6 = 1\cdot252 \times 10^8$
or = 1'252 volts.

(4) *Electromotive-force of a Daniell's Cell.* Here zinc is dissolved at one pole to form zinc sulphate, the chemical action setting up a + electromotive-force, while at the other pole copper is deposited by the current out of a solution of copper sulphate, thereby setting up an opposing (or -) electro-

motive-force. That due to zinc is shown above to be $+ 2.359$ volts, that to deposited copper to be $- 1.242$. Hence the net electromotive-force of the cell is (neglecting the slight electromotive-force where the two solutions touch) $2.359 - 1.242 = 1.117$ volts. This is nearly what is found (Art. 170) in practice to be the case. It is less than will suffice to electrolyse water, though two Daniell's cells in series electrolyse water easily.

415. Secondary Batteries : Storage of Electric Currents.

—A voltmeter, or series of voltmeters, whose electrodes are thus charged respectively with hydrogen and oxygen, will serve as *secondary batteries*, in which the energy of a current may be stored up (as chemical work) and again given out. Ritter, who in 1803 constructed a secondary pile, used electrodes of platinum. Gaston Planté, in 1860, devised a secondary cell consisting of two pieces of sheet lead rolled up (without actual contact) as electrodes, dipping into dilute sulphuric acid, as in Fig. 155; the lead becoming with repeated charges in alternate directions coated with a semi-porous film of brown dioxide of lead on the anode plate, and on the kathode plate assuming a spongy metallic state presenting a large amount of surface of high chemical activity. When such a battery, or *accumulator of currents*, is charged by connecting it with a dynamo-electric machine or other powerful generator of currents, the anode plate becomes peroxidised, while the kathode plate is deoxidised by the hydrogen that is liberated. The plates may remain for many days in this condition, and will furnish a current until the two lead surfaces are reduced to a chemically inactive state. The electromotive-force of such cells is about 2.0 volts during discharge. Plante has ingeniously arranged batteries of such cells so that they can be charged in parallel arc, and discharged in series,

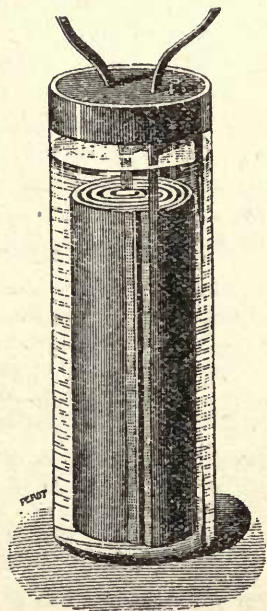

Fig. 155.

giving (for a short time) currents of extraordinary strength. Faure, in 1881, improved the Planté accumulator by giving the two lead plates a preliminary coating of *red-lead* (or minium). When a current is passed through the cell to charge it, the red-lead is peroxidised at the anode, and reduced,—first to a condition of lower oxide, then to the spongy metallic state,—at the cathode, and thus a greater thickness of the working substance is provided, and takes far less time to form than is the case in Planté's cells. For electric lighting, Faure's cells are made up

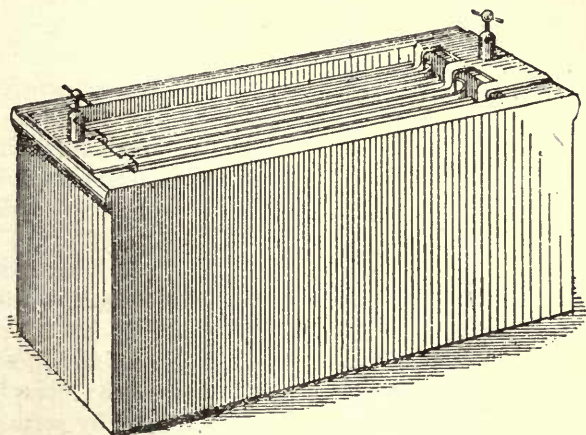

Fig. 156.

with flat plates in the form shown in Fig. 156. In Sellon's and Volckmar's accumulators the minium is packed into interstices in the lead plates. A secondary cell resembles a Leyden jar in that it can be charged and then discharged. Its time-rate of leakage is also similar. The residual charges of Leyden jars, though small in quantity and transient in their discharge, yet exactly resemble the polarisation charges of voltmeters.

416 Grove's Gas Battery.—Sir W. Grove devised a cell in which platinum electrodes, in contact respectively with hydrogen and oxygen gas, replaced the usual zinc and copper plates. Each of these gases is partially occluded by the metal platinum, which, when so treated, behaves like a different metal. In Fig. 157 one form of Grove's Gas Battery is shown, the tubes O and H containing the + and - electrodes, surrounded with oxygen and hydrogen respectively.

417. **General Laws of Electrolytic Action.**—In addition to Faraday's quantitative laws given in Art. 211,

the following are important:—

(a.) Every electrolyte is decomposed into two portions, an anion and a kation, which may be themselves either simple or compound. In the case of simple binary compounds, such as fused salt (Na Cl), the ions are simple elements. In other cases the products are often complicated by secondary actions. It is even possible to deposit an alloy of two metals—*brass* for example—from a mixture of the cyanides of zinc and of copper.

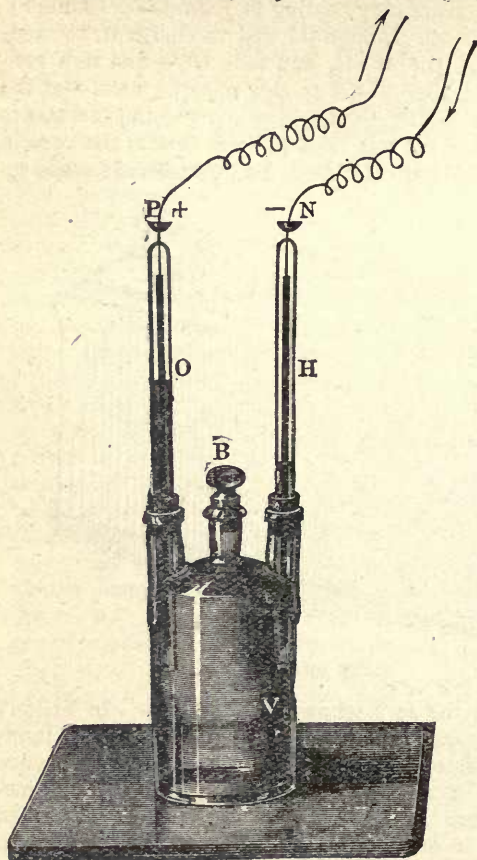

Fig. 157.

(b.) In binary compounds and most metallic solutions, the metal is deposited by the current where it leaves the cell, at the kathode.

(c.) Aqueous solutions of salts of the metals of the alkalis and alkaline earths deposit no metal, but evolve

hydrogen owing to secondary action of the metal upon the water. From *strong* solutions of caustic potash and soda Davy succeeded in obtaining metallic sodium and potassium, which were before unknown. If electrodes of mercury are employed, an amalgam of either of these metals is readily obtained at the kathode. The so-called *ammonium*-amalgam is obtained by electrolysing a warm, strong solution of salammoniac between mercury electrodes.

(*d.*) Substances can be arranged in a definite series according to their electrolytic behaviour; each substance on the list behaving as a kation (or being "electropositive") when electrolysed from its compound with any other on the list. In such a series the oxidisable metals, potassium, sodium, zinc, etc., head the list; after which come the less oxidisable or "electronegative" metals; then carbon, oxygen, phosphorus, iodine, chlorine, sulphur, and lastly ozone.

(*e.*) From a solution of mixed metallic salts the least electropositive metal is deposited first, unless the current be very strong.

(*f.*) The liberated ions appear only at the electrodes.

(*g.*) For each electrolyte a *minimum electromotive-force* is requisite, without which complete electrolysis cannot be effected. (See Art. 413.)

(*h.*) If the current be of less electromotive-force than the requisite minimum, electrolysis may begin, and a feeble current flow at first, but no ions will be liberated, the current being completely stopped as soon as the opposing electromotive-force of polarisation has risen to equality with that of the electrolysing current.

(*i.*) There is no opposing electromotive-force of polarisation when electrolysis is effected from an anode of the same metal that is being deposited at the kathode. The feeblest cell will suffice to deposit copper from sulphate of copper if the anode be a copper plate.

(j.) Where the ions are gases, pressure affects the conditions but slightly. Under 300 atmospheres acidulated water is still electrolysed; but in certain cases a layer of acid so dense as not to conduct collects at the anode and stops the current.

(k.) The chemical work done by a current in an electrolytic cell is proportional to the *minimum* electromotive-force of polarisation.

(l.) Although the electromotive-force of polarisation may exceed this minimum, the work done by the current in overcoming this surplus electromotive-force will not appear as chemical work, for no more of the ion will be liberated; but it will appear as an additional quantity of heat (or "local heat") developed in the electrolytic cell.

(m.) Ohm's law holds good for electrolytic conduction.

(n.) Amongst the secondary actions which may occur the following are the chief:—(1.) The ions may themselves decompose; as SO_4 into $\text{SO}_2 + \text{O}$. (2.) The ions may react on the electrodes; as when acidulated water is electrolysed between zinc electrodes, no oxygen being liberated, owing to the affinity of zinc for oxygen. (3.) The ions may be liberated in an abnormal state. Thus oxygen is frequently liberated in its allotropic condition as ozone, particularly when permanganates are electrolysed. The "nascent" hydrogen liberated by the electrolysis of dilute acid has peculiarly active chemical properties. So also the metals are sometimes deposited abnormally: copper in a black pulverulent film; antimony in roundish gray masses (from the terchloride solution) which possess a curious explosive property, etc.

418. Hypotheses of Grotthuss and of Clausius.—A complete theory of electrolysis must explain—*firstly*, the transfer of electricity, and, *secondly*, the transfer of matter, through the liquid of the cell. The latter point is the one to which most attention has been given, since the "migration of the ions" (*i.e.* their transfer through the liquid) in two opposite directions, and

their appearance at the electrodes *only*, are salient facts.

The hypothesis put forward in 1805 by Grotthuss serves fairly, when stated in accordance with modern terms, to explain these facts. Grotthuss supposes that, when two metal plates at different potentials are placed in a cell, the first effect produced in the liquid is that the molecules of the liquid arrange themselves in innumerable chains, in which every molecule has its constituent atoms pointing in a certain direction; the atom of electropositive substance being attracted toward the kathode, and the fellow atom of electronegative substance being attracted toward the anode. (This assumes the constituent atoms grouped in the molecule to retain their individual electric properties.) The diagram of Fig. 158 shows, in the case of Hydrochloric

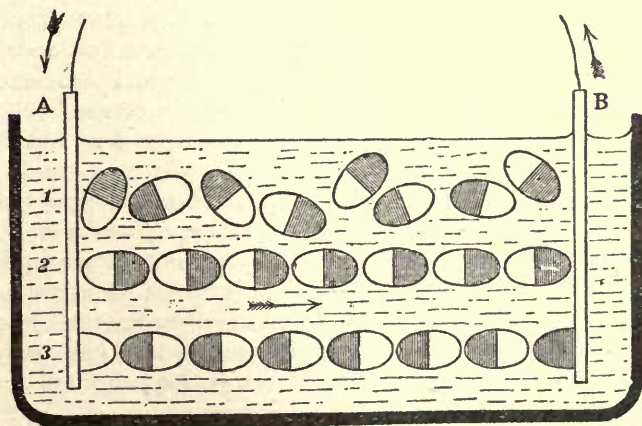

Fig. 158.

Acid, a row of molecules 1, 1, at first distributed at random, and secondly (as at 2, 2,) grouped in a chain as described. The action which Grotthuss then supposes to take place is that an interchange of partners goes on between the separate atoms all along the line,

each H atom uniting with the Cl atom belonging to the neighbouring molecule, a + half molecule of hydrogen being liberated at the kathode, and a - half molecule of chlorine at the anode. This action would leave the molecules as in 3, 3, and would, when repeated, result in a double migration of hydrogen atoms in one direction and of chlorine atoms in the other, the free atoms appearing only at the electrodes, and every atom so liberated discharging a certain definite minute charge of electricity upon the electrode where it was liberated.¹

Clausius has sought to bring the ideas of Grotthuss into conformity with the modern kinetic hypothesis of the constitution of liquids. Accordingly, we are to suppose that in the usual state of a liquid the molecules are always in movement, gliding about amongst one another, and their constituent atoms are also in movement, and are continually separating and recombining into similar groups, their movements taking place in all possible directions throughout the liquid. But under the influence of an electromotive-force these actions are controlled *in direction*, so that when, in the course of the usual movements, an atom separates from a group it tends to move either toward the anode or kathode; and if the electromotive force in question be powerful enough to prevent recombination, these atoms will be permanently separated, and will accumulate around the electrodes. This theory has the advantage of accounting for a fact easily observed, that an electromotive force *less* than the minimum which is needed to effect complete electrolysis may send a feeble current through an

¹ Mr. G. J. Stoney has lately reckoned, from considerations founded on the size of atoms (as calculated by Loschmidt and Sir W. Thomson), that for every chemical bond ruptured, a charge of 10^{-20} of a coulomb is transferred. [E. Budde says 17×10^{-20} coulomb.] This quantity would appear therefore to be the natural atomic charge or unit. To tear one atom of hydrogen from a hydrogen compound this amount of electricity must be sent through it. To liberate an atom of zinc, or any other di-valent metal from its compound, implies the transfer of twice this amount of electricity.

electrolyte for a limited time, until the opposing electromotive force has reached an equal value. Helmholtz, who has given the name of *electrolytic convection* to this phenomenon of partial electrolysis, assumes that it takes place by the agency of uncombined atoms previously existing in the liquid. This assumption is virtually included in the kinetic hypothesis of Clausius.

419. *Electrometallurgy*.—The applications of electro-chemistry to the industries are threefold. *Firstly*, to the reduction of metals from solutions of their ores, a process too costly for general application, but one useful in the accurate assay of certain ores, as, for example, of copper; *secondly*, to the copying of types, plaster casts, and metal-work by kathode deposits of metal; *thirdly*, to the covering of objects made of baser metal with a thin film of another metal, such as gold, silver, or nickel. All these operations are included under the general term of *electrometallurgy*.

420. *Electrotyping*.—In 1836 De La Rue observed that in a Daniell's cell the copper deposited out of the solution upon the copper plate which served as a pole took the exact impress of the plate, even to the scratches upon it. In 1839 Jacobi in St. Petersburg, Spencer in Liverpool, and Jordan in London, independently developed out of this fact a method of obtaining, by the electrolysis of copper, impressions (in reversed relief) of coins, stereotype plates, and ornaments. A further improvement, due to Murray, was the employment of moulds of plaster or wax coated with a film of *plumbizo* in order to provide a conducting surface upon which the deposit could be made. Jacobi gave to the process the name of *galvano-plastic*, a term generally abandoned in favour of the term *electrotyping* or *electrotype process*.

Electrotypes of copper are easily made by hanging a suitable mould in cell containing a saturated solution of sulphate of copper, and passing a current of a battery

through the cell, the mould being the kathode; a plate of copper being employed as an anode, dissolving gradually into the liquid at a rate exactly equal to the rate of deposition at the kathode. This use of a separate battery is more convenient than producing the electro-types in the actual cell of a Daniell's battery. The process is largely employed at the present day to reproduce repoussé and chased ornament and other works of art in facsimile, and to multiply copies of wood blocks for printing. Almost all the illustrations in this book, for example, are printed from electrotype copies, and not from the original wood blocks, which would not wear so well.

421. **Electroplating.**—In 1801 Wollaston observed that a piece of silver, connected with a more positive metal, became coated with copper when put into a solution of copper. In 1805 Brugnatelli gilded two silver medals by making them the kathodes of a cell containing a solution of gold. Messrs. Elkington, about the year 1840, introduced the commercial processes of electroplating. In these processes a baser metal, such as German silver (an alloy of zinc, copper, and nickel) is covered with a thin film of silver or gold, the solutions employed being, for *electro-gilding*, the double cyanide of gold and potassium, and for *electro-silvering* the double cyanide of silver and potassium.

Fig. 159 shows a battery and a plating-vat containing the silver solution. From the anode is hung a plate of metallic silver which dissolves into the liquid. To the kathode are suspended the spoons, forks, or other articles which are to receive a coating of silver. The addition of a minute trace of bisulphide of carbon to the solution causes the deposited metal to have a bright surface. If the current is too strong, and the deposition too rapid, the deposited metal is grayish and crystalline.

In silvering or gilding objects of iron it is usual first to plate them with a thin coating of copper. In gilding

base metals, such as pewter, they are usually first copper-coated. The gilding of the insides of jugs and cups is effected by filling the jug or cup with the gilding solution, and suspending in it an anode of gold, the vessel itself being connected to the - pole of the battery.

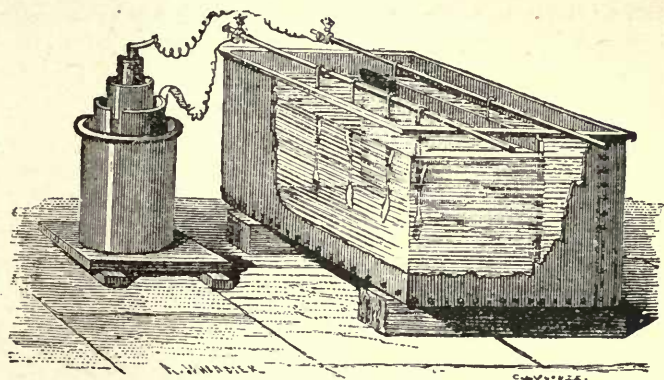

Fig. 159.

Instead of a battery a thermo-electric generator (Art. 384), or a dynamo-electric generator (Art. 408), is now frequently employed.

422. **Metallo-chromy.**—In 1826 Nobili discovered that when a solution of lead is electrolysed a film of peroxide of lead forms upon the anode. If this be a sheet of metal, — a plate of polished steel, for instance, — placed horizontally in the liquid beneath a platinum wire as a kathode, the deposit takes place in symmetrical rings of varying thickness, the thickest deposit being at the centre. These rings, known as Nobili's rings, exhibit all the tints of the rainbow, owing to interference of the waves of light occurring in the film causing rays of different wave-length and colour to be suppressed at different distances from the centre. The colours form, in fact, in reversed order, the "colours of thin plates" of Newton's rings. According to Wagner this production of chromatic effects by electrolysing a solution of lead in caustic soda, is applied in Nuremberg to ornament metallic toys. The author of these Lessons has observed that when Nobili's rings are made in a magnetic

field they are no longer circular, the depositing currents being drawn aside in a manner which could be predicted from the observed action of magnets on conductors carrying currents.

422 (*bis*). **Electro-Chemical Power of Metals.**—The following Table gives the electromotive-force of the different metals as calculated by the method of Art. 414 from their electro-chemical equivalents (Art. 212), and from the heat evolved by the combination with oxygen of a portion of the metal equivalent electro-chemically in amount to one gramme of hydrogen. The electromotive-forces (in volts) as observed (in dilute sulphuric acid) are added for comparison.

Substance.	Heat of Equivalent.	E. M. F. calculated.		E. M. F. observed.
		Relatively to Oxygen.	Relatively to Zinc.	
Potassium . . .	69,800	3'01	+1'18	+1'13
Sodium . . .	67,800	2'91	+1'09	...
Zinc . . .	42,700	1'83	0'	0'
Iron . . .	34,120	1'55	-0'28	...
Hydrogen . . .	34,000	1'47	-0'36	...
Lead . . .	25,100	1'12	-0'71	-0'54
Copper . . .	18,760	'80	-1'08	-1'047
Silver . . .	9,000	'39	-1'44	...
Platinum . . .	7,500	'33	-1'50	-1'53
Carbon . . .	2,000	'09	-1'74	...
Oxygen . . .	0	0'	-1'83	-1'85
(Nitric Acid) . .	-6,000	-0'26	-2'09	-1'94
(Black Oxide of Manganese)	-6,500	-0'29	-2'12	-2'23
(Peroxide of Lead)	-12,150	-0'52	-2'35	-2'52
(Ozone) . . .	-14,800	-0'63	-2'46	-2'64
(Permanganic Acid) . . .	-25,070	-1'09	-2'92	-3'03

The order in which these metals are arranged is in fact nothing else than the order of oxidisability of the metals (in the presence of dilute sulphuric acid); for that metal tends most to oxidise which can, by oxidising, give out the most energy. It also shows the order in which the metals stand in their power to replace one another (in a solution containing sulphuric acid.) In this order too, the lowest on the list first, are the metals deposited by an electric current from solutions containing two or more of them: for that metal comes down first which requires the least expenditure of energy to separate it from the elements with which it was combined

CHAPTER XII.

TELEGRAPHS AND TELEPHONES.

LESSON XXXIX.—*Electric Telegraphs.*

423. The Electric Telegraph.—It is difficult to assign the invention of the Telegraph to any particular inventor. Lesage (Geneva, 1774), Lomond (Paris, 1787), and Sir F. Ronalds (London, 1816), invented systems for transmitting signals through wires by observing at one end the divergence of a pair of pith-balls when a charge of electricity was sent into the other end. Cavallo (London, 1795) transmitted sparks from Leyden jars through wires “according to a settled plan.” Soemmering (Munich, 1808) established a telegraph in which the signals were made by the decomposition of water in voltmeters; and the transmission of signals by the chemical decomposition of substances was attempted by Coxe, R. Smith, Bain, and others. Ampère (Paris, 1821) suggested that a galvanometer placed at a distant point of a circuit might serve for the transmission of signals. Schilling and Weber (Göttingen, 1833) employed the deflections of a galvanometer needle moving to right or left to signal an alphabetic code of letters upon a single circuit. Cooke and Wheatstone (London, 1837) brought into practical application the first form of their *needle* telegraph. Henry (New York, 1831) utilised the attraction of an electromagnet to transmit signals, the movement of the armature producing audible sounds according to a certain code. Morse (New York, 1837) devised a telegraph in which the attraction of an armature by an electromagnet was made to mark a dot or a dash upon a moving strip of paper. Steinheil (Munich, 1837) discovered that instead of a return-wire the *earth* might be used, contact being made to earth at the two ends by means of earth

plates (see Fig. 160) sunk in the ground. Gintl (1853) and Stearns (New York, 1870) devised methods of *duplex* signalling, Stark (Vienna) and Bosscha (Leyden, 1855) invented *diplex* signalling, and Edison (Newark, N. J., 1874) invented *quad-ruplex* telegraphy. For fast-speed work Wheatstone devised his automatic transmitter, in which the signs which represent the letters are first punched by machinery on strips of paper; these are then run at a great speed through the transmitting instrument, which telegraphs them off at a much greater rate than if the separate signals were telegraphed by hand. Hughes devised a type-printing telegraph. Wheatstone invented an ABC telegraph in which signals are spelled by a hand which moves over a dial. For cable-working Sir W. Thomson invented his mirror galvanometer and his delicate siphon-recorder. It is impossible in these Lessons to describe more than one or two of the simpler and more frequent forms of telegraphic instruments. Students desiring further information should consult the excellent manuals on Telegraphy by Messrs. Preece and Sivewright, and by Mr. Culley.

424. Single-Needle Instrument.—The single-needle instrument (Fig. 160) consists essentially of a

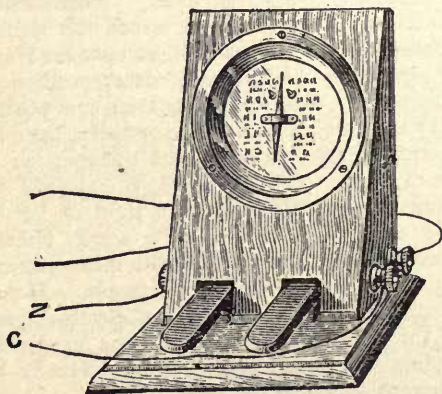

Fig. 160.

vertical galvanometer, in which a lightly hung magnetic needle is deflected to right or left when a current is sent, in one direction or the other, around a coil surrounding the needle; the needle visible in front of the dial is but an index,

the real magnetic needle being behind. A code of movements agreed upon comprises the whole alphabet in combinations of motions to right or left. In order

to send currents in either direction through the circuit, a "signalling-key" or "tapper" is usually employed. The tapper at one end of the line works the instrument at the other; but for the sake of convenience it is fixed to the receiving instrument. In Fig. 160 the two protruding levers at the base form the tapper, and by depressing the right hand one or the left hand one, currents are sent in either direction at will.

The principle of action will be made more clear by reference to Fig. 161, which shows a separate signalling key. The two horizontal levers are respectively in communication with the "line," and with the return-line through "earth." When not in use they both spring up against a cross strip of metal joined to the zinc pole of the battery.

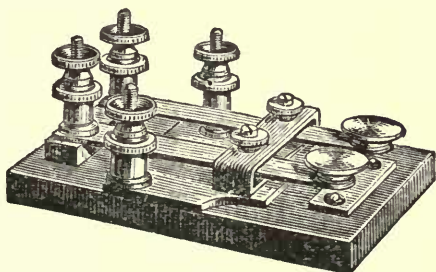

Fig. 161.

Below them is another cross strip, which communicates with the copper (or +) pole of the battery. On depressing the "line" key the current runs through the line and back by earth, or in the *positive* direction. On depressing the "earth" key (the line key remaining in contact with the zinc-connected strip), the current runs through the earth and back by the line, or in the *negative* direction. Telegraphists ordinarily speak of these as positive and negative *currents* respectively.

As it is necessary that a line should be capable of being worked from either end, a battery is used at each, and the wires so connected that when at either end a message is being received, the battery circuit at that end shall be open. Fig. 162 shows the simplest possible case of such an arrangement. At one end is a battery

zc , one pole of which is put to earth, and the other communicates with a key K . This key is arranged (like that in Fig. 164), so that when it is depressed, so as to send a signal through the line, it quits contact with the receiving instrument at its own end. The current flowing through the line passes through K' and enters a

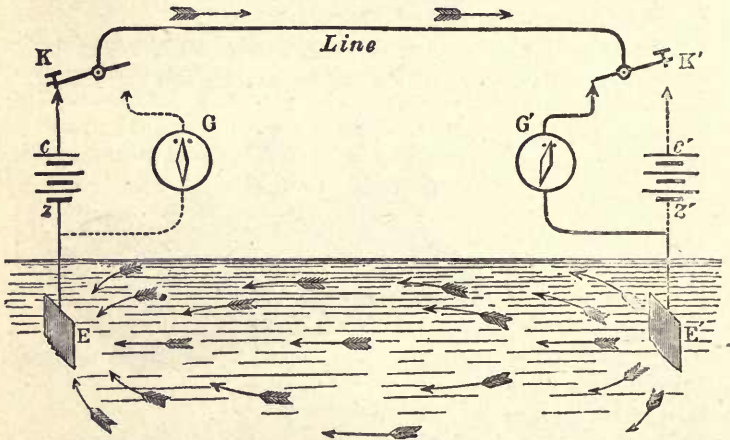

Fig. 162.

receiving instrument G' at the distant end, where it produces a signal, and returns by the earth to the battery whence it started. A similar battery and key at the distant end suffice to transmit signals in the opposite direction to G when K is not depressed. The diagram is drawn as if G were a simple galvanometer; but the arrangement would perfectly suit the Morse instrument, in which it is only required at either end to send long and short currents without reversing the direction.

425. The Morse Instrument.—The most widely used instrument at the present day is the Morse. The Morse instrument consists essentially of an electromagnet, which, when a current passes through its coils, draws down an armature for a short or a long time.

It may either be arranged as a "*sounder*," in which case the operator who is receiving the message listens to the clicks and notices whether the intervals between them are long or short; or it may be arranged as an "*embosser*," to print dots and dashes upon a strip of paper drawn by clockwork through the instrument. In the most modern form, however, the Morse instrument is arranged as an "*ink-writer*," in which the attraction of the armature downwards lifts a little inky wheel and pushes it against a ribbon of paper. If the current is momentary it prints a mere dot. If the current continues to flow for a longer time the ribbon of paper moves on and the ink-wheel marks a dash. The Morse code, or alphabet of dots and dashes, is as follows:—

A . —	K — . —	U . . —
B — . . .	L . — . .	V . . . —
C — . — .	M — —	W . — —
D — . .	N — .	X — . . —
E .	O — — —	Y — . — —
F . . — .	P . — — .	Z — — . .
G — — .	Q — — . —	Full stop
H	R . — .	Repetition . . — — . .
I . .	S	Hyphen — —
J . — — —	T —	Apostrophe . — — — — .

426. *Relay*.—In working over long lines, or where there are a number of instruments on one circuit, the currents are often not strong enough to work the recording instrument directly. In such a case there is interposed a *relay* or repeater. This instrument consists of an electromagnet round which the line current flows, and whose delicately poised armature, when attracted, makes contact for a local circuit in which a local battery and the receiving Morse instrument are included. The principle of the relay is, then, that a current too weak to do the work itself may set a strong local current to do its work for it.

In Fig. 163 is shown a Morse instrument (an "embosser") M, joined in circuit with a local battery B, and

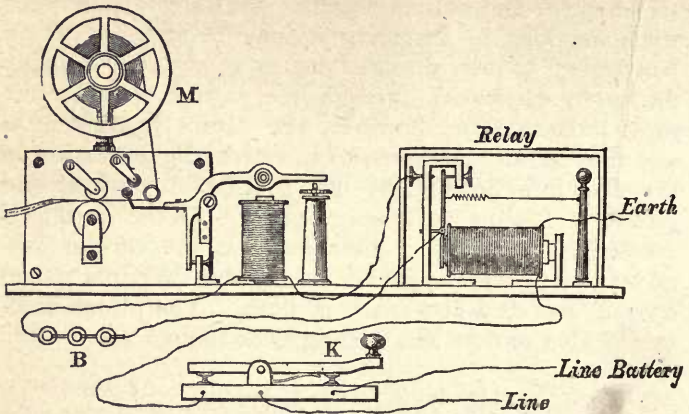

Fig. 163.

a relay. Whenever a current in the line circuit moves the tongue of the relay it closes the local circuit, and causes the Morse to record either a dot or a dash upon the strip of paper. The key K is shown in an enlarged

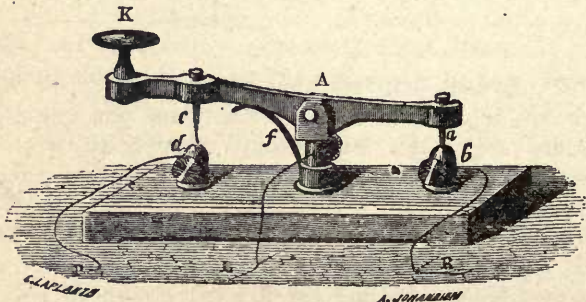

Fig. 164.

view in Fig. 164. The line wire is connected with the central pivot A. A spring *f* keeps the front end of the key elevated when not in use, so that the line wire is in

communication through the rear end of the key with the relay or receiving instrument. Depressing the key breaks this communication, and by putting the line wire in communication with the main battery transmits a current through the line.

427. Faults in Telegraph Lines.—Faults may occur in telegraph lines from several causes: either from the breakage of the wires or conductors, or from the breakage of the insulators, thereby short-circuiting the current through the earth before it reaches the distant station, or, as in overhead wires, by two conducting wires touching one another. Various modes for testing the existence and position of faults are known to telegraph engineers; they depend upon accurate measurements of resistance or of capacity. Thus, if a telegraph cable part in mid-ocean it is possible to calculate the distance from the shore end to the broken end by comparing the resistance that the cable is known to offer per mile with the resistance offered by the length up to the fault, and dividing the latter by the former.

428. Duplex Telegraphy.—There are two distinct methods of arranging telegraphic apparatus so as to transmit two messages through one wire, one from each end, at the same time. The first of these, known as the *differential method*, involves the use of instruments wound with differential coils, and is applicable to special cases. The second method of duplex working, known as the *Wheatstone's Bridge Method*, is capable of much more general application. The diagram of Fig. 165 will explain the general principle. The first requirement in duplex working is that the instrument at each end shall only move in response to signals from the other end, so that an operator at R may be able to signal to the distant instrument M' without his own instrument M being affected, M being all the while in circuit and able to receive signals from the distant operator at R'. To accomplish this the circuit is

divided at R into two branches, which go, by A and B respectively, the one to the line, the other through a certain resistance P to the earth. If the ratio between the resistances in the arms RA and RB is equal to the ratio of the resistances of the line and of P, then, by the principle of Wheatstone's Bridge, *no* current will pass through M. So M does not show any currents sent from R; but M' will show them, for the current on arriving at C will divide into two parts, part flowing round to the earth by R', the other part flowing

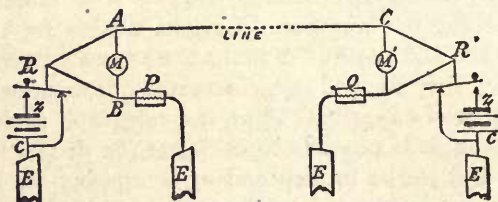

Fig. 165.

through M' and producing a signal. If, while this is going on, the operator at the distant R' depresses his key and sends an equal current in the opposite direction, the flow through the line will cease; but M will now show a signal, because, although no current flows through the line, the current in the branch RA will now flow down through M, as if it had come from the distant R', so, whether the operator at R be signalling or not, M will respond to signals sent from R'.

The **Diplex** method of working consists in sending two messages at once through a wire in the same direction. To do this it is needful to employ instruments which work only with currents in one given direction. The method involves the use of "relays" in which the armatures are themselves permanently magnetised. (or "polarised"), and which therefore respond only to currents in one direction.

The **Quadruplex** method of working combines the

duplex and the diplex methods. On one and the same line are used two sets of instruments, one of which (worked by a "polarised" relay) works only when the *direction* of the current is changed, the other of which (worked by a non-polarised relay adjusted with springs to move only with a certain minimum force) works only when the *strength* of the current is changed and is independent of their direction.

429. Submarine Telegraphy.—Telegraphic com-

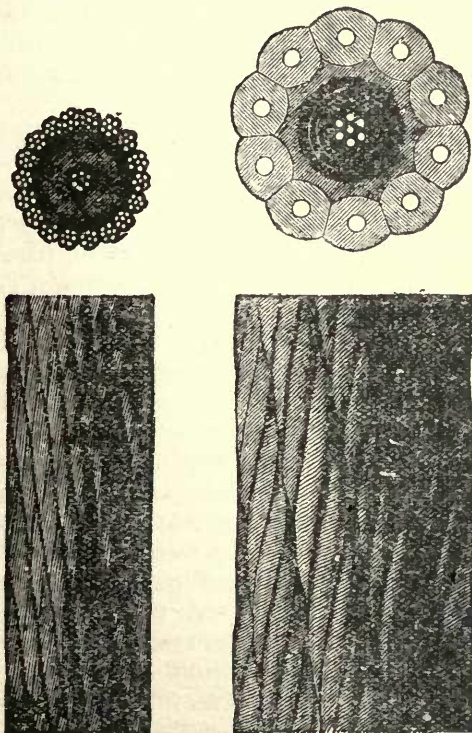

Fig. 166.

munication between two countries separated by a strait or ocean is carried on through cables, sunk to the

bottom of the sea, which carry conducting wires carefully protected by an outer sheath of insulating and protecting materials. The conductor is usually of purest copper wire, weighing from 70 to 400 lbs. per nautical mile, made in a sevenfold strand to lessen risk of breaking. Fig. 166 shows, in their natural size, portions of the Atlantic cables laid in 1857 and 1866 respectively. In the latter cable, which is of the usual type of cable for long lines, the core is protected first by a stout layer of guttapercha, then by a woven coating of jute, and outside all an external sheath made of ten iron wires, each covered with hemp. The *shore ends* are even more strongly protected by external wires.

430. **Speed of Signalling through Cables.**—Signals transmitted through long cables are retarded, the retardation being due to two causes.

Firstly, The self-induction of the circuit may prevent the current from rising at once to its height, the retardation being expressed by Helmholtz's equations, given in Art. 405.

Secondly, The cable in its insulating sheath, when immersed in water, acts like a Leyden jar of enormous capacity (as explained in Art. 274), and the first portions of the current, instead of flowing through, remain in the cable as an electrostatic *charge*. For every separate signal the cable must be at least partially charged and then discharged. Culley states that when a current is sent through an Atlantic cable from Ireland to Newfoundland no effect is produced on the most delicate instrument at the receiving end for two-tenths of a second, and that it requires three seconds for the current to gain its full strength, rising in an electric wave which travels forward through the cable. The strength of the current falls gradually also when the circuit is broken. The greater part of this retardation is due to electrostatic charge, not to electromagnetic self-induction; the retardation being proportional to the *square of the length*

of the cable. The various means adopted to get rid of this retardation are explained in Art. 275.

431. Receiving Instruments for Cables.—The *mirror-galvanometer* of Sir W. Thomson (Art. 202) was devised for cable signalling, the movements of the spot of light sweeping over the scale to a short or a long distance sufficing to signal the dots and dashes of the Morse code. The *Siphon Recorder* of Sir W. Thomson is an instrument which writes the signals upon a strip of paper by the following ingenious means:—The needle part of a powerful and sensitive galvanometer is replaced by a fine siphon of glass suspended by a silk fibre, one end of which dips into an ink vessel. The ink is spurted without friction upon a strip of paper (moved by clock-work vertically past the siphon), the spurting being accomplished electrically by charging the ink vessel by a continuous electrophorus, which is itself worked by a small electromagnetic engine.

LESSON XL.—*Electric Bells, Clocks, and Telephones.*

432. Electric Bells.—The common form of *Electric Bell* or Trembler consists of an electromagnet, which moves a hammer backward and forward by alternately attracting and releasing it, so that it beats against a bell. The arrangements of the instrument are shown in Fig. 167, in which E is the electromagnet and H the hammer. A battery, consisting of one or two Leclanché cells placed at some convenient point of the circuit, provides a current when required. By touching the "push" P, the circuit is completed, and a current flows along the line and round the coils of the electromagnet, which forthwith attracts a small piece of soft iron attached to the lever, which terminates in the hammer H. The lever is itself included in the circuit, the current entering it above and quitting it at C by a contact-breaker, consisting of a spring tipped with platinum resting against the platinum

tip of a screw, from which a return wire passes back to the zinc pole of the battery. As soon as the lever is attracted forward the circuit is broken at C by the spring moving away from contact with the screw; hence the current stops, and the electromagnet ceases to attract the armature. The lever and hammer therefore fall back,

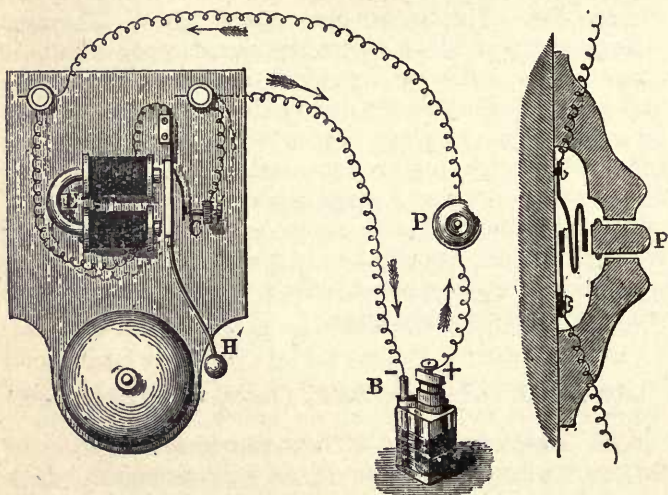

Fig. 167.

again establishing contact at C, whereupon the hammer is once more attracted forward, and so on. The push P is shown in section on the right of Fig. 167. It usually consists of a cylindrical knob of ivory or porcelain capable of moving loosely through a hole in a circular support of porcelain or wood, and which, when pressed, forces a platinum-tipped spring against a metal pin, and so makes electrical contact between the two parts of the interrupted circuit.

433. **Electric Clocks.**—Clocks may be either driven or controlled by electric currents. Bain, Hipp, and others, have devised electric clocks of the first kind, in which the ordinary motive power of a weight or spring is

abandoned. the clock being driven by its pendulum, the "bob" of which is an electromagnet alternately attracted from side to side. The difficulty of maintaining a perfectly constant battery current has prevented such clocks from coming into use.

Electrically controlled clocks, governed by a standard central clock, have proved a more fruitful invention. In these the standard timekeeper is constructed so as to complete a circuit periodically, once every minute or half minute. The transmitted currents set in movement the hands of a system of dials placed at distant points, by causing an electromagnet placed behind each dial to attract an armature, which, acting upon a ratchet wheel by a pawl, causes it to move forward through one tooth at each specified interval, and so carries the hands round at the same rate as those of the standard clock.

Electric *chronographs* are used for measuring very small intervals of time. A style fixed to the armature of an electromagnet traces a line upon a piece of paper fixed to a cylinder revolving by clockwork. A current sent through the coils of the electromagnet moves the armature and causes a lateral notch in the line so traced. Two currents are marked by two notches; and from the interval of *space* between the two notches the interval of *time* which elapsed between the two currents may be calculated to the ten-thousandth part of a second if the speed of rotation is accurately known. The velocity with which a cannon ball moves along the bore of the cannon can be measured thus.

434. **Electric Telephones** — The first successful attempt to transmit sounds electrically was made in 1861 by Reis, who succeeded in conveying musical and other tones by an imperfect telephone. In this instrument the voice was caused to act upon a point of loose contact in an electric circuit, and by bringing those parts into greater or less intimacy of contact (Art. 346), thereby varied the resistance offered to the circuit. The transmitting part of Reis's telephone consisted of a battery and a contact-breaker, the latter being formed of a tym-

panum or diaphragm of stretched membrane, capable of taking up sonorous vibrations, and having attached to it a thin elastic strip of platinum, which, as it vibrated, beat to and fro against the tip of a platinum wire, so making and breaking contact wholly or partially at each vibration in exactly the same manner as is done with the carbon contacts in the modern transmitters of Blake, Berliner, etc. The receiving part of the instrument consisted of an iron wire fixed upon a sounding-board and surrounded by a coil of insulated wire forming part of the circuit. The rapid magnetisation and demagnetisation of such an iron core will produce audible sounds (Art. 113), which, since the pitch of a note depends only on the *frequency* and not on the form or amplitude of the vibrations, will reproduce the pitch of a note sung into the transmitting part. If the current vary less abruptly, the iron wire is partially magnetised and demagnetised, giving rise in turn to vibrations of varying amplitudes and forms; hence such a wire will serve perfectly as a receiver to reproduce speech if a good transmitter is used. Reis himself transmitted speech with his instrument, but only imperfectly, for all tones of speech cannot be transmitted by abrupt interruptions of the current, to which Reis's transmitter is prone when spoken into, owing to the extreme lightness of the contact: they require gentle undulations, sometimes simple, sometimes complex, according to the nature of the sound. The vowel sounds are produced by periodic and complex movements in the air; the consonants being for the most part non-periodic. If the parts in contact be not too light, and speech be not too loud, Reis's transmitter works fairly as a transmitter, the platinum contacts when clean serving as a satisfactory current-regulator to vary the current in proportion to the vibrations of the voice.

Reis also devised a second receiver, in which an electro-magnet attracted an elastically-supported armature of iron, which vibrated under the attraction of the more or less interrupted current.

435. Graham Bell's Telephone.—In 1876 Graham Bell invented the magneto-telephone. In this instrument the speaker talks to an elastic plate of thin sheet iron, which vibrates and transmits its every movement electrically to a similar plate in a similar telephone at a distant station, causing it to vibrate in an identical manner, and therefore to emit identical sounds. The transmission of the vibrations depends upon the principles of magneto-electric induction explained in Lesson XXXVI. Fig.

168 shows Bell's Telephone in its latest form, and its internal parts in section. The disc D is placed behind a conical mouthpiece, to which the speaker places his mouth or the hearer his ear. Behind the disc is a magnet AA running the length of the instrument; and upon its front pole, which nearly touches the disc, is fixed a small bobbin,

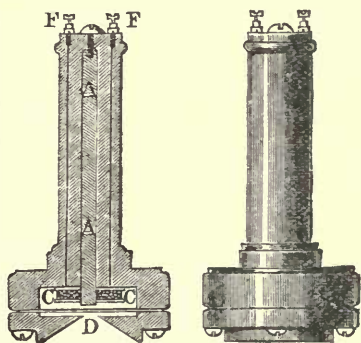

Fig. 168.

on which is wound a coil C of fine insulated wire, the ends of the coil being connected with the terminal screws F F. One such instrument is used to transmit, and one to receive, the sounds, the two telephones being connected in simple circuit. No battery is needed, for the transmitting instrument itself generates the induced currents as follows: The magnet AA induces a certain number of lines-of-force through the coil C. Many of these pass into the iron disc. When the iron disc in vibrating moves towards the magnet-pole, more lines-of-force meet it; when it recedes, fewer lines-of-force meet it. Its motion to and fro will therefore *alter the number of lines-of-force which pass through the hollow of the coil C*, and will therefore (Art. 394) generate in the wire of

the coils currents whose strength is proportional to the rate of change in the number of the lines-of-force which pass through the coil. Bell's telephone, when used as a transmitter, may therefore be regarded as a sort of magneto-electric generator, which, by vibrating to and fro, pumps currents in alternate directions into the wire. At the distant end the currents as they arrive flow round the coils either in one direction or the other, and therefore either add momentarily to or take from the strength of the magnet. When the current in the coils is in such a direction as to reinforce the magnet, the magnet attracts the iron disc in front of it more strongly than before. If the current is in the opposite direction the disc is less attracted and flies back. Hence, whatever movement is imparted to the disc of the transmitting telephone, the disc of the distant receiving telephone is forced to repeat, and it therefore throws the air into similar vibrations, and so reproduces the sound. Bell's Telephone, used as a receiver, differs only from the second receiver of Reis in having as its armature a thin elastic iron plate instead of an iron bar oscillating on an elastic support, and in having its central magnet of steel instead of iron.

436. Edison's Telephone.—Edison constructed a telephone for transmitting speech, in which the vibrations of the voice, actuating a diaphragm of mica, made it exert more or less compression on a button of prepared lamp-black placed in the circuit. The resistance of this is affected by pressure of contacts; hence the varying pressures due to the vibrations cause the button to offer a varying resistance to any current flowing (from a battery) in the circuit, and vary its strength accordingly. This varying current may be received as before in an electromagnetic receiver of the type described above, and there set up corresponding vibrations. Edison has also invented a Telephone Receiver of singular power, which depends upon a curious fact discovered by himself, namely,

that if a platinum point presses against a rotating cylinder of moist chalk, the friction is reduced when a current passes between the two. And if the point be attached to an elastic disc, the latter is thrown into vibrations corresponding to the fluctuating currents coming from the speaker's transmitting instrument.

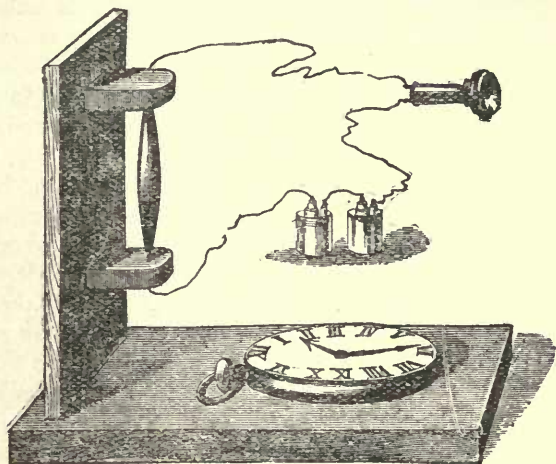

Fig. 169.

436 (*bis*). Dolbear's Telephone.—Telephone Receivers have also been invented by Varley and Dolbear, in which the attraction between the oppositely-electrified armatures of a *condenser* is utilised in the production of sounds. The transmitter is placed in circuit with the primary wire of a small induction-coil; the secondary wire of this coil is united through the line to the receiving condenser. In Dolbear's telephone the receiver consists merely of two thin metal discs, separated by a very thin air-space, and respectively united to the two ends of the secondary coil: As the varying currents flow into and out of this condenser the two discs attract one another more or less strongly, and thereby vibrations are set

up which correspond to the vibrations of the original sound.

437. **Hughes' Microphone.**—Hughes, in 1878, discovered that a *loose contact* between two conductors, forming part of a circuit in which a small battery and a receiving telephone are included, may serve to transmit sounds without the intervention of any specific tympanum or diaphragm like those of Reis and Edison, because the smallest vibrations will effect the amount of the resistance at the point of loose-contact, if the latter be delicately set. The **Microphone** (Fig. 169) embodies this principle. In the form shown in the figure, a small thin pencil of carbon is supported loosely between two little blocks of the same substance—fixed to a sounding-board of thin pine-wood, the blocks being connected with one or two small cells and a Bell telephone as a receiver. The amplitude of the vibrations emitted by this telephone may be much greater than those of the original sounds, and therefore the microphone may serve, as its name indicates, to magnify minute sounds, such as the ticking of a watch or the footfalls of an insect, and render them audible. The less sensitive *carbon-transmitters*, used frequently in conjunction with the telephone, are sometimes regarded as varieties of the microphone. In some of these instruments—Blake's, for instance—there is a tympanum like that of Edison's and of Reis's telephone.

438. **Hughes' Induction Balance.**—The extreme sensitiveness of Bell's telephone (Art. 435) to the feeblest currents has suggested its employment to detect currents too weak to affect the most delicate galvanometer. The currents must, however, be intermittent, or they will not keep the disc of the telephone in vibration. Hughes applied this property of the telephone to an instrument named the **Induction Balance** (Fig. 170). A small battery B, connected with a microphone M, passes through two coils of wire P_1 , P_2 , wound on bobbins fixed

on a suitable stand. Above each of these primary coils are placed two secondary coils, S_1 , S_2 , of wire, of the same size, and of exactly equal numbers of turns of wire. The secondary coils are joined to a telephone T , and are wound in opposite directions. The result of this arrangement is that whenever a current either begins or stops flowing in the primary coils, P_1 induces a current in S_1 , and P_2 in S_2 . As S_1 and S_2 are wound in opposite ways, the two currents thus induced in the secondary wire neutralise one another, and, if they are of equal strength, balance one another so exactly that no sound

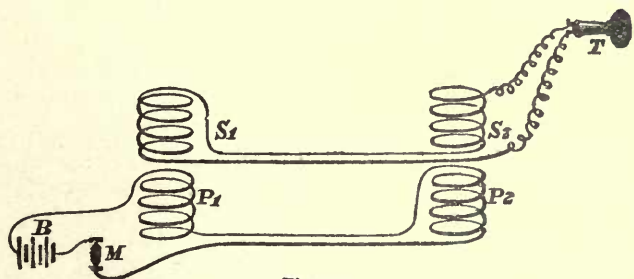

Fig. 170.

is heard in the telephone. But a perfect balance cannot be obtained unless the resistances and the co-efficients of mutual induction and of self-induction are alike. If a flat piece of silver or copper (such as a coin) be introduced between S_1 and P_1 , there will be less induction in S_1 than in S_2 , for part of the inductive action in P_1 is now spent on setting up currents in the mass of the metal (Art. 401), and a sound will again be heard in the telephone. But balance can be restored by moving S_2 farther away from P_2 , until the induction in S_2 is reduced to equality with S_1 , when the sounds in the telephone again cease. It is possible by this means to test the relative conductivity of different metals which are introduced into the coils. It is even possible to detect a counterfeit coin by the indi-

cation thus afforded of its conductivity. The induction balance has also been applied in surgery by Graham Bell to detect the presence of a bullet in a wound, for a lump of metal may disturb the induction when some inches distant from the coils.

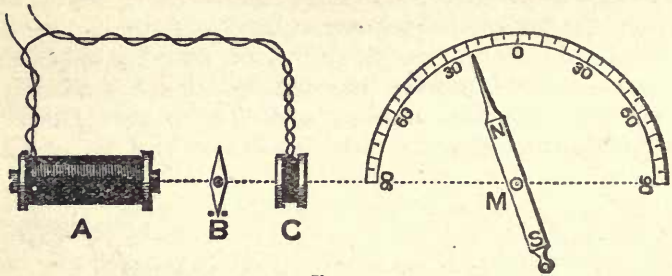

Fig. 171.

439. Hughes' Magnetic Balance.—A very convenient instrument for testing the magnetic properties of different specimens of iron and steel was devised by Hughes in 1884. The sample to be tested is placed in a magnetising coil A (Fig. 171), and a current is sent round it. It deflects a lightly-suspended indicating needle B, which is then brought to zero by turning a large compensating magnet M upon its centre. A small coil C is added to balance the direct deflecting effect due to coil A. The author of this book has shown that if the distance from M to B is 2.3 times the length of M, the angle through which M is turned is proportional to the magnetic force due to the iron core at A, provided the angle is less than 60° .

PROBLEMS AND EXERCISES.

QUESTIONS ON CHAPTER I.

1. From what is the word "*electricity*" derived?
2. Name some of the different methods of producing electrification.
3. A body is charged so feebly that its electrification will not perceptibly move the leaves of a gold-leaf electroscope. Can you suggest any means of ascertaining whether the charge of the body is positive or negative?
4. Describe an experiment to prove that moistened thread conducts electricity better than dry thread.
5. Why do we regard the two electric charges produced simultaneously by rubbing two bodies together as being of opposite kinds?
6. Explain the action of the electrophorus. Can you suggest any means for accomplishing by a rotatory motion the operations of lifting up and down the cover of the instrument so as to obtain a continuous supply instead of an intermittent one.
7. Explain the Torsion Balance, and how it can be used to investigate the laws of the distribution of electricity.
8. Two small balls are charged respectively with $+ 24$ and $- 8$ units of electricity. With what force will they attract one another when placed at a distance of 4 centimetres from one another?
Ans. 12 dynes.
9. If these two balls are then made to touch for an instant

and then put back in their former positions, with what force will they act on each other?

Ans. They repel one another with a force of 4 dynes.

10. Zinc filings are sifted through a sieve made of copper wire upon an insulated zinc plate joined by a wire to an electroscope. What will be observed?

11. Explain the principle of an *air-condenser*; and state why it is that the two oppositely charged plates show less signs of electrification when placed near together than when drawn apart from one another.

12. There are four Leyden jars A, B, C, and D, of which A, B, and D, are of glass, C of guttapercha. A, B, and C, are of the same size, D being just twice as tall and twice as wide as the others. A, C, and D, are of the same thickness of material, but B is made of glass only half as thick as A or D. Compare their capacities.

Ans. Take capacity of A as 1;
that of B will be 2;
that of C will be $\frac{3}{4}$;
and that of D will be 4.

13. How would you prove that there is no electrification within a closed conductor?

14. What prevents the charge of a body from escaping away at its surface?

15. Explain the action of Hamilton's mill.

16. Two brass balls mounted on glass stems are placed half an inch apart. One of them is gradually charged by a machine until a spark passes between the two balls. State exactly what happened in the other brass ball and in the intervening air up to the moment of the appearance of the spark.

17. Define electric density. A charge of 248 units of electricity was imparted to a sphere of 4 centims. radius. What is the density of the charge?

Ans. 1.23 nearly.

QUESTIONS ON CHAPTER II.

1. A dozen steel sewing-needles are hung in a bunch by threads through their eyes. How will they behave when hung over the pole of a strong magnet?

2. Six magnetised sewing-needles are thrust vertically through six little floats of cork, and are placed in a basin of water with their N.-pointing poles upwards. How will they affect one another, and what will be the effect of holding over them the S.-pointing pole of a magnet?

3. What distinction do you draw between magnets and magnetic matter?

4. On board an iron ship which is laying a submarine telegraph cable there is a galvanometer used for testing the continuity of the cable. It is necessary to screen the magnetised needle of the galvanometer from being affected by the magnetism of the ship. How can this be done?

5. How would you prove two magnets to be of equal strength?

6. The force which a magnet-pole exerts upon another magnet-pole decreases as you increase the distance between them. What is the exact law of the magnetic force, and how is it proved experimentally?

7. What force does a magnet-pole, the strength of which is 9 units, exert upon a pole whose strength is 16 units placed 6 centimetres away? *Ans.* 4 dynes.

8. A pole of strength 40 units acts with a force of 32 dynes upon another pole 5 centimetres away. What is the strength of that pole? *Ans.* 20 units.

9. It is desired to compare the magnetic force at a point 10 centimetres from the pole of a magnet with the magnetic force at 5 centimetres' distance. Describe four ways of doing this.

10. Explain the phenomenon of Consequent Poles.

11. In what direction do the lines of magnetic induction (or "lines of force") run in a plane in which there is a single magnetic pole? How would you arrange an experiment by which to test your answer?

12. What is a *Magnetic Shell*? What is the law of the potential due to a magnetic shell?

13. A steel bar magnet suspended horizontally, and set to oscillate at Bristol, made 110 complete oscillations in five

minutes; the same needle when set oscillating horizontally at St. Helena executed 112 complete oscillations in four minutes. Compare the horizontal component of the force of the earth's magnetism at Bristol with that at St. Helena.

Ans. H at Bristol : H at St. Helena :: 484 : 784

14. Supposing the dip at Bristol to be 70° and that at St. Helena to be 30° , calculate from the data of the preceding question the total force of the earth's magnetism at St. Helena, that at Bristol being taken as '48 unit. *Ans.* '307.

[*N.B.*—The student should see Footnote 1, on p. 116.]

15. A small magnetic needle was placed magnetically north of the middle point of a strong bar-magnet which lay (magnetically) east and west. When the magnet was 3 feet away from the needle the deflexion of the latter was 2° ; when moved up to a distance of 2 feet the deflexion was $6^\circ 30'$; and when only 1 foot apart the deflexion was 43° . Deduce the law of the *total action* of one magnet on another.

16. Describe how the daily irregularities of the earth's magnetism are registered at different stations for comparison.

QUESTIONS ON CHAPTER III.

1. Show that the total of the differences of potential by contact in three simple voltaic cells joined in series is three times as great as the difference of potential in one cell, the materials being the same in each.

2. How can local action and polarisation be prevented in a voltaic cell?

3. Supposing the length of spark to be proportional to the difference of potential, calculate from the data of Arts. 291 and 178 how many Daniell's cells would be required to yield a sufficient difference of potential to produce a spark *one mile* long through air. *Ans.* 1092 million cells.

4. On what does the internal resistance of a battery depend? Is there any way of diminishing it?

5. Twenty-four similar cells are grouped together in four rows of six cells each; compare the electromotive-force and the

resistance of the battery thus grouped, with the electromotive-force and the resistance of a single cell.

Ans. The E.M.F. of the battery is six times that of one cell. The total internal resistance is one and a half times that of one cell.

6. A piece of silk-covered copper wire is coiled round the equator of a model terrestrial globe. Apply Ampère's rule to determine in which direction a current must be sent through the coil in order that the model globe may represent the condition of the earth magnetically.

Ans. The current must flow across the Atlantic from Europe to America, and across the Pacific from America toward India; or, in other words, must flow always from east toward west.

7. A current of .24 ampères flows through a circular coil of seventy-two turns, the (average) diameter of the coils being 20 centimetres. What is the strength of the magnetic field which the current produces at the centre of the coil?

Ans. 1.08.

8. Suppose a current passing through the above coil produced a deflection of 35° upon a small magnetic needle placed at its centre (the plane of the coils being in the magnetic meridian), at a place where the horizontal component of the earth's magnetic force is .23 units. Calculate the strength of the current in ampères. (Art. 200.)

Ans. 0.035.

9. The current generated by a dynamo-electric machine was passed through a large ring of stout copper wire, at the centre of which hung a small magnetic needle to serve as a tangent galvanometer. When the steam engine drove the armature of the generator at 450 revolutions per minute the deflection of the needle was 60° . When the speed of the engine was increased so as to produce 900 revolutions per minute the deflection was 74° . Compare the strength of the currents in the two cases.

Ans. The current was twice as great as before, for $\tan 74^\circ$ is almost exactly double of $\tan 60^\circ$.

10. The current from two Grove's cells was passed through a sine-galvanometer to measure its strength. When the conducting wires were of stout copper wire the coils had to be turned through 70° before they stood parallel to the needle. But when long thin wires were used as conductors the coils

only required to be turned through 9° . Compare the strength of the current in the first case with that in the second case when flowing through the thin wires which offered considerable resistance. *Ans.* Currents are as 1 to $\frac{1}{6}$, or as 6 to 1.

11. A plate of zinc and a plate of copper are respectively united by copper wires to the two screws of a galvanometer. They were then dipped side by side into a glass containing dilute sulphuric acid. The galvanometer needle at first showed a deflection of 28° , but five minutes later the deflection had fallen to 11° . How do you account for this falling off?

12. Classify liquids according to their power of conducting electricity.

13. Name the substances produced at the anode and kathode respectively during the electrolysis of the following substances:—*Water, dilute sulphuric acid, sulphate of copper* (dissolved in water), *hydrochloric acid* (strong), *iodide of potassium* (dissolved in water), *chloride of tin* (fused).

14. A current is sent through three electrolytic cells, the first containing acidulated water, the second sulphate of copper, the third contains a solution of silver in cyanide of potassium. How much copper will have been deposited in the second cell while 2.268 grammes of silver have been deposited in the third cell? And what *volume* of mixed gases will have been given off at the same time in the first cell?

Ans. .6614 grammes of copper and 352.8 cubic centimetres of mixed gases.

15. A current passes by platinum electrodes through three cells, the first containing a solution of blue vitriol (cupric sulphate), the second containing a solution of green vitriol (ferrous sulphate), the third containing a solution of ferric chloride. State the amounts of the different substances evolved at each electrode by the passage of 1000 coulombs of electricity

<i>Ans. First Cell,</i>	}	Anode .0828 gramme of oxygen gas.
		Kathode .3261 gramme of copper.
<i>Second Cell,</i>	}	Anode .0828 gramme of oxygen.
		Kathode .2898 gramme of iron.
<i>Third Cell,</i>	}	Anode .3675 gramme of chlorine.
		Kathode .1449 gramme of iron.

16. A tangent galvanometer, whose "constant" in absolute units was 0.080, was joined in circuit with a battery and an

electrolytic cell containing a solution of silver. The current was kept on for one hour; the deflection observed at the beginning was 36° , but it fell steadily during the hour to 34° . Supposing the horizontal component of the earth's magnetic force to be $\cdot 23$, calculate the amount of silver deposited in the cell during the hour, the absolute electro-chemical equivalent of silver being $0\cdot 01134$.
Ans. $\cdot 526$ gramme.

17. A piece of zinc, at the lower end of which a piece of copper wire is fixed, is suspended in a glass jar containing a solution of acetate of lead. After a few hours a deposit of lead in a curious tree-like form ("Arbor Saturni") grows downwards from the copper wire. Explain this.

18. Explain the conditions under which electricity excites muscular contraction. How can the converse phenomenon of currents of electricity produced by muscular contraction be shown?

QUESTIONS ON CHAPTER IV.

1. Define the *unit* of electricity as derived in absolute terms from the fundamental units of *length*, *mass*, and *time*.

2. At what distance must a small sphere charged with 28 units of electricity be placed from a second sphere charged with 56 units in order to repel the latter with a force of 32 dynes?
Ans. 7 centimetres.

3. Suppose the distance from the earth to the moon to be (in round numbers) 383×10^8 centimetres; and that the radius of the earth is 63×10^7 centimetres, and that of the moon 15×10^7 centimetres; and that both moon and earth are charged until the surface density on each of them is of the average value of 10 units per square centimetre. Calculate the electrostatic repulsion between the moon and the earth.

4. A small sphere is electrified with 24 units of + electricity. Calculate the *force* with which it repels a unit of + electricity at distances of 1, 2, 3, 4, 5, 6, 8, and 10 centimetres respectively. Then plot out the "*curve of force*" to scale; measuring the respective distances along a line from left to right as so many centimetres from a fixed point as origin; then setting out as

vertical ordinates the amounts you have calculated for the corresponding forces; lastly, connecting by a curved line the system of points thus found.

5 Define electrostatic (or electric) "*potential*;" and calculate (by the rule given in *italics* in Art. 238) the potential at a point A, which is at one corner of a square of 8 centimetres' side, when at the other three corners B, C, D, taken in order, charges of +16, +34, and +24 units are respectively placed.

Ans. 8, very nearly exactly.

6, A small sphere is electrified with 24 units of + electricity. Calculate the *potential* due to this charge at points 1, 2, 3, 4, 5, 6, 8, and 10 centimetres' distance respectively. Then plot out the "*curve of potential*" to scale, as described in Question 4.

7, What are equipotential surfaces? Why is the surface of an insulated conductor an equipotential surface? Is it always so?

8. A sphere whose *radius* is 14 centimetres is charged until the surface density has a value of 10. What *quantity* of electricity is required for this? *Ans.* 24,640 units (nearly).

9. In the above question what will be the *potential* at the surface of the sphere? (See last sentence of Art. 246.)

Ans. 1760 (very nearly).

10. In the case of question 8, what will be the *electric force* at a point outside the sphere and indefinitely near to its surface? (Art. 251.)

Ans. 125.7 (very nearly).

11. Suppose a sphere whose radius is 10 centimetres to be charged with 6284 units of electricity, and that it is then caused to share its charge with a non-electrified sphere whose radius is 15 centimetres, what will the respective charges and surface-densities on the two spheres be when separated?

Ans. Small sphere, $q = 2513.6$, $\rho = 2$:

Large sphere, $q = 3770.4$, $\rho = 1.33$.

12. A charge of + 8 units is collected at a point 20 centimetres distant from the centre of a metallic sphere whose radius is 10 centimetres. It induces a negative electrification at the nearest side of the sphere. Find a point inside the sphere such that if 4 negative units were placed there they would exercise

a potential on all external points exactly equal to that of the actual negative electrification. (See Art. 250.)

Ans. The point must be on the line between the outside positive charge and the centre of the sphere and at 5 centims. from the surface.

13. Two large parallel metal plates are charged both positively but unequally, the density at the surface of A being + 6, that at the surface of B being + 3. They are placed 2 centimetres apart. Find the force with which a + unit of electricity is urged from A towards B. Find also the work done by a + unit of electricity in passing from A to B.

Ans. Electric force from A towards B = 18.85 dynes; work done by unit in passing from A to B = 37.5 ergs.

14. What is meant by the *dimensions* of a physical quantity? Deduce from the Law of Inverse Squares the dimensions of electricity; and show by this means that electricity is not a quantity of the same physical dimensions as either *matter, energy, or force*.

15. Explain the construction and principles of action of the quadrant electrometer. How could this instrument be made self-recording?

16. One of the two coatings of a condenser is put to earth, to the other coating a charge of 5400 units is imparted. It is found that the difference of potential thereby produced between the coatings is 15 (electrostatic) units. What was the capacity of the condenser? *Ans.* 360.

17. What is the meaning of *specific inductive capacity*? Why does hot glass *appear* to have a higher specific inductive capacity than cold glass?

18. Compare the phenomenon of the residual charge in a Leyden jar with the phenomenon of polarisation in an electrolytic cell.

19. A condenser was made of two flat square metal plates, the side of each of them being 35 centimetres. A sheet of indiarubber .4 centim. thick was placed between them as a dielectric. The specific inductive capacity of indiarubber being taken as 2.25, calculate the capacity of the condenser.

Ans. 548.8 electrostatic units.

20. Calculate (in electrostatic units) the capacity of a mile of telegraph cable the core being a copper wire of .13 centim. diameter, surrounded by a sheathing of guttapercha .91 centim. thick. [k for guttapercha = 2.46; one mile = 160,933 centims.] *Ans.* 82 164 units.

21. A Leyden jar is made to share its charge with two other jars, each of which is equal to it in capacity. Compare the energy of the charge in one jar with the energy of the original charge. *Ans.* One ninth as great.

22. A series of Leyden jars of equal capacity are charged "in cascade." Compare the total *energy* of the charge of the individual jars thus charged, with that of a single jar charged from the same source.

23. Classify the various modes of discharge, and state the conditions under which they occur.

24. Suppose a condenser, whose capacity is 10,000 charged to potential 14, to be partially discharged so that the potential fell to 5. Calculate the amount of heat produced by the discharge, on the supposition that all the energy of the spark is converted into heat. *Ans.* .020357 of a unit of heat.

25. How do changes of pressure affect the passage of electric sparks through air?

26. Why are telegraphic signals through a submerged cable retarded in transmission, and how can this retardation be obviated?

27. How is the difference of potential between the earth and the air above it measured? and what light do such measurements throw on the periodic variations in the electrical state of the atmosphere?

28. What explanation can be given of the phenomena of a thunderstorm?

29. What are the essential features which a lightning-conductor must possess before it can be pronounced satisfactory? And what are the reasons for insisting on these points?

30. How can the duration of an electric spark be measured?

QUESTIONS ON CHAPTER V.

1. Define *magnetic potential*, and find the (magnetic) potential due to a bar magnet 10 centimetres long, and of strength 80, at a point lying in a line with the magnet poles and 6 centimetres distant from its N.-seeking end. *Ans.* 8·3.

2. A N.-seeking pole and a S.-seeking pole, whose strengths are respectively + 120 and - 60, are in a plane at a distance of 6 centimetres apart. Find the point between them where the potential is = 0; and through this point draw the curve of zero potential in the plane.

3. Define "intensity of the magnetic field." A magnet whose strength is 270 is placed in a uniform magnetic field whose intensity is $\cdot 166$. What are the forces which act upon its poles? *Ans.* + 45 dynes and - 45 dynes.

4. Define "intensity of magnetisation." A rectangular bar-magnet, whose length was 9 centimetres, was magnetised until the strength of its poles was 164. It was 2 centimetres broad and $\cdot 5$ centimetre thick. Supposing it to be uniformly magnetised throughout its length, what is the intensity of the magnetisation? *Ans.* 164.

5. Poisson suggested a two-fluid theory of magnetism, the chief point of the hypothesis being that in the molecules of iron and other magnetic substances there were equal quantities of two opposite kinds of magnetic fluid; and that in the act of magnetisation the two fluids were separated. What facts does this theory explain? What facts does it fail to explain?

6. A current whose strength in "absolute" electromagnetic units was equal to 0·05 traversed a wire ring of 2 centimetres radius. What was the strength of field at the centre of the ring? What was the potential at a point P opposite the middle of the ring and 4 centimetres distant from the circumference of the ring. *Ans.* $f = \cdot 1571$; $V = \pm 0\cdot 0421$.

7. What limits are there to the power of an electromagnet?

8. What is the advantage of the iron core in an electromagnet?

9. Assuming the effective coefficient of magnetisation of iron

to be 20, calculate the strength of the pole of an electromagnet whose coils consist of 50 turns of wire of an average radius of 1 centimetre, when a current of .2 ampères passes through the coils, the core consisting of a bar 5 centimetres long and of 1 square centimetre of area in its cross section [see Art. 328].

Ans. 528 units.

10. Enunciate Maxwell's rule concerning magnetic shells, and from it deduce the laws of parallel and oblique currents discovered by Ampère.

11. A circular copper dish is joined to the zinc pole of a small battery. Acidulated water is then poured into the dish, and a wire from the carbon pole of the battery dips into the liquid at the middle. A few scraps of cork are thrown in to render any movement of the liquid visible. What will occur when the N.-seeking pole of a strong bar-magnet is held above the dish?

12. Roget hung up a spiral of copper wire so that the lower end *just* dipped into a cup of mercury. When a strong current was sent through the spiral it started a continuous dance, the lower end producing bright sparks as it dipped in and out of the mercury. Explain this experiment.

13. It is believed, though it has not yet been proved, that ozone is more strongly magnetic than oxygen. How could this be put to proof?

QUESTIONS ON CHAPTER VI.

1. The resistance of telegraph wire being taken as 13 *ohms* per mile, and the E. M. F. of a Leclanché cell as 1.5 *volt*, calculate how many cells are needed to send a current of 12 *milli-ampères* through a line 120 miles long; assuming that the instruments in circuit offer as much resistance as 20 miles of wire would do, and that the return-current through *earth* meets with no appreciable resistance.

Ans. 15 cells.

2. 50 Grove's cells (E. M. F. of a Grove = 1.8 *volt*) are united in series, and the circuit is completed by a wire whose resistance is 15 *ohms*. Supposing the internal resistance of each cell to be 0.3 *ohm*, calculate the strength of the current.

Ans. 3 *ampères*.

3. The current running through an incandescent filament of carbon in a lamp was found to be exactly 1 *ampère*. The difference of potential between the two terminals of the lamp while the current was flowing was found to be 30 *volts*. What was the resistance of the filament?

4. Define specific resistance. Taking the specific resistance of copper as 1642, calculate the resistance of a kilometre of copper wire whose diameter is 1 millimetre. *Ans.* 20.9 *ohms*.

5. On measuring the resistance of a piece of No. 30 B. W. G. (covered) copper wire, 18.12 yards long, I found it to have a resistance of 3.02 *ohms*. Another coil of the same wire had a resistance of 22.65 *ohms*; what length of wire was there in the coil?
Ans. 135.9 yards.

6. Calculate the resistance of a copper conductor one square centimetre in area of cross-section, and long enough to reach from Niagara to New York, reckoning this distance as 480 kilometres.
Ans. 78.8 *ohms*.

7. You have given an unlimited number of Telegraph Daniell's cells (Fig. 77), their E. M. F. being 1.1 *volt* each, and their average internal resistance being 2.2 *ohms* each. What will be the strength of the current when five such cells, in series, are connected through a wire whose resistance is 44 *ohms*?
Ans. 0.1 *ampère*.

8. Show in the preceding case that with an infinite number of cells *in series*, the current could not possibly exceed 0.5 *ampère*.

9. The specific resistance of guttapercha being 3.5×10^{23} , calculate the number of *coulombs* of electricity that would leak in one *century* through a sheet of guttapercha one centimetre thick and one metre square, whose faces were covered with tinfoil and joined respectively to the poles of a battery of 100 Daniell's cells.
Ans. 9.7 *coulomb*.

10. Six Daniell's cells, for each of which $E = 1.05$ *volts*, $r = 0.5$ *ohm*, are joined in series. Three wires, X, Y, and Z, whose resistances are severally 3, 30, and 300 *ohms*, can be inserted between the poles of the battery. Determine the current (in *ampères*) which flows when each wire is inserted separately; also determine that which flows when they are all inserted at once, in parallel arc.

<i>Ans.</i> Through X	1.05	ampères	per sec.
Through Y	0.1909	"	"
Through Z	0.0207	"	"
Through all three	1.105	"	"

11. Calculate the number of cells required to produce a current of 50 *milli-ampères*, through a line 114 miles long, whose resistance is $12\frac{1}{2}$ *ohms* per mile, the available cells of the battery having each an internal resistance of 1.5 *ohm*, and an E.M.F. of 1.5 *volt*.

Ans. 50 cells.

12. You have 20 large Leclanché cells (E.M.F. = 1.5 *volt*, $r=0.5$ *ohm* each) in a circuit in which the external resistance is 10 *ohms*. Find the strength of current which flows (a) when the cells are joined in simple series; (b) all the zincs are united, and all the carbons united, in parallel arc; (c) when the cells are arranged two abreast (*i.e.* in two files of ten cells each); (d) when the cells are arranged four abreast.

<i>Ans.</i> (a)	1.5	ampère.
(b)	0.1496	"
(c)	1.2	"
(d)	0.702	"

13. With the same battery how would you arrange the cells in order to telegraph through a line 100 miles long, reckoning the line resistance as $12\frac{1}{2}$ *ohms* per mile?

14. I have 48 cells, each of 1.2 *volt* E.M.F., and each of 2 *ohms* internal resistance. What is the best way of grouping them together when it is desired to send the strongest possible current through a circuit whose resistance is 12 *ohms*?

Ans. Group them three abreast.

15. Show that, if we have a battery of n given cells each of resistance r in a circuit where the external resistance is R , the strength of the current will be a maximum when the cells are coupled up in a certain number of rows equal numerically to $\sqrt{nr \div R}$.

16. Two wires, whose separate resistances are 28 and 24, are placed in parallel arc in a circuit so that the current divides, part passing through one, part through the other. What resistance do they offer thus to the current?

Ans. 12.92 *ohms*.

17. Using a large bichromate cell of practically no internal resistance, a deflection of 9° was obtained upon a tangent

galvanometer (also of small resistance) through a wire whose resistance was known to be 435 *ohms*. The same cell gave a deflection of 5° upon the same galvanometer when a wire of unknown resistance was substituted in the circuit. What was the unknown resistance?

Ans. 790 *ohms*.

18. In a Wheatstone's bridge in which resistances of 10 and 100 *ohms* respectively were used as the fixed resistances, a wire whose resistance was to be determined was placed: its resistance was balanced when the adjustable coils were arranged to throw 281 *ohms* into circuit. What was its resistance?

Ans. 28.1 *ohms*.

19. A battery of 5 Leclanché cells was connected in simple circuit with a galvanometer and a box of resistance coils. A deflection of 40° having been obtained by adjustment of the resistances, it was found that the introduction of 150 additional *ohms* of resistance brought down the deflection to 29° . A battery of ten Daniell's cells was then substituted in the circuit and adjusted until the deflexion was 40° as before. But this time it was found that 216 *ohms* had to be added before the deflection was brought down to 29° . Taking the E.M.F. of a single Daniell's cell as 1.079 volt, calculate that of a single Leclanché cell.

Ans. 1.499 volt.

20. How are standard resistance coils wound, and why? What materials are they made of, and why?

21. Three very small Daniell's cells gave, with a sine galvanometer (itself of no appreciable resistance), a reading of 57° . On throwing 20 *ohms* into the circuit the galvanometer reading fell to 25° . Calculate the internal resistance of the cells.

Ans. 6.6 *ohms* each.

22. A knot of telegraph cable was plunged in a tub of water and then charged for a minute from a battery of 120 Daniell's cells. The cable was then discharged through a long-coil galvanometer with a needle of slow swing. The first swing was 40° . A condenser whose capacity was $\frac{1}{2}$ *microfarad* was then similarly charged and discharged; but this time the first swing of the needle was only over 14° . What was the capacity of the piece of cable?

Ans. 0.934 *microfarad*.

23. Using an absolute electrometer, Sir W. Thomson found the difference of potential between the poles of a Daniell's cell

to be $\cdot 00374$ *electrostatic* units (C.G.S. system). The ratio of the electrostatic to the electromagnetic unit of potential is given in Art. 365, being $= \frac{1}{v}$. The *volt* is defined as 10^8 electromagnetic units. From these data calculate the E.M.F. of a Daniell's cell in *volts*.
Ans. $1\cdot115$ *volt*.

24. The radius of the earth is approximately 63×10^7 centimetres. The ratio of the electrostatic to the electromagnetic unit of capacity is given in Art. 365. The definition of the *farad* is given in Art. 323. Calculate the capacity of the earth (regarded as a sphere) in *microfarads*.

Ans. 700 *microfarads* (nearly).

25. The electromotive-force of a Daniell's cell was determined by the following process:—Five newly-prepared cells were set up in series with a tangent galvanometer, whose constants were found by measurement. The resistances of the circuit were also measured, and found to be in total $16\cdot9$ *ohms*. Knowing the resistance and the absolute strength of current the E.M.F. could be calculated. The deflection obtained was 45° , the number of turns of wire in the coil 10, the average radius of the coils 11 centimetres, and the value of the horizontal component of the earth's magnetism at the place was $0\cdot18$ C.G.S. units. Deduce the E.M.F. of a Daniell's cell.

Ans. $1\cdot0647 \times 10^8$ C.G.S. units, or $1\cdot0647$ *volt*.

QUESTIONS ON CHAPTER VII.

1. I have seen a small chain in which the alternate links were of platinum and silver wires. When an electric current was sent through the chain the platinum links grew red hot while the silver links remained cold. Why was this?

2. Calculate by Joule's law the number of heat units developed in a wire whose resistance is 4 *ohms* when a steady current of $\cdot 14$ *ampère* is passed through it for 10 minutes.

Ans. $11\cdot2$ units of heat.

3. What sort of cells ought to be the best for providing currents to fire torpedo shots?

4. Explain why a regulator like that of Duboscq is employed in obtaining a steady voltaic arc.

5. I once tried to obtain an electric light by using a battery of 3000 telegraph Daniell's cells in series, but without success. Why did this enormous battery power fail for this purpose? Could it have been made to give a light by any different arrangement of the cells?

6. A battery of 2 Grove's cells, a galvanometer, and a little electromagnetic engine, were connected in circuit. At first the engine was loaded, so that it could only run slowly; but when the load was lightened it spun round at a tremendous speed. But the faster the little engine worked the feebler was the current indicated by the galvanometer. Explain this.

7. A current of 9 *ampères* worked an electric arc light, and on measuring the difference of potential between the two carbons by an electrometer it was found to be 140 volts. What was the amount of horse-power absorbed in this lamp?

Ans. 1.69 H.-P.

8. You have a lathe in your workshop which requires power to turn it. There is a stream of water tumbling down the hill-side, two miles off, with power enough to turn twenty lathes. How can you bring this power to the place where you want to use it?

9. What is the use of the electro-dynamometer? Assuming that the moment of the force acting on the movable coil of the electro-dynamometer is proportional to the product of the strengths of the currents in the two coils, show that the *work* performed by a current is really measured by the electro-dynamometer of Marcel Deprez, in which one set of coils has a very small resistance and the other a very high resistance (consisting of many turns of fine wire), the latter being arranged as a shunt to the lamp, motor, or other instrument, in which the work to be measured is being done, the former having the whole current passed through it.

QUESTIONS ON CHAPTER VIII.

1. A strong battery-current is sent, for a few moments, through a bar made of a piece of antimony soldered to a piece of bismuth. The battery is then disconnected from the wires and they are joined to a galvanometer which shows a deflection. Explain this phenomenon.

2. A long strip of zinc is connected to a galvanometer by iron wires. One junction is kept in ice, the other is plunged into water of a temperature of 50°C . Calculate, from the table given in Art. 381, the electromotive-force which is producing the current, *Ans.* 690 microvolts.

3. When heat is evolved at a junction of two metals by the passage of a current, how would you distinguish between the heat due to resistance and the heat due to the Peltier effect?

4. Sir W. Thomson discovered that when a current flows through iron it absorbs heat when it flows from a hot point to a cold point; but that when a current is flowing through copper it absorbs heat when it flows from a cold point to a hot point. From these two facts, and from the general law that energy tends to run down to a minimum, deduce which way a current will flow round a circuit made of two half-rings of iron and copper, one junction of which is heated in hot water and the other cooled in ice.

QUESTIONS ON CHAPTER IX.

1. Give the reasons which exist for thinking that light is an electromagnetic phenomenon.

2. How is the action of magnetic forces upon the direction of the vibrations of light shown? and what is the difference between magnetic and diamagnetic media in respect of their magneto-optic properties?

3. It was discovered by Willoughby Smith that the resistance of selenium is less when exposed to light than in the dark. Describe the apparatus you would employ to investigate this phenomenon. How would you proceed to experiment if you wished to ascertain whether the amount of electric effect was proportional to the amount of illumination?

QUESTIONS ON CHAPTER X.

1. The ends of a coil of fine insulated wire are connected with terminals of a long-coil galvanometer. A steel bar-magnet

is placed *slowly* into the hollow of the coil, and then withdrawn *suddenly*. What actions will be observed on the needle of the galvanometer?

2. Round the outside of a deep cylindrical jar are coiled two separate pieces of fine silk-covered wire, each consisting of many turns. The ends of one coil are fastened to a battery, those of the other to a sensitive galvanometer. When an iron bar is poked into the jar a momentary current is observed in the galvanometer coils, and when it is drawn out another momentary current, but in an opposite direction, is observed. Explain these observations.

3. A casement window has an iron frame. The aspect is north, the hinges being on the east side. What happens when the window is opened?

4. Explain the construction of the induction coil. What are the particular uses of the condenser, the automatic break, and the iron wire core?

5. It is desired to measure the strength of the field between the poles of an electromagnet which is excited by a current from a constant source. How could you apply Faraday's discovery of induction currents to this purpose?

6. What is meant by the term "extra-currents?" A small battery was joined in circuit with a coil of fine wire and a galvanometer, in which the current was found to produce a steady but small deflection. An unmagnetised iron bar was now plunged into the hollow of the coil and then withdrawn. The galvanometer needle was observed to recede momentarily from its first position, then to return and to swing beyond it with a wider arc than before, and finally to settle down to its original deflection. Explain these actions.

7. In what respect do dynamo-electric machines differ from magneto-electric machines? Where does the magnetism of the field-magnets come from in the former? Where does the dynamical energy of the currents come from in the latter?

8. The older magneto-electric machines produced only *intermittent* currents, and these were usually *alternating* in direction. By what means do the more modern magneto-electric generators produce currents which are *continuous* and *direct*?

9. A compass needle, when set swinging, comes to rest sooner if a plate of copper is placed beneath it than if a plate of glass or wood lies beneath it. Explain this fact.

10. Explain how it is that on making circuit the current rises only gradually to its full strength, especially if there are large electromagnets in the circuit.

11. Foucault set the heavy bronze wheel of his gyroscope spinning between the poles of a powerful electromagnet, and found that the wheel grew hot, and stopped. What was the cause of this? Where did the heat come from?

12. The strength of the field between the poles of a large electromagnet was determined by the following means:—A small circular coil, consisting of 40 turns of fine insulated wire, mounted on a handle, was connected to the terminals of a long-coil galvanometer having a heavy needle. On inverting this coil suddenly, at a place where the total intensity of the earth's magnetic force was $\cdot 48$ unit, a deflection of 6° was shown as the first swing of the galvanometer needle. The sensitiveness of the galvanometer was then reduced to $\frac{1}{10}$ by means of a shunt. The little coil was introduced between the poles of the electromagnet and suddenly inverted, when the first swing of the galvanometer needle reached 40° . What was the strength of the field between the poles? *Ans.* 315.7 units.

QUESTIONS ON CHAPTER XI.

1. It is found that a single Daniell's cell will not electrolyse acidulated water, however big it may be made. It is found, on the other hand, that two Daniell's cells, however small, will suffice to produce continuous electrolysis of acidulated water. How do you account for this?

2. When a gramme of zinc combines with oxygen it gives out 1301 heat-units. When this zinc oxide is dissolved in sulphuric acid 369 more units are evolved. To separate an equivalent amount of copper sulphate into sulphuric acid and copper oxide requires 588 heat-units to be expended. To separate the copper from the oxygen in this oxide requires 293 more heat-units. The absolute electro-chemical equivalent of zinc is 0.003412 (*see* Art. 212), and Joule's dynamical equivalent

of heat is 42×10^6 . From these figures calculate the electromotive force of a Daniell's cell.

Ans. 1.1306×10^3 C.G.S. units, or
1.1306. volt.

3. Explain the operation of charging a secondary battery. What are the chemical actions which go on during charging and during discharging?

4. Most liquids which conduct electricity are decomposed (except the melted metals) in the act of conducting. How do you account for the fact observed by Faraday that the amount of matter transferred through the liquid and deposited on the electrodes is proportional to the amount of electricity transferred through the liquid?

5. Describe the process for multiplying by electricity copies of engravings on wood-blocks.

6. How would you make arrangements for silvering spoons of nickel-bronze by electro-deposition?

QUESTIONS ON CHAPTER XII.

1. Sketch an arrangement by which a single line of wire can be used by an operator at either end to signal to the other; the condition of working being that whenever you are not sending a message yourself your instrument shall be *in circuit* with the line wire, and *out of circuit* with the battery at your own end.

2. What advantages has the Morse instrument over the needle instruments introduced into telegraphy by Cooke and Wheatstone?

3. Explain the use and construction of a relay.

4. It is desirable in certain cases (diplex and quadruplex signalling) to arrange telegraphic instruments so that they will respond only to currents which come in one direction through the line. How can this be done?

5. A battery is set up at one station. A galvanometer needle at a station eighty miles away is deflected through a certain number of degrees when the wire of its coil makes twelve turns round the needle; wire of the same quality being used for both line and galvanometer. At 200 miles the same deflection is obtained when twenty-four turns are used in the galvan-

ometer-coil. Show by calculation (a) that the internal resistance of the battery is equal to that of 40 miles of the line-wire; (b) that to produce an equal deflection at a station 360 miles distant the number of turns of wire in the galvanometer-coil must be 40.

6. Suppose an Atlantic cable to snap off short during the process of laying. How can the distance of the broken end from the shore end be ascertained?

7. Suppose the copper core of a submarine cable to part at some point in the middle without any damage being done to the outer sheath of guttapercha. How could the position of the fault be ascertained by tests made at the shore end?

8. Explain the construction and action of an electric bell.

9. Describe and explain how electric currents are applied in the instruments by which very short intervals of time are measured.

10. Explain the use of Graham Bell's telephone (1) to transmit vibrations; (2) to reproduce vibrations.

11. Describe a form of telephone in which the vibrations of sound are transmitted by means of the changes they produce in the resistance of a circuit in which there is a constant electromotive-force.

12. Two coils, A and B, of fine insulated wire, made exactly alike, and of the same number of windings in each, are placed upon a common axis, but at a distance of 10 inches apart. They are placed in circuit with one another and with the secondary wire of a small induction-coil of Ruhmkorff's pattern, the connections being so arranged that the currents run round the two coils in opposite directions. A third coil of fine wire, C, has its two ends connected with a Bell's telephone, to which the experimenter listens while he places this third coil between the other two. He finds that when C is exactly midway between A and B no sound is audible in the telephone, though sounds are heard if C is nearer to either A or B. Explain the cause of this. He also finds that if a bit of iron wire is placed in A silence is not obtained in the telephone until C is moved to a position nearer to B than the middle. Why is this? Lastly, he finds that if a disc of brass, copper, or lead, is interposed between A and C, the position of silence for C is now nearer to A than the middle. How is this explained?

INDEX.

N.B.—*The Figures refer to the Numbered Paragraphs.*

A

ABSOLUTE Electrometer, 261
Galvanometer, 200
Measurements, 325a, 363, 364
Units of Measurement, 255

Accumulator, 47, 48, 266
of currents (see *Secondary Batteries*)

Action at a distance, 21, 56, 272

Air condenser, 48, 267

Air, resistance of, 291, 325b

Aldini, Giovanni, Experiments on
Animals, 229

Amalgam, electric, 41

Amalgamating zinc plates, 162

Amber, 1

Amœba, the sensitiveness of, 230

Am-meter, 200 (*bis*)

Ampère, André, Theory of Electro-
dynamics, 331, 334
"Ampère's Rule," 186
Laws of Currents, 332
suggests a Telegraph, 423
Table for Experiments, 333
Theory of Magnetism, 338
Ampère, the, 323

Angles, Ways of Reckoning, 129
Solid, 133

Animal Electricity, 68, 231

Anion, 210

Annual variations of magnet, 143

Anode, 207

Arc, voltaic, 371

Arago, François Jean,
classification of lightning, 304
magnetisation by current, 326
on magnetic action of a voltaic
current, 191
on magnetic rotations, 401

Armature of magnet, 101
of dynamo-electric machine,
407, 409, 410

Armstrong, Sir Wm., his Hydro-
electric Machine, 44.

Astatic magnetic needles, 190
Galvanometer, 190

Atmospheric Electricity, 64, 301, 306

Attracted-disc Electrometers, 261

Attraction and repulsion of elec-
trified bodies, 1, 3, 18, 20,
66, 236
and repulsion of currents, 331,
and repulsion of magnets, 76, 80
332

Aurora, the, 144, 145, 309

Ayrton (W. E.) and Perry (John)
on contact electricity, 72
on dielectric capacity, 271
value of "v," 365
am-meter, 200 (*bis*)
voltmeter, 360 (*d*)

Azimuth Compass, 134, 136

B

B. A. UNIT (or ohm), 323, 363, 364

Back Stroke, 26, 304

Bain's Chemical Writing Telegraph,
218

Balance, *Wheatstone's*, 358

Ballistic Galvanometer, 204

Bancalari on diamagnetism of flames,
344

Battery of Leyden Jars, 54

Batteries, voltaic, 154, 167, 182
" list of, 178
secondary, 415

Beccaria, Father G., on electric
distillation, 223

- Beccaria, Father G.*, on atmospheric electricity, 306
- Becquerel, Antoine Cesar*, on atmospheric electricity, 307
on diamagnetism, 339
- Becquerel, Edmond*, on photo-voltaic currents, 389
- Becquerel, Henri*, on magneto-optic rotation, 387
- Bell, Alexander Graham*, his Telephone, 435
The Photophone, 389
- Bells, electric, 432
- Bennet's Doubler*, 23
Electroscope, 13, 25
- Bertsch's Electric Machine*, 45
- Best grouping of cells, 351
- Bichromate Battery, 165
- Bifilar Suspension, 118, 262, 336
- Biot, Jean Baptiste*, Experiment with hemispheres, 30
Law of magnetic distribution, 128
on atmospheric electricity, 307
- Bismuth, diamagnetic properties of, 87, 313, 339
- Blasting by electricity, 286, 370
- Blood, diamagnetism of, 339
- Boracite, 67
- "Bound" electricity, 24, 149 (Foot-note)
- Boltzmann*, on Dielectric capacity, 270, 271, 390
- Boyle, Hon. Robert*, on electrical attraction, 2
- Branched circuit, 353
- Breaking a magnet, 106
- Breath-figures, 297
- Bridge, *Wheatstone's*, 358
- British Association Unit, 323, 364, 365.
- Brugmans* discovers magnetic repulsion of bismuth, 339
- Brush discharge, 290
- Brush's* dynamo-electric machine, 411
- Bunsen's Battery*, 172
- O**
- CABLE, Atlantic, 274 (Footnote), 275, 296, 429
submarine, 429
" as condenser, 274, 296, 430
- Cabot, Sebastian*, on magnetic declination, 136
- Caillelet* on resistance of air, 291
- Calibration of Galvanometer, 108
- Callan's Battery*, 172
- Callaud's Battery*, 176
- Canton, John*, discovers Electrostatic Induction, 18
on Electric Amalgam, 41
- Candle, electric, 373
- Capacity, definition of, 246
measurement of, 362
of accumulator or condenser, 50, 267, 277
of conductor, 37, 47, 247, 277
of Leyden Jar, 50, 267
specific inductive, 21, 49, 268, 272
unit of (electrostatic), 247
unit of (practical), 276
- Capillary Electrometer, 225, 265
- Carnivorous Plants, sensitive to electricity, 230
- Carré, F.*, Dielectric machine, 45
on magnets of cast metal, 97
- Cascade arrangement of Jars, 279
- Cautery by electricity, 369
- Cavallo Tiberius*, his attempt to telegraph, 423
his pith-ball electroscope, 3
on a fireball, 304
on atmospheric electricity, 302, 306
- Cavendish, Hon. H.*, on Specific Inductive capacity, 268, 269
on nitric acid produced by sparks, 286
- Coca, Father*, on atmospheric electricity, 306
- Cell, voltaic, 152
- Charge, electric, 7
resides on surface, 27
residual of Leyden Jar, 53, 272
- Chart, magnetic, 136, 169
- Chemical actions in the battery, 159
laws of, 166, 211, 417
of spark discharge, 286
outside the battery, 205, 412
- Chemical test for weak currents, 218, 286
- Chimes, electric, 43
- Chronograph, electric, 433
- Circuit, 152
simple and compound, 181
- Clark's (Latimer)* standard cell, 177
- Clausius, R.*, theory of Electrolysis, 418
- Cleavage, electrification by, 60
- Clocks, electric, 433
- Cobalt, magnetism of, 86
- Coefficient of Magnetic induction, 89
313
of mutual induction, 397

- Coercive force, 89
 Colour of spark, 289
Columbus, Cristoforo, on magnetic variation, 136
 Combustion a source of electrification, 02
 Commutator, 375, 399, 407
 Compass (magnetic), Mariner's, 79, 134
 Compound circuit, 181
 Condensation 48
 Condensers, 48, 267
 standard, 276
 use of, 275
 Condensing electroscope, 71, 149
 Conduction, 27, 158
 by liquids, 205
 of gases, 158
 Conductivity, 158, 346, 348
 Conductors and Non-conductors, 8, 27
 Consequent Poles, 104, 109
 Contact Electricity, 71, 149
 Series of metals, 72
 Continuous electrophorus, 23, 45
 Convection of Electricity, 45, 337
 Convection-currents, properties of, 337
 Convection-induction machines, 45
 Convection-streams at points, 35 (a), 43, 249
 Cooling and heating of junction by current, 380
 Cost of power derived from electricity, 378
Coulomb, Torsion Balance, 15, 119
 Law of Inverse Squares, 16, 117, 119, 235, 245
 on distribution of charge, 35, 248
 Coulomb, the, 323
 Couple, magnetic, 123
Crookes, William, on shadows in electric discharge, 293
 on repulsion from negative electrode, 300
 Crown of cups, 151
Cruikshank's Trough Battery, 102
 Crystals, electricity of, 06
 dielectric properties of, 270
 magnetism of, 343
 Crystallisation, 61
Cumming's phenomenon, 382
Cunee's discovery of Leyden Jar, 52
 Current, effects due to, 153
 Current Electricity, 747
 strength of, 152, 179
 " unit of, 196
 Current-reverser (see *Commutator*)
 Current sheets, 340
 Curvature affects surface-density, 35, 249
- Curves, magnetic (see *Magnetic Figures*)
Cuthbertson's Electric machine, 38, 289
 Cylinder Electrical machine, 39
- D
- DAILY variations of magnet, 142
Dalibard's lightning-rod, 302
Daniell's Battery, 170
Davy's (Marié) Battery, 175
Davy, Sir Humphrey, magnetisation by current, 326
 discovers electric light, 371
 electrolyses caustic alkalies, 417 (c)
De Haldat, magnetic writing, 111
De la Rive's Floating Battery, 194
De la Rue, Chloride of Silver Battery, 174, 291
 on electrotyping, 420
 on length of spark, 291
 Declination, Magnetic, 136
 variations of, 136, 141
 Decomposition of water, 206, 413
 of alkalies, 417
 Deflections, method of, 118, 123, 325a
Dellmann's electrometer, 260
 Density (surface) of charge, 35, 248
 magnetic, 127, 311
Dewar, James, on currents generated by light in the eye, 231
 his capillary electrometer, 225
 Diagram, thermo-electric, 383
 Diamagnetic polarity, 342
 Diamagnetism, 87, 339
 of flames, 344
 of gases, 340
 Diaphragm currents, 224
 Dielectric capacity (see *Specific Inductive Capacity*)
 strain, 56, 272
 strength, 284
 Dielectrics, 8, 49, 270
 Differential Galvanometer, 203
 Dimensions of Units (see *Units*)
 Dip, or Inclination, 137
 variation of, 141
 Diplex signalling, 428
 Dipping Needle, 137
 Discharge affected by magnet, 294
 brush, 43
 by evaporation, 223
 by flame, 7, 291
 conductive, 282
 convective, 43, 283
 disruptive, 281

- Discharge affected by points, 43, 290,
302
effects of, 43, 284, 286
electrical, 7, 280
glow, 290, 302 (*footnote*)
limit of, 248
sensitive state of, 294
velocity of, 296
- Discharger, Discharging-tongs, 51
Universal, 54
- Disruption produces electrification, 60
- Dissectable Leyden Jar, 55
- Dissipation of Charge, 299
- Distillation, electric, 223
- Distribution of Electricity, 28, 35,
248, 249
of Current, 240
of Magnetism, 104, 122
- Divided Circuit, 353
Touch, 93
- Dolbear's* Telephone, 436
- Doubler, 23, 45
- Double Touch, 94
- Dry-Pile, 182, 264
- Duboscq's* Lamp, 372
- Du Fay's* experiments, 4, 27
- Duplex Telegraphy, 275, 428
- Duration of Spark, 296
- Duter* on Electric Expansion, 273
- Dynamic Electricity (see *Current Electricity*)
- Dynamo-electric machines, 408
- Dyne, the (unit of force), 255
- E**
- EARTH, the, a magnet, 88
currents, 275, 403
electrostatic capacity of, 325b
intensity of magnetisation, 313
magnetic moment of, 325b
used as return wire, 423
- Earth's magnetism (see *Terrestrial Magnetism*)
- Edison, Thomas Alva*, electric lamp,
374; steam-dynamo, 411 (b)
carbon telephone, 436
meter for currents, 216
quadriplex telegraphy, 428
- Edlund* on galvanic expansion, 221
- Eel, electric (*Gymnotus*), 68
- Electrics; 1
- Electric Air-Thermometer, 288
Cage, 34
Candle, 373
Clocks, 433
Distillation, 223
(Frictional) machines, 39
- Electric Egg, the, 292
- Expansion, 273
- Force, 155 (*footnote*), 241
- Fuze, 286, 370
- Images, 250
- Kite, 302
- Lamps, 372
- Light, 371
- Mill or Fly, 43
- Oscillations, 295
- Osmose, 222
- Pistol, 286
- Shadows, 293
- Shock, 226
- Wind, 43
- Electricity, theories of, 6, 300
- Electro-capillary phenomena, 225
- Electro-chemical equivalents, 211, 212
- Electro-chemistry, 412
- Electrodes, 207
unpolarisable, 231
- Electrodynamics, 331
- Electrodynamometer, 336, 378 (*bis.*)
- Electrolysis, 208
laws of, 211, 414, 417
of copper sulphate, 209
of water, 207, 413
theory of, 414
- Electrolytes, 207, 417
- Electrolytic convection, 413
- Electromagnets, 98, 325
laws of, 330
- Electromagnetic engines (motors), 275
- Electromagnetics, 310
- Electromagnetic theory of Light, 390
- Electromagnetism, 326
- Electrometallurgy, 419
- Electrometer, absolute, 261
attracted-disc, 261
capillary, 225, 265
Dellmann's, 260
divided-ring, 71
Peltier's, 260, 307
portable, 261
quadrant (*Sir W. Thomson's*),
262
repulsion, 260
torsion, 15
trap-door, 261
- Electromotive-force, 155
measurement of, 360
unit of, 322, 323
- Electromotors, 375
- Electro-Optics, 385
- Electrophorus, 22
continuous, 23, 45
- Electroplating, 421
- Electroscopes, 11
Bohnenberger's, 13, 264

- Electroscopes, *Bennet's* gold-leaf, 13, 25
Fechner's, 264
Gauguin's discharging, 259
Gilbert's straw-needle, 12
Hankel's, 264
Henley's quadrant, 14
 Pith-ball, 2, 3
Volta's condensing, 71, 149
- Electrostatics, 7, 233
- Electrotyping, 420
- Energy of charge of Leyden Jar, 270
 of electric current, 378
- Equator, Magnetic, 78
- Equipotential surfaces, 242, 310 (f)
 magnetic, 310
- Equivalents, electro-chemical, 212
- Erg, the (unit of work), 255
- Evaporation produces electrification, 63, 303
 discharge by, 223
- Everett, James D.*, on atmospheric electricity, 307
 on exact reading of galvanometer, 202 (*footnote*)
 on intensity of magnetisation of earth, 313
- Expansion, electric, 273, 386
- Extra-current (self-induced), 404
- F**
- FAILURE and exhaustion of batteries, 160
- Fall of Potential along a wire, 263, 357
- Farad, the (unit of capacity), 276, 323
- Faraday, Michael*, molecular theory of electricity, 6
 chemical theory of cell, 156
 dark discharge, 290
 Diamagnetism, 339, 340, 344
 discovered inductive capacity, 21, 269, 271
 Discovery of magneto-induction, 391
 Electro-magnetic rotation, 375
 experiment on dielectric polarisation, 272
 gauze-bag experiment, 31
 hollow-cube experiment, 31
 ice-pail experiment, 34
 laws of electrolysis, 211, 214
 Magnetic lines-of-force, 108, 402
 on *Arago's* rotations, 401
 on dissipation of charge, 291
 on identity of different kinds of electricity, 217, 218, 286
 Voltmeter, 214
- Faraday, Michael*, Magneto-optic discovery, 387
 predicted retardation in cables, 274
- Faure's* Secondary Battery, 415
- Favre's* experiments on Heat of Currents, 368
- Fechner's* electroscope, 264
- Feddersen, W.*, on electric oscillations, 296
- Ferromagnetic substances, 339
- Field, magnetic, 105, 191, 312
- Figures, magnetic (see Magnetic figures)
 electric, 297
- Fire of St. Elmo, 302 (*footnote*)
- Flame, currents of, 291
 diamagnetism of, 344
 discharge by, 7, 291
 produces electrification, 62
- Fleming's* Battery, 182
- Fontana* on electric expansion, 273
- Force, electric, 155 (*footnote*), 241, 251, 252
 magnetic, 83, 155 (*footnote*), 328
 electromotive, 155
- Foucault's* Regulator Lamp, 372
 Interruptor, 398
- Franklin, Benjamin*, discovered action of points, mentioned in, 35 (c), 43, 302
 cascade arrangement of Leyden Jars, 279
 Electric Chimes, 43
 Electric Kite, 302
 Electric portraits, 288
 his charged pane of glass, 47
 invents Lightning Conductors, 305
 kills turkey by electric shock, 286
 One-fluid theory of Electricity, 6
 on seat of charge, 55
 theory of the Aurora, 309
- "Free" electricity, 24, 149 (*footnote*)
- Friction produces electrification, 1, 10
- Frog's legs, contractions of, 148, 2
- Froment's* Electromotor, 375
- Fuze, electric, 286, 370
- G**
- Galvani, Aloysius*, observed movements of frog's leg, 148

- Galvani, Aloysius*, on preparation of frog's limbs, 229
on Animal Electricity, 231
Galvanic Batteries (see *Voltaic Batteries*)
Electricity (see *Current Electricity*)
Taste, 227
Galvanism (see *Current Electricity*)
Galvanometer, 197
absolute, 200
astatic, 193, 231
ballistic, 204
constant of, 200
differential, 203
De Bui's *Reynold's*, 231
Helmholtz's, 199
reflecting (*Sir W. Thomson's*), or mirror, 202
sine, 201
tangent, 199
Galvanoplastic (see *Electrotyping*)
Galvanoscope, 188
Gas Battery, 416
Gases, resistance of, 158
Gassiot, J. P., on striz, 294, 300
Gaugain, Jean Mothé, discharging electroscope, 259
on Pyroelectricity, 66
Tangent Galvanometer, 199
Gauss, F., invented absolute measurement, 325a
magnetic moment of earth, 325b
magnetic observations, 313
Gay, Lussac, on atmospheric electricity, 307
Geissler's tubes, 291
Gernez on electric distillation, 223
Gitson and Barclay on dielectric capacity of paraffin, 270
Gilbert, Dr. William, discovers electrics, 1
discovered magnetic reaction, 83
discovers that the earth is a magnet, 88, 135
heat destroys magnetism, 99
his balanced-needle electroscope, 12
observation of moisture, 9
observations on magnets, 78
on de-electrifying power of flame, 291
on magnetic figures, 103
on magnetic substances, 85
on magnetic permeability, 84
on methods of magnetisation, 96, 97
Gilding by Electricity, 431
Globular lightning, 304
Glow Discharge, 290, 302 (*footnote*)
Glowing of wires, 369
Gold-leaf Electroscope (see *Electroscope*)
Gordon, J. E. H., on magneto-optic rotatory power, 387
on dielectric capacity, 270, 271
on length of spark, 291
Gramme's dynamo-electric machine, 410
Gravitation Battery, 176
Gray, Stephen, discovers conduction, 27
on lightning, 302
Grotthuss's theory, 160, 418
Grove, Sir William R., his Gas Battery, 416
Grove's Battery, 171
magnetic experiment, 113
on electric property of Flame, 291
Guard-ring, Guard-plate, 248, 261
Guericke, Otto von, discovered electric repulsion, 3
invents electric machine, 38
observes electric sparks, 9
Gunpowder fired by electricity, 286, 288, 370
Gymnotus (electric eel), 68, 218
- ## H
- Hall's* phenomenon, 337
Hankel's electroscope, 264
Harris, Sir W. Snow, his unit Leyden jar, 259
attracted disc electrometer, 261
on length of spark, 291
Heat, effect of, on magnets, 99, 100
" batteries, 183
" conductivity, 349
Heating effects of currents, 171, 366, 380
due to magnetisation, 113, 401
effect of sparks, 288
" dielectric stress, 272
local, at electrodes, 41
Helmholtz, Hermann L. on effect of current on silk, 229
Electrolytic convection, 418
Equations of Self-induction, 405
Galvanometer, 199
Henry, Joseph, invented the "sounder," 423

- Henry, Joseph*, on induced currents of higher orders, 406
Holtz, W., his electric machine. 46
 on electric shadows, 293 (*foot-note*)
 on tubes having unilateral resistance, 300
Hopkinson, John, on dielectric capacity of glass, 270
 on residual charge and its return, 53, 272
 Horizontal component of magnetism, 123, 138
Hughes, David Edward, the Printing Telegraph, 423
 the Microphone, 437
Humboldt, Alexander von, on electric eels, 68
 discovers galvanic smell, 228
 produced electric contractions in fishes, 229
Hunter, Dr. John, on effect of current on sight, 228
 Hydroelectric machine, 44

I

- IMAGES, electric, 250
 Incandescent electric lights, 374
 Inclination (or Dip), 137
 variation of, 141
 Index Notation, 325b
 Induced charges of electricity, 18
 currents, 391
 Induction (*electrostatic*) of charges, 18
 (*magnetic*) lines of, 89
 (*magnetic*) of magnetism, 89, 313
 „ coefficient of, 342
 (*magneto-electric*) of currents, 391
 Induction-coil or Inductorium, 398
 Induction-convection machines, 45
 Inductive-capacity, specific, 21, 49, 208, 272
 Insulators, 8, 27
 Intensity of current, 179
 of earth's magnetic force, 138, 325a
 of magnetic field, 312
 of magnetisation, 313
 Inverse Squares, Law of, 16, 117, 235, 245
 Inversion, Thermo-electric, 382
 Ions, 210
 Isoclinic lines, 139
 Isogonic lines, 139

J

- Jacobi, Moritz Hermann*, on local action, 162
 discovers galvanoplastic process, 420
 his boat propelled by electricity, 375
 theory of electromotors, 377
Jablochhoff, Paul, his battery, 182
 electric candle, 373
Jar, Leyden, 51
 „ capacity of, 50, 267, 277
 „ cascade arrangement of, 279
 „ discharge of, 51, 295
 „ discovery of, 52
 „ energy of charge of, 278
 „ seat of charge of, 55
 „ spark of, 289, 296
 „ theory of, 267
 Unit, 259
Jenkin, Fleeming, on cable as condenser, 274
 on retardation in cables, 296
Joule, James Prescott, on effects of magnetisation, 113
 Law of Heat of Current, 367
 Mechanical equivalent of Heat, 255, 414
 on atmospheric electricity, 306
 on lifting-power of electro-magnet, 328
Joule-effect, the, 380, 367

K

- KATHODE, 207
 Kation, 210
 Keeper, 101
Kerr, Dr. John, Electro-optic discoveries, 273, 386
 Magneto-optic discoveries, 114, 388
Kinnersley, Elijah, Electric Thermometer, 288
Kirchhoff, Gustav, Laws of Branched Circuits, 353
 Kite, the electric, 302
Kohlrausch, F., on residual charge, 272
 on electro-chemical equivalent, 211 (*foot-note*)

L

- LAMELLAR magnetisation, 107

- Laminated magnets, 95
 Law of Inverse squares, 16, 117, 235, 245
 Leakage, rate of, 299
Leclanché's Battery, 173
Le Bailif on diamagnetism of antimony, 339
Lemonnier discovers atmospheric electricity, 306
 Length of spark, 291
Lenz's Law, 396
 alcohol calorimeter, 367
 Leyden Jar (see *Jar*)
Lichtenberg's figures, 297
 Lifting-power of magnets, 103
 of electromagnets, 328
 Light affects resistance, 389
 Electric, 371
 Electromagnetic theory of, 365, 390
 polarised, rotated by magnet, 114, 387, 388
 Lightning, 9, 302, 304
 conductors, 32, 305
 duration of, 296, 304
 Lines-of-force, electric, 243
 due to currents, 191, 329, 334
 magnetic, 89, 108, 310, 312
Lippmann, G., Capillary Electrometer, 225, 265
 Liquids as conductors, 205
 resistance of, 348
 "Local Action" in batteries, 161
 Lodestone, 76, 340
 "Long-coil" instruments, 352
 Loss of Charge, 15, 299
Louis XV. electrifies 700 monks, 226
Lullin's experiment, 285
 Luminous effects of spark, 289, 400
- M**
- MACHINE, Alternate-current, 411
 Electric, 38
 Compound-wound, 411
 convection-induction, 45
 cylinder, 39
 dynamo-electric, 408
 Holtz's, 46
 hydro-electrical, 44
 invention of, 38
 magneto-electric, 407
 plate, 44
 Winter's, 40
 Magne-crystallic action, 343
 Magnet, breaking a, 106
 Magnets, natural and artificial, 76, 77, 326
 Magnetic actions of current, 184, 318, 326, 329, 334
- Magnetic attraction and repulsion, 80, 110
 cage, 84
 curves, 108, 191
 field, 105, 191, 312, 327
 figures, 108, 109, 110, 191
 " theory of, 126
 fluids, alleged, 91
 force, 83, 310 (c)
 " measurement of, 118, 325a
 induction, 89
 " coefficient of, 342
 iron ore, 76
 lines-of-force, 89, 108, 109, 110, 316
 lines-of-force of current, 191, 320, 329
 maps, 139
 meridian, 136
 metals, 86, 339
 moment, 123 (*footnote*), 313, 325a
 needle, 79, 134
 oxide of iron, 76, 172 (*footnote*)
 paradox, a, 128
 pole, unit, 125
 potential, 310, 314, 315
 proof-plane, 402
 saturation, 102, 330
 " *Beetz*, on, 115
 screen, 84
 shell, 107, 192, 311 (*h*)
 " force due to, 127
 " potential due to, 127, 325
 storms, 145, 309
 substances, 85, 339
 units, 321
 writing, 111
- Magnetisation, coefficient of (or susceptibility), 89, 313
 intensity of, 313
 lamellar, 107
 mechanical effects of, 113
 methods of, 92-98, 327
 solenoidal, 107
 sound of, 113, 434
 time needed for, 330
- Magnetism, 76
 action of, on light, 114, 387
 caused by heat, 98
 destruction of, 99
 distribution of, 104
 of gases, 339, 387
 lamellar, 107
 laws of, 81, 116, 310, 330
 permanent, 90, 313
 residual, 102

- Magnetism, solenoidal, 107, 314**
 temporary, 90, 102, 313
 terrestrial, 83, 135
 theories of, 91, 115, 338
 unit of, 125
Magnetite, 76
Magneto-electricity, 74, 391
Magneto-electric induction, 391
 machines, 407
Magnetographs, 146
Magnetometer, 124
 self-registering, 146
Magneto-optic Rotations, 387
Magnets, artificial, 71
 compound, 95
 forms of, 101
 lamellar, 107
 laminated, 95
 methods of making, 92-98
 natural, 76, 101
 power of, 103
Mance's method, 361
Maps, magnetic, 139
Mariner's Compass, 134
Marked pole, 80
Mascart, E., on self-registering apparatus, 288
 on atmospheric electricity, 308
Matteucci, Carlo, on physiological effects, 68, 230
 on electromotive-force in muscle, 231
Maynooth Battery (see Callan's Battery)
Maxwell, James Clerk, Electro-magnetic theory of Light, 337, 365, 390
 on Electric Images, 250
 on protection from Lightning, 32, 305
 on residual charge of jar, 272
 on self-repulsion of circuit, 334
 rule for action of current on magnet, 193, 317
 Theorem of equivalent Magnetic shell, 192, 318
 Theory of Magnetism, 115
Measurements, electrical, 355-363
 magnetic, 118, 325a
Mechanical effects of Discharge, 284, 43
 effects of magnetisation, 113
 " in dielectric, 272
Medical Applications of Electricity, 232, 369
Megohm, 323
Meidinger's Battery, 176.
Meridian, Magnetic, 136
Metallo-chromv, 432
Microfarad condenser, 276
Microphone, the, 437
Milli-ampère, 323
Mimosa, the, electric behaviour of, 229
Minotto's Battery, 176
Mirror Galvanometer, 203
Moisture, effect of, 1, 8, 269
Molecular theory of Electric action, 6
 actions of current, 221
Moment of Couple, 123
 of inertia, 325a
 magnetic, 123 (*footnote*), 325a
Morse Telegraph instrument, 425
Mouse-mill (see Replenisher)
Müller, Johannes, on strength of electromagnets, 330
Multiplier, Schweigger's, 189
Muscular contractions, 229, 231
Musschenbroek, Peter van, discovery of Leyden Jar, 52
 on Magnetic Figures, 110
Mutual Induction, coefficient of, 320, 397
Mutual Potential, coefficient of, 320
- N
- Napoleon III.'s Battery, 182*
Needle, magnetic, 79
Needle Telegraph, 424
Negative electrification, 4, 300
Newton, Sir Isaac, observations on action and reaction, 83
 his lodestone, 103
 suggests electric origin of lightning, 9, 302
 suggests glass for electric machines, 38
Niaudet's Battery, 173
Nobili, Leopoldo, on muscular contractions, 68
 on currents of animal electricity, 231
 discovers *Nobili's rings*, 422
Non-conductors, 8
Non-electrics, 2
North and south, 81, 135
North magnetic pole, the, 81, 135
Null methods, 263
- O
- Oerstedt, Hans Christian, discovers magnetic action of current, 184, 185, 191*
Ohm, Dr. G. S., 179.
 "Ohm's Law," 180, 345

- Ohm, the, or unit of resistance, 333
 determination of, 364
 One-fluid theory of electricity, 6
 Optical strain, electrostatic, 386
 " electromagnetic, 387
 Oscillations, electric, 295
 method of (for electrostatics),
 120 (*footnote*), 235
 method of (for magnetic mea-
 surement), 120, 121, 122, 325a
 Osmose, electric, 222
 Other sources of electricity than fric-
 tion, 10, 57
 Ozone, 208, 298, 302 (*footnote*)
- P**
- Page, Charles G.*, discovers magnetic
 sounds, 113
 Parallel currents, laws of, 332
 Paramagnetic, 339
 "Passive" state of iron, 172 (*footnote*)
Peltier, Athanase, his electrometer,
 260, 307
 heating effect at junctions, 380
 theory of thunderstorms, 303
 Penetrative power of discharge, 284
 Periodicity of aurora and magnetic
 storms, 144, 145, 309
Perry and Ayrton (see *Ayrton and
 Perry*)
 Pile, Voltaic, 150
 Pith-ball electroscope, 2, 3
 Phosphorescence caused by discharge,
 292
 Photo-voltaic property of selenium,
 589
 Photophone, 389
 Physiological actions, 226, 287
 Plane, the proof-, 29
 " for magnetism, 402
Planté, Gaston, his secondary bat-
 teries, 415
 on globular lightning, 304
 Plants, electricity of, 69, 230
 Plate condenser, 48, 268, 277
 electrical machine, 40
Plücker, Julius, on magne-crystallic
 action, 343
Poggendorff, J. C., his battery, 165
 Points, density of charge on, 35, 249
 discharge at, 39, 42, 43, 249
 Polarity, diamagnetic, 342
 magnetic, 82, 106, 115
 Polarisation (electrolytic) in battery
 cells, 163, 414
 of Voltmeter, 272, 413, 415
 remedies for, 165
- Polarised light rotated by magnetic
 forces, 337
 relay, 428
 Poles of magnets, 78, 122
 of pyroelectric crystals, 66
 of Voltaic battery, 154
Porret's phenomenon, 222
 Portable electrometer, 261
 Portative force, 103
 Positive and negative electrification,
 4, 300
 Potential, electric, 37, 237
 " zero, 37, 239
 magnetic, 310, 314, 315
 " due to current, 318
 mutual, of two circuits, 319,
 320
Pouillet, Claude S. M., sine galvan-
 ometer, 201
 tangent galvanometer, 199
 Power, transmission of, 376
 Practical Units, 323
Preece, William Henry, on space
 protected from lightning, 305
 Pressure produces electrification, 65
Priestley, Joseph, on electric expan-
 sion, 273
 Prime conductor, 39
 Printing telegraphs, 423
 Proof-plane, 29
 " (magnetic), 402
Poisson, on magnetism in crystals
 343
 Protoplasm, electric property of, 231
 Pyroelectricity, 66
- Q**
- Quadrant electrometer (*Sir W.
 Thomson's*), 262
 electroscope (*Henley's*), 14
 Quadruplex telegraphy, 428
 "Quantity" arrangement of cells,
 etc., 181
 of electricity, unit of, 17, 236
Quetelet, E., on atmospheric elec-
 tricity, 308
Quincke, Georg, on diaphragm cur-
 rents, 224
 on electric expansion, 273
 on electro-optic phenomena,
 386
- R**
- Ray, electric (torpedo), 68
 Recovery, elastic, 272

- Redistribution of charge, 36
 Reflecting galvanometer, 202
 Registering magnetographs and electrometers, 146, 307
Reis, Philip, invention of telephone, 434
 Relation between currents and magnets, 184, 318, 326, 391
 between current and energy, 378
 between current and heat and light, 366
 Relays, 426
 Replenisher, 45, 261, 262
 Repulsion and attraction of electrified bodies, 1, 3, 18, 20, 66, 236 and attraction, experiments on, 43
 and attraction of currents, 331
 and attraction of magnets, 76, 80
 Repulsion electrometers, 260
 Residual charge of Leyden jar, 53, 272
 " of cable, 274, 430
 " of Voltmeter, 272, 415
 magnetism, 102
 Resinous electricity, 4
 Resistance, 27, 158, 179, 346
 absolute unit of, 363, 364
 affected by temperature, 349
 " light, 389
 " sound, 436
 as a velocity, 363
 bridge or balance, 358
 coils, 359
 internal, of cell, 181, 350
 " " measurement of, 361
 laws of, 347
 measurement of, 356
 of gases, 158, 348
 of liquids, 158, 349
 specific, 348
 Retardation of currents through cables, 274, 296, 430
 Retentivity (magnetic), 90, 313
 Return shock or stroke, 26, 304
Reymond, Du Bois, his galvanometer, 231
 on animal electricity, 231
 unpolarisable electrodes, 231
 Rheocord, 356
 Rheostat, 356
 Rheometer, }
 Rheoscope, } *see footnote to 197*
 Rheotrope, }
Riess, Peter, on electric distribution, 35
Riess, Peter, on length of spark, 291
 electric thermometer, 288 (*footnote*)
Ritchie's electromotor, 375
Ritter, Johann Wilhelm, on action of current on sight, 228
 his secondary pile, 415
 on subjective galvanic sounds, 230
 on the sensitive plant (*Mimosa*), 230
 Rolling friction, 10
Romagnosi, Dr., discovers magnetic action of current, 184
Romas, De, his electric kite, 302
Ronalds, Sir Francis, invented a telegraph, 423
 Rotations, electromagnetic, 335
 Arago's, 401
Rowland, Henry A., on magnetic effect of electric convection, 337
 on intensity of magnetisation, 313
Ruhmkorff's induction coil, 398
 commutator, 399
 electromagnet, 339

S

- St. Elmo's fire, 302 (*footnote*)
 Salts, electrolysis of, 417
Sanderson, J Burdon, on electric sensitiveness of carnivorous plants, 231
 Sawdust battery, 158, 176
Schweigger's multiplier, 189
 Secondary batteries, 178, 415
 Secular variations of magnetic elements, 141
Seebeck's discovery of thermo-electricity, 379
 Selenium, photo-voltaic properties of, 389
 Self-induction of circuit, 404
 Self-recording apparatus, 146, 288, 307
 Self-repulsion of current, 334
 Sensitive plant, behaviour of, 230
 Series, union of cells in, 171
 Shadows, electric, 293
 Sheet conductor, flow of electricity in, 354
 Shell, magnetic (*see Magnetic Shell*)
 Shock, electric, 226
 of current, 226
 "Short-coil" instruments, 352
 Shunt, 202, 353
Siemens, Carl Wilhelm, on heating effect in Leyden jar, 272

- Siemens, Carl Wilhelm*, his dynamo-electric machine, 409
his longitudinal armature, 407
Sight affected by current, 228
Silurus, the, 68
Sine galvanometer, 201
Single touch, 92
Single-fluid cells, 169
Siphon-recorder, 431
Smees's Battery, 165, 169
Soap-bubble, electrified, 3
Solenoid, 329
 magnet, 314
Solid angles, 133
Solidification, 61
Sound of magnetisation, 113
Sunder, the, 425
Sources of electricity, 10, 57
Spark, 9, 43, 281
 duration of, 296
 length of, 44, 291, 302
Specific resistance, 348
 inductive capacity, 21, 49, 263, 272
Speed of signalling, 274, 275, 296, 430
Sphere, distribution of charge over 35 (a), 248, 249
Spottiswoode, William, on strizæ, 294
Stewart, Balfour, on atmospheric electricity, 308
 on magnetic storms, 144
Storms, magnetic, 145
Standards of resistance (see *Resistance Coils*)
Strain, dielectric, 56
Strength of current, 158, 179
 " in magnetic measure, 195, 196
Strength of magnet pole, 102
 of magnetic shell, 315
Strizæ in vacuum tubes, 292, 294
Sturgeon, W., invents the electro-magnet, 326
Submarine telegraphs, 429
Sulzer's experiment, 227
Symmer, on two kinds of electrification, 4
Surface-density of charge, 35, 243
 limit of, 248
 of magnetism, 127, 311
Swammerdam's frog experiment, 229
Swan's electric lamp, 374
- T
- Tait, Peter Guthrie*, electrification by evaporation of sulphate of copper solution, 63
Tait, Peter Guthrie, thermo-electric diagram, 383
Tangent galvanometer, 199
Taste affected by current, 227
Telegraph, electric, 423
 Bain's chemical, 218
 Morse's instrument, 425
 needle instrument, 424
Telegraphy, diplex, 428
 duplex, 428
 quadruplex, 428
 submarine, 429
Telephone, *Philip Reis's*, 434
 currents of, 229
 Dolbear's, 436
 Edison's (carbon), 438
 Graham Bell's (articulating), 435
 Varley's (condenser), 272
Temperature affects resistance, 183
 affected by resistance, 369
Tension of electrostatic forces, 248
 (footnote)
Terquem, A., parrot-cage experiment, 31
Terrestrial Magnetism, 88, 135
Test for weak currents (chemical), 218, 286
 for weak currents (physiological), 229
Testing for faults, 427
Tetanus produced by interrupted currents, 230
Theories of Electricity, 6, 300, and preface, ix
Theories of Magnetism, 91, 115
 " *Ampère's*, 338
 " *Maxwell's*, 115
Theory of Electrolysis, *Joule's*, 414
 Grotthuss's and *Clausius's*, 418
Thermo-electric currents, } 70, 379
Thermo-electricity, }
Thermo-electric Diagram, 383
Thermo-electromotive Series, 382
Thermo-pile, 384
Thompson, Silvanus Phillips, on magnetic figures due to currents, 334
 on Magnetic writing, 111
 on *Nobili's* rings, 422
 on Positive and Negative states, 300
 on opacity of Tourmaline, 390
 (footnote)
Thomson, Joseph J., on Contact Electricity, 73; value of "v," 305
Thomson, Sir William, the Replenisher (or Mouse-Mill), 45, 261, 262

- Thomson, Sir William*, Proof of Contact Electricity, 71
 Attracted-disc Electrometers, 261
 Divided-ring Electrometer, 71
 Electric convection of Heat (the "*Thomson-effect*"), 383
 Mirror Galvanometer, 202, 431
 Modified *Daniell's* Battery, 176
 on atmospheric electricity, 306
 on Electric Images, 250
 on length of spark, 291
 on nomenclature of Magnet Poles, 81 (*footnote*)
 on sounds in condensers, 272
 predicts electric oscillations 295 (*footnote*)
 Quadrant Electrometer, 262
 Siphon Recorder, 431
 Thermo-electric Diagram, 383
 Water-dropping Collector, 307
- Thunder, 9, 304
 Thunderstorms, 302
 Theory of, 303
- Tin-foil Condensers, 47, 275
 Tongs, Discharging-, 51
 Torpedo (electric fish), 68, 218
 Torpedoes, fuzes for firing, 286, 370
 Torsion affected by magnetisation, 113
 Torsion Balance, or } (*Coulomb's*)
 Torsion Electrometer } 15, 119
 Total action of magnet, 325a
 Tourmaline, 66, 297, 390 (*footnote*)
 Transformers, 400 [376
 Transmission of Power by Electricity
 Tubes of force, 243, 311
 Two-fluid cells, 170
 Two-fluid theory, 6
 Two kinds of Electrification, 4, 5
 " " Magnetic poles, 81
- Tynhall, John*, on diamagnetic polarity, 342
 on magne-crystallic action, 343
- U**
- UNIT Jar, 259
 Unit (Electrostatic) of Electricity, 17, 236
 (Electrostatic) of Capacity, 247
 Magnetic Pole, 125
 of difference of potential, 242 322, 323
 of Electromotive-force, 322, 323
 of Resistance, 322, 323
 of Strength of Current, 196, 322, 323
- Units, Fundamental and Derived. 254, 255
 dimensions of, 258, 324
 Electrical (Electrostatic), 257
 Electromagnetic. 322, 323
 Magnetic, 321
 Physical Dimensions of, 258, 324, 351
 Practical, 323
 Universal Discharger, 54
Ure, Dr., on Animal Electricity, 229
- V**
- "v," values of, 365, 390
 Vacuum, induction takes place through, 50, 84, 89
 partial, spark in, 9, 292
 spark will not pass through, 291
 Vacuum-tubes, 292
 "Variation," the (see *Declination*)
 Variation of Declination and Dip, secular, 141; annual, 143; diurnal, 142; geographical, 136
Varley, C. F., his Telephone, 273
 Vegetables. Electricity of, 09
 carnivorous. sensitiveness of, 230
 Velocity of Discharge, 296
 of Electricity (alleged), 296
 of Light, 365, 390
Verdet's Constant, 387
 Vibration produces Electrification, 59
 Vitreous electricity, 4
 Volt, the, 323
Volta, Alessandro, his Electrophorus, 22
 Condensing Electroscope, 71, 149
 Contact Series, 72
 Crown of Cups, 151
 on Atmospheric Electricity, 307
 on Contact Electricity, 71, 148
 on Electric Expansion, 273
 on Electrification due to combustion, 62
 Subjective Sounds due to Current. 228
Volta's Law, 72, 148, 156
 Voltaic Pile, 150
 Voltaic Electricity (see *Current Electricity*)
 Arc, 371
 Battery, 154, 167; Pile, 150
 Cell, simple, 152
 Voltmeter, 214, 215, 216
 Voltmeter, 360 (*d*)

W

- WATER, Electrolysis of, 206, 413
 Weber, the 323
Weber, Wilhelm, the Electro-dynamometer, 336
 on diamagnetic polarity, 342
Wheatstone, Sir Charles, on the brush discharge, 290
 Automatic Telegraph, 423
 Dynamo-electric Machines, 408
 on supposed velocity of electricity, 296
 Wheatstone's Bridge or Balance, 358
Wiedemann, Gustav, on effect of magnetism on torsion, 113

- Wiedemann, Gustav*, on diamagnetism of platinum, 339
Wilde, Henry, Electric Candle, 373
 Magneto-electric Machine, 401
 Wind, Electric, 43
Wöhler's Cell, 182
Wollaston's Battery, 169
Wüllner on dielectric capacity, 270

Z

- Zamboni's Dry Pile*, 13, 182, 264
Zanotti, experiment on grasshopper 229
 Zero Potential, 37, 239

THE END.

UC SOUTHERN REGIONAL LIBRARY FACILITY



A 000 037 201 1

