

U
15
U632
no. 14
c. 3

Colonel Shumway
U. S. Army Military History Institute

Japanese

Ground and Air Forces



MILITARY INTELLIGENCE SERVICE

INFORMATION BULLETIN NO. 14

WAR DEPARTMENT · WASHINGTON, D. C.

PROPERTY OF US ARMY

When an officer just returned from service in Bataan and Malaya was shown this bulletin, he said that it should carry this comment:

“A careful reading of this bulletin may save your life.”

US Army Military History
Research Collection

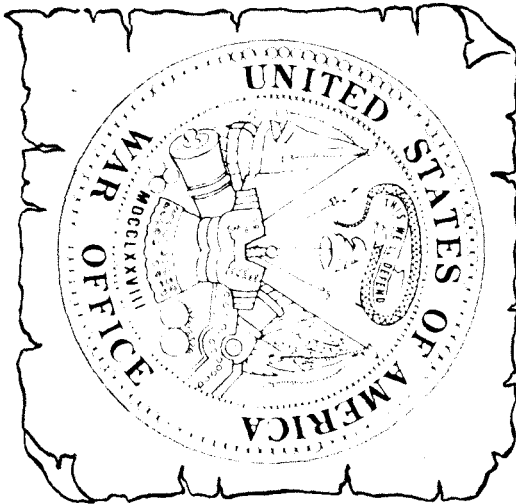

Presented by -

COLONEL ROBERT W. JOHNSON

NOT TO BE PUBLISHED

Military Intelligence Service
War Department
Washington, D. C., May 1, 1942

Information Bulletin
No. 14
MID 461

SPECIAL NOTICE

1. This bulletin has been prepared in response to requests from units in the field. The photographs are for the purpose of enabling members of the U. S. armed forces to identify the Japanese soldier and his equipment and to grasp his capabilities.

2. Units are being supplied with copies on a basis similar to the approved distribution for other Information Bulletins. Additional copies are furnished units in Pacific areas. Distribution to air units is being made by the A-2 of Army Air Forces.

3. Each command should circulate available copies among its personnel. It is suggested that where facilities and equipment permit, these photographs be shown on a screen to assembled units and accompanied by lectures based on material contained in Information Bulletin No. 6 and following bulletins. The contents of this bulletin will not be communicated to the public or to the press, but may be given to any person known to be loyal to the United States.

4. Suggestions for future bulletins are invited. Any correspondence relating to Information Bulletins may be addressed directly to the Dissemination Branch, Military Intelligence Service, War Department, Washington, D. C.

LOOK FOR THE WINGS

TYPES

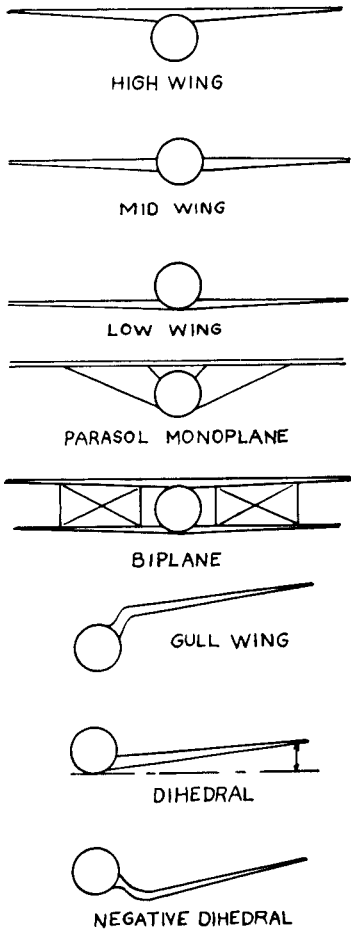

SHAPES

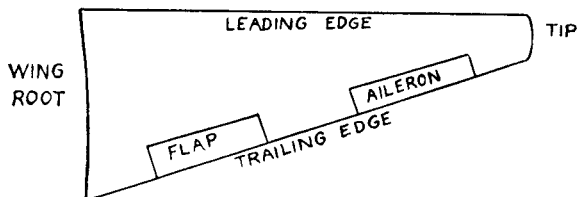
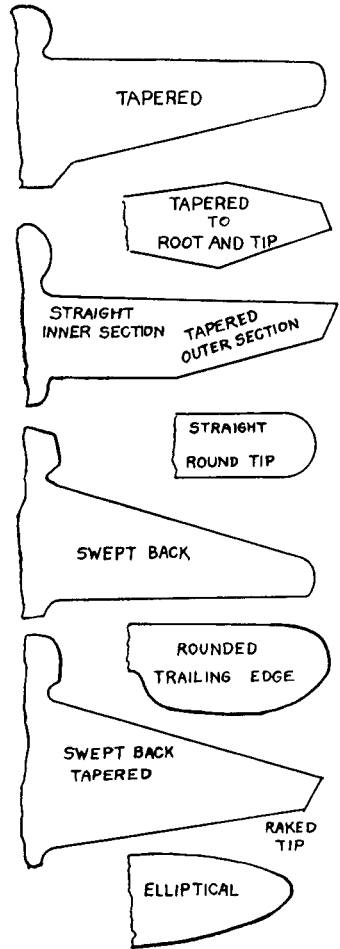

IN IDENTIFYING BY WING LOOK FOR: POSITION-SHAPE-ETC.

SE FEATURES

ENGINE

LOOK FOR
NUMBER
POSITION
RADIAL OR IN LINE
RADIATORS

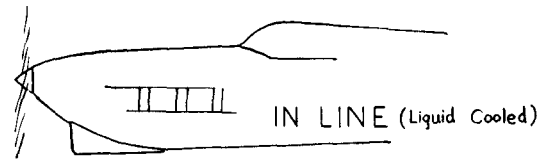
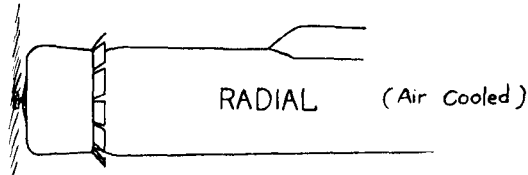

NORMALLY HAS RADIATOR UNDERNEATH

FUSELAGE

THE BODY OF THE PLANE

LOOK FOR: ROUND OR SQUARE TURRETS-STEPS-ETC.

TAIL

THE TAIL UNIT CONSISTS OF
THE TAIL PLANE RUDDER AND ELEVATOR

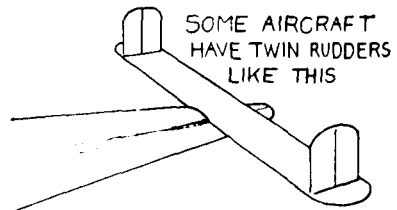
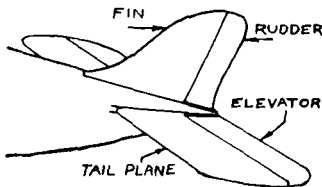

THE TWIN RUDDER MAY BE :

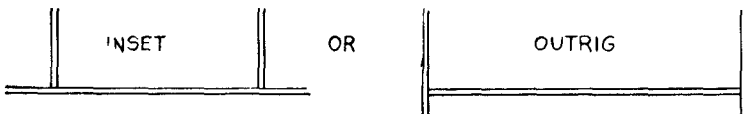

LOOK FOR: ONE OR TWO RUDDERS "INSET" OR "OUTRIG"

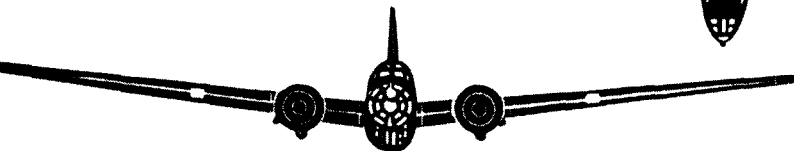
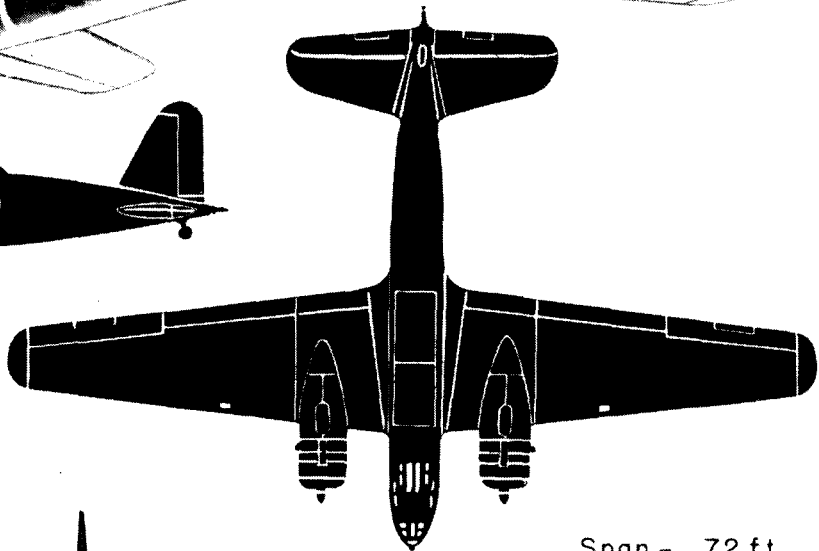
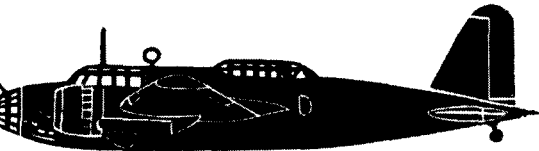
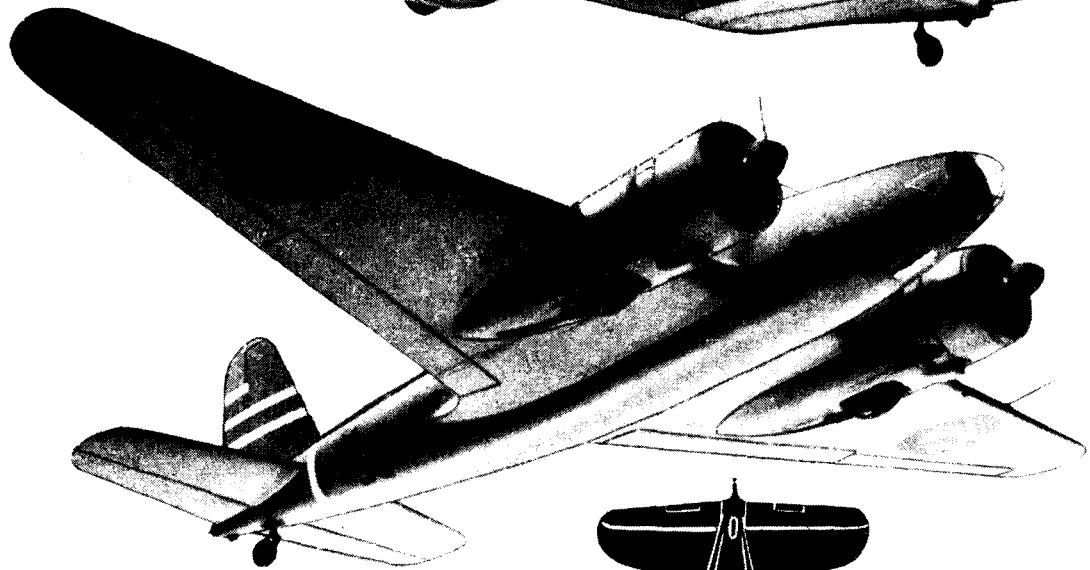
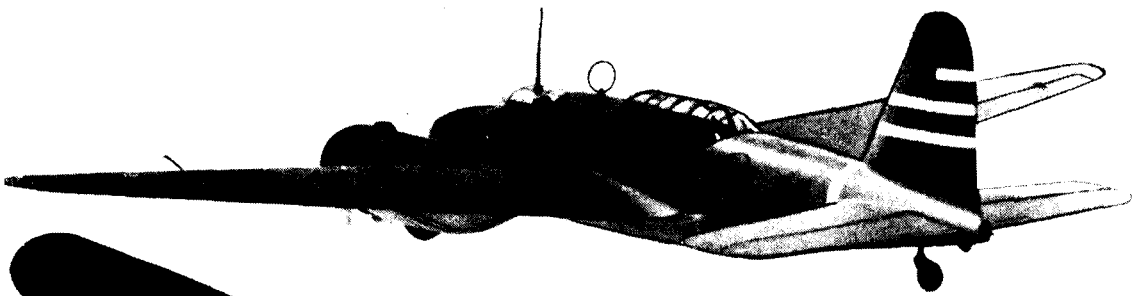

Span - 72 ft.

Length - 47 ft.

Height - 12 ft.

Maximum Speed - 245 MPH at 10,000 ft.

Service Ceiling - 24,000 ft.

HEAVY BOMBER 97 (MITSUBISHI)

This plane has been used extensively by the Japanese.

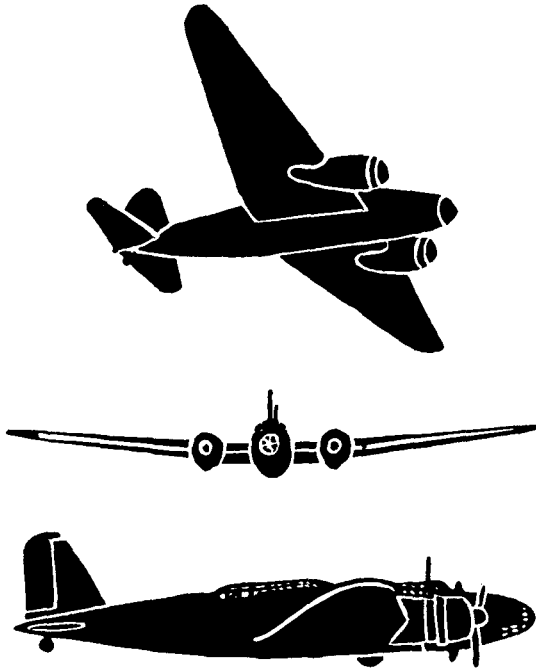

HEAVY BOMBER 97 (MODIFIED)

Slightly sweptback, round-tip, low-wing cantilever monoplane; alloy monocoque smooth skin; flush riveting construction; retractable landing gear into wing.

This plane carries a crew of seven men and mounts four flexible 7.7-mm machine guns (one in nose, one in forward turret, one in after turret, one in lower fuselage trap door). Some machine guns are replaced by 20-mm Oerlikon cannon. Bomb loads up to 3,000 pounds are carried.



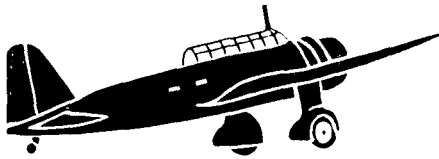

LIGHT BOMBER 98

Round-tip, slightly dihedral midwing monoplane; single engine; blunt nose; enclosed cockpit; fixed landing gear.

This plane carries a crew of two or three. It is motored by one air-cooled, radial engine, and mounts machine guns and carries bombs. Its service ceiling is 16,000 feet.

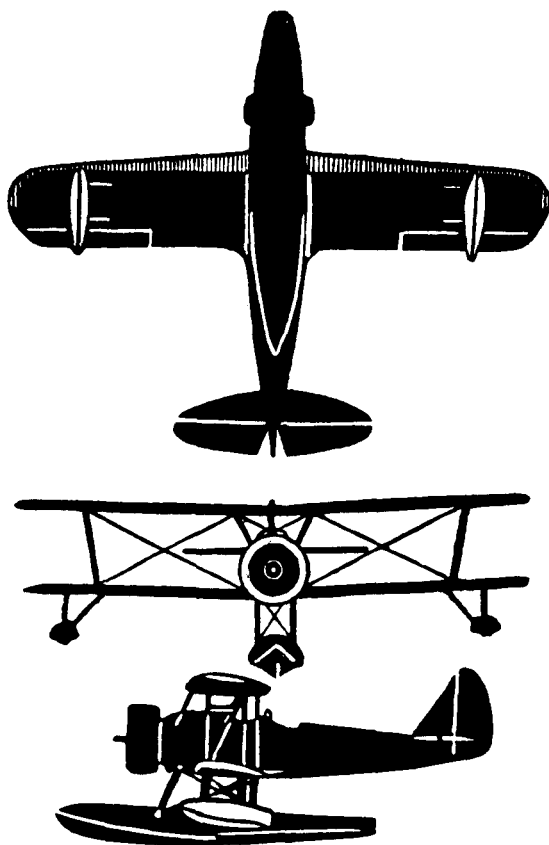

RECONNAISSANCE BOMBER 95

Round-tip, straight-wing biplane with pick-up fittings; one large center and two small wing floats; convertible to land plane.

This plane carries a crew of two and is equipped to mount two machine guns and carry 220 pounds of bombs. It resembles the Curtiss Hawk.

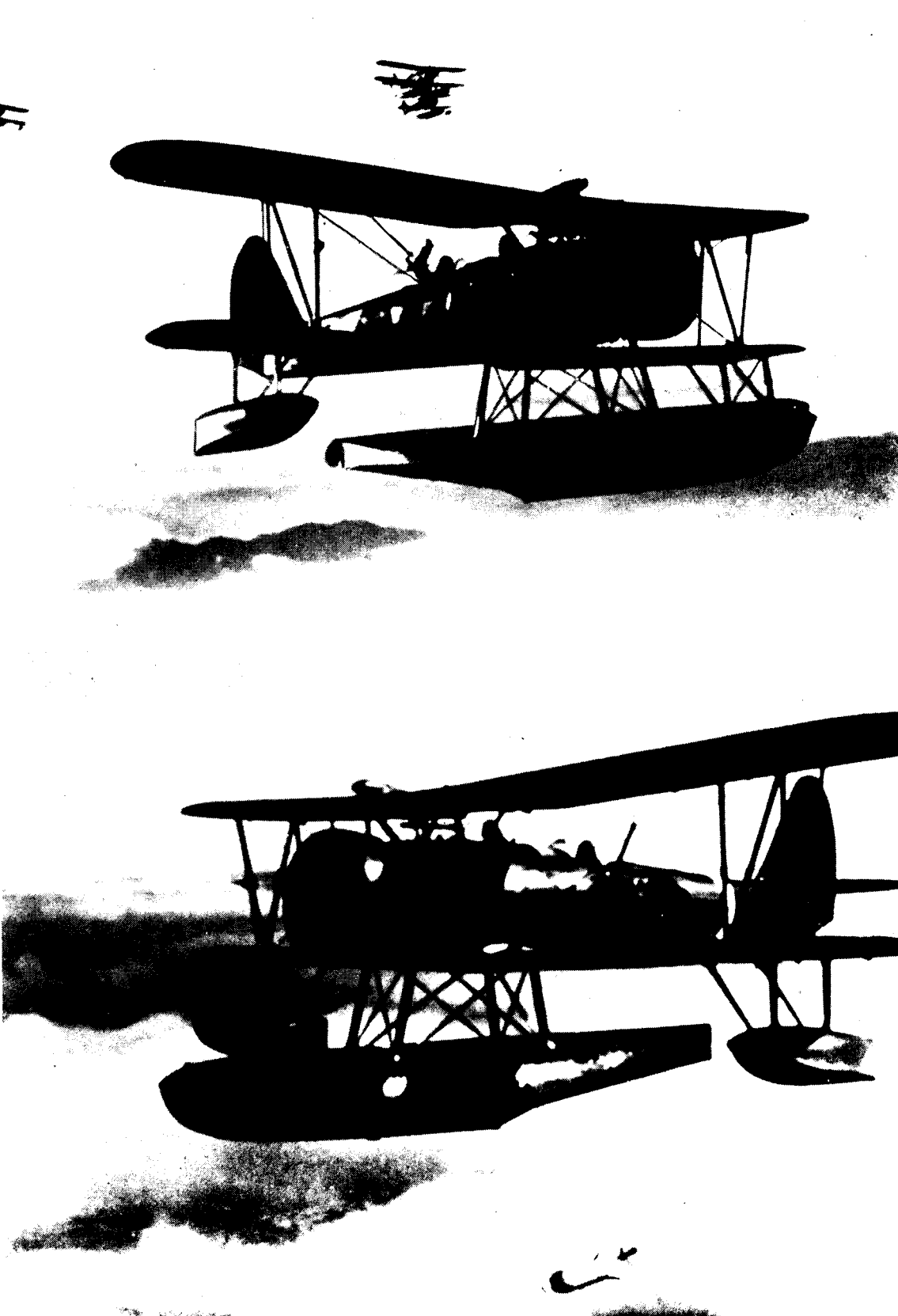

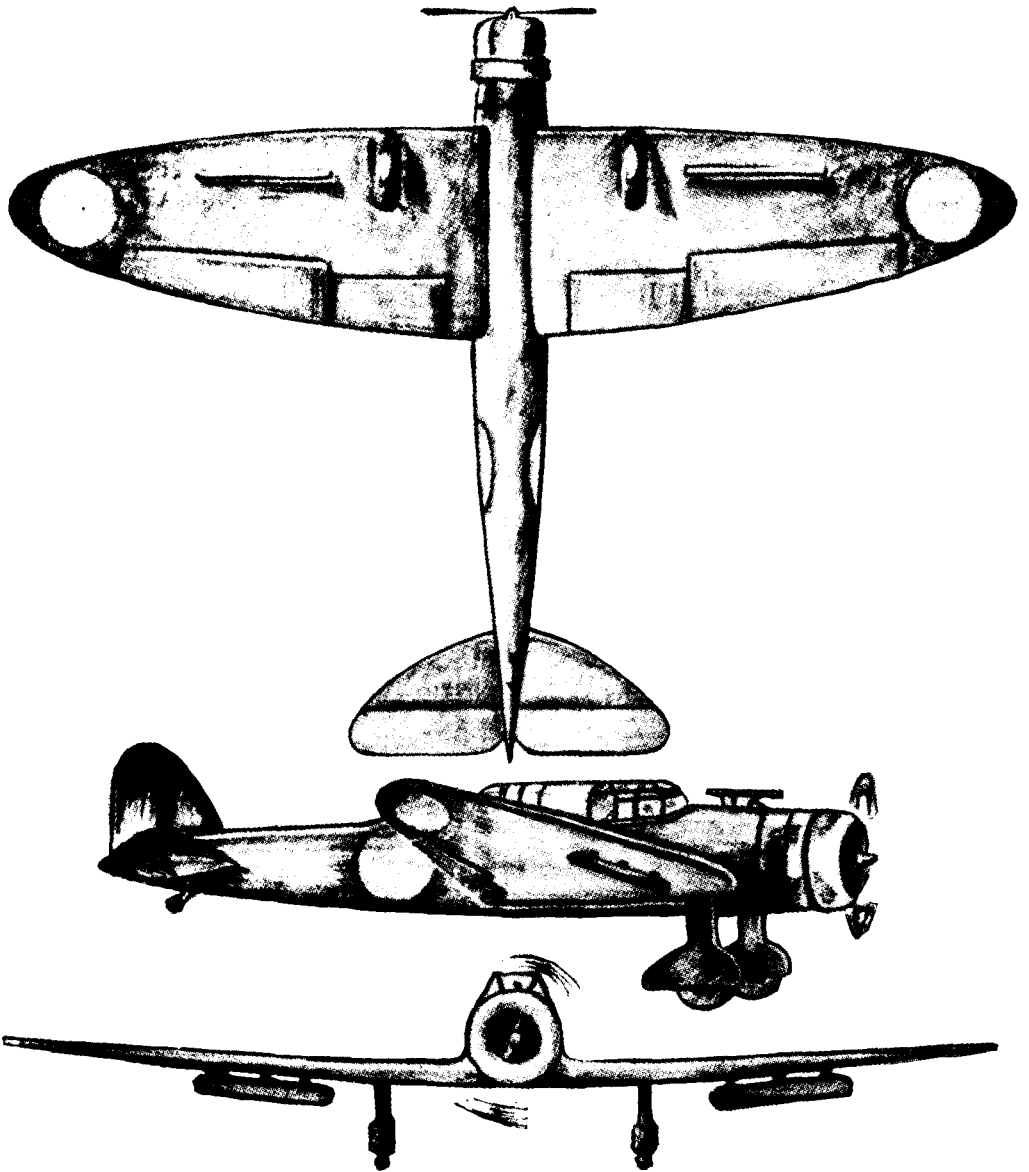

DIVE-BOMBER 99 (AICHI)

Low-wing monoplane; stub nose; pronounced diving flaps; fixed landing gear; span 47 feet.

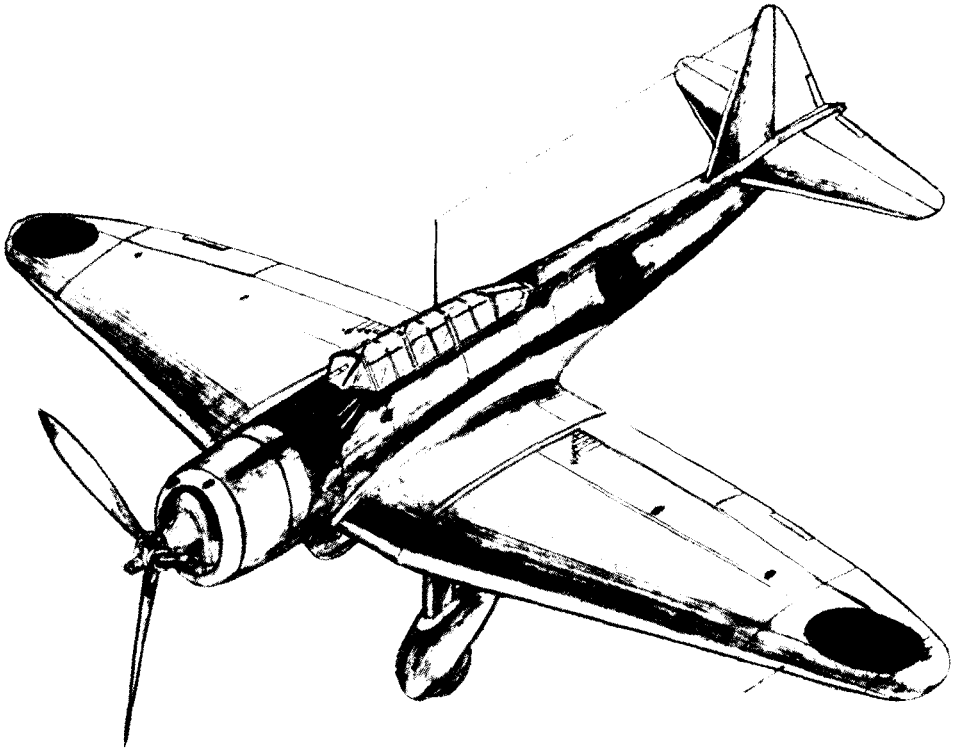

DIVE-BOMBER 99

Low-wing monoplane; stub nose; pronounced diving flaps; fixed landing gear; span 47 feet. This drawing differs from the ones on the next page; it illustrates variations resulting probably from different manufacturers.

JAPAN

T. 97 NAVY TORPEDO-BOMBER.

MITSUBISHI AND KAWAJIMA

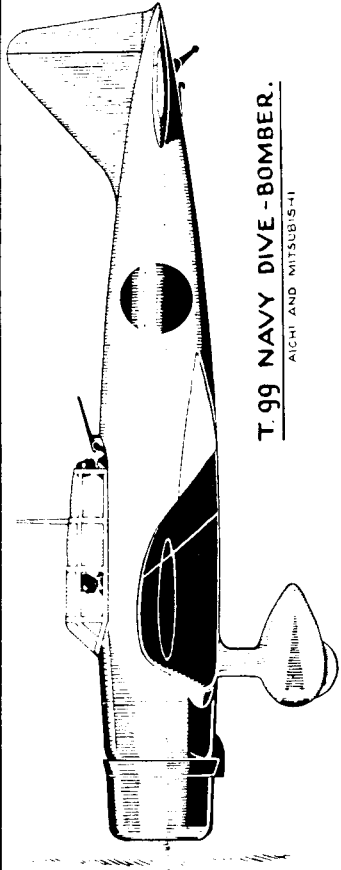
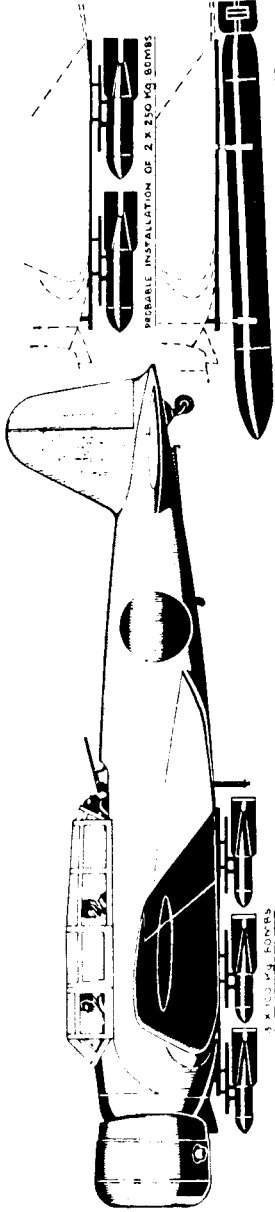

T. 99 NAVY DIVE-BOMBER.

AICHI AND MITSUBISHI

• NOTE •

A LATER VERSION OF THE
T. 99 NAVY DIVE-BOMBER
WITH A MORE POWERFUL
ENGINE & RETRACTABLE
LANDING GEAR HAS BEEN
REPORTED.

DRAWINGS BASED ON INFORMATION
RECEIVED TO DATE.
SCALE: APPROX. 1/4" = 1'.



Identification of planes becomes difficult when the plane is camouflaged and the sky is cloudy. Many Japanese planes have not been camouflaged, being left unpainted. These flash in the sun while maneuvering but are difficult to see when they are between the sun and the observer.

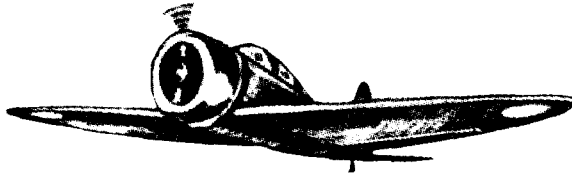
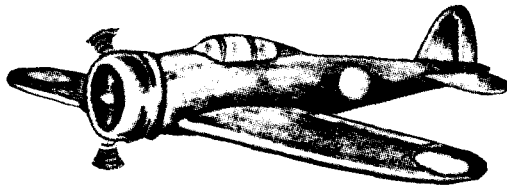
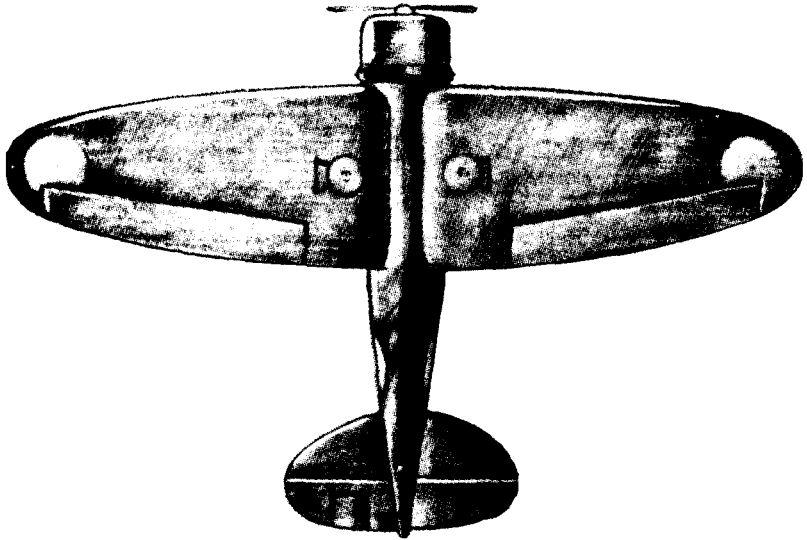

ZERO FIGHTER (MITSUBISHI)

Elliptical wing, round-tip, dihedral low-wing monoplane; single engine; short, blunt nose; enclosed cockpit; retractable landing gear.

This single-seater plane has a short, stubby appearance. Most of the planes of this type are powered by one Junkers 800-horsepower engine. Its service ceiling is 39,300 feet; its maximum range, 2,000 miles. It has a high rate of climb because of its light weight and lack of armor plate.

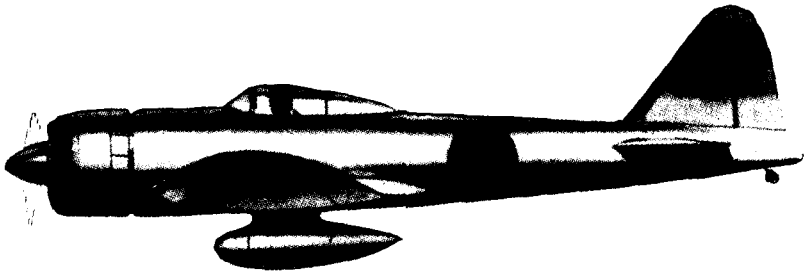

JETTISONABLE FUEL TANK

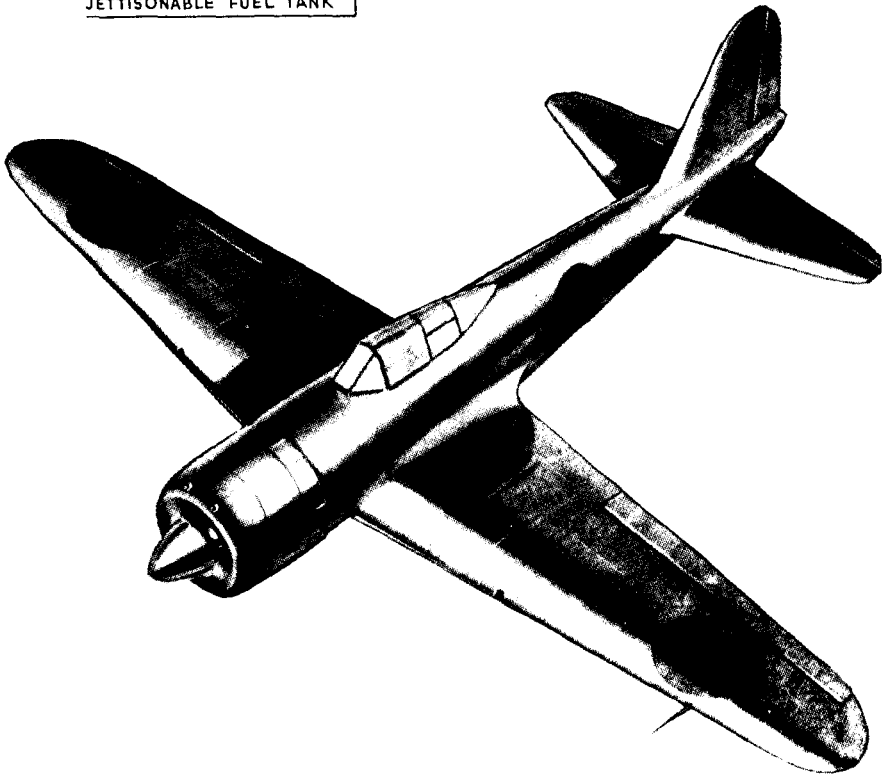

ZERO FIGHTER (NAGOYA)

Sweptback, tapered, round-tip, slightly dihedral, all metal low-wing monoplane; single engine; blunt nose; enclosed cockpit; retractable landing gear.

This single-seater has a maximum speed of 344 mph. It is reported to be armed with two 20-mm cannon wing guns and two fixed machine guns. Its service ceiling is 32,810 feet; it can remain aloft 6 to 8 hours by using the belly tank, which holds 70 gallons of gasoline.

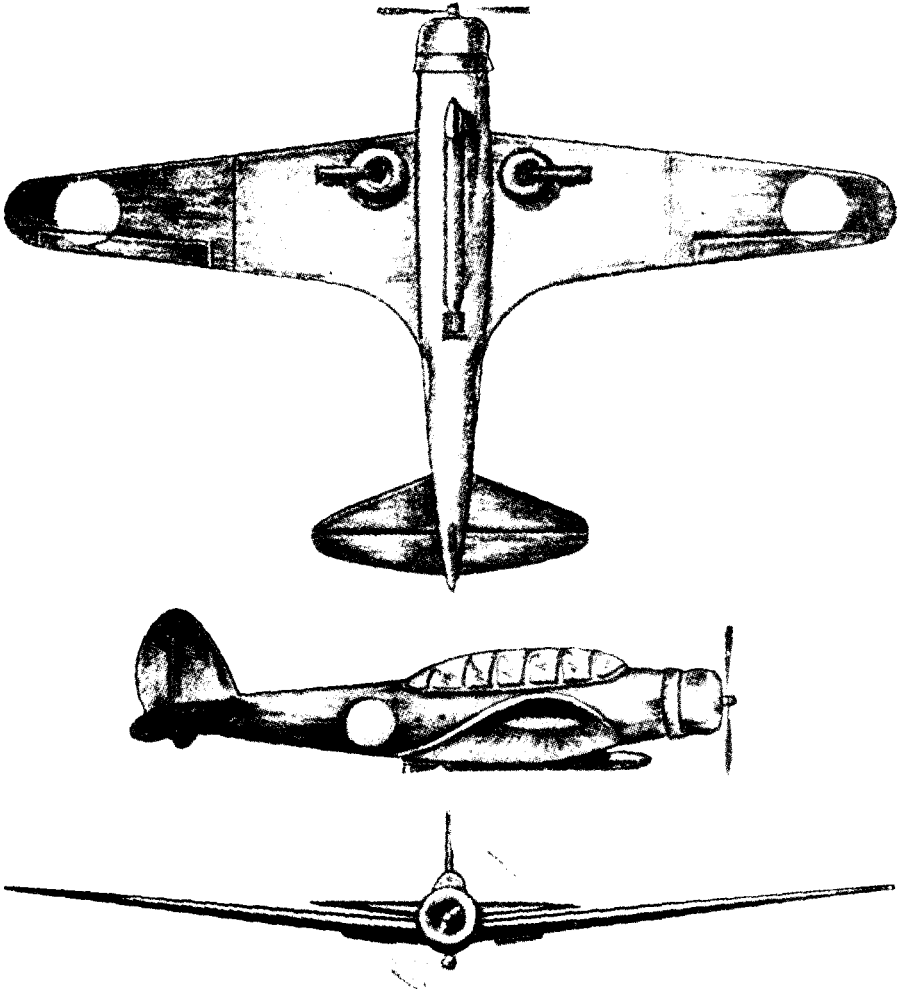

TORPEDO-BOMBER 97

Low-wing monoplane; obviously dihedral; long, enclosed cockpit; retractable landing gear; two fixed 7.7-mm machine guns and one free 7.7-mm gun; one 1,700-pound torpedo or two 550-pound bombs; crew of three; span of 52 feet. This is an old type but may still be in use.



OBSERVATION PLANE 96

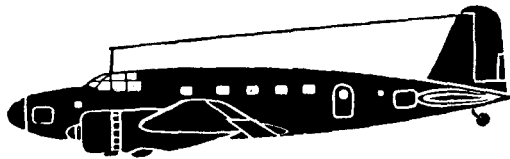
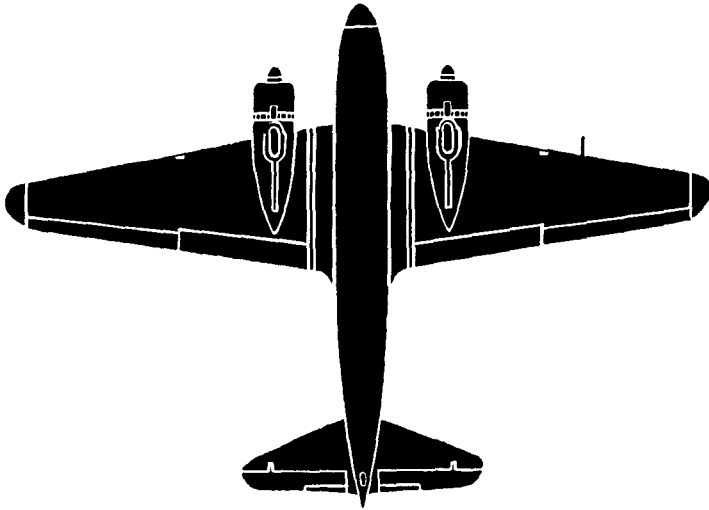
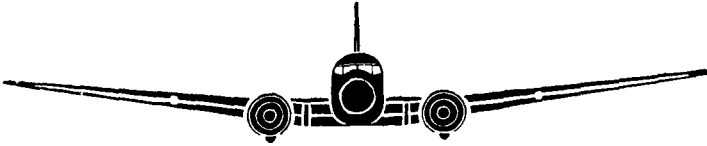
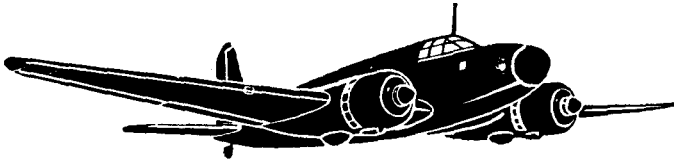

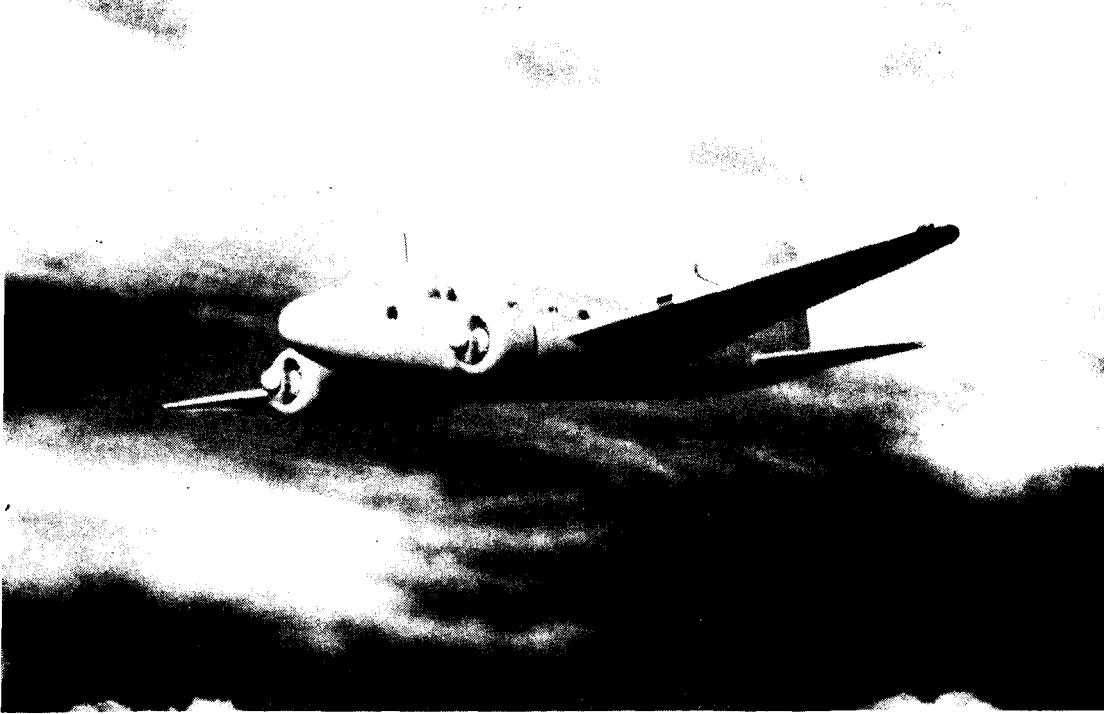

TRANSPORT M. C. 20 (MITSUBISHI)

Sweptback, tapered, round-tip, dihedral low-wing monoplane; twin engines; long, tapered nose; enclosed cabin; retractable landing gear.

This plane has a wing span of 74 feet and is able to carry 11 passengers.



LANDING CRAFT

The Japanese have had much experience and training in landing operations. Special equipment has been devised to land on hostile shores. A knowledge of the shapes and kinds of craft which have been used by the Japanese to land troops should assist scouts, pilots, observers, and others to sound an early warning of the presence of Japanese troops.



Life jackets have been worn by Japanese landing parties. When the soldiers reach land, they take off these jackets and pile them on the beach. The star on the helmet is the distinctive symbol of the Army (a small anchor being the symbol of the Navy).



Members of a naval landing party are here awaiting orders to make a landing on a hostile shore. Notice the life jackets which are being worn.

A heavy machine gun and a light machine gun are set up near the bow of each boat for the landing attack, and each man, not otherwise engaged, has a rifle or a light automatic weapon to fire. Patrol boats armed with pompoms and machine guns give close support to the landings. Air support is available if needed. The bulk of the air task force is held in reserve to counterattack opposition bases within effective range.

When very near the shore the Japanese, all equipped with life-jackets, plunge into the water regardless of its depth, since the waves will carry them to shallow water. If at all possible, the Japanese try to land with the initial force some light artillery, usually mountain-type (75's), and light tanks. Transports with the main body of troops remain some distance from the shore until the beach has been secured. Then the remainder of the troops are disembarked. The landings are directed either against fixed objectives or into localities which will permit flanking movements.

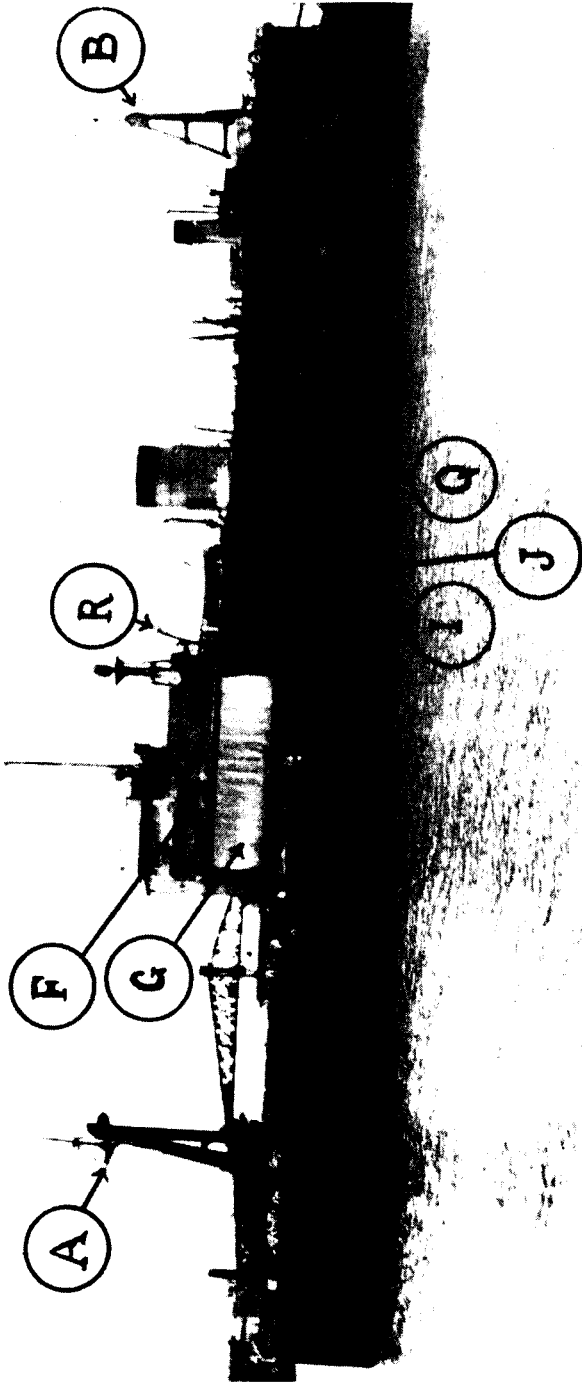

Profile of Japanese landing force tender

The vessel has the following distinctive features (letters refer to the photograph):

Cranes (A and B).—There are two large cranes forward and aft, secured to heavy tripod masts. The boom of the forward one consists of a large built-up girder. There are two purchases, one near the center and one at the end. When secured, this girder reaches well past the forward deck house, to a distance of about 90 feet. The capacity of this crane is estimated at 25 tons. The tripod construction aft has a simple spar boom swung from it, and its estimated capacity is 15 tons.

Forward superstructure, lower part (G).—A large hangar-like space with openings on each side covered by a canvas screen.

Forward superstructure, upper part (F).—The topmost part of the forward superstructure contains the pilot's house and offers no unusual features. Just below this is an armored structure in the shape of a **U**, the two wings extending well aft. The armored structure is armored with a veneer of concrete blocks 3 inches thick. The body of the **U** seems to be designed as a conning tower, and the wings are pierced on both sides by bays for machine and quick-firing guns.

Superstructure.—Used as a boat deck and fitted with four pairs of davits (**R**) on each side. All types of landing boats have been observed on these davits. There are two 3-inch double-purpose guns (**Q**) mounted on

spondons on each side of the boat deck.

The lower part of the superstructure is built of heavy side plating and is pierced by numerous ports and doors (**J**). On each side of this structure just off of the hangar openings is a gangway (**I**) fitted with a brow which folds up and closes the opening. Aft of these gangways the side is pierced with at least eight doors (**J**), which lead into the interior spaces immediately beneath the boat deck.

Afterpart of the vessel.—This presents no unusual features except for a raised platform over the stern which is heavily beamed and extends well out over the side. No gear of any kind is on the top of this platform.

Afterhatches.—The stern is rather flat and both it and the quarters are pierced by large cargo ports whose doors are bolted to the side and swing up and out, being hauled open by davits placed around the sides. These doors are quite large and are arranged one on each side of the stern, with possibly one or two on each quarter. Both the doors and the hull in this part of the vessel are pierced by numerous portholes.

Amidships hatch.—On each side of the hull amidships is a large elongated cargo port. The doors of these ports are split horizontally in the center and are hinged at the top and bottom, so that they open down and up. When the doors are opened on both sides, one is able to see clear through the vessel.

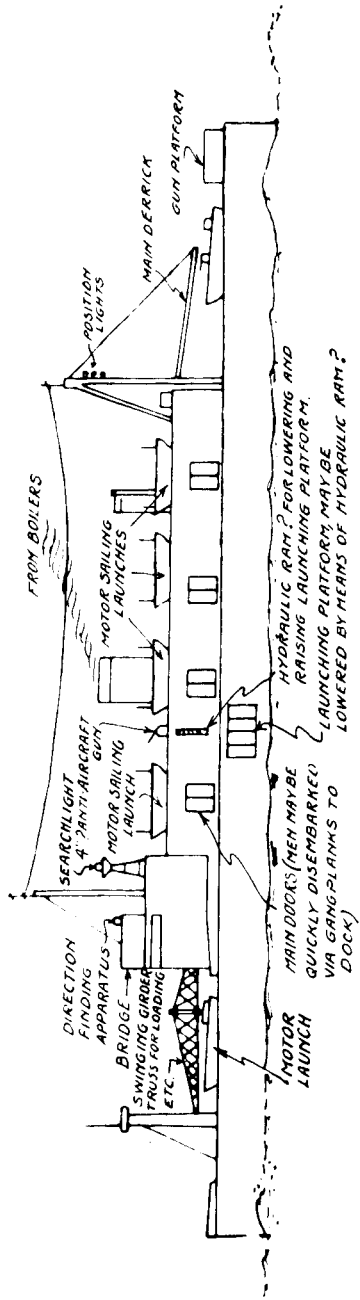

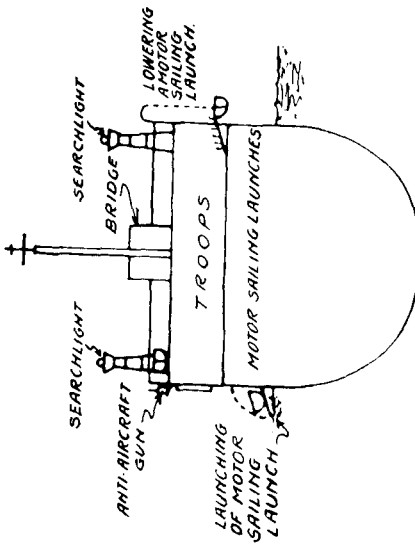

SECTION THROUGH A-B LOOKING FORWARD (IMAGINARY)

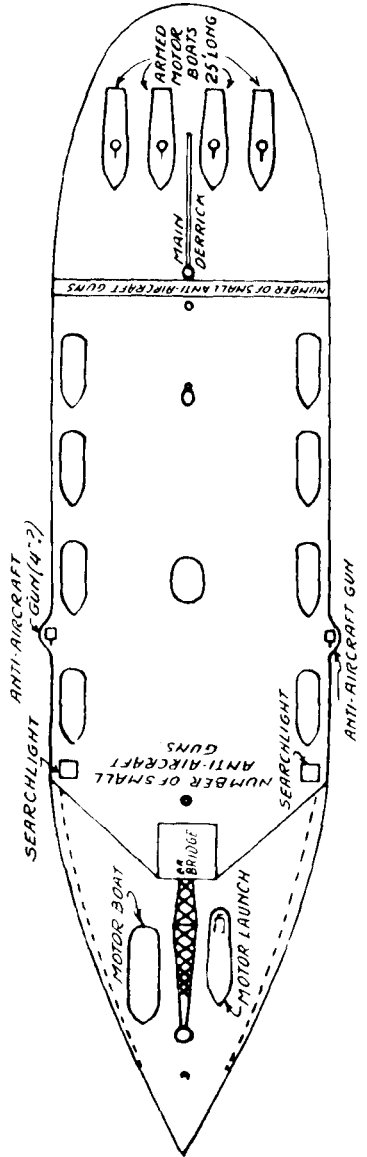

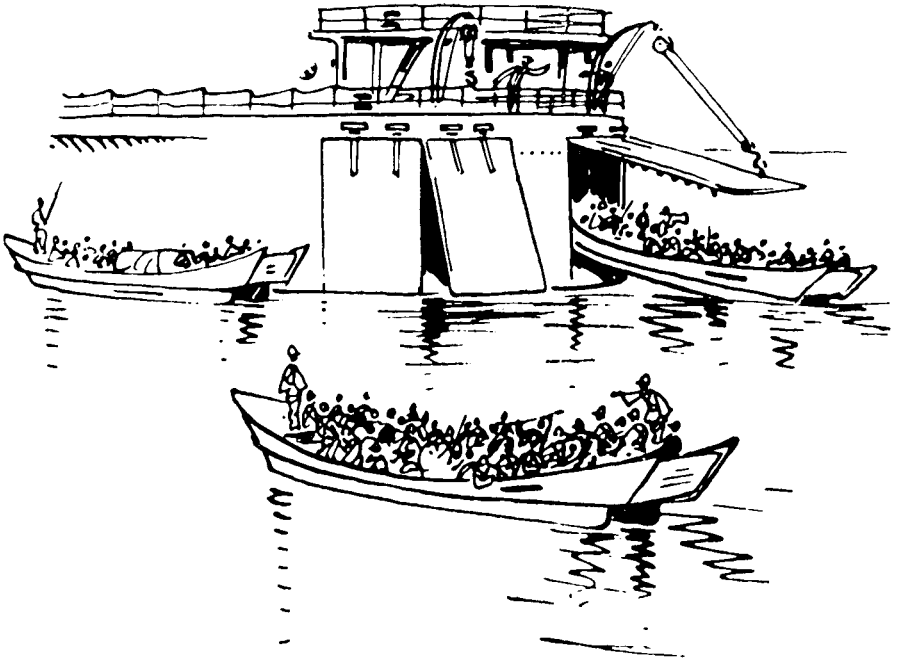

Stern doors of the landing force tender may be used for disembarking fully loaded landing boats

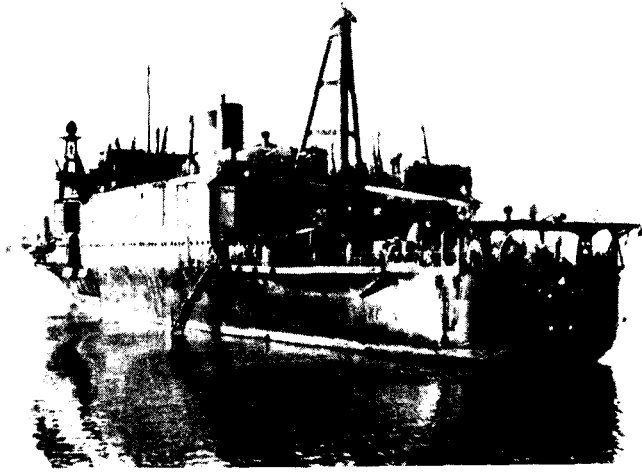

Stern view of landing force tender

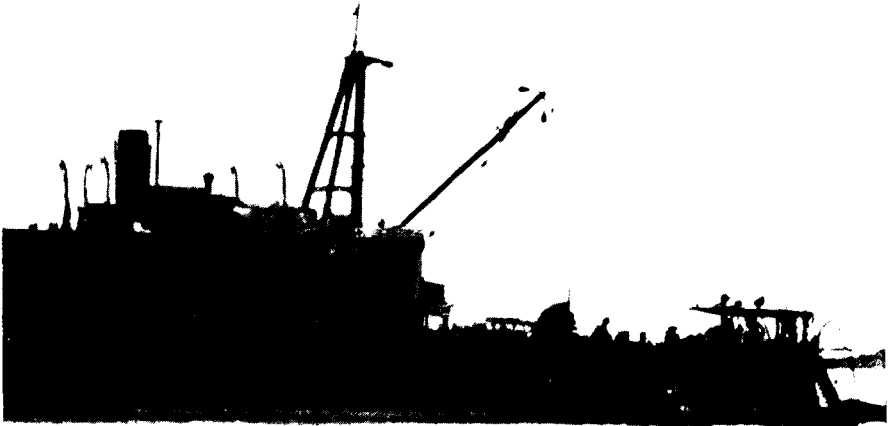

Landing force tender showing stern doors partly opened

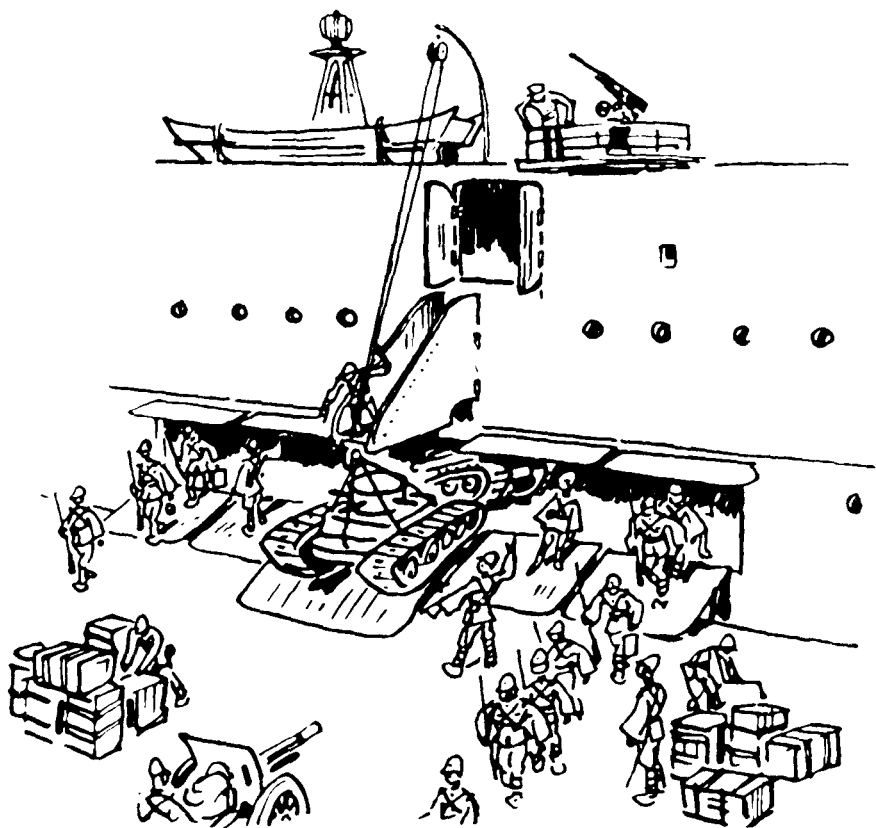

The landing force tender has equipment sufficient to disembark heavy material, troops, and stores alongside a jetty or pier

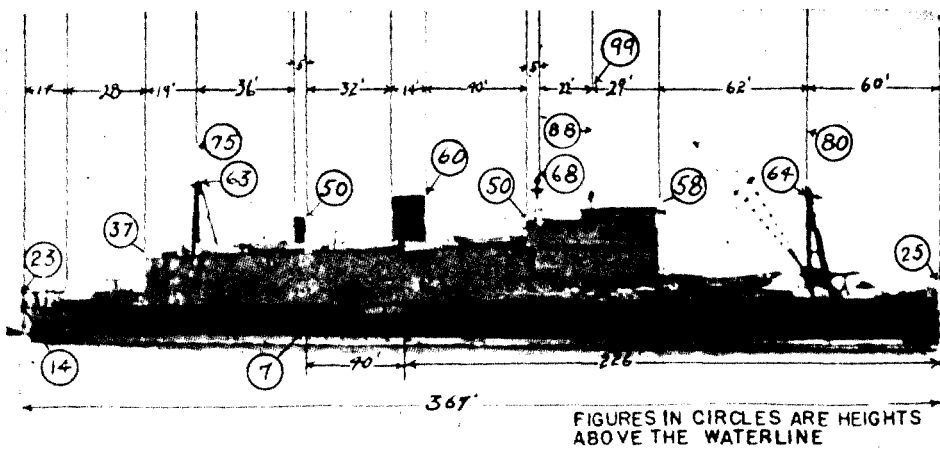

Estimated dimensions of landing force tender

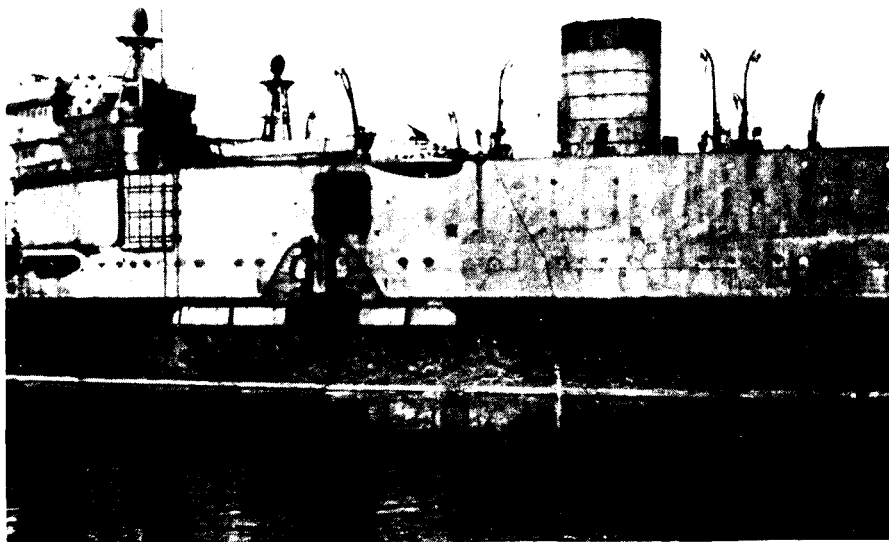

Landing force tender, amidships view

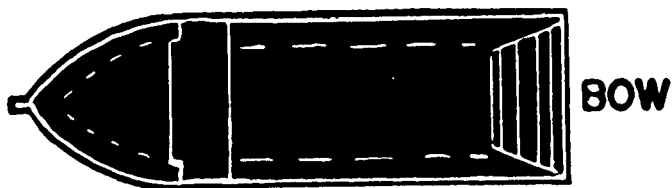

PLAN

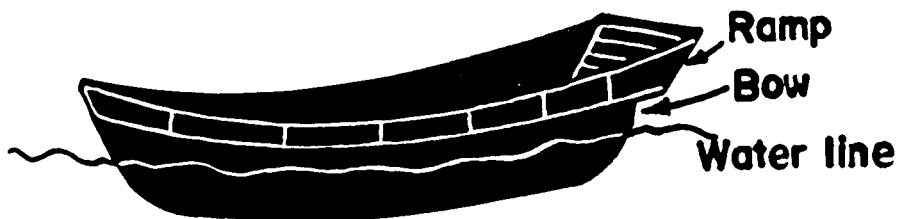

BROAD-SIDE



BOW

TYPE "A" JAPANESE LANDING BOAT

Approximately:

Over-all: 50 feet. (Also same type boat- Over-all: 57 feet.)

Water line: 41 feet. Beam: 13 feet.

Loaded mean draft: 3 feet by 3 feet. Loaded least free-board: 3 feet.

Powered with low-speed 2-cylinder gasoline engine. (A few Diesel engines used.) Approximate speed: 10 knots.

Estimated capacity: 110 to 120 men fully equipped.

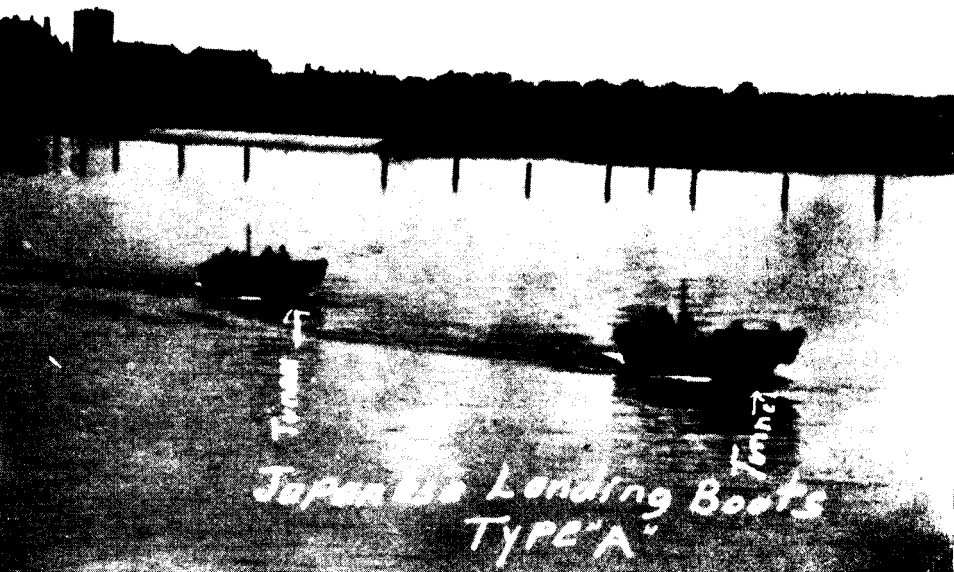

Landing boat type "A" has a double keel at the bow, extending about one-third aft where it is joined in a single keel. The double keel prevents the boat from tipping when landing.

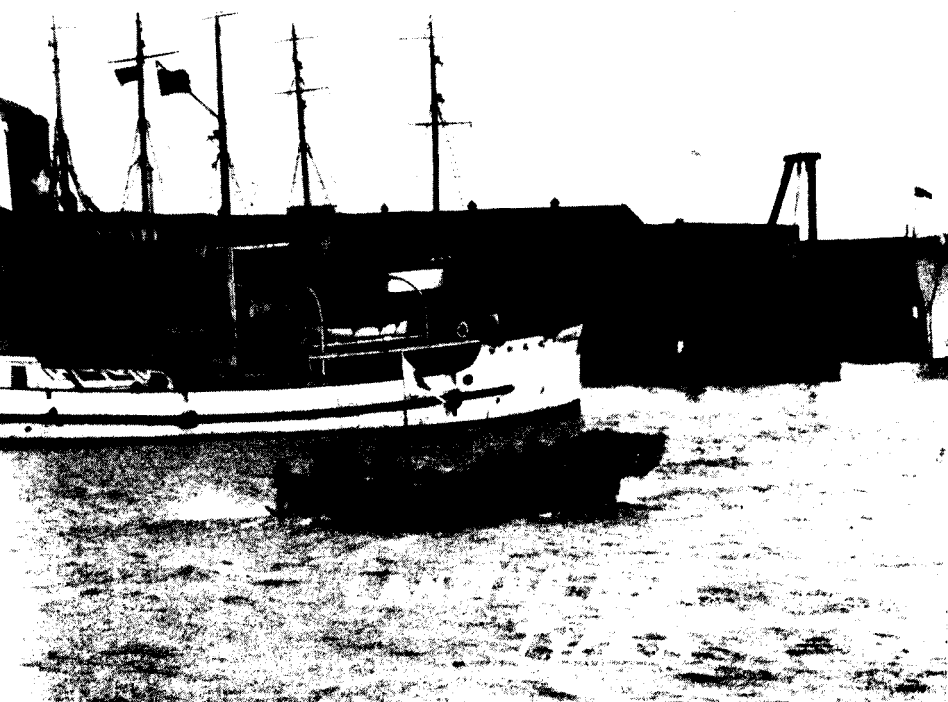

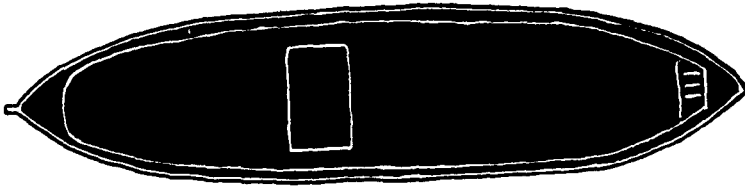

PLAN



BROAD-SIDE

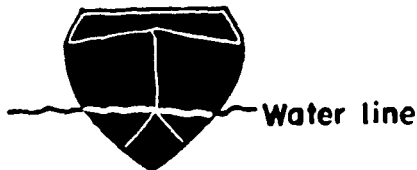

BOW

TYPE "B" JAPANESE LANDING BOAT

Over-all: 20 feet to 40 feet.

Powered with gasoline engine.

Construction similar to a steamer lifeboat.

Only some are equipped with bullet-proof shield in bow. This shield will stop .50-caliber bullets.

Some carry a light machine gun in bow.

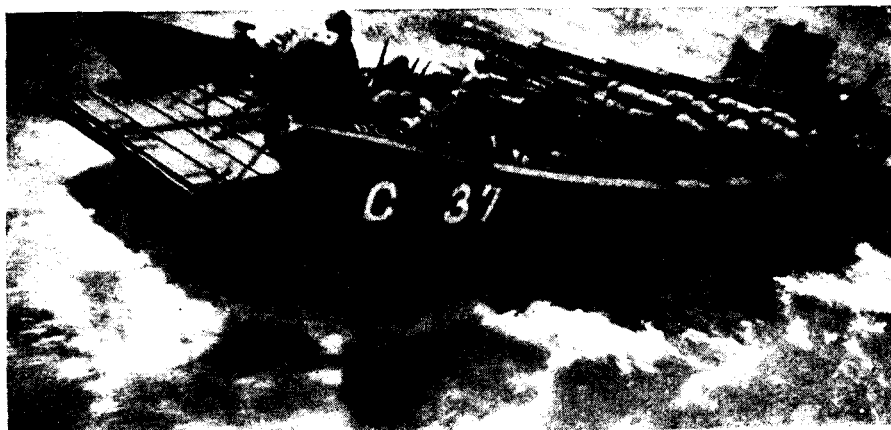

LANDING BOAT TYPE "A"

The bow ramp is for landing heavy equipment. It is here shown folded and partly lowered

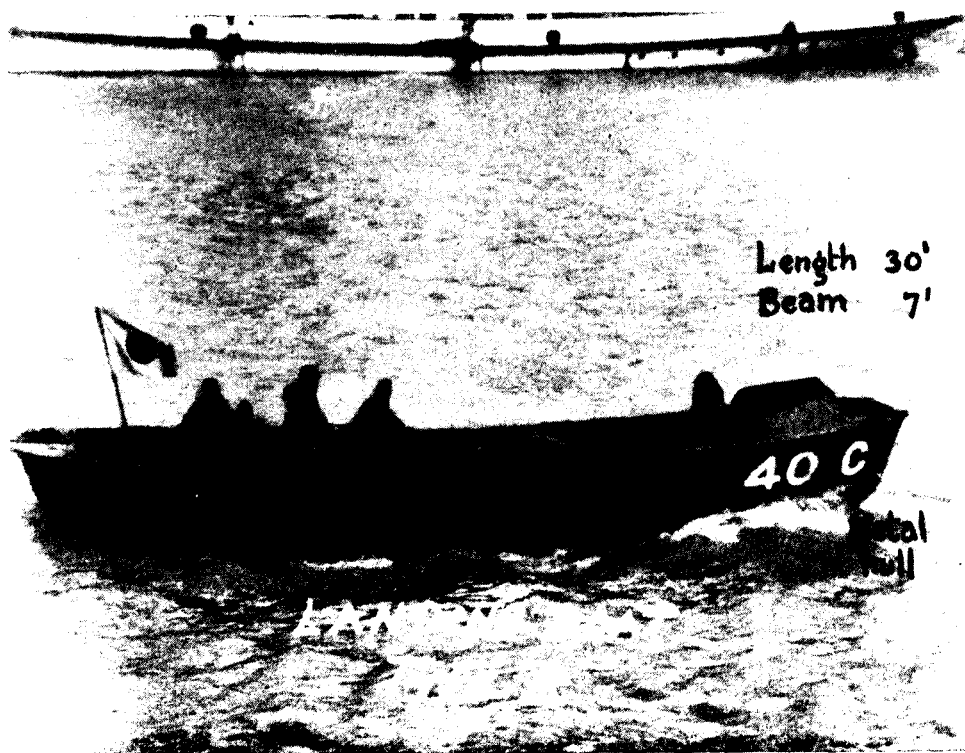

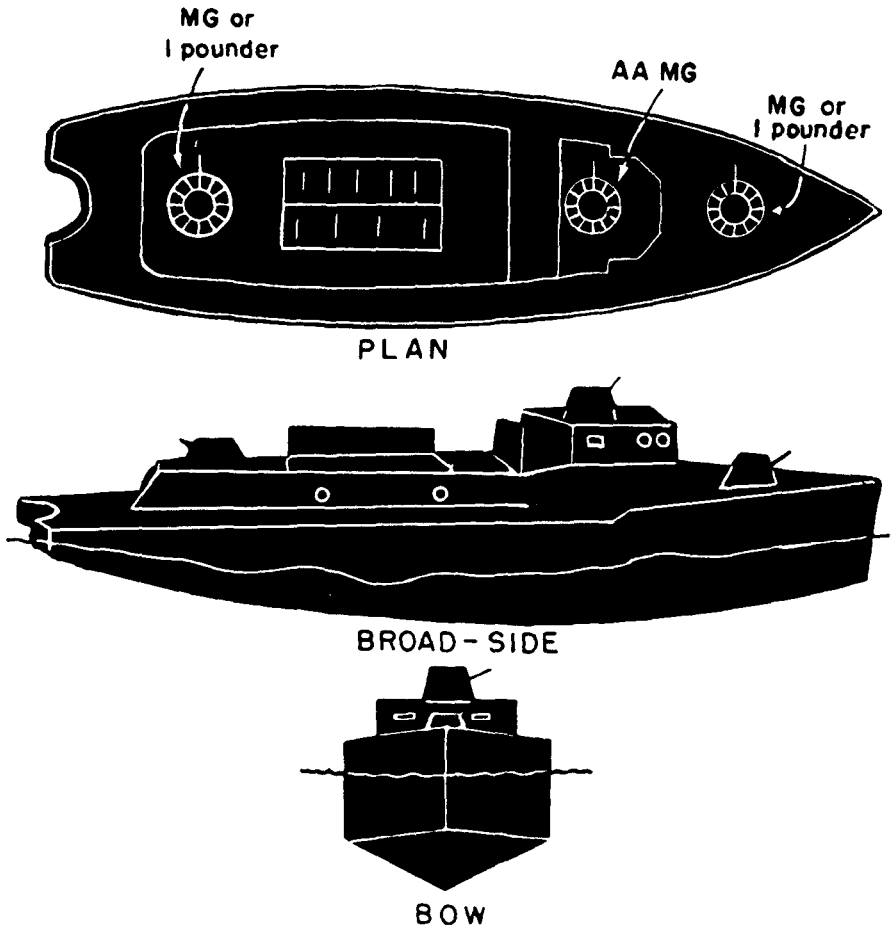

TYPE "C" COMBINATION PICKET AND COMMAND BOAT

Approximately:

Over-all: 40 feet.

Beam: 13 feet.

Constructed of steel plate along fine lines.

One boat clocked at 15 knots.

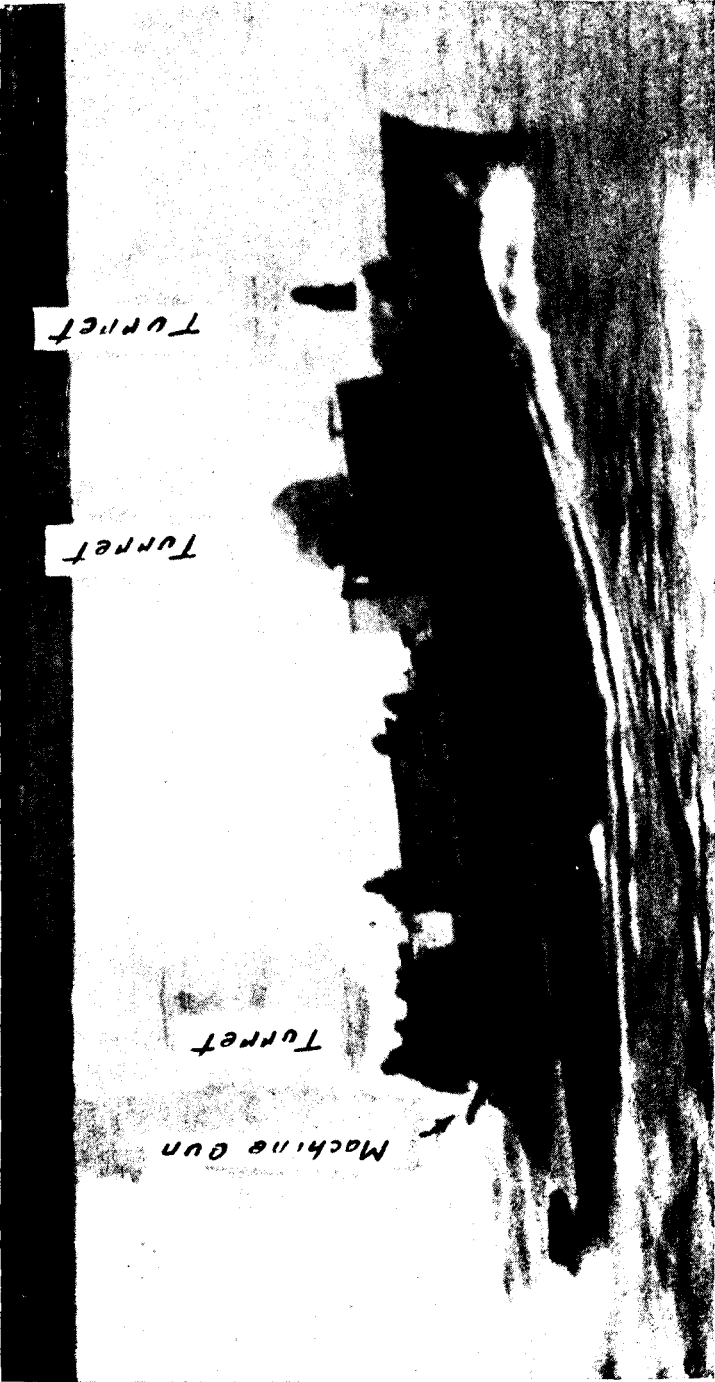

Turret

Turret

Machine gun

Turret

LANDING BOAT TYPE "C"

TYPE "E" LANDING BOAT

The airplane-type propeller drives this boat over shallow and weed-infested waters without the usual danger of fouling the propeller.





PLAN

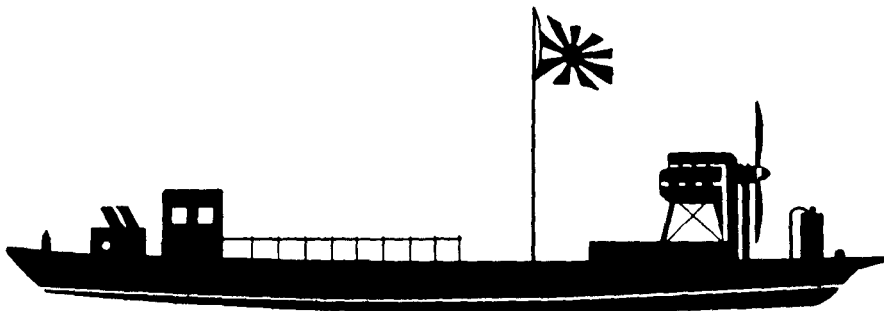

BROADSIDE

APPROXIMATE SCALE

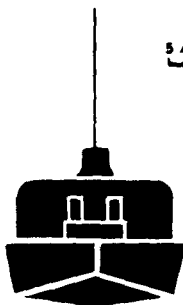

BOW

TYPE "E" JAPANESE LANDING BOAT



This type of landing boat, similar to a Japanese fishing scow, appears to be about 50 feet long and probably carries between 110 and 120 fully equipped men. The ramp in the broad bow facilitates disembarking.

Japanese landing operations show that considerable thought and training have been devoted to the coordinated employment of the army, the navy, and the air arm in amphibious warfare. Task forces composed of units from such fighting arms have specially devised tactics and highly developed landing equipment. The latter includes both landing-craft carriers which disgorge fully loaded boats from their sterns and sides and landing craft specially designed to negotiate shallow and weed-infested waters. These are illustrated on the preceding pages. Rubber assault boats and special equipment to aid the individual soldier, such as rubber belts which can be inflated, have also been used.



Note. 1. Camouflage on helmets; 2. Camouflage body netting; 3. Machine gun.

The Japanese make extensive use of individual camouflage. These nets are the individual equipment of the Nipponese soldier. Twigs, branches, leaves, and other foliage can be easily inserted. The machine gun in this picture is probably the heavy machine gun, Model 3 (1914) (sannen shiki kikanju).



Camouflage has been stressed by the Japanese in their training. A sedan has here been used to simulate a tank. Note the coverings over the headlights and windshield to prevent reflection of light. This photograph does not exaggerate the lengths to which the Japanese go in an effort to deceive their foes. With the Japanese, tricks and devious means of defeating the enemy are laudable; it is part of their tradition.

An eyewitness account of the make-up of one Japanese sniper indicates the methods used on Bataan:

“A little man painted green, who was so much a part of the tree in which he had lashed himself that he couldn’t be detected from 50 feet, took pot shots at me, but his sniping days are over.

“We had stopped to talk. Suddenly something kicked up the dirt 3 feet from where I stood. Then three shots whizzed past my ear. Presently I learned that a countersniper had got my sniper, and I was allowed to inspect his remains.

“As we approached, I had the sniper’s tree pointed out to me and I took a look at it through high-powered binoculars. All I could see was trunk, leaves, and branches. Even from almost directly under the tree it appeared no different from those around

it. You almost had to climb up and poke the sniper to realize that he was there.

“He wore a green uniform. His face, hands, and even shoes were painted green. There are shades and shades of green, but the coloring of this green man from Nippon matched perfectly the foliage of the big dau tree among whose twisting branches he had lashed himself. The sniper was equipped with linesmen’s climbers to expedite his getting in and out of trees, and smokeless ammunition for his low-caliber rifle. That made it impossible to detect his whereabouts by a smoke trail.”

Japanese soldiers are trained to use treetops for their sniping. Agility in climbing is gained by practice. In this manner trees were used to advantage by the Japanese in Malaya.





The 7.7-mm (.303-inch) heavy machine gun 92 is equipped with an anti-aircraft adapter giving a maximum elevation of 80° and a vertical range of 1,100 yards.



This formal pose of a machine-gun squad should be compared with the photograph on opposite page.

Note.—1. Ammunition boxes; 2. Rope, flasks, and other material carried on backs of soldiers; 3. Tripod on back of soldier second from left; 4. Demolition of road. This appears to be part of a heavy machine-gun section. The men are advancing across a primitive type of tank trap. The sides of the road have been excavated, leaving only a path along the center.





The characteristic shape of the 6.5-mm (.256-inch) Nambu light machine gun (1922). It weighs about 23 pounds and will fire 500 rounds per minute. The hopper holds 6 clips of 3 rounds each.

Note.—1. Light machine gun on bipod mount; 2. Flag carried by soldier for identification.

This machine gun (juichinen shiki kei kik-anju) is gas-operated, air-cooled, and hopper-fed. The bipod support is permanently fixed to the piece near the muzzle. The hopper has a capacity of 20 rounds. It weighs about 23 pounds and has a maximum range of 4,374 yards. Although it is usually fired from the prone position, supported by the bipod mount as shown, nevertheless a tripod mount, Model 1922, is carried by the gun squad and used as desired.





Here is a close-up of a heavy machine gun Model 92 (1914), with telescopic sight. It is not known just how many of these heavy machine guns (sannen shiki kikanju nato) have been equipped with this sighting device. (See TM 30-480, Handbook on Japanese Military Forces, for a diagrammatic sketch of this model.)

Note.—1. Method of carrying machine gun by hand; 2. Gas mask equipment; 3. Camouflage netting over helmets; 4. White cloth wrapped around rear leg of the mount.

This heavy machine gun (sannen shiki kikanju), Model 3 (1914), on tripod mount weighs about 120 pounds. It is a modified Hotchkiss, gas-operated, air-cooled, and a strip-fed gun. The pasteboard strips are loaded at the factory with 30 rounds each of regular rifle ammunition (caliber 6.5-mm). The maximum range of the gun is 4,374 yards. The white cloth on the rear tripod may be for the comfort of the gunner.





In Malaya the British captured this new type of Japanese light machine gun. It is basically patterned after the French Hotchkiss light machine gun with several features copied from the British Bren gun. It is gas-operated and magazine-fed and probably can be fired either automatically or semiautomatically. The gun has a curved magazine holding 30 rounds. Curvature of the magazine indicates that the model is of 6.5-mm caliber (.256-inch). The gun has a bipod attached about 6 inches from the muzzle on the gas-cylinder bracket. The height of the bipod is about 16 inches, and the head of the bipod is provided with two positions: one, a folding position; the other, a position with

the bipod perpendicular to the gun barrel. It does not have an adjustment for height. The sling attached to the butt stock and to the gas-cylinder bracket is provided for carrying the weight from the shoulder. This means that the gun may be fired from a position generally used in firing a Thompson-type submachine gun. For this reason it is believed this new gun may have been referred to erroneously as a "Tommy gun" in previous reports on Japanese tactics. The weight of the gun is 19.18 pounds, and its over-all length is 42 inches. The weight of the barrel is 5.83 pounds. A bayonet lug is provided for mounting the rifle bayonet, which is similar to the U. S. M1917.



Shown here is a 20-mm (.79-inch) combination anti-aircraft and anti-tank gun an Oerlikon type. Its muzzle velocity is 2,720 feet per second with a vertical range of 12,200 feet and a horizontal range of 5,450 feet.

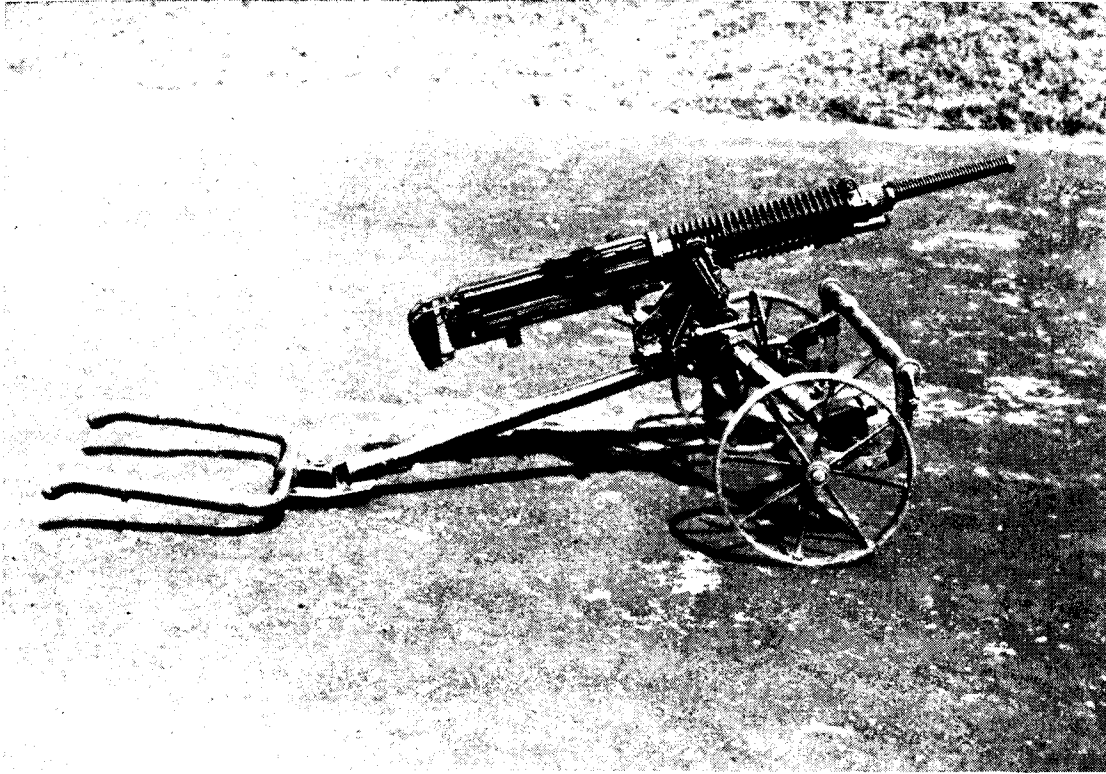

The heavy machine gun is shown on a wheeled mount which provides greater mobility. The Japanese lay much stress on rapid movement of men and equipment in order to attain the element of surprise.

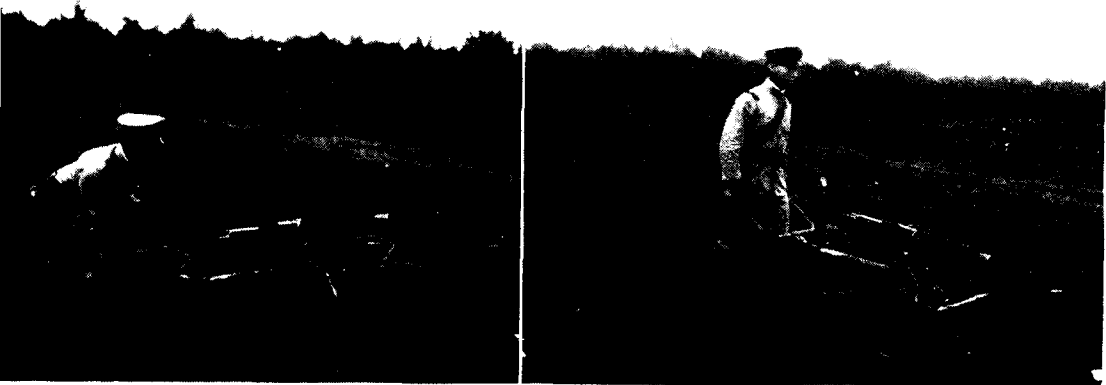



In Malaya the Japanese used two types of grenade dischargers, both of which are muzzle-loaded and are fired from the ground while resting on a small base plate. Usually one section of the Japanese infantry platoon is equipped with grenade dischargers which are utilized as reserve fire power. See page 3, MID Information Bulletin No. 9, Notes on Japanese Warfare, for a description of the organization and tactics of grenade dischargers in the Japanese platoon.



Japanese flame thrower



The infantry battalion gun combines the lightness and portability of the mortar with the stability of a field gun. Because of the weakness of the crank-shaped axle in the original design, it is presumed that later models have straight axles, as illustrated above. The gun has a varying range depending on the ammunition used, and this range does not exceed 3,000 yards. The gun is inadequate as an antitank weapon.

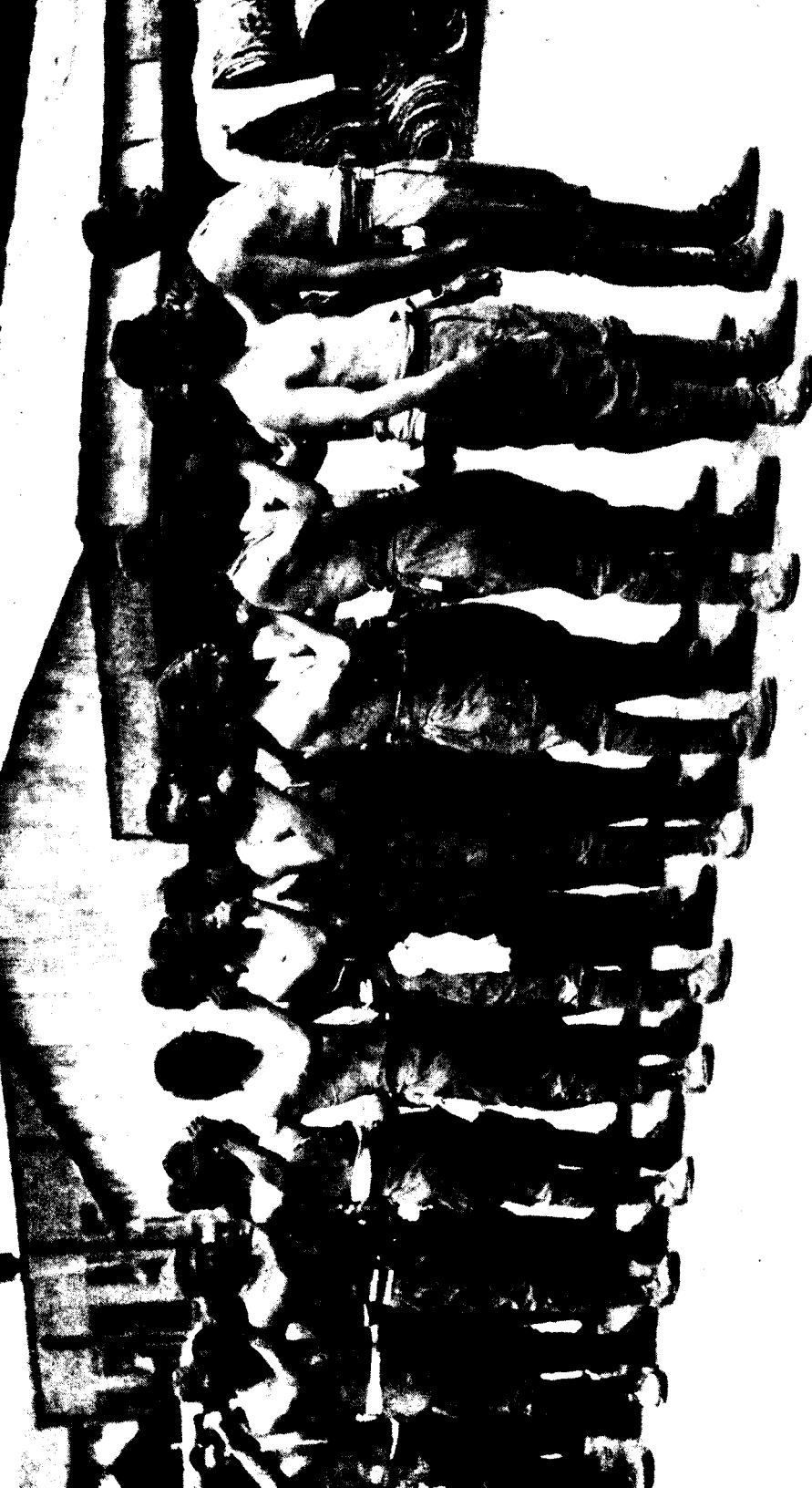

Note.—1. Caps; 2. Clothing; 3. Cloth around waist of some soldiers; 4. Soldiers' physical appearance. These Japanese soldiers are massaging each others' shoulder muscles. A careful examination of the clothing will reveal that some of the men are wearing a stomach band (domaki) around the waist.

Many articles of the Japanese soldier's individual equipment are shown in this photograph: the rubber-soled shoe, which is similar to a sneaker (note the separate compartment for the big toe); the three types of headgear, the cap and the steel and pith helmets; the camouflage net; and the ever-present flags.





Transport units delivering ammunition to the front lines under fire



Japanese soldiers preparing their own meals



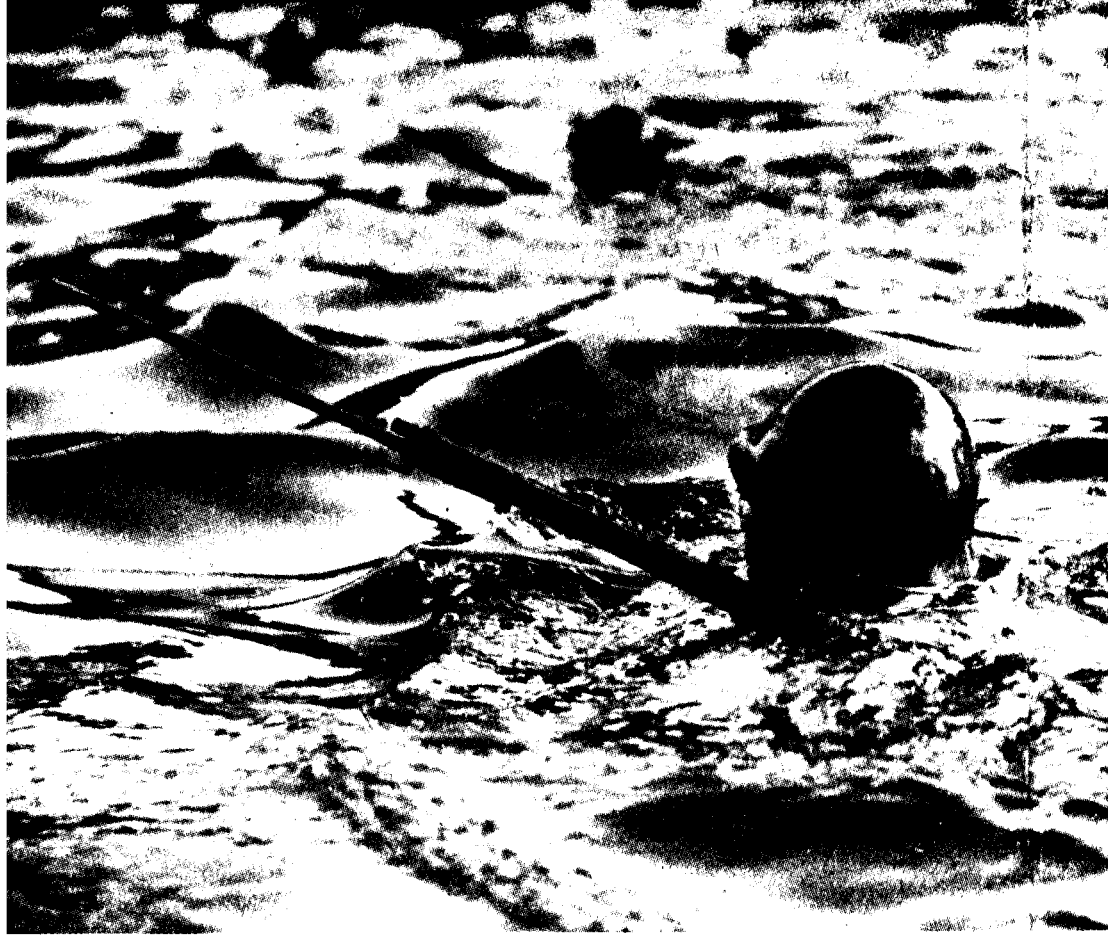

In Malaya and elsewhere the Japanese have made effective use of envelopment by crossing streams and waterways. The soldier above is shown swimming with helmet and gun. The soldiers on the opposite page are shown with rifles before taking off into the water.

The Japanese look on water as a highway, not as an obstacle. In both Malaya and Burma, the Japanese employed small, specially designed river boats and small confiscated civilian boats to infiltrate patrols to the flanks and rear of defending forces. The patrols, sometimes composed of large numbers of troops, generally moved at night. When they moved in daylight, air protection was afforded them.



Japanese soldier waiting to jump into a trench with water canteens



Japanese soldier
supplying water
to comrade at
the front



Cavalry plays an important part in the Japanese conquest and rule in Manchuria and conquered parts of China. These troopers are wearing caps with a protective neck covering. The flag shown is the red ball in a field of white; this flag has accompanied small units in the fighting in China. It has been used not only to develop an esprit de corps but also for identification.

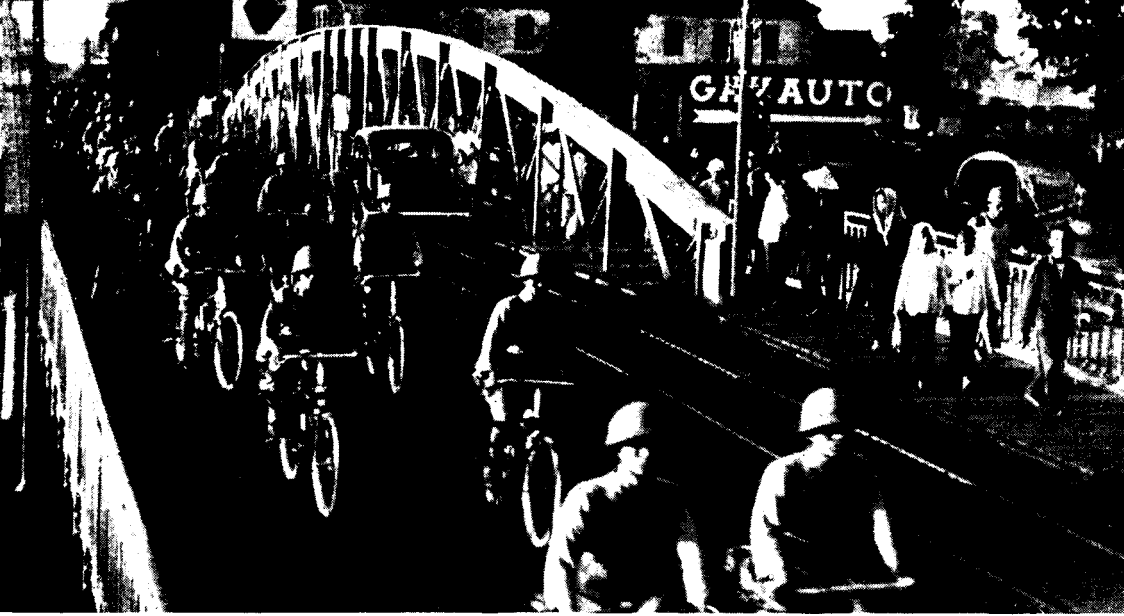

This picture shows the type of bicycles used by the Japanese, and gives some idea of the equipment carried by cyclists. Hats worn by the soldiers appear to be cloth or papier-mâché. Note the gun mounted on the bicycle handle bars, third from left front.

Japanese cyclists were used in penetrating Indo-China and Thailand. They were used to move through quiet areas to the active front in Malaya. These soldier cyclists moved quietly. No one ate or smoked on the move. They did not question natives. They traveled without scouts.

Groups numbered about 60. On level ground they rode bunched—on hills spread—averaging 8 mph. It appeared that leaders rode motorcycles. At night, they progressed in closer formation. Only one in ten had lights. They made more noise at night, evidencing nervousness.

About one-third wore tropical helmets, another third cup-shape brimless steel helmets, and the remainder khaki caps with peaks. White or green shirts—with an assortment of trousers, including shorts, leggings, and rubber-soled shoes—completed their outfit. Long oilskin or mackintosh capes were worn during rain. Rifles were attached to bicycles. About half of the rifles were carried in covers. No pistols, knives, or submachine guns were observed. Some bicycles were commandeered. The average load, apart from the weight of the rider and machine, varied from 75 to 100 pounds.

Fighting a war of movement in China and Manchuria has given the Nipponese an appreciation of the usefulness of fast-moving vehicles. These motorcycles and side cars with their heavy machine guns enable Japanese forces to attain a high degree of mobility and surprise.





Note.—1. Khaki uniform; 2. Portable radio phone; 3. Camouflage netting over helmet; 4. Naval insignia on right arms.

These radios operate on short wave, transmitting and receiving messages by voice. The maximum transmitting radius is 25 miles by voice and 13 miles by using the key. The radios will receive up to 50 miles. The apparatus requires about 4 minutes to install and uses dry cells for power.



Reconnaissance
in a millet
(kaoliang)
field



Balloons of this type have been used by the Japanese during the offensive in China. They are for the purpose of observing the enemy positions.

This Japanese version of the Bangalore torpedo appears to be formed of a shell of bamboo filled with high explosives. The explosion of the torpedo will blow a gap in the wire 20 feet wide.

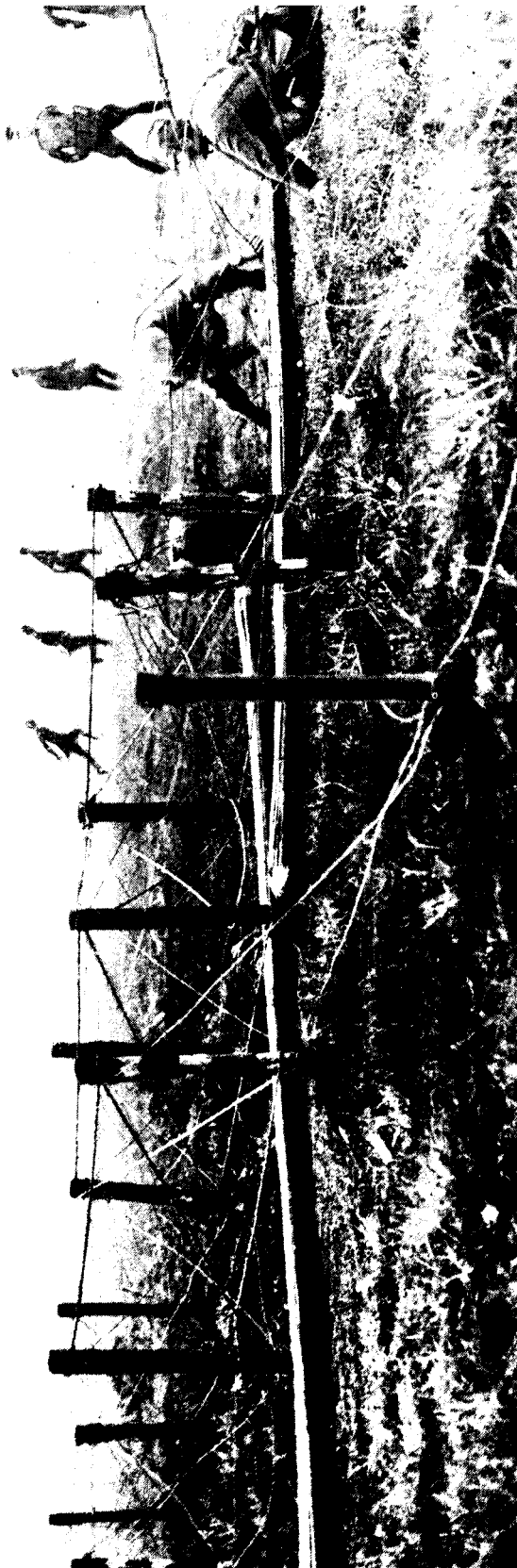



Pneumatic reconnaissance boats are used by Japanese patrols. Like its German counterpart this boat probably is compartmental so that it cannot be sunk by a single hit.

A standard Japanese footbridge is being assembled for launching. The floats are believed to be canvas bags filled with kapok or a similar material. The superstructure is made up of small steel tubing.





This footbridge is being supported by soldiers standing in the stream, a method that enables their comrades to go across the stream more quickly than would be the case if each waded across. This system of human bridgework has been reported to have been used by the Japanese to support even light tanks.



This footbridge is improvised from small boats or pontoons joined lengthwise one to the other. If the current is strong, this construction is not practicable.

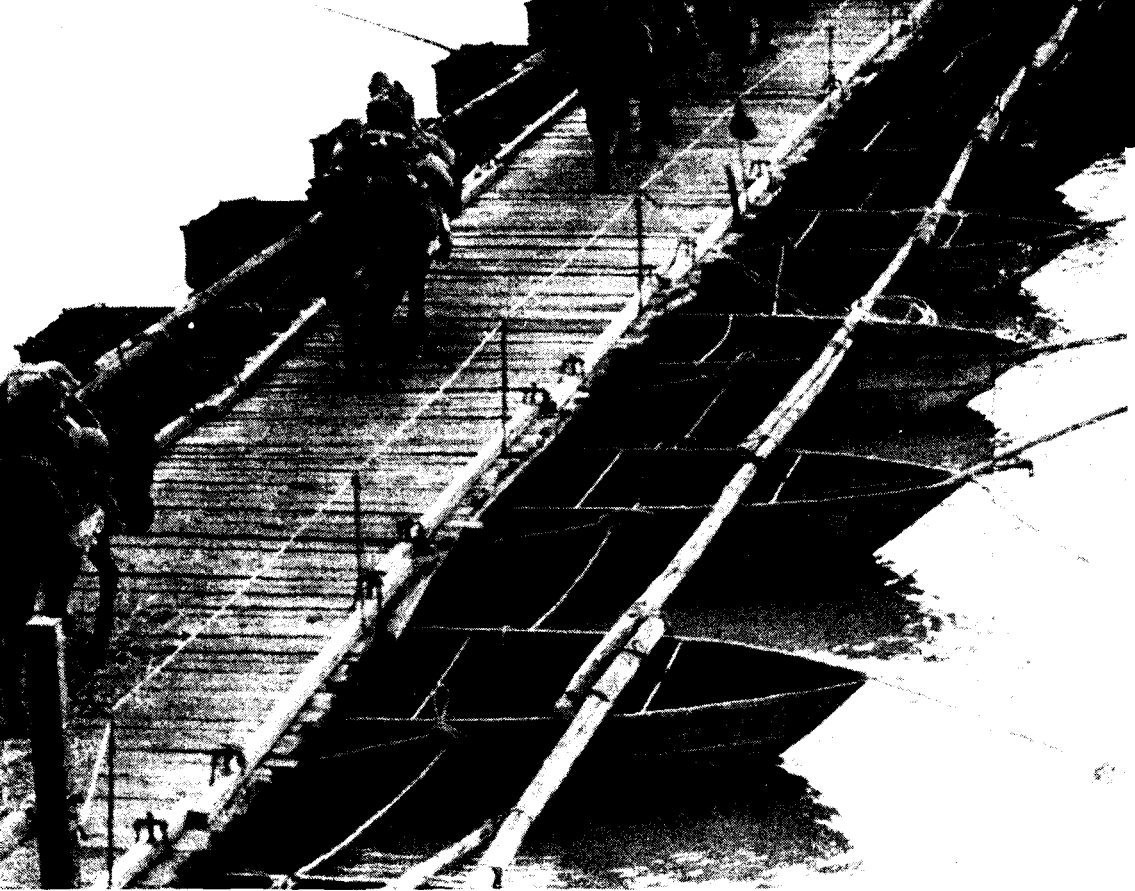

This light ponton bridge is made up of a wooden superstructure on pontoons of the folding-boat type. The walls of these pontoons may be folded inward to facilitate their transport on the road. Their capacity probably does not exceed 5 tons.

Japanese engineers, skilled in replacing demolished bridges, are constructing these piers of timber cribs. The truss appears to be made of timber with steel-tension members.





This Japanese field piece is believed to be a 150-mm howitzer, with an estimated range of about 9,000 yards. The Japanese have placed an armor shield on the limber, as well as on the piece, for protection of the crew. The howitzer has drum brakes, a panoramic telescope, and steel-tired wheels.



This weapon is apparently an obsolescent field howitzer taken from an old war reserve stock. It compares with U. S. field pieces designed in 1908. Its maximum elevation probably is not over 20° and its maximum range not more than 7,500 yards. It is about 90-mm caliber, and by present-day standards a low-power weapon. It has a tangent sight, a box trail, and steel-tired wheels.

The second soldier from the left has on a heavy-soled "tabi," a rubber-soled shoe with a separation between the big toe and the rest of the toes. A story from China indicates that when the Chinese are uncertain as to the identity of an Asiatic soldier, they make him remove his shoes. If his stockings have a separation for the big toe or if there is a callus on the inside of the big toe, the soldier is considered Japanese. This test, though of some use, is not considered a positive one. The symbol on top of the color standard follows the Japanese conventional sign for artillery units.



Designed primarily for use against tanks, this split-trail field gun is believed to be 75-mm caliber. The trails have driven spades to stabilize the piece for firing. The gun has muzzle brakes and pneumatic tires. It closely resembles the French Schneider field gun and may have been purchased from the French. Its estimated range is about 10,000 yards.

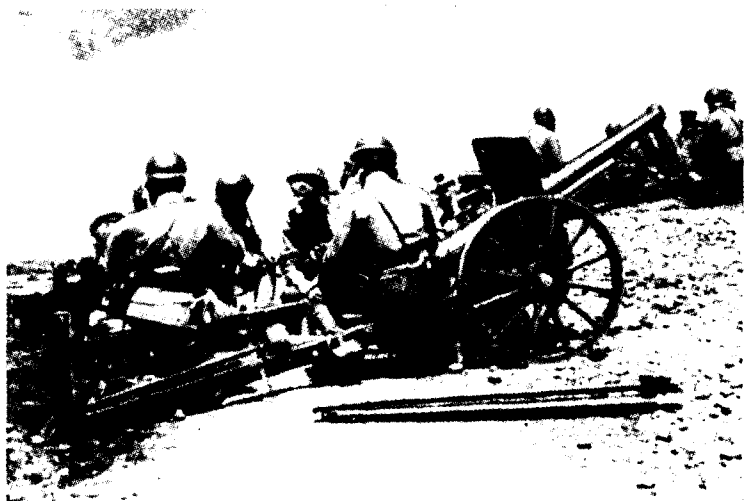

This 75-mm (2.95-inch) mountain gun 94 (1934) has a maximum range of 9,800 yards. Its muzzle velocity is 1,670 feet per second.

This appears to be a 75-mm anti-aircraft gun. It is the pedestal type and has a horizontal sliding-breech mechanism. The range finder shown to the left has a telescopic mount which rests in the soldier's belt.





These Japanese are using the dead-end embankment of a railroad switch as an observation and signaling post. The whitish panel on the slope probably is a signal to planes. The soldier manipulating it also has a battery commander's telescope. The soldiers on top of the rise are setting up or firing some type of automatic weapon.

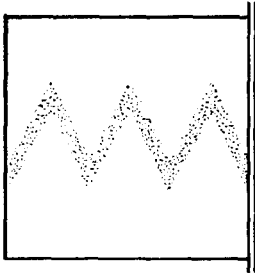

1st Infantry Bn.

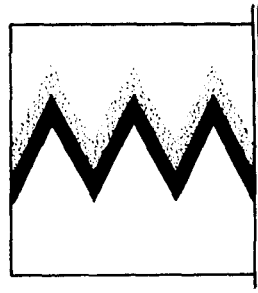

2d Infantry Bn.

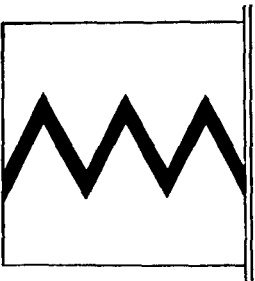

3d Infantry Bn.

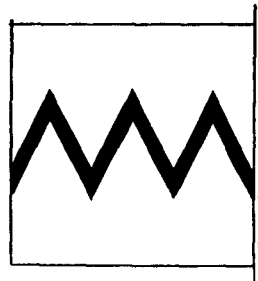

1st Infantry Bn. (Reserve)

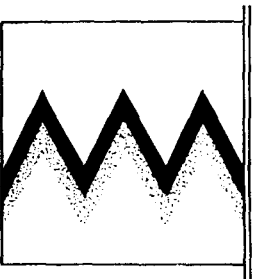

2d Infantry Bn. (Reserve)

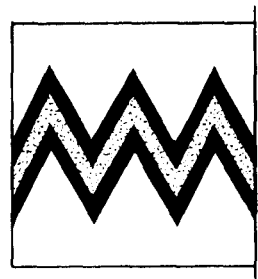

3d Infantry Bn. (Reserve)

BATTALION FLAGS

Each battalion of the active army carries a distinguishing flag to mark the position of the battalion headquarters. These flags are about three feet square with markings as shown. Shaded areas indicate red.



Identification flags are used to enable ground forces to be readily recognized by pilots. This picture shows a battalion headquarters on the move. The identification panel or flag on the back of the soldier indicates it is the 2d Infantry Battalion. Orange panels are also used for identification. The arrangement of the panels is changed daily.



A six-horse Japanese artillery team in China is carrying what appears to be a 75-mm gun across a ponton bridge. The wheels of both the caisson and the piece are constructed of wood with steel rims. The two rolls protruding from the rear of the caisson appear to be grass mats.



Camouflage nets for body and helmet are issued to each Japanese soldier. They are used to hold straw and twigs. Note the camouflaged anti-aircraft gun, the air defense instruments, and the gun emplacement.



This Japanese anti-aircraft gun appears to be a 75-mm with a low-velocity shell. It is made mobile by wheels which are taken off when the gun is fired. The platform base has out-riggers to give it additional stability. Notice the stakes and sandbags to the rear— placed there for stabilizing the piece.



The Japanese use this dual-purpose truck-tractor to pull artillery and carry personnel. It is propelled by the use of steel tracks, which have pin joints. The suspension appears to be of a rigid type. Similar truck-tractors in the U. S. Army carry 8 to 13 men, whereas only 7 are riding in the Japanese vehicle. The Japanese crew is afforded little or no armor protection. Note the camouflage being worn by the Japanese soldiers.

To the left in this picture is the Osaka M2592 (1932) armored car. It is equipped with two machine guns in its rounded, dome-shaped turret. Second from the left is the naval six-wheel, landing-party type, which is equipped with five machine guns, including one for use against aircraft. The armor on these vehicles varies from 8 to 11 mm (.315 to .433 inch).





The ability of tanks to maneuver in relatively deep water without trouble greatly extends their range of operation. This has been a feature which the Japanese have developed to a great extent, probably induced by a realization that the interior of China and other Oriental countries is crisscrossed with paddy fields and marshes.





Note.— 1. Relative size of man and tank; 2. Driver's port open; 3. Bogie wheels; 4. One gun in turret.

This light armored vehicle, weighing about 3 tons, called Ishikawajima Tankette, M2592 (1932), carries two men. It is often used with an armored trailer for supply and intercommunication. Its maximum speed is 30 mph. Its dimensions are: length 10 feet 2 inches, width 5 feet 9 inches, height 5 feet 4 inches.

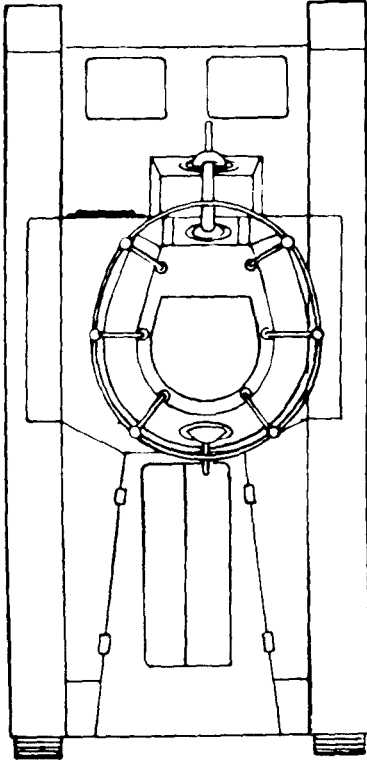

JAPANESE
CRUISER TANK

SCALE
0 1 2 3 4 5 6 7 FEET

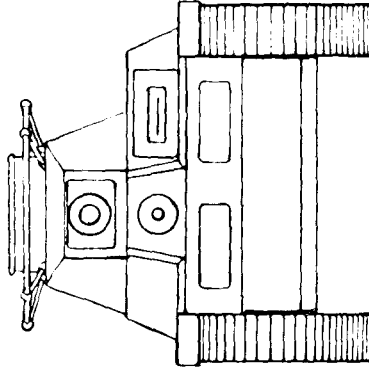
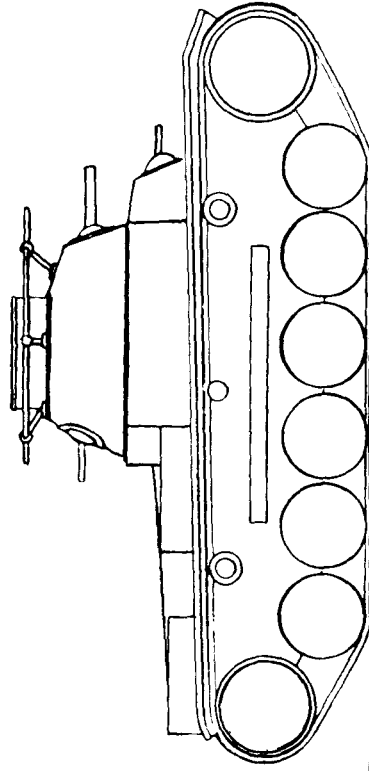

Model 2595 (1935)

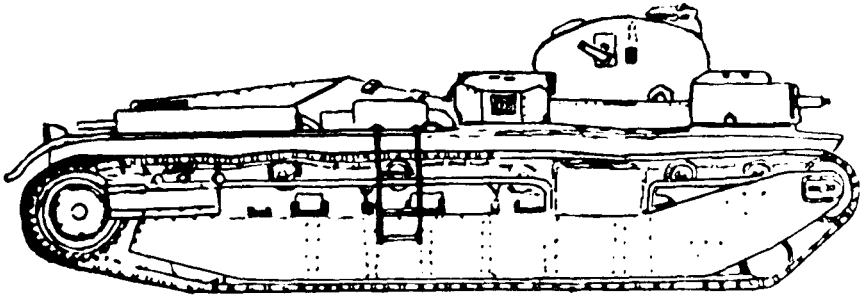

Side view

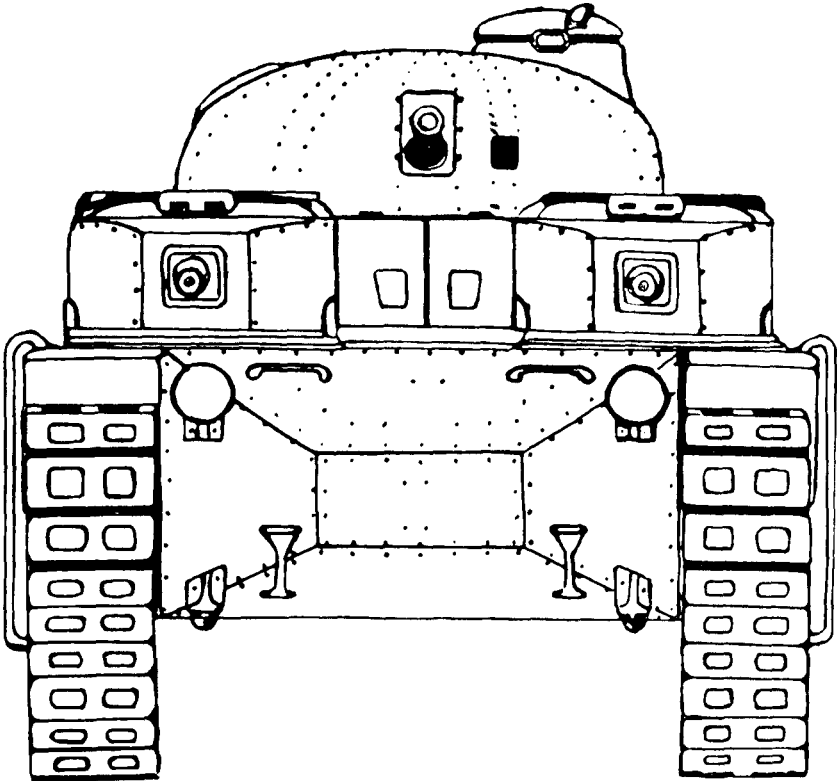

ISHI 108

Armament: Two 37-mm (1.45-inch) guns in turret. Three machine guns and flame thrower in hull fore.

Weight: 38 tons.

Information about this tank of recent type is unconfirmed.

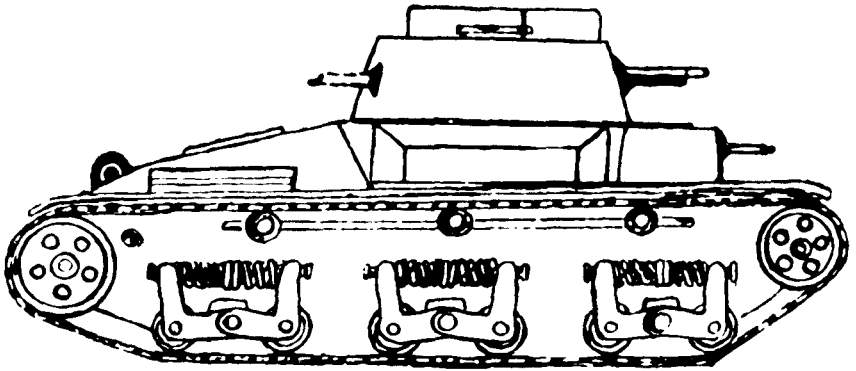

Side view

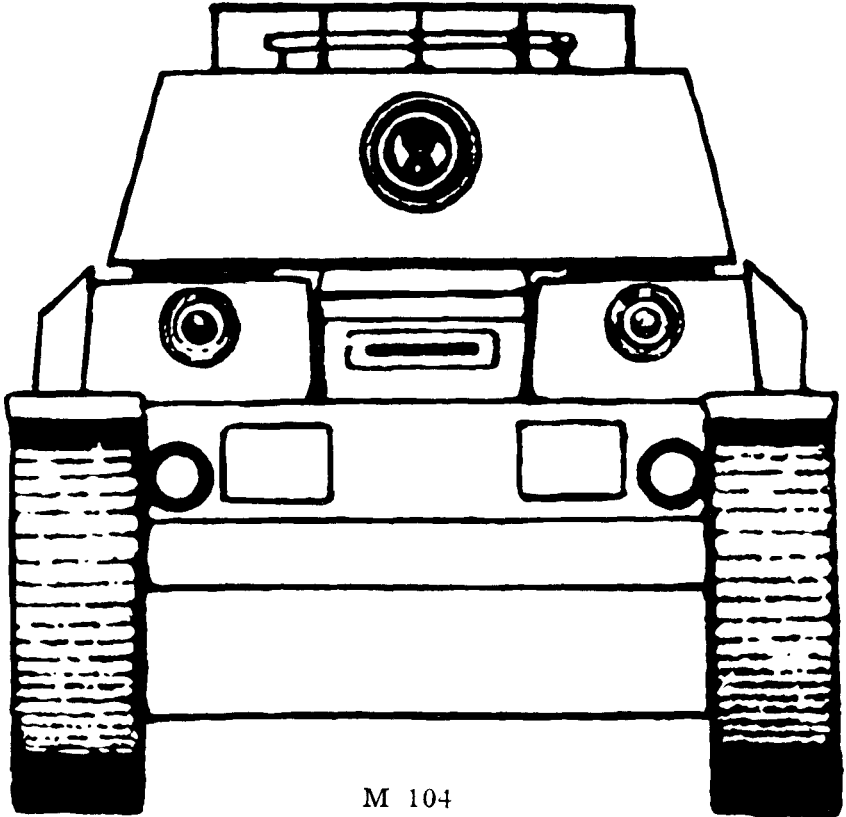

M 104

Weight: 29 tons.

Armament: In turret one 37-mm (1.45-inch); one 75-mm (2.95-inch).

In hull fore one 37-mm (1.45-inch); one machine gun.

Armor: 25-30-mm (.98-1.18-inch).

Information about this tank of recent type is unconfirmed.

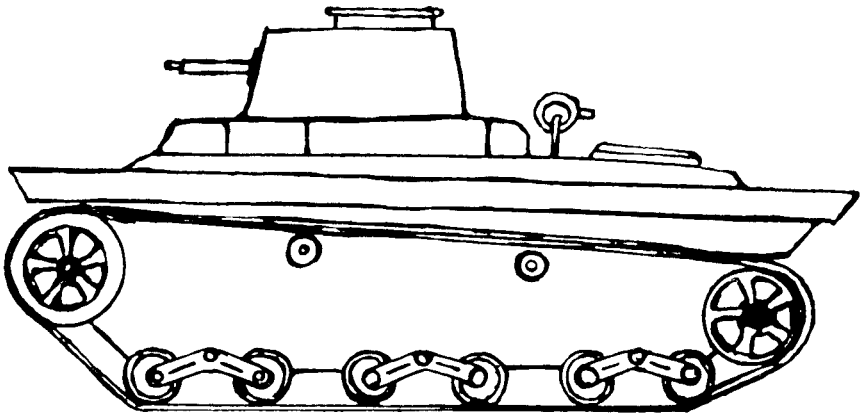

Side view

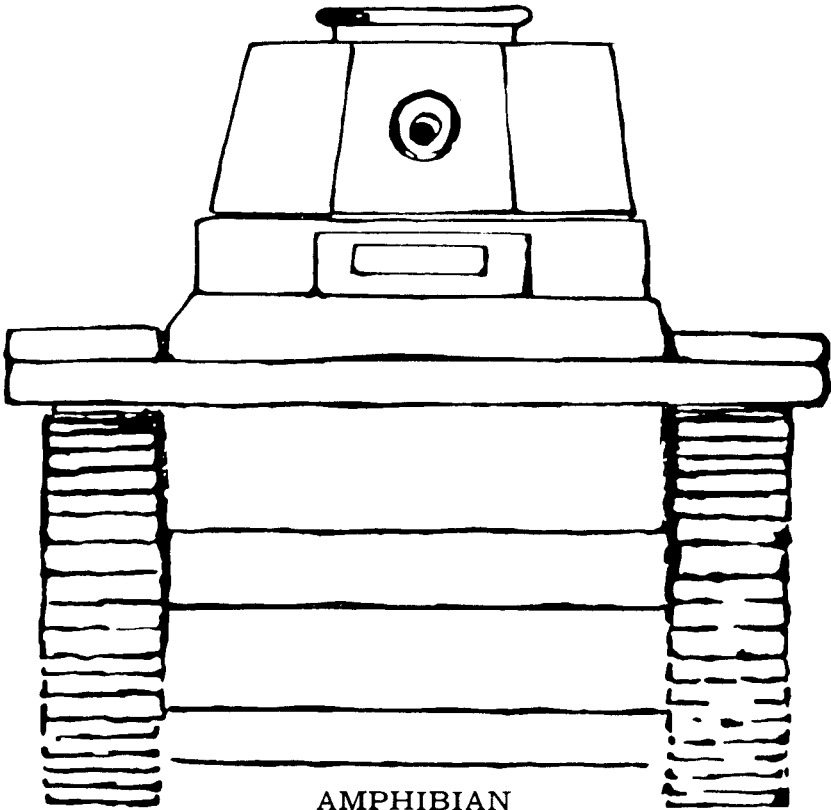

AMPHIBIAN

Armament: One machine gun in turret.

One 37-mm (1.45 inch) gun hull fore.

Armor: 15-20-mm (.59 .78 inch).

Weight: 4 tons.

Information about this tank of recent type is unconfirmed.



Various models of this 14-ton medium tank, model 2594 (1934), have been used with naval landing parties. They carry five-man crews, negotiate trenches $10\frac{1}{2}$ feet wide, and ford streams 3 feet deep. They are equipped with a 37-mm cannon and one machine gun in the turret and another in the forward part of the hull. A mortar and bombs are carried inside. The communication within this tank is reported to be poor.



New type Japanese two-man tankette



This area is probably a bivouac. Notice the coverings over hoods and windshields for preventing reflection of light or for protecting motors.

Vehicles usually have been camouflaged with paint and local vegetation, and sometimes nets have been used. Armored force vehicles normally are painted irregularly in indeterminate shades of khaki, yellow, brown, and green. Some of the ordinary motor transports are painted like the armored vehicles, though usually they are of a sandy khaki color.

The Japanese have made full use of camouflage, using nets for personnel, horses, and equipment and adding jungle foliage to complete the job.

Each Japanese soldier has body and head nets, either or both of which may be worn according to circumstances. The nets are made of a greenish-colored straw fiber cord or ordinary twine with a square mesh slightly less than 2 inches in size. The body net is 1 by 1½ yards, and the head net fits snugly over a cap or metal helmet.

The picture below shows one method used by the Japanese for inland transport. The Japanese Army has shown considerable ingenuity in taking advantage of all available means of moving troops and supplies in enemy country.





Where the roads are impassable or difficult for motor vehicles, the Japanese are prepared to utilize horses and small carts, of which they have many.

The Japanese supply system is marked by adaptability. Impedimenta are lightened, thus enabling troops to move fast and with great ease. They carry simple, compact rations; light, small-caliber arms and ammunition; light clothing; and employ a minimum of transportation. In many instances the transportation of units as large as a company has been carried out by natives impressed into service as carriers.

Note that the sides as well as the backs of these trucks can be lowered for rapid unloading. These vehicles are used to supply units and transport troops. Flags are carried in each truck for identification.





These Japanese motor trucks form part of the Japanese supply lines in China

CHINESE AND JAPANESE CHARACTERS

CHINESE AND JAPANESE CHARACTERS













ABOUT 1,500 years ago, the Japanese first began to be interested in the problem of writing. Before that time they had been living so simple a life that they had not thought of writing books and letters; but by the fourth or fifth century of the Christian era, they had learned enough about civilization in general from China that they began to feel the need of writing down their thoughts and their knowledge.

About the same time, the peoples in northern Europe were faced with this same problem, and they solved it very simply by borrowing the Latin alphabet, which could be conveniently used to write any language. Unfortunately for the Japanese, they did not know about the Latin alphabet or any other alphabet, for that matter. Since the only writing system they knew of was the Chinese, they proceeded to borrow it.

The Chinese writing system was, and still is today, about as difficult a thing to learn or to use as man's mind has ever invented. It started out being a sort of picture language with each word represented by a simplified picture. This system was all right for words like "horse" or "fish," words that could be drawn, but it would not do for more difficult words like "duty," "courage," or "honesty." Obviously, the writing system had to develop far beyond simple pictures, and this it did more than 3,000 years ago. But Chinese writing never lost some of its original pictorial quality. There still is one symbol, if not picture, for each word. As a result, there are thousands of symbols, or characters, as they are usually called, in use today in China.





The Chinese system was not a handy one for the Japanese to borrow, but it was all they knew. They later had to supplement it with other writing systems they developed themselves, which showed sounds, the way our alphabet does, and not ideas, the way the Chinese characters do. But even after inventing these phonetic writing systems, they still kept to the Chinese characters. They were pronounced quite differently in Japan than in China, because the two spoken languages are not at all alike, but still they represented the same idea. Consequently, most Chinese words can be read





and understood by Japanese, and many Japanese words can be read and understood by Chinese, but neither people can pronounce even the words they know in the other language.

Some of the Chinese characters are extremely difficult, like , which is nothing more than a little “silkworm,” but others are both simple and obvious. For instance, anybody who knows Roman numerals should be able to figure out that 一, 二, and 三 are the characters for “one,” “two,” and “three.” Perhaps the character  with its four sides and four corners suggests “four,” but this does not explain the two lines inside. The other numbers do not make much sense as pictures, but at least they are simple. “Five” is , “six” is , “seven” is , “eight” is , “nine” is , and “ten” is . It is not hard to go on from there, because  is obviously “eleven,”  is “twelve,”  is “twenty,” and  is “twenty-two.” Watch out, though, because both the Chinese and Japanese usually write from top to bottom or from right to left and not from left to right as we do.



The ancient Chinese drew the symbol for “sun,” which also meant “day,” as a circle with a spot, perhaps a sun spot, in the middle . This has become the character



日. The early Chinese symbol for “moon” showed the crescent moon to distinguish it from the sun. It was , but now it is written 月. When these two symbols are put together, 日月, they quite fittingly mean “bright.”

The ancient Chinese drew the word for “mountain” this way: , which has become the modern character 山. A stream was made to look like this: , with the water winding between the two banks. The modern form is . Anyone who has seen the small squares into which “fields” and particularly “rice fields” are divided in China or Japan will recognize the character 田. Perhaps the oddest character is “gate”: 門, the ancient form of which is .

The ancient Chinese drew his symbol for “man” much the way any other person might draw it. It looked like this: . Gradually, however, he simplified even this already simple picture to the most essential part, the two legs; so the modern character is . Perhaps this change was made by some poor soldier after a long day’s march when his legs and feet were all he could think of. The original picture of a man, now written , the Chinese reserved for the big shots, we believe. In any case, the character  means “big” today. The same symbol with an extra big head, , became the character

for “heaven,” which was the early Chinese idea of the top big shot, or God.

Another interesting Chinese character is 木. This may not look like much to you at first, and the earliest form, , may not help either, but add an imaginary line  and you have a drawing of a “tree” with the branches above the ground and the roots below it. If 木 is a “tree,” then, obviously, 林, which is just two trees put together, is a “grove” and 森 is a “forest.”

You can play around with the tree character and get some interesting results. Put a line across the trunk marking the basic central part of the tree thus, , and you obviously have the character for “main,” “origin,” or “basic.” Look at the sun through a tree in this way, , and clearly you are looking at the rising sun low on the horizon, not yet above the tree tops. What symbol could better represent the idea of “east” where the sun rises? Do not ask what the sun looks like through the trees in the west when it sets, or you will ruin the whole system.

The Chinese thought of Japan as a country in the east where the sun rises. Instead of calling it the land of the east, they called it the Land of the Origin of the Sun,

or, as we say today, the Land of the Rising Sun. This they wrote 日本, which should be clear to you if you know your Chinese characters. It need scarcely be pointed out that a Japanese is simply a 日本人.

Words like “up” (or “upper” or “top”) and “down” (or “lower” or “bottom”) and “middle” are very important ones but are not too easy to draw. The Chinese solved the problem pretty neatly. Starting with a middle line 一, they made this 上 “up” and this 下 “down.” “Middle” they showed as a square, perhaps a target, with a line which might be an arrow or the like, going right through the middle of it like this: 中.

One pretty simple character is 口, which serves very nicely as “mouth,” evidently an open mouth, which is the type that counts either from the point of view of eating or speaking. A combination like 川口 is obviously the mouth of a river, but 人口 is not merely the mouth of a man, as you might suppose. It is the mouth of many men and therefore means “population,” because the Chinese, being very practical people, realized that there was more point in counting mouths than in counting noses.

One of the best symbols, but one which we would never think of drawing that way, is 車, now written 車.

That is a “cart” or “wagon” or “carriage,” not viewed from the side or the front, as one would expect, but looked at from directly above with the long axle going through the two big wheels on either side and under the body of the cart in the middle. Since the ancient Chinese fought primarily in war chariots like those of the ancient Greeks, the chariot was used to symbolize “war” or the “army.” This they made by adding a protecting shield of some sort to the cart thus, 軍. Why the protection was on the side instead of the front, we do not know, but perhaps it shows that the Chinese knew their tactics well enough to expect enveloping rather than frontal attacks. If 軍 means “war” or “army,” then obviously 軍人 means “soldier” and 日本軍人 means a “Japanese soldier.”

This is not all there is to know about Chinese and Japanese characters, but it is a start. Following is a list of the characters and words you have learned or have you?—with their pronunciations in Chinese and Japanese.

Character	Meaning	Chinese		Japanese	
		Spelling	Pronunciation	Spelling	Pronunciation
一	one	i	ee	ichi	itchy
二	two	érh	err	ni	knee
三	three	san	sahn	san	sahn
四	four	ss'	ss	shi	she
五	five	wu	woo	go	go
六	six	liu	leo	roku	roku
七	seven	ch'i	chee	shichi	she-chee
八	eight	pa	bah	hachi	hah-chee
九	nine	chiu	jee-o	ku	koo

十	ten	shih	shirr	jū	joo
十一	eleven	shih-i	shirr-ee	jūichi	joo-itchy
十二	twelve	shih-érh	shirr-err	jūni	joo-knee
二十	twenty	érh-shih	err-shirr	nijū	knee-joo
二十二	twenty-two	érh-shih-érh	err-shirr-err	nijūni	knee-joo-knee
日	sun	jih	jrr	hi	he
月	moon	yüeh	you-eh	tsuki	tsoo-kee
明	bright	ming	ming	akarui	ah-kah-roo-ee
山	mountain	shan	shahn	yama	yah-mah
川	river	ch'uan	choo-ahr	kawa	kah-wah
田	field; rice field	t'ien	tee-en	ta	tah

Character	Meaning	Chinese		Japanese	
		Spelling	Pronunciation	Spelling	Pronunciation
門	gate	mén	mun	kado	kah-do
人	man, person	jén	run	hito	he-toe
大	big	ta	dah	ōkii	oh-kee-ee
天	heaven	t'ien	tee-en	ten	ten
木	tree	mu	moo	ki	kee
林	grove	lin	lin	hayashi	hah-yah-shee
森	forest	sén	sun	mori	mo-ree
本	origin, main, basic	pén	bun	hon	hawn

東	east	tung	doong	higashi	he-gah-she
日本	Japan	Jih-pên	Jrr-bun	Nippon	Nippawn
日本人	a Japanese	Jih-pên-jên	Jrr-bun-run	Nipponjin	Nippawnjin
上	up	shang	shahng	ue	oo-eh
下	down	hsia	she-ah	shita	she-tah
中	middle	chung	joong	naka	nah-kah
口	mouth	k'ou	ko	kuchi	koo-chee
川	mouth of a river	ch'uan-k'ou	choo-ahn-ko	kawaguchi	kah-wah-goo- chee
人口	population	jên-k'ou	run-ko	jinkō	jin-ko
車	cart, wagon, carriage	ché	chaw	kuruma	koo-roo-ma

Character	Meaning	Chinese		Japanese	
		Spelling	Pronunciation	Spelling	Pronunciation
軍	army, war	chün	jin	gun	goon
軍人	soldier	chün-jén	jin-run	gunjin	goon-jin
日本軍人	Japanese soldier	Jih-pén chün-jén	Jrr-bun jin-run	Nippon gun-jin	Nippawn goon-jin

JAPANESE ALPHABETS

Along with the use of Chinese characters the Japanese use two alphabets which are more or less phonetic: (1) *hira-gana*, which resembles handwriting; and (2) *kata-kana*, which corresponds to our printing and is used in writing foreign names, formal documents, telegrams, etc. The table following gives the *hira-gana*, under which is given the corresponding *kata-kana* and the equivalent in Roman letters. The columns are read in order beginning with the right: *a, i, u, e, o; ka, ki, ku, ke, ko*, etc.

	わ ワ wa	ら ラ ra	や ヤ ya	ま マ ma	は ハ ha	な ナ na	た タ ta	さ サ sa	か カ ka	あ ア a
	ゐ ヰ wi	り リ ri		み ミ mi	ひ ヒ hi	に ニ ni	ち チ chi	し シ shi	き キ ki	い イ i
ん ン n		る ル ru	ゆ ユ yu	む ム mu	ふ フ fu	ぬ ヌ nu	つ ツ tsu	す ス su	く ク ku	う ウ u
	ゑ ヱ we	れ レ re		め メ me	へ ヘ he	ね ネ ne	て テ te	せ セ se	け ケ ke	え エ e
	を ヲ wo	ろ ロ ro	よ ヨ yo	も モ mo	ほ ホ ho	の ノ no	と ト to	そ ソ so	こ コ ko	お オ o

Figure a

Another of the tabular presentations of *kata-kana* is shown in figure b.











	A	E	I	O	U	YA	YO	YU	WA
	ア	エ	イ	オ	ウ	/	/	/	/
B	バ	ベ	ビ	ボ	ブ	ビャ	ビョ	ビュ	/
D	ダ	デ	ヂ	ド	ヅ	ヂャ	ヂョ	ヂュ	/
G	ガ	ゲ	ギ	ゴ	グ	ギャ	ギョ	ギュ	グヅ
H	ハ	ヘ	ヒ	ホ	フ	ヒャ	ヒョ	ヒュ	/
K	カ	ケ	キ	コ	ク	キャ	キョ	キユ	クヅ
M	マ	メ	ミ	モ	ム	ミャ	ミョ	ミユ	/
N	ナ	ネ	ニ	ノ	ヌ	ニャ	ニョ	ニユ	/
P	パ	ペ	ピ	ポ	プ	ピャ	ピョ	ピュ	/
R	ラ	レ	リ	ロ	ル	リャ	リョ	リュ	/
S	サ	セ	シ	ソ	ス	シャ	ショ	シユ	/
T	タ	テ	チ	ト	ツ	チャ	チョ	チュ	/
W	ワ	ヱ	ヰ	ヲ	/	/	/	/	/
Y	ヤ	/	/	ヨ	ユ	/	/	/	/
Z	ザ	ゼ	ジ	ゾ	ズ	ジャ	ジョ	ジュ	/

N = ン











Figure b

Japanese words are written with Roman letters in many dictionaries. The most general system of Romanization has been secured through the efforts of the *Rōma-ji-kwai* (*ji* letter, *quai* association), and is called *rōmaji*. No accent is used by the Japanese. Each syllable is pronounced with the same tone.

Insignia of Rank—Commissioned Officers

<i>Insignia and Rank</i>	<i>Character</i>	<i>Insignia and Rank</i>	<i>Character</i>
 GENERAL Taisho (tie show)	大 將	 MAJOR Shosa (show sah)	小 佐
 LIEUTENANT GENERAL Chusho or Chujo (chew joe)	中 將	 CAPTAIN Taii (tie ee)	大 尉
 MAJOR GENERAL Shosho (show show)	小 將	 FIRST LIEUTENANT Chui (chew ee)	中 尉
 COLONEL Taisa (tie sah)	大 佐	 SECOND LIEUTENANT Shoi (show ee)	小 尉
 LIEUTENANT COLONEL Chusa (chew sah)	中 佐	 WARRANT OFFICER Junshikan (june she kahn)	准 士官

Insignia of Rank—Noncommissioned Officers

<i>Insignia and Rank</i>	<i>Character</i>	<i>Insignia and Rank</i>	<i>Character</i>
 SERGEANT MAJOR Socho (soh choh)	曹長	 PRIVATE 1st CLASS Ittosotsu (it toh sots)	一等卒
 SERGEANT Gunso (goon soh)	軍曹	 PRIVATE 2d CLASS Nitosotsu (knee toh sots)	二等卒
 CORPORAL Gocho (go choh)	伍長	 NON-COMMISSIONED OFFICER Kashi (kah she)	下士
 LANCE CORPORAL Gocho Kimmujotohei (go choh kim moo joe toh hay)	上等兵 伍長勤務	 SUPERIOR PRIVATE Jotohei (joh toh hay)	上等兵
 SUPERIOR PRIVATE Jotohei (joh toh hay)	上等兵	 ACTING CORPORAL Dairi-Gocho (die ree go choh)	代理伍長

UNITS

<i>Unit</i>	<i>Japanese Sign</i>	<i>Unit</i>	<i>Japanese Sign</i>
ARMY Gun (goon)	軍	COMPANY Chūtai (chew-tie)	中隊
CORPS Dan; tai; bu (dahn; tie; boo)	團隊部	PLATOON Shōtai (show-tie)	小隊
BRIGADE Ryodan (ryo-dahn)	旅團	SECTION Hanshōtai (hahn-show-tie)	半隊
DIVISION Shidan (she-dahn)	師團	SQUAD Buntai (boon-tie)	分隊
REGIMENT Rentai (ren-tie)	聯隊	SQUADRON (Air) Hikō chūtai (he-ko-chew-tie)	中飛行隊
BATTALION Daitai (dye-tie)	大隊	BATTERY Hōdai (hoh-dye)	砲臺

BRANCH OF SERVICE

<i>Branch</i>	<i>Japanese Sign</i>	<i>Branch</i>	<i>Japanese Sign</i>
CAVALRY Kihei (key hay)	騎兵	INFANTRY Hohei (ho hay)	歩兵
CHEMICAL WAR- FARE Kagakusembu (kah gahku sen boo)	化學戰部	MEDICAL CORPS Gun-i-dan (goon ee dahn)	軍醫團
COAST ARTILLERY Kaigan Hōhei (ki gahn hoh hay)	海岸砲兵	QUARTERMASTER CORPS Hokyūbu (ho kyu boo)	補給部
ENGINEERS Kōhei (koh hay)	工兵	SIGNAL CORPS Tsūshinhei (tsu shin hay)	通信兵
FIELD ARTILLERY Yasen Hōhei (ya sen hoh hay)	野戰砲兵	ORDNANCE Heiki (hay key)	兵器

EXPLANATION

<i>Japanese Alphabet</i>	<i>Chinese Character</i>	<i>Pronunciation</i>	<i>Explanation</i>	<i>Terms in English</i>
タイ	大	tie	big	General
シヨウ	將	show	command	
チユウ	中	chew	middle	Lieutenant General
ジョウ	將	joe	command	
シヨウ	小	show	small	Major General
シヨウ	將	show	command	
タイ	大	tie	big	Colonel
サ	佐	sah	help; assistance	
チユウ	中	chew	middle	Lieutenant Colonel
サ	佐	sah	help; assistance	
シヨウ	小	show	small	Major
サ	佐	sah	help; assistance	
タイ	大	tie	big	Captain
チ	尉	ee	to pacify; a company officer	

EXPLANATION

<i>Japanese Alphabet</i>	<i>Chinese Character</i>	<i>Pronunciation</i>	<i>Explanation</i>	<i>Terms in English</i>
チユウ	中	chew	middle	First Lieutenant
チ	尉	ee	to pacify; a company officer	
シヨウ	小	show	small	Second Lieutenant
チ	尉	ee	to pacify; a company officer	
ジユン	准	june	associate	Warrant Officer
シ	士	she	gentleman	
カン	官	kahn	government service	
ソウ	曹	soh	room; office	Sergeant Major
チヨウ	長	choh	headman	
ケン	軍	goon	army; war	Sergeant
ソウ	曹	soh	room; office	
ゴ	伍	go	group	Corporal
チヨウ	長	choh	headman	

EXPLANATION

<i>Japanese Alphabet</i>	<i>Chinese Character</i>	<i>Pronunciation</i>	<i>Explanation</i>	<i>Terms in English</i>
ゴ	伍	go	group	Lance Corporal
チヨウ	長	choh	headman	
キム	勤	kim	diligent	
ム	務	moo	serve	
ジョウ	上	joh	superior	
トウ	等	toh	grade	
ハイ	兵	hay	soldier	
カ	下	kah	inferior; lower; under	Noncommissioned Officer
シ	士	she	a figure; gentleman	
ダイ	代	die	a substitute	Acting Corporal
リ	理	ree	acting; act	
ゴ	伍	go	group	
チヨウ	長	choh	headman	

EXPLANATION

<i>Japanese Alphabet</i>	<i>Chinese Character</i>	<i>Pronunciation</i>	<i>Explanation</i>	<i>Terms in English</i>
ジョウ	上	joh	superior	Superior Private
トウ	等	toh	grade	
ハイ	兵	hay	soldier	
イチ	一	it	first	Private 1st Class
トウ	等	toh	grade	
ソツ	卒	sots	private	
ニ	二	knee	second	Private 2d Class
トウ	等	toh	grade	
ソツ	卒	sots	private	

EXPLANATION

<i>Japanese Alphabet</i>	<i>Chinese Character</i>	<i>Pronunciation</i>	<i>Explanation</i>	<i>Terms in English</i>
グン	軍	goon	army	Army
リョ	旅	ryo	troops under flag; travel	Brigade
ダン	團	dahn	body	
シ	師	she	pile up; large number	Division
タン	團	dahn	body	
レン	聯	ren	link; join	Regiment
タイ	隊	tie	unit	
ダイ	大	tie	big	Battalion
タイ	隊	tie	unit	
チュウ	中	chew	middle	Company
タイ	隊	tie	unit	
ショウ	小	show	small	Platoon
タイ	隊	tie	unit	

EXPLANATION

<i>Japanese Alphabet</i>	<i>Chinese Character</i>	<i>Pronunciation</i>	<i>Explanation</i>	<i>Terms in English</i>
ハ	半	hahn	half	Section
シ	小	show	small	
タイ	隊	tie	unit	
ブン	分	boon	divide	Squad
タイ	隊	tie	unit	
ヒ	飛	he	fly	Squadron
コウ	行	ko	go; away	
チュウ	中	chew	middle	
タイ	隊	tie	unit	
ホウ	砲	hoe	gun	Battery
ダイ	臺	die	watching place; a base	
キ	騎	key	mounted	Cavalry
ヘイ	兵	hay	soldier	

EXPLANATION

<i>Japanese Alphabet</i>	<i>Chinese Character</i>	<i>Pronunciation</i>	<i>Explanation</i>	<i>Terms in English</i>
カ	化	kah	change	Chemical Warfare
ガク	學	gahku	science; study; learn	
セン	戰	sen	fight	
ブ	部	boo	party	
カイ	海	ki	sea	Coast Artillery
ガン	岸	gahn	coast	
ホウ	砲	hoe	gun	
ハイ	兵	hay	soldier	
コウ	工	koe	skilled	Engineers
ハイ	兵	hay	soldier	
ヤ	野	ya	field	Field Artillery
セン	戰	sen	fight	
ホウ	砲	hoe	gun	
ハイ	兵	hay	soldier	

EXPLANATION

<i>Japanese Alphabet</i>	<i>Chinese Character</i>	<i>Pronunciation</i>	<i>Explanation</i>	<i>Terms in English</i>
ホ	歩	ho	foot	Infantry
ハイ	兵	hay	soldier	
ガン	軍	goon	army; war	Medical Corps
イ	醫	ee	heal; cure	
タン	團	dahn	body; party	
ホ	補	ho	supply	Quarter-master Corps
キウ	給	kyu	give	
ブ	部	boo	party	
ツウ	通	tsu	communicate	Signal Corps
シン	信	shin	message	
ハイ	兵	hay	soldier	
ハイ	兵	hay	soldier	Ordnance
キ	器	key	tool; weapon	

IDENTIFICATION OF JAPANESE

1. *General.* Most Americans say that it is difficult to distinguish the Japanese from the Chinese. The Japanese are aware of this confusion which exists in the minds of their enemies, and they have not hesitated to take advantage of it by posing as Chinese or native troops. It is therefore important that U. S. troops learn how to identify the Japanese. A few notes are included here to help in making quick identifications of the Japanese, but it must be remembered that none of the tests presented can be foolproof.

2. *Appearance.* The Japanese and Chinese differ in their physical appearances. The Japanese have very short legs, but their bodies are normal size. When seated, they appear to be of normal height, and you may therefore be surprised at their short stature when they stand up. You will find, however, that the Chinese are physically well formed and are about the same height as the average American. The Japanese have a light beard and thus need to shave only about twice a week. The Chinese

are even more fortunate, as their faces are free of beard and require no shaving. The eye of the Chinese is set much like that of the European but it has a marked squint, whereas the eye of the Japanese is set at a slant to the nose. The nose of the Chinese usually has a definite bridge, and his teeth are even and well formed. The Japanese teeth tend to "buck" or protrude, and the nose lacks a distinct bridge.

3. *Feet.*—The feet and legs of the Japanese differ greatly from those of the Chinese and other orientals. Practically all the Japanese are pigeon-toed and many are bow-legged, so that in walking they usually shuffle along. In no Chinese, and in no other native of the Far East except the Japanese, will be found the characteristic wide spreading of the big toe or the extreme hardening of flesh between the big and second toes. In the case of many Japanese, this hardening amounts to a callus. This condition results from the wearing of the "geta," or wooden sandals, and the constant pressure of the heavy thong that is the method of securing the "geta" to the foot.

4. *Pronunciation.*—The Japanese, excepting some of the officer class, have speech difficulties. These may invariably be discovered by a pronunciation test. Request the subject to repeat this, or a similar test phrase:

“Smit” ft t, Japanese pronounce an “s” or “z” without a definite inward inhalation that amounts to a hiss; rarely can a Japanese begin any sentence without this “inward” tone. The liquid “l” sound does not exist in Japanese. Consequently, the questioner would hear this phrase from the Japanese: “(hiss) Smit reft the fortress,” and a Chinese would say: “Smith left the faultless.” Thus the Chinese will say “lice” for “rice,” and the Japanese will say “rice” for “lice.” These differences are inherent in the native languages. “Th” is difficult too for Japanese to pronounce. For “think” they say “sink” or “shink.” Too many consonants together will cause a break for a vowel.

5. *Caution.*—The Japanese wear a piece of clothing which resembles a long towel. This long towel, fundoshi (foon-doh-shee), is wrapped around the waist and between the legs. It resembles a G string but it consists of many folds in which a Japanese prisoner will be able to hide many things. Japanese prisoners will strenuously object to removing this G string, but the personal safety of your entire command may depend upon it. Have the prisoners remove their G strings while keeping them covered with rifles. Have them step away, and then examine the G strings for papers, weapons, and other articles which may be hidden in the folds and pockets.

EQUIPMENT TAKEN FROM JAPANESE SNIPERS BY U. S. TROOPS IN THE PHILIPPINES

- A gas mask.
- A green combination mosquito-net camouflage hood covering his helmet, head, and shoulders.
- A green corded net to camouflage the rest of his body and a black wire eye-screen to protect him from sun glare.
- A coil of rope for miscellaneous uses.
- A 5-inch-long sack of rice.
- A small bag of hardtack.
- A half pound of hard candy.
- A package of concentrated food.
- A can of field rations.
- A small can of coffee and vitamin pills.
- A can of chlorine to purify water.
- A mess kit.
- A canteen.
- An antidote for mustard gas.
- Quinine.
- Stomach pills.
- Gauze pads.
- Roll and triangular bandages.
- Spare socks.
- A toothbrush and a flashlight.
- A half-dozen spare lenses for the eyeholes of the gas mask, some usable in zero and subzero weather.
- Medical supplies packed in a nest of wicker baskets.

(This equipment has enabled each man to fight independently for from 2 weeks to a month, obtaining a minimum of food and water from the countryside.)