





MANUFACTURE  
OF  
ARTILLERY AMMUNITION

# McGraw-Hill Book Company

*Publishers of Books for*

Electrical World	The Engineering and Mining Journal
Engineering Record	Engineering News
Railway Age Gazette	American Machinist
Signal Engineer	American Engineer
Electric Railway Journal	Coal Age
Metallurgical and Chemical Engineering	Power

# MANUFACTURE OF ARTILLERY AMMUNITION

BY MEMBERS OF THE EDITORIAL  
STAFF OF THE AMERICAN MACHINIST

L. P. ALFORD, EDITOR-IN-CHIEF

F. H. COLVIN

E. A. SUVERKROP

ROBERT MAWSON

JOHN H. VAN DEVENTER

FIRST EDITION

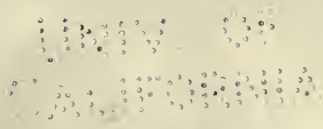

McGRAW-HILL BOOK COMPANY, INC.  
239 WEST 39TH STREET. NEW YORK

LONDON: HILL PUBLISHING CO., LTD.  
6 & 8 BOUVERIE ST., E. C.

1917

UF 760  
A4

COPYRIGHT, 1917, BY THE  
MCGRAW-HILL BOOK COMPANY, INC.

THE  
MCGRAW-HILL  
BOOK COMPANY



L. C.

## FOREWORD

BY HOWARD E. COFFIN

Member, Naval Consulting Board of the United States, and Chairman of its Committee on Industrial Preparedness; Member, Advisory Commission of the Council of National Defence. Vice-President, Hudson Motor Car Co.

Our vital national need for a text-book dealing with the quantity manufacture of army and navy materials should require little either by way of explanation or comment. Two years of experience on orders for foreign governments have taught our American manufacturers that the making of materials of modern warfare is a new art. It is an art with which we have had little or no previous experience and in which our workmen are unskilled.

In England, a little over two years ago there were not more than three government arsenals. Today more than four thousand of England's leading industrial plants are being operated as government factories for the production of war materials, and many other thousands of factories still under private control are concentrating their energies in the same direction. The teaching of the munition-making art to these thousands of manufacturers and to millions of industrial workers, both men and women, has called for a work in industrial organization and education such as the world has never before seen. In France, in Germany, in Italy, in Japan, and even in Russia, this same education and organization of the industrial forces is going forward.

We have here in the United States vast resources in manufacturing and producing equipment, but they are unorganized and uneducated for the national service. Our observations of the European war have taught us that it is upon organized industry that we must base any and every plan of military defence, and that in the event of trouble with any one of the several first-class powers, between eighty and ninety per cent. of our industrial activity would, of necessity, be centered upon the making of supplies for the government. We have learned also that from one to two years of time and of conscientious effort are needed to permit any large manufacturing establishment to change over from its usual peace time commercial line to the quantity-production of war materials for which it has had no previous training. Delays of this kind, in time of

emergency, cannot but result in closed plants, in the disruption of labor organizations built up over a period of years, in a loss of skilled men through enlistment for the fighting front, and in those same chaotic conditions which wrought near disasters to several of the nations at the outbreak of the European struggle.

We have had no experience in the kind of warfare now being waged abroad, and yet this is exactly the sort of thing for which we must prepare, or it is worse than useless that we prepare at all. Industrial preparedness is strictly in keeping with the natural tendencies and abilities of our people. It is the basic and at the same time the cheapest form of preparedness. We have already the investments in plants, in tools and in machinery, and more important still are our resources in skilled workers. But it is only through the most careful methods of organization and education that we may make all these resources available to us in time of emergency. Each manufacturing plant must be taught in time of peace to make that particular part or thing for which its equipment is best suited and for which, by a carefully prepared classification, it is to be held accountable in time of war. Annual educational orders, of such small sizes as not to interfere with commercial products, must be delivered each year under government inspection. There exists no other method of harnessing industry in the defensive service of this government. Every manufacturing institution in the country carries fire insurance; for the future it must demand war insurance as well.

An up-to-date text-book, dealing with munitions work, will be found indispensable in this educational campaign. We have heard much of the difficulties that American manufacturers have experienced in getting out foreign war orders. Months of experimentation, argument and delay have resulted because of the lack of proper information as to the tools, processes and methods involved in the quantity-production of such materials. Fortunately for us, we have not been one of the principals involved in the European struggle, and however costly failure in delivery may have been to individual manufacturers, it has not produced a national calamity.

The work of the Naval Consulting Board involves three steps: First, an inventory of the country's manufacturing and producing resources;\*

\*Under the Committee on Industrial Preparedness, many thousands of patriotic American engineers have devoted time and money in an inventory of the more than thirty thousand manufacturing institutions in this country doing a business in excess of one hundred thousand dollars per year.

The American Society of Civil Engineers, the American Institute of Mining Engineers, the American Society of Mechanical Engineers, the American Institute of Electrical Engineers, and the American Chemical Society, having a combined membership of more than thirty-five thousand, have co-operated in this work through state and territorial directorates of five men each. These directors, two hundred and fifty in all, have served at the request of the Secretary of the Navy as associate members of the Naval Consulting Board

second, the training and education of these resources for a national service both in peace and in war; third, the enlistment of the skilled laborer of the country in an industrial reserve which shall keep the trained worker in his place in the factory, the mill or the mine, and prevent his loss through enrollment in the fighting army. It is in the second step in this program, that the text-book of munition manufacture will prove invaluable. In the event of any future war in this country, the munition industry must become our one great national industry.

The work accomplished by the Committee on Industrial Preparedness of the Naval Consulting Board, has now been turned over to the newly created governmental body, known as the Council of National Defence. It is under the auspices of this Council that the education and organization of our resources for national emergency service will be carried forward. It is by this body that the text-book of munition-making will be put into the service of the nation.

Too much credit for this vitally important work cannot be given to Mr. L. P. Alford, Editor-in-Chief of the *American Machinist*, and to his corps of efficient workers who have coöperated so largely with the Committee on Industrial Preparedness. To him and to his staff is due the patriotic initiative, which has given to us in permanent form a record of the invaluable experience gained by our manufacturers in the filling of foreign munition orders.

---

The personnel of the Committee on Industrial Preparedness, which created and directed this nation-wide patriotic activity, is as follows: HOWARD E. COFFIN, Chairman; WM. L. SAUNDERS, THOMAS ROBINS, LAWRENCE ADDICKS, W. L. EMMET, B. G. LAMME, BENJAMIN B. THAYER.



## PREFACE

"Manufacture of Artillery Ammunition" has been written to preserve in permanent form a record of some of the great work done in United States and Canadian machine shops in producing munitions for the belligerent nations of Europe. Much, though not all, of the information in its four sections has previously appeared in the *American Machinist*. All of the matter has been especially prepared for the book to make the treatment uniform and consistent.

Two major purposes have been before the authors in writing this record of one of the sensational periods of the history of American machine shops. Never before have modern munitions of war been produced on this continent in large quantities. Never before have our machine shops been called upon to turn out such an enormous volume of new products in such a short time. A record should be preserved of this work to aid Americans in producing their own munitions of war if occasion should ever arise, and to show the excellent machining methods, machines, tools and appliances that have a much wider application in manufacturing than merely to make shells, cartridge cases and fuses. Such is the two-fold purpose that has brought this book into being—to aid in making munitions; to further machine-shop practice.

The material naturally divides into four sections: Shrapnel, high-explosive shells, cartridge cases and fuses. In each, manufacturing methods are shown on a variety of sizes. The range for shrapnel is from 3 in. to 12 in.; for explosive shells from the 1-pounder to the 12 in.; for cartridge cases from the 1-pounder to the 4.5 in.; while the fuse section includes combination fuses, detonators and primers. Several appendices contain associate information, of which one part deals with machine tools and outlines some of the steps that might be taken for their control by the United States authorities in the emergency of war.

One of the important features of the book is the giving of production data, operation by operation, for each kind and size of ammunition whose manufacture is shown. It is believed that no other book has ever been written in any branch of the great machine-shop industry that gives such complete information on times and quantities of production.

The authors are glad to express their appreciation of the kindness of all the Canadian and United States manufacturers who opened their plants and made the collection of material possible. They also acknowledge their indebtedness to a few contributors to the *American Machinist*, whose articles have been incorporated in the book. And, finally, much

credit for whatever excellence of presentation the book may possess is due to Mr. Reginald Trautschold. It was his industry that shaped the previously published material, collected additional information, and fitted all together into a consistent whole.

THE AUTHORS.

NEW YORK CITY.

*January, 1917.*

# CONTENTS

	PAGE
FOREWORD . . . . .	v
PREFACE . . . . .	ix

## SECTION I

### SHRAPNEL

CHAPTER		
I.	What a Shrapnel Is and Does—The French 75-mm. Shrapnel . . . . .	3
II.	Forging the Blanks for 18-Lb. British Shrapnel—Forging 3.3 Shrapnel Blanks on Steam Hammers and Bulldozers. . . . .	8
III.	Making the 18-Lb. British Shrapnel—The Double-Spindle Flat Turret and the 18-Lb. British Shrapnel . . . . .	31
IV.	The Powder Cups for 18-Lb. British Shrapnel—Punching Steel Disks for British Shrapnel Shells—The Manufacture of 18-Lb. Shrapnel Shell Sockets and Plugs—From Birch Log to Fuse Plug . . . . .	66
V.	Three Inch Russian Shrapnel—Making 3-In. Russian Shrapnel in a Pump Shop . . . . .	83
VI.	Manufacturing 12-In. Russian Shrapnel . . . . .	146
VII.	Making Shells with Regular Shop Equipment—Manufacturing Shrapnel Parts on Automatic Machines—Automatic Production of Shrapnel Parts—A Bridge Shop Transformed into an Arsenal . . . . .	183

## SECTION II

### HIGH-EXPLOSIVE SHELLS

I.	What a High-Explosive Shell Is and Does—Explosives Used with High-Explosive Shells—Steel for High-Explosive Shells . . . . .	231
II.	Casting Steel Forging Blanks for 4.5-In. Explosive Shells—Forging the Blanks for 4.5-In. High-Explosive Shells—Forging Base-Plates for High-Explosive Shells . . . . .	236
III.	Manufacturing British 18-Pounder High-Explosive Shells . . . . .	251
IV.	Manufacturing British 4.5-In. High-Explosive Shells . . . . .	312
V.	Manufacturing British 8-In. High-Explosive Shells . . . . .	366
VI.	Operations on the British 9.2-In. Mark IX Howitzer Shell . . . . .	389
VII.	Operations on the British 12-In. Mark IV Howitzer Shell . . . . .	399
VIII.	Manufacturing the Russian 1-Lb. High-Explosive Shell . . . . .	412
IX.	Manufacturing Russian 3-In. High-Explosive Shells . . . . .	442
X.	Manufacturing 120-Millimeter Serbian Shells . . . . .	460
XI.	Manufacturing French 120-Millimeter Explosive Shells . . . . .	494

## SECTION III

### CARTRIDGE CASES

I.	Manufacture of Cartridge Brass—Rolling Cartridge Brass . . . . .	517
II.	Making 1-Lb. Cartridge Cases . . . . .	536

CHAPTER	PAGE
III. Making the 18-Lb. Cartridge Case—Drawing 18-Lb. Cartridge Cases on Bulldozers and Frog Planers—Cartridge Heading Presses and Accumulators at the Angus Shops . . . . .	555
IV. Making the 4.5-In. Howitzer Cartridge Case . . . . .	595

## SECTION IV

## FUSES AND PRIMERS

I. The Detonator Fuse—Making the British Detonator Mark-100—Making Adapters for British Detonator Fuse . . . . .	623
II. Making the British Time Fuse Mark 80-44—Caps and Base Plugs for Time Fuse—Making the Small Parts of the British Time Fuse . . . .	660
III. Making Primers for Cartridge Cases—Loading the Primers . . . . .	705

## APPENDIX

Machine Tools for Munition Manufacture—Composition and Properties of Shell Steel—Light Shells—Details of Some Shrapnels—Details of Some High-Explosive Shells—British Requirements for Projectile Inspection—British Prices for Hand Painting Shells—Diameter of British Shells Over Paint—Weights and Dimensions of Some British Shells—Temperatures and Duration of Heat Treatment for British Shells. . . . .	729
INDEX . . . . .	761



SECTION I  
SHRAPNEL

By

JOHN H. VAN DEVENTER

	Page
CHAPTER I. WHAT A SHRAPNEL IS AND DOES.....	3
CHAPTER II. FORGING SHRAPNEL BLANKS.....	8
CHAPTER III. MAKING THE 18-LB. BRITISH SHRAPNEL.....	31
CHAPTER IV. POWDER CUPS, DISKS, SOCKETS AND PLUGS FOR 18-LB. BRITISH SHRAPNEL.....	66
CHAPTER V. MAKING 3-IN. RUSSIAN SHRAPNEL.....	83
CHAPTER VI. MANUFACTURING 12-IN. RUSSIAN SHRAPNEL.....	146
CHAPTER VII. MAKING SHELLS WITH REGULAR SHOP EQUIPMENT.....	183

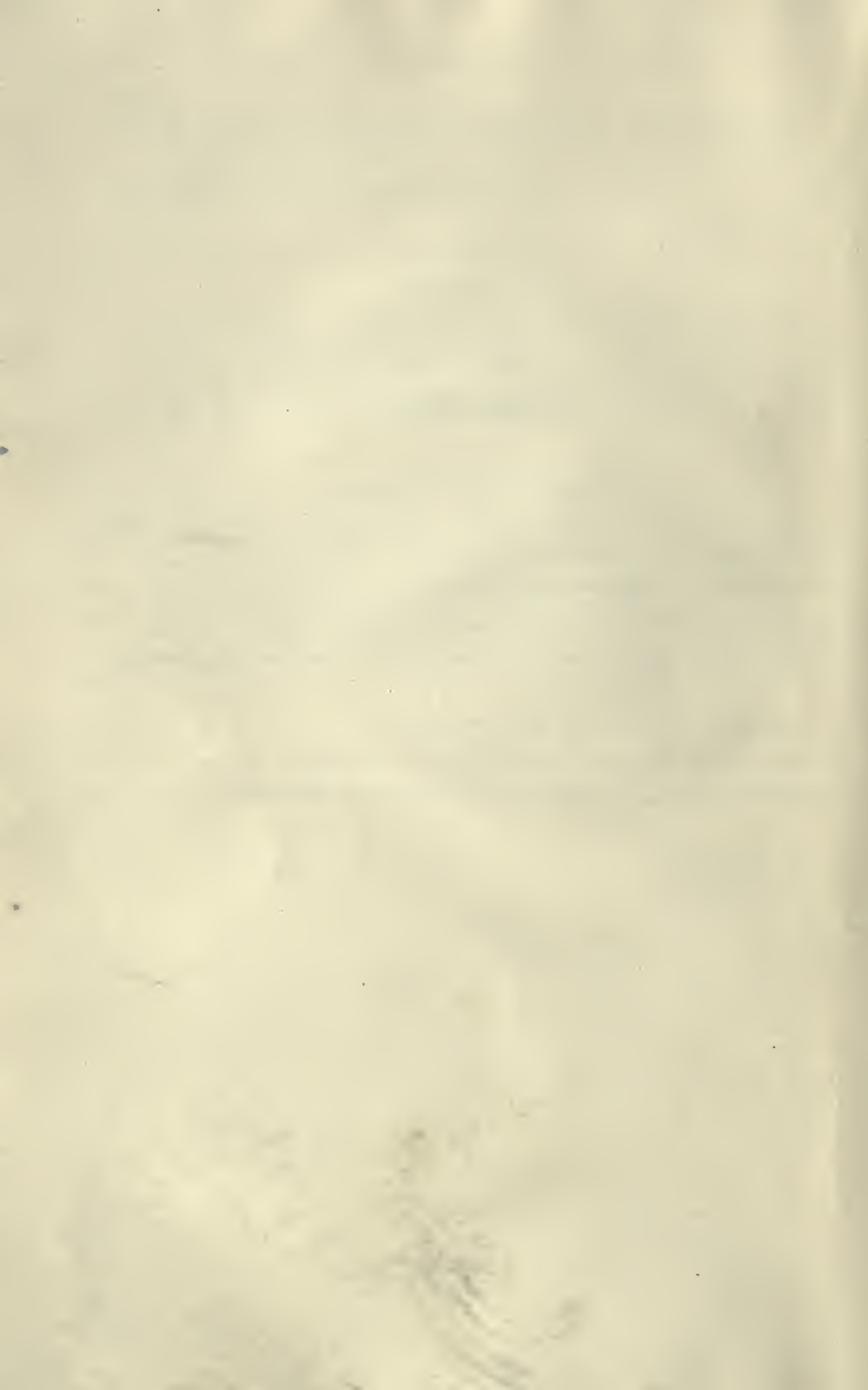

# MANUFACTURE OF ARTILLERY AMMUNITION

## CHAPTER I

### WHAT A SHRAPNEL IS AND DOES<sup>1</sup>—THE FRENCH 75-MM. SHRAPNEL

Shrapnel, because its explosion may be timed to a nicety, its rain of shot scattered at just the right instant, has proved one of the most effective tools of destruction in modern trench storming and defence. The shells of the various nations vary somewhat in shape and proportions, but their general construction is quite similar.

Fig. 1 shows a shrapnel shell casing such as has been extensively used in the great European war. These shells are manufactured in sizes from 2 to 15 inches in diameter.

The brass shell *A* that envelops the outside of the shrapnel casing is filled with powder, which is carefully measured to have the exact amount in each shell. This powder is ignited similarly to a cartridge in a gun and is intended to discharge the shell from the gun.

At *B* is a powder pocket which contains the necessary amount of powder to explode the casing and scatter the charge.

A copper band, which is shrunk and also hydraulically pressed over the body of the shell, is shown at *C*. The outside diameter is turned somewhat larger than the gun bore, which is rifled or grooved in a spiral through its entire length.

When the shell is placed in the gun, the breech end admits it freely, but the gun bore being somewhat smaller and the copper being soft material, it is compressed and a portion of the copper ring sinks into these spiral grooves. Thus, when a shell is fired it has a rotary motion corresponding to the spiral of the gun, which means that the shrapnel is revolving at the same time it is traveling longitudinally. The rotary motion is so rapid that it keeps the shrapnel in practically a straight line laterally in its flight. If the gun did not have spiral grooves, when the shrapnel started to travel it would swerve against the resistance of the air, which would make it impossible to determine in what position it would explode. In other words, a smooth-bored gun and a smooth-surface shrapnel could not be depended upon for accuracy, and no scientific calculations could be made whereby shrapnel fired one after another would land in about the same place.

<sup>1</sup> J. P. Brophy, Vice-President and General Manager, Cleveland Automatic Machine Co.

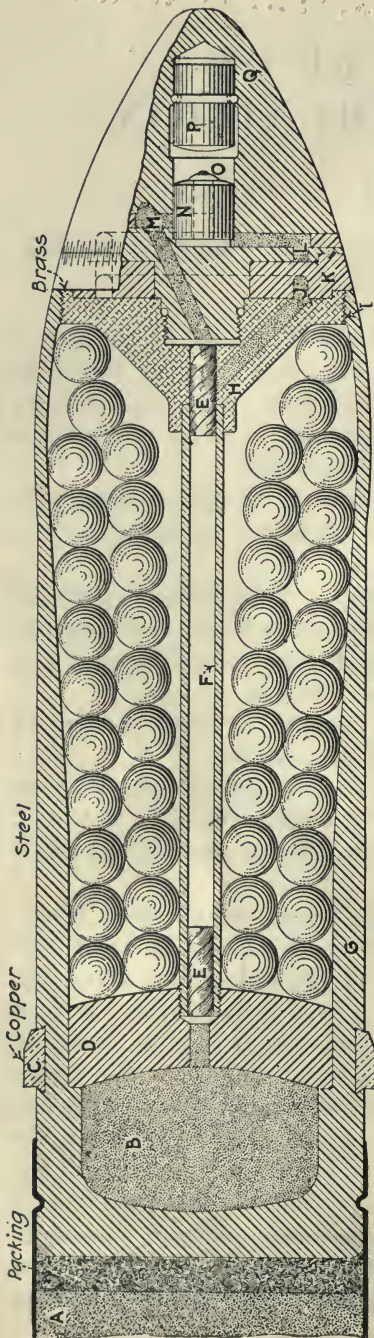

FIG. 1. CROSS-SECTION OF A COMMON SHRAPNEL

From this explanation it will be understood that the piece *C* is an important part of the shrapnel.

**Details of Design.**—A steel washer, which is pressed in position, is shown at *D* separating the powder pocket from the chamber of the shrapnel proper. This is commonly called “the diaphragm.”

A copper tube connecting the powder pocket *B* with the fuse body *H* is shown at *F*. This contains an igniting charge of gun cotton *E* at either end.

The shell casing is shown at *G*, the fuse body at *H* and a powder passage *J* is shown at an angle connecting with the gun cotton.

The threaded connection between fuse and shrapnel bodies at *I* is of fine pitch, so that when the powder is ignited at *B* the threads strip, allowing the balls to be discharged. After the powder is ignited, if the pressure is not great enough to destroy the thread, the shell casing will burst at the end, which is its weakest point, and open up in umbrella shape, the balls and body of the shell being driven with great force in all directions similar to the explosion of a skyrocket. This is very destructive within a radius of 60 ft. from where the explosion occurs.

**The Timing Device.**—The time ring, graduated on its periphery, is shown at *K*. This controls the time of igniting the fuse *J*. When the time ring is set to zero the shell explodes just after it leaves the muzzle. The graduations indicate the explosion time at practically any

number of feet desired up to the full range of the gun. On the inside of the graduated ring *K* a small opening is milled for about three-

fourths of a circle, so that the fuse cannot burn all way around. In this small opening the time fuse is placed, and at the bottom of the ring are small holes.

A loose piece *N* moves freely and carries at *O* an ignitable and highly explosive substance, which is so sensitive that if one drop were struck with a lead pencil held in the hand, it would shatter the end of the pencil before it could be withdrawn.

When the gun is in position, the range finder immediately estimates the distance to the enemy, and this information is given the gunners. The ring *K* is moved to the position which indicates the number of yards the shrapnel will travel after leaving the gun before it explodes. This is all taken care of in a few moments. The fuse on the inside of ring *K*, when ignited, burns in the direction that leads to the powder passage *J*, and the time taken to reach this determines the distance that the shrapnel will travel before exploding.

When the powder at *J* commences to burn, it ignites the gun cotton at *E*, and the flame passes through the tube *F* to the gun cotton at the opposite end, igniting the powder at *B*. The time taken by the flame to travel from *J* to *B* is difficult to estimate because of its rapidity, but may be compared to the speed of electric current.

**How the Fuse is Ignited.**—A piece called a “free-moving slug” is shown at *P*. The moment the gun is fired, the shrapnel travels with such great rapidity that it causes this moving slug to rebound and come in contact with *O*. The ignitable substance at *O* creates a flash, which burns back and around the chamber to the powder *L*, which leads to the fuse embedded in the face of the graduated ring *K*. The time, reckoned in fractions of seconds, that it takes to burn the fuse in the ring *K* before it reaches the powder *J* is calculated according to the distance the shell travels in flight before the charge is to be ignited at *B*.

If the shrapnel fails to explode at the correct distance because of the slug *P* not responding, then at the moment it comes in contact with anything in its path the sudden impact will carry forward the loose piece *N*, which is free to oscillate. This will mean a contact of the ignitable substance at *O* with the piece *P*. Ignition immediately takes place, and as piece *N* is in the forward position, the flame will travel in the direction of *M*. This action reverses the direction of the flash, as already explained. This means direct ignition through the powder passage *M* to the powder pocket *B* at lightning speed. The consequence is an instantaneous explosion of the shell at the moment it comes in contact with any object in its path, and extreme destruction at this point.

**Refinements of Destruction.**—The outside shape of the fuse body *O* is such as to offer the least resistance; in other words, it breaks up the air as it bores its way through. If this nose were longer or shorter,

or a different shape, it would offer greater resistance, which would lessen both its speed and its range.

The muzzle velocity of the 3-in. shrapnel shell, which is being used so extensively abroad, varies from 1,500 to 1,900 ft. per sec. during the first second of flight, and because of the air resistance, diminishes in speed gradually through the remaining distance that it travels. The maximum effective range is about 6,000 yd., and as the time fuse can be set to explode at 100 yd. or less, and at any point up to 6,000 yd., the time it would take to travel 100 yd. would be about one-sixth second.

The balls are placed in the position shown and a special wax is melted and poured around them so that they are practically a solid mass. The destruction which takes place when these balls, traveling at great velocity, spread in the midst of hundreds of human beings can easily be imagined.

**The French 75-mm. Shrapnel.**—The shrapnel used in the celebrated 75-mm. French field guns differs in certain details from the shrapnel used by the British and American armies. No powder cap is used (see Fig. 2) and a nose containing balls is fitted in place of the timer. The fuse is screwed into this nose, the thread to receive it being shown in the illustration. A feature of this loaded nose is the wooden holder that

carries the lead balls. These are composed of 90 parts lead and 10 parts antimony.

The space for the powder charge in the base of the shell is varnished on

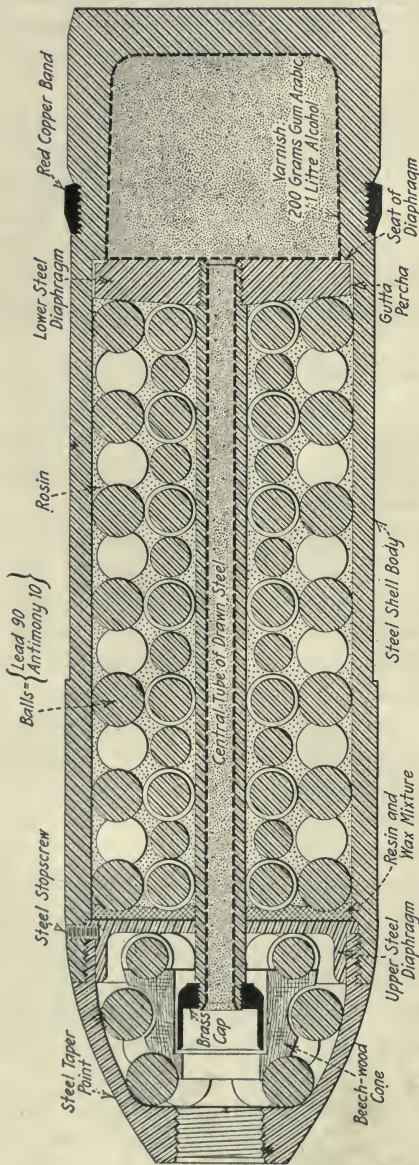

FIG. 2. FRENCH 75-MM. SHRAPNEL

all surfaces with a varnish composed of 200 grams of gum arabic cut in one liter of alcohol. This coating is also applied to the lower surfaces of the lower steel diaphragm. This diaphragm is seated in a packing of rubber to make a sealed joint.

Another point of difference between the British and French construction is the method of keying the copper band. The British design calls for cutting a series of waves or drunken threads, around which the dead soft copper band is swaged. The French construction merely cuts a series of V-grooves into which the band is compressed.

## CHAPTER II

### FORGING THE BLANKS FOR 18-LB. BRITISH SHRAPNEL<sup>1</sup>— FORGING 3.3 SHRAPNEL BLANKS ON STEAM HAMMERS AND BULLDOZERS<sup>1</sup>

The Montreal Locomotive Co., Montreal, Canada, when confronted with the task of forging shell blanks for 18-lb. British shrapnel put every piece of equipment to work and in a remarkably short time were able to turn out an average of 3,000 completed blanks every 24 hr. These blanks were forged from 0.50 carbon steel and the allowable error on surfaces not subsequently machined was only 0.01 in. The bar stock steel blocks were heated and in only two operations squirted and drawn into shrapnel blanks. This record was maintained for months, notwithstanding the rigid inspection and tests demanded by the British Government, and a detailed description of the processes in vogue in the shops of the Montreal Locomotive Co. is one of a standard of efficiency in manufacture.

The steel for the forgings come in commercial bars, 10 to 12 ft. in length, the specifications for which call for 0.45 to 0.55 carbon, 0.70 manganese and less than 0.04 sulphur and phosphorus. These bars are stamped by the steel mill to indicate the "melt" from which they were made and test pieces from each "melt" are analyzed and broken by the Canadian Inspection Co. Three bars are then selected from each "melt" by the Montreal Locomotive Co.'s chemist and two pieces cut from each bar, one of which is again analyzed and the other made into a "test" shell and given the heat treatment. The "test" shells are then carefully tested for tensile strength, etc., and if satisfactory in *all respects* the rest of the bars from the "melt" are cut to the standard length for shell-forging blanks, the blanks from each "melt" being kept together throughout manufacture.

**Cutting the Bars.**—Four methods of cutting the commercial bars into standard  $4\frac{7}{8}$ -in. lengths for the shell blanks were employed, which are of interest as examples of rapid and accurate production. Fig. 3 shows a large Gorton cold-saw cutting four blanks at a pass. The bars *A* are held between the soft-wood clamps *B*, which are shaped to bring the bars to the same circle as the saw, thus reducing the travel and time of cutting to a minimum. Hardwood was tried at first, but did not grip the bars securely. On this machine 250 blanks can be cut in 10 hr.

<sup>1</sup> E. A. Suverkrop, Associate Editor, *American Machinist*.



The clamps to the extreme right are not loosened until the bars are too short to handle in the saw, thus avoiding a lot of unnecessary adjusting of the individual bars.

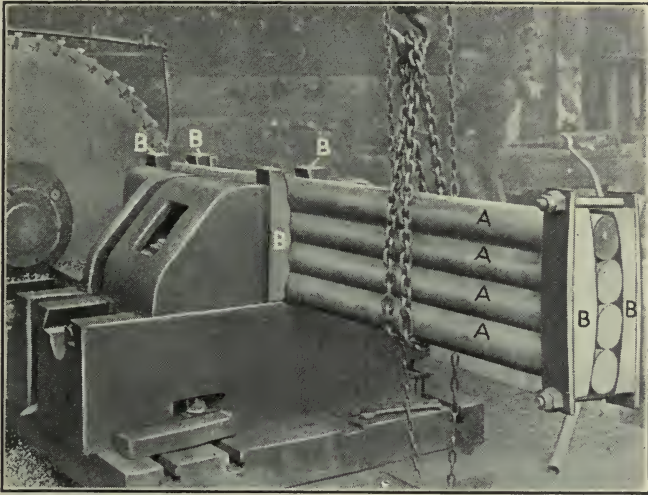

FIG. 3. CUTTING BLANKS ON A GORTON COLD-SAW

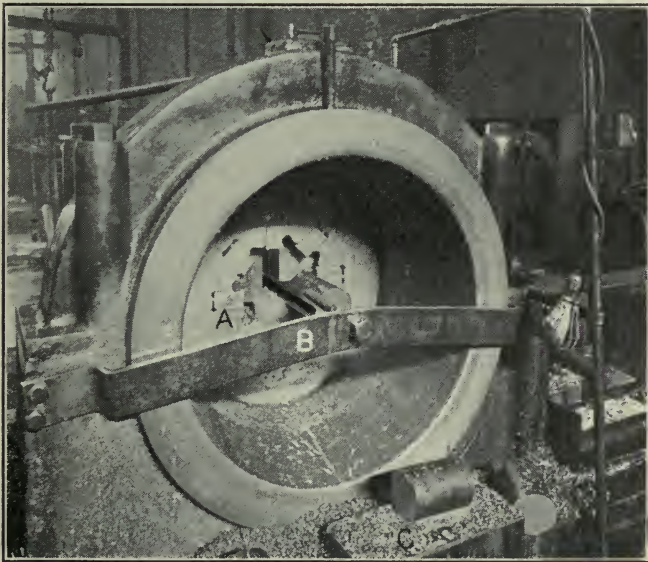

FIG. 4. NEWTON COLD-SAW

In Fig. 4 is shown a Newton saw on the same work. This saw has a capacity of 190 blanks in 10 hr. The stop A was at first secured to a

bracket attached to *C*. When thus attached, its position with regard to the work was stationary and trouble was encountered with the nearly severed blank jamming between the stop and the saw and breaking out the teeth. With the bracket *B* secured as shown to the saw housing, the stop *A* is in contact with the end of the bar only when the saw is out of contact with the work. During the cut it is entirely out of contact, and at completion of the cut the blank is free to drop clear of saw and stop.

In Fig. 5 is shown a turret lathe used for cutting blanks. On the machine shown 256 blanks can be cut in 10 hr.

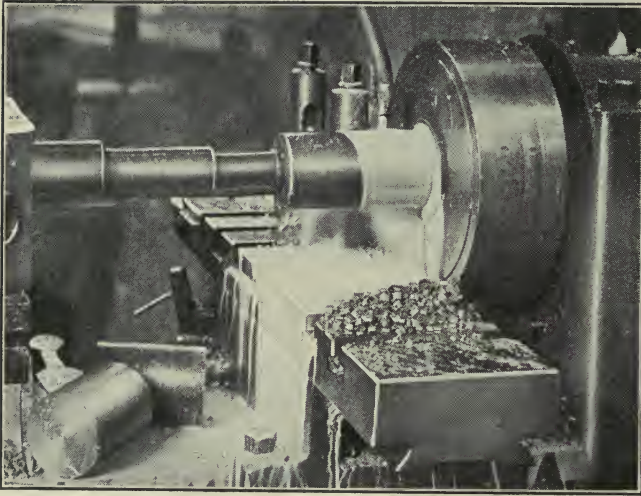

FIG. 5. CUTTING BLANKS ON TURRET

In Fig. 6 is shown the cutting of blanks on a large planer. The bars are held down by ordinary strap clamps and spacers are placed between them. Special holding devices for tools and work are in course of construction, whereby the output by this method will be from 400 to 600 blanks per day. Two tools are used in each head. The outer tools on each side are about  $\frac{3}{4}$  in. in advance of the inner tools so as to leave enough metal to resist the bending stresses. With all these methods ordinary cutting compound is used as a lubricant.

**Removing the Burr.**—A burr is left on all blanks except those which are cut while the bar rotates. This must be removed. The removal is a simple job with a pneumatic chisel, but the method of holding the work is worth showing. The machine steel block *A*, Fig. 7, secured to the bench is about  $3\frac{1}{2}$  in. high, 6 in. wide and 20 in. long, and weighs about 100 lb. The blank *B* is gripped by a  $\frac{7}{8}$ -in. setscrew operated by a long crank handle *C*. The inertia of this heavy block steadies the work

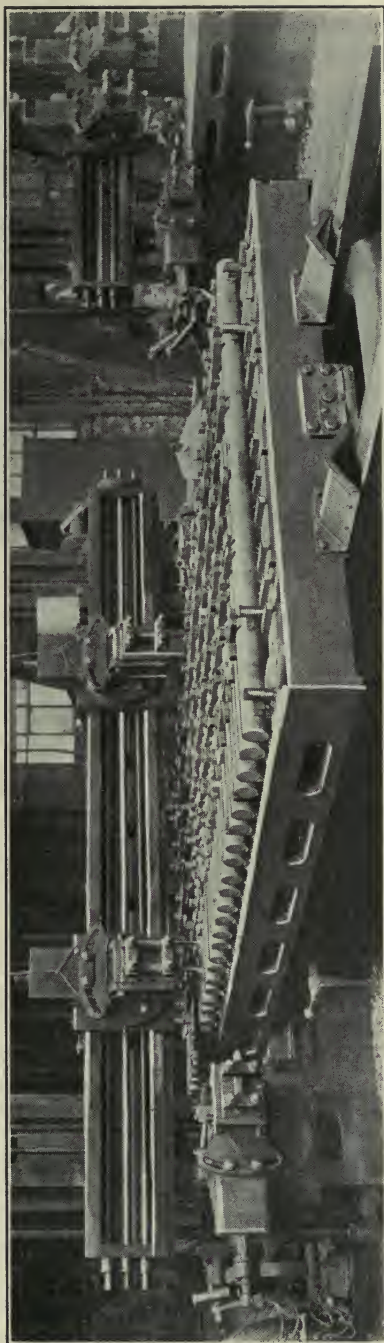

FIG. 6. CUTTING BLANKS ON THE PLANER

and makes cutting an easy matter. The crank handle is quickly operated. One operator can easily remove the burrs from all the blanks.

**Forging.**—Forging was undertaken on a large flanging press, on a



FIG. 7. REMOVING BURRS

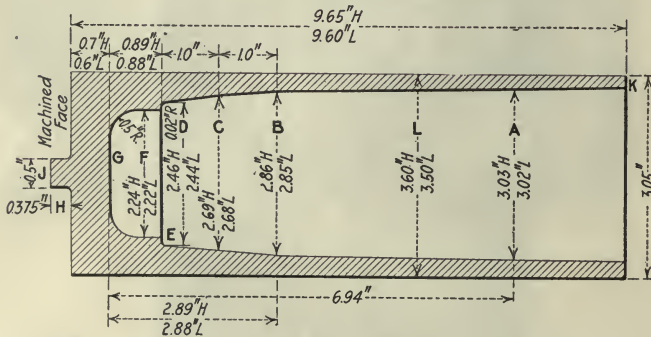

FIG. 8. SHRAPNEL SHELL  
(Dimensions in Inches)

(1) Dimensions "A," "B" and "C" are the finished internal sizes of shell. (2) At "D" this dimension allows material for machining equal to 0.05 in. per side. (3) The material on inside wall allowed for machining from "C" to "D" tapers from 0.0 to 0.05 in. per side. (4) At the shoulder "E" on which disk rests material 0.1 in. is allowed for machining. (5) At "F" material is allowed for machining equal to 0.05 in. per side. (6) At "G" material is allowed for machining equal to 0.05 in. Care must be taken to remove all scale from this part. (7) Face "H" to be machined by forging manufacturers. (8) Projection "J" to be left as shown on base unless otherwise specified when forgings are ordered. (9) Face "K" to be machined by forging manufacturers to dimensions given. (10) Dimension "L" allows for machining, but this should not exceed 3.55 or 3.50 in. (11) Inside finish of forgings from mouth of shell at face "K" to dimension "C" to be smooth and free from scale, projections, irregularities and other blemishes. The body must also be straight.

bulldozer and on drop presses and it is of interest to note that the dimensions and limits shown on Fig. 8 were maintained by workmen who had previously forged only locomotive frames and had never before been called

upon to work to hundredths of an inch. The metal was worked hot which further complicated matters by necessitating allowances for shrinkage, and finally both the shop and the Government inspectors rejected any work which did not rigidly meet specifications.

**First Forging Operation.**—The cut-off blanks are charged into ordinary reverberatory furnaces, of which there are two for each press. The furnaces are fired with oil at 25-lb. pressure and air at 7 oz. Each press is equipped with two sets of punches and dies, as shown in Fig. 9. The punches are made of 0.70 carbon steel, finished all over and hardened but

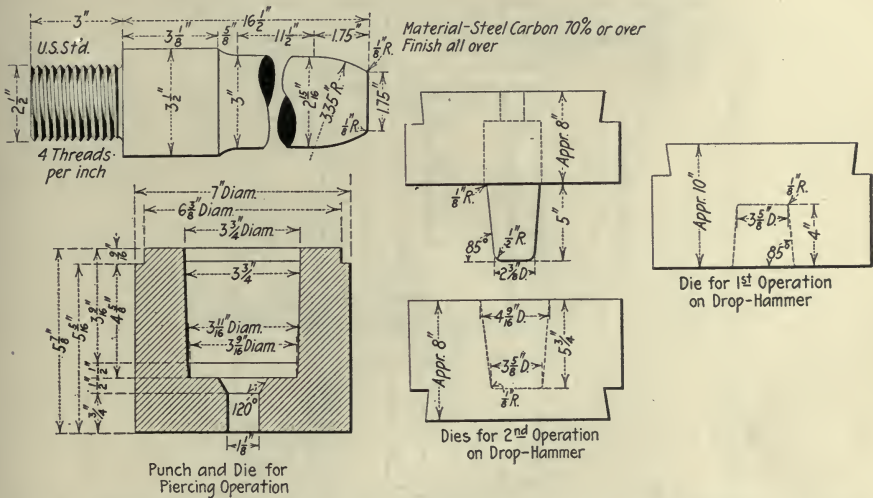

FIG. 9. PUNCHES AND DIES FOR FIRST FORGING OPERATION ON PRESSES AND DROP HAMMERS

not drawn. The dies are made of 0.70 carbon steel or chilled iron. It has been found that new punches and dies have a tendency to stick to the work unless they are first heated.

The work of adapting the large flanging press and bulldozer to shell forging was taken care of by Robert Allison, works engineer, and while these two machines are now employed for the second operation, a description of the fixtures applied to them will not be out of place. In Fig. 10 is shown the fixture for the flanging press. With the exception of the punches and dies, which are for the second, or drawing, operation on the shell blanks, the fixture is the same as used for the first operation.

The flanging press is 155 tons capacity with a stroke of 30 in. It was found that to assure proper stripping a pull-back of 25 tons per forging is necessary. For that reason the pull-back on the press was increased to 55 tons.

**Equipment for Flanging Press.**—The flange *G* is bolted to the upper platen. The distance-piece *D* connects with the original ram to bring

the tools to handy working height. The two punches *B* are secured in the head as shown. A swinging stop operated by the handle *C* is dis-

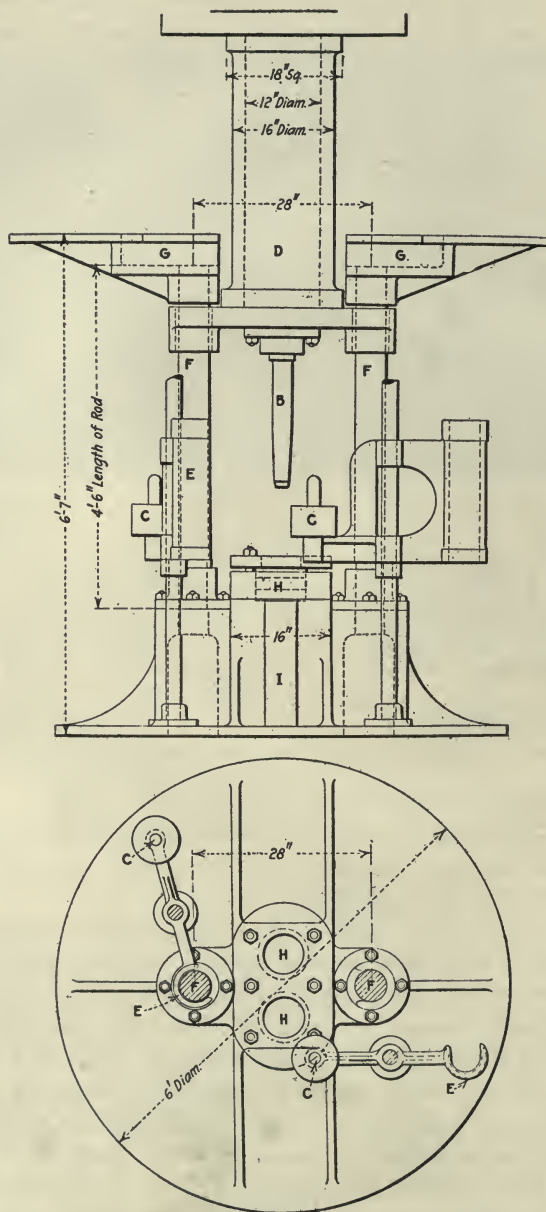

FIG. 10. EQUIPMENT SHOWN FOR SECOND OR DRAWING OPERATION

posed on each side of the press. In the plan view to the right the stop *E* is shown swung out of the way, while to the left it is in operating posi-

tion. The swinging stop is used only when the second operation is in progress. At *F* are the guides for the punch head; at *H* are the seats for

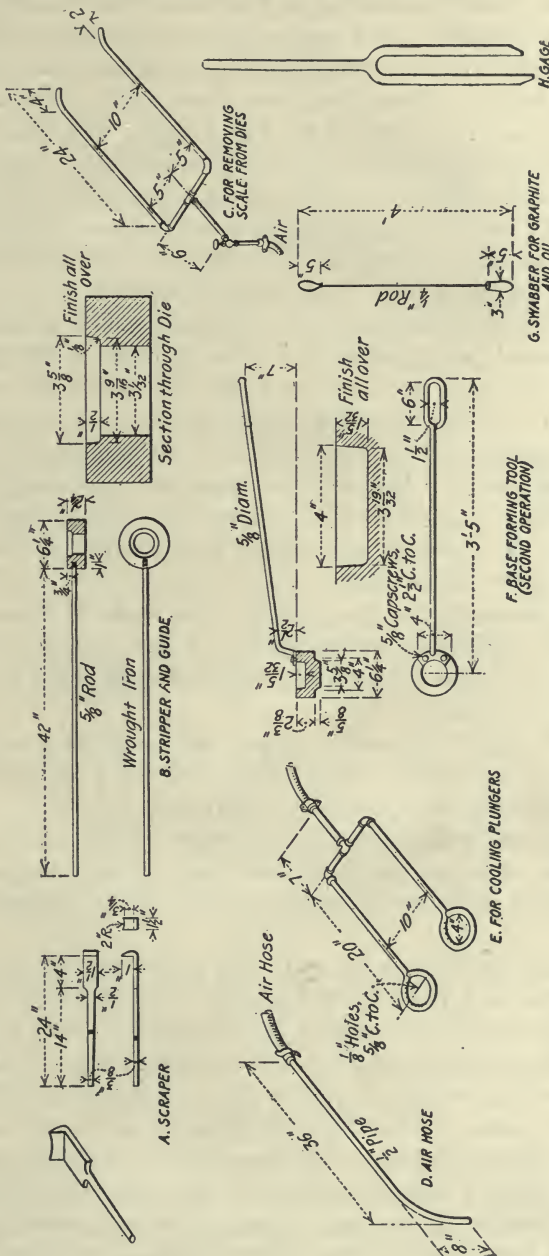

FIG. 11. ACCESSORIES IN CONNECTION WITH HYDRAULIC FORGING PRESS

the dies for both first and second operations; at *I* is a cored opening for the removal of the work on completion of the second operation.

When the blanks have attained the proper temperature, a press feeder at each furnace removes one with a pair of tongs and, swinging it over his head, brings it down end-on against an iron block to jar off as much of the scale as possible. Two men with the scrapers *A*, Fig. 11, and brooms then rapidly remove the rest of the scale and the feeders place the blanks in the dies. They then drop their tongs and take the guide *B*, Fig. 11, and lay it on top of the hot blank. The  $3\frac{5}{8}$ -in. recess is downward, surrounding the hot blank and centering it. The punch then descends, enters the  $3\frac{1}{2}$ -in. opening on top, centers the guide and work with relation to itself and, passing on down, causes the hot metal to squirt upward around the punch. The press is then reversed and the punch ascends, bringing with it the forging, which is now about  $7\frac{1}{2}$  in. long. Occasionally a forging will seize; then the punch is unscrewed and a new one inserted, which takes but a few minutes. When things are running right, the press will turn out 1,000 first-operation cups in 10 hr. At *C* in Fig. 11 is shown the blowpipe for removing scale from the dies in the first operation and at *D* the one for removing scale from the dies in the second operation. At *E* is shown the spray for cooling the punches in the second operation when they get too hot. The length of service of a punch or die depends upon many variables; it is, however, not uncommon for a die to last 24 hr.

As the requirements for the insides of the shells are more exacting, there being no machining inside except at the bottom, the punches under normal conditions require to be replaced more often than the dies, averaging 4 to 5 per day.

The gage *H*, Fig. 11, is used in inspecting the finished forging. The short leg goes on the inside of the shell, the difference between the length of the legs indicating the proper base thickness.

**Special Fixtures for First Forging Operation.**—Special fixtures designed by Mr. Allison to secure accuracy and high production on a special R. D. Wood & Co. press are illustrated in Fig. 12, the operation of which is as follows:

The plates *B* (in connection with the guide and stripping tool *B*, Fig. 11) strip the work from the punches *A*. The dies, Fig. 9, are seated at *C*. The knock-out *D* is operated by the frame *E* hung from the ram by chains in the eye-bolts, which it will be noted hang at a slight angle. The knock-out *D* is simply a rivet which is actuated by the frame *E*. In the position shown, the bottom of the knock-out *D* enters a hole in the frame member *E* and the top of *D* comes flush with the bottom of the die. As the punch *A* descends, frame *E* also descends and on clearing the end of the knock-out *D* swings by gravity to such position that when the punch and frame again ascend, the bottom of *D* is struck and the work ejected from the die *C*. After the removal of the work, the operator pushes frame *E* in the direction of the arrow until the stop *H* strikes the



frame of the press, when the knock-out *D* again drops into the pocket of frame *E* and the die *C* is ready to receive another blank.

In construction, the two stops *I* are simple and efficient, but under the repeated poundings, the punches and the stops are gradually upset so that adjustments must be made from time to time. Adjustment is

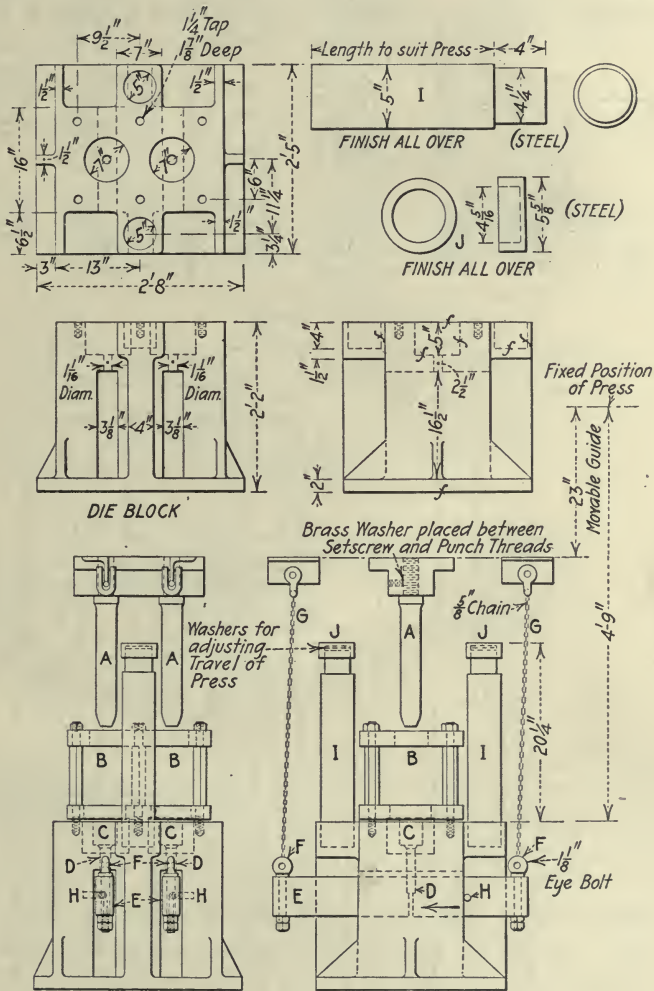

FIG. 12. SHELL-PIERCING DETAILS

secured in the following simple manner: On top of each post-stop *I* is an inverted cup *J* supported by thin sheet-steel shimes, one or more of which can be removed or inserted to readjust the length of stroke.

**Second Forging Operation.**—A bulldozer is chiefly employed for the second-operation work. This machine, see Fig. 13, has accommodation for the three punches and dies shown in Fig. 14.

The work goes through one die at a time, passing in succession through the three dies mounted in the consecutive seats *B* in the fixture *A*, Fig. 13. The bottom of the shell is formed at the end of the stroke between the punch end and a bottoming die located at *C*. It will be noted that

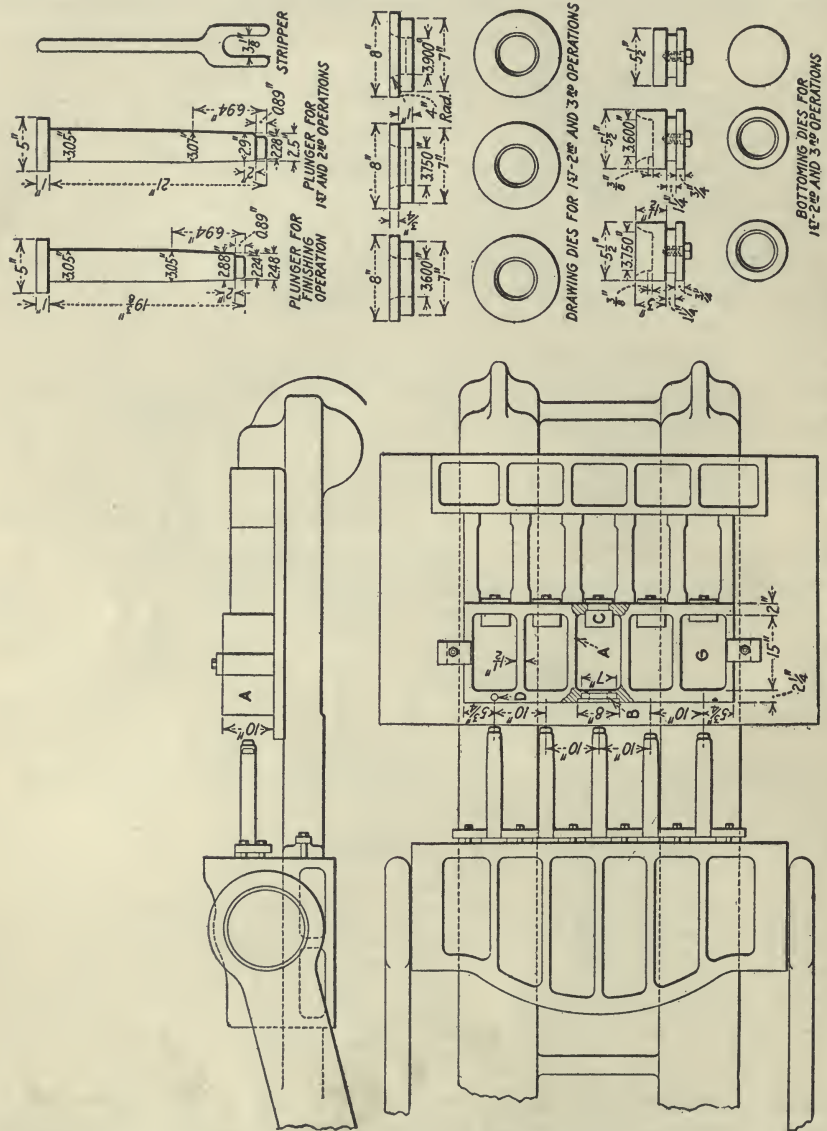

FIG. 13. BULLDOZER EQUIPMENT FOR FORGING SHELLS

the punches have a head instead of a thread to hold them in. A  $\frac{3}{4}$ -in. setscrew *D* on top prevents the dies falling out. The cups from the first operation being hot, the operator takes them one at a time and holds them with the base toward the die. The bulldozer is tripped and the

advancing punch enters the hole in the work, pushing it through the die and against the bottoming die *C*. By this time the operator standing on top of the fixture *A* has had time to replace his tongs with a hand stripper which is merely a crotch of steel with a long handle, shown at *E*, Fig. 13. The crotch is placed over the punch between the work and the front flange *F* of the fixture, and on the return of the punch, the work is stripped, dropping to the bottom of the cavity *G*, from which it is removed with tongs.

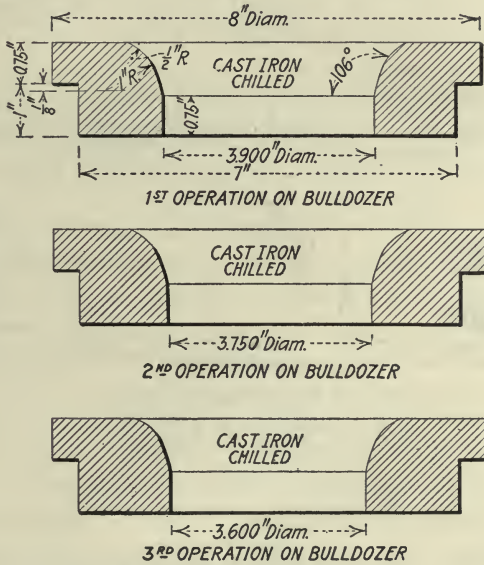

FIG. 14. SHELL-DRAWING DIES

**Second-operation Forging on Special Press.**—The second operation on the special press is entirely different from that done on the bulldozer. There the work passes through three separate operations in three dies held in three different holders; here the work passes at a single stroke through three dies placed in sequence in the same holder. In the bulldozer the bottom is formed inside and the base of the forging brought to the desired thickness at the completion of the stroke. In the special press it immediately precedes drawing, although it does not consist of a separate operation.

The drawing punch and dies are shown in Fig. 15. The arrangement of the three dies, one above the other, the largest at the top and the smallest at the bottom, is shown in the elevation at *H* in Fig. 10 and *T* in Fig. 16.

**The Drawing Operation.**—The cups from the first operation being hot, the pressman at each side of the press removes one from the furnace. On each side is a jet of water, vertically disposed. The cup is inverted

over the jet for an instant which causes the scale on the inside to loosen. Striking the inverted cup a sharp blow on an iron block shakes the scale out. Both inside and outside is then scraped and brushed to remove as far as possible the scale. A man on each side of the press then takes a base-forming tool, shown at *F* in Fig. 11, and lays the die end of the tool in the top of the die in the press. The hot forgings are then placed base down in the recess in the top of the base-forming tool, and the press tripped.

On this press two stops are provided, one for forming the base to thickness and the other at the extreme stroke of the ram after drawing

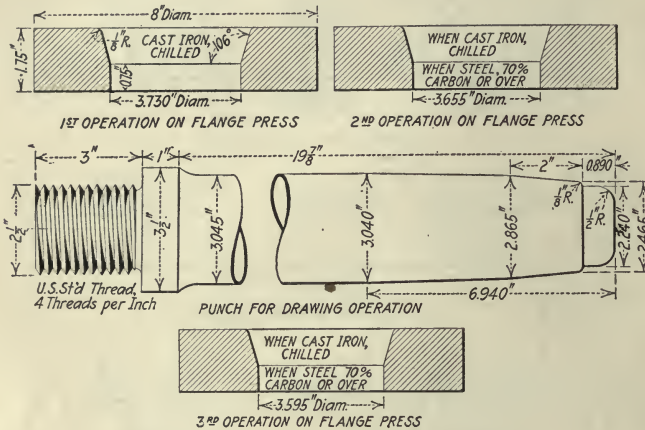

FIG. 15. DRAWING PUNCHES AND DIES

has been completed. The first stop is adjustable, and after being used must be swung out of the way before the punch can descend and draw the shell.

The handling of stops in the large flanging machine, is by hand, as shown in Fig. 10. Stripping also is by hand, the same as described for the bulldozer operation. There are many objections to hand operation of stops and strippers. There is too much chance of the human equation getting out of balance and too much expenditure of energy. With hand stripping there is always a possibility of spoiling the work on bending the punches by getting the stripper cocked on the edge of an unequally drawn shell. To overcome these difficulties Mr. Allison designed a system of air-operated stops and strippers which entirely obviate any chance of something being forgotten and consequent disaster. The device is shown in Fig. 16.

Before describing the automatic-stripping mechanism, an outline of the drawing operation as performed without it will give the reader a clearer conception of the duties performed by it and enable him to appreciate its simplicity and effectiveness.

When the first stop is reached, the punches have formed the inside of the shell bases and brought the bases to the desired thickness. The man in control of the hydraulic operating valve raises the punches so that the base-forming die can be removed. In the meantime, the first stops on each side of the press base have been thrown clear of the stops on the ram. The ram is again caused to descend and the punches push the shells down through the three dies, drawing them from  $7\frac{1}{2}$  to 10 in. in length. The pressman at each die has in the meantime taken a stripper similar to the one used in the bulldozer and shown at *E*, Fig. 13, and placed the crotch over the punch between the drawn shell (which clings to the punch) and the base of the die seat. On reversal of the ram the forged shell is stripped from the punch and falls to the ground below the die, whence it is removed to a large three-sided iron bin.

When things are going right, the press on second-operation work turns out about 70 finished forgings an hour. The work is not only heavy, but must be rapidly performed and, owing to the proximity of the furnaces, the temperature is high.

**Automatic Base-forming Stops and Strippers.**—Referring to Fig. 16, the stops *A* for the base-forming operation are secured to the plunger plate of the press, one at the front and one at the back. The lower member *B* of the stop, when in operating position, covers a cored hole *S* in the main frame, which is large enough to permit the stops *A* to pass downward when the members *B* are drawn out of the way. The members *B* are in slides and actuated by connecting-rods from the bell cranks *C*. The stop *A* seats in a cup in *B*, in the bottom of which are a number of disk-shaped shims. A slot *D*, which runs through the cup, serves a double purpose, facilitating both the removal of shims and the egress of water, which is apt to fall into the upturned mouth of the cup when the punches are being cooled with the spraying tool shown at *E*, Fig. 11. Before this slot was made the water caused the men much annoyance through squirting in their eyes.

The bell cranks *C* are operated by the air cylinder *E*. The two strippers *F* are actuated by the bar *G*, which has a yoke, or opening, *H* of sufficient size to permit the removal of the stripper for repairs or replacement or the use of a hand-stripper, should that be for any reason necessary. One end of the bar *G* is pivoted through a link to the main body; the other end is connected to the yoke-end *I* on the piston rod of the air cylinder *J*, shown in the upper right-hand corner of the detail. This cylinder receives air at one end only and the piston is returned by the coiled spring *K*, also shown.

At *L* is an air valve which is normally kept closed by a heavy compression spring *M*. The spindle of this valve is embraced by a yoke, the upper end of which finishes in a pin *N* which is in line with a trip plunger, mounted on the plunger plate of the press, which depresses *N* just as the

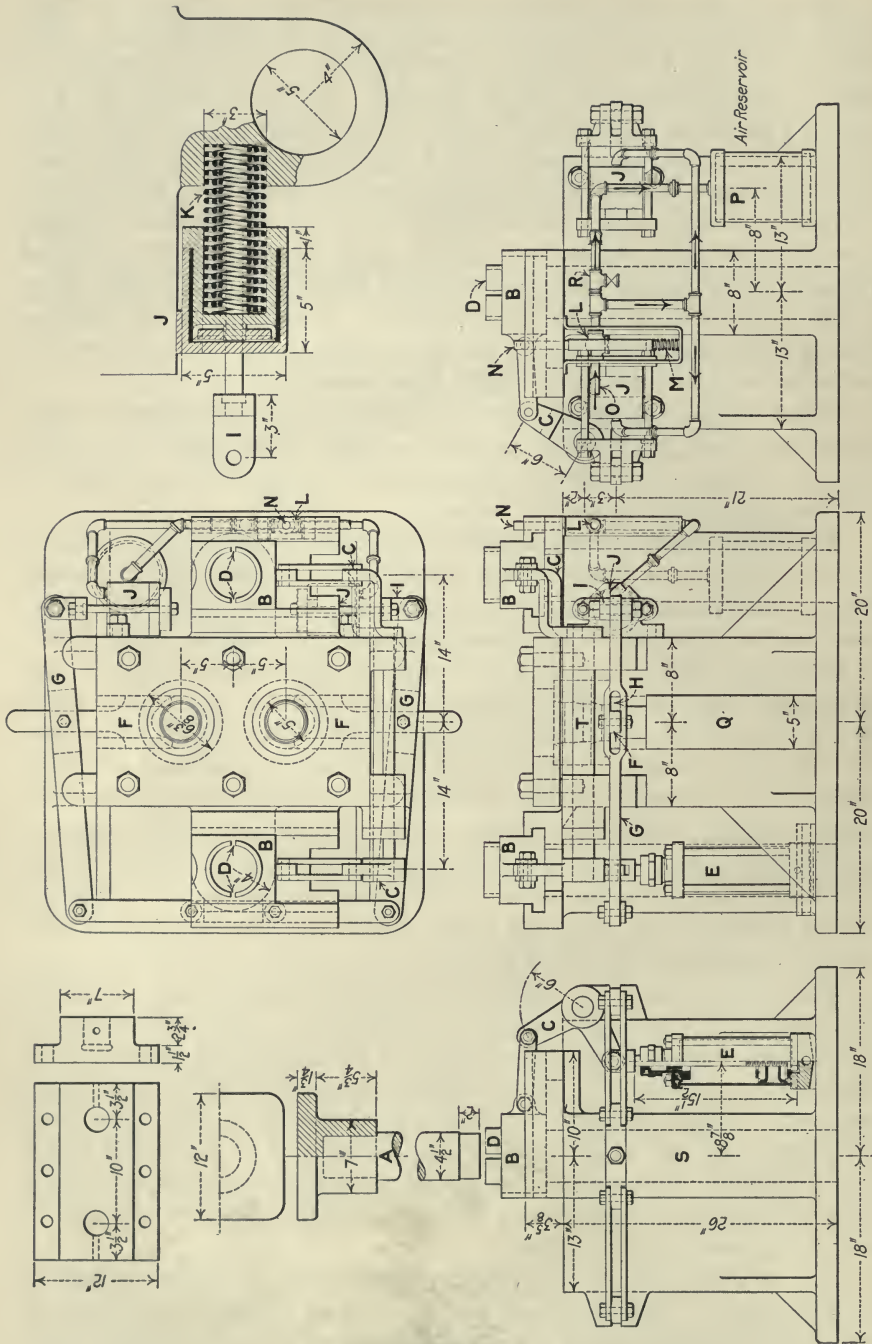

FIG. 16. EQUIPMENT FOR SHELL-DRAWING WITH AUTOMATIC STRIPPERS AND BASE-FORMING STOPS

plunger completes its downward stroke. This permits the air under pressure in the pipe *O* to pass through the pipes as shown by the arrows, actuating both pistons in the air cylinders *J* and filling the reservoir *P* (the duty of which will be explained later). The piston in the air cylinders *J* forces the strippers *F* into contact with the punches, and as the press ram ascends, the finished forgings fall to the bottoms of the cored openings *Q* in the base.

In the pipe system is an adjustable needle valve *R*, which permits the air to leak gradually from the pipe system, the air cylinders *J* and the air reservoir *P*, when the valve *L* is in normal, or closed, position. By regulating the leakage through the needle valve *R*, the device can be so timed that, shortly after the finished forgings are stripped from the punches, the pressure in the pipe system and reservoir will have fallen so low that the pull-back springs *K* in the air cylinders act, and the strippers are drawn back where they will on the next stroke of the press clear the descending work.

#### ACTION OF THE AUTOMATIC DEVICE

Briefly, then, the action of the device is as follows: The work is placed in the base-forming die and the ram descends until the stop *A* brings up against the lower member *B*. The ram is raised to remove the base-forming die and the operator opens the air-control valve. The air entering the cylinder *E* throws both lower members *B* back, so that the stops *A* are free to enter the cored holes *S*. The ram, being reversed, comes on down forcing the forging through the triple dies *T*. Near the bottom of its stroke the stripper trip on the plunger plate strikes the plug *N*, allowing the air to enter the stripping system and to actuate the stripping operation as described. While still hot, the forgings are gaged with the forked gage shown at *H*, Fig. 11.

**Forging Hints.**—It is most imperative to remove as much of the scale from the work as possible, as this is liable to cause a great deal of trouble cutting the dies and making cavities in the work. Proper lubrication of both punches and dies has been a source of considerable thought. When the job first came up, the old blacksmith's trick of putting a pinch of soft coal in ahead of the punch was tried, but discontinued. While hot, the hole would look good and clean, but when being machined, pockets of scale and slag would break out and the work would not pass inspection.

At present graphite and water applied with the swabber shown at *G*, Fig. 11, are used on the punches. For the dies, graphite and oil are applied with a similar tool. But there is still much to be desired in the way of a good lubricant.

Correct temperatures are of great importance. For the first forging operation, the work should be as near 2,000 deg. F. as practicable; for the second operation, the work should be at a temperature of 1,800 deg. F.

Speeds are also of considerable importance. On the first operation, a speed of 30 ft. per min. is permissible and satisfactory; on the second operation, a speed of 22 ft. per min. is all that the work can safely stand, an increase over this of only 2 ft. per min. being liable to cause trouble. A decrease of speed by the same amount also gives unsatisfactory results.

**Heat Treatment.**—After the forgings are machined, up to the completion of operation 10, as shown in "Making the 18-Lb. British Shrapnel," page 41. They then go to the heat-treating department, shown in Fig. 17. The shells are placed 30 at a time in reverberatory furnaces *A*. It takes about 30 min. to bring them to a temperature of 1,500 deg. F. They are then taken one at a time and quenched in whale oil in the tank *B*, provided with a screen bottom which can be raised by the air hoist *C*, as shown in Fig. 17. After the bulk of the oil has drained

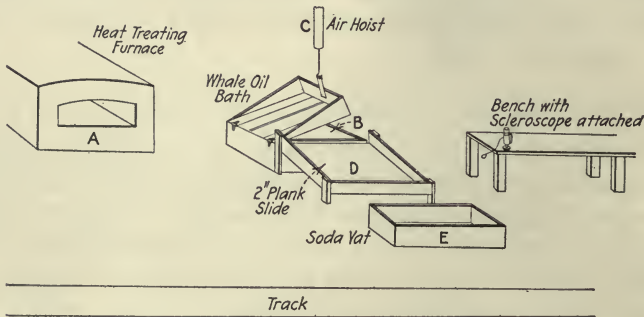

FIG. 17. HEAT-TREATING ARRANGEMENT

from the shells, they are placed on the angular draining surface *D*. After the first treatment, the shells, if too hard, are reheated and drawn at a temperature varying from 700 to 900 deg. F., depending on the steel, to give the required scleroscope hardness of 38 to 42. As previously stated, the heat treatment is determined by Mr. Hendy, the chemist, from the coupons taken from each melt. Of three lots passed through in 5 days, 3,000 required no second treatment, while the remaining 12,000 had to be drawn.

After heat treatment the shells are washed in soda water in the vat *E*. It has, however, been found that bending of the metal in this operation at the low temperature attained by the metal at the point where the curved nose strikes the cylindrical body is apt to make it brittle; so, after nosing, the shells are returned to the lead pot, shown in Fig. 18 to bring the metal at this point to a low red heat and prevent shortness.

The pins *A* are of such length that when the shells are inverted over them the open ends reach down the required distance into the lead.

The nosing die is shown in Fig. 19, at *A*, and at *B* is the bolster to locate the base of the shell in line with the die. Formerly, for every 120



shells nosed, there was a wastage of 100 lb. of lead due to evaporation. The present chemist suggested covering the surface with broken charcoal, and now the wastage is about 20 lb. for 500 shells, and the bulk of this

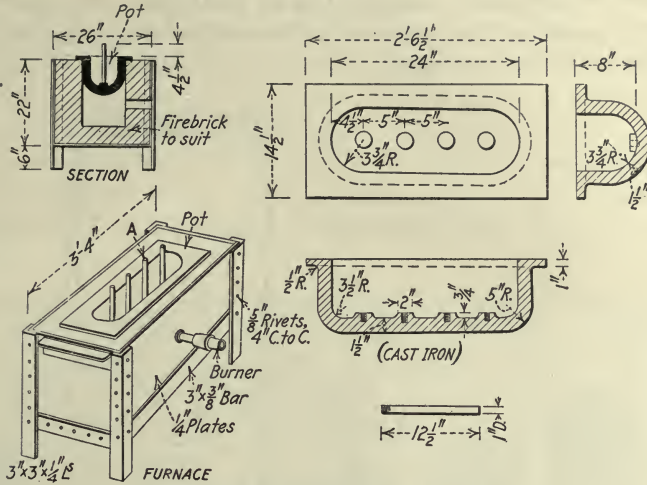

FIG. 18. LEAD POT AND FURNACE

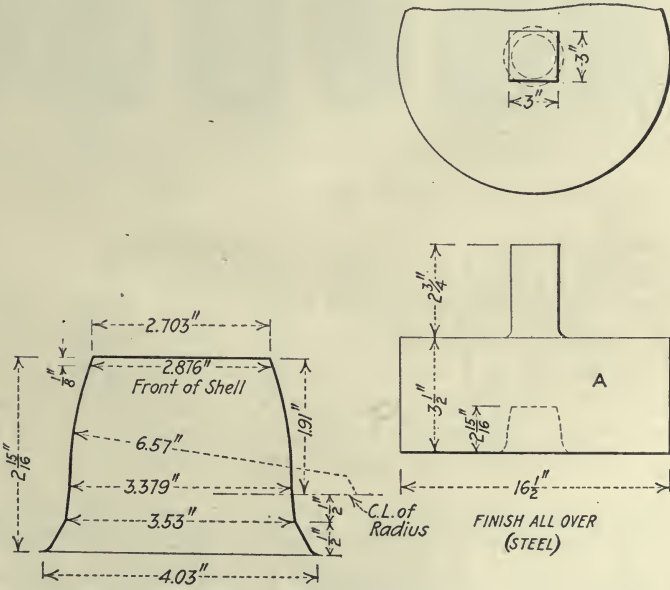

FIG. 19. NOSING DIES

is what sticks to the work. In all lead-pot heating, the protection of the surface with charcoal is advisable, as unprotected lead hardens and depreciates rapidly.

If the thin part of the shell, that is, above the line AB in Fig. 20,

shows a scleroscope hardness according to specification, the test piece will invariably pull apart in the thick part below the line *AB* of the test piece. This, of course, is because the heat treatment affects the thin section more readily, and because in this as in all other work the thickness of the work, as well as the hardness, influences the rebound of the indicating member of the scleroscope.

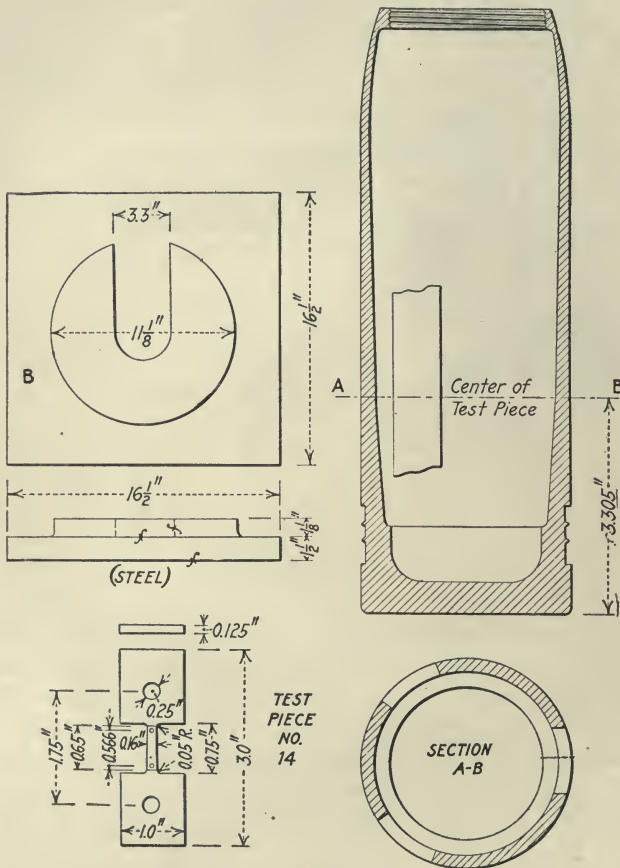

FIG. 20. LOCATION OF PHYSICAL TEST PIECES

The scleroscope is mounted on a base and perpendicular to the center of a V for the reception of the shell. At the back of the V is a stop to locate the shell, so that the testing point is always a given distance from the base of the shell. This testing point is slightly below the line *AB*, Fig. 20.

#### FORGING 3.3 SHRAPNEL BLANKS ON STEAM HAMMERS AND BULLDOZERS

At the Turcot works of the Canadian Car & Foundry Co., Ltd., Montreal, Canada, quite another method of forging the shell blanks re-

sulted in the completion of 1,200 every 24 hr. This record was attained and maintained without adding a single new machine and though seven operations were required to perform the work done at the Montreal Locomotive Co. works in three, still the adaptation of the plant's steam hammers and bulldozers to the work is of interest.

**Cutting Off the Blanks.**—In this shop the cutting of the blank shown at *A*, Fig. 21, is done hot. The bar stock is received from the mill cut to lengths which are an exact multiple of  $5\frac{3}{16}$  in., the length of *A*. With the shearing method there is no kerf to allow for, and should the last blank on a bar be too short to use for a forging, it is a solid chunk of scrap steel readily salable at a much better price than cuttings from a cold-saw.

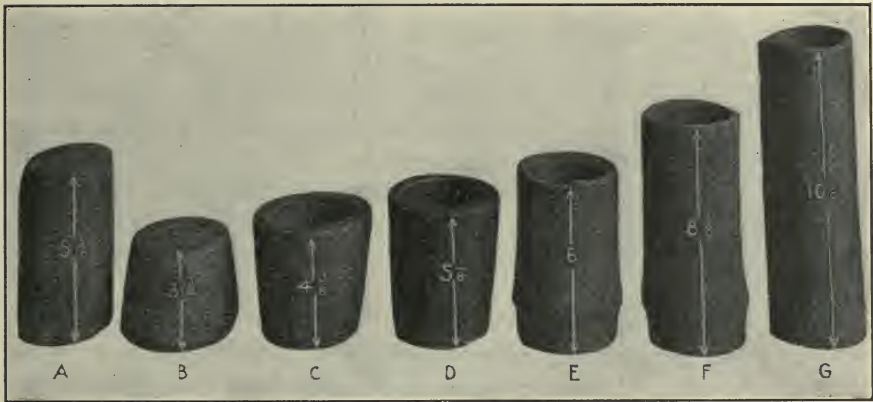

FIG. 21. THE SEVEN STAGES IN THE EVOLUTION OF THE SHELL

The bars, approximately 6 ft. long, are heated four to six at a time in a furnace above which runs a trolley, connecting with an Acme forging machine, with block and fall for handling the bars between the furnace and machine. The dies for cutting off are arranged as shown in Fig. 22 (*a*), so that two blanks are cut each time the machine is tripped and completes its cycle of operation. Three men make up the gang and have under their care the furnace, the forging machine and a steam hammer. Their work consists simply of cutting off the blanks and upsetting them.

The fixed holding dies *A* are secured to the housing *D* of the machine. It will be noted that the lower dies are  $5\frac{3}{16}$  in. deep and are spaced  $5\frac{3}{16}$  in. from the upper dies, both these measurements being equal to the length of the blank. The movable holding dies *B* are similar in all respects to the fixed dies *A*. The operation is as follows:

The red-hot bar is lowered till its end strikes the bottom *E*. The machine is then tripped, and the two movable holding dies *B* advance and clamp the bar in the fixed dies *A*. The shearing die *C* then advances

and shears a blank out of the space between the upper and lower dies *A*, leaving a similar blank in the lower dies *A* and *B*. On the return of the slides to open position, the two sheared blanks are removed by the operator and the process repeated.

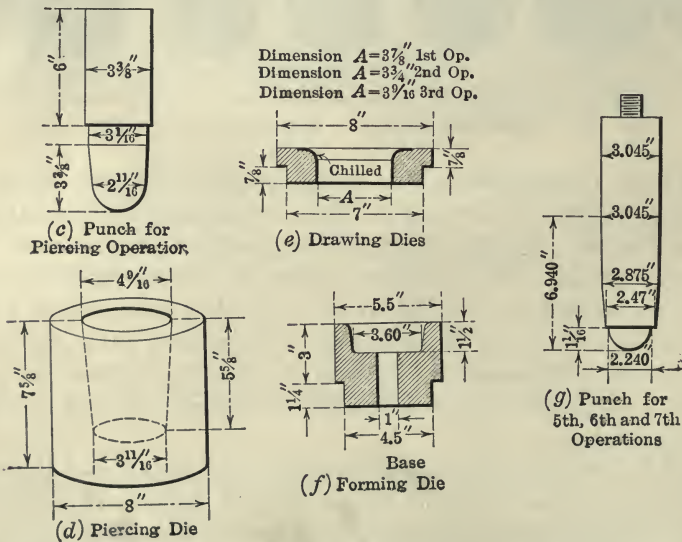
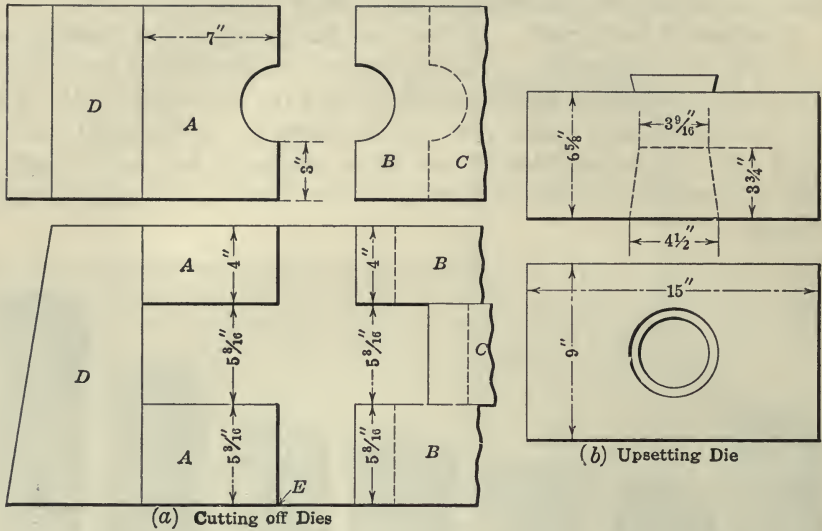

FIG. 22. DETAILS OF PUNCHES AND DIES USED IN FORGING SHRAPNEL-SHELL BLANKS ON STEAM HAMMERS AND BULLDOZERS

**Upsetting the Blanks.**—On removal of the sheared blanks from the machine, the operator throws them to the hammerman, who takes the hot blank and, placing it near the center of the anvil, brings the head

down slowly to center it with relation to the die in the hammer head. From two to four sharp blows with the hammer shape it to the form shown at *B*, Fig. 21. With a new die in the hammer head, the upset piece readily drops out, and one man can handle the upsetting operation. When the die becomes worn, help is necessary and the two other men of the gang assist at the upsetting.

The upsetting is done without reheating, direct from the shearing operation and by the same gang of men, so that each shift handles 600 pieces sheared and the same pieces upset—1,200 handlings per shift.

**The Piercing Operations.**—While still hot the upset blanks are placed in a furnace and raised to forging temperature for the first piercing operation. This is performed on a steam hammer fitted with the punch and die shown in Figs. 22(c) and (d) respectively. Two or three blows with the hammer drive the punch  $2\frac{1}{2}$  in. into the work and lengthen it about  $\frac{5}{8}$  to  $\frac{3}{4}$  in., resulting in a blank  $4\frac{3}{8}$  in. high,  $3\frac{5}{8}$  in. in diameter at the bottom,  $4\frac{1}{2}$  in. at the top with a 3-in. hole  $2\frac{1}{2}$  in. deep. The blank is then returned to the furnace and reheated for the final piercing operation. This is done with the same punch and die and in the same manner, resulting in a blank  $5\frac{1}{8}$  in. high,  $3\frac{5}{8}$  in. in diameter at the bottom,  $4\frac{3}{8}$  in. at the top with a 3-in. hole  $3\frac{1}{4}$  in. deep.

**The Drawing Operations.**—On completion of the second piercing operation, the fourth of the series, the work, while still hot, is placed in the first operation drawing die of a bulldozer, provided with four sets of punchers and dies, two of which are for the first drawing operation and the other two for the second drawing operation.

The two dies for the first drawing operation are of chilled iron as shown in the detail Fig. 22(e) with a  $3\frac{7}{8}$ -in. hole. Both sets of dies are used alternately to prevent overheating. The hot blanks are taken direct from the previous operation and, held with a pair of pick-ups, are slipped over the end of the advancing punch. This forces the work through the drawing die and at the completion of the stroke pushes it into a base-forming die. The effect of this base-forming die can be readily seen at the bottom of the pieces *E* and *F*, Fig. 21. The bottom-forming die is shown in the detail, Fig. 22(f). The bulldozer runs at a speed of 9 strokes per minute.

After being formed to the shape shown at *E*, Fig. 21, the work which comes from the first drawing operation 6 in. long,  $3\frac{7}{8}$  in. diameter at the top,  $3\frac{5}{8}$  in. at the bottom, with a 3 in. hole 5 in. deep is returned to the furnace until they reach a full yellow heat. The heated blanks are then pushed through the second set of drawing dies in the bulldozer. These are similar to the first operation dies but  $\frac{1}{8}$  in. smaller in diameter, measuring  $3\frac{3}{4}$  in. at the small end of the throat. On the completion of the second drawing operation the blanks are as shown at *F*, Fig. 21,  $8\frac{1}{8}$  in. long,  $3\frac{3}{4}$  in. in diameter, with a 3-in. hole  $7\frac{3}{8}$  in. deep.

The work is then passed through the final drawing operation without reheating, but is cleaned of the inside scale before it is passed through the final operation die of the last operation bulldozer. In this machine the base-forming die is replaced with a flat die which, just at the completion of the stroke, flattens the bottom of the shell and imprints the manufacturer's mark.

The work from the final forging operation is  $10\frac{1}{2}$  in. long,  $3\frac{1}{2}$  in diameter, with a 3-in. hole  $9\frac{3}{4}$  in. deep.

## CHAPTER III

### MAKING THE 18-LB. BRITISH SHRAPNEL<sup>1</sup>—THE DOUBLE-SPINDLE FLAT TURRET LATHE

The British 18-pounder, 3.3-in. diameter, represents the highest efficiency in shrapnel, for this size possesses the maximum damaging ability with a minimum of labor in handling the gun and its ammunition. Furthermore, this size is small enough to be within the capacity of ordinary machine tools and large enough to require, for its manufacture, rigid boring bars and other equipment suitable for heavy cuts. These characteristics make the output of 18-pounders typical of shrapnel manufacture in general, and a detailed description of the shop operations required for this size will constitute a comprehensive and reliable guide for the manufacture of all shrapnel shells from 3-in. diameter, 15-lb. shrapnel, up.

The Canadian Ingersoll-Rand Co. was among the first to undertake to deliver a definite number of shells per week (2,000 per week at first and subsequently 3,000) and a record of this shop's operations sets an excellent guide for all plants which may in future be called upon to undertake the manufacture of shrapnel.

**Reconstructed Engine Lathes.**—An advantage which this plant already had was the possession of a first-class toolroom. The tooling-up for a proposition that runs into hundreds of thousands of pieces is vitally important, for every cent nipped off of an operation means a thousand dollars or more. As a result of this, one finds many reconstructed engine lathes fairly well disguised by the addition of special chucks, revolving turrets, or square-turret tool posts of the Gisholt type. Their builders would hardly recognize them. But where the original machines, as a general utility tool, had a possible average of 40 to 50 per cent. efficiency, the reconstructed machines with their specialized attachments probably figures nearer to 80 or 90 per cent., from a viewpoint of doing what they have been designed to do. Even the addition of a square-turret tool post to an engine lathe, in cases where the same tools are used over and over again in sequence, cuts down the loss of time very noticeably.

Here one finds an illustration of good work done on old tools. Possibly the most important part of the entire shell, as far as the limit of accuracy is concerned, is the thickness of wall directly behind the thread seat at the nose end. While other dimensions have high and low limits,

<sup>1</sup> John H. Van Deventer, Managing Editor, *American Machinist*.

this particular one is marked simply by the exact dimension, and the slightest deviation shown by the inspector's micrometer from this dimension, causes the rejection of the shell. One of the machines used for performing the operations on this part is an old turret lathe so inaccurate that it had the reputation of not being able to hold a size within one-eighth inch of any given dimension. But when equipped with a positive turret-locking device and a cam which controlled the movement of the cutting tools, the machine was able to live down its former bad reputation and is today producing work fully up to the exacting requirements.

**The Evolution of the Completed Shrapnel Case.**—The thirty odd main operations required, from that of trimming the rough forged blanks to length to that of boxing the completed steel cases for shipment to England, where the explosives, the fuses, the timing devices, etc., are added and the shrapnel assembled with its brass cartridge shell, are explained in the concise descriptions of Operations 1 to 32, inclusive, which follow.

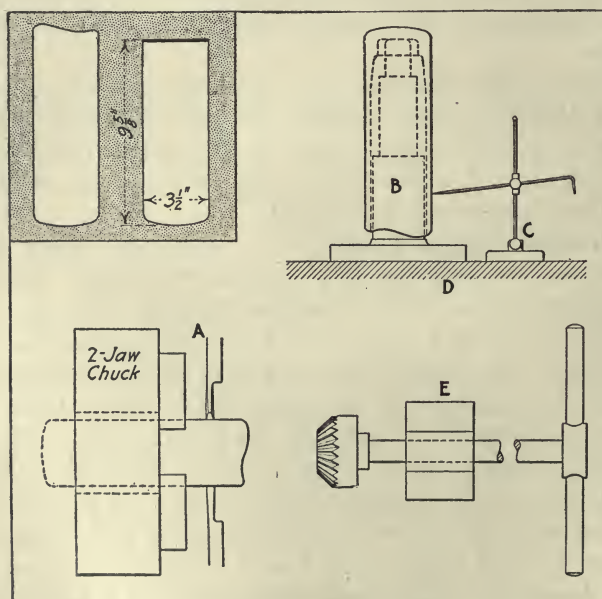

OPERATION 1. LAY OUT, CUT OFF AND REAM BURR

Machines Used—Cutting-off machines with front and back cutting tools, A.

Special Fixtures and Tools—Mandrel for laying out, B; surface gage, C; surface plate, D; bevel hand reamer for removing burr (held against rotating shell), E.

Gages—None.

Production—From one machine and one operator, 20 per hour, including laying out.

Note—Soap-water lubrication used in cutting.



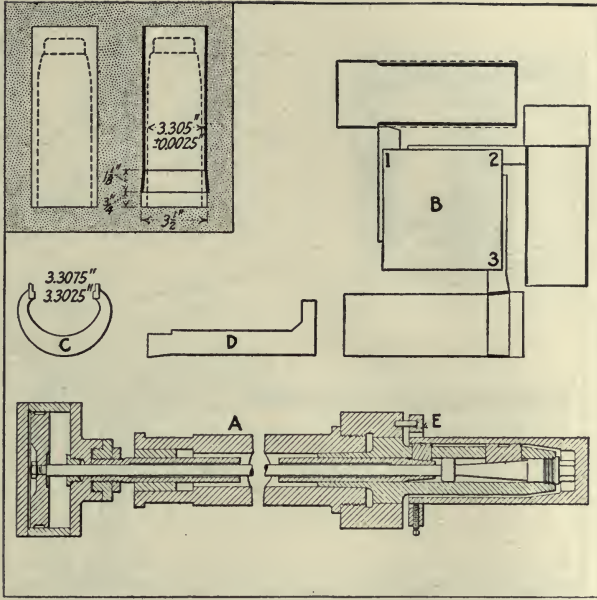

OPERATION 2. ROUGH-TURN BODY AND TURN BEVEL

Machine Used—Gisholts and engine lathes fitted with turret tool-posts.

Special Fixtures and Tools—Expanding mandrel, A; special driving dog, E. Cutting tools: For rough-turning body, B1; for finish-turning body, B2; for forming taper, B3.

Gages—Limit snap-gage for diameter, C. Gage for setting taper-turning tool (used against mandrel before shell is chucked), D.

Production—From one machine and one operator, six per hour.

Note—The accuracy of finish of the body at this stage is on account of future chucking in special chucks.

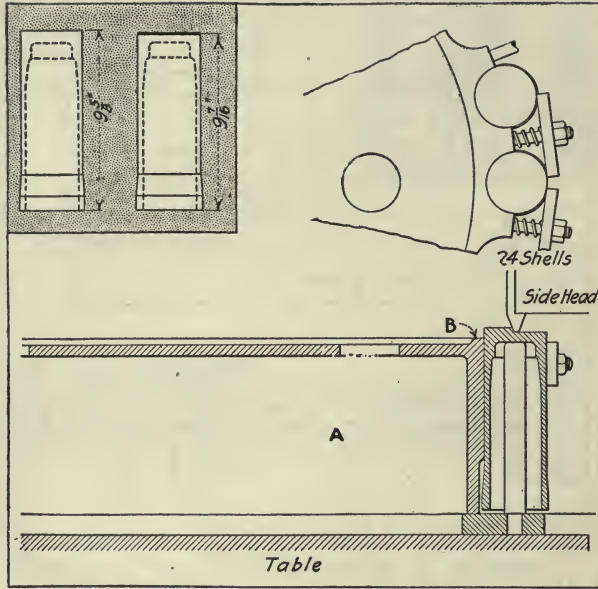

OPERATION 3. ROUGH-FACE BASE END OF SHELL

Machine Used—42-in. vertical turret lathe.

Special Fixtures and Tools—Circular chucking fixture to hold 24 shells, A.

Gages—Thickness gage,  $\frac{5}{8}$  in. square, for setting tool at correct height in connection with finished surface B.

Production—From one machine and one operator, 48 shells per hour.

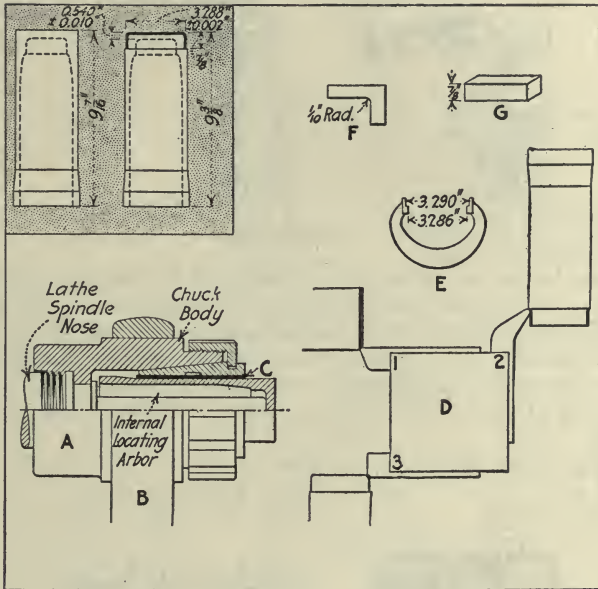

OPERATION 4. FINISH-FACE END, FINISH-TURN BASE AND MAKE RADIUS ON BASE EDGE

Machines Used—16-in. turret lathes and engine lathes with square-turret tool-posts.

Special Fixtures and Tools—Split-collet chuck, with internal distance arbor, A; steady-head for supporting the collet chuck, B; split adapter bushing, to make up for taper end of shell, C. Cutting tools: For finish-facing base, D1; for finish-turning base, D2; for rounding corner, D3.

Gages—Limit snap-gage for base diameter, E; radius gage, F; distance block for setting facing cut from internal distance arbor, G.

Production—From one machine and one operator, 10 per hour.

Note—The completion of the base end at this operation eliminates one operation on the grinders.

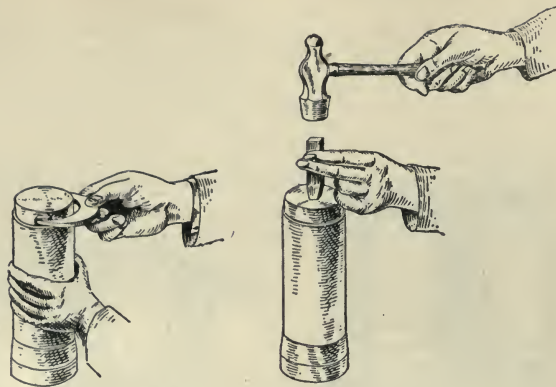

OPERATION 5

First Shop Inspection—The cases are inspected for size of base diameter, radius of corner, etc., using gages similar to those in the operation 4. The carbon content is also stamped on the shell base at this point, shells being put through in lots of the same carbon content. Up to this point the various lots were distinguished by paint marks inside the shell. At this inspection particular attention is paid to defects and flaws, especially at the base of the shell, so that further labor will not be put on defective cases.

Production—Sixty per hour per inspector.

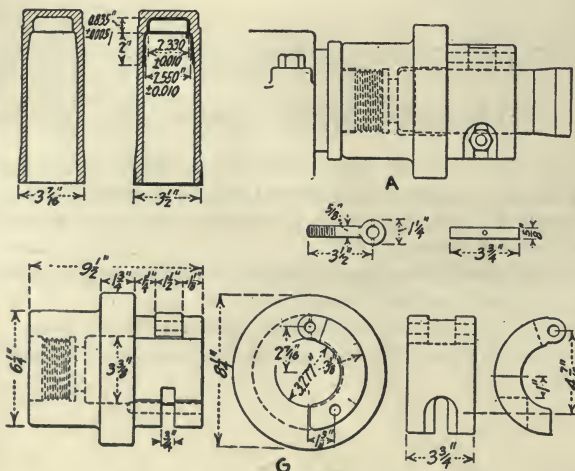

OPERATION 6. BORE POWDER-POCKET AND DISK-SEAT, ROUGH-TURN AND FACE NOSE END

Machines Used—J. & L. flat-turret lathes.

Special Fixtures and Tools—Special hinged chuck, A. Cutting tools: For rough-boring powder pocket, B1; for finish-boring powder pocket, B2; for rough-boring disk seat, B3; for reaming disk seat, B4; for facing nose end, B5; for turning nose end, B6.

Gages—Double-end limit plug-gage for diameter of powder pocket, C; double-end limit plug-gage for diameter of disk-seat, D; special limit gage for depth of powder-pocket, E.

Production—From one machine and one operator, 10 per hour.

Note—1. Lard oil is used on this operation as a cutting lubricant. 2. Upper end of gage E, illustrating register of + and - surfaces, shown at F. 3. Details of hinged chuck, shown at G.

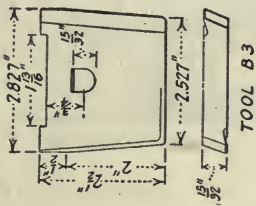
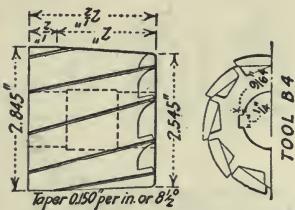
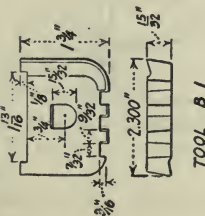
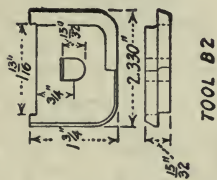
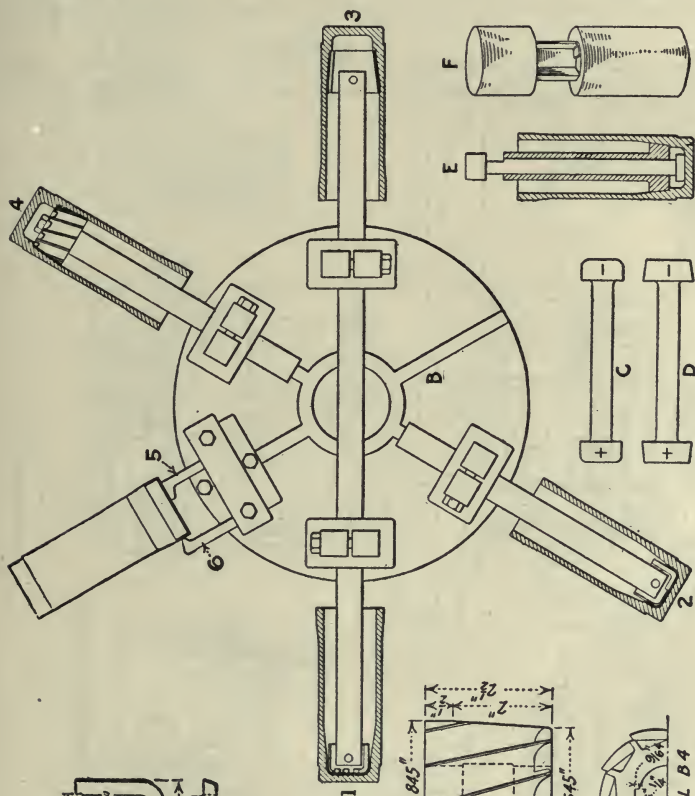

OPERATION 6



## OPERATION 7. CUT RECESS AND MAKE WAVES

Machines Used—P. & J. automatic chucking machines.

Special Fixtures and Tools—Special chuck, jaws bored for shell diameter, A; wave cam, attached to faceplate, B. Cutting tools: For roughing recess (carried on cross-slide), C1; for forming wave (carried on cross-slide), C2; for undercutting recess (carried on cross-slide and fed by arm on turret), C3.

Gages—Limit snap-gage for bottom of groove, D; limit snap-gage for diameter of top of waves, E; template for height and form of wave, F; limit gage for distance of recess from base, G; limit gage for width of recess, H; minimum limit gage for undercut, J.

Production—From one machine and one operator, 10 per hour.

Note—Method of cutting the three-wave cam on engine lathe, shown at K.

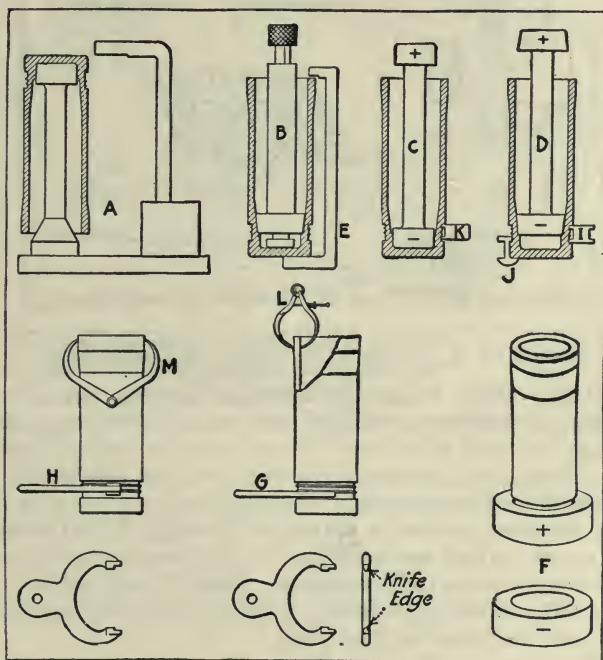

## OPERATION 8. PRELIMINARY SHOP INSPECTION

Gages—For  $\pm$  thickness of base, A; for  $\pm$  depth of powder pocket, B; for  $\pm$  diameter of powder pocket, C; for  $\pm$  diameter of disk seat, D; for  $\pm$  length over all, E; for  $\pm$  diameter of base, F; for  $\pm$  diameter of recess at bottom, G; for  $\pm$  diameter over waves, H; for  $\pm$  recess width, I; for  $\pm$  distance of recess from base, J; for  $\pm$  undercut, K; for  $-$  thickness of nose, L; for  $-$  diameter of nose, M. Total, 23 gaging operations.

Production—Fifty shells per hour inspected by two men.

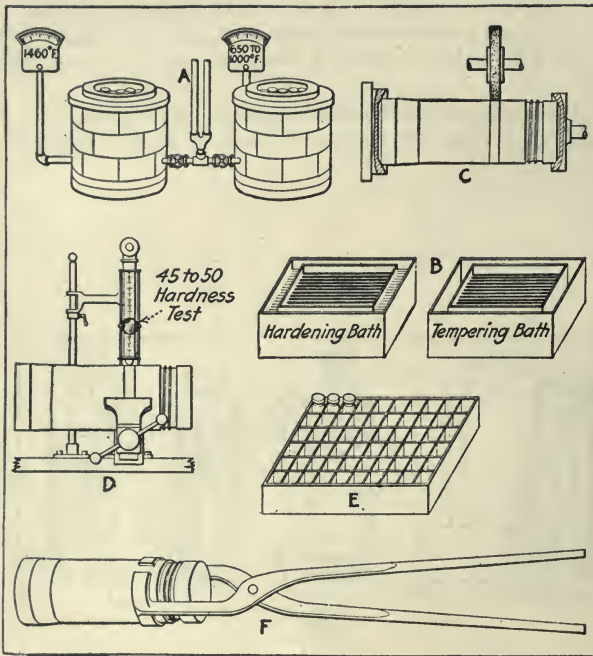

OPERATION 9. HEAT-TREAT, GRIND SPOT AND TEST

Equipment Used—Muffle furnaces for hardening and tempering, A; oil baths for quenching, B; plain grinder for spotting, C; scleroscope, D; boxes for 120 shells, E; special shell tongs, F.

Production—Heating and quenching; 16 shells per hour per furnace. Four furnaces in operation, tended by two men.

Note—Heat treatment consists of heating to 1,460 deg. F., and quenching, then reheating to between 650 deg. and 1,000 deg. F., according to carbon contents, and tempering. Carbon varies from 45 to 55 points. Oil fuel is used, and heat is controlled by pyrometers. After sorting into batches, two shells are selected at random, one for tensile-strength test, the other for firing proof.



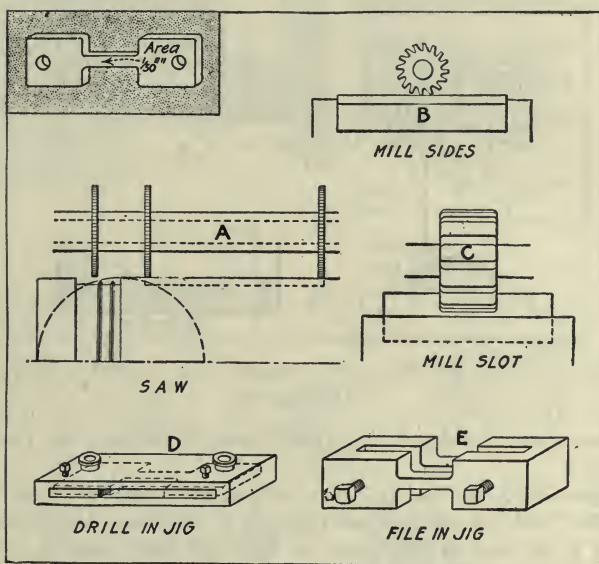

OPERATION 10—MAKE TENSILE-STRENGTH TEST-PIECE

Saw out test-piece on miller, mill flat-faces, mill slot, drill test-piece and file in jig

Machines Used—Drilling machines and plain miller.

Special Fixtures and Tools—Distance collars for miller arbor for sawing test-piece, A; thickness blocks for miller vise for milling flat faces, B; round-corner cutter for milling slot, C; drill jig for drilling, D; filing jig for filing, E.

Gages—Micrometer.

Production—One man performing all operations can produce one in  $2\frac{1}{3}$  hr.

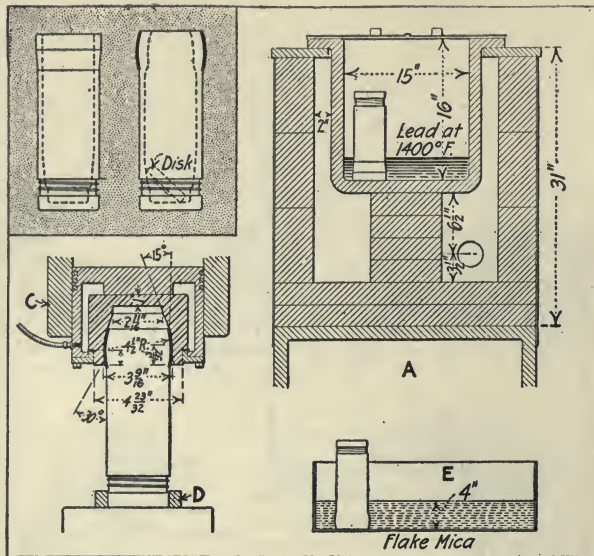

OPERATION 11. REHEAT IN LEAD BATH, INSERT DISK, "BOTTLE" NOSE END, REHEAT AND ANNEAL

Equipment Used—Lead pot A; bottling press, B; bottling die, C; lower ring, D; mica box, E.

Production—With one lead pot, one bottling press and two men, 60 per hour.

Note—The "disk" is inserted just previous to "bottling," after heating the case. The bottling press used at the Canadian Ingersoll-Rand plant is a rebuilt Leyner mine drill sharpener. The die is water-cooled so the shell will not stick to it.

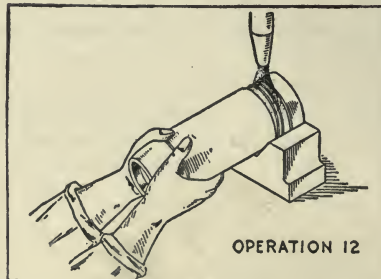

OPERATION 12. SANDBLAST BASE END AND RECESS

Note—The sandblast has been found most satisfactory to remove the scale due to heat treatment.

Production—One apparatus and one operator, 60 per hour.

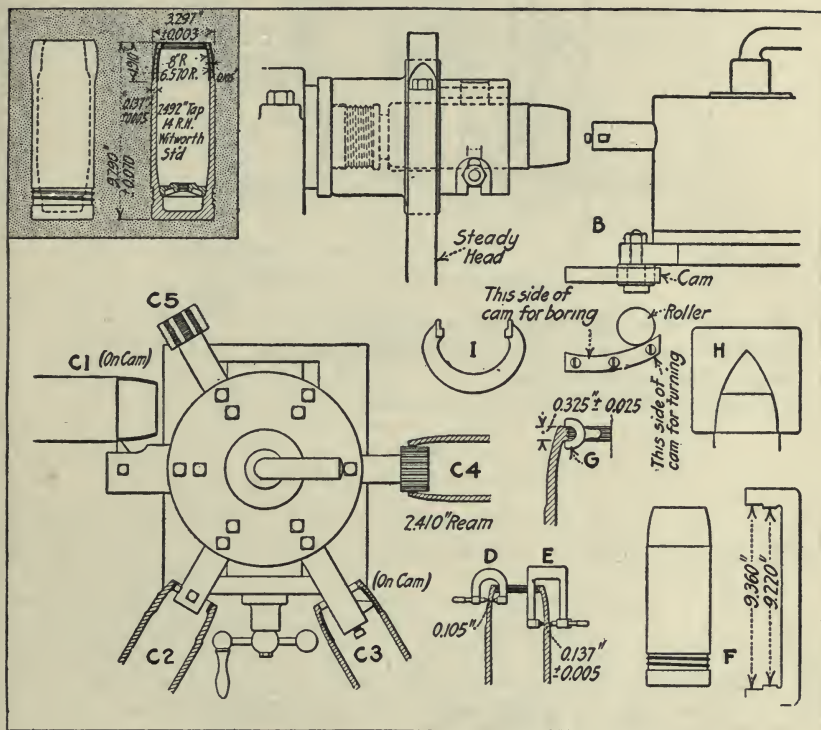

OPERATION 13. TURN, BORE AND TAP NOSE END

Machine Used—Turret lathes and engine lathes with improvised turrets.

Special Fixtures and Tools—Hinged and collet chucks, same as operations 4 and 6 (hinged chuck shown at A); nose turning and boring cam, B. Cutting tools: Outside turning and facing tool, C1; boring tool for roughing thread seat in nose, C2; boring tool for boring inside of nose, C3; reamer for thread seat, C4; collapsible tap for tapping thread in nose, C5.

Gages—Gage for wall thickness, D; gage for wall thickness, E; length gage, F; profile template for nose, H.

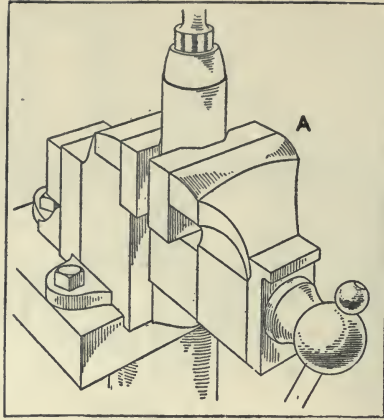

OPERATION 14. RETAP NOSE

Machines Used—Radial drilling machines.

Special Fixtures and Tools—Vise for holding shell, A.

Gages—Plug gage for thread.

Production—One operator and one machine, 20 per hour.

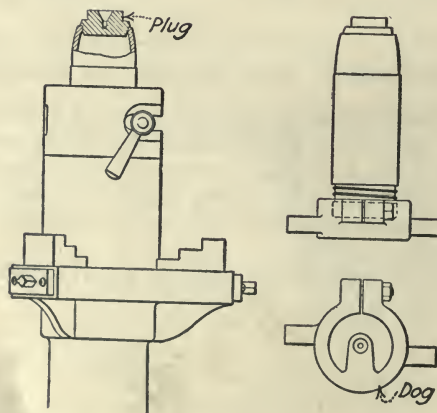

OPERATION 15. FIT DOG AND PLUG-CENTER FOR GRINDERS—REMOVE DOG AND PLUG-CENTER

Equipment Used—Hinged chuck used as vise.

Production—Two men, 60 per hour.

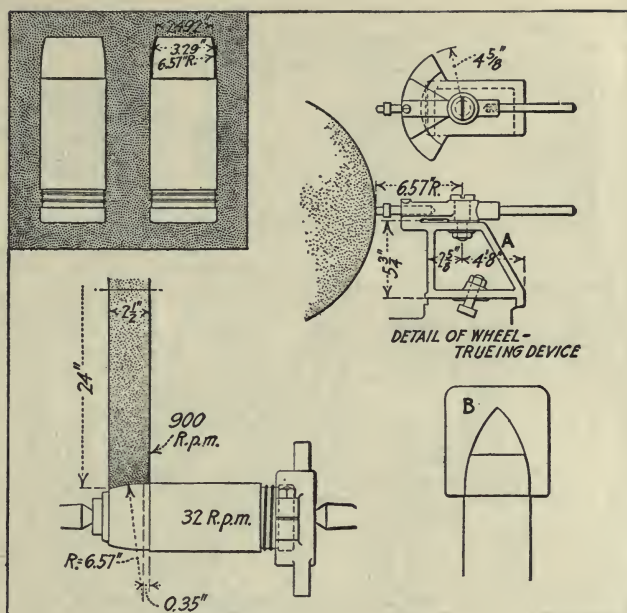

OPERATION 16. GRIND NOSE

Machines Used—Norton and Landis plain grinders.

Special Fixtures and Tools—Wheel-truing device, A; driving dog and center-plug (see operation 15).

Gages—Profile gage for nose, B; micrometer for large diameter.

Production—One operator and one machine, 40 per hour.

Note—Grinding wheel used is crystolon, grade L, in a grain mixture of  $\frac{1}{3}$  each 24–36 and 46. The output per wheel varies between 3,200 to 9,800 shells. The frequency of wheel dressing is once per 10 to 30 shells, with a maximum of 1 in 3 and a minimum of 1 in 78 shells.

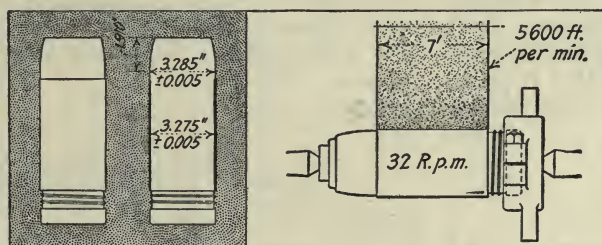

OPERATION 17. GRIND BODY

Machines Used—Norton and Landis plain grinders.

Special Fixtures and Tools—Driving dog and plug-center (see operation 15).

Gage—Micrometer.

Production—One operator and one machine, 20 per hour.

Note—Wheel and work speed, and composition of wheel, same as in operation 16. Wheel maintenance averages 1c. per shell. Power required averages 30 hp.

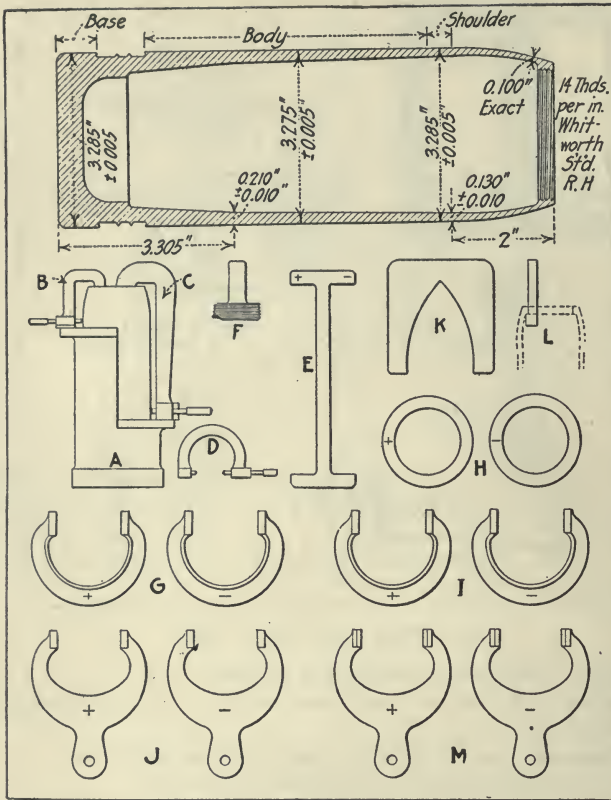

OPERATION 18. SHOP INSPECTION

Special Fixture—Holder for shell for gaging wall thickness, A.

Gages—Micrometer for wall thickness, B; for wall thickness, C; for wall thickness, D; for  $\pm$  overall length, E; for thread in nose; for  $\pm$  diameter of base, G; for  $\pm$  diameter at shoulder, H; for  $\pm$  body diameter, I; for  $\pm$  diameter over waves, J; for nose profile, K; for depth of nose recess, L; for  $\pm$  diameter of bottom of wave recess, M. Total of 17 gaging operations.

Production—Sixty shells per hour for two men.

OPERATION 19. FIRST GOVERNMENT INSPECTION

(Not illustrated)

Gages—Similar to those shown in operations 8 and 18.

Production—Six government inspectors take care of both the first and final inspection of 600 shells per day.

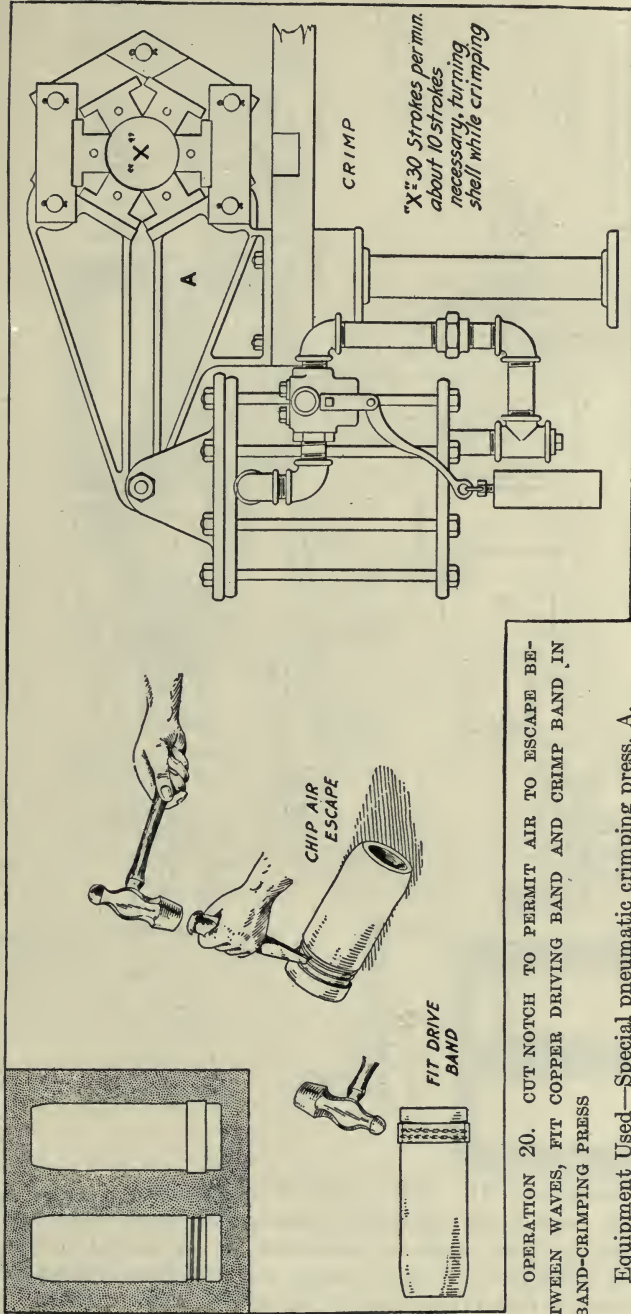

OPERATION 20. CUT NOTCH TO PERMIT AIR TO ESCAPE BETWEEN WAVES, FIT COPPER DRIVING BAND AND CRIMP BAND IN BAND-CRIMPING PRESS

Equipment Used—Special pneumatic crimping press, A.  
 Production—One machine and two operators (double shift), 30 shells per hour.  
 Notes—This press was designed and constructed at the Canadian Ingersoll-Rand shops. The copper drive bands must be annealed dead soft.

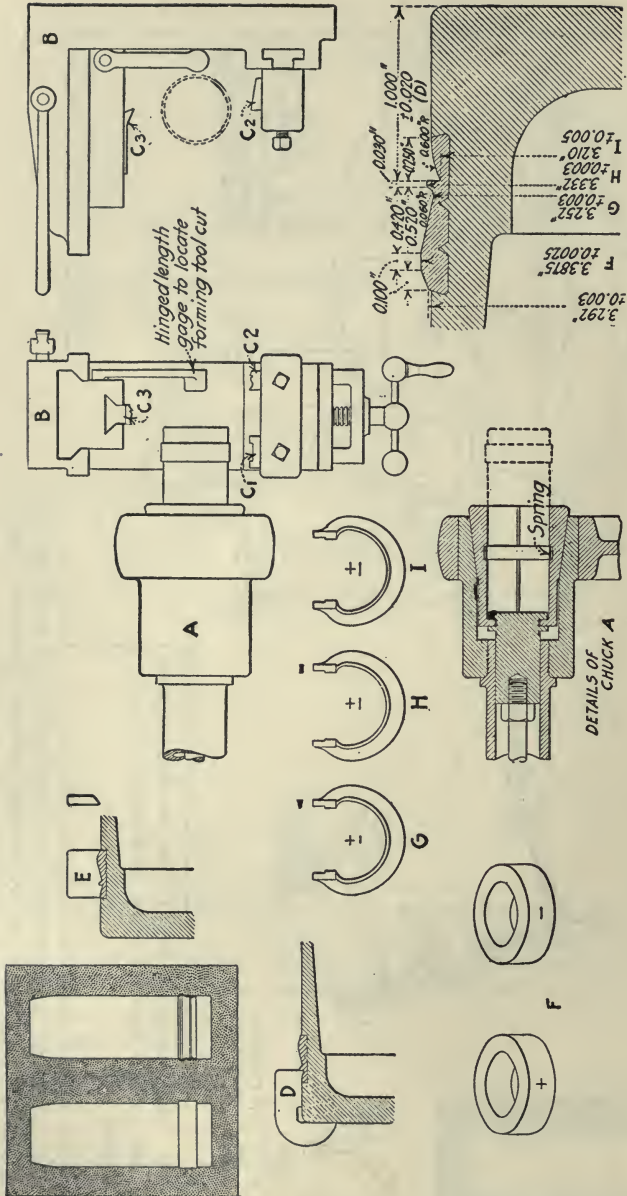

OPERATION 21. TURN AND FORM DRIVE BAND

Machines Used—Brass lathes and engine lathes with special forming slides.

Special Fixtures and Tools—Draw-in collet-chuck, A, and special forming slide,

- B. Cutting tools: Width tool, C1; rough turning tool, C2; finish forming tool, C3.  
 Gages—For height of radius from base, D; for form of band, E; for  $\pm$  diameter at F, F; for  $\pm$  diameter at G, G; for  $\pm$  diameter at H, H; for  $\pm$  diameter at I, I.

Production—From one machine and one operator, 15 per hour.



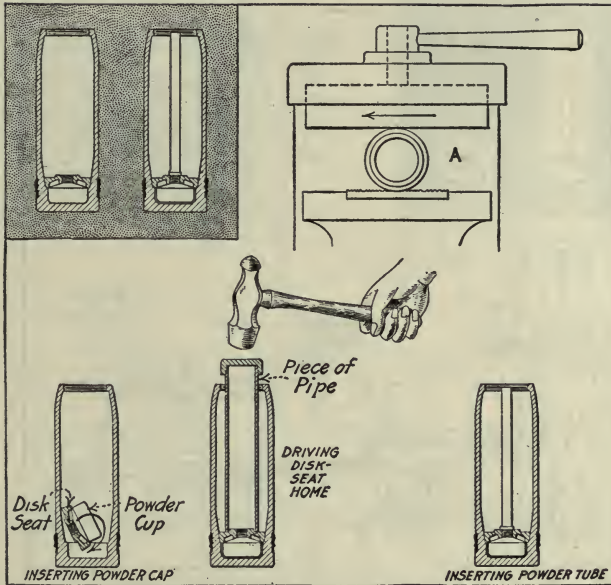

OPERATION 22. STAMP SHELL WITH INSCRIPTION, INSERT TIN POWDER CUP, DRIVE DISK HOME, AND INSERT BRASS POWDER TUBE

Equipment Used—Rolling press for inscription, A.

Production—One man, 40 per hour.

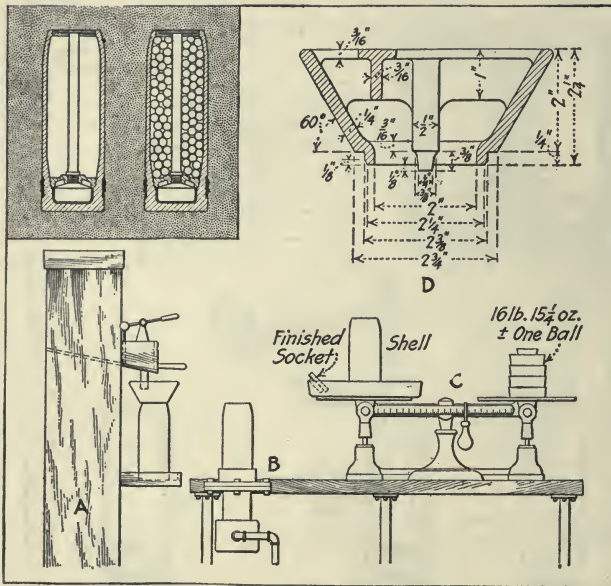

OPERATION 23. FILL WITH BALLS, JAR DOWN ON VIBRATOR AND WEIGH

Equipment Used—Shot box with self-measuring hopper, A; vibrator table, B; scales, C; shot funnel for centering powder tube, D.

Production—One man, 50 per hour.

Note—The necessity for shaking down on the vibrator depends on the roughness of the shot used. The vibrator is “borrowed” from a molding machine.

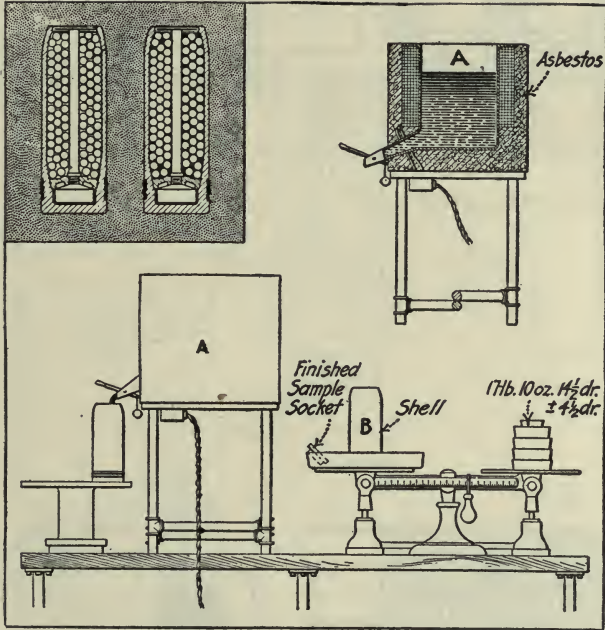

OPERATION 24. FILL WITH ROSIN AND WEIGH

Equipment Used—Electric rosin pot, A; scales, B.

Production—Two men and two rosin pots, 60 shells per hour.

Note—The rosin must be heated between 360 deg. to 400 deg., to fill the shell properly. The current consumption of each pot is  $2\frac{1}{2}$  kw., 11 oz.  $10\frac{1}{2}$  drams of rosin are required per shell. Exact weight is made with buckshot.

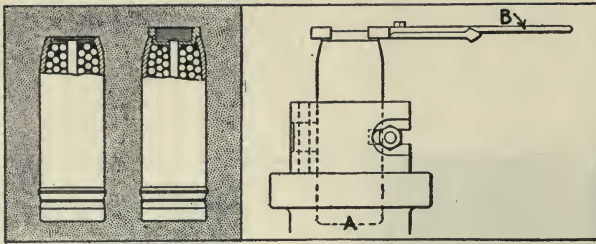

OPERATION 25. SCREW IN FUSE SOCKET

Equipment Used—Special hinged chuck, as vise, A; special tongs used as a wrench, B.

Production—One man, 60 per hour.

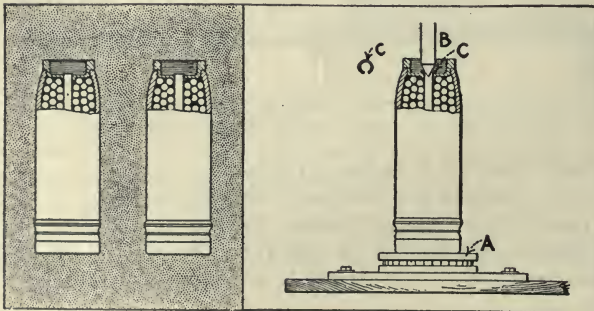

OPERATION 26. SOLDER POWDER TUBE INTO FUSE SOCKET

Equipment Used—Special ball-bearing table for rotating shell, A; electric soldering iron, B; solder rings, C.

Production—One man, 50 to 60 shells per hour.

Note—This remarkably high production rate has been maintained for several months.

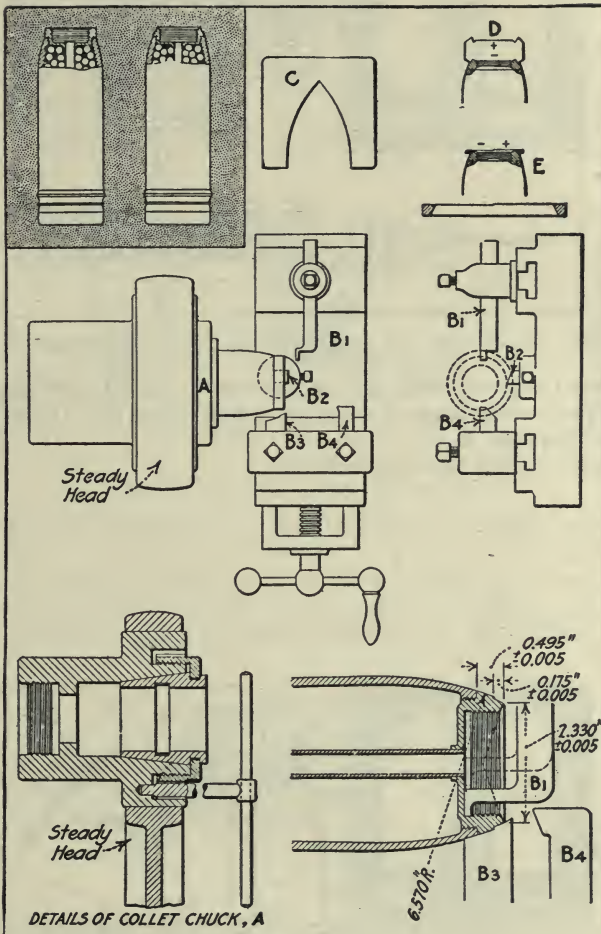

OPERATION 27. TURN, FACE AND UNDERCUT FUSE SOCKET, FACE CENTRAL POWDER TUBE

Machines Used—Brass turrets and modified engine lathes.

Special Fixtures and Tools—Special split collet chuck with scroll ring, A. Cutting tools: Facing and recessing tool, B1; rough turning tool, B2; forming tool, B3; forming tool, B4.

Gages—Profile template, C; limit bevel gage, D; nose undercut limit gage, E.

Production—One man and one machine, 10 per hour.

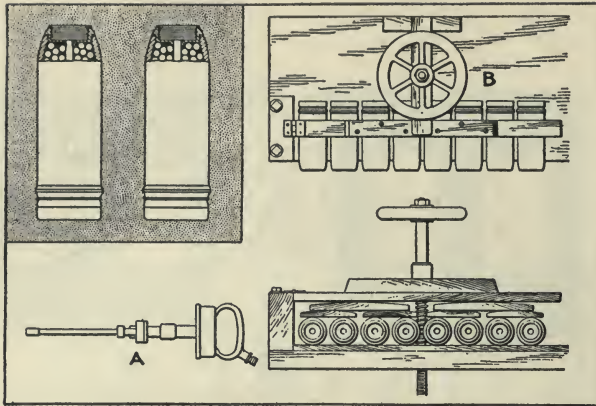

OPERATION 28. CLEAN OUT AND REAM POWDER TUBE (IF NECESSARY) AND INSPECT

Equipment Used—Air drills driving reamers, A; special equalizing clamp, B.

Gages—Fuse socket gages as described for operation 27. Drive band gages as described for operation 21.

Production—Twenty per hour per man.

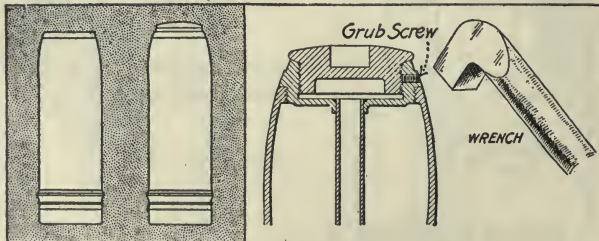

OPERATION 29. INSERT FUSE-HOLE PLUG AND GRUB-SCREW

Equipment Used—Special vise, similar to those shown in operation 25.

Production—One man, 50 per hour.

Note—The fuse-hole plug is a brass protecting plug and is removed when the fuse itself is attached.

OPERATION 30. FINAL GOVERNMENT INSPECTION

(Not illustrated)

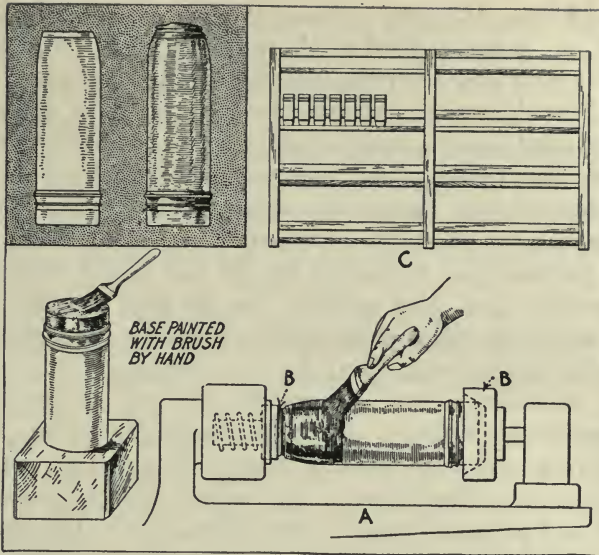

OPERATION 31. PRIME AND PAINT

Equipment Used—Reconstructed bolt threaders, A; spring cup centers, B; drying racks, C.

Production—Four men; prime, paint and stack 60 shells per hour.

Note—Shells are left to dry 24 hr. between primer and finish coat. Steel work is finished in naval gray, copper parts are finished with red lead.

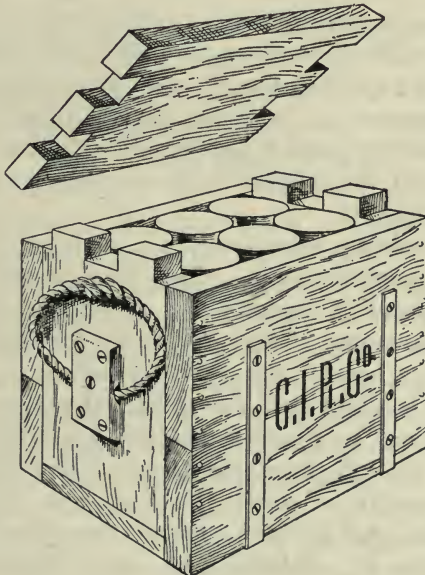

OPERATION 32. BOX FOR SHIPMENT

Note—Six shells are placed in each box.

**Various Kinds of Chucks.**—One of the first considerations, and a very important one, is the method of chucking the shell. The requirements are firm gripping and complete and rapid self-centering. The internal chuck used for the second operation presents the most difficult problem. With a restricted space in which to act, and its dimensions limited by the inside of the rough shell, it has nevertheless to withstand the most severe cutting strain of any during the whole process. The details of this chucking arbor are shown on the second operation sheet, and that it serves its purpose may be judged by the fact that a rough cut  $\frac{3}{16}$  in. deep and with a  $\frac{1}{8}$ -in. feed is taken over the shell at a speed of 70 ft.

The external chucking of the shell is a simpler proposition. Various types of chucks are being used for this purpose. The hinged chuck shown in operation 6 was one of the first put in service, but was not altogether satisfactory, as slight variations in the diameter of the shell, even within permissible limits of accuracy, made considerable difference in holding power. Split-collet chucks, as shown in operations 4, 21 and 27, have proved more satisfactory. The latest improvement is to equip several of these chucks with draw-in collets operated by compressed-air pistons, which effects a creditable economy in the time of chucking. It will be noticed that in nearly all cases the special chuck is equipped with a "steady-head," which is necessary to avoid spring due to the length of the shell.

**The Advantages of Subdivided Operations.**—There are two widely different principles in quantity manufacturing, each of which has its apparent advantages and supporters. These are nowhere any better illustrated than in the manufacture of shrapnel shells. Some believe in putting as many operations as possible upon one machine; others, in reducing each operation to its lowest terms. The Canadian Ingersoll-Rand management advocates the latter. It produces several arguments in favor of this plan, in addition to the final proof of a remarkably low total-production time.

"When you multiply operations, you multiply trouble," says Mr. Sangster, plant superintendent. "You have more trouble in making an expert operator out of a green hand, and the delay is more serious in case anything goes wrong. Taking all in all, the flexibility and freedom from serious delays accompanying fine subdivision of operation more than make up for the slight extra cost of handling pieces from one machine to another." It may be possible that this simplification of operations has something to do with the quickness with which this organization has taken hold of a new line of work. Each man has a simple and definite task to accomplish, and his work presents a problem which is not made difficult of solution by containing too many variable and unknown quantities.

**Gages.**—Shell manufacture is strictly a limit-gage proposition and



necessitates, in addition to the master set of gages used for reference purposes, a set of inspection gages and corresponding gages at each machine for which inspections are required.

Most of the gages employed by the Canadian Ingersoll-Rand Co. are of the "snap" type, having maximum and minimum measuring surfaces on the same gage. One of the most ingenious is shown in operation 8 at *B*. This is used to measure the depth of the powder pocket. The inner gaging spindle slides within the outer reference sleeve, and is provided with a notch milled at its upper end, with two surfaces, one plus and one minus. The inspector, by grasping the outer sleeve and placing his thumb on the notch, can readily feel the register of maximum and minimum surfaces with the outer sleeve and perform his inspection without the necessity of looking at the gage.

Another well-designed device indicates the thickness of the base of the shell. It is shown at *A*, operation 8, and consists of a surface plate, a mandrel for holding the shell and a maximum and minimum gage fastened into a heavy base which slides upon the surface plate.

**Shop Conveniences.**—The transportation system which was in use at the Canadian Ingersoll-Rand Co. plant was well adapted to care for the requirements of shell manufacture. Transfer trucks with removable platforms formed an important part of the complement of the shop, so special box platforms were constructed conveniently to hold the shells. Each of these box platforms holds 60 shells, one-half the common unit lot of 120.

**Inspection.**—The arrangement of the shop inspections is made with the idea of catching defectives in time to prevent unnecessary labor loss. The first inspection, operation 5, is made to come before the shells are bored, so that any defects or pipes which would condemn the shell may be discovered at this time. Shells which have the least sign of defect at the base end are immediately rejected, since a flaw at this point might be the means of igniting the bursting charge in the shell at the time that the exploding charge in the cartridge case is fired.

**Heat Treatment.**—Heat treatment is one of the most critical operations on the shell and must be given careful handling. The insistence upon this point is due to the tendency of a shell when fired to change its shape while in the gun. There are enormous strains imposed at this time, and if the material in the shell is of low elastic limit or too ductile, it is likely to expand and grip the bore of the gun, causing an explosion.

The muffle type of furnace has been adopted for heat treating the shells as being more convenient than the ordinary heating furnace, which necessitates a higher lift in placing and removing the shrapnel. It must be stated, however, that the cast-iron pots which are used in the muffles at present are not altogether satisfactory, since they burn out quite frequently. Steps are now being taken to design furnaces of the

same general type but constructed entirely of firebrick. Electrical pyrometers are used to indicate and control the temperatures.

**Closing-in the Shell.**—The “bottling,” or closing-in, of the shell is a simpler operation than most people imagine. The nose end of the shell is heated to a dull red heat in a lead pot. At this temperature, very little force is required to close up the nose end, and it has been done on almost every conceivable kind of a machine from tire upsetters to bulldozers, not excluding steam hammers and punch-presses. At this plant, a reconstructed mine-drill sharpener is used for the purpose, and the bottling die is water-cooled so that the shell will drop out without sticking.

**Grinding Operations.**—The main metal cutting operations are completed with operation 14, after which the body and nose of the shell are ground to finished size. This is quite a recent development and was introduced in the shops of the Canadian Ingersoll-Rand Co. to increase output rather than for the slight saving in cost realized from grinding the shells instead of finishing them in a lathe, as was the former practice. A very considerable increase in output from a given floor space was made possible by the adoption of the grinding process.

The critical inspection following the grinding operations, however, makes it imperative to keep the grinding wheels in proper shape. This is done by means of diamond truing-up devices. One of these for the nose wheel is shown in operation 16; it consists of a radial diamond holder mounted so as to reproduce the radius of the shell nose on the grinding wheel. It will be noticed that, in addition to its curve, this wheel has a straight face for approximately  $\frac{3}{8}$  in. at the side nearest the base end of the shell. This is produced on the wheel after truing the curve by locking the diamond in position and allowing the wheel to traverse. At this point is the “shoulder” of the shell, which is from one to two thousandths larger at this diameter than at any other, excepting, of course, the copper drive band.

Every effort is made to economize in time and labor on the part of the grinder operators. The driving dog and plug center required prior to grinding are fitted by an operator who does nothing else, thus enabling the grinder operators to produce shells at the rate of 20 an hour for the body grinding and 40 per hour for nose grinding.

Two grinding operations are employed at this plant. This is less than the usual number, one grinding being eliminated by operation 4, in which the base end of the shell was turned to its finished size. Where this is not done, it is necessary to readjust the driving dogs and finish the base of the shell by a third grinding operation.

**The Preliminary Inspection.**—After the grinding processes, the shell is completed as far as its steel case is concerned, all further machining operations being upon the copper and brass attached parts. Therefore,

the shells are at this point checked up by the Government inspectors, and to insure as small a percentage of rejections as possible, they are prior to this given what is called a preliminary inspection by the shop inspectors.

One of the most interesting gaging fixtures used is that for determining the thickness of shell walls at various points. This consists of a holder shown in operation 18. This fixture is made so as to locate the shell accurately with reference to two finished surfaces that serve as bases for special micrometers to rest upon, insuring that the thickness of wall shall be gaged in each case at similar points.

The micrometers, if such they may be called, are also unusual. The measurement is not made by means of a screw, but by plus and minus location surfaces on the sliding spindle, which indicate by their alignment with a milled recess in the holding sleeve. The register of these plus and minus surfaces can be felt with the finger nail without the necessity of looking at the gage.

The Government inspectors have been forced instinctively to adopt a sort of motion study in order to keep up with their work. With over 40 inspections on each shell and 500 shells per day, it requires a great deal of activity on the part of six men to keep up the 20,000 necessary measurements. As a result, the operation has become very specialized. The inspectors follow one another, some of them with gages in each hand, along the lines of shells laid out on benches. It is a question as to how much these methods which have resulted from having to get the job done in a given time could be improved by actual time or motion study made in advance of the work.

**The Copper Drive Band.**—The copper drive band is a very important part of the shell. It is forced into the rifled grooves of the field piece, and causes the shell to rotate as it travels through the air. This copper band in reality imparts the spin to the entire shell and does this in such a short interval that the strain to which it is subject is enormous. There must be no possibility of its turning on the shell. This is the reason for the peculiarly waved ribs in the band recess.

The drive bands in the rough shape are simply copper rings large enough to go over the base end of the shell. One or two blows of a hammer secures them from falling off until they are forced down into the recess by the band-crimping press. The machine used for this purpose at the Ingersoll-Rand plant is one of their own design. The crimping dies are actuated by toggles connected with a lever arm that is operated by a compressed-air piston. This type of banding press appears to be more convenient than the horizontal type, in which the weight of a shell must be supported at arm's length.

The drive band is machined to a very peculiar finished shape. This is shown in operation 21, which also indicates the process by which the

copper band is turned to its final form. The lathe on which this operation was observed had a "home-made" forming slide attached to the rear of the carriage. This slide carried a tool which took the finishing cut. Being fed tangentially across the work instead of straight in toward the center, this tool took a shearing cut and distributed the heat much more than a radially fed forming tool would do. In fact, before this attachment was used, front and back radial forming tools were employed, and the shell became so hot that to prevent distortion it was necessary to fill it with soda water previous to this operation.

**Filling the Shell.**—An understanding of the succeeding few operations in which the shells are filled will be helped by referring to Fig. 23. Here are shown the parts to which reference will be made frequently. The

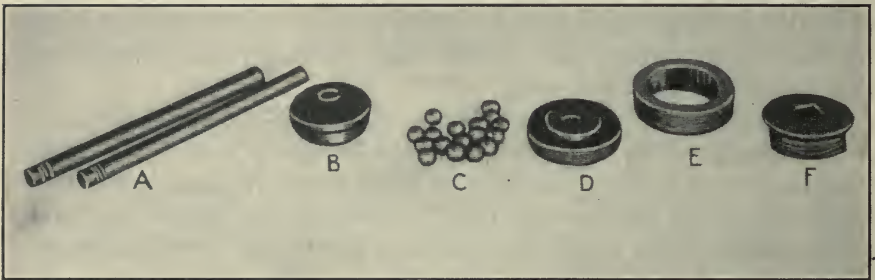

FIG. 23. THE POWDER TUBE, POWDER CUP, LEAD BALLS, STEEL DISK, FUSE SOCKET AND PLUG

brass powder tube having a shoulder at one end and a thread cut beneath it is shown at *A*. At *B* is the tin powder cup of a shape to fit in the powder pocket, and at *C* the  $\frac{1}{2}$ -in. lead balls which are used in this size of shell. At *D* is the steel drive disk, which is an unfinished drop forging, and at *E* the brass fuse socket, which is machined from a brass stamping. At *F* is the brass plug, which is made from a casting. All of these parts, as well as the steel shell forgings are furnished to the plants that are turning out shrapnel. The parts *A*, *B*, *C*, *D* and *F* are in finished shape when received and require no labor other than that of assembling them into the shell. The fuse socket *E*, however, after becoming a part of the shell, is machined as shown in operation 27. The Canadian shell manufacturers who perform the operations described in this article furnish only their labor.

It is somewhat of a problem to the uninitiated to figure out how the tin powder cup, which goes into the powder pocket underneath the steel disk, can be introduced after this disk is within the shell, but the man who is doing this work does not seem to find it difficult. Proportions and dimensions are so figured that a dexterous movement causes the steel disk to turn a somersault, carrying the tin powder cup with it to its correct position. The powder cup is, of course, empty. Later on, but

not at this plant, it is to be filled with the explosive charge which will cause the shell to burst. The brass powder tube makes this possible by keeping a source of communication open between the fuse socket and the tin powder cup.

**Lead Balls Embedded in Rosin.**—The Government is particular to have each shell inscribed with the date of manufacture and the initials of the plant in which it was made. This is done upon the side or body of the shell, and for this purpose the Ingersoll-Rand Co. has pressed into use the inscription-rolling machine with which they formerly marked the barrels of their pneumatic hammers. That it is well adapted for this purpose is indicated by the fact that the man who operates it is also able to take care of inserting the tin powder cups and of screwing the brass powder tubes into the disks after the latter have been driven home with blows of a hammer.

One who might anticipate difficulty in getting a full measure of peas or potatoes on account of their not settling to the bottom of the receptacle, would not expect to encounter similar trouble in connection with shot. But it exists, and for that reason it is necessary to do one of two things to get the required number of balls in a shrapnel shell—either put them in under pressure or jar them down by vibration. The latter plan has been adopted as cheaper, and a molding machine vibrator has been “borrowed” for this purpose and attached to a small round table upon which the shells are placed while being filled from the shot box. The funnel which is used to introduce the shot has a central boss with a hole in it that serves the purpose of centering the free end of the brass powder tube. The man who fills the shells with shot must also give them a preliminary weighing to be sure that he has introduced a sufficient number.

**One Reason for the Rosin.**—If one tries to imagine the action of a rapidly rotating hollow shell filled with round balls of such a heavy material as lead, one can see a very good reason for cementing the shell and its contents into one solid mass by means of rosin. If they were not held homogeneously by some such material as this, the shell would perform very peculiar actions during its flight very similar to those of a “loaded” ball on a bowling alley. Another reason for filling up the air spaces between the balls is that it gives the explosive charge less room to expand and therefore bursts the shell with greater force.

The men who fill the shells with rosin also take care of the final weighing. They are allowed to make up the weight of one  $\frac{1}{2}$ -in. ball by means of bucketshot; this giving them a slight margin whereby they can correct variations in the weight of the metal parts. This weighing must be done in a hurry, for the shell must be handed to another operator who screws home the fuse socket before the rosin sets.

Extreme uniformity of weight is very necessary in these shells. The

fuse, which will be added before the shells are fired, is graduated in  $\frac{1}{6}$ -sec. divisions, each of which corresponds to approximately 50 yd., becoming less, of course, as the shell nears the end of its flight. Therefore, to make range-finding possible, the action of shells of the same caliber must be very similar. A slight difference of weight would be fatal to accuracy. The total allowance is plus or minus  $4\frac{1}{2}$  drams, making a total tolerance of a little over  $\frac{1}{2}$  oz. on a weight of 18 lb.

**Soldering 60 Tubes per Hour.**—Soldering the powder tubes to the fuse sockets is performed by laying the shells, one at a time, upon a rotating ball-bearing table (operation 26), placing a solder ring over the outside of the tube where it projects through the fuse socket, and then completing the operation by holding the point of an electric soldering iron within the tube and spinning it around by hand until the solder melts. Such simple helps as the ball-bearing table and the solder rings make possible the soldering of 60 tubes per hour.

**Final Machining Operation.**—The last machine operation (operation 27) consists of finishing off of the protruding part of the fuse socket, facing off the powder tube and removing the surplus solder. Sometimes it is necessary to clean out and ream the powder tubes with an air drill and reamer, but if not, the shells go direct to a final inspection, after the brass plug has been inserted in the fuse socket and fastened with a grub screw.

**Painting with Bolt Thread-Cutting Machines.**—Rotating the shells between spring cup centers of bolt threadcutting machines greatly expedites the painting of the shells in the Canadian Ingersoll-Rand Co. plant. Two machines are used for this work, one for applying the priming coat and the other the finishing coat.

**Boxing for Shipment.**—After the newly painted shells have been allowed to dry for 24 hr. they are packed in substantial wooden boxes, holding six shells each, for shipment to England. These boxes are of heavy construction, bound together by iron bands, and 26 wood screws are used for each box. Spliced rope handles are provided for convenience and safety in handling—see operation 32.

#### THE DOUBLE-SPINDLE FLAT TURRET LATHE.

Economical as have proved the methods of manufacture employed in the plant of the Canadian Ingersoll-Rand Co., munition plants which were equipped with doublespindle flat turret lathes fitted up these machines with the necessary tool accessories for shrapnel work with such excellent results that a description of the operations performed on such lathes is of particular interest.

In one plant where the machine mentioned was observed, it had been fitted with a chuck of novel design. Ordinarily, for the first operation,

the shells are gripped on the inside by means of an expanding arbor. In this case, almost unlimited additional driving power was secured by the use of a three-jaw exterior-gripping chuck. Since the thickness of the shell varies in the rough forging, it was necessary to make provision so that the alignment of the work should be determined by the inside chucking and gripped by the exterior chuck jaws simply in conformity to this. This was accomplished by cutting away the scroll support of the chuck so that in reality it forms a floating scroll ring, permitting the jaws to accommodate themselves to the work as chucked on the internal arbor but retaining the function of closing together when the scroll is turned.

Three main operations, the first two performed in sequence and the third after the shell is heat-treated, the disk inserted and the nose end bottled, are performed on the double-spindle machine. These differ little from those performed on single-spindle machines, but can be performed much more expeditiously—the production of cases on the double-spindle machine averaging some 60 per cent. greater than can be obtained on the single-spindle machines with the same set-up. Two double-spindle flat turret lathes have an output, including all three operations, of about eight shells per hour. Briefly outlined, the operations, taken in sequence, are as follows:

*First Operation.*—1. Rough-turn the outside diameter of shell body. 2. Form the recess and shape the base end of the shell. 3. Form the waves. 4. Undercut the recess for the drive band.

*Second Operation* —1. Rough-bore the powder pocket and turn the nose-end taper for bottling. 2. Rough-bore the disk seat. 3. Finish-bore the powder pocket. 4. Finish-bore the disk seat.

*Third Operation.*—1. Bore the nose for its tap hole and rough-turn the nose profile. 2. Face the end and rough-form the inside of the nose. 3. Finish-face the end and finish-form the inside of the nose. 4. Tap with a collapsible tap.

In the first operation (see Fig. 24), the shell is held by the nose end, while in the second and third operations (see Figs. 25 and 26) the shell is grasped by its base. In each of the four positions of the turret in each operation, two shells are worked upon at the same time, so that in the three main operations, necessitating but three set-ups of the work, twenty-four separate tasks are performed—twelve on each shell. This enables a shell proper to be completely finished in about fifteen minutes.

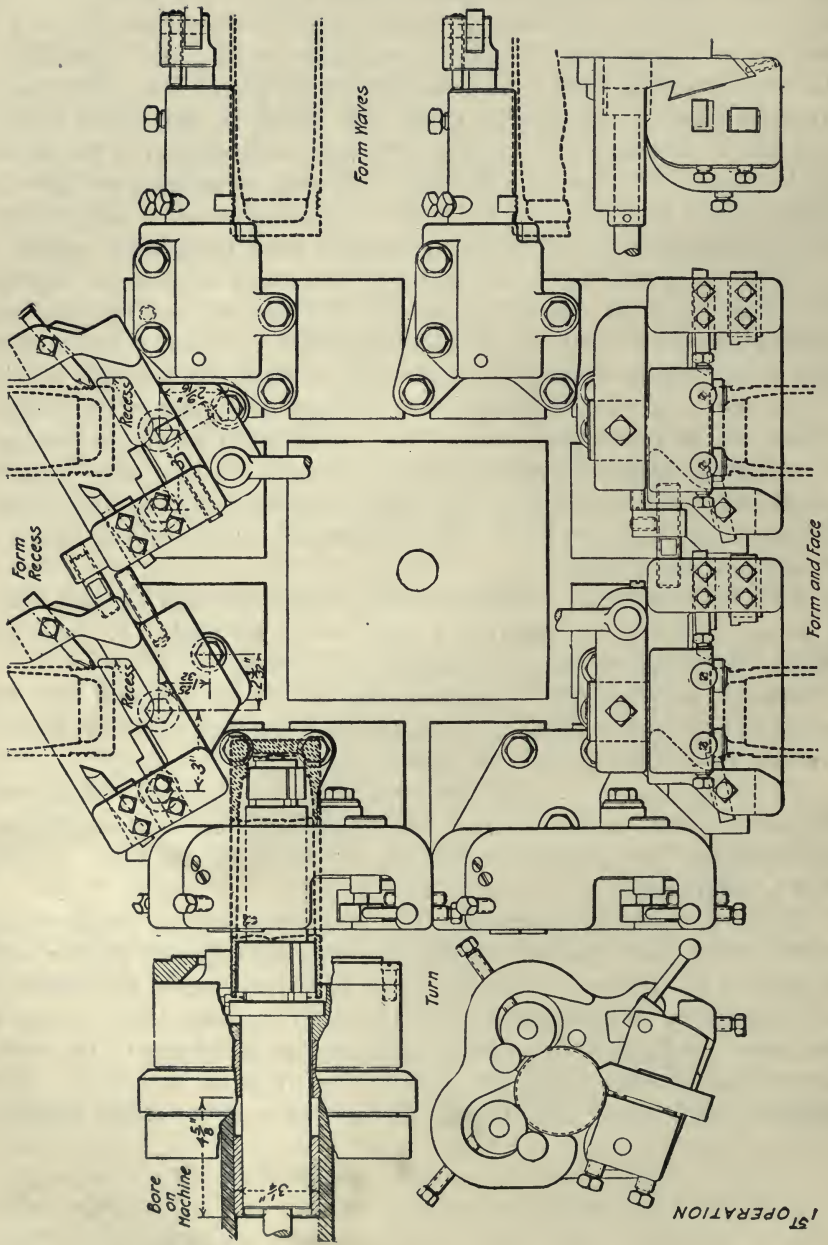
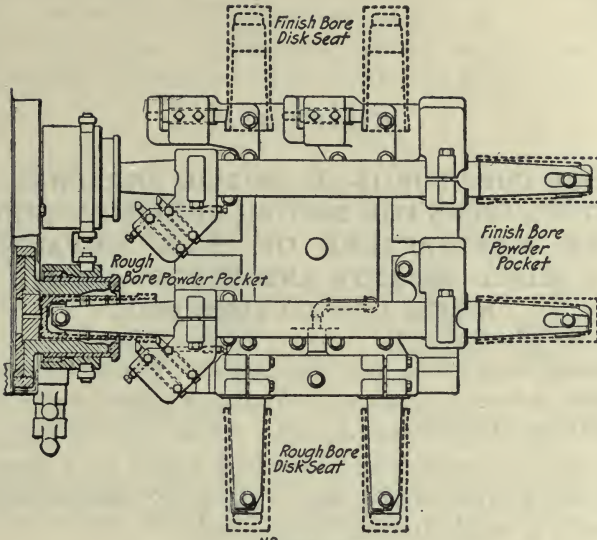

FIG. 24.





2<sup>ND</sup> OPERATION

FIG. 25.

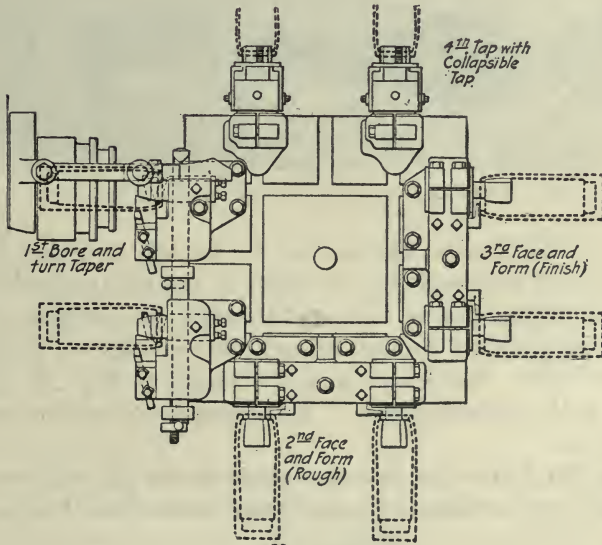

3<sup>RD</sup> OPERATION

FIG. 26.

## CHAPTER IV

### TIN POWDER CUPS FOR 18-LB. BRITISH SHRAPNEL<sup>1</sup>—PUNCHING STEEL DISKS FOR BRITISH SHRAPNEL SHELLS<sup>2</sup>— THE MANUFACTURE OF 18-LB. SHRAPNEL SHELL SOCKETS AND PLUGS<sup>3</sup>—FROM BIRCH LOG TO FUSE PLUG<sup>4</sup>

The powder cups which hold the explosive charge for shattering the shrapnel shell and scattering the load of lead balls fits into a machined recess in the base of the shrapnel shell. These cups are made of heavily coated tin and are connected to the fuse socket by a brass or copper tube. The top portion of the cups is made of 0.036-in. stock and the bottom portion of stock 0.022-in. in thickness.

**Drawing the Cup Bottom.**—The bottom of the powder cup is completed in one operation, and the die-blanking and drawing in one stroke of the press. In Fig. 27, at *D* can be seen the shape of the bottom after

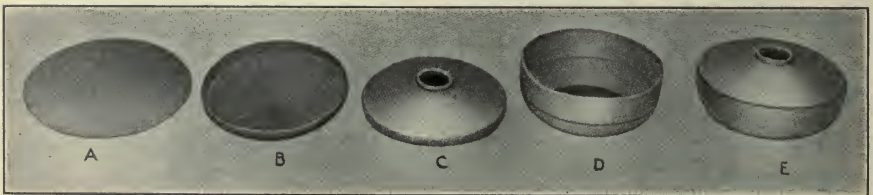

FIG. 27. STEPS IN THE PROCESS OF MAKING A TIN POWDER CUP

coming from the press. The bottom die for this operation is shown in Fig. 28. Here *C* represents the die itself; *A*, the ejector, and *D*, the form block, which is operated by four pins through the holes *B*. These pins come in contact with a rubber stripper underneath the press, which is of the usual type. The upper punch is shown in Fig. 29, *A* being the punch and *B* the drawing block. These punches and dies complete the bottom portion.

**Forming the Top.**—The first operation on the top requires a straight blanking-die, and as this is an every-day proposition I have not illustrated it.

<sup>1</sup> J. H. Moore.

<sup>2</sup> E. A. Suverkrop, Associate Editor, *American Machinist*.

<sup>3</sup> J. H. Moore.

<sup>4</sup> John H. Van Deventer, Managing Editor, *American Machinist*.

The second operation dies for forming the top, are shown in Fig. 30. In this, *A* represents the upper form punch; *B*, the knockout pin operated from the upper stripping attachment on the press, and *C*, the lower form die and ejector. The illustration shows this die clearly.

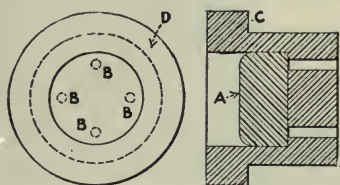

FIG. 28. BOTTOM DIE USED FOR DRAWING THE POWDER-CUP BOTTOM

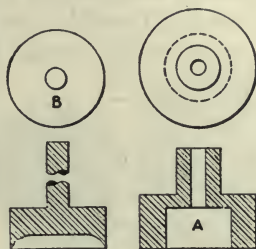

FIG. 29. PUNCH USED IN DRAWING POWDER-CUP BOTTOM

The third operation is the piercing of the top hole to take the copper tube, and this again being an exceedingly simple operation is not illustrated.

The fourth and last operation is that of making the small flange on top, and the dies shown in Fig. 31 will clearly illustrate this work, *A*

being the upper form punch with the flange-forming punch inserted; *B*, the lower die, and *C*, a hole of sufficient diameter to allow the forming of the flange.

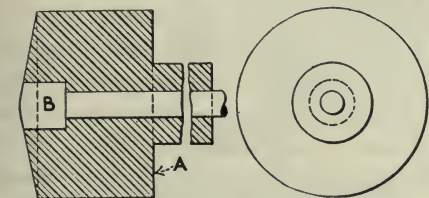
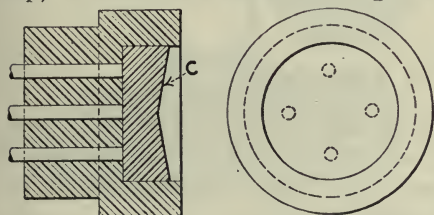

FIG. 30. PUNCH AND DIE FOR POWDER-CUP TOP

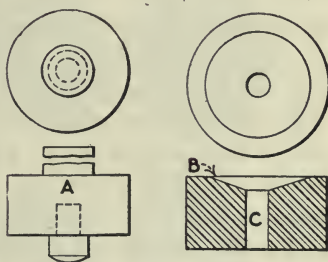

FIG. 31. FLANGING TOOLS

Referring to Fig. 27, *A* represents a blank from which the top portion is formed; *B*, the blank after the forming operation; and *C*, the blank after being pierced and flanged. The finished bottom portion is illustrated by *D* and in *E* is shown a finished powder cup.

**Assembling the Powder Cup.**—Power presses or simple lever foot presses are used for assembling the cups, a die similar to that shown in Fig. 32 pressing the two portions together. The cups are then soldered

and this is expeditiously done on the special soldering machine shown in Fig. 33.

The cups are spun around in the machine and the soldering operation consists simply in holding a hot soldering iron against the revolving cup, the necessary solder being supplied meanwhile. A releasing attachment on the handle *B* enables the cups to be rapidly inserted and removed so that output of the simple machine is high.

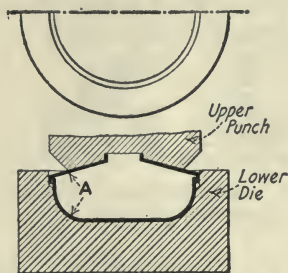

FIG. 32. ASSEMBLING THE TIN CUP

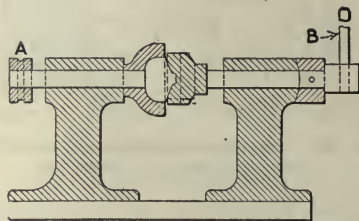

FIG. 33. ELEVATION OF SOLDERING MACHINE

Soldering completes the operations on the powder cups with the exception of the necessary inspection, as the loading of the cups is done at the government arsenals.

### THE PROTECTING STEEL DISK

Heavy as are the powder cups for British shrapnel shells, the crushing force caused by the inertia of the lead balls, etc., before fracture of the shell takes place, is such that additional protection is necessary for these containers of the explosive charge. This is afforded by a comparatively heavy steel disk of a good grade of low-carbon steel which is forced into the shrapnel shell base immediately over the powder cup.

The stock from which the disks for 18-lb. shrapnel are punched comes in bars about 10 ft. long,  $2\frac{1}{2}$  in. wide and approximately  $1\frac{5}{32}$  in. thick. Fig. 34 shows the various stages in the manufacture of the disks as performed in the Dominion Works plant of the Canadian Car & Foundry Co., Montreal, Canada, the first three of which are performed with the metal hot.

**First Operation.**—The bars, after being heated to a medium yellow in an oil-fired reverberatory furnace of the regular type, are presented to the press one at a time, the furnaceman supporting the cold end of the bar, while the press operator locates the hot end over the die. The two men can punch out about 3,500 blanks in 10 hr.

The press die, which is cooled by the drippings from a water spray played on the punch, is a plain cylindrical one,  $2\frac{1}{4}$  in. in diameter. The punch has a conical end in the middle of which is a teat, and the function

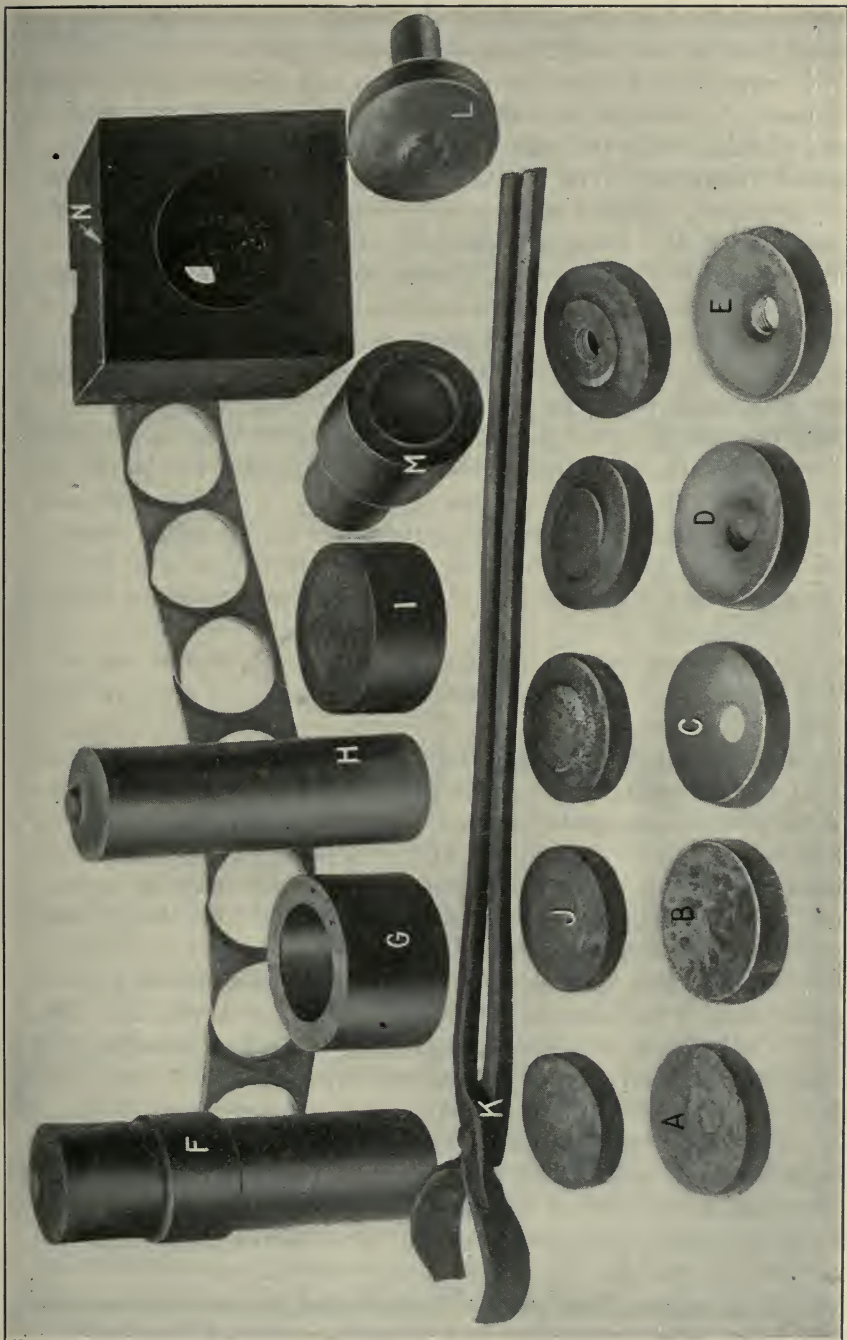

FIG. 34. TOOLS, SAMPLES OF CONSECUTIVE OPERATIONS AND SCRAP

of this tool, aside from punching out the blank, is to raise the edges of the blank, on the face entering the die, about  $\frac{5}{16}$  in.

The operation is quite severe on the dies and punches, particularly the former. An average die will produce about 2,000 blanks before it requires closing, while the punches stand up for about 5,000 blanks.

**Second Operation.**—The blanks from the first operation are, in the second operation, reheated and squeezed between the male and female dies shown at *H* and *I*, Fig. 34, the lower die throwing up the boss *J*.

The dies in this operation are also water cooled, and made of the same material as those used in the previous operation, and are usually good for from 6,000 to 7,000 pieces. The press, as in the first operation, runs continuously, but the output is somewhat less, about 2,800 being the average production for 10 hr.

**Third Operation.**—After the second operation, the disks are tumbled to remove the scale, and appear as shown at *C*, Fig. 34. The blanks are then heated for the last time and are subjected to a coining operation, the plastic steel being squeezed between the upper die *M* and the “knock-out” *L* which fits into the bottom of the lower die *N*, see Fig. 34. A lever inserted in the slot at the base of *N* ejects the coined disk by forcing up the “knock-out” *L*.

In this operation the dies are flooded with water, and a vent hole in the lower die provided for the escape of the steam so as to prevent possibility of fracture.

The dies for the coining operation are good for about 5,000 pieces each, but as the heated blanks can be handled only one at a time the output of the press is somewhat restricted, about 1,700 disks being produced in 10 hr.

**Fourth Operation.**—After the coining operation the work has a clean “bloom” on the outside, which is left on; that is, the disks are not tumbled after the last forging operation.

The next operation, shown at *X*, Fig. 35, is done on a Jones & Lamson flat turret lathe. The machine and tools are shown in Fig. 32. The work *A* is held in an ordinary spring collet. The flat centering-drill *B* is first brought into action so that the twist drill *C* will start true. Finally, the tap *D* is run in. In operation, the attendant chucks a disk with the small part of the taper at the inner end of the collet. The center drill *B*, twist drill *C* and tap *D* are run in in rotation. The tap, however, is not backed out by power. On reaching the proper depth the machine is stopped and the turret drawn back with the tapped disk still on the tap. The operator chucks another disk and repeats the operations as before, but while feeding the twist drill in with his right hand, with the left he removes the threaded disk from the tap.

The disk must be carefully chucked, for the tube which screws into it must be square with the seat, otherwise it will be cocked over and

trouble would ensue when the shell is fired, due to the inertia forcing the disk to seat properly, with resultant distortion of the tube or powder cup or both.

On this operation 600 can be produced in 10 hr.

The fifth and last operation is performed on a D. E. Whitton double-spindle centering machine, although in this operation only one spindle is used.

The work *A* is screwed on the rotating spindle. The spindle and work are advanced by a lever, not shown. The facing cutter *B* removes the

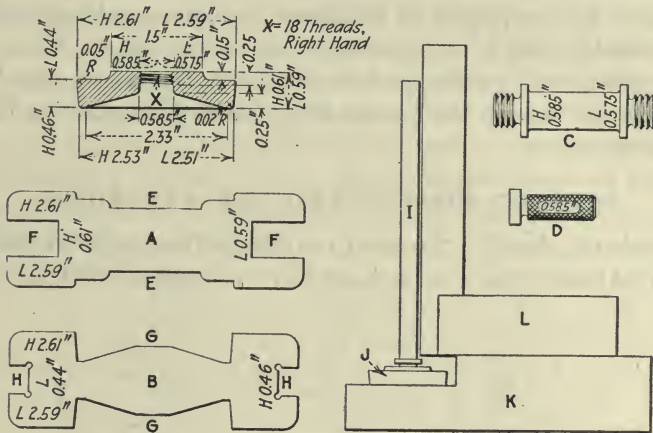

FIG. 35. MAKING STEEL DISKS FOR SHRAPNEL SHELLS

slight burr raised around the edge in the last forging operation by the metal entering the space between the knock-out and the lower die, and also finishes the slight flat surface required on the lower edge. The operator also gives the other edge a touch with a file to remove any slight burr formed at the space between the upper and lower dies. Pivoted on the pin *C* is a lever *D* with the front end provided with a toothed cam for holding the disk while removing it from the spindle.

The production of the burring and facing operation is 1,000 in 10 hr.

Inspection is rigid on the disks. The requirements are fairly close, if one takes into consideration the way the pieces are produced. The tolerance of 0.02 in. would perhaps be considered large for a re-striking operation in an up-to-date drop-forge shop; but it must be remembered that this is an ordinary blacksmith shop, where large rough work has been produced and the machine used is intended for the usual run of plate punching. In Fig. 35 are shown the work, in section with dimensions, and the inspection gages.

The gage *A* (about  $\frac{1}{8}$  in. thick) at *E* is for ascertaining the shape and diameter of the disk top and at *F* the total depth of the disk. The

dimensions being given, the application of the various gages to the disk will be apparent.

The gage *B*, also  $\frac{1}{8}$  in. thick, is for ascertaining at *G* the shape and diameter of the base of the disk (note the flats in the corners of the openings *G*). At *H* the thickness of the edges of the disk is gaged. The gage *C* is a thread gage for the central threaded hole. The plug gage *D* is for the recess which receives the top of the powder cup.

Having passed these inspections a tube is screwed into a disk *J*, as shown in Fig. 35, and with the disk *J* resting on the lower level of the two-surface plate *K*, is tested for squareness with the square *L*.

Owing to the inequality in thickness of commercial bar stock, disks are occasionally found, on inspection, to be too thick. These are returned to the smith's shop and re-struck, the excess of metal flowing into the tapped hole in the center, from which it is removed in the re-threading operation.

#### SHRAPNEL SHELL SOCKETS FOR 18-POUNDERS

The socket is placed in the mouth of the shell and turned to the desired shape. It is made from a very cheap alloy, consisting of 50 per cent. cop-

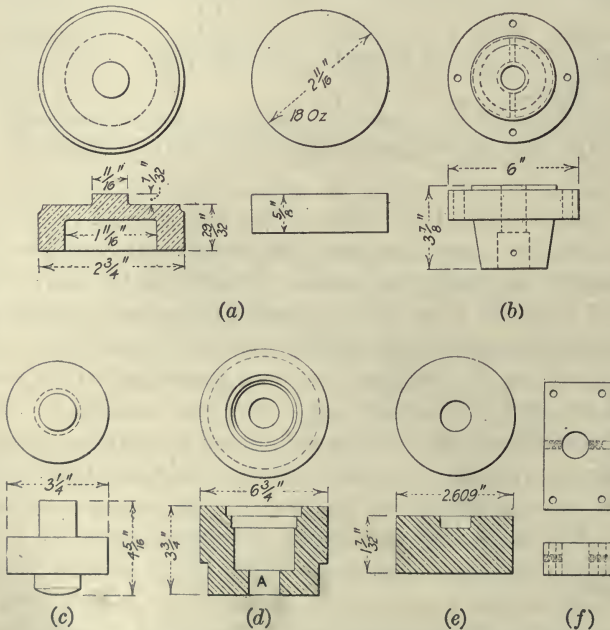

FIG. 36. DETAILS OF 18-LB. SHRAPNEL-SHELL SOCKETS

per, 40 per cent. zinc, and 2 per cent. lead. This metal is so poor that it has been found practically impossible to make satisfactory castings. They must, therefore, be forged to the desired form from slugs. For this pur-



pose a 300-ton knuckle-jointed press is used, as the pressure necessary to complete this work is enormous. A dry furnace for heating is generally used, gas being the heating medium. Some, however, prefer the lead bath for this part of the work. Either is satisfactory, though the gas furnace is a shade the better, as, with the bath, the lead usually gets into the dies. The slugs are placed in this furnace, and withdrawn at from 1,200 to 1,400 deg. F. At this temperature they flow easily and are not liable to rupture.

In Fig. 36(a) is shown the socket before and after forging. The slug is  $2\frac{1}{16}$  in. diameter,  $\frac{5}{8}$  in. thick and weighs 18 oz. This will give some idea of the displacement of the metal. The dies, with the exception of the lower bolster, are shown in detail in Figs. 36(b), (c), (d) and (e). The lower bolster is shown in (f). In (b) is indicated the type of top die, or punch holder, used, while (c) illustrates the top punch. In (d) the lower die for forming is shown, and in (e), the ejector block which goes into this die. This ejector is operated on by an ejector rod, which comes through the hole, A, (d). One blow completes the form, and the output of one press and furnace, with two men working, reaches approximately 4,000 per 20-hr. day.

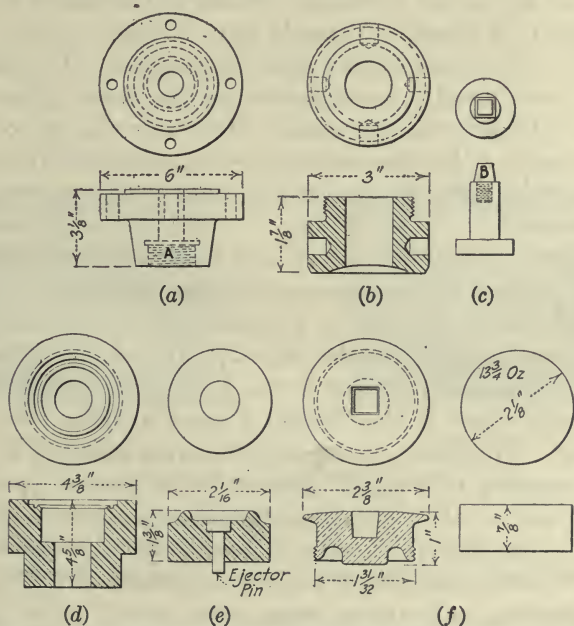

FIG. 37. DETAILS OF 18-LB. SHRAPNEL-SHELL PLUGS

**The Fuse Plug.**—The fuse plug is the portion screwed into the socket just described. It is made from the same alloy. When the shells are desired for use in actual warfare, this plug is unscrewed on the battlefield and discarded.

As the forging of this piece is practically the same as that described, the dies only will be shown. The top punch holder is shown in Fig. 37(a). In (b) is represented the outer sub-punch, to which is added the inner sub-punch, shown in (c). These two punches are screwed into A, (a). The small square punch shown at B in (c) is made from high-speed steel and is designed for easy replacement, as a great many break off while at work. In (d) is shown the lower form die, and in (e), the ejector block with ejector pin in place. The bolster plate for both plug and socket dies is shown in Fig. 36(f), the reason for making the dies interchangeable being to save the removal of this piece from the bed of the press. In Fig. 37(f) is shown the plug before and after forging; dimensions and weights being given.

The thread shown on the finished work is not done in the forging operation, but is produced afterward on the turret lathe.

#### BIRCH LOG FUSE PLUGS.

The throwing out of metal plugs on the battlefield to accommodate a time fuse or an impact detonator results in the loss of or damage to a great number of plugs; it scarcely pays to collect and return to the manufacturer of shrapnel those found undamaged. Obviously a quite appreciable waste results, notwithstanding the cheap grade of alloy of which the metal fuse plugs are made. Here then was an excellent problem for the display of Yankee ingenuity—one economically solved by the Estes Co. of New York by substituting hard wood plugs for the more costly metal ones.

White birch, yellow birch, beech and hard maple have been proved to withstand successfully exposure to climatic conditions without deformation, and serve quite as well as a protection to the threads of the fuse socket and for closing the powder tube opening as did the metal plugs. The birch which has been utilized by the Estes Co. comes from the Berkshire Mountains where is also located a wood working plant owned by that company. Proximity to the source of raw material is a necessity for a plant engaging in quantity production of wooded specialties and it is often cheaper to take the plant to the trees than it is to take the trees to the plant. The Estes Co. owns its forest and cuts timber according to a definite rotation plan which assures a constant and plentiful supply of timber—planting and cutting taking place twenty years apart.

**Manufacturing the Birch Log Fuse Plug for 18-Lb. Shrapnel.**—The logs, which range from 6 to 10 in. in diameter, are ripped into  $2\frac{5}{8}$  in. strips and stacked in dry kilns, the usual process of air seasoning having had to be accelerated to meet the enormous demand created for the plugs. After being thoroughly dried, the plugs are finished to the dimensions shown in Fig. 38 in six operations—see operations 1 to 6.

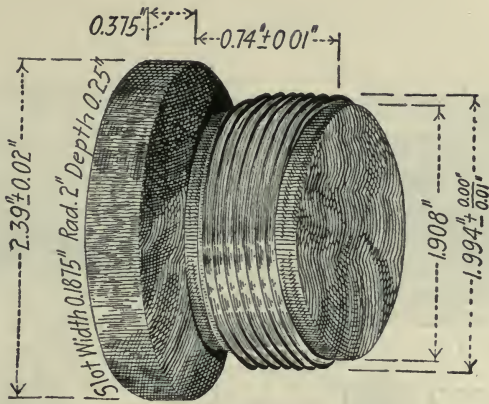
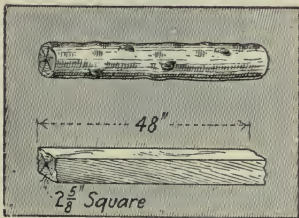
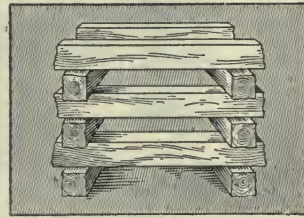

FIG. 38. PRINCIPAL DIMENSIONS OF THE WOOD FUSE-HOLE PLUG



OPERATION 1.



OPERATION 2.

OPERATION 1. RIPSAWING LOGS

Machines Used—Portable ripsawing outfits.

Special Fixtures and Tools—None.

Production—Depends on size of logs available. Four rip cuts taken at from 150 to 200 ft. per minute.

OPERATION 2. KILN DRYING

Machines Used—Dry Kilns.

Special Fixtures and Tools—None.

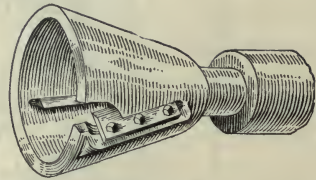
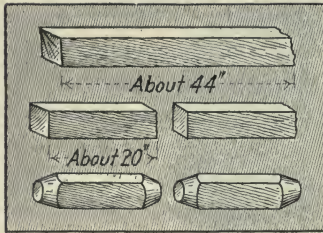

Section through Sniper showing Knives

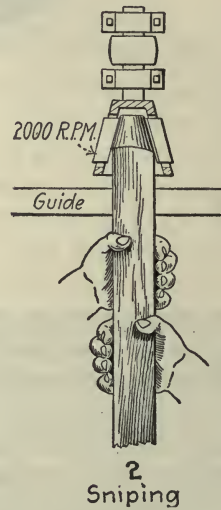
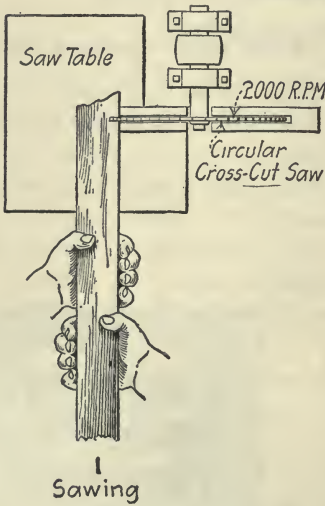

OPERATION 3. CROSS-SAWING AND SNIPIING

Machines Used—Combination Sawing and Sniping Bench.

Special Fixtures and Tools—None.

Production—One man saws and snipes both ends of from 15,000 to 20,000 pieces per day of 10 hr.

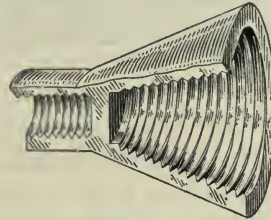
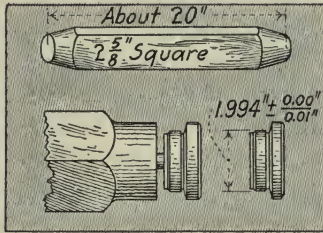

Conical Driving Chuck

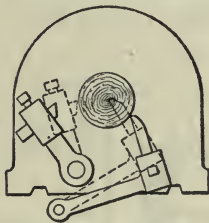
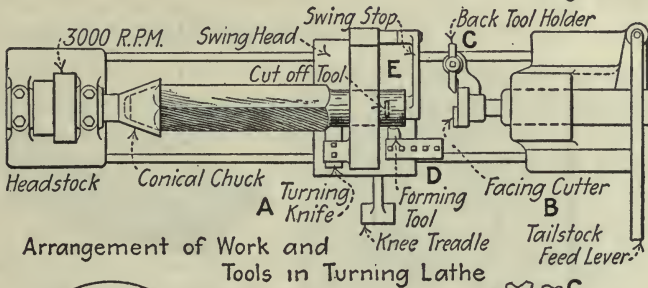

Action of Forming and Cut-Off Tools

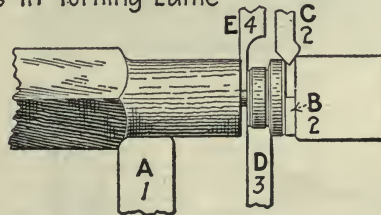

Sequence of Operations

OPERATION 4. TURN PLUGS

Machines Used—Special forming and turning lathes.

Special Fixtures and Tools—Turning Knife A; facing cutter B; beveling tool C; forming Tool D; cutoff tool D, special conical cup-screw chuck.

Gages—Ring gage for diameter of threaded part.

Production—One lathe and one operator, 8,000 pieces per day of 10 hr.

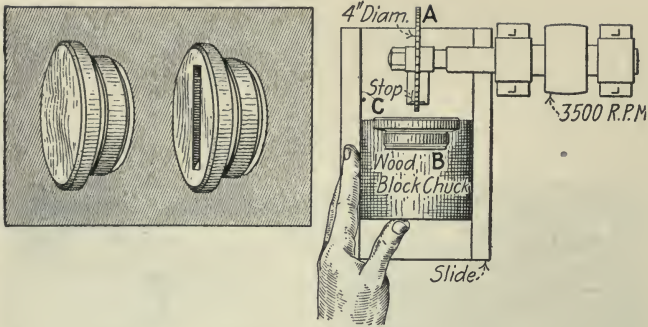

OPERATION 5. SLOTTING

Machine Used—Saw head and cross-slide.

Special Fixtures and Tools—4-in. cross-cut saw A; sliding wood chuck block B; position stop C.

Production—From one man and one machine, 15,000 pieces per day.

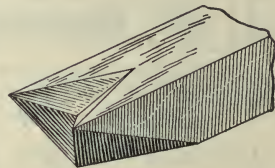
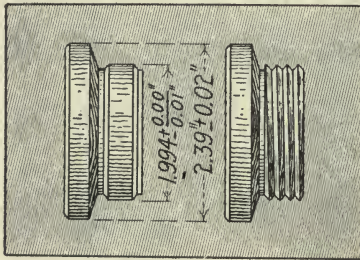

A-Threading Tool

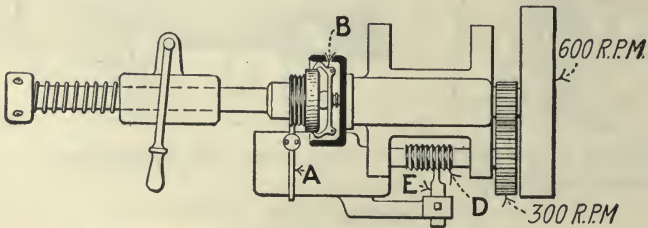

Arrangement of Work and Tools in Threading Machine



The "Nut"

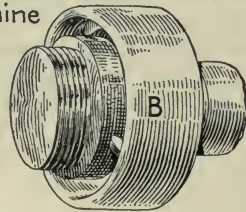

OPERATION 6. CUT THREAD

Machines Used—Special threading machine.

Special Fixtures and Tools—Square notched threading tool A; special self-acting chuck.

Gages—Ring thread gage for thread.

Production—From one man and one machine, 15,000 pieces per day.

Following the seasoning of the logs, they are cut into lengths ranging from 20 in. to 24 in. and of "sniping" or coning the ends of these sticks to fit the cone-shaped lathe chucks and the steadyrests. One operator takes care of both steps in this operation and completes a stick in less than 2 sec.

Five cutting tools are combined in the fourth operation, in which the sniped stick is turned into plug-blanks at the rate of 8,000 per day for one machine and one operator. One end of the stick is introduced into a conical chuck threaded upon the inside, which grips by cutting threads upon the conical end of the stick placed within it, thus forming a most secure combined drive and holdback. The other conical end is placed in the steadyrest.

This rest has a number of functions. It carries three tools—a turning tool for reducing the square stock to round, a forming tool that produces a large part of the plug profile, and the cutting-off tool that severs the completed blank from the stick. In making the plug, the steady head is first fed along the lathe shears toward the headstock, thus exposing sufficient of the rounded stock through the circular rest opening to allow of making one plug. The tailstock spindle is next advanced by means of a hand lever, bringing the facing tool and the beveling back-tool into contact with the plug. By pressing a knee-treadle, the lathe hand next brings up the forming tool, which swings on a pivot, into contact with the work. This same movement next causes the cutting-off tool to rise and completes the operation by detaching the plug.

The method of cutting the screw slot, which is done in the fifth operation, is quite similar to that employed in slotting metal screw-heads. A saw is used for this purpose, illustrated at *A* in operation 5. The plug, which rests in a simple chucking block, is pushed against the saw until the sliding block strikes the stop *C*. Fifteen thousand pieces per day from one machine and one operator is the usual production.

The method of making chucking fixtures such as used in this operation is quite simple. It consists in roughing out a recess in the block a little larger than the piece to be held, then securing the piece in the proper position and pouring melted lead around it.

Cutting the threads, the last operation in the manufacture of the fuse plugs, is performed on a simple type of lathe, illustrated in Fig. 39. The head and tail stock of this machine swing upon a pivot *C*, the tailstock serving simply to hold the fuse plug in the chuck. Geared to the head spindle is the feed screw *D*. After the plug is placed within the chuck and held by the advanced tailstock spindle, the operator presses down upon the tailstock lever, thus swinging the head and the tailstock on the pivot *C*, so that the feed screw comes in contact and engages with the single-thread bronze nut *E*, and at the same time the cutting tool *A* comes into proper relation with the blank to begin its cut. The action is

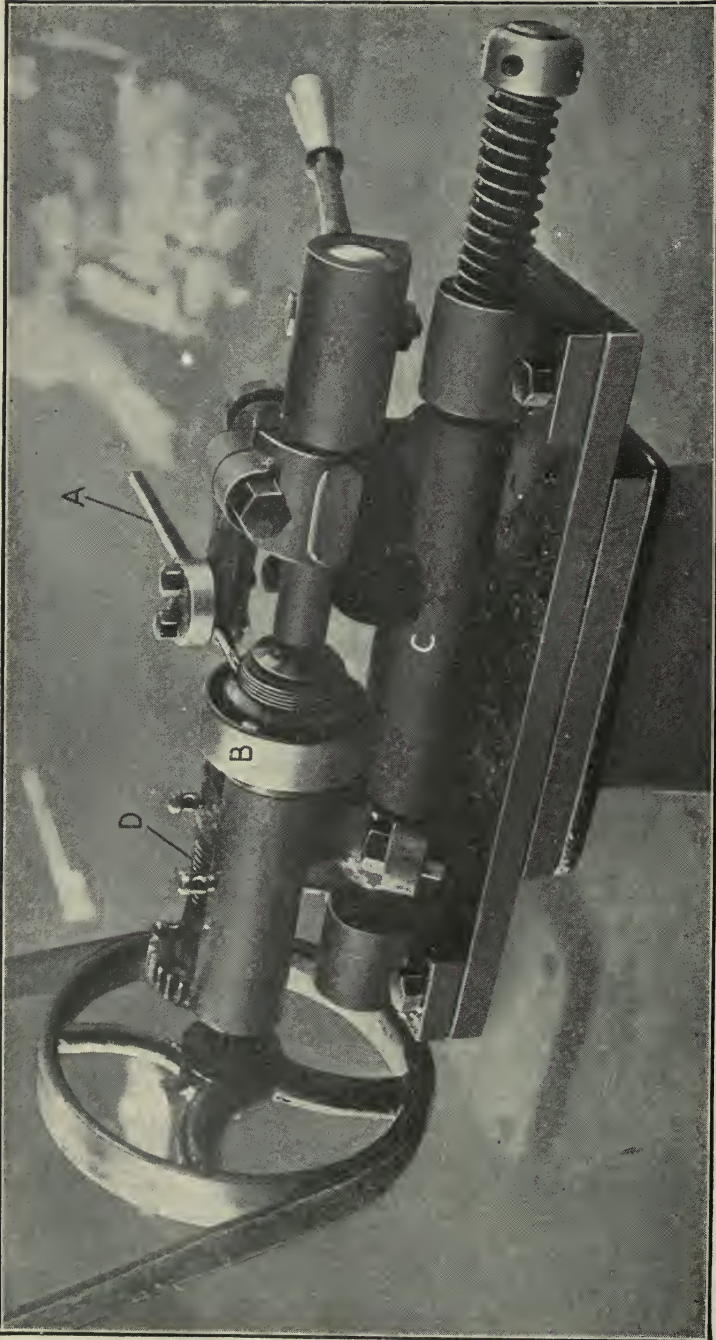

FIG. 39. SPECIAL MACHINE FOR THREADING WOOD FUSE PLUGS



exactly similar to threading with a single-point lathe tool. In the time that it has taken to read the description of this operation, the man running it would have completed some 40 or 50 plugs, for he turns out 15,000 in 10 hr.

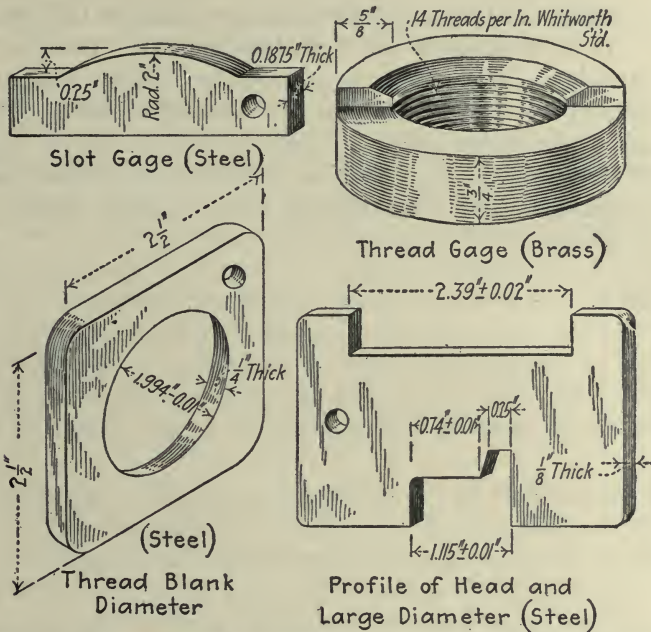

FIG. 40. GAGES USED IN INSPECTING WOODEN FUSE-HOLE PLUGS

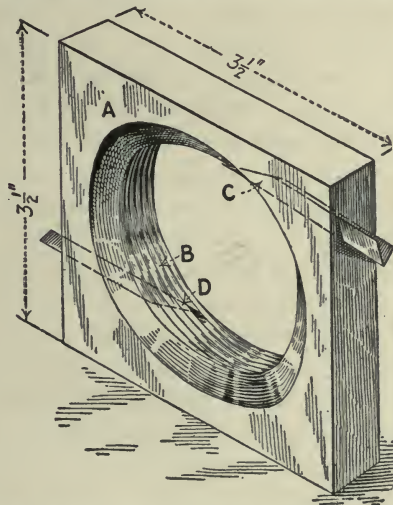

FIG. 41. DIE USED IN ALTERNATE THREADING METHOD

**Inspection of Fuse Plugs.**—Accuracy within quite narrow limits is required of the wooden fuse plugs, and, though the inspections and gagings are not as frequent as in the case of metal plugs, they are nevertheless insisted upon. Fig. 40 illustrates a set of template gages and

thread gage used for the various inspections and very little variation is permitted, even though the material worked is wood.

**An Alternate Method of Threading the Plugs.**—A western plant also engaged in the manufacture of wooden fuse plugs performs the thread cutting operation in quite a different manner from the one used by the Estes Co. It is in reality a die threading process. The die block *A*, Fig. 41, contains a hole having a continuous thread represented at *B* interrupted only for the admission of the two tools *C* and *D*. The front tool *C* makes the preliminary cut and is followed by the threads *B*, which form a lead for the die. The rear tool *D* cleans out the rear threads which are sometimes left a trifle rough by the leading tool *C*.

## CHAPTER V

### THREE-INCH RUSSIAN SHRAPNEL<sup>1</sup>—MAKING 3-IN. RUSSIAN SHRAPNEL IN A PUMP SHOP<sup>2</sup>

With its much higher muzzle velocity requiring extreme accuracy in all dimensions and weights, Russian 3-in. shrapnel presents quite a different manufacturing proposition from that of the British 18-pounder.

The Russian requirements are extremely strict, yet the American manufacturer has successfully undertaken the work in 30 main operations, including the boxing of the finished shells for shipment. Certain modifications in the regular Russian specifications have had to be made in order to realize the output required under the contracts, it is true, but the work has been performed in a manner satisfactory to the Russian government at a rate exceeding a completed shell every 2½ min., and that in a shop where the manufacture of ammunition was a new departure.

Neglecting fine subdivisions, the various steps in producing a finished Russian shell at this plant are as follows: The forgings on receipt are given the continuous total count, heat lots are separated and counted and the shells are then cut off at both ends. This preliminary work is followed by rough-turning and inside finishing, after which come the heat-treating operations. After these come the outside base finishing and band grooving, followed by either the base grinding or nosing, which, although consecutive operations, are often reversed in order to accommodate shop conditions. Next, the heat-lot number, which has been removed by machining, is stamped upon the finished base of the shell, which then goes to the chucking lathes to have its nose end threaded and formed. The body profile is next turned, followed by a filing and polishing operation, after which the shells are washed inside and out and delivered to the Government inspectors for the first inspection. This test is succeeded by inside painting, the diaphragm is next inserted and the copper bands are pressed on. The shells are loaded with bullets and smoke powder, the fuse cap is screwed in, the brass plug inserted and the spaces between the lead balls filled with rosin, after which the standard weight is established. Next, the rosin filling-holes are plugged and riveted, and the shells go to a series of high-speed sensitive drill spindles which drill and tap for the cap-holding screws, which are then inserted and riveted over. The operation which follows is that of turning the copper band to its finished size and forming the nose end of the cap. This step is followed

<sup>1</sup> John H. Van Deventer, Managing Editor, *American Machinist*.

<sup>2</sup> Ethan Viall.



by nose filing and polishing, which is succeeded in turn by a final cleaning and the last Government inspection. The accepted shells are lacquered, the zinc plugs inserted and the shells boxed for shipment. Many of these operations, as will be noticed by following the operation schedule, are still further subdivided.

Machines Used  
—Cochrane-Bly  
No. 2-B saws.

Special Fixtures and Tools—15-in. saw blades A,  $\frac{1}{8}$  in. thick,  $\frac{3}{4}$  in. pitch; regular-type holding-down block B; adaptation of regular length stop C.

Gages—None necessary after length stop is correctly set.

Production—20 to 25 per hr. per machine (on double-shell operation). One man can run 4 to 6 saws. Cut requires  $3\frac{1}{2}$  min.

Note—Saws cut at 40 ft. per min. Blades require changing, on an average, every 7 hr. Cincinnati Bickford No. 10 automatic saw sharpener used for re-grinding. Soap-water lubrication used. When run double, as shown, the succeeding operation is eliminated.

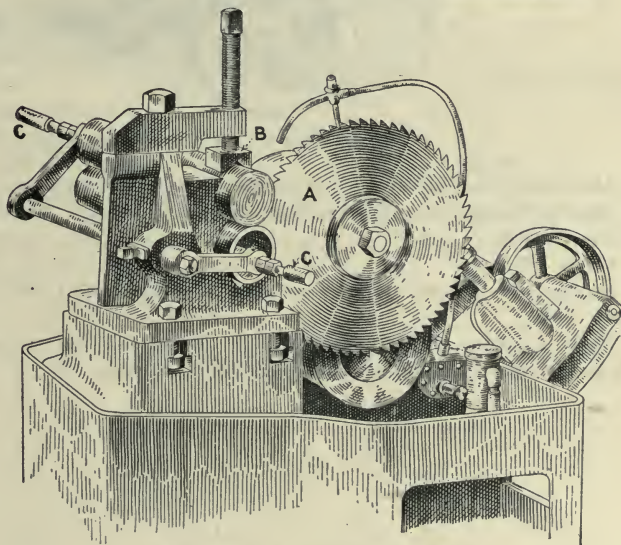
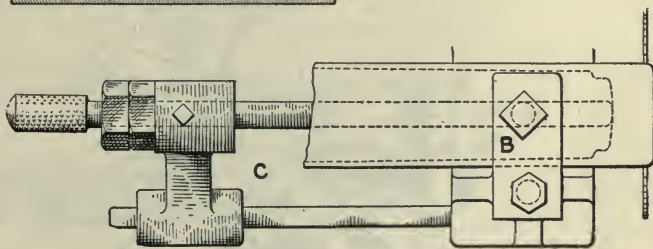
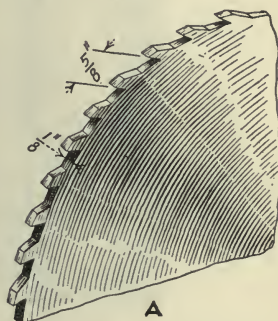
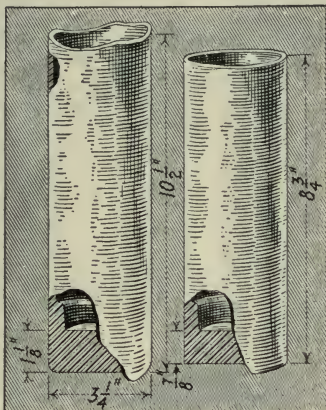

OPERATION 1. CUT OFF BASE END

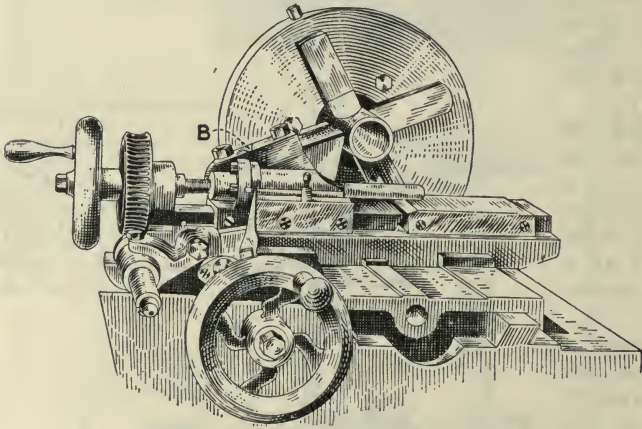
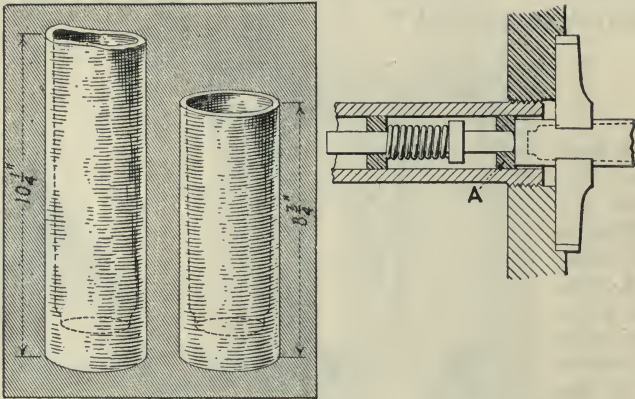

OPERATION 2. CUT OFF FUSE END

Machines Used—Hurlbut-Rogers 4-in. cutting-off machines.

Special Fixtures and Tools—Stop collar A in spindle for positioning shell, front cutting head B.

Gages—None.

Production—40 per hr. per machine. One operator to each machine. Cut requires 1 min.

Note—Cutting speed, 90 ft. per min. Front tool only is used. Feed (through belt and worm) approximates 0.003 in. per revolution.

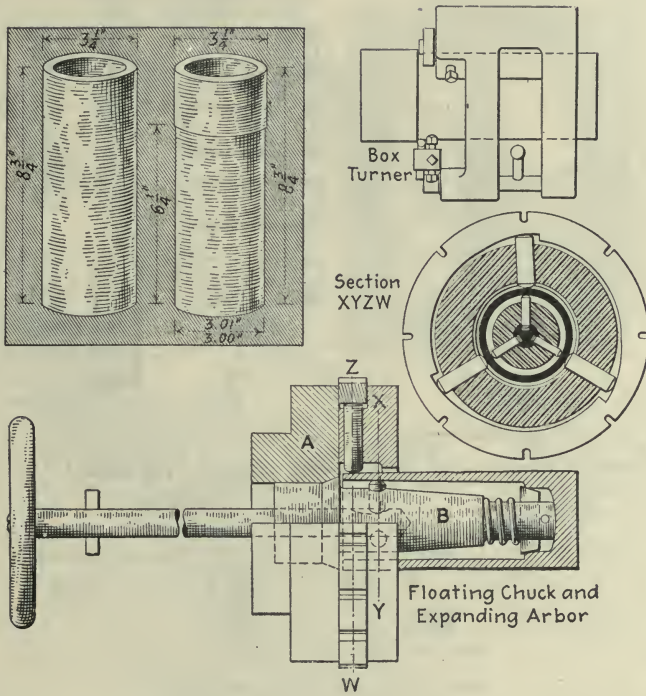

OPERATION 3. ROUGH-TURN BASE END

Machines Used—Special-purpose chucking lathes.

Special Fixtures and Tools—Floating shell chuck A, internal expanding arbor B, roller back-rest box turning-tool C.

Gages—Go and not go snap gage; limits, 3 to 3.01 in.

Production—From 25 to 30 per hr. from one machine and one operator.

Note—Cutting speed, 75 to 90 per min.; feed,  $\frac{1}{8}$  in. Cut requires  $\frac{3}{4}$  min. Soap-water lubrication used. The forging is located in chucking position by the interior mandrel and then gripped by the floating chuck pins as an additional drive.

Reference—Chucking lathe, shown in Fig. 43.

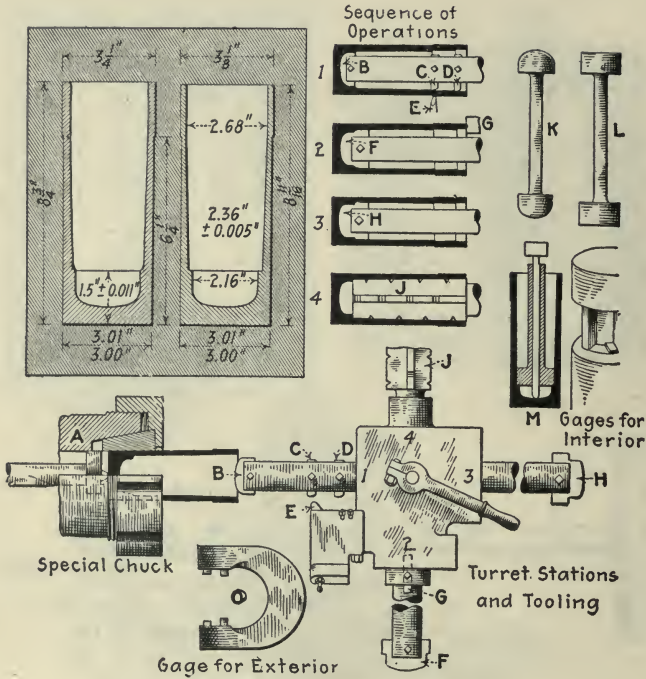

OPERATION 4. BORE AND REAM

Machines Used—Special-purpose chucking lathes.

Special Fixtures and Tools—Special shell chuck A. Cutting tools: 1—Powder-pocket roughing cutter B, roughing cutters C and D for reamer, outside turning tool E. 2—Rough step cutter F for powder pocket and diaphragm seat, facing tool G. 3—Finishing step cutter H for powder pocket and diaphragm seat. 4—Reamer J.

Gages—Double-end limit plug gage K for diameter of powder pocket, double-end limit plug gage L for diameter of diaphragm seat, special limit gage M for depth of powder pocket, snap gage O for diameter of open end.

Production—12 per hr. from one machine and one operator.

Note—Cutting speed, 70 ft. per min. Hand feed used on all suboperations except No. 1. Reaming speed, 45 ft. per min.

Reference—Chucking lathe, shown in Fig. 43.



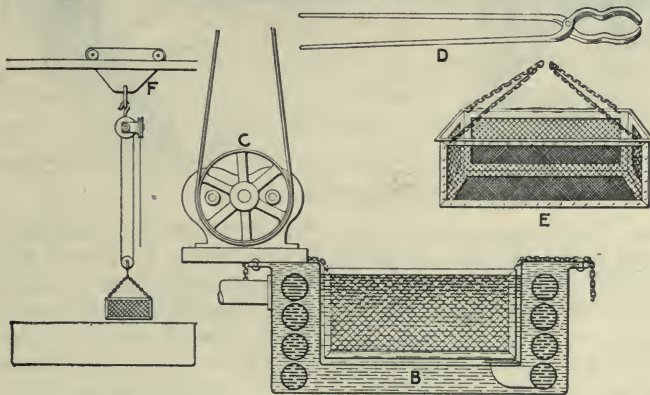
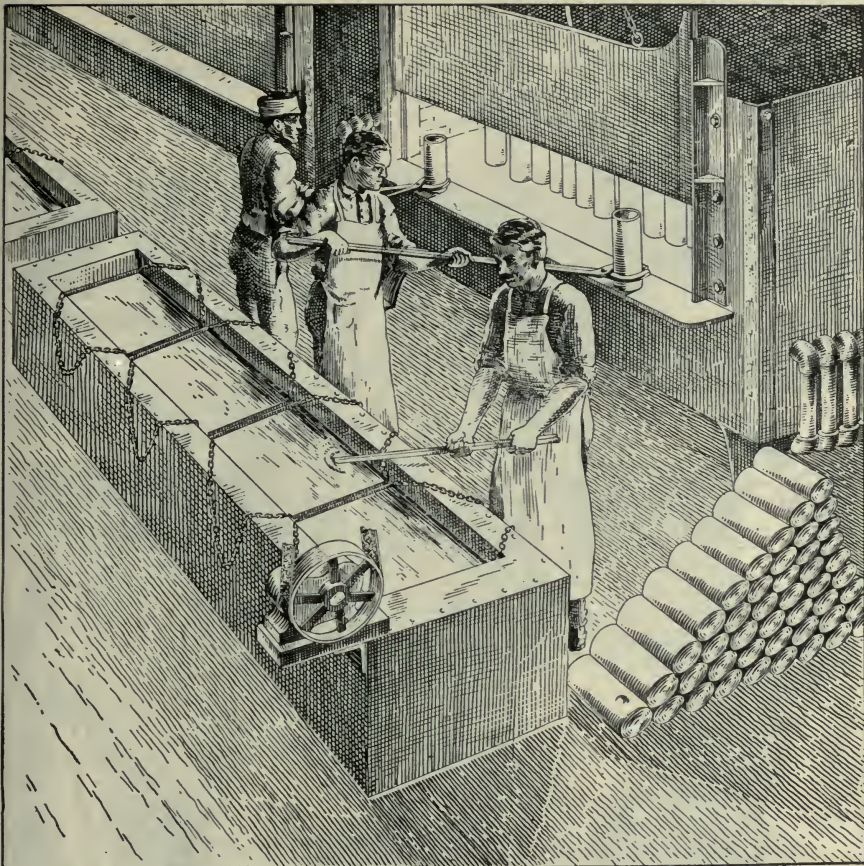

OPERATION 5. HARDEN

Machines Used—Equipment of Strong, Carlisle & Hammond No. 118 crude-oil fired muffle furnaces, blast from Root's positive blower; water-cooled oil-quenching tanks B; oil circulation supplied by rotary pump C.

Special Fixtures and Tools—6- and 8-ft. shell tongs D, wire-mesh tank basket E, overhead trolley and hoist F.

Gages—None. Pyrometers to control furnace temperature.

Production—From each furnace, one batch of 50 shells every 35 to 45 min. Three men required to handle each heat. One man pulls out the heated shells with the long tongs while the other two dip them.

Note—Furnace temperature maintained at 1,420 deg. F.



OPERATION 6. DRAW

Machines Used—Equipment of two Strong Carlisle & Hammond No. 118 oil-fired muffle preheating furnaces and one Frankfort No. 2 crude-oil fired lead pot.

Special Fixtures and Tools—Eight-spindle shell crib attached to melting pot.

Gages—Scleroscope hardness tester. Hardness ranges from 40 to 46.

Production—From one pot, using alternate preheating furnaces, three men draw 2,500 shells per day of 10 hr. One man takes shells from preheating furnaces, placing them in the pot. The second man operates the hoist and turns the crib. The third man takes shells from the pot and places them on the truck. An additional man is required to operate the scleroscope, and one man (the foreman, regulates temperatures and sees that trucks keep moving.

Note—The preheating furnaces heat the shells to 940 deg. F. The lead pot raises this to the drawing point, 1,040 deg. F.

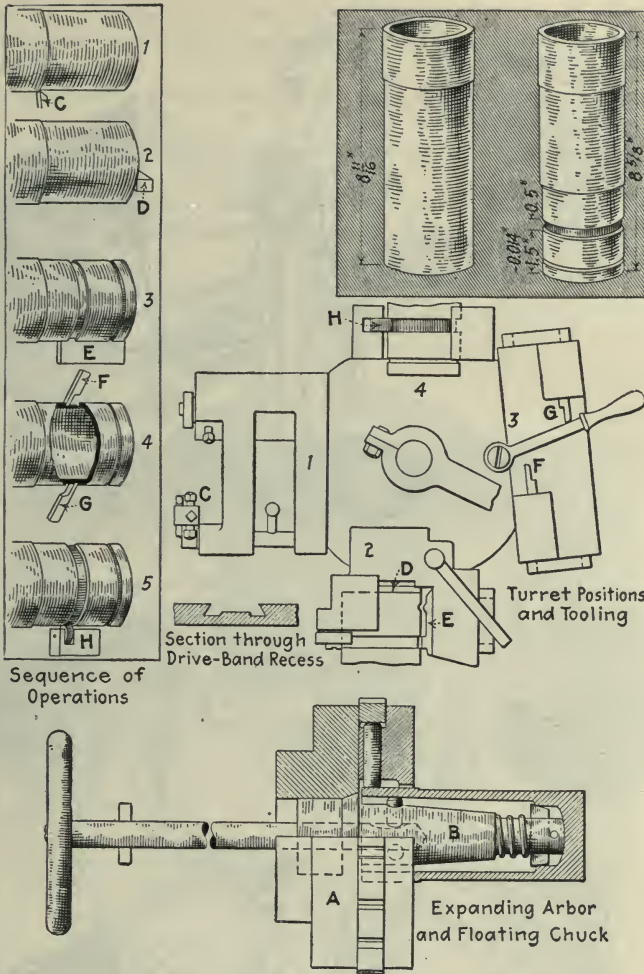

OPERATION 7. FINISH FORM BASE END

Machines Used—Special-purpose chucking lathes.

Special Fixtures and Tools—Special floating chuck A, hand-wheel-operated, expanding arbor B for gripping internally.

Cutting Tools—1—Roller-back-rest turner C. 2—End-facing tool D, groove-forming tool E. 3—Recess undercutting tools F and G. 4—Knurling tool H.

Gages—Limit snap gages for diameters of base and groove, limit templet gage for undercut and location of groove from base.

Production—From one machine and one operator, 12 per hr. Cutting speed, 75 ft. per min. Hand-lever longitudinal and cross-slide feeds.

Note—Soap-water lubrication used. This operation brings the base end of shell to a finish. The forming tool E by careful handling will stand a day's run. The end-facing tool D is operated in connection with the crossfeed on tool E for cutting to the center of the shell.

Reference—Special-purpose lathe, shown in Fig. 43.

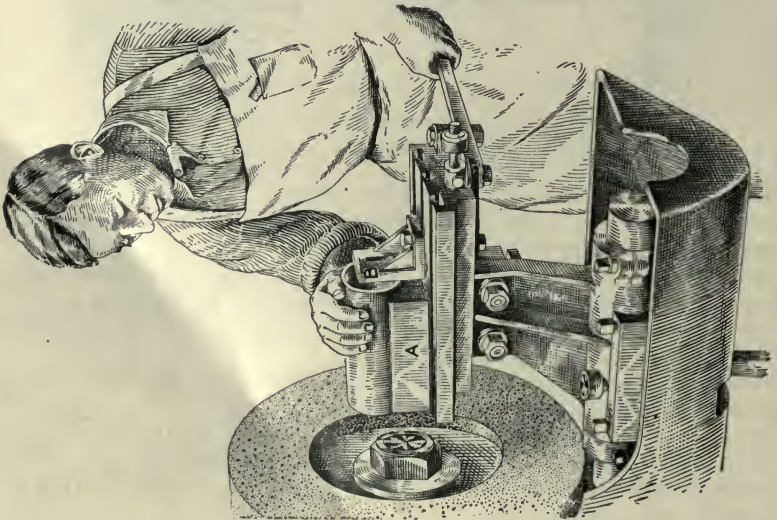
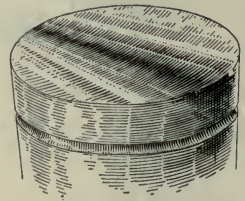
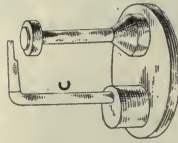
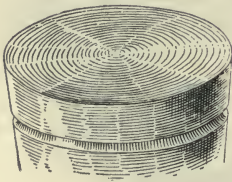
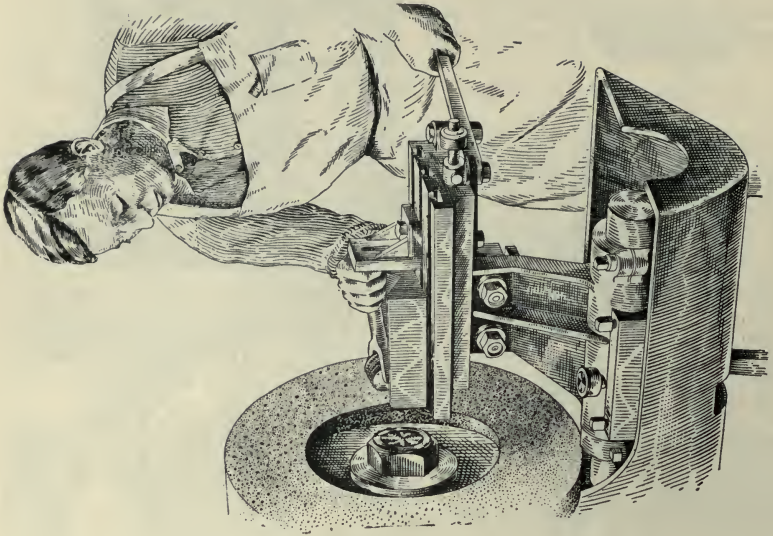

OPERATION 8. GRIND BASE END

Machine Used—Gardner No. 4 double-disk grinder.

Special Fixtures and Tools—Regular equipment used. Vee-block for shell A, length stop B.

Gages—Straight-edge to test base for flatness. Swing gage to test for thickness of base C.

Production—One machine with two operators can grind the bases of 250 shells per hr.

Note—This operation is performed both dry and wet. The use of a coolant is not necessary, as the amount of metal removed is only one or two thousandths of an inch. The heat-lot number is replaced on the shell base after grinding. This operation and the following operations are often reversed in sequence to suit shop conditions.

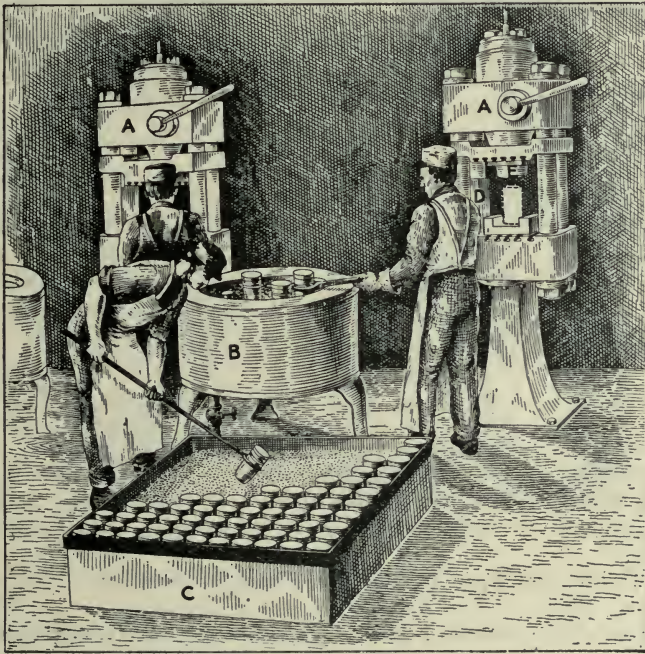

OPERATION 9. BOTTLING AND ANNEALING

Machines Used—Watson-Stillman hydraulic punching press A, Frankfort crude-oil fired lead pot B, galvanized-iron annealing trays C.

Special Fixtures and Tools—Distance stops D, heading die E, locating piece F.

Gages—None.

Production—Two men, with one lead pot and one press, head and anneal 240 shells per hr.

Note—Flake mica used for annealing.

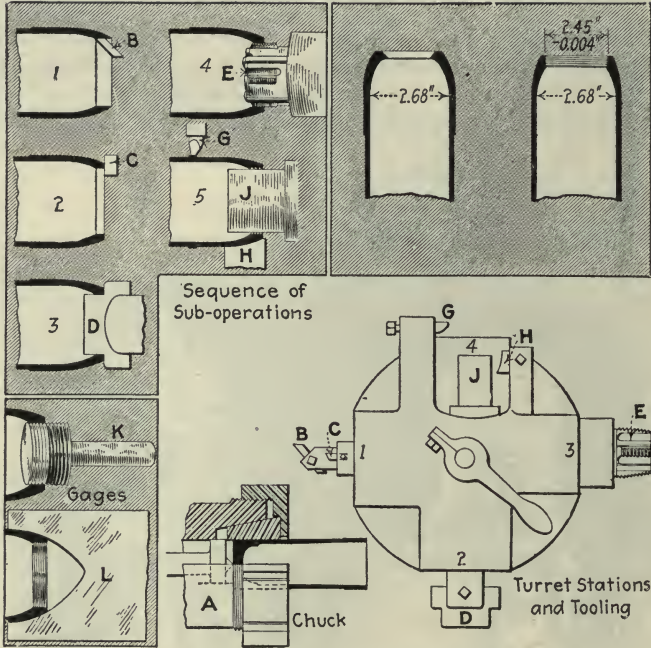

OPERATION 10. BORE, FACE, TURN AND TAP NOSE

Machines Used—Special-purpose chucking lathes.

Special Fixtures and Tools—Special shell chuck A. Cutting tools: 1—Tool for rough-boring thread seat B, rough-facing tool C. 2—Finish cutter D for thread seat and facing end. 3—Collapsing tap E. 4—Turning and forming tools G and H, roller rest J.

Gages—Thread gage K, go and not go; templet for profile L.

Production—From one man and one machine, 18 per hr.

Note—Soap-water lubrication used. The third and fourth suboperations may be reversed in sequence if desired. The form of Whitworth thread prevents injury to threads in nose by the roller rest in the sequence as shown.

Reference—Special-purpose chucking lathe, shown in Fig 43.

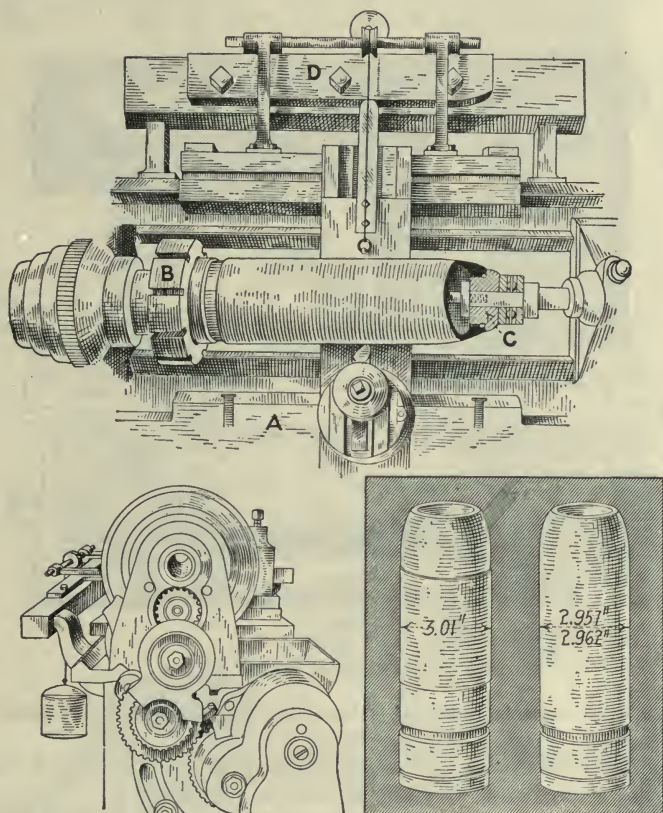

OPERATION 11. FINISH-TURN BODY

Machines Used—Special 16-in. engine lathes fitted with form templets for guiding crossfeed travel A.

Special Fixtures and Tools—Special split collet chuck B, special ball-bearing thrust tailstock plug C, feed templet D.

Gages—Limit snap gages for roughing and finishing.

Production—One operator running two lathes finishes 20 shells per hr.

Note—No lubrication. Cutting speed, 118 ft. per min. Feed per min., 3 in.

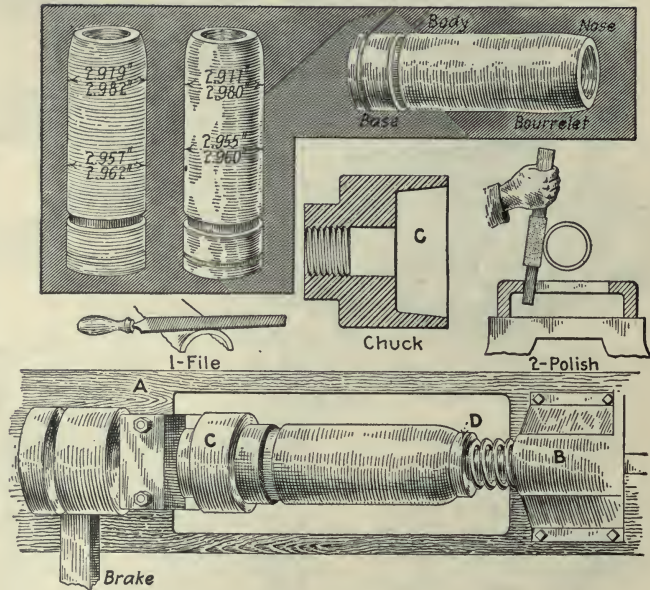

OPERATION 12. FILE AND POLISH

Machines Used—Special polishing lathes A, with spring-actuated tailstock spindles B.

Special Fixtures and Tools—Cup chuck C for base end of shell; ball-bearing tail center D, same as used on body-finishing lathes in operation 11.

Gages—Limit snap gages for bourrelet and body. Body limits, 2.955 to 2.960 in. Bourrelet limits, 2.977 to 2.980 in.

Production—From one machine and one operator, 20 per hr.

Note—Body and bourrelet are both filed and then polished with emery cloth, from  $\frac{1}{1000}$  to  $\frac{2}{1000}$  in. having been left for this operation.



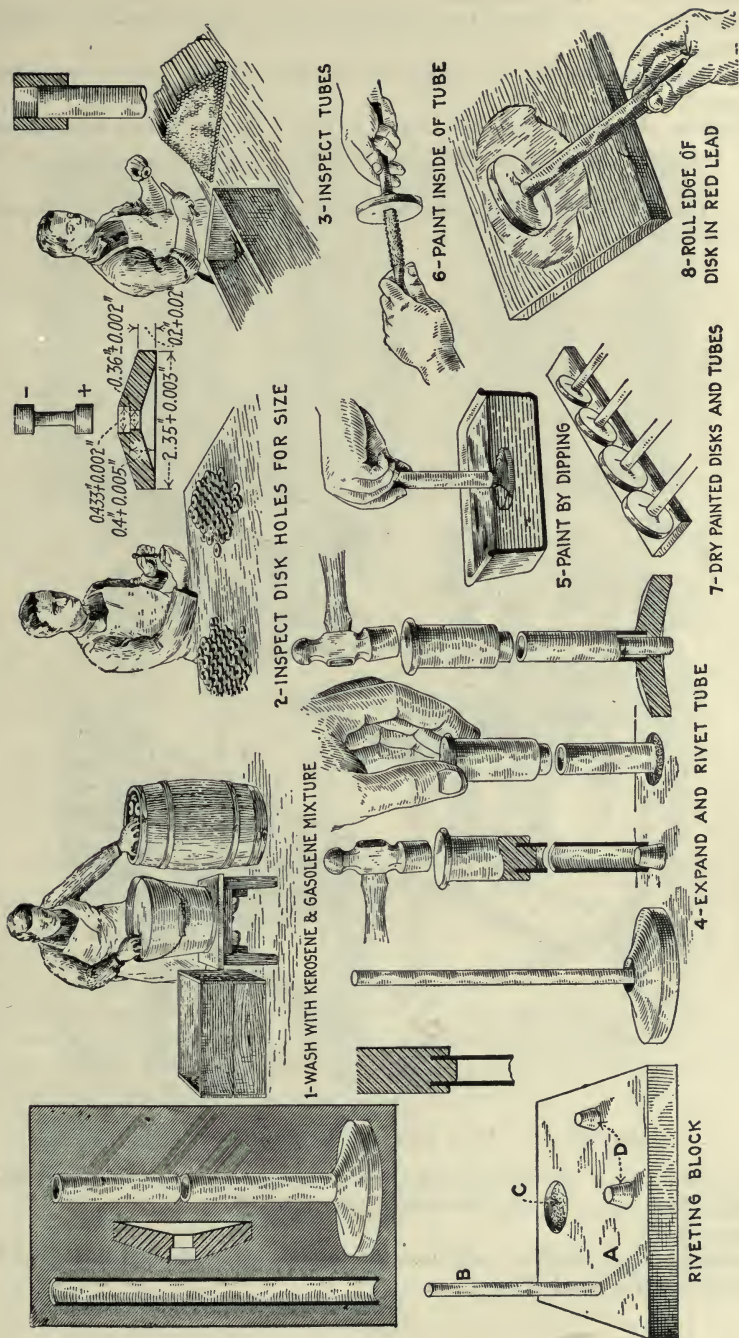

OPERATION 13. PREPARE DIAPHRAGM AND CENTRAL TUBE

Machines Used—Hand operations.

Special Fixtures and Tools—For suboperation 4, a special cast-iron expanding and riveting block D.

Gages—For suboperation 2, a go and not go plug gage A. For suboperation 3, a ring gage B.

Production—No definite rate can be put on this or the succeeding hand operation No. 16. One man and two boys easily handle both operations for 2,500 shells per 10 hr.

Note—The red lead is applied just previous to operation 15 and after the asphaltum paint has dried.

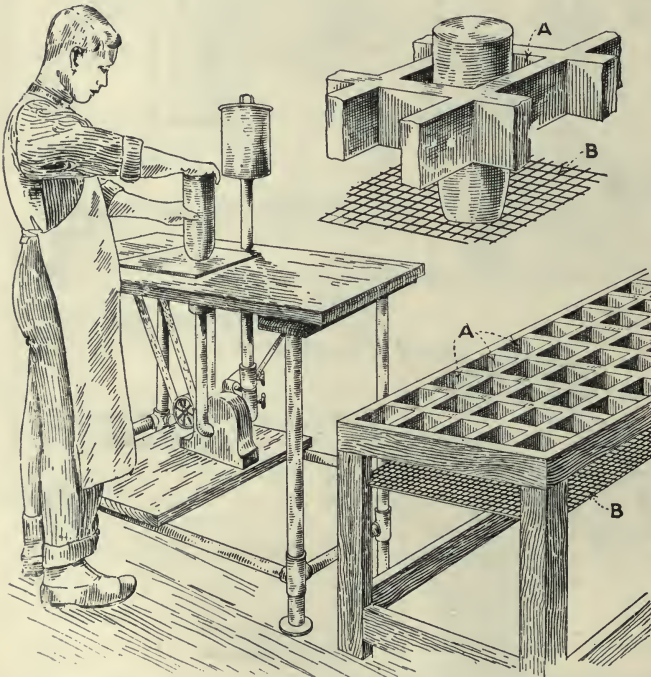

OPERATION 14. BLOW OUT AND PAINT INSIDE OF SHELL

Machines Used—Spray Engineering Co.'s compressed-air shell-painting machine A.

Special Fixtures and Tools—Portable drying racks B.

Gages—None.

Production—One machine will coat the interior of 250 to 400 shells per hour, depending on the method of handling.

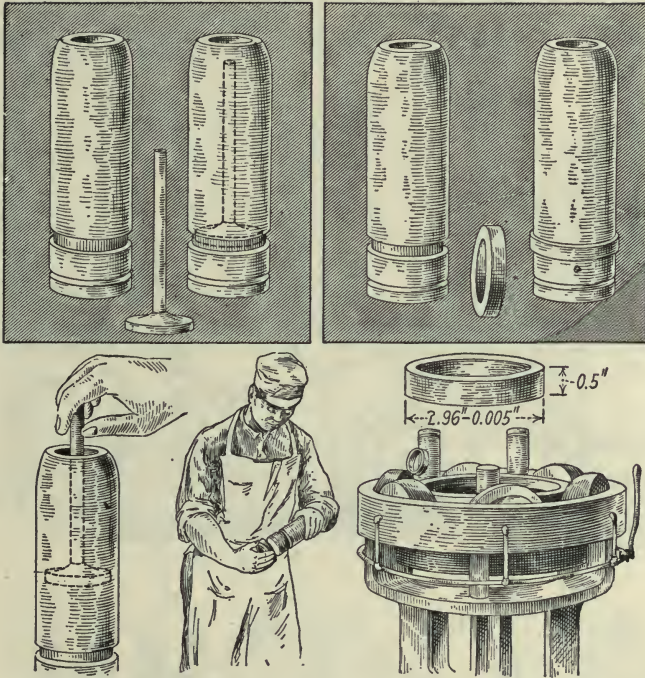

OPERATION 15. PUT ASSEMBLED DIAPHRAGM AND TUBE IN SHELL

Machines Used—Hand operation.

Special Fixtures and Tools—None.

Gages—None.

Production—Included in operation 14.

Note—The assembled diaphragm and tubes are simply dropped in by hand. They must fit loosely, and tight ones are rejected. The succeeding operation, crimping the drive band, must not cause the shell to pinch the diaphragm, and this acts as a check on the distortion of shell wall due to crimping.

## OPERATION 16. SET OR CRIMP DRIVE BAND

Machines Used—West hydraulic band-crimping machine A, 6 plungers 6 in. in diameter, operated from accumulator.

Special Fixtures and Tools—None.

Gages—None. The test for crimping is made by tapping the band with a light hammer.

Production—One machine and one operator produce from 30 to 40 pieces per hour.  
Note—A maximum unit pressure of 1,000 lb. per square inch is required.

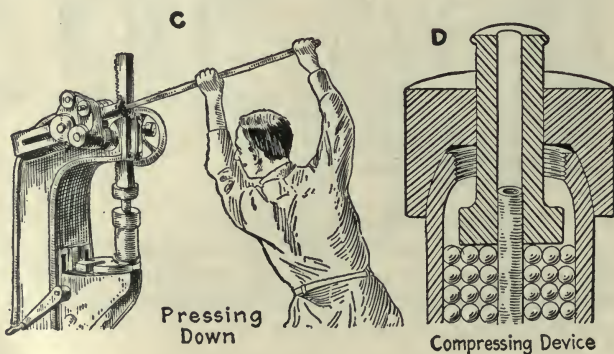
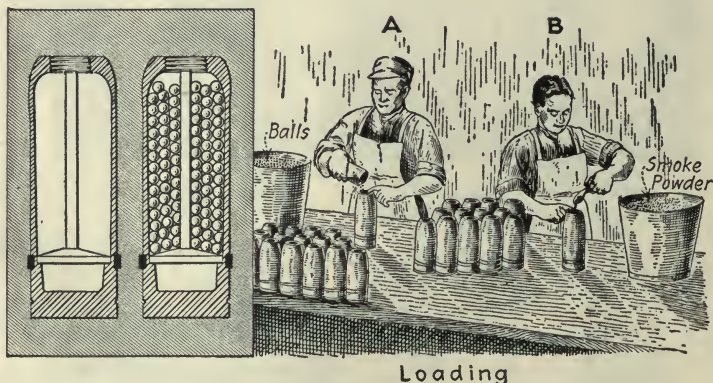

## OPERATION 17. LOAD WITH BALLS AND SMOKE POWDER

Machines Used—Hand operation with exception of arbor press C for pressing the balls into the shell.

Special Fixtures and Tools—Ball presser and guide D.

Gages—None.

Production—Three men and two arbor presses, 250 shells per hr.

Note.—Five rows of balls are first inserted, then 13 drams 5 grains of a smoke powder composed of 55 parts of metallic antimony and 45 parts of magnesium.

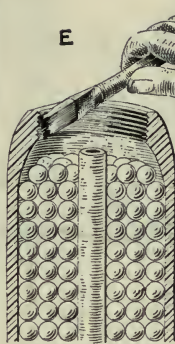
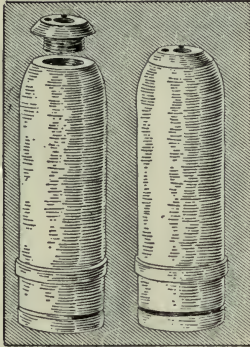

Greasing Threads



Starting Fuse-Socket

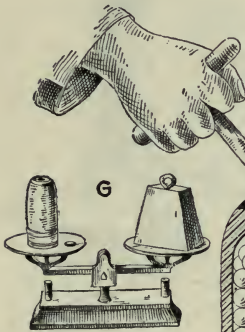

Weighing

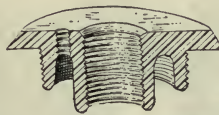

I-The Fuse-Socket

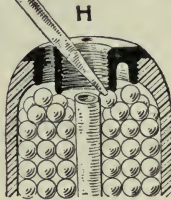

Inserting a Ball

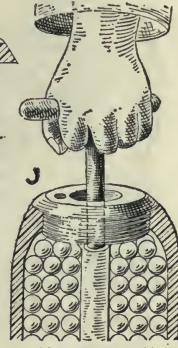

Testing Powder-Tube

OPERATION 18. START FUSE SOCKET AND MAKE WEIGHT

Machines Used—Hand operations.

Special Fixtures and Tools—Brush *E* for smearing grease in threads; drift *H* for inserting balls.

Gages—Scales *G* for weight; rod *J* for testing powder tube.

Production—Three men take care of 250 shells per hour.

Note—Weight at this operation is held to 13 lb. 5.6 oz. plus or minus the weight of one of the small lead balls.



OPERATION 19. SCREW DOWN FUSE SOCKET

Machines Used—Hand operation.

Special Fixtures and Tools—Hinged chuck vise mounted on pedestal; double-ended screw-plug wrench with guide to fit powder pocket.

Gages—None.

Production—One man screws down from 40 to 60 sockets per hour.

Note—The production rate is variable, caused by the variation of threads on the fuse sockets as received.

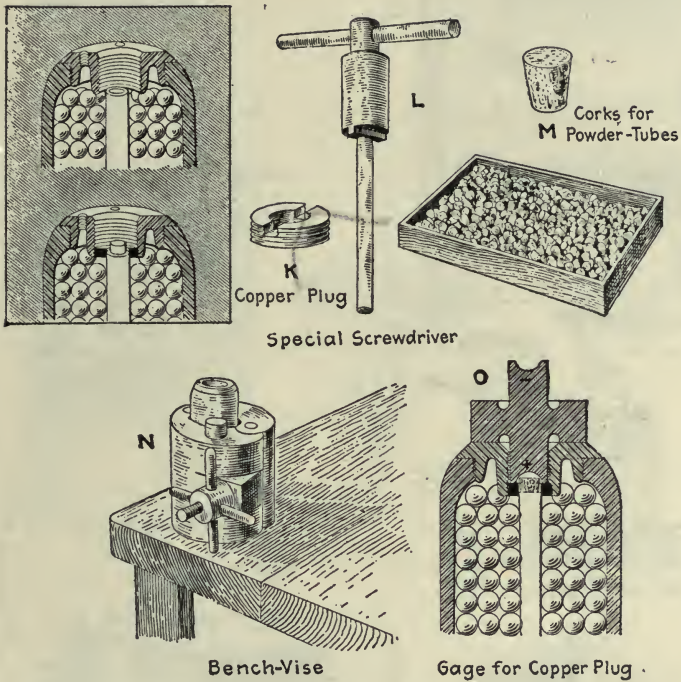

OPERATION 20. INSERT COPPER PLUGS AND CORKS AND TEST COPPER-PLUG SEATING

Machines Used—Hand operations.

Special Fixtures and Tools—Special plug screwdriver L, with pilot extension to fit powder tube; hinged chuck N used as a bench vise in order to provide ample holding power.

Gages—Limit snap gage O, to test depth and squareness of copper-plug seating.

Production—Two men handle from 175 to 250 shells per hour.

Note—Variations in the threads varies production rate.

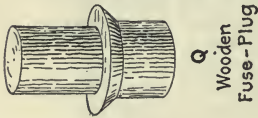
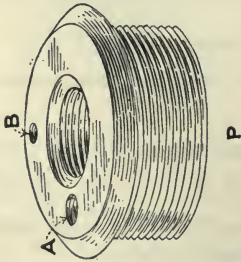
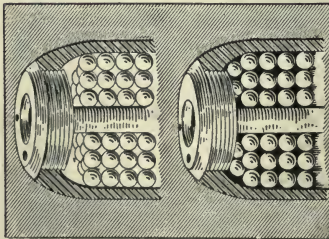

Q  
Wooden  
Fuse-Plug

Filling and Air-Outlet Holes

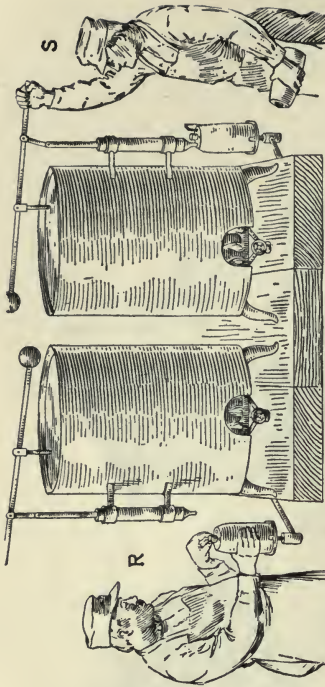

R  
Inserting Plug

S  
Filling Shell

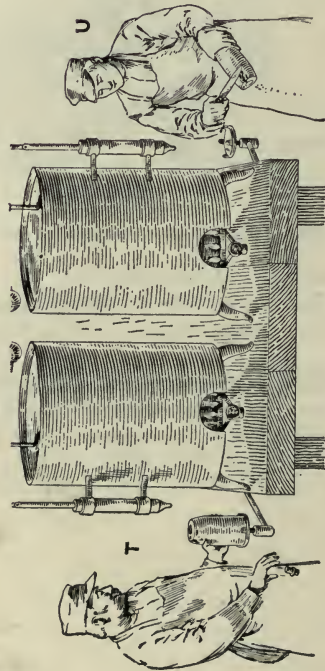

T  
Removing Plug

U  
Scraping off Surplus Rosin

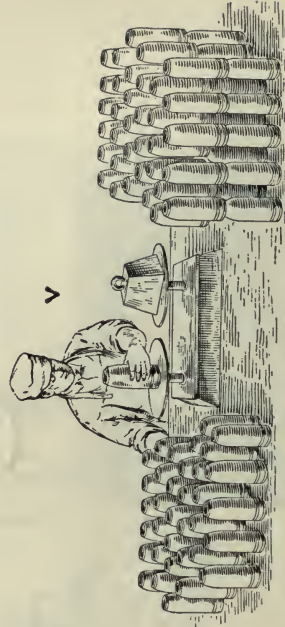

V  
Weighing

OPERATION 21. FILL WITH ROSIN AND WEIGH



Machines Used—Hand operations.

Special Fixtures and Tools—Wooden plugs Q for fuse sockets; rosin kettles R and S, fitted with force pumps.

Gages—Scales for checking weight, shown at V.

Production—One operator at each kettle can produce 50 to 60 loaded shells per hour.

Note—The rosin kettles are gas-fired and are provided with handy tapping device.

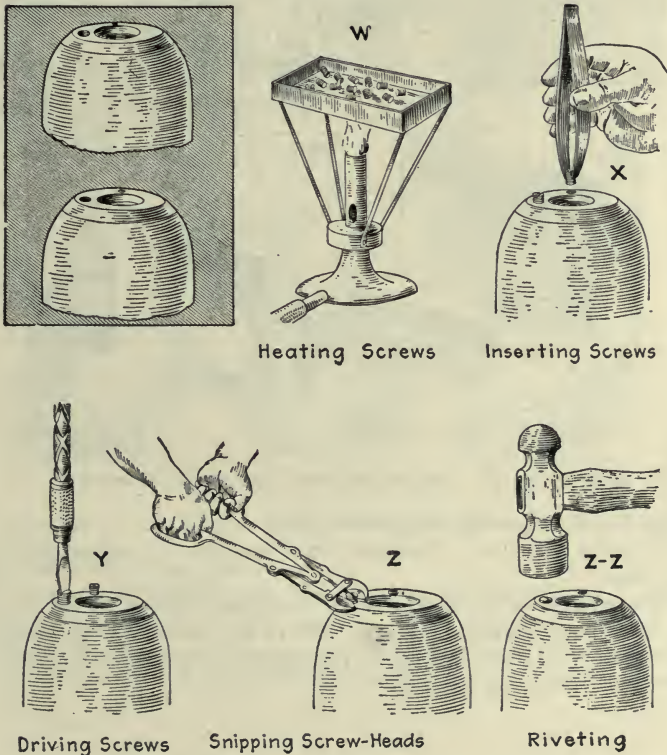

OPERATION 22. INSERT PLUGGING SCREWS, SNIP HEADS AND RIVET

Machines Used—Hand operations.

Special Fixtures and Tools—Heating pan and gas burner W; tweezer pliers X; Yankee screwdriver Y; hand snips Z.

Gages—None.

Production—Two men insert screws, screw down, snip heads and rivet 250 shells per hour.

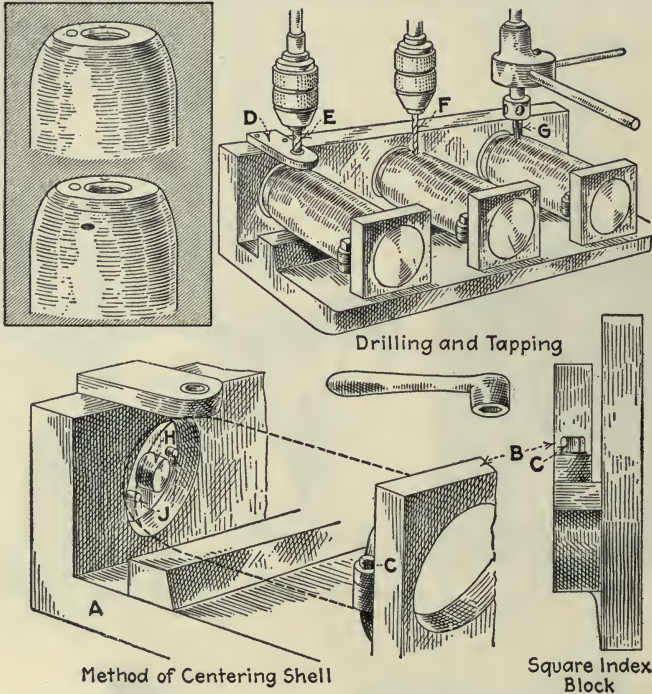

OPERATION 23. DRILL AND TAP FOR HOLDING SCREWS

Machines Used—Three-spindle sensitive drills.

Special Fixtures and Tools—Stationary centering fixture A; square index block B.  
Gages—None.

Production—From one operator and one machine, 30 shells per hr.

Note—Speed for drilling and tapping, 1,200 r.p.m.; reversing tapping chuck used. Countersink with No. 11 and drill  $\frac{5}{32}$  in. for tapping; turpentine and white lead used as tap lubricant. Drills are run dry.

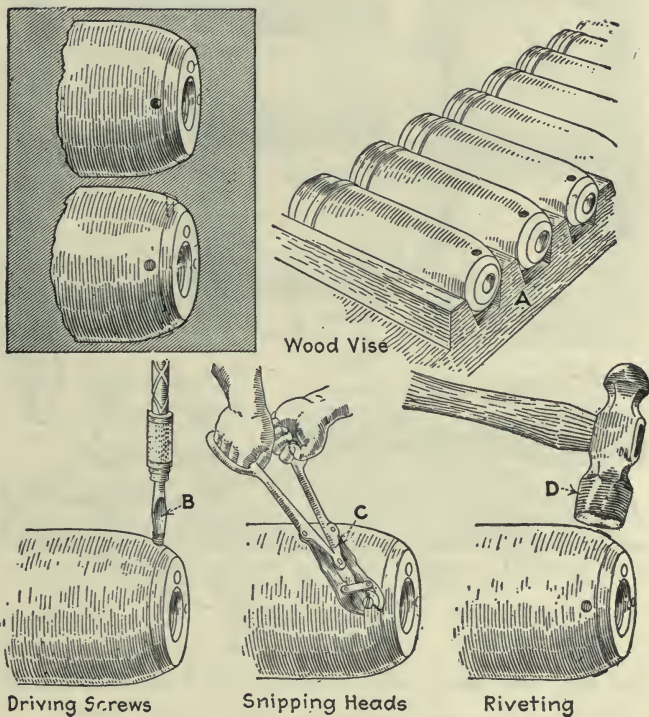

OPERATION 24. INSERT HOLDING SCREWS, SNIP AND RIVET

Machines Used—Hand operations.

Special Fixtures and Tools—Special wood-block bench vise A; Yankee screwdriver B; hand shears C; hammer D.

Gages—None.

Production—From three men, 2,500 shells in 10 hr.

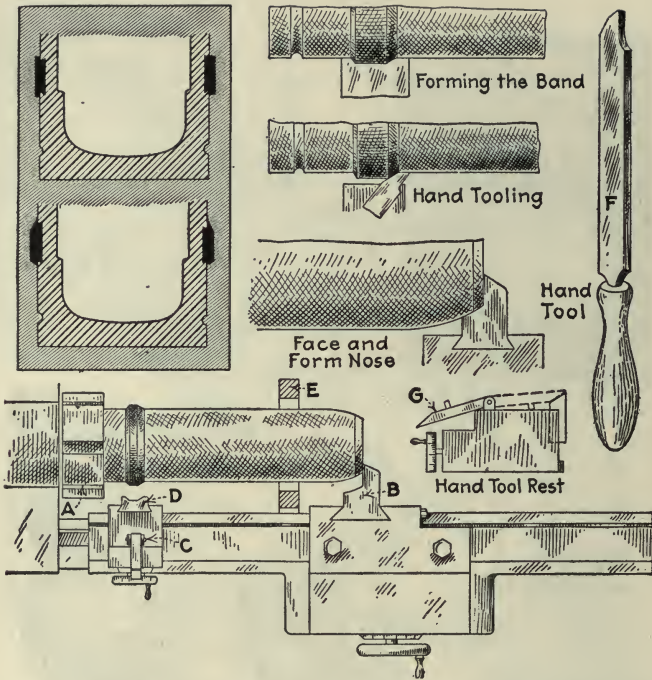

OPERATION 25. FORM DRIVE BAND, AND FACE AND FORM FUSE END OF SHELL

Machines Used—Converted engine lathes.

Special Fixtures and Tools—Split collet chuck A; nose-forming and end-facing tool B; auxiliary tool slide C, with band-forming tool D; steadyrest E; hand turning Tool F.

Gages—Limit snap gages for diameter of copper band; templet gage for drive band; templet gage for nose profile.

Production—From one man and one machine, 30 to 40 shells per hr.

Note—No tool lubrication used in forming the copper drive band; cutting speed, 65 ft. per min.; sequence of operations—(1) form band, (2) hand-tool band, (3) face nose end and form.

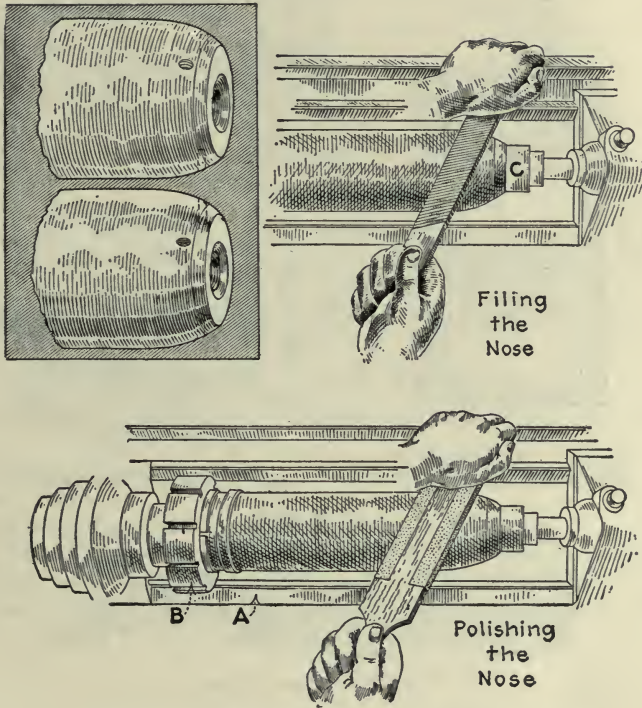

OPERATION 26. FILE AND POLISH NOSE OF SHELL

Machines Used—Special polishing lathes, with cup chucks and ball-bearing, spring-actuated tail centers.

Special Fixtures and Tools—None.

Gages—Templet gage for nose profile.

Production—From one operator and one machine, 30 to 40 shells per hr.

Note—The polishing lathes used on this operation work in step with a like number of band-turning lathes, one of each, back to back, forming a unit.

Reference—Special polishing lathe, shown in Fig. 43.

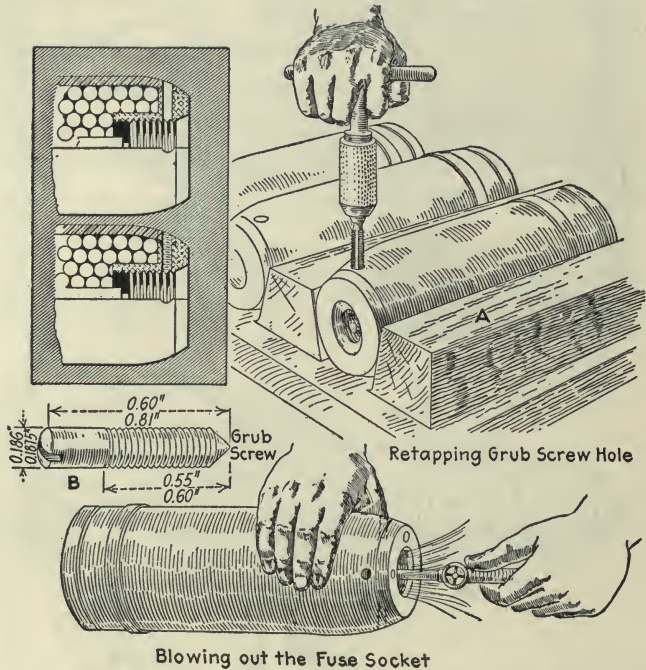

OPERATION 27. RETAP FOR FUSE-HOLE PLUG GRUB SCREW

Machines Used—None.

Special Fixtures and Tools—Wooden taper-wedge block vises A; hand tap.

Gages—None.

Production—Two men can handle 2,500 shells in 10 hr. on this operation.

Note—Compressed air used to blow out the fuse socket; the cork inserted in powder tube prior to operation 20 is now removed.

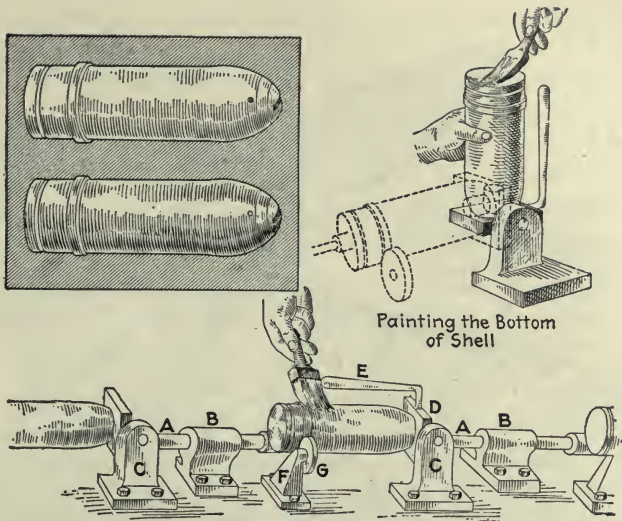

OPERATION 28. LACQUER OUTSIDE OF SHELL

Machines Used—Special driving device mounted on bench and driven from floor shaft.

Special Fixtures and Tools—None.

Gages—None.

Production—Three men lacquer 2,500 shells in 10 hr.

Note—Shell is placed vertically on tipping block D, rotated by hand while the base is lacquered, then tipped horizontally and power driven by a leather friction wheel running on the copper driving band, while the cylindrical surface is lacquered.

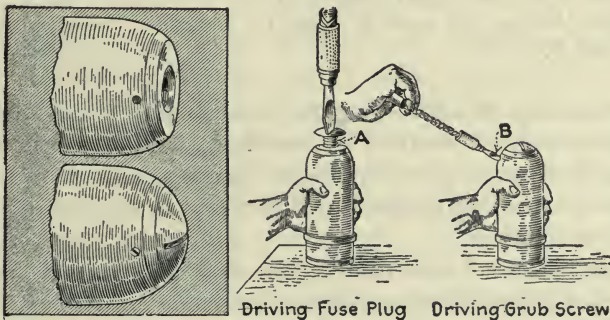

OPERATION 29. INSERT FUSE-HOLE PLUG AND GRUB SCREW

Machines Used—None.

Special Fixtures and Tools—None.

Gages—None.

Production—Two men produce 2,500 in 10 hr. on this operation.

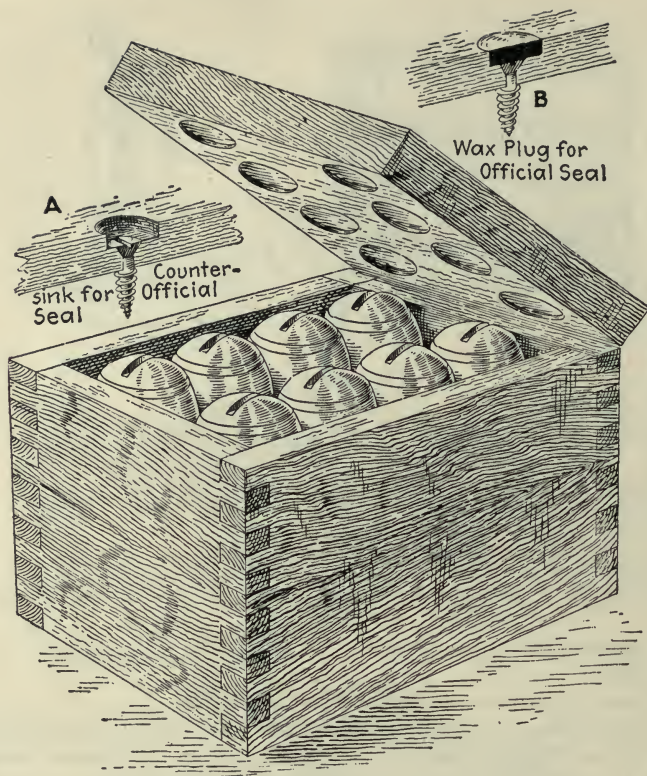

OPERATION 30. PACK FOR SHIPMENT

Machines Used—None.

Special Fixtures and Tools—None.

Gages—None.

Production—Four men, 2,500 shells in 10 hr.

Note—After boxing, the cover is sealed by means of a countersunk wax plug, shown at A and B.

The production of 2,500 completed shells per 10 hr. day demanded a specialization in tools marked by simplicity and ruggedness. This is well exemplified in the special-purpose chucking lathe shown in Fig. 43, a machine which accomplishes much in the way of sustaining the high production demanded.

The machines are driven from a floor shaft and the use of spring- and lever-actuated idler pulleys, which, by tightening or loosening the driving belt as desired, start and stop the machines without the need of clutches. These features, by eliminating stoppages for belt adjustment, are operating conveniences which also insure plenty of driving power at the spindle, while the unusually large spindle bearings and the low turret mounting provide rigidity for fast and heavy cut.



The transportation and inter-operation storage conveniences naturally bear considerable weight in maintaining the output of the plant, for floor space is too valuable to permit using it for storage space between machines. This problem was solved in this particular plant by the use of special trucks, shown in Fig. 44, which, with the addition of detachable top shelves, also serve as inter-machine inspection tables. The wooden pins of these trucks are so spaced that shells which are "bottled" may be laid between them, while shells in a condition previous to this operation are placed over the pins.

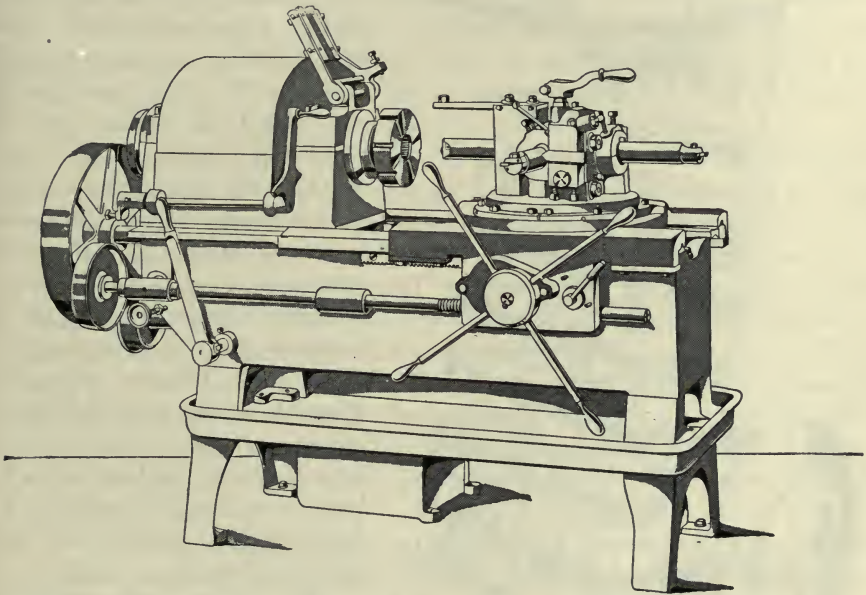

FIG. 43. SPECIAL-PURPOSE CHUCKING LATHE USED FOR SHELL OPERATIONS

Certain modifications in the order of the operations scheduled in the Russian specification also materially assist in speeding up production. Formerly the heat-treating operations headed the sequence, but by preceding the hardening of the shells by the inside finishing and outside roughing operations greatly benefited the cutting tools and materially reduced the time consumed in the heating operations. The removal of the forging skin by machining, although amounting in weight to not more than 15 per cent. of that of the rough shell, increased the capacity of the same number of furnaces and tables over 30 per cent. The outer skin of a steel forging has about double the resistance to the conduction of heat of the inner metal of the same piece.

Another modification of the Russian specification was the suspension of the requirement of nickel plating the finished shrapnel shells. This refinement was specified as a protection against the rusting of shells in

storage, but is quite unnecessary when the shells are destined for early use.

The problem of balance is naturally more difficult to solve for the hand operations than for machine operations. The first heat-treatment is a good example of careful planning to avoid lost motions. One furnaceman pulls the hot shells from the furnace interior with a pair of long shell-

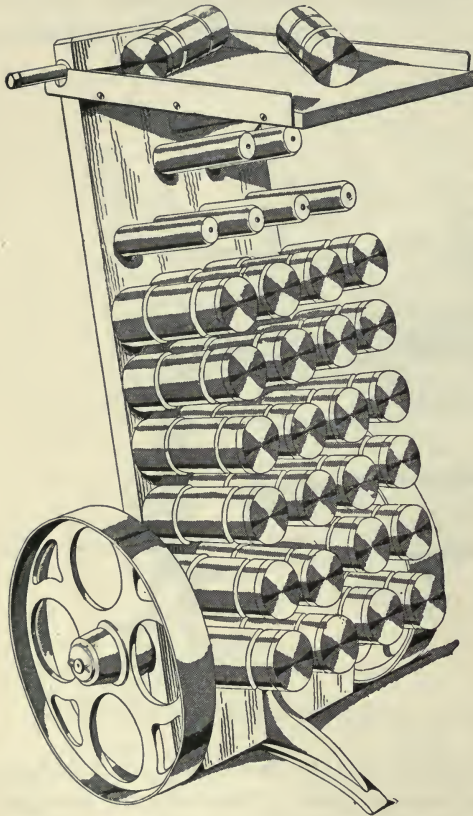

FIG. 44. PARTLY LOADED SHELL TRUCK WITH INSPECTION SHELF

tongs, a man on either side of him taking the shell which he draws out and plunging it endwise into the oil-quenching tank. After one or two endwise motions to insure proper cooling, the shell is dropped into the tank, falling into a wire-mesh basket. The location of the quenching tanks with reference to the furnaces is so well chosen that the two quenchers need not move their positions, simply swinging their bodies as they transfer the hot shells from furnace to tank. After the entire batch has been pulled and while waiting for the next batch of shells in the adjoining furnace, the three men lift out the baskets and remove the hardened shells.

The shells after coming from their heat-treatment are neither sand-blasted nor pickled, it having been found that these processes are unnecessary. The inside surfaces of the shells do not scale appreciably,

due to the fact that the air within them is not in circulation, and in fact the exterior of the shells is remarkably free from scale also, due to quick handling between furnace and oil bath.

Remarkably fast forming of tough heat-treated material is done in the seventh operation. The cut, which is over 2 in. wide, is taken at a cutting speed of 75 ft. per minute; and under this hard usage the tool, by careful handling, will stand a day's run without regrinding. Another interesting example of forming will be shown in the fifth suboperation of operation 10, in which the nose-forming tool *H* roughs off the

nose profile. This, however, is not altogether a forming operation, the tool being fed parallel with the axis of the shell until the full reduction in size is reached.

This operation was formerly divided into two parts with the purpose of putting less strain on the forming tools and thus securing longer service from them. Under this procedure, the base end was first rough formed to within 10 thousandths in. of finished size leaving the removal of this amount of metal together with the knurling and undercutting for the second half of the operation. Experience has shown, however, that the additional chucking and handling time offset the wear on the forming cutter and as a result, the two operations were combined into one, and are now performed as here described. This is an illustration of the fact that the best way to do a certain thing can be determined only by trying it out, and letting experience dictate the answer.

The lead bath following the hardening operation is an example of the unusually high production made possible by preheating of the shells to within 100 deg. of the drawing temperature in the oil-fired muffle furnace (operation 5). The lead pot shown in operation 6 takes care of drawing the temper of 2,500 shells in 10 hr.—an example of nicely timed hand work. The man at the pot rotates the shell filling fixture and raises and lowers the weighted spindles with the aid of a hook and tackle. The man standing in front of the furnace at the left takes the preheated shells from it and places them, one at a time, upon the spindle made vacant by the man in the center who removes the shells from the pot and places them upon the pins of the special trucks, where they are allowed to cool.

The air entrapped when the inverted shell is thrust into the lead pot is vented by the siphon device which acts as a support for the inverted shell.

From the manufacturer's standpoint, aside from its close limits, the Russian shell presents many difficulties which are avoided in the British shrapnel. It has one feature, however, which goes a long way toward offsetting these, in that the diameter of the hole in the finished shell nose is large enough to admit a bar with a cutter that is the full size of the finished powder pocket. This means that it is possible not only to finish bore the shell before heat-treatment, but also to correct that portion of the product that shrinks in heat-treatment and in which the powder-pocket diameter and disk seat come under the minimum limit.

The Russian shell is finished inside as well as outside wherein it differs from the British shell, in which considerable of the rough forging skin is left in the interior. This seeming drawback serves really as an advantage for it would be difficult to maintain the close limits required unless the finishing is done. Furthermore the inside finishing has been so carefully planned in connection with the nose bottling that it is un-

necessary to finish the inside contour of the nose after the shell is closed in, as is required in the British shell.

One of the noticeable features of the Russian shell is its highly polished base. This finish is secured in the eighth operation by means of a Gardner No. 4 double-disk grinder. Two operators work on this machine, one at each disk, the shell being merely held in a V-block on the swing table and secured by the operator's left hand, his right being used to traverse the shell across the surface of the disk. No lubrication is needed to take care of the light cut, which amounts to but 0.001 or 0.002 in. at the most.

In the illustration accompanying this operation, the method of truing up the special abrasive wheel is shown at the right. Special abrasive wheels are shown mounted on this disk grinder, but the ordinary type of grinding disk is also used with good success and in fact seems to be preferred by the operators. This operation definitely determines the thickness of the base of the shell. A careful gaging follows it, the apparatus shown at *C* being used for this purpose. The shell is placed over the vertical spindle with its powder pocket resting upon the spindle enlargement; and the surface gage, shown at the left, which has plus and minus ground measuring surfaces, is passed over the base of the shell.

Bottling and annealing are combined in the ninth operation. The perspective illustration accompanying this operation shows another example of nicely timed handwork. Two men are kept busy at each pot, one of them working from the pot to the machine and back to the pot again, while the other works from the pile of shells on the floor to the melting pot and from the melting pot back to the annealing trays of flake mica. The die used on the heading press is not water-cooled, yet does its work without causing the shells to stick.

The operation of bottling and annealing is often reversed in order with respect to that of grinding the shell base, this depending upon shop conditions. It makes no difference whether bottling precedes or follows the grinding operation. The rough stock that has been left upon the body and bourrelet of the shell is removed in the eleventh operation. Each man who does this finishing work runs two engine lathes of simple but rigid construction, which are equipped with form-turning templets corresponding to the contour of the Russian shell. From each lathe the operator gets 10 shells an hour, or a total of 20 per hour per man per two machines. This is remarkably fast production, considering the fact that the material is heat-treated nickel steel. Fast cutting must be done to obtain this result; as a matter of fact the cutting speed is over 118 ft. per minute, and the lineal feed is 3 in. per minute. The finish-turning operations leave approximately 0.002 in. for the succeeding filing and polishing operations. A clever tail-end centering device is used on these lathes. It incorporates in its design a plug that fits the finished end of the shell nose and a ball thrust bearing that removes friction which

would otherwise result in heating at this high speed. This same centering device is also used on the tailstock of the speed lathe in the following operation.

The speed lathes used in this operation are examples of effective simplicity. They are mounted upon wooden beds and driven from below through belts tightened with idler pulleys. Brakes are provided to bring the head spindles to a quick stop. The tail spindles of these lathes are actuated by springs, so that all that it is necessary for the operator to do is to release the lever handle, whereupon the ball-bearing centering plug forces the shell into the taper cup chuck, where it is held and driven by friction. This filing and polishing are confined to the body and bour-relet of the shell and do not extend to the nose, which receives attention after the fuse-socket plug has been inserted and the screws put in.

Unlike that of the British shell of corresponding size, the powder tube of the Russian shrapnel is not threaded upon the disk end, but is held into the disk by expanding the sides of the tube, which are thinned down at one end for this purpose. There are a number of distinct hand operations required in preparing the disk and tube for insertion in the shell, all of which are shown in operation 13. The apparatus used here is extremely simple, consisting of a cast-iron hammering block, a special punch to protect the upper end of the tube, and a hammer. A steel pin the size of the hole in the outer tube is fixed in the hammering block at *B*. At *D* will be noticed two conical stubs. These are expanding plugs. They are used for opening up the end of the tube which is to be inserted. One plug is a little larger than the other and is used when the tubes run undersize. A small drilled hole in the hammering block holds a wad of waste saturated with red lead.

To show the actions making up this suboperation in sequence more clearly, the steps have been laid out in a straight line, beginning with the dropping of the disk over the steel pin, followed by the expanding of the tube, the dipping of the expanded end into red lead and the final riveting of the tube into the disk. The simplicity of the ways and means employed enables this operation to be performed at a remarkably high speed.

Coating the edge of the disk with red lead, as shown at 8, is done just previously to inserting the completed disk and tube in the shell, but not before the paint on the exterior of the disk and on the interior of the tube has become thoroughly dried.

While the preparation of the outer tube and disk has been in progress, the shell itself has been thoroughly washed, cleaned and delivered to the Government inspectors. In this first official inspection it receives practically the same tests as those described for the British 18-pounder. Particular stress is laid upon the inspection of the interior of the shell at this point, for it is the last opportunity for the Government inspectors

to examine this part of the shell, unless they take the completed shrapnel apart or saw it in half. Cracks, scratches, scale, or hair lines on the interior or outside surfaces of the shell are carefully watched for during this inspection.

The painting of the interior of the shell becomes simply a matter of arranging the handling in order to get as high an output as desired from the apparatus shown in operation 14. The machine used is a compressed-air shell-painting machine made by the Spray Engineering Co., of Boston. Pressing the inverted shell over the discharge tube of this apparatus causes it to inject a measured quantity of paint, which is forced up into the powder pocket by compressed air. The air is delivered in such a way that the paint is uniformly distributed and drops are prevented from running down and gumming up the finished thread surfaces.

One of the conveniences designed to facilitate the handling of shells during the painting operation is shown in this operation. It is a drying rack mounted on wheels, and it may be readily pushed back and forth to bring it into convenient location with respect to the painting machine. The shells rest upon heavy wire netting, which permits free circulation of air to their interiors and helps to dry them quickly.

In the Russian shell, any disks which fit tightly into the disk seats are at once rejected. The disk must be a loose, easy fit and must readily drop into its place. It is inserted before the shell goes to the band-crimping machine and serves as a check upon this operation, for upon coming from this machine the disks must still be free within the shell. Any distortion of the metal due to compression would of course be noticed by a binding of the disk, and this arrangement is made to serve as a convenient gage upon an operation which would otherwise be rather difficult to check up. An additional reason for this free fit is to insure that the disk and outer tube will be readily discharged from the exploded shell and thus serve to back up and give impetus to the discharge of its content of lead balls, acting in this way something like the wad back of the charge of shot in a shotgun shell.

Considerable attention is given to the inspection of the copper drive band. The metal must be of such a character that it may be folded upon itself and may be then flattened with a hammer without signs of breaking. It must be capable of being forged in a cold state until reduced to one-half of its thickness, without giving indications of tearing. The correct seating of the copper band in the band groove of the shell is determined after the crimping operation by tapping the band with a hammer and noticing the clearness of the ring. In addition to this the inspector has the privilege of removing rings from 1 per cent. of the total number of projectiles for the purpose of seeing that they are properly seated.

At the seventeenth operation—that of loading or filling the shrapnel—a number of elements are introduced which have considerable effect

on the further handling of the shell. Owing to the design and construction of these parts and the limitations of the requirements concerning them, it is no longer possible to handle the Russian shell mechanically, but its completion through the next six operations becomes an example of handwork pure and simple, quite a bit more so than in the case of the British shell of corresponding size, in which loading is a semimechanical proposition.

One of the causes for this difference is the fact that Russian specifications call for the insertion of "smoke powder" after five rows of balls are introduced into the shell. This composition is a mixture of metallic antimony and magnesium, the former producing dense black smoke and the latter a brilliant light, so that the explosion of the shell may be traced either by day or by night. The purpose of this smoke powder is to serve as a guide to the artillery observer who takes care of the range-finding, and of course has nothing to do with assisting in the explosion of the shell itself.

Russian shrapnel balls are cast from a mixture of four parts by weight of lead and one part by weight of antimony. The diameter of the balls is  $\frac{5}{12}$  in., and the average weight of one is 6 drams. They are tested by being struck a slight blow with a hammer and must not crack under this test. A shell is supposed to contain from 256 to 265 balls, but in some cases in this country special provision reducing the number has been made by the inspectors, since the density of the metal employed made it impossible to get the full number of given-sized balls within the allotted space in the interior of the shell.

In order even to get the reduced number of balls into the shell, it is necessary to press them down by means of an arbor press, such as shown at *C* in operation 17. The first pressing down occurs after the smoke powder has been introduced, and in some cases a second and even a third pressing at certain stages of the filling are necessary in order to make the required weight. The tool shown at *D* in this operation is used to facilitate this work. It consists of a plunger having a hole through its center, to admit the powder tube, and running in a guide the bottom of which conforms to the outside shape of the shell. Considering the restrictions and disadvantages under which this operation must be handled, three operators do well to produce 250 shells per hour.

The fuse socket of the Russian shrapnel is shown at *I* in operation 18. It differs in many respects from the British shrapnel fuse socket, and most notably in the coarse pitch of the thread that receives the fuse. After the thread in the shell nose has been daubed with grease, as shown at *E*, the fuse socket is entered by hand; then the projectile is put upon a pair of scales so that the weight may be brought up to 13 lb. 5.6 oz., within the limit either way of the weight of one ball. Should the weight be found not sufficient, a ball is introduced, as shown at *H*, this process

requiring considerable skill and manipulation. If the weight is excessive, there is nothing to do but remove the plug and take out a ball. It must be said that very few corrections need to be made, as experience soon teaches those who handle the assembling of shells to judge weight by "heft" almost as accurately as scales will measure it.

One of the most essential precautions in hand assembling is to make sure that the powder tube has not been distorted or crimped or otherwise injured. Therefore as soon as the weight has been found to be correct, a rod gage is run down through the powder tube. It must go all the way to the bottom of the powder pocket. This gage consists simply of a tool-steel rod of a diameter equal to that of the interior of the tube and provided with a handle at the top, such as is shown at *J* in operation 18. After the weight of the loaded shell and the condition of the powder tube have been found to be correct, the fuse socket is screwed down. This process is like the operation of a miniature treadmill and is shown in operation 19. The shell is held securely in a hinged vise mounted upon a pedestal, and the socket is driven home through the exertions of an operator who walks backward in a circle, pulling the pipe extension handle after him. One feature of this operation is the wrench used, which is a screw plug wrench conforming to the thread of the fuse socket and having an extension pilot that projects into and protects the central powder tube.

A difference in design between the British and the Russian shrapnel is noticed in the means used for sealing the upper end of the powder tube to the fuse socket. In British shell the brass powder tube was soldered direct to the bronze fuse socket after the loading was completed. In the Russian shrapnel the joint is made by means of a copper plug, shown at *K* in operation 20, which screws down within the fuse socket and has a recessed central hole that fits over the central powder tube. No solder is employed to make this joint, but the plug is screwed down in such a way that the powder tube is securely held. For this purpose a wrench, shown at *L*, is employed. It is quite similar in principle to that used in operation 19, for screwing down fuse sockets, except that it has a screw-slot key projection instead of threads.

Since this joint is not made tight with solder or other packing, it is essential to seat the copper plug squarely against the tube. This is tested by means of a gage, shown at *Q*, which has a double purpose—first, to indicate whether the copper plug has been screwed down the correct distance; and second, to show whether it is squarely seated.

A cork is inserted in the powder tube of each shell and remains there during the succeeding operations as an insurance against the entrance of dirt or other foreign material. Just before the fuse-hole plugs are inserted, these corks are withdrawn and returned to the bench at which this operation is performed, to be used over again.

The shell is then filled with rosin, introduced through hole *A*, the



larger of the two holes shown in suboperation *P* in operation 21. The smaller hole *B* is provided for the escape of the air.

In order to introduce the rosin through such a small opening as has been left for it, a force pump is provided on the side of the rosin kettle, as shown at *R* in this operation. The nose, or discharge opening, of this force pump is made to fit inside of the hole *A* in the fuse socket. One stroke downward of the pump lever fills the shell with rosin and causes a little to flow over, which is necessary to indicate that the shell is completely filled. The rosin is prevented from entering the threads by means of wooden plugs, such as shown at *Q*, which fill up the thread nose and prevent the necessity of cleaning out these threads later on. The rosin kettles are heated by means of gas burners and are arranged to be supplied from above by means of a rosin storage supply.

It is necessary to remove the few drops of rosin which overflow through the air outlet, and this is done by means of one or two passes of a hand scraper, as shown at *X* in this operation. Next, the shell is placed upon a pair of scales to determine its weight. One advantage of the Russian method of filling shells with rosin is the fact that the operator does not need to exercise an unusual degree of haste in entering and screwing down the fuse socket before the rosin becomes solidified. In the British shell it is important that this be done, and the necessity of doing so in a hurry does not add to the convenience of the operation.

The next step following the filling of the shell with rosin consists in plugging the rosin-admission and air-outlet holes, this work being shown in operation 22. The screws used in plugging these holes are kept at a blue heat by means of the apparatus shown at *W*, it being necessary to have them at this temperature in order that they may melt whatever rosin remains in these two holes and thus clear the way for themselves without the necessity of cleaning the holes out otherwise. An operator becomes quite expert at handling these hot screws, having a pair of tweezers as an aid in starting them. They are driven home by means of a Yankee screwdriver, after which the protruding heads are snipped off with a pair of hand snips, and whatever remains is riveted down with a hammer. This operation completely seals up the interior of the shell and its contents of balls and smoke powder, leaving an opening, however, to the powder pocket through the central powder tube, which has been and is still during this operation closed with a cork.

There are a number of checks upon the proper filling of the Russian shell. One of these is the weight of the complete shell, which indicates whether it contains the required number of balls. In addition to this a certain number of shells are unloaded or disassembled, the inspector having the right to disassemble not over one-half of one per cent. of the entire number of finished shells. Sometimes instead of disassembling a shell a section is sawed out longitudinally upon a milling machine,

exhibiting the cross-section of the interior of the shell and showing the regularity of loading. Points that are observed or looked for in these examinations are as follows: The proper fastening of the fuse socket to the body of the shell; the correct seating to the upper end of the powder tube into the copper plug; the regularity of the powder tube, and whether it has been mashed through loading; the proper filling of rosin and smoke powder; the position of the diaphragm in its seat, and whether the proper number of balls has been inserted. This latter point is established by the actual count of the contents of the disassembled shrapnel.

Notwithstanding the fact that the fuse socket is screwed down firmly in operation 19, the Russian ordinance officials insist on additional precautions against possible loosening in the shape of two  $\frac{3}{8}$ -in. screws that extend through the steel shell into the metal of the fuse socket. The drilling and tapping for these screws, as well as for the "grub" screw that is to hold the zinc fuse-hole screw plug, is done on multi-spindle high-speed sensitive drills and is shown in operation 23. The fixtures used in this operation consist of a stationary angle plate screwed to the drill table, represented at *A*, and a number of square index blocks, shown at *B*. These blocks are for the purpose of properly spacing the holes at 90 deg. of the shell circumference. They are clamped to the bases of the shells by means of the clamping screws, shown at *C*, which are tightened by means of a special socket wrench and which hold the split portion of the index block upon the base of the shell.

The stationary fixture *A*, while simple, is well adapted to fast production. There are three shell positions on this fixture, each located centrally with one of the three drill spindles. One of these shell positions consists of the central plug *H*, which enters and fits the hole in the fuse socket, and the distance plugs *J*, which butt up against the outside edge of the shell and maintain it at the proper distance from the face of the fixture. The thrust of the drill is not taken altogether by plug *H*, but upon a strip that runs across the jig and upon one of the faces of the square index blocks.

The procedure in this operation is to spot a center with a counter-sinking drill, shown at *E*, through the bushing *D*. Then the shell is moved to the second position, in which the hole for the tap is drilled at *F*. Finally, the shell goes to the third position, in which these holes are tapped by the tap *G* in an automatic reversing tapping chuck. Three holes are drilled and tapped in each shell.

A converted engine lathe furnishes the means of performing the double operation shown in operation 25, in which the copper band is formed to size and shape, and the nose end of the shell is formed and faced. The shell is held in a simple split collet chuck, shown at *A*, and runs in the steadyrest *E*, with its outer end projecting beyond this so that the combination forming tool *B* may be advanced to face off the end of the fuse

socket and also to remove the projecting ends of the riveted screwheads that remain from the preceding operation. An auxiliary tool slide is used for the copper-band forming. It is mounted on the lathe carriage at the proper distance away from the facing and forming tool *B* and is provided with a micrometer feed dial by means of which the size is determined.

A hand operation is necessary after the forming tool *B* completes its work, in order to remove the rough edges of the band. This tool is simply a flat file that has been dressed up on a grinding wheel to the shape

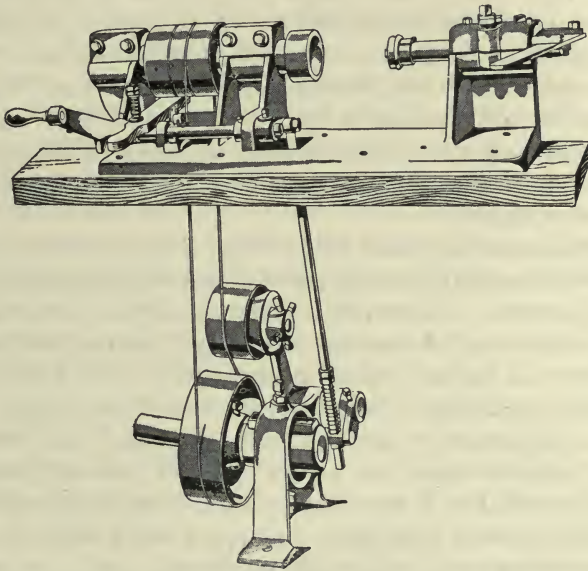

FIG. 45. BELT-DRIVEN SHELL FILING AND POLISHING MACHINE OF SIMPLE CONSTRUCTION

shown at *F*. It is used in connection with the hinged hand-tool rest, shown at *G*, which is ordinarily flapped back out of the way except when hand-tooling, at which time it is brought into the position shown in the dotted lines and forms a tool rest. No lubricant is used in this operation, which is performed at a cutting speed of 65 ft. per minute with an output ranging between 30 and 40 shells per hour.

The same type of simple speed lathe that was used in the twelfth operation in filing and polishing the body and bourrelet of the shell is brought into use again in operation 26 for filing and polishing the nose. One of these lathes is placed back to back with each of the band-turning lathes, and the operators of each keep pace together, so that the two operations can really be looked upon as forming one unit. The chuck used, which is shown at *B*, is a simple cup chuck that grips the shell by friction and requires no tightening. The tailstock spindle is spring actuated

and has a ball thrust bearing at *C*, similar to that shown in detail on the body-finishing lathe in operation 11. These machines are run at a speed of 150 r.p.m. They are driven from below by means of a floor shaft and started and stopped by means of an idler pulley and an automatic brake, which is brought into action as soon as the belt tension is decreased. Lathes of this type are mounted upon a wooden base and are quite simple in construction, as shown by the one illustrated in Fig. 45.

But two of the three holes drilled and tapped in operation 23 are used for fuse-socket holding screws. In preparing the third hole for the fuse-hole socket grub screw that keeps the zinc plug from coming loose a retapping operation is necessary. It is shown in operation 27. The shell is held in the tapered wood-block chuck, shown at *A*, while a hand tap is run through the threads to remove any burrs that may have been put on by the forming of the nose. At this time, also, the fuse socket is cleaned out with compressed air, and the cork that has remained in the powder tube since the twentieth operation is removed and returned to be used over again.

An ingenious arrangement for painting shells is shown in operation 28. It is about as effective an arrangement as has yet been developed by the shell manufacturers. The device is mounted on top of a work bench and consists of a drive shaft *A* running in bearing *B* and provided with leather friction drivers at various points in its length. The shells are held on swivel stands, consisting of brackets, shown at *C*, and tipping blocks *D*, which are manipulated by means of the handle *E*. The bottom of the shell is first painted while in a vertical position, the shell being rotated by hand, after which it is tipped over against the leather friction driver and the idler *G*, which runs upon the copper band, and the painting of the outside is completed. The shell is held at its nose, or fuse, end upon the tipping block by means of a plug that fits within the hole in the fuse socket and permits the shell to rotate.

After the fuse-hole screw plug has been driven home, it is held by means of the setscrew inserted in the small  $\frac{5}{32}$ -in. hole, the pointed end of which bears against the thread of the screw. Russian shells of this size are shipped eight in a box in substantial wooden packing cases made with locked corners. One of these is shown in operation 30.

An interesting point is the manner of sealing these boxes so that when received on the other side there will be assurance that they have not been tampered with. At *A* is shown a counterbore through which one of the cover screws is drilled and countersunk. There are two of these counterbored holes in each cover in addition to the other screws, which are flush with the top surface. Wax plugs are inserted in these counterbores after the screws have been driven home. The plugs are heated by means of a gasoline blow torch and then sealed by the official receiver of the goods after the case has been packed.

Factory inspection by no means determines the final acceptability of the Russian shells. This final decision is made under what is known as a controlling test, in which test specimens are actually fired from guns. For each batch of 5,000 shells which have passed the Government inspector located at the factory, a selection of 10 shells is made for a tensile test. Three flat longitudinal strips are cut from a cylindrical part of the shell, parallel to its axis, immediately above the band groove. The test requirements are a breaking strength not under 8,000 atmospheres (117,600 lb. to the square inch) and a final lengthening distention not less than 8 per cent.

In addition to these 10 shells which are tested for tensile strength, 50 projectiles from each batch are given a firing test. After being fired without explosive charges in the shell itself, the projectiles are gathered and tested by exploding them in a pit, those shells being used which have received no damage during the firing test. Ten of these shells are thus tested by exploding. An idea of the strictness of the controlling-batch test may be gathered by the following requirements: No breakage must occur in the bore or in front of the muzzle of the gun during firing. There must be no separation of the head from the case of the shrapnel in the bore or in front of the muzzle of the gun. No traces of the rifling must be apparent on the cylindrical part of the butt of the projectile picked up after firing, although weak traces of the rifling on the bourrelet, extending over not more than one-half the circumference, are not considered causes for the rejection of the batch.

There must be no curving of the base of the shell, nor an increase of the diameter of its cylindrical part, in excess of one point. Among the shells that are given a firing test there must not be over 20 per cent. in which the upper end of the powder tube has issued from the socket of the copper plug. In addition to this there must be no considerable crimping of the central tubes, cracks on these tubes or a penetration of the tubes themselves into the powder chamber.

In the explosion test there must be no tearing off of the bases of the shell, and the bodies of the cases must remain entire in at least 70 per cent. of those tested.

As far as the copper drive bands are concerned, there must be no tearing off or displacement of these during the firing test, and the rifling marks left upon them must have a regular appearance and not be broadened.

If any shell during the firing test breaks in the bore of the gun or in front of the muzzle, the entire batch of 5,000 shells is at once unconditionally rejected.

The failure of a test batch to meet some of these requirements does not necessarily mean the immediate rejection of the entire lot. The manufacturer is permitted to present more test shells at his own expense;



5 lb. 7 oz. or a maximum of 5 lb. 10 oz. The shell is shown in section, Fig. 46, together with the various measurements and specifications. Some of the lots of forgings have to be pickled before machining, but frequently this is unnecessary.

Disregarding for the time being several inspections, the main shop operations proceed in the following order:

- |   |   |
|---|---|
| 1. Pickling (if needed)                               | 14. Roughing out powder pocket                          |
| 2. Cutting off in lathe                               | 15. Finishing powder pocket, diaphragm chamber and seat |
| 3. Machining for centering in drilling machine        | 16. Finish facing base                                  |
| 4. Centering in drilling machine                      | 17. Nosing  |
| 5. Scoring for driver in air press                    | 18. Rough-boring and facing open end                    |
| 6. Rough-turning                                      | 19. Finish-boring end                                   |
| 7. Facing base  | 20. Tapping   |
| 8. Rough taper boring                                 | 21. Profiling   |
| 9. Roughing out diaphragm chamber and seat            | 22. Grooving for rotating band and crimping seat        |
| 10. Rough-drilling powder pocket                      | 23. Dovetailing   |
| 11. Heat-treated                                      | 24. Knurling  |
| 12. Finish taper bored                                | 25. Grinding two diameters                              |
| 13. Second roughing of diaphragm chamber and the seat | 26. Grinding end of base                                |
|   | 27. Inspection all over                                 |
|   | 28. Banding   |

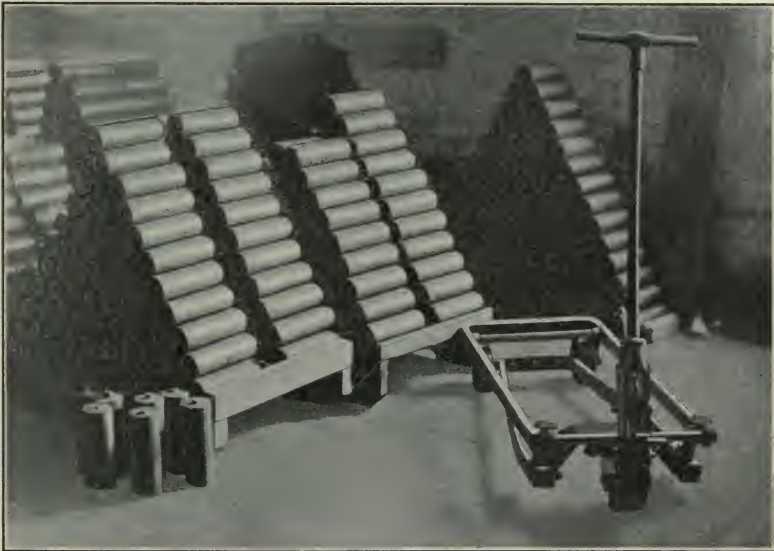

FIG. 47. SHELL FORGINGS ON TRUCK PLATFORMS, AND LIFT TRUCK USED

The shell-machining shop is well lighted and well arranged for its single purpose. A good concrete floor makes the trucking an easy matter. The forgings as received are stacked in double pyramidal piles on wooden

truck platforms, Fig. 47. Lift trucks of the type shown are used to move the work from place to place. Both the forgings and a large part of the machined work are thus moved.

The first machining operation is to trim or cut off the forging to a length of  $8\frac{3}{16}$  in., measuring from the inside. This is done in a Hill motor-driven lathe, operation 1. The forging is chucked in a universal, three-jawed chuck. The right setting is obtained by a setting rod *A*, the end of which butts against the inside end of the work. This rod is made to slide in the holding bracket *B*, and when in gaging position may be locked by a pin that fits into an offset slot at *C*. A trimmed shell is shown at *D*. As soon as the work is set and the chuck jaws are tightened, the gaging rod is pulled back out of the way.

After being cut off, the forging goes to the drilling-machine fixture, operation 2, and the plug on the bottom, or "button" is machined off to a definite distance from the inside end. One of the forgings is shown at *A*. It is slipped down over the expanding mandrel *B* until the inside end rests on the stop *C*. After the shell is on the mandrel, it is swung up under the bushing yoke and locked by the knurled-head pin *D*, which

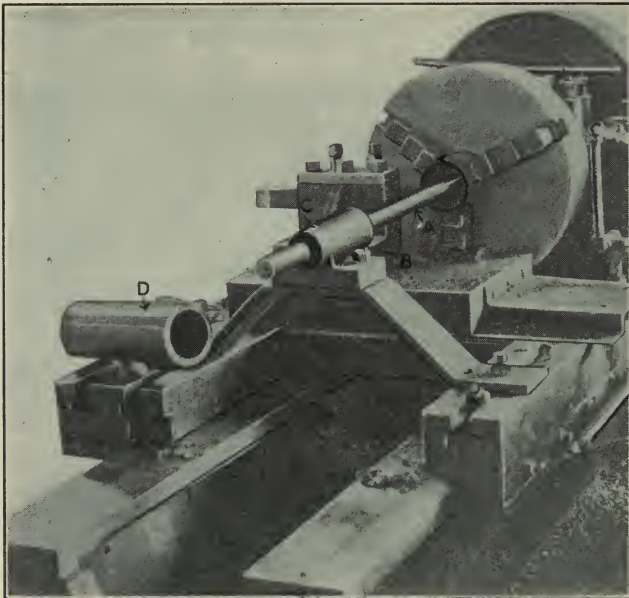

OPERATION 1. CUTTING OFF END

Machine-Used—Hill motor-driven lathe.

Fixtures—Three-jaw universal chuck and extra heavy tool block.

Gages—Work-setting gage on machine.

Production—40 to 45 per hr.

Lubricant—Soapwater.



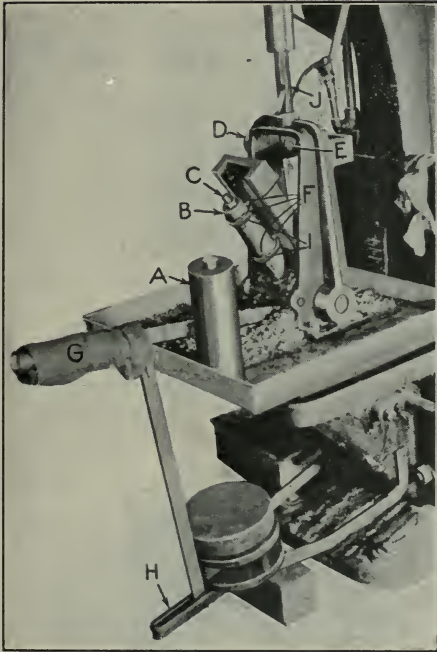

**OPERATION 2. MACHINING FOR CENTERING**

Machine Used—Drilling machine.

Fixtures Used—Special, with expanding mandrel holder, drill with very slight lip angle to provide center.

Gages—Stop on end of mandrel.

Production—55 to 60 per hr.

Lubricant—Soapwater.

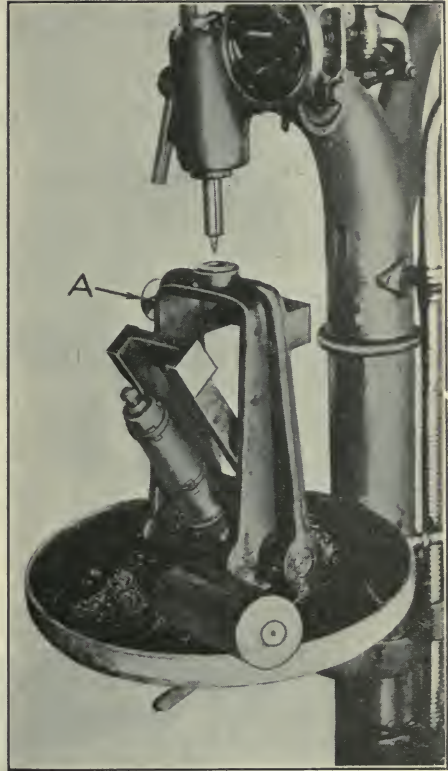

**OPERATION 3. CENTERING**

Machine Used—Drilling machine.

Fixtures Used—Special, with expanding mandrel holder, combination drill and countersink.

Gages—Stop on end of mandrel.

Production—55 to 60 per hr.

Lubricant—Soapwater.

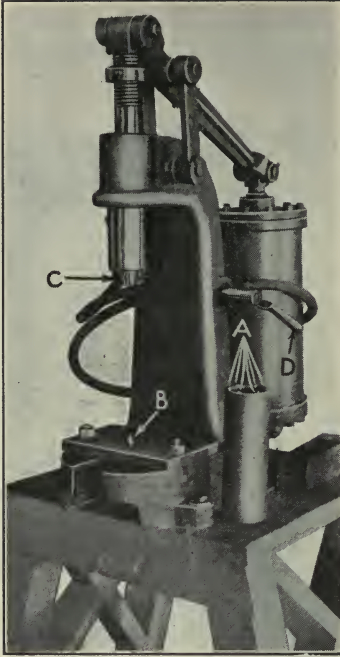

#### OPERATION 4. SCORING FOR DRIVER

Machine Used—Hannifin air press, 100 lb. pressure.

Fixtures Used—Baseplate with center, six-blade scoring tool.

Gages—None.

Production—10 to 15 per min.

Lubricant—None.

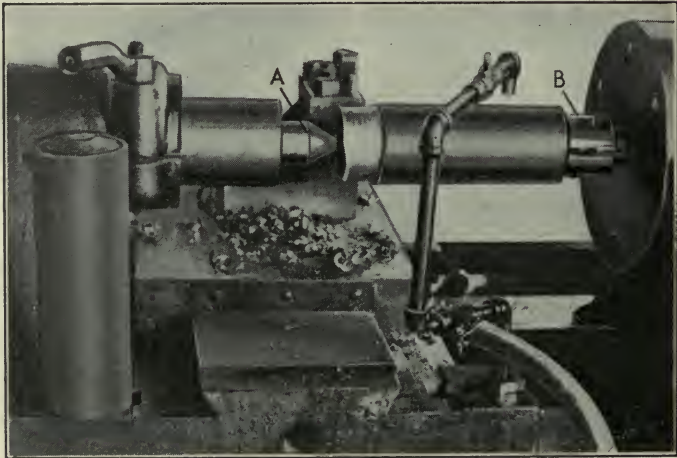

#### OPERATION 5. ROUGH-TURNING

Machine Used—Hill No. 3 motor-driven lathe, 160 r.p.m.

Fixtures Used—Six-blade driven in spindle, No. 2 stellite tool.

Gages—Snap, go and not go.

Production—18 per hr.

Lubricant—Soapwater.

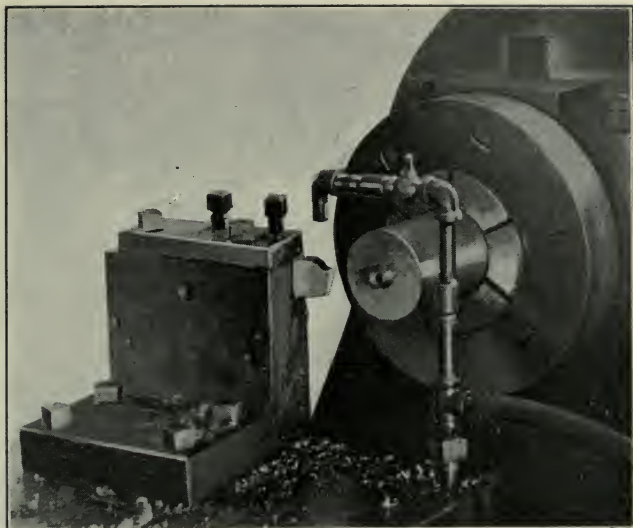

OPERATION 6. FACING BASE

Machine Used—Hill No. 3 motor-driven lathe.

Fixtures Used—Regular expanding chuck and tool block.

Gages—One chuck and two carriage stops, go and not go gage for length.

Production—31 per hr.

Lubricant—Soapwater.

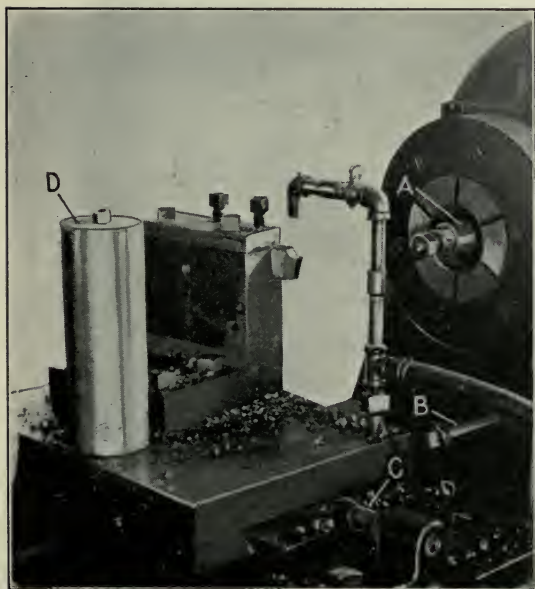
OPERATION 7. BASE-FACING  
LATHE, SHOWING STOP

Machine Used—Hill No. 3 motor-driven lathe.

Fixtures Used—Same as shown for operation 6.

Gages—One chuck and two carriage stops, go and not go gage for length.

Production—31 per hr.

Lubricant—Soapwater.

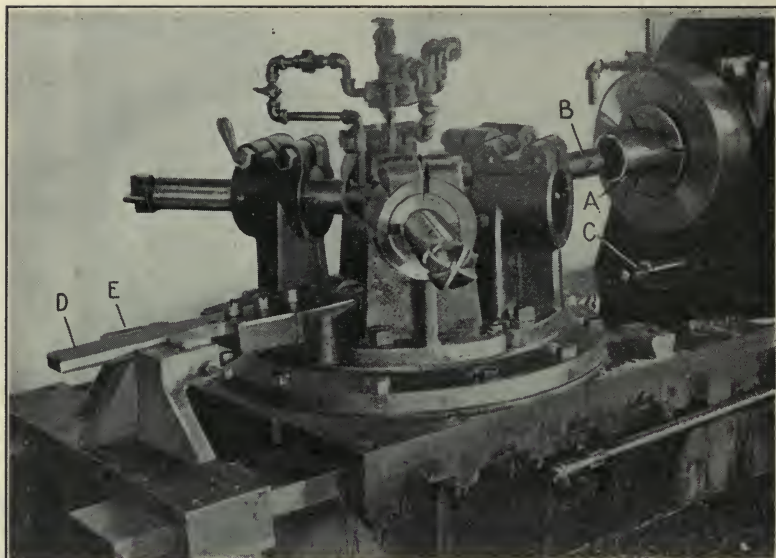

OPERATION 8. ROUGH TAPER BORING

Machine Used—Hill No. 3 turret lathe.

Fixtures Used—Profiling attachment for turret, single-point boring tool.

Gages—One chuck and one carriage stop, plug and taper-plug.

Production—21 per hr.

Lubricant—Soapwater.

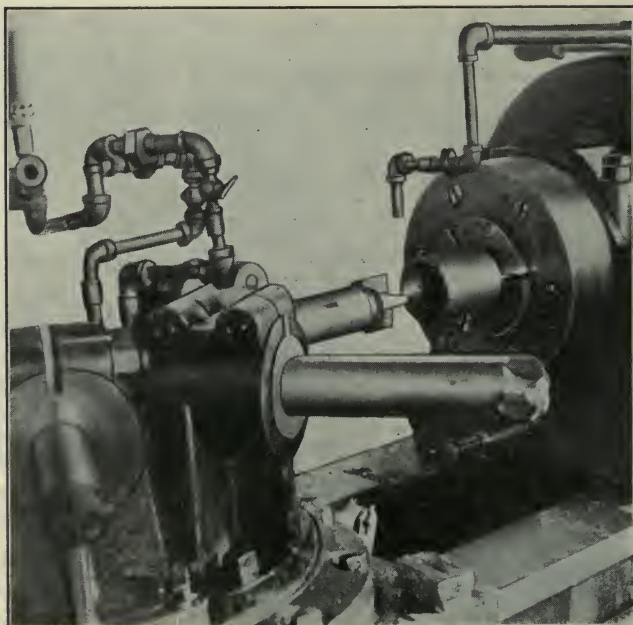

OPERATION 9. ROUGHING OUT DIAPHRAGM CHAMBER AND SEAT

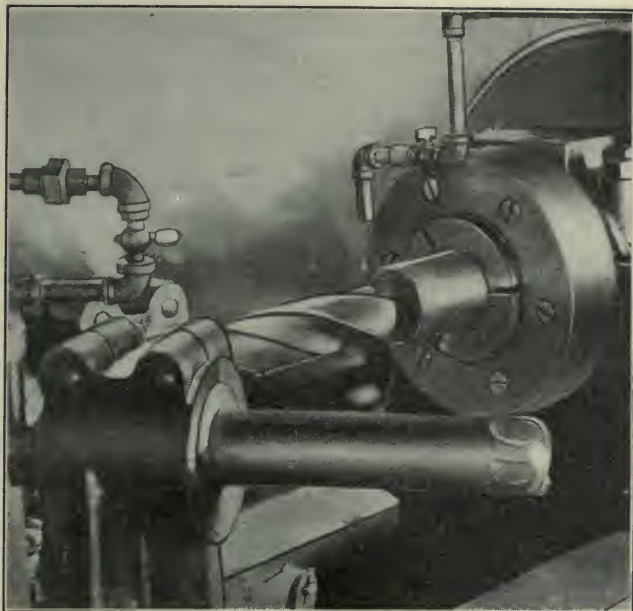

OPERATION 10. ROUGH-DRILLING POWDER POCKET

Machine Used—Hill No. 3 turret lathe.

Fixtures Used—One special boring tool and one round-cornered drill.

Gages—One chuck and one carriage stop, flat steel, double end, go and not go.

Production—15 per hr.

Lubricant—Soapwater.



OPERATION 11. THE PREHEATING AND HEATING FURNACE

Furnace Used—Tate-Jones.

Special Apparatus—Handling tongs and handled weights, pyrometers and alarm bells for timing.

Production—1 per min., heated 8 min. each.

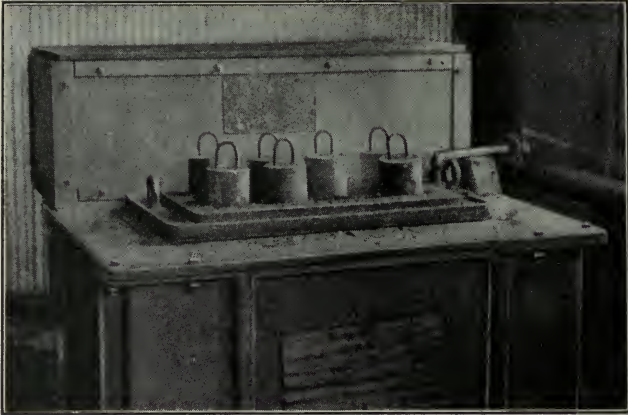

OPERATION 12. DRAWING FURNACE AND LEAD BAT APPLIED PRIOR TO FINISHING CUTS

Furnace Used—Tate-Jones.

Special Apparatus—Handling tongs and handled weights, pyrometers and alarm bells for timing.

Production—1 every 2 min., heated 16 min. each.

Note—Drawing temperatures vary with different lots of steel. The variations are charted.

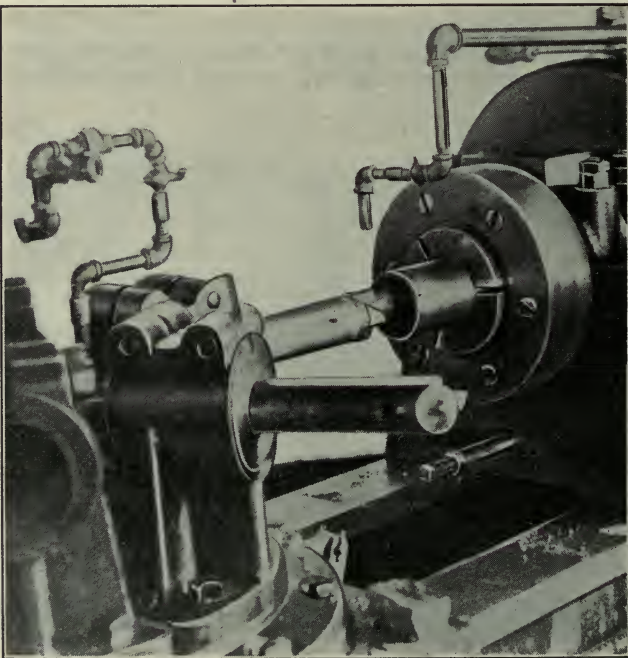

OPERATION 13. FINISHING DIAPHRAGM CHAMBER AND SEAT AND POWDER POCKET

Machine Used—Hill No. 3 turret lathe.

Fixtures Used—Special head cutters.

Gages—Plug and flat double end, go and not go.

Production (three operations)—12 per hr.

Lubricant—Oil.

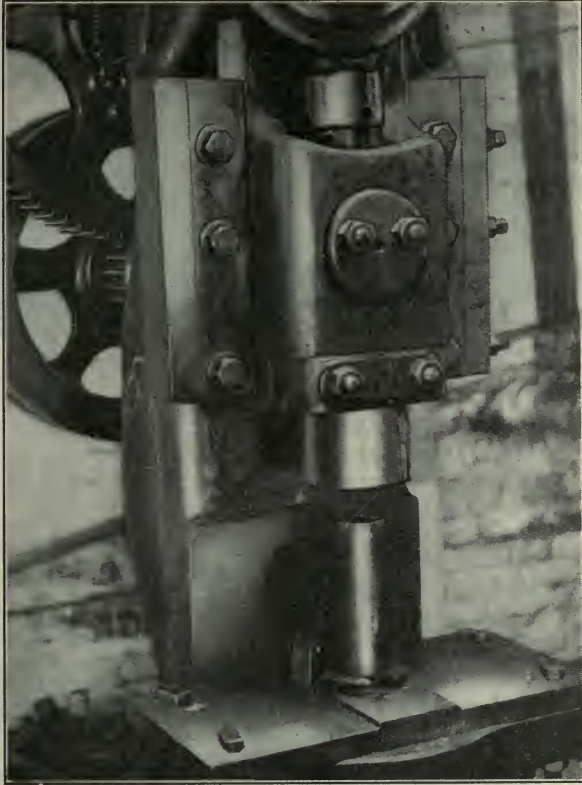

OPERATION 14. NOSING

Machine Used—Punch press.

Fixtures Used—Closing die and slotted bed block.

Gages—Two setting stops at back of holder.

Production—300 per hr.

Lubricant—Lard oil.

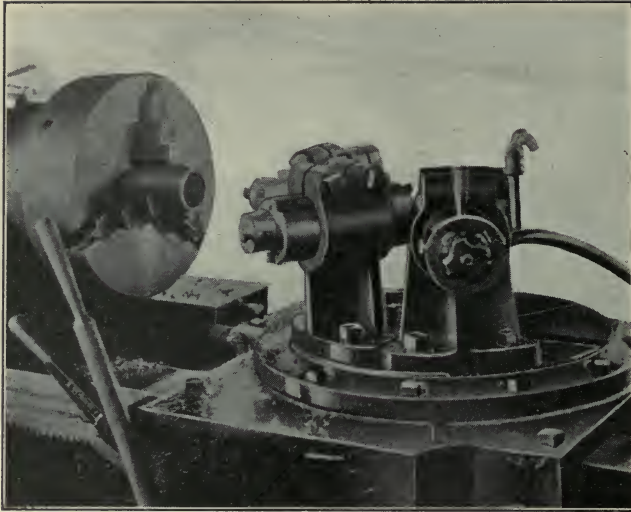

OPERATION 15. BORING AND TAPPING NOSE

Machine Used—Hill No. 3 turret lathe.

Fixtures Used—Two single-point boring tools and Murchey collapsing tap.

Gages—Stop back of chuck, carrier stop, plug thread gage.

Production (three operations)—25 per hr.

Lubricant—No. 1 lard oil with 5 per cent. kerosene.

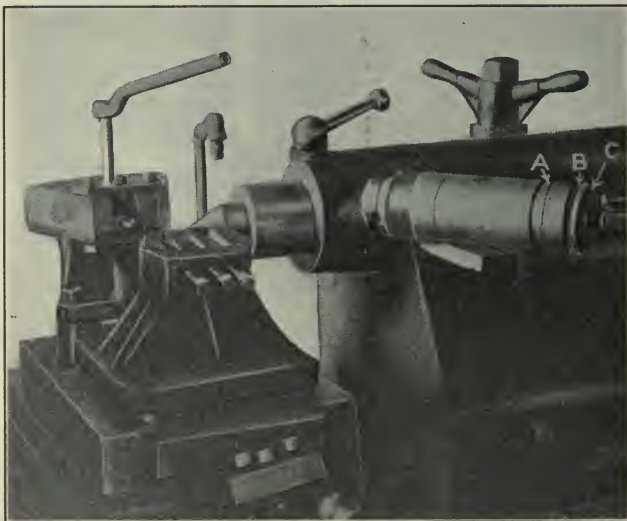

OPERATION 16. GROOVING AND DOVETAILING

Machine Used—Lathe.

Fixtures Used—Special three-cutter tool block, special dovetail cutting device.

Gages—Three carriage stops, groove snap gage, dovetail gage.

Production—31 per hr.

Lubricant—Soapwater.



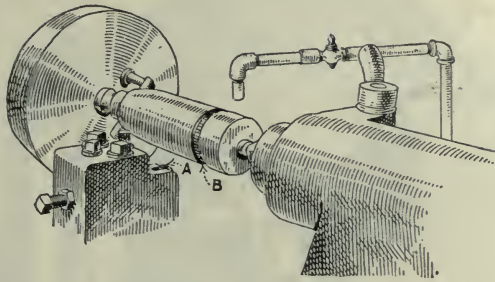

OPERATION 17. KNURLING

Machine Used—Lathe.  
 Fixtures Used—Tool block to hold knurl.  
 Gages—Snap gage.  
 Production—60 per hr.  
 Lubricant—Soapwater.

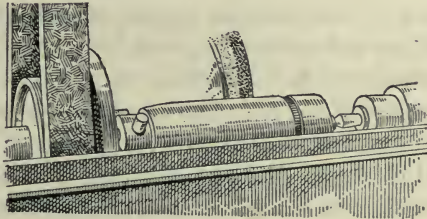

OPERATION 18. GRINDING—TWO DIAMETERS

Machine Used—Landis grinder.  
 Fixtures Used—None.  
 Gages—Snap, go and not go.  
 Production—10 per hr.

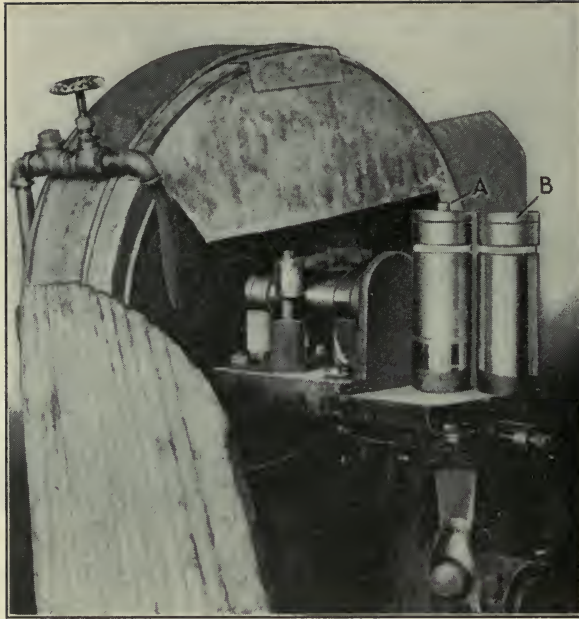

OPERATION 19. GRINDING OFF CENTER BUTTONS

Machine Used—Gardner disk grinder.

Fixture Used—Special holder on swing carrier.

Gages Used—Overall.

slides in the hole *E* and enters a corresponding bushed hole in the carrier. The expanding jaws of the mandrel consist of two sets, of three each, like those at *F*. They are moved in or out by a sliding taper pin in the center of the mandrel, which is operated by a sliding cam movement and by the hand and foot levers *G* and *H*. The expanding-mandrel jaws are held in contact with the taper center pin by bands springs *I*, which are snapped into recesses milled in the jaw ends. The drill *J* works through a steel bushing in the top of the yoke and is ground almost straight on the cutting end. Just enough lip angle is ground on it to leave a slightly hollowed spot for the center drill to operate in.

The centering is done with a combination center drill and countersink, using the fixture seen in operation 3. This is very similar to the one just shown, except that there is no hand or foot lever used. The action of swinging the carrier up under the yoke slides the lower end of the taper pin over a cam underneath and causes the jaws to expand and grip the shell. The carrier is locked in place by a sliding pin *A* exactly as in the other fixture. As the carrier is pulled toward the operator after the work is drilled, the action automatically releases the jaws, and the shell may be easily lifted off the mandrel.

For the roughing outside work the shell is held between a tail center and a six-point driver in the lathe spindle. To make it easy for the lathe operators to set the shells, the driving points are scored into the open end of the shells in the air press, operation 4. One of the shells is shown with the scored points indicated at *A*. In doing the work the shell is set with its center hole over the locating center *B*. The scoring tool *C* is then brought down by operating the valve lever *D*.

Next comes a lathe operation, which consists in roughing off the outside. The shell is held, between the tail center *A* and the six-point driver *B*, shown in detail in Fig. 48. Except for some minor

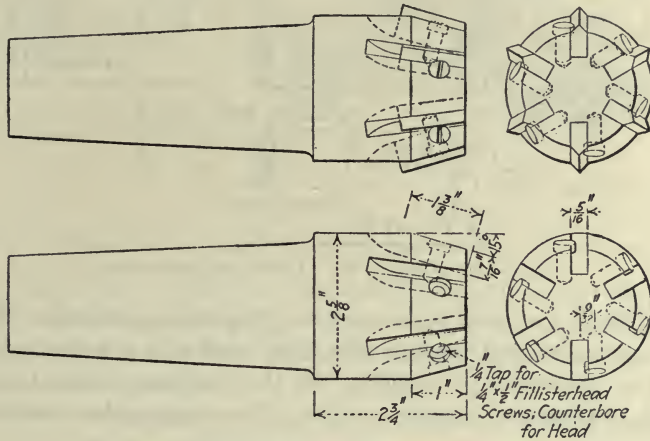

FIG. 48. DETAILS OF SIX-POINT WORK DRIVEN

features it is the same as the scoring tool of the previous operation. About  $\frac{9}{32}$  in. of metal is removed from the diameter of the forging in this roughing operation, using a No. 2 stellite tool in an Armstrong holder.

For facing the base the shell is chucked as in operation 6. In order quickly to set the shells a uniform distance into the chuck jaws, a special stop *A*, operation 7, is used. Another stop *B* is provided to butt the carriage against, and the stop *C* gives the correct distance for feeding in the cross-slide. A shell roughed all over the outside may be seen at *D*.

The first machine operation on the inside is to rough taper bore, operation 8. The bore is not a straight taper, but from the outside end the shell is bored straight for 1.631 in., then taper for 3.60 in. and straight again for 1.850 in. The shell is held in the lathe chuck, as at *A*. The boring is done with a single-point tool *B*, which is shown in detail in Fig. 49. A stop *C* regulates the carriage travel. The taper boring is really a profile operation, controlled by a master *D* on the back of the turret. This master slides between guides in the bracket *E*, which is bolted to the lathe bed. When other operations are being performed, the master is raised up out of the guides and is carried by the turret, to which it is

hinged. Details of this attachment, and the way it is placed on the turret, are given in Fig. 50.

In some cases the taper boring and the next two operations are performed on the same machine; in others the last two are done on another machine, which accounts for some apparent discrepancies in the set-ups

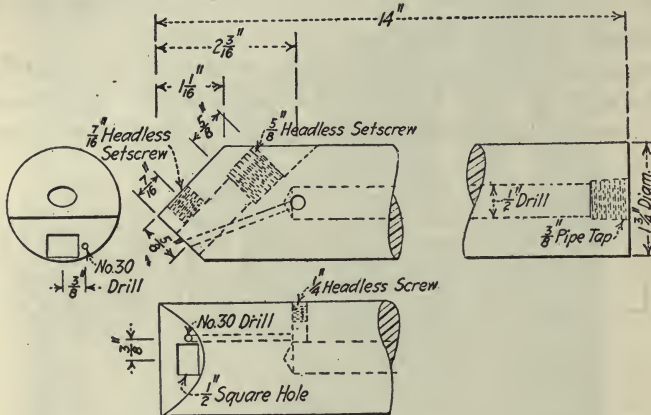

FIG. 49. DETAILS OF TAPER-FORMING TOOL

shown. This is also true of some of the finishing operations. However, for convenience we will consider the taper boring as a separate operation and the two operations of roughing out the diaphragm chamber and seat and rough drilling the powder pocket as done on another machine.

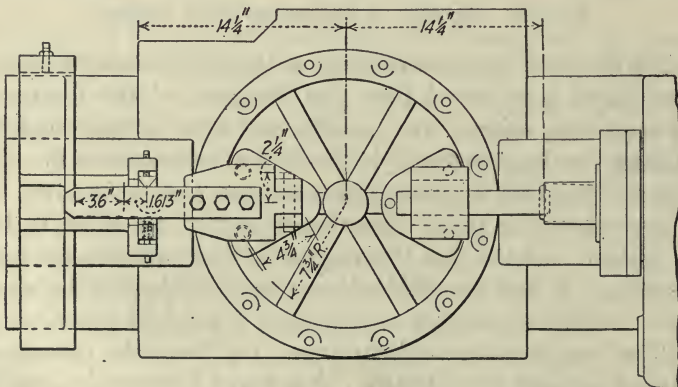

FIG. 50. DETAILS OF TAPER-TURNING ATTACHMENT

Following the taper boring, the diaphragm chamber and seat are roughed out with the tool seen in operation 9 and again, in detail, in Fig. 51.

The rough-drilling of the powder pocket is accomplished with a round-cornered drill, operation 10, which is  $2\frac{1}{8}$  in. in diameter and is run in to a depth of  $8\frac{3}{16}$  in.



operation, the production being 40 per hr. The heat number is then restamped on the base, and the shell is ready for nosing.

The nosing operation consists of closing in the open end of the shell, operation 14. This is done cold, using a little lard oil to lubricate the closing die. The end is closed in to about  $2\frac{21}{64}$  in., the main body of the shell being 3.01 in. in diameter. The closing-in extends back about

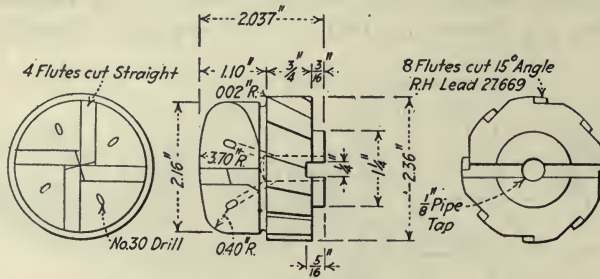

FIG. 53. DETAILS OF TOOL FOR FINISHED DIAPHRAGM CHAMBER AND SEAT AND POWDER POCKET

$1\frac{5}{16}$  in., the measurements being outside and only approximate. Details of the nosing die are shown in Fig. 54.

The next three operations are completed on the same lathe. The shell is chucked as in operation 15, and the nose is rough-bored and faced. It is then finish-bored and tapped. For this work No. 1 hard oil is employed, with about 5 per cent. kerosene in it to make it run right.

A centering plug with a crosshandle for driving purposes is screwed into the shell, giving it two center holes to locate it between centers. It is then placed in a lathe fitted with a heavy tool block carrying three cutting tools that profile the shell as they are fed along parallel to it, turning the

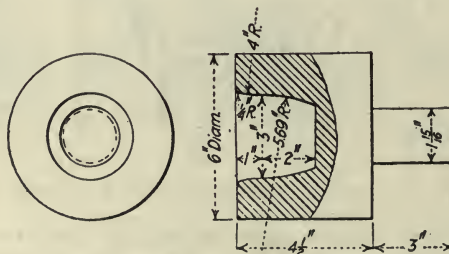

FIG. 54. DETAILS OF NOSING DIE

shell to three different diameters in different sections of its length. Details of the tool block used are given in Fig. 55. The production is 27 per hr., with soapwater as a lubricant.

The grooving and dovetailing for the rotating band are done in the machine shown in operation 16. Besides the band groove, a groove is also cut for crimping in the edges of the cup that holds the propelling

charge. Besides these two grooves, the base edge is chamfered. The two grooves and the chamfer are cut with three tools at once, set in the block on the front of the carriage. The clamping top is removed from this block in order to show the position of the three cutters. The grooves and the chamfer are indicated on the shell at *A*, *B* and *C*. The dovetailing is cut with the special crosstool device on the rear of the carriage. This device is shown in detail in Fig. 56. The operation of the dovetailing cutters leaves a slight ridge in the center of the groove for the knurling operation.

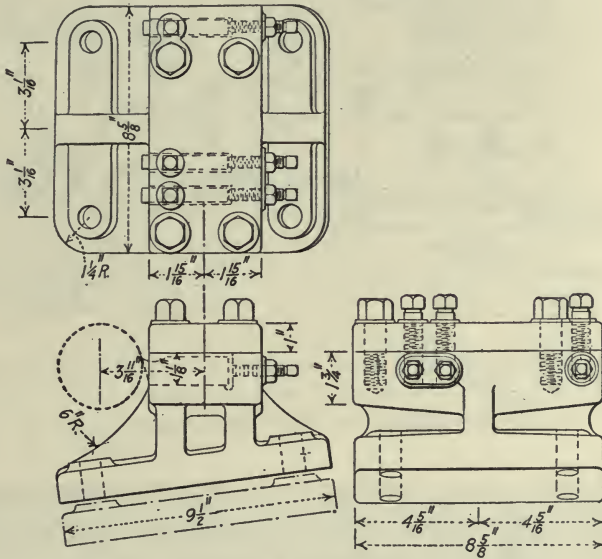

FIG. 55. DETAILS OF PROFILING TOOL BLOCK

From the grooving lathe the shells go to the lathe illustrated in operation 17, where the bottom of the rotating-band groove is knurled. The knurl is seen at *A* and the work at *B*.

The shells are ground on two diameters in front of the band groove, operation 18. Next, they go to the grinder, shown in operation 18, where the buttons are ground off the bases. A shell with the center button still in place is shown at *A* and a ground one at *B*. The grinding fixture is simple and consists of two V-blocks and an adjustable end stop. A screw clamp holds the shell in place as the operator swings the work back and forth past the wheel.

After this last grinding the shells are thoroughly inspected all over. Careful check is kept in the shop also by inspectors as the shells pass from one machine to another. In addition to this the machine operators have gages to use where needed. Some of the rough and shop gages are shown in Fig. 57 and some of the finish gages in Fig. 58.

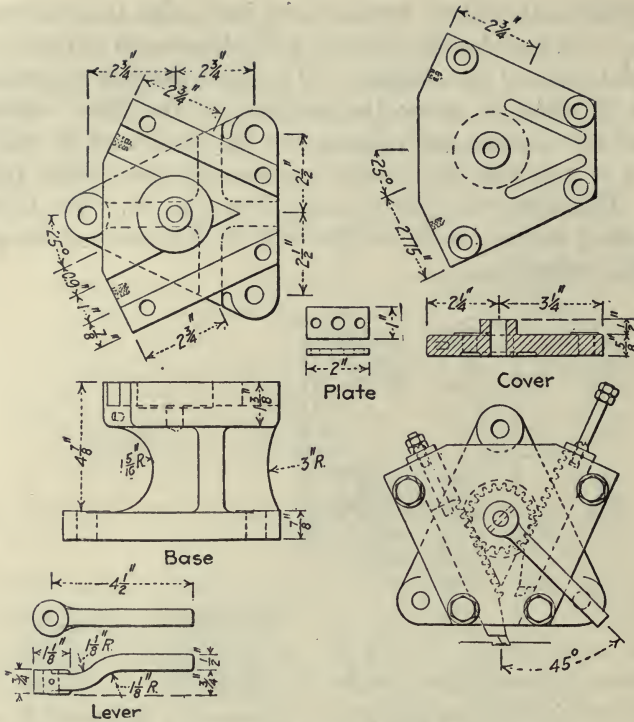

FIG. 56. DETAILS OF THE DOVE-TAILING TOOL

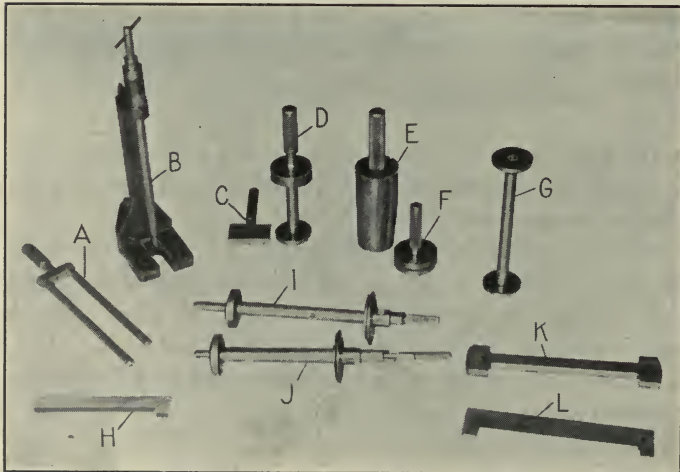

FIG. 57. ROUGH OR SHOP GAGES

A—Rough cut bottom; B—Finish cut bottom; C—Rough taper; D—Rough taper; E—Finish taper; F—Finish taper; G—Lower cylinder; H—Profile; I—Rough powder pocket, depth; J—Finish powder pocket, depth; K—Powder pocket, go and not go; L—Overall rough.



The copper rotating bands are received all ready to slip down over the shell. This work is done by hand, or sometimes the bands need to be lightly tapped down. The shell with a band in place is set into a West banding machine at the rate of 95 per hr. The holder is just high enough to guide the copper band into the groove as the jaws close in around it.

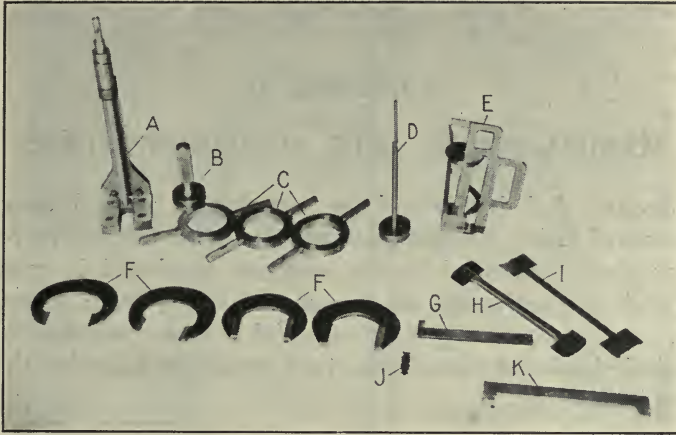

FIG. 58. FINAL GAGES

A—Bottom thickness; B—Go and not go plug; C—Ring diameter; D—Powder pocket depth; E—Wall thickness indicator; F—Go and not go diameter snap; G—Profile; H—Powder pocket, go and not go; I—Diaphragm chamber go and not go; J—Dovetail; K—Overall.

An expanding plug or mandrel is placed inside the shell to prevent any possibility of distortion or crushing. This mandrel is shown in detail in Fig. 59. Here the taper center *A* is seen projecting slightly from the end of the expanding sleeve *B*. The mandrel is dropped into the shell until the shoulder *C* rests on the nose. The handle *D* is then held with one hand and the handle *E* turned with the other. This action draws in

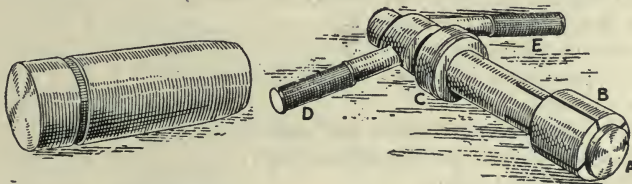

FIG. 59. THE EXPANDING MANDREL

the taper center expanding the sleeve and supports the inside of the shell just under the band groove, effectually preventing the groove from bulging inward.

This is the last operation in this shop, as the rest of the work is done elsewhere. After the final inspection the shells are shipped out.

## CHAPTER VI

### MANUFACTURING 12-IN. RUSSIAN SHRAPNEL<sup>1</sup>

On account of their size and the accuracy of finish demanded, the manufacture of 12-in. shrapnel shell presents many interesting problems, which are well exemplified in the processes employed in making the Russian shell detailed in Fig. 60. Some twenty-five main operations are entailed, an economical sequence of which follows, together with diagrammatical views of the more important operations following the centering of the billets:

#### SEQUENCE OF OPERATIONS

1. Lay off ends of billet for center and center punch.
2. Square center and countersink.
3. Rough-turn and cut blanks to length.
4. Rough-bore.
5. Second bore.
6. Bore powder chamber and bore for diaphragm.
7. Fit in diaphragm.
8. Nose.
9. Turn inside form.
10. Open end faced and thread cut to suit adapter.
11. Fit in adapter and turn part of outside and machine contour.
12. Face back end and turn rest of body on outside.
13. Turn channel and knurl.
14. Force on copper band.
15. Turn copper band to shape.
16. Final inspection.
17. Remove plug, adapter bottom and adapter.
18. Fit in spider to hold powder tube central.
19. Fill in bullets and rosin.
20. Remove spider, place on adapter, fill with bullets to required weight.
21. Insert adapter bottom.
22. Fill with powder through powder tube.
23. Fill powder tube with pellets.
24. Final weighing.
25. Screw in plug and grease ready for packing.

<sup>1</sup> Robert Mawson, Associate Editor, *American Machinist*.

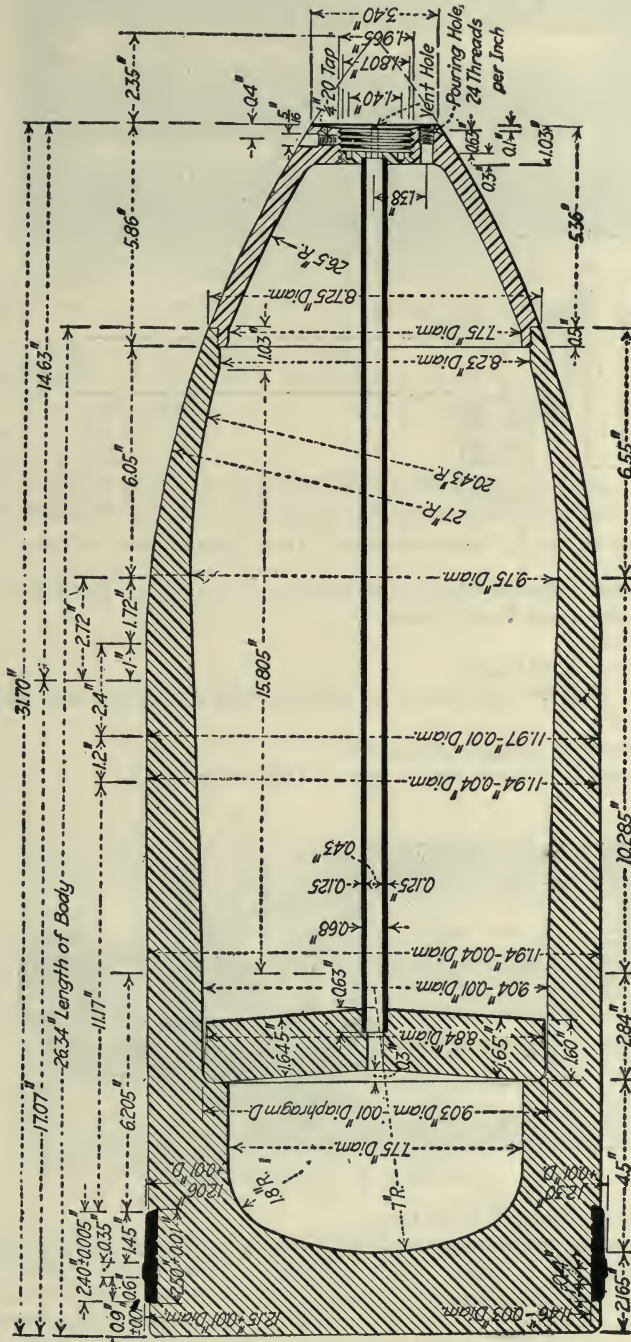
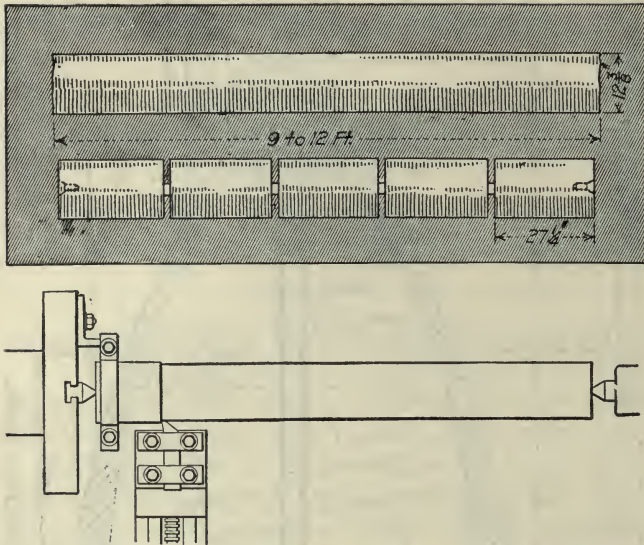

FIG. 60. DETAILED ILLUSTRATION OF 12-IN. SHRAPNEL SHELL



OPERATION 3. ROUGH-TURNING AND CUTTING THE BLANKS

Machine Used—Bement-Miles lathe, using  $\frac{1}{2}$ -in. width cutting-off tool.

Special Fixtures and Tools—None.

Gages—None.

Production—4 in 12 hours.

Lubricant—Turn dry and use 50 per cent. lard oil and 50 per cent. kerosene oil when cutting off.

Note—Between grindings of tool—Two.

Lathe operates at 6 r.p.m. with a feed of 0.125 in. per rev.

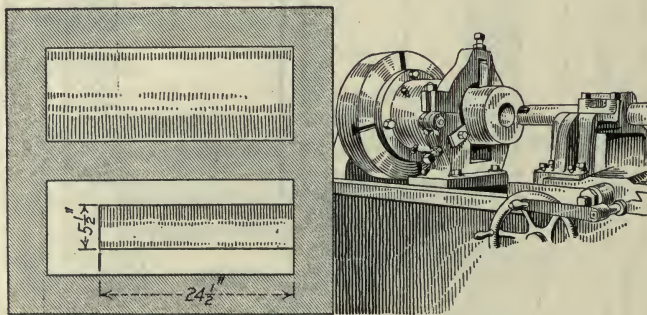

OPERATION 4. ROUGH BORING

Machine Used—Bement-Miles lathe.

Special Fixtures—Steadyrest, supports for boring bar, boring bar, head and cutter.

Gages—None.

Production—One in 8 hours.

Lubricant—"Exanol."

Note—Between grindings of tool—Average two shells.

Note—Lathe operates at 30 r.p.m. and feed of 0.014 in. per revolution.

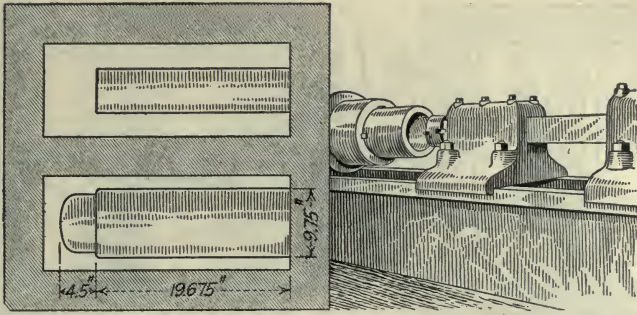

OPERATIONS 5 AND 6. SECOND BORING; POWDER CHAMBER AND SEAT FOR DIAPHRAGM

Machine Used—Specially designed lathe.

Special Fixtures—Holding chuck for shell.

Gages—Depth and contour.

Production—One in 7 hours.

Lubricant—“Exanol.”

Note—Average number of shells between grindings of tools—One.

Lathe operates at 30 r.p.m. with a feed of 0.014 in. per revolution.

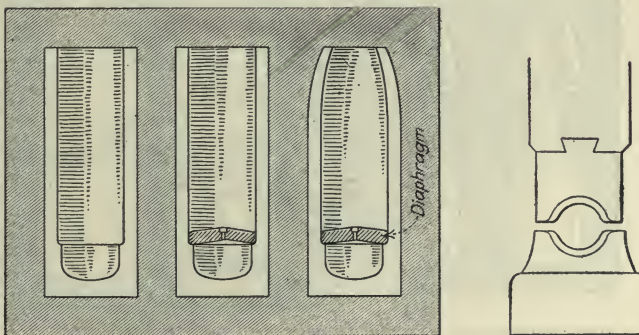

OPERATIONS 7 AND 8. THE NOSING

Machine Used—Niles-Bement-Pond 2,500 lb. steam hammer.

Special Fixtures Used—Crude-oil furnace heating four at once, special tongs for handling work, truck to convey shells to hammer, special top and bottom dies and trucks to machining department.

Gages—Contour.

Production—Steam hammer and four men, four shells per hour.

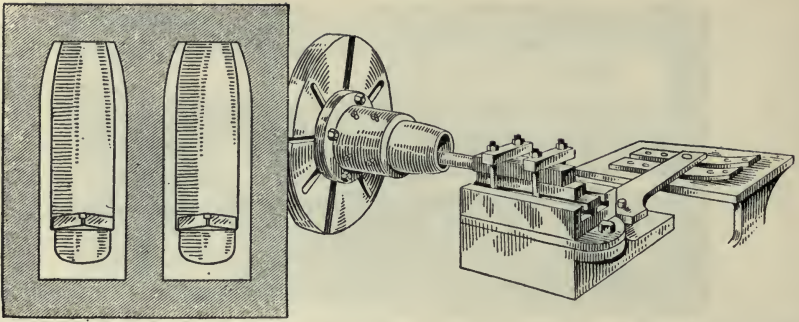

OPERATION 9. TURNING INSIDE FORM

Machines Used—Fitchburg and special.

Special Fixtures—Chuck, boring bar and radius attachments.

Gages—Form.

Production—One in 4 hr.

Lubricant—None.

Note—Between grindings of tool, 3 shells. Lathe operates at 20 r.p.m. with feed of  $\frac{1}{32}$  in. per revolution.

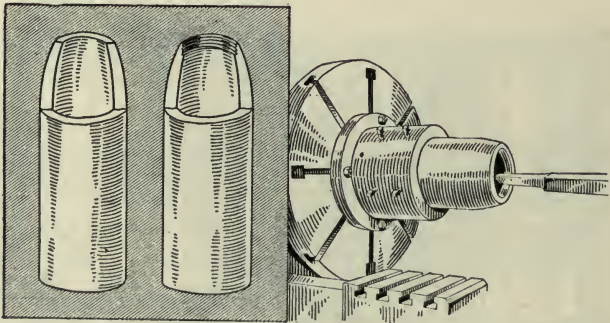

OPERATION 10. FACING OPEN END AND CUTTING THREAD

Machines Used—Fitchburg and special.

Special Fixtures—Chuck, facing and thread-cutting tools.

Gages—Depth.

Production—One in  $1\frac{1}{2}$  hr.

Lubricant—None.

Note—Between grindings of tool, 4 shells. Lathe operates at 20 r.p.m. with feed of  $\frac{1}{32}$  in. per revolution.

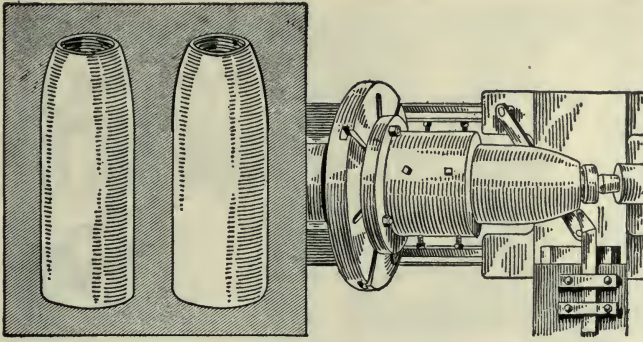

OPERATION 11. FORMING THE OUTSIDE

Machines Used—Fitchburg and special.

Special Fixtures—Chuck, link and radius attachments.

Gages—Form.

Production—One in 5 hr.

Lubricant—None.

Note—Between grindings of tool, 5 shells. Lathe operates at 20 r.p.m. with  $\frac{1}{32}$ -in. feed.

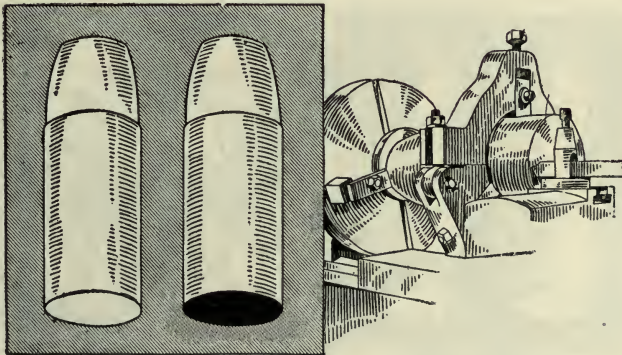

OPERATION 12-A. FACING BACK END OF SHELL

Machines Used—New Haven, Boye & Emmes and special.

Special Fixtures—Threaded chuck and steadyrest.

Gages—Length and snap.

Production—One in 3 hr.

Lubricant—None.

Note—Between grindings of tool, 1 shell. Lathe operates at 20 r.p.m. with feed of  $\frac{1}{16}$  in. per revolution.

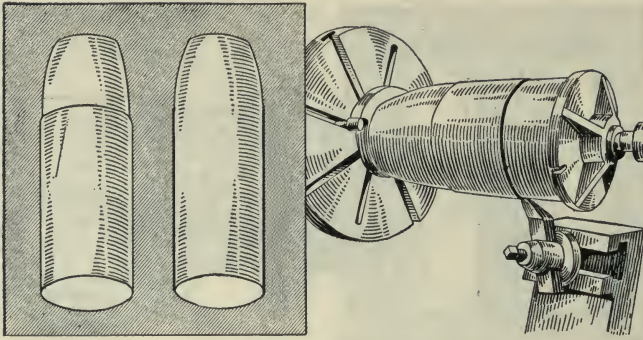

OPERATION 12-B. TURNING REST OF BODY

Machines Used—New Haven, Boye & Emmes and special.

Special Fixtures—Chucks.

Gages—Snap.

Production—One in 2 hr.

Lubricant—None.

Note—Between grindings of tool, 2 shells. Lathe operates at 20 r.p.m. with feed of  $\frac{1}{16}$  in. per revolution.

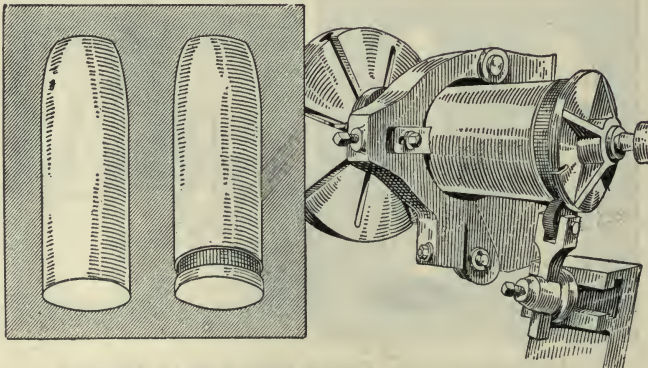

OPERATION 13. TURNING AND KNURLING

Machines Used—New Haven, Boye & Emmes and special.

Special Fixtures—Two chucks and steadyrest.

Gages—Snap and form.

Lubricant—None.

Note—Between grindings of tool, 2 shells. Lathe operates at 20 r.p.m. with feed of  $\frac{1}{16}$  in. per revolution.



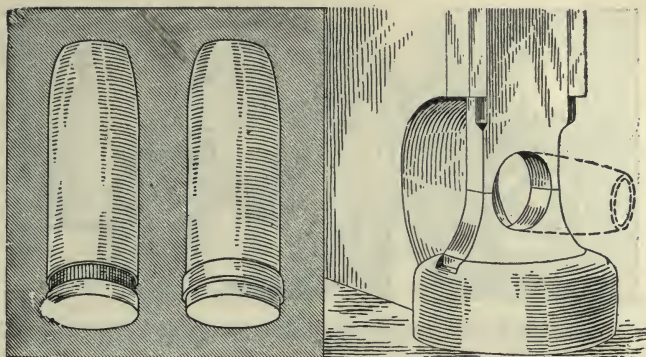

OPERATION 14. COMPRESSING THE COPPER BAND

Machine Used—Niles-Bement-Pond steam hammer.

Special Fixtures—Dies fitted to steam hammer; special screw bar and clamp for turning shell between dies; trucks to convey between forge and machine shop.

Gages—None.

Production—Six per hour.

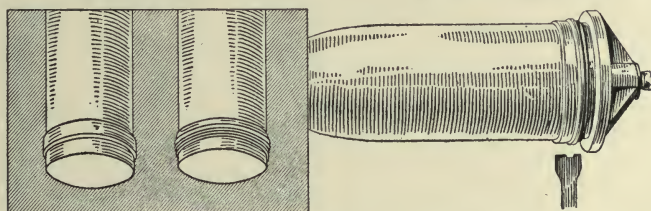

OPERATION 15. MACHINING COPPER BAND

Machine Used—Boye & Emmes.

Special Fixtures—Threaded-plate chuck and form tool.

Gages—Form.

Production—One shell per hour.

Lubricant—None.

Note—Between grindings of tool, 2 shells. Lathe operates at 150 r.p.m., and feed is by hand.

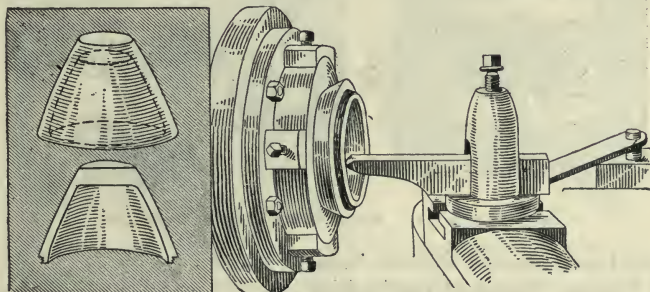

OPERATION I. MACHINING THE ADAPTER—FORMING INSIDE, FACING AND THREADING

Machine Used—Lodge & Shipley.

Special Fixtures—Chuck, link and attachment to lathe.

Gages—Form.

Note—Between grindings of tool, 1 piece; speed and feed of lathe, 42 r.p.m. with feed of  $\frac{1}{16}$  in. per revolution.

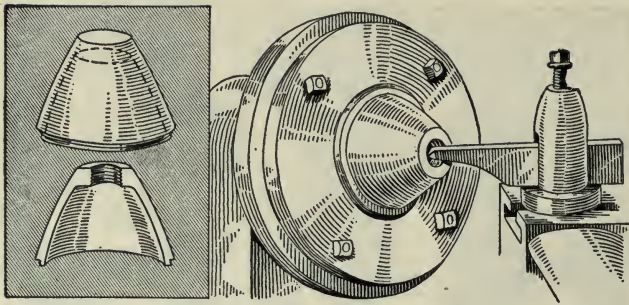

OPERATION II. MACHINING THE ADAPTER—FACING SMALL END, BORING AND THREADING

Machine Used—Lodge & Shipley.

Special Fixtures—Chuck, flat twisted drill and counterbore.

Gages—Thread and form.

Lubricant—None.

Note—Between grindings of tool, 2 pieces; speed and feed of lathe, 42 r.p.m. with feed of  $\frac{1}{16}$  in. per revolution.

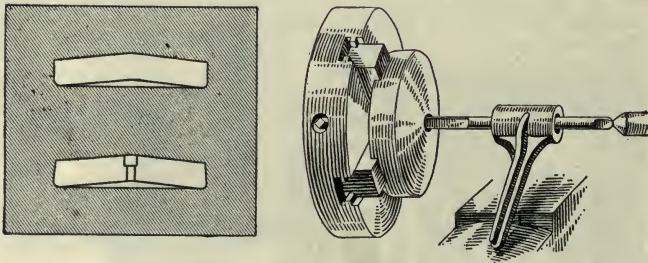

OPERATION III. MACHINING THE DIAPHRAGM

Machines Used—Boye & Emmes, Lodge & Shipley.

Special Fixtures—Standard chuck, drills and turning tools.

Gages—Radius, depth and form.

Production—One in 2 hr.

Lubricant—None.

Note—Between grindings of tools, 2 pieces; speed and feed of lathe, 42 r.p.m. with feed of  $\frac{1}{16}$  in. per revolution.

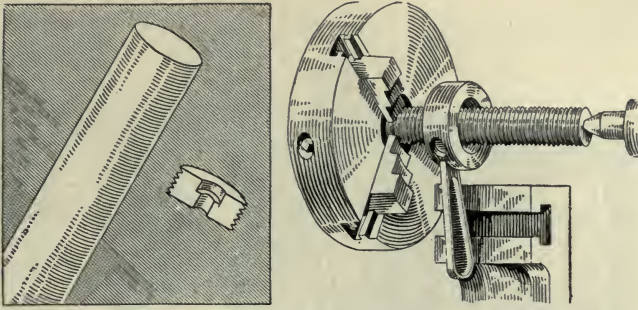

OPERATION IV. MACHINING ADAPTER BOTTOM

Machines Used—Lodge & Shipley, Boye & Emmes.

Special Fixtures—Standard chuck and jig.

Production—Four per hour.

Lubricant—None.

Note—Between grindings of tool, 25 pieces; speed and feed of lathe, 110 r.p.m. with feed of  $\frac{1}{16}$  in. per revolution.

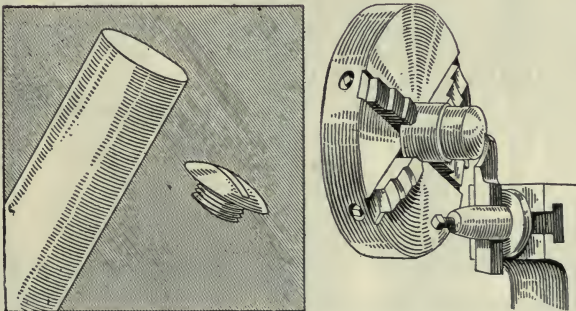

OPERATION V. MACHINING ADAPTER PLUG

Machines Used—Lodge & Shipley, Boye & Emmes.

Special Fixtures—Chucks and turning tools.

Gages—Ring and thread.

Lubricant—None.

Note—Between grindings of tool, 5 pieces; speed and feed of lathe, 110 r.p.m. with feed of  $\frac{1}{16}$  in. per revolution.

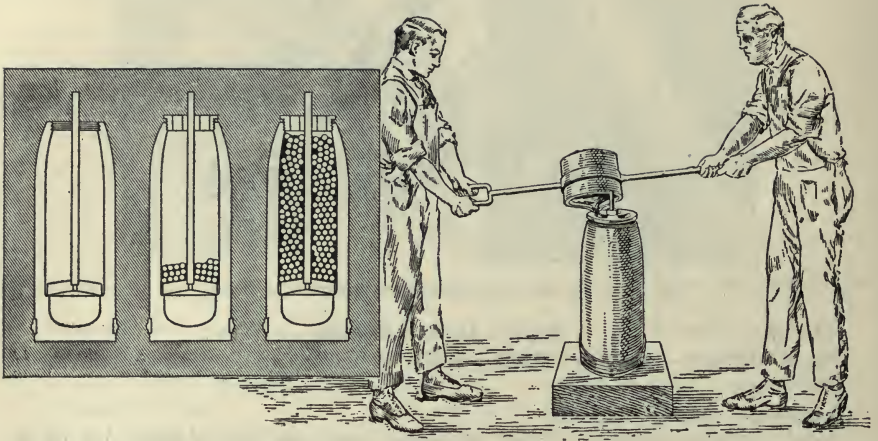

OPERATION 19. FILL WITH BALLS AND ROSIN

Equipment—Spider, funnel and rosin-pouring pan.

Production—Two men, 2 per hr.

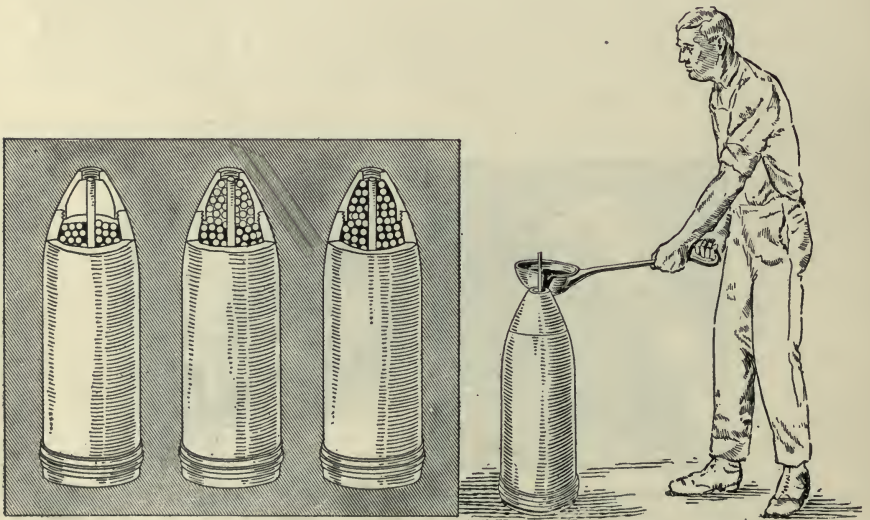

OPERATION 20. FILLING ADAPTER WITH BALLS AND ROSIN

Equipment—Plug to fit in top of powder tube and rosin-pouring scoop.

Production—Two men, 6 per hr.

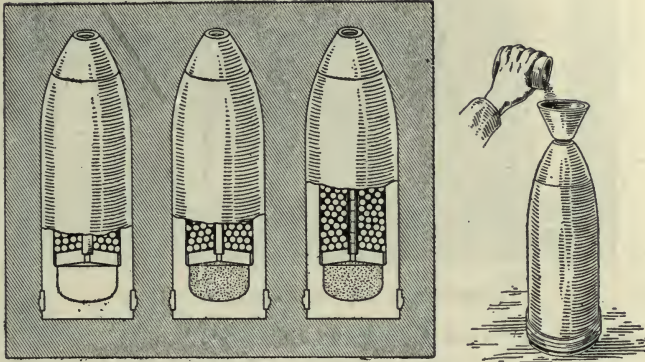

OPERATIONS 22 AND 23. LOADING WITH POWDER

Equipment—Funnel to suit adapter end of shell.  
 Production—One man, 3 per hr.

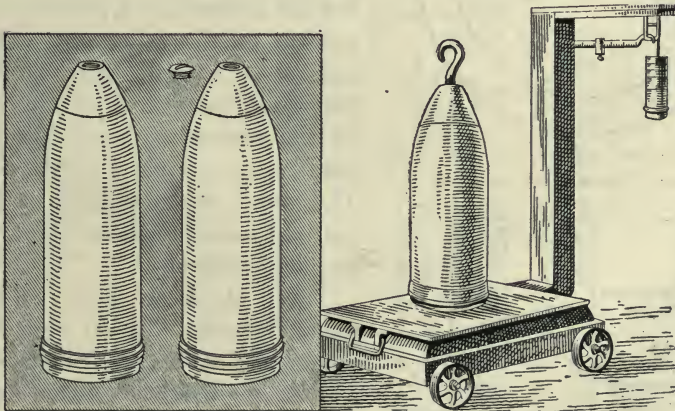

OPERATION 24. FINAL WEIGHING

Equipment—Hook in shell nose; crane and scales.

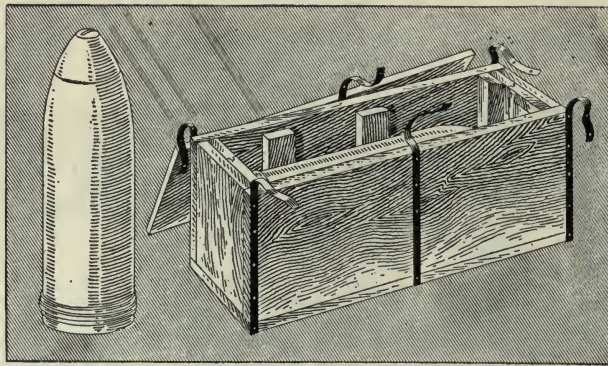

OPERATION 25. BOXING THE SHELL

Equipment—Crane, truck and packing case.

The steel from which the blanks are made comes in billets averaging from 9 to 12 ft. in length and approximately  $12\frac{3}{8}$  in. in diameter. Its chemical analysis is: Carbon, 0.47 per cent.; manganese, 0.68 per cent.; phosphorus, 0.022 per cent.; sulphur, 0.035 per cent. The physical analysis is: Tensile strength, 90,000 to 110,000 lb. per sq. in.; elastic limit, 50,000; elongation, not less than 8 per cent.; reduction of area, not less than 21 per cent. For the operation of rough-turning the outside of the billet and cutting the blanks to length, which follows the centering operations, the billet is held on the centers of a lathe and driven with a dog attached to the faceplate. The bar is rough-turned to  $12\frac{1}{16}$  in. and cut into lengths of about  $27\frac{1}{4}$  in., no gage being used.

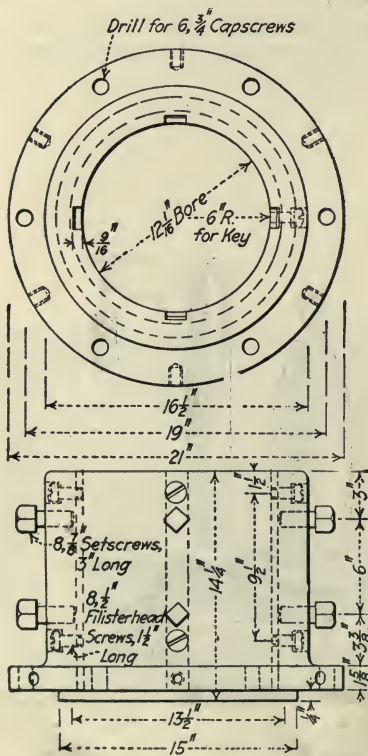

FIG. 61. HOLDING CHUCK FOR LATHE

on the lathe carriage. A detail of this attachment is given in Fig. 64. It will be observed that the guide clamp is fitted with a  $\frac{7}{8}$ -in. key

The blank is then held in the special chuck, Fig. 61, for the next operation, which is rough-boring to  $5\frac{1}{2}$  in. in diameter. The boring bar, head and cutter for this operation are shown in Fig. 62. The depth gage, which is of the pin type may be seen in Fig. 63. The bar is supported and guided through special clamps fitted







that is set into a keyway machined in the boring bar, thus holding the bar from rotating. The outer end of the shell is supported by a steady-rest, a detail of which appears in Fig. 65.

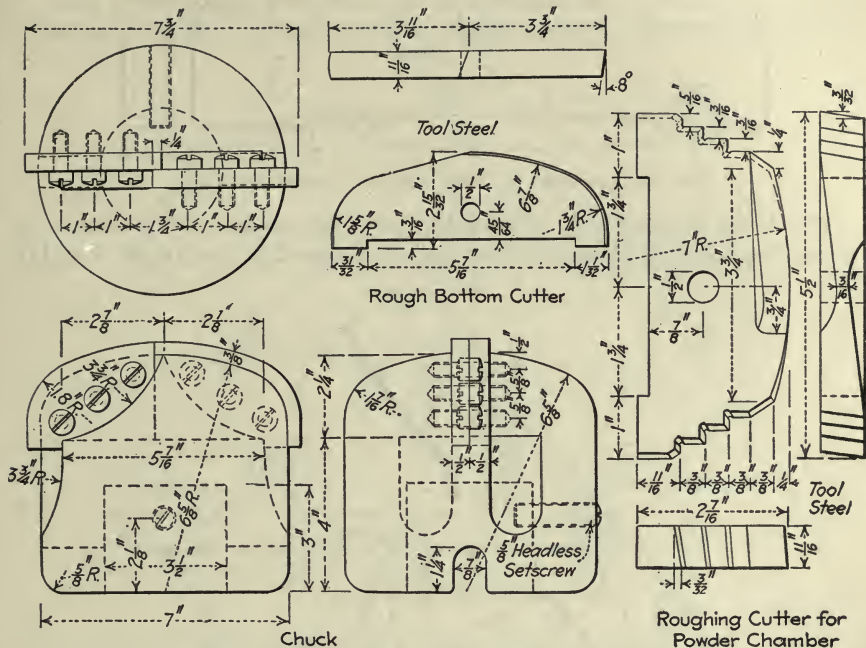

FIG. 68. CUTTER AND CHUCK FOR POWDER CHAMBER

For the next operation the blank is held in a chuck similar to that in Fig. 61. This operation is opening out the bored hole to 7.6875 in., using a boring bar like that in Fig. 62 and the head and cutter of Fig. 66. This tool is fed into the shell to the same depth as the roughing cutter—24½ in. The cutter is then removed and the 9.07-in. tool, Fig. 67, inserted in the same head. This cutter is then fed into the shell for approximately 16 in., measuring from the open end.

The next operation—the sixth—is performed with the shell in the same setting on the lathe. The powder chamber is rough- and finish-bored with a bar similar to that in Fig. 62 holding the head and cutters, Fig. 68. The gage, Fig. 63, is for testing the depth of the bored hole. The machined contour of the powder chamber is measured by the gage shown in Fig. 69.

The next suboperation is machining the surface to suit the diaphragm. A boring bar similar to the one in Fig. 62 is used, holding a head like that

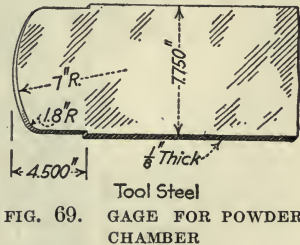

FIG. 69. GAGE FOR POWDER CHAMBER

illustrated in Fig. 66. The boring cutter appears in Fig. 70. The gage for testing this bored hole, so that the correct depth of powder chamber will be obtained, is illustrated in Fig. 71.

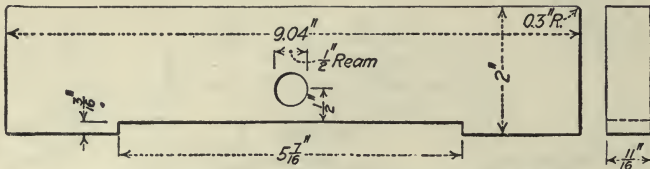

FIG. 70. BORING CUTTER FOR DIAPHRAGM SURFACE

The lathe employed in boring the powder chamber and machining for the diaphragm is shown in the view of the work in operations 5 and 6.

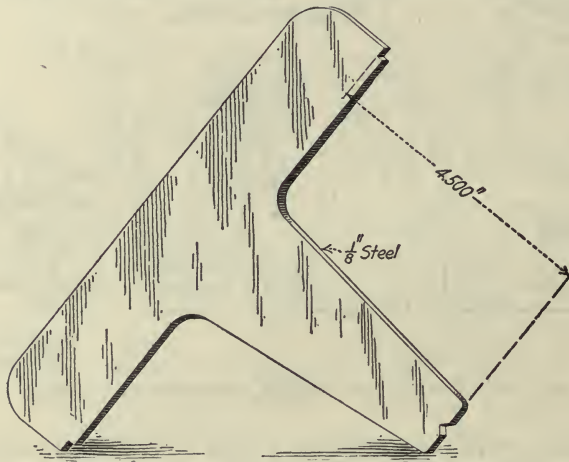

FIG. 71. GAGE FOR DEPTH OF POWDER CHAMBER

Before the shell is removed from the chuck, the front end is chamfered down for about 3 in., thereby facilitating the nosing-in operation, which

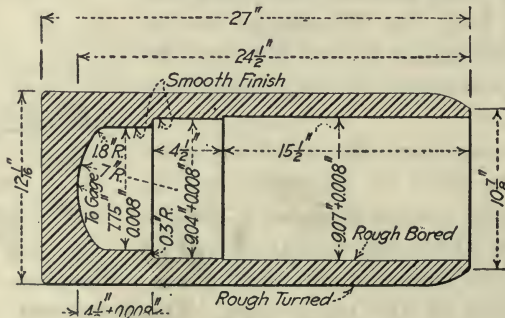

FIG. 72. DETAIL OF ROUGH-TURNED SHELL

follows. The shell at this stage is detailed in Fig. 72. For the nosing operation, for which it is transferred to the blacksmith shop, the shell is



nosing is obtained. The dies, Fig. 73, are simply fed down on the heated shell until their horizontal edges meet, no gage being used for testing the diameter, the contour of the dies producing the desired shape.

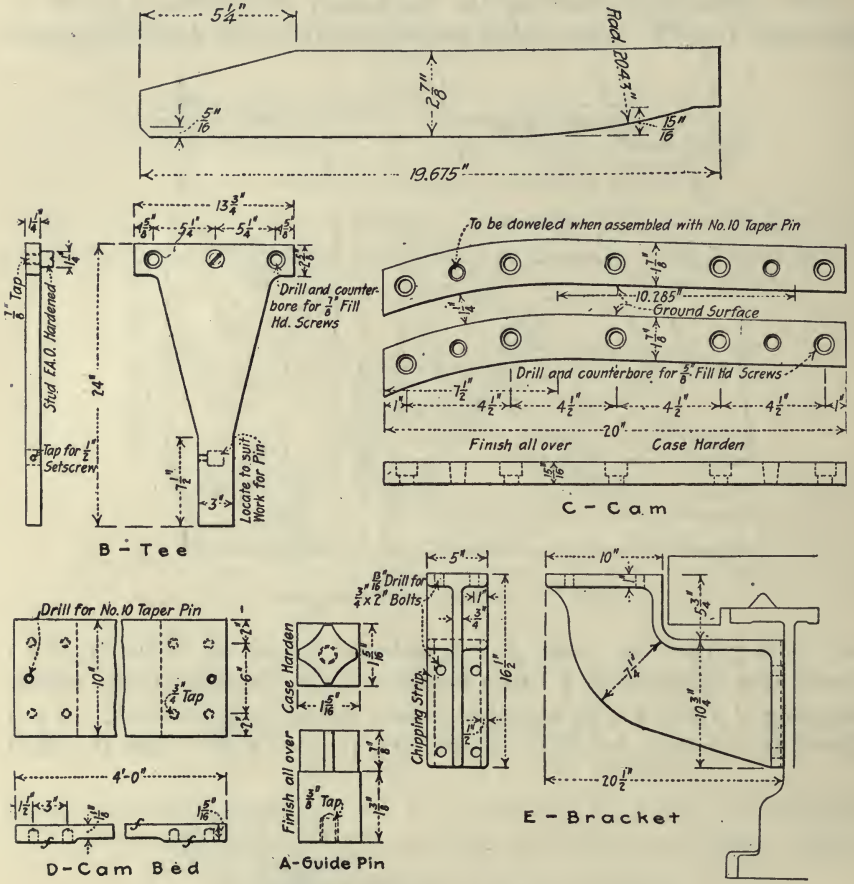

FIG. 75. DETAILS OF CONTOUR MACHINING FIXTURES.

The nosing gang consists of four men, one of whom is the hammer man. One man handles the tongs for placing the shell in the furnace and also guides the blank between the dies under the hammer. After the correct contour has been secured, the shell is allowed to cool in the air; then it is returned to the machine shop for the subsequent operations. The first operation (9) is turning the inside form. The shell is held in the chuck,

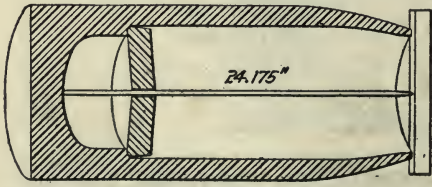

FIG. 76. GAGE AND METHOD OF USING IT TO TEST DEPTH OF BORE

Fig. 61. The boring bar and tool are shown in Fig. 74. The bar is

held in the tool carriage of the lathe in the usual manner. The desired contour on the shell is obtained by the guide pin A, Fig. 75, which is

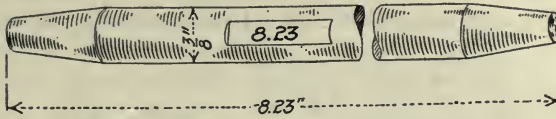

FIG. 77. GAGE FOR OPEN END OF SHELL

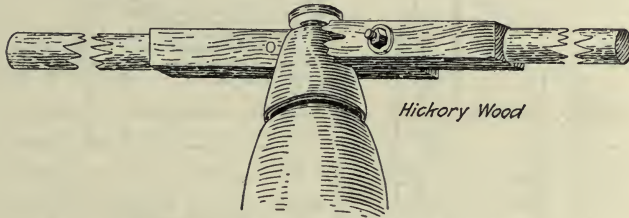

FIG. 78. METHOD OF USING THE CIAMP

attached to the bracket tee B and follows the path between the two former cams C. The latter are fastened on the cam bed D, which is held on the brackets E, fastened on the side of the lathe bed. The bracket tee is attached rigidly to the tool carriage of the lathe. The open end of the shell is next faced, the correct length being obtained from the powder chamber with a gage and straight-edge, as in Fig. 76. The hole is then bored to 8.23 in. in diameter, the pin gage, Fig. 77, being employed to test the machined bore.

A thread is machined in the bored hole, to suit the partly machined adapter, the manufacture of which will be treated subsequently. The adapter is screwed into the shell, using a clamp, in the way illustrated in Fig. 78; the chuck, Fig. 79,

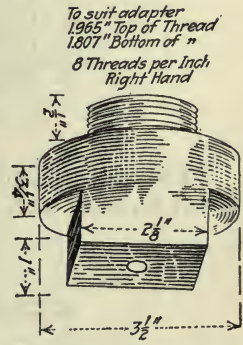

FIG. 79. CHUCK FOR ADAPTER END OF SHELL

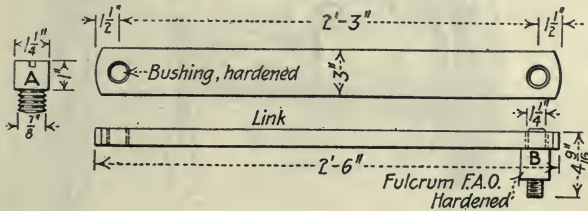

FIG. 80. DETAIL OF LINK

is screwed into the end of the adapter and the lathe center set up in the counter-sunk hole of the chuck. The outside of the adapter and also part of the outside of the shell are then turned to the correct contour.

For this operation the link, Fig. 80, is attached to the bracket tee with the stud *A*, Fig. 80, after the guide pin has been removed. The fulcrum pin *B* is placed in position, fitting into a machined hole in the cam bed. The arrangement of the attachment may be seen in Fig. 81.

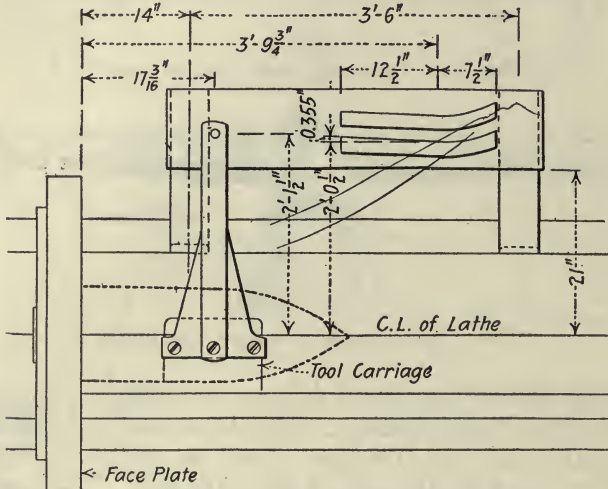

FIG. 81. ARRANGEMENT OF PROFILING FIXTURE

The turning tool is held in the carriage of the lathe. As the carriage is fed forward with the shell revolving, the link, fulcruming on the pin,

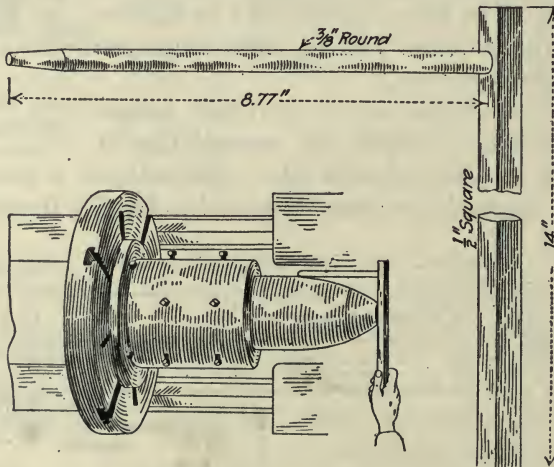

FIG. 82. GAGE FOR MEASURING LENGTH OF MACHINED CONTOUR

draws the carriage and turning tool on an arc. Thus the desired contour of the part is obtained. The gage for measuring the length of the machined surface appears in Fig. 82.

The gage in Fig. 83 is for testing the machined contour while the shell is in the lathe with the chuck in position. Fig. 84 depicts the tool employed as the final profile test gage after the chuck has been removed.

For the next operation the first suboperation is machining a surface to suit the steadyrest, Fig. 64, and at right angles to the end already faced. The chuck, Fig. 85, is screwed into the open end of the shell after the adapter has been removed.

A strap held on the faceplate of the lathe comes in contact with one of the lugs on the chuck, thus providing the driving medium. The chuck, Fig. 86, is placed on the base end, and the shell is adjusted with

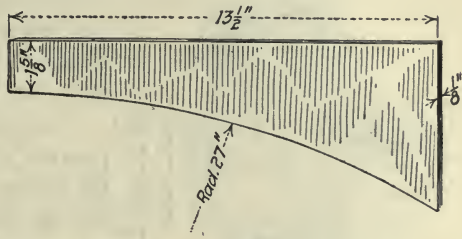

FIG. 83. GAGE FOR RADIUS OF HEAD

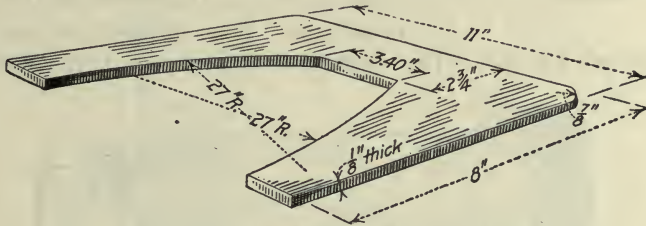

FIG. 84. GAGE FOR PROFILE OF HEAD

the four setscrews until it runs concentrically. A surface is then machined to suit the steadyrest. The chuck is then removed, and the

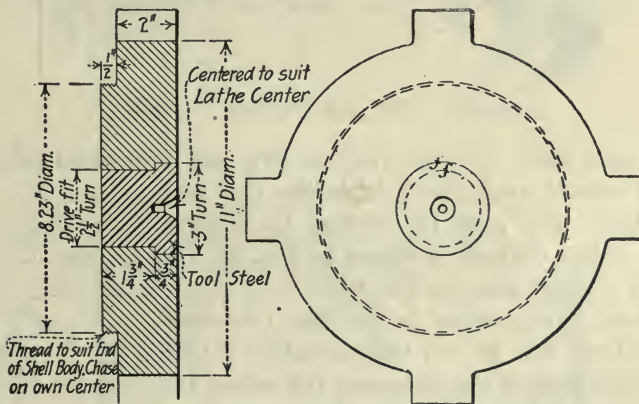

FIG. 85. CHUCK FOR OPEN END OF SHELL

base of the shell is faced to length, using the gage, Fig. 87, in the manner shown.

The gage, Fig. 88, is for testing the radius on the corner of the base

and for turning the outer periphery. A notch is cut to suit the 0.9-in. section and to serve as a guide from which the channel will be machined.

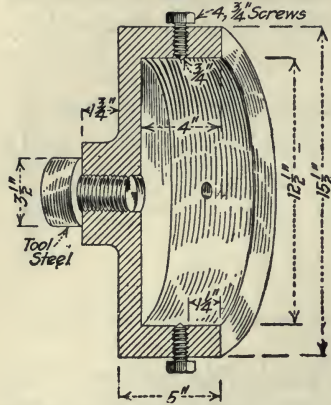

FIG. 86. CHUCK FOR BASE END OF SHELL

The outer periphery is also turned at the same setting to 11.94 in. for a width of about 1 in. The gage for the diameter is given in Fig. 89.

The chuck, Fig. 90, is slid on the turned portion at the base end and the lathe center set up. The steadyrest is thrown back out of the way for the next suboperation—turning the remainder of the body. The gages for the turned diameters are seen in Figs. 89 and 91.

In turning and knurling the channel the shell is held as described for the previous operation. It is, however, supported with the steadyrest, Fig. 64. The channel is machined with an undercut or

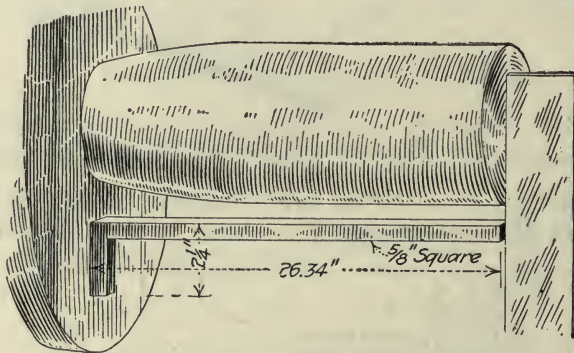

FIG. 87. GAGE FOR OVERALL OF SHELL

bevel, on each side. For this purpose left- and right-hand side tools are set at the correct angle and held in the tool post of the lathe. The gage for testing the bottom diameter of the channel is shown in Fig. 92; the width and contour gage, in Fig. 93.

The next suboperation is knurling the channel. The tool, Fig. 94, for this operation is held in the tool carriage of the lathe and fed across the surface of the turned channel, with the shell revolving, until the desired depth of knurl is secured.

The shell is then transferred to the forge shop, to have the copper band compressed on. Fig. 95 is a detail of the band as received at the plant.

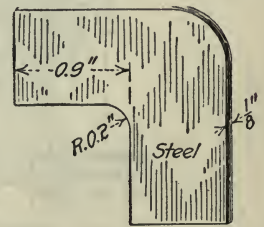
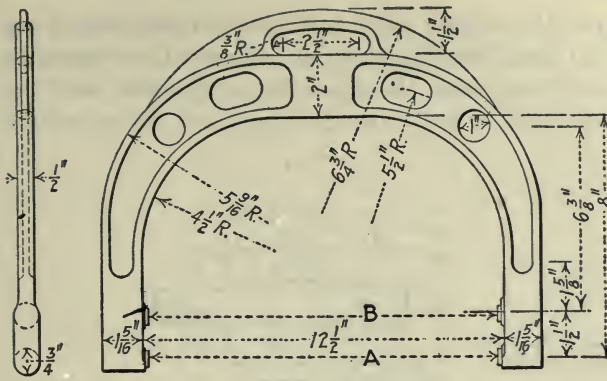

FIG. 88. RADIUS GAGE FOR BASE





A	B
11.46	11.43
12.31	12.30
11.97	11.96
11.94	11.90

FIGS. 89, 91, 92 AND 103. SNAP GAGES

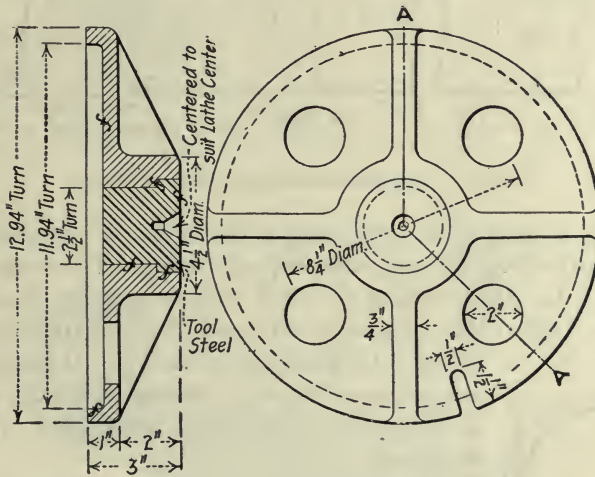

Section A-A

FIG. 90. CHUCK FOR BASE END OF SHELL

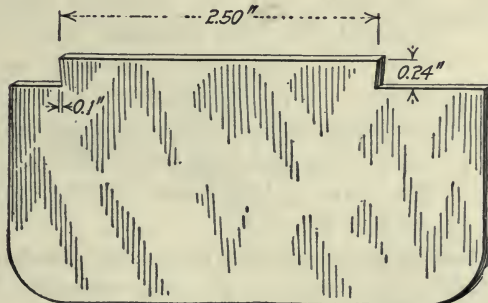

FIG. 93. GAGE FOR BAND GROOVE

To compress the band on the shell, the band is first slipped on and the shell placed between the dies, Fig. 96, which are attached to the steam hammer. With the shell in position the upper die is fed down until the copper band has been forced, or compressed, firmly into the machined channel.

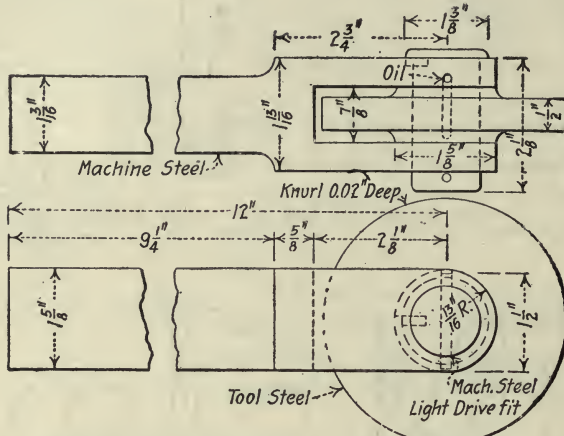

FIG. 94. THE KNURLING TOOL FOR CHANNEL

The gang employed in compressing the band on the shell numbers three—one adjusting the crane that supports the shell, one operating the hammer and the other turning the shell around between the dies. For this purpose the rod that screws into the end of the adapter has a clamp fitted with handles, as shown. A leather cover is slipped over the shell, around which the crane sling is placed, so that the turned shell will not be damaged.

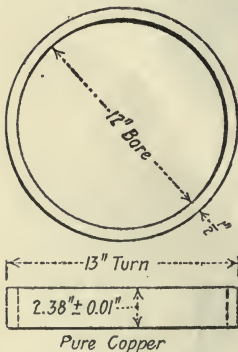

FIG. 95. DETAIL OF COPPER BAND

The shell is next returned to the machine shop for the operation of machining the copper band. The chuck, Fig. 90, is placed on the base end of the shell, and the threaded chuck, Fig. 97, is screwed into the threaded end of the adapter. The dog, Fig. 98, is fastened on the threaded chuck. A plate held by a bolt on the faceplate of the lathe comes in contact with one of the arms on the dog and thus furnishes the driving medium. The form tool for machining the band is illustrated in Fig. 99.

The gage for testing the machined contour of the band is shown in Fig. 100. The shell is now ready for the final inspection before loading, weighing and shipping.

For the final inspection the shell is first tested with the adapter out,

the gage shown in Fig. 101 being used. The powder chamber is then measured and also the inside of the shell from the bottom of the powder chamber to the top of the adapter seat.

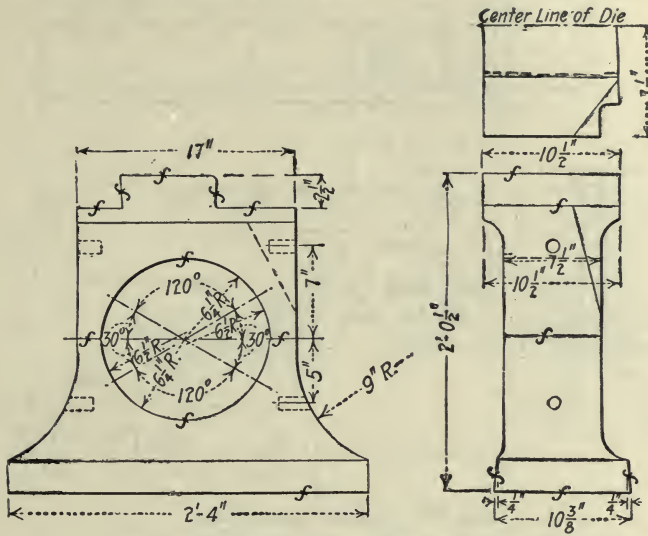

FIG. 96. DIES FOR COMPRESSING BAND

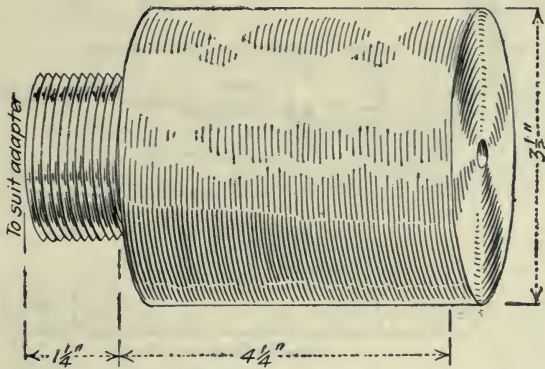

FIG. 97. CHUCK FOR ADAPTER END WHEN TURNING END

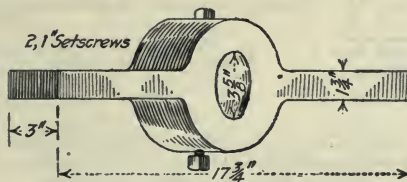

FIG. 98. DRIVING DOG FOR NOSE END OF SHELL

The adapter is screwed down home by a clamp, Fig. 77. The long gage illustrated in Fig. 101 tests the overall length of the shell, and the



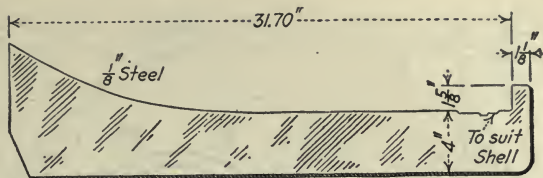
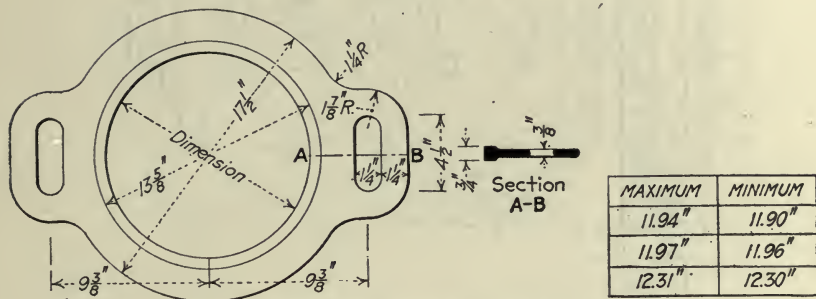

FIG. 102. OUTSIDE CONTOUR GAGE



FIGS. 104, 105 AND 106. RING GAGES

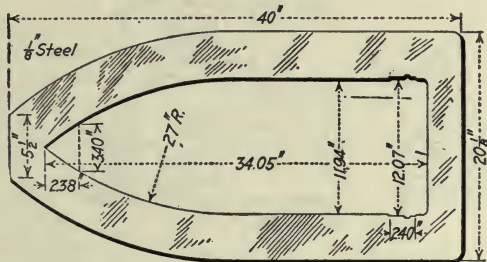

FIG. 107. CONTOUR GAGE FOR SHELL

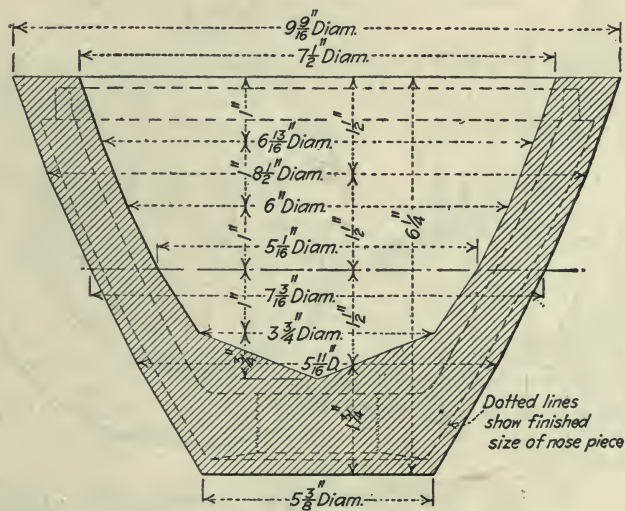

FIG. 108. ADAPTER FORGING

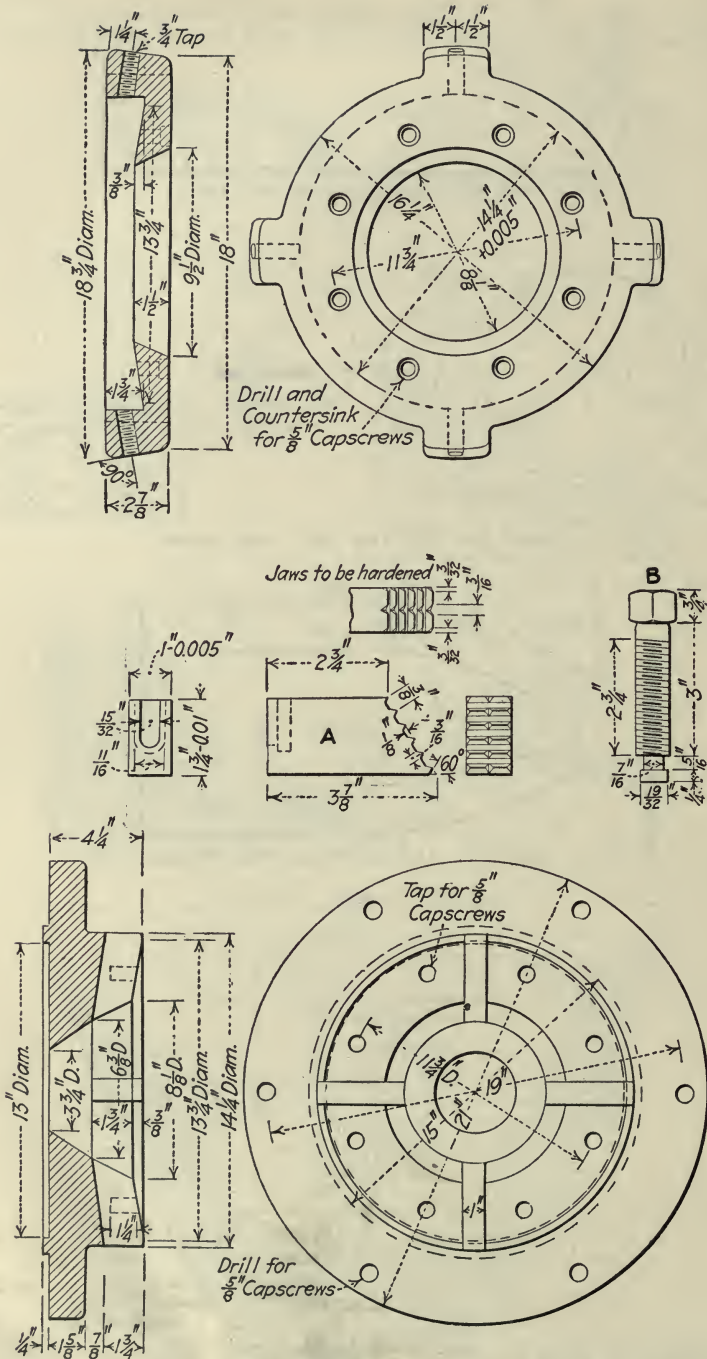

FIG. 109. CHUCK FOR HOLDING ADAPTER IN THE LATHE

The first operation in machining the adapter, operation I in the sequence, is forming the inside, facing the large end and machining the

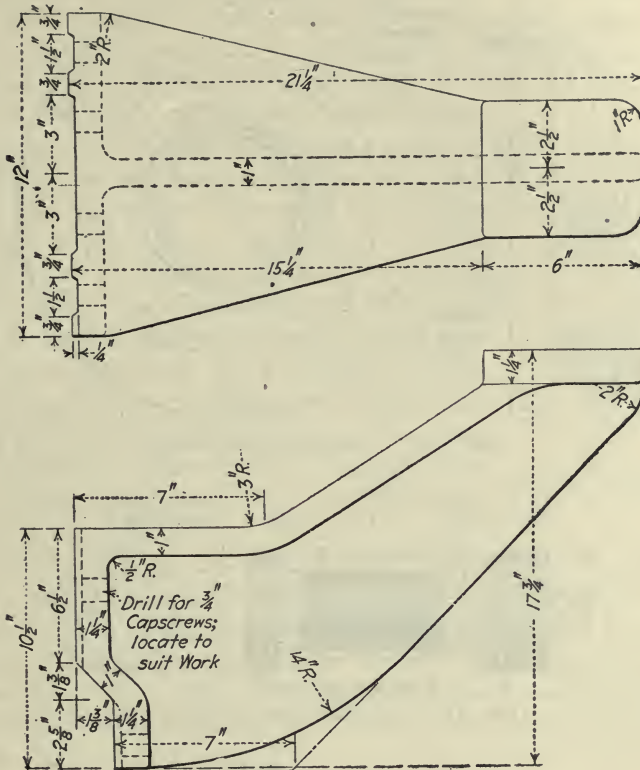

FIG. 110.—BRACKET TO FASTEN ON LATHE

thread. Fig. 108 is a detail illustration of the adapter forging. For the first operation the rough forging is placed in the chuck, Fig. 109, which is held to the faceplate of the lathe with capscrews. The chuck jaws

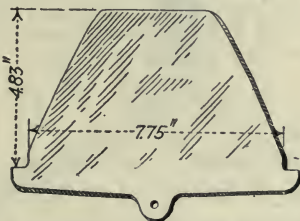

FIG. 111. GAGE FOR INSIDE OF ADAPTER

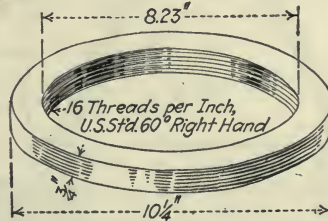

FIG. 112. RING THREAD GAGE

A are tightened against the forging by means of the setscrews B, thus holding the part securely. It will be observed that the jaws are operated

independently, enabling the operator to hold the forging in the chuck so that it will be concentric.

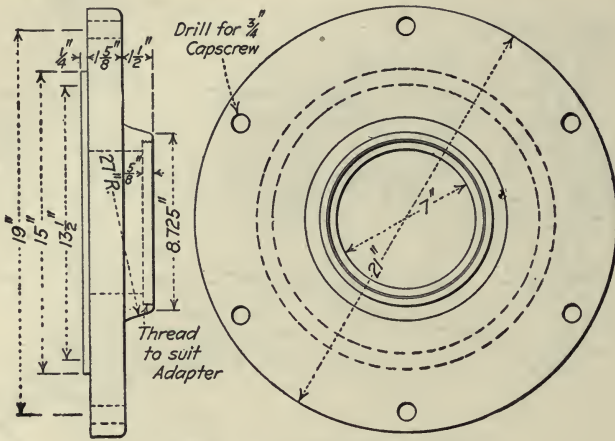

FIG. 113. ADAPTER LATHE CHUCK

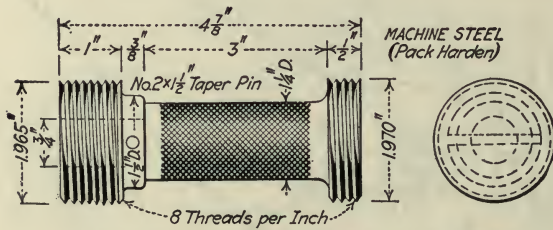

FIG. 114. ADAPTER THREAD PLUG GAGE

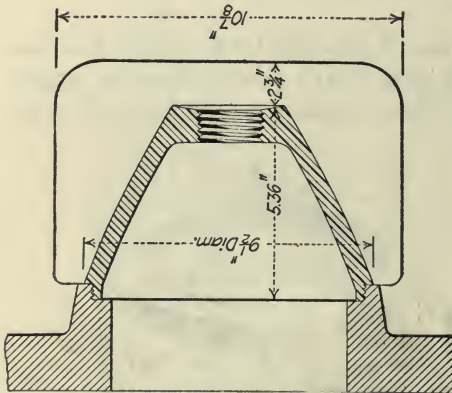

FIG. 115. FORM GAGE FOR LENGTH OF ADAPTER

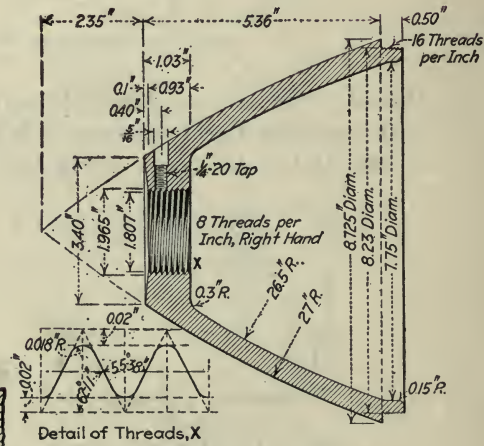

FIG. 116. DETAILS OF ADAPTER FOR 12-IN. SHELLS

The link, Fig. 80, is set up and operated in a similar manner to that described for machining the inside of the shell. As the tool carriage is



fed forward with the adapter revolving, the link, drawing the carriage on an arc, machines the desired contour on the inside of the part.

The special bracket to hold the link is fitted to the side of the lathe bed, as in Fig. 110. An illustration of the set-up for performing the machining operation is shown in diagrammatical form in operation I. The gage for testing the machined contour is illustrated in Fig. 111.

The link is thrown out of contact, the shoulder of the large end is faced and the thread machined, using tools held in the tool carriage in the usual manner. The ring gage for testing the thread may be seen in Fig. 112.

The adapter is screwed into the chuck, Fig. 113, which is held on the faceplate of the lathe. The hole is drilled and tapped at the small end of the adapter, the tools being held in the tool carriage of the lathe. The gage for testing the machined thread is shown in Fig. 114. The tool carriage is set over approximately  $7\frac{1}{4}$  deg., and with an ordinary turning tool the beveled surface on the end is machined.

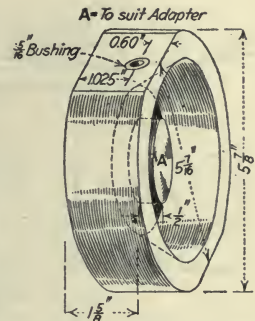

FIG. 117. JIG FOR DRILLING ADAPTER HOLE

The gage for testing the overall length and contour at the end of the adapter and the manner in which it is used are illustrated in Fig. 115.

A detail of the finish-machined adapter may be seen in Fig. 116. The outside of the adapter is machined while it is in position on the shell, as has been described. After the adapter has been completely machined, a hole is drilled for the fuse setscrew. The jig employed for this purpose is shown in Fig. 117.

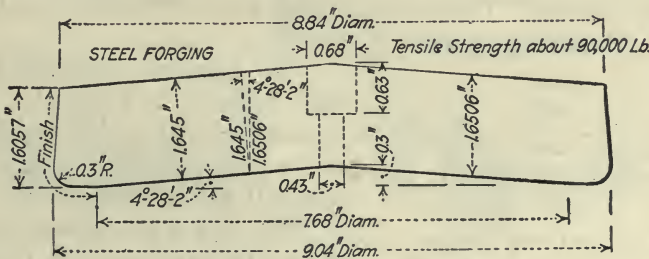

FIG. 118. FINISH-MACHINED DIAPHRAGM

The diaphragm is made from a steel forging, a detail of a finished piece being given in Fig. 118. The first operation, for which the forging is held in a universal-type chuck, is turning part of the outside and forming radius. The outside is first turned with the tool carriage thrown around approximately  $4\frac{1}{2}$  deg. The front edge is faced with the tool carriage set squarely, the test gage being shown in Fig. 119. The radius tool, shown in the same cut, is fastened in the tool carriage and the radius

machined on the corner. The gage for testing this radius is also shown in Fig. 119 as well as the gage for testing the entire contour.

The diaphragm is then reversed and held again in the same chuck for the second operation—turning the rest of the outside, drilling and counterboring the hole. The gage and the method in which it is used to test the depth of the counterbored hole are shown in Fig. 119.

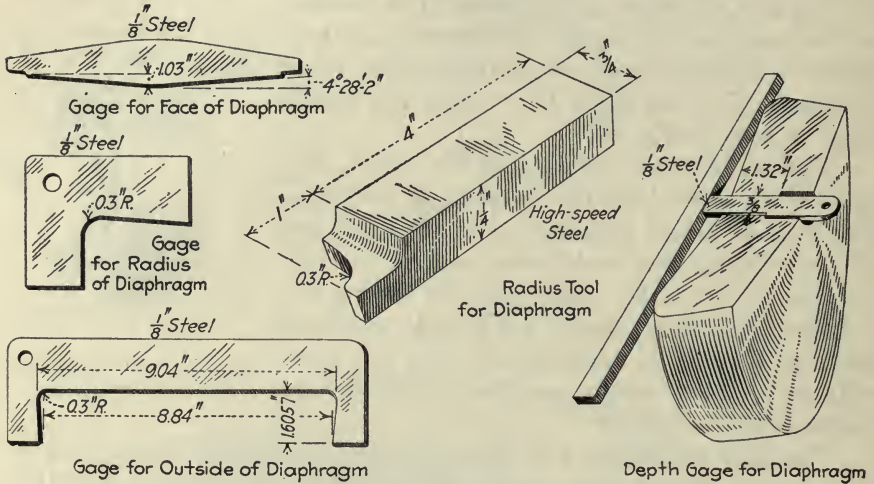

FIG. 119. GAGES AND RADIUS TOOL

The adapter bottom, Fig. 120, is made from 2-in. bar stock. It is held in a universal-type chuck and turned to size and the thread machined. An 0.43-in. hole is drilled through the center and then counterbored to 0.68 in. for 0.15 in. deep. A part is cut off 0.30 in. wide, thus making an adapter bottom. The counterboring and cutting-off operations are carried on alternately to make the parts.

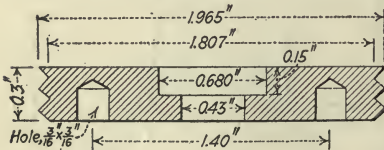

FIG. 120. ADAPTER BOTTOM

The gage for testing the thread may be seen in Fig. 121. The pin spanner wrench holes are drilled in the adapter bottom, using the jig shown in the same cut.

The plug is made from 3 3/4-in. bar stock, the first operation being turning the outside to 3 1/2-in. diameter and forming the shoulder. The shouldered portion is threaded to suit the adapter, testing with the gage shown in Fig. 121. The plug is then cut off by a parting tool in the lathe carriage, the width of stock on the large diameter being 1/2 in. The head of the plug is formed to shape, being screwed in the chuck, Fig. 121. This chuck is held in a standard three-jawed chuck secured to the lathe spindle. The form tool, Fig. 121, is held in the lathe carriage and fed against the revolving plug until the desired contour is obtained.

The ring gage, Fig. 121, tests the 3.4-in. diameter of the head.

The plug is held in the chuck, Fig. 121, and the slot machined on a miller. A detail of the finish-machined adapter plug is given in Fig. 122. In Fig. 123 is illustrated the key used to insert the adapter plug in the adapter.

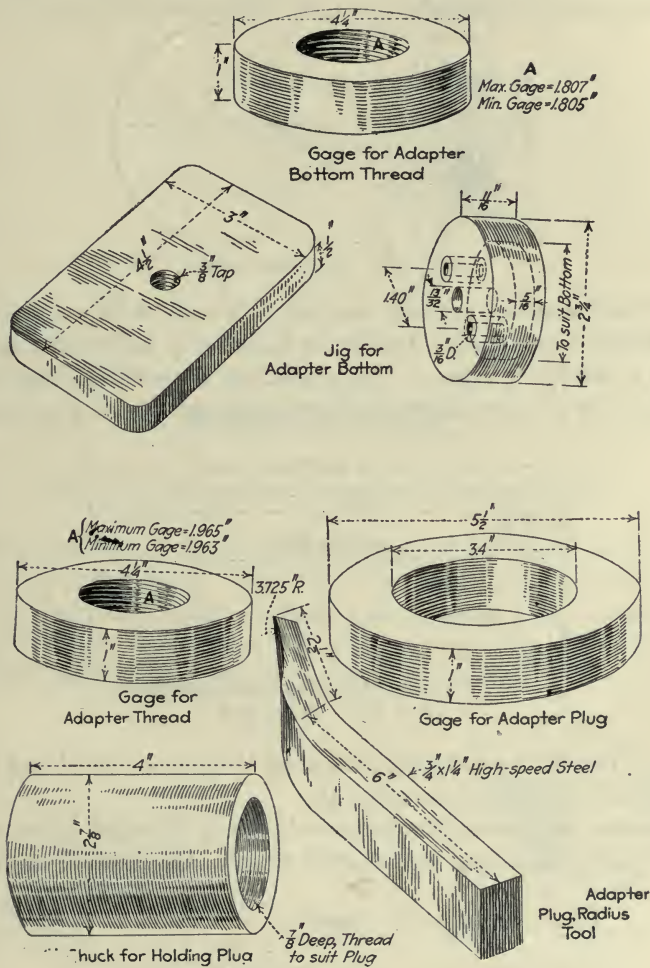

FIG. 121. GAGES AND TOOLS

The powder tube, Fig. 124, is made from seamless tubing and is cut to length with a hacksaw. The elements are finally carried to the assembling department, ready to be placed in the shell.

After the shell has been finally inspected and passed, the powder tube, adapter, adapter bottom and plug are inserted. The shell is then transferred to the loading department. The plug, adapter bottom and adapter are there removed. The spider, Fig. 125, is screwed into the thread at

the open end of the shell. It will be observed that the spider is made with an  $1\frac{1}{16}$ -in. hole, which the powder tube fits, thus holding it central.

The shell receives  $\frac{1}{2}$ -in. diameter balls, composed of lead and antimony, for about 4 in. of its height. Melted rosin is then poured over

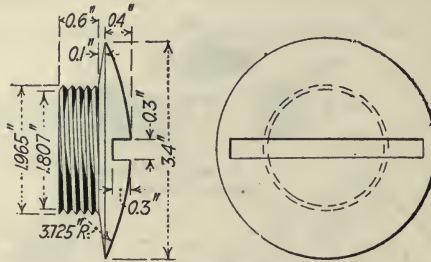

FIG. 122. ADAPTER PLUGS

the balls until they are entirely covered. On top of this is placed about 6 oz. of smoke compound. Another 4-in. layer of balls and rosin is then added in a similar manner. This operation is repeated until the balls and rosin come to approximately  $\frac{1}{2}$  in. from the top of the open end of

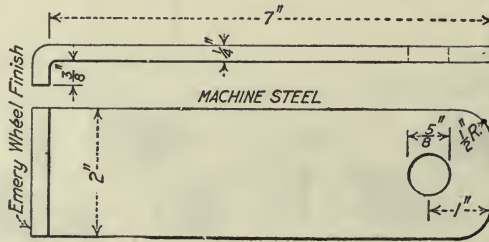

FIG. 123. PLUG KEY

the shell. The balls are fed into the shell through a funnel and the rosin is poured in as shown in operation 19.

The reason for placing the balls and rosin in the shell in layer form is to insure their cementing into a solid mass. As the shell is so large, if

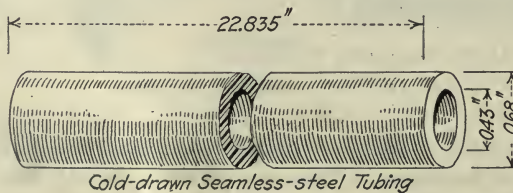

FIG. 125. POWER TUBE FOR 12-IN SHRAPNEL

the balls were all inserted and then the rosin poured in, the probability is that the rosin would not reach between all the balls before solidifying. Under such conditions the mass would not be homogeneously held to-

gether; and when the shell was fired, it would act in a biased manner and its "flight" would not be true.

Further, as all air is expelled from the shell by the rosin filling the gaps between the balls, the explosive charge has less room to expand and the shell, besides being fired with a truer aim, also bursts with greater force. To insure the best results, it is found that the melted rosin should

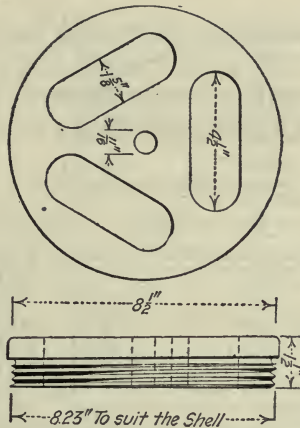

FIG. 125. SPIDER FOR HOLDING THE POWDER TUBE

be at a temperature of from 365 to 400 deg. F. Then the crevices between the balls are properly filled. The spider is next removed, and the threads on the inside of the shell and adapter are covered with red-lead paint. The adapter is screwed down, using the clamp, Fig. 77. More balls and melted rosin are added until the shell weighs 729 lb.

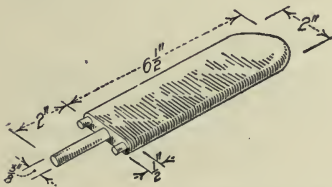

FIG. 126. SPANNER WRENCH FOR ADAPTER

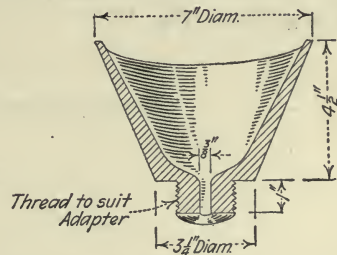

FIG. 127. FUNNEL FOR LOADING THE POWDER

The adapter bottom is then placed in the adapter by the aid of the wrench, Fig. 126. It will be noticed that this tool is provided with a "tit" that enters the powder tube. The purpose of this is to hold the tube central while the bottom is being screwed down. The shell is left for about 4 hr., so that the rosin will properly solidify and cool.

The funnel, Fig. 127, is then screwed into the end of the adapter.

Powder fed into the funnel passes through the powder tube into the powder chamber. The funnel is afterward removed, and powder pellets are put into the tube. One purpose of the pellets is to prevent the powder grains from coming back against the fuse threads if the shell should be turned over. This precaution eliminates accidents that would result when the fuse is inserted, if powder grains were resting on the threads

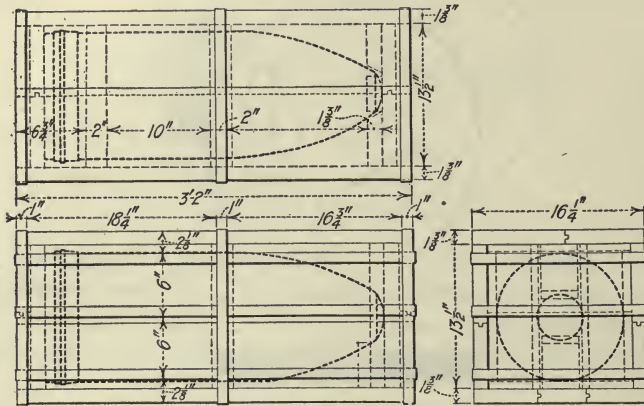

FIG. 128. DETAILS FOR PACKING CASE SPECIFIED FOR THE 12-IN. SHRAPNEL

and the fuse was screwed down against them. The primary purpose of the pellet is, however, to convey the spark from the fuse to the powder chamber.

The plug is next screwed into the shell, which is then ready for the final weighing, after which the shells are covered with axle grease, to prevent rust, and are packed in individual cases. A detail of the packing case is given in Fig. 128.

## CHAPTER VII

### MAKING SHELLS WITH REGULAR SHOP EQUIPMENT<sup>1</sup>—MANUFACTURING SHRAPNEL PARTS ON AUTOMATIC MACHINES<sup>2</sup> —AUTOMATIC PRODUCTION OF SHRAPNEL PARTS— A BRIDGE SHOP TRANSFORMED INTO AN ARSENAL

A shop possessing the standard equipment of engine lathes, turret lathes and automatics, with the addition of comparatively few pieces of special equipment, the necessary fixtures and tools, all of which can be built with the shop equipment, is in a position to undertake the rapid production of shrapnel shells, and to earn a good profit thereby. A high grade of mechanical ability with good common sense is the only other requisite.

British shrapnel shells, those of the 18-pounders, were so manufactured in such a shop—the value of the scrap machined from the shells more than compensating for the cost of building the special machines, special tools and fixtures. The sequence of the principal operations performed, which will be described in some detail, was as follows:

#### OPERATION 1. PUNCHING DRIVING SLOT

Machine Used—Any punch press.  
Fixtures—Length stop and holder.  
Gages—Length—First inspection.  
Production—1 man, 1,000 in 6 hr.

#### OPERATION 2. BORING POWDER CHAMBER

Machine Used—Any heavy drill press.  
Fixtures—Special drills, gages, etc.  
Lubricant—Soda water.  
Production—3 min. each.

#### OPERATION 3. CENTERING SHELLS

Machine Used—Old Jones & Lamson turret.  
Fixtures—Air drill, facing cutter, center, center holder, facing tool block, expanding mandrel.  
Gages—Flat steel templet.  
Production Time—4½ min.

<sup>1</sup> Fred H. Colvin, Associate Editor, *American Machinist*.

<sup>2</sup> J. P. Brophy, Vice-President and General Manager, Cleveland Automatic Machine Company.

## OPERATION 4. TURNING OUTSIDE OF SHELL

Machine Used—Ordinary lathe.  
Cutting Speed—42 ft. per min.  
Production—7 min. each.

## OPERATION 5. ROUGHING OUT BAND GROOVE AND CHAMFERING CORNERS

Machine Used—J. & L. turret lathe.  
Production—2½ min. each.

## OPERATION 6. CUTTING OFF AND FORMING OPEN END

Machine Used—Cleveland automatic.  
Fixtures—Forming tools.  
Gages—Templets of form shown.  
Production—9.5 per hr.

## OPERATION 7. CLOSING IN NOSE

Machine—Home-made hydropneumatic press and heating furnaces.  
Fixtures—Dies and tongs.  
Gages—Templets.  
Production—2 men, 1,400 in 12 hr.

## OPERATION 8. BORING AND TAPPING NOSE

Machine Used—Bardons & Oliver turret.  
Fixtures—Chuck and steadyrest shown.  
Gage—Plug thread gage and nose form.  
Production—3 min. each.

## OPERATION 9. SCRAPING INSIDE OF NOSE

Machine Used—Any suitable turret or engine lathe.  
Fixtures—Cross slide and form tool.  
Gage—Templet or contour gage.  
Production—2 min. each.

## OPERATION 10. GRIND OUTSIDE OF SHELL

Machine Used—Heavy grinder.  
Fixtures—Heavy saddle.  
Tools—Plain face wheel for body, formed wheel for nose.  
Production—8 men, 1,400 shells in 22 hr.

## OPERATION 11. CUTTING THE WAVES

Machine Used—Old Fitchburg lathe.  
Fixtures—Cam, tool block, air spring.  
Gage—Usual templet.  
Production—3 boys, 1,400 in 10 hr.

## OPERATION 12. CUTTING OFF ENDS

Machine Used—No. 4 Cincinnati miller.  
Fixture—Holder for shells.  
Gages—Templets.  
Production—2 men, 1,400 in 22 hr.



## OPERATION 13. VENTING WAVE GROOVES

Machine Used—Specially arranged air hammers.

Fixtures—None.

Gages—None.

Production—Man and boy, 1,400 in 12 hr.

## OPERATION 14. BANDING

Machine Used—Special 30-ton press.

Fixtures—None.

Gages—None.

Production—Man and boy, 1,400 in 12 hr.

## OPERATION 15. FORMING THE BANDS

Machine Used—Special rotary miller.

Fixtures—Formed cutters.

Gages—Templets.

Production—3 men, 1,400 in 22 hr.

The first operation is to cut in the open end of the shell a notch that is used in driving the shell during subsequent operations. This work is done in an ordinary punch press, something as shown in Fig. 129, the shell being supported in a holder *C* under the punch *B* and located

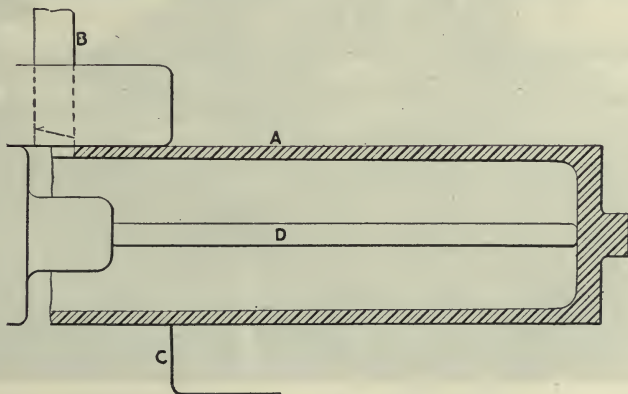

FIG. 129. PUNCHING DRIVING SLOT

by the rod *D*. In this way a uniform distance is secured between the bottom of the forging and the punch slot. The stop *D* is loosely mounted in the supporting center.

Occasionally a shell is too long to be handled on the driving mandrel, and in such cases the surplus metal is punched off by simply rotating the shell under the punch for a complete turn. Then the driving slot is punched in the usual manner and is ready for machining. A preliminary inspection takes place during this operation, one man handling 1,000 shells in 6 hr. without difficulty.

The second operation bores the powder chamber under the spindle

of a heavy Baker drill, the vertical boring bar centering itself in the forged cavity. Soda water is fed in through the center of the bar itself, this operation requiring 3 min.

An old Jones & Lamson turret has been utilized for operation 3, and it also performs the three suboperations of facing the center projection, centering and counter-boring, and facing the back end of the shell. The turret is not revolved during these operations, but is locked in a fixed position on the bed.

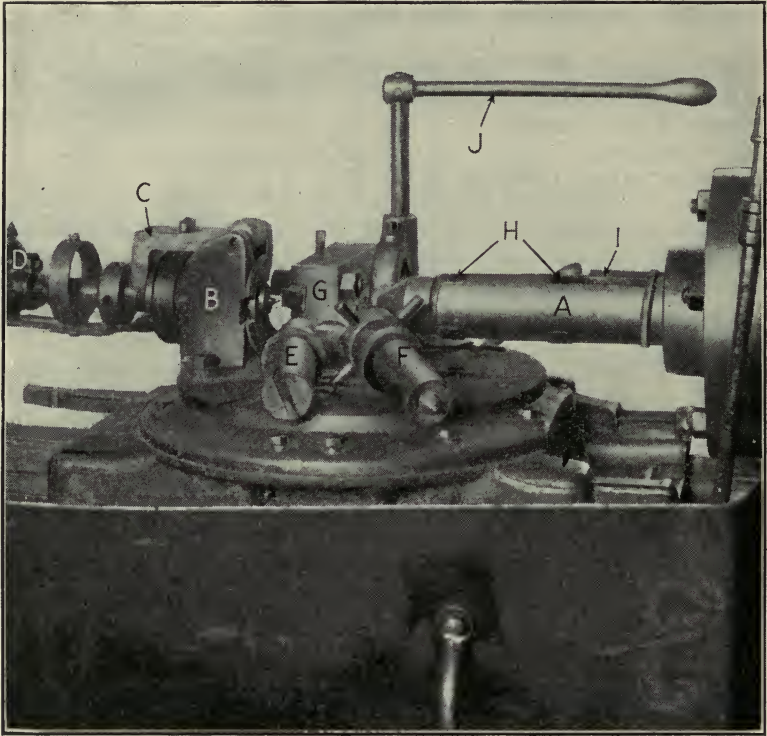

FIG. 130. CENTERING SHELLS

Fig. 130 shows the driving mandrel *A* with the centering jaws *H* and the driving key *I*. Bolted to the turret is the substantial tool block *B* with the locking device *C*, which is in reality a tool holder. The drill for centering and countersinking is shown in position. It is an air drill fitted with a special spindle sleeve that fits into the block *B* and has a flange that allows the clamp *C* to hold it against the thrust of drilling.

As soon as the center has been drilled, the clamp is removed by simply turning the thumb-latch shown, and the facing tool *E* is substituted. This is in turn removed and the tail center *F* slipped into place and held by the clamp *C*. This center has a screw that allows the tail center to

be forced against the work as hard as may seem desirable and is used during the suboperation of facing off the back end. The side tool that does this facing, shown in the tool block *G*, has a sliding movement across the turret, through a rack and pinion, the latter being operated by the lever *J*. This arrangement gives a good leverage and makes it easy for the operator to face the ends. This operation takes  $4\frac{1}{2}$  min.

The fourth operation is the turning of the outside of the shell nearly its whole length, the turning tool running up practically to the notch cut for driving. This cut is handled by two tools in an ordinary lathe, so that each travels only half the length of the shell. A cutting speed of 42 ft. per min. is maintained, this operation requiring 7 min.

The shells are held on a special equalizing expanding mandrel during the turning operation, illustrated in Fig. 131. This mandrel holds the shells at two points of their length and equalizes the pressure so as to insure equal bearing and equal driving power. It also centers the shells along their entire length. It is shown attached to almost any type of screw machine or other lathe, the headstock being omitted and only the faceplate and end of the headstock shown, the rest being unnecessary.

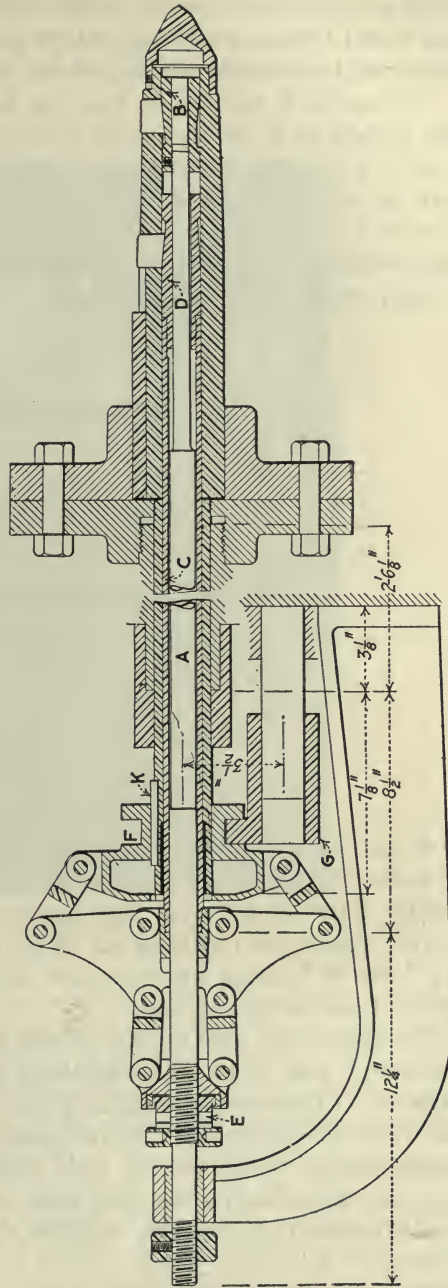

FIG. 131. DETAILS FOR EQUALIZING EXPANDING MANDREL FOR TURNING SHELLS

The mandrel consists primarily of the inner rod *A* carrying the wedge *B*, which is turned taper as shown, and the tube *C* with its wedge *D*. Both *C* and *D* operate separate sets of jaws, three in number in each case; and as will be noticed, the inclines are in opposite directions.

The spools *E* and *F* run free, the latter being feather-keyed to the lathe spindle at *K* and revolving with it, but free to move endwise both on the key and with the spool *G*. The chucking lever controls the movement by means of the sliding spool *G*. When this is moved, it pulls back the rod *A* and pushes forward the tube *C*, or vice versa, by means of the toggle levers shown. This movement forces the jaws up the incline and tightens the shell on the mandrel. Should one set of jaws take hold

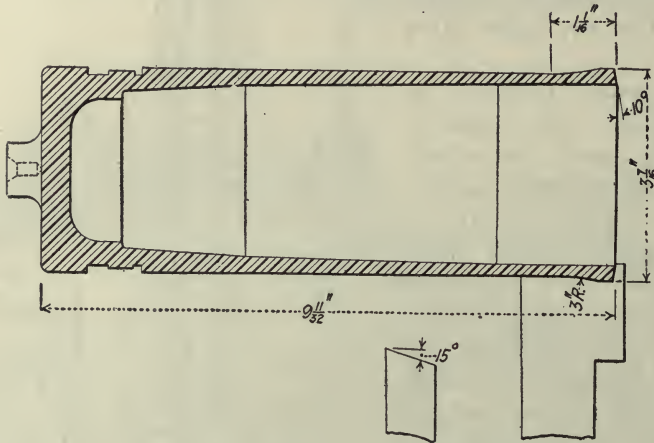

FIG. 132. DETAIL OF TRIMMED SHELL

before the other, they act as the stationary member and the other cone forces out the second set of jaws until all bear equally. This is a particularly interesting device that can be adapted for many other uses.

Next comes the roughing out of the band groove, operation 5, done on a Jones & Lamson turret, which also chamfers the corners, the production time being  $2\frac{1}{2}$  min.

The ends of the shell are cut off and formed for closing in, in the sixth operation. This is done on Cleveland automatics, which happen to be available. Considerable experimenting developed the proper shape of nose to be closed into the desired shape for boring and tapping. The dimensions are shown in Fig. 132, where it will be observed that the open end of the shell is beveled back 10 deg. After being closed, this bevel is turned in and simply requires a little trimming to fit the fuse or adapter.

The closing in of the nose is done on the hydropneumatic press, Fig. 133. This press has a 12-in. air cylinder with a possible stroke of 12 in. The hydraulic ram is 3 in. with a 12-in. stroke. A 7-in. stroke

is sufficient to close the shell nose. The form die comes to a positive stop on the base which clamps the shell. This secures a uniform nosing and eliminates the necessity of turning afterward. Two men handle 1,400 shells, the daily output, in 12 hr. The diaphragms are slipped inside before closing the nose.

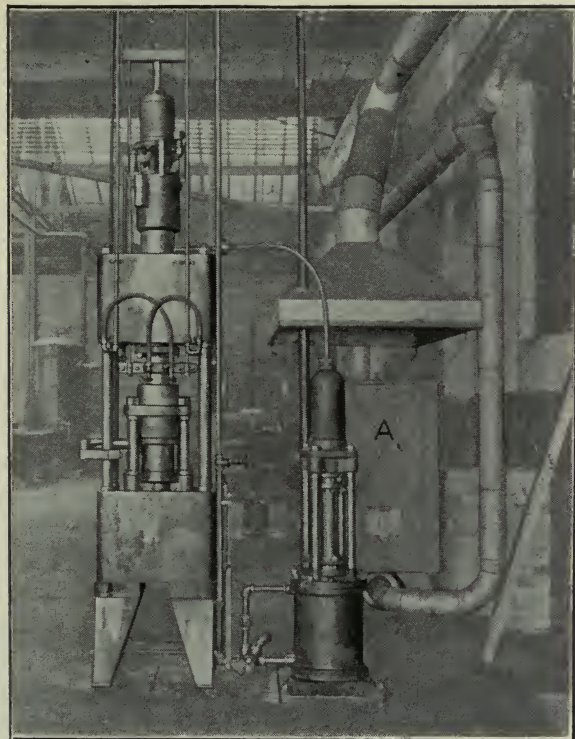

FIG. 133. HOMEMADE HYDROPNEUMATIC PRESS AND HEATING FURNACE

The nose is bored and tapped in a Bardons & Oliver turret, equipped with special holding chucks and steadyrests. The boring and facing tool is shown at *A*, Fig. 134, the nose of the shell resting in a revolving support. This sleeve *B* forms the inner race of the double ball bearing and takes care of both the radial and the end thrust, while the felt washer keeps out dirt and chips. It will also be noticed that the outer case *C* projects so as to act as a guide for the boring and facing tool.

The tool *A* is provided with a shoulder that makes contact with the collar *D* and compresses the spring as the tools feed into the shell. The opening *E* provides escape for chips. This guiding the tool with relation to the shell insures the hole being concentric with the outside, which is quite an important point in inspection.

The tapping is done in the same fixture and at the same setting. This complete operation takes 3 min.

After the boring and tapping of the nose the inside of the shell just beyond the thread is scraped out with a round-formed cutter, Fig. 135.

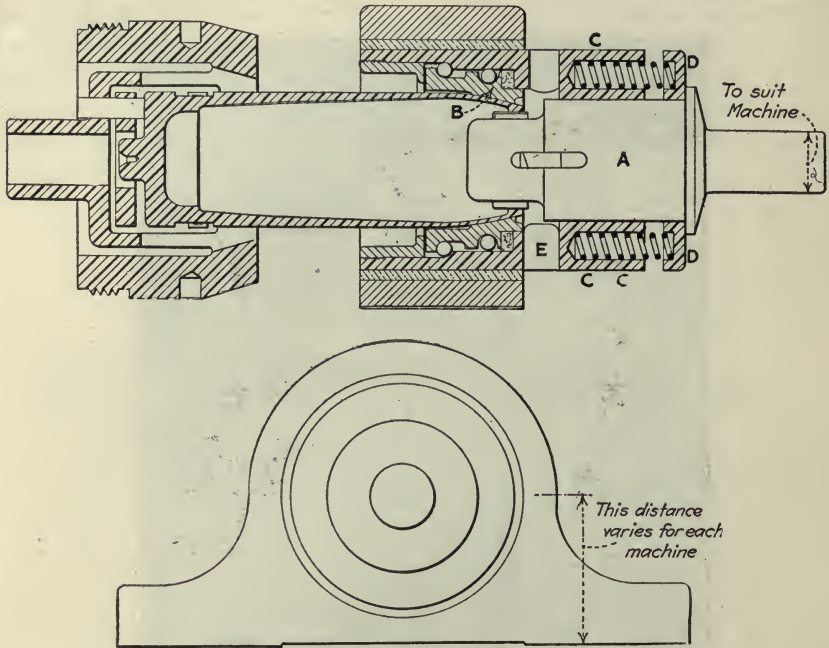

FIG. 134. DETAILS OF FIXTURE FOR TAPPING NOSE

This is a circular forming cutter of the regular type, held from turning by the serration shown at the end, where it bears against the tool rest. The cutter is mounted on a Jones & Lamson cross-slide, the shell itself being held in the draw-in chuck and the special bearing, Fig. 136. The

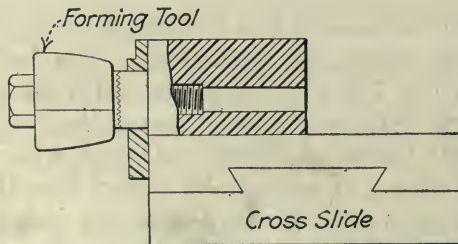

FIG. 135. FORM TOOL USED IN OPERATION 9

contracting sleeve A clamps the jaws on the back end of the shell, the front end being supported by the steel quill B, which is mounted in the cast-iron block C. The spring plunger D regulates the pressure on the

thrust bearing *E* and also prevents the front race from turning. The threaded collar *F* holds the other end of the quill in position.

The next, or tenth, operation is to grind the shell all over, a very heavy wheel saddle weighing 400 lb. being employed for this purpose. A

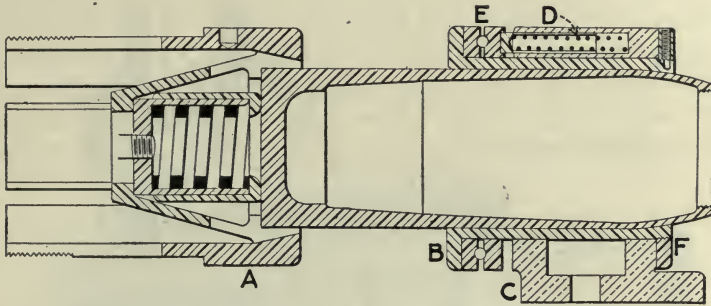

FIG. 136. DRAW-IN CHUCK AND SPECIAL BEARING

formed wheel is used for shaping the nose of the shell, the straight part being ground by a plain-faced wheel 6 in. wide. The grinding allowance is 0.015 in., and eight men—four men to each shift—grind 1,400 shells in 22 hr.

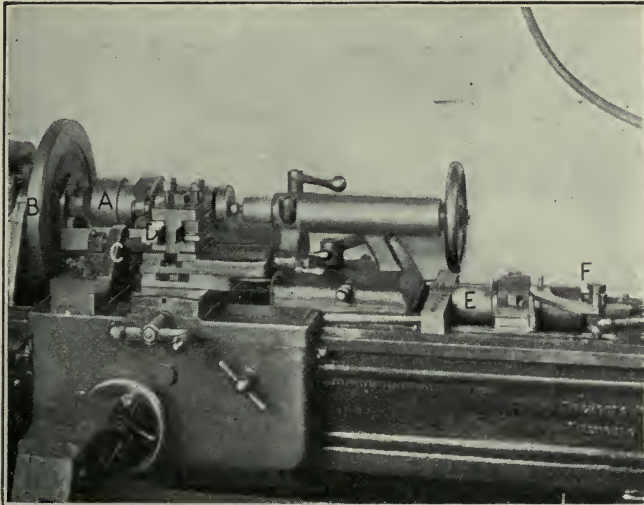

FIG. 137. LATHE FITTED FOR OPERATION 10

Waving in the groove already roughed out in operation 5 is done in an old lathe, as indicated in Fig. 137. The nose of the shell is supported in a sort of bell chuck *A* and held in position by the strap shown in front of it. The cam is on the faceplate *B*, while *C* is a stop to locate the position

of the waved tool *D*, which is held in the compound rest set parallel with the lathe ways.

When the spring action of the pneumatic cylinder *E* is necessary, the cock *F*, swung on the quadrant between the two pins shown, admits air

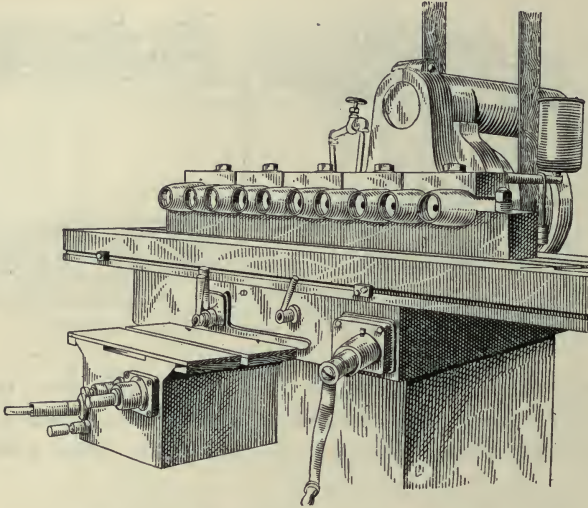

FIG. 138. MILLING ENDS OF SHELLS

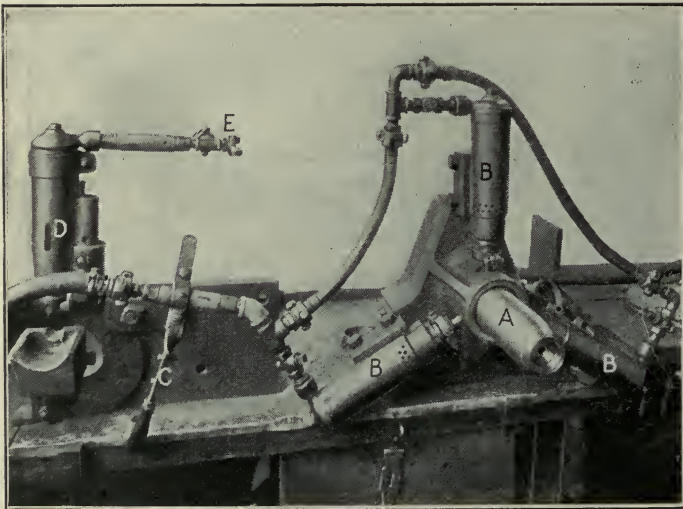

FIG. 139. VENTING WAVE GROOVES

to the cylinder and forces the roller on the lathe carriage against the cam on the faceplate. When the spring is not needed and it is desired to move the tailstock or the carriage, the cock *F* is swung into the other



position, which shuts off the air and opens an escape vent from the cylinder. With this arrangement, three boys can handle 1,400 shells in 10 hr., or about 45 shells per hour for each lathe.

The projection on the closed end of the shell is next milled off, as shown in Fig. 138. The fixture is a simple one that goes on a No. 4 Cincinnati knee-type miller and holds ten shells at one setting. It will be noticed that these shells are held by five separate straps, these being used so that as soon as a section has passed the milling cutter the milled shells can be removed and others put in their places. In this way almost continuous milling can be done, two men handling the 1,400 shells in 22 hr.

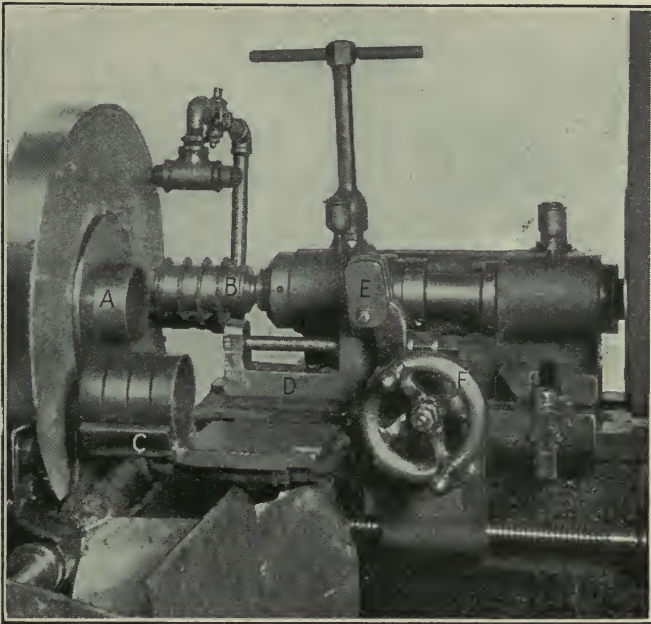

FIG. 140. CUTTING OFF BANDS

The device for cutting the air grooves across the waves is illustrated in Fig. 139. The shell *A* is acted on by the three air hammers *BBB*, the piping connections being shown. Needless to say, these vent or nick the waves very rapidly, as fast as a man can handle the shells. The handle *C* controls the air to the hammers.

At *D* are a single air hammer and a simple holder for the shells. They are solely for use in case the triple arrangement gets out of order from any cause. Should this occur, all that is necessary is to connect the air hose at *E* and go ahead.

The banding is handled in a somewhat different manner than usual, both the machine for cutting off the bands and the one for pressing them

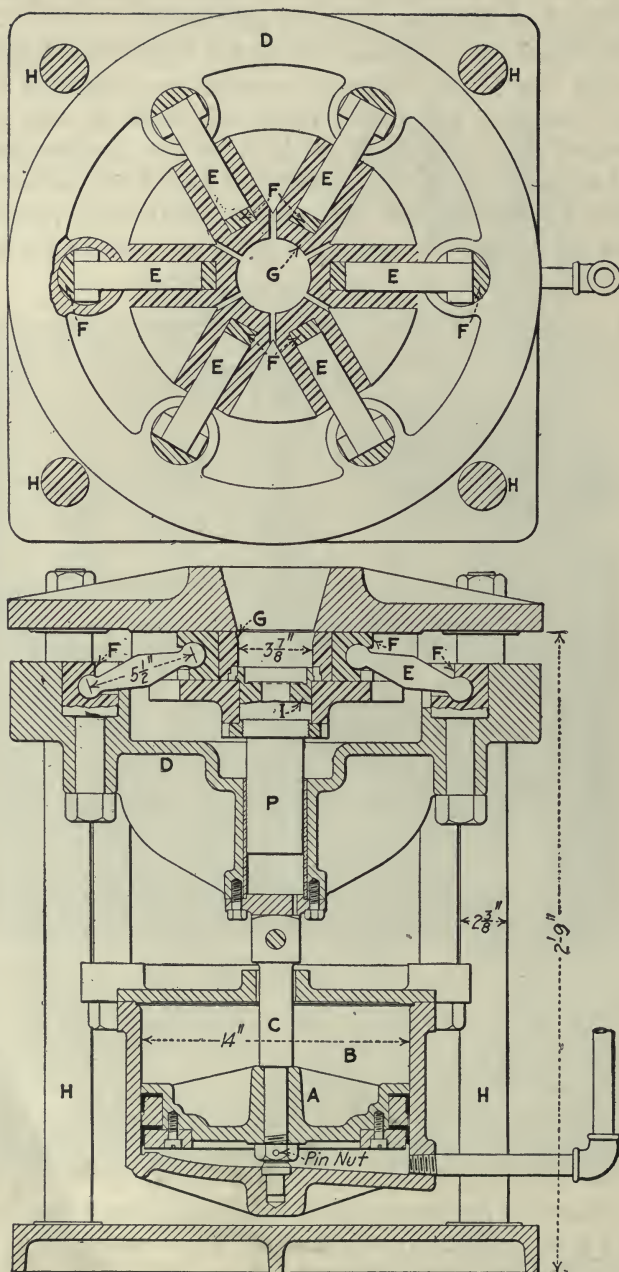

FIG. 141. PNEUMATIC COPPER-BANDING MACHINE

into place being built especially for this job. The cutting-off machine is shown in Fig. 140, with a tube in place at *A* and with the four milling saws *B* properly spaced for the width of band desired. The backrest *C* is shown thrown down and holding the four rings, which have just been cut off. It effectually supports the rings being cut against the thrust of the milling saws; and when the cut is completed, lifting the latch *E* releases the rest and allows the four rings to be easily removed. This backrest is located in position by the surface *D*. The cutters are fed into the work by the handwheel *F*. These four saws are but  $\frac{1}{32}$  in. thick, so that the waste of copper is very slight. The machine cuts 180 bands per hour and while this may not be as fast as in some other cases,

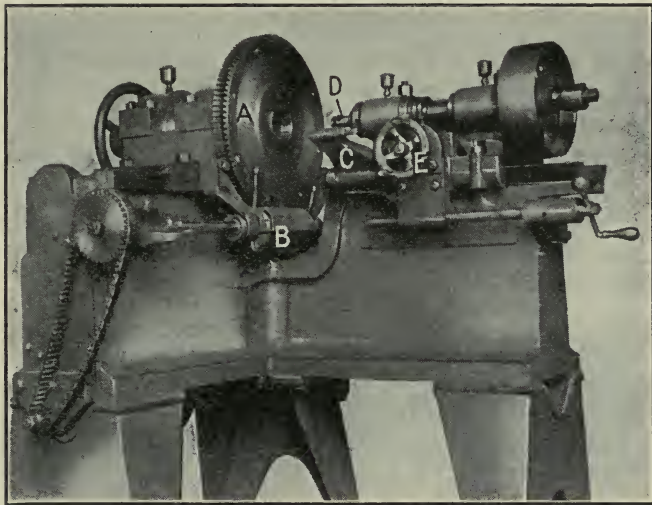

FIG. 142. FORMING THE BANDS

the saving in copper probably more than compensates for any loss of time. Furthermore they are very true to length.

The banding machine, Fig. 141, is operated by air at the regular shop pressure of 100 lb. to the square inch. This acts on the 14-in. piston *A* in the cylinder *B*, giving a total pressure of 30 tons to the square inch. By means of the toggle *F*, pressure is transmitted through the rod *C* to the head *D*, which slides on the four round guides *H* and also the central plunger *P*. The toggles *E*, working in the thrust blocks *F*, force the six steel jaws *G* against the copper band, compressing it into the band groove from all sides. This press is very quick acting, and five or six strokes are usually employed, turning the shell slightly each time, as is usual. One man and a boy band 1,400 shells in 12 hr. The main dimensions of the press are given in Fig. 141.

Instead of turning the bands as usual, this shop found it advisable to build two special millers, Fig. 142. These are simple affairs, as can

be seen, consisting of a work-holding spindle carrying a wormwheel *A* and being driven by the worm *B*. The shell, with the band in place, is slipped into the hollow spindle and held by a draw-in chuck operated by the wheel at the end. The shell is located by the swinging stop *C*, which drops out of the way as soon as the shell is in position. The milling cutter *D*, which is formed to give the shape of the copper band, is driven by an independent belt and can be moved either longitudinally for location or fed into the work by the crossfeed wheel *E*. This method of finishing the bands, the last operation, has been found very satisfactory, three men and two machines finishing 1,400 bands in 22 hr.

### MANUFACTURING SHRAPNEL PARTS ON AUTOMATIC MACHINES

In time of war, speed of production is of the utmost importance and this depends, naturally, largely upon the rapidity in producing the parts which ordinarily take the longest time to finish, *i.e.*, the shrapnel cases, the fuse bodies and the fuse caps. These parts can all be efficiently machined on properly equipped automatic turret lathes at a surprisingly high rate of production. The following descriptions and illustrations of the operations entailed give the actual time required for each of the specified operations.

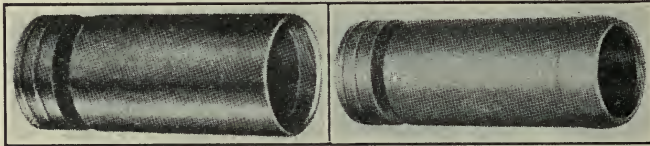

FIG. 143. A SHRAPNEL CASE PRODUCED FROM THE BAR

FIG. 144. A SHRAPNEL CASE PRODUCED FROM A FORGING

**The Shrapnel Case.**—The case is the most important part of all, and requires the most time to produce. It is made either from steel forgings or from the bar; in the first instance two chuckings are required, and in the latter only one.

Fig. 143 shows the appearance of shrapnel cases produced from bar stock, and Fig. 144 that of cases made from forgings. Both are shown as they come from the machine.

The process of machining 3-in. cases from the bar is clearly shown in Fig. 145. The tool set-up is illustrated in Figs. 146 and 147. The tools in these illustrations are lettered similarly to those in the machining diagram, Fig. 145, as a convenience in following the operations.

The tooling arrangement and operations for producing 3-in. common shrapnel cases from forgings are shown in Fig. 148. The machine upon which this work is done is a  $4\frac{1}{2}$  model A Cleveland automatic equipped with a rotary tilting magazine and an air-expanding arbor to grip the

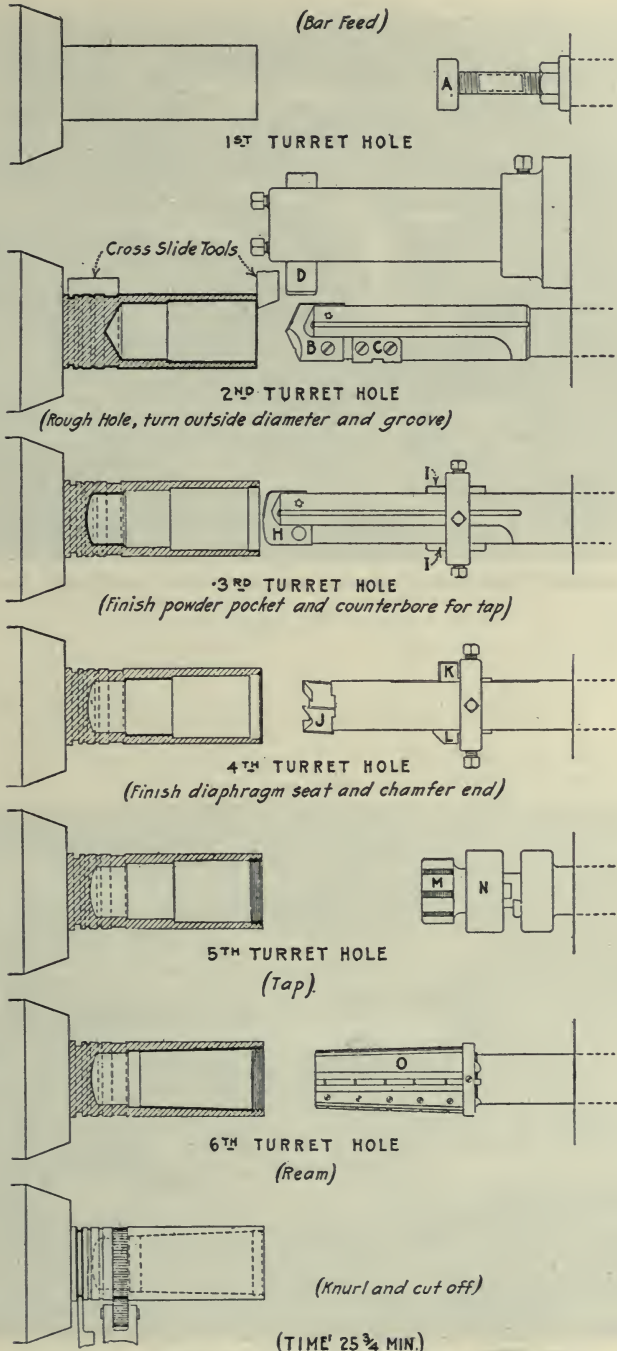

FIG. 145.. MACHINING A 3-IN. SHRAPNEL CASE FROM BAR STOCK

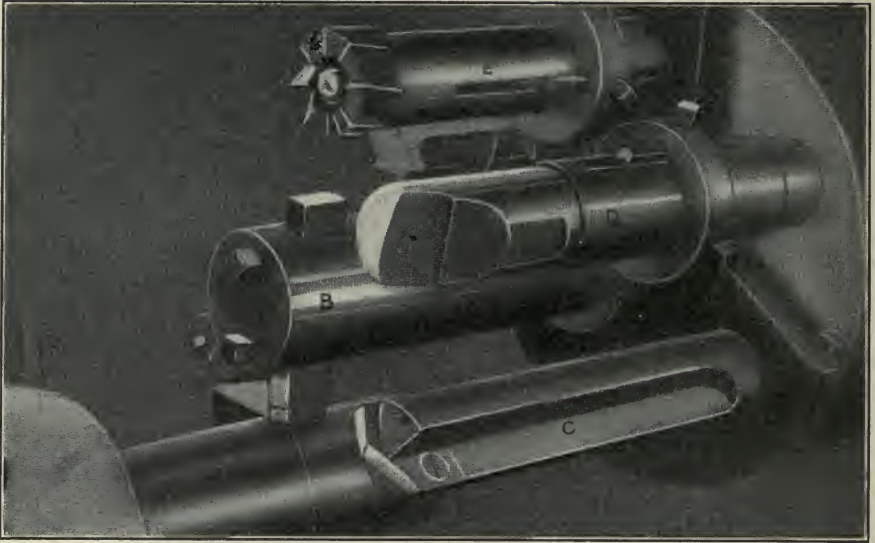

FIG. 146. FIRST OPERATION IN MAKING 3-IN. SHRAPNEL CASES FROM BAR STOCK

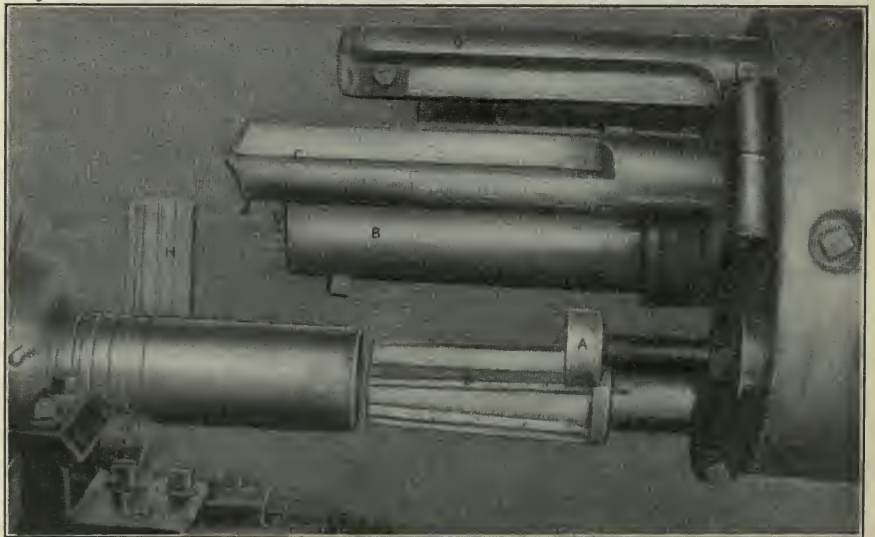

FIG. 147. LAST OPERATION IN MAKING 3-IN. SHRAPNEL CASES FROM BAR STOCK

forgings on the inside for the first chucking. This arbor is arranged with two sets of jaws, of three jaws each, gripping on either end of the case, and are controlled by a double-acting taper shaft working directly on the jaws. The end of the arbor also serves as a gage stop, as it seats on the bottom of the powder pocket.

After the first chucking, the case is heated and upset at the mouth end before completing the operations in the second chucking.

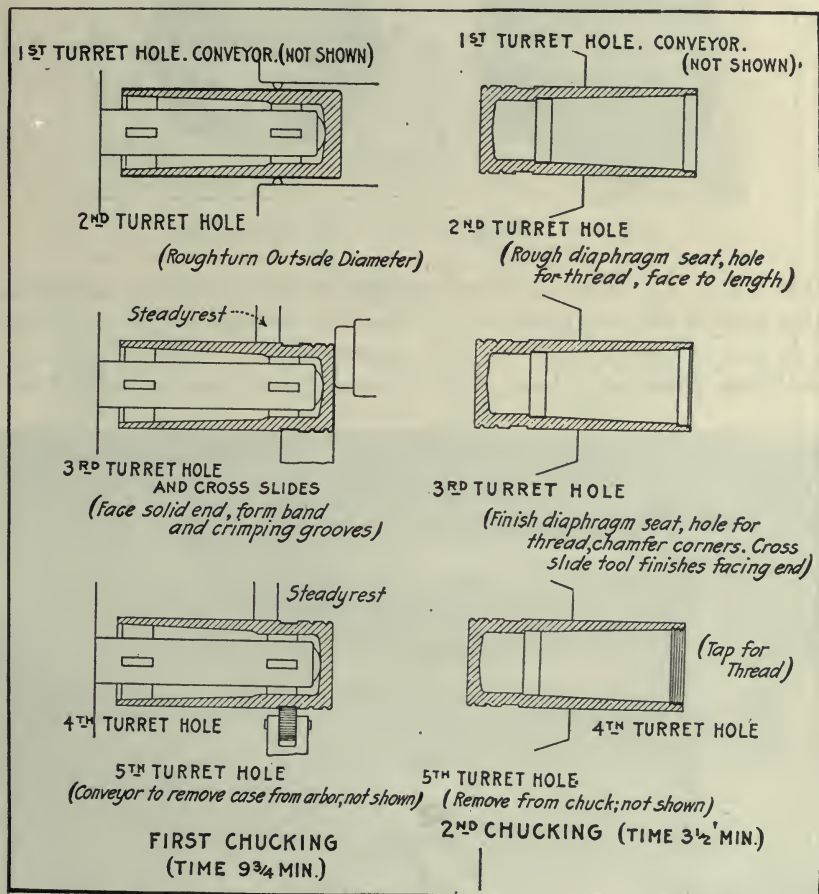

FIG. 148. MACHINING A 3-IN. FORGED SHRAPNEL CASE

It will be noted, from reference to the production time for the forged case in Fig. 148 as compared with the case produced from the bar shown in Fig. 145, that there is considerable machining time saved with the forged cases. This, however, does not account for the forging time which must be added to make a true comparison between the two methods.

**Shrapnel Heads.**—Shrapnel heads vary considerably in proportions according to the nominal size. This is indicated in Fig. 149, which shows

3 $\frac{3}{10}$ -in. and 6-in. heads. The tool set-up used in connection with these pieces is shown in Fig. 150.

Shrapnel heads are produced from 20-carbon cold-rolled-steel bar-stock. All operations are completed in one chucking, and are as shown

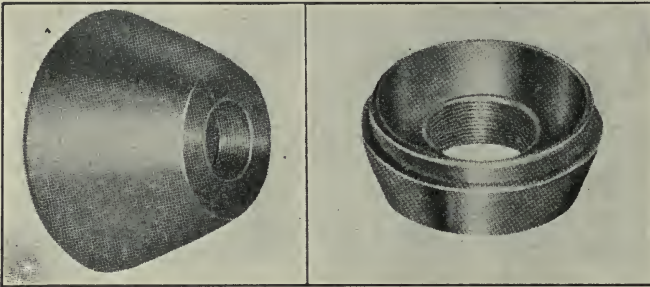

FIG. 149. 3.8-IN. AND 6-IN. SHRAPNEL HEADS

in Fig. 151. An interesting feature in connection with the machining of this piece is the employment of a cross-slide counterboring attachment which gets in its work on the fifth turret position. This consists of a lateral slide mounted in front of the cross-slide and carrying a head with

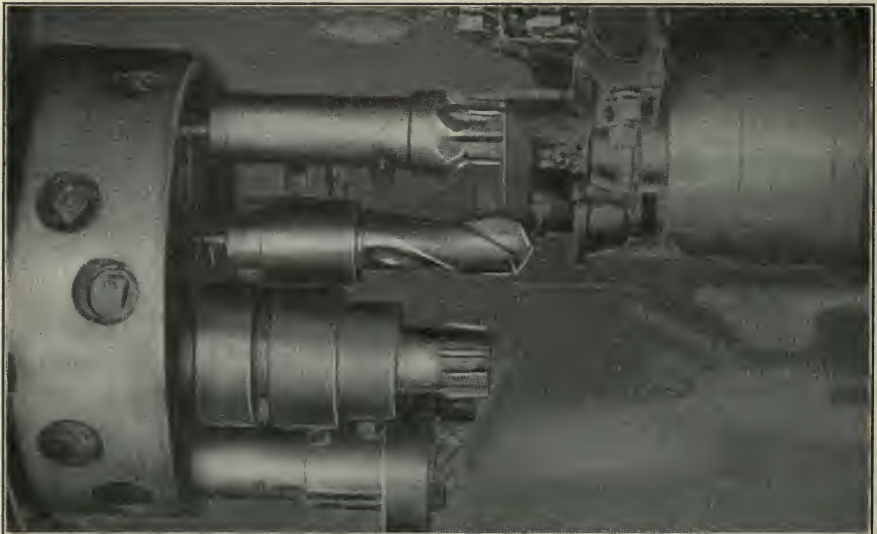
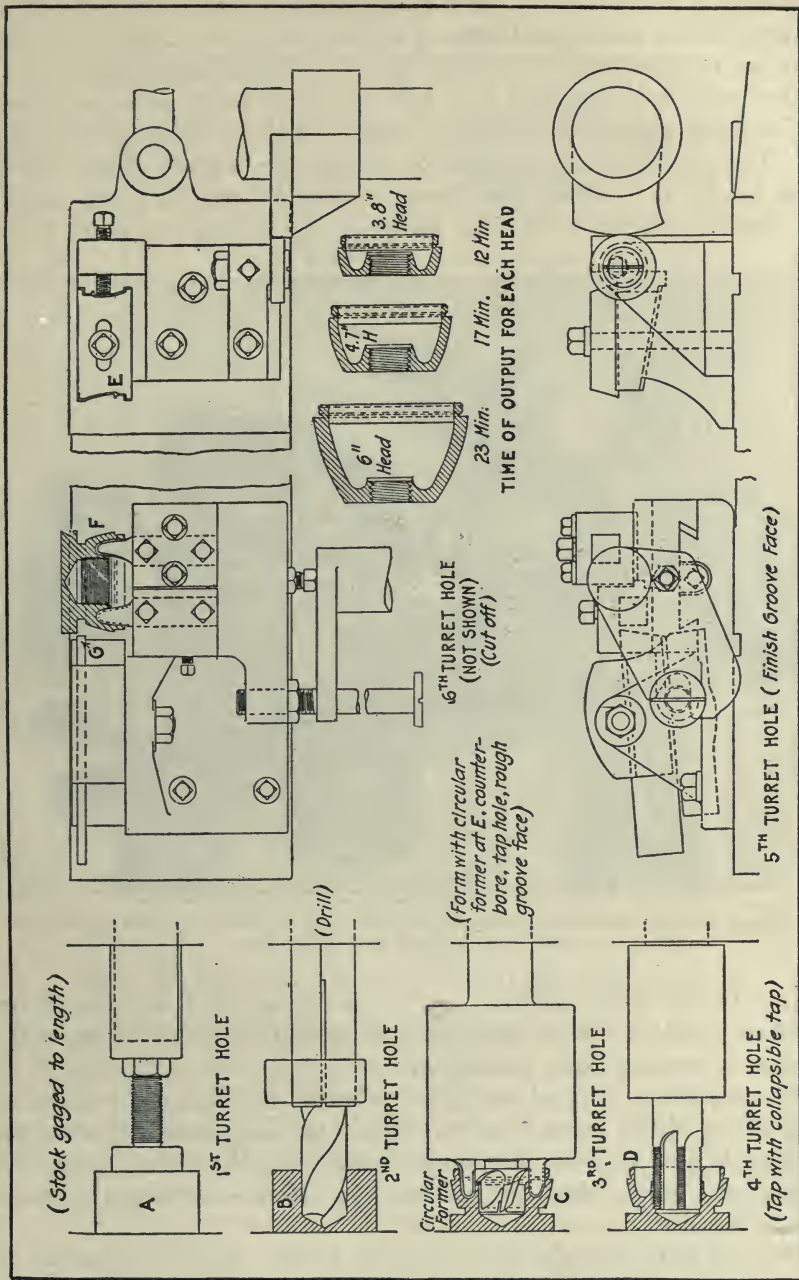

FIG. 150. THE SET-UP FOR PRODUCING SHRAPNEL HEADS ON A CLEVELAND AUTOMATIC

inserted formed cutters. The attachment is operated by a push-and-pull rod in the fifth turret hole. Provision is made for stopping and locking the cross-slide in the proper location for this attachment to operate this being cared for by an adjustable cam and roll stop, the latter,





MATERIAL, 20 CARBON, C.R. STEEL  
 FIG. 151. MACHINING A 3.8-INCH, 30 POUND SHRAPNEL HEAD

mounted on a block in conjunction with the flat forming-tool post, the stopping cam being clamped on the camshaft.

**Fuse Bodies and Fuse Caps.**—The fuse bodies are made of bronze stampings or brass castings and the fuse caps of bar-brass stocks. Both of these parts are machined on a full automatic turret lathe, equipped with a tilting magazine and an air chuck, such as illustrated in Fig. 152. The air chuck *A* is screwed on the spindle in place of the regular chuck hood. It is fitted with three removable jaws, *B*, which receive pads that are shaped to suit the work. A connecting rod fitted to the

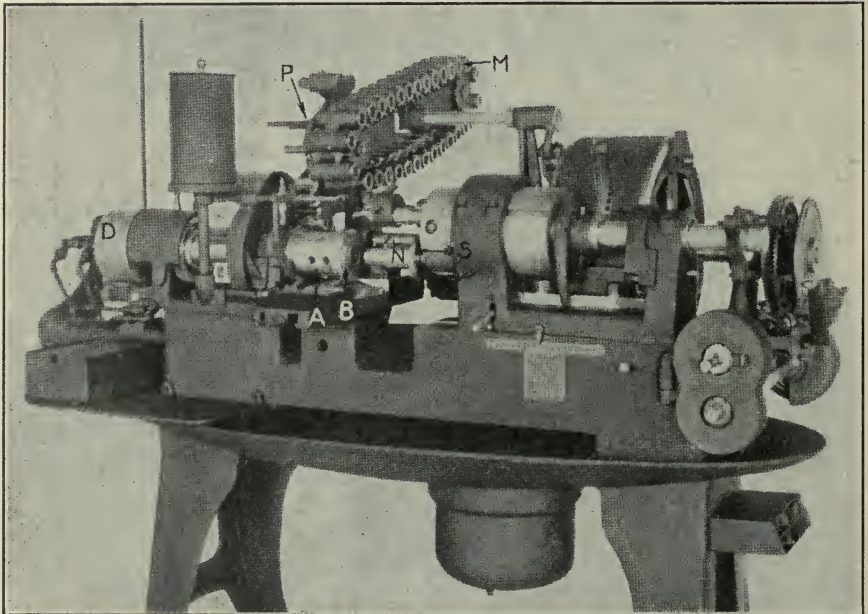

FIG. 152. MACHINE EQUIPPED WITH MAGAZINE AND PNEUMATIC CHUCK FOR PRODUCING FUSE BODIES AND FUSE CAPS

piston in the air cylinder is attached to the chuck jaws *B* and the admission of air to either side of the piston, controlled by the camming of the machine, opens and closes the chuck.

The magazine *L* is fitted with a link *M* which has bushings conforming to the shape of the work handled. When the magazine tilts after the conveyor *N* has removed the piece operated on, the lever *P* comes in contact with a pin which indexes the link belt and advances the next piece of work.

The fuse body requires two chuckings, both of which are handled by the automatic magazine. The operations on this piece are shown in sequence in Fig. 153. The fuse cap in its first chucking is handled in bar form, and in its second chucking is held in the pneumatic chuck and fed

by the automatic magazine. The method of machining the fuse caps, in order of operations, is shown in Fig. 154.

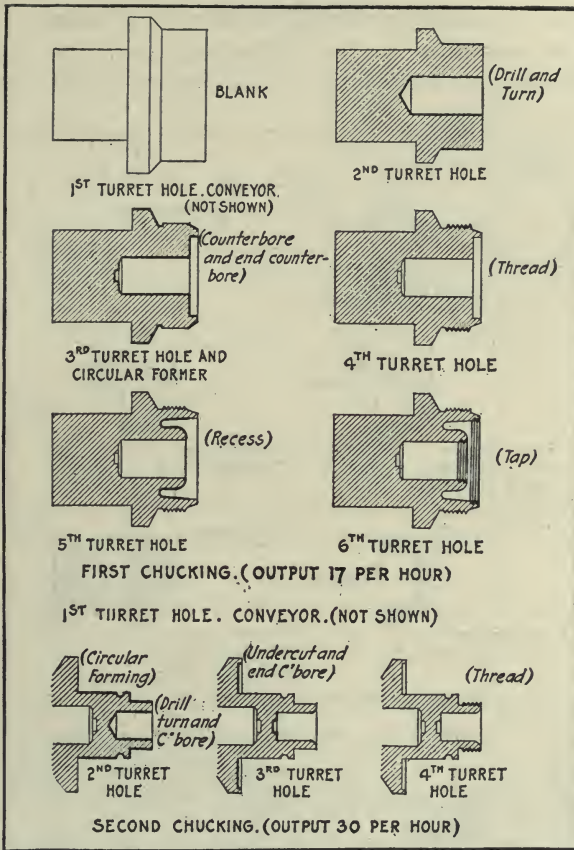

FIG. 153. MACHINING A FUSE BODY (BRONZE STAMPING OR BRASS CASTING)

**AUTOMATIC PRODUCTION OF SHRAPNEL SHELL PARTS**

Special automatic turret lathes equipped for handling the first and second settings in the manufacture of shrapnel shell heads and fuse parts are employed by the New Britain Machine Co., New Britain, Conn. The multiple spindle machines, when two settings are employed, produce work within a limit of 0.004 in. of being perfectly concentric and in thread cutting the agreement is within one-eighth turn. Among the operations performed on this highly developed tool may be mentioned the following:

**Machining Fuse Heads.**—The machine steel fuse heads, shown in Fig. 155, are finished in one setting on special seven spindle chucking machines, known as size No. 73, illustrated in Fig. 156. The fuse head

blanks weigh 15 oz. each and are operated upon by the tools in the sequence indicated in Fig. 157. The work is threaded externally and internally and the ends are machined.

The blanks are held on threaded draw-back collets. The end *A*, Fig. 155(b), is machined in the following order: The hub is drilled, counterbored, tapped, turned on two diameters, necked and threaded;

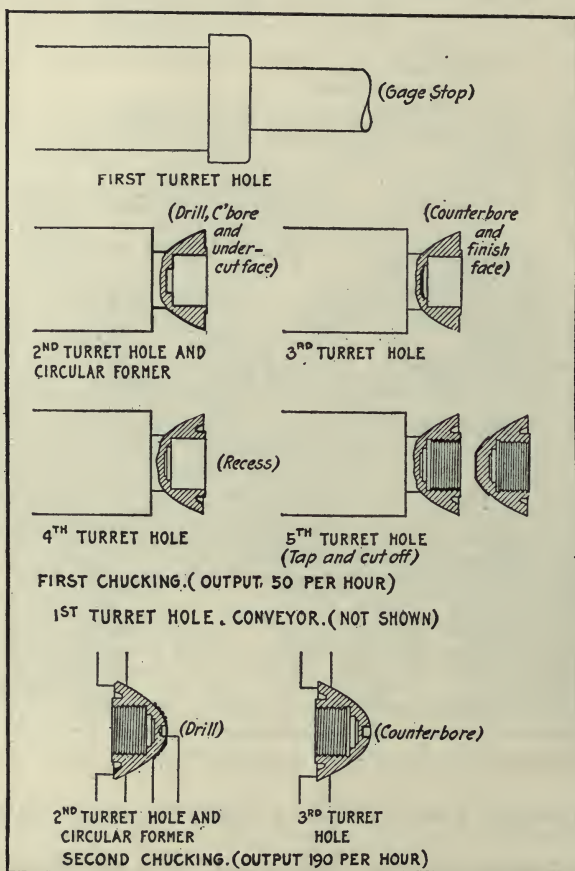

FIG. 154. MACHINING A FUSE CAP (BAR BRASS)

and the flange is faced, grooved and turned. The finished pieces weigh 13 oz. The tools operate at a cutting speed of approximately 40 ft. per min. The production is 52 pieces per hour.

**Machining Shrapnel Heads.**—The tools—first setting—used for machining the 4.7-in. shrapnel head, Fig. 158, are shown in Fig. 159. The parts are made on a size No. 24 four-spindle chucking machine. These parts are cold-drawn steel stampings; the blanks weigh 42 oz. and are machined in two settings. The weight of the finished piece is

31 oz. The first setting is on the end *A*, which is faced, chamfered, grooved, bored and tapped. For these operations the pieces are held in two-jaw chucks arranged with stop plugs, Fig. 160, which fit inside the forms of the pieces, thus locating them accurately. This method of

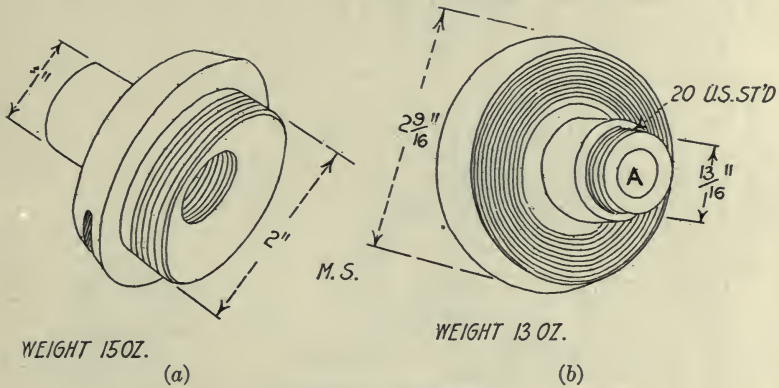

FIG. 155. FUSE HEAD

locating is necessary, as the distance from the inside concave surface to the outside face must be accurate. The production is 62 pieces per hour.

For the second setting the pieces are held on threaded drawback arbors by the thread formed at the end *A*. The tools used on the large

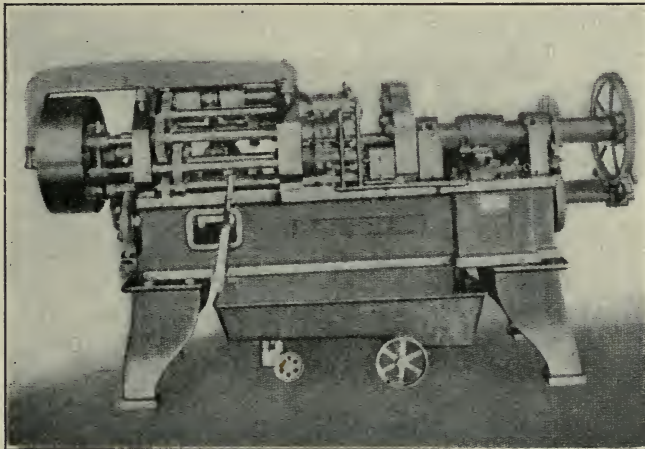

FIG. 156. SEVEN-SPINDLE AUTOMATIC

end are shown in Fig. 161. The operations are facing, chamfering, turning, necking, counterboring and threading. It will be noticed that the tools used for the first and second spindles are piloted in draw-back arbors to insure the machined surfaces being concentric. The production for

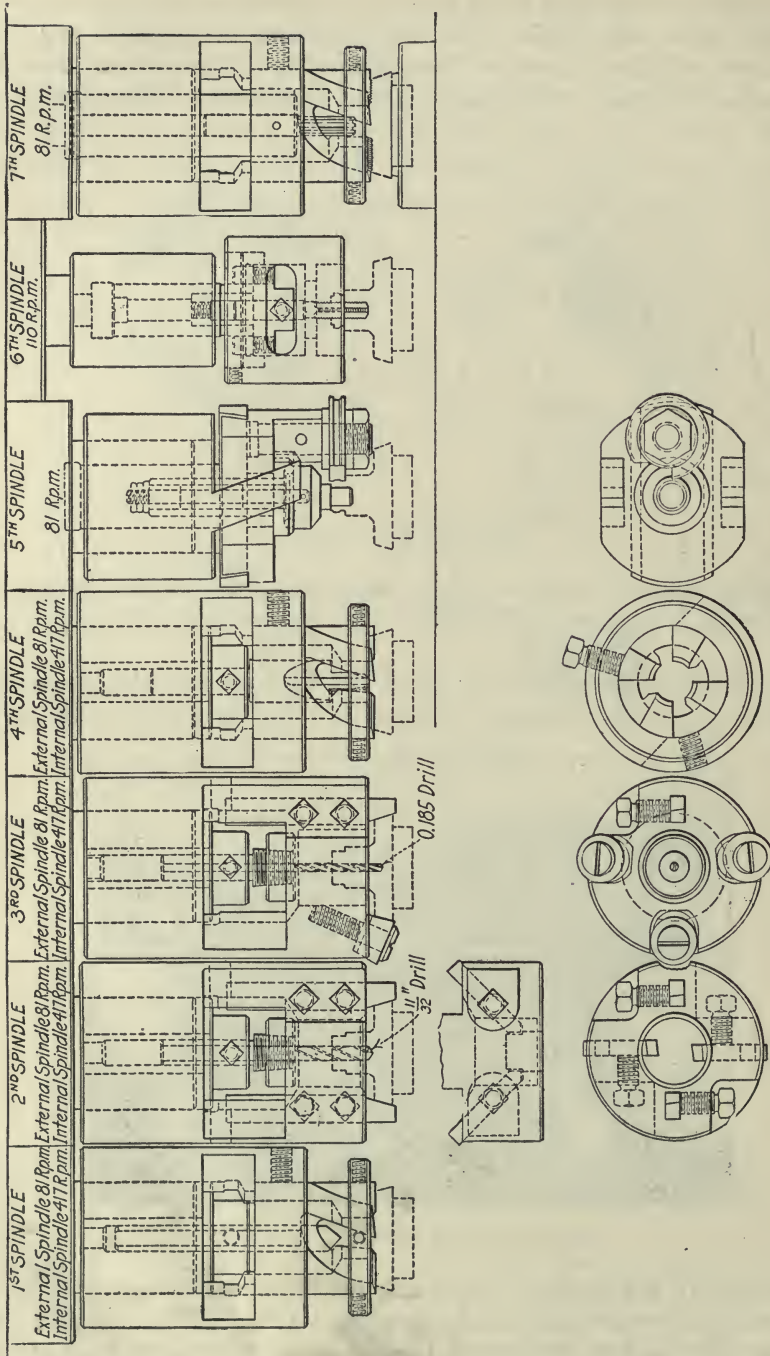

FIG. 157. TOOLING FOR MACHINING FUSE HEADS

this setting is 94 pieces per hour. The cutting speed is approximately 120 ft. per min.

**Machining Shell Heads.**—When machining the heads used on 18-lb. high-explosive shells, the tools shown in Figs. 162 and 163 are used. The blanks, which are made as shown in Fig. 164(a), weigh 2 lb. 2 oz.

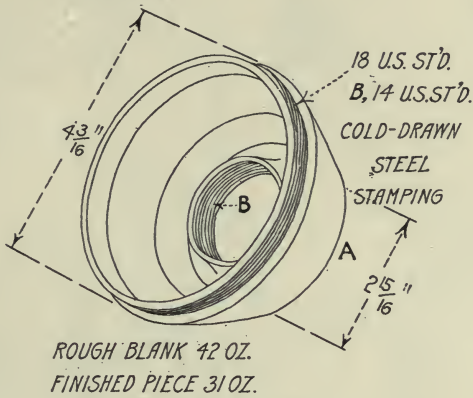

FIG. 158. 4.7-IN. SHRAPNEL HEAD

each. They are machined to the form shown in Fig. 164(b), the weight of the finished piece being 1 lb. 12 oz. These parts are made from brass forgings and are machined in a size No. 24 four-spindle chucking machine. The first setting is for machining the ends A. The pieces are gripped in two-jaw chucks and the ends faced, formed three diameters, bored, recessed, and threaded two diameters. The production is 120 pieces per hour. The parts are then placed on threaded draw-back arbors

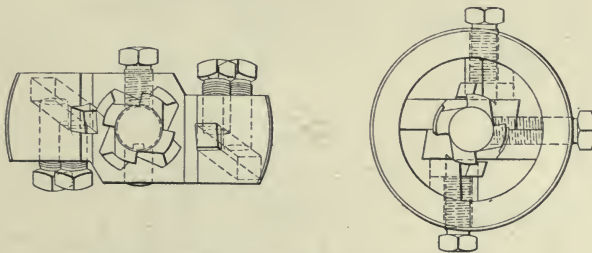

FIG. 159. FIRST SETTING FOR SHRAPNEL HEAD

which fit into the internal threads formed for the second setting. The machining operations consist of facing, turning, necking and threading. The production for this setting is also 120 pieces per hour. When machining this part the approximate speed of the tools is 80 ft. per minute.

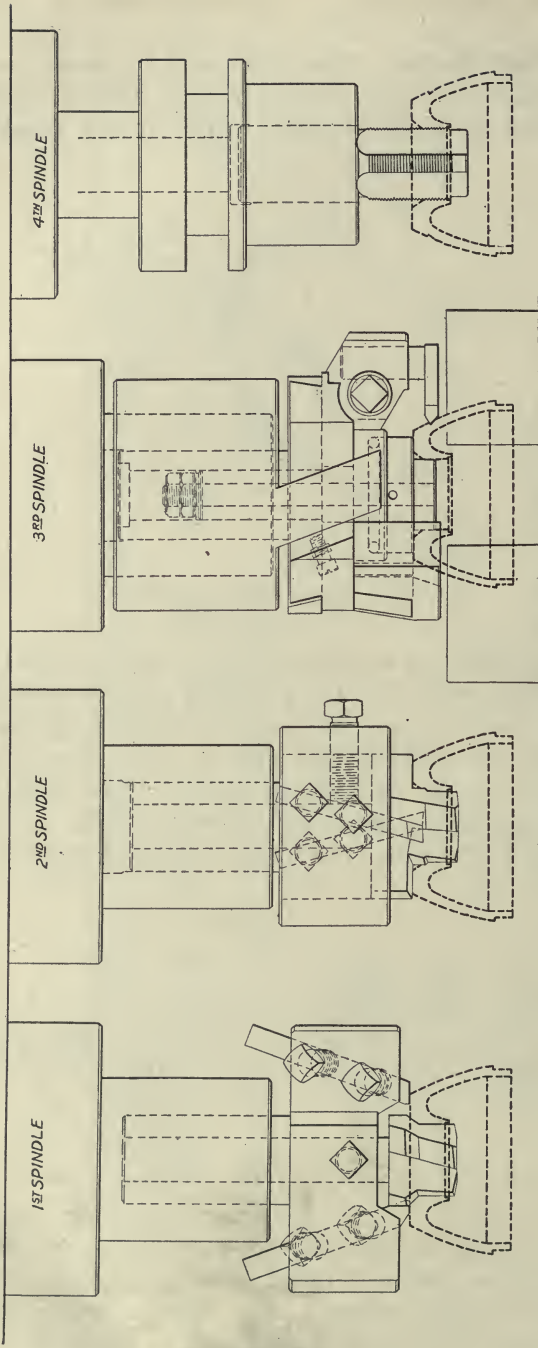

FIG. 160. MACHINING SHRAPNEL HEADS



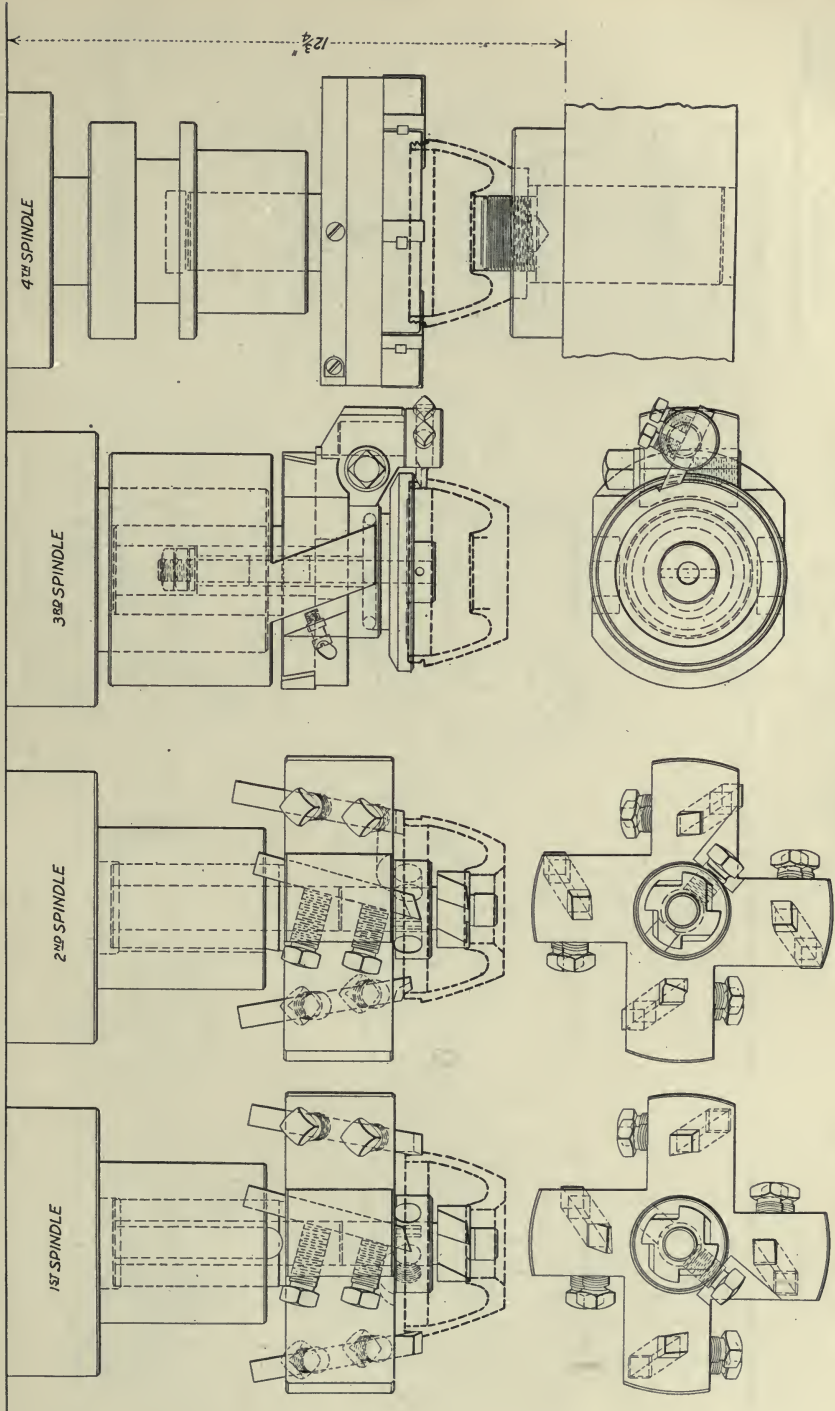

FIG. 161. SECOND SETTING FOR SHRAPNEL HEAD

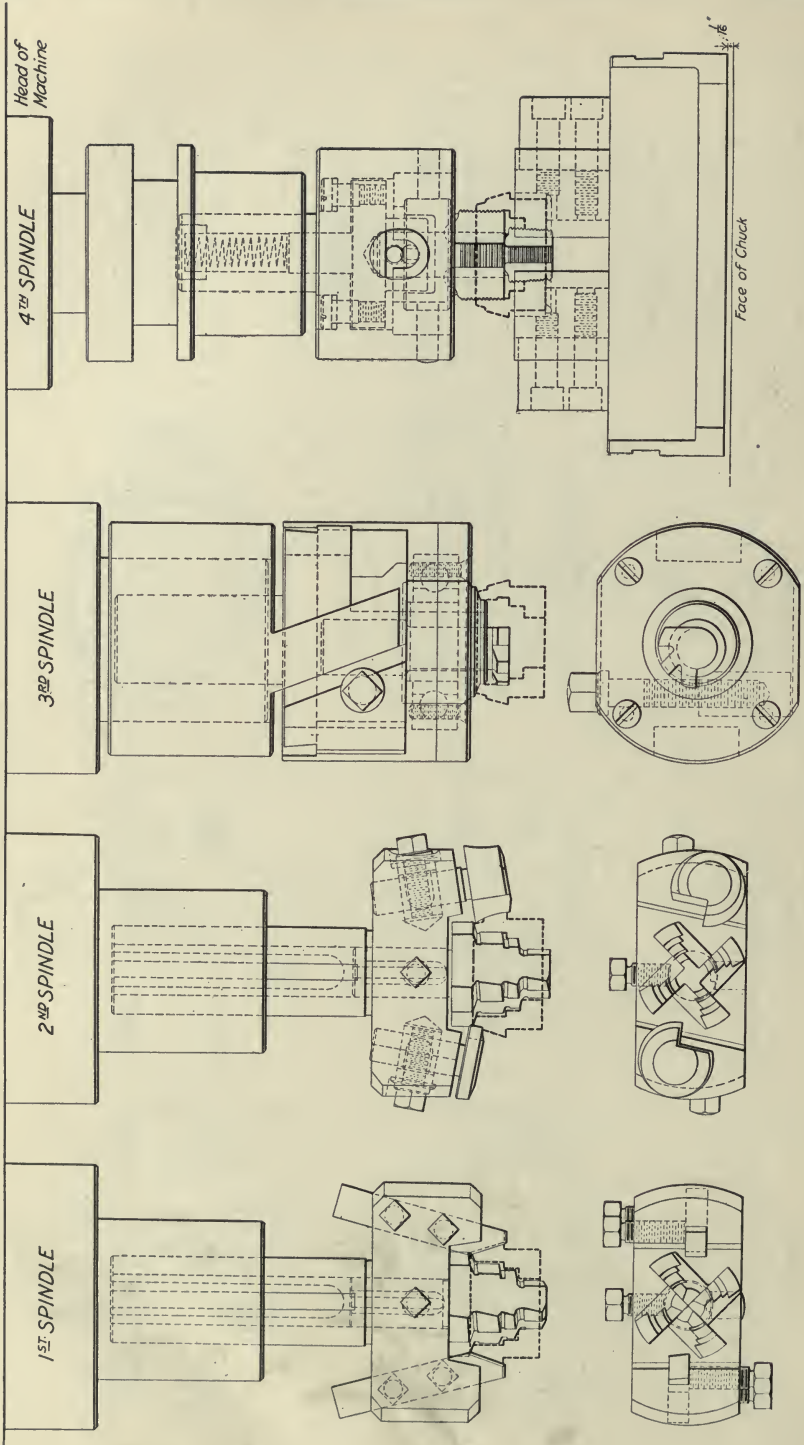

FIG. 162. FIRST SETTING FOR SHELL HEADS

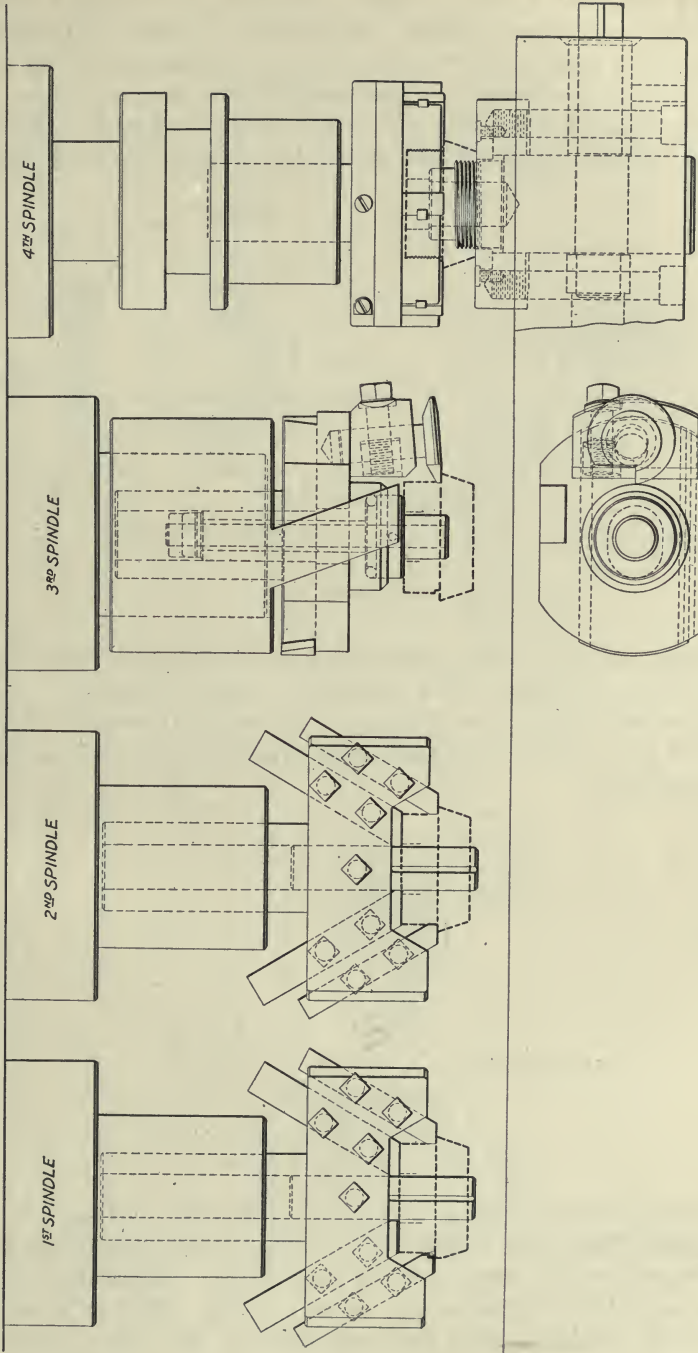

FIG. 163. SECOND SETTING FOR SHELL HEADS

**Making Shrapnel Sockets.**—When machining the shrapnel sockets, Fig. 165, the tools shown in Figs. 166 and 167 are used. These parts, which are made from solid brass forgings, are manufactured on a size No. 24 four-spindle machine. The rough blank weighs 13 oz. The first setting is on the end *A*, Fig. 165. The blank is solid, the parts being gripped in two-jaw chucks. The machining consists of facing, boring,

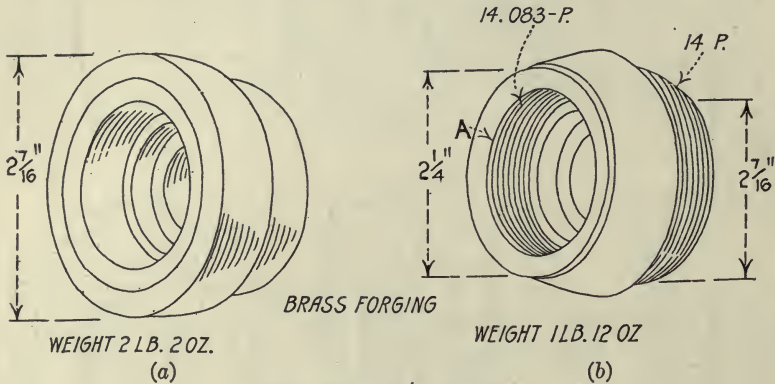

FIG. 164. SHELL HEAD

recessing and tapping. The pieces are held on arbors located by the thread formed in the end. The production is 160 per hour.

In the second setting three diameters are turned, the end formed and necked and the outside threaded. The production for this setting is also 160 per hour.

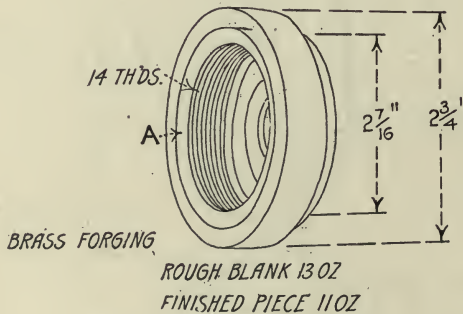

FIG. 165. SHRAPNEL SOCKET

The tools operate at a speed of 116 r.p.m. for both settings.

**Producing Time-fuse Noses.**—The time-fuse nose pieces are made of brass forgings of the form shown in Fig. 168(a). These are then machined in one setting to the contour shown in Fig. 168(b) on a size No. 33 five-spindle machine, using the tools shown in Fig. 169. The rough blanks weigh 4 oz. each and the finished parts,  $3\frac{1}{2}$  oz. For these opera-

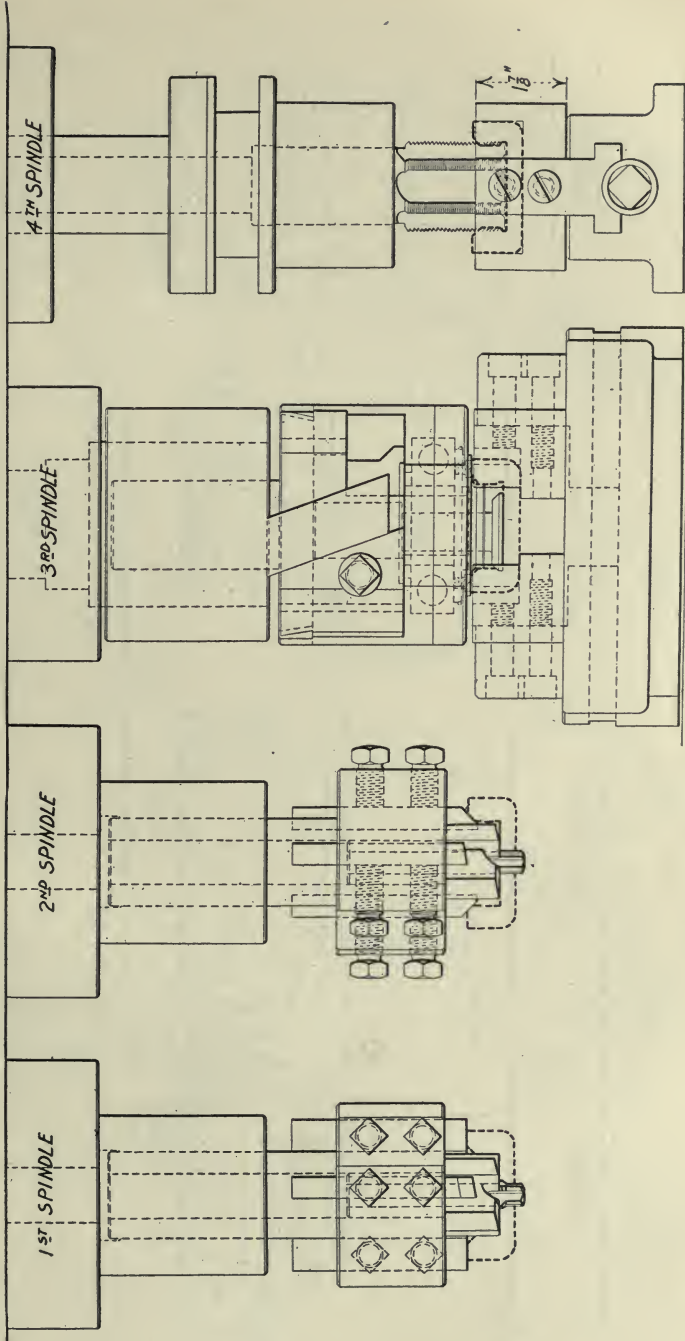

FIG. 166. FIRST SETTING ON SHRAPNEL BRASS SOCKETS

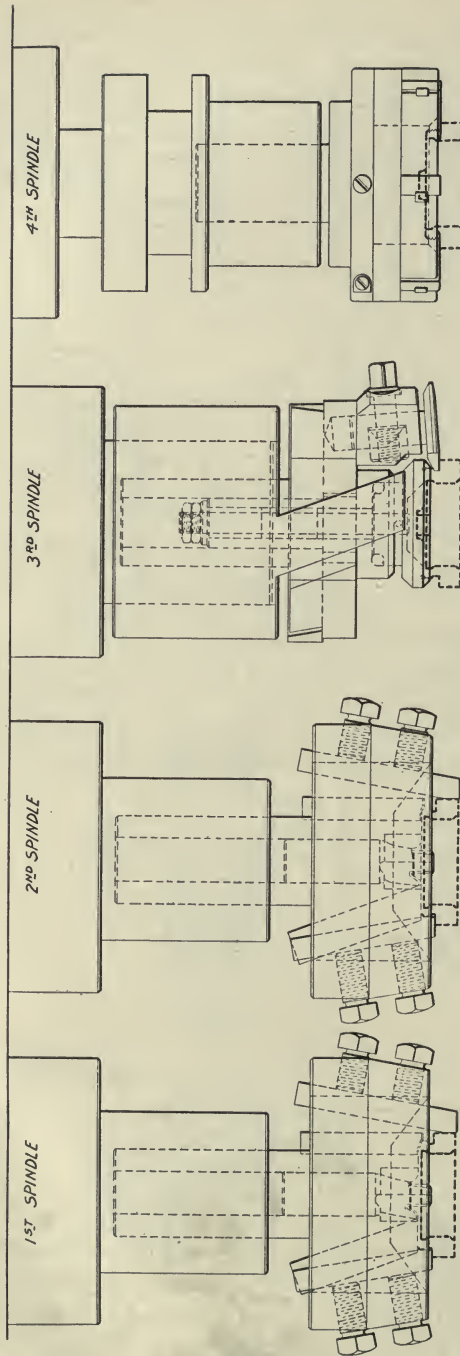
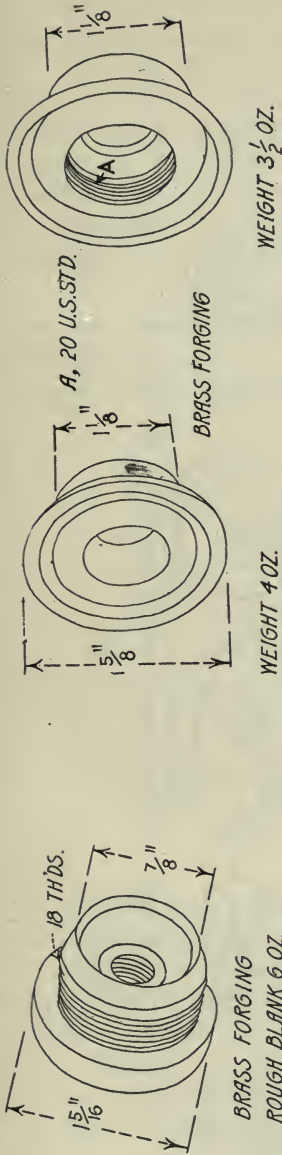

FIG. 167. SECOND SETTING ON SHRAPNEL BRASS SOCKETS



(a)

(b)

FIG. 168. TIME-FUSE NOSE

FIG. 170. PROJECTILE PRIMING PLUG

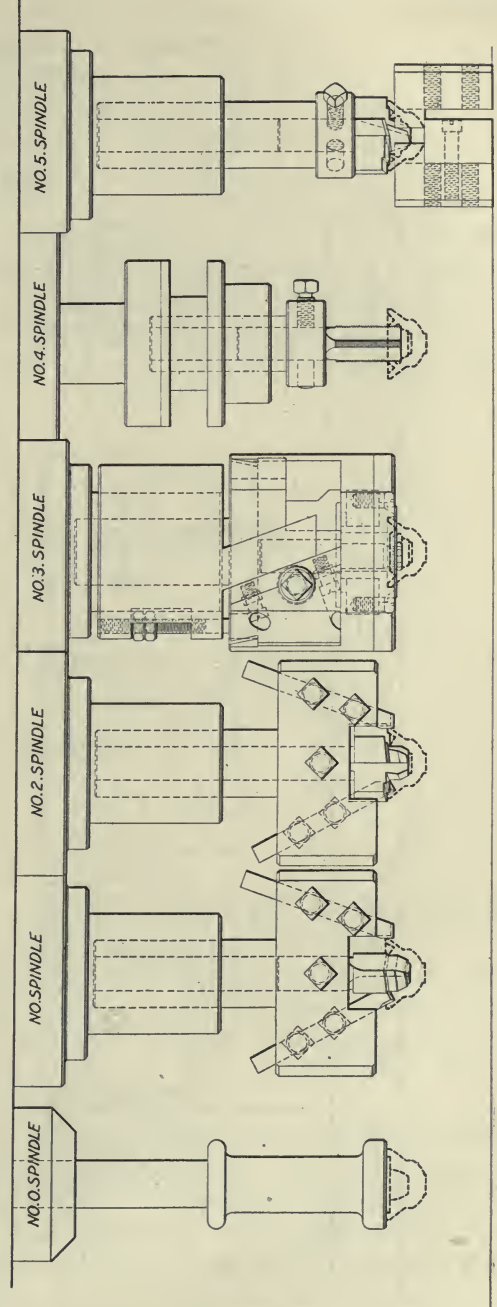

FIG. 169. TOOLING FOR MACHINING TIME-FUSE NOSES

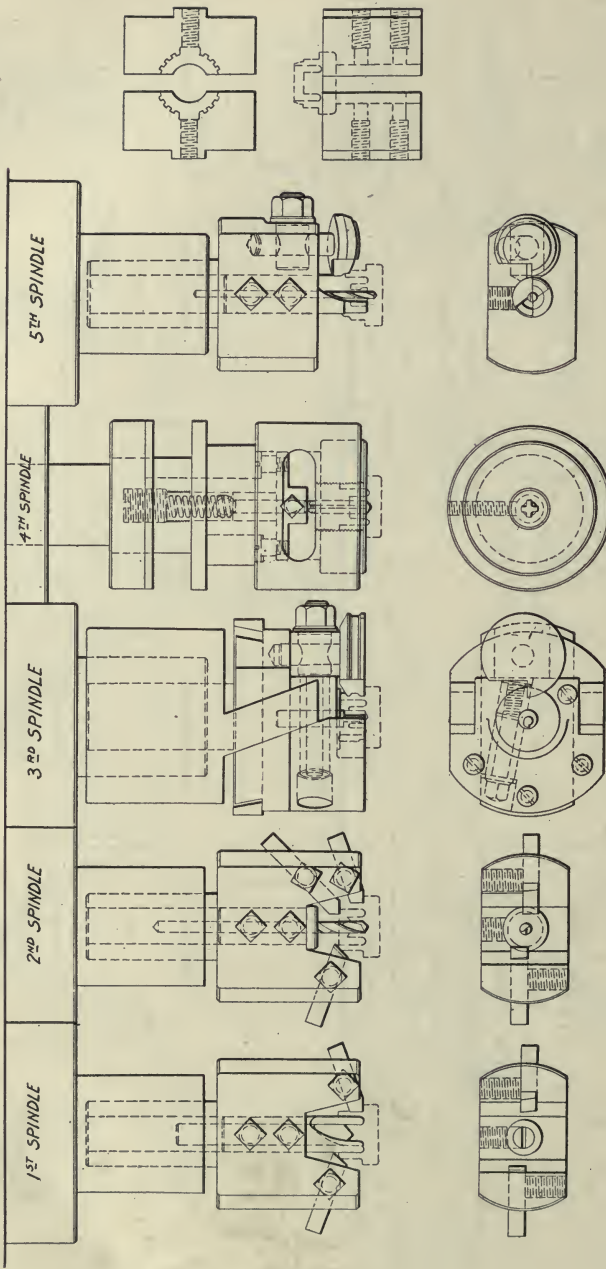

FIG. 171. TOOLING FOR MACHINING PROJECTILE PRIMING PLUG



tions the forgings are held in two-jaw chucks. The inside is faced, formed, recessed and tapped. The production is 225 pieces per hr., the cutting speed being approximately 80 ft. per minute.

**Making Projectile Priming Plug.**—The tools used for making the projectile priming plug, Fig. 170, are shown in Fig. 171. These are made from brass forgings on a size No. 33 five-spindle machine. They are solid and weigh 6 oz. each. The pieces are gripped in two-jaw chucks and the outside and inside operations are completely finished. The outside is turned, formed, necked and threaded. The inside is formed out with hollow mills, drilled, counterbored, necked back of tap and tapped, the tap and outside thread being of *different* pitch, but both threads being cut simultaneously by means of a specially designed combination tap and die head which allows the tool of *steeper* pitch to advance independently of the other.

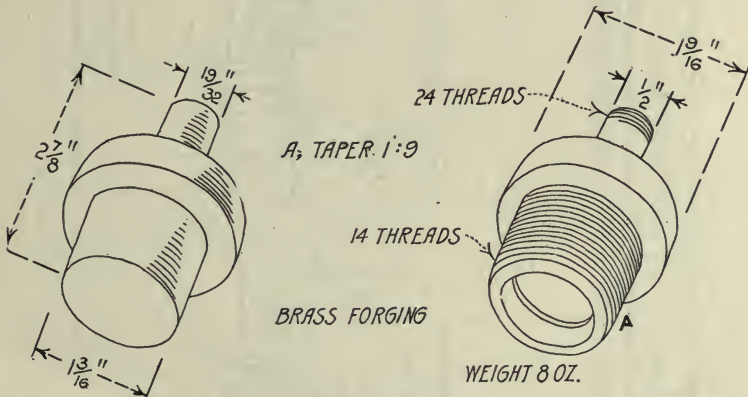

FIG. 172. TIME-FUSE BODY

Production on this piece is 180 per hour; weight of finished piece, 3 oz., and approximate cutting speed of tools, 100 ft. per minute.

**Machining Time-fuse Bodies.**—Time-fuse bodies, which are made from brass forgings, come to the machine in the form shown in Fig. 172(a). They weigh 13 oz. each. They are machined to the shape shown in Fig. 172(b), using for the two settings the tools shown in Figs. 173 and 174 on a size No. 23 four-spindle machine.

For the first setting the parts are gripped in two-jaw chucks and the end A is bored from the solid, reamed, recessed and tapped, and the outside taper turned, faced and threaded. Although not so shown, this end is also internally threaded. The production for this setting is 55 pieces per hour. For the second setting the pieces are held in threaded draw-back collets which fit into the threads formed in the previous setting. The head and stem are turned and faced, and the stem is chamfered and threaded. The production is 120 per hour. The weight of the finished

parts is 8 oz. each. For the machining operations on these parts, the tools operate at a cutting speed of approximately 80 ft. per minute.

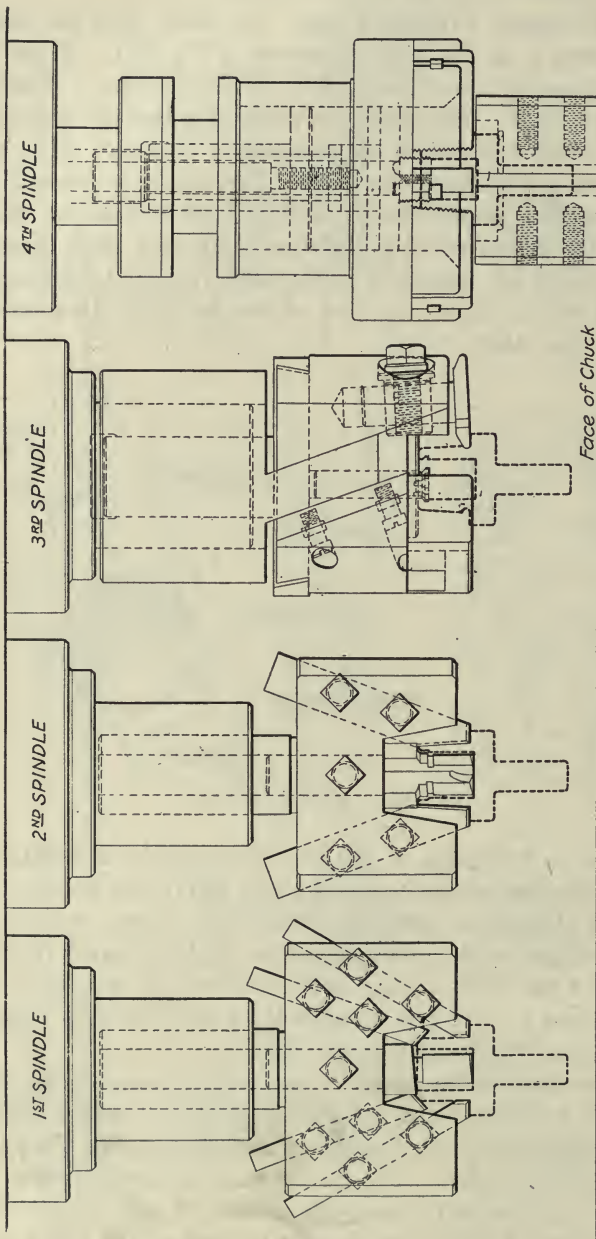

FIG. 173. FIRST SETTING ON TIME-FUSE BODIES

**Making Time-fuse Rings.**—The time rings shown on Fig. 175 are made of brass forgings. The rough blanks for the pieces weigh 6 oz.

each, and the finished parts, 4 oz. The operations are performed in one setting on a size No. 23 four-spindle machine, using the tools shown on

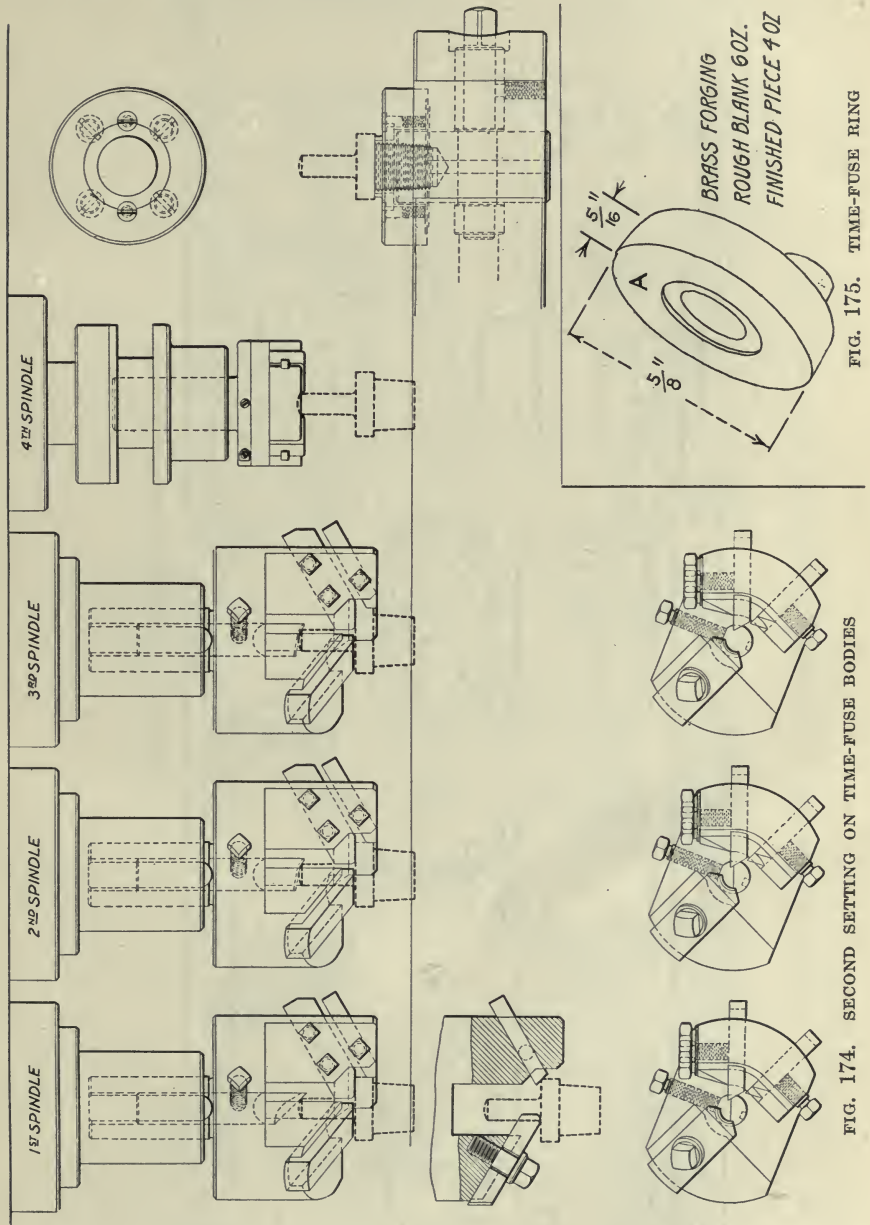

FIG. 175. TIME-FUSE RING

FIG. 174. SECOND SETTING ON TIME-FUSE BODIES

Fig. 176. The parts are gripped in two-jaw chucks and then the end A is faced, drilled and counterbored. The production is 240 per hour, and the cutting speed of the tools approximately 80 ft. per minute.

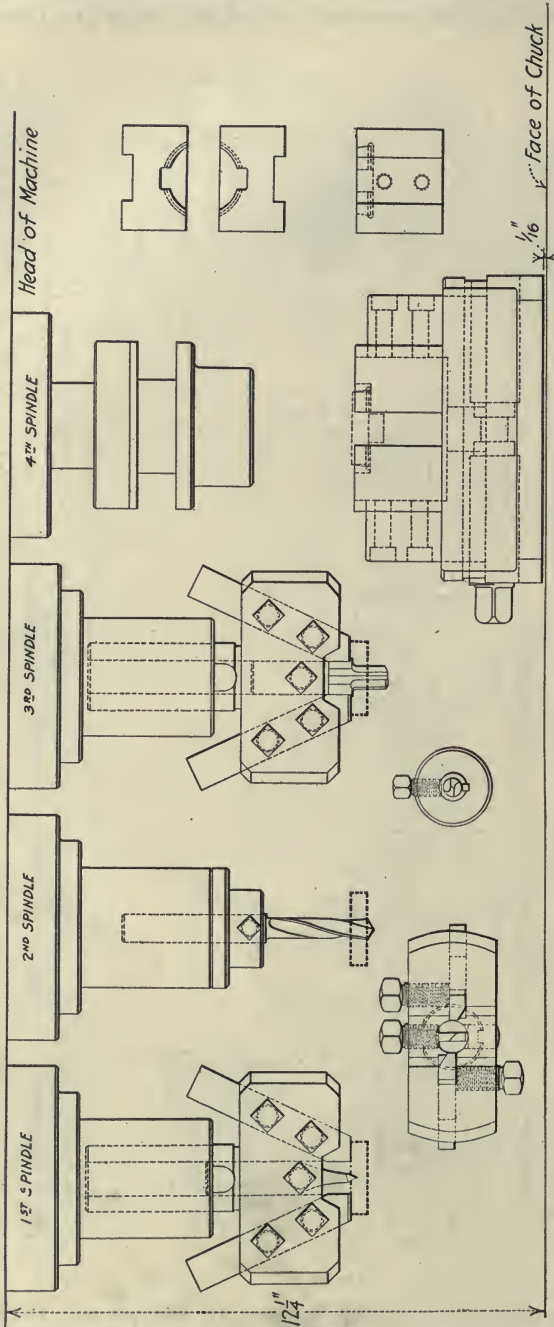

FIG. 176. TOOLING FOR MACHINING TIME-FUSE RINGS

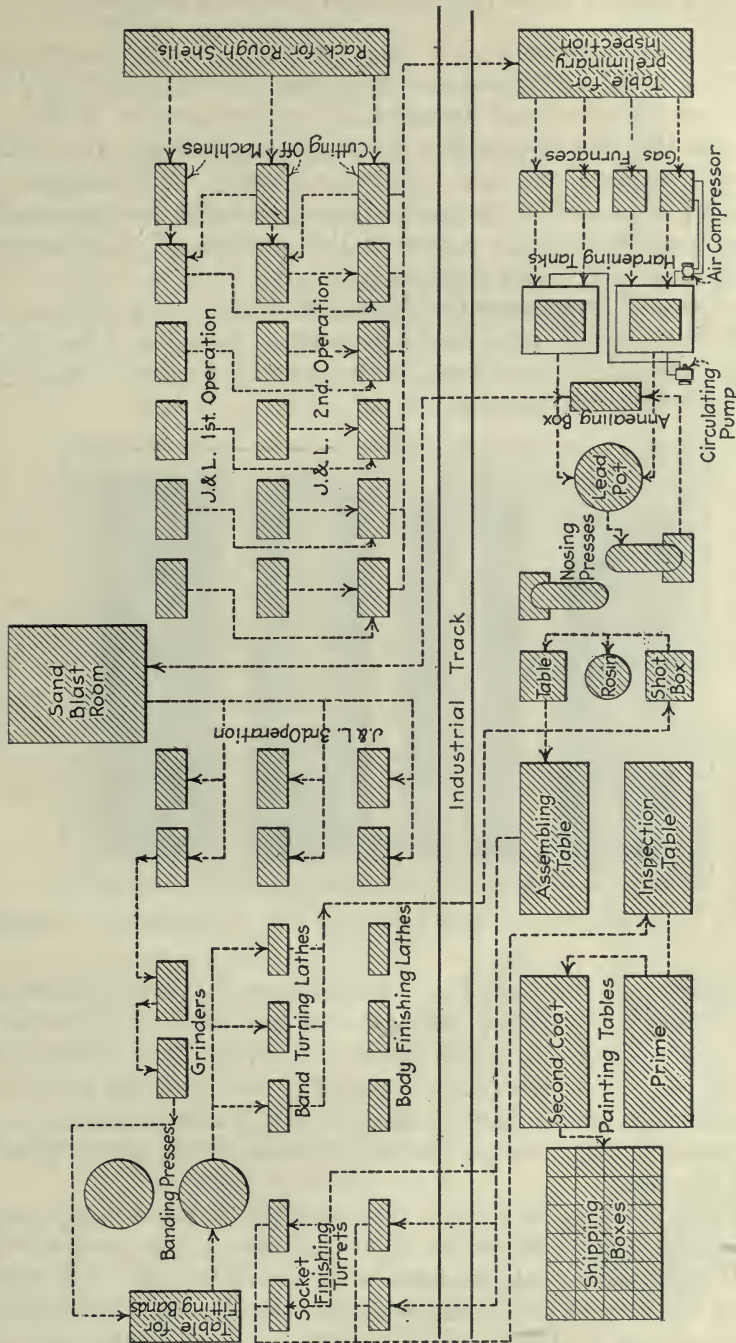

FIG. 177. GENERAL ARRANGEMENT OF DOMINION BRIDGE CO.'S PLANT

## A BRIDGE SHOP TRANSFORMED INTO AN ARSENAL

The Dominion Bridge Co., of Montreal, Canada, devoted one entire department in their large plant to the production of 15 and 18-lb. British shrapnel and installed and arranged the tool equipment of this shop solely with the view of handling the work expeditiously and with as little back tracking and lost motion as possible. As this shop was planned and arranged for the special task of shrapnel shell manufacture it presents an interesting example of the processes of manufacture in a special shop with special equipment.

**The General Arrangement of Machines, Etc.**—The general arrangement of the machines in the shell department is indicated in Fig. 177, by which the general course of work, from the rough forging to the finished shell, can readily be followed.



FIG. 178. THE ROUGH SHELLS (AFTER END IS CUT OFF) AND THE THREE FLAT-TURRET OPERATIONS

The shells are first cut off and rough-faced on cutting-off machines. They then go to the first-operation flat turrets, where the work on the outside of the case is cared for; then to the battery of second-operation machines, where they are bored. After this the shells are taken to an inspection table, where they are given a preliminary inspection before heat-treating so that defective shells may be discarded without incurring further expense.

The next operation is the heat treatment, gas furnaces being used for the purpose. This is somewhat outside of customary practice, but it leaves the shell in first-rate condition with very little scale. The hardening tanks contain whale oil, which is circulated and cooled in coils running through inclosing water tanks. In addition to this it is found necessary to agitate the oil by means of compressed-air jets.

Following this heat treatment, the noses of the shells are brought to a low red-heat by immersion in a lead pot, after which they are "bottled" under a punch press. The chill produced by this process is removed by annealing, after which the shells go to the sandblast room, where the recess which contains the "wave" is cleaned out.

Next comes the third flat-turret operation, in which the inside and outside of the nose are machined. From here the shells go either to grinders or to body-finishing lathes—both processes being employed at present—where the outside and the curved nose of the shell are brought to the correct finished sizes. The copper driving bands are next fitted and squeezed, after which the shells proceed to the band-turning lathes, from there going to the filling department, where they are filled with shot and rosin and have the fuse socket screwed home.

The next operation is finishing the socket, which is cared for on brass-finishing turret lathes. Next comes the final inspection, after which the shells are painted and shipped.

**The Flat-turret Operations.**—Fig. 178 shows the various stages of the shell as it comes to and goes from the flat-turret lathes.

At *A* is the rough shell with its end cut off, *B* represents the completion of the first operation, *C* shows the shell bored and turned taper, and *D* represents the completion of the third flat-turret operation, in which the inside of the nose is completed and the outside is roughly shaped. One of the most difficult problems is to securely grip the shell internally for the first operation. Fig. 179 shows the construction of the driving and centering arbor which was finally devised for this purpose.

**A Difficult Operation Handled Simply.**—The action of the flat turrets may be followed very readily by inspecting Figs. 180, 181 and 182, in which the successive operations are represented by diagrams. The most interesting part of the first operation is undoubtedly the forming of the waved ribs. An idea of the nature of the wave may be had from Fig. 183. The construction of

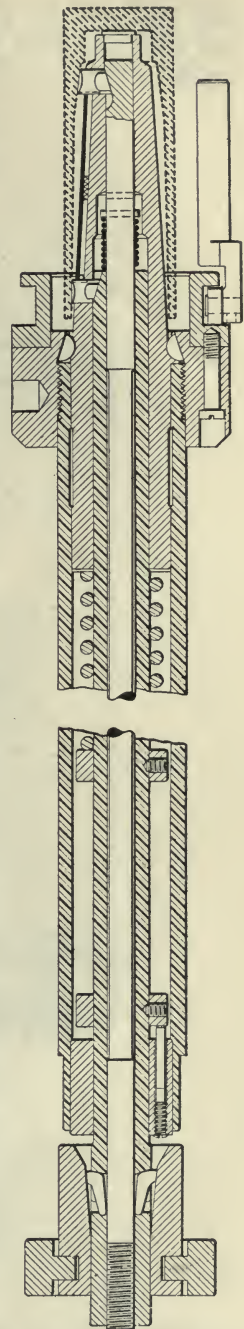

FIG. 179. DETAILS OF THE CENTERING MANDREL

the tool used for this purpose is shown in Fig. 184. It operates when the roller is forced against a wave cam mounted upon the chuck of the machine.

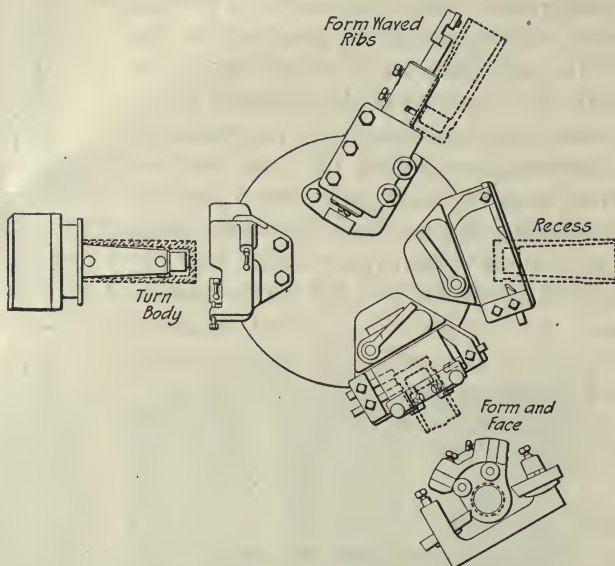

FIG. 180. FIRST FLAT-TURRET OPERATION

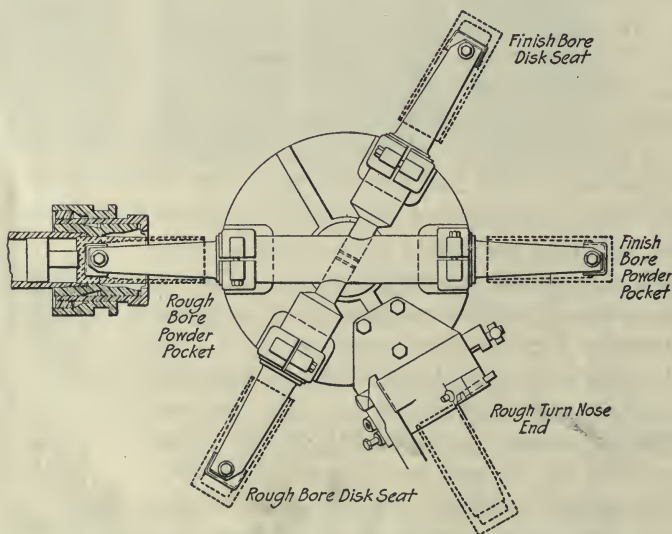

FIG. 181. SECOND FLAT-TURRET OPERATION

The second operation set-up finishes the powder pocket and disk seat, and also turns the outside of the nose-end taper for purposes of bottling.



**Reinforced Boring Bars.**—The construction of the boring bars is rather unique and is illustrated in Fig. 185. It will be noticed that a solid bar extends clear across the turret through two tool holders, thus

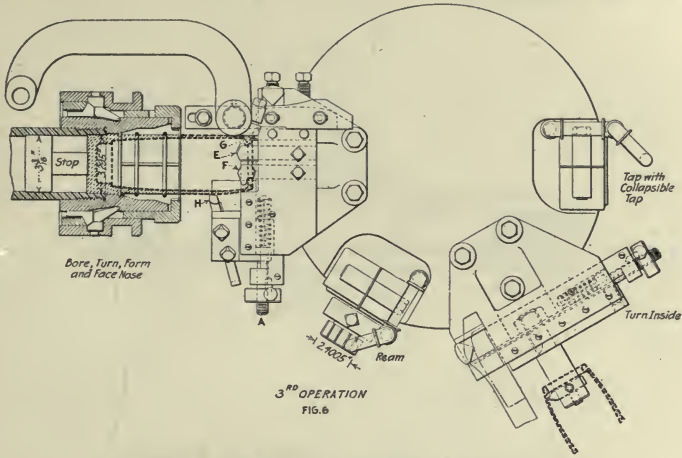

FIG. 182. THIRD FLAT-TURRET OPERATION

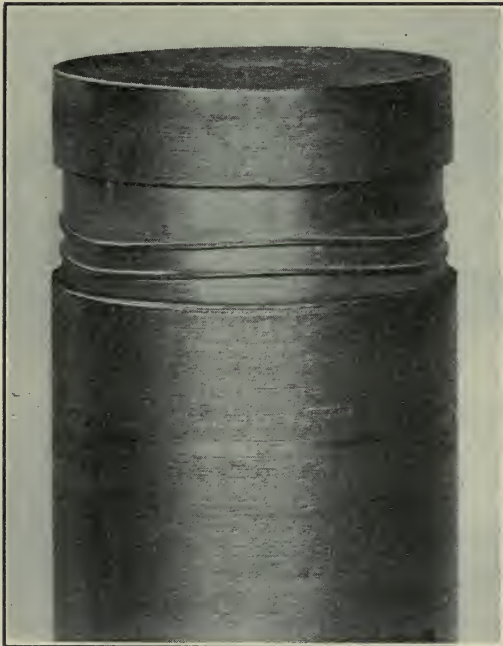

FIG. 183. THE WAVE

giving an extremely strong construction as compared with the ordinary single support. The other two bars obtain a similar support by being mortised into the large bar at their shank ends.

One of the short bars used for this purpose is shown at *A*, Fig. 186, and at *B* and *C* finishing cutters for the powder pocket and disk seat are shown. The roughing cutters are quite similar, except that they are gashed for chip clearance.

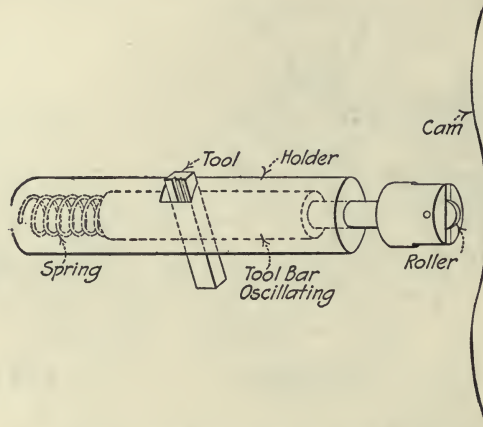

FIG. 184. THE WAVING TOOL AND HOLDER

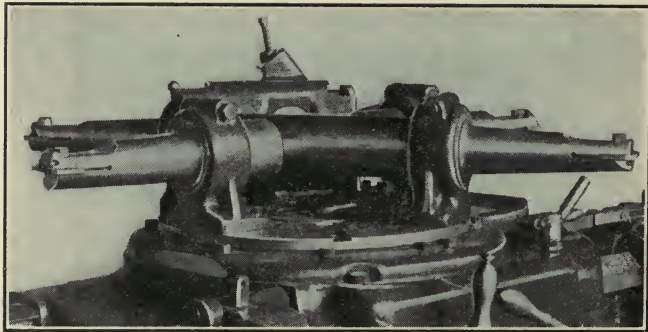

FIG. 185. THE REINFORCED BORING BAR

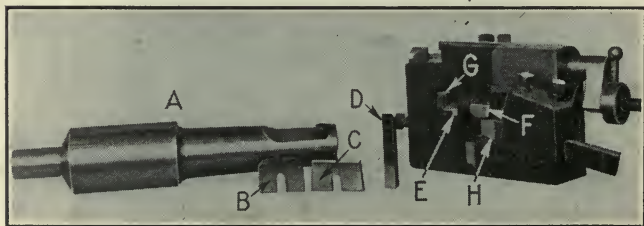

FIG. 186. SOME INTERESTING TOOLS

The third operation on the flat turrets, while appearing to be rather complicated, works out well, the curved form of the outside being cared for by a modification of the usual flat-turret taper-turning device.

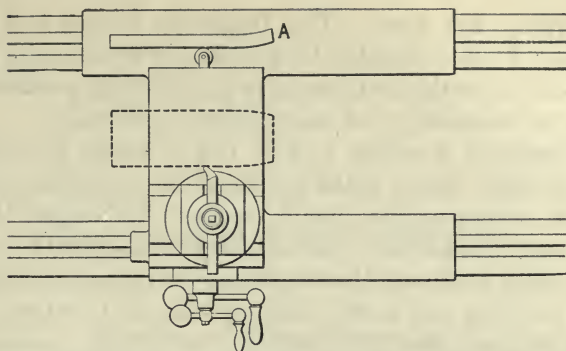

FIG. 187. ARRANGEMENT FOR FINISH-TURNING THE CASE ON AN ENGINE LATHE

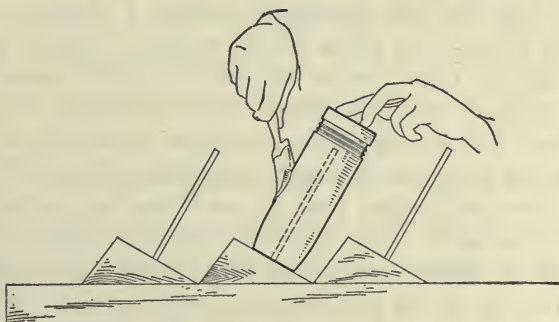

FIG. 188. THE PAINTING BENCH

PRODUCTION BOARD			
DOMINION BRIDGE CO		LACHINE, QUEBEC.	
RECORD OF BEST RUN		FEB. 23 <sup>RD</sup> , 1915	
OPERATION	PIECES	HOURS	PRODUCTION RATE PER HOUR
But off & face (1 Operator)	145	11½	12.6 ✓
" " " (2 Operators)	209	21	9.95 ✓
Outside Turn (J & L #1)	59	10½	5.62 ✓
Inside Bore (J & L #2)	140	11½	12.2 ✓
Cutting Fin	88	2	44 ✓
Mark	483	10½	46 ✓
Hander	272	11	24.7 ✓
Sledge Nose	962	21½	44.7 ✓
Turn Nose (J & L #3)	140	11½	12.2 ✓
Finish Turn	101	10½	9.6 ✓
Press Band	430	14½	29.6 ✓
Turn Band	225	10½	21.4 ✓
Assemble	402	57½	7 ✓
Turn Socket	211	11½	18.4 ✓
Paint	335	18	18.6 ✓

FIG. 189. DIAGRAM OF THE PRODUCTION BOARD

**Finish-turning the Case.**—The Dominion Bridge Co. finishes the body and nose of the shell either by grinding or in an engine lathe. The latter method is of particular interest as an ingenious attachment enables the work to be accurately and expeditiously performed.

The arrangement is shown in Fig. 187 in which the template *A* is made with the exact shape of the profile of the projectile and a roller on the cross-slide is kept against this by means of a weight, the cross-feed screw being disconnected and tool adjustment made with the compound rest. After being annealed, the shells may be turned at a speed of from 40 to 50 ft. per min. and a feed ranging from 40 to 60 per inch.

**A Simple Painting Bench.**—A simple and effective painting bench is used for holding the shells while applying the priming and finishing coats. It is shown in Fig. 188 and consists of a number of inclined spindles of such size that the powder tubes of the assembled shells will slip over them. The painter then rotates the shell upon the spindle with one hand while applying the paint brush with the other.

**Production.**—The average time consumed in turning out one completed shell at the Dominion Bridge Co., including the handling time and one or two minor operations, such as sand blasting, annealing, etc., is very little over one hour. The piecework system of payment is practised and production is further stimulated by a large "Production Board" upon which records of the best runs are posted daily. A fac-simile of one day's record is shown in Fig. 189. In the right-hand column, the production rate is recorded and the betterment of this record is enthusiastically aimed at.

SECTION II  
HIGH-EXPLOSIVE SHELLS

By  
E. A. SUVERKROP

	PAGE
CHAPTER I. WHAT A HIGH-EXPLOSIVE SHELL IS AND DOES .....	231
CHAPTER II. FORGING BLANKS FOR 4.5-IN. HIGH-EXPLOSIVE SHELLS.....	236
CHAPTER III. MANUFACTURING BRITISH 18-POUNDER HIGH-EXPLOSIVE SHELLS.....	251
CHAPTER IV. MANUFACTURING BRITISH 4.5-IN. HIGH-EXPLOSIVE SHELLS.	312
CHAPTER V. MANUFACTURING BRITISH 8-IN. HIGH-EXPLOSIVE SHELLS..	366
CHAPTER VI. OPERATIONS ON BRITISH 9.2-IN. HIGH-EXPLOSIVE SHELLS..	389
CHAPTER VII. OPERATIONS ON THE BRITISH 12-IN. MARK IV HOWITZER SHELL.....	399
CHAPTER VIII. MANUFACTURING RUSSIAN 1-LB. HIGH-EXPLOSIVE SHELLS.	412
CHAPTER IX. MANUFACTURING RUSSIAN 3-IN. HIGH-EXPLOSIVE SHELLS.	442
CHAPTER X. MANUFACTURING SERBIAN 120-MILLIMETER SHELLS .....	460
CHAPTER XI. MANUFACTURING FRENCH 120-MILLIMETER EXPLOSIVE SHELLS.....	494



## CHAPTER I

### WHAT A HIGH-EXPLOSIVE SHELL IS AND DOES<sup>1</sup>—EXPLOSIVES USED WITH HIGH-EXPLOSIVE SHELLS<sup>1</sup>—STEEL FOR HIGH-EXPLOSIVE SHELLS

The modern high-explosive shell is an elongated hollow projectile which is filled with some kind of high explosive, called a bursting charge, which is fired by a fuse provided in the nose of the projectile.

**Materials of Construction and Shape.**—In order to get the rotating motion necessary for precision the projectile is provided with a soft copper band near its base. This band has a diameter of from  $\frac{1}{10}$  to  $\frac{3}{10}$  of an inch greater than the caliber of the projectile and the force of the explosion forces the band to conform to the lands and grooves of

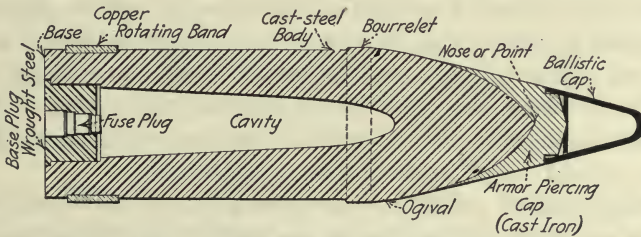

FIG. 190. SECTION OF ARMOR-PIERCING SHELL

the rifling in the bore of the cannon. This not only assures proper rotation, but the soft band is thus made to fill the entire cross-section of the bore and therefore to act as a gas check to prevent the powder gases from escaping around and in front of the projectile.

These copper rotating bands are forced into an undercut groove, cut around the projectile near the base. The band of copper is hammered in and the ends of the band beveled and scarf jointed or in the smaller calibers the band is cut from copper tubing and is forced into the groove by hydraulic pressure. Longitudinal or irregular cross grooves are made in the seat for the rotating band to prevent its rotation separately from the projectile. The outer surface of the rotating band is smooth for small calibers and is grooved for the larger calibers, to diminish the resistance of forcing the rotating band into the grooves of the rifling, as well as to provide space for the metal forced aside by the bands.

All shells have the same general shape, consisting of a cylindrical body with a pointed or ogival head, which shape for the head has been

<sup>1</sup> First Lieutenant Percy E. Barbour, 22nd Regiment, New York Engineers, N.G. U.S.

found by experience to be most advantageous in decreasing the wind resistance of the projectile in its flight and in increasing its penetration when it is fired against armor. The length of the projectile varies from  $2\frac{1}{2}$  to 5 times the caliber of the gun.

The projectile does not have the same diameter as the caliber of the gun. The bourrelet, see Fig. 190, which is just behind the ogival head, has a diameter of about 0.01 in. less than the bore of the gun. The rotating band, as has been described, has a diameter greater than the bore of the gun until the force of explosion reduces it to take the lands and grooves.

Between the bourrelet and the rotating band the diameter of the projectile is about 0.07 in. less in diameter than the bore of the gun. This is to facilitate and cheapen the cost of manufacture, and to prevent any greater bearing of the projectile in the bore than is absolutely necessary for accuracy of fire.

**Fuse and Charge**—For field work the shells are manufactured to take a nose fuse, which may be a time fuse or a percussion fuse or a combination of the two. In the first instance the fuse will explode after the lapse of the desired number of seconds. A percussion fuse is one which will explode only when the projectile meets with sufficient resistance, which of course is the case when fired at material objects. The combination fuse is a combination of the two methods and insures the explosion of the shell when it falls, even should the time device fail.

The high-explosive shell carries from about 3 per cent. to 30 per cent. of its weight in high explosive, the amount depending upon the use for which the shell is destined. A smaller percentage is used when the shell is to be fired at men than when the purpose is to demolish a structure or destroy opposing artillery.

The most common size for use with infantry is the 3-in. shell. There is a logical reason for fixing upon this size. Experience has shown that, under average conditions, a horse cannot pull more than 650 lb. and be as mobile as the rapidly moving troop column. Six horses are provided for a 3-in. battery and the limit of weight within the required degree of mobility is therefore 3,900 lb. This is just about the weight of the 3-in. field gun, together with the carriage, limber, equipment and a reasonable amount of ammunition.

Artillery of position, consisting of guns permanently mounted in fortifications, use high-explosive shells of very much greater caliber and much different character. The projectiles are designed for use against armor plate, and range up to 16 in. in diameter.

In seacoast projectiles the detonating fuse is invariably placed in the base of the projectile instead of in the nose, as in the case of mobile artillery. Time fuses are never used with this type of projectile. There are three types of seacoast projectiles, viz.: Armor-piercing shot, armor-



piercing shell and deck-piercing shell. The first is intended to perforate the armor and to be exploded in the interior of the ship by a comparatively small bursting charge. The armor-piercing shell is not expected to affect complete perforation of the armor, but is expected to make some penetration and continue destruction by exploding against the partially ruptured plate. The deck-piercing shell is fired from high-angle-fire guns, has a nearly vertical fall and is intended to pierce the lightly protected decks of vessels.

Unlike the high-explosive shells of mobile artillery, the coast-artillery shells do not have the same sharp point or nose. They are equipped with a cast-iron cap, see Fig. 190, which increases the penetration of the projectile when it strikes the armor. The function of this cap is to prevent the deformation of the point of the projectile at the instant of contact with the armor plate. The advantage of this cast-iron cap is so great that an 8-in. capped projectile fired at a 3.5-in. plate effected complete perforation at a specified range, while a similar projectile uncapped, fired from the same range, indented the plate only  $\frac{1}{2}$  to  $1\frac{1}{8}$  in.

The wind resistance due to this blunt cap is very great and the new shells are being equipped with a ballistic cap or wind shield which is attached in front of the cast-iron cap and continues the taper of the ogival head and makes a long-pointed projectile. This so reduces the loss of energy due to wind resistance that in some cases the penetration is doubled.

**Explosives Used with High-explosive Shells.**—Cotton is the basis of the most important propulsive explosive used in modern warfare, viz., smokeless powder, which is also called nitro-cellulose, the principal ingredients of which consist of cotton or cellulose, nitric acid, sulphuric acid, ether and alcohol. The manufacture of this explosive is complicated only from a mechanical standpoint. There are no chemical mysteries about it.

Smokeless powder in the chamber of a gun is not intended to be detonated, but to be exploded by a progressive combustion, the result of which is determined by the characteristics of the gun or the service expected of it. The rate of the combustion depends upon the amount of surface exposed, hence the perforations in the powder grain which give this added surface.

**Cellulose the Basis of Smokeless Powder.**—Nitro-cellulose is a general term applied to products resulting from the action of nitric acid on cellulose, in which the organic cellular structure of the original cotton fiber has not been destroyed. Guncotton is a nitro-cellulose of high nitration, consisting of a mixture of insoluble nitro-cellulose with a small quantity of soluble nitro-cellulose, and a very small quantity of unnitrated cellulose. The chemical name for guncotton is tri-nitro-cellulose, and the formula is  $C_{12}H_{14}O_4(NO_3)_6$ .

In the manufacture of nitro-cellulose, by varying the strength and the proportions of the nitric and sulphuric acids, their temperature and the length of time that the cotton is in them, a number of different products are obtained varying in the rate at which they will burn and the effects produced, and in the degree to which they are soluble in various solvents. This gives many different grades of explosives to which various names are applied at the will of the manufacturer and which are capable of a wide latitude of adaptability to different requirements.

Cordite is a British smokeless powder consisting of 37 parts of guncotton, 58 parts nitroglycerin and 5 parts vaseline. This powder gives a very high muzzle velocity with a low pressure in the powder chamber, but the temperature of its explosion is so high that it causes a rapid erosion of the bore of the gun. Therefore, another form of this powder, known as Cordite M. B., in which the ratio of the guncotton and nitroglycerin are reversed, has been made, which overcomes these disadvantages. This illustrates the possibilities of different combinations of the same materials to effect different purposes.

**Benzol, Toluol and Trotol.**—Benzol is a coal-tar distillation product comprising a mixture of benzene with variable quantities of toluene and other homologues of the same series which are obtained commercially by distillation of coal-tar products, principally as a byproduct from coke ovens. The product known as "crude benzol" is further fractionally distilled, and by this means separated into pure benzene, toluene and other true chemical compounds. Benzene is  $C_6H_6$  and toluene is  $C_7H_8$ . A 90 per cent. benzol is a product of which 90 per cent. by volume distills before the temperature rises about 100 deg. C. The composition of a 90 per cent. benzol is about 70 benzene, 24 toluene, and 4 to 6 of lighter hydrocarbons. Toluol is an impure form of toluene, so alike that the difference is only detected by a slight discoloration on the addition of sulphuric acid.

Toluene possesses the property of rendering oxygen very active and when treated with nitric and sulphuric acid and heated for several days, yields tri-nitro-toluene, an explosive of a high order which is superseding the use of picric acid as a base for shell fillers for artillery use.

**Picric-acid Shell Fillers.**—Benzene, a redistillation product from benzol, is used in the manufacture of carboic acid or phenol; this in turn is the basis of picric acid, which latter is the base of most of the high explosives used at the present time. When phenol (carboic acid) is treated with nitric acid, a nitrate called tri-nitro-phenol is formed. Its only use is as an explosive. It is not only an explosive in itself but more particularly is used as an ingredient of special explosive mixtures. Most of the new so-called shell-filler explosives are either picric acid or mixtures of picric acid salts called picrates. Among these are ecrasite (Austrian), lyddite (English), melinite (French), shimose (Japanese), etc. The

exact compositions of these are secrets carefully guarded by the different governments.

Picric acid, although a powerful explosive, forms in connection with lead, iron and some other metals very sensitive and dangerous compounds. This is true to such an extent that it is dangerous to paint the interior of a shell—which is to be loaded with a picric-acid derivative—with a paint which has either red or white lead in it, and it is also dangerous to use red or white lead in screwing in a base plug. Trolol does not have this disadvantage.

Both picric acid and trolol are safe to handle and are loaded into the shells either by hand, in which case they are tamped in solidly with wooden rammers and mallets, or they are compressed into the shell cavity by machinery.

Owing to their relative insensitiveness, a very strong detonator is required in the shell to cause their explosion which, unlike the slower explosion due to the inflammation of propulsive powders, is desired to be as instantaneous as possible to produce the greatest shattering and destructive effect.

#### STEEL FOR HIGH-EXPLOSIVE SHELLS

The steel for high-explosive shells can be produced either by the "acid-openhearth" or the "stock-converter" process. When produced by the stock-converter process, nonphosphoric pig iron must be used. The steel must be of the best quality, homogeneous, free from flaws, seams and piping. Apart from the iron the following chemical elements may occur in the percentages given in the table herewith:

	Minimum Per Cent.	Maximum Per Cent.
Carbon.....	....	0.55
Nickel.....	....	0.50
Silicon.....	....	0.30
Manganese.....	0.40	1.00
Sulphur.....	....	0.04
Phosphorus.....	....	0.04
Copper.....	....	0.10

## CHAPTER II

### CASTING STEEL FORGING BLANKS FOR 4.5-IN. EXPLOSIVE SHELLS<sup>1</sup>—FORGING THE BLANKS FOR 4.5-IN. HIGH-EXPLOSIVE SHELLS<sup>1</sup>—FORGING BASE-PLATES FOR HIGH-EXPLOSIVE SHELLS<sup>1</sup>

The bodies of high-explosive shells larger than 3.3-in. in diameter are customarily made from forged blanks, while shells 3.3-in. in diameter and smaller can be most economically made from bar stock. Before taking up the actual processes of manufacture of high-explosive shells, therefore, it is advisable to consider the making of the blanks for the larger shells, so that the subsequent chapters devoted to the manufacture of specific shells may be limited to a description of the machining operations on the blanks or stock as received at the machine shop.

The Canadian Steel Foundries, Ltd., at their plant at Longue Pointe, Montreal, Canada, casts ingots for 4,000 British 4.5-in. howitzer shells every 24 hours, and the methods employed in this foundry, as well as the forging operations conducted at the Dominion works of the Canadian Car & Foundry Co., Ltd., to which the forging blanks are delivered, typifies highly efficient and economical practice.

The ingots are cast in metal molds, procedure which, to the man familiar with iron-foundry practice, would be expected to chill the steel and to make necessary a long annealing operation to render the metal machinable.

As a matter of fact there is no chilling effect—that is to say, no hardening due to casting in metal molds, although there is a chilling effect in the sense that there is a shortening of the cooling time. No annealing is necessary however, the ingots, as soon as possible after casting, being knocked out of the molds and sent to the machine shop.

The government requirements for this steel are the same as those for the bar steel used for the production of the forgings for the 15- and 18-lb. shrapnel. It must have a yield point of at least 19 long tons; tensile strength between 35 and 49 long tons and elongation of 20 per cent. The carbon must be between 0.45 and 0.55 per cent.; nickel under 0.50; manganese between 0.4 and 1.0; sulphur and phosphorus under 0.05.

**The Mixture.**—A steel fulfilling these demands is obtained from the following mixture:

About 20 per cent. Chautauqua or similar low-phosphorus pig iron,

<sup>1</sup> E. A. Suverkrop, Associate Editor, *American Machinist*.

40 per cent. openhearth scrap steel and the balance low-phosphorus heavy-melting scrap steel. The steel is produced in two 30-ton furnaces by the acid openhearth process. These are fired with ordinary fuel oil at a pressure of 80 lb. per sq. in. and air at 100 lb. per sq. in.

The consumption of oil is very low, amounting to 33 or 34 gal. per ton of melt. The time necessary to melt a charge is about 5 hours.

**The Ladle.**—The entire charge of 25 tons of steel is run from the furnace into the 40-ton bottom-pouring ladle, which is made of heavy boiler plate lined with firebrick. The plug which stops the hole in the bottom of the ladle is made of graphite, conical in shape with the end entering the hole somewhat rounded. These graphite plugs will stand up for about 300 openings and closings before erosion makes them useless as stoppers.

**The Molds and Rotary Tables.**—To avoid moving the traveling crane supporting the heavy ladle, the ladle is brought to a convenient position and held stationary while the molds, mounted on a circular rack table, are rotated under the ladle by the manipulation of a hand wheel operating the turning mechanism. (See Fig. 191.)

The molds are 33 in. long with a  $4\frac{5}{16}$ -in. hole. The wall is  $1\frac{1}{8}$  in. thick; the trunnions rectangular, 3 in. square, with a 2-in. square opening in them and projecting 2 in. from the side of the mold.

The runner cups rest on the mold and are  $9\frac{1}{2}$  in. diameter at the bottom, tapering to  $8\frac{1}{2}$  in. at the top. They are 4 in. deep, and the pouring hole is 6 in. diameter at the top, tapering to 3 in. on the end next the mold.

The circular tables, of which there are four, are 16 ft. 8 in. inside diameter and 18 ft. 4 in. outside diameter. Fifty machined rectangular surfaces provide accommodation for 50 molds.

**Pouring.**—The 40-ton ladle is picked up by the crane and suspended over one of the molds in the position shown in Fig. 191. The man at *A* is provided with heavy blue-glass goggles and directs both the men at the turning gear and the valve operator (not shown), who manipulates the opening and closing of the valve in the ladle through the lever *B*. The entire heat is run off in about 55 minutes.

**Losses in Casting.**—Forty per cent. of each ingot (or 13 in. of the long ingots) is cropped off. This part contains the "pipe" due to shrinkage, which measures 2 to 3 in. diameter at the top and tapers to nothing, generally in considerably less than the 13 in. mentioned above. Another cause of loss is seizing in the mold.

The losses due to shrinkage and other defects amount to only about 3 per cent.

**Emptying the Molds.**—When the ingots have set satisfactorily, but while they are still quite hot, the molds are emptied, preparatory for the next heat. The molds are lifted by the crane and usually the ingots

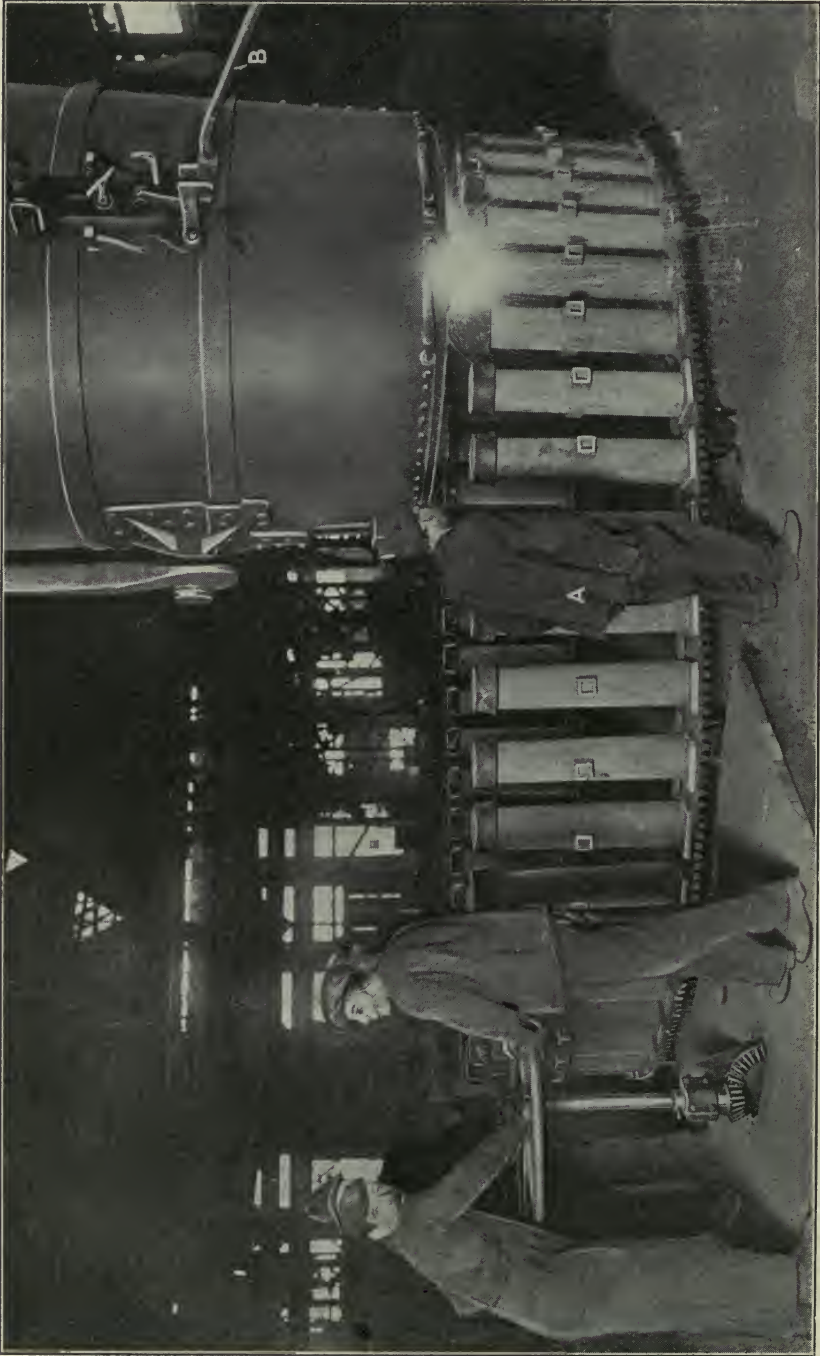

FIG. 191. POURING THE INGOTS

readily slide out. Those that do stick can readily be loosened by striking the mold with one or two blows from a hammer. In cases where the ingots cannot be dislodged by the hammer, they are forced from the molds by the aid of a large Bertram hydraulic press.

**First Inspection.**—While the ingots are still hot, they are loaded into heavy tote boxes and taken to the inspection floor, where they are carefully examined for cracks or other defects which would render them useless.

The heads of the ingots, through the base of which the shrinkage "pipe" passes, are then broken off, leaving the end smooth enough for the reception of a "false center." This consists simply in a centered steel cap which is slipped over the end of the ingot and secured by two setscrews.

**Parting the Blanks.**—The ingots are of such length that two shell blanks are secured from each casting, the blanks being parted in heavy axle lathes.

The government specification for shell blanks produced in this way requires that one-sixth of the cross-sectional area shall be left for breaking, so that the fracture may be inspected. Five heavy lathes on which simple chucks, with a hinged clamping member and swing-bolt, have been mounted on each side of the central driving head are run night and day on the cutting-off job. The parting tools are forged from Firth high-speed steel 1 × 2 in section, and vary from  $\frac{3}{8}$  to  $\frac{1}{2}$  in. wide in the cut. The speed of the work depends on the hardness of the stock, which varies slightly from heat to heat. The depth of cut is approximately 2 in. The feed is by hand and is all that the tool will stand.

**Breaking Out the Blanks.**—After being taken from the parting lathes, the ingots are laid on the floor with one end resting on a 3 × 4-in. piece of timber, and the blanks broken out with the end of a 3-ft. sledge. The rate of production is about 2 sec. for each blank.

**Second Inspection.**—After breaking, the blanks and crop ends are loaded into separate boiler-plate tote boxes. The crop ends are returned to the foundry for remelting and the blanks go to the government inspection tables. Each table is manned by two inspectors and two helpers. It is a piece of 2-in. pine, 12 in. wide and about 6 ft. long, supported on well-braced trestles.

A helper takes a blank from the tote box and lays it on the table. One of the inspectors rolls it along the table, examining it carefully for cracks. It is then inspected on the ends for possible "pipes" and defective fractures; having been inspected, the second inspector at the end of the table stamps it. Two inspectors and two helpers can pass blanks at the rate of about three to four per minute.

**Removing the Buttons.**—The round projection left at the point of fracture is removed by planing, shaping and, if there is not too much metal to remove, by grinding.

In Fig. 192 is shown a Bertram open-side planer working on this job. The heads on the cross-rail serve the double jig *A*, which holds 40 shell blanks, while the side head takes care of the 20 blanks in the single jig *B*.

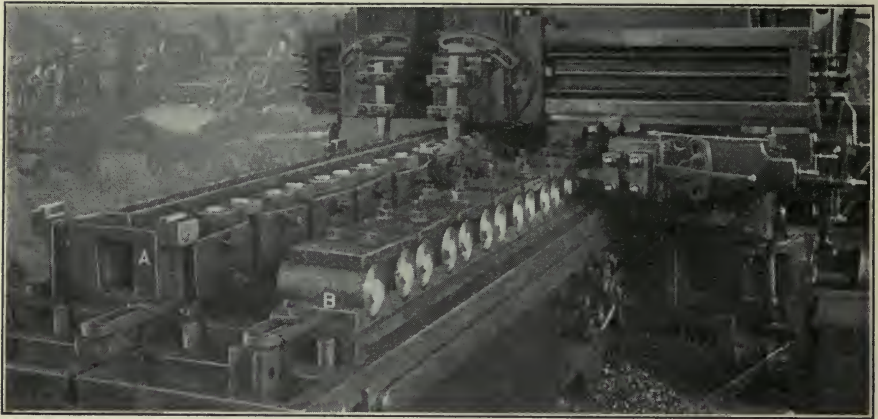

FIG. 192. PLANING THE BUTTONS OFF

Two sets of jigs are used, and while one set is on the planer, the other is being emptied and refilled with blanks. After planing the buttons off one side, the jig *A* is turned over and the jig *B* is turned end for end to

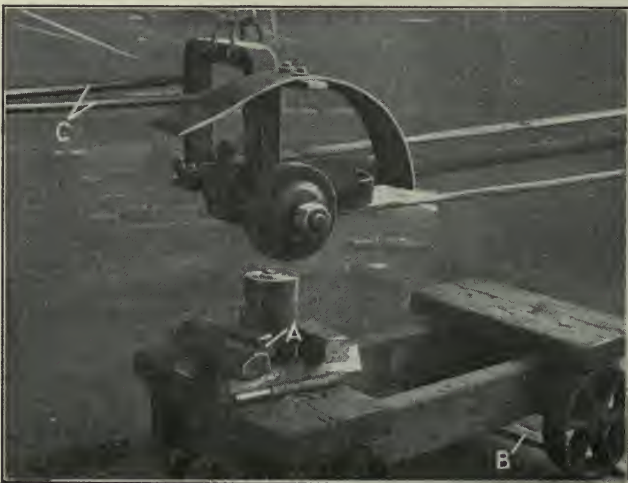

FIG. 193. GRINDING BUTTONS

present the buttons on the other side to the tools. The output for 10 hr. on the planer is 450 shell blanks.

Where the buttons are not too thick, they are removed by grinding on the machines shown in Fig. 193. The shell blank is "chucked"



with the wedge *A*, and the truck rolled in under the abrasive wheel until its wheels are stopped by the bar *B*. The direction of rotation of the wheel keeps the truck against the stop. The operator applies pressure to the wheel by leaning on the two bars *C*. By this method from 150 to 175 ends per man can be ground in 10 hr.

**Analyses and Tests.**—Two sample ingots for analysis are usually taken from each heat. One of these is obtained when about one-third of the heat has been run off, and the other at the end of the run. In case of necessity, a complete analysis can be run through in an hour, but there is generally plenty of time to run the analysis before the ingots are ready to be cut into blanks.

Drillings are taken from the test-block and analyzed for carbon, sulphur, phosphorus and manganese. The carbon content is ascertained

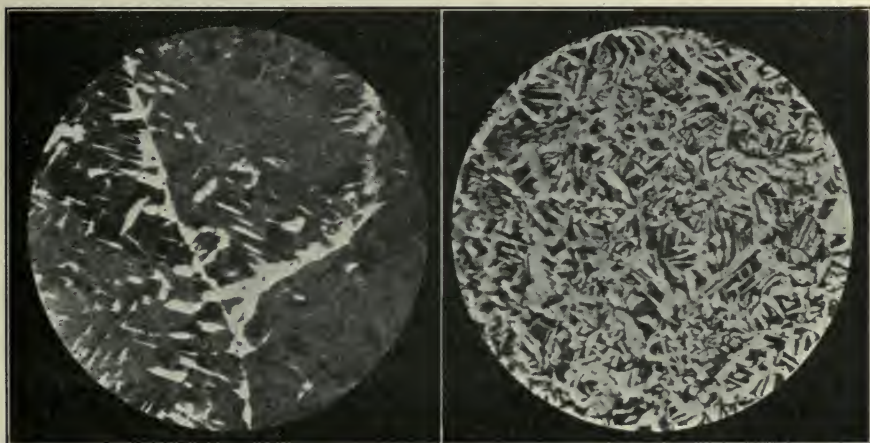

FIG. 194. 42-CARBON STEEL AS CAST

FIG. 195. 42-CARBON FORGED SAMPLE

by the combustion method as the color method gives only an approximation, except when the standard has been given exactly the same treatment as the sample.

In Fig. 194 is shown a reproduction from a photo-micrograph of the metal in an ingot containing 0.42 carbon, 0.28 silicon, 0.72 manganese, 0.032 sulphur, 0.031 phosphate.

In Fig. 195 is shown a sample taken from one of the shell blanks after forging. Forging has brought the yield point up to 19.2 long tons. The tensile strength is 40.7 long tons, just about the same as in the unforged casting. The elongation is 25.7 per cent.

Drillings for analysis are also taken from several blanks from each heat. A  $\frac{3}{4}$ -in. drill is run in  $1\frac{1}{2}$  in. in the cut end, so there will be no scale to influence the analysis.

Chemical and physical tests are made of each heat, both by the works

chemist and by the government. Records are kept of each and every melt. The metal, as cast, must also withstand a compression test.

The test piece is in the shape of a cylinder the height of which is equal to the diameter. This cylinder must stand compression to one-half the height without showing cracks.

In the table, Fig. 196, are shown analyses and physical properties of four heats, running from 0.38 to 0.42 per cent. carbon. The physical tests were made from test-bars cut from forged shell blanks and the analyses were found to prove out as described.

FORGING THE BLANKS

As received at the Dominion works of the Canadian Car & Foundry Co., Ltd., the blanks from the Canadian Steel Foundries, Ltd., measure  $4\frac{7}{8}$ -in. in diameter by 9-in. in height. They weigh from 46 to 48 lb. each, the variation being due to slight differences in diameter. A difference of  $\frac{1}{16}$  in. in diameter on a blank of this size causes difference of about one pound in the weight. Center-punch marks on the end of the blank indicate the melt number and also whether it is a test blank which is to be forged. If the latter, it must pass both chemical and physical tests before the rest of the blanks bearing that melt number are shipped from the foundry. All blanks have the melt number stamped with ordinary steel stamps on their sides, but as this would be obliterated by the forging operations, the heavy center-punch marks are necessary. During forging they are distorted, but they appear on the rim after the final forging operation and can be readily deciphered.

**Piercing.**—The first forging operation is piercing and this is done under a Bertram steam hammer with the tools shown in Fig. 197.

The blanks are placed with a scoop 25 or so at a time, in a reverberatory furnace using oil at 30 lb. pressure, with air at 80 lb., for fuel.

Once the furnace is hot, the blanks reach the forging temperature in about 45 minutes. Three men handle the piercing operation—one

HEAT NO.	DESCRIPTION	DIA.	AREA	ELASTIC LIMIT		MAX. STRENGTH		ELONGATION IN. 1/1632"	RED. DIMENSIONS		CHEMICAL ANALYSIS												
				ACTUAL	PER SHM INR	ACTUAL	PER SHM INR		DIA.	AREA	PER CENT	C	P	MN	S	SI	VA						
	4.5. Arrows	4.61		19.2	40.70	25.7							42	0.31	72	0.32	28						
	Shells	"		21.9	41.8	27.6							41	0.36	85	0.32	30						
	"	"		22.3	42.0	26.3							40	0.36	87	0.34	27						

FIG. 196. TABLE OF CHEMICAL ANALYSIS AND PHYSICAL TESTS OF COUPONS FROM FOUR HEATS

furnaceman, a hammerman and a blacksmith. When the blanks have reached a full yellow heat, the furnaceman takes a long iron hook and tumbles one out on the floor in front of the furnace. He then seizes it with a pair of pick-up tongs and drops it into the die, the hole in which is large enough to let it drop clear to the anvil face. He next takes the punch guide and places it over the blank. The smith, in the meantime, has taken the punch in a pair of pick-ups and entered it in the hole in the guide punch. The hammerman, guided by a nod from the smith,

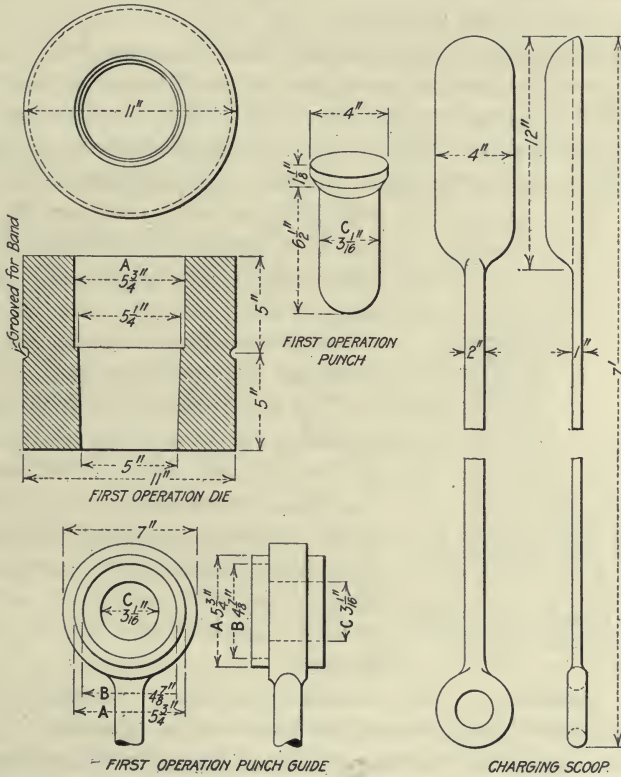

FIG. 197. DETAILS OF FIRST OPERATION PUNCH AND DIE AND CHARGING SCOOP

makes two or three strokes with the hammer. With the hammer in raised position the smith quickly removes the punch and plunges it for an instant in water. As the hole now started is capable of acting as a guide for the punch, the guide is removed by the furnaceman and dropped in a tub of water. Just before the smith replaces the punch in the hole in the work, the hammerman throws a pinch of soft-coal dust in ahead of it. Again guided by a nod from the smith, the hammerman strikes four or five blows. The gas generated from the coal dust, blowing out around the punch, prevents it sticking in the work. The punch

is again removed and dropped in water. The furnaceman now presses down on the long die handle and the die and work are lifted clear of the anvil. While thus raised the hammerman places a steel disk about 4 in. diameter and 1 in. thick under the work in the die, which is then lowered so that the work within it rests on the steel disk. A single stroke of the hammer on the die top drives the die down past the work, and the disk forces the work into the large part of the tapered hole in the die. The furnaceman now turns the die over with the handles, the finished first-operation blank drops out of the die and is picked up by the smith and thrown into an iron tote box.

The entire operation of piercing the blank consumes but about 1 min.

The die is a steel casting machined to the dimensions shown in Fig. 197 and will stand up for about two days before it has to be re-dressed inside. Re-dressing becomes necessary because of upsetting and getting smaller, not, as one would expect, because it gets larger. The punches,

Fig. 197, are made of about 80-point carbon steel, and last from four to five days. They usually fail because of heavy checking on the extreme end. In Fig. 197 reference letters are used to indicate dimensions that are correlated.

The work after the first operation is conical, measuring about  $5\frac{1}{4}$  in. diameter at the top and 5 in. at the bottom. In length it is about 9 in., the same as the ingot blank, from which it was forged. The pierced hole is 3 in. diameter and about 4 in., more or less, in depth. The average output for a 24-hr. day is 500 pieces.

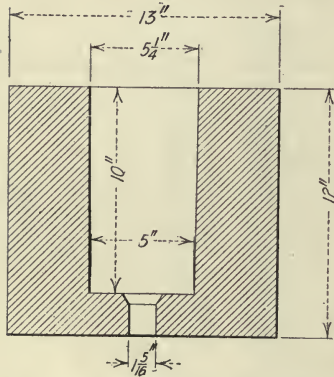

FIG. 198. SECTION OF SECOND-OPERATION DIE

**Second Operation.**—The second operation is in reality a further piercing operation to which is added the effect of squirting. The metal displaced by the punch, following the line of least resistance, flows upward between the punch and die.

This operation is done on the 500-ton R. D. Wood flanging press. The upper part of this press, carrying the punch, is stationary, while the base, carrying the die holder, moves. The die holder is a heavy iron casting with accommodation for two sets of dies. The die is a steel casting made by the same concern that casts the blanks. It is machined as shown in Fig. 198. In the bottom is a countersunk hole to accommodate a  $1\frac{1}{4}$ -in. rivet that acts as a knock-out.

The work for the second operation is heated in a furnace similar to that used for the first operation. It is, however, provided with an inclined chute down which the hot blanks roll as they are pulled from the

furnace. The lower end of the chute is within easy reaching distance for the pressman. The operation is as follows: The furnaceman pulls a hot blank from the furnace with a long hook. A helper, grasping it with a pair of pick-ups, places it upright on a block of iron. After scraping the scale off, the helper picks it up again and drops it in the die, which is about an inch deeper than the length of the first-operation work. He then opens the valve and the ram ascends. Just before the work reaches the punch, the smith in charge of the second operation throws a pinch of soft-coal dust in ahead of the punch. The work coming upward, strikes the punch and is pierced by it. Just before the completion of the stroke the excess of metal in the blank squirts upward about 3 in. around the punch. The gas generated from the coal dust bursts out in a jet of flame all around the punch and keeps it from sticking. The stroke of the plunger is positively controlled by the two piles of parallel blocks coming in contact with the upper platen of the press. The ram is reversed, and the die and work recede from the punch. When near the end of the downward travel of the ram, chains raise a bar, which strikes the knock-out in the die and causes it to lift the work and loosen it in the die. It is then readily removed with a pair of pick-ups and laid to one side. The stroke of the second-operation press is 20 in. This operation takes a little longer than the first, but an output of 500 pieces in 24 hours can be maintained.

These dies also are made from steel castings and have an average life of about 1,000 pieces. The punches, Fig. 199, are made of the same steel as those for the first operation, and will stand up for about 500 pieces. They are secured in the upper platen by means of a nut passing over the body of the punch and clamping the flange of its seat in the upper platen.

The work comes from the second operation, conical in shape, about  $5\frac{1}{4}$  in. diameter at the top, 5 in. diameter at the bottom and about  $11\frac{3}{4}$  in. high. The hole is tapered, 3 in. at the bottom  $3\frac{1}{8}$  in. at the top. The base of the work at the completion of the second operation is  $1\frac{1}{2}$  in. thick.

**Third Operation.**—The third and last operation, the final drawing of the shell, is performed on an R. D. Wood 500-ton press similar in every particular to that used for the second operation. Owing to the length of the punch and work the stroke of the press is increased to 30 in. for this operation.

The punch is mounted in the upper platen, as in the previous operation. The die holder is bored centrally to receive two dies placed tandem, one above the other. The bored die seat communicates with the cored

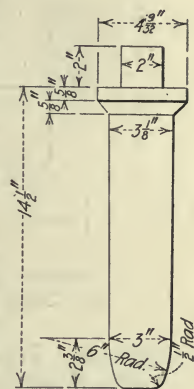

FIG. 199. SECOND-OPERATION PUNCH

recess in the die holder, which is for the insertion of a forked stripper, and the removal of the completed work.

Heating of the completed second-operation blanks for the final drawing is accomplished in a furnace similar to those used for the first and second operations. The hot blank, on being taken from the furnace, is first scraped to remove the outside scale. It is then placed mouth-up

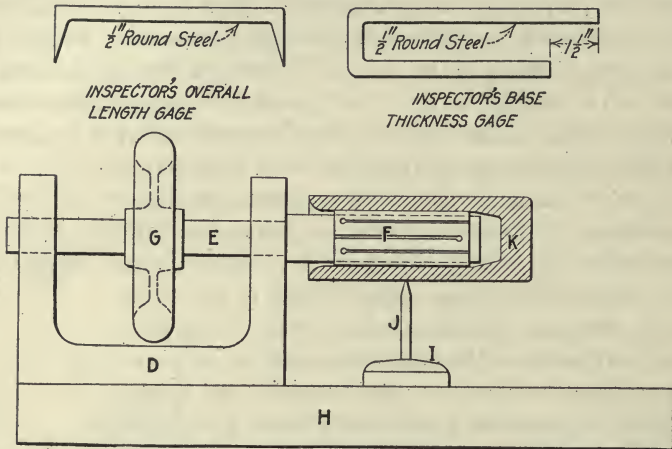

FIG. 200. FIXTURE FOR TESTING AMOUNT OF METAL FOR TURNING

in the die. The valve being opened, the ram ascends. Just before the punch enters the work, the smith throws the usual pinch of soft coal into the hole. At the completion of the stroke the work, still clinging to the punch, is in the recess under the dies. The pressman takes the forked stripper, inserts it above the work, the ram is reversed and the work drops to the lower platen, from which it is taken. The smith then gages it with a forked gage similar to that shown in Fig. 200.

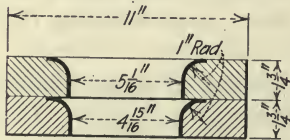

FIG. 201. THIRD-OPERATION DIES

With the forging lying on its side, the shorter leg is inserted till it touches the bottom of the hole. The end of the longer leg should then be flush with the bottom on the outside, the difference in the lengths of the two legs,  $1\frac{1}{2}$  in., indicating the thickness of the base. The forgings are placed in a pile and allowed to cool slowly, so as to leave them in workable condition. The forging, as completed, is  $4\frac{7}{8}$  in. diameter by  $12\frac{3}{4}$  in. long, with a base  $1\frac{1}{2}$  in. thick.

The dies for the third operation, shown in Fig. 201, are cast iron, the drawing faces being cast against a chill. Their life varies from one or two pieces up to as high as 1,000. A fair average would be 500. They generally fail by wearing out, that is, becoming too large, so that they

do not draw the shell long enough. It will be noted by referring to Fig. 201 that the upper die is  $\frac{1}{8}$  in. larger in diameter than the bottom one. When the latter wears too large it is re-dressed by grinding and used as an upper die. The punches, Fig. 202, are made of the same steel as those for the previous operations and average about 500 pieces; in one instance 5,000 were produced with a single punch. They fail principally through bending, which is difficult to offset. Care in centering the blank properly in the dies is of considerable assistance in keeping the punches straight.

**Inspection.**—After the forgings have cooled they are taken to the government inspection tables, which are equipped with the inspection appliances shown in Fig. 200. The forging is first inspected for length with the overall gage. Next, the thickness of the base is tested with the forked gage, which is similar to, but shorter than, the smith's gage. The relation of the hole to the outside and whether the forging will "clean up" are ascertained with the fixture which is shown in Fig. 200.

The head *D* carries a spindle *E*, the nose of which is tapered to receive the expanding sleeve *F*, which fits in the hole in the forging *K*, shown in section. A hand-wheel *G* provides means for rotating the spindle and work. The head *D* is bolted to a flat piece of boiler plate *H*, which is sufficiently accurate for this work. The height gage *I* is provided with a hardened fixed indicator *J*. Inspection consists of sliding the forging *K* on the expanding mandrel *F*. While rotating it with the handwheel *G*, the height gage *I* is slid on the plate *H*, the hardened end of *J* coming in contact with the forging at various points. So long as the height gage will not pass under *K* at any point, the forging will clean up. Should it pass under, the forging is condemned. Having passed inspection, the forgings are loaded on cars and shipped to the machine shop.

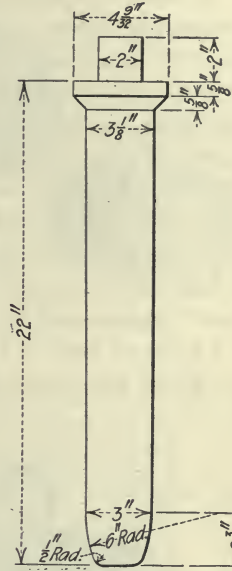

FIG. 202. THIRD-OPERATION PUNCH AND DIES

### BASE-PLATES FOR HIGH-EXPLOSIVE SHELLS

Should a pipe exist in one of the original blanks made from either cast bar-billets or rolled bar-stock it is almost certain to be in the forged blank. With ordinary British shrapnel this is of no consequence, as the explosive charge is contained in a metal receptacle—the cup—and there is no chance of the flame from the propulsive charge communicating with it by way of a pipe.

With the explosive shell conditions are different. The hollow body of the shell itself acts as a container for the explosive charge, and should there be a pipe in the shell base, there is immediate connection between the propulsive and explosive charges. The flame from the propulsive charge traversing such connection would detonate the explosive charge and cause the destruction of the gun and probably of all the men near it.

In order to prevent such possible disaster the high-explosive shell has a bored and threaded recess in the center of the base on the outside, to receive a base-plate forged from flat steel. The grain of the metal in the base-plate therefore runs at right angles to the axis of the shell. The base-plate is accurately machined to fit the threaded hole, is screwed and riveted in place, and finally turned flush with the base of the shell. It thus securely seals any pipe or fissure, should one exist, and prevents premature explosion of the charge contained in the shell.

In the Turcot shops of the Canadian Car & Foundry Co. the blanks for base-plate for 4.5- and 5-in. high-explosive shells are made on an Acme forging machine.

The stock used is 1×3-in. cut in 3-ft. lengths, which weigh about 27 lb. These bars are heated four at a time in an oil-fired furnace.

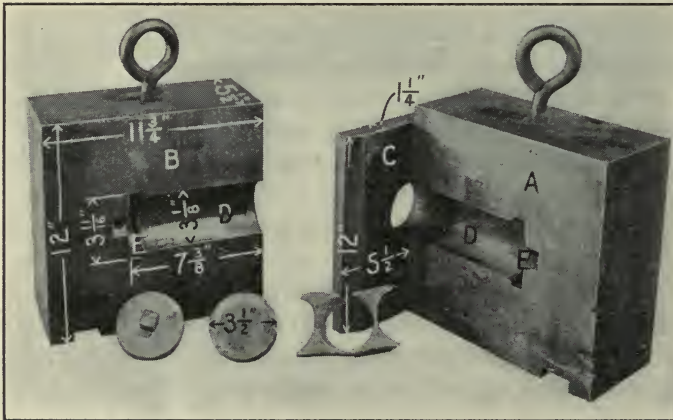

FIG. 203. THE WORK DIES AND SCRAP

**The Forging Operation.**—An enlarged view of the dies, work and scrap appear in Fig. 203. The die A is fixed, while B is mounted in the movable slide. The hot bar is fed down past the blanking die C secured to the face of A. The die B advances until it strikes the face of A, where it dwells till the advancing punch, not shown, blanks a disk through the hole in C, pushes it along the tubular opening D, and squeezes it into the form E at the end of the stroke. On the completion of the stroke the punch and the die B recede and the forged base-plate is removed with a





**Restriking Imperfect Work.**—The work that fails to pass inspection is heated in the furnace *B*, Fig. 208. The operator takes the hot base-plate in a pair of tongs, dips it for an instant in cold water, which causes

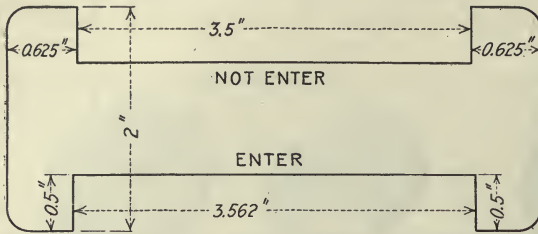

FIG. 207. GAGE USED FOR DIAMETER OF THE FORGING

the scale to break and fall off, and places it with the shank in the square hole in the die *A*. His helper holds the die between the members *C* and *D* with the face of the work toward the moving member *C*. When the machine is tripped *C* strikes the face of work and the rear end of the

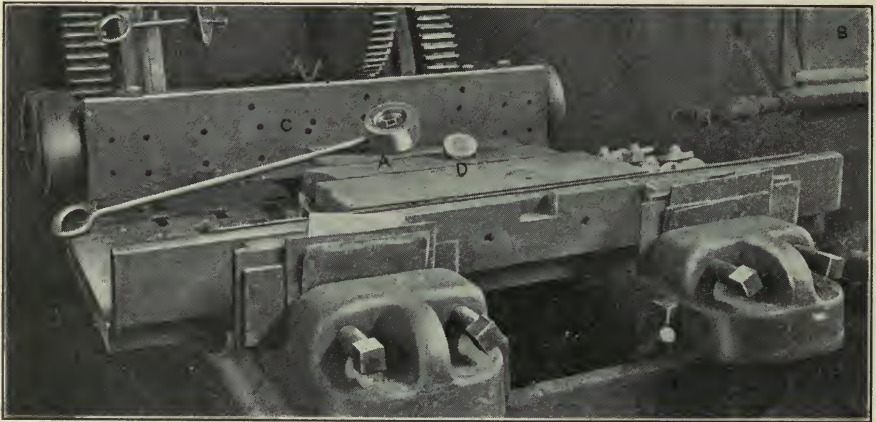

FIG. 208. RESTRIKING DIE AND BULLDOZER

die *A* brings up against the metal blocking *D*. The work comes from the restriking die as shown at *C*, Fig. 204, practically without scale, and as there are no joints or fissures in the die there are no fins to be removed.

## CHAPTER III

### MANUFACTURING BRITISH 18-POUNDER HIGH-EXPLOSIVE SHELLS<sup>1</sup>

The Dominion Bridge Co., Ltd., Montreal, Canada, undertook, in addition to their activities in turning out 18-lb. British shrapnel, to produce 4,000 18-lb. high-explosive shells per day. The newer work was kept entirely separate, for though similar it was by no means identical.

A special shop for housing the equipment required for the manufacture of high-explosive shells (see Table 1) was constructed according to the plan shown in Fig. 209. This arrangement permits the rough blanks to enter the shop at one end (the left) and, with practically no backtracking, to leave in the form of finished and accepted shells at the other.

The rough blanks, as received at the steel shop, measure  $3\frac{1}{2}$  in. in diameter by  $9\frac{3}{4}$  in. in length and possess the following physical and chemical characteristics: tensile strength, 78,400 to 87,360 lb.; yield point, at least 42,500 lb.; elongation, 20 per cent.; carbon content, 0.45 to 0.55 per cent.; nickel, under 0.50; manganese, between 0.4 and 1.0; sulphur and phosphorus, under 0.05 per cent.

In their passage through the shell shop, the blanks are subjected to some 40 main operations—see sequence of operations and descriptive sketches.

#### SEQUENCE OF OPERATIONS

1. Removing burrs from blanks.
2. Rough-drilling blanks.
3. Centering base.
4. Rough-turning body.
5. Rough-turning nose.
6. Facing and squaring base.
7. Facing to length.
8. Boring, reaming, recessing at end of thread and checking outside.
9. Mill-threading shell nose.
10. Finish-turning body.
11. Weighing shells.
12. Facing to correct weight.
13. Turning riveting face angle on base of shell.
14. Rough-turning band groove and rounding edge of base.
15. Undercutting and waving band groove.
16. Recessing bottom of shell for base-plate.
17. Drilling fixing-screw hole.
18. Tapping fixing-screw hole.

<sup>1</sup> E. A. Suverkrop, Associate Editor, *American Machinist*.

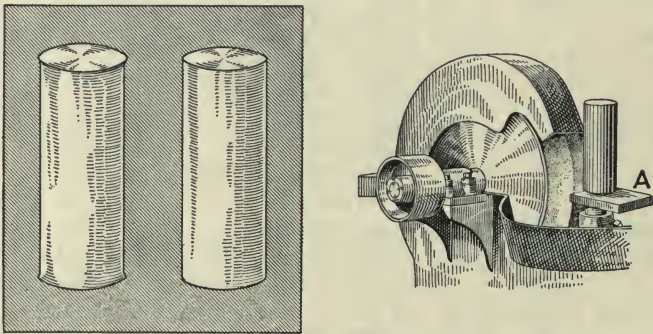

TABLE 1. LAYOUT OF WORK; MAKE AND CAPACITY OF MACHINES

Operation	Number of Machines in Operation	Size and Name of Machine	Capacity per Machine		Total Capacity in Shells
			Per Hr.	Per 22-Hr. Day	
Drill.....	3	2-spindle Bertram.....	12	264	792
		Dom. bridge drills.....	15	345	
Center.....	3	Herbert drills.....	65	1,430	4,290
Rough turn.....	10	24×10 C.M.C. lathes.....	20	440	4,400
Rough nose.....	6	18×8 Mueller.....	23	506	4,554
		24×10 C.M.C.....	23	506	
		18×8 McDougall.....	23	506	
Face base.....	4	20×6 Gardner.....	48	1,056	4,224
Face to length.....	3	20×6 Gardner.....	30	660	1,980
Bore and ream.....	12	3×36 J. & L.....	9	198	4,752
		3×36 Acme.....			
		2×24 J. & L.....			
		2×26 P. & W.....			
Thread nose.....	8	Thread millers.....	25	550	4,400
		18×8 C.M.C.....	20	440	4,400
Finish turn.....	4	18×8 Walcott.....			
		16×6 American.....			
		16×6 Champion.....			
Face to weight.....	6	18×8 Mueller.....	35	770	4,620
		20×6 Gardner.....			
Round corner, groove.....	6	20×6 Gardner.....	35	770	4,620
Wave and undercut.....	9	20×8 Gardner.....	21	462	4,150
Recess base.....	2	2×24 J. & L.....	25	550	4,400
		18×8 Mueller.....			
		20×10 C.M.C.....			
		16×6 Gardner.....			
File base to gage.....	2	16×6 Prentiss.....	35	770	4,620
		16×6 Flather.....			
		16×8 Twink.....			
Mill base thread.....	6	Thread millers.....	36	790	4,740
Drill ¼ hole in nose.....	1	4-spindle drill.....	200	4,400	4,400
Tap ¼ hole.....	3	Herbert drills.....	80	1,760	5,280
Marking.....	2	London air markers.....	125	2,750	5,500
Saw-off square on base-plate.....	6	Racine hacksaws.....	25	550	3,300
Rough face base-plate....	6	20×6 Gardner.....	35	770	4,620
Rivet base-plate.....	2	High speed hammers.....	100	2,200	4,400
Finish face base-plate....	7	20×6 Gardner.....	30	660	4,620
Band press.....	1	6-cylinder Lymburner... }	120	2,640	5,280
		West Tyre Co.....			
Band turn.....	2	20×8 C.M.C.....	50	1,100	4,400
		18×12 L. & S.....			
		Jenckes.....			
Threading base-plates....	8	Automatic (Bridgeport)....	10	220	1,760
Turn base-plates.....	4	16×6 S. Bend.....	75	1,720	4,300

In addition to the lathes there are on shell work, exclusive of the toolroom 1 London 18×12; 1 C.M.C. 20×8; 1 C.M.C. 18×8; 1 J. & L. 2×24; 1 C.M.C. 20×8; 1 Gardner 20×6.

19. Sorting shells by heat numbers.
20. Marking shells.
21. First general shop inspection and hospital work.
22. Drop-forging base-plates.
23. Rough-turning base-plates.
24. Finish-turning base-plates.
25. Filing nicks in edge of base-plates.
26. Assembling base-plate in shell base.
27. Driving-in base-plates.
28. Riveting base-plate.
29. Sawing-off square base-plate stems.
30. Facing base-plate and base.
31. Pressing-on copper band.
32. Turning copper band.
33. Varnishing.
34. Baking varnish.
35. Cleaning-off varnish from outside of shell.
36. Hand-tapping fuse hole.
37. Painting with priming coat.
38. Finish painting.
39. Luting and screwing in plugs and fixing screws and painting plug.
40. Packing and shipping.



OPERATION 1. REMOVE BURRS FROM BLANKS

Machine Used—Dry grinder.

Special Tools and Fixtures—Wide rest A set in line with the wheel center.

Gages—None.

Production—One man and one machine, 300 per hr.

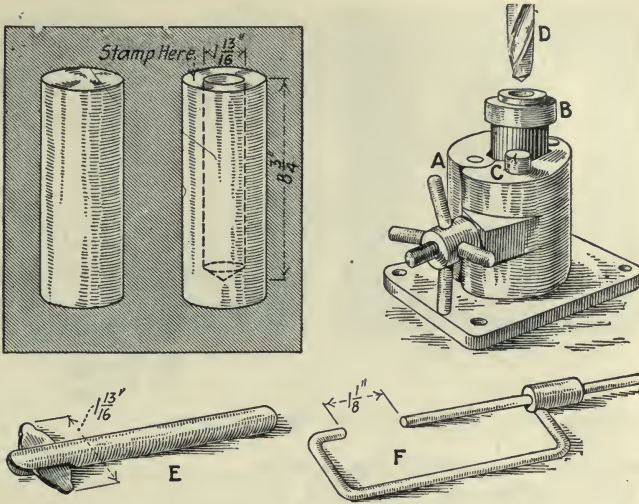

OPERATION 2. ROUGH DRILL

Machines Used—Foote-Burt vertical drilling machines. Dominion Bridge Co.'s air-feed horizontal drilling machines.

Bertram two-spindle horizontal drilling machines.

Special Tools and Fixtures—Chuck like A or vise with R- and L-screw operated jaws for the vertical machines. Centering jig B. Drill setting block C.  $1\frac{3}{16}$  in. twist drill D. For horizontal machines  $1\frac{3}{16}$  in. hogging drill is used.

Gages—Diameter gage E. Base thickness gage F.

Production—One man and 2 vertical machines, 10 per hr. One man and one horizontal machine, 15 per hr.

Note—Drilling compound used as lubricant.

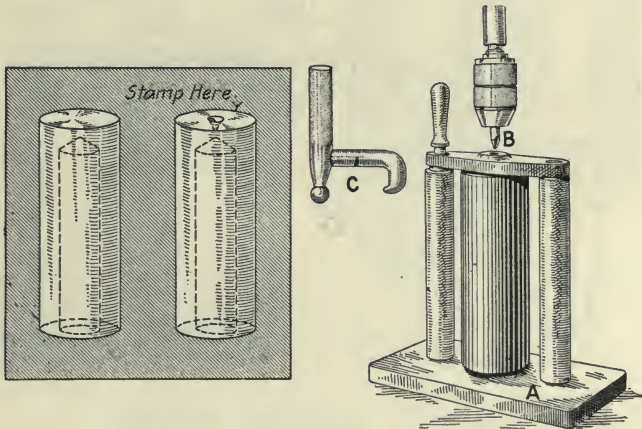

OPERATION 3. CENTER THE BASE END OF THE BLANK

Machines Used—Herbert sensitive drilling machines.

Special Tools and Fixtures—Centering jig A. Combination center drill B.

Gages—Wing caliper gage to test if stock will clean up.

Production—One machine and one boy, 65 per hr.

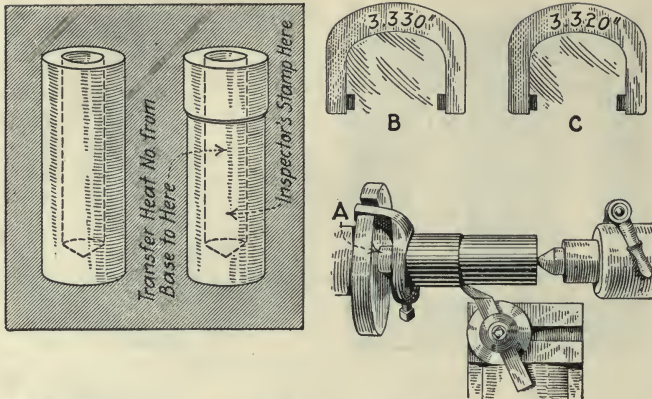

OPERATION 4. ROUGH TURN

Machines Used—18- and 24-in. engine lathes.

Special Tools and Fixtures—Plug center A.

Gages—High and low limit snap gages B and C.

Production—One man and one machine, 20 per hr.

Note—Cutting compound used.

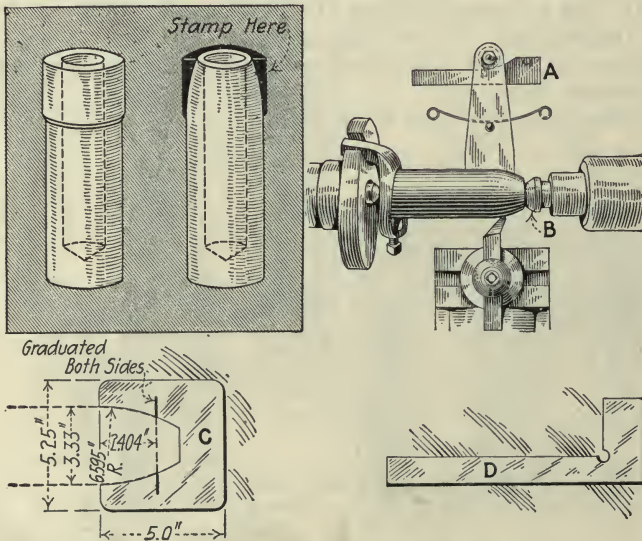

OPERATION 5. ROUGH TURN THE NOSE

Machines Used—18- and 24-in. engine lathes.

Special Tools and Fixtures—Former and roller A. Plug center B.

Gages—Profile gage C. Over-all length gage D.

Production—One machine and one man, 23 per hr.

Note—Cutting compound used.



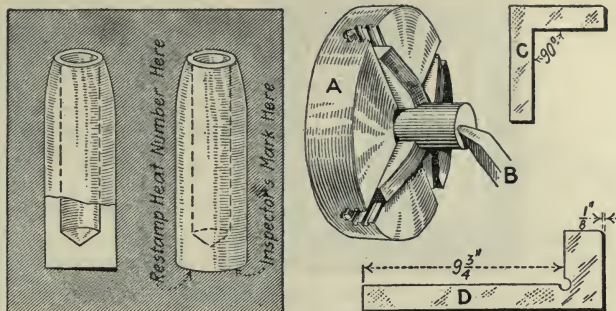

OPERATION 6. FACE THE BASE SQUARE WITH THE BODY

Machines Used—20 in. by 6 ft. engine lathes.

Special Tools and Fixtures—Heavy combination chuck A; roughing tool B.

Gages—Length gage D, square C.

Production—One man and one machine, 48 pieces per hour.

Note—Cutting compound used.

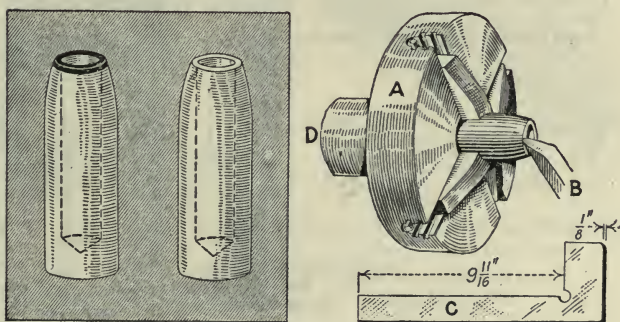

OPERATION 7. FACE TO LENGTH

Machines Used—20 in. by 6 ft. engine lathes.

Special Tools and Fixtures—Heavy combination chuck A; roughing tool B; stop D.

Gage—Length gage C.

Production—One man and one machine, 30 per hour.

Note—Cutting compound used.

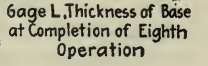
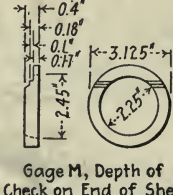
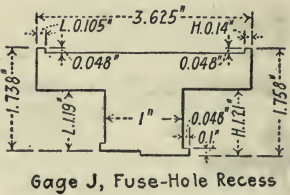
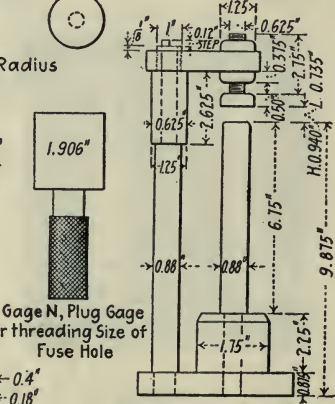
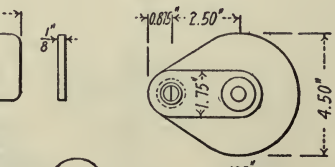
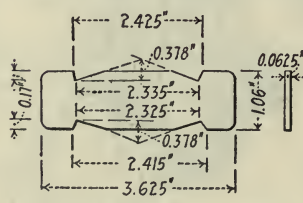
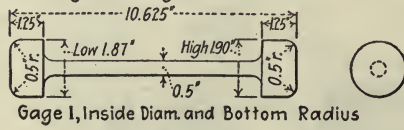
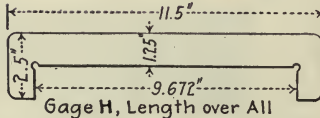
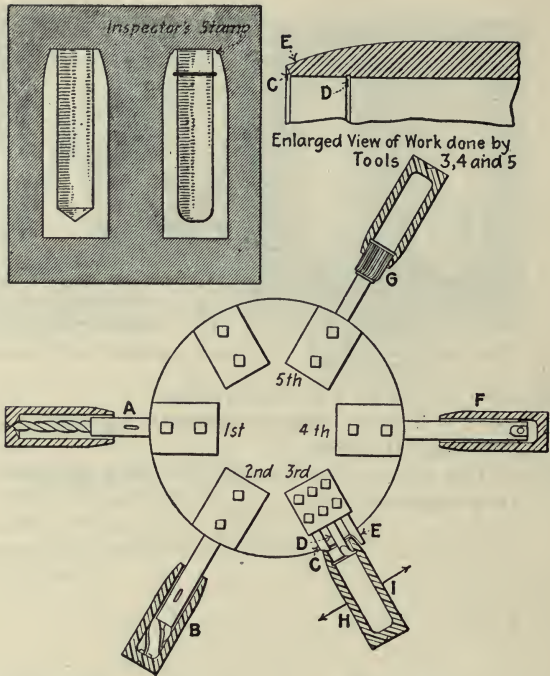

Gage J, Fuse-Hole Recess

Gage M, Depth of Check on End of Shell

Gage N, Plug Gage for threading Size of Fuse Hole

Gage L, Thickness of Base at Completion of Eighth Operation

Gage H, Length over All

Gage I, Inside Diam. and Bottom Radius

Gage K, Diam. and Angle of End of Shell

Gage L, Thickness of Base at Completion of Eighth Operation

## OPERATION 8. BORE, REAM, RECESS AT END OF THREAD, AND CHECK OUTSIDE

Machines Used—3×36 Jones & Lamson flat turret lathes.

Special Tools and Fixtures—Twist drill and holder A; roughing reamer B; beveling tool C; undercutting tool D; outside checking tool E; finish reaming and bottom forming tool F; sizing reamer G for thread space.

Gages—Gage H for length; gage I for inside diameter and bottom rad; gage J, fuse hole recess; gage K, diameter and angle of end of shell; gage L, thickness of base; gage M, depth of check on end of shell; gage N, plug gage for threading size of inside of nose.

Production.—One man operating one machine, average 10 shells per hour.

Note—Cutting compound used.

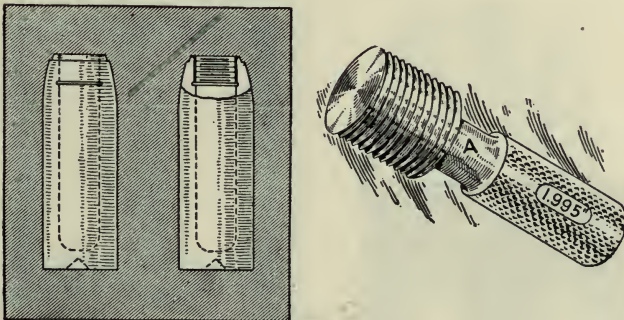

## OPERATION 9. MILLING THE INTERNAL THREAD IN THE SHELL NOSE

Machines Used—Holden-Morgan thread millers.

Special Tools and Fixtures—None.

Gage—Plug thread gage A.

Production—One man and one machine, 25 noses threaded per hour.

Note—Cutting compound used.

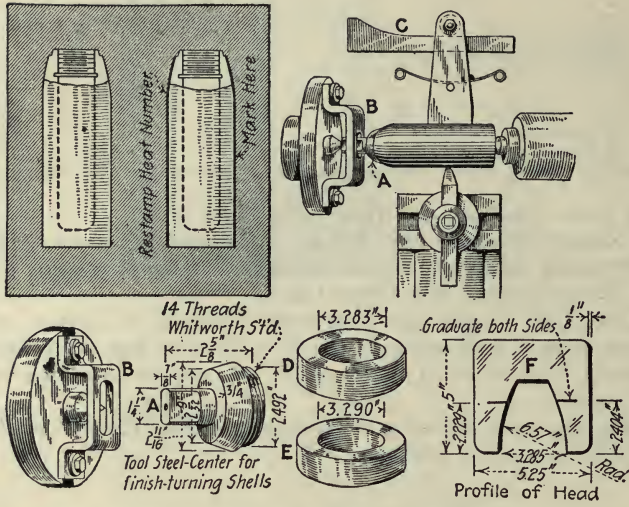

OPERATION 10. FINISH TURNING THE SHELL BODY

Machines Used—Engine lathes, 16 and 18 in. swing.

Special Tools and Fixtures—Plug driver A; female driver B attached to small faceplate; former and roller C at the back of the lathe.

Gages—High and low body diameter gages D and E; profile of head F.

Production—One man and one machine, 20 per hour.

Note—Cutting compound used.

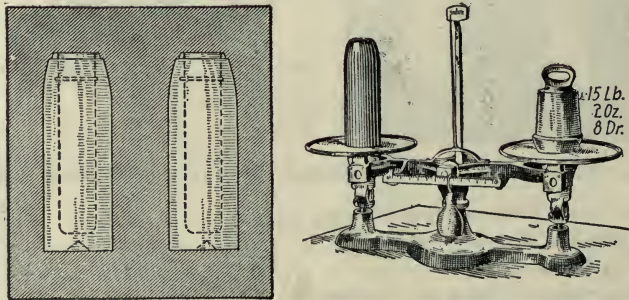

OPERATION 11. WEIGHING THE SHELLS

Machine Used—Ordinary weighing scales.

Special Tools and Fixtures—None.

Gages—None.

Production—One man and one set of scales can weigh about 100 shells per hour.

Note—About 10 per cent. of the shells are correct weight.

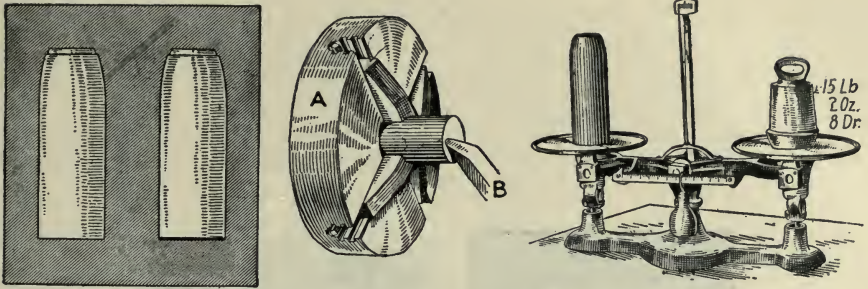

OPERATION 12. FACE TO CORRECT WEIGHT

Machines Used—20-in. engine lathes without tailstocks.

Special Tools and Fixtures—Combination chuck A; facing tool B.

Gages—The scales act as gages for this operation.

Production—One man and one machine, 35 shells per hour.

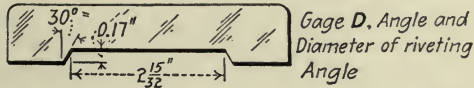
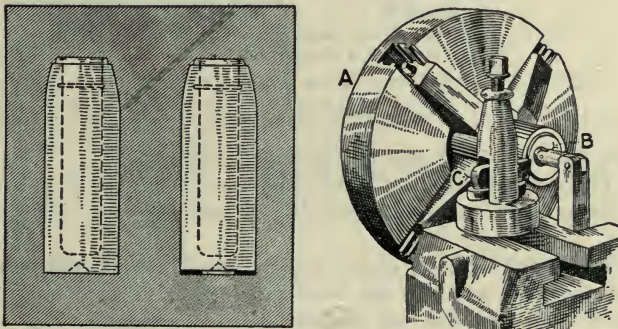

OPERATION 13. TURN THE RIVETING FACE ANGLE ON THE BASE OF THE SHELL

Machine Used—20-in. engine lathes without tailstocks.

Special Tools and Fixtures—Combination chuck A; compensating gage B; angular tool C.

Gage—Angle gage D.

Production—One man and one machine, 50 shells per hour.

Note—Cutting compound used.

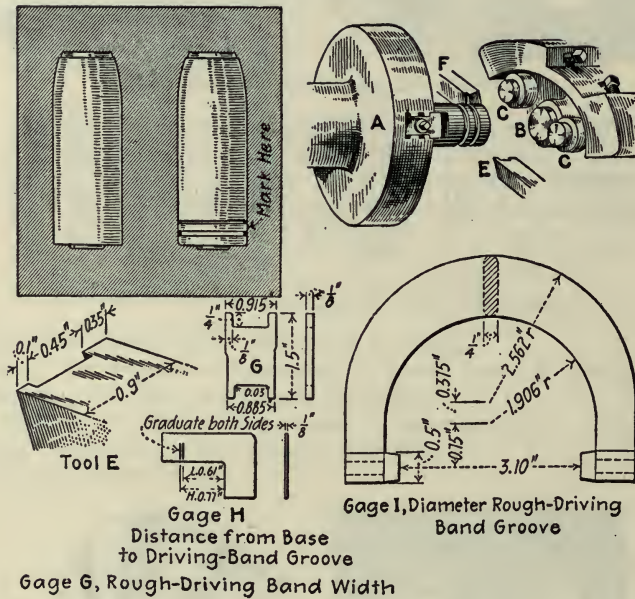

OPERATION 14. ROUGH TURN DRIVING BAND GROOVE AND ROUND EDGE OF BASE

Machines Used—20-in. engine lathes without tailstocks.

Special Tools and Fixtures—Combination chuck A; fixture on saddle holding the stop B and rollers C; cross-slide carrying the grooving tool E and edge-rounding tool F.

Gages—Rough driving band groove gage G; distance from base of driving band, gage H; gage for diameter of driving band groove I.

Production—One man and one machine, 35 shells per hour.

Note—Cutting compound used.

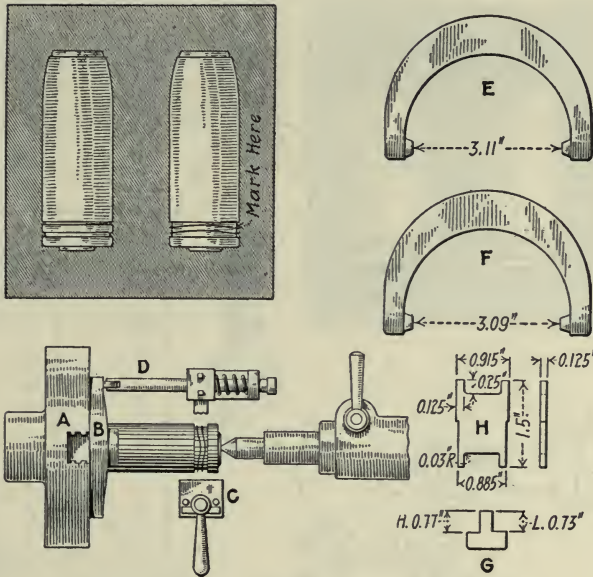

OPERATION 15. UNDERCUTTING AND WAVING

Machines Used—20-in. by 8-ft. engine lathes.

Special Tools and Fixtures—Universal chuck A. Waving cam B. Undercutting attachment C. Waving attachment D.

Gages—High and low snap gages E and F. Gage G, distance from base to driving-band groove. Gage H, width of driving-band groove.

Production—One man and one machine, 21 per hr.

Note—Cutting compound used.





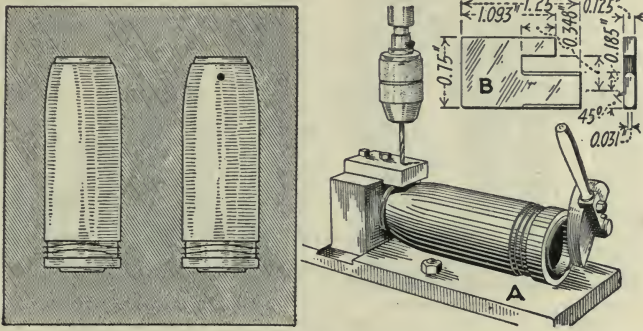

OPERATION 17. DRILLING FIXING-SCREW HOLE

Machines Used—Sensitive drilling machines.

Special Tools and Fixtures—Drill jig A.

Gages—Distance of fixing screw from top, gage B.

Production—One boy and one machine, 50 per hr.

Note—Drilling compound used.

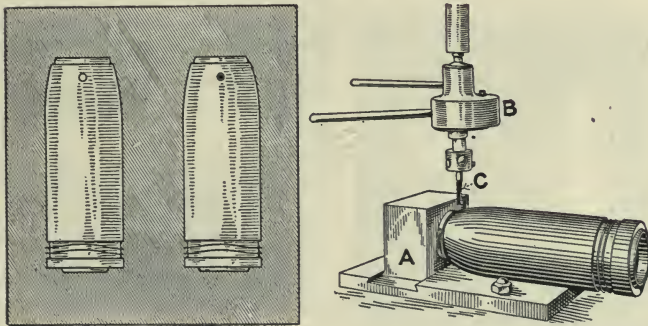

OPERATION 18. TAPPING THE FIXING-SCREW HOLE

Machines Used—Sensitive drilling machines.

Special Tools and Fixtures—Jig A. Tapping attachment B.  $\frac{1}{4}$ -in. tap C.

Gages—None.

Production—One boy and one machine, 80 holes per hr.

Note—Oil used as lubricant.

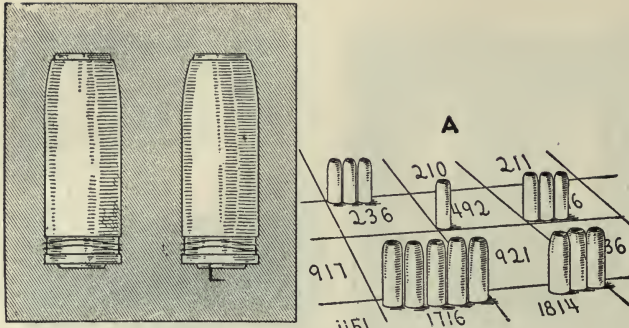

OPERATION 19. SORTING SHELLS BY HEAT NUMBER

Machines Used—None.

Special Arrangements—Tote boxes and trucks. The floor A is divided into squares marked with current heat numbers as shown.

Gages—None.

Note—14 series of 250 shells in 10 hr. by 8 men.

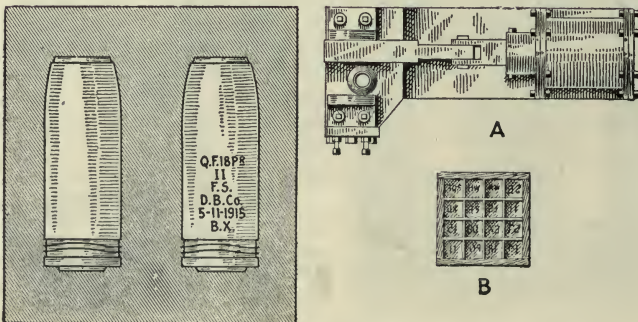

OPERATION 20. MARKING THE SHELLS

Machines Used—London air marker A.

Special appliances—Font of steel type B.

Gages—None.

Production—Two men and one machine, 125 per hr.

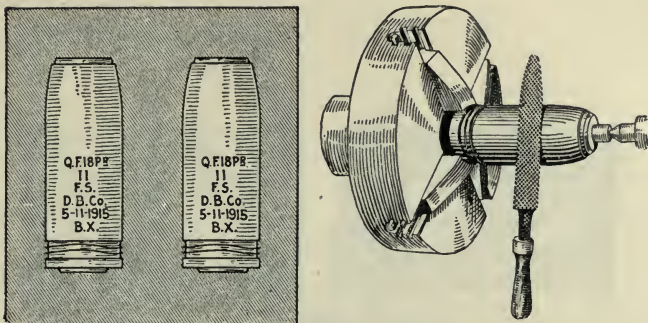

OPERATION 21. FIRST GENERAL SHOP INSPECTION AND HOSPITAL WORK

Machines Used—Lathes for filing off marking burrs and reaming noses of damaged shells.

Special Appliances—Tanks for hot caustic soda and for hot water.

Gages—All gages that have been used in the operations which have preceded this operation.

Production—8 inspectors and 4 men in the hospital gang put through 350 shells per hr.

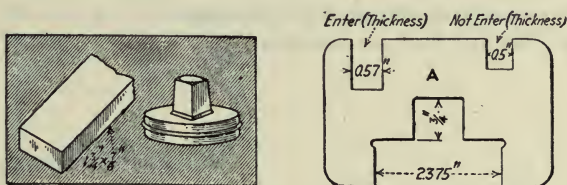

OPERATION 22. DROP-FORGING BASE PLATES

Machines Used—Billings & Spencer and Bliss drop hammers.

Special Fixtures and Tools—Oil furnaces, trimming press and dies.

Gages—Diameter and thickness gages A and B.

Production—One man, one furnace and one hammer, 110 pieces per hour.

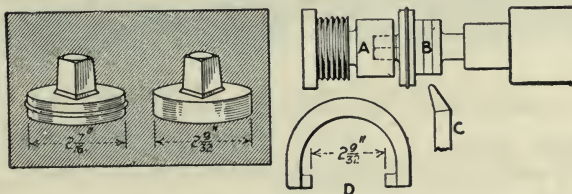

OPERATION 23. ROUGH-TURNING BASE PLATES

Machines Used—16-in. engine lathes.

Special Tools and Fixtures—Socket driver A; disk center B; turning tool C.

Gages—Snap gage D.

Production—One man and one lathe, 175 to 200 per hour.

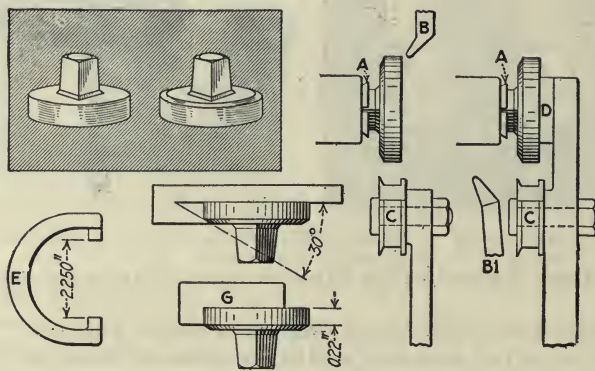

OPERATION 24. FINISH-TURNING BASE PLATES

Machines Used—Engine lathes.

Special Tools and Fixtures—Draw-in collet A; facing tool B; formed tool C; for the engine lathes the special stop D and turning tool B1.

Gages—Snap gage E; angle gage F; height gage G.

Production—One man and one machine, 75 per hour.

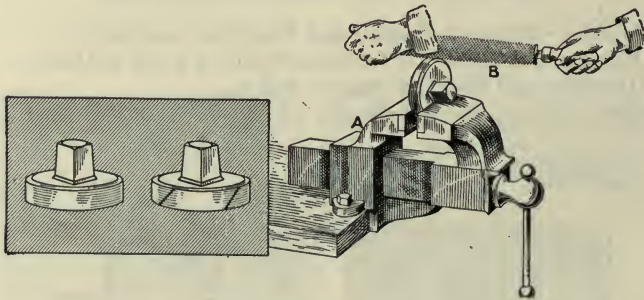

OPERATION 25. FILE NICKS IN EDGE OF BASE PLATE

Machines Used—None.

Special Tools and Fixtures—Machinist's vise A; half-round file B. Hand operation.

Gages—None.

Production—One man, vise and file, 60 per hour.

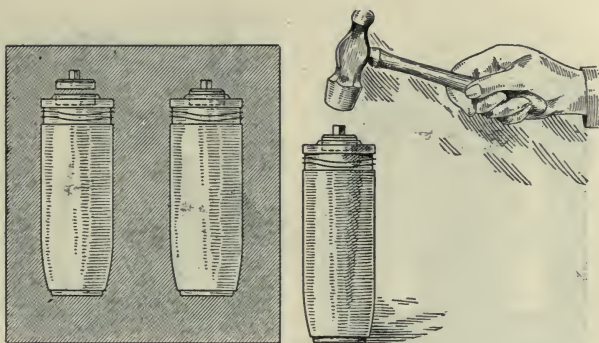

OPERATION 26. ASSEMBLE BASE PLATE IN SHELL BASE

Machines Used—None.

Special Fixtures and Tools—None; hand hammer only used to enter the plates in the shell.

Gages—None.

Production—One man, about 200 per hour.

Note—No Pettman cement used with this type of base plate.

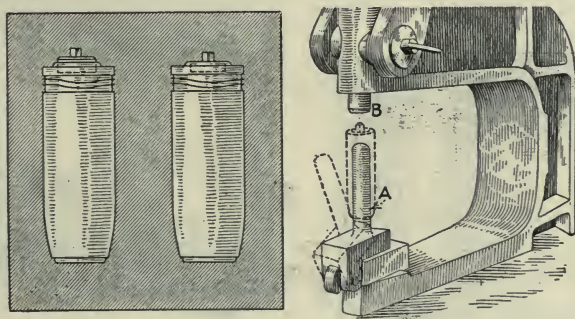

OPERATION 27. DRIVE IN THE BASE PLATES

Machines Used—Murphy pneumatic riveters.

Special Tools and Fixtures—Tilting post A; hollow punch B to clear the shank of the base plate.

Gages—None; the hand hammer is used to test the work.

Production—Two men and one machine, 200 per hour.

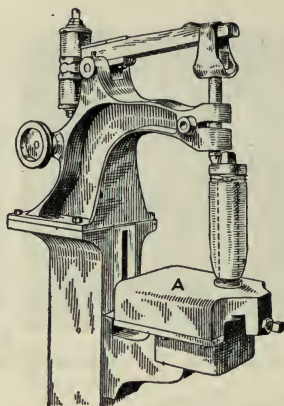
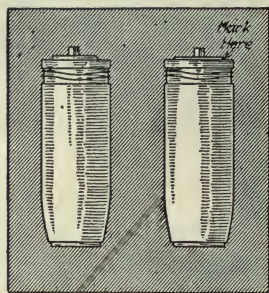

OPERATION 28. RIVET BASE PLATE

Machines Used—High-speed hammers.

Special Tools and Fixtures—Slide and post A.

Gages—None; the hand hammer is used to test the work.

Production—One man and one machine, 30 per hour.

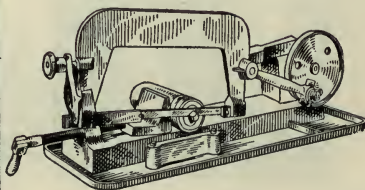
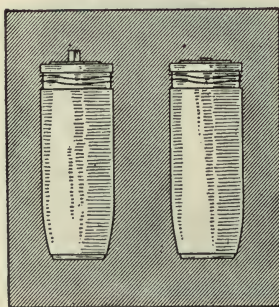

OPERATION 29. SAW OFF SQUARE STEMS

Machines Used—Racine power hacksawing machines.

Special Fixtures and Tools—None.

Gages—None; the boy operator works as close to the shell base as he can.

Production—One boy and two machines, 120 per hour.

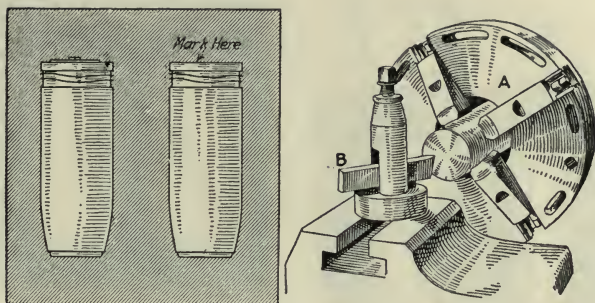

OPERATION 30. FACE THE BASE PLATE AND BASE

Machines Used—Engine lathes 20 in. by 6 ft.

Special Tools and Fixtures—Combination chuck A; facing tool B.

Gages—None.

Production—One man and one machine, 30 per hour.

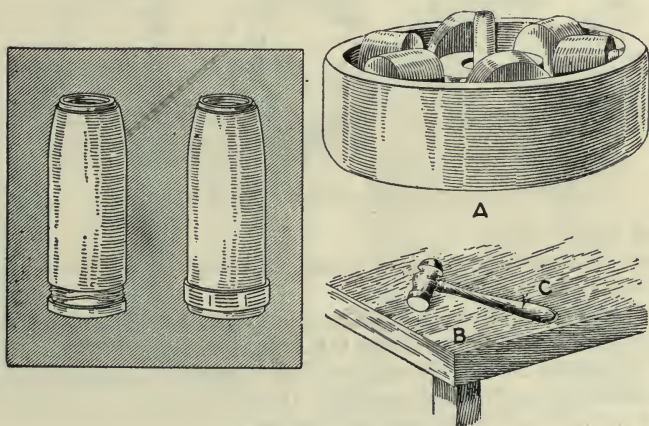

OPERATION 31. BANDING

Machines Used—Triple-cylinder hydraulic pumps; accumulator; banding press A.

Fixtures and Tools—Bench B; hand hammer C.

Gages—None. The hand-hammer test is used on the bands.

Production—From one banding press and three men, 330 per hr.

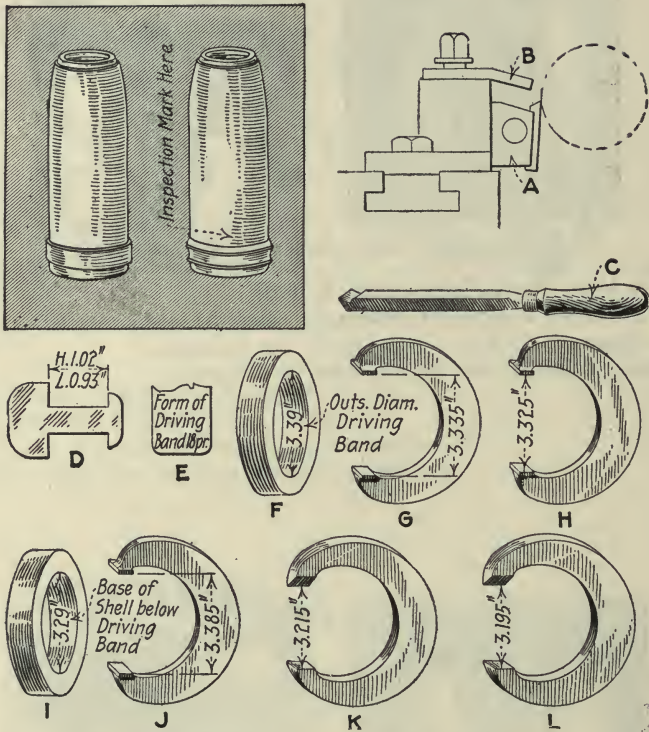

OPERATION 32. TURN COPPER BAND

Machines Used—Lathes.

Tools and Fixtures—Special collet chuck; cup center for tail-stock; formed tool A; scraper rest B; scraper C.

Gages—Gage D from rib to base; E, form of driving band; F, outside diameter of driving band; high and low gages G and H for rib; ring gage I, base of shell; low snap gage J for driving band; K and L, high and low for groove in driving band.

Production—One machine and one man, 110 per hr.

Note—Soluble oil and water used as lubricant.



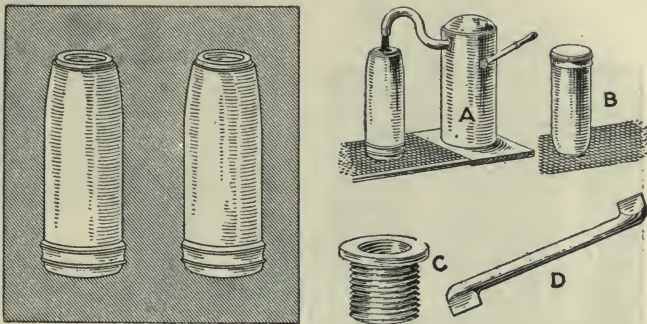

OPERATION 33. VARNISHING

Machines Used—Bowser tank A.

Special Appliances—Draining screen B; thread-protecting bushings C; bushing wrench D.

Gages—None.

Production—Five men can screw in bushings and varnish 3,000 shells in 10 hr.

Note—Shells drain on B for 10 min.

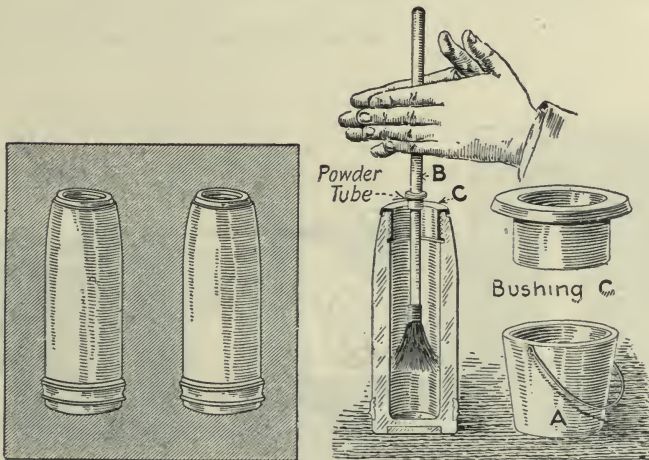

OPERATION 33. (ALTERNATIVE A): VARNISHING

Machines Used—None.

Appliances—Varnish pot A; special long-handled brush B; sheet-steel slip bushing C, to protect the fuse-hole threads.

Gages—None.

Production—One man, 100 per hr.

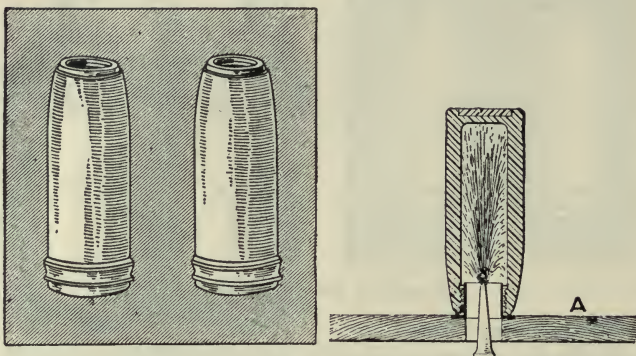

OPERATION 33. (ALTERNATIVE B): VARNISHING

Machine Used—Varnish-spraying machine.

Special Appliances—None.

Production—One man, one machine and two helpers, 250 per hr.

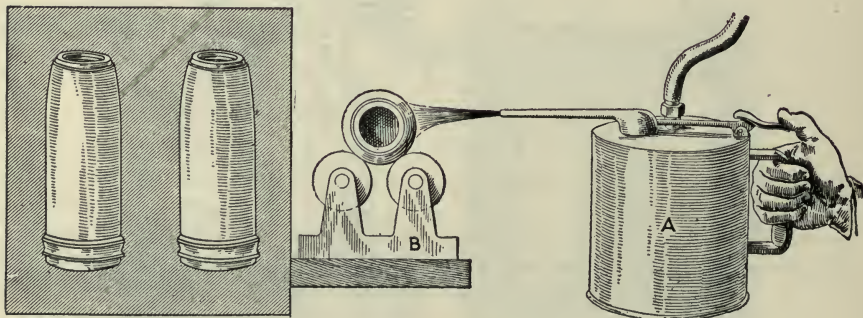

OPERATION 33. (ALTERNATIVE C): VARNISHING

Machines Used—Hand-operated atomizer A connected to shop air service.

Special Appliances—Roller shell support B; gloves for handling the hot shells.

Production—One man and one atomizer, 100 per hr.

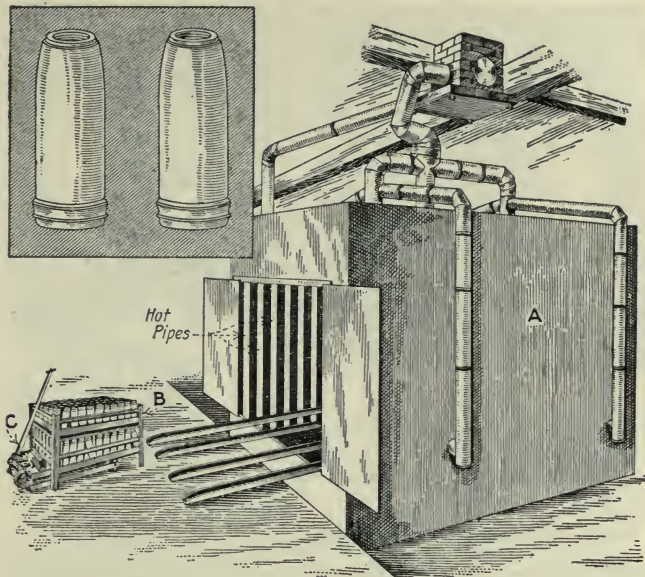

OPERATION 34. BAKING THE VARNISH

Machines Used—None.

Special Appliances—Two furnaces A holding two and four trays B respectively; thermometer; clock; trucks C.

Production—With both furnaces, 200 per hr.



OPERATION 35. CLEANING VARNISH OFF OUTSIDES

Machines Used—None.

Appliances Used—Benches; scrapers; waste; bushing wrench.

Production—One man, 25 shells per hr.

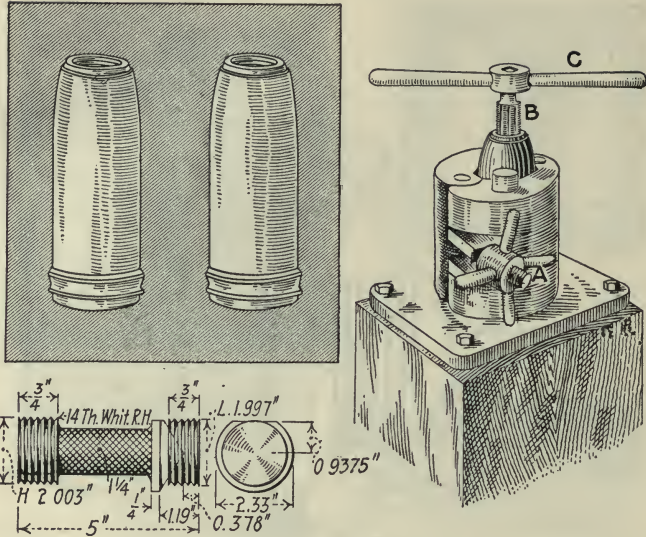

OPERATION 36. HAND TAPPING THE FUSE HOLE TO FINISHED SIZE

Machines Used—None.

Special Tools and Fixtures—Hinged vise A; adjustable tap B; tap wrench C.

Gages—High and low plug gage with angular seat on one end.

Production—One man, 30 per hr.

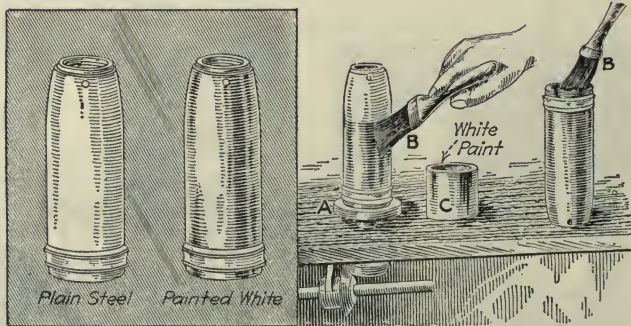

OPERATION 37. PAINTING THE PRIMING COAT

Machines Used—Motor-driven turntables A.

Tools and Accessories—Benches and drying cupboards; flat paint brush B; paint pot of white paint C.

Gages—None.

Production—Six boys, 15 series (2,750 shells) in 10 hr.



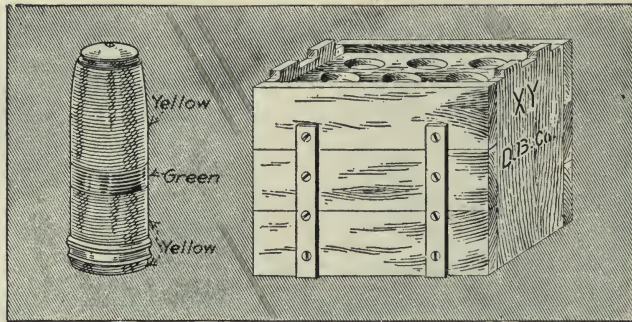

OPERATION 40. PACK AND SHIP

Machines Used—None.

Tools and Accessories—Cases holding six shells each; screw-driver.

Gages—None.

Production—Twenty men can screw in plugs and fixing screws, paint tops of plugs, put in cases 3,220 shells and screw down the case lids ready for shipping. This work is under the supervision of a man from the Canadian Inspection Co.

A modification in the usual construction of the shell was here inaugurated which greatly simplified manufacture and stimulated production. The base plate, instead of being threaded and screwed into the base was made with a beveled edge and simply inserted into a plain cylindrical blind hole in the base. Here it is firmly riveted in place with the riveting flange left on the base for that purpose. This practice necessitated slight alterations in dimensions worked to during certain operations (noted in the table in Fig. 210) but the finished shell differs in no respect as to weight, dimensions, etc.

The first operation on the shell blanks, which are cut to length before they are received at the shell shop, consists in grinding off the burr left by the cold-saws. This is removed, as it might prevent the blank from centering properly in the chucks in the first machining operation. For this work an ordinary dry-grinder is used with a wide rest for the work, as shown in operation 1. A man can remove the burrs from about 300 blanks per hour.

The drilling operation, which follows, is, from the viewpoint of time consumed, the most important of the machining operations. Three different makes of machines are used for this operation. There are nine 24-in. and eleven 25-in. Foote-Burt heavy-duty drilling machines, three 2-spindle Bertram horizontal drilling machines and sixteen Dominion Bridge Co.'s air-feed horizontal drilling machines.

Two Foote-Burt drilling machines are attended by one operator. Their nominal output is 5 pieces per machine per hour. A man can, however, do a little better than this, but in many of the shops where

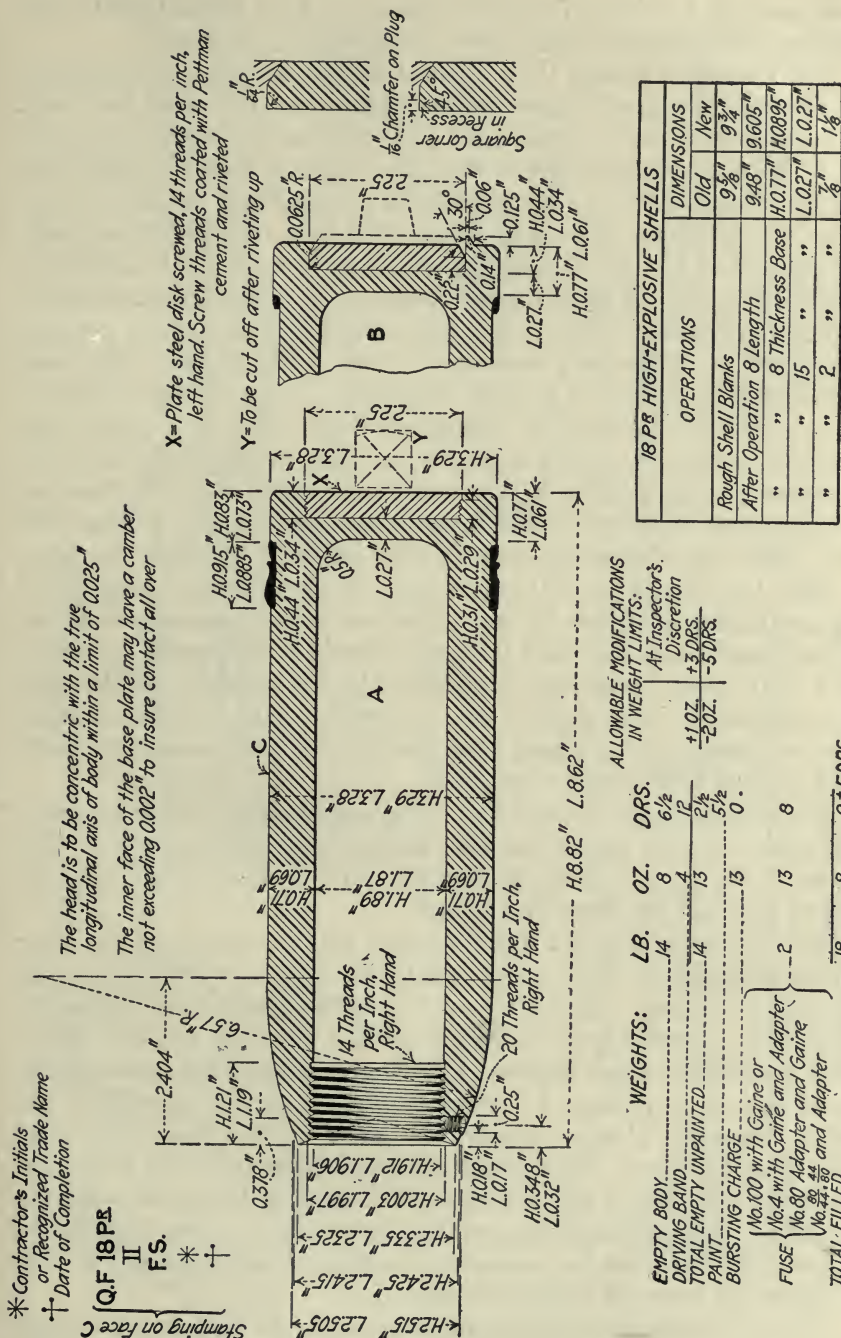

these machines have been forced there has been more or less trouble with breakage, so it has been found more economical to run slower.

The Dominion Bridge Co.'s air-feed drill is a recent development. It is simple and rugged in construction, drills a more accurate hole than the vertical machine in about a third of the time and costs very much less. The machine is shown in Fig. 211, together with the drill used. The air cylinder is 7 in. in diameter and is supplied with air at 90 lb. per sq. in., giving a total pressure of about 3,500 lb. on the piston and drill. The piston rod is 4 in. in diameter and at its forward end is secured to the sliding saddle. A taper reamed socket in the extreme end accommodates the drill shank. The drill is hollow, and lubricant under pressure is admitted to it through a connection in the sliding saddle. The main spindle of the machine is 6 in. in diameter. At the forward end is a heavy combination chuck for holding the work. The rim of the faceplate that carries the chuck is used as a brake drum, the band of the brake being controlled by a conveniently located lever. In front of the rear spindle bearing is a ball thrust bearing to take the drilling pressure. With one of these machines a man can drill 15 blanks per hour.

After the blanks are drilled the work is inspected for diameter of hole and thickness of base by one of the four inspectors assigned to the drilling department, who uses the gages shown in the second operation. Work that passes inspection is stamped by the inspector as indicated in the operation. The checker now credits the driller with the number of pieces drilled, the truck gang is notified and the work loaded on trucks and transferred to the next operation.

The next operation is centering. The center must conform as nearly as possible with the axis of the hole, not the outside of the piece. The details of the jig are shown in Fig. 212. The work is slipped over the vertical post, the jig closed and locked.

By referring to Fig. 212 it will be seen that the weight of the piece and the drill pressure throw three radial locking pieces which prevent the piece from turning. At the top of the center post is the wedge-like plunger *A*. A helical spring normally keeps it up in the position shown. Three radial jaws *B* are disposed 120 deg. from each other around the conical part of the plunger *A*. When the drilled blank is placed over the post it forces the plunger downward, and it in turn forces the three radial jaws outward. These simultaneously center the work with relation to the hole, grip it and prevent it from turning during the centering operation. The scheduled time on this operation for a boy is 65 blanks centered per hour, but this operation has been done at the rate of over 81 blanks per hour for a period of 10.5 hr.

After centering, the work is again inspected to see that there is enough metal all around for the shell to clean up properly in the subsequent operations. The inspection gage is a set wing gage with a ball point.



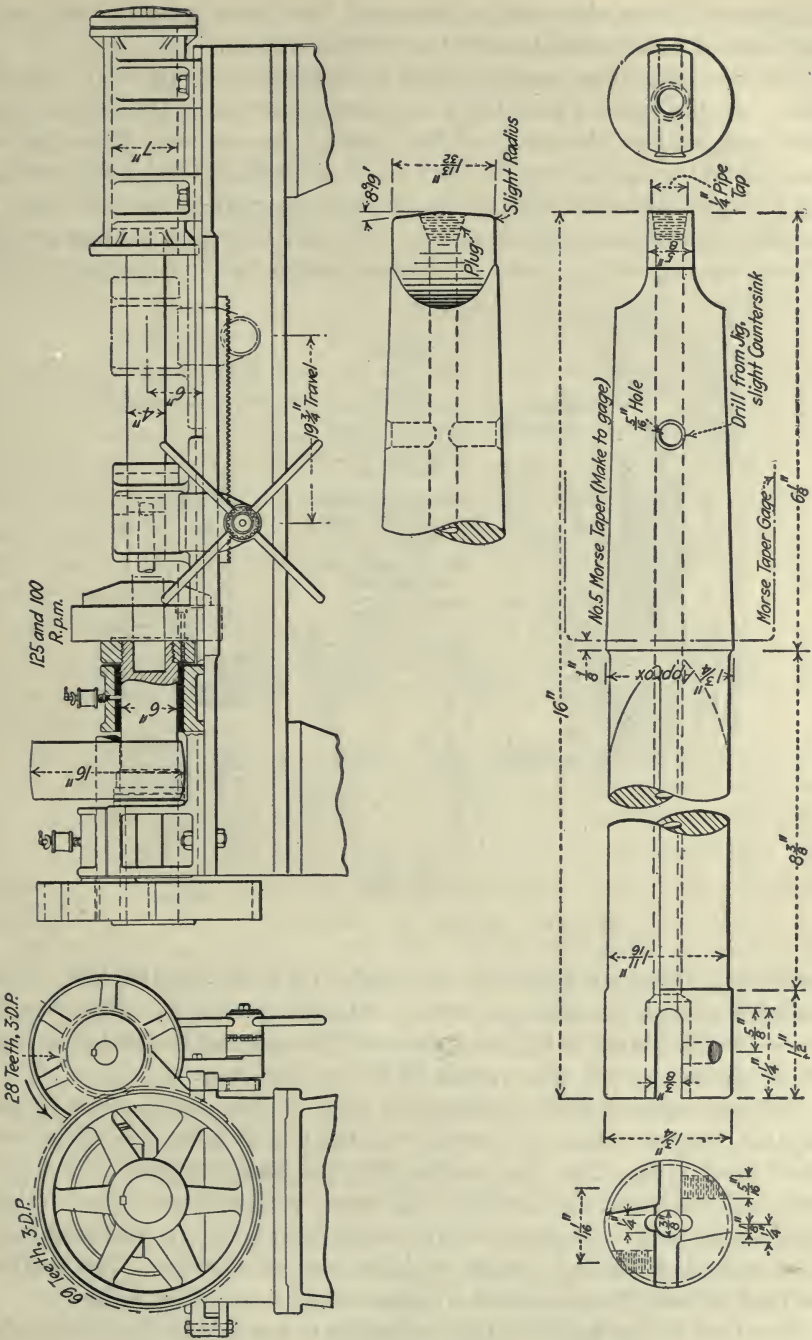

BORING BAR FOR SHELL-BORING MACHINES THE HIGH-EXPLOSIVE SHELL-BORING MACHINE

FIG. 21.



not quite to the same depth. The second cut is started a little way back on the parallel part of the body and to the same diameter as the rough body size. The scheduled output on this operation is 23 per hour, but with everything going right a man can get out 28 pieces per hour.

The work is now inspected to see if the contour of the nose is correct and if the length overall is right.

For the sixth operation short, heavy engine lathes are used. These are of 20-in. swing with 6-ft. bed, with no tailstock and are equipped with heavy combination chucks. The operation just cleans up the base and does not use any gage. The scheduled output for this operation is 48 pieces per hour.

After facing, the work is inspected for squareness with the body and also for length, as subsequent operations, if not actually finishing operations, are more nearly allied to finishing operations. It therefore becomes necessary to bring the blanks to uniform length. Those blanks which, with the base squared, are of the correct length, pass direct to the boring and reaming operation. Those which are found by the inspector to be too long are checked and transferred by the truck gang to the length-facing operation.

This seventh operation is done on lathes of the same size and make as those used for facing the base. They are equipped in exactly the same manner, except that they have a stop in the chuck for the base of the blank.

The blank is chucked with the base against the stop in the chuck. The tool is an ordinary roughing tool, and with it the operator takes one or more cuts to remove the excess of metal from the nose of the blank. The length gage is the only gage used. This operation takes a little longer than the previous one, and 30 pieces per hour is the scheduled production.

The eighth operation is the first of the finishing operations and consists in finishing the hole to diameter and depth, cutting the annular recess at the rear of the location for the nose thread, turning the check on the outside of the end and finishing the angle on the inside of the nose.

This is one of the jobs on which the turret lathe has been retained, and it requires altogether seven tools and five turret stations for completion.

The work is held in the regular Jones & Lamson collet chuck. The first tool used is the twist drill. The size of this drill is of no great consequence; any drill about  $\frac{5}{8}$  in. in diameter will do, as its work consists merely in removing the metal in the center to nearly the finished depth of the hole. The drill is carried in an ordinary socket in the turret.

The second turret station carries the reamer *B*, shown in Fig. 213. It is in reality a four-fluted roughing reamer that is provided with one pair of end-cutting lips to remove the metal at the end of the hole to the depth cleared by the twist drill.

The third station of the turret carries three tools. One tool turns the bevel on the inside of the nose, another tool cuts the recess inside the shell at the point which will later be the extreme end of the thread and the third tool turns the check on the outside of the nose. It will of course be understood that the headstock is fed over for these cuts. The fourth station of the turret carries the finish-boring tool *F*, shown in Fig. 213. This tool finishes the bore and faces the end of the hole. The fifth station carries a Pratt & Whitney adjustable reamer that finishes to size the part of the bore which later will be threaded. This completes the eighth operation. The scheduled time is 10 pieces per hour. When the operator removes the finished work from the chuck he inverts it over an air jet, turns the air on and blows the chips out.

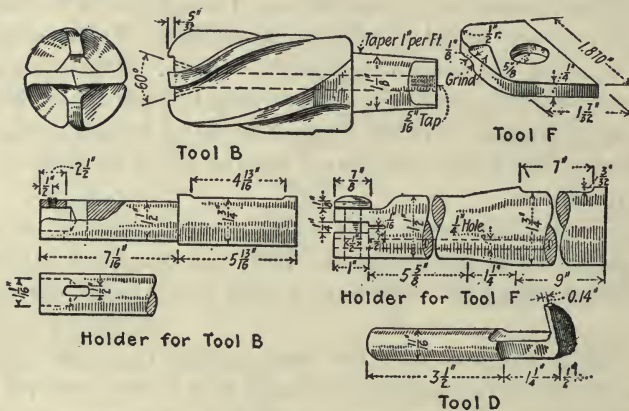

FIG. 213. SOME OF THE TOOLS FOR THE FINISH-BORING OPERATION ON THE TURRET LATHE

The ninth operation is threading the nose. This is done on Holden-Morgan thread-milling machines. In the eighth operation the check on the outside of the shell was finished to accurate dimensions and concentric with the bore, so this is taken as a locating point for the forward end of the shell. The spindle of the thread-milling machine is arranged so that it clears the shell contour *R*, as shown in Fig. 214, at *S* in the small broken section. A plate *T* attached to the forward end of the spindle *S* and acts as a seat for the checked end of the shell. The other end of the shell is centered by the conical spindle plug, *A*, of the machine. This method results in accurate work and very few discards.

The exterior of the spindle of the machine, with the exception of a short section about midway of its length, is a plain cylinder without flanges, so that it is free to slide endwise in the bearings at each end of the main head of the machine. About midway between the bearings the spindle has an external thread. This thread is of the same pitch and "hand" as the one it is intended to mill in the nose (or base recess) of the

shell. Between the bearings is a half-nut *B*, which is fitted to a slot running from front to back of the machine at right angles to the axis of the spindle, so that it has no side-play in relation to the head, that is to say, in line with the spindle axis.

This half-nut *B* is hinged at the back; at the front there are a swing-bolt and a nut *C* to clamp it in operation position in mesh with the thread *K*, Fig. 214, when it is desired to cut a thread.

The hob *D* consists of what is virtually a stack of disks of the shape of the standard Whitworth thread 14 pitch. In other words, it is a Whitworth screw without lead. In appearance, with the exception of having

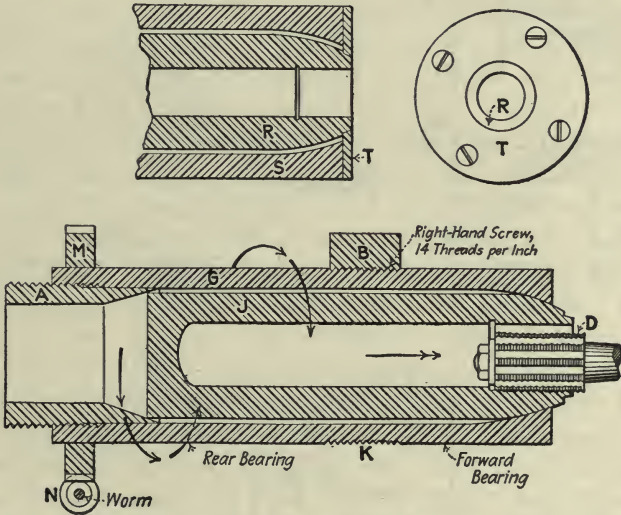

FIG. 214. SPINDLE OF NOSE-THREAD MILLER

no lead, it is just like an ordinary hob, is fluted and has cutting clearance; in some cases, to afford extra chip space, it is provided with the type of teeth used on the Eccles tap. In length it is a thread or two greater than the length of the female screw it is to cut. It is mounted on a carriage, which affords it lengthwise motion to permit it to be moved in and out of the hole in the nose, crossfeed to obtain the correct depth of thread, and clamps so that when located in cutting position it can be rigidly held. The scheduled time for threading is 25 pieces per hour, but as high as 29 have been done.

The tenth operation is finish turning and it is done on engine lathes of 16- and 18-in. swing, with 6- and 8-ft. beds respectively. The threaded plug and driver *A*, shown in detail for the tenth operation, is screwed into the nose of the shell. Secured to the driver plate of the lathe is the slotted female driver *B*, which receives the flattened end of the driver *A*. The base end of the shell is supported on the tail center. At the back of the



actual weighing is done by an employee of the shop, but the operation is under the eye of a Government inspector. The shells are weighed on ordinary scales and the amount which they are over 15 lb. 2 oz. 8 dr. is chalked on the side of the shell in ounces and fractions and an amount of metal equal in weight to these chalked figures must be removed from the base in the twelfth operation.

The schedule output on this facing to weight is 35 shells per hour. Having been adjusted to weight, the shells are taken by the truck gang to the next operation. Facing to weight is day's work, and the operation is not checked.

The thirteenth operation is one which is necessary with the base plate only. Those shells which have the threaded base plate do not undergo it. The work is done on 20-in. by 6-ft. engine lathes. No tail-stock is used. The shell *A* is gripped in a heavy combination chuck, the nose of the shell bringing up against a stop. Owing to the fact that the shells in the twelfth operation have, in order to bring them to specified weight, been turned slightly varying lengths and will therefore not all project an equal distance from the chuck, some sort of self-accommodating gage is in this operation a manufacturing necessity. The gage *B* (operation sketch) fulfills the requirements, is simple in construction and produces results that are sufficiently accurate. It is secured to the tool slide. The hinged member can be swung out of the way if desired. The forward end is slotted to accommodate the roller. The angular tool *C* is  $\frac{1}{8}$  in. nearer the chuck than the roller, thus gaging a cut  $\frac{1}{8}$  in. deep irrespective of the length of the shell.

The operation of turning the "fa e angle" (for riveting) is as follows: A shell is chucked, then the operator brings the carriage toward the chuck till the roller touches the face of the base of the shell. With the carriage held in this position the angular tool *C* is fed across the face of the work till the stop is encountered. The scheduled time for this operation is 50 pieces per hour.

The fourteenth operation is rough turning the groove for the wave and rounding the edge of the base. This work is done on 20-in. by 6-ft. engine lathes with a special set-up of tools.

Mounted rigidly on the cross-slide of the lathe is the block which is connected with the crossfeed screw, but for the purpose of crosswise adjustment only. Once the block is set in the correct position, the crossfeed handle is removed and the gib screws are set up hard to prevent shifting. Rigidly secured to the top of the block is a fixture supporting a sliding member which carries at the front a rough groove-forming tool and at the back an edge-rounding tool. The sliding member is provided with a rack that is engaged by a pinion on the lower end of a lever shaft which controls the movement of the slide. Rigidly secured to the supporting fixture is a member which acts as a housing for the shaft and also

carries the stop and rollers that bear on the plain part of the shell behind the groove and prevent it from lifting during the grooving operation.

The operation of cutting a groove is very simple. The shell is chucked, and the carriage is brought forward till the stop bears on the base of the shell, thus determining the distance from the base to the groove. The carriage is then clamped, and the operator pulls the lever toward him till the stop for the grooving tool is reached. He then pushes it away from him till the stop for the edge-rounding tool is encountered. The first movement roughs the groove, and the second rounds the edge of the base. The carriage is now unclamped and run back and the work removed.

The scheduled time for the fourteenth operation is 35 pieces per hour. The shop inspection covers the diameter of the driving-band groove in the rough, the limits for which are 3.090 and 3.110 in. However, but a single gage is used here, 3.100 in. in diameter. The distance from the base to the driving band is between 0.73 and 0.77 in., but the high limit alone is used. The width of the driving-band groove in the rough, is between 0.885 and 0.915 in.

The method of applying the driving band to British shells is much more elaborate. The groove is dovetailed on each side, and depending

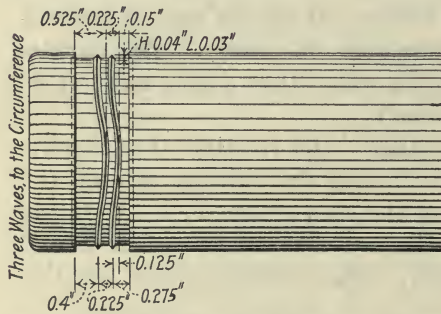

FIG. 216. WAVE RIBS FOR HIGH-EXPLOSIVE SHELL

on the size of the projectile, two or more wave ribs, as shown in Fig. 216, are turned in the bottom. When the copper band is pressed on, the wave ribs embed themselves in. The object sought is to assure that, at the moment of firing, the friction between the band and the shell shall be sufficient to overcome the inertia of the shell and cause it to follow the rifling in a rotary as well as a forward motion.

The rough grooved shells from the fourteenth operation go to 20-in. by 8-ft. engine lathes. They are equipped with heavy combination chucks to hold the shells and drive them. The base end of the shell is supported by the tail center. Mounted on the carriage of the lathe is a stop which is so located that it brings up against the base of the shell between the edge and the riveting flange. This stop is fixed in the carriage and bears a positive position relatively to the undercutting attachment on the front of the carriage, and also to the waving attachment on the back. The waving cam is secured to the face of the chuck in such manner that it does not interfere with the operation of the chuck.

The operations of undercutting and waving are performed as follows:



The operator enters a shell in the chuck of the engine lathe. Inside the spindle and backed up by a stiff spring is a sliding plug. The nose of the shell fits over this. The rear end of the shell is located on the tail center, which is then run out, compressing the spring and holding the shell. The jaws of the chuck are now tightened on the body of the shell. The carriage is run forward till the stop *B* (Fig. 217) brings up against the base end of the shell, thus correctly locating the undercutting and waving attachments in relation to the rough-turned driving-band groove. The carriage is now clamped and the undercutting tool fed to the bottom of the groove, a stop controlling the motion of the cross-slide. The diagonally disposed tools are alternately advanced, first to the right and then to the left. When both sides are undercut, the cross-slide is run back. This brings the waving attachment at the back of the cross-slide into operating position, with the roller *F* in contact with the wave cam *E*. While the waving tool is reciprocated by the cam and roller, it is fed to depth in the groove by the crossfeed screw, which in turn is controlled by the handwheel *L*. The scheduled output for undercutting and waving is 21 shells per hour.

After the wave is cut, a small thread-like ridge is left on one side of the driving-band groove. This is removed by a boy with a hammer and a chisel. This completes the fifteenth operation.

The sixteenth is another operation on which the Jones & Lamson flat turret lathes have been retained. It consists of forming the recess in the base of the shell for the reception of the base plate.

It is performed on 2×24-in. machines, of which three turret stations are used. The shell is held in the regular Jones & Lamson collet chuck. The first station of the turret carries an ordinary stop. The second station carries a flat recessing tool, and the third station carries a single-pointed boring and facing tool.

The shell is entered in the chuck and lightly gripped. The stop is then brought forward, forcing the shell in the chuck to the correct depth; this is determined by the stop for the turret slide. The chuck is then fully closed. The turret is indexed and the recessing tool brought to operating position. The turret is fed forward till the stop is reached. The recessing tool used is shown in Fig. 218. Its body is made of machine steel and the inserted cutter of high-speed steel. The collar *G* prevents the holder from opening up when the setscrew *H* is tightened on the cutter. The tool is set so that it cuts from the center outward. It leaves the recess about  $\frac{1}{64}$  in. smaller in diameter and the same amount shallower than final size.

The third station of the turret carries a combination boring and facing tool, which is also shown in Fig. 218. The operator sets the head of the machine over to bore the correct diameter. The turret is fed by hand till the stop is reached. The turret is then clamped and the cross-

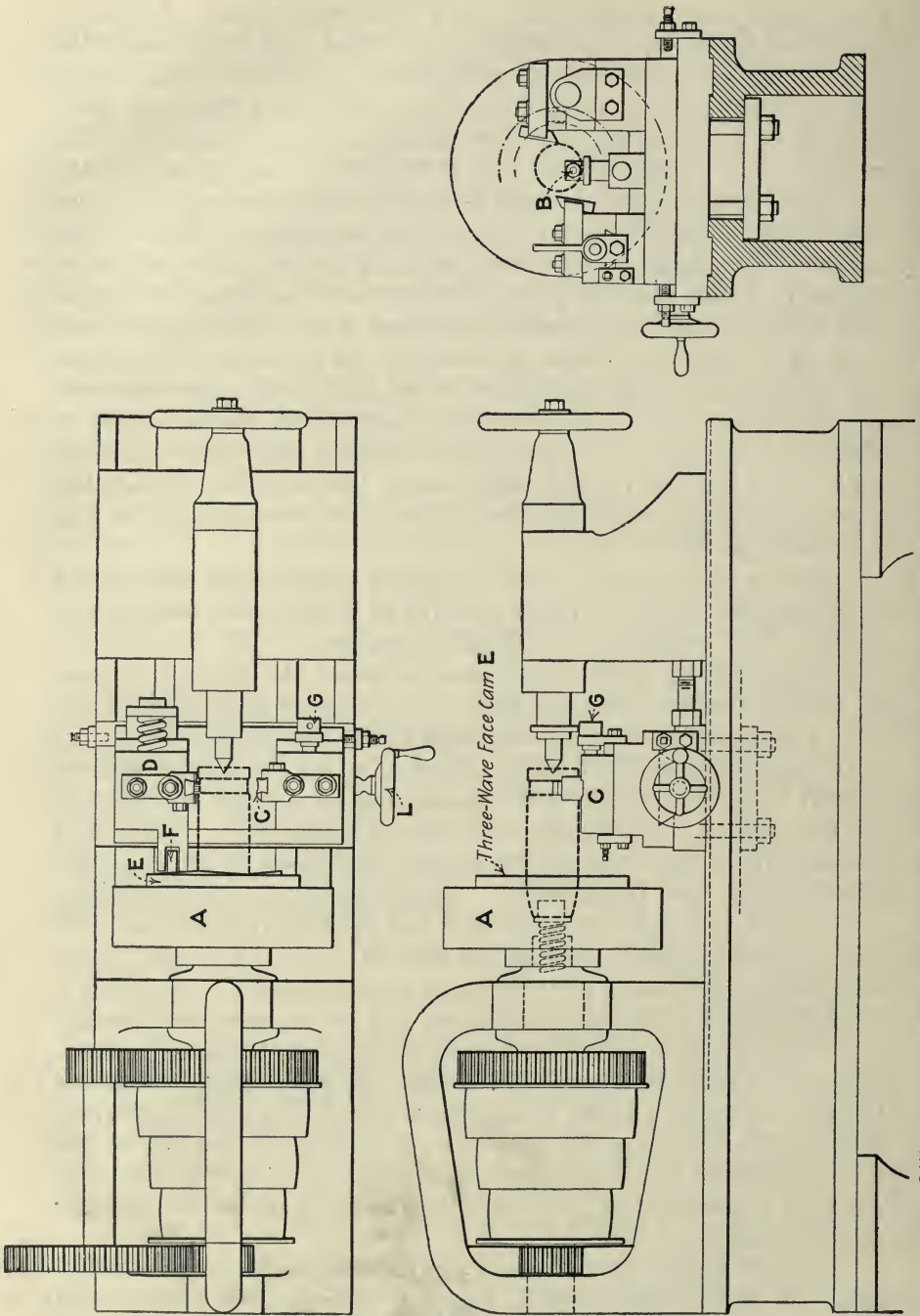

FIG. 217. ARRANGEMENT OF GARDNER 20-IN. BY 8-FT. ENGINE LATHES FOR WAVING AND UNDERCUTTING

feed on the head thrown in to face the bottom of the recess. The scheduled output for the recessing operation is 25 pieces per hour.

Inspection covers the thickness of the base of the shell measured from the bottom of the hole in the shell to the bottom of the base-plate recess and the diameter and flatness of the bottom of the recess.

The seventeenth operation is done on sensitive drilling machines handled by boys. It consists of drilling a hole,  $\frac{1}{4}$ -in. tapping size, for

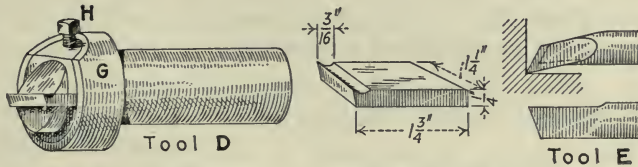

FIG. 218. ROUGHING AND FINISHING RECESSING TOOLS

the fixing screw. The outfit used is shown in Fig. 219. The jig *A*, like all the other tools used in this shop, very substantial in construction. The base *A* is made of cast iron and carries a horizontal post *B* which is an easy fit for the hole in the shell. A keyway or slot runs along the top of *B* so that the burrs caused by drilling will not jam when the work is removed. It must be remembered that owing to wear on the boring tools and other conditions in the boring operation, the holes are not all of exactly the same size; for this reason the post *B* must be of such size that it will fit the smallest acceptable size of hole. Mounted on the base at the rear end of the shell is a vertical member which carries a circular wedge *E*. This is used to force the shell against the vertical member of

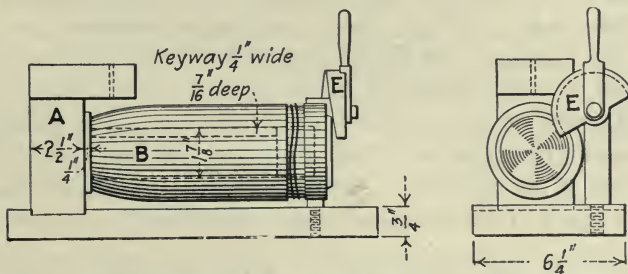

FIG. 219. DRILL JIG FOR FIXING-SCREW HOLE

*A* which acts as a stop and also prevents the shell from shifting during drilling. The scheduled time for drilling the tapping-size hole for the fixing screw is 50 per hour, but as high as 80 per hour has been done.

The eighteenth operation is tapping the  $\frac{1}{4}$ -in. fixing-screw hole. It is done on sensitive drilling machines which are situated within easy reach of the machines where the hole is drilled. As soon as a shell is drilled, the boy lays it on a table convenient for the boy who does the

tapping. The jig, shown in Fig. 220, is similar to the one used for drilling, except that the wedge is dispensed with so that the work is free to float slightly and accommodate itself to the tap. This operation is handled by boys, and the scheduled output is 80 holes per hour. As in the drilling operation, the tapping must keep pace with the speed of the shop.

The nineteenth operation is the selection of shells to make up a series. The number of shells in a series is 250, and 15 heat numbers are permitted in its make-up. Reference will again be made to heat numbers as they constitute an important consideration in the manufacture of the shells.

A series having been selected, the shells are taken by the truck gang to the air-operated marking machine to undergo the twentieth operation, that of marking.

The air cylinder of the marking machine, is about 6 in. in diameter and is supplied with air at 80 lb. pressure per

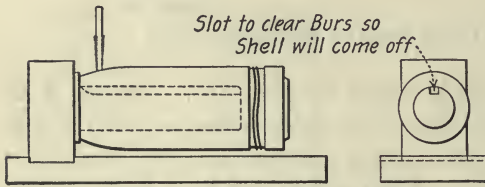

FIG. 220. THE TAPPING FIXTURE

square inch. The forward end of the ram is loosely connected by means of a yoke with the slide. In the center of the slide is a chase to hold the removable hardened-steel type.

The shells are laid on their sides on tables and as they are rolled along toward the marking machine three chisel cuts are made across the wave ribs. The shell to be marked is placed in position by the operator who then signals his assistant to open the air valve. The plunger goes forward, and the shell is rolled between the type in the chase and the inner surface of the housing. As there is only a line contact between the type and the shell, the imprint can be made very deep and distinct.

The scheduled output of the marking machine is 125 shells per hour. This represents the speed at which the operators can handle the shells, not the speed of the machine. With the shells arranged so that they are within easy reach of the operator he can mark them at the rate of 20 per minute.

**First Complete Shop Inspection and Hospital Work.**—The twenty-first operation is the first complete shop inspection. It covers all the work done in the various operations up to this point of manufacture. It also includes the discovery and correction, if possible, of all injuries suffered by the shells in their passage through the shop. Having undergone so many operations and handlings, many of the shells are slightly bruised and dented. It is the duty of the shop inspectors to look for such defects and of the "hospital gang" to correct all which can be corrected. The hospital gang works under the direction of the shop inspect-

ors, and among its duties is the removal, by filing in the lathe, of the burrs raised by the type in the marking operation. The removal of these burrs permits the high-diameter ring gage to pass over the shell. The edge of the fuse seat in the nose of the shell is quite sharp and for that reason is likely to be dented by coming in contact with the other shells and hard materials in its way through the shop. These dents are corrected with a rose reamer of the proper shape. After passing shop inspection and the necessary corrections having been made by the hospital gang, the shell bodies are thoroughly cleaned. Exceptional care is taken with this part of the work. All dirt and grease both inside and out, are removed by immersing the shells in hot caustic soda. While thus immersed, they and the soda are agitated. After draining, the work is put through two baths of clean boiling water to remove all traces of soda.

For the preliminary examination, shells with the machined parts finished are presented in lots and inspected for freedom from cracks, flaws, scale, rust and other material defects and for smoothness of surface. The operations enumerated in Table 2 are carried out. The recess in the base of the shell is examined.

TABLE 2. INSPECTION OF HIGH-EXPLOSIVE SHELLS

Operation No.	Operation	Per Cent. to Be Done on 18-Pounder
1	Examination of fractures and work marks on billets.	100
2	Internal and external examination before varnishing.	100
3	Undercut in groove for driving band.....	100
4	Low diameter of groove for driving band high and low	100
5	Examination of threads in base and head.....	100
6	Concentricity of cavity.....	100
7	Depth and flatness of recess for base plate.....	100
8	Examination of base plate before insertion.....	100
9	Examination of base recess for flaws.....	100
10	Base calipers.....	100
11	Wall calipers.....	50 <sup>1</sup>
12	Diameter of body high and low.....	100

No patching, stopping, plugging or electric welding is allowed. Shells found correct are marked by the inspector with this work mark in the following manner, as illustrated in Fig. 221.

1. A work mark is stamped on the body immediately in front of the driving-band groove to indicate that the driving-band groove is correct and ready for the band.

2. A second work mark is stamped above the first if the shell is found correct to body gaging and visual examination. (As an alternative these

<sup>1</sup> When a shop has been turning out satisfactory work for some time, the percentage of shells inspected for wall thickness is only from 10 to 20.

work marks may be placed in the rear of the driving-band groove, the one indicating the correctness of the groove being next to it.)

3. A work mark is stamped on the shoulder to indicate that the threads in the head are correct.

4. A work mark is stamped in the bottom of the base-plate recess and one on the base of the shell near the edge of the recess to indicate the correctness of the recess.

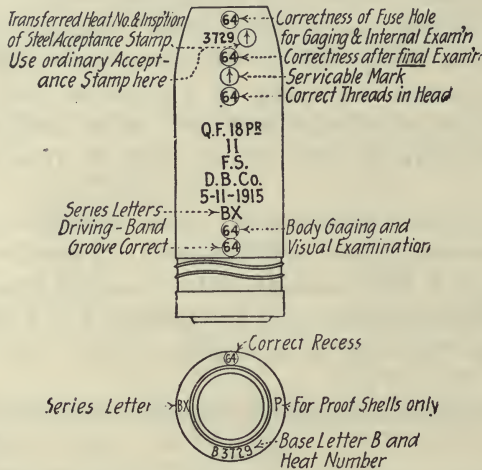

FIG. 221. MARKING CHART FOR GOVERNMENT INSPECTOR

In Fig. 222 is shown the drop-forging die for base plates. The steel used for these dies—one that has given entire satisfaction—is Jessop's, containing 0.75 per cent. carbon. The dies are heated to about 1,450 deg. F. and quenched in water. Before they are quite cold, they are removed from the water and immersed in fish oil, where they are allowed to cool off gradually.

The average life of the dies on this work is about 20,000 forgings before the impression wears so that resinking becomes necessary.

The steel used for forging the base plates is 0.50 carbon, the stock used is  $1\frac{3}{4} \times \frac{7}{8}$  in.

The drop-hammer operator can on an average make 110 small plates an hour. The trimming die is an ordinary round die with a punch to match. An operator can trim about 550 forgings per hour. While not actually an operation on the shell itself, this making of the base plate will be considered as the twenty-second operation in the series.

After forging, the base plates are subjected to a rigid visual inspection. Test pieces are also taken from a certain percentage of the forgings and pulled to destruction. The base plates that pass inspection are trucked from the forge shop to the rough-turning lathes in the shell shop. In these machines the forging undergoes the twenty-third operation, in



The twenty-fourth operation, which consists of finishing the base plates, is done on engine lathes. The spindles of the machines are hollow and provided with draw-in collets to hold the work. The rear tool block *C* is controlled by the ball handle *D*, which is mounted on a screw that passes through a hole in the screw operating the front tool block which in turn carries a circular formed tool of the same shape as the finished base plate.

The operation of finish-turning a base plate is as follows: The rough-turned base plate is chucked in the collet chuck and the facing tool in the rear tool block is then brought forward. When the bottom of the base plate is faced, the tool is returned clear of the work. The operator then feeds the circular forming tool into the work until the stop is encountered. This determines the diameter of the work and finishes the operation.

For inspection three gages are used—a 2.250-in. snap gage for the diameter; a 30-deg. angular gage for the angular part of the work and a 0.22-in. height gage for the height of the cylindrical part. The scheduled time on the finish-turning is about 75 pieces per hour. This is about five times as fast as the highest possible production on the threaded base plate. Furthermore, the tools used are much more rugged than those used for threaded base plates and consequently give less trouble.

To preclude the possibility of trapping the air in the base-plate recess when the base plate is forced home, the Government requires that the base plates have three grooves cut in the periphery of the cylindrical part. These act as vents for the release of the air. The requirement is that the nicks be cut out; that is to say, the metal must be removed, not merely wedged to the sides with a cold chisel, as is the method when the wave ribs are nicked for the same purpose in the copper driving-band groove.

A special machine was constructed for this work, but it was found that using a file was quicker. The base plates are held in a vise, and the operator takes three strokes with the edge of a half-round file. He makes three nicks at an angle of 45 deg. with the base and approximately 120 deg. apart. This finishes the twenty-fifth operation, as there is no inspection. When done, the base plates are trucked to the bench, where they and the shell bodies are assembled preparatory to forcing in the base plate. Assembling, which is the twenty-sixth operation, consists merely of entering the base plate in the recess in the base of the shell body.

In Fig. 223 is shown a 40-ton Murphy pneumatic riveter used for the twenty-seventh operation, which is pressing in the new type of base plate. The assemblers enter the base plates in the recess in the bottom of the shell body. The shells are then placed on a bench convenient to the operator of the riveter. The post, Fig. 223, is hinged so that it can be tilted forward for placing and removing the shell.



The operation of forcing a base plate into the shell base is as follows: The operator slips a shell over the post, which is tilted toward him, as shown by dotted lines. The post and shell are then pushed back to a vertical position, when its axis is in line with the axis of the plunger.

The air valve is then opened, forcing the plunger downward. One or two strokes of the plunger are sufficient to force the base plate firmly to its seat in the recess in the shell base.

The speed of handling depends on the men and not on the machine. Two men handle the job, and they can press in 200 base plates per hour. After being pressed in, a Government inspector tests each base plate with a hammer blow. Any that sound hollow are removed, and slightly larger ones are fitted and driven in. From the Murphy riveter the shells are trucked to the riveting hammers, of the type shown in Fig. 224, where they undergo the twenty-eighth operation.

The operation of riveting is as follows: The operator slides the table toward him and places a shell from the previous operation over the post *F*. The table is then pushed away from him until brought up by the stop *I*. The operator then depresses the foot lever, and the hammer is started. With both hands embracing it, the shell is slowly revolved on the post until practically all the metal in the riveting

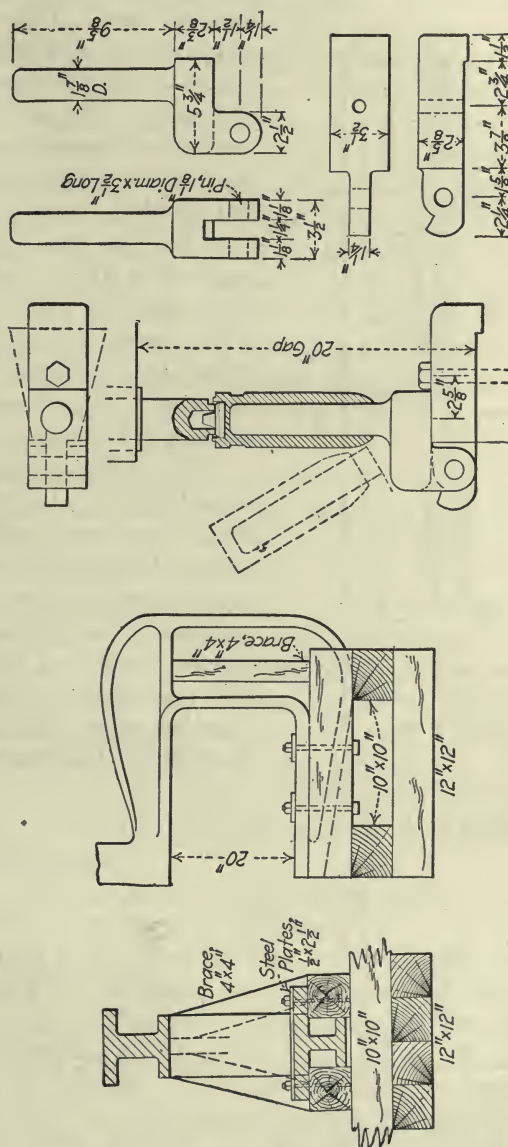

FIG. 223. DETAILS OF MURPHY PNEUMATIC RIVETER FOR FORCING IN BASE PLATES

flange is driven down onto the angular part of the base plate. Riveting the new type of base plate can be done at the rate of about 30 base plates per hour.

After riveting, the work is visually inspected and also given the hammer test. The shells are then credited to the operator and trucked to a bank of Racine hacksaws, where they undergo the twenty-ninth operation. One boy runs two saws, and they are never stopped except to renew blades. The time for sawing is one minute, so the boy's output should be nearly 120 shells per hour.

After the stems are sawed off, the shells are trucked to 20-in. engine lathes, where the base plate and the base of the shells are faced off. This constitutes the thirtieth operation. The lathes are equipped similarly to those used in operation 12. From three to four cuts are necessary to face the bases correctly.

The shells are then trucked to the banding department. The copper bands come in boxes from the copper mills. The dimensions of the copper bands are as shown in Fig. 225. The banding gang, when everything is going right, consists of three men. One man assembles the copper bands and the bodies of the shells, and two men handle the shells into and out of the banding press and operate it. When the gang is working, the operation is as follows:

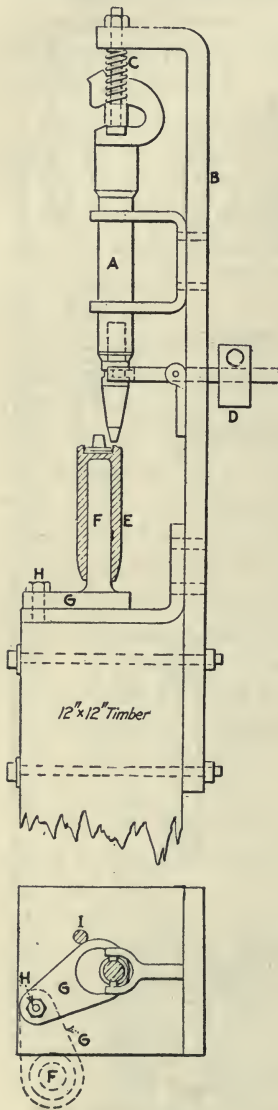

FIG. 224. PNEUMATIC HAMMER ARRANGED FOR RIVETING

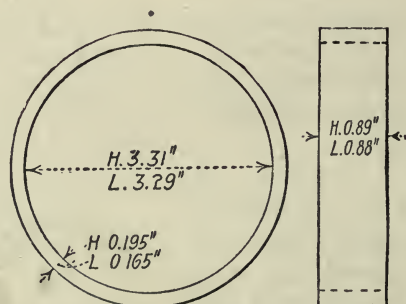

FIG. 225. ROUGH COPPER DRIVING BAND FOR 18-POUNDER HIGH-EXPLOSIVE SHELL

A number of copper bands from one of the boxes are dumped on the assembling bench. The truck boxes with the shell bodies are placed

conveniently for the band assembler. He takes a shell from a truck box and a copper band from the pile on the bench. Laying the band on the bench, he enters the base of the shell into it. Owing to the way the copper bands are shipped and to the fact that they are annealed dead soft, they are usually enough out of round to cling to the shell. The assembler then raises the shell and the band, which clings to it. With the shell as a ram he bunts the band on the base of the shell, using the bench to bunt it against. When the band is as far on as it can be driven in this way, he lays the shell on its side and taps the band lightly with a hand hammer at several places on its perimeter, to expand it slightly so that it can be slipped along the body to its position over the driving-band groove. It is a fairly snug fit sidewise in the groove; but as it has been expanded sufficiently to pass over the body, it will not remain in position in the groove. To assure that it remains in place till it is compressed, the assembler closes it into the driving-band groove at two diametrically opposite places by blows with the hand hammer. He then stands the assembled shell and band on its base in a position convenient for the operator of the banding press.

The banding-press operator takes the shell and centers its base downward in the dies of the press. He then opens the operating valve, which causes the six dies, connected with the six cylinders of the press, to close on the driving band and force it into the driving-band groove. The operating valve is then reversed, and the dies open. As soon as the work is clear of the dies, the operator gives the shell a slight turn, approximately the twelfth part of a circle, so that the ridges formed on the compressed band between the dies in the first squeeze are about in the centers of the individual dies. The work is then given a second squeeze. After the second squeeze, the bands are given the hammer test, the work is credited, and the shells are trucked to the band-turning lathes, which are located near the banding presses. A banding gang has assembled and pressed copper bands on 3,300 shells in 10 hr.

The arrangement of the tool holder on the lathes used for band-turning is shown in Fig. 226. The taper of the jaws and the pitch of the thread on the chuck are such that it is self-closing. The operator places the base of a shell in the jaws of the chuck and brings the cup tail center up against the nose of the shell. The lathe is then started. The inertia of the shell and the friction cause the chuck jaws to tighten themselves automatically on the base of the shell. The operator feeds the tool in to the stop. As soon as the stop is encountered, the tool is withdrawn.

The tool leaves a slight burr on the edge of the copper driving band. This burr must be removed with the band scraper, shown at A, Fig. 226. This band scraper is pivoted and remains on the tool post above the tool while the band is being turned.

A mere touch on the edges of the copper band removes the burrs.

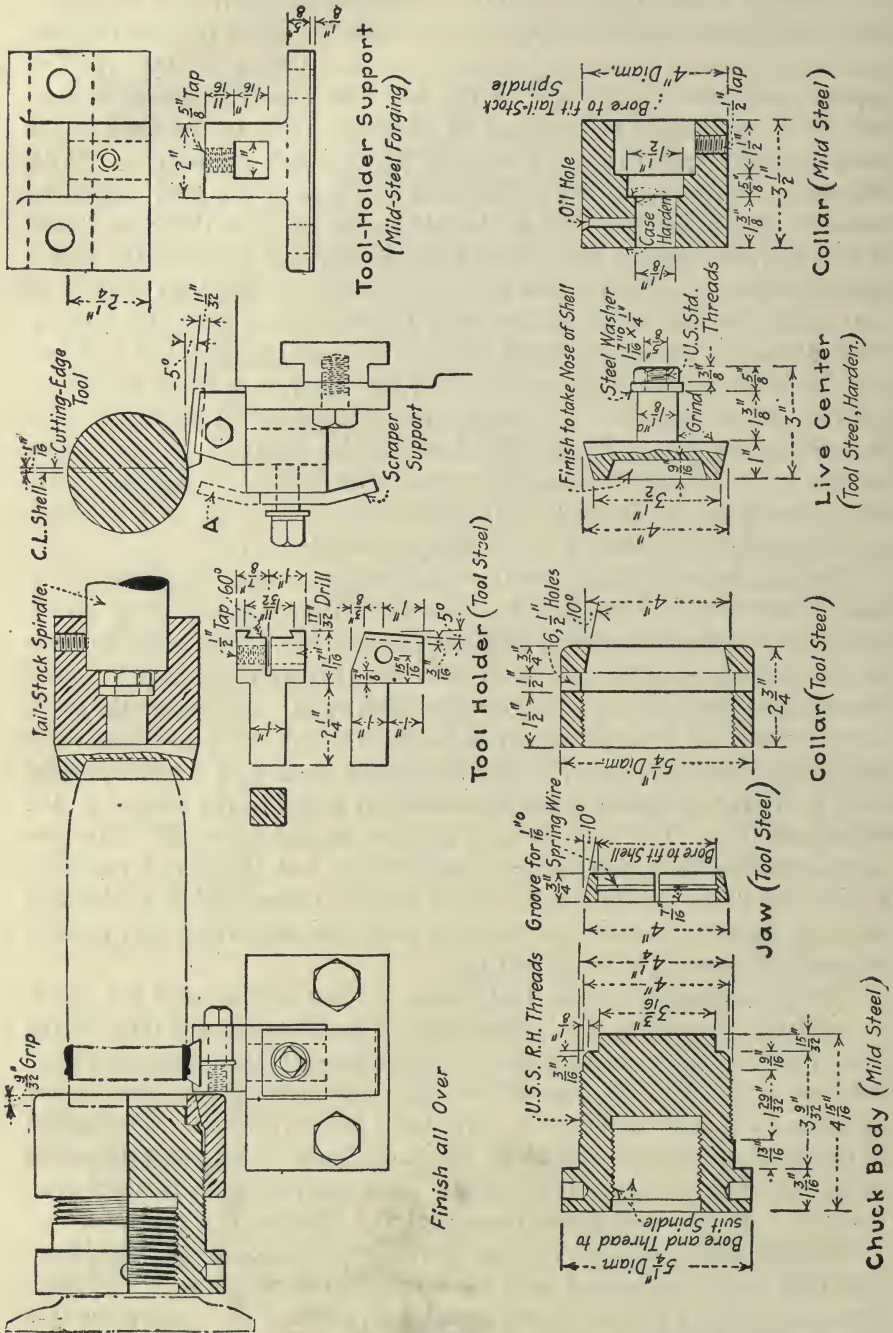

FIG. 226. DETAILS OF BAND-TURNING LATHE ACCESSORIES

Owing to the fact that the copper is turned at a much higher speed than would be possible with steel, the formed tool is made slightly narrower than the copper band, so that there will be no chance of the tool coming in contact with the steel body of the shell and thus destroying its edge. After scraping, the chuck is opened with a pin spanner, the shell taken out and the gage passed over the band by the operator for the only and final inspection.

High-speed steel is used at the Dominion Bridge Works for the formed tools for turning copper driving bands. The contour of the form-turned driving band is shown in Fig. 227.

The life of a tool is dependent on a number of factors and therefore varies greatly. From 100 to 430 copper bands have been turned by a tool at one grinding. As it must be kept very keen, the operator touches up the edge of the tool with an oil stone about every 30 bands. An emulsion of soluble oil and water is used to lubricate the cut.

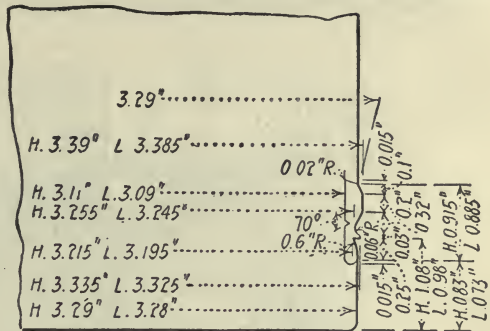

FIG. 227. FORM OF DRIVING BAND

After turning, the shell is subjected to a rigid inspection in which nine gages are used. They are shown in operation sketch 33. In Fig. 228 is shown the latest drawing of the 18-pounder high-explosive shell, which is known as Mark III and supersedes Mark II. Having passed inspection and having been stamped and credited to the operator, the shells are trucked to the varnishing department.

At the Dominion Bridge Works the first operation in the varnishing department consists in screwing bushings into the thread-milled fuse hole in the shell. These bushings are made of cast brass and are very light. They have a hole entirely through them, and their object is to protect the threads in the nose from the varnish. Once screwed in they remain in the shells till after the baking. The operation of screwing in the bushings is a simple one. The men enter the bushings in the shells and screw them down as far as they will go by hand. Then with a flat cranked key, which engages with the lugs projecting inwardly from the upper part of the bushing, the men screw the bushings down as far as they will go.

Varnishing at this works is done with a Bowser oil tank. The tank is filled with varnish. The shells, with the bushings screwed in their noses, are placed conveniently for the operator who handles the Bowser tank. They are taken one at a time and placed under the spigot and



the same time that the brush is caused to rotate as described, the hands and brush are reciprocated up and down so that the varnish is evenly distributed all over the inner surface of the shell. When carefully done, no varnish is smeared on the outside of the shell, which of course eliminates the cleaning operation after the shells are baked. By this method three men can varnish 3,000 shells in 10 hr.

In one of the large factories in the United States the varnishing department is laid out as shown in Fig. 229 and run in the following manner: Just previous to varnishing, the shells are thoroughly washed in gasoline in the tank *A*. When taken from the tank, they are placed on vertical

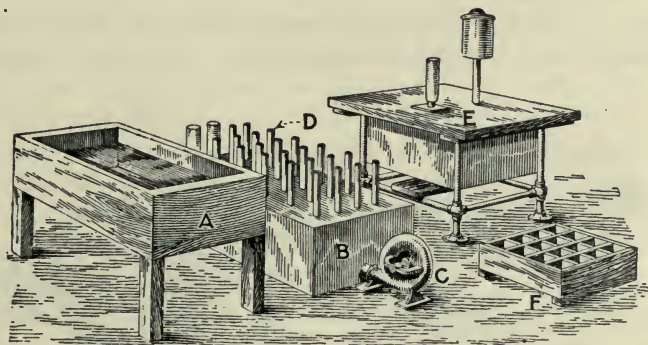

FIG. 229. LAYOUT OF SHOP USING VARNISH SPRAYER

tubes *D*, projecting from the top of the sheet-iron box *B*, to dry. The arrangement of the box *B* is as follows: It is made of sheet iron on an angle-iron frame and is inclosed on all sides. Inside the box is a series of steam-heating coils. Outside the box is a motor-driven blower *C*, which drives air in over the coils. The top of the box is perforated to receive the short pipes *D*. The lower ends of these pipes open to the hot-air space in the box; and the upper ends, to the atmosphere. All the air that passes into the box from the blower must pass out through these pipes.

At *E* is the varnishing machine made by the Spray Engineering Co., of Boston, Mass. The operation of varnishing with this outfit is as follows: By the time the pipes *D* are all filled with shells the first shell is not only dry, but has attained a temperature of approximately 150 deg. *F*. and is ready for varnishing. The operator of the varnishing machine has two helpers to assist him. A hot shell is taken by the first helper from a pipe *D* and placed nose down on the table of the varnishing machine. The varnisher lifts it and places it over the spraying nozzle. The mechanism that does the actual varnishing is an atomizer, the nozzle of which is vertically disposed. Surrounding the nozzle is a sheet-metal bushing that is small enough in diameter to enter the fuse hole in

the shell. It is of sufficient length adequately to protect the thread in the fuse hole from the atomized varnish.

In some cases the weight of the shell opens the air valve of the atomizer; in others the valve is operated by a foot lever. In either case the time consumed is very short. The atomizing nozzle sprays the varnish over the inner surface of the shell so evenly and in such accurate quantity that, while the surface is entirely covered, there is no excess or dribbles of varnish. The shell is removed, and the second helper places it in the tray *F*, which takes the shells to the baking ovens. In the meantime the first helper has another shell ready. With this outfit one varnisher can varnish 2,500 shells in 10 hr.

Another method of varnishing, employed in one of the large shops in the United States, also uses an atomizer. The device was made at

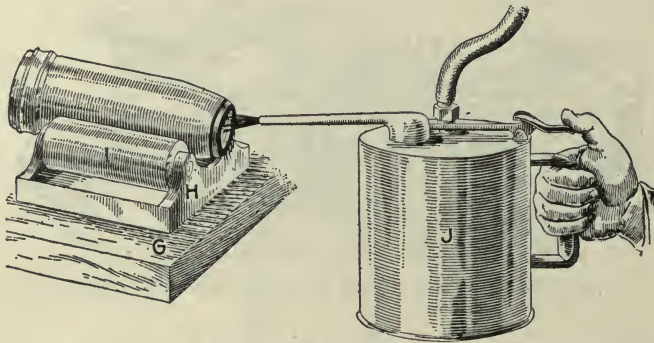

FIG. 230. VARNISH ATOMIZER FOR INSIDES OF SHELL

the works, where they have had a great deal of experience in varnishing and lacquering brass goods. Just before varnishing in this factory the shells are cleaned in hot caustic soda, after which they pass through two washings in boiling water to remove all traces of the caustic soda. They go direct from the last boiling-water bath to the varnishing operation and are so hot (approximately 150 deg. F.) that the varnisher has to protect his hands with gloves.

On the bench *G*, Fig. 230, is the fixture *H*, which has two rollers *I* about 3 in. in diameter and 6 in. long. The operator takes a shell with his right hand and lays it on the rollers *I*. In his left hand he holds the atomizer *J*. The atomizer has a long nozzle which the operator enters in the nose of the shell. The valve of the atomizer is controlled by the thumb of the left hand. The atomizer is operated by air at 90 lb., from the shop compressed-air service. While the varnish is being sprayed in the shell from the atomizer held in the left hand, the operator's right hand keeps the shell rotating on the rollers. As the work is in plain view of the operator and the atomizer valve is under control of his left thumb, no bushing is used or necessary to protect the thread. By



this method one man can varnish 1,000 shells in 10 hr. The work is very good, the number of rejects for poor varnishing amounting to only 1 per cent.

After varnishing, at the Dominion Bridge Works, the shells are placed in steel racks accommodating 77 shells each. The racks are stacked and trucked to the drying ovens in which they are subjected to a temperature of 300 deg. F. for 6 hr. (operation 34). The ovens are heated by the hot gases from Bunsen burners, situated at the bottom of the furnaces, circulating through thin sheet-iron ducts that entirely cover the floor, sides and roof on the inside of the ovens.

In another shop, the shells are heated to 350 deg. F. before the varnish is applied. This treatment gives fairly good results.

The varnish adhering to the outside of the shells is then removed with scrapers, waste, etc., and the temporary bushing which was inserted to protect the threads of the fuse-hole removed—operation 35.

The fuse-hole is next hand-tapped to finished size, the shells being held in cast-iron hinged chucks, and mounted on stout posts set in the floor of the shop. Adjustable taps are used and give fair satisfaction. Ordinary tap wrenches are used with either type of taps, and a man can tap about 30 fuse holes per hour.

After tapping, the shells are trucked to the Government inclosure to undergo the final Government inspection. The finished shells weigh 14 lb. 13 oz.  $2\frac{1}{2}$  dr., with an allowance of plus 1 oz. 3 dr. or minus 2 oz. 5 dr. The operations for the final Government inspection are enumerated in Table 3. Shells that are found correct are stamped with the inspectors' work marks in the following manner.

A work mark is placed immediately below the fuse hole to indicate correctness of the fuse-hole examination, gaging and external examination. The serviceable sign is stamped above it to signify the correctness of the final examination and external gaging. The serviceable sign, which is the British broad arrow with a *C*, will not, however, be stamped until results of the proof and varnish tests are received. While awaiting receipt of these, the shells may be painted. Reports on the preliminary and final inspections are kept on forms supplied by the Government.

From each consignment of varnish and paint that the contractor proposes to use, one-quarter pint is taken by the inspector, put in bottles supplied for the purpose and forwarded by express to the Government analyst.

Varnish is also scraped from varnished shells. A sample at least  $\frac{1}{4}$  oz. in weight must be obtained, and this governs five lots of shells. The contractor is not informed from which shells scrapings are to be taken.

All samples—liquid varnish and scrapings—must be clearly labeled. The label for the liquid sample shows the firm which supplied the varnish, the firm which received it, the amount of the consignment and the date

received. The bottles containing the scrapings are labeled to show the name of the firm, the lot or lots from which the sample is actually taken and the lots which will be governed by the sample.

TABLE 3. INSTRUCTIONS FOR FINAL INSPECTION OF 18-POUNDER  
HIGH-EXPLOSIVE SHELLS

No. of Operation	Operation	Per Cent. To Be Done
13*	Testing base plate for looseness.....	100
14	Screw-gage fuse hole, high and low.....	100
15	Examination of screw threads in fuse hole.....	100
16†	Depth of recess in fuse hole.....	Optional
17	Diameter and angle of recess.....	100
18	Internal examination for flaws and varnish.....	100
19	Weight.....	100
20	Width of driving band and distance from base.....	100
21	Form of driving band.....	100
22	Distance of fixing screw hole.....	100
23	Hammer test, driving band.....	100
24	Form and radius of head.....	100
25	Cylinder gage.....	100
26	Length over all.....	100
27	Examination of markings on body and base.....	100
28	Examination of heat number.....	100
29‡	Diameter rear part of driving band.....	100
30	Diameter driving band, high and low.....	100
31	Greasing and fixing plugs and setscrews.....	100
32	Ring-gage diameter over paint.....	100

The results of the analysis are reported to the inspection office at Quebec, which notifies the manufacturers when the lots successfully pass the final Government proof and varnish tests.

When scraping the varnish from the shells, the following points are to be strictly attended to:

1. The nose of the shell down to 2 in. from the fuse hole outside and also the threads are to be wiped clean with a clean piece of rag or waste.
2. The scraper is to be in a polished and bright condition and kept for this purpose only.
3. The examiner is to have clean hands.
4. The paper on which the scrapings of varnish are collected is to be clean and is not to have been previously handled.
5. There must be no steel in the scraped samples.

As it is practically impossible to scrape varnish off the surface of the shell without scraping some of the steel, the fifth requirement has given the inspectors some trouble.

\* This test will be made by the inspector in the open shop as soon as the base plate has been inserted and machined off. † The forming of the recess in the fuse hole is itself optional. ‡ All shells that measure 3.286 in. or over are marked with a cross in green paint below the driving band. In the loading station these shells are fitted to cases that are large in the mouth.

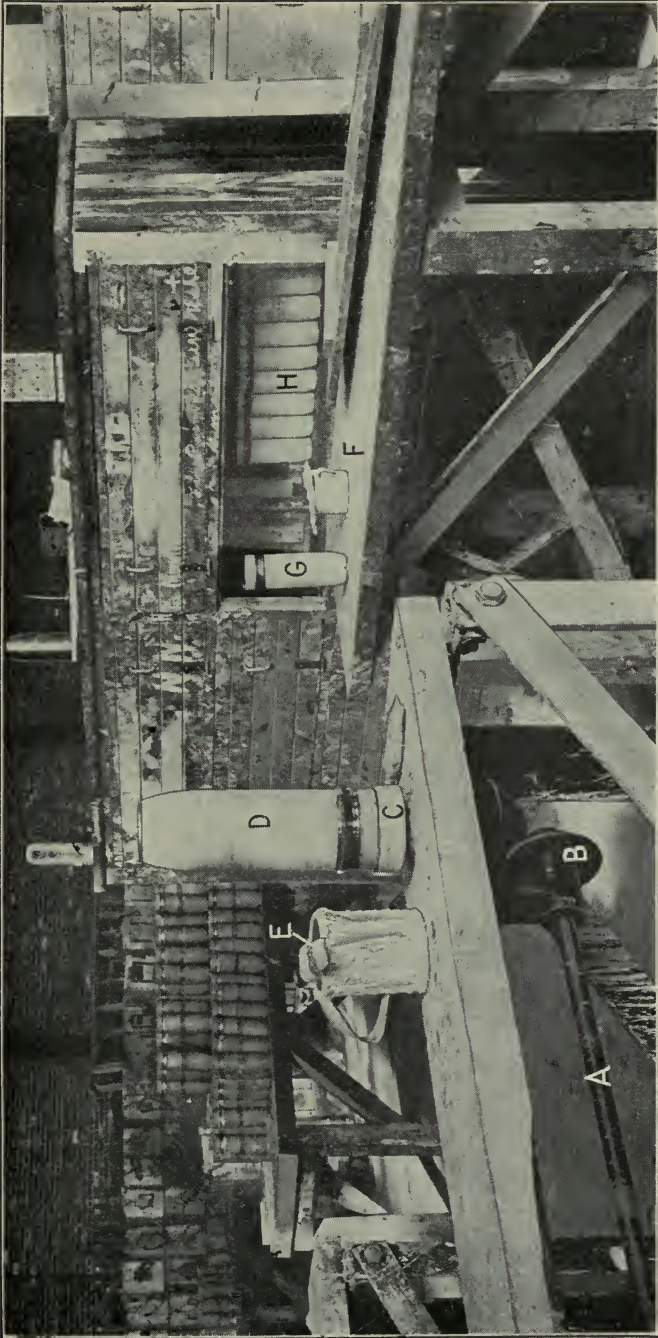

FIG. 231. PAINTING DEPARTMENT IN WHICH THE PRIMING COAT IS APPLIED

Having passed the final inspection the shells are trucked to the painting department. The painting machines are driven by friction cones mounted on shafts instead of being belt driven from small individual motors. The arrangement of the friction-driven painting machine is shown in Fig. 231. A single motor and a system of shafts and friction cones drive the six painting machines in this department. At *A* is a shaft that is driven from a small motor. At *B* are the friction cones, and at *C*, on the end of the vertical shaft from the friction cones *B*, is the painting machine, or turntable. A small vertical flange is provided on the upper surface of the turntable, to retain the shell and prevent it from being thrown off. The priming coat is white and is made up from the following ingredients in the proportions given:

Dry zinc oxide, free from lead,  $9\frac{3}{4}$  lb.; boiled linseed oil, free from lead,  $1\frac{1}{4}$  pints; terebene, free from lead,  $1\frac{1}{4}$  pints; spirits of turpentine,  $1\frac{1}{2}$  pints. It is of the utmost importance that the ingredients employed in the manufacture of paints for high-explosives shells be entirely free from lead.

The actual work of painting is done by boys in the following manner: Referring to Fig. 231, a boy takes a shell *D* from the truck tray and places it on the turntable *C* of the painting machine. The paint is applied with an ordinary flat brush *E* about 2 in. wide, which is dipped into the paint and traversed up and down over the body of the shell, which rotates with the turntable. Care is exercised to keep the paint from getting on the copper band and also to keep the film of paint from being too thick, as the painted shells must later pass through a ring gage.

As the boys finish the painting, others take the shells carefully and stand them on their noses on a bench. When in this position, shown at *G*, Fig. 231, the bottom of the shell base is painted with the priming coat. Again the shells are carefully lifted, so as to remove as little of the paint as possible, and stood nose down, as shown at *H*, in the hot cupboard. This is of wood, and at the bottom is a steam-heating coil. Above are several sheet-steel shelves perforated so that the heat from the coil at the bottom can circulate freely through the whole cupboard. Each compartment will accommodate an entire series. The shells are stood in the cupboard as close as they will go without touching. They remain there till they are dry, which under normal conditions takes about an hour. The cupboards are provided with doors on both sides, so that the boys who put on the second coat of paint can take the shells direct from their own side.

The finish-painting department, where the second coat is applied, is laid out in exactly the same manner and has the same equipment. The paint used for the second coat on the 18-pounder high-explosive shell is yellow. It consists of dry Oxford yellow stone ocher,  $8\frac{1}{2}$  lb.; boiled linseed oil, free from lead,  $1\frac{1}{4}$  pints; terebene, free from lead,  $2\frac{1}{2}$  pints;

spirits of turpentine,  $1\frac{1}{2}$  pints. It is applied in exactly the same way as the first coat, with this exception: The first-coated shells are taken by a boy, who places them on the turntable of the painting machine. With a steel gage he then scribes two parallel lines an inch apart around the body of the shell. After the yellow paint has been applied to the parts of the shell above and below the lines *D*, a band of green paint is

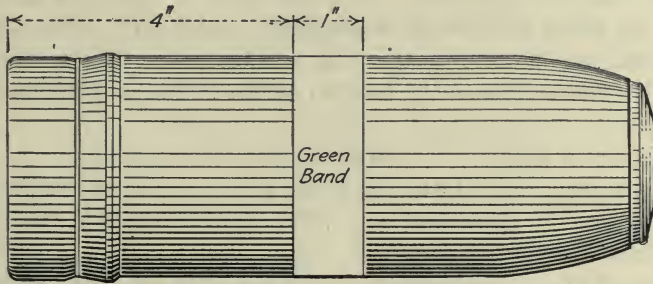

FIG. 232. LOCATION OF GREEN BAND

applied between them. This green band of paint signifies that this is the 18-pounder *high-explosive* shell and not the 18-pounder *shrapnel*.

Six boys on first-coat painting will average 15 series in 10 hr.—that is, 2,750 shells in 10 hr., or approximately 46 shells per boy per hour. On the second-coat painting, owing to the extra work necessary because of the green band, 8 boys are employed, and on this work the 8 boys will average the same as the 6 on the priming coat—15 series in 10 hr.

The drawing, Fig. 232, shows the official location of the green band on the shell body.

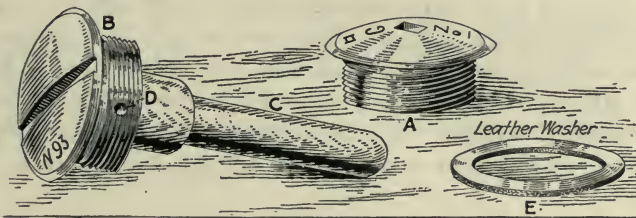

FIG. 233. TWO TYPES OF PLUGS AND A WOODEN GAIN

After the second coat is thoroughly dry, the shells are taken to the bench to have the temporary plugs and fixing screws inserted. The plugs are made of cast iron; and to prevent their rusting, they are plated with zinc, copper or nickel. Two shapes of plugs are in common use; these are shown in Fig. 233. The one at *B* is fitted with a wooden gain *C*. This wooden gain fits a cylindrical recess in the lyddite explosive charge, which later accommodates the steel gain that is screwed into the adapter in the fuse.

These cast-iron plugs are bored, concentric with the thread on the outside, for the reception of the large end of the wooden gaine. The hole in the plug is about  $1\frac{1}{4}$  in. in diameter, 1 in. deep. The large part of the gaine is required to be a snug push-fit in this hole. When the gaine is pushed to the bottom of the hole, a  $\frac{3}{16}$ -in. hole is drilled through the plug and gaine at right angles to their axes and about  $\frac{5}{8}$  in. from the face of the plug. Into this hole a steel pin is driven, to prevent the gaine from being accidentally pulled out. The pin is made shorter than the diameter of the plug, so that, when driven into the hole, both of its ends are below the bottom of the thread on the outside of the plug.

The wooden gaines are usually made of beechwood. After being turned on a back-knife lathe, they are given a coat of shellac varnish, as required by the specifications. The wood for gaines should be well seasoned and absolutely dry.

The small grub screws in the nose of the shell are called fixing screws. They are  $\frac{1}{4}$  in. in diameter, and their function is to hold the plug from turning and to prevent its being lost. After the plug is removed and the fuse screwed into the nose of the shell, the fixing screw is tightened down on it.

The plugs are screwed in with the wrench, which fits a square hole in them. The grub screws are put in with a screwdriver. There is a leather washer between the nose of the shell and the flange of the plug. Both the fixing screws and the plugs are luted with the Government luting compound.

The luting consists of 80 parts of whiting and 21 parts of oil, both by weight, kept fluid by heating. The materials must be of the finest quality. The oil is 20 parts vaseline and 1 part castor oil, well mixed before it is added to the whiting. The vaseline is to be a genuine mineral-oil residue, without any foreign mixture. It should have a flash point not below 400 deg. F., a melting point not below 86 deg. F. and be free from solid mineral matter. The castor oil must be genuine. The whiting is to be of the quality known as "Town Whiting" and is to be free from moisture.

The luting must be thoroughly mixed, plastic and free from lumps. If on examination of a sample of 10 per cent. of the invoice, it is found that the sample does not comply with the specification, all the material invoices will be rejected without further examination. The luting may be inspected during the manufacture by, and after delivery will be subjected to test and to the final approval of, the chief inspector, Royal Arsenal, Woolwich, or an officer deputed by him.

With the plugs luted and screwed home and the fixing screws set up tight, the shells are ready to pack.

Throughout manufacture, an accurate record is kept of all shells by

heat numbers until they are made up into selected series, in the nineteenth operation, and after every important operation by standard stamps signifying approval. Without this stamp, which must be put on each shell after inspection, no subsequent operation may be performed. This rule allows of no exception.

The standard stamps which appear on all passed shells are as follows:

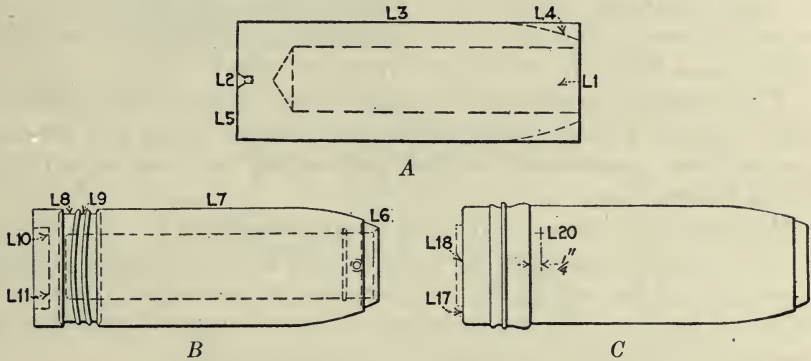

STANDARD STAMPS FOR OPERATIONS ON THE 18-POUNDER HIGH-EXPLOSIVE SHELL

Operation	Description	Stamp, In.	Operation	Description	Stamp, In.
L1	Drill $1\frac{3}{16}$ in. $\phi$ hole.....	$\frac{1}{8}$	L11	Mill base thread....	$\frac{1}{16}$
L2	Center.....	$\frac{1}{8}$	L12	Drill $\frac{1}{4}$ in. $\phi$ hole..	none
L3	Rough turn body.....	$\frac{1}{8}$	L13	Tap $\frac{1}{4}$ in. $\phi$ hole..	none
L4	Rough turn nose.....	$\frac{1}{8}$	L14	Screw in base plugs.	none
L5	Face base.....	$\frac{1}{8}$	L15	Saw off square end .	none
L6	Bore, ream and tap inside.	$\frac{1}{16}$	L16	Rough face plug....	none
L7	Finish turn.....	$\frac{1}{8}$	L17	Rivet or roll plug.	$\frac{1}{8}$
L8	Face base round corners and rough groove.....	$\frac{1}{8}$	L18	Finish face plug....	$\frac{1}{8}$
L9	Wave and undercut.....	$\frac{1}{8}$	L19	Band press.....	none
L10	Recess base.....	$\frac{1}{8}$	L20	Band turn.....	$\frac{1}{16}$

All men, whether on piece work or daywork, must stamp all shells as shown above.

## CHAPTER IV

### MANUFACTURING BRITISH 4.5-IN. HIGH-EXPLOSIVE SHELLS<sup>1</sup>

The British 4.5-in. high-explosive shell is made from a steel forging and the operations employed by the Canadian Allis-Chalmers Co. in converting the rough forged blank into a finished shell ready for loading represents an efficiently developed system of manufacture.

This company overhauled its entire plant; designed and built new tools; conducted much preliminary experimental work and produced a satisfactory sample shell before undertaking any contracts for the British Government.

By careful planning, the Canadian Allis-Chalmers Co. was enabled to resolve the production of the shells into 27 main operations, including thorough shop inspection, the final government inspection, painting the shells and packing them for shipment. The sequence of operations and descriptive sketches of the principle ones are as follows:

#### SEQUENCE OF OPERATIONS

1. Cutting off the rough forgings.
2. Facing ends of forgings.
3. Rough-turning outside of shell.
4. Finishing outside of shell.
5. Finishing inside of shell and facing open end.
6. Nosing.
7. Boring, reaming, facing nose to length and profile boring inside of nose.
8. Tapping nose of shell for socket.
9. Form turning outside of shell to finished size.
10. First shop inspection.
11. Boring to weight.
12. Threading the base-plate recess.
13. Cleaning and sand blasting.
14. Turning and threading base plate.
15. Screwing in base plate.
16. Rough-facing base plate.
17. Riveting base plate.
18. Finish-turning base.
19. Screwing in socket.
20. Turning the socket.
21. Banding.
22. Varnishing inside of shell.
23. Baking varnish.
24. Turning drive band.
25. Final government inspection.
26. Painting.
27. Packing.

<sup>1</sup> E. A. Suverkrop, Associate Editor, *American Machinist*.



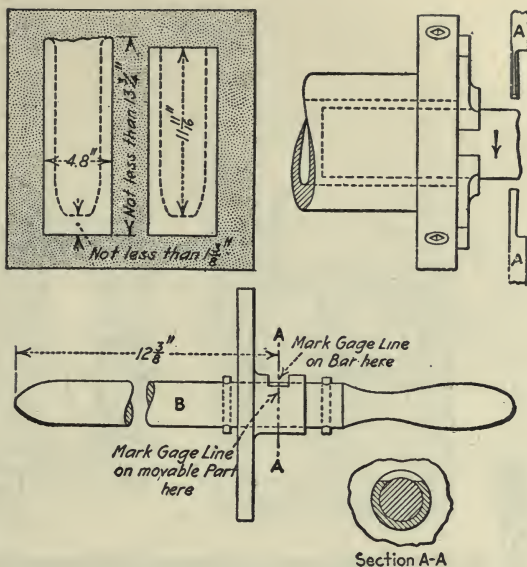

OPERATION 1. CUTOFF

Machines Used—Davis cutting-off machines with front and back tools A.

Special Fixtures and Tools—None.

Gages—Depth gage B or gage which forms part of the machine.

Production from one machine and operator, 20 per hr.

Note—Soap water to lubricate the cut.

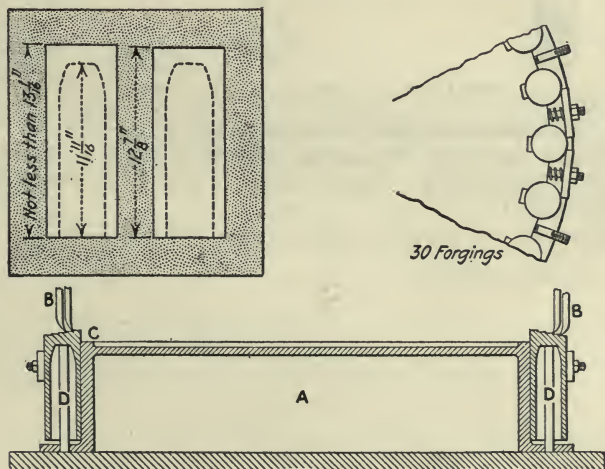

OPERATION 2. FACE ENDS OF FORGINGS

Machine Used—Bertram boring mill with 2 tools, B, in each head.

Special Fixtures and Tools—Circular chucking fixture A to hold 30 forgings. Special tool-holders to hold two tools, one behind the other, so spaced that the one is taking a chip while the other is in the space between forgings.

Gages—Height blocks to set tools from face C.

Production—One man and helper (for loading and unloading only), 30 per hr.

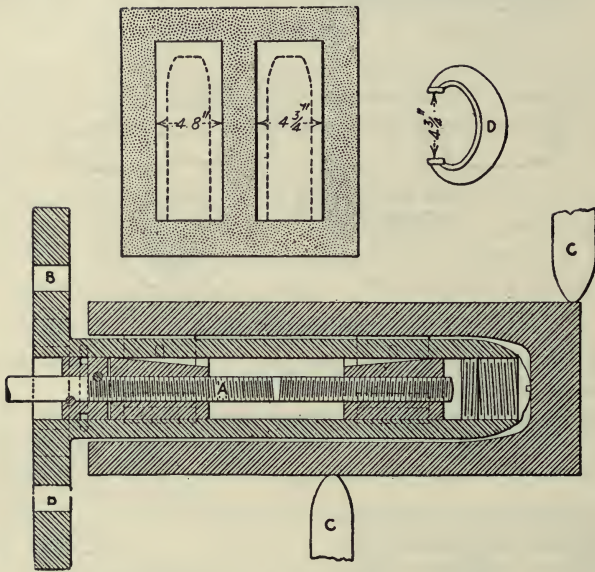

OPERATION 3. ROUGH TURN OUTSIDE

Machines Used—Engine lathes, 24 to 36 in swing.

Special Fixtures and Tools—Expanding mandrel A driven by bolts in holes B, which hold it to lathe face plate. Tools C located to each cut half the length of work.

Gages—Snap-gage D.

Production—From one machine and one operator, 8 to 9 per hour.

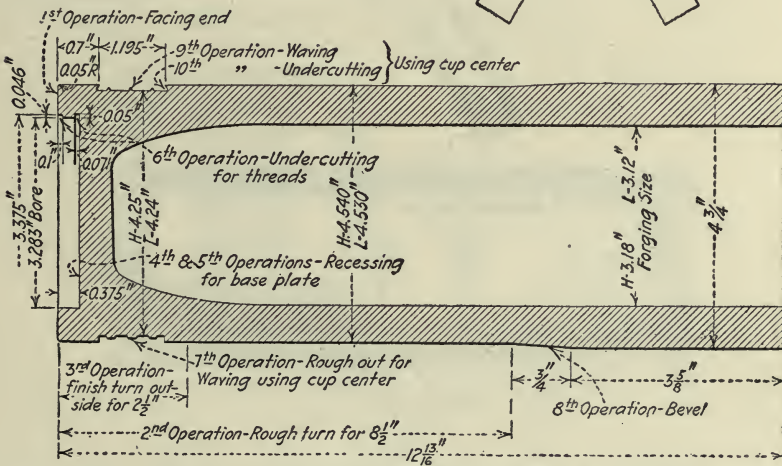
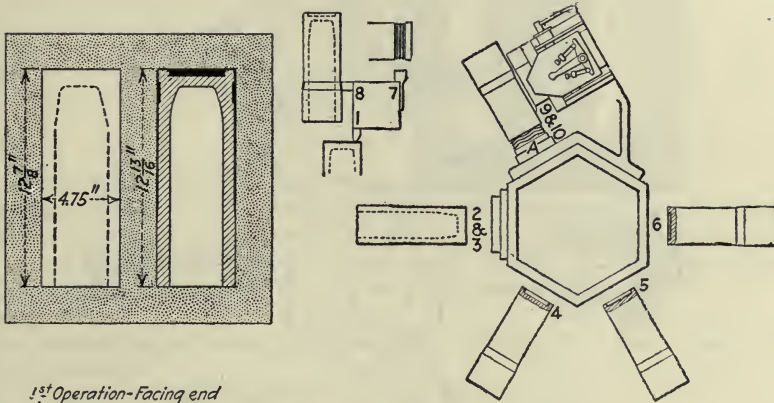

Machines Used—Warner & Swasey lathes.

Special Fixtures and Tools—See text.

Production—From one machine and one operator, 3 per hr.

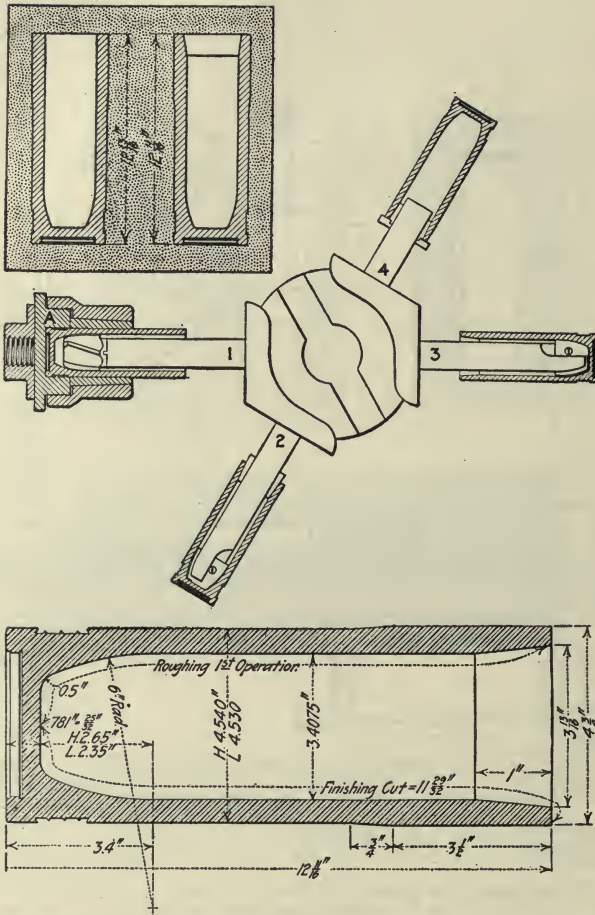

OPERATION 5. FINISH INSIDE OF SHELL AND FACE OPEN END

Machine Used—Steinle, Davis and other turret lathes and vertical boring mills.

Special Fixtures and Tools—Special collet chuck A. Special 4-flute chucking reamer and bar for suboperation 1. Special flat 2-lip rough-boring tool and 2-lip taper reaming cutter and bar for suboperation 2. Special 2-lip finish boring tool and bar for suboperation 3. Special 2-lip facing cutter and bar for suboperation 4.

Gages—None, as tools are made to size and machine stops are used for depths.

Production—From single machine and one operator, 4 per hour; double machine and one operator, 8 per hour.

Note—Soap water lubrication through tubes in boring bars.

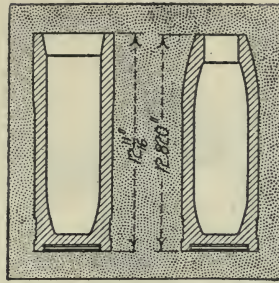

OPERATION 6. NOSING

Machines Used—Steam hammer and special hydraulic forging press.

Special Fixtures and Tools—Two special oil-fired furnaces. Special tongs for handling the work. Overhead trolley support for tongs and work. Special top and bottom dies for steam hammer and hydraulic press. Workstand to facilitate handling. Annealing floor. Trucks and tracks to machining department.

Gages—None.

Production—Steam hammer and three men, 4 shells per minute. Press output not yet determined.

Note—Output is controlled by the speed of the furnaces.

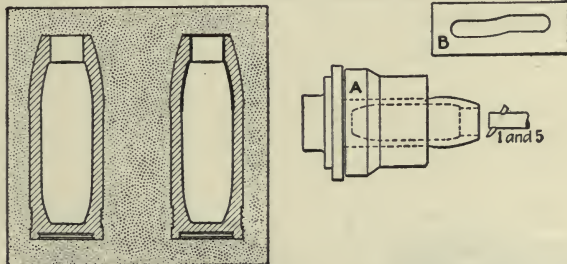

OPERATION 7. BORE, REAM, FACE, NOSE TO LENGTH AND PROFILE BORE INSIDE OF NOSE

Machine Used—Engine lathe.

Special Fixtures and Tools—Collet chuck A, profile cam B, Armstrong boring tool for suboperations 1 and 5; special boring bar for suboperation 2; special reamer and arbor for suboperation 3; special facing cutter and arbor for suboperation 4.

Gages—Plug gage for hole.

Production—From one machine and one man, 4 per hr.

Note—Soap-water lubricant.

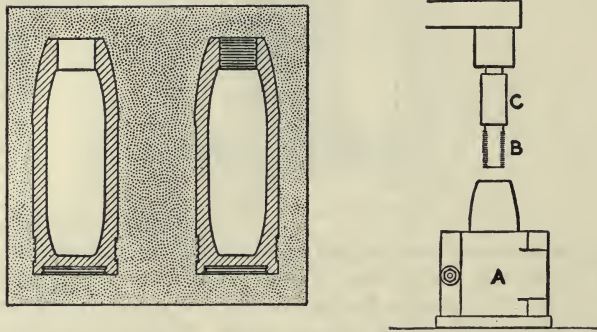

OPERATION 8. TAP NOSE OF SHELL FOR SOCKET

Machine Used—Radial drilling machine.

Special Fixtures and Tools—Special work holder A; special tap B; special tap-holder C.

Gages—Plug thread gage.

Production—From one machine and one man, 15 per hr.

Note—Soap-water lubricant.

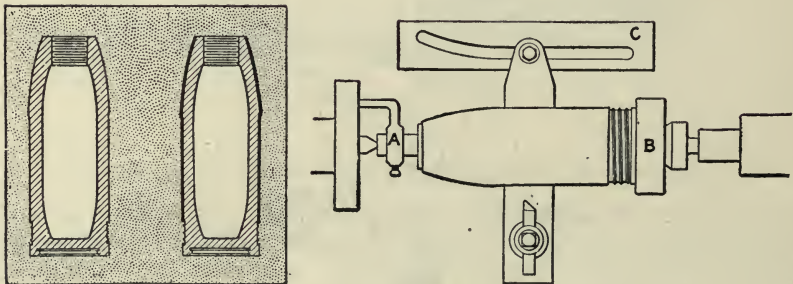

OPERATION 9. FORM TURN OUTSIDE TO FINISHED SIZE

Machine Used—Engine lathe.

Special Fixtures and Tools—Threaded driving plug A, female center B, former G.

Gages—Limit snap gage for body size.

Production—From one machine and one man, 4 per hr.

Note—Soap-water lubricant.

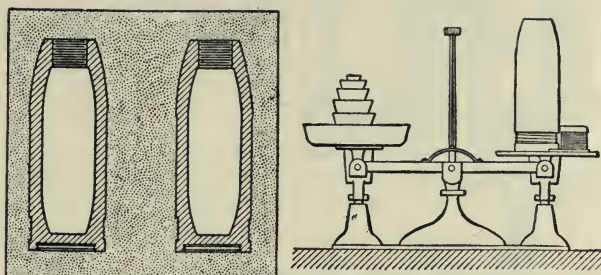

OPERATION 10. FIRST SHOP INSPECTION

Machine Used—None.

Special Fixtures and Tools—Weighing scales.

Gages—For diameter and shape.

Production—One inspector can examine 20 shells per hr.

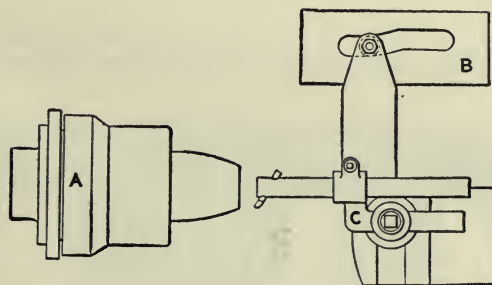

OPERATION 11. WHICH IS NECESSARY IN ONLY ABOUT 50 PER CENT. OF THE SHELLS

Machine Used—Engine lathe same as in operation 7, but without turret.

Special Fixtures and Tools—Collet chuck A, profile cam B, Armstrong boring tool C.

Gages—None. Weight verified by scales.

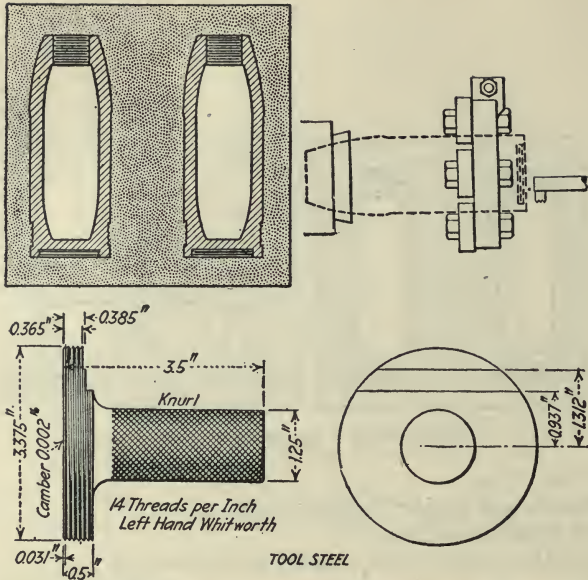

OPERATION 12. THREADING THE BASE-PLATE RECESS

Machines Used—2-in. Jones & Lamson flat turret lathes.

Special Fixtures and Tools—Jones & Lamson thread-chasing attachment. Draw-in chuck. Roller steadyrest.

Gages—Thread gage of the plug type.

Production—From one man and one machine, 16 per hour.

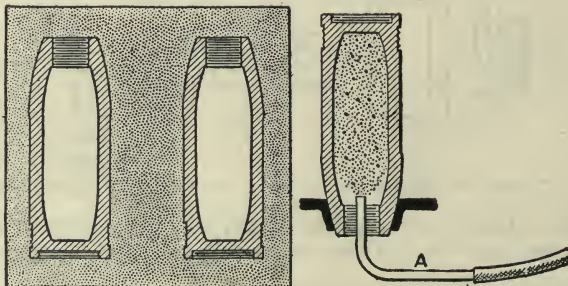

OPERATION 13. CLEANING AND SANDBLASTING

Machine Used—Sandblasting machine.

Special Fixtures—Soda and hot-water tanks. Cast-iron trays. Bent nozzle A for sandblasting hose.

Gages—None.

Production—One man and one helper, 100 per hour.



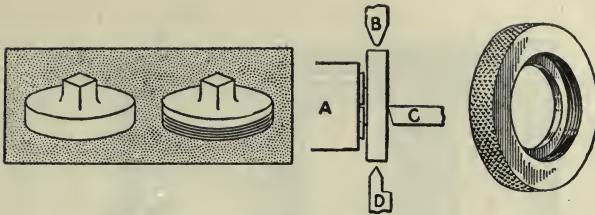

OPERATION 14. TURN AND THREAD BASE PLATE

Machines Used—Bridgeport semiautomatic lathe.

Special Fixtures and Tools—Draw-in chuck A. Turning tool B at back. Hand-operated facing tool C. Threading tool D at front.

Gages—Ring type thread gage.

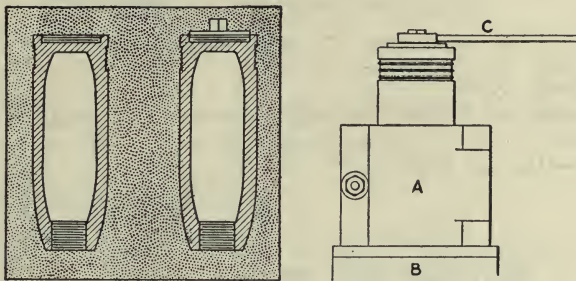

OPERATION 15. SCREWING IN BASE PLATE

Machines Used—None.

Special Fixtures and Tools—Clamp holder A mounted on 12×12 yellow pine post. 6-ft. wrench C.

Gages—None.

Production—Two men about 15 per hour.

Note—Witness mark of Pettman cement on face of base plate.

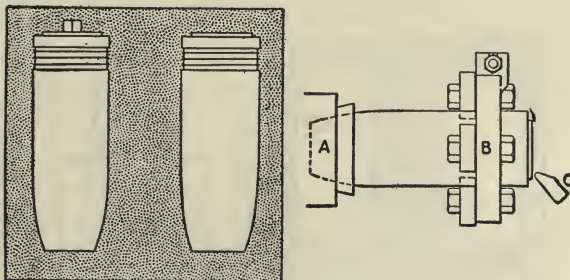

OPERATION 16. ROUGH-FACING BASE PLATES

Machines Used—Jones & Lamson flat turret lathes.

Special Fixtures and Tools—Draw-in chuck A, roller steadyrest B, facing tool C.

Gages—None.

Production—One man and one machine 18 per hr.

Note—Operation 18 is practically a duplication in methods and speed of this operation.

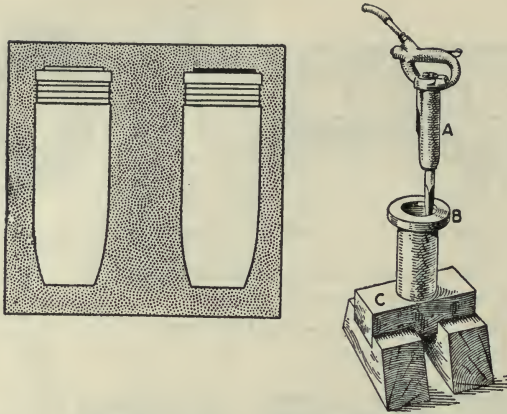

OPERATION 17. RIVET BASE PLATE

Machines Used—None.

Special Fixtures and Tools—Pneumatic hammer A, guide ring B, cradle C.

Gages—None.

Production—One man 45 per hr.

OPERATION 18. FINISH-FACING BASE

Machines Used—Jones & Lamson turret lathes.

Special Fixtures and Tools—Draw-in chuck, steadyrest, facing tool.

Production—One man and one machine, 18 per hr.

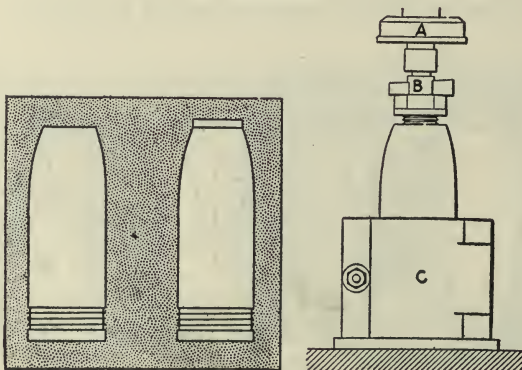

OPERATION 19. SCREWING IN SOCKETS

Machine Used—Back-gear drilling machine.

Special Fixtures and Tools—Frietion driver A, wedge and nut driver B, special clamp holder C.

Gages—Plug thread gage, to test size of socket after inserting.

Production—One man and one machine 30 per hr.

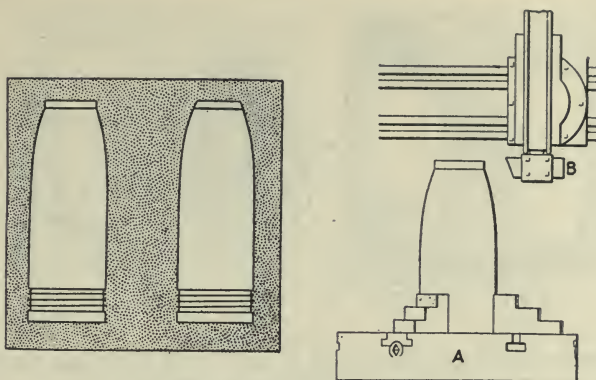

OPERATION 20. TURNING THE SOCKET

Machines Used—Vertical boring mills.

Special Fixtures and Tools—Universal chuck A set central on table. Formed tool B.

Gages—Radius gage.

Production—One man and one machine 30 per hr.

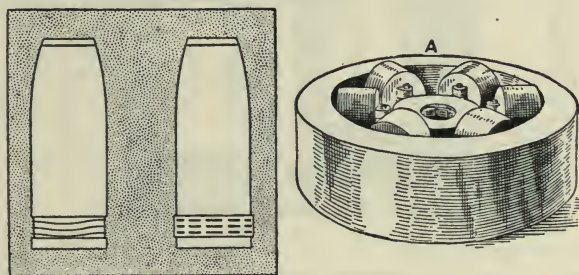

OPERATION 21. BANDING

Machine Used—Hydraulic banding press A.

Special Fixtures and Tools—None.

Gages—None.

Production—From one machine and two men, 45 shells per hr.

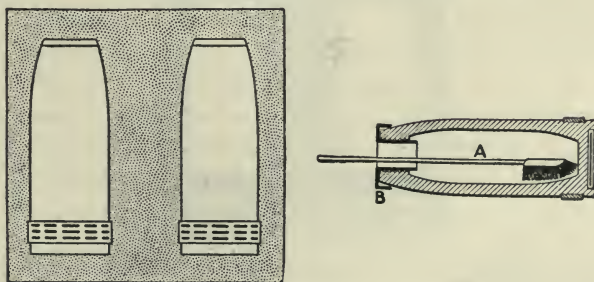

OPERATION 22. VARNISH INSIDE

Machine Used—None.

Special Fixtures and Tools—Varnish brush A; sheet-metal bushing B; varnish pot.

Gages—None.

Production—From one man, about 30 shells per hr.

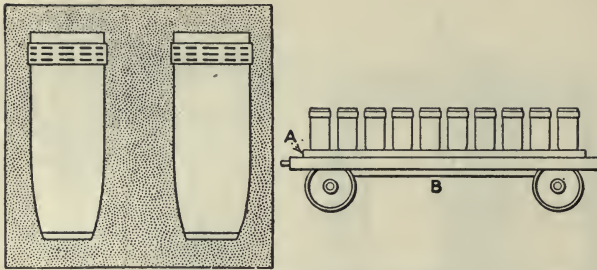

OPERATION 23. BAKE VARNISH

Machine Used—None.

Special Fixtures and Tools—Iron trays A, each for 50 shells; iron trucks B; steam- and electric-heated ovens; thermometer reading to 300 deg.; clock.

Gage—None.

Production—From two ovens, about 400 shells in 8 hr.

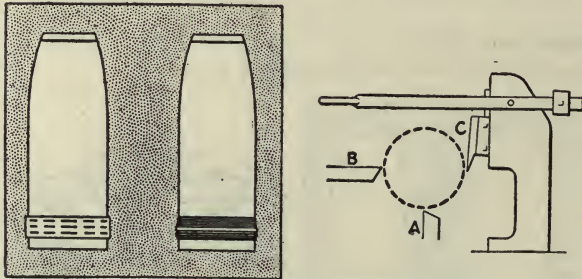

OPERATION 24. TURN DRIVING BAND

Machine Used—Special lathe.

Special Fixtures and Tools—Special chuck cup tail-center; rough-turning tool A; rough-form tool B; finish-form tool C.

Gages—High and low caliper gages and contour gages.

Production—One machine and operator, 20 per hr.

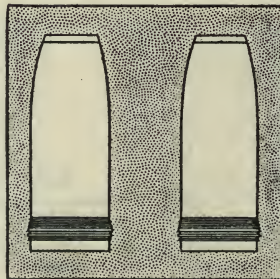

OPERATION 25. FINAL GOVERNMENT INSPECTION

Machine Used—None.

Special Fixtures and Tools—Weighing scales; inspectors' stamps and hammer.

Gages—Complete set to cover all dimensions.

Production—Five men handle the entire inspection for about 1,500 shells per week.

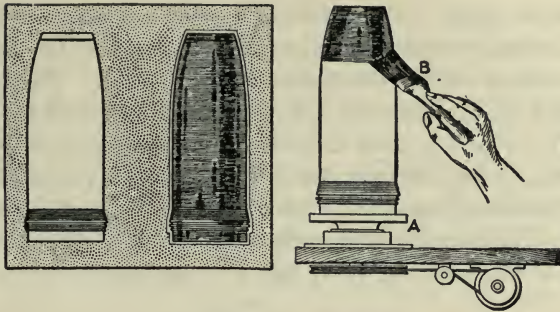

OPERATION 26. PAINTING

Machine Used—Motor-driven turntable A.  
 Special Fixtures and Tools—Paint brush B.  
 Gage—None.  
 Production—One man, 40 per hr.

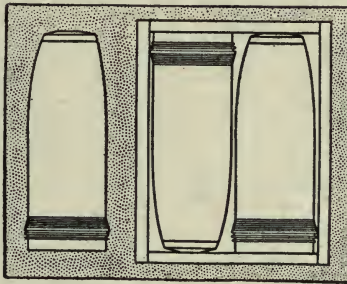

OPERATION 27. PACKING

Machine Used—None.  
 Special Fixtures and Tools—Screwdriver.  
 Gage—None.  
 Production—One man can pack and close about 15 cases per hr.

**Cutting Off the Rough Forgings.**—The first operation consists in cutting off the ragged end of the blanks. The rough forgings are  $13\frac{3}{4}$  in. (or over) in length, over all. These go to Davis cutting-off machines which are provided with gage rods rigidly set in sliding brackets by means of setscrews. The brackets slide on a lower rod held in the machine frame. An adjustable sliding stop limits the travel of the bracket.

There is considerable difference in the thicknesses of the bases of the forgings. The minimum allowance here is  $1\frac{3}{8}$  in., but some forgings have bases over 2 in. in thickness. It is obviously easier to machine the excess metal from the outside rather than from the inside, where there is difficulty in getting rid of the chips and preventing them from crowding the cut. For this reason the gaging of the forgings in the cutting-off operation is done from the inside of the base outward toward the mouth. Two methods of gaging are available—the gage rod previously referred

to and the hand gage. The machine gage is operated as follows: The gage rod is swung forward and entered into the hole in the forging, the face of the bracket coming in contact with the stop. The forging is next pulled forward till the extreme end of the gage rod strikes the bottom of the hole. The chuck is then tightened and the machine started. Two tools are used, an angular one at the back to break the chip for the front tool. The distance from the bottom of the hole to the cutting-off tool is  $11\frac{1}{16}$  in. Each machine can cut off about 20 forgings an hour.

The feed of the machine is by hand or automatic by means of worm and gear.

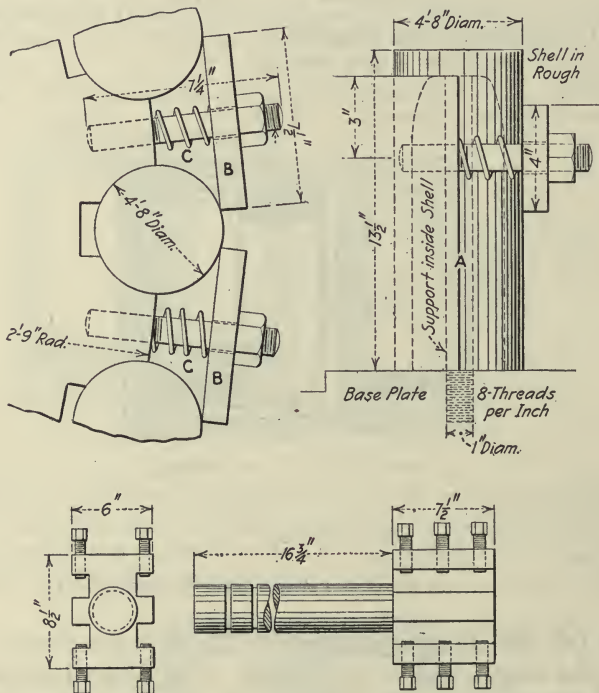

FIG. 234. FACING JIG AND TOOL HOLDER FOR BORING MILL

**Facing the Outside of the Base.**—The next operation is facing the outside of the base. This is done on the 8-ft. Bertram boring mill. Details of the fixture used are shown in Fig. 234 and also in the second-operation sketch.

The jig holds 30 forgings. The same locating point, the inside of the base, is used in this operation as in the previous one. The work rests on the pins *A*, Fig. 234, and is held by the clamps *B*. Four tools are used, two in each holder. The feed is toward the center. Because of the lack of uniformity in the forgings, as previously stated, the amount of stock to be removed varies from a mere scrape to  $\frac{3}{4}$  in. depth.

With work of this character the ordinary tool holder is very inefficient by reason of the continual jolting as the tool passes from piece to piece. To overcome this difficulty a tool holder was made as shown in detail in Fig. 234. The tools in this holder are so spaced, one behind the other, that one of them is always in the cut.

An entire fixture full, 30 pieces, can be faced off in one hour. The operator gages the depth of cut of the lowest, or finishing, tool from the upper face of the jig. The work comes from this operation  $12\frac{7}{8}$  in. long outside.

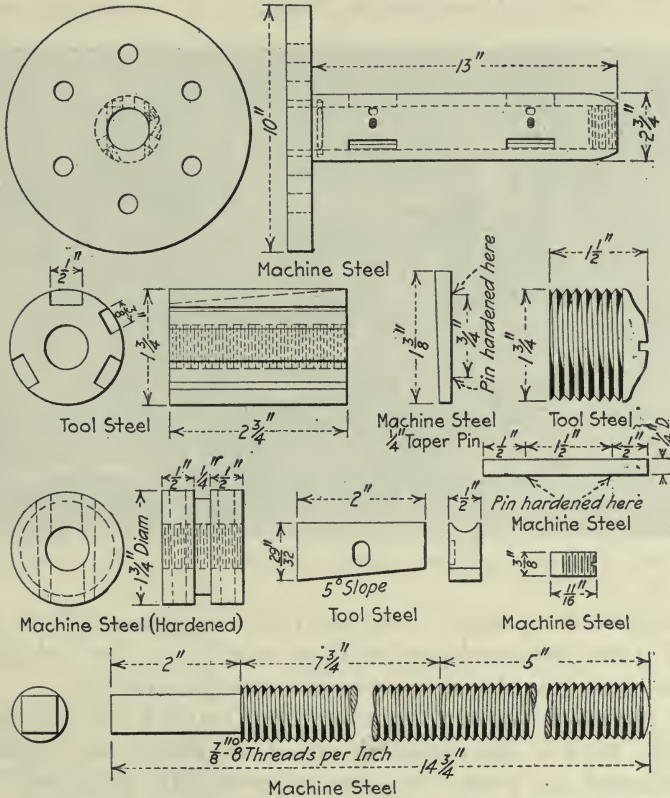

FIG. 235. DETAILS OF EXPANSION ARBOR

The shell is now rough-turned on the outside in the lathe. The shell is held on an expanding mandrel, as shown in detail in Fig. 235 and the third-operation sketch. It is driven by the collar driving dog B.

Two tools C, one at the front and one at the back, are arranged as shown in the operation sketch. The front tool starts its cut at the middle of the forging, while the one at the back starts at the base end. The feed is approximately 1/8 in. and the speed, all the tool will stand. As the forged hole is not concentric, the depth of cut is not uniform. In this

operation the forging is reduced to  $4\frac{3}{4}$  in. diameter. The output is from 8 to 9 per hour for each lathe.

Warner & Swasey hollow hexagon lathes are employed on the fourth operation, with an hourly output of 3 shells per machine. This operation consists of 10 suboperations.

One of these lathes is shown in Fig. 236, the photograph for which was taken from an elevation so as to show all the tools, with the exception of the roller turner.

The work *A*, as in the previous operation, is chucked on an expanding mandrel *B*. But in this set-up the flange of the expanding mandrel is

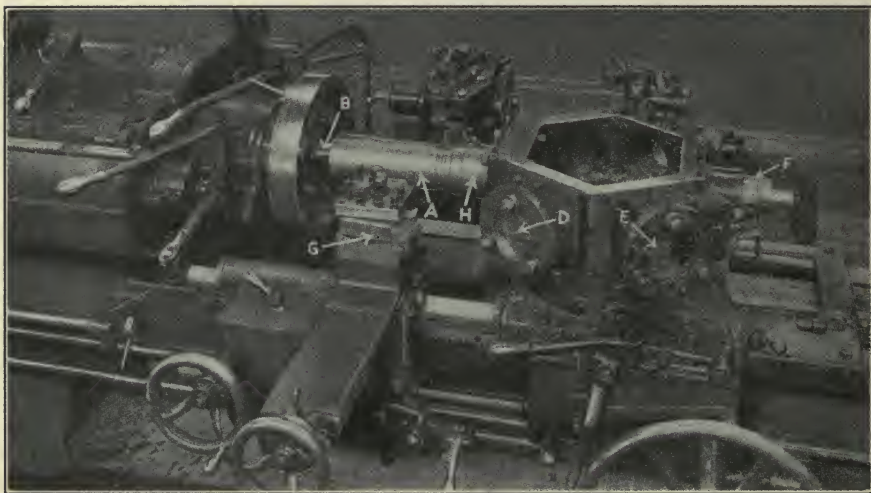

FIG. 236. WARNER & SWASEY TURRET ARRANGED FOR FOURTH OPERATION

bolted to the waving cam *C*, secured to the face-plate. Three tools are mounted in the turret tool-post on the cross-slide and five tools and a cup center are secured to the six faces of the hexagonal turret.

With the exception of the formed tool, marked 7 in the operation sketch, the tools in the cross-slide turret are simple ones forged from high-speed steel and ground to shape on an ordinary tool grinder.

**Facing the Base.**—The operator faces the base end of the shell with the tool for suboperation 1. The cross-slide is then run toward the waving cam, out of the way of the next operation. The roller turner for suboperations 2 and 3 is brought to working position and the shell is rough-turned for about  $8\frac{1}{2}$  in. (suboperation 2).

The turret is returned and the tool set in to finish to turning size. The shell is then turned to finished size (suboperation 3) for about  $2\frac{1}{2}$  in. The turret is indexed and the flat tool *D*, Fig. 236, roughs the recess for the base plate (suboperation 4). This tool is provided with three rollers *A*, Fig. 237, to support the base of the shell during the recessing operation.



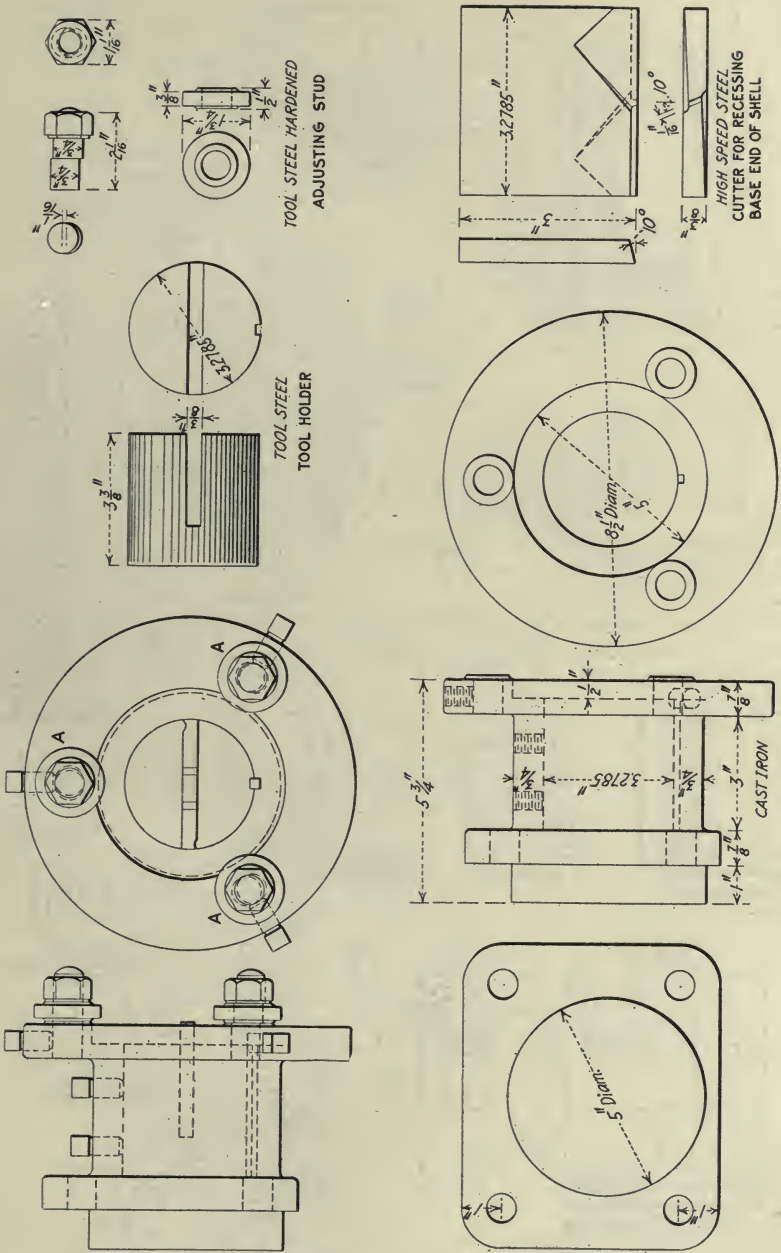

CUTTER HEAD BRACKET  
 FIG. 237. ROUGH RECESSING TOOL AND HOLDER

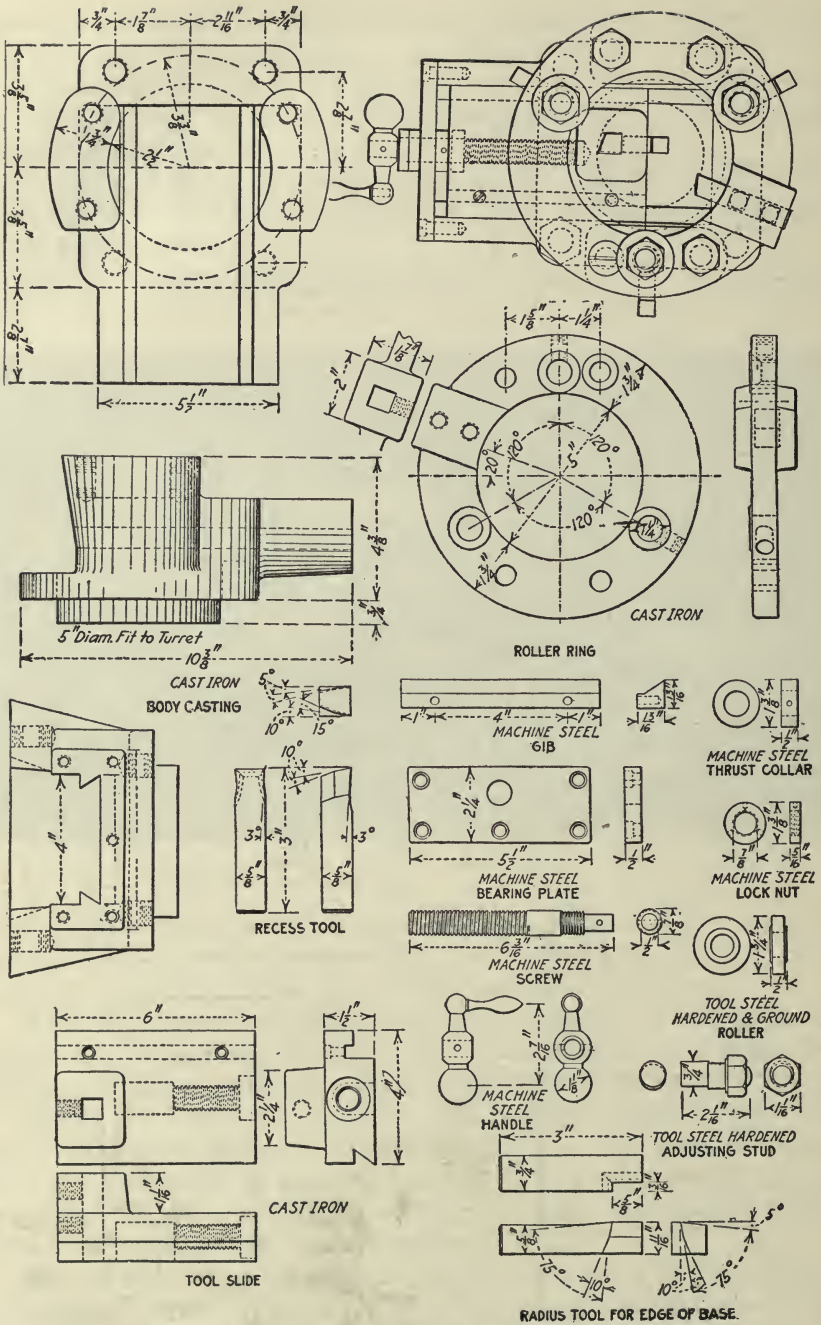

FIG. 238. RECESSING AND RADIUS TOOL FOR SHELL BASES

These rollers are mounted on eccentric studs so that they can be adjusted should the work vary in size.

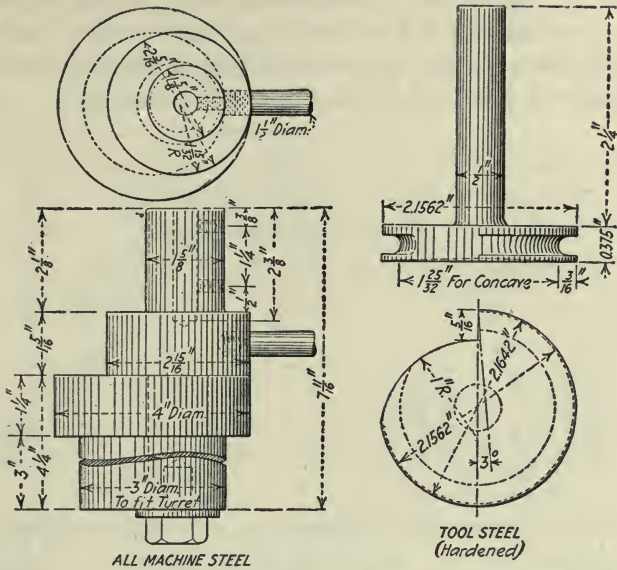

FIG. 239. UNDERCUTTING TOOL AND TOOL HOLDER FOR BASE OF SHELL

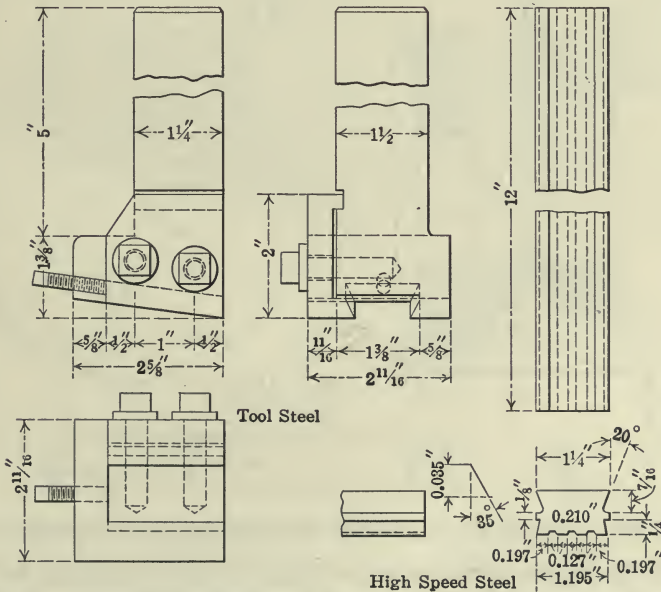

FIG. 240. TOOL HOLDER AND TOOL STOCK FOR ROUGHING OUT FOR WAVING

The finish recessing tool for suboperation 5 is a simple tool of square high-speed steel shown at *E* in Fig. 236 and in the detail Fig. 238. A

square hole is provided in the holder which holds a tool for rounding the bottom edge of the shell at the same time the finish recessing is done. When in use the radius tool is mounted in the stationary steadying ring. The recess-finishing tool is mounted in a hand-operated cross-slide.

The sixth suboperation is performed with a hand-operated eccentric undercutting tool shown at *F*, Fig. 236, and in Fig. 239.

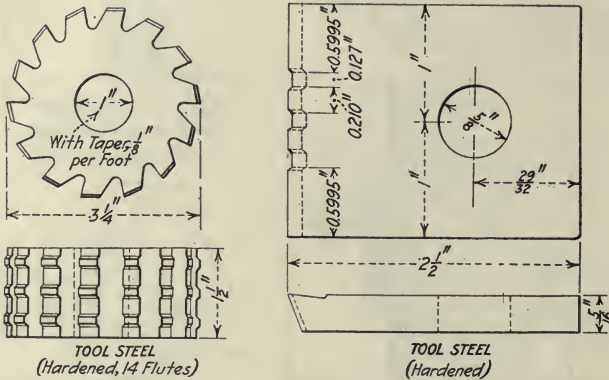

FIG. 241. MILLING CUTTER FOR ROUGHING-OUT TOOL AND TOOL FOR MAKING IT

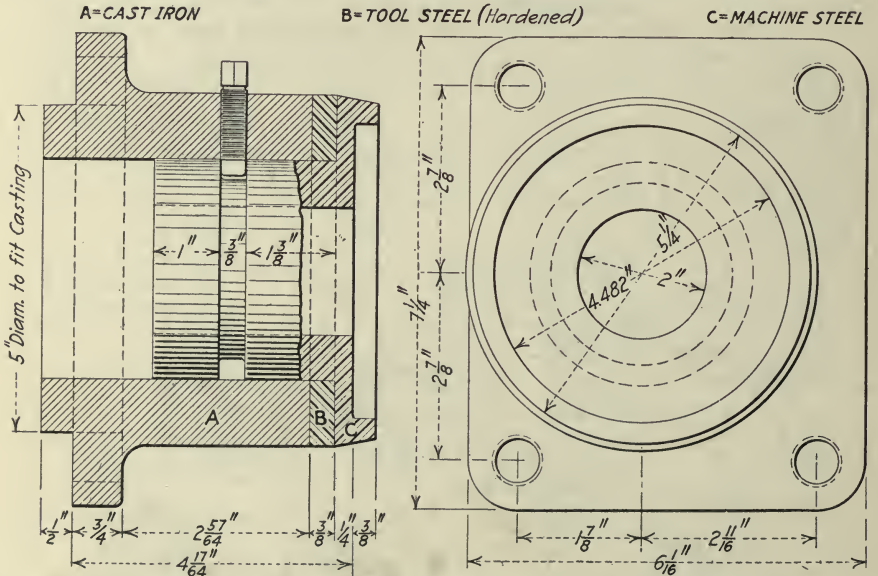

FIG. 242. FEMALE OR CUP CENTER FOR WAVING AND UNDERCUTTING

The seventh suboperation is performed with the formed tool in the cross-slide turret tool post shown at *G*, Fig. 236, and in the detail, Fig. 240.

The roughing-out tools to prepare the work for waving are manufactured from high-speed steel in 12-in. lengths and cut to suitable lengths for the tool holders.

In Fig. 241 are shown in detail the milling cutter for making the roughing tools and the tool for making the cutter.

The eighth suboperation is performed with a forged-steel tool held in the turret tool post in the cross-slide. It is  $\frac{3}{4}$  in. wide, ground at an angle so that the advance edge is flush with the  $4\frac{3}{4}$ -in. diameter of the work and the rear edge flush with the diameter to which the work was roughed in the second suboperation.

For the ninth and tenth suboperations—waving and undercutting the wave groove respectively—the cup center *H*, Fig. 236, is used to support the work. The cup center is shown in detail in Fig. 242.

Waving and undercutting are done by a combination fixture of exceptionally clever design.

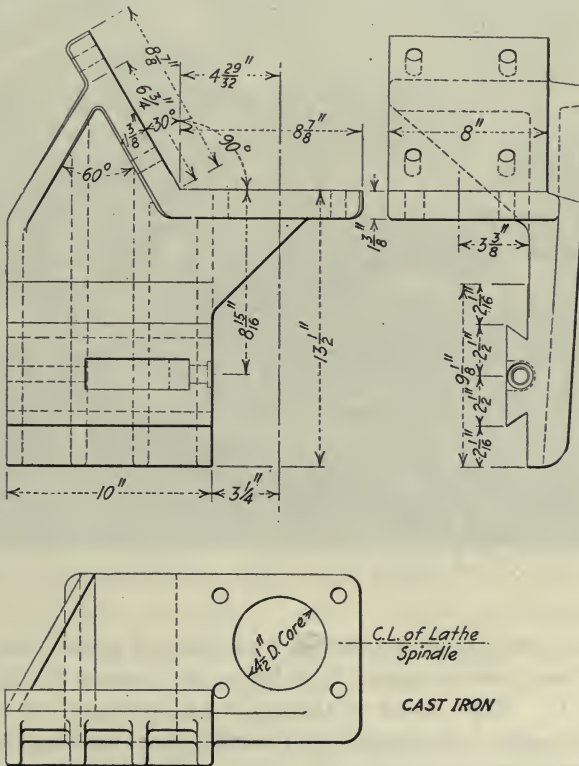

FIG. 243. BRACKET FOR WAVING TOOL ON WARNER & SWASEY LATHES

**Description of Waving Fixture.**—The supporting bracket (Fig. 243) of the fixture is a single casting fitted and bolted securely to two of the faces of the hexagonal turret.

The cup center *H* is bolted to one of the wings of the supporting bracket, and thus forms practically a part of the fixture itself. The bracket *A* is bolted to two faces of the turret. On it is a machined slide for the

member *B*, which is operated toward or from the lathe center line by the screw *C*. This is in turn actuated by a socket crank in the hands of the operator. The member *B* is bored lengthwise of the lathe, to receive the plunger *D*.

The plunger *D* is splined to prevent turning and has a square hole in it for the reception of the shank of the waving tool holder *E*. The tool holder *E* passes through an elongated slot in the member *B*, of sufficient width to permit of the necessary movement lengthwise of the lathe for producing the wave. An elongated hole is also provided at the top for similar traverse of the setscrew *F*, which is tapped into the plunger *D*

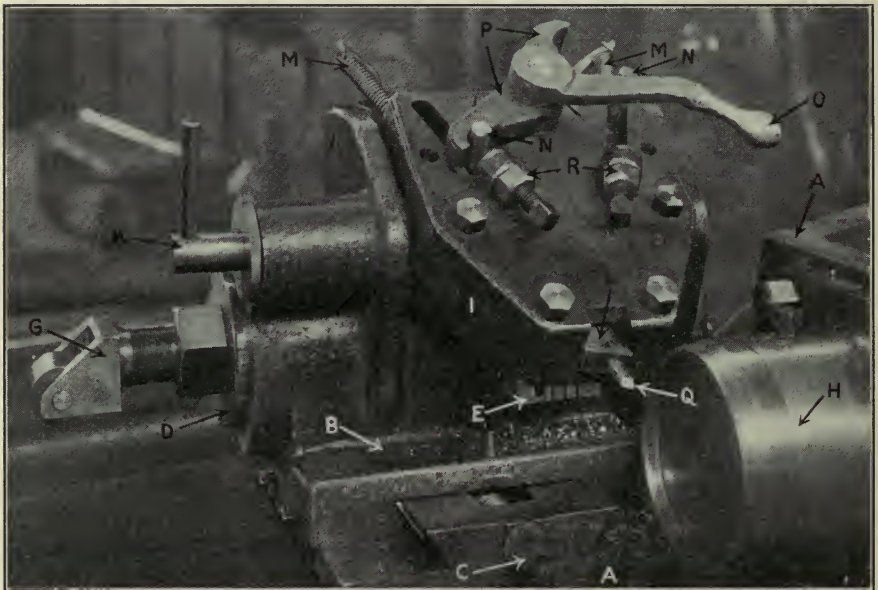

FIG. 244. VIEW OF CUP CENTER AND WAVING AND UNDERCUTTING ATTACHMENT

and binds the tool-holder *E* therein. At the end nearest the lathe head and waving cam, the plunger *D* is bored to receive the shank of the roller holder *G*. This shank is threaded and provided with a nut for endwise adjustment, and is kept from turning in *D* by a key and keyway. The other end of *D* is backed up by a heavy double helical spring to keep the roller against the cam ring while the fixture is in use.

**The Undercutting Member.**—Hinged to the member *B* is the undercutting attachment *I*, which in Fig. 244 is shown in working position. The member *I* is provided with a bushing which when in line with and locked by the pin *K*, holds the undercutting attachment in working position. While the waving attachment is in use the lower edge of the member *I* is thrown up and rests on the pin *K*.

Referring to Fig. 244, two slots machined in the member *I* meet at the opening *L*. In these slots two tool-holders are fitted so that they will slide readily. A tension spring *M* holds them back in their respective slots. Each tool-holder is provided with a pin *N*.

When the lever *O* is swung one way or the other the wings *P* striking one or other of the pins *N* force an undercutting tool *Q* down to its work, as shown in Fig. 244.

**Waving Operation.**—Returning to the waving, which is the ninth suboperation. The roller holder *G* (Fig. 244) is slipped into its seat in *D*, and the turret is run forward so that the cup center *H* supports the end of the work, as shown in Fig. 236. This brings the roller against the face of the wave cam *C* (Fig. 236). The lathe spindle is stopped in such position that the roller is in one of the hollows of the wave cam. When the cup center brings up against the base of the shell the carriage is locked to the bed and the lathe started. With a socket crank on the screw *C* (Fig. 244) the member *B* is fed toward the already roughed wave groove. The formed wave tool *E* is then fed to correct depth. The tool is moved from side to side of the groove, alternately by the wave cam and the heavy helical spring, which keeps the roller in contact with the wave cam. During this operation the undercutting member, as previously stated, is up out of the way.

**Undercutting the Sides of the Wave Groove to Hold Copper Band.**—After the limit snap gage is tried on the bottom diameter of the wave groove, and it is found correct, the undercutting member is swung down into working position for the tenth suboperation. The operator then swings the lever *O*, first one way and then the other, until the pins *N* strike the stops *R*. The undercutting tools are thus alternately fed to depth in their respective cuts. The undercutting completes the fourth operation.

In Fig. 245 are shown the waving tool, the milling cutter for machining it and the tool used for turning the milling cutter.

Boring and finishing the interior, which is the fifth operation on the 4.5 high-explosive shell, is almost, if not quite, as important as the preceding one, for the result of these two is to bring the work within reasonable range of the established weight limits.

This operation is performed on turret lathes of various makes, on a double-spindle turret lathe, and also on a gang of vertical boring mills.

The work is held in the collet chuck shown in detail in Fig. 246.

The first tool presented to the work is the four-fluted chucking reamer, shown in detail in Fig. 247. This tool takes a cut the full length of the straight part of the bore. The lubricant—soda water—passes through a central hole in the reamer arbor. Squirting in ahead of the cut, it washes the chips back through the flutes, which are of ample size for their passage.

The second bar carries two tools—the rough boring and seat-facing flat cutter and the mouth-reaming flat cutter, both of which are shown in Fig. 247.

The finish-boring and seat-facing flat cutter is next presented to the work. This cutter is shown in detail in Fig. 247. It finishes the hole

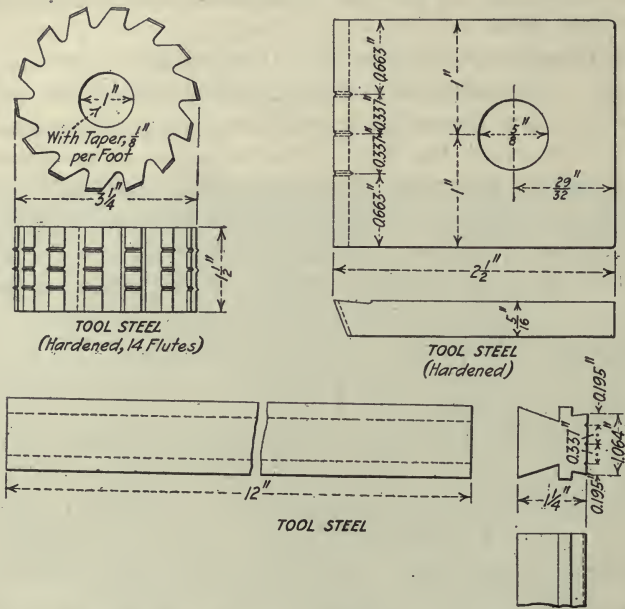

FIG. 245. WAVING TOOL MILLING CUTTER AND TOOL FOR TURNING CUTTER

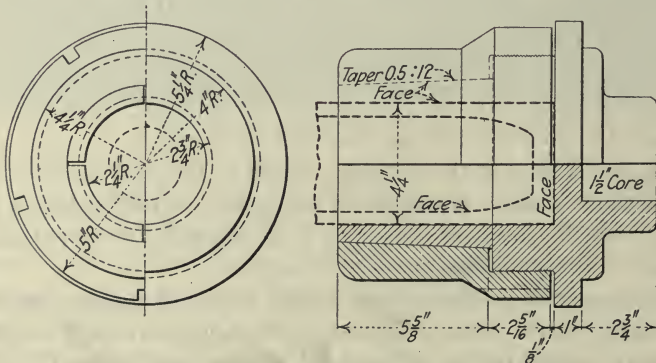

FIG. 246. SHELL CHUCK FOR USE ON LATHES

to size and depth. The facing cutter completes the fifth operation by facing the shell to length.

The tooling for the various machines for this operation is similar, but not the same. Changes have been made necessary by variations in the pulling power of the machines. Four stations are used on the



Steinle lathe and only three on the Bertram machine. The fourth tool in the Steinle set-up is mounted together with the third in the Bertram set-up. This was made possible because of the great power of the last-mentioned machine.

The output of the Steinle lathe is about 4 per hour and on the double-spindle lathe about 6 per hour.

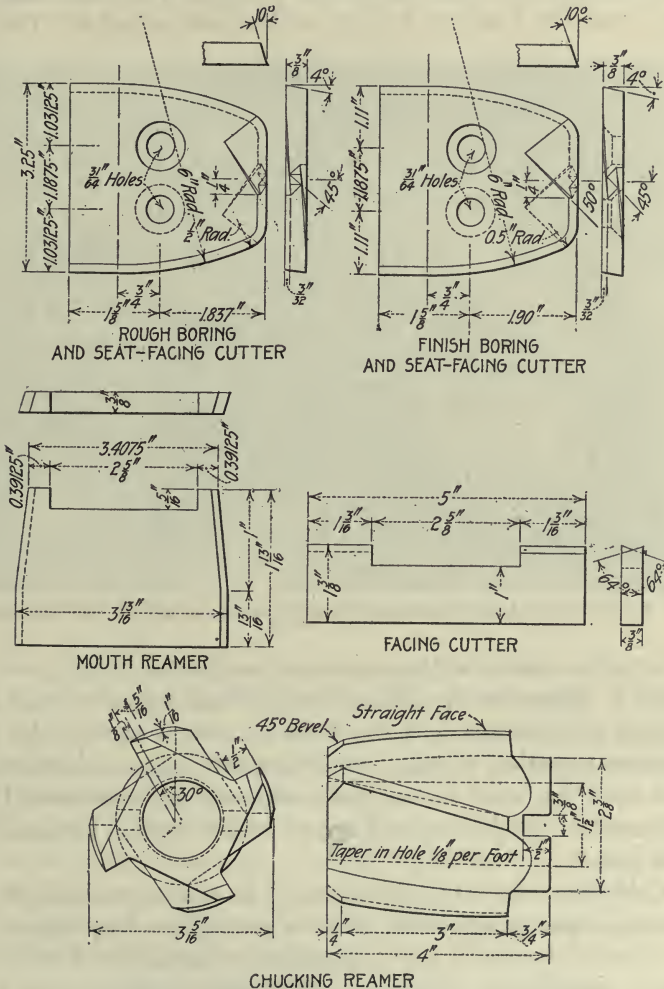

FIG. 247. CUTTERS USED IN FIFTH OPERATION

The bars used for this operation are shown in Fig. 248. The method of fastening the flat cutters in the bars is excellent. Referring to section AB, Fig. 248, it will be noted that the end of the bar is slotted entirely through. The direction of the cutting forces tends to spread the members C and D, but the cutter E is secured with two flat head screws F

and *G*, one in each member *C* and *D*, which bind these two together and prevent spreading.

**Set-up for Boring Mills.**—Besides the turret lathes, a gang of small boring mills is also used on this same job. Owing to the difficulty of removing the chips, three handlings, from machine to machine, have been found more economical than completing the hole at one chucking.

Each boring mill is provided with a single tool, chucking reamer, roughing reamer or finishing reamer, as the case may be. The work is

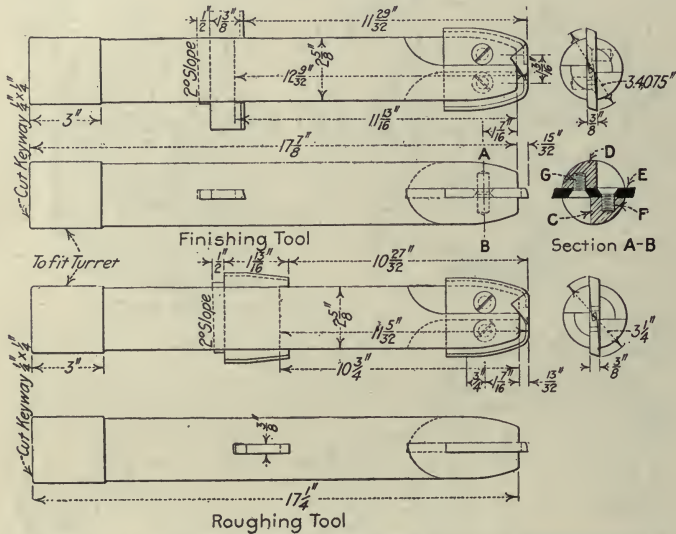

FIG. 248. BORING BARS FOR ROUGH AND FINISH BORING, FACING AND REAMING FLARE

chucked in collet chucks similar to those used in the lathes, and the tool fed to depth. When the work is removed and passed to the next machine the chips are dumped out. If the three bars were used in the one machine the accumulation of chips would require removal between operations, and with the work in vertical position much time would be lost. The tools used in the boring mill are of course similar to those used in the turret lathes.

The shells from the fifth operation are loaded on trucks and run out to the nosing department, which forms a part of the forge shop. Taken from the trucks, the shells are stacked at *D*, Fig. 249. The equipment for nosing is simple but complete. The entire outfit is shown in this illustration. At *A* is an oil-fired nosing furnace built by the Strong, Carlisle & Hammond Co., Cleveland, Ohio. The waterjacketed front casting *B* accommodates seven shells. Seven shells from the fifth operation occupy the top of the stand *C*. The Bertram steam hammer *E* has exceptionally long guides and is eminently suitable for the nosing job. At *F* is a hydraulic nosing press, designed and built in the works,

to take care of the nosing job in case of accident to the steam hammer. The tongs *G* are supported at the correct height by chains from the trolley on the overhead track *H*. This track is rigid, as the chain is flexible enough to permit the amount of movement necessary. The tongs *G* are for handling the cold shells from the stand *C* into the furnace *A* and removing the hot ones from it. The tongs *I* are for taking the hot shells from the tongs *G* and handling them into and out of the lower die on the steam-hammer block.

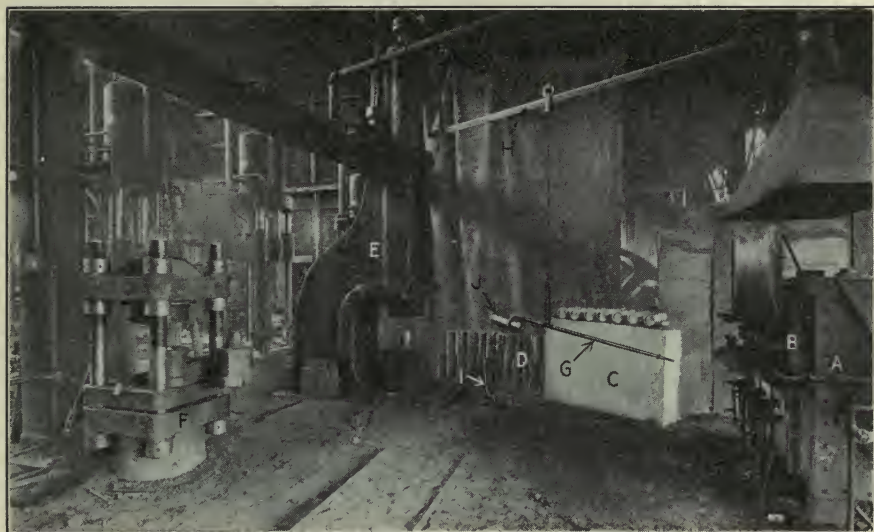

FIG. 249. COMPLETE EQUIPMENT OF NOSING DEPARTMENT

The nosing gang consists of two men and a hammer man. Seven shells are placed on the stand *C* by the man who handles the work to and from the hammer. The man who handles the long tongs *G* places the shells in the furnace. While the first charge of shells is heating seven more shells are placed on top of the stand *C*.

The charging of the furnace is from left to right. When the first shell has attained the proper heat the first operator removes it with the tongs *G*, swings it around to the position shown at *J* in Fig. 249. The second operator takes it with the tongs *I* and places it nose end up in the bottom die block on the steam hammer.

From two or three strokes of the hammer are sufficient to form a perfect nose.

While the nose is being formed the first operator swings the tongs *G* back, picks up one of the shells from the stand *C* and inserts it in the vacant opening in the furnace. As soon as the nose is shaped the second operator lifts the work from the bottom die with tongs *I* and lays it on the floor, out of the way. By this time the first operator has

removed the second hot shell from the furnace, and the operation just described is repeated.

Nosing in this manner is a very rapid operation. It takes just 65 sec. to nose the seven shells and recharge the furnace. After all the shells of a charge are nosed the hammerman places them nose down in about 2 in. of ashes on the annealing floor to cool slowly, the second operator refills the top of the stand *C*, and the operation is repeated with the shells in the second furnace.

Taken by the day, nosing takes about 15 sec. per shell, which is the heating capacity of the furnaces.

The furnace shown is 7 ft. 6 in. wide by 3 ft. 6 in. deep. It is built up of cast-iron plates and lined with firebricks. Three  $1\frac{1}{4}$ -in. low-pressure

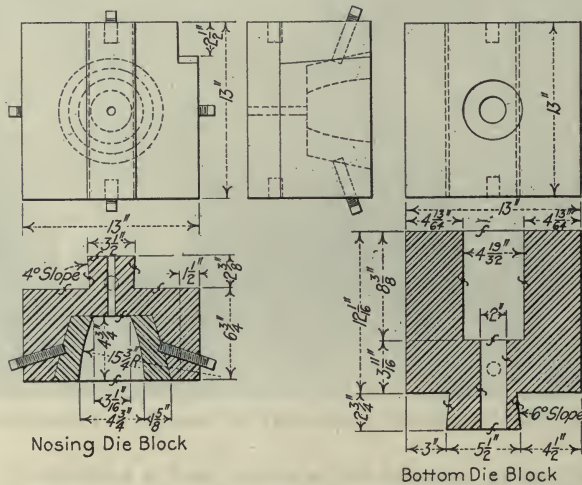

FIG. 250. NOSING DIE BLOCKS FOR STEAM HAMMER

oil burners are used. The casting for the reception of the shells is water-jacketed, and a continuous circulation of water keeps their bodies cool while their noses are brought to the required temperature.

The upper and lower dies (see Fig. 250) are so dimensioned that when their two faces come together nosing is complete. The lower die has a 2-in. central hole clear through it, so that dirt and scale can be easily blown out by an air hose.

When the nosed shells have cooled off in the ashes on the annealing floor they are loaded on trucks and run back to the machine shop. The seventh operation consists of five suboperations—rough boring, finish boring, reaming the nose to tapping size, facing the shell to correct length, and form-boring that part of the interior which was closed, in beyond the parallel bore by the nosing operation.

A number of engine lathes have been fitted up for this operation.

Collet chucks similar to those used in the fifth operation, and shown in Fig. 246, are mounted on their spindles. The tailstocks have been replaced by hand-operated hexagonal turrets designed and built in the works.

**Form-boring Lathe.**—In Fig. 251 is shown one of these lathes set up for this job. At *A* is the work held in the collet chuck *B*. The work is pushed to its seat in the bottom of the chuck, which acts as a locating point from which the traverse of the facing tool is gaged. In this way uniform length of the finished shells is assured.

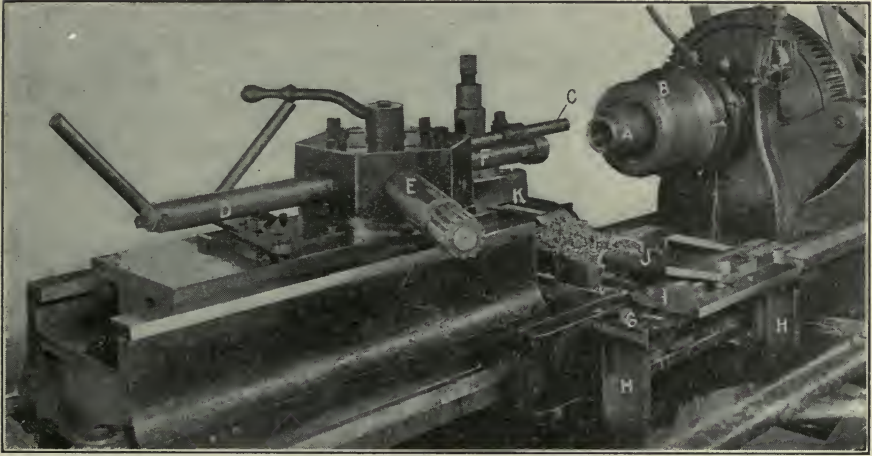

FIG. 251. BORING, FACING AND FORM-BORING NOSE END OF SHELL

In the tool post of the lathe is an ordinary Armstrong boring tool *C*. In the turret are three tools—the boring bar *D* with a single pointed tool, the reamer *E* and the facing cutter *F*.

The cross-feed screw has been removed from these lathes and a former carrier *G* bolted to the brackets *H*, which in turn are secured to the lathe bed. Fastened to the top of *G* is the former *I*, which is the shape to which the inside of the shell nose must be bored. A roller fitting the cam slot in the former is carried on the end of the link *J*, which is bolted to the cross-slide as shown. Thus as the carriage moves along the ways, the tool *C* in the tool post is constrained to follow the form of the cam slot in *I*, and the boring tool reproduces this form in the work. Above the regular cross-slide is the short cross-slide *K* to permit feeding the tool to and away from the work.

**Form-boring and Facing.**—The work *A* is secured in the chuck *B*. The turret is run back out of the way and the boring bar *C* in the tool-post run in and a roughing cut taken to true the hole. It is then run out and withdrawn by means of the cross-slide *K* to the position shown in the illustration.

The boring bar *D*, the tool in which is set to bore the work to reaming size, is then run in by hand. This is followed by the reamer *E*. In

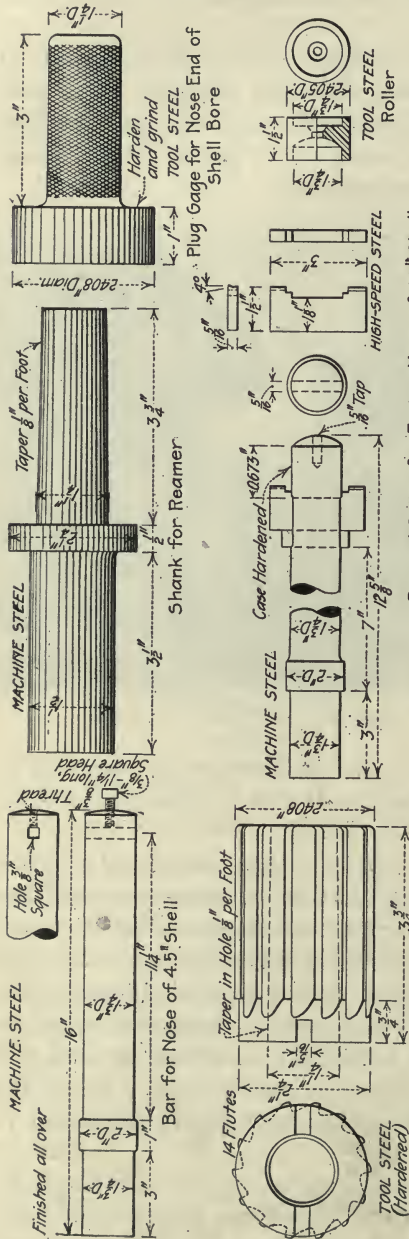

Bar and Cutter for Facing Nose of 4.5" Shell.

FIG. 252. TURRET TOOLS AND GAGES FOR SEVENTH OPERATION

front of the facing cutter *F* is a hardened pilot which rotates freely on the end of the bar. It is a snug fit for the reamed hole in the nose of the work and supports the end of the bar. The facing cutter *F* is then advanced the correct distance, a mark on the turret slide indicating when correct depth is reached as a stop. The turret is again run back and the boring bar *C* in the tool post brought into action again. With the highest part of the edge of the tool in *C* in line with the edge of the faced hole in the work, the start of the curve of the cam should be 1 11/16 in. in advance of the center of the cam roll. Having set the boring bar so that this dimension is correct, a mark is made on the ways of the lathe 1 11/16 in. in advance of a mark on the carriage. Once set, this adjustment need not again be made, as the cutter can be removed and ground without disturbing the holder or bar. The carriage is then advanced to this mark (without the tool cutting), the tool fed to the cut by the upper cross-slide *K* and a cut taken. Two cuts are usually taken, the operator *feeling* when the formed cut runs into the parallel bore of the work.

In Fig. 252 the boring bar, reamer, reamer holder and facing bar and tool are shown in detail, together with the plug gage for the hole.

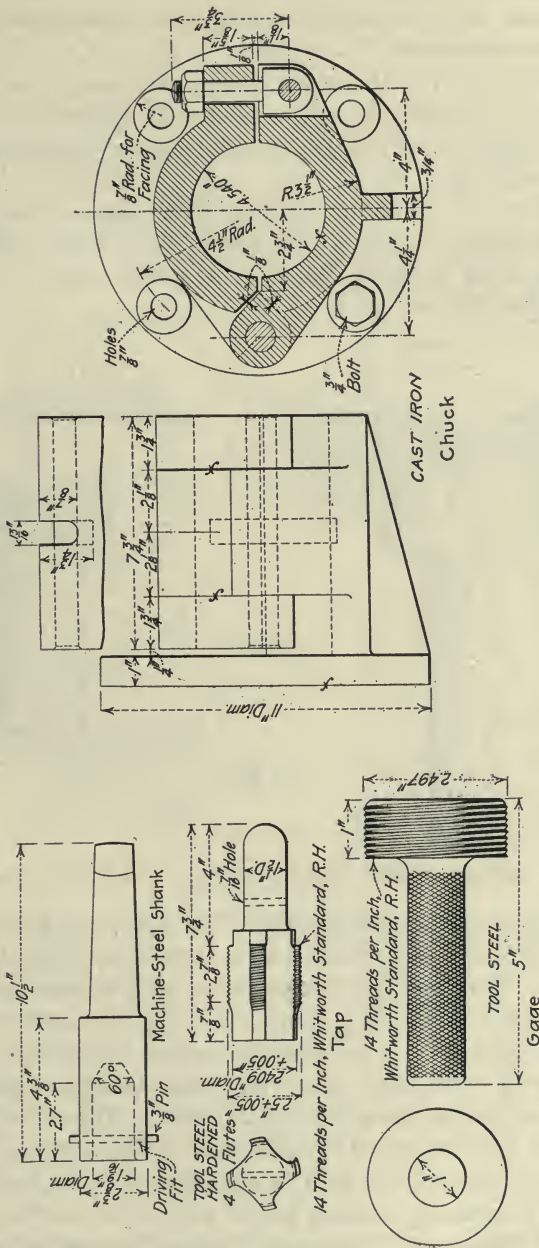

FIG. 253. WORK HOLDER, TAP, TAPHOLDER AND THREAD GAGE FOR SHELL NOSSES

The output for one lathe and operator is about four per hour.

**Tapping on the Radial Drill.**—The eighth operation is performed on a radial-drill press. It is a simple tapping job, requiring neither special skill nor special accessories.

The work is gripped in the work holder, shown in detail in Fig. 253. Several of these are used at various stages of manufacture. The tap and tapholder, together with the plug thread gage, are also shown in detail in this same illustration.

Cutting compound is used on the tap. The steel in the shells is very hard and consequently severe on the taps. They have, however, a life of from one hundred to two hundred holes before they wear too small. About 15 noses are tapped per hour.

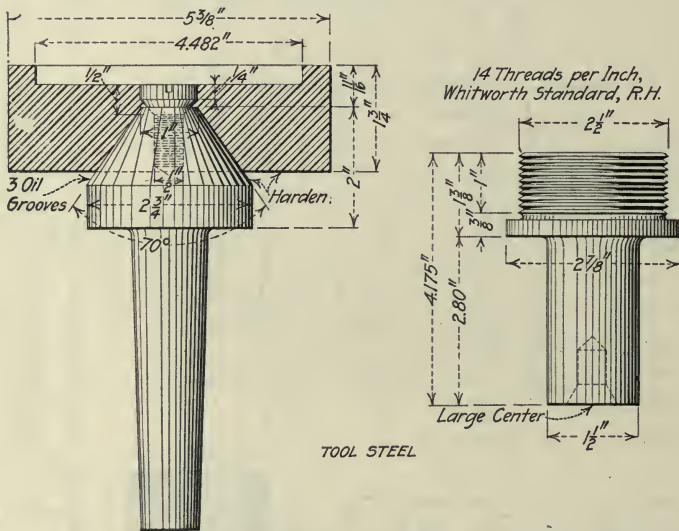

FIG. 254. FEMALE CENTER AND SCREW PLUG FOR NINTH OPERATION

From the tapping operation the shells are again run over to the lathe for the ninth operation, which consists of turning the outside to finished size and shape. This work is done on lathes with former holders similar to that shown at *G* in Fig. 251, upon which former cams are mounted. The connection between the rest and the former is precisely the same as shown in Fig. 251. The work, however, is held between centers and the former cams conform to the profile of the shell. The screw plug shown in detail in Fig. 254 is screwed into the nose of the shell and fitted with a dog. The base end of the shell is supported by the female member (Fig. 254) and an ordinary turning tool is secured in the tool post.

A rough cut is taken over the nose of the shell, averaging about  $\frac{3}{32}$  in. in depth, and prepares the whole body of the shell for the finishing cut. This cut is commenced at the edge of the band groove and is run to the nose end, the section of the shell below the band groove having been





The implements and gages used in this operation are shown in Fig. 255. The body is first tested with high and low snap gages, 4.480 and 4.460 in. respectively. The high and low ring gages, also 4.480 and 4.460 in. respectively, are then tried over the body. The nose gage with high and low limits is tried on the nose. The head profile gage is also tried on the shell nose to see whether it is in conformity. The length gage is for testing the length of the shell minus the socket. The gage for testing the thickness of the gage is worthy of note. The shell is inverted and slipped over the vertical standard, after which the swinging member is swung to rest on the base of the shell. The method of using the gage for measuring the thickness of the side shown in Fig. 255 is self evident and requires no further explanation.

To revert for a moment, the heat number which was stamped on the original cast billet, and subsequently on the forging, must always find a place on the work as it passes from one stage of manufacture to another. On the completion of the fourth operation it is stamped in the wave groove, for here it is safe from effacement till it is covered by the copper band. At no other place on the shell would this be the case, for all other parts of the exterior of the shell are subjected to either machining or nosing operations. Having passed the various gagings, the heat number (stamped in the wave groove) is transferred to the body of the shell, which is now finished, this being its final location.

The shell is next placed on the scales. On the one pan are the necessary weights and on the other a base plate of finished size and a finished socket, for the weight of each complete shell must include these two parts. The weight requirements are that the shell at this stage must not weigh more than 27 lb. nor less than 26 lb. 12 oz. On leaving the scales the weight of each shell is marked on it with red chalk. The shells pass from the scales in two classes—those that come within the required weight limits and those which are heavier. There are no “too light” shells, for this is a fault which cannot be corrected. The percentage of weight-passing and heavy shells runs about equal. The shells falling within each of these classes are stacked in separate piles. The “passing” shells go through to completion, while the heavy shells are brought to passing weight by an extra operation.

**Boring to Weight.**—The eleventh operation consists of form-boring the inside of the shell. The equipment is exactly similar to that used in the fifth suboperation of operation 7. Engine lathes equipped with a form-boring cam, as shown in Fig. 251, are used. The turret is dispensed with but the boring tool in the tool post is used. The men employed on this work have become so expert that a single cut almost invariably brings the shell to correct weight. After this operation the shells are again weighed and if found correct are stacked with the passing shells.

After passing shop inspection the work goes to the threading operation. This is done on 2-in. Jones & Lamson flat-turret lathes as shown in Fig. 256. The work *A* is held in a special draw-in chuck *B* shown in detail

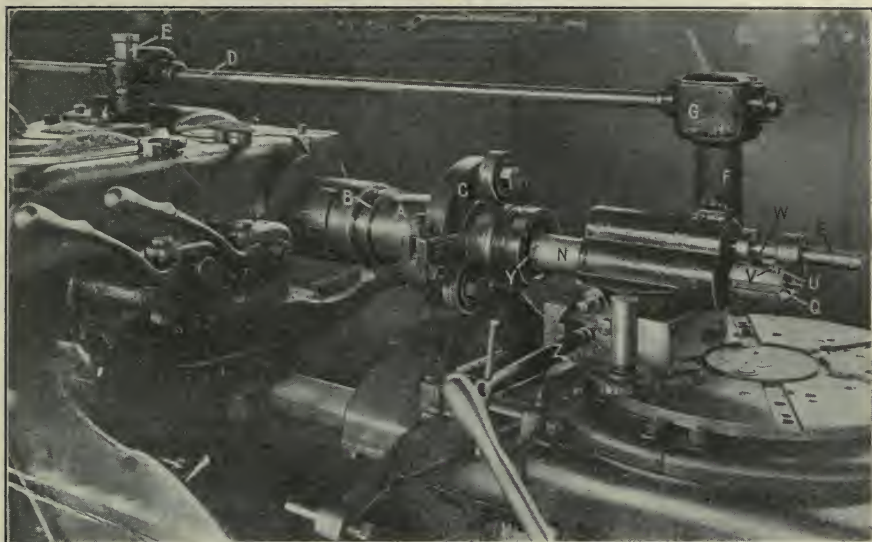

FIG. 256. THREADING BASE-PLATE RECESS ON FLAT-TURRET LATHES

in Fig. 257. The forward end of the shell is supported in the roller steadyrest, shown in detail in Fig. 258. The rollers are mounted on eccentric studs so that they can be adjusted to hold work varying slightly in size from piece to piece.

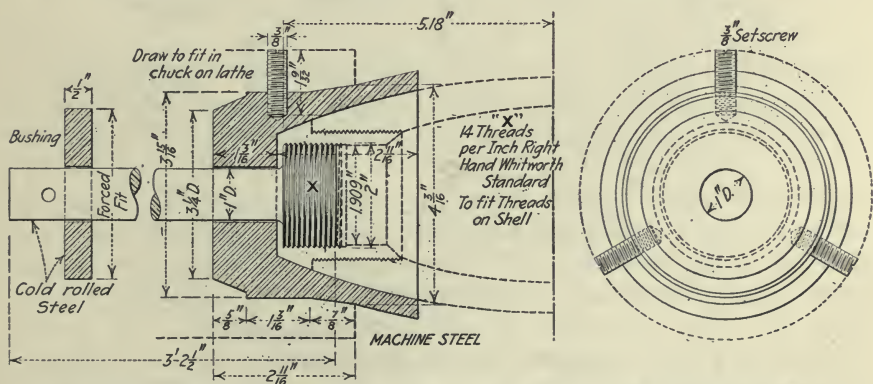

FIG. 257. DRAW-IN CHUCK FOR BASE-PLATE RECESS THREAD-CHASING TOOL

**Thread-chasing Attachment.**—The thread-chasing attachment shown in Fig. 256 is an example of clever design. The splined rod *D* is driven through gearing from the live spindle of the lathe. At *E* is a clutch, so

that the rotation of *D* can be stopped or started at the will of the operator without stopping the spindle of the lathe. Running in the upright *F* is a vertical shaft driven by *D* through spiral gears. The upper part *G*, in which these gears are located, has a stem projecting downward into

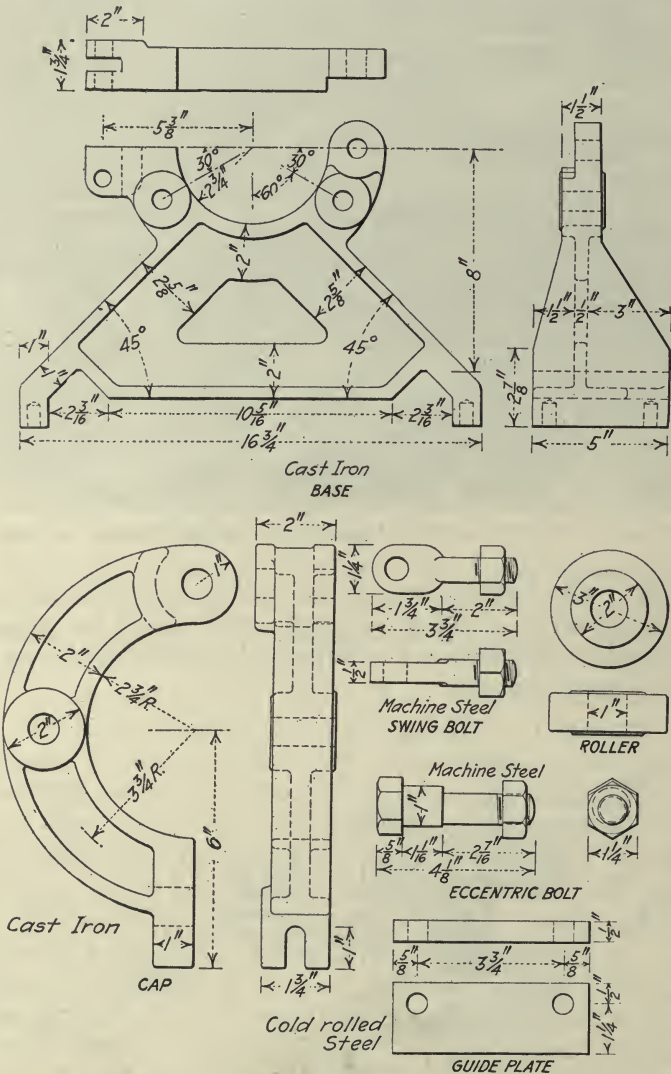

FIG. 258. ROLLER STEADYREST

a bearing in *F*, in which it is free to turn in a horizontal plane. The member *E* can also turn horizontally.

The splined driving shaft *D* is provided with collars on each side of *G* so that it has no endwise motion with relation to *G*. It is, however, free

to slide endwise at *E* in its bearings and in the spiral gear. This feature, with the two horizontally rotatable supports at *E* and *G*, makes possible the rotation of the flat turret when the machine is used for more than the threading of the base-plate recess, although in this particular case it is not so used.

At the lower end of the vertical shaft in *F* (Fig. 256) is another spiral gear shown at *H* in Fig. 259. This gear is rigidly secured to its shaft *I*. Near the end of the shaft is a collar *J*, also rigidly secured to *I*, and above it a spur pinion *K*. This pinion is loose on the shaft *I*, but a heavy spring *L* holds it in frictional contact with the collar *J*, so that it will transmit a drive sufficiently powerful for the purpose at one part of the cycle of the threading operation, but will slip at that part of the cycle when it is its duty to slip.

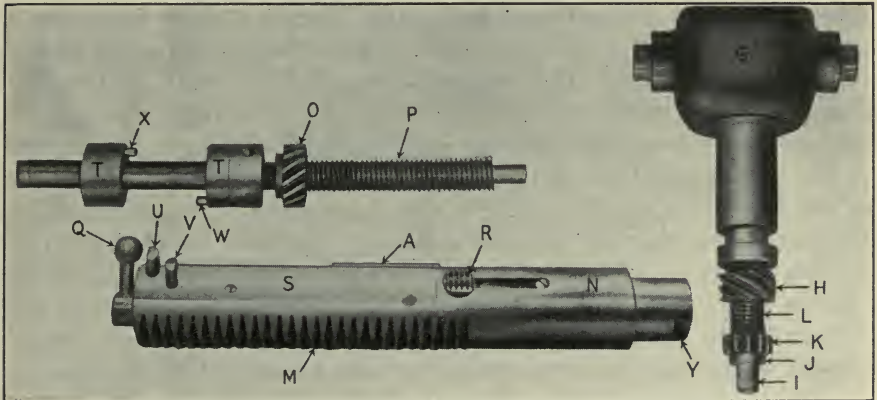

FIG. 259. DETAILS OF THE THREAD-CHASING ATTACHMENT

The spur pinion *K* engages the rack *M* on the cylindrical chasing bar *N*, and the spiral gear *H* engages the spiral gear *O* on the lead screw *P*. The relative positions of the members *N* and *P* under working conditions are best shown in Fig. 256.

The chasing bar *N* is bored lengthwise to receive a bar terminating at one end in the ball handle *Q*. This bar is cylindrical except for a flat formed on a part of its circumference. This flat part is under the half-nut *R*. A rounded groove *S* in *N* permits the lead screw *P* to be placed close to *N*. It is deep enough to clear the collars *T*. At *U* and *V* are two pins. On the inside of *N* these pins engage the bar (previously referred to) with the flat on it. The collars *T* on the lead screw are disposed, one on each side of these pins. Each collar has a pin *W* or *X* disposed vertically to its face. These pins *W* and *X* are so located that when in a favorable position only one of them can strike one of the pins *U* or *V*. When the pin *U* is struck by the pin *X* the inner bar is turned

in the chasing bar *N* so that the cylindrical part is under the half-nut *R*. This raises the half-nut *R* into operating position in mesh with the lead screw *P*. When the pin *V* is struck by the pin *W* the inner bar is turned in the chasing bar *N* so that the flattened part is under the half-nut *R*. This permits the half-nut to drop out of engagement with the lead screw.

The chasing bar *N* is a sliding fit in its housing and is held from turning by a feather shown at *A* in Fig. 259. The fixture is so set that the bar *N* at its extreme forward traverse carries the chaser *Y* to the bottom of the base-plate recess.

On the forward end, that is, the end of the inner bar most remote from *Q*, is an eccentric pin which, working in a crosswise slot in the body of the chaser *Y*, throws it in or out of cutting position.

**Operation of Chasing a Thread.**—Referring to Figs. 256 and 259, when the bar *N* has retreated far enough the pin *U* in it arrives at a position where the pin *X* in the collar of the rotating lead screw strikes it and forces it down. This causes the bar in *N* to rotate. The cylindrical part at the middle of the inner bar lifts the half-nut *R* into engagement with the lead screw *P* and the lead screw feeds the chasing bar *N* forward at the correct speed to cut the thread. Simultaneously with the lifting of the half-nut *R*, in the middle of the chasing bar *N*, the eccentric on the end of the inner bar assumes a position that sets the chaser out to cutting position. The direction of rotation of the pinion *K*, which meshes with the rack *M* of the chasing bar, would tend to move the bar *N* from left to right while the lead screw *P* is forcing it from right to left. This is where slipping of the spring-controlled friction *L* takes place.

The chasing bar *N* is forced by the half-nut and lead screw to move from right to left and the chaser to take a cut while the friction slips. When the chaser in the end of the chasing bar *N* reaches the bottom of the base-plate recess, the pin *V* in the chasing bar is in position to be struck by the pin *W* in the lead-screw collar. This rocks the inner bar in *N* so that the flat is under the half-nut *R*. The half-nut *R* having nothing to support it, drops out of engagement with the lead screw. The friction pinion *K* being relieved of the opposition of the lead screw, racks the chasing bar *N* back from left to right as before. Simultaneous with the release of the half-nut *R* the eccentric on the end of the inner bar withdraws the chaser from cutting position so that it clears the work on the return of the chasing bar *N*.

During the threading operation the lathe is run backward as the base-plate thread is left-hand. The pitch is 14 per inch and the Whitworth form of thread is required.

Referring to Fig. 256 it will be noted that the fixture is secured to a base slide fastened to the turret. The slide is shown in Fig. 260. The feed for each individual cut is controlled by the cross-handle *Z* and cross-

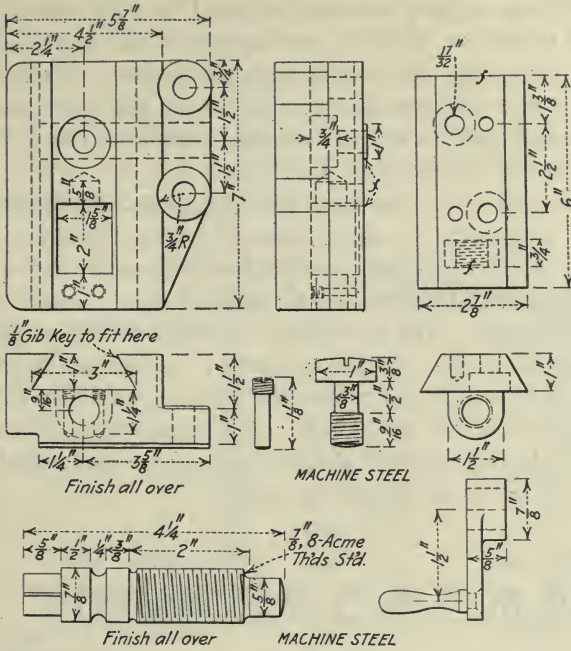

FIG. 260. BASE FOR THREADING ATTACHMENT

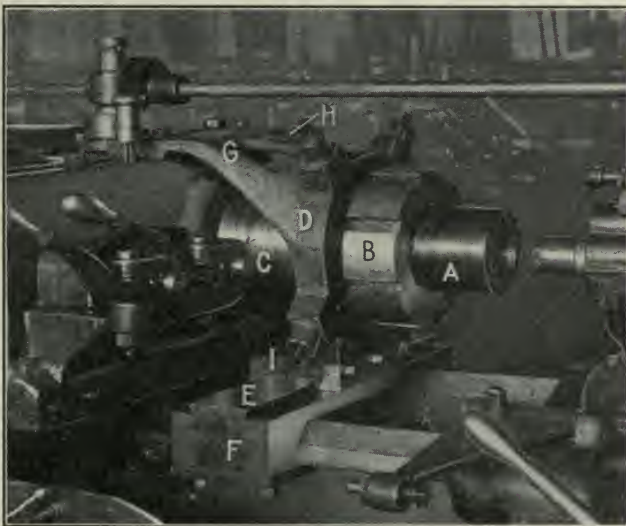

FIG. 261. CROSS-SLIDING HEAD TO HOLD 4.5 SHELLS FOR THREAD CHASING







and returned to starting position, when the same cycle of operations is repeated. About six cuts are required to finish the thread. On completion of the thread the machine is automatically tripped. A machine and operator finish about 8 base plates per hour.

The next operation is fitting the base plates. The shells are held nose down in a clamp holder mounted on a piece of 12×12 yellow pine cemented into the concrete floor. The wrench handle and pipe together, used to screw in the base plates, form a lever about 6 ft. long and two men do the job, so a rigid support for the clamp holder is necessary.

The clamp holder is shown in detail in Fig. 253.

A drop of Pettman cement is daubed on the center of the cambered face of the base plate. The base plate is then screwed down hard and the drop of Pettman cement acts as a witness and proves the fit. The shells next go to the preliminary Government inspection. While no previous mention has been made of the work of the Government inspectors, their duty is to follow the work through the entire course of manufacture. Wherever an inspection mark must be effaced in the course of machining it is their duty to replace it on the shell.

It would, therefore, perhaps be as well to go over the work that has been done by them before the preliminary inspection is taken up.

**Government Inspectors' Duties.**—In the Allis-Chalmers plant the work is taken care of by a chief inspector and four assistants. When the hollow forgings are received at the works a Government inspector goes over them to see that they bear the acceptance mark of the inspector of steel. This mark is a diamond with the well-known British "broad arrow" within it.

The inspector's acceptance mark is removed during the facing operation; he therefore superintends the facing of the shell bases and transfers the acceptance mark (stamped by the inspector of steel) to the head of the shell above the shoulder. Under his direction the contractor transfers the steel maker's cast and ingot numbers to the head of the shell.

After the heading operation is completed on a "lot" of 4.5-in. shells, the lot is stacked and an inspector selects one shell for the compression and tensile tests required by the specification. It is his duty to check the number of shells in a lot and see that all bear a lot mark on their bases. The selected shell is taken by him to the employee who has been detailed to cut out the test pieces. Should it be impossible to cut the test pieces at once, the inspector returns to his regular duties and takes the shell with him until such time as may be agreed upon when the work of test-piece cutting can be carried out. It is his duty to superintend the entire operation of cutting out the test pieces.

When complete the test pieces are stamped with the firm's monogram, the lot letter of the shell and the inspector's own work mark. He then personally mails the pieces to the testing center. The shell bodies from

which the test pieces have been cut are retained by the inspector until he is authorized by the inspector-in-charge to scrap them. When they are scrapped it is his duty to see that they are so destroyed that no further test pieces can be cut from them. The duty of superintending test-piece cutting as described is carried out by the chief inspector, or an assistant detailed by him. All inspectors take a turn at this duty, but they must not be detailed in any regular order.

**Preliminary Inspection of Shells.**—For the preliminary examination, shells, with the machined parts finished, are presented in lots and inspected for freedom from cracks, flaws, blow-holes, scale, rust and other material defects and for smoothness of surface. The operations enumerated in Table 1 are carried out. The steel base plate is unscrewed and examined for flaws and camber, and the recesses are also examined for flaws and gaged for depth and flatness and also to see that the front thread is cut away correctly.

TABLE 1. INSPECTION OF HIGH-EXPLOSIVE SHELLS

Operation No.	Operation	Per Cent. to Be Done, 4.5-In. Howitzer
1	Examination of fractures and work marks on billets.....	100
2	Internal and external examination before varnishing.....	100
3	Undercut in groove for driving band.....	100
4	Low diameter of groove for driving band high and low.....	100
5	Examination of threads in head and base.....	100
6 <sup>1</sup>	Concentricity of cavity.....	
7	Depth and flatness of recess for base plate.....	100
8	Examination of base plates before insertion....	100
9	Examination of base recess for flaws.....	100
10	Base calipers.....	100
11	Wall calipers.....	50
12	Diameter of body (high and low).....	100

No patching, stopping, plugging or electric welding is allowed.

Shells found to be correct are marked by the inspector with his work mark in the following manner, illustrated in Fig. 264:

1. A work mark is stamped on the body immediately in front of the driving-band groove to indicate that the groove is correct.

2. A second work mark is stamped above the first if the shell is found correct to body gaging and visual examination. (As an alternative these work marks may be placed in the rear of the driving-band groove, the one indicating the correctness of the groove being next to it.)

3. A work mark is stamped on the shoulder to indicate that the threads in the head are correct.

<sup>1</sup> Operation No. 6 is necessary on the 18-pounder only.

4. A work mark is stamped in the bottom of the recess for the base plate and one on the base of the shell near the edge of the recess to indicate correctness of the recess.

5. A work mark is stamped on the inner face of the base plate to indicate flatness and freedom from flaws.

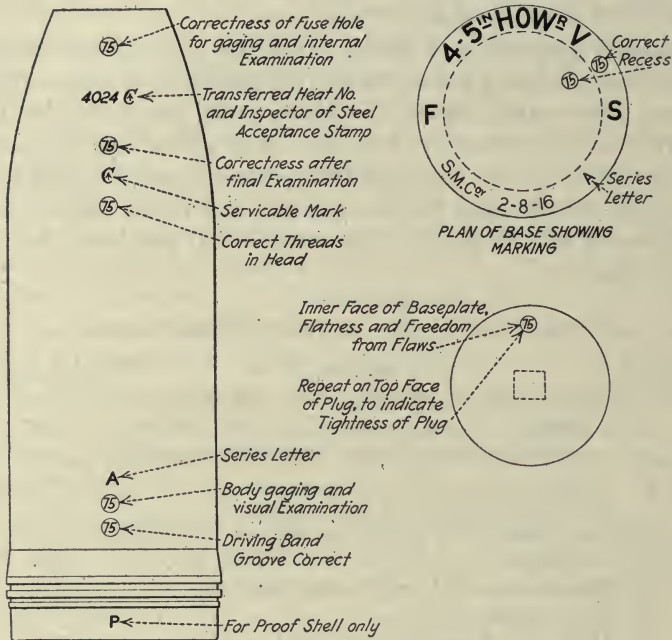

FIG. 264. MARKING FOR ACCEPTED SHELLS

**Preliminary Selection of Shells for Proof.**—If the manufacturer desires, a shell may be selected for “proof” at this stage, a distinguishing mark *P* and his work mark being put on its base by the inspector. The completion of this shell can now be hastened. When completed it is subjected to the usual final examination and forwarded by the contractor to the Chief Inspector of Arms and Ammunition, Cartridge Factory, Cove Fields, Quebec, for proof. The preparation of the shell for proof is done at Quebec.

From the preliminary inspection the shells go back to have the base plate screwed in. This time the entire threaded end and face of the base plate is brushed with Pettman cement and the plate screwed home to stay.

**Rough-facing the Base on the Flat Turret Lathe.**—The square shank and excess metal in the base plate is cut off in Jones & Lamson lathes. The shell is gripped by a draw-in chuck similar to the one shown in detail in Fig. 257. The body is supported in a roller steadyrest similar to the

one shown in detail in Fig. 258. When the work comes from this operation the base plate is left about  $\frac{3}{64}$  in. higher than the base of the shell, so as to provide sufficient metal for riveting, in the next operation.

The method used to secure the base plate is shown in the operation sketch. The shell is placed nose down in a hardwood cradle and a machine-steel guide ring *C* is placed on top of the base. The operator then manipulates a pneumatic hammer around in a circle, keeping the curved tool in contact with the ring. The dimensions of the guide ring are given in Fig. 265. One man can rivet about 45 base plates per hour.

The outfit for finish-turning the base after riveting is practically the same as that used for rough-facing. The production on finish-facing is about the same as on rough-facing; that is, 18 per hour. The bases of the shells as they come from this operation must show no crevice between the base plate and the shell body and there is no trouble in securing this condition.

The brass sockets are next screwed into place. This work is done on a back-geared drilling machine. The work is held in the clamp holder (shown in detail in Fig. 253). The socket is screwed on the end of the driver, which is provided with a nut, backed up by a loose wedge—see operation sketch.

In driving a socket the wedge is entered in the slot as far as it will go. The socket and the nut are prevented from turning on the driver when the friction between the wedge and the nut becomes greater than the friction between the socket and the shell nose. When the socket is screwed to position, the friction drive slips, the machine is stopped and the wedge driven back. This slackens up the nut, and the driver is easily backed out.

The upper end of the driver shank is squared to fit the friction driver disk. Details of the socket driver are shown in Fig. 266. The sockets are painted with Pettman cement before screwing them in. One man can screw in about 30 sockets per hour. Sockets which are not screwed down tight when the friction driver slips are screwed to place by hand with a wrench. Less than one per cent. require this treatment.

As the sockets are screwed tight into the shell nose there is a tendency to close some of them slightly. Those which are closed are cleaned out with the tap, shown together with the plug thread gage in Fig. 266.

The shells now go to a small vertical boring mill equipped with a universal chuck for holding them and with a formed tool (the shape of the nose of the shell) mounted in the tool post for the twentieth operation.

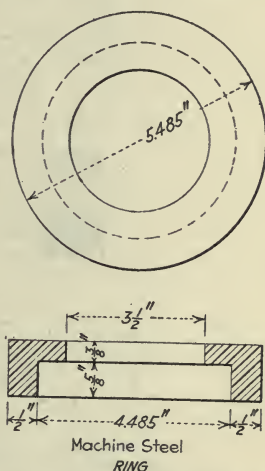

FIG. 265. GUIDE RING FOR RIVETING BASE PLATES

The tool is fed sidewise to the cut. One man can finish about 30 per hour.

The next operation, banding, is done in a self-contained banding plant located in that part of the works where the rest of the finishing operations, the final inspection, varnishing, painting, packing and shipping are done.

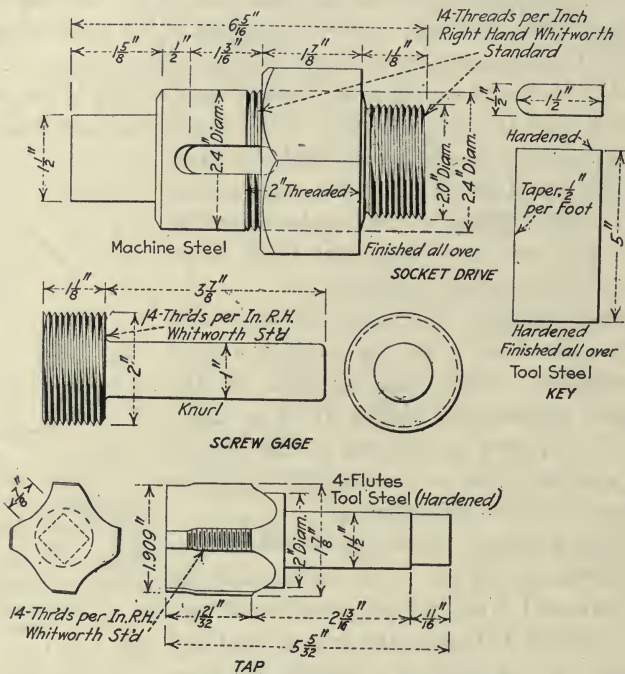

FIG. 266. DETAILS OF SOCKET-THREAD GAGE, SOCKET-THREAD TAP AND NUT AND WEDGE-TYPE DRIVING TOOL FOR THE SOCKETS

**Placing and Compressing the Copper Bands.**—The copper bands shown in Fig. 267 are large enough to just slip over the base of the shell. They are sheared from drawn-copper tube or parted from copper cups thick in the wall. They are narrow enough to just enter the driving band groove. The operation of banding is performed in a special hydraulic banding press, operating under a pressure of 1,500 lb. per sq. in.

The banding press (see detail Fig. 267) consists of a ring-like cast-steel body, enclosing six stationary pistons. Mounted in each piston is a movable cylinder carrying on its forward end a lug. Connected at each lug and guided by a central hub through which they pass are the six banding punches. These punches are pressed forward against the inserted shell and copper band by water under 1,500 lb. per sq. in. pressure entering the cylinders from the supply pipe encircling the press body. The punches are withdrawn by heavy helical springs. The operating

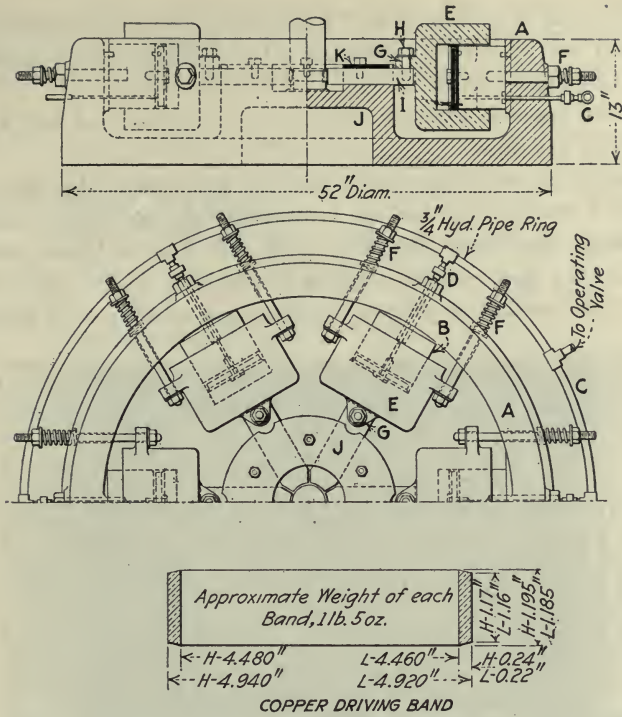

FIG. 267. 225-TON PRESS FOR PRESSING COPPER BANDS ON SHELLS

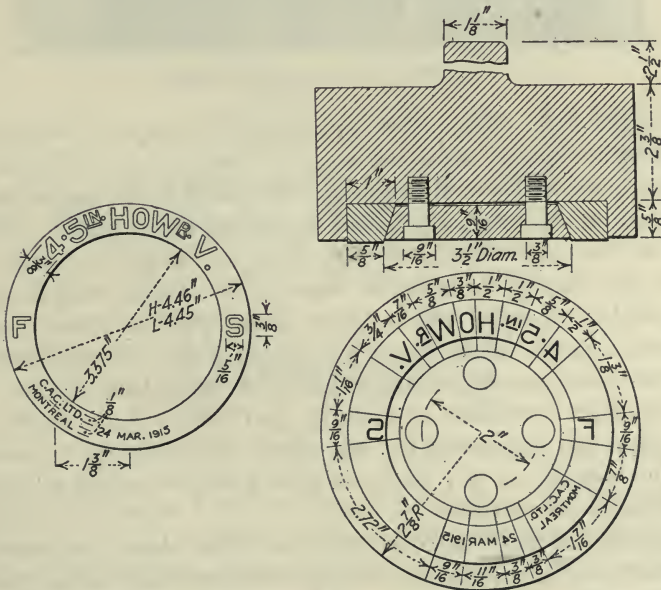

FIG. 268. STEEL DIE FOR STAMPING BOTTOM OF 4.5-IN. HOWITZER SHELLS

valve is controlled by one lever, admitting the water under pressure in one position and in another shutting off the supply and opening the discharge to the supply tank.

Two men operate one banding press, their output being about 45 banded shells per hour.

The shells are taken from the banding press, and the base of each is stamped in a drop press with the impression shown in Fig. 268.

**Varnishing the Shells Inside.**—After all dust is blown out with an air blast, a thin sheet-metal bushing is inserted in the nose of the shell to protect the threads in the socket from the varnish and prevent them

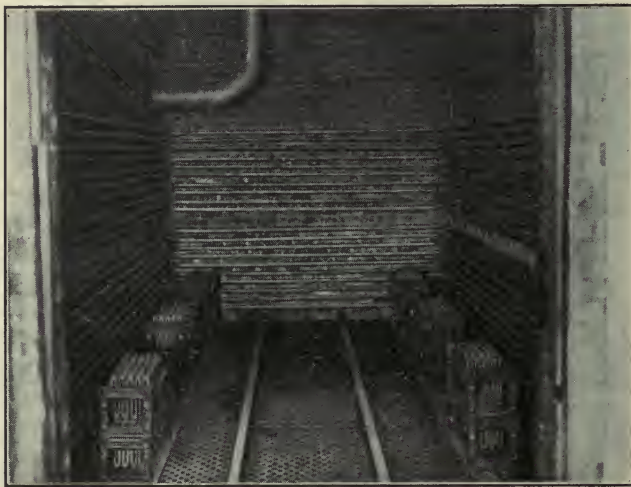

FIG. 269. VARNISH-BAKING OVEN

from being filled up. The operator, having first dipped a brush provided with bristles at the end and along one side for about 4 in. from the end in the varnish pot, inserts it in the shell. The shell is then rolled backward and forward on the table, the brush in the meantime being reciprocated so that the varnish covers the whole inner surface of the shell. When complete, the shell is stood on its base. The excess varnish collects in the base and is removed with a brush before the shell goes to the oven. The varnish must be made from a high grade of African copal gum. The only metallic impurities permitted are: Not more than 0.5 per cent. of manganese; lead calculated as metallic lead (Pb) not to exceed 0.05 per cent.; copper not to exceed 0.1 per cent. Preparatory to passing the shell to the operator, a boy cleans out the grub screw hole in the socket, using a tap for the purpose.

The shells are now loaded on the iron trays shown in detail in Fig. 262. These are then placed on trucks and run into the baking oven shown in Fig. 269. There are two of these ovens. Three of their sides are lined



with live-steam pipes. To bring the ovens to the desired temperature electric heaters were necessary. With the arrangement shown the specified 300 deg. F. is readily attained and is maintained for the required 8 hr.

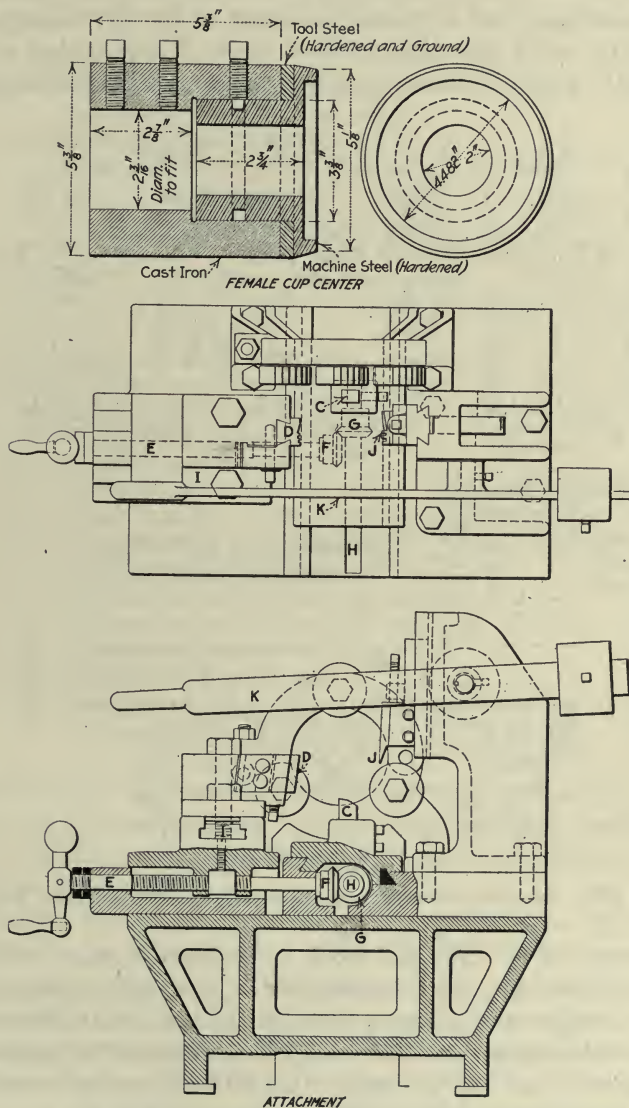

FIG. 270. ATTACHMENT FOR TURNING COPPER BANDS

**Turning the Copper Driving Band.**—The copper driving bands are turned on a special lathe which has been evolved from one formerly used for winding electrical apparatus. Three tools are employed as shown in Fig. 270.



minus 4 oz. The inspection operations for the final inspection are enumerated in Table 2. Shells which are found correct are stamped with the inspectors' work marks as indicated in Fig. 264.

TABLE 2. INSTRUCTIONS FOR FINAL INSPECTION OF 4.5 HIGH-EXPLOSIVE SHELLS

No. of Operation	Operation	Per Cent. to Be Done
13 <sup>1</sup>	Testing base plate for looseness.....	100
14	Screw gage, fuse hole, high and low.....	100
15	Examination of threads in fuse hole.....	100
16	Depth of recess fuse bush.....	...
17	Diameter and angle of recess.....	...
18	Internal examination for flaws and varnish.....	100
19	Weight.....	100
20	Width of driving band and distance from base.....	100
21	Form of driving band.....	100
22	Distance of fixing screw hole.....	100
23	Serrations on driving band.....	100
24	Hammer test, driving band.....	100
25	Center punch test driving band.....	As required
26	Form and radius of head.....	100
27	Concentricity and cylinder gage....	100—200% for concentricity
28	Length overall.....	20—shells for fixed ammunition, 100
29	Plug gage, plain part of socket.....	100
30	Examination of markings on body and base.....	100
31	Examination for cast and code number.....	100
32	Diameter of driving band, high and low.....	100
33	Diameter of rear part of driving band.....	100
34	Stamping work marks, etc.....	...
35	Greasing and fixing plugs and setscrews.....	100
36	Ring gage, diameter over paint.....	100

The serviceable sign, which is the British broad arrow within a C, will not, however, be stamped until results of the proof and varnish tests are received. While awaiting the receipt of these the shells may be painted and laid out for drying.

Reports on the preliminary and final inspection are kept on forms supplied by the government.

From each consignment of varnish which the contractor proposes to use one-quarter pint is taken by the inspector, put in bottles supplied for the purpose and forwarded by express to the government analyst.

Varnish is also scraped from proof and defective shells. A sample, at least  $\frac{1}{4}$  oz. in weight, must be obtained, and this governs five lots of shells. The least delay is occasioned if the samples are obtained from proof shells. The contractor is not informed from which proof shell scrapings are to be taken. Inspectors insist on proof shells being sub-

<sup>1</sup> This test will be made by the inspector in the open shop as soon as the base plate has been inserted and machined off.

mitted with as smooth and dry surfaces as is required for the general run of shells. Any failure on the contractor's part to comply with this results in withdrawal of the privilege of expediting the completion of proof shells. The scrapings are also forwarded by express, in the bottles supplied, to the government analyst.

All samples, liquid varnish and scrapings must be clearly labeled. The label for the liquid sample shows the firm which supplied the varnish, the firm which received it, the amount of the consignment and the date received. The bottles containing the scrapings are labeled to show the name of the firm, the lot or lots from which the sample is actually taken and the lots which will be governed by the sample.

The results of the analysis are reported to the inspection office at Quebec, which notifies the manufacturers when the lots successfully pass the proof and varnish tests.

When scraping the varnish from the shell the following points are to be strictly attended to:

1. The nose of the shell down to 2 in. from the fuse hole outside, and the threads, are to be wiped clean with a clean piece of rag or waste.
2. The scraper to be in a polished and bright condition, and kept for this purpose only.
3. The examiner is to have clean hands.
4. The paper on which the scrapings of varnish are collected is to be clean and is not to have been previously handled.
5. To insure that no brass shall be scraped off the fuse socket the fuse hole must be protected by a leather or cardboard liner, or else the sockets must be removed while the scraping operation is being performed on the shells.

The shells are next washed with gasoline to prepare them for painting. The whole of the body is covered first with a priming coat made up of the following ingredients: Dry zinc oxide free from lead,  $9\frac{3}{4}$  lb.; boiled linseed oil free from lead,  $1\frac{1}{4}$  pints; terebene free from lead,  $1\frac{1}{4}$  pints; spirits of turpentine,  $1\frac{1}{2}$  pints. It is of the utmost importance that the ingredients employed in paints for lyddite shells shall be absolutely free from lead for the reason already given. It is therefore required that samples of ingredients be submitted to the Chief Inspector of Arms and Ammunition, Quebec, for chemical analysis to guard against the presence of lead in the paint.

After the first coat is thoroughly dry in the air the second coat is applied. It consists of dry Oxford yellow stone ochre,  $8\frac{1}{2}$  lb.; boiled linseed oil free from lead,  $1\frac{1}{4}$  pints; terebene free from lead,  $2\frac{1}{2}$  pints; spirits of turpentine,  $1\frac{1}{2}$  pints.

The paint is applied to the surface of the shell as it rotates at about 200 r.p.m. on the electrically driven turntable. The table is controlled by a foot-operated switch. One man can paint about 40 shells per hour.

When the second coat is dry the brass plugs are luted and screwed into the sockets, thus completing the job.

The luting consists of 80 parts of whiting and 21 parts of oil, both by weight, kept fluid by heating. The materials are to be of the best quality. The oil is 20 parts vaseline and 1 part castor oil well mixed before it is added to the whiting.

The vaseline is to be a genuine mineral residue without any foreign mixture. It should have a flash point not below 400 deg. F. and a melting point not below 86 deg. F., and is to be free from solid mineral matter. The castor oil must be genuine. The whiting is to be of the quality known as "Town Whiting" and is to be free from moisture.

**Luting and Packing.**—The luting, when finished, must be thoroughly mixed, plastic and free from lumps. If on examination of a sample of 10 per cent. of the invoice it is found that the sample does not comply with the specification, all the material invoices will be rejected without further examination. The luting may be inspected during the manufacture by, and after delivery will be subject to test and to the final approval of, the Chief Inspector, Royal Arsenal, Woolwich, or an officer deputed by him.

Substantial wooden boxes are used for shipping and two shells are packed "heads and tails" in each box. A government inspector examines each container to see that it holds two shells and he also "hefts" the weight of each shell. The cover is then screwed down and the case is ready for shipment.

## CHAPTER V

### MANUFACTURING BRITISH 8-IN. HIGH-EXPLOSIVE HOWITZER SHELLS<sup>1</sup>

In the manufacture of 8-in. shells, the problem of economically handling the heavy forgings is one the solution of which governs the output of a shop almost as much as does the machining operations involved.

The rough body forgings weigh in the neighborhood of 250 lb. each and the finished shell with its adapter plug in place (see Fig. 273) weighs 177 lb. Tackle is required for putting the work into and taking it out of the various machines and, for efficient operation, the work should be mechanically handled between machines in its journey through the shop. Also, a one-story machine shop is better adapted to the work than one in which the heavy forgings have to be raised to galleries, etc.

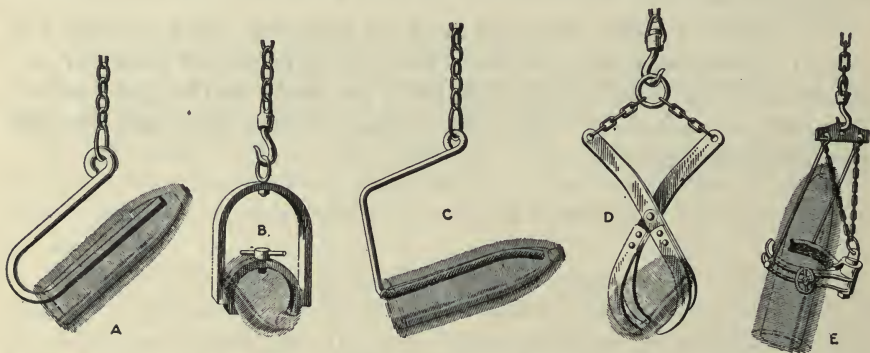

FIG. 272. TYPES OF HOOKS AND CLAMPS USED IN HANDLING 8-IN. SHELLS FOR THE VARIOUS OPERATIONS

A one-story machine shop with a capacity of 1,000 8-in. high-explosive howitzer shells per week—the time required for completing one shell being  $4\frac{1}{2}$  hours—was housed in a building  $88 \times 128$ -ft., divided into four 22-ft. saw-tooth bays running lengthwise of the building. This shop handled the rough blanks from the forge shop and the heavy work as it was converted into a finished shell by tackle suspended from a monorail system, which ran down one bay and up the next in a zigzag passage through the building. Various types of hooks and clamps were required at different stages in the manufacture of the shell (see Fig. 272) but, except for the interruptions at the machines, for inspections, etc., the work traveled forward expeditiously.

<sup>1</sup> Fred H. Colvin, Associate Editor, *American Machinist*.



**Making the Shell.**—The rough blanks, the body forging and the adapter block, undergo twenty-five operations, 18 on the body and 7 on the adapter, before they leave the shop, in the form of finished shells, for the bonded warehouses.

The sequence of operations, together with illustrations of the work at the various stages, is as follows:

### SEQUENCE OF OPERATIONS

1. Drilling the shell nose.
2. Cutting off open end of forging.
3. Rough-turning shell body.
4. Rough-boring shell body.
5. Finish-boring shell body.
6. Finish-turning shell body.
7. Boring and tapping nose for fuse plug.
8. Drilling and tapping for grub screw.
9. Cutting band groove.
10. Banding.
11. Counterboring and threading for adapter plug.
  - A. Facing and first rough-turning of adapter plug.
  - B. Drilling wrench holes in adapter plug.
  - C. Second rough-turning and roughing out contour of adapter plug.
  - D. Finish-turning outside and contour of adapter plug.
  - E. Roughing adapter plug thread.
  - F. Finishing adapter plug thread.
  - G. Turning fillet and squaring head of adapter plug.
12. Screwing-in adapter plug.
13. Facing shell to weight.
14. Stamping end of shell.
15. Removing adapter plug.
16. Washing shells.
17. Varnishing inside of shells.
18. Turning copper band.

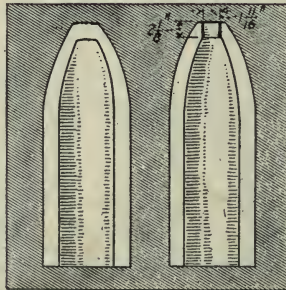

OPERATION 1 DRILLING NOSE

Machine Used—W. F. & John Barnes vertical drilling machine.

Fixtures—Revolving stand with drill bushings.

Gages—None.

Production—8 min. each.



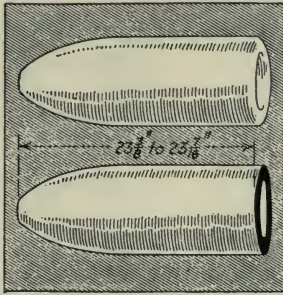

OPERATION 2. CUTTING OFF OPEN END

Machine Used—Root & Van Dervoort special.

Fixtures—Chuck length stop and handling truck.

Gages—Length.

Cutting Speed—35 to 45 ft. per min.

Production—8 min. each.

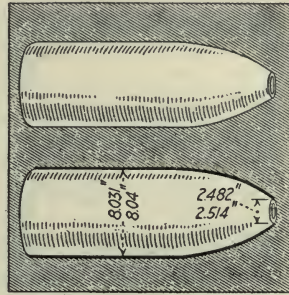

OPERATION 3. ROUGH TURN OUTSIDE

Machine Used—Root & Van Dervoort special lathe.

Fixtures—Mandrel and forming cam for tool slides.

Gages—Snap for outside diameter; nose gage.

Cutting Speed—55 ft. per min.

Production—35 min.; expect to reduce to 25.

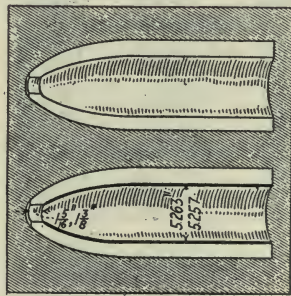
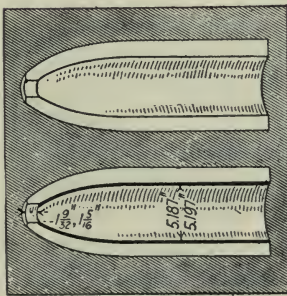

OPERATIONS 4 AND 5. ROUGH AND FINISH BORE

Machine Used—Root & Van Dervoort special.

Fixtures and Tools—Boring bars and formers.

Gages—Diameter and contour.

Cutting Speed—55 ft. per min.

Production—25 min. roughing, 20 min. finish.

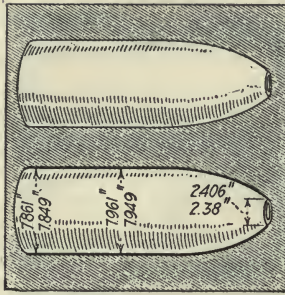

OPERATION 6. FINISH TURN

Machine Used—Root & Van Dervoort special.

Fixtures and Tools—Mandrel, one round tool former.

Gages—Diameter and contour.

Production—30 min. each.

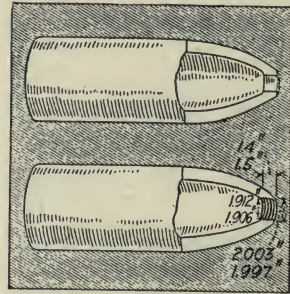

OPERATION 7. BORE AND FACE NOSE

Machines Used—Root & Van Dervoort special, Boker drilling machine.

Fixtures and Tools—Collet chuck, Kelley reamer, Murchey tap.

Gages—Diameter, thread and bevel surface.

Production—6 min. each.

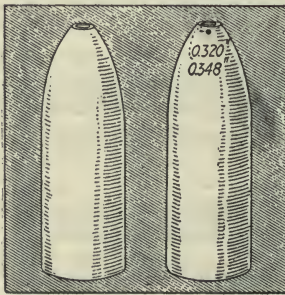

OPERATION 8. DRILL AND TAP FOR GRUB SCREW

Machines Used—Portable drill and bench drill.

Fixtures and Tools—Pot chuck, drilling jig, drill and tap.

Gages—Location of holes, diameter and thread.

Production—3 to 6 min.

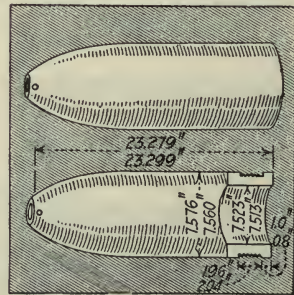

OPERATION 9. CUTTING WAVE GROOVE

Machine Used—Root & Van Dervoort special.

Fixture and Tools—See Fig. 278.

Gages—Diameter, width, wave and undercut.

Production—20 min. each.

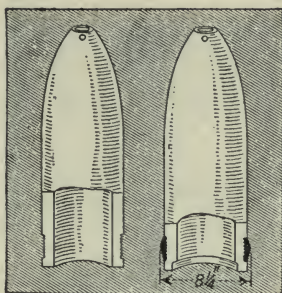

OPERATION 10. BANDING

Machine Used—West banding machine.

Fixtures and Tools—None.

Gages—None.

Production—3 min. each.

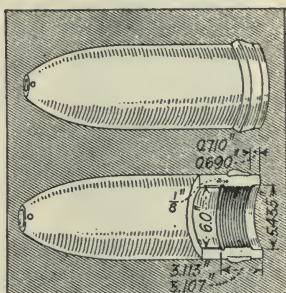

OPERATION 11. COUNTERBORING AND THREADING FOR ADAPTER PLUG

Machine Used—Root & Van Dervoort Special.

Fixtures and Tools—Boring bar and Murchey tap.

Gages—Diameter and thread.

Production—15 min. each.

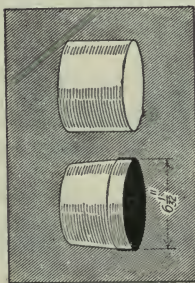

OPERATION A. FACING AND FIRST ROUGH-TURNING ADAPTER PLUG

Machine Used—Potter & Johnson lathe.

Fixtures and Tools—Regular equipment.

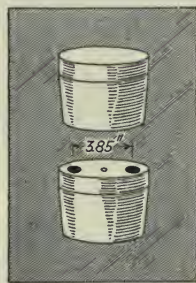

OPERATION B. DRILLING WRENCH HOLES ADAPTER PLUG

Machine Used—Vertical drilling machine.

Fixtures and Tools—Drilling fixture, stop drill socket and collar.

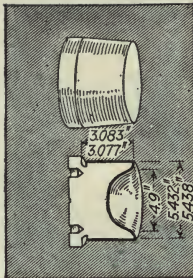

OPERATIONS C AND D. ROUGH AND FINISH-TURNING AND CONTOUR ADAPTER PLUG

Machine Used—Potter & Johnson, Root & Van Dervoort.

Fixtures and Tools—Special cutters, chuck and tools.

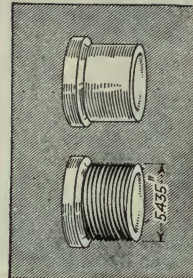

OPERATIONS E AND F. CUTTING THREAD WITH DIE ADAPTER PLUG

Machine Used—Baker heavy duty drill.

Fixtures and Tools—Tool holder and Murchey die.

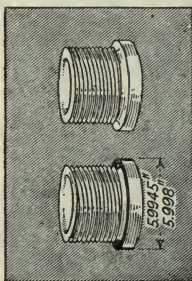

OPERATION G. TURNING FILLET AND SQUARING HEAD ADAPTER PLUG

Machine Used—Engine lathe.

Fixtures and Tools—Sleeve chuck.

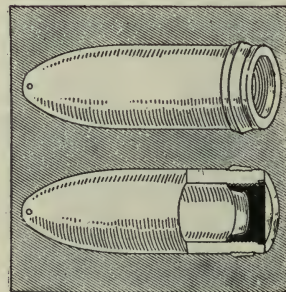

OPERATION 12. SCREWING IN ADAPTER PLUG

Machine Used—None.

Fixtures and Tools—Pot chuck and pin wrench.

Production—5 min. each.

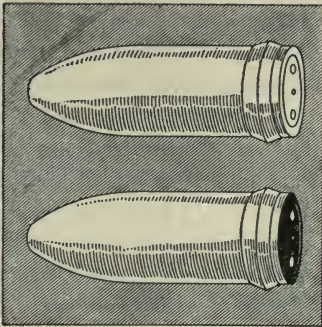

OPERATION 13. FACE TO WEIGHT

Machine Used—Root & Van Dervoort special.  
 Fixtures—Scales and clamp.  
 Production Time—15 min. each.

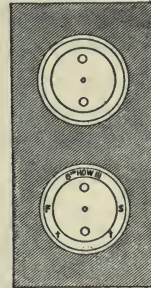

OPERATION 14. STAMPING END OF SHELL

Machine Used—None.  
 Fixtures and Tools—Guiding plate, dies and hand tools.

OPERATION 15. REMOVING ADAPTER PLUG

Machine Used—Electric drill.  
 Fixtures and Tools—Special wrench.

OPERATION 16. WASHING SHELLS

Machine Used—None.  
 Fixtures and Tools—Special frame and tanks.  
 Cleansing Liquids—Hot soda and water, hot water.

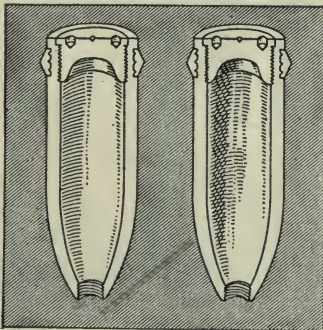

OPERATION 17. VARNISHING INSIDE OF SHELLS

Machine Used—None.  
 Fixtures and Tools—Special trucks, air and varnish tanks, baking oven.  
 Baking Temperature—300 to 325 deg. F.

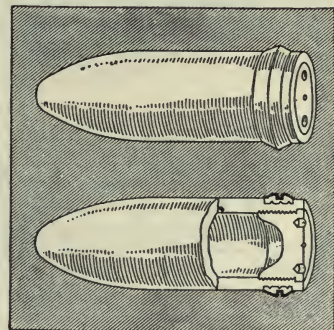

OPERATION 18. TURNING COPPER BAND

Machine Used—Root & Van Dervoort lathe.  
 Fixtures and Tools—Roughing and undercutting tools.

The first operation is the drilling of a hole in the nose, which is done on a W. F. & John Barnes drilling machine. A special drilling fixture of the turntable variety carries two mandrels, upon which the rough blanks from the forge shop are slipped. These mandrels have a ring at the upper end, which fits inside the shell near the nose, so as to center the shell from the inside, but at the same time leaves plenty of room for

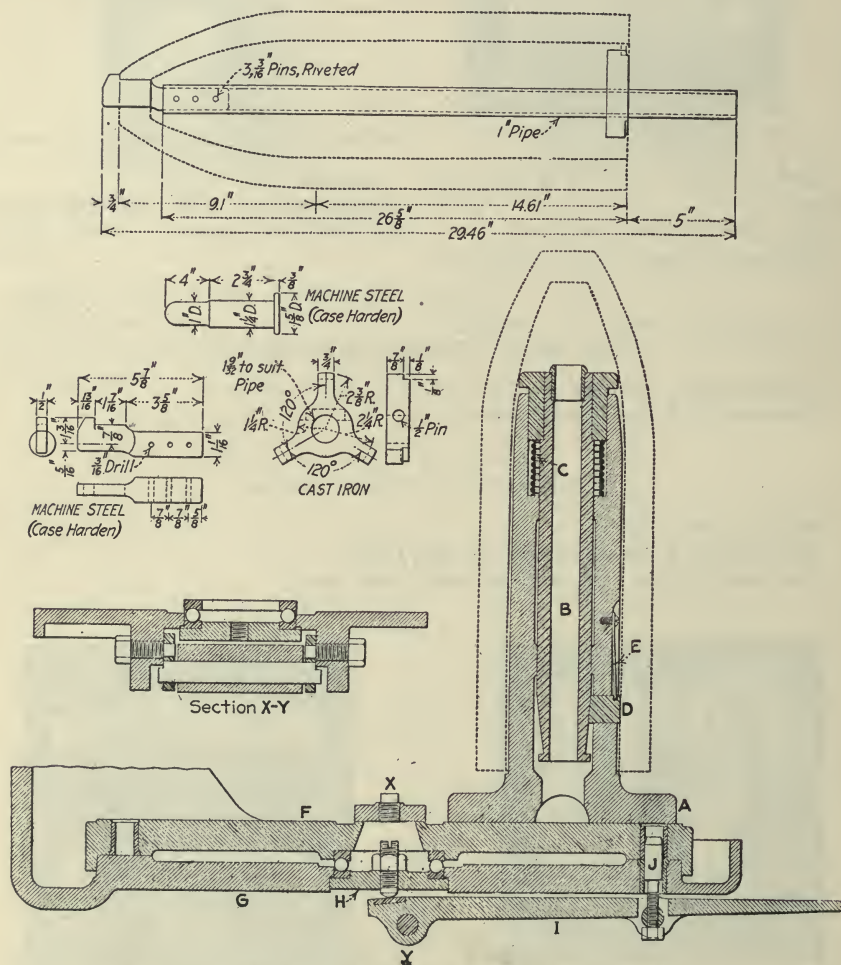

FIG. 274. DETAILS OF DRILLING FIXTURE AND GAGES

the nose drill to break through without interfering with the mandrel. Details of these mandrels appear in Fig. 274, only one spindle being given.

The post *A* carries the centering plunger *B*, which is kept in the upper position by the spring *C*. The weight of the shell forces the plunger *B* down, so that the tapered lower end forces out the three fingers *D* to center the lower end of the shell while the collar on *B* centers the upper

end. The shell is centered by the hole in the forging, it being easier to take care of eccentricity on the outside, where turning tools and carriages can be made stiffer, than in boring. The spring *E* throws the finger *D* in when the shell is removed.

The posts are mounted on the turntable *F*, which is carried on a central ball bearing *H* and has two indexing positions. The base *G* carries the indexing pin *J* operated by the lever *I* and is also provided with a raised edge to retain the lubrication. Stepping on the lever *I* withdraws the indexing pin *J* and also throws the ball bearing into action, making it easy to turn the table *F*. Releasing the lever allows the table to rest on the large and substantial annular bearing of the base.

This drilling fixture has a swinging plate, which centers itself over the shell to be drilled and also carries the drill bushing. It can be swung in either direction, so that only one drill bushing is required for both mandrels.

After the hole is drilled, the shell goes to a special Root & Van Dervoort cutting-off machine with a spindle large enough for the shell to be slipped inside and held by three substantial screws. This places the shell inside the main bearing and avoids all overhang, permitting a cutting speed of from 35 to 40 ft. per min. with a heavy feed. In order to assist in centering the shell so that the ends shall be square with the

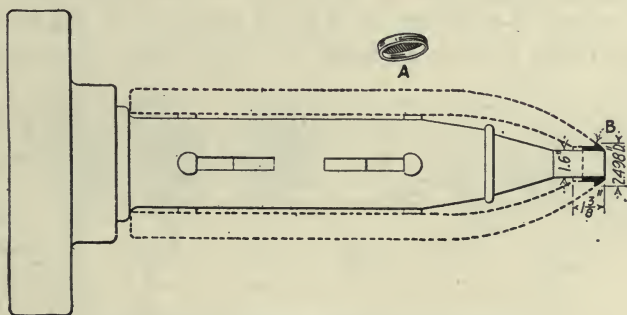

FIG. 275. DRIVING MANDREL FOR SHELL

bore, there is a tapered stop or plug on the inside of the spindle, which enters the hole already drilled in the nose and centers that end of the shell, while the outer end is clamped by the three screws in the chuck previously referred to. This stop also locates the shell for cutting off to length.

After this cutting-off operation the heat number, which had previously been stamped on the body of the shell, is transferred to the end, to prevent its being lost in the turning operation.

Rough-turning comes next the shell being tested at the point to see if it will true up to the required size. In case the point is somewhat eccentric, it can be coaxed over a limited amount by means of special

brass cups, of varying thickness, which are placed over the ends of one or more of the locating and holding points in the work-holding mandrel. These mandrels, illustrated in Fig. 275, are operated by air chucks. The shell is set by the bent gage, Fig. 276, so as to conform to the location of the cam at the back of the lathe. This gages from the flange of the shell mandrel to the point of the shell.

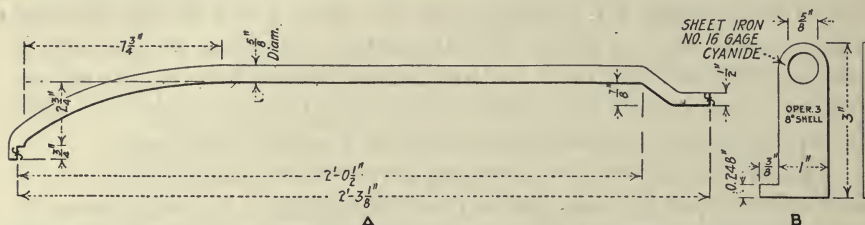

FIG. 276. GAGE FOR SETTING SHELL FOR ROUGH-TURNING, OPERATION 3; B, THICKNESS OF NOSE

Two tools are used in the rough-turning—one starting at the nose and the other about midway of the shell. They are held in independent tool slides on the carriage. One slide—the one with the nose tool—is controlled by the forming cam at the back of the lathe.

This operation is also performed on a Root & Van Dervoort special lathe having the same type of headstock as the cutting-off machine. The main bearing in each case is 14 in. in diameter by  $7\frac{5}{8}$  in. long, the rear bearing being 7 in. in diameter by  $7\frac{1}{2}$  in. long. The same lathe

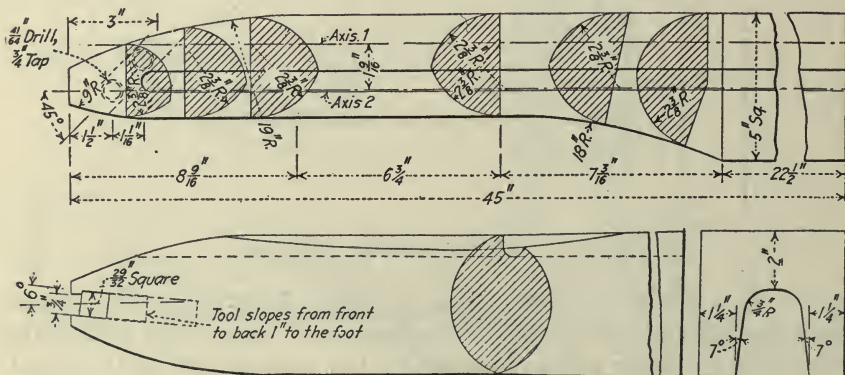

FIG. 277. DETAILS OF CAST-STEEL BORING BAR.

head is used for both the turning and the boring lathe, a special mandrel, Fig. 275, being bolted to the end of the hollow lathe spindle for the outside operations.

The lathes for the internal work are fitted with special steel draw-in collets operated by air and fitting the roughly turned shell.

Rough-boring comes first, the shell fitting inside the lathe spindle as



in cutting off. A heavy boring bar made of a steel casting is used for this work, being guided for contour by the slotted cam at the back of the lathe bed. Details of the boring bar will be found in Fig. 277. Finish-boring is done in a similar manner on an adjoining lathe, the work progressing from one machine to the next, in order to reduce handling to a minimum.

Finish-turning is performed by a single round tool that is held stationary and turned only when it is desirable to present a fresh cutting edge to the work. This method gives a fairly broad contact and leaves a smooth finish on the work. After the finish-turning, the heat number is stamped on the nose of the shell, so as to preserve it when the outer end has been faced off to length and to secure the specified weight.

Boring and tapping the nose for the fuse, the next operation is done under a Baker vertical drilling machine, the reamer and tap being changed by means of a magic chuck.

Drilling and tapping for the fixing or grub screw, operation 8, comprise one of the vexatious operations on a shell of this kind. The procedure which is proving satisfactory, both for drilling and tapping, however, is the use of sensitive vertical bench drills, under which the shells are rolled, along a bench, until they come under the drill. ]

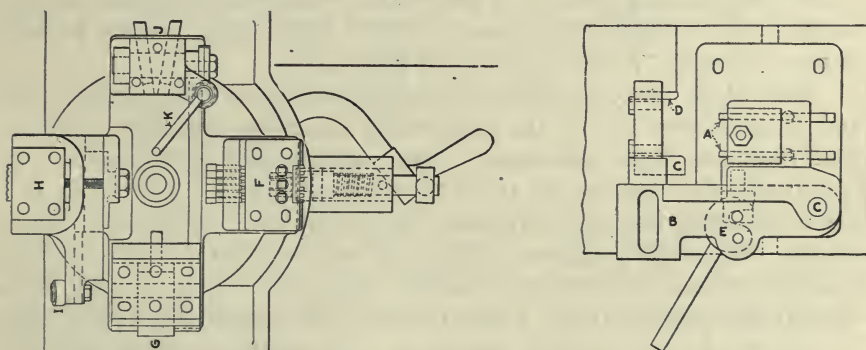

FIG. 278. TURRET FOR WAVE GROOVING AND BACK GROOVING TOOLS ON SAME CARRIAGE

The wave groove for the band is the succeeding, or ninth, operation, for which another Root & Van Dervoort machine is made to serve by using a special turret and a cross-slide, Fig. 278. First, two parting tools *A*, Fig. 278, come in from the back and cut down the side of the groove. Then a tool block *B* is swung in from the pivot *C*. It carries the tool which chamfers the end of the shell and faces it square with the groove for the banding operation.

Then six grooves are cut in the band space by a gang of parting tools *F*, to break up the width of the chip, which would be about 2 in. wide. The metal that is left is faced down with the flat cutter *G*. The waves

are then cut with the formed cutter *H* by means of the wave cam on the face of the chuck and the roller *I*. The sides of the groove are undercut by two tools *J* moving at the proper angle and controlled by the handle *K*, which operates through a worm and racks on the back of the tools. The indexing is by the side handle, which first withdraws the bolt and then turns the turret. This arrangement gives a particularly convenient mode of operating tool-post turrets of this kind. Then comes the first government inspection for the operations as far as they have proceeded.

Banding is done on the West hydraulic machine, the band being heated in a Stewart gas-burning furnace. Considerable experimenting was necessary to secure entire satisfaction in this operation, as it is a large band to force into place so as to fill completely the undercut at the side of the band groove.

It has been found that 1,150 deg. F. gives the best results with about 2,400 lb. pressure, there being three squeezes in order to seat the ring properly in every way. It was also found that the width of the ring plays quite an important part in having it fill the undercut. Best results are secured by turning the ring to  $\frac{1}{64}$  in. less than the minimum width of the groove when cold. This means that a slight shaving takes place from the ring when it is forced into place, but it insures enough metal at the bottom of the band groove to flow nicely into the corners of the undercut. Production time, 3 min. each.

Next come the counterboring and threading for the adapter plug and for the open end of the shell. The threading operation and the plug itself are both interesting. The shell is held in the same type of lathe as for cutting off in the second operation. The tools consist of a boring bar and a Murchey tap, mounted in a specially heavy turret. When the toughness of the steel is considered and also the fact that this thread is 5.435 in. in outside diameter with an 8-pitch, left-handed Whitworth thread, it will be seen that considerable metal must be removed at each tapping operation. The shells are bored, counterbored at the end of the thread and the tap run in at 10 r.p.m., making exceptionally fast threading for this diameter. A finishing tap is also used, in order to maintain the thread size. Production time, 15 min. each.

The thread is then cleaned out with a brush and an air jet, preparatory to the insertion of the adapter.

The adapter plug, which screws into the base of the shell, is made from a forging weighing 30 lb. The first operation, is to face and rough-turn the head on a large Potter & Johnston machine, the regular tool equipment being used for this purpose. The piece is chucked by the head and rough-turned on the outside, while the curved contour is also roughed out by flat cutters approximating the correct form.





The thread is an 8 to the inch, of Whitworth form and left-handed, and the cutting is done at 8 r.p.m., using for a lubricant Sol-cut with a trace of tri-sodium phosphate added to it. It has proved much more satisfactory than the cutting oil that was first tried, as it leaves a better finish on the work and is apparently easier on the die.

The plug is held for threading by simply placing the two wrench holes over dowels in the holding fixture on the drilling table. The operator makes a small punch mark to show which way the plug was placed on the fixture for the first threading.

The feed is geared so as to lead the die at its proper rate, and the punch mark allows the plug to be replaced for the finish (operation *F*, the sixth on the plug). By bringing the die head down on a distance block before throwing in the feed, the proper lead is maintained, and there is no trouble experienced in catching threads. The finishing die removes  $\frac{1}{64}$  in. and leaves a good thread on the plug. The roughing cut is taken at the rate of 8 r.p.m., while the finish cut is speeded up to 12 r.p.m.

For the final operation on the plug as a separate piece it is screwed into a sleeve chuck. This is to bottom it so as to allow the fillet to be turned and the under side of the head to be squared. The outside is then turned true with the thread and the fillet turned, this being done on an engine lathe. The finished plug weighs about 19 lb.

The finished plug is then screwed into place in the shell. For this operation, the twelfth, the shell is held in a clamping stand of the pot chuck type and the adapter screwed firmly in place with a long handled pin wrench.

With the adapter snugly fitted, the large end of the shell is faced to weight on a special Root & Van Dervoort lathe. The shell is held in a regular draw-in chuck and over the lathe is a jib crane which carries a beam scale. The shell is carefully weighed before being placed in the chuck. It is then chucked and an amount of metal faced from the adapter end to bring the shell to weight. The removal of  $\frac{1}{32}$  in. of both shell and adapter reduces the weight  $6\frac{3}{4}$  oz., while a  $\frac{3}{32}$ -in. cut takes off 1 lb. 4 oz.; and a  $\frac{1}{4}$ -in., 3 lb.  $5\frac{3}{4}$  oz. An accurate table giving fine weight records is hung in plain sight of the operator so that he can see at a glance the exact thickness of cut required for a particular reduction in weight.

After facing to weight, the end is again stamped with the heat number and other symbols, operation 14, this work being done by hand through a specially made guiding plate. The adapter plug is then removed for cleaning the inside and varnishing, an electrically driven drill properly geared down serving for this purpose.

The shells are cleaned with hot soda and water in a special device. It consists of a framework *A*, built up of wood and steel, into which the

shells are set point down. The whole framework is then lowered into a tank of hot soda water, where it remains as long as necessary. The shells are next washed in plain water, after which they are ready for varnishing.

The varnishing is done by a different method than usually employed.



FIG. 283. SECTION OF TRUCK

For this purpose special trucks have been made, the upper part consisting of a framework that carries 12 shells, nose down, in a cast-iron frame. The construction of this frame is given in Fig. 283, a bronze collar with the same curve as the nose of the shell being placed in the lower section to hold the shell firmly without bruising.

The truck with its load of shells is run beside the varnishing tanks, which are shown in outline in Fig. 284. An elbow is screwed into the nose of a shell, completely covering the threaded portion and thereby preventing varnish from getting into it. The elbow is then connected to a hose running to the varnish tank. Manipulating the three-way cock allows pressure from the air tank to force varnish up into the shell, which is stopped when the height reaches the recess below the adapter-plug thread. The air is then shut off, and the varnish returns by gravity to its tank, allowing just enough to adhere to cover the inside of the shell. With the elbow left in place, to prevent the varnish

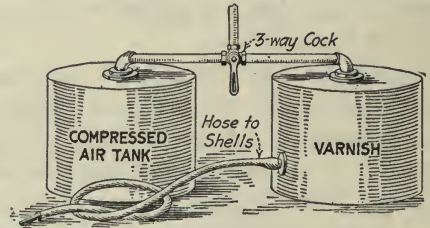

FIG. 284. THE VARNISHING TANKS

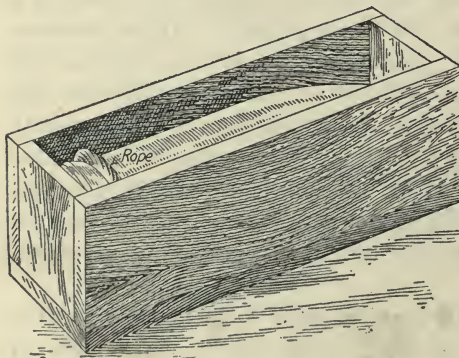

FIG. 285. GROMMET IN PLACE

from running down into the thread, the truck load of shells is run into the baking oven where they are held at a temperature of 300 to 325 deg. for a sufficient period thoroughly to bake the varnish.

The bands are next turned on a short-bed Root & Van Dervoort lathe by means of two formed tools. The front tool merely roughs out the band to the approximate shape, while the rear undercutting or shaving

tool gives it the final form, including the proper serrations at the point.

Final inspection comes next, after which the grommet or endless-rope band is slipped over the shell close up to the front of the upper band

as in Fig. 285. The grommet remains on the shell, as it affords protection to the band, both in handling and in shipping. Then the plug is screwed into the body, and the shells are boxed for shipment, one shell in a box.

During the course of manufacture, the shell body is subjected to some seventeen rigid inspections, in addition to the examination of the rough forgings and the final shop inspection. The adapter plug is examined likewise at various stages of development. Accurate gages are essential and exacting inspection instructions are issued as a precautionary measure. Standard instructions for inspecting the main shell are as follows:

### INSPECTION INSTRUCTION

**Inspection of Rough Forging**—The rough forging is examined for heat number and for the two acceptance marks. If the heat number should come directly on the nose of the shell, it is transferred by the inspector to the side of the nose of the shell. The shells are inspected for lengths, outside diameter and inside diameter, which is done by the use of calipers, and are also measured for concentricity by the use of a special concentricity gage.

From four to eight shells are placed on the bench by the inspector's helper, and the inspector does the measuring, carefully marking the amount of concentricity at the high point of the shell. This marking is done with a brush and yellow ochre. Shell forgings are piled so that all forgings eccentric  $\frac{1}{8}$  in. or more are in one pile, while forgings that come eccentric  $\frac{1}{8}$  in. or less are piled in another pile.

The forgings are also inspected for deep flaws or grooves. All forgings not coming up to requirements are held for the decision of the chief inspector, who in turn takes up any questions as to the availability of the forgings with the British inspector.

*Operation 1.*—Drill and Rough-Face—The length of hole is carefully inspected by the use of gage provided. The inspector also looks through the hole in the nose of shell from the rear end, ascertaining if the hole is reasonably concentric with the bore. The inspector ascertains that there are no flaws in the hole.

*Operation 2.*—Cut-Off End—The inspector ascertains that the operator has transferred the heat number from the nose of the shell to the end which has been cut off. The length of the shell is ascertained by use of gage provided. The forging also is inspected for cracks or flaws.

*Operation 3.*—Rough-Turn—The inspector ascertains that the outside diameter is within the limits according to special gage and also ascertains that the contour of the outside is according to the special gage. The diameter of the small end is carefully measured with a special limit gage. The finish is examined, and care is taken to see that there is no step of appreciable depth in the forging, and also the whole exterior surface is carefully examined for flaws.

*Operation 4.*—Rough-Bore—The inside diameter is checked with limit gages provided. The inside contour is checked with gage provided and the length of the hole in front carefully checked to see that same will clean up. A special gage must be provided for this. The interior surface is carefully inspected by the aid of a looking-glass and a small electric light, or other suitable means to ascertain that there are no flaws or cracks in the forging.

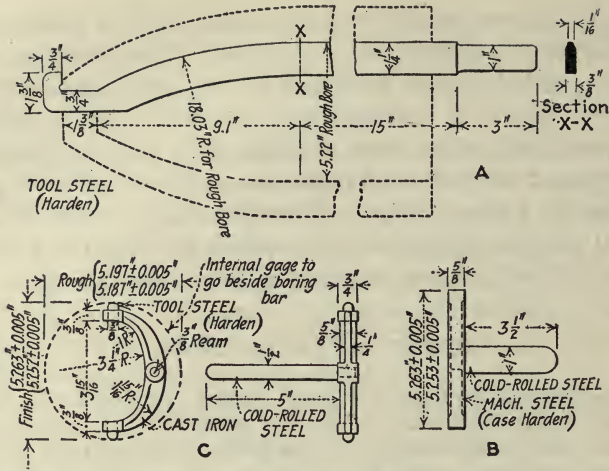

FIG. 286. GAGES FOR OPERATIONS 4 AND 5

*Operation 5.—Finish-Bore*—The inside diameter is checked according to gages. The contour of the inside is checked according to gages, and the general concentricity of the shell is ascertained by the use of calipers. The length of hole and nose is also carefully watched for, and a special gage is used. Special care is taken to ascertain that the proper finish is obtained in the bore, any irregularities being cause for the rejection or holding for correction of the work. The shell is also inspected for flaws.

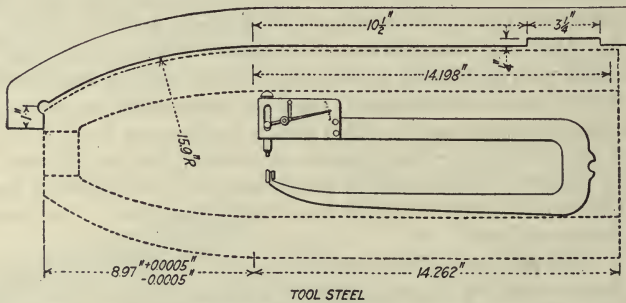

FIG. 287. GAGES FOR LENGTH AND WALL THICKNESS

*Operation 6.—Bore and Thread Nose*—The final stamping of the heat number on the rounded part of the outside of the shell is ascertained. The outside diameter in front of the copper band is checked with gages provided. The diameter of the sides below the copper band is checked with gages provided. The diameter of the face of the nose is also carefully checked. The outside finish is inspected and must be as good or better than the sample.

The diameter of the side of the hole is carefully ascertained by the use of limit gages provided, and the diameter and angle of facing are carefully checked. The finish of the thread is carefully inspected and is also inspected for flaws or chipping out in this thread.

*Operation 7.—Drill and Tap for Grub Screw*—The distance of the hole from the face is ascertained, and size of the thread is tried with a tap used as a plug gage. The



appearance of the thread is carefully checked, and if the thread causes a burr on the large thread in the nose the shell body must be retapped.

*Operation 8.—Wave Grooves—*The width of the groove, the diameter at the bottom of the groove, the diameter of the waves, the throw of the waves and the amount of undercutting are carefully checked by the use of gages provided. The finish of the waves and the groove in general is carefully checked.

*Operation 9.—Bands—*All copper bands are examined before they are placed on the shell, to ascertain that no scale is on the inside of same. After the shell is banded, the inspector tests the band by the use of a very small hammer, placing his left finger on the part near where he strikes a blow, and he can readily ascertain whether the band has been properly seated. Great care is exercised at all times so that careful inspection is maintained on this point.

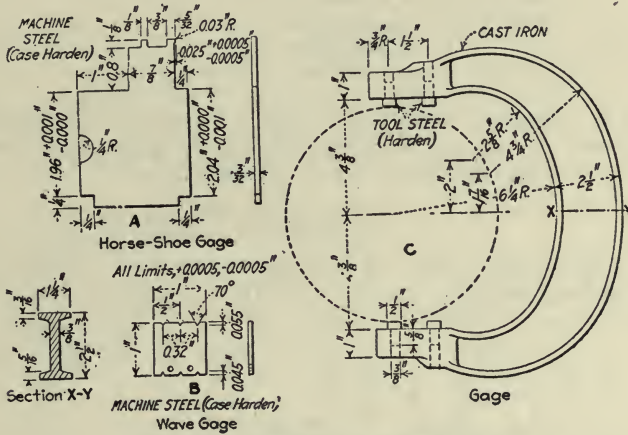

FIG. 288. GAGES FOR OPERATION 9

*Operation 10.—Thread and Counterbore—*The forging is carefully inspected for size of counterbore, for fillet at bottom of counterbore, for smoothness of machining, for correct size of thread and depth of same in relation to necking.

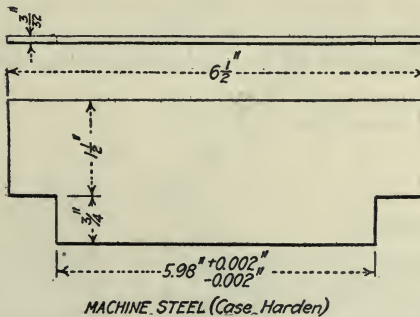

FIG. 289. GAGES FOR OPEN END OF SHELL

*Operation 11.—Clean Threads—*The threads are inspected to ascertain that they are perfectly clean, the operator calling on inspector before screwing in the adapter plug. The adapter plug is then screwed in, in the inspector's presence, and same

must be screwed in so that the head will seat properly in the counterbore. A little vaseline mixed with gasoline is used as a lubricant.

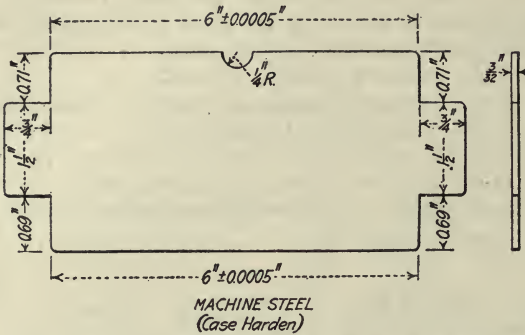

FIG. 290. LIMIT GAGE FOR OPEN END OF SHELL

*Operation 12.—Facing to Weight*—The shell is examined to see that the face is smooth, to see that the radius of the fillet is correct, and is also carefully weighed to see that it comes within the limits of the weight requirements.

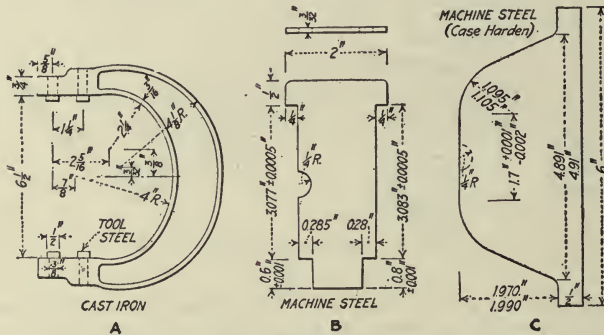

FIG. 291. GAGES FOR ADAPTER PLUG

*Operation 13.—Stamp*—The shells are carefully inspected to see that the proper stamping, consisting of 8-in. Howitzer—3, F & S, date of completion, trade-mark, heat number and serial numbers are stamped neatly and correctly.

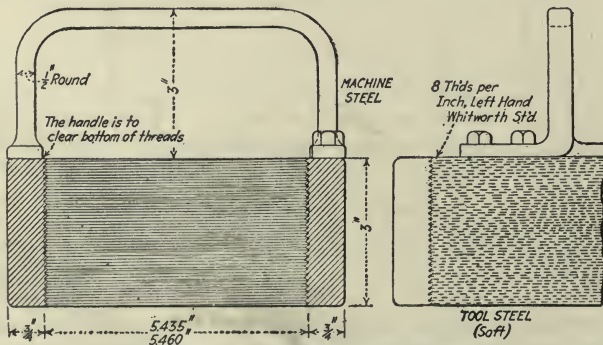

FIG. 292. GAGE FOR PLUG THREAD

*Operation 14.—Remove Adapter Plug—*No inspection is necessary except to be sure that the operator does not damage the threads of either the shell or adapter plug in this operation.

*Operation 15.—Clean Shell—*The shell body, especially the interior, is gone over carefully to see that shell is perfectly dry and clean.

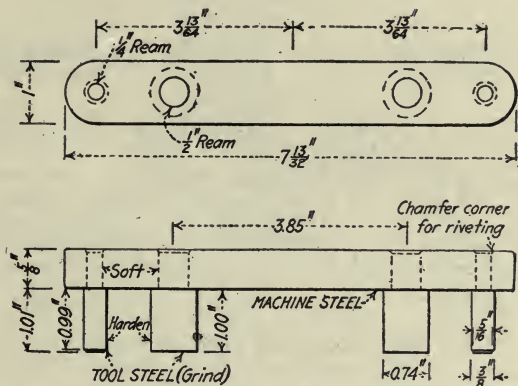

FIG. 293. GAGE FOR HEAD OF PLUG

*Operation 16.—Varnish—*Special attention is given to this operation, as it is imperative that the coating of the varnish is absolutely smooth, free from cracks and that there is no varnish in either of the threads. The inspection can be well done with an electric light and a mirror.

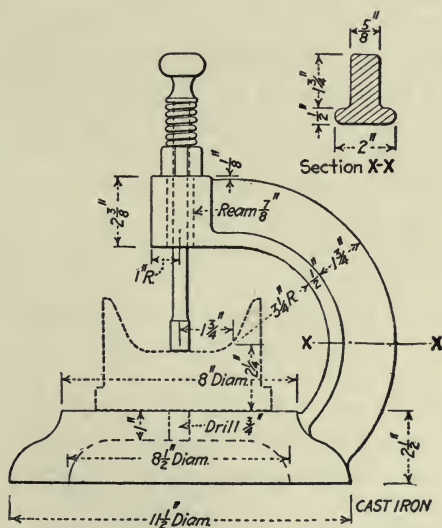

FIG. 294. MEASURING THICKNESS OF HEAD

*Operation 17.—Turn Copper Bands—*The diameter and general shape, the width and depth of groove, the spacing of serrations and the shape of the band are carefully inspected by the use of gages provided. The finish according to sample must be maintained.

Preliminary and Final Inspection—The preliminary inspection consists of going over each shell body and adapter plug and ascertaining that all dimensions and conditions are according to the drawing and specifications. Gages are provided for this operation, but a scale is used in order to enable the checking of the weight of various parts, so that the weight will come out right in the end.

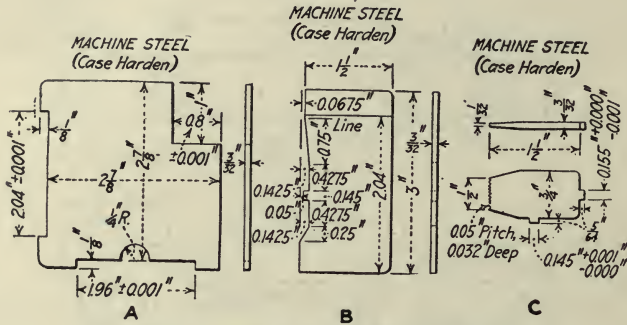

FIG. 295. GAGES FOR BAND, OPERATION 18

The final inspection consists of going over all inspection done prior to this operation and checking up each item to see that the shell is according to the accepted standards. The adapter-plug fit is carefully tried on each shell.

## CHAPTER VI

### OPERATIONS ON THE BRITISH 9.2-IN. MARK IX HOWITZER SHELL<sup>1</sup>

The American Brake Shoe and Foundry Co. at their plant in Erie, Pa., have developed a system of manufacture for 9.2-in. high-explosive shells which not only enabled the carrying out of their original contract with the British Government of 150,000 of these powerful projectiles in record time, but further secured for that company new contracts aggregating several hundred thousand more shells. The original shop has a capacity of some 2,000 shells per day of 24 hours and has proved so efficiently planned and laid out that a second shop, practically a duplicate of the first, has been erected and similarly equipped to care for the increased business.

Fig. 296 depicts the original shop and general arrangement of equipment, etc. It will be noted that the shop is divided lengthwise into five units, each one of which is a complete and individual shell producing plant with duplicate sets of machines, and quite independent of the other units. There is absolutely no back tracking. The rough forgings enter at the north end of the shop, progressing from operation to operation in virtually a straight line, and leave the southern end of the shop as completed shells ready for final inspection, then for boxing and shipping.

Extending down each unit center aisle is a continuous table or bench on which the shells are rolled as they progress through the shop from machine to machine for the various operations, and upon which the individual inspections following each operation are performed. That is, the work from the various machines is gaged and inspected on these tables and rolled forward to the group of machines for the next operation, but not until proved satisfactory in every particular. An overhead I-beam trolley system follows these inspection tables and any work which may not be quite up to standard or which would have a tendency to retard uniform rate of progress is lifted out of the procession by a block and tackle trolley and run over to the hospital unit, the unit reserved for the correction of faulty shells. This arrangement assures rapid progress of work down four of the five units by avoiding all interruptions for correction of errors, etc.

The arrangement of machines in parallel units duplicating one another has also the effect of stimulating output, for, consciously or

<sup>1</sup> Reginald Trautschold.

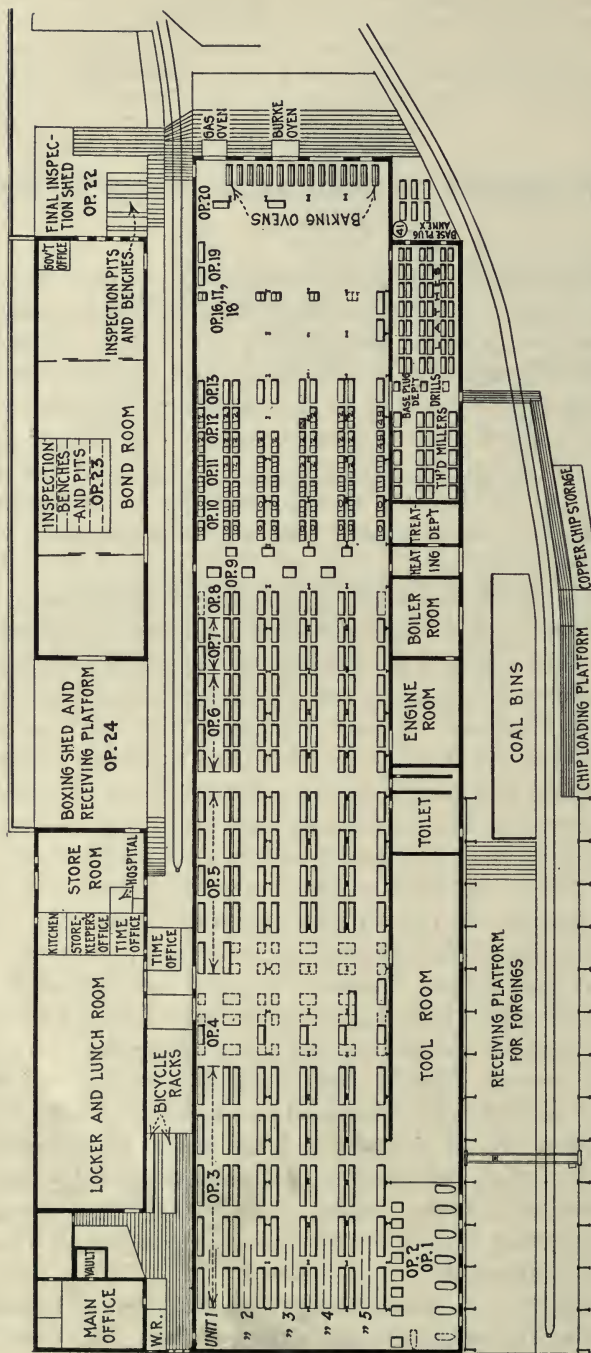

FIG. 296. GENERAL LAYOUT OF THE PLANT OF THE AMERICAN BRAKE SHOE AND FOUNDRY CO. AT ERIE, PA.

unconsciously, similar work moving down the shop in four adjacent lines keeps the operators in each unit in competition with their neighbors and the results of each line are at once apparent by the delivery of work at the southern end of the aisle tables.

On completion of the thirteenth operation on the shell, the finished base plug, manufactured in a separate department located as shown on the plan of the shop, Fig. 296, joins the procession to the baking ovens at the far southern end of the shop so there is no interruption to the progressive system of manufacture.

The machine equipment is planned for the balance of all units. That is, the equipment of each unit is such that an average output of about 400 shells per unit can be secured, the number of machines installed for each particular operation being such that the average hourly capacity production from each unit group of machines is between 15 and 18 shells. This gives about 1,600 shells for the daily capacity of four of the units which is supplemented by the output of the "hospital unit," placing the total capacity of the shop at some 2,000 completed shells every 24 hours.

Charging each operation with the time consumed in inserting the work, in the actual operation, in removing the completed work and in the required inspection, the production rate per machine can be closely approximated, for the high output of the American Brake Shoe and Foundry Co. has only been secured by keeping all machines busy for 24 hours per day.

The rough forgings are received on the siding to the west of the machine shop and are unloaded by means of overhead traveling cranes equipped with electric magnets. One magnet will lift ten forgings, a load of between  $1\frac{1}{2}$  and 2 tons. These forgings pass through but 25 operations, only 13 of which are really machining operations, before they are actually on their way to the loading plant in the form of completed and accepted shells. The sequence of these operations is as follows:

#### SEQUENCE OF OPERATIONS

1. Drilling nose.
2. Trimming open end of shell.
3. Finishing inside.
4. Reboring nose-hole.
5. Rough turning.
6. Finish turning.
7. Cutting band groove.
8. Waving band groove.
9. Pressing on copper band.
10. Finishing base.
11. Threading base.
12. Finishing nose.

13. Turning copper band.
14. Weighing and assembling base plug.
15. Removing base plug, cleaning and washing.
16. Weighing.
17. Cementing base plug in shell and riveting.
18. Facing base.
19. Varnishing.
20. Baking varnish.
21. Cleaning, sizing and removing burrs.
22. Company final inspection.
23. Government inspection.
24. Boxing.
25. Shipping.

**Making the Shell.**—The shell shown in Figs. 297 and 298 is made from a forging from 29 to 30 in. in length, about 10 in. in diameter with a 6-in. hole extending up from the base to within 3 in. of the nose end of the forging, the 9-in. section toward the nose being contracted to conform roughly to the inner profile of the finished shell.

The first operation on the shell forging consists in drilling a hole through the nose of the shell, an unusual initial step but one adopted by the American Brake Shoe and Foundry Co. in view of the fact that their method of procedure involves the complete inside finishing of the shell before working on its exterior and the drilled nose furnishes a concentric and accurately located surface upon which to center the forging for the inside work. The nose is drilled on vertical drilling machines in which the work table is of the turntable type supporting two vertical arbors of the mushroom variety mounted 180 deg. apart. The location of these arbors is such that revolving the turntable brings first one and then the other directly under the drill spindle. The rough forgings are simply slipped over the arbors, one being drilled while the drilled forging is removed from the other arbor and a fresh forging mounted in its place. A production of more than 15 forgings per hr. can thus be maintained per machine.

The second operation consists in trimming off the open end of the forging, about 2 in. of the ragged shell being removed. This is done on special cutting-off machines with hollow spindles for the accommodation of the forging, which is centered on a mandrel slipping into the nose-hole drilled in the first operation. An average of 10 forgings can be trimmed easily per machine per hr.

The machine used in the next operation, which consists in completely finishing the inside of the shell, is the heavy boring machine built by the Amalgamated Corporation, Chicago, Ill. This is one of the machines developed to meet the unprecedented demand for heavy lathes for shell work. The boring machine (see Fig. 299), as well as the turning machine used for the fifth and sixth operations on the shell, is of simple but unusual design. The headstock, bed and tailstock are cast in one piece.





The heavy driving spindle has a plain nose, attachment faceplate and a morse taper center. The boring machine carriage is 67 in. long with a travel of 44 in. and carries a boring bar  $5\frac{15}{16}$  in. in diameter. The drive is through double back gears with 16 to 1 reduction. The machine is provided with both hand and power feed and thrust bearings are furnished on both the spindle and the lead screw.

The Amalgamated heavy-turning machines used for the turning operations on the shell are similar in design to the boring machines manufactured by the same company except that the carriage is but 40 in. long with a travel of 39 in. on the ways. This machine is furnished with a forming attachment for following the contour of the shell and is also driven through double back gears.

In the operation in which the inside of the shell is finished in the heavy Amalgamated boring machines, the shell is centered on the hole

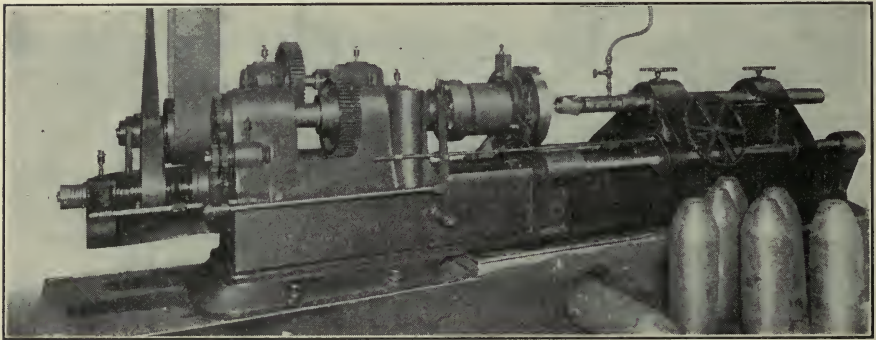

FIG. 299. HEAVY BORING MACHINE FOR SHELLS

drilled through the nose and is supported by a steadyrest. The boring bar is furnished with bits conforming in contour to the inside finished profile of the shell. This operation, including the setting-up, removing the work and all inspections, etc. can be performed in from 30 to 40 min. on the special boring machines.

As the finished inside of the shell may not be exactly concentric with the hole drilled through the nose this hole is rebored in the next operation, the shell being mounted on an expansion arbor to assure concentricity. This operation consumes but 3 or 4 min.

In the next two operations, the fifth and sixth, Amalgamated turning machines are used, the shells being driven by their bases. In the fifth operation, the shell is roughly turned to form and in the sixth operation finish turned. The turning tool, in either operation, is clamped to the tool slide of the machine and is controlled by a suitable former at the rear of the machine. The production rate, including the customary inspections, etc., is about 2 shells per hr. per machine, for either operation. This production is made possible through the ruggedness and

power of the turning machine, it being possible to take a chip  $\frac{7}{8}$  in. wide and  $\frac{1}{8}$  in. thick on a 9.2-in. shell at a speed of but 28 r.p.m. on these machines.

The driving band is formed, but not waved, in the next operation. This is a turret lathe task, four tools being used to rough-out the groove, undercut the two edges and finish the groove on the sides adjacent to the waved section which is cut in the eighth operation. The scoring of the band groove, the seventh operation, consumes about 15 min.

The shell with the cut band score is then transferred to another lathe equipped with a waving attachment and waved ribs cut encircling the groove, sufficient metal having been left in the previous operation to permit the forming of 70-deg. sharp angled ribs protruding  $\frac{5}{100}$  in. from the smooth bottom of the band groove. This waving operation takes about  $7\frac{1}{2}$  min.

The copper driving bands are next pressed on. These bands are furnished in the form of rings, 10 in. in outer diameter, approximately 9 in. in inside diameter and  $2\frac{1}{2}$  in. wide, which when heated to a red heat will just slip over the open end of the shell. Several squeezes are given to the band in the banding press to assure uniform tightness. About 4 min. is all that is required to band a shell.

Banding before the insertion of the base plug, as is required in the manufacture of this shell, tends to offset the concentricity of the shell base so that the next operation consists in truing up the base and finishing it preparatory to the threading for the base plug. Four sub-operations are required: 1st, reboring; 2d, counterboring; 3d, rounding the edge of the base, cutting the radius; and 4th, facing the base. This ordinarily takes about 2 or 3 min.

The threading of the base for the insertion of the base plug is done on Lees Bradner threading machines and is of particular interest in that the shoulder against which the base plug seats is squared up with the threaded section at the same time. This is accomplished by mounting a suitable milling cutter upon the spindle with the threading hob so that the shoulder is lightly touched up and trued as the last thread is cut. This assures the perfect seating of the base plug in the fourteenth operation. The finishing of the base takes but 2 or 3 min.

In the next operation, the nose is finished in about 15 min. This includes the reaming out of the nose-hole, the cutting of the recess below the threaded section, threading and counterboring, as well as the necessary gaging and inspecting.

The turning of the copper driving band completes the operations on the shell forging as an individual unit and is performed in about 7 min., notwithstanding the fact that five distinct sub-operations, besides the necessary inspection, are entailed. The rough band is turned to size, the forward end tapered, the two square grooves cut, the back of the

band beveled and the serrations cut on the forward tapered section. These are all performed with one setting of the machine, the various tools being carried on a multi-station turret with cross feed.

At this point in the development of the shell, the base plugs join the procession. These are made in a separate department equipped with the necessary lathes, drilling machines and thread millers. The lathe work, including the various turning operations, inspections, etc., takes about 35 min. per base plug; the drilling work about 2 min. and the threading about 15 min. per base plug.

The shoulder of the base plug is trued up with the threads in a manner similar to that employed in squaring up the seat in the shell forging—*i.e.* mounting a milling cutter on the spindle with the threading hob of the, Lees Bradner threading machine, with which the shoulder is touched up on completion of the thread milling.

The fourteenth operation consists in weighing the shell and inserting the base plug to ascertain the perfection of fit, seating, etc. The base plug is then removed from the shell and the parts thoroughly cleaned and washed.

After a careful weighing of both shell body and base plug, the tolerance from the required weight of 252 lb. 8 oz. being but plus 1 lb. 4 oz. or minus 2 lb. 8 oz., the base plug threads are coated with Pettmen cement and the plug firmly screwed down into the body. The base plug is then further secured by riveting. This completes the seventeenth operation.

Facing the base scarred by the riveting constitutes the eighteenth operation and completes the shell with the exception of the varnishing and baking.

The varnishing operation consists simply in spraying the inside of the shell with a light uniform coat of varnish but requires considerable care, as if carelessly performed might cause the rejection of an otherwise satisfactory shell.

The baking of the varnish, the twentieth operation, is regularly performed in an unusual and ingenious manner, the gas oven and the Burke electric oven shown at the south end of the shop being simply reserve units which are not usually used. The baking oven regularly employed consists of a box-like receptacle which is inverted and supported on standards on which it can be raised and lowered by means of suitable tackle, inside of which are suspended a number of vertical electric heating coils. These coils are so located that as the box cover is lowered over freshly varnished shells placed between cleats on the floor they enter the nose of the shells and bake the varnish from the inside of the shells. Considerable experimenting was required to produce a heater which would emit heat at varying rate along the coil so that the baking would be uniform the full length of the shell and not too rapid.

The heater coil being further from the varnished sides toward the bottom of the shell than in the contracted nose section, more heat is required low down in the shell than in the upper sections. This is secured by placing more wire toward the lower end of the heating coil, the number of turns decreasing toward the top of the heating coil. The amount of wire is regulated not only by the distance of the heating from the varnished sides, but is affected also by the natural tendency of the heat to rise and unduly bake the varnish about the nose section. The suitable distribution of wire has been ascertained, however, and the heating coils dry and bake the varnish at the uniform rate required to guard against burning or overbaking in any section during the three hours during which the shells remain in the oven.

The gas oven and the Burke Electric Oven have both been used to bake many shells but it has been found that the results are not as satisfactory either from a question of rapidity in production or uniformity in baking. By the time the heat in the ordinary types of ovens permeates through the comparatively thick walls of the shells and commences drying out the varnish, the ovens baking from within the shells have already commenced to bake the varnish.

From the electric ovens, the shells are placed on the sheltered platform at the south end of the building and adjacent to the baking ovens and are allowed to cool off naturally. When cool enough, the shells are thoroughly cleaned, touched up (sized) and burrs removed, after which they are trucked to the neighboring inspection shed and subjected to the final and exacting shop inspection.

In the inspection shed and also in the bond house where the government inspection takes place, considerable time and much effort is saved by depressed pits in which the inspectors stand. The shells do not leave the floor level during inspection. Raising the shells to an inspection bench but 3 ft. above the floor level would entail the expenditure of over  $1\frac{1}{2}$  million foot-pounds of energy each day, provided 2,000 shells are inspected during the 24 hours. In addition to this expenditure of force there would be the possibility of damage to the shells when returning them to the floor which is at the level of the freight car in which the shells are shipped to the loading factory.

During the final shop inspection all previous inspections are duplicated and the shell thoroughly examined for faults, omissions or possible defects in workmanship, besides being carefully weighed and tested in every way, so that the shells passing to the government bond room are as near perfect as can be realized in commercial production of such projectiles. Any imperfect shell which might have slipped through the previous inspections is returned to the hospital unit for treatment.

The government inspection, which follows the final shop inspection, is presumably just as exacting.

After being suitably stamped by the government inspectors, the shells are individually boxed in substantial metal bound wooden boxes and are ready for shipment. The boxes are made up at the plant to assure an adequate supply at all times. They are received in knocked-down form, to minimize the carpentry work and also to economize in freight charges.

During the manufacture of the shell, fifty or more pounds of chips are cut from each forging and the daily disposal of these is an important consideration. As fast as the cars in which the rough forgings are received are unloaded by the overhead traveling cranes with their electric magnets the same cranes are employed in reloading the emptied cars with chips.

## CHAPTER VII

### OPERATIONS ON THE BRITISH 12-IN. MARK IV HOWITZER SHELL<sup>1</sup>

The operations entailed in the manufacture of 12-in. Mark IV high-explosive shells for the British Government do not differ to any great extent from those required in making the smaller projectiles, but the weight of the shell, close to 800 lb., complicates handling and necessitates the use of heavy equipment for all main operations.

The shell shown in Fig. 300 is made from a forging approximately 40½ in. long, 13 in. in diameter, with a 7-in. hole 37 in. deep extending up from the base end. In one large plant where between 400 and 500 of these shells are produced each day the following manufacturing methods are pursued:

The first operation is cutting off to 38 in. in length. This is done on a special cutting-off machine with a hollow spindle large enough to take the shell blank. The shell is pushed, nose end first, into the spindle. The nose end seats in and is centered by the internal conical end of the spindle. The rear end is centered and driven by four heavy setscrews spaced 90 deg. apart near the spindle end. Four similar setscrews on the nose end of the spindle are then tightened down on the work. The spindle is driven by a worm gear midway of its length, between the two bearings of the spindle. The machine is provided with three tool slides. One is at the front of the machine at the nose end of the spindle. At the base end of the spindle there are two tool slides, one at the front and one at the back of the machine.

The tools are of high-speed steel, about ½ in. wide. One tool operates on the nose end of the shell, while on the base end two tools of the same size and material operate on the shell simultaneously from the front and back. The front tool of the two is ground square, while the rear tool has a rounded V-point to break the chip for the front tool. The spindle makes nearly 20 turns per minute, equal to about 65 ft. cutting speed on the work. The production is one shell cut off at both ends in 15 min. The cutting to length operation is shown in diagrammatical form in Fig. 301.

The second operation—drilling and reaming the nose end of the shell—is done in a jig on large radial drilling machines.

The shells are taken away from the cutting-off operation in National

<sup>1</sup> E. A. Suverkrop, Associate Editor, *American Machinist*.





Chapman trucks specially constructed for the purpose. With these trucks one man can easily handle shells weighing in the neighborhood of 800 lb. An end view of the truck, before raising the shell, is shown in

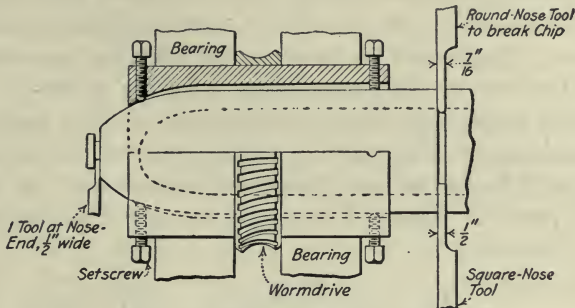

FIG. 301. CUTTING TO LENGTH

Fig. 302. In this illustration *A* is the shell lying on the floor. The angular wooden pieces *B* run the whole length of the elevating part of the truck and are located at such height that when the elevating part is

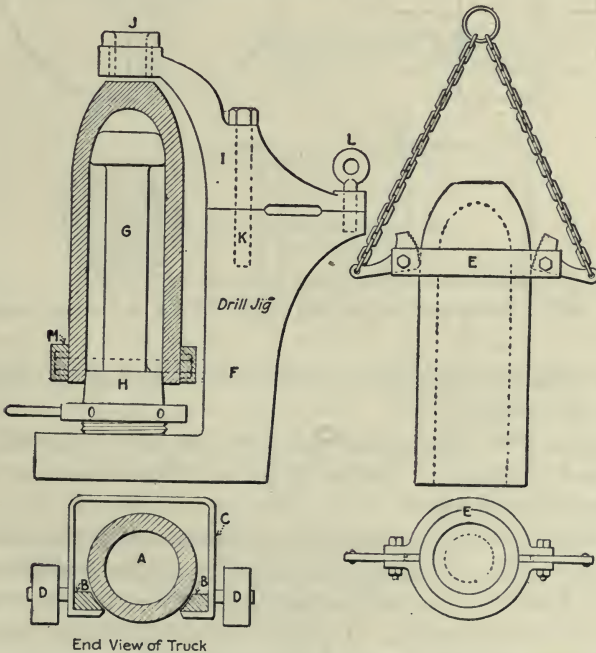

FIG. 302. SHELL TRUCK, DRILL JIG AND LIFTING CLAMP

at its lowest position they will clear the sides of the shell below its center about as shown in the illustration. When the elevating part is raised, the shell rests on the wooden pieces *B*. The braces *C* bridge over the

shell from side to side of the truck to stiffen it. The shells are lifted into and out of the jig for the next operation by a hoist and the clamp *E*, Fig. 302.

At *F*, Fig. 302, is shown the jig. Two of these jigs are placed back to back on the base plate of the radial so that two laborers can then serve both fixtures. The post *G* for locating the work has a conical head that centers the top end by the conical bore. At the bottom, *G* is threaded for the conical centering collar *H*, which is run up after the top is located on the conical head. The part *I*, carrying the bushing *J*, pivots on *K*. The index pin *L* locks the part *I* so that the bushing is in line with the center of the post *G*. When *L* is removed, the part *I* can be swung around

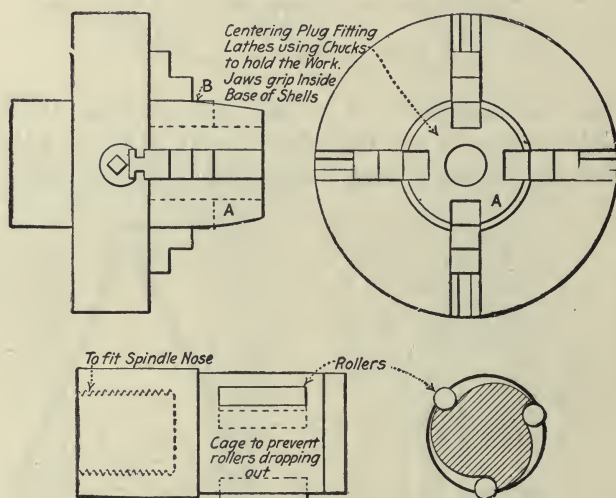

FIG. 303. DRIVING AND CENTERING DEVICES FOR ROUGH-TURNING

so that the work can be inserted or removed. The strap clamp *M* holds the shell from turning.

The nose of the shell is first drilled  $1\frac{13}{32}$  in. Then the bushing is removed, and the hole is reamed  $2\frac{1}{32}$  in. The time for drilling and reaming is 6 min. per shell.

The third operation is rough-turning the outside of the shell from base to nose. This is done on heavy engine lathes with a double-track former and roller follower at the back connecting with and controlling the tool at the front of the machine. A plug with a very slight taper is driven into the reamed hole in the nose of the shell. This plug is provided with a female center to fit the tail center of the lathe.

Two methods are used for driving and centering the base end of the shell. A heavy three-lobed cam with three rollers, as shown in Fig. 303, is entered in the rough-forged hole in the base of the shell. With

this drive, the greater the cutting stress the farther the rollers are driven up the cam lobes and the tighter they grip the shell.

The other method of drive is by four-jawed chucks provided with a simple but efficient centering device. The tapered plug *A*, Fig. 303, is securely fastened to the face of the chuck. It has four slots so that the jaws can enter it part way, as shown. With the jaws removed from the chuck this plug is turned slightly tapered to a diameter that will permit the base end of the shell to enter to about the point *B*, Fig. 303. When in operation the tail spindle of the lathe is used to force the base end of the shell to a seat on the centering plug *A*. The chuck jaws are then tightened in the hole, and the work is ready to turn. A single cut averaging  $\frac{1}{2}$  in. in depth is taken on the body, reducing it to 12.1 in. in diameter. Two cuts are required on the nose. The speed is 16 r.p.m., and the production is about one shell in 1 hr. 40 min.

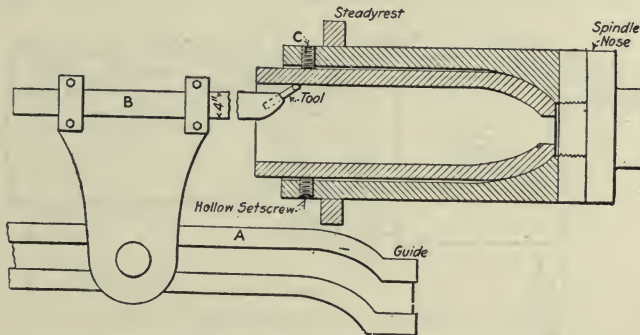

FIG. 304. BORING THE SHELL

The fourth operation is boring, which is done on heavy lathes with a double-track former *A* at the back to guide the boring bar *B*, as shown in Fig. 304. The work is held in a heavy pot chuck, split and hinged longitudinally. The rear end of this chuck screws on the spindle nose, while the front end runs in a steadyrest. The nose of the rough-turned shell is centered at the back end of the chuck by forcing it to a seat in the machined conical inner end of the chuck. At the forward end of the chuck, outside the steadyrest and easily accessible, are four equally spaced hollow setscrews *C*, which are used to center and drive the work. The front end of the chuck is bored; and the operator uses a feeler between it and the work when tightening the setscrews, to make sure that the work is concentric with the chuck.

The boring bar is about 4 in. in diameter—that is to say, as heavy as it can be made and still clear the opposite side of the hole when at the small end of the bore. The forward end is tapered on the side opposite the cutter, so that it will clear the conical end of the hole. For boring, the speed is about 30 r.p.m. One to two cuts are required to finish the

inside to  $7\frac{1}{4}$  in. in diameter,  $35\frac{1}{2}$  in. deep. The production time is about the same as for rough-boring—one shell in 1 hr. 40 min.

The fifth operation, facing and threading the nose end of the shell for the socket, is done on heavy engine lathes. The work is held in a pot chuck with the nose of the shell projecting therefrom. The carriage of the lathe carries a square turret, as shown in Fig. 305. The hole in the nose is supported on the center held in No. 1 station while the set-screws in the pot chuck are adjusted. The nose is then faced and the hole trued up with the tool in No. 2 station. The double cutter in No. 3 station brings the hole to tapping size, and the tap in No. 4 station taps the nose. The socket is then smeared with Pettman cement and screwed in with the aid of an alligator wrench with a long piece of pipe for a handle. After the socket is screwed in, the tap is removed from No. 4 station, and the forming tool No. 5 is secured in its place. With this the inner end of the socket is brought to the same curve as the inside of

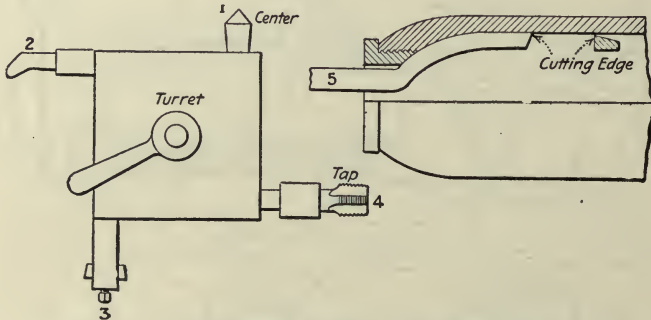

FIG. 305. THREADING NOSE AND INSERTING FUSE SOCKET

the shell nose. Owing to the frailty of this slender tool there are apt to be chatter marks on the inside of the shell. They are subsequently removed by small emery wheels mounted on spindles driven by flexible shafts. The output on facing and threading the nose, screwing in fuse sockets and form-turning the inside end of the socket is about one shell in 30 min.

The sixth operation is threading the base for the adapter. This work is done in an engine lathe equipped with a hexagonal turret on the carriage, as shown in Fig. 306. The work is chucked with the nose end in a pot chuck about one-half the length of the shell. The rear end of the shell is run in a steadyrest. The base end of the shell is faced off with the tool in the first station of the turret. A similar tool is used to rough out the recess, which is finished with the tool shown in the third turret station. Then, with the tool as shown, in the fourth station, the clearance check is cut at the extreme end of the threaded part. This tool is followed by the single-point threading tool in station 5, and the thread is chased. Three cuts over the threaded part prepare it for chasing with

the tool in the sixth station. This chasing tool is of the ordinary kind, with three threads of the Whitworth form. The time on this operation is 1 hr. 15 min. per shell.

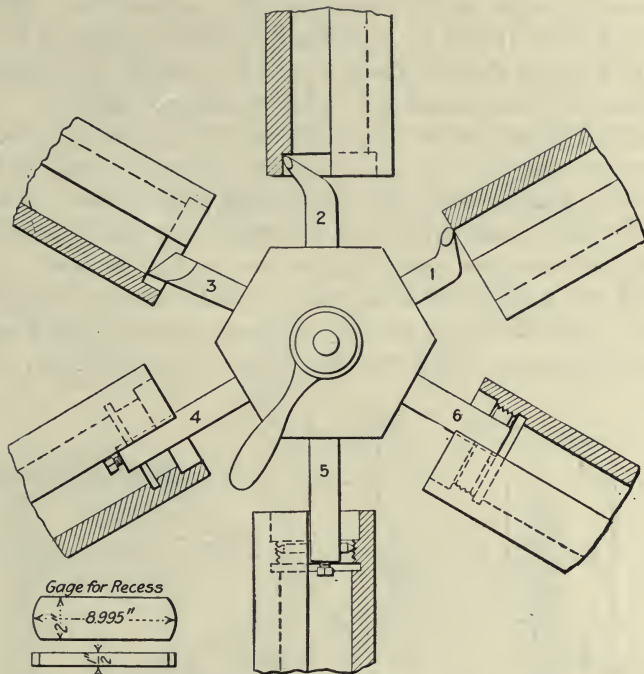

FIG. 306. THREADING THE BASE FOR ADAPTER

The seventh operation, finish-turning, shown in Fig. 307, is done on engine lathes. Some of them are equipped with a single carriage that operates the whole length of the shell. Others are special lathes with

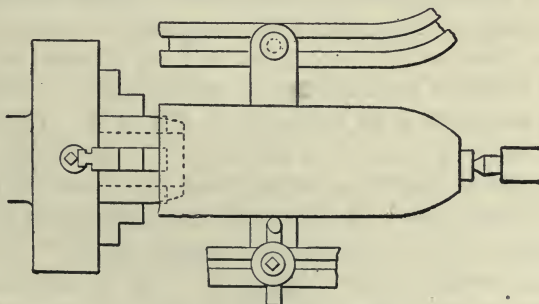

FIG. 307. FINISH TURNING

two carriages, the tool in one carriage operating on the nose at the same time that the tool in the other carriage is operating on the body of the shell. Both types of lathes are provided with a double-track former at

the back. The drive of the shell is by means of the jaw chuck and centering cone used in the rough-turning operation. The nose of the shell has a threaded plug screwed into the fuse bushing. The ratio of production of the one- and two-carriage lathes is as 5 to 6. The body of the shell is turned 11.960 in. At the base end, just below the driving band in the finished shell, a check is turned 11.855 in. in diameter. The average time for this operation is 1 hr. 40 min. per shell.

The eighth operation is to groove and undercut the driving-band groove preparatory to waving. No special fixture is provided for this work; a heavy engine lathe with turret tool post is used. The base of the shell is held in and driven by a shallow cup chuck, Fig. 308, with four heavy setscrews for centering the base end of the shell. The nose of the shell has a threaded plug with a female center that runs on the tail center. The turret tool post has a formed tool with eight projections for forming the grooves and two side tools for undercutting. The time

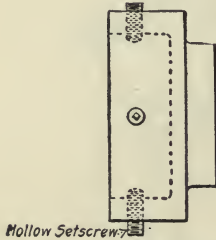

FIG. 308. CUP CHUCK

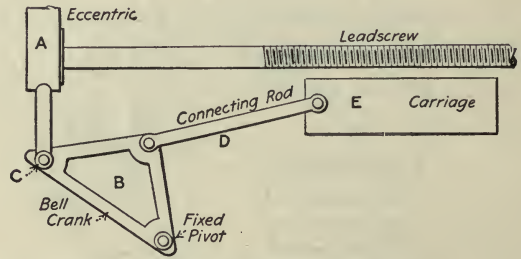

FIG. 309. WAVING ATTACHMENT

for this operation is about 30 min. The grooves are 11.260 in. at the bottom and 11.350 in. at the top.

The ninth operation is waving. The same type of lathe and the same set-up are used as in the previous operation. The wave tool is mounted in a turret tool post. The method of imparting the reciprocating motion to the tool is, however, slightly different from those already described in connection with the manufacture of smaller shells. Mounted on the lead screw of the lathe is an eccentric *A*, Fig. 309. The eccentric rod connects with the bell crank *B* at the point *C*. To function with exactness the eccentric should be spherical, and the connection at *C* should be a ball and socket joint. However, the mechanism works well without these refinements, if the joints are left slightly slack. The connecting-rod *D* transmits motion to the carriage *E*. The waving operation takes about 10 min.

The tenth operation is washing. Various methods of handling this work are in use. In one shop the shells are dropped over a perforated pipe, a sheet-metal cover is placed over the shell, and hot water under pressure is turned into the perforated pipe. This washes all the loose

particles of steel and dirt from both outside and inside the shell, which is then plunged into cold water so that it can be handled.

A rotary washing machine that works satisfactorily is shown diagrammatically in Fig. 310. At *A* is a clamp used for lifting shells into and out of this washing machine. The part *C* is about 160 deg. in length. In it the part *D* slides. A clamp at *E* secures *D* in *C*. When at its extreme outward position and clamped by the lever *E*, the device embraces the shell body so that it cannot fall out when lifted by the eye-bolt *F*.

After being washed in hot and cold water, the shells are placed under a cold blast of air to dry. When dry, small defects, such as chatter

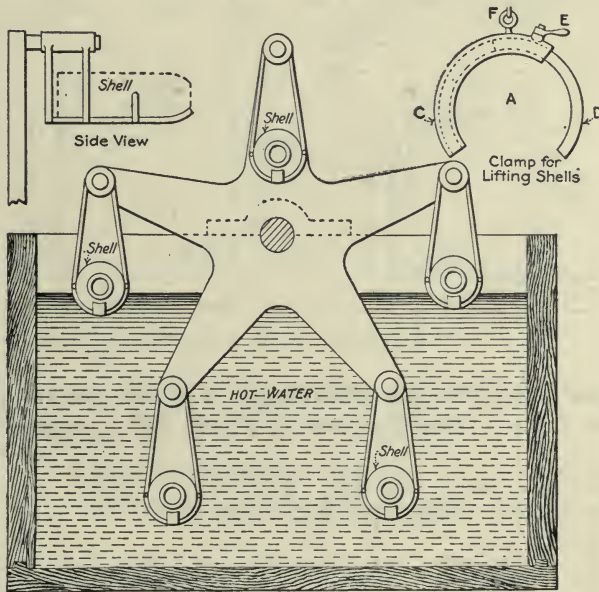

FIG. 310. WASHING MACHINE AND LIFTING CLAMP

marks are corrected. A flexible shaft grinder is a useful tool for this work. Preliminary inspection follows but need not be detailed here.

Having passed the preliminary inspection, the shells are varnished. This is done with an ordinary hand spray, Fig. 311, with a nozzle long enough to reach from the base to the nose of the shells, which are laid on their sides on a bench of convenient height. One man holds an electric lamp at the nose end of the shell while the other man, at the base end, sprays the varnish on the inside of the shell. Varnishing occupies about 2 min. An eye-bolt is then screwed into the base, and the shell is dropped nose down into a cast-iron seat *B*. These seats are arranged in rows on the floor. A portable electric oven, shown in Fig. 311, is then placed over the top of each shell, and the varnish is baked for 2 hr.

The adapters for the base are usually brush-varnished, as they are easy to get at with a brush. They are baked in an electric oven built for the purpose.

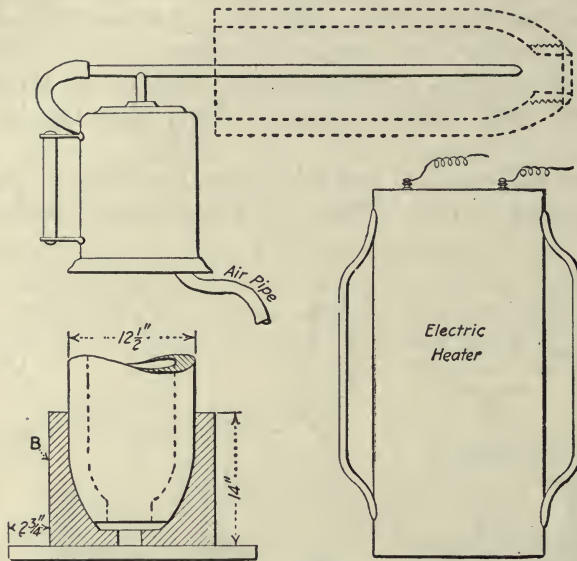

FIG. 311. VARNISH SPRAYER, SEAT AND ELECTRIC HEATER

**Making the Adapter for the Shell Base.**—The first operation in making of the adapter from the forging shown at A, Fig. 312, is rough-turning and

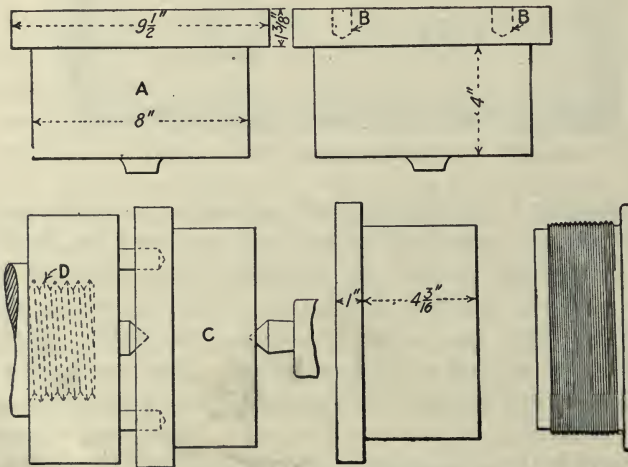

FIG. 312. THE ADAPTER

facing the flange. The forging is gripped by the smaller diameter in a four-jaw chuck of an engine lathe. The flange is reduced to  $9\frac{3}{8}$  in. in



diameter and the face of the flange cleaned up. A centering tool in the tail spindle is then run in, and the operation is complete; elapsed time, 15 min.

The work next goes to the drilling machine, where two  $\frac{3}{4}$ -in. holes *B*, Fig. 312, are drilled  $\frac{7}{8}$  in. deep in the flange. They are  $2\frac{1}{2}$  in. from the center and 180 deg. apart on the circle. A simple jig is used to locate the work from the center. About 5 min. is sufficient time for drilling the two holes. The adapter is then located in another jig, and both ends are properly centered.

The adapters are rough-turned between centers, as shown at *C*, Fig. 312. The driver *D* screws on the spindle nose and has two  $\frac{3}{4}$ -in. pins  $2\frac{1}{2}$  in. off center. These enter the holes in the flange of the adapter

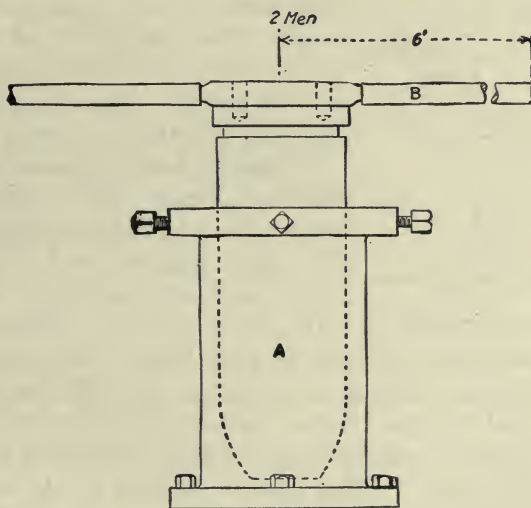

FIG. 313. INSERTING THE ADAPTER

and drive it. The body is reduced to  $7\frac{3}{4}$  in. in diameter and the flange to 1-in. thickness; time, about 30 min. each.

The adapters are then turned for threading, as shown in Fig. 312. They are held between centers and driven by pins precisely as in the previous operation. The flange is finished to 8.995 in., the threaded part to 7.696 in. and the pilot between 7.44 and 7.461 in. The recess between the flange and the thread is 7.460 in. in diameter. The time for this operation is about 25 min.

In some plants it has been found advisable to rough-thread the adapters in one operation and then pass them to another lathe for finishing. Formed chasers, such as those made by Pratt & Whitney or the Landis Machine Co., are used for both rough and finished threading. The work is held between centers and driven by the pins, as in the previous operations. Rough-threading can be done at the rate of about

one adapter in 20 min. Finish-threading with practically the same equipment takes from 12 to 15 min. per adapter.

**Fitting the Adapter.**—Returning to the shell, the fourteenth operation is fitting the adapter. The shells are held in heavy cast-iron stands, as at *A*, Fig. 313, which are bolted to the floor. Heavy pin wrenches *B*, with pipe extension handles 6 ft. long, are used to screw the adapters in and out. A facing tool built like a valve-seat facing tool is used when necessary to smooth the seat in the shell. Hand scrapers are also employed to obtain a fit between the shell and the adapter. The time for fitting an adapter is about 20 min. It is screwed tight into the shell with the pin wrench by two men, one on the end of each 6-ft. handle. The base of the shell and the adapter are faced off in the engine lathe.

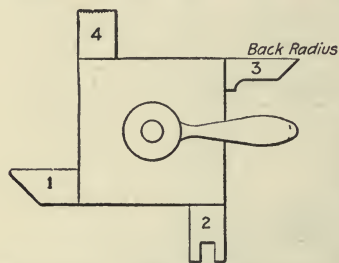

FIG. 314. BAND-TURNING TOOLS

The shell is held in and driven by a pot chuck. The outer end of the shell just above the driving-band groove is run in a steadyrest. The time for this, the fifteenth operation, is about 20 min.

**Applying and Compressing the Copper Driving Band.**—The copper bands are  $12\frac{5}{16}$  in. in outside diameter,  $11\frac{3}{16}$  in. in inside diameter and  $2\frac{5}{16}$  in. wide.

The operation of banding is similar to that described in connection with the 3.3- and 4.5-in. high-explosive shells, except that the bands are heated to a red heat. The press has six 10-in. hydraulic cylinders working at a pressure of 3,500 lb. per sq. in. A loose ring of steel is located below the dies. An eye-bolt is screwed into the fuse hole in the nose of the shell; the shell is raised by an air hoist and located over the dies. The hot band is dropped on the loose steel ring, which locates it to the proper height in the dies. The shell is then lowered into the two rings till its base rests on the bottom of the press. The band is given five squeezes. A squad of laborers handle the shells into and out of the banding department. Of the banding squad one man operates the air hoist, one tends the furnace and places the bands in the press, two handle the shell and turn it in the dies, and one man operates the controlling levers of the hydraulic press. The time for banding is about 5 min. for the complete time from floor to floor.

**Turning the Copper Band.**—Band turning is done on a lathe without back gear. The shell is held in a short cup chuck, Fig. 308, and has a threaded plug in the nose. A turret tool post is used with four tools, as shown in Fig. 314. The band is roughed all over with the tool shown in station 1, the grooves are cut with the gang tool in station 2, the back taper is made with the tool in station 3, and the serrations with the tool in station 4. The time on this operation is about 15 min. The

use of separate tools for band turning results in longer life for the various tools.

The shells are next weighed and then go to final inspection, boxing and shipping. The boxes hold one shell each. They are made of  $1\frac{3}{8}$ -in. yellow pine well battened inside and out and have steel box strapping around the ends and center. They are stenciled: "1 12-in. H. E. Mark IV Lot No. . . . Net 880 gross 780 lb. Size 41×19×19 in."

## CHAPTER VIII

### MANUFACTURING THE RUSSIAN 1-LB. HIGH- EXPLOSIVE SHELL<sup>1</sup>

The 1-lb. high-explosive shell is used on the battlefield in a light type of field gun that is extensively employed to destroy machine guns,

*Gas check must be a tight fit in the shell and must be set home so as to require great force to start out again*

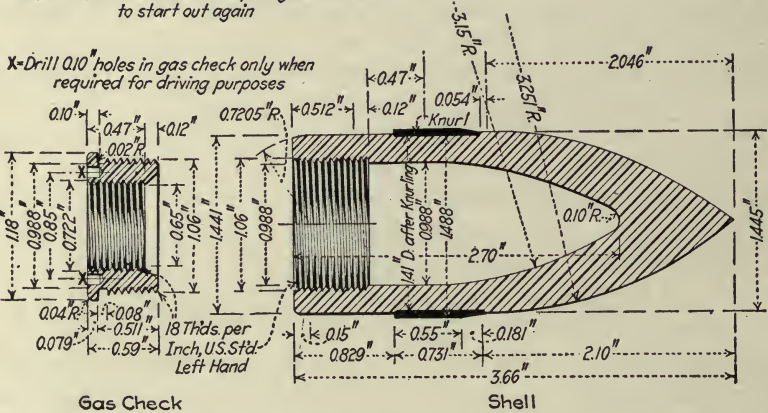

FIG. 315. DETAIL DRAWING OF 1-LB. SHELL

PURE COPPER SEAMLESS TUBING  
(To be thoroughly annealed)

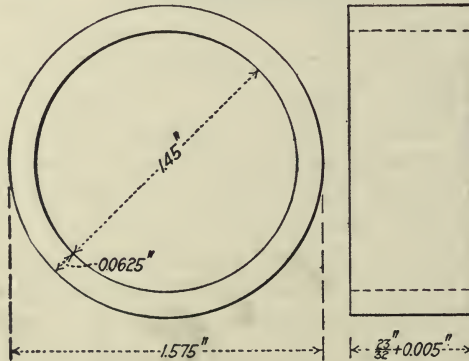

FIG. 316. DETAILS OF COPPER BAND

etc. These light field pieces have a range of over 2 miles at 15-deg. elevation and can be handled with great facility.

<sup>1</sup> Robert Mawson, Associate Editor, *American Machinist*.

In Fig. 315 is shown a detailed illustration of the Russian 1-lb. shell and its gas check. A detail of the copper band as it is received at the factory is shown in Fig. 316. Fig. 317 shows samples from each operation followed, also the elements used in the manufacture of a shell.

The shell is made from cold-drawn bar steel  $1\frac{1}{2}$  in. in diameter. The tensile strength of the stock is 70,000 lb., with an elongation of 20 per cent. and a reduction in area of 40 per cent.

The chemical analysis is as follows: Silicon, 0.03 per cent.; manganese, 0.66 per cent.; phosphorus, 0.094 per cent.; sulphur, 0.107 per cent.; carbon, 0.17 per cent.

The manufacture and loading of the shell entail 25 main operations on the shell proper and 5 on the gas check. These are efficiently performed in the order given in the table of sequence of operations, and the principal operations are graphically depicted in the descriptive sketches.

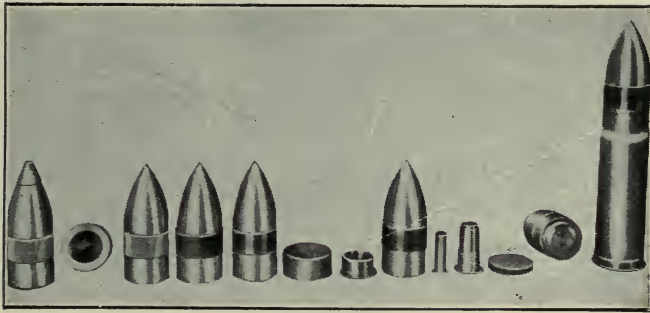

FIG. 317. PROGRESSIVE STAGES IN THE MANUFACTURE OF A 1-LB. SHELL

TABLE OF SEQUENCE OF OPERATIONS ON SHELL BODY

- |  |  |
|--|--|
| 1. First drill and turn for steadyrest | 13. Shellac                                  |
| 2. Second drill and form outside       | 14. Put in gas check                         |
| 3. Ream, face end and chamfer          | 15. Retap                                    |
| 4. Tap                                 | 16. Clean out dirt from threads              |
| 5. Knurl and cut off                   | 17. Inspect                                  |
| 6. Inspect                             | 18. Load shell with powder                   |
| 7. Nose                                | 19. Force primer in cartridge case           |
| 8. Inspect                             | 20. Fill cartridge case with nitro-cellulose |
| 9. Compress on copper band             | 21. Insert percussion fuse                   |
| 10. Turn copper band                   | 22. Insert shell in cartridge case           |
| 11. Inspect                            | 23. Inspect                                  |
| 12. Wash                               | 24. Grease steel part                        |
|  | 25. Pack                                     |

TABLE OF OPERATIONS FOR GAS CHECK

- |                         |                         |
|-------------------------|-------------------------|
| A. Drill and form       | D. Tap and cut off      |
| B. Ream and counterbore | E. Face and chamfer end |
| C. Thread outside       |                         |

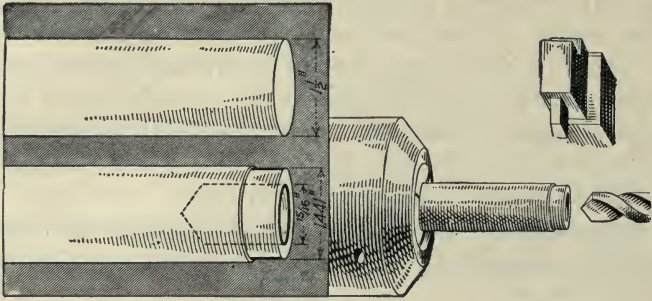

OPERATION 1.

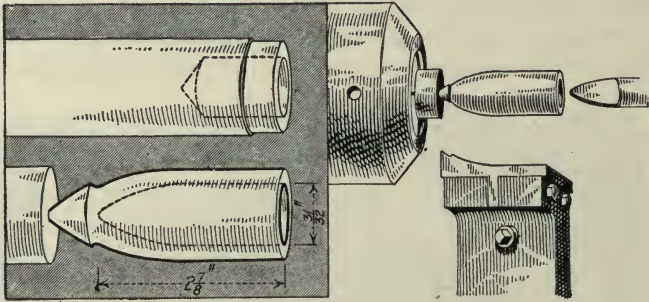

OPERATION 2.

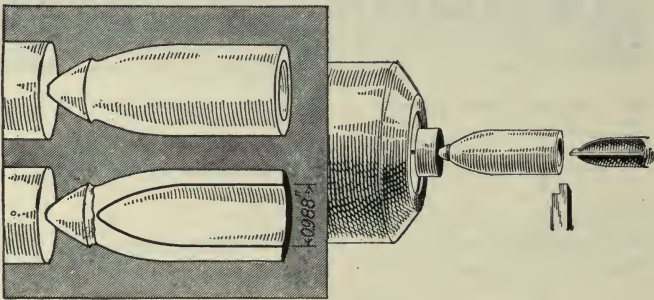

[OPERATION 3.]

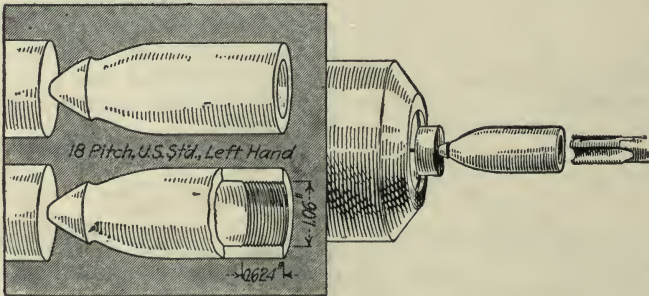

OPERATION 4.

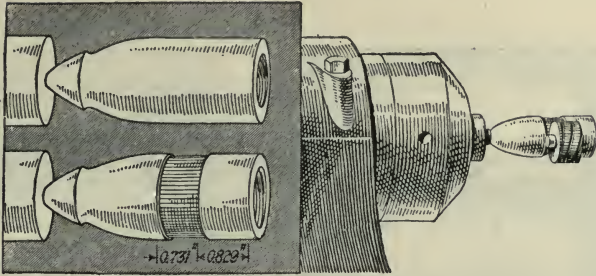

OPERATIONS 1 TO 5. MACHINING BODY

Machine Used—2¼-in. Gridley single-spindle automatic.

Production—12 to 15 per hr.

Cutting Compound Used—“Alco,” made by Texas Fuel Oil Co.

Note—Speed of machine when turning and forming, 180 r.p.m.; when tapping, 80 r.p.m.

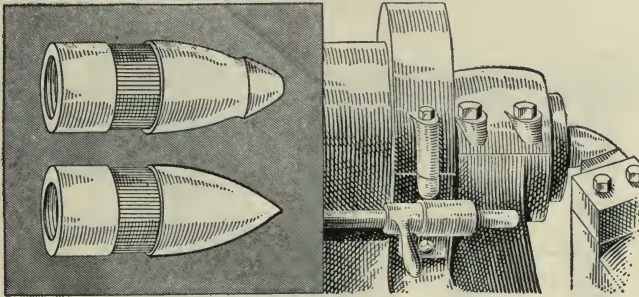

OPERATION 7. NOSING

Machine Used—16-in. Reed-Prentice lathe.

Production—70 per hr.

Cutting Compound Used—“Alco,” made by Texas Fuel Oil Co.

Note—Speed of machine, 450 r.p.m.

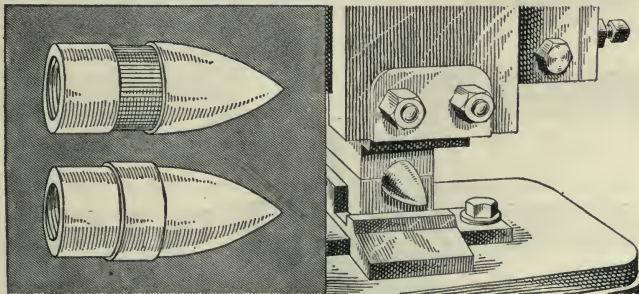

OPERATION 9. COMPRESSING ON COPPER BAND

Machine Used—Zeh & Hahnemann Co. press.

Production—180 per hr.

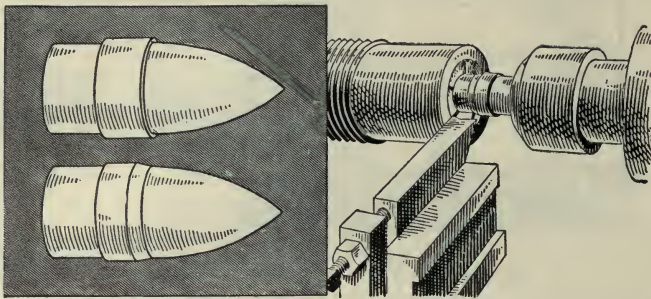

OPERATION 10. MACHINING COPPER BAND

Machine Used—16-in. Reed-Prentice lathe.

Production—60 per hr.

Note—Speed of lathe, 450 r.p.m.

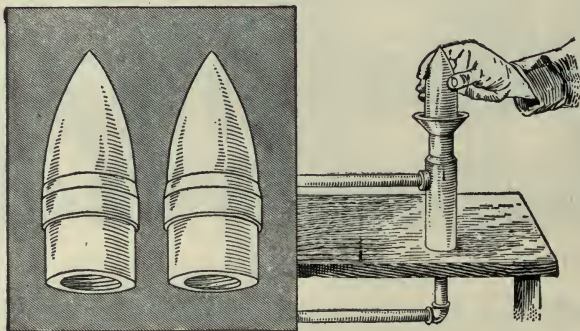

OPERATION 12. WASHING

Machine Used—Special washing machine and attachment

Production—120 per hr.

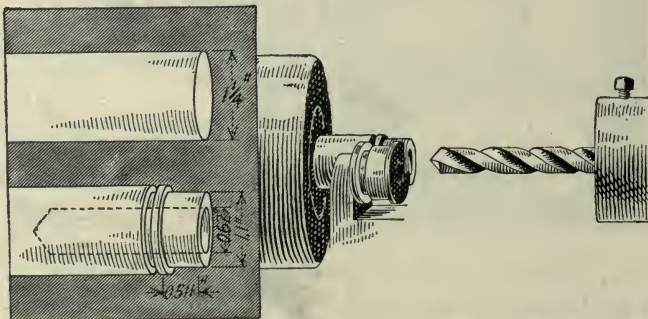

OPERATION A.



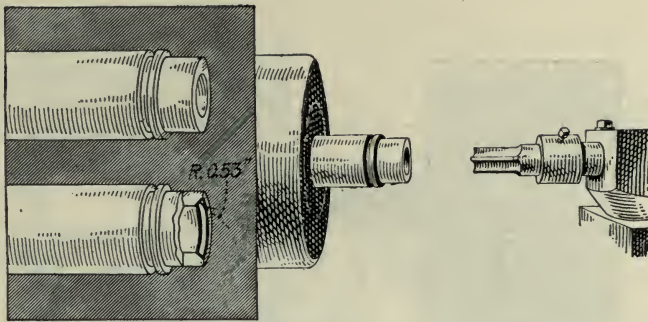

OPERATION B.

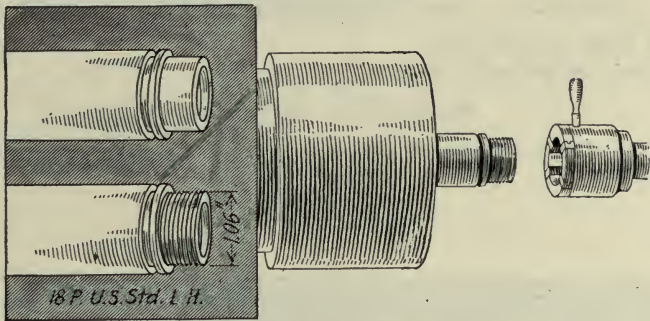

OPERATION C.

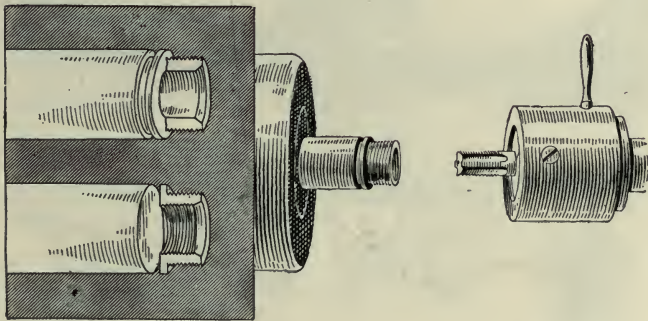

OPERATION D.

OPERATIONS A TO D. DRILL AND FORM, REAM COUNTERBORE, THREAD OUTSIDE, TAP AND CUT OFF GAS CHECK

Machines Used—Chicago No. 3 automatic and Wood turret lathe.

Production—20 per hr.

Cutting Compound Used—"Aleo," made by Texas Fuel Oil Co.

Note—Speed of machine when turning, 340 r.p.m.; when tapping, 130 r.p.m.

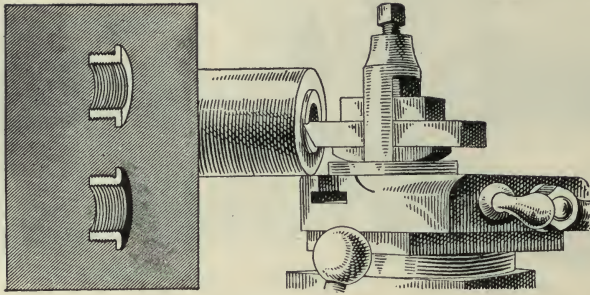

OPERATION E. FACING AND CHAMFERING END OF GAS CHECK

Machine Used—Dalton lathe.

Production—100 per hr.

OPERATION E1. INSPECTION

Production—1 man inspects 150 per hr.

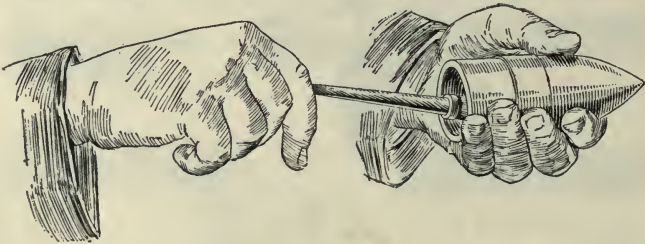
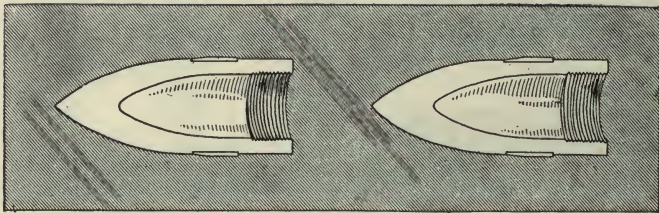

OPERATION 13. SHELLACKING INSIDE OF SHELL

Production—1 man lacquers and starts gas check in shell at the rate of 120 per hr.

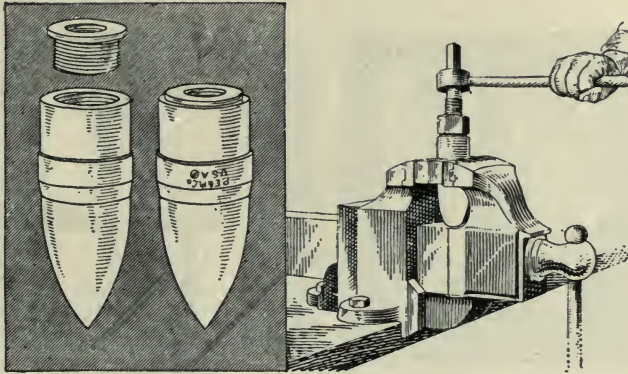

OPERATION 14. SCREWING DOWN GAS CHECK

Fixtures Used—Special vise jaws and arbor.

Production—1 man 120 per hr.

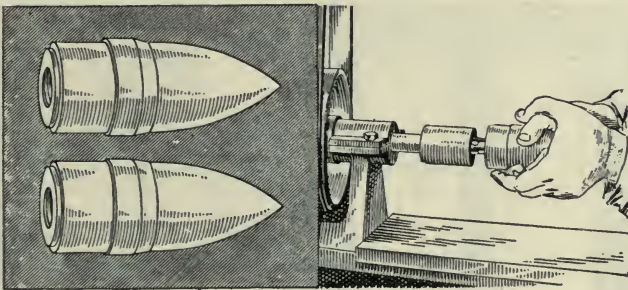

OPERATION 15. TAPPING

Machine Used—Harvey-Hubbell horizontal tapper.

Production—1 man 120 per hr.

OPERATION 16. CLEANING OUT DIRT FROM THREAD

Machine Used—Vertical drill with circular wire brush.

Production—120 per hr.

OPERATION 17. FINAL INSPECTION

Production—1 man inspects 600 per hr.

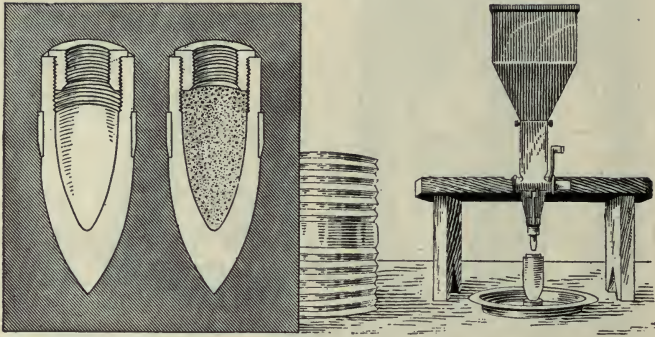

OPERATION 18. LOADING SHELL WITH POWDER

Machine Used—Ideal Manufacturing Co.'s measuring machine with scales and weights.

Production—1 man can load 420 shells per hr.

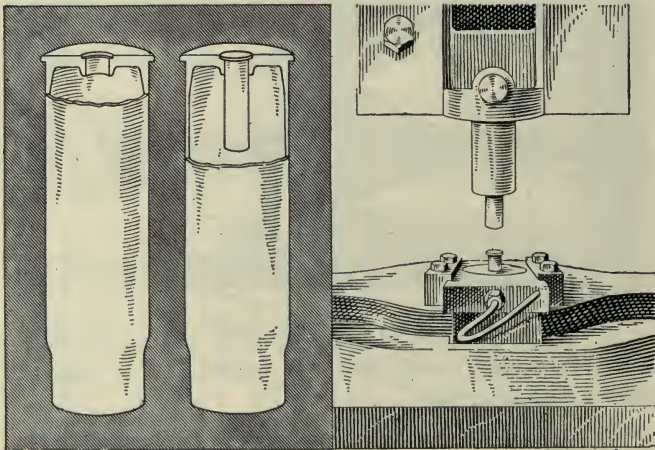

OPERATION 19. FORCING PRIMER IN CARTRIDGE CASE

Machine Used—Foot-operated press.

Production—1 man 420 cases per hr.

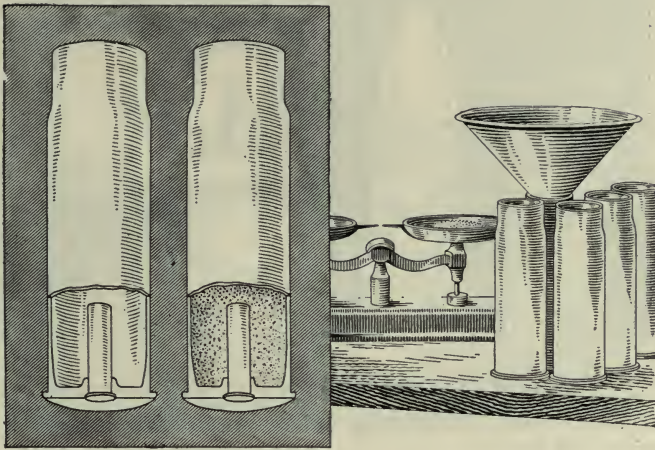

OPERATION 20. FILLING CARTRIDGE CASE

Machine Used—Scales, weights, funnel and wooden pestle.

Production—1 man 240 per hr.

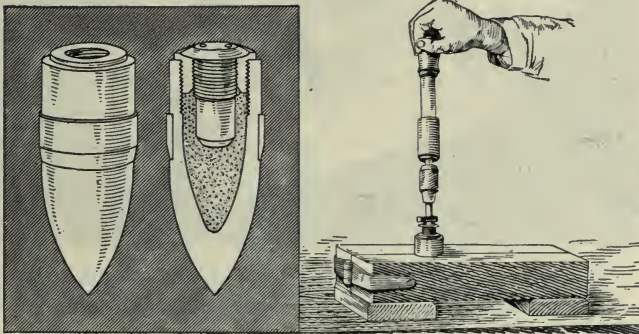

OPERATION 21. INSERTING PERCUSSION FUSE

Tools Used—Wooden vise and special screw-driver.

Production—1 man 300 per hr.

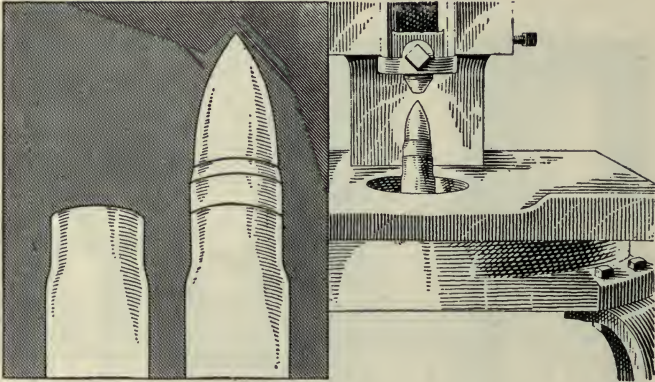

OPERATION 22. INSERTING SHELL IN CARTRIDGE CASE

Machine Used—Foot-operated press.  
Production—500 per hr.

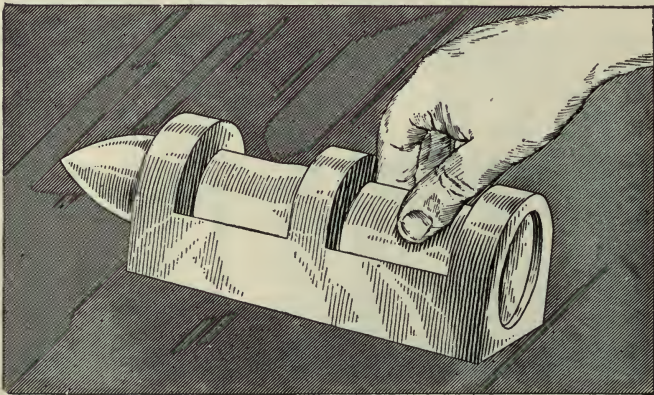

OPERATION 23. INSPECTING ASSEMBLED PROJECTILE

Production—1 man 500 per hr.

OPERATION 24. GREASING STEEL PART OF PROJECTILE

Production—1 man 500 per hr.

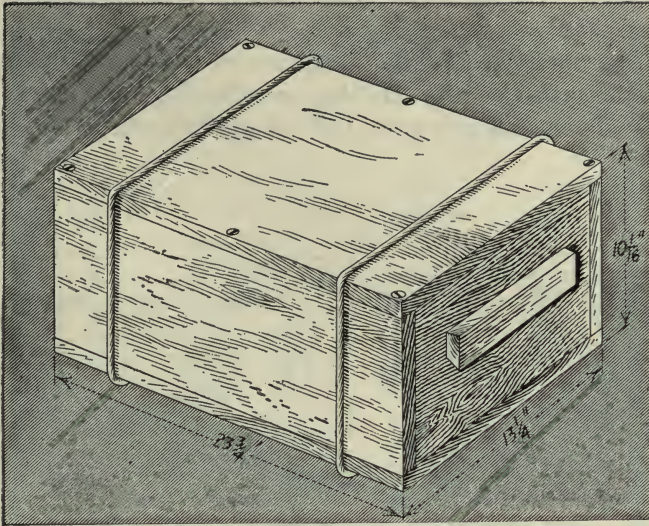

OPERATION 25. PACKING

Production—1 man 4 cases per hr, or 240 assembled projectiles.

The first five machining operations are performed on the bar stock before the shell blank is cut off, and precede the first inspection. These operations are all expeditiously performed on a Gridley single-spindle automatic. The stock is fed against a stop, placed between the fourth and first stations on the turret of the automatic, for length. The turret is then fed around to the first station, the hole rough-drilled and the outer end of the bar trued for the roller steadyrest. On the second station of the turret the hole is second drilled and the outside form turned. During this operation the outer end of the bar is supported with the roller steadyrest. The turret is then revolved to the third station and the hole reamed to size, the end faced and chamfered. In the fourth station of the turret the hole is first tapped as the fifth operation. The recess for the band is then knurled and the shell blank cut off. During these operations the blank is again supported with the steadyrest. The cutting-off tool is made with a contour similar to the nose of the shell, as by so doing, the amount of stock to be removed in the next operation is reduced.

Details of the tools used in the Gridley automatics are shown in Fig. 318. The gage used to test the drill when grinding is shown in Fig. 319 and the gage for the reamer in Fig. 320. The gages used on the automatic are illustrated in Fig. 321.

The shell blank is then inspected, using the gages, Fig. 322, after which the next operation is nosing. This work is performed in a Reed-





of the machined shell, is shown in Fig. 324. The shell is then inspected for length and contour of nose. The gages used for this operation are

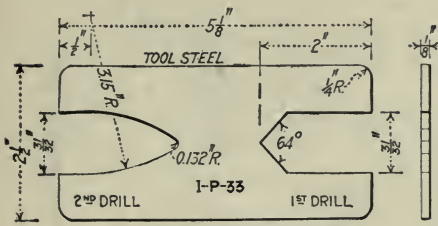

FIG. 319. DRILL GAGE

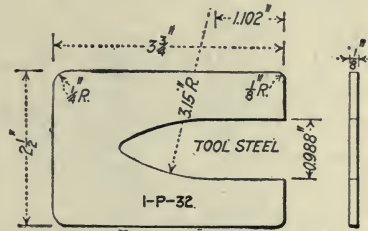
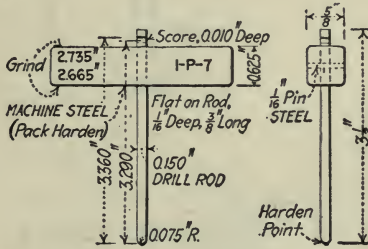
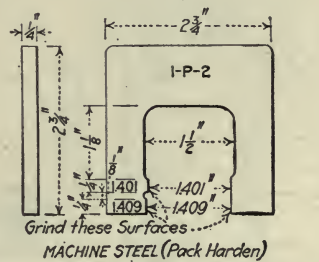

FIG. 320. REFRAMER GAGE



Gage for Inside Depth of Shell



Gage for Diameter of Band Groove

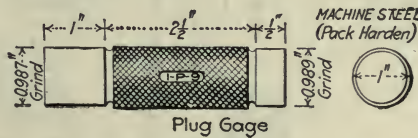

Plug Gage

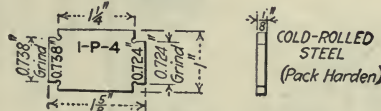

Gage for Width of Band Gage

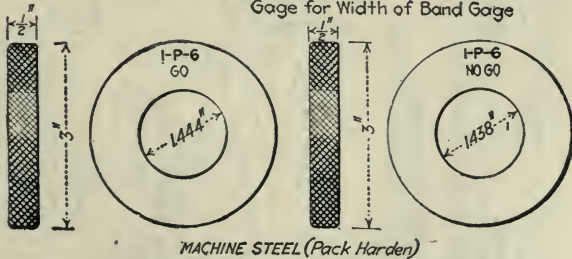

Gages for Front End of Shell Body

FIG. 321. GAGES FOR SCREW MACHINE OPERATIONS

also shown in Fig. 324. The shell is then taken to the press and the copper band compressed into place.

The copper bands are purchased in the dimensions given on the detail, Fig. 316. They are annealed in a crude-oil furnace at a temperature of



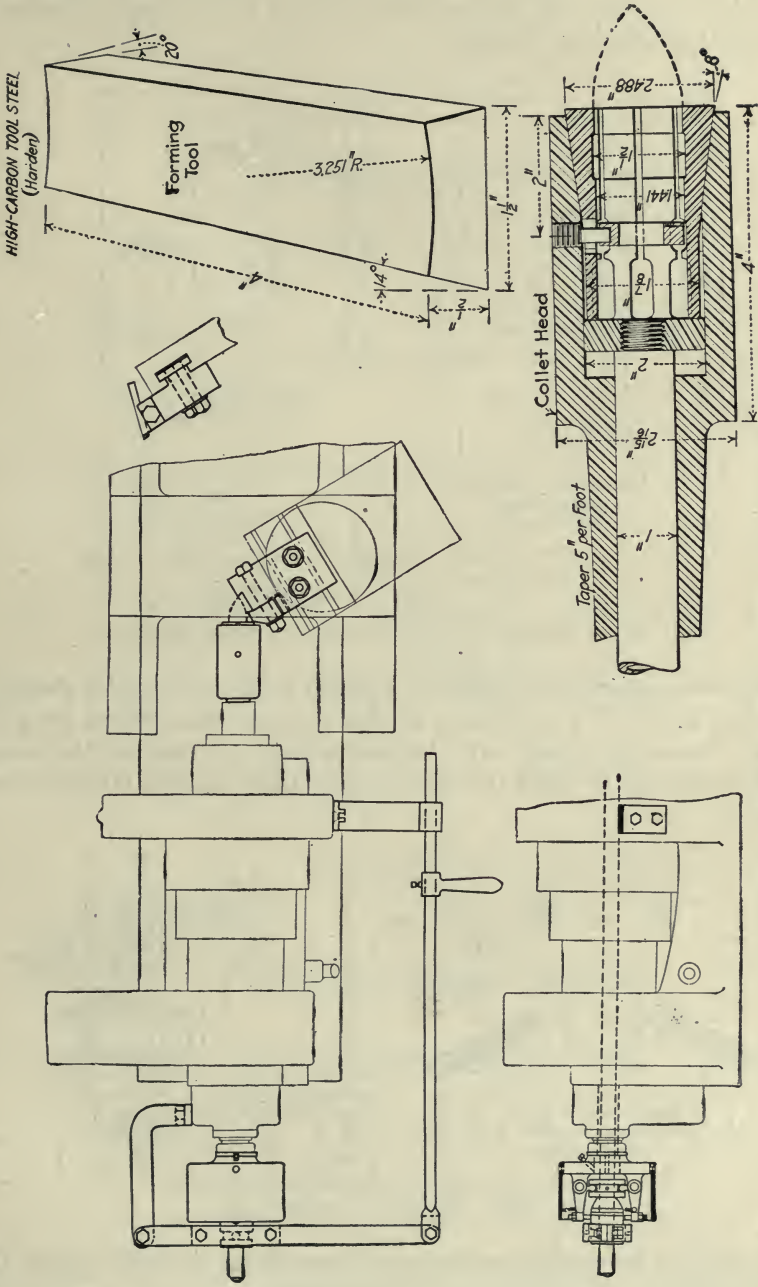

FIG. 323. DETAILS OF TOOLS USED IN NOSING OPERATION

1,375 deg. F. The bands are passed in on one side of the furnace and out on the opposite side, sliding down a chute into a tank of water to complete the annealing operation.

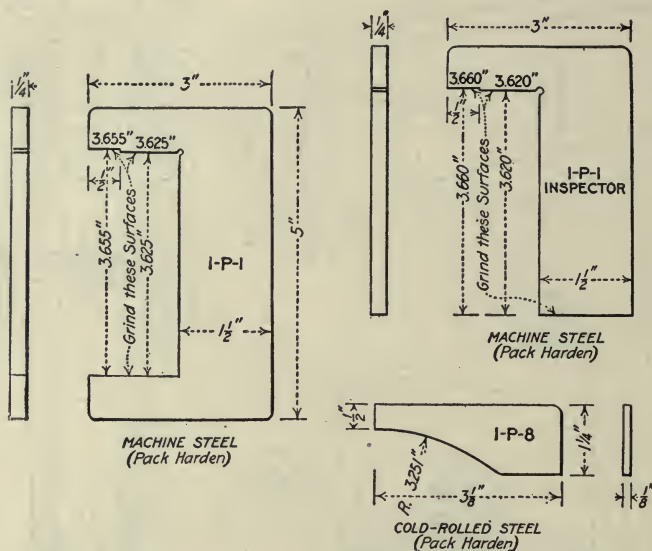

FIG. 324. GAGES FOR SHELL LENGTH AND NOSE CONTOUR

An improved form of banding die is fitted to the press and is shown in detail in Fig. 325. The features of this tool are the inclined steel die blocks. These are fitted with tension springs so that as the upper element of the die is raised the springs draw back the side blocks, allow-

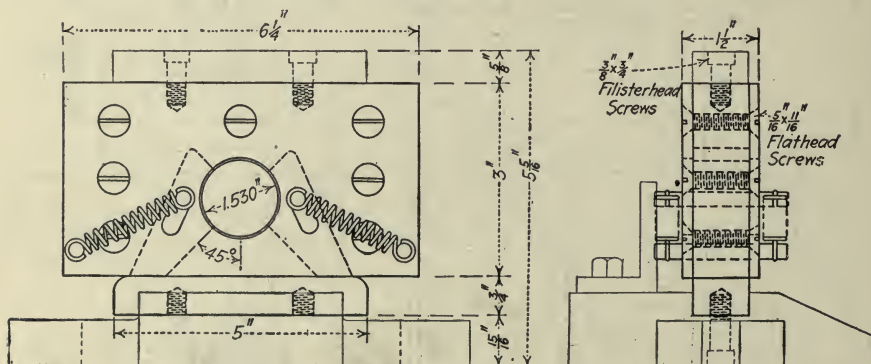

FIG. 325. DETAILS OF BANDING DIE

ing the shell to be quickly removed and preventing the shell seizing the dies after the copper band has been compressed.

The copper band is next machined in a lathe. For this operation the shell is held in a drawback collet operated in a similar manner to the

lathe when machining the nose and shown in detail in Fig. 323. Details of the forming tool for the copper band are shown in Fig. 326. The nose end of the shell is supported in a center operated by air. Details of the

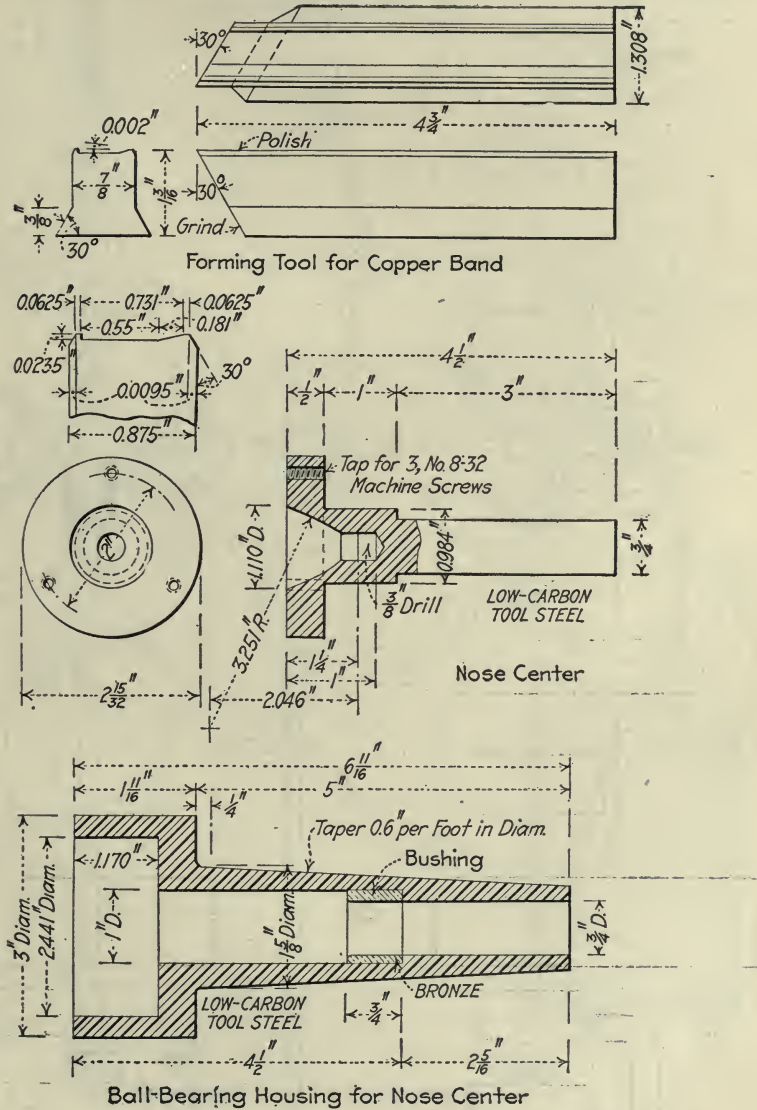

FIG. 326. FORMING TOOL AND DETAILS OF NOSE CENTER

nose center, the housing and the device for operating it by air are also shown in Fig. 327. An assembled view of the shell in position to be machined is shown in Fig. 327. The gages for use on the lathe are shown in Fig. 328.

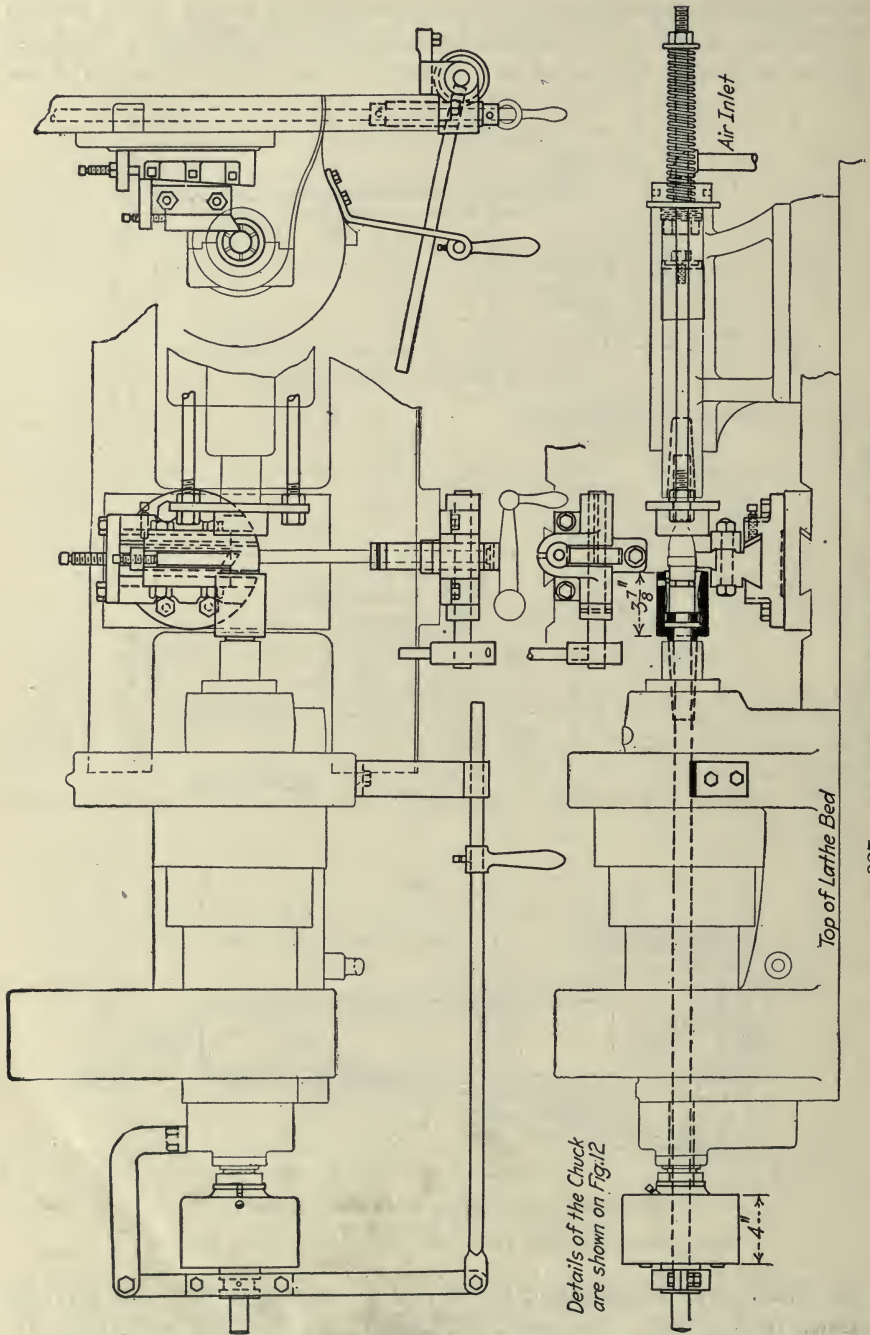

FIG. 327. MACHINING THE SHELL IN THE LATHE

The next operation is inspecting the band; the gages used are shown in Fig. 328.

A detail of the washing tank is shown in Fig. 329. A jet of steam impinges the open end of the shell and as the shells are brought against

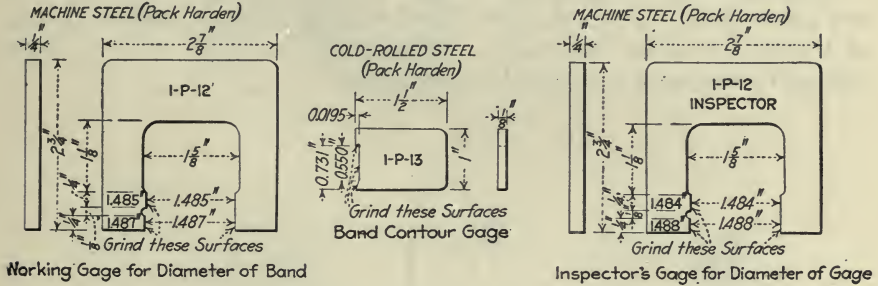
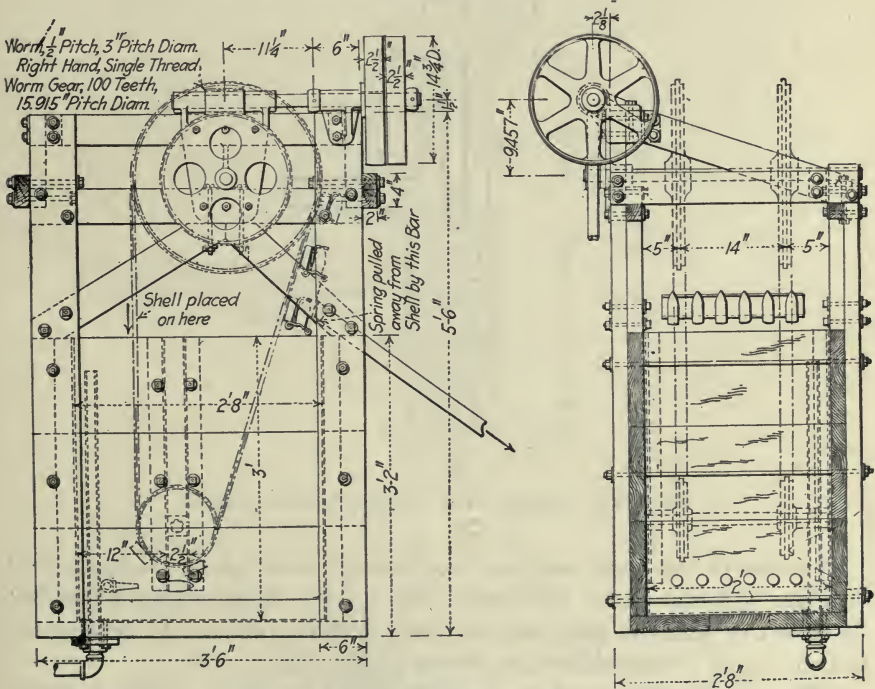

FIG. 328. DETAILS OF BAND GAGES



the chute the clips are pushed back and the shells automatically drop down the chute. To remove the grease the shells are then washed in soda water heated to 180 deg. F.

In Fig. 330 another washing arrangement is illustrated. In this device the shell is placed in the funnel and steam is forced through the

inlet pipe. As the shell pushes down the funnel to the position shown the steam enters the shell and cleans it. When the funnel is allowed to raise, by action of the spring, the steam and condensation passes under the piston and through the outlet.

The manufacture of the gas checks will be next described. These are made from  $1\frac{1}{4}$ -in. cold-rolled steel with an analysis similar to that of the steel used for the bodies. These parts are being made on both Chicago automatics and Wood turret lathes.

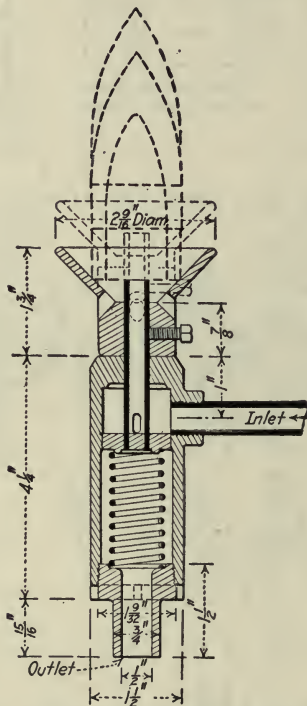

FIG. 330. ALTERNATIVE WASHING ARRANGEMENT

Details of the tools used on the Chicago automatics are illustrated in Figs. 331 and 332. The tools used on the Wood turret lathes are described in detail in Figs. 332 and 333. The gages used for testing the gas checks on the machines are shown in Fig. 334.

The gas checks are then chamfered and faced in a Dalton lathe. The check is held on a threaded drawback chuck. The tool carried in the toolpost is then fed across the revolving part, the outer edge faced and the outer edge of the threaded hole faced.

At the next operation the gas check is inspected, the gages used for this purpose being shown in Fig. 335. The shells are then covered with shellac on the inside, using a small brush for the operation. The pur-



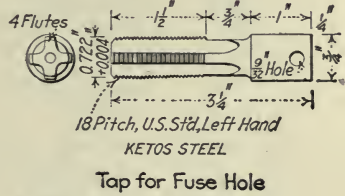
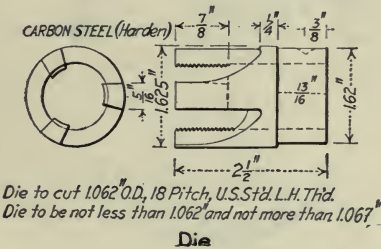
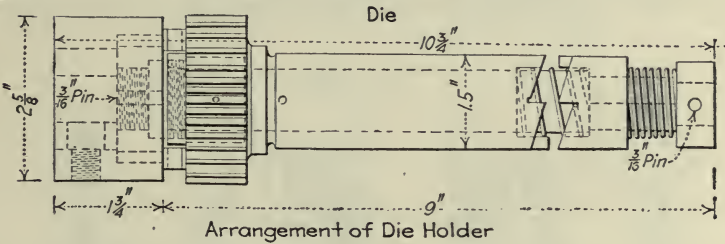
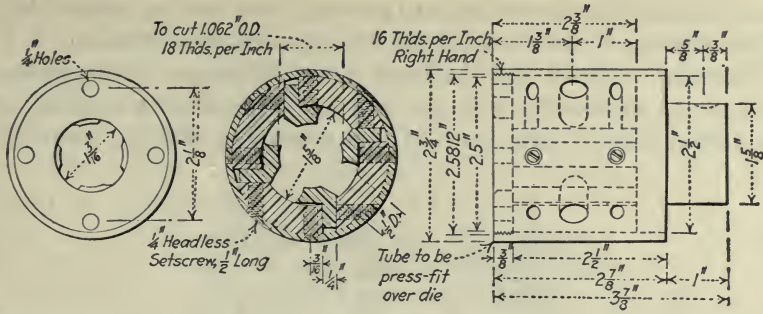

FIG. 331

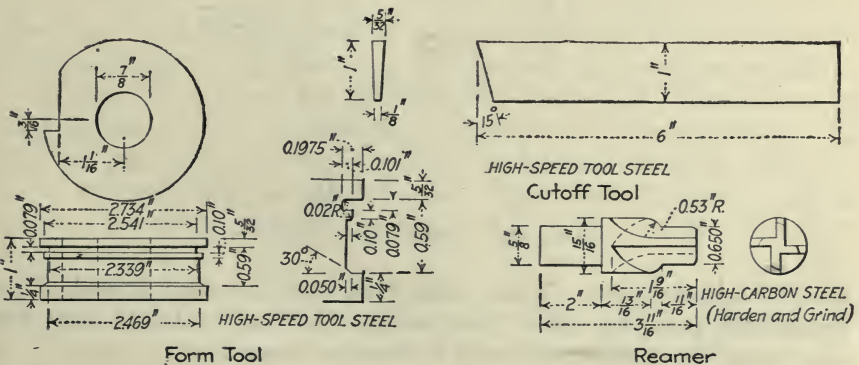

FIG. 332

DETAILS OF TOOLS AS USED ON TURRET LATHES

pose of this shellac is twofold—to prevent rust and to obtain the best possible coating of the shell for the reception of the powder.

After the operator has shellaced a shell he screws in one of the gas checks as far as possible with the fingers. This saves a motion on the part of the man who performs the next operation, which is screwing the

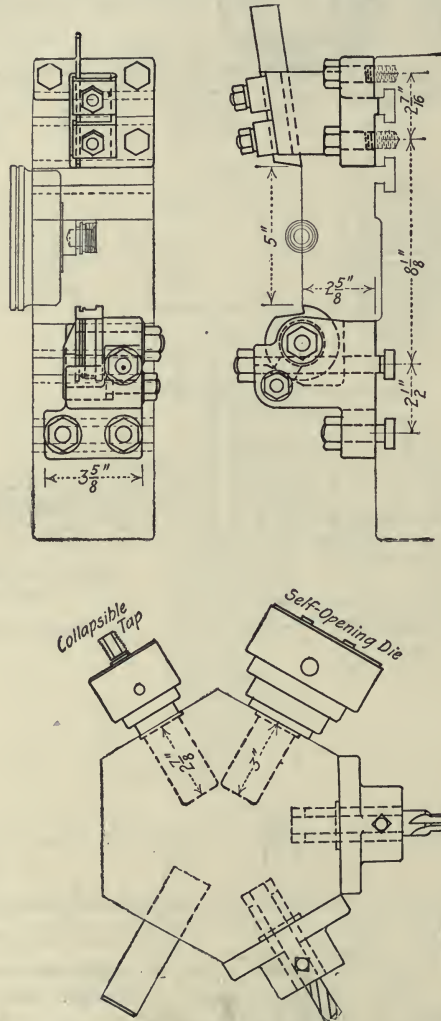

FIG. 333. LATHE TOOL DETAILS

gas check down tight. While doing this work the shell is held in the special vise jaws, Fig. 336. The vise jaws not only hold the shell, but also stamp the maker's name on the copper band.

The shell, where the copper band has been compressed on, rests against a jaw for half of its circumference. The other jaw, carrying the stamp-

ing die is forced against the band and makes the impression on the copper band of the shell. Tension springs fitted in holes of the stationary jaw press against the movable jaw and thus prevent any binding action. This vise also holds the shell while the gas check is being inserted.

The next operation is retapping the gas check. The machine set up for this work is a Harvey-Hubbell horizontal tapper. The special tap used for this operation is shown in Fig. 337.

The dirt is removed from the threads with a circular brush driven by a drill press and the shell is then finally inspected, using the gages, Figs. 321, 322, 324, 328, 335 and 338. The gage or weights, Fig. 338, are used for testing the weight of the finished shell with the gas check in position.

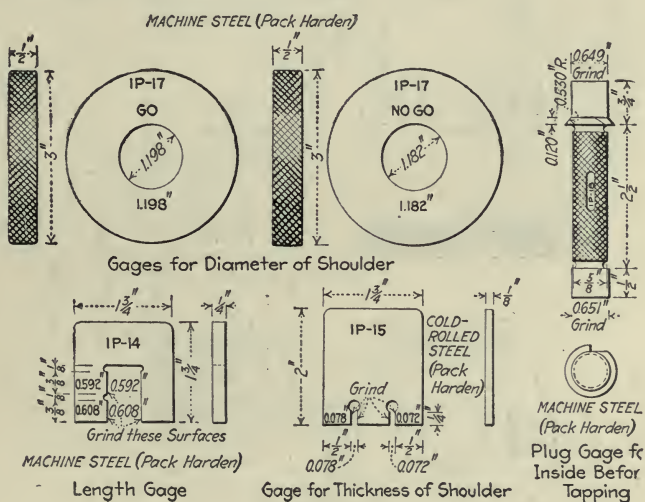

FIG. 334

They are used with a pair of ordinary scales and the shell must register more than the minimum and less than the maximum weight.

In Fig. 339 is shown the tray used for conveying the gas checks to different parts of the machine shop as required. A handy stand, Fig. 340, has been fitted to the automatics to support the tray, Fig. 341, which holds the machined shell blanks. With this arrangement the oil from the blanks drains into the trough and through the pipe shown back to the automatic.

The shell is now ready for loading with the high-explosive black powder. The amount of powder placed in the shell is 240 grains or 15.552 grams. The primer contains 20 grains of powder. The cartridge case is loaded with nitro-cellulose averaging 69 to 85 grains, according to the varying explosive charges of powder placed in the shell.



A felt pad is placed on top of the nitro-cellulose in the case. This is done for two reasons—to prevent the gases from reaching the powder in the shell and, as the pad expands, to form an airtight compartment so that the gases formed when the charge is fired will result in the required explosive effect, which averages in pressure from 9 to 10 tons.

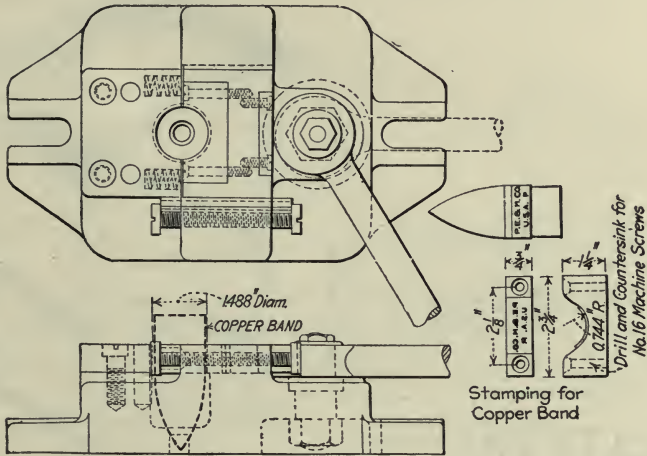

FIG. 336

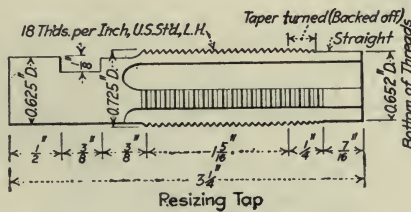

FIG. 337

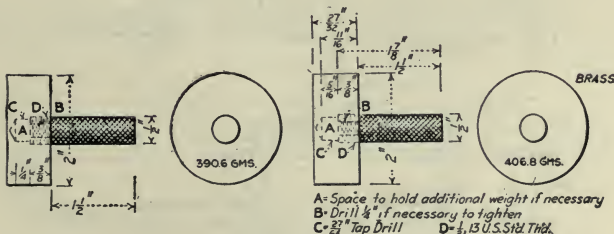

FIG. 338

The percussion fuse is inserted by holding a shell in a wooden vise, pressure being applied by the operator's foot to hold the fuse firmly. The fuse is then screwed down with a pin-type screw-driver designed especially for this purpose and acting on the "Yankee" principle.

The shell is then forced into the cartridge case by a foot-operated

press. The cartridge case rests on its base, and the moving element of the press is furnished with a center to guide the shell when it is being forced into position.

The shell is then tested with the gage, Fig. 342. This gage is used

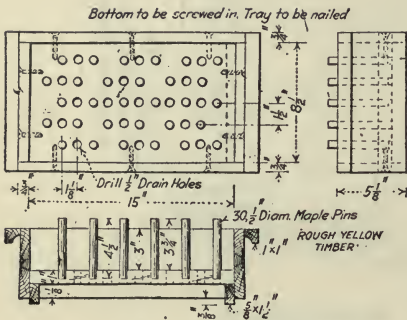

FIG. 339

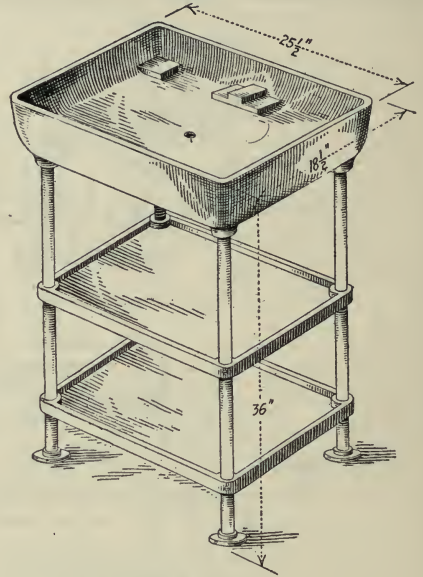

FIG. 340

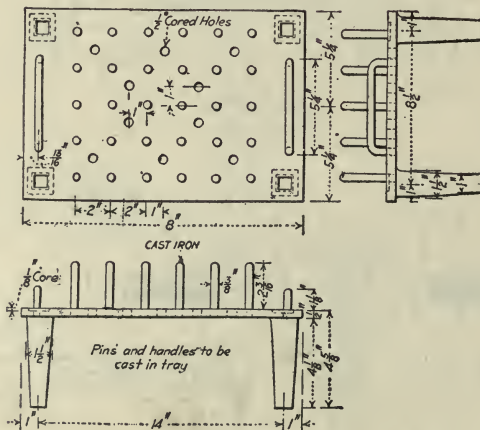

FIG. 341

as the final check on the machined and assembled projectile. The shell does not fit tightly in the gage, but slides in as it would into the barrel of the gun. However, should it be found that the inspector could not slide the projectile, or that the steel shell part did not reach to the







detail of the packing case is shown in Fig. 345. After the packing case has been filled with the 60 projectiles, and the cardboard cover placed over them, the cover is fastened down with wires and screws and the Government seal placed in a countersunk hole in the cover. The case is then ready for shipment for either land or marine warfare as required.

After the shell has been fired from the gun the receiving end of the cartridge case is opened out or forced oversize. In Fig. 346 is shown a device for resizing the end of the case and afterward forcing in the shell.

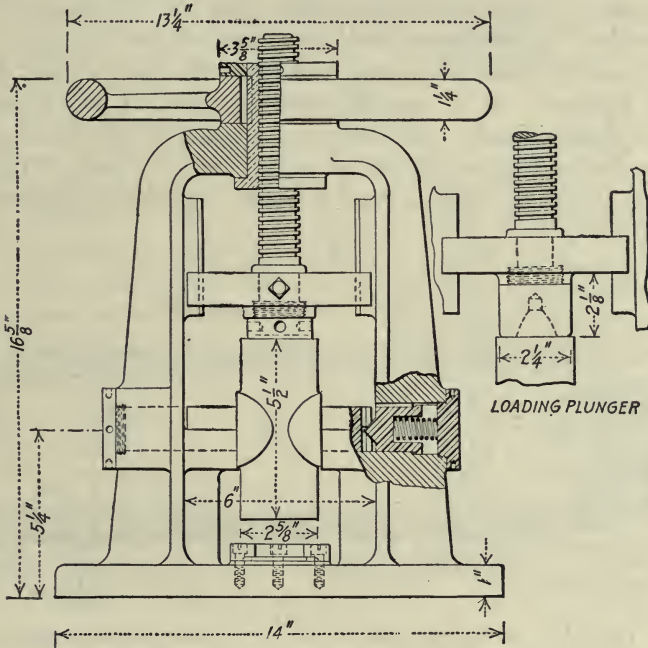

FIG. 346. PRESS FOR RELOADING USED CASES

The case is placed in the forming die and the forming plunger forced onto the end of the case with the handwheel operating the screw shown. After the plunger has been forced down, thus forming the end of the case to size, the loading plunger is substituted for the forming plunger. In a similar manner the steel shell is then forced into the cartridge case, using the handwheel. This attachment is useful, as it may be taken either to the proving ground or to any other place where it may be found necessary to insert shells into cartridge cases that have already been fired.

## CHAPTER IX

### MANUFACTURING RUSSIAN 3-IN. HIGH-EXPLOSIVE SHELLS<sup>1</sup>

The Russian 3-in. high-explosive shell (see detail, Fig. 347) is somewhat simpler in design and construction than the British shells, but the manufacturing requirements and specifications are no less stringent. Notwithstanding these exactions, however, the East Jersey Pipe Corporation, Paterson, N. J., set for itself the task of converting 3½-in. stock into finished shells—inspected and passed by the Russian officials and ready for loading—at a rate of 10,000 every 24 hours, the ultimate capacity of its shop. This record is made possible through the use of

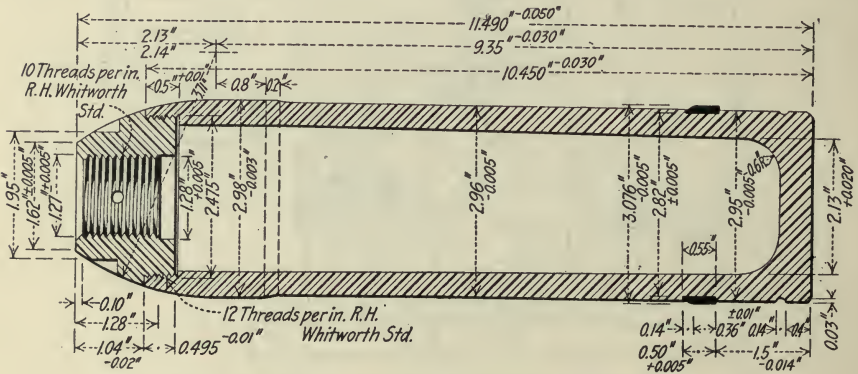

FIG. 347. DETAIL OF RUSSIAN 3-IN. HIGH-EXPLOSIVE SHELL

specially constructed hydraulic machines, an exceptionally economic system of conveyors—for the work is only manually handled when placed in and taken out of the various machines and for the inspection after each operation—and very efficient shop management.

**Shop and Equipment.**—Fig. 348 shows the plan of one end of the machine shop and the general layout of machines, which as far as possible are grouped in pairs so that one operator can attend to two machines. The machines are further located in rows between which run two lines of gravity roller conveyors, one line carrying the work to the machines and the other from them to the inspector's table.

Previously to the machine operations on the cut blanks, the stock is cut to length in another department in which monorail electric hoists and gravity conveyors do all the handling and from which the blanks

<sup>1</sup> Reginald Trautschold.

are conveyed to the main machine shop by a system of gravity and chain conveyors.

On completion of the heavy machine operations the work is taken by a conveyor to the heat treating department where a complete inventory is taken, after the heated shells have been quenched. Even this quenching is done with the aid of conveyors, the shells passing from the oil-fired pots to an apron conveyor which carries them through a tank of quenching oil. After the inventory, the shells are returned to the machine shop, also by conveyor, and passed between the various machines and the inspector's table on the completion of each operation by means of a continuation of the shop gravity roller conveyor system.

The one interruption to the continuous travel by conveyor occurs just before the copper band is pressed onto the shell, when the assembled body and nose-piece passes to the government enclosure for a complete inspection before the copper band is squeezed into place. Even here there is really little interruption to the conveying system, for the inspectors' tables extend practically the whole length of the enclosure and the shells are rapidly passed from inspector to inspector, each one of whom examines the shell in one specific detail. The shell bodies are then lacquered inside

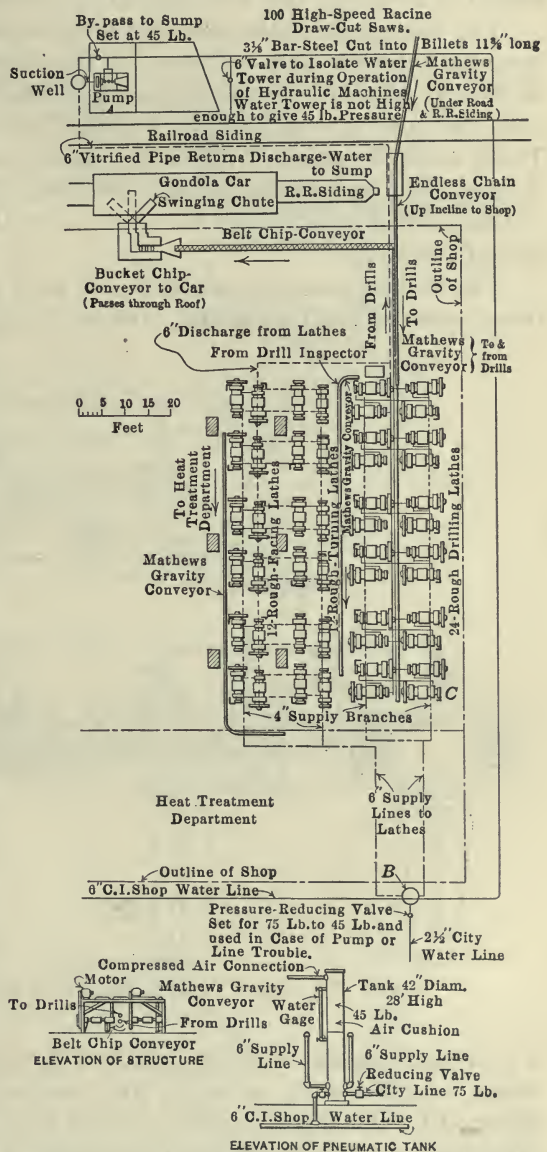

FIG. 348. ARRANGEMENT OF HYDRAULIC MACHINES

The shell bodies are then lacquered inside

and returned to the machine shop, where the shells resume their conveyor travel until the final government inspection. They are then lacquered on the outside, packed in individual cardboard containers and loaded in box cars, also with the aid of conveyors.

The equipment of the shop has been selected with the sole object of securing economy and efficiency in the manufacture of 3-in. Russian shells. It is unique in the hydraulic machines employed for all heavy cuts and for some of the less arduous but more exacting operations. These machines, two of which are shown in Figs. 349 and 350, were designed and built in the shops of the East Jersey Pipe Corporation and to them is due in large part the ability of that shop to maintain its high rate of production.

The drilling machine, which is also used for facing by the substitution of a facing tool for the drill, is shown in detail in Fig. 349. The work

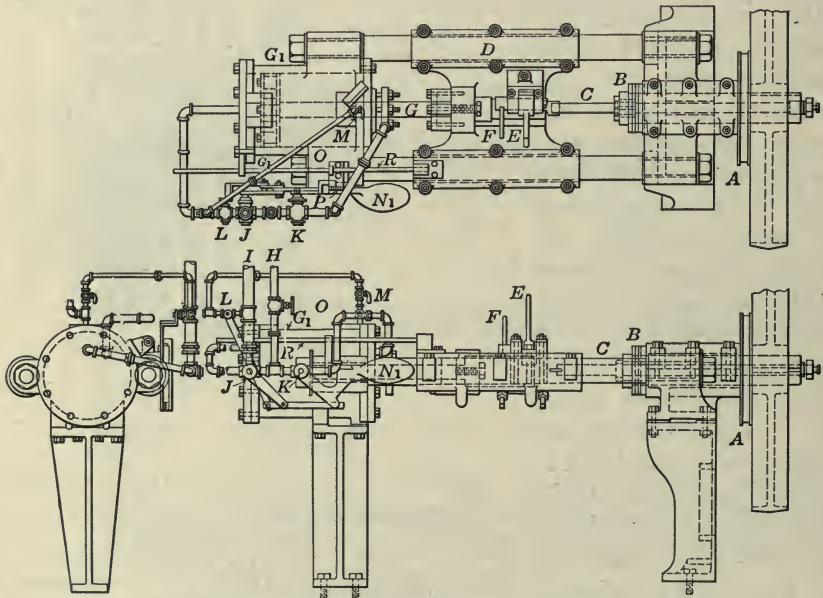

FIG. 349. EAST JERSEY HYDRAULIC DRILLING MACHINE

is held rigidly in the movable carriage *D* by means of a powerful eccentric clamp, and the drill or facing tool rotates. The clamp is manually operated by the slightly eccentric lever *E* and the thrust of the drill is taken care of by the large ball thrust bearing *B*. The machine which is run at 140 r.p.m. is directly belt driven and the pulley *A*, mounted on the spindle with the large driving pulley, drives a small cutting-lubricant pump (not shown). A copious supply of lubricant is required inasmuch as a 2-in. drill is fed into the hard shell blank at a rate of 2 to 3 inches per

min. The drill bit is of high speed steel and the drill bar has two deep chip grooves and a center hole through which the cutting-lubricant is forced—see Fig. 351.

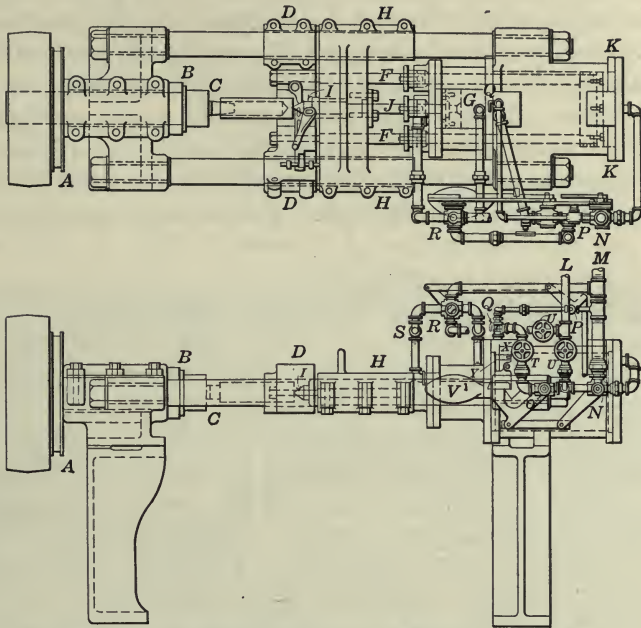

FIG. 350. EAST JERSEY HYDRAULIC TURNING MACHINE

Water under a pressure of 60 lb. per sq. in. enters the large hydraulic cylinder through the supply pipe H and forces the carriage D and the work against the rotating drill by means of the piston rod G. At J

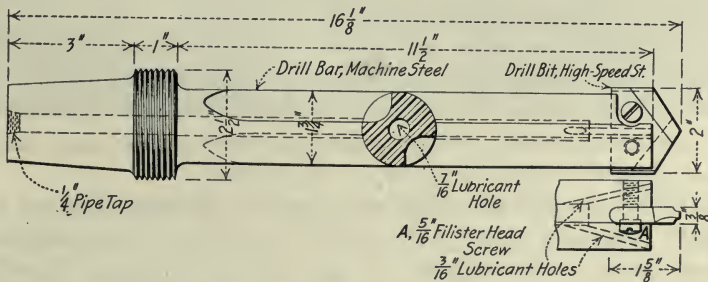

FIG. 351. DETAIL OF DRILLING BAR

is a three-way cock which alternately admits water to the rear of the piston from the supply pipe H and from the rear of the piston to the discharge pipe I. Another cock at K admits water from the supply pipe

to the front of the piston for withdrawing the carriage and work. The operation of the cocks is automatically controlled by the weighted operating lever *N*. In the horizontal position shown, *N* holds open the connection from the supply pipe to the rear of the piston and also the connection between the front of the cylinder and the discharge pipe. In a vertical position, that is dropped, *N* reverses the connections, opening the discharge from the rear of the piston and admitting water to the front end of the cylinder. The forward travel of the carriage necessitates manual operation on the part of the machinist. He has to raise the main operating lever to the horizontal position, where it is held in position by a latch finger (not shown). The reverse is entirely automatic, however, the trip rod *R* coming in contact with the trip finger and dropping the weighted operating lever.

The turning machine, shown in Fig. 350, differs from the drilling and facing machine in several respects. The work rotates and the tool, except for its feed, is held stationary. The hydraulic cylinder is of the duplex type. The rear section furnishes the feed for the turning tool through two piston rods, one to the front and the other to the rear (see *F* and *F*, Fig. 350). The forward cylinder has one central piston rod and operates the tailstock carriage, the hydraulic pressure being exerted on the piston during the turning operation. The thrust of the cutting tool and also of the tail center are taken care of by a large ball thrust bearing. The operating mechanism actuating the respective cocks to the supply and discharge pipes, *L* and *M* respectively, is quite similar to that of the drilling machine, pressure being exerted behind the piston during the turning operation and on the opposite side when withdrawing the tool carriage and the work.

The East Jersey Turret Lathe, used for finishing the inside of the shells, is another of the special machines developed primarily for shell work. It is a motor driven machine equipped with a pneumatic three-jaw chuck and a six station turret.

A tapping machine with automatic reverse, a duplex slot miller and a special band turning lathe, all built on the same general principle as the East Jersey Turret Lathe, are among the important units in the corporation's equipment. These machines were also designed and built in the shops of the East Jersey Pipe Corporation.

One other institution which aids greatly the high output of this excellently equipped plant, and without which even the efficient tools could not maintain the standard, is the system for keeping track of the output of the individual machines. Every machine in the shop upon which shell work is performed is connected with a magnetically operated "Productograph" in the superintendent's office (see Fig. 352) and it is part of the duties of each operator to record the completion of each piece worked on. This he accomplishes without loss of time by simply throw-

ing a lever situated in a convenient position on or near his machine. A magnetically operated pencil records, on the "Productograph" sheet, each movement of the lever and at the same time the register is advanced a unit. The output of every machine in the shop is thus directly under the eye of the management and if the production from any machine falls down for even a few minutes it is at once known and the trouble discovered and remedied. The importance of the knowledge thus gained can be appreciated when it is realized that, with the exception of the heat treatment and the cutting off of the blanks, there is not an operation in the manufacture of the shells that consumes more than two or three minutes and many of the operations take but a few seconds.

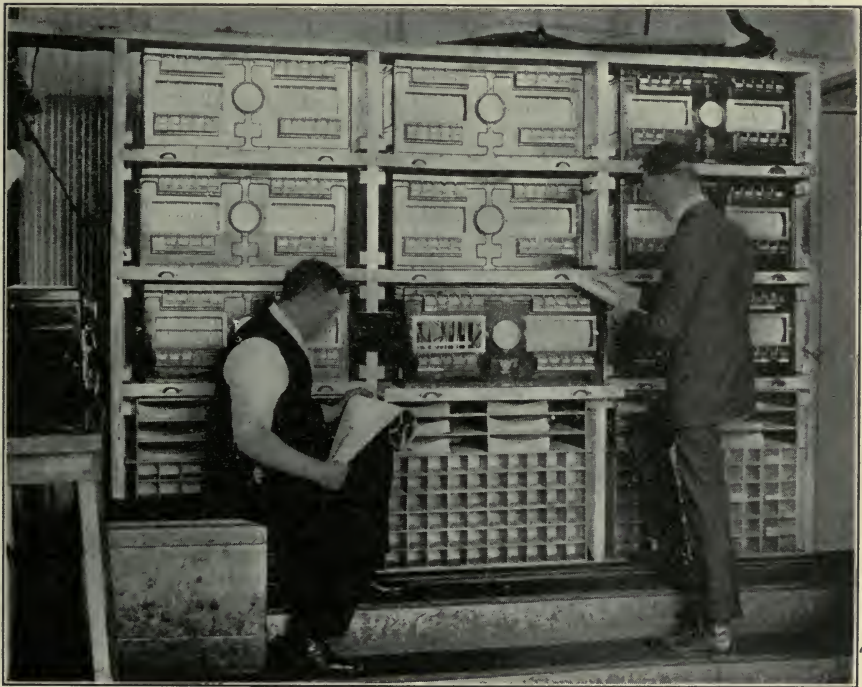

FIG. 352. THE "PRODUCTOGRAPH"

The installation of the "Productograph" not only speeded up production by at least 25 per cent., but reduced the number of "runners" from 15 or 20 men to but two.

**Making the Shells.**—Thirty-seven main operations are required to make a shell from the bar stock received at the shop—17 on the body-piece, 10 on the nose-piece and 10 on the nose and body pieces assembled as a unit. The sequence of operations, together with brief data, is as follows:

## SEQUENCE OF OPERATIONS

1. Cutting-off body blanks.
2. Drilling body blanks.
3. Centering body blanks.
4. Rough-turning body.
5. Rough-facing base.
6. Heat treatment.
7. Finishing inside of shell.
8. Recentering base.
9. Second rough body turning and turning bourlette.
10. Finish-turning body and finish-turning base.
11. Finish-facing base.
12. Counterboring and recessing body.
13. Grooving body for band.
14. Undercutting band groove.
15. Knurling band groove.
16. Thread-milling body.
17. Washing body.
- A. Cutting-off nose-piece blanks.
- B. Drilling and tapping nose-piece.
- C. Rough-forming nose-piece.
- D. Squaring and beveling nose-piece.
- E. Milling slots on nose-piece.
- F. Drilling for screw in nose-piece.
- G. Tapping for screw in nose-piece.
- H. Finish-tapping nose-piece.
- I. Sizing and recessing base of nose-piece.
- J. Thread-milling nose-piece.
18. Assembling body and nose-piece.
19. Rough-turning profile.
20. Finish-turning profile.
21. Beveling bourlette.
22. Grinding bourlette.
23. Forming gas check and rounding base.
24. Filing and polishing.
25. Pressing-on copper band.
26. Turning copper band.
27. Removing burr.

## OPERATION 1. CUTTING-OFF BODY BLANKS

Machine Used—Racine power hack saw.

Special Tools and Fixtures—None.

Production—12 min. each.

Inspection—For length (11.250-in. min., 11.375-in. max.).

Remarks—One man operates 9 machines.

## OPERATION 2. DRILLING BODY BLANKS

Machine Used—East Jersey Hydraulic Drilling Machine.

Special Tools and Fixtures—Drilling bar.

Production—5 min. each.

Inspection—Diameter and depth of hole. Limits; diameter, 2.120-in. and 2.140-in.; depth, 9.937-in. and 10.000-in.

Remarks—One man operates four machines.



## OPERATION 3. CENTERING BODY

Machine Used—Drill press.

Special Tools and Fixtures—Expanding mandrel, Sipp drill.

Production—15 sec. each.

## OPERATION 4. ROUGH-TURNING BODY

Machine Used—East Jersey Hydraulic Turning Machine.

Special Tools and Fixtures—Fluted driving arbor.

Production—55 sec. each.

Inspection—Diameter (3.032-in. min., 3.062-in. max.).

Remarks— $\frac{1}{8}$ -in. feed, 140 r.p.m.; one man operates 2 machines. Cut is made with "Stellite" without lubricant.

## OPERATION 5. ROUGH-FACING BASE

Machine Used—East Jersey Hydraulic Facing Machine.

Special Tools and Fixtures—Eccentric clamp, tool holder.

Production—1 min. 35 sec. each.

Inspection—Length.

Remarks—One man operates 2 machines.

## OPERATION 6. HEAT TREATMENT

Machine Used—East Jersey Heating Pot.

Temperatures—1,500 deg. F. for heat, 1,100 deg. F. for draw.

Duration of Treatment—30 min. for heat, 20 min. for draw.

Inspection—Inventory.

Remarks—One pot accommodates 10 shells.

## OPERATION 7. FINISHING INSIDE OF BODY

Machine Used—East Jersey Turret Lathe.

Special Tools and Fixtures—Cutters, reamers, etc.

Production—4 min. each.

Inspection—Diameters of hole. Limits: main diam., 2.230-in. and 2.250-in.; bottom diam., 2.130-in. and 2.150-in.

## OPERATION 8. RECENTERING BASE

Machine Used—Lathe.

Special Tools and Fixtures—Recentering arbor.

Production—20 sec. each.

## OPERATION 9. SECOND ROUGH-TURNING

Machine Used—Lathe.

Special Tools and Fixtures—Tool post, expanding mandrel.

Production—2 min. 30 sec. each.

Inspection—Diameters and lengths. Limits: bourlette, 2.995-in. and 3.005-in.; body, 2.975-in. and 2.985-in.; base, 2.958-in. and 2.965-in.

Remarks—Two sub-operations.

## OPERATION 10. FINISH-TURNING BODY

Machine Used—Whitcomb Lathe.

Special Tools and Fixtures—Expanding mandrel.

Production—1 min. 40 sec. each.

Inspection—Diameters, limits for body, 2.958-in. and 2.964-in.; base, 2.945-in. and 2.950-in.

Remarks—Two sub-operations.

## OPERATION 11. FINISH-FACING BASE

Machine Used—Whitcomb Lathe.

Special Tools and Fixtures—None.

Production—1 min. 30 sec. each.

Inspection—Thickness of bottom and length of body. Limits: thickness, 0.520-in. and 0.540-in.; length, 10.420-in. and 10.480-in.

Remarks—Rejection for rough base.

## OPERATION 12. COUNTERBORING AND RECESSING BODY

Machine Used—Gisholt Lathe.

Special Tools and Fixtures—Cutting tools.

Production—1 min. 30 sec. each.

Inspection—Depth and diameter of counterbore, form and dimensions of recess by limit gages. Limits: depth, 0.510-in. and 0.520-in.; diam. 2.357-in. and 2.378-in.

Remarks—Rejection for rough shoulder or face.

## OPERATION 13. GROOVING FOR DRIVING BAND

Machine Used—Woods Lathe.

Special Tools and Fixtures—None.

Production—27 sec. each.

Inspection—Location, width and diameter of groove. Limits: location from base, 1.486-in. and 1.500-in.; width, according to limit gage; diameter, 2.817-in. and 2.823-in.

## OPERATION 14. UNDERCUTTING BAND GROOVE

Machine Used—Woods Lathe.

Special Tools and Fixtures—None.

Production—1 min. each.

Inspection—By special limit gages.

Remarks—Rejection for burrs.

## OPERATION 15. KNURLING BAND GROOVE

Machine Used—Woods Lathe.

Special Tools and Fixtures—Knurling tool.

Production—24 sec. each.

Inspection—Diameters adjacent to knurled section. Limits: 2.815-in. and 2.825-in.

Remarks—Rejection for chuck marks on body.

## OPERATION 16. THREAD-MILLING BODY

Machine Used—Lees Bradner Threading Machine.

Special Tools and Fixtures—High speed steel milling hob.

Production—1 min. 30 sec. each.

Inspection—By thread plug gage. Limits; 2.475-in. and 2.478-in.

Remarks—All shells to be cleaned by air before gaging. One man operates 2 machines.

## OPERATION 17. WASHING SHELL BODIES

Machine Used—None.

Equipment—2 washing tanks.

Cleansing Liquids—Tank 1, potash solution. Tank 2, solution of "oakite" at boiling temperature.

## OPERATION A. CUTTING-OFF NOSE-PIECE BLANKS

Machine Used—Racine power hack-saw.  
Special Tools and Fixtures—None.  
Production—9 min. each.  
Inspection—For length (1.625 in. min., 1.750 in. max.).  
Remarks—One man operates 9 machines.

## OPERATION B. DRILLING AND TAPPING NOSE-PIECE

Machine Used—Gisholt lathe.  
Special Tools and Fixtures—Steadyrest, pilot, etc.  
Production—1 min. 45 sec. each.  
Inspection—Depth and diameter of base, depth and diameter of counterbore, and by plug thread gage. Limits: base depth, 0.445 in. and 0.465 in.; base diam., 2.487 in. and 2.534 in.; bore depth, 0.220 in. and 0.255 in.; bore diam., 1.280 in. and 1.285 in.  
Remarks—Rejection for rough counterbore hole.

## OPERATION C. ROUGH-FORMING NOSE-PIECE

Machine Used—Gisholt lathe.  
Special Tools and Fixtures—Tool holder and h.s.s. forming tool.  
Production—28 sec. each.

## OPERATION D. FACING AND BEVELING NOSE-PIECE

Machine Used—Gisholt lathe.  
Special Tools and Fixtures—Screw arbor, tool block, tools.  
Production—28 sec. each.  
Inspection—Length of nose and bevel form gaging. Limits: length, 1.020 in.; and 1.060 in.  
Remarks—Rejection for rough shoulder.

## OPERATION E. MILLING SLOTS ON NOSE-PIECE

Machine Used—East Jersey slot miller.  
Special Tools and Fixtures—Milling cutters.  
Production—15 sec. each.  
Inspection—Spacing and depth of slots. Limits: spacing, 1.750 in. and 1.935 in.; depth, 0.650 in. and 0.600 in.

## OPERATION F. DRILLING FOR SCREW IN NOSE-PIECE

Machine Used—Sipp drill press.  
Special Tools and Fixtures—Holding jig.  
Production—13 sec. each.

## OPERATION G. TAPPING FOR SCREW IN NOSE-PIECE

Machine Used—East Jersey automatic tapping machine.  
Special Tools and Fixtures—Holding fixture, Errington tapping chuck.  
Production—8 sec. each.  
Inspection—Thread plug gage, length of threaded hole. Limits: diam., 0.1875 in. and 0.1890 in.; length gage must show through on inside thread.  
Remarks—Rejection for imperfect thread.

## OPERATION H. FINISH-TAPPING NOSE-PIECE

Machine Used—Drill press.  
Special Tools and Fixtures—Tap holder, tap and jig.  
Production—15 sec. each.  
Inspection—By thread plug gage. Limits: diam., 1.270 in. and 1.275 in.  
Remarks. Rejection for imperfect thread.

## OPERATION I. SIZING AND RECESSING NOSE-PIECE

Machine Used—Lathe.

Special Tools and Fixtures—Tool block, cutting tools.

Production—52 sec. each.

Inspection—Location, diameter and form of recess; diameter of base. Limits: loc. recess, 0.475 in. and 0.485 in.; diam. recess, 2.355 in. and 2.365 in.; form recess by limit gage, diam. base, 2.472 in. and 2.487 in.

Remarks—Rejection for rough shoulder.

## OPERATION J. THREAD-MILLING NOSE-PIECE

Machine Used—Holden Morgan thread miller.

Special Tools and Fixtures—Special arbor.

Production—1 min. 45 sec. each.

Inspection—Ring thread gage.

Remarks—Rejection for imperfect shoulder and for marred or imperfect thread.

## OPERATION 18. ASSEMBLING BODY AND NOSE-PIECE

Machine Used—None.

Special Tools and Fixtures—Shell holder and wrench.

Production—27 sec. each.

## OPERATION 19. ROUGH PROFILING

Machine Used—Gisholt lathe.

Special Tools and Fixtures—Air chuck, tool block, profile tool.

Production—25 sec. each.

## OPERATION 20. FINISH PROFILE

Machine Used—Oliver lathe.

Special tools and Fixtures—Air chuck, profile tool, etc.

Production—1 min. each.

Inspection—By profile gage.

## OPERATION 21. BEVELING BOURLETTE

Machine Used—Forming lathe.

Special Tools and Fixtures—Female centers, etc.

Production—10 sec. each.

## OPERATION 22. GRINDING BOURLETTE

Machine Used—East Jersey grinder.

Special Tools and Fixtures—Female centers, etc.

Production—35 sec. each.

## OPERATION 23. FORMING GROOVE AND RADIUS

Machine Used—Engine lathe.

Special Tools and Fixtures—Screw arbor, shallow steadyrest.

Production—25 sec. each.

## OPERATION 24. FILING AND POLISHING

Machine Used—Speed lathe.

Special Tools and Fixtures—None.

Production—45 sec. each.

## OPERATION 25. PRESSING ON COPPER BAND

Machine Used—Hydraulic band press.

Special Tools and Fixtures—None.

Production—12 sec. each.

## OPERATION 26. TURNING COPPER BAND

Machine Used—East Jersey band turning lathe.

Special Tools and Fixtures—Tool post, roller stop, tools.

Production—15 sec. each.

## OPERATION 27. REMOVING BURR

Machine Used—Lathe.

Special Tool Fixtures—None.

Production—8 sec. each.

The stock from which the body blanks are cut comes in bars, 125 in. in length by  $3\frac{1}{8}$  in. in diameter, has an average carbon content of 0.55 per cent.; manganese, 0.70; phosphorus 0.027; and sulphur, 0.035 per cent. Its tensile strength, after heat treatment, is about 135,000 lb., with 95,000 lb. elastic limit.

These bars are received at a siding adjacent to the machine shop, are unloaded by an electric chain hoist in loads of about five bars and conveyed by a monorail to the hack-saw department where they are cut into  $11\frac{3}{8}$ -in. lengths. This work is done with Racine high-speed power hack-saws, one operator attending to nine saws. A stop on the saw-frame measures off the stock as it is fed to the saws, and as each piece is cut off, the operator re-feeds the saw and places the severed piece on the adjacent roller conveyor. This takes the blank to the inspector who records the number and stamps each piece with its heat number. The blanks are then placed on another gravity conveyor, passed under the railroad siding and by the aid of an inclined chain conveyor are delivered to the machine shop proper at an elevation sufficient to enable them to reach the furthest of the heavy East Jersey hydraulic drilling machines over the first section of the shop gravity conveyor system.

The first operation in the machine shop is that of drilling the blanks. This work is done on the East Jersey hydraulic drilling machines. The operator who cares for four machines—a setter-up being employed for every eight machines, takes a blank from the supply conveyor and simply inserts it in the work holding clamp of the machine and raises the operating lever. A hole 2 in. in diameter and 10 in. deep is drilled, the entire operation of feeding the machine, drilling and subsequently removing the drilled blank occupying about 5 min. While the drill is being fed into the blank, the operator attends to his other machine, withdrawing a drilled blank and inserting a fresh one. The drilled blank he places on the roller conveyor bound for the inspection table, at the same time signalling the completion of the work to the "Productograph."

The work then goes to vertical drilling machines for the third operation, *i.e.*, centering. The drilled blank is simply slipped over a vertical expansion mandrel under the drill, the drill brought down and the blank centered.

The next operation is performed on an East Jersey Hydraulic Lathe. The work is slipped onto the fluted driving arbor of the machine, the hydraulically operated tailstock and tool carriage brought up and a roughing cut taken the full length of the blank. The work, after inspection, then goes to an East Jersey Hydraulic of the facing type for the fifth operation.

The shell is placed in the machine, as for the drilling operation, and the base rough-faced. This squares up the base with the rough-turned body. A small central teat is left by the cutting tool for subsequent recentering.

After the customary inspection, the roughly turned shell bodies pass from the machine shop to the heat treating department. This department (see Fig. 353) contains a number of oil-fired East Jersey heating pots, accommodating ten shells each. Two heat treatments of the shell are made, the heat and the draw. For the former, the temperature maintained in the pots is 1,500 deg. F. and the shells are subjected to this heat for 30 min. For the draw, the temperature is 1,100 deg. F. and the shells remain in the pots for 20 min.

In the quenching, which constitutes an important part of this heat treating operation, the shells are slowly passed through the quenching oil on an inclined apron conveyor, the upper end of which elevates the shells some distance above the ground, while the lower end is below the ground level and passes between the pots. As the shells emerge from their subterranean journey the surplus oil drains back to the quenching tank. After the quenching, the shells are drawn and a test specimen is taken for subsequent test. A careful inventory is taken at the same time of all treated shells as a check on previous operations, etc.

From the heat treating department, the shells return to the machine shop for the seventh operation, that of finishing the inside. This is done on East Jersey Turret Lathes. The work is held in a deep three-jaw pneumatic chuck and the turret is fitted with five tools. The end of the shell is faced, the shell bored and reamed to size and all interior work, other than counterboring, recessing and threading the body for the insertion of the nose-piece, done in this one operation, the complexity of which necessitates careful inspection.

To assure accuracy in future operations, the shell is then recentered. For this operation, the shell is placed on a taper arbor, in a lathe, the tailstock carrying a centering tool is brought up, and a center made in the protruding teat.

The shell then goes to an engine lathe for the ninth operation, which consists of the second rough body turning and the turning of the bourlette. For this work the shell is held on an expansion stub arbor, the tailstock brought up to support the work and the cut taken with an ordinary lathe tool.

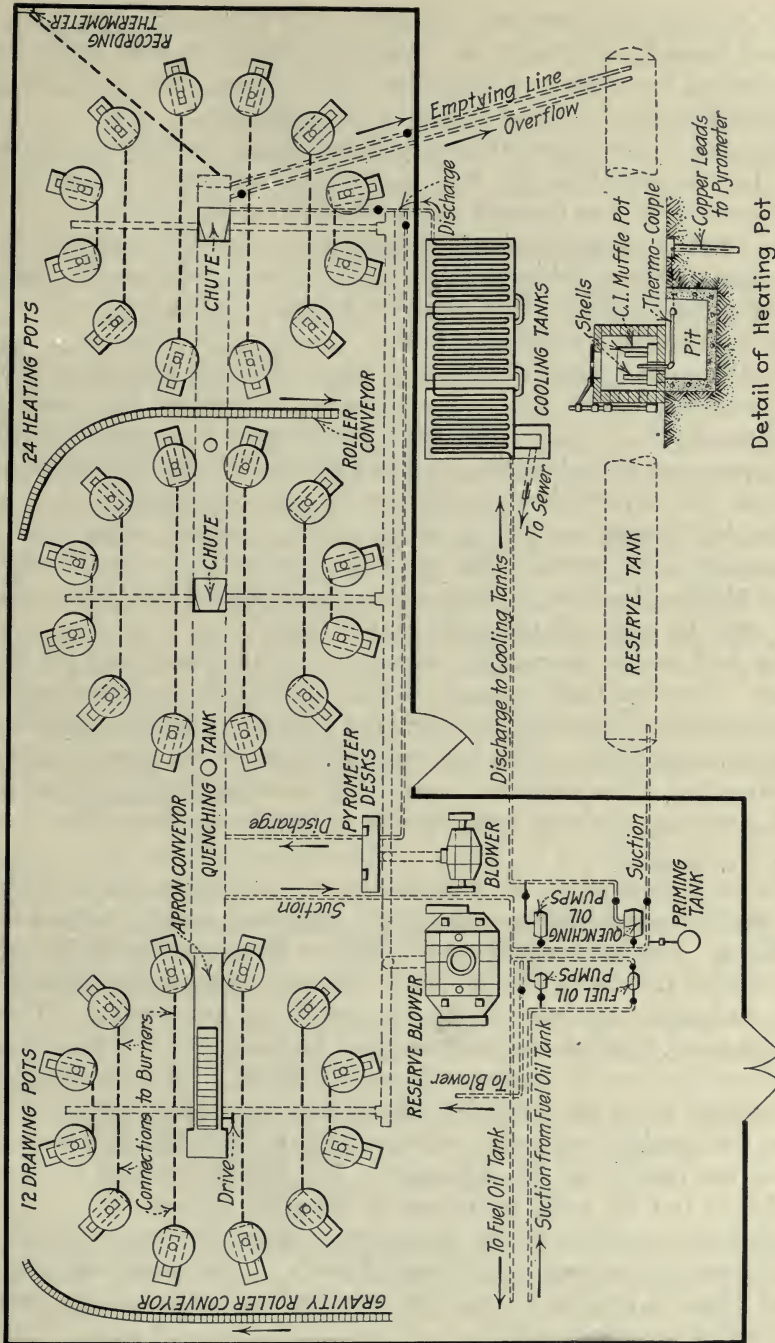

FIG. 353. GENERAL LAYOUT OF HEAT TREATMENT DEPARTMENT

The succeeding operation is performed on a Whitcomb engine lathe, the work being held again on an expansion stub arbor, and consists in finish-turning the body and finish-turning the base. The body cut is commenced at the base and ended at the bourlette.

The work is then transferred to a Gisholt Lathe for finish-facing the base. In this operation the work is held in a pneumatic chuck with inside stops, the cutter brought up and the base finally finished.

The twelfth machine operation consists in counterboring the shell and cutting the recess below that section to be threaded for the accommodation of the nose-piece. This is done on a Gisholt Lathe, the work being held in a deep jawed pneumatic chuck.

The three operations following are done on Woods Lathes, in all of which the work is held in pneumatic chucks. Operation 13 consists in cutting the groove for the copper band, operation 14 in undercutting the band groove and 15 in knurling the band groove. These operations are all simple but nevertheless require care in their execution.

The shell bodies are now in shape to be threaded, preparatory to receiving the nose-pieces. This operation is done on a Lees Bradner Thread Milling Machine, the base of the shell being held in a deep collet chuck and the nose mill-threaded on the inside.

The shell is then thoroughly washed, two tanks being used for that purpose. The first tank contains a solution of potash for removing the oil and grease and the second a solution of "oakite" which is maintained at boiling temperature. The hot shells are then set on a table to dry. This takes but a few minutes. After this cleansing process, the seventeenth operation, the shell bodies are ready for the insertion of the nose-piece.

The stock from which the nose-pieces are machined is similar to that from which the shell bodies are made, but somewhat smaller in diameter, *i.e.*,  $2\frac{3}{4}$  in. The bars, which are of sufficient length to furnish 50 nose-piece blanks, are cut by Racine power hack-saws into pieces measuring  $1\frac{3}{4}$  in. in length, nine saws being attended to by one operator. These saws are located within the machine shop building, but the operations, inspections, etc. are all similar to those performed on the body blanks.

From the saws, the nose-piece blanks are conveyed to turret lathes for the first machine operation, which consists in both drilling and rough tapping the blanks for the detonator. The blanks are held in three-jaw chucks and the work performed in the usual manner.

The next operation on the nose-piece is performed on turret lathes and consists in roughing out the conical profile. The drilled and rough-tapped blank is held in a three-jaw universal air chuck and the rough form cut with a single tool.

In the fourth operation, the base of the nose-piece is held against a shoulder on a screw arbor and the conical end is squared and beveled.



An East Jersey Slot Miller is used for the following operation on the nose-piece. This work, operation *E*, is about the prettiest performed in the shop. Two small end milling cutters straddle the conical end of the nose-piece as the tool carriage is brought up. These mills rotate in opposite directions and feed toward one another and simultaneously cut the two slots in the rigidly mounted nose-piece, held by means of a pneumatic clamp.

The screw hole in the nose-piece is next drilled on a drill press and then the hole is tapped out on an East Jersey Tapping Machine.

The roughly tapped detonator hole is then finish-tapped to size and the work, after being gaged and inspected, is transferred to another lathe where the thread shoulder is sized and recessed—operation *I*.

The tenth operation on the nose-piece is then performed on a Holden Morgan Machine. This consists of thread-milling the nose for insertion in the body-piece. After being tested with a ring thread gage, the nose-piece loses its identity as an individual unit.

The next operation consists in assembling the shell-body and nose-piece, both of which are finished as far as interior work is concerned. A cork is inserted in the threaded detonator hole to guard against foreign substances entering the shell during subsequent operations. The body-piece is then held rigidly in a vise, or work holder, mounted on a bench and the nose-piece firmly screwed down with a wrench.

The assembled shell then goes to a Gisholt Lathe where the profile of the conical end is rough-formed. In this operation, the shell is held in a pneumatic chuck.

Finish-turning the profile follows, this work being done on an Oliver engine lathe with a special forming tool. In this operation, a cutting lubricant is employed.

Following the finish profiling operation, the shells are taken to forming lathes on which the chamfer behind the bourlette is formed, the twenty-first operation.

The next step in the evolution of the shell is grinding the bourlette and is done on East Jersey Grinders in which the shell is held between female centers by means of pneumatic pressure.

The gas check is then formed and the edge of the base rounded. This is an engine lathe operation in which the shell is driven by a screw arbor inserted in the nose-piece, the shell being supported by a shallow steadyrest.

The shell is then filed and polished on a speed lathe preparatory to the final shop inspection. This constitutes the thirty-fourth operation performed in the shop, excluding the various inspections which are not considered as individual operations but chargeable to the shop operations.

The corks are removed from the nose-pieces and the shells subjected to a thorough examination by the shop, duplicating every previous inspec-

tion. Passing this exacting test, the shells go to the government enclosure and are once more examined and gaged, inside and out, by the Russian Government inspectors. During the government examination, the nose-piece and shell-body are separated and on their return to the shop they are blown out and lightly sprayed inside with lacquer, before reassembling.

The copper band is then pressed on. The bands come in the form of rings which just slide over the base of the shell. They are slid onto the shell by hand and fit tightly enough to remain in position over the band groove while the shells are placed into a hydraulic band press—see Fig. 354. These machines force the band into the groove under 1,500 lb. per sq. in. pressure. After one grip of the press plungers, the pressure

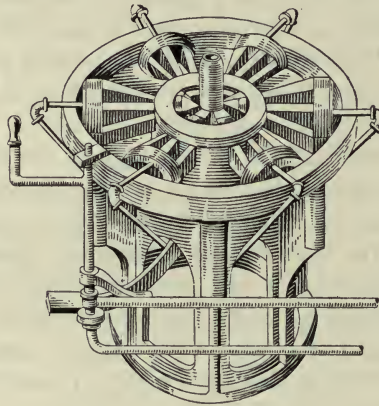

FIG. 354. BAND PRESS

is taken off, the shell revolved a few degrees and given another squeeze to assure band tightness. The shell is then slightly elevated by a foot lever and the top of the band lightly pressed.

From the banding machines the shells are taken to East Jersey band turning lathes on which three tools are employed; the first one for rough-turning the band, the second for beveling the edges of the band and the third for finishing the band to the proper diameter. The shells are then transferred to an engine lathe for the final operation, which consists in removing the slight burr left by the band turning lathe. In this last operation, the shells are held in female centers by means of pneumatic pressure.

After the band has been carefully tested for tightness and gaged by the shop inspector, the finished shell passes once more to the government enclosure for its final inspection and acceptance. This examination is not as extended as the first government inspection, for the shells have already been examined, passed and stamped with the first of the Russian Government's marks. The bands are subjected to close scrutiny, however, and the shells weighed on the official scales. A variation in

weight of only an ounce or two either way is all that is permitted. Shells varying more from the specified weight of 10 lb. 14 or 15 oz. are returned to the shop. Those over weight go to the shop hospital (which is equipped with a complete set of machines for making the shells) and they can usually be rectified; while those which are too far under weight, and there are remarkably few such, have usually to be scrapped.

The accepted shells then have the manufacturer's mark rolled on the base and are passed to the shop inspector who examines them to see that they carry all the required marks, the serial number, the batch number, the two Russian Government marks, the manufacturer's mark, etc. The records are carefully entered in a book by a clerk, the batch number, etc. being called out to him by an assistant who wears a pair of cotton gloves with which he carefully wipes each shell as he inspects it.

The cleaned shells are then given a light coat of lacquer, after which they are slipped into cardboard containers and placed on the conveyor supplying the box car loaders. An ordinary box car, carefully loaded will accommodate about 7,000 shells, so that a car or more is loaded each day, aggregating between 8 and 10 carloads of Russian 3-in. high-explosive shells that leave the Paterson works of the East Jersey Pipe Corporation each week.

## CHAPTER X

### MANUFACTURING 120-MILLIMETER SERBIAN SHELLS<sup>1</sup>

The shop of the Providence Engineering Works, Providence, R. I., affords an example of the way in which a plant of moderate size can be transformed from heavy engine work to the making of shrapnel and high-explosive shells from 70 to 150 mm. in diameter.

The shells are all made from forgings and in four diameters—70, 75, 120 and 150 mm. They are again divided into shrapnel and high-explosive shells, while the 120- and 150-mm. sizes are also made in two lengths. All of this goes to make the manufacturing problem more difficult, but adds interest to the final solution.

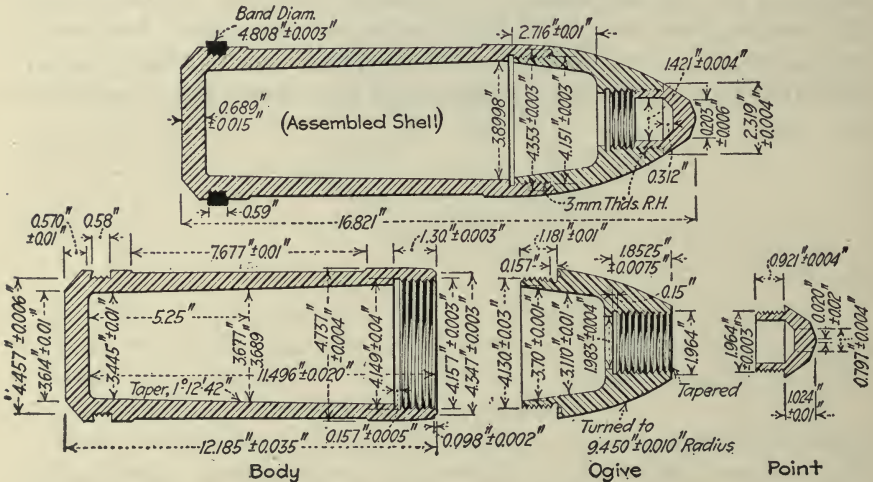

FIG. 355. SERBIAN HIGH-EXPLOSIVE 120-MM. SHORT SHELL

Taking the 120-mm. short high-explosive shell as the subject, the manufacturing operations will be followed through, and the methods used on the other sizes will be shown. Fig. 355 gives a general view of the complete shell, with the protecting point screwed in place.

Thirty-four main operations are performed on the shells before they leave the manufacturer's plant, including two exhaustive inspections on the part of the Serbian officials and the boxing of the shell for shipment—25 on the shell body as a unit or with the ogive in place, 5 on the ogive and 4 in the manufacture of the point. The sequence of these operations, together with brief tabulated data for the individual tasks, follow:

<sup>1</sup> Fred H. Colvin, Associate Editor, *American Machinist*.

SEQUENCE OF OPERATIONS

1. Cutting-off end of shell forging.
2. Centering base.
3. Facing base.
4. Rough-turning shell.
5. Boring shell.
6. Threading nose of shell.
7. Grooving and knurling for copper band.
8. Finish-turning shell.
9. Finish-facing base.
10. Marking base.
11. Washing shell body.
12. First government inspection.
  - A. Drilling ogive.
  - B. Forming and threading ogive.
  - C. Boring and reaming ogive.
  - D. Threading ogive nose.
  - E. Rough-turning ogive.
13. Screwing-in ogive.
14. Finish-turning ogive and shell.
15. Pressing on copper band.
16. Turning copper band.
17. Washing shell.
18. Final shop and government inspections.
19. Cleaning completed shells.
20. Varnishing shells.
21. Baking varnish.
22. Painting shells.
23. Drying shells.
  - A'. Forming and threading point.
  - B'. Milling key slots on point.
  - C'. Shaving point.
  - D'. Rethreading point.
24. Screwing-in point.
25. Packing.

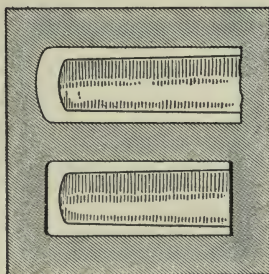

OPERATION 1. CUTTING OFF END

Machine Used—Espen-Lucas.

Special Fixtures and Tools—Milling cutter face back end.

Gages—Special depth gages on machine.

Production—10 per hr.

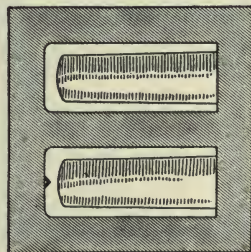

OPERATION 2. CENTERING BASE

Machine Used—Snyder 24-in. vertical drilling machine.

Special Fixtures—Swinging drill jig.

Gages—None; use stop on center drill.

Production—50 per hr.

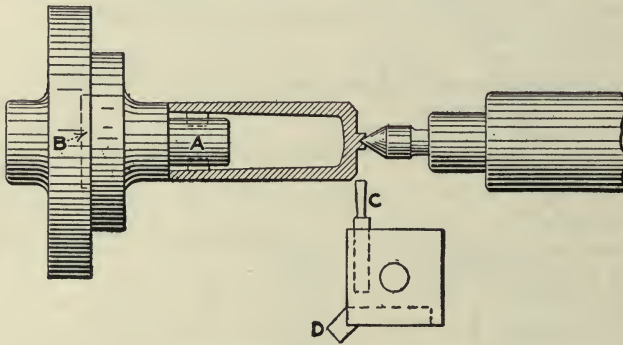
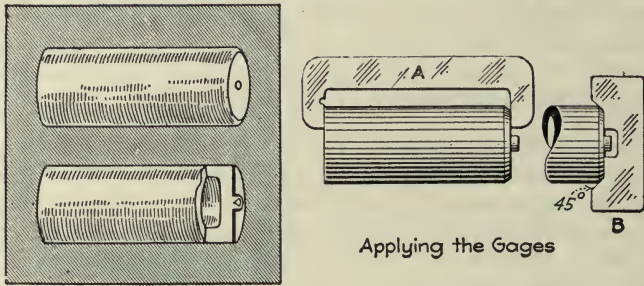

OPERATION 3. FACING BASE

Machines Used—Blaisdell and LeBlond 21-in. lathes.

Special Fixtures—Driving mandrel, multiple tool block.

Gages—Flat former A, length; B, form of bevel.

Production—2½ to 4 per hr., depending on lathe.

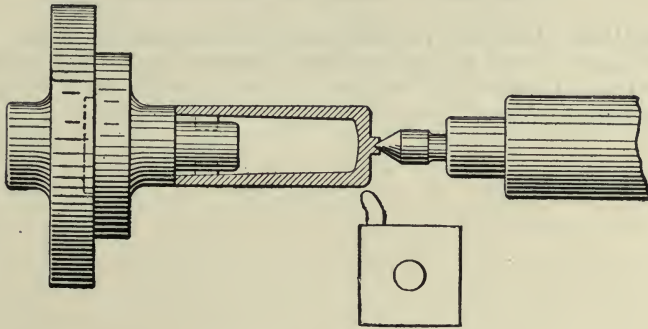
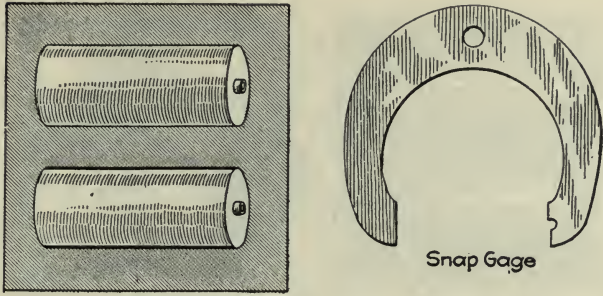

OPERATION 4. ROUGH TURN

Machine Used—LeBlond 21-in. lathe.  
 Special Fixture—Same driving mandrel as operation 3.  
 Gages—A, diameter.  
 Production—4 per hr. first cut, 8 per hr. for second cut.

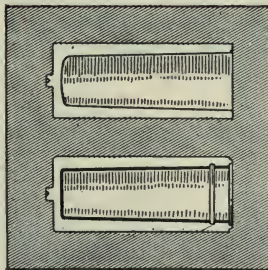

OPERATION 5. BORING SHELL

Machine Used—LeBlond 21-in. turret lathe.  
 Special Fixtures—Stops, position index—special chuck.  
 Gages—A, bore for thread; B, form of bore; C, thickness of bottom; D, width of tongue; E, length of tongue; F, recess for thread.  
 Production—40 min. each.

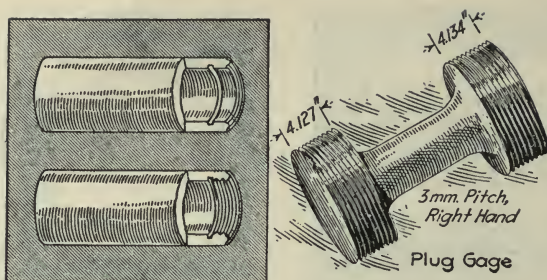

OPERATION 6. THREADING NOSE OF SHELL

Machines Used—Automatic threading lathe and Lees-Bradner hobber.

Special Fixture—Roller rest; one tool only in lathe.

Gage—Threaded plug.

Production—8 per hr.

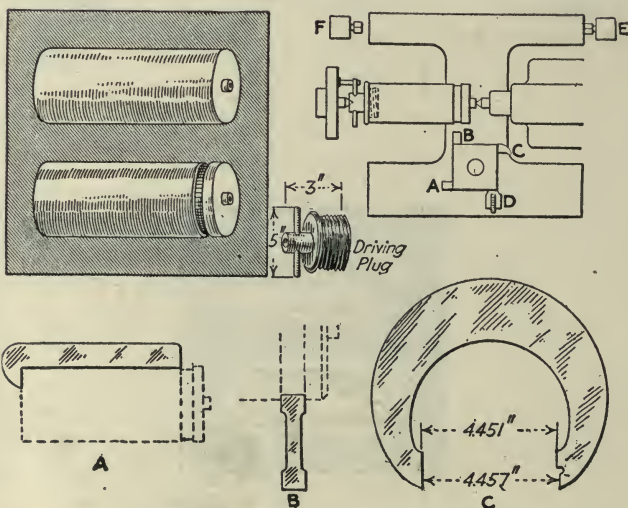

OPERATION 7. GROOVING AND KNURLING

Machine Used—LeBlond 21-in. lathe.

Special Fixtures—Stops for carriage in undercutting driving plug.

Gages—A, location of groove; B, width of groove; C, diameter of groove.

Production—5 to 6 per hr.



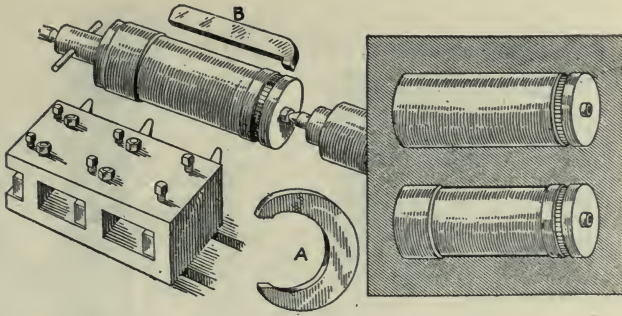

OPERATION 8. FINISH TURNING

Machine Used—Prentice geared head lathe.

Special Fixtures—Driving plug and multiple tool block.

Gages—A, diameter, one for size, one for relief; B, length of relief from groove.

Production—14 min. each.

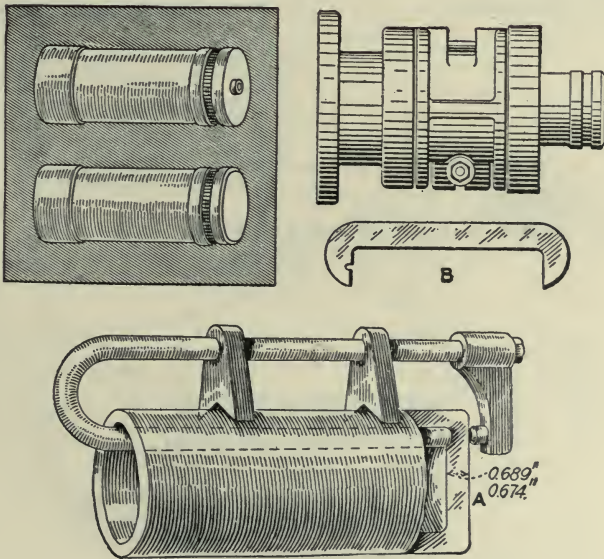

OPERATION 9. FINISH BASE

Machine Used—LeBlond 21-in. lathe.

Special Fixture—Flap jaw chuck.

Gages—A, thickness of bottom; B, length.

Production—11 min. each.

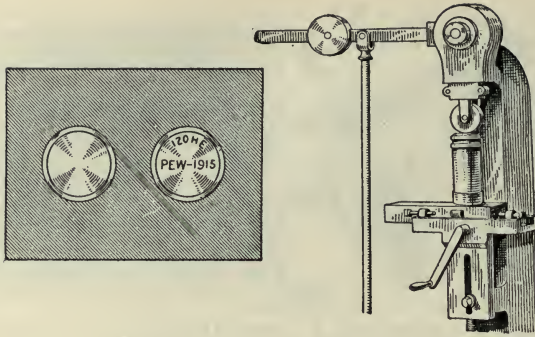

OPERATION 10. MARKING BASE

Machine Used—Noble & Westbrook.  
 Special Fixture—Roll stamp.  
 Gage—None.  
 Production—50 per hr.

OPERATION 11. WASHING SHELL BODY

Machine Used—None.  
 Equipment—Soda tank.

OPERATION 12. FIRST GOVERNMENT INSPECTION

Machine Used—None.  
 Equipment—Inspection bench, full set of gages, etc.

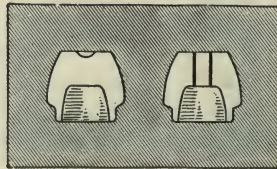

OPERATION A. OGIIVE—DRILLING

Machine Used—Barnes gang drilling machine.  
 Special Fixtures—Holding chucks.  
 Gage—None.  
 Production—5 per hr.

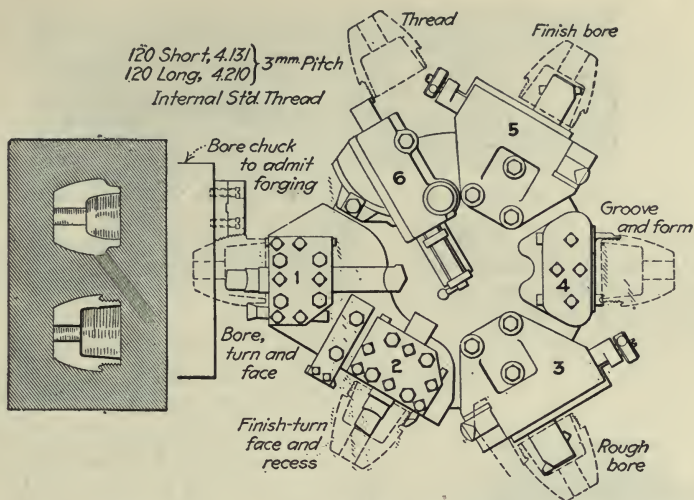

OPERATION B. OGIVE—FORM INSIDE AND THREADS

Machine Used—Jones & Lamson.

Special Fixtures—Chuck jaws.

Gages—A, thread diameter; B, recess for thread; C, length of thread; D, depth of bore; E, form of bore; F, diameter of annular groove; G, depth of annular groove; H, operation gage for groove.

Production—1½ to 2 per hr.

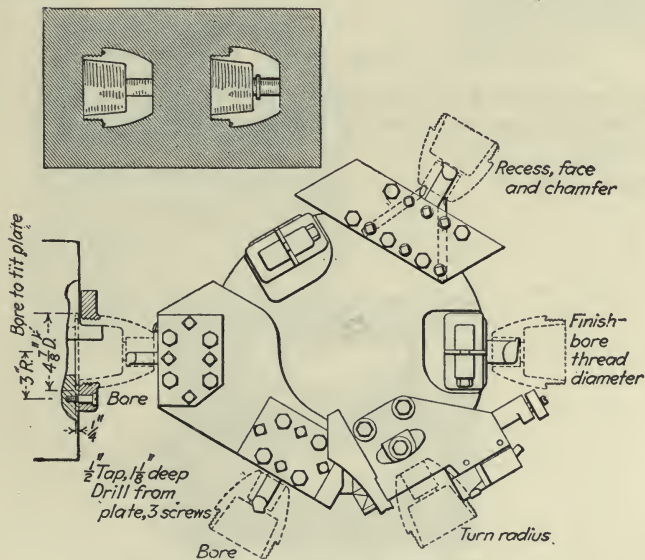

OPERATION C. OGIVE—BORE AND REAM NOSE

Machine Used—Jones & Lamson.

Special Fixture—Holding ring on chuck.

Gages—A, length; B, diameter of hole; C, hole for thread; D, diameter of recess below thread.

Production—8 to 10 per hr.

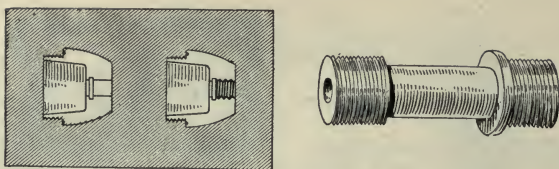

OPERATION D. OGIVE—THREADING NOSE

Machine Used—21-in. lathe.  
 Special Fixture—Hobbing head.  
 Gage—Plug thread gage.  
 Production—9 per hr.

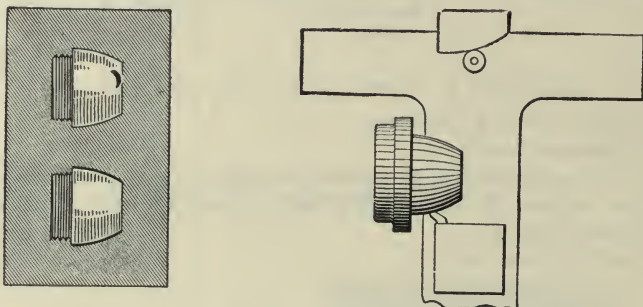

OPERATION E. OGIVE—ROUGH TURN OUTSIDE

Machine Used—LeBlond 21-in. lathe.  
 Special Fixtures—Form on taper slide, chuck.  
 Gage—None.  
 Production—15 per hr.

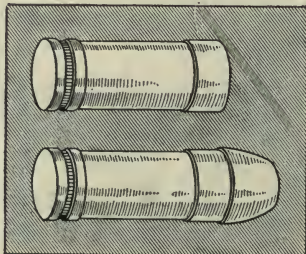

OPERATION 13. SCREWING IN OGIVE

Machine Used—None.  
 Special Fixtures—Vise and screw plug.  
 Gage—None.  
 Production—30 per hr.

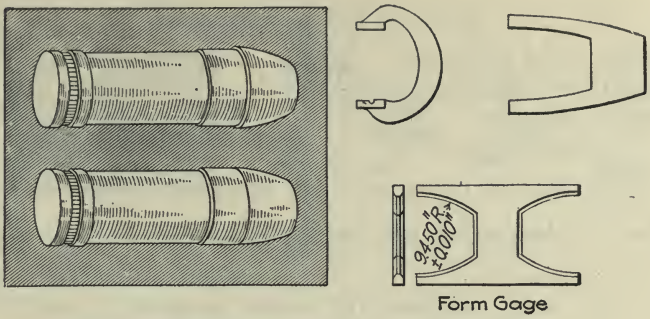

OPERATION 14. FINISH-TURN OGIVE AND SHELL

Machines Used—Hendey and LeBlond 21-in. lathes.  
 Special Fixtures—Chuck and formers.  
 Gage—Form of nose.  
 Production—2 to 2½ per hr.

OPERATION 15. PRESSING-ON COPPER BAND

Machine Used—West tire-setter.  
 Pressure—1,500 lb. per sq. in.  
 Production—30 per hr.

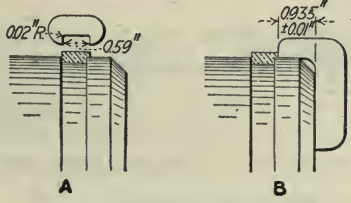
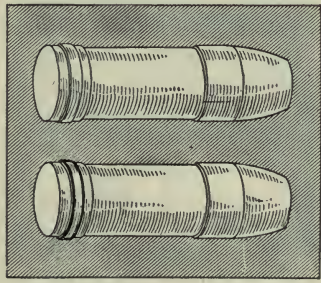
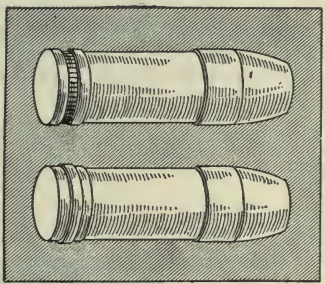

OPERATION 16. TURN HAND

Machine Used—LeBlond 21-in. lathe.  
 Special Fixtures—Chuck; tool post.  
 Gages—A, width of band; B, distance from end of shell.  
 Production—20 per hr.

## OPERATION 17. WASHING SHELL

Equipment—Tank and air jet.

Cleansing Liquid—Solution of heated soda.

Production—50 per hr.

## OPERATION 18. FINAL SHOP AND GOVERNMENT INSPECTIONS

Equipment—Inspection benches, gages, etc.

## OPERATION 19. FINISH WASHING

Equipment—Special compartment tank, washing pipes, etc.

Cleansing Liquids—Hot solution of soda, hot water.

## OPERATION 20. VARNISHING

Equipment—Inside varnishing machine, Fig. 378. De Vilbiss painting machine for outside varnishing.

Production—Inside varnishing, 120 per hr. Outside varnishing, 120 per hr.

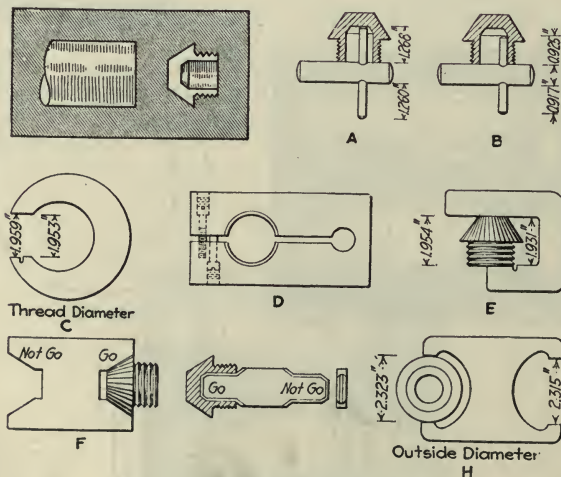

## OPERATION A'. POINTS—FORM AND THREAD

Machine Used—Gridley  $4\frac{1}{4}$ -in. automatic.

Special Fixture—None.

Gages—A, total depth of hole; B, depth of straight hole; C, thread diameter; D, adjustable ring gage sealed over screws; E, total length; F, form of head; G, form of inside; H, diameter of outside.

Production—5 per hr.

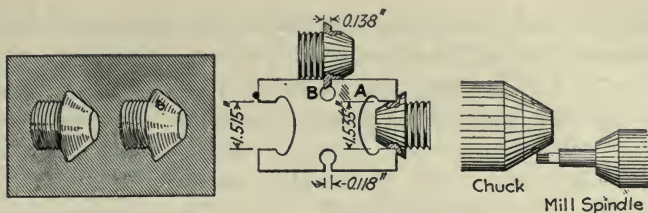

OPERATION B'. POINTS—MILL KEY SLOT

Machine Used—Hand miller.

Special Fixture—Split chuck.

Gages—A, center distance of slots; B, thickness of metal below slot.

Production—25 per hr.

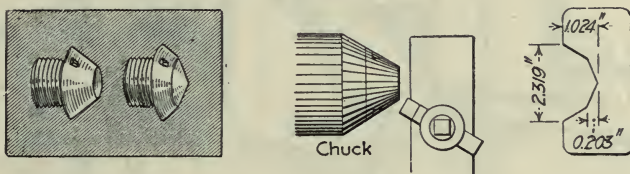

OPERATION C'. POINT—SHAVE

Machine Used—Bardons & Olive hand screw machine.

Special Fixture—Split chuck.

Gage—Form of head.

Production—20 per hr.



OPERATION D'. POINT—RETHREAD

Machine Used—Vertical drilling machine.

Special Fixtures—Prong die and chuck.

Gage—Adjustable ring thread gage.

Production—22 per hr.

The rough forgings weigh about 55 lb. and are approximately  $5\frac{1}{4}$  in. in outside diameter,  $3\frac{1}{4}$  in. in the bore and probably average  $14\frac{1}{2}$  in. long. The first operation is cutting off the open end to length on the Espen-Lucas saw. The forgings are clamped in the holders at each side of the saw, being handled in pairs, as shown in Fig. 356. They are gaged from the bottom of the forged hole by means of simple stops, shown on the machine and also in detail in Fig. 357. There is a varying amount to be cut off, owing to the difference in the depth of the forged hole, but all operations are gaged from the bottom of the pocket. The back end of the shell is also faced off by a large milling cutter suitably spaced

on the same arbor as the cutting saw, so that the face of the shell is given an approximately equal thickness in each case.

The device for setting these shells in the cutting-off machine, as shown in Fig. 357, has several points of interest. It consists primarily

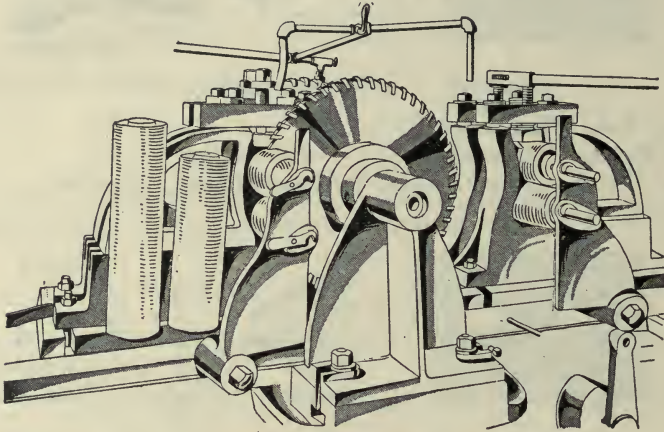

FIG. 356. ESPEN-LUCAS SAW FOR OPERATION 2

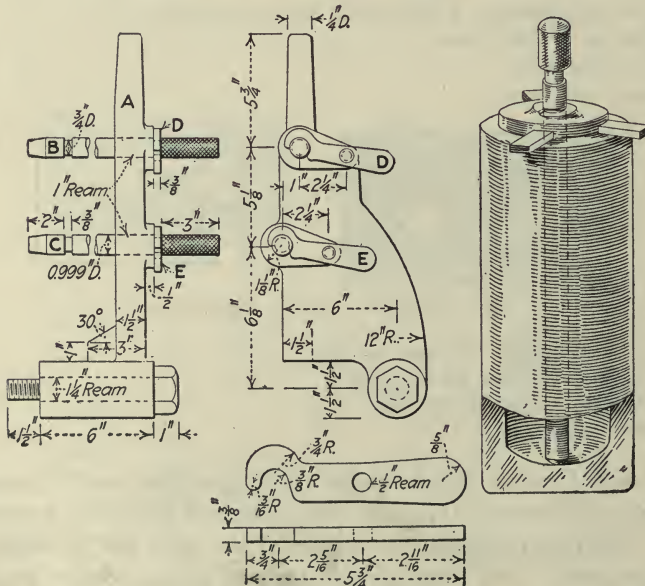

FIG. 357. DETAILS OF DEPTH STOP

of the arm *A*, which swings on a stud screwed into the bed and carries the gages *B* and *C*. These are a good sliding fit through the arm *A*, have the inner point tapered and the outer end knurled for easy handling. They also have two  $\frac{3}{8}$ -in. grooves, one near each end, for locking them in either the in or the out position.



This locking is done by the latch handles *D* and *E*, which are pivoted so that the weight of the hooked end will keep them in place in the notch unless they are lifted out by the other end. The latches hold them in either position, and the whole arm can be easily swung out of the way except when the blanks are being gaged for location in the machine.

Next comes the centering of the back end. This operation is done in the fixture shown in Fig. 358, which is mounted on a 24-in. Snyder vertical drilling machine, that carries a centering pintle mounted on trunnions in the side of the fixture and is fitted with two sets of three centering fingers, so as to insure the hole being drilled central with the bore of the shell. This fixture is shown in two positions in Fig. 358,

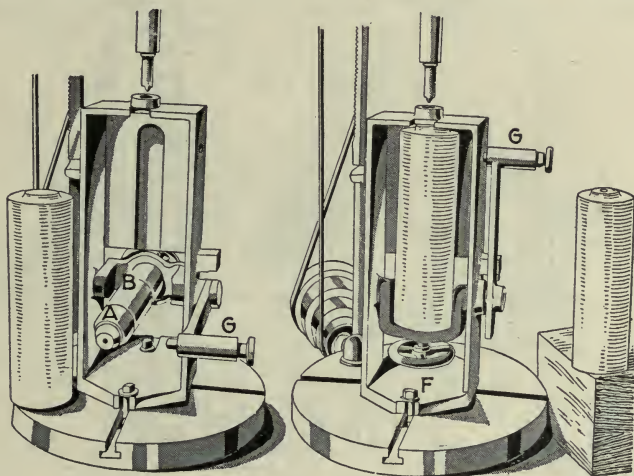

FIG. 358. SWINGING DRILL JIG

while Fig. 359 gives the details of its construction. The action of the centering fingers can be easily seen from the sectional view in Fig. 359, these fingers *A* and *B* being forced out by adjusting the nuts *C* and *D* on the rod *E*. The nuts carry right and left threads, and the rod *E* is easily controlled by the handwheel *F*, beneath.

In operation the shell is placed over the spindle while in the horizontal position shown. The shell is then thrown into the vertical position and locked by the index pin *G*, on the side. The handwheel *F* is turned until the locking fingers grip the bore of the shell, centering it for the drill, which comes through the bushing at the top. Details of this pintle are also shown in Fig. 359. The fingers *A* and *B* are held in a closed position.

The third operation brings the shell blanks to the lathe for rough-facing the back end and turning the bevel, which is considerably larger on these shells than on some others. This operation removes a large amount of metal, as can be seen from the operation sketch, which, together with the time required for handling, consumes some 15 to 25 min.



The shell is held on a three-jawed mandrel, or pintle *A*, these jaws being expanded by a taper draw-in plug operated by a handwheel on the rod that goes through the hollow spindle. The three jaws are of hardened steel and are curved on the bottom to insure even seating on the inside forged surface of the shell.

The operation sketch gives a view of the tool layout, with the squaring tool *C* and beveling tool *D* shown in position in the turret tool post. This picture also shows how the face of the firer is set into a recess in the faceplate and is then bolted to it. Fig. 360 shows all details of the holding mechanism. It is set into the faceplate, as shown at *B*.

A similar holding device is used for the fourth operation of rough-turning the outside diameter of the shell. This work is in reality split

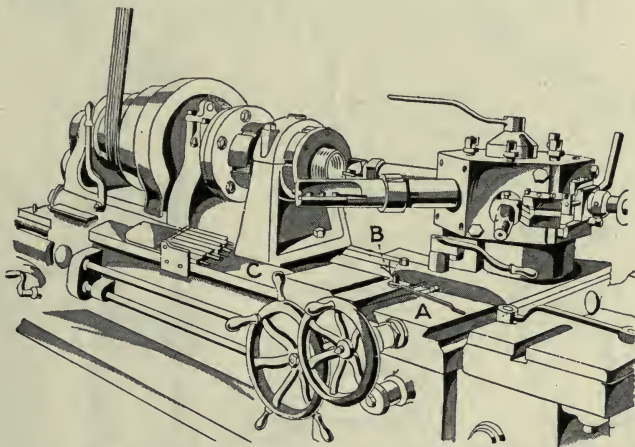

FIG. 361. THE LATHE WITH STOPS AND INDEX NEEDLE

into two suboperations, the first lathe leaving about  $\frac{1}{16}$  in. to be removed by a second lathe, as this method has been found more satisfactory in maintaining the desired allowance for finishing on the last cut. No particular lathe set-up is required, except as represented in operation sketch, the only difference between this and the layout in the previous operation being in the tool used. The production on the first lathe is 4 per hr.; and on the second roughing cut, a production of 8 per hr. is easily reached.

The work has now progressed to the boring of the shell, which is done in a LeBlond turret lathe equipped with a special chuck, shown in Fig. 361. The tool layout is shown in Fig. 362, while Fig. 361 gives a general view of the lathe set-up for this operation.

Details of the special chuck are shown in Fig. 363 and contain several interesting features. It consists of the cylindrical body, which is bolted to the faceplate by the flange *A* and turned on the outside at *B* to run in the steadyrest shown. The chuck carries two adjusting collars *C*

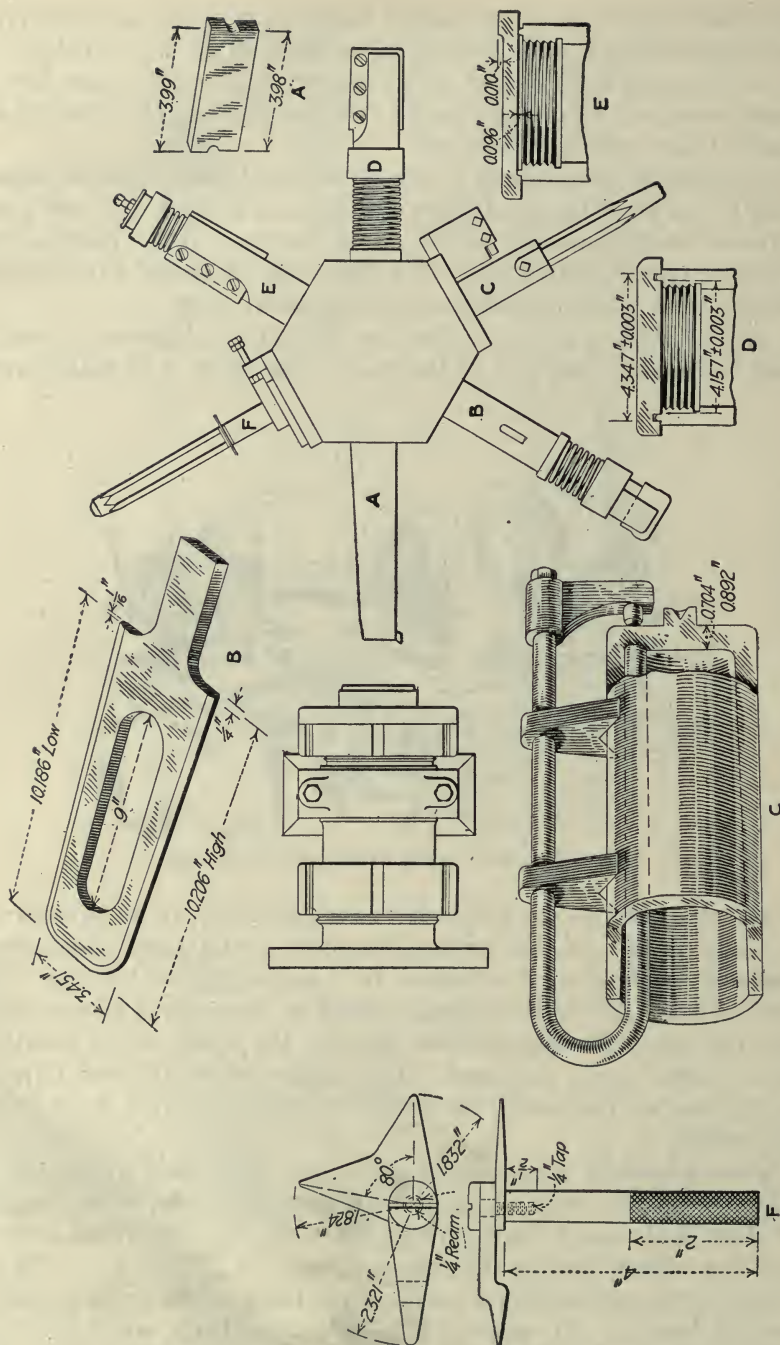

FIG. 362. TOOL LAYOUT FOR OPERATION 5

and *D*. The front collar carries the split taper bushing *E*, which is forced inward by the front plate *F*, and closes on the shell by means of the saw cuts on the comparatively thin taper section. The other end of the shell is screwed up by the collar *C* forcing three equally spaced pins *F* down against the shell.

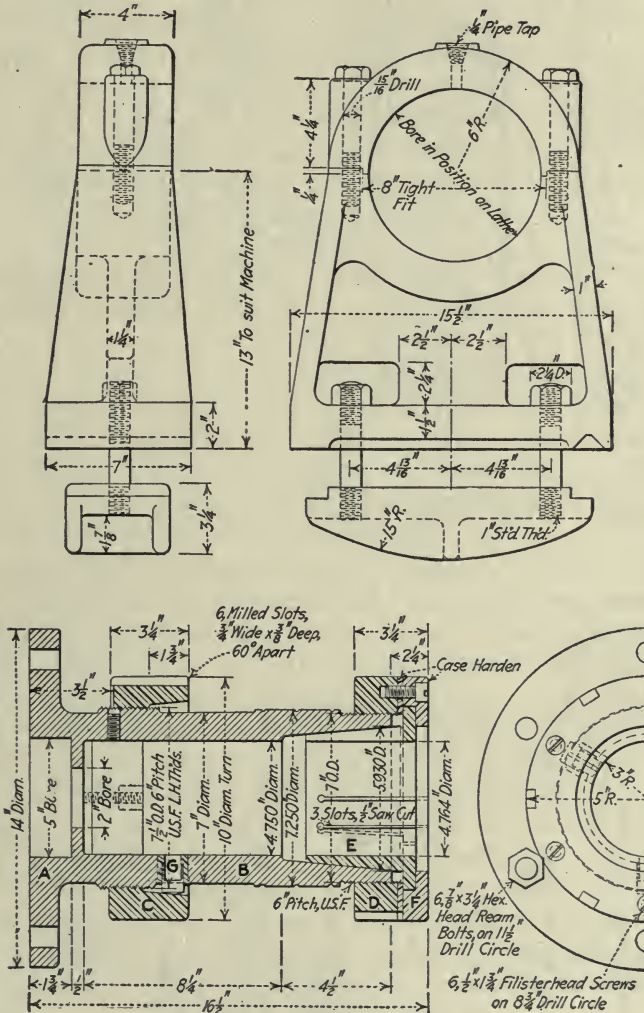

FIG. 363. DETAILS OF CHUCK AND REST

The boring tool, shown in Fig. 364 at *A*, is for rough-boring the inside of the shell and consists of a heavy steel shank carrying a 1/2-in. square high-speed steel cutter. This is hollow and has a brass tube that carries the lubricant direct to the cutting point. The construction of the other boring bars can be readily seen from the details and require little explana-

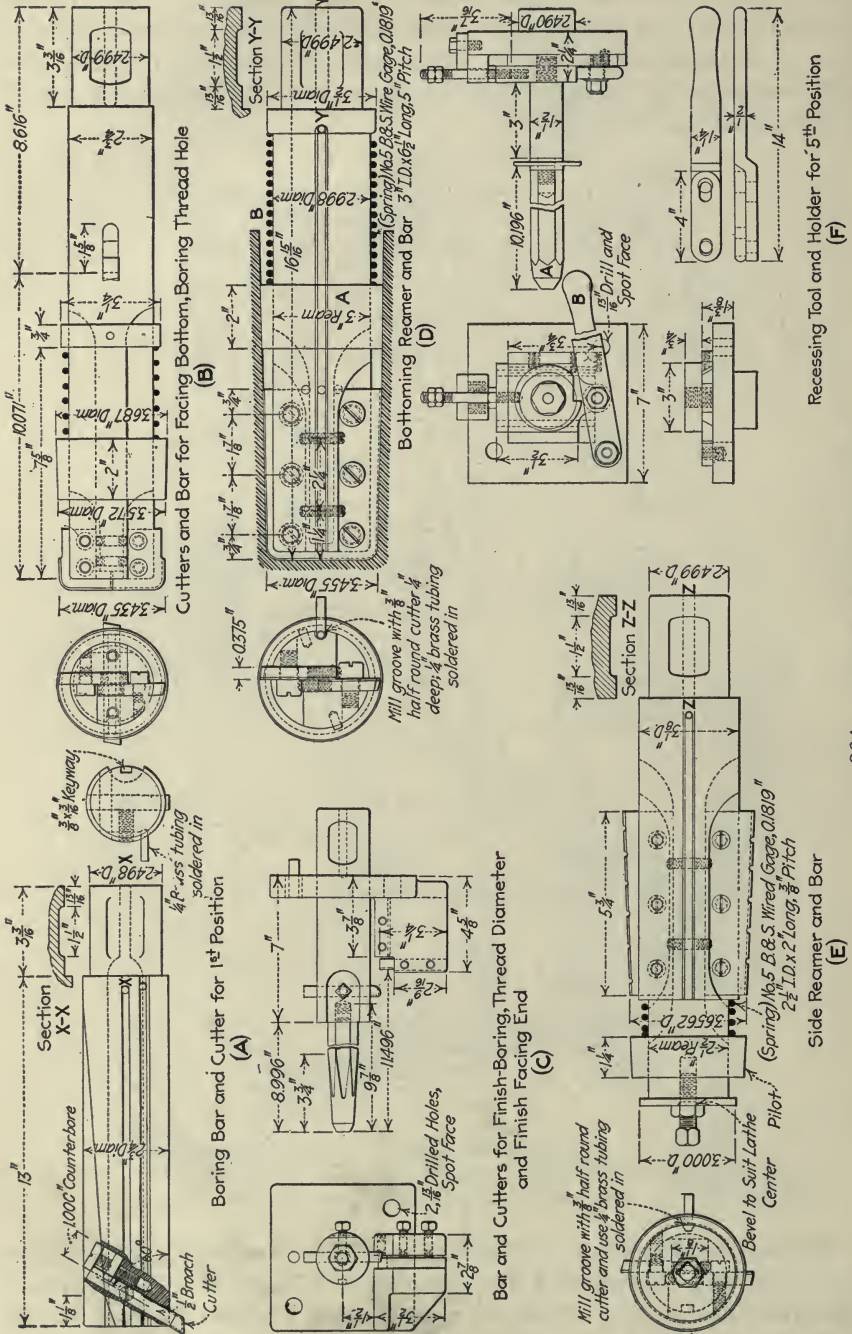

FIG. 364. DETAILS OF BORING TOOLS

tion. Another reamer is shown at *B*, carrying two long blades, that lap by each other so that each can present its cutting edge on the center line. Each also has adjusting and clamping screws.

Behind the cutter blade is the pilot bushing *A*, which is pressed forward by the helical spring *B*. This pilot enters the shell body in the space bored for the thread and assists in guiding the bar so that the whole will be reamed true to the correct taper of  $1^{\circ} 12' 42''$ . The finishing reamers are shown at *E* and *F*, also the tool for recessing at the bottom of the thread. This carries a central stud, or distance piece *A*, which locates the recess with reference to the bottom of the bore. The necessary side movement is obtained by means of the lever *B*.

Fig. 361 shows the carriage stops at *C*, a separate stop being provided for each turret position. A large multiplying lever *A* has also been added on the front of the lathe carriage to aid in quickly setting the turret central at any time. The short end of this, at the left of the capscrew *B* that forms the pivot, is in the form of a bell crank, having a curved surface presented to the end of the turret slide.

The upper surface of the cross-slide way is graduated so as to make it easy for the operator to bring the turret to the desired position quickly. This view also gives a good idea of the construction of some of the tools shown in Fig. 364. It shows the roughing reamers, the tool for trimming the end of the shell, and the circular recessing tool, which cuts the groove at the bottom of the thread in the shell nose.

The boring is divided into six suboperations, the first being to rough-bore by using the taper attachment at the back of the carriage, which has been fitted with a form of the proper shape. This is then released by means of a special nut, and the turret is brought to its central position by using the pointer already referred to.

The second suboperation rough-faces the bottom of the hole and rough-bores the thread diameter. The third suboperation finishes the taper at the bottom of the shell with a two-bladed reamer, shown at *E* in Fig. 364 and also in the turret-tool layout. The fourth suboperation finishes the taper reaming and also finishes the thread diameter. Suboperation No. 5 takes care of the recess for the thread and chamfers the inside of the shell, while the sixth and last suboperation finishes the tongue at the outer end of the shell, completing the fifth operation in an average time of 40 min., although the operation has been done in 24 min.

After this comes a bench inspection, from which the shells go to a Lees-Bradner thread miller, to have the threads cut in the nose. Three threading lathes of the Automatic Machine Tool Co. are also used for this work, a roller rest being provided, as shown in Fig. 365. Only one threading tool is used on the work in the automatic threading lathe. The production averages 8 shells per hr.

The seventh operation is grooving and knurling. The driving plug is screwed into the nose of the shell, as shown, the work being done in a 21-in. LeBlond lathe with a turret tool post. The groove is roughed out with a square-nosed tool in an Armstrong holder. The second suboperation cuts the eight small grooves, leaving seven ridges. The third suboperation is undercutting the back side of the groove, this being done by a tool fixed at the proper angle and fed into the bottom of the groove before cutting. By moving the carriage the desired distance to the right the undercut is easily made. This is controlled by two stops on the lathe bed, as shown, the depth of all the tools being determined by a single stop at the back of the cross-slide.

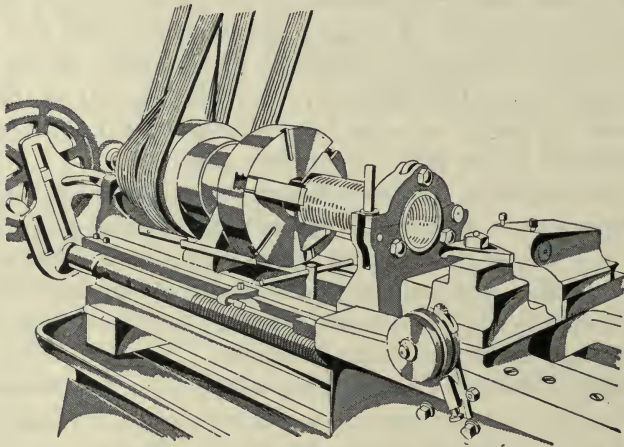

FIG. 365. AUTOMATIC THREADING LATHE

The fourth and last suboperation is the knurling, with a knurl about 2 in. in diameter and having plain, straight grooves properly spaced so that the resulting effect at the bottom of the band groove is a series of square raised points all around the groove. The use of the large knurl, mounted on a substantial  $\frac{1}{2}$ -in. pin, makes this a comparatively easy operation.

With the driving plug still in the end of the shell, it goes to the eighth operation—finish-turning in a Prentice geared head lathe. Three tools are used in a special tool post, as shown in the operation sketch. One tool turns the relief ahead of the groove, the second roughs the back end for the cartridge case, and the third finishes. This operation averages 14 min. each.

Then follows a bench inspection, after which the driving plug is unscrewed and the shells go to a lathe equipped with a flap chuck, as shown in operation 9, to have the back end faced off and the finish bevel put on the corner. This requires 11 min. Details of the chuck are given in Fig. 366.



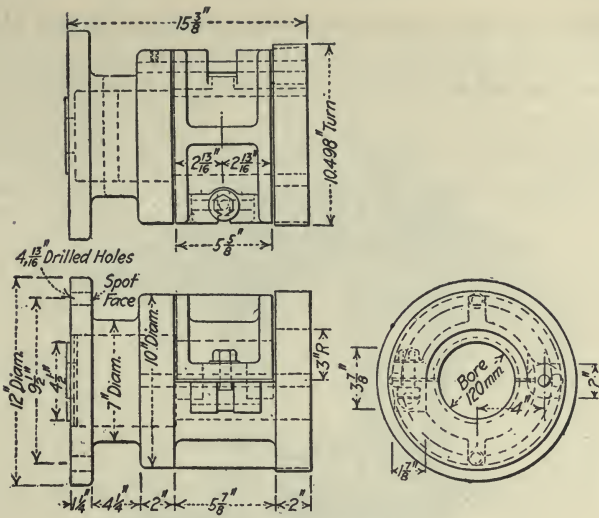

FIG. 366. DETAILS OF FLAP CHUCK

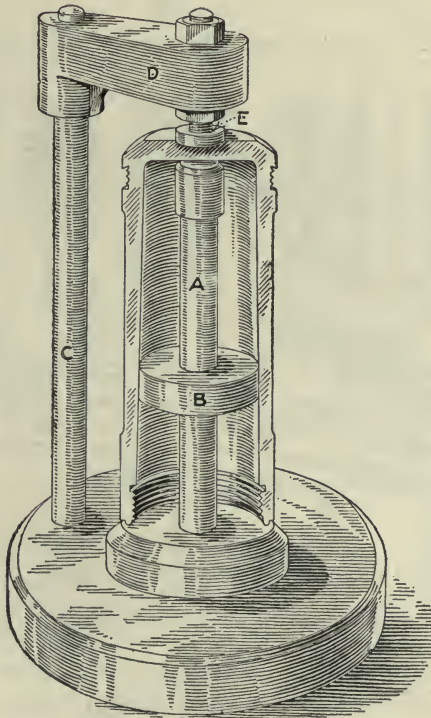

FIG. 367. BENCH INSPECTION GAGE FOR THICKNESS OF BOTTOM

The back end is then marked on a machine of the Dwight-Slate pattern at the rate of about 50 per hr. After the stamping, the shells are cleaned in a soda tank to cut out all the grease and oil, after which they go to

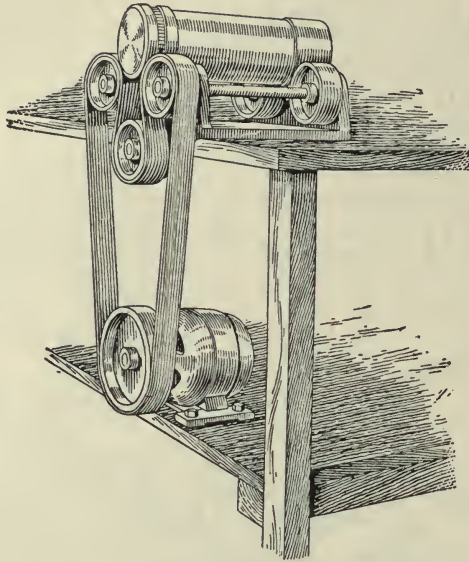

FIG. 368. RUNNING BELT FOR THREAD INSPECTION

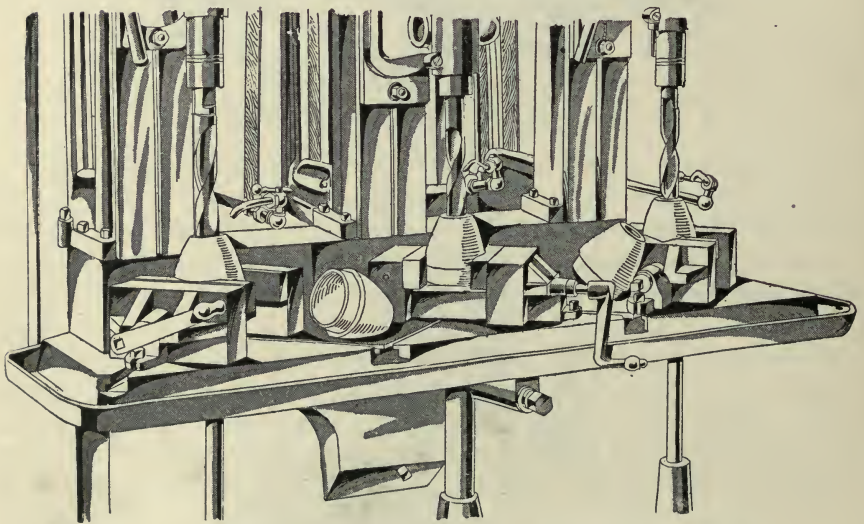

FIG. 369. THREE-SPINDLE BARNES GANG DRILL BORING OGVES

the inspection bench to be looked over by the Serbian Government inspectors. If satisfactory, the shells are stamped and passed for further operations.

The inspection benches are well equipped with gages and are built of the most convenient height for the work to be done. A gage used for testing the thickness of the back end is shown in Fig. 367. The shell is placed over the center spindle *A*, being guided by the enlarged portion *B*. The measuring upright *C* carries the head *D*, which is located by a shoulder on *C* and carries the adjustable measuring point *E*. This can be handled very rapidly and gives good results.

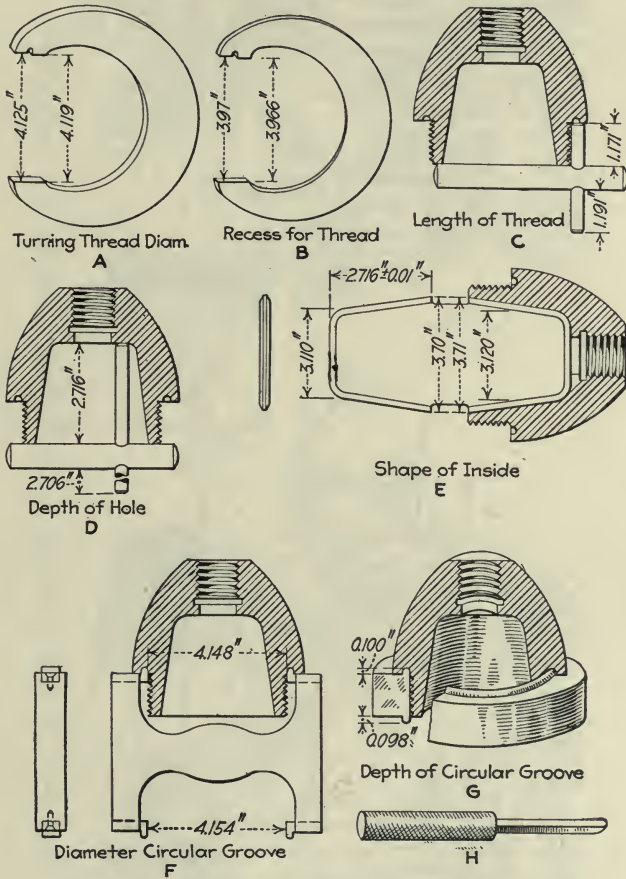

FIG. 370. GAGES FOR SECOND OGIVE OPERATION

For testing the threads in the ends of shells a belt arrangement is used, as shown in Fig. 368, which saves both time and fatigue on the part of the inspector. This belt runs continuously. By laying a shell on the belt-covered pulleys it is revolved so that the plug gage need only be held still in the hand. For running the gage out, the inspector uses the gage as a handle and turns the shell end for end on the belt. In this way the rotation is reversed and the plug gage is unscrewed.

The shells are now ready to have the ogives screwed in, so that these can be finished in place on the shell body.

The ogive, which is the term for the nose, or "pointed arch," comes

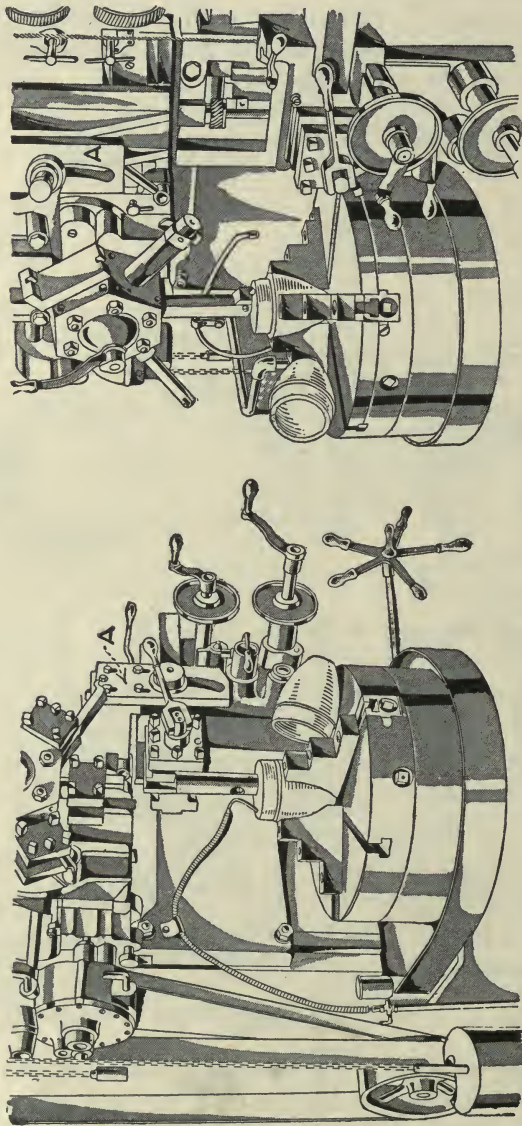

FIG. 371. ANOTHER METHOD OF BORING OGIVES ON BULLARD VERTICAL LATHES

in the shape of a forging weighing about 15 lb. The first operation is to drill a  $1\frac{1}{2}$ -in. hole through the ends, a three-spindle Barnes gang drill being used for this purpose, as shown in Fig. 369. One man handles about 5 pieces per hour on this machine.

The second operation forms the inside, turns the outside, and threads for screwing into the body of the shell. This operation is performed on a Jones & Lamson machine, its threading attachment proving very satisfactory for this work. The gages for this operation are shown in Fig. 370. The production is 20 for a 10-hr. day.

Two alternate methods of boring the ogives are shown in Fig. 371. Both are on Bullard vertical lathes, the difference being in the method of using the forming cam. In the first, at the left, the boring was done by the side head, the cam being placed at A, as shown. This formed the inside of the ogive as the side head was fed down.

The second method is an improvement over this, as by placing the cam so as to utilize the boring tools in the turret it leaves the side head

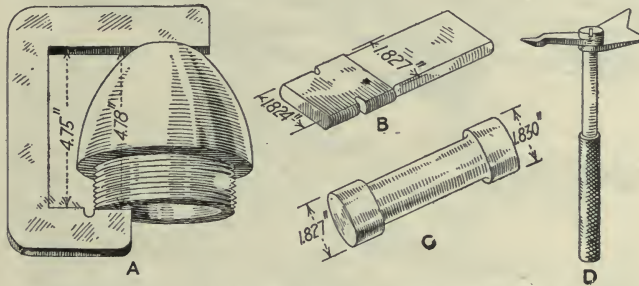

FIG. 372. GAGES FOR THIRD OGIVE OPERATION

free to turn the outside for the thread at the same time. The difference in these methods is seen in the production times. For 150-mm. ogives the first way required about 2½ hr. each; and the second, 35 min.

For the third operation also performed on a Jones & Lamson machine, the ogive is held in a special chuck having a steel ring fastened to its face and threaded to receive the large end of the ogive. After it is screwed in place, the three inside jaws grip it firmly, while the outer ring not only centers it, but also prevents distortion.

The small end is then bored out, enlarging the drilled hole to the proper size; a recess is cut for the end of the thread and the outer end faced to length. The gages for this operation are shown in Fig. 372.

The fourth operation threads the hole in the point, a special thread-hobbing fixture being used, as shown in Fig. 373. The hob runs 225 r.p.m., while the work turns 1 revolution in 2 min. This gives a production of 9 per hr.

The fifth and last operation rough-forms the ogive on a Prentice geared head lathe, using a form at the back of the carriage. The inspection is then made before the ogive goes to be assembled for final turning.

The ogives are then screwed solidly into place, operation 13. This work is done by hand while the shell itself is held in the vise of a clamp, shown in Fig. 374, which is mounted on a stand so as to be of convenient

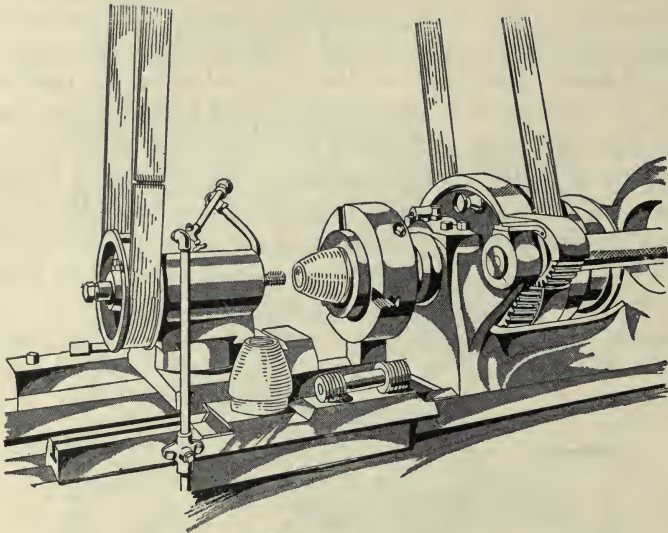

FIG. 373. HOB-THREADING OGIVES

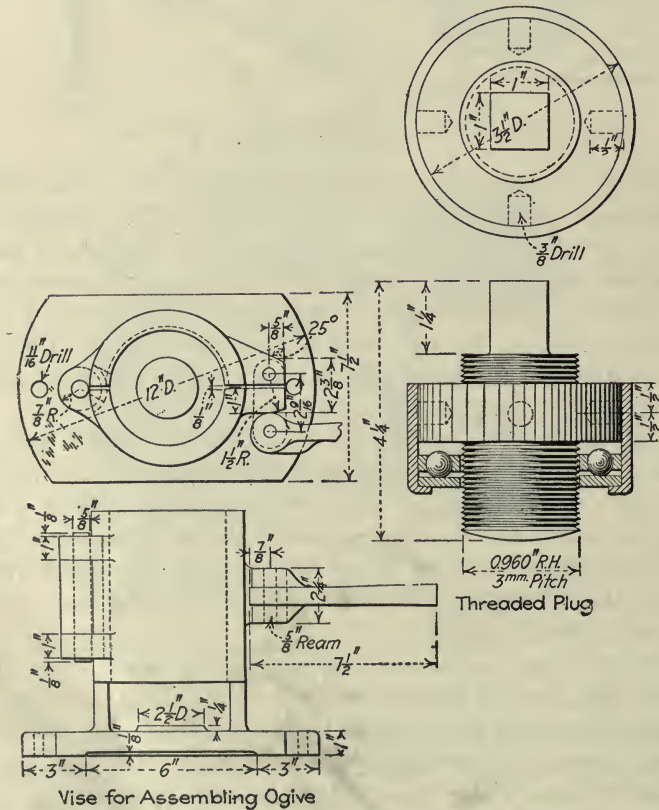

FIG. 374. FIXTURES FOR SCREWING IN OGIVE

height. The shells are clamped in this vise by means of the cam shown, the ogives started in by hand and the assembling plug screwed into the nose of the ogive.

This plug consists of a central stud squared at one end, threaded at the other and having a thrust collar against which the ball thrust, shown, bears. The ball thrust is held in position by the three side fingers with hooked ends so that it is perfectly free to move. The stud is screwed into the nose of the ogive, and the ogive itself is forced into the shell by a large ratchet wrench fitting on the squared end of the plug.

These parts must be forced together very tightly, both on account of the necessity of their being virtually one piece of metal and on account of

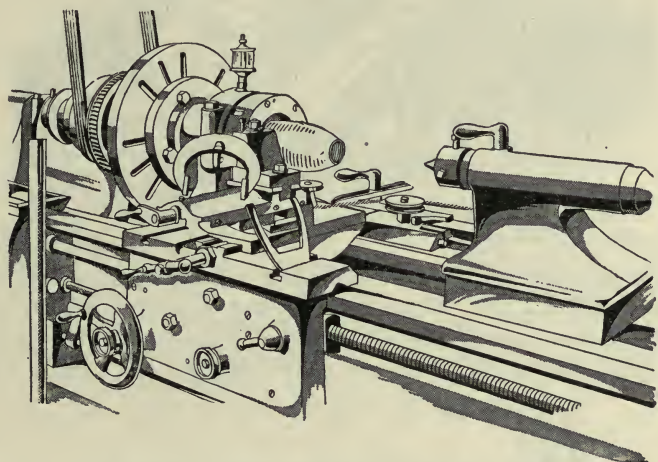

FIG. 375. FINISH-TURNING OGIVE AND SHELL

the difficulty of varnishing in case they are not. The latter difficulty comes from the fact that, if the stud and the ogive are not tight, oil is apt to be forced out when the shells are cleaned by air pressure on the inside, and this makes it difficult for either the varnish or the paint to dry satisfactorily. Two men working in conjunction obtain an average output on this operation of 30 pieces per hour.

The fourteenth operation, Fig. 375, uses the same style of chuck as that shown in operation No. 9 and finishes the curve on the ogive by a form on the back of the lathe-carriage turret. It also finishes the front end of the shell body itself, this curve continuing from the ogive back on to the body for about  $1\frac{1}{2}$  in. The finishing is done on 21-in. lathes of both Hendey and LeBlond makes, the production being from 2 to  $2\frac{1}{2}$  per hr. The gages are shown in Fig. 375.

The copper bands are next swaged on the shells, on a West tire-setting machine, each band being pressed in three positions at 1,500 lb. pressure. This work is handled at the rate of 30 per hr.

Then comes the turning of the band by the use of two tools in a tool post, Fig. 376. The first tool turns the band to the approximate outside diameter, while the second forms both sides and the outside diameter at the same time. The finished band is a trifle wider than the slot

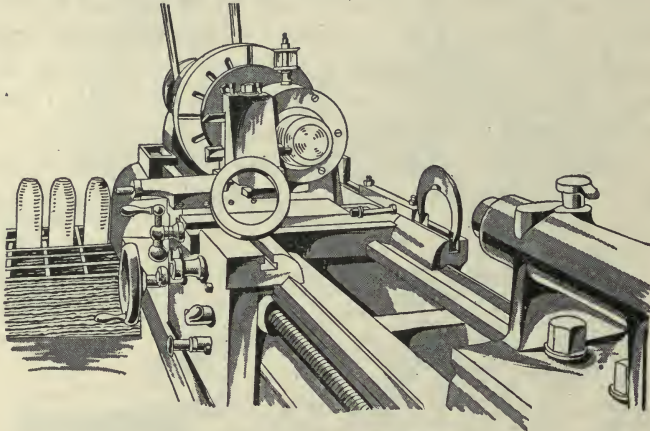

FIG. 376. TURNING THE BAND

in which it is held. This operation uses the same style of chuck as that in operations 9 and 14, and production is 30 per hr. per machine. The whole shell is then cleaned in a tank of heated soda that is blown up into the inside by an air jet at the rate of 50 per hr. Then comes the

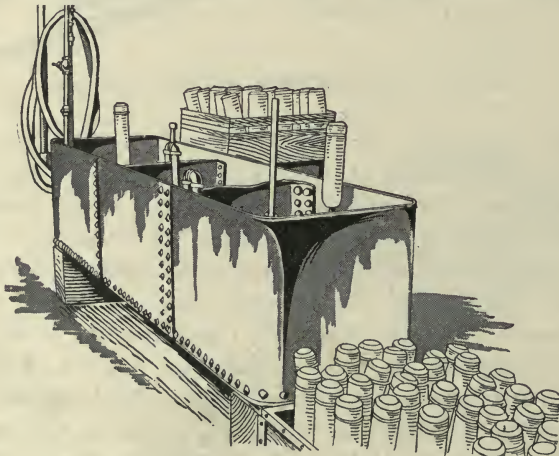

FIG. 377. OPERATION 19: TANK FOR CLEANING

final shop inspection and at the same time the inspection by the representatives of the Serbian government.

From here the shells go to the finishing department, where they are again washed in hot soda and also hot water. The tank used for



this purpose is shown in Fig. 377, the compartment at the left being for soda water, while the other two compartments contain simply hot water as free from soda as can be maintained as the shells pass from one to the other.

Arrangements are made for a gang of six men, three on each side, each being provided with an upright washing pipe that has radial perforations at the upper end. The central stem controls an air valve, so that by dropping a shell over the upright pipe and pressing down, the air valve at the bottom is opened and a shower of hot water, either soda or plain, is forced all over the interior, cleaning it perfectly and allowing

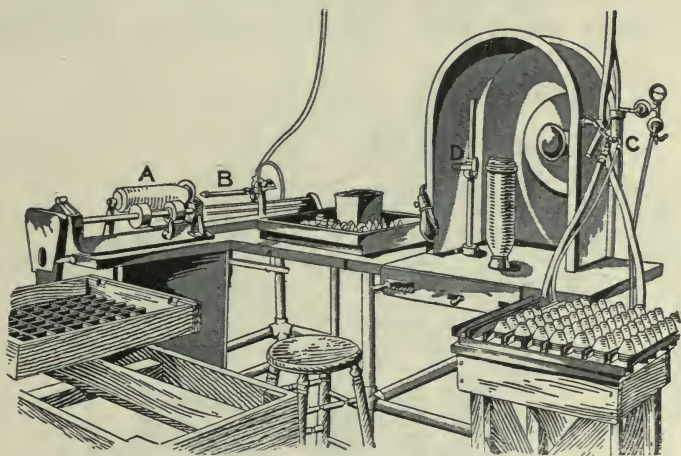

FIG. 378. OPERATION 20: VARNISHING SHELLS

the shells to be handled very rapidly. The exact rate varies of course with the size and weight of the shells to be handled and the strength and agility of the men.

After cleaning, the shells are then ready for the inside varnishing, which forms the twentieth operation and is done on the machine shown in Fig. 378. This consists merely of two pairs of rollers, which are revolved by power and on which the shell to be varnished is laid as at *A*. The varnishing head is seen at *B*, carrying a nozzle that reaches to the bottom of the shell. This nozzle sprays the varnish on the inside, but does not become operative until the head has been pushed into the shell. Then an air valve is tripped, and the varnish is sprayed over the interior of the revolving shell as the varnishing head moves out by power. The spray is cut off at a predetermined point, as it is only necessary to varnish the lower part of the bore in most cases. This limit can, however, be easily varied for any length of shell and to varnish either a part or the whole interior, as may be desired. This inside varnishing can be done at the rate of 120 per hr.

The suboperation is the varnishing of the outside of the shell, which is done under a hood, shown at the right. A revolving spindle supports the nose of the shell and revolves it vertically, while the operator sprays on the varnish with the air-spraying arrangement shown at *C*. The protector *D* is swung in front of the shell to keep the varnish off the band. Inside the hood is a large exhaust fan to keep the atmosphere as clear of the varnish vapors as possible. The outside varnishing of the shells can also be handled at the rate of about 120 per hr. This is done in the De Vilbiss painting machine.

The next, or twenty-first, operation is baking the varnish for 8 hr. at a temperature of about 300 deg. F. For this purpose the shells are placed in metal trucks, one of which is shown in Fig. 379. The trucks vary

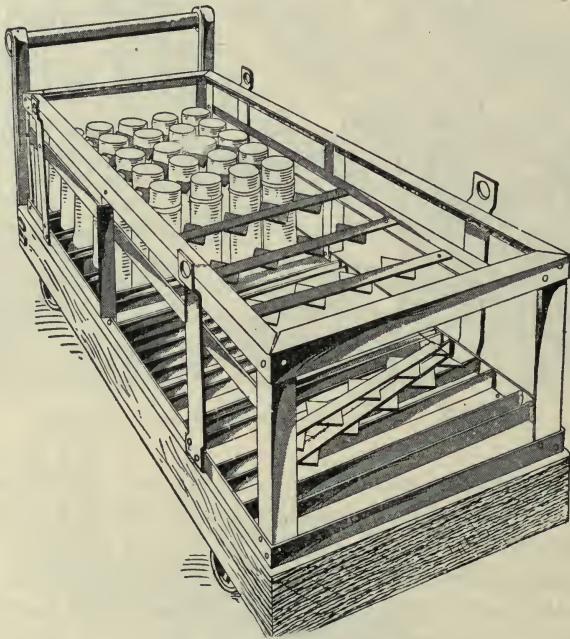

FIG. 379. TRUCK FOR BAKING SHELLS

somewhat in construction, according to the size of the shell. The one shown is for the 70- and 75-mm. shells and contains movable separation strips, as shown. The trucks for the larger shells contain permanent divisions formed by crossbars of angle iron.

Operation 22—painting—is shown in Fig. 380. As can be seen, it is divided into stages, according to the number of operators. Four men are generally used, the first painting the end of the shell, the next a band the width of his brush, just below the bronze rifling ring, the third a band at the other end, and the fourth filling in the unpainted space. By working in this way 120 shells per hr. can be handled regularly.

High-explosive shells are painted a bright yellow, while shrapnel are painted a vivid red; but no paint must go on what might be called the bearing surface of the shell—both the copper band and the part just behind the ogive, which is an important diameter, as it fits the gun bore.

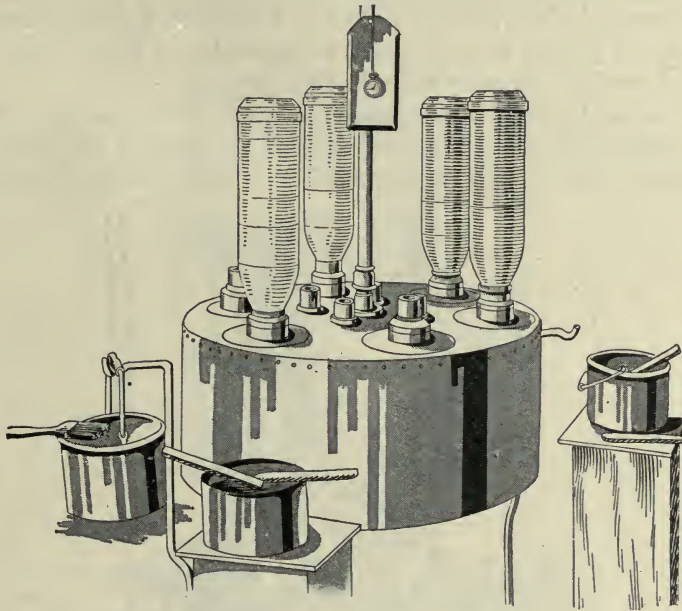

FIG. 380. PAINTING THE SHELLS

After painting, the shells go to another drying oven at a temperature of 150 deg. F. for 12 hr. They are then ready to have the point screwed into place in the nose as a protector; this is done just before packing. These points have previously been varnished in the same place as the outside of the shell, some being shown in Fig. 378.

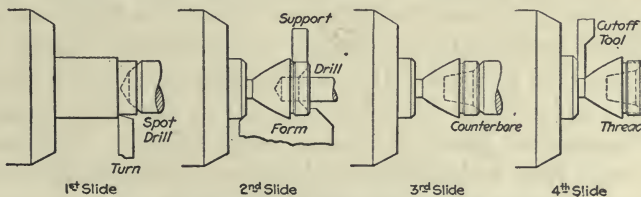

FIG. 381. FORMING AND THREADING POINT

The point, or cap, that protects the thread in the ogives so that the fuse can be screwed in without difficulty is made from bar stock. This usage is an interesting variation from the brass, zinc and wooden caps that are now employed for this purpose. These points are turned from  $2\frac{1}{16}$  bar steel on Gridley  $4\frac{1}{4}$ -in. automatics. The first operation is

shown in Fig. 381, together with the tool layout, the production being 5 per hr. The side wrench slots are then milled, the point being held in a split chuck on a small hand miller and indexed in two positions, so that the end mill can cut the desired slot, the depth being determined by a suitable stop. The production here is 25 per hr.

The cone end of the point is shaved on a Bardons & Oliver hand turret at the rate of 20 per hr., the point being held in a screw chuck and a single tool used in the cross-slide for this purpose.

Then comes the rethreading, which, instead of being done by hand, as in most cases, is handled on a vertical drill, as shown in Fig. 382 (spring prong) dies are used in the drilling-machine spindle, while the point to be

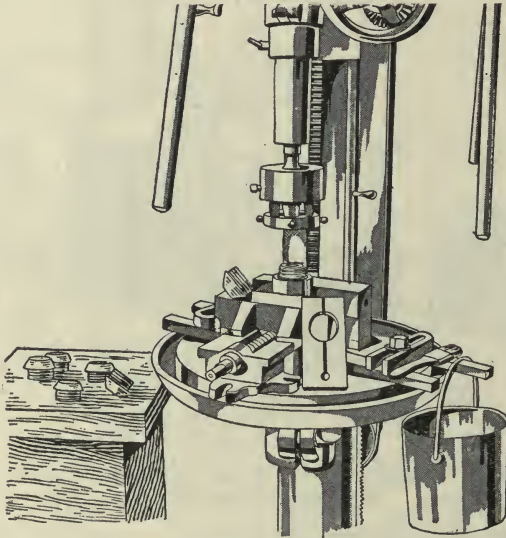

FIG. 382. RETHREADING POINT

rethreaded rests in a suitable pocket in a holding fixture on the table. The cap is prevented from turning by two studs that fit the wrench slots.

No difficulty seems to be experienced in catching the thread, a tapping head being used for reversal. It is also easy to prevent the die going on too far, by simply lifting the whole spindle so that the prongs do not engage, allowing the point to revolve with the die. This method is certainly easier than rethreading by hand, even though the production may not be as much higher as might be imagined. In this case it is 22 to 25 per hr., but it must be remembered that these points are of steel and that the thread is nearly 2 in. in outside diameter. The points are then inspected and after being varnished inside are screwed into place on the otherwise completely assembled shell, operation 24.

Each shell is then wrapped in oiled paper and packed four in a box, as shown in Fig. 383. Separators are used to hold the shells firmly in

position, and corresponding forms go on top of the shell, so that the cover holds them tightly in place. The construction of the box, the handles of light rope and the marking of the box are clearly shown.

The covers are screwed in place, and it will be noticed that some of the screw holes *A* are counterbored to nearly an inch in diameter—before

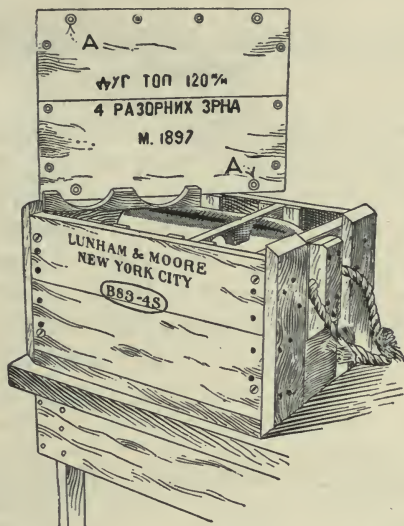

FIG. 383. BOXING BEFORE SHIPPING

the official sealing. After the screws have been put in place, sealing wax is poured into these holes, and the inspector presses into the wax a seal bearing the Government coat of arms. This is to insure against the shells being tampered with between the last Government inspection at the factory and their arrival at the various points where they are to be loaded.

## CHAPTER XI

### MANUFACTURING FRENCH 120-MILLIMETER EXPLOSIVE SHELLS<sup>1</sup>

The manufacture of 120-millimeter high-explosive shells for the French Government (see Fig. 384) entails exacting work with very little tolerance and is further complicated by the requirements of a test for hardness of shell, hydraulic pressure tests, volumetric measurements and a test for the center of gravity of the shell. Altogether, from the unloading of the rough shell forgings at the manufacturer's plant to the shipping of the completed shell, some 52 distinct operations have proved advisable. These, in the order in which they are performed, are as follows:

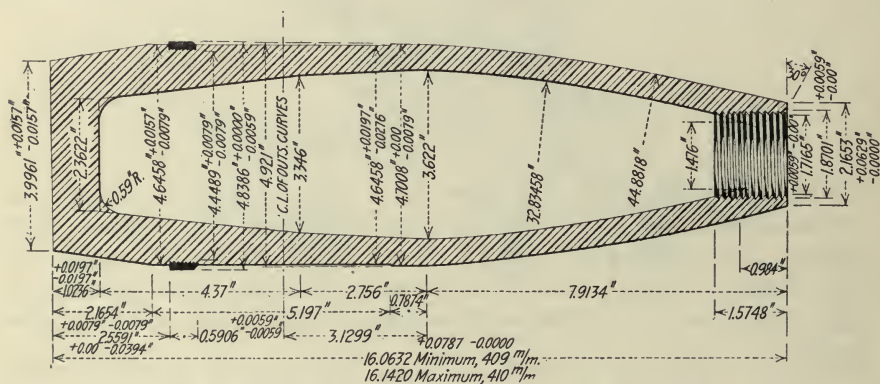

FIG. 384. DETAIL OF FRENCH 120-MILLIMETER EXPLOSIVE SHELL

#### SEQUENCE OF OPERATIONS

1. Unloading the shell forgings.
2. Pickling the forgings.
3. Cleaning-out and inspection of forgings.
4. Centering the base.
5. Reaming out powder pocket.
6. Cutting-off open end.
7. Cleaning out burr and rough turning.
8. Reaming out lower end of shell.
9. Facing closed end and gaging for thickness of bottom.
10. Re-centering base.
11. Turning to profile.

<sup>1</sup> Reginald Trautschold.

12. Inspection.
13. Nosing-in open end of shell.
14. Rough-boring nose and facing to length.
15. Washing and testing for volume.
16. Heat treatment.
17. Quenching.
18. Drawing.
19. Testing for hardness.
20. Pickling nosed-in shell.
21. Finish-boring and tapping nose.
22. Tapping nose on drill press.
23. Facing bottom to thickness.
24. Washing.
25. Screwing-in center plug.
26. Turning body.
27. Rough-turning taper.
28. Finish-turning taper.
29. Rough-turning nose.
30. Finish-turning nose.
31. Forming band groove.
32. Grinding shoulder.
33. Grinding taper and back of band.
34. Finish-turning body.
35. Preliminary weighing.
36. Re-turning nose to weight.
37. Removing center plug.
38. Cutting-off central teat.
39. Re-facing nose.
40. Hydraulic pressure test.
41. Banding.
42. Hand tapping.
43. Band turning.
44. Washing.
45. Final gaging.
46. Final interior inspection and eccentricity test.
47. Government inspection.
48. Marking shells.
49. Greasing shells.
50. Putting plug in nose.
51. Boxing.
52. Loading shells into freight car.

## PRINCIPAL EQUIPMENT AND OPERATING DATA

### OPERATION 2. PICKLING THE FORGINGS

Equipment—Wooden pickling vats.

Solutions—Vat No. 1, dilute sulphuric acid. Vat No. 2, hot water. Vat No. 3, solution of lime water.

Production—20 to 25 per hr.

### OPERATION 3. CLEANING-OUT AND INSPECTION

Equipment—Wire brush, bristle brush, electric lamp.

Inspection—Interior gaging.

Production—35 per hr.

## OPERATION 4. CENTERING BASE

Machine Used—24-in. stationary drill press.  
Special Tools and Fixtures—Tilting arbor.  
Production—15 per hr. (av.), 25 per hr. (high).

## OPERATION 5. REAMING OUT POWDER POCKET

Machine Used—Acme Bolt Cutter.  
Special Tools and Fixtures—Cutting bar, work clamp.  
Production—7.5 per hr. (av.), 15.6 per hr. (high).

## OPERATION 6. CUTTING-OFF

Machine Used—Acme Bolt Cutter.  
Special Tools and Fixtures—Air chuck, cutting-off attachment, high-speed steel cutters.  
Production—7.5 per hr. (av.), 12.1 per hr. (high).

## OPERATION 7. ROUGH TURNING

Machine Used—24-in. American Lathe.  
Special Tools and Fixtures—Air chuck, cutting tools.  
Production—7.5 per hr. (av.), 12 per hr. (high).

## OPERATION 8. REAMING LOWER END

Machine Used—Acme Bolt Cutter.  
Special Tools and Fixtures—Reaming bar, clamp.  
Production—7.5 per hr. (av.), 14.4 per hr. (high).

## OPERATION 9. FACING CLOSED END

Machine Used—24-in. Bradford Lathe.  
Special Tools and Fixtures—Two facing tools.  
Inspection—Gaging thickness of bottom.  
Production—6 per hr. (av.), 9.4 per hr. (high).

## OPERATION 10. RE-CENTERING BASE

Machine Used—Drill press.  
Special Tools and Fixtures—Tilting arbor.  
Production—15 per hr.

## OPERATION 11. TURNING TO PROFILE

Machine Used—24-in. Boy & Emmes Lathe.  
Special Tools and Fixtures—Guide plate and follower, air chuck.  
Production—7.5 per hr. (av.), 10 per hr. (high).

## OPERATION 13. NOSING-IN

Machine Used—400-lb. Beaudry Hammer.  
Special Tools and Fixtures—Hammer dies, chuck.  
Production—30 per hr.

## OPERATION 14. ROUGH-BORING NOSE AND FACING TO LENGTH

Machine Used—24-in. drill press.  
Special Tools and Fixtures—Drilling jig, high-speed drill, high-speed steel facing cutter.  
Production—5 per hr. (av.), 7.5 per hr. (high).



## OPERATION 16. HEAT TREATMENT

Equipment—Tempering furnace.  
Temperature—1,800 deg. F.  
Duration of Treatment—30 min.  
Remarks—16 shells treated at one time.

## OPERATION 17. QUENCHING

Equipment—Special needle bath.  
Remarks—Shells to be sprayed with cold water, both inside and out, until cold.

## OPERATION 18. DRAWING

Equipment—Drawing furnace.  
Temperature—1,000 deg. F.  
Duration of Draw—20 min.  
Production—2 men average 15 shells per hr.  
Remarks—Shells are allowed to cool in sand.

## OPERATION 19. TESTING FOR HARDNESS

Machine Used—Brinell Ball Testing Machine.  
Duration of Test—30 sec.  
Production—30 per hr.

## OPERATION 20. PICKLING NOSED-IN SHELLS

Equipment—Wooden pickling vats.  
Solutions—Same as for operation 2.  
Remarks—Nosed-in shells are pickled while the rough forgings are being treated.

## OPERATION 21. FINISH-BORING AND TAPPING NOSE

Machine Used—Turret lathe.  
Special Tools and Fixtures—Cutters and Murchey taps.  
Production—5 per hr. (av.), 6 per hr. (high).

## OPERATION 22. TAPPING ON DRILL PRESS

Machine Used—24-in. drill press.  
Special Tools and Fixtures—Work holder.  
Production—20 per hr.

## OPERATION 23. FACING BOTTOM TO THICKNESS

Machine Used—Engine lathe.  
Special Tools and Fixtures—Screw arbor and steadyrest.  
Inspection—Gaging for bottom thickness.  
Production—5 per hr.

## OPERATION 26. TURNING BODY

Machine Used—24-in. American Lathe.  
Special Tools and Fixtures—Tool carriage and two tools.  
Production—6 per hr. (av.), 10.6 per hr. (high).

## OPERATION 27. ROUGH-TURNING TAPER

Machine Used—24-in. American Lathe.  
Special Tools and Fixtures—Flat turning tool, profile plate.  
Production—8 per hr. (av.), 15 per hr. (high).

## OPERATION 28. FINISH-TURNING TAPER

Machine Used—24-in. American Lathe.  
Special Tools and Fixtures—Profile plate.  
Production—8 per hr. (av.), 20 per hr. (high).

## OPERATION 29. ROUGH-TURNING NOSE

Machine Used—24-in. American Lathe.  
Special Tools and Fixtures—Profile plate.  
Production—5 per hr. (av.), 8.5 per hr. (high).

## OPERATION 30. FINISH-TURNING NOSE

Machine Used—24-in. American Lathe.  
Special Tools and Fixtures—Profile plate.  
Production—5 per hr. (av.), 15 per hr. (high).

## OPERATION 31. FORMING BAND GROOVE

Machine Used—24-in. turret lathe.  
Special Tools and Fixtures—Grooving and undercutting tool, scoring and knurling tools.  
Production—10 per hr.  
Remarks—4 sub-operations.

## OPERATION 32. GRINDING SHOULDER

Machine Used—24-in. Modern Grinder.  
Special Tools and Fixtures—Profile plate.  
Production—12 per hr. (av.), 26 per hr. (high).

## OPERATION 33. GRINDING TAPER AND BACK OF BAND

Machine Used—24-in. Modern Grinder.  
Special Tools and Fixtures—Profile plate.  
Production—12 per hr. (av.), 20 per hr. (high).

## OPERATION 34. FINISH-TURNING BODY

Machine Used—24-in. American Lathe.  
Special Tools and Fixtures—None.  
Production—10 per hr.  
Remarks—Shells turned to 4.665-in. diameter.

## OPERATION 38. CUTTING-OFF CENTRAL TEAT

Machine Used—Power hack-saw.  
Special Tools and Fixtures—None.  
Production—15 per hr.  
Remarks—The stub left by the saw is removed on a Besley ring grinder.

## OPERATION 39. RE-FACING NOSE

Machine Used—24-in. American Lathe.  
Special Tools and Fixtures—None.  
Remarks—This operation required only for shells on which the nose has become roughened.

## OPERATION 40. HYDRAULIC PRESSURE TEST

Machine Used—Special hydraulic press.

Pressure—15,700 lb. per sq. in.

Duration of Test—30 sec.

Maximum Allowable Expansion—0.004-in. (permanent).

Production—35 per hr.

## OPERATION 41. BANDING

Machine Used—West Tire Setter.

Pressure—1,500 lb. per sq. in.

Production—50 per hr.

Remarks—Shell subjected to 3 squeezes.

## OPERATION 42. HAND TAPPING

Machine Used—Portable air drill.

Special Tools and Fixtures—Adjustable hand taps.

Production—2 men, 12.5 per hr.

## OPERATION 43. BAND TURNING

Machine Used—Engine lathe.

Special Tools and Fixtures—Tool carriage and tools.

Production—12 per hr. (av.), 30 per hr. (high).

Remarks—5 sub-operations.

**Making the Shells.**—Fig. 385 depicts an efficiently laid-out factory engaged in the manufacture of French 120-millimeter high-explosive shells and illustrates an economic routing system, back tracking being reduced to a minimum.

The rough shell forgings are received at a railroad siding adjacent to the pickling department and as unloaded are stacked in storage piles along the track. From this storage, the rough forgings are trucked to the pickling house where the scale is removed and the shells thoroughly cleaned.

In the pickling house there are three wooden vats, one containing a solution of 10 per cent. sulphuric acid, the next water and the third lime water. The liquids are maintained at a temperature of about 200 deg. F. by steam pipes from the gas heated boiler located in the building. The forgings are first placed in the sulphuric acid vat, laid on their sides, for about 30 min., or until all scale is eaten off. They are then rinsed in the hot water vat and placed in the lime water vat for 20 min. to nullify their acidity. Two men can handle from 20 to 25 forgings per hour.

From the pickling house, the forgings are trucked to the machine shop where they are laid on tables and thoroughly brushed out inside, first with a wire brush and then with a bristle brush. At the same time they are carefully examined for exterior cracks and seams and inspected for general dimensions. An electric lamp is next inserted in the shell

and the interior examined for seams, cracks, pit holes, etc. One inspector can examine about 35 forgings per hour.

The cleaned forgings are then taken to a 24-in. stationary drill press furnished with a tilting arbor for centering. The shell forging is slipped

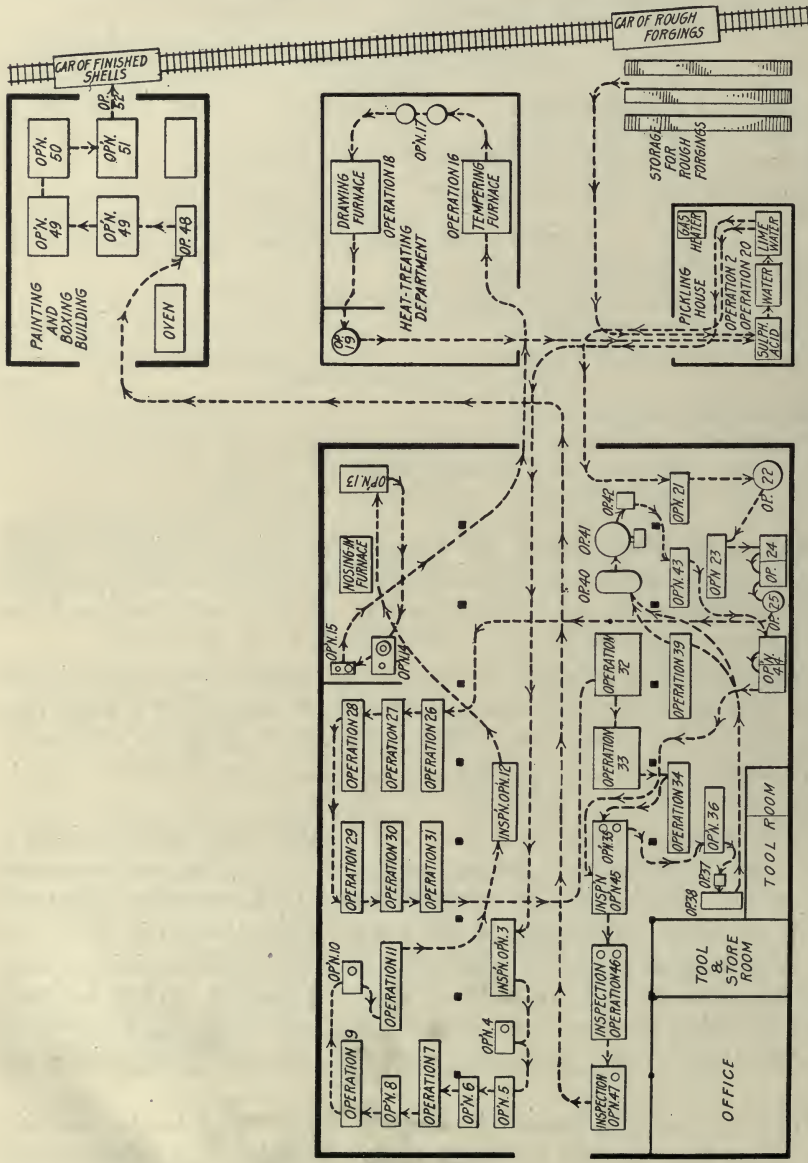

FIG. 385. GENERAL LAYOUT OF PLANT ENGAGED IN THE MANUFACTURE OF FRENCH 120-MILLIMETER EXPLOSIVE SHELLS

over the arbor and a 60-deg. center drilled, care being taken to have the center as near concentric with the inside of the shell as possible. Accuracy is secured by revolving the forging to a different position after the center

has been about one-half drilled and completing the drilling with the shell in the new position. This operation should be performed by the average operator at a rate of 15 per hour, while 25 shells per hour can be centered by an expert.

The centered forgings are then taken to an Acme Bolt Cutter for the fifth operation—*i.e.*, reaming out the powder pocket at the bottom of the shell. The shell forging is placed in a powerful clamp and backed up against a center on the work carriage—see Fig. 386. The boring, or cutting, bar carries a tool steel cutter conforming to the shape of the

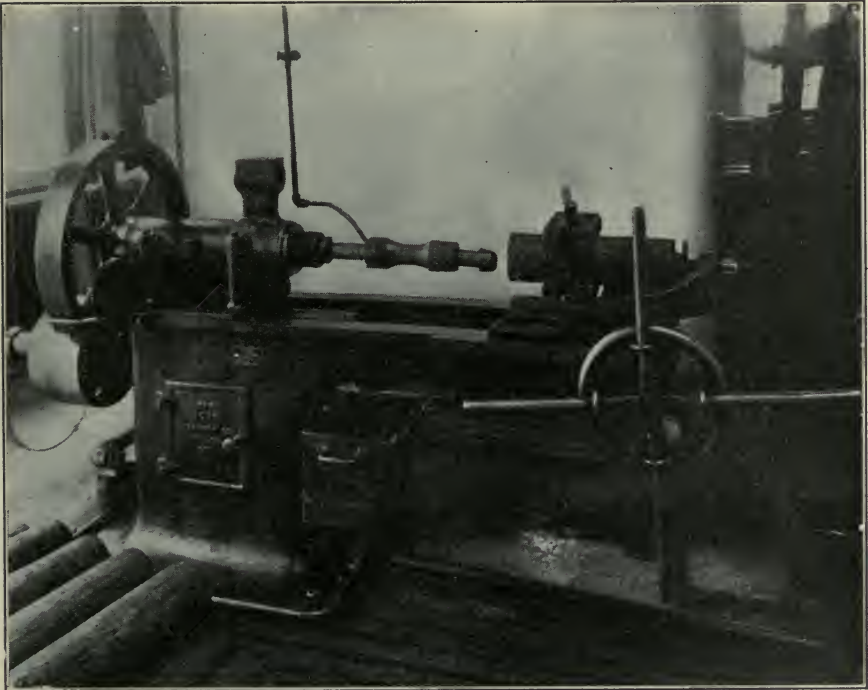

FIG. 386. ACME BOLT CUTTER SET-UP FOR REAMING OUT POWDER POCKET

powder pocket and is fed into the forging until clean metal is cut. In the illustration the boring bar is shown equipped with a heavy cast-iron pilot with commodious chip grooves to assure rigidity and maintain concentricity. A cutting lubricant is used in this operation which should be performed at a rate of 8 min. per shell. Such production can be materially bettered, however, for as high as 156 forgings have been reamed out in 10 hours.

Cutting-off the open end of the forging is also done on an Acme Bolt Cutter, one furnished with an air chuck and a Hurlburt-Rogers cutting-off attachment carrying two high-speed steel cutters. One tool cuts in

front and the other at the back of the forging—see Fig. 387. The tail-stock on the machine is also somewhat unusual in being hinged so as to permit the rapid insertion and removal of the work. Eight minutes are ordinarily required for this operation, but 121 shells have been trimmed off in 10 hours.

After this the shell is turned over to the operator of a 24-in. American Lathe who first cleans out the burr left by the cutting tools of the previous operation and then rough-turns the forging. The shell is driven by an air chuck. Two tools are again used, one roughing on the back and the other finishing on the front, the shell being turned to  $4\frac{5}{16}$ -in. diameter.

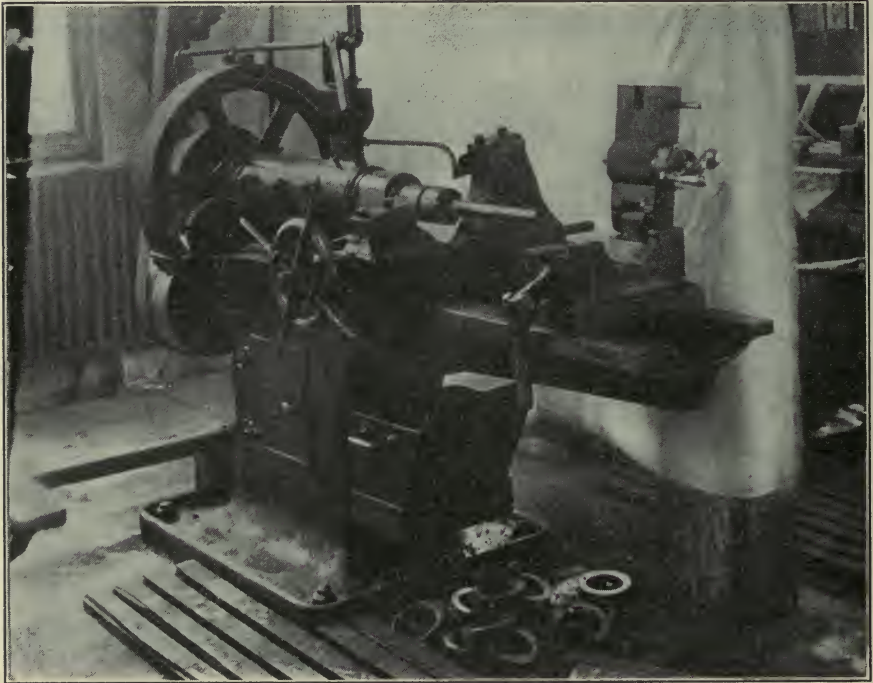

FIG. 387. ACME BOLT CUTTER SET-UP FOR CUTTING-OFF FORGINGS

This consumes from 5 to 8 min. the former being the record and the latter the average time.

The work is then taken to an Acme Bolt Cutter, similar to the one employed for operation 5 but with a somewhat different carriage and clamp, and the lower end of the shell reamed out concentrically with its roughly turned outside. The average time for this operation is about 8 min. and the record  $4\frac{1}{8}$  min.

The ninth operation is performed on a 24-in. Bradford Lathe and consists in facing the closed end of the shell. A steadyrest supports the deep overhung chuck (see Fig. 388) and two cutting tools are employed,

one set 1 in. in advance of the other. One tool faces off the end of the shell and the other faces the central teat so that it protrudes but 1-in. from the base of the shell. The central teat is also reduced to  $1\frac{1}{4}$  in. in diameter. The facing of the base leaves only enough metal in excess of the required bottom thickness for the final facing cut, so the thickness of the bottom is carefully gaged after this operation. The required rate of production is 6 shells per hour but as high as 94 shells have been faced in 10 hours, by one operator.

The operation of facing the base having removed the base center of the rough forging, the base is now re-centered and the new center counter-

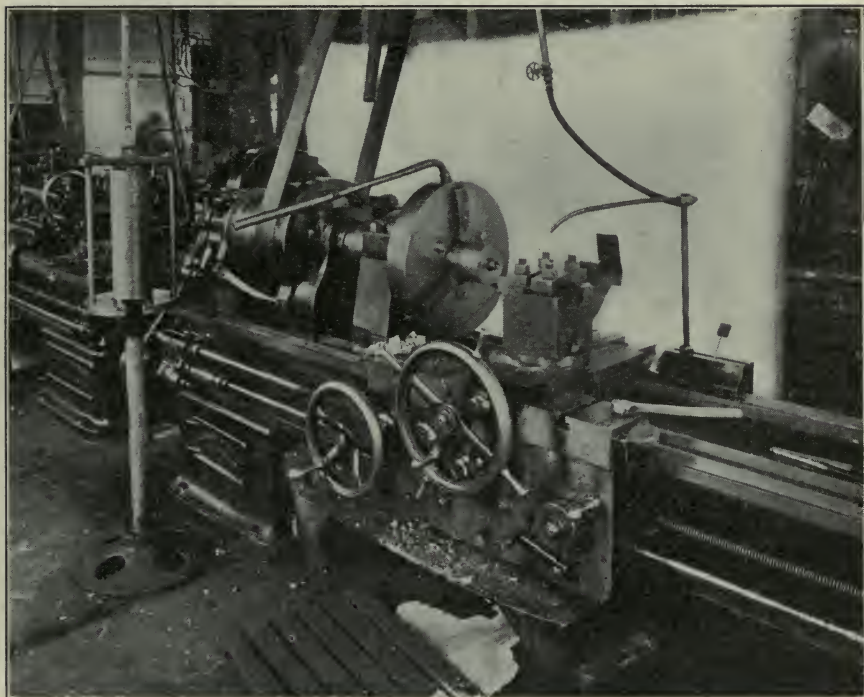

FIG. 388. 24-IN. BRADFORD LATHE SET-UP FOR FACING BASE

bored for protection during the subsequent nosing-in operation. This is done on a vertical drill press similar to the one employed for operation 4 and the production rate, owing to the double operation of centering and counterboring, is rarely in excess of 15 per hour.

The re-centered shell is then placed in a Boy & Emmes Lathe and a straight taper from 4.9 in. to 4.6 in. in diameter,  $5\frac{1}{2}$  in. long, taken on the open end of the shell preparatory to the nosing-in operation. The required production per lathe is 7.5 per hour but 10 per hour have been produced. The shell is driven by an air chuck, as in operation 7, but

only one tool is used, care being taken to see that the chuck turns centrally and that an even thickness of metal is left.

The nosing-in is preceded by a thorough inspection of shells as to their concentricity and thickness of walls and to determine whether they run true when revolved. Rough spots on the inside, which might interfere with the proper closing of the nose, are removed by means of a portable electric grinder. Though thorough, this inspection does not consume much time, one inspector passing as many as 35 shells in an hour. A view of the inspection table is shown in Fig. 389.



FIG. 389. INSPECTOR'S BENCH

The inspected shells are then placed in a 7-hole Tate-Jones Furnace and about 8 in. of the open end of the shell brought to the proper condition of heat for working under the hammer. The heated shells are placed in the holding chuck of a 400-lb. Beaudry Hammer (see Fig. 390) and the heated end hammered into required form. The hammer dies are of forged steel and stand up well under the work, as all surplus metal has previously been removed from the shells. The nosed-in shells are allowed to cool off naturally. Two men are employed on this operation, one to run the hammer and the other to take the shells to the cooling ground. They can handle as many as 300 shells in 10 hours.

Forming the nose about closes the shell so the first operation follow-



ing the nosing-in consists in rough-boring the nose and facing the nose end to length. Both of these tasks are performed on a 24-in. drill press, the boring with a  $1\frac{1}{2}$ -in. high-speed drill and the facing with a high-speed steel facing cutter. From 5 to 7 min. are required for the drilling and 3 to 5 min. for the facing, the production being from 5 to 7.5 shells per hour.

The chips which fell into the shell while boring the nose are then washed out and the shells tested for volume. This test is found to be of

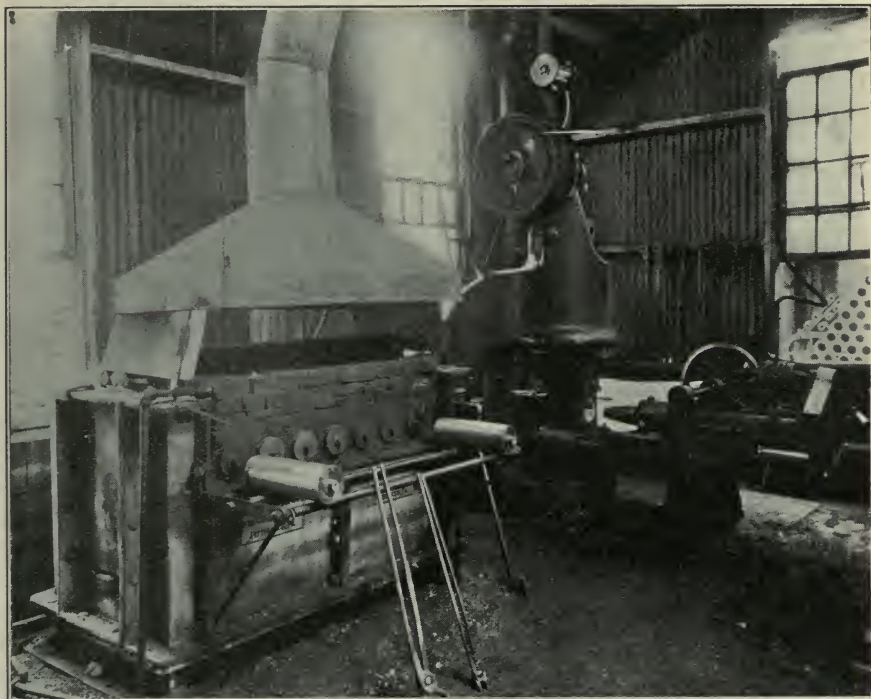

FIG. 390. TATE-JONES CO. FURNACE AND 400-LB. BEAUDRY HAMMER

considerable assistance in arriving at the correct weight of shell, for if the volume is correct and the outside of the shell is subsequently finished to correct proportions, the weight of the finished shell will be uniform and correct.

An ingenious gage employed for making such volumetric test is shown in Fig. 391. To conduct the test, 1.610 liters of water are poured into the shell and then the gage plug, through which passes a  $\frac{1}{16}$ -in. hole, inserted into the shell nose. The gage rod is pressed down until water issues from the hole in the plug. Two marks on the gage rod indicate the minimum and maximum allowable shell contents, corresponding to a tolerance of 30 cu. cm. in volume, and for correct volu-



that no air may be trapped in the shell. The shells remain in the sulphuric acid for about 30 minutes, or until all scale has been removed from the inside. After rinsing and washing, the shells are dried and then greased on the inside to guard against rusting in storage. The pickling of the nosed-in shells is carried on while rough forgings are being similarly treated and is much more expeditiously conducted. The rough forgings weigh in the neighborhood of 70 lb. and require two men for handling, while the heat-treated shells only weigh about 45 lb. and can be easily handled by one man.



FIG. 392. HEAT TREATING DEPARTMENT

The next operation on the shell, the twenty-first, consists in finish-boring and tapping the nose on a turret lathe. The shell is driven in a deep chuck similar to the one used in facing the base in operation 9, the nose protruding from the chuck in this case instead of the base of the shell. The turret carries three boring bars and two Murchey taps. The shell is first rough-bored with a single cutter, then rough-bored with a double headed cutter and finish-bored with a double-sided cutter. One Murchey tap then roughs out the thread and is followed by the second tap. This operation ordinarily consumes about 12 min. but 60 shells have been bored and tapped in 10 hours.

The shells are then transferred to a 24-in. drill press where the tapped nose is brought up to rough size with the passage of one tap. This simple operation consumes about 3 min.

The base of the shells are next faced off to bottom thickness. This is done on an engine lathe, the shell being mounted on and driven by a screw arbor and supported in a steadyrest. This takes about 12 min. Accurate gaging of bottom thickness forms a part of this operation.

The next step is thoroughly to wash the shells by first immersing them in hot soda water and then rinsing in clear water.

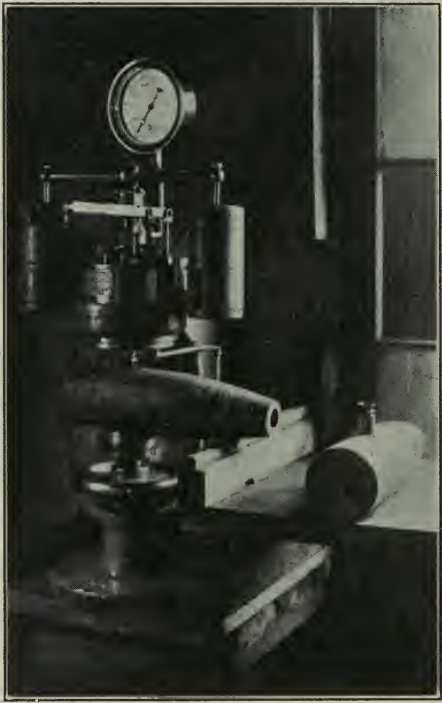
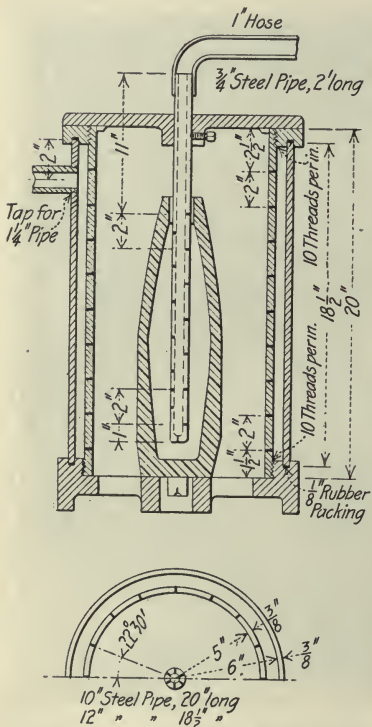

FIG. 393. DETAIL OF NEEDLE BATH

FIG. 394. BRINELL BALL TESTING MACHINE

A hard steel center plug is screwed firmly into the nose, careful inspection of the shell for imperfect threads being made before this is done. Shells with defective or broken threads are returned to the blacksmith and re-nosed sufficiently to allow correction of the fault.

The plugged shell is then placed in a 24-in. American Lathe and the body turned with two tools, one in back and one in front. The production required per machine for this twenty-seventh operation is 6 per hour, but as high as 106 shells have been body turned in 10 hours.

The bottom taper and the nose of the shell are turned and finished in the next four operations, a roughing and finishing cut constituting the

two operations for each end of the shell. These are done on 24-in. American Lathes, suitable profile plates being employed for each operation. Rough-turning the taper is done with a flat tool and consumes about  $7\frac{1}{2}$  min. on the average. Finish turning the taper consumes about the same amount of time, while the rough-turning and finish-turning of the nose each occupy about 12 min. High records for the four operations are: rough-turning taper, 15 per hour; finish-turning taper, 20 per hour; rough-turning nose, 8.5 per hour; and finish-turning nose, 15 per hour.

The thirty-first operation consists in forming the band groove and though performed on a turret lathe requires but three tools for four sub-operations: one tool for both grooving and undercutting, one tool for scoring and one for knurling. The resulting groove has seven rounded scores circling the shell and a series of sharp-pointed knurled ridges running lengthwise on the shell. The band grooves are finished at a rate of from 12 to 26 per hour.

The next two operations consist in grinding the shoulder for one and grinding the taper and the section from the back of the band to the commencement of the taper for the other. This work is done on 24-in. Modern grinders, the average time required for either operation being about the same—*i.e.*, 5 min. per shell. For high productions, grinding the shoulder leads, 26 per hour against 20 per hour for grinding the taper and behind the band.

Following the grinding operations, the shell is placed in a 24 in. American Lathe and the body finish-turned to 4.665 in. in diameter. This consumes about 6 min. per shell.

A preliminary weighing of the shell is then made and if found excessively heavy it is returned to the profile lathe used for operation 29 where it is retouched for weight. This constitutes the thirty-sixth operation and is only required for such shells as are unusually heavy.

The center plug is next removed and the teat protruding from the base then cut off with a power hack-saw. Removing the teat in this manner leaves a slight stub which is ground off with a Besley Ring Grinder, the time consumed in removing the teat and grinding off the stub being about 4 min.

Inasmuch as practically all the shells are slightly scarred on the nose face at this stage of development, another minor operation is here introduced, consisting of re-facing the nose so that a tight connection may be made for the following hydraulic pressure test.

This pressure test is made in the presence of the French inspector and consists in subjecting the shell to 15,700-lb. hydraulic pressure for 30 seconds. The shells are first filled with water, the sealing gasket inserted in the nose and the shell then connected under the yoke of a hydraulic press built by the Cleveland Tool & Supply Co.—see Fig.

395. A permanent expansion of 0.004 in. is allowed but even this is very seldom, if ever, encountered, slightly defective shells being more apt to burst under the strain and those which are correct in proportions showing no permanent expansion. The capacity of this machine is about 25 shells per hour. Tested shells receive the inspector's stamp.

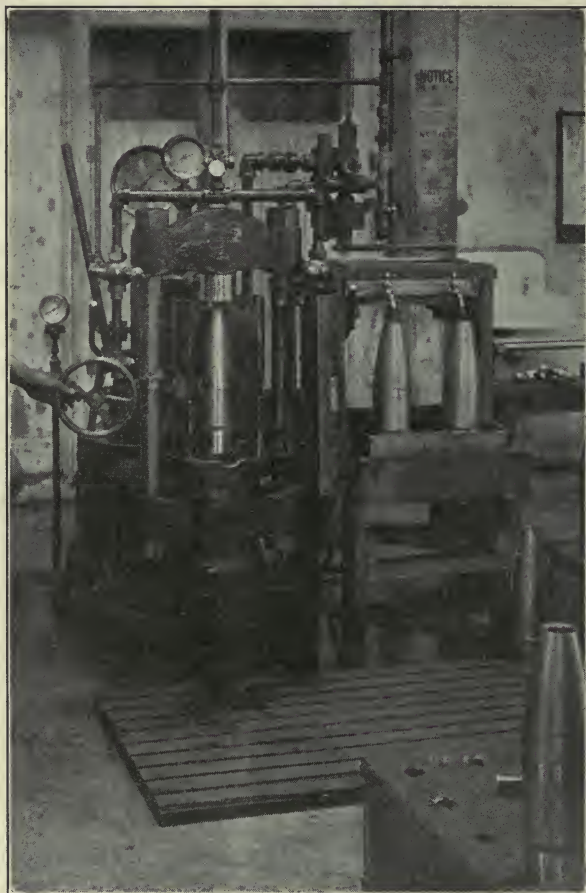

FIG. 395. THE HYDRAULIC PRESSURE TEST

The copper band is then pressed into the knurled groove by a West Tire Setter, three squeezes at 1,500 lb. per sq. in. being given each shell. One operator can band 500 shells in 10 hours.

The forty-second operation consists in hand tapping the nose to size, the sealing gasket in the hydraulic test having slightly damaged the top of the threads. The shell is rigidly held in a work holder and an air tap employed. Two men can tap 125 shells in 10 hours.

The final machining operation on the shell, the forty-third in the

evolution of the shell, is done on an engine lathe with two tools in 5 sub-operations and consists in turning the copper band. The shell is held in a deep collet chuck and a roughing cut over the width of the band is first taken, followed by a finishing cut which leaves the diameter of the band just under 123 mm. A 45-deg. taper is then turned on the front edge of the band until the edge of the groove is located. The back edge of the band is then faced to width and the secondary taper cut on the forward section of the band leaving the flat section 10 mm. wide.



FIG. 396. TESTING SHELLS FOR ECCENTRICITY AND WEIGHT

The time allowed for this operation is 5 minutes but the work has been done at the rate of 300 shells in 10 hours.

The finished shells are carefully washed in soda water and thoroughly cleaned with a brush and rags preparatory to the final gaging. This examination is most thorough, consisting of gaging the shell for all dimensions, inspection of threads, etc. For any irregularity, the shell is returned for correction to the operator whose work offends.

The shells which satisfactorily pass the gaging test, and they nearly all do, are then sent to the head inspector's bench for the forty-sixth operation, where they are inspected for thickness of bottom, diameter of barrel, diameter of base, interior defects, contour of nose and the nose

thread plug-gaged a second time. The shells are also tested for eccentricity and weighed—see Fig. 396. The correct weight is 15.575 kg. plus or minus 0.160 kg.

The eccentricity test is performed with the aid of the brass “eccentricity weight” shown in Fig. 397 and two perfectly level and parallel hardened steel bars. The shell is first laid across the parallel bars and allowed to come to rest, when its center of gravity, if the shell is not exactly concentric with its gravity axis, will lie below the longitudinal axis of the shell. The “eccentricity weight” is then clamped to the base of the shell with its weighed end up, that is, opposite the heavy side of the shell, and is then adjusted by moving its weight up or down so that its center of gravity is 15 mm. off the center axis of the shell, toward the weighted end of the “eccentricity weight.” The shell is then rolled on

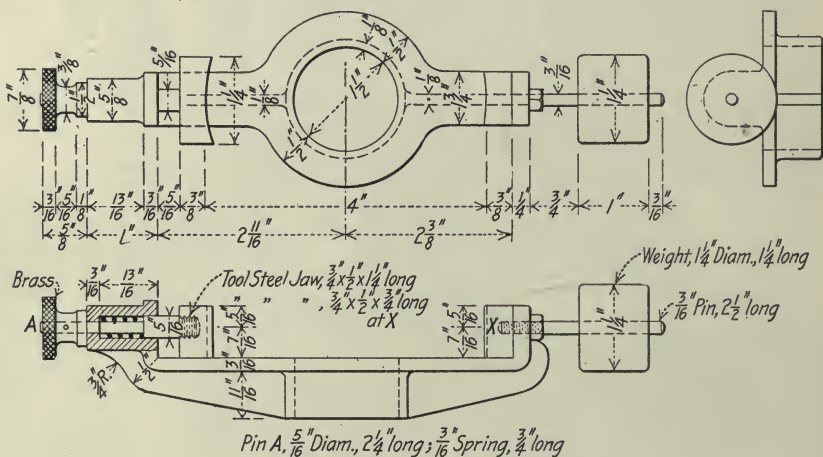

FIG. 397. ECCENTRICITY WEIGHT

the parallel bars until the “eccentricity weight” is in a horizontal position, then released. If the shell remains stationary or the weighted end of the “eccentricity weight” rises, the eccentricity of the gravity axis of the shell equals or exceeds the tolerance of 0.6 mm.; if the weighted end of the “eccentricity weight” drops the tolerance is not exceeded and the shell is satisfactory as far as the distribution of its weight about its longitudinal axis is concerned.

The center of gravity is then located by balancing the shell, longitudinally, upon knife edges and measuring the distance from the normal plane of the center of gravity to the base of the shell. The fixture shown in Fig. 398 is used for this purpose. The shell is carefully balanced on the knife edges of the  $\frac{1}{2}$ -in. balance plate and the adjustable square brought up against the base of the shell, the scale of the square accurately measuring the distance of the center of gravity from the base of the shell. A tolerance of but 0.1969 in., 5 mm., either way is all that is allowed.



Locating the gravity axis of the shell and also balancing for the center of gravity are shown in Fig. 396. The order in which these sub-operations are performed can be reversed, of course; *i.e.*, the shell may first be balanced on the knife edges and the eccentricity of the longitudinal gravity axis found subsequently, or vice versa.

The 15-mm. offset of the center of gravity of the "eccentricity weight" is arrived at by direct proportion. The weight of the completed shell is 15.575 kg. and the maximum eccentricity allowance of the gravity axis of the shell is 0.6 mm., giving a 9,345 mm. gram moment ( $15,575 \times 0.6$ ). This moment divided by the weight of the "eccentricity weight," 600 grams, gives the offset of the center of gravity of the testing device required to balance the 9,345 mm. gram moment ( $9,345 \times \frac{1}{600} = 15.565$

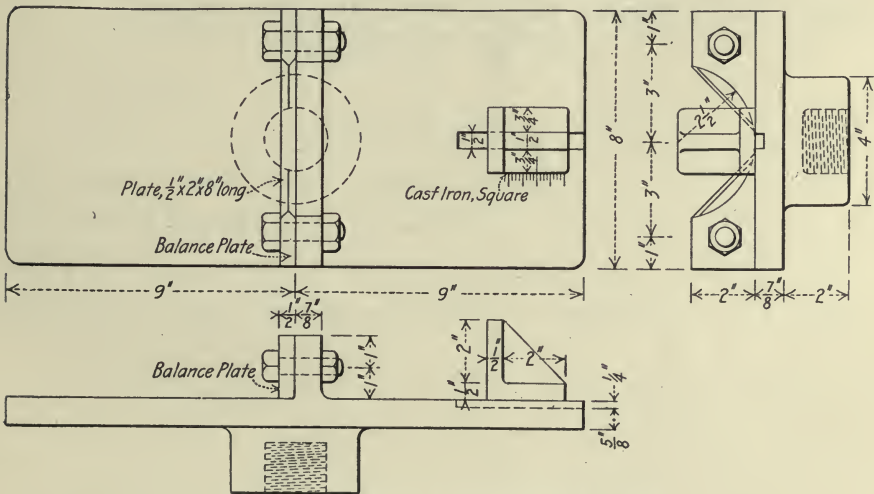

FIG. 398. DETAIL OF BALANCING FIXTURE

mm.)—that is, as regards the gravity axis of the shell. This necessary offset is taken as 15 mm. in order to be on the safe side.

The shells are then presented in lots of 500 to the French inspector who selects 25 from the lot and goes over them for all measurements, weights, eccentricity, etc. If he finds the 25 all acceptable he passes the balance of the 500 and affixes his stamp on the nose of each shell.

The shells are then stamped with the manufacturer's symbol, the lot number and the year. The stamps are made on the nose of the shell, halfway between the shoulder and the end of the shell, and also in an arc of a circle on the base of the shell, midway between the center and outer circumference. Two men, with the aid of a stencil plate, can mark about 500 shells in 7 1/2 hours.

The shells are then greased on the inside with vaseline and on the

outside with a mixture of white zinc, tallow and oil, two men doing the work of greasing 500 shells in about 10 hours.

The fiftieth operation consists simply in driving a wooden plug into the nose of the shell to keep out foreign matter. The shells are then packed in substantial wooden boxes. They are laid flat, nose and tail, four to the box, separated from one another by strips of wood extending the full length of the box. The cover is securely screwed down, the boxes being proportioned so that there is no possibility of the contents shifting. An endless rope passing under the box and cleated to its sides forms handles by which two men can easily carry a loaded box. Three men can box about 500 shells in 10 hours.

The loaded boxes are then transferred to a departing freight car, which, by two men and a truck, can be loaded with 1,000 shells in 10 hours. This constitutes the fifty-second and final operation.

SECTION III  
CARTRIDGE CASES

By

ROBERT MAWSON

	PAGE
CHAPTER I. MANUFACTURE OF CARTRIDGE BRASS.....	517
CHAPTER II. MAKING 1-LB. CARTRIDGE CASES.....	536
CHAPTER III. MAKING THE 18-LB. CARTRIDGE CASE.....	555
CHAPTER IV. MAKING THE 4.5-IN. HOWITZER CARTRIDGE CASE.....	595



## CHAPTER I

### MANUFACTURE OF CARTRIDGE BRASS<sup>1</sup>—ROLLING CARTRIDGE BRASS<sup>1</sup>

The characteristics of cartridge brass, chemical, physical and thermal, are of the utmost importance, for the efficiency of a gun depends in large part upon the behavior of the *cartridge case* at moment of discharge, the ease and rapidity with which it can be ejected, etc. These requirements call for extreme care in the manufacture of the cartridge cases from the blank, but of just as great if not even greater importance is the necessity that the bars from the casting shop should be homogeneous, comparatively free from all impurities, and of uniform composition—*i.e.*, of definite chemical analysis.

Cartridge brass should analyze about 70 per cent. copper and 30 per cent. spelter, though a variation of plus or minus 1 or 2 per cent. is usually allowed. The principal requirements of the average specifications are as follows:

#### AVERAGE SPECIFICATIONS FOR CARTRIDGE BRASS

1. **QUALITY OF METALS.**—Pure electrolytic or pure lake copper and “Horsehead” spelter, or its equivalent.

2. **IMPURITIES ALLOWABLE.**—In copper: not to exceed 0.03 per cent. In spelter (maximum): lead, 0.03 per cent.; iron, 0.04 per cent.; cadmium, 0.20 per cent.; total not over 0.25 per cent.

3. **SCRAP ALLOWABLE.**—50 to 60 per cent. of scrap brass, consisting of scrap from blanking press, overhauling machines and shears.

No foreign scrap, skimmings or scrap from floor and mold pits allowed.

4. **CHEMICAL ANALYSIS, FINISHED METAL.**—Copper, 67 to 71 per cent. Spelter, 33 to 29 per cent. Impurities, (average), 0.2 to 0.4 per cent. Arsenic, phosphorus and cadmium from 0.04 to 0.08 per cent.

5. **PHYSICAL TESTS.**—Breaking lead: (Min.) 40,000 to 44,000 lb. per sq. in., (Max.) 48,000 to 50,000 lb. per sq. in.

Elongation: (Min.) 50 to 62 per cent. Cupping Test—Advisable but not always specified.

6. **VARIATIONS IN DIMENSIONS OF FINISHED BLANKS.**—In diameter, plus or minus 0.005 in. to plus or minus 0.015 in.

In thickness, plus or minus 0.003 in. to plus or minus 0.007 in.

7. **INSPECTION.**—100 per cent. visual examination for flaws, folding cracks and other defects in the surface and for pipes and cracks in the edge of the blank.

8. **PURCHASER'S RESERVATION.**—Right to take samples and make chemical analysis of metals in stock, to check for conformity with specifications, etc.

In addition to the foregoing, other clauses are usually inserted in the specifications covering number of rehandlings allowed on rejected materials,

<sup>1</sup>C. R. Barton.

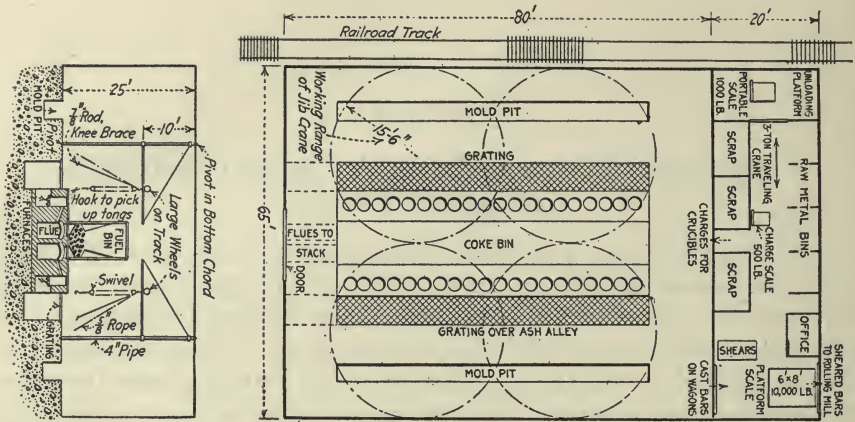

FIG. 399. PLAN AND SECTION OF CASTING SHOP

TABLE OF EQUIPMENT FOR ONE SET OF TEN FURNACES<sup>1</sup>

Name of Article	Number Required	Life in Heats, Each	Weight, Lb., Each	Cost, Each
Crucible tongs.....	2	7,000	55	\$6.00
Spelter tongs.....	2	800	12	1.25
Stirring-rod tongs.....	2	2,500	13	1.25
Band tongs.....	1	Indefinite	6	....
Mold tongs.....	1	Indefinite	9	....
Bar tongs.....	2	7,000	6	....
Skimmer.....	1	35	5	....
Scrapers.....	3	Indefinite	4	....
Punch bars, 7 ft. of 1-in. round iron.....	3	....	..	....
Chisel, 7/8-in. hexagon flat, 14 in. long.....	1	....	..	....
Files, 18-in. bastard-cut mill.....	2	....	..	....
Hammers, 6-lb. crosspeen blacksmiths', 12-in. handle.....	3	....	..	....
Fuel cover.....	1	Indefinite	20	....
Wire brushes.....	3	10,000	..	0.20
Charcoal box, wooden, 4×4×3 ft.	1	....	..	....
Oil pail, heavy 2-qt. bucket.....	1	....	..	....
Oil brushes, 4-in. flat paint.....	2	....	..	....
Salt pail, heavy 4-qt. bucket.....	1	....	..	....
				Per Lb.
Molds.....	20	2,000	450	0.05
Bands.....	60	200	25	0.05
Wedges.....	100	3,000	5	0.03
Strainers.....	20	Indefinite	27	0.03

<sup>1</sup> The figures are approximate, as in some instances they are based on estimate only.

size of lots submitted for inspection, micro-photography and the manufacture of selected disks into cartridge cases for the development of interior flaws or defects not shown by visual examination.

**Layout and Equipment of a Plant.**—A typical layout of a casting shop, the department which covers the work from receipt of copper and spelter to delivery of sheared bars to the rolling department, is shown in Fig. 399. The unit of equipment is known as a set of fires, generally consisting of 10 furnaces and the necessary auxiliary equipment—see accompanying table of equipment. Each set of fires (Fig. 399 shows four) is handled by one caster and his helpers, and occupies a space of 10 furnaces. The pots are lifted from the furnaces by a jib crane which carries them to the molds in the mold pits.

**The Furnace.**—A furnace proportioned for handling a No. 90 crucible,  $13\frac{3}{8}$ -in. outside diameter, is shown in Fig. 400. The furnaces are made square to facilitate grasping the crucibles. Below the crucibles, the furnaces should be deep enough to permit maintaining, when the bottom

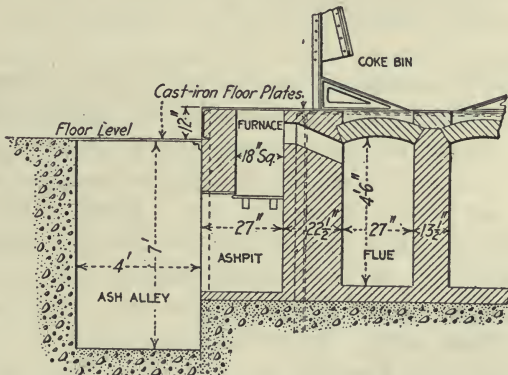

FIG. 400. TYPICAL SQUARE PIT CRUCIBLE FURNACE

of the flue opening is above the top of the crucible, a fire of at least 12 in. in depth, in order that the pot may be subjected to an even heat. The furnace should be bricked up so that but one course of brick around the inside need be removed when the furnaces are relined, putting in only enough tie-bricks to the second course to hold the lining. The life of the lining varies greatly with the fuel used, coke making a much hotter fire than coal. Operating two shifts for four months made relining necessary on furnaces burning coke. The quality of firebrick and fuel must be considered as in other furnace work. The grate bars are 1 in. square, set on two bearers, such as a piece of 60-lb. rail. The draft may be natural or induced. A forced-draft system does not give satisfaction, as it rarely balances, thus throwing out into the room intense heat, which becomes a serious consideration in hot weather.

The ash alley should be of a cross-section that will allow easy passage of a wheelbarrow for removing the ashes when cleaning the fires. The coke bin, as shown, should provide storage for at least two days' requirements, and the monorail trolley is probably the simplest means for filling the bin from outside storage.

The quickest fire is not always the most desirable in the long run. Using a special 21-in. square furnace, we have been able to take out 21 heats in 24 hr., including cleaning fires twice. This is during cold weather; but it is doubtful if it is economical, as men cannot be secured readily who will stand up to such work, and the life of the crucible is greatly reduced. We believe 14 and possibly 15 heats per 24 hr. in winter a good production, falling off to 10 or 12 in warm weather.

There are other styles of furnaces, such as reverberatory furnaces, the Schwartz furnace and the type known as the tilting furnace, in which the crucible is tilted for pouring. In all these a distributing ladle must be used, which means a second pouring of the metal. Repeated installations of the old-style crucible furnace, replacing some of the foregoing, show that for certain classes of work it is still the best in spite of the crucible expense.

**Fuel.**—Of late there has been considerable experimenting with various kinds of fuel. The plant here discussed is laid out for burning coke or coke and coal. Where maximum production is demanded, that method is most efficient which will enable the greatest number of heats to be obtained from one furnace in a given time. Hard coal is probably the slowest fuel used, and the length of time required for getting out a heat is the only objection to it, as in other respects it is very satisfactory. Coke gives a much hotter and therefore faster fire, with a greatly increased wear on the furnace lining. Both oil and natural gas would seem to be desirable. The author has not had experience with oil-fired furnaces. Twenty of the furnaces shown were equipped for burning natural gas, using forced draft. Different methods for venting the furnaces were tried, but without great success. The heat from the furnaces was such that the cover brick became red hot and conditions were made intolerable for the workmen. We do not believe that the gas fuel was given a thorough trial, as it is no doubt the ideal fuel for crucible furnaces and will prove successful as soon as it has been put through an experimental stage in a large plant, where furnaces are necessarily set close together.

The fuel consumption varies with the rate of production and the size of the crucible furnace. No exact data can be given; the most reliable figures indicate from 0.4 to 0.6 lb. of coke and coal (mixed) per pound of metal melted during a period of several months, with 18-in. round and 21-in. square furnaces.

**Molds.**—The molds for the cartridge brass may be seen in Figs. 401 and 402. They are made of gray iron containing 2.5 silicon and finished



as shown. The size of the mold is determined by the width of bar required and the weight, which should be such that one pot of metal will make full-length bars. For convenience in handling, the bars are usually made from 80 to 125 lb., unless the size of the finished bar or sheet re-

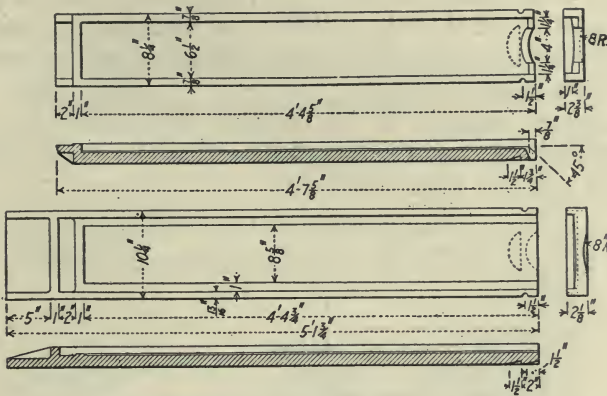

FIG. 401-402. MOLD FRONT AND BACK

quires more metal. In rolling, the metal flows almost entirely in the direction of the rolls, so that if bars are passed through straight, there is no appreciable widening. Bars are cast in regular work up to 15 in. wide in short bars and up to 10 and 12 ft. long in narrow bars. It is always best to cast the bar of a thickness that will avoid as much rolling as

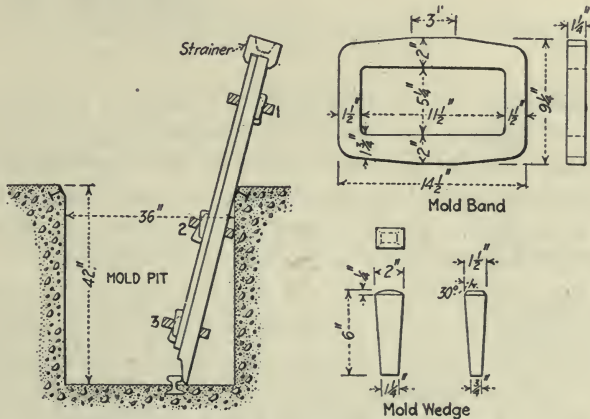

FIG. 403. MOLD BANDED FOR POURING

possible, and the 7/8-in. thick bar is now about standard size, although 1 1/4-in. bars are made at times.

The mold is held together, as illustrated in Fig. 403, by three bands wedged up tightly. The bands and wedges should be made of first-quality cast steel, if the use of expensive forged pieces is to be avoided.

The order and manner of driving the wedge are shown by the numbers. This method has been found to reduce leakage.

The life of a mold is very uncertain. Some few foundries make a specialty of ingot molds, and their product has a high reputation. One of the largest brass makers in this country, after some years of experiment and experience, found that the molds of one firm gave uniformly 50 per cent. longer life than any other make. Molds should average at least 2,000 to 2,500 heats.

An important adjunct of the mold is the strainer, Fig. 404. In pouring, the strainer should be kept full, so that the slag and dirt passing the skimmer will not enter the mold.

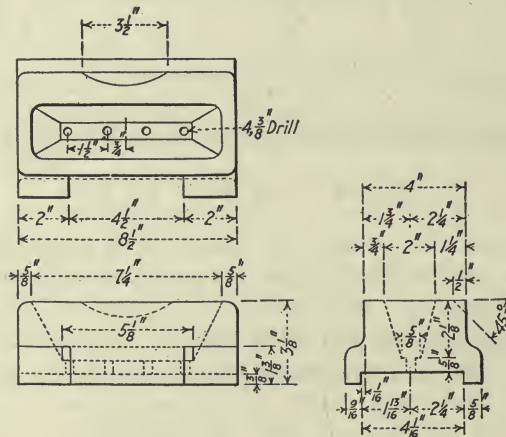

FIG. 404. MOLD STRAINER

**Tool Equipment.**—The several kinds of tongs may be seen in Fig. 405. All are made of wrought iron by the blacksmith shop in the plant. The most important are the crucible tongs for handling the crucibles. In forging, these tongs should be shaped to a cast-iron crucible of the same size as that to be used. Tongs should always be refitted whenever there is a change in either the make or the size of the crucible.

Other tongs are spelter tongs for dipping the spelter in the molten copper, mold tongs for lifting the fronts and backs of molds, band tongs for handling the hot bands, stirring-rod tongs for holding the graphite stirring rods, and bar tongs for lifting the hot bars from the pit when the molds are stripped. These different kinds are illustrated in Fig. 405, and the weights, number required and other data are given in the table.

The remaining equipment includes skimmers for skimming the pot when it is lifted from the fire and for holding back slag and charcoal that is not removed by skimming when pouring, scrapers for scraping the molds, wire brushes for cleaning molds after scraping, heavy buckets for mold dressing, powdered charcoal and flux, cheap 4-in. flat brushes for

applying mold dressing, sledges, hammers, etc. Some of these tools may be seen in Fig. 405, and other data are given in the table. In most cases two sets of tools are allowed for each set of fires, as the tongs become too hot to be comfortably handled if used continuously.

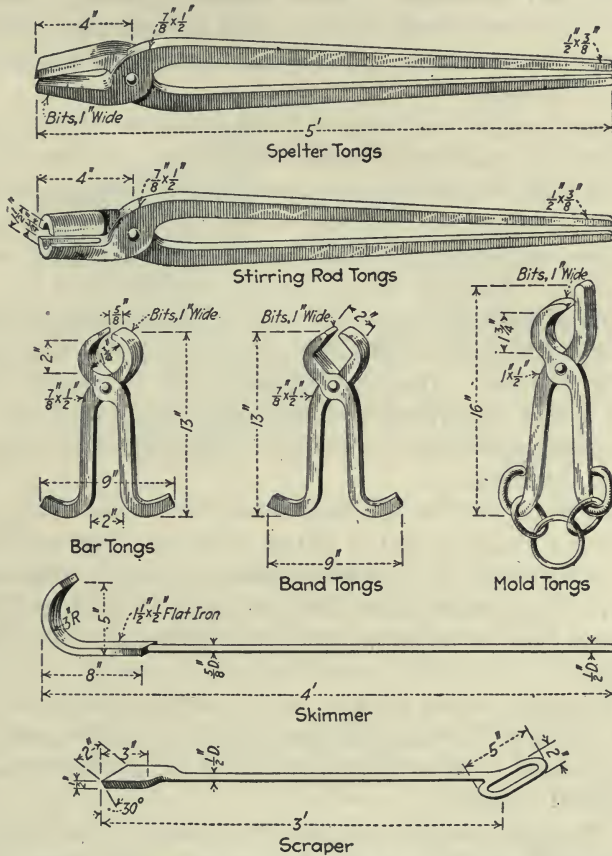

FIG. 405. A VARIETY OF TONGS USED FOR HANDLING THE WORK

**Crucibles.**—Crucibles are, aside from losses, the greatest single item in the cost of producing brass. For this reason many attempts have been made to get away from the use of crucibles. Long experience in crucible making shows that the best materials are Ceylon graphite and Klingenberg crown clay. Ceylon graphite is free from mica and is about 98 per cent. pure. The Klingenberg clay comes from a small district around the village of that name in Germany. The materials are blended and mixed in proper proportions, molded, dried and burned in a kiln. The amount of excess air in the kiln determines whether or not the graphite is burned out of the surface of the crucible, thus making the white or blue crucible. Obviously, the matter of color is of no importance,

although manufacturers are called upon to supply crucibles of a given color. Crucibles usually contain from 50 to 60 per cent. of graphite.

Crucibles are known by number, each unit in the number representing nominally the capacity to hold 3 lb. of molten metal. Therefore, a No. 90 should hold 270 lb. service. This is frequently done by storing them on a floor on top of the muffle furnaces used for annealing in the rolling mill. A careful record of the size and number of crucibles given to the casters should be kept.

The life of a crucible is shortened by ill-fitting tongs by excess fluxes of various kinds, by soaking in the fire longer than necessary to melt the metal, by too high furnace temperatures in the endeavor to get quick heats, by wet or sulphurous fuels that attack the outside of the crucible, by carelessness in stirring the metal and by general lack of care in handling.

In the employment of fluxes such as fluorspar and various silicates a mean must be determined so that the metal will be purified with a minimum erosion of the crucible. The crucibles should be thoroughly dried and annealed for two of three weeks before being put into the brass. About 80 to 90 per cent. of the capacity of the crucible may be used, depending on the care of the caster.

The best size of crucible has been found by long practice to be the No. 80, holding a charge of 200 to 220 lb. of brass. This crucible makes two bars of convenient size in narrow metal or one in wide metal. It seems to have a somewhat longer life than larger crucibles and therefore, striking a mean between labor and crucible expense, gives the lowest cost of production.

Broken crucibles should be freed of any metal adhering to the inside surface, for old crucible material commands a market price of from \$10 to \$15 per ton. The metal chipped from the crucibles can later be reclaimed with the ashes.

**Fluxes.**—For clean scrap and new metals such as must be provided in making cartridge brass, phosphorus and common salt seem to give the best results. The phosphorus is in the form of 15 per cent. phosphorized copper, 1 oz. per 100 lb. of metal. A larger quantity may be used if needed, but not enough to give a perceptible amount of phosphorus in the finished metal. Common salt, somewhat finer than crude rock salt, should be added, about one handful per 100 lb. of metal. Care should be taken to avoid an excess, as this attacks the crucible.

The impurities to be removed are mainly copper oxide, sand and dirt. The foreign metals—tin, iron and lead—cannot be removed, and none should be introduced by iron stirring rods, brass scrap containing lead, etc. The copper oxide forms readily, and for this reason the melting metals should be covered with powdered charcoal to prevent oxidation. Patent fluxes are generally to be avoided.

**The Scraproom.**—The scraproom of a brass manufacturing plant is the department at which the new metals are received and stored, all scrap received and weighed, and the charges for each heat are proportioned. In Fig. 399, it is shown at one end of the shop. This illustration shows the usual equipment of a scraproom and Fig. 406 shows one of the small iron pans, the tote box, in which the charges are weighed and carried to the furnace.

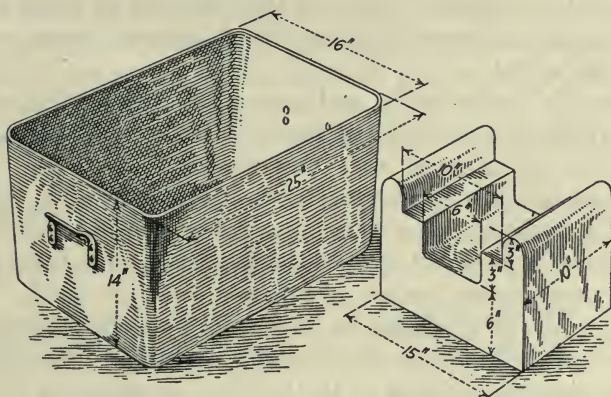

FIG. 406. TOTE BOX AND SHELTER-BREAKING BLOCK

**Processes of Making Cartridge Brass.**—The first operation, starting each day's work, is to clean the fires by pulling out the grate bars and removing the ashes, care being taken to punch out the clinker that has formed at the bottom, as this sometimes reduces the cross-section of the grate to one-third its actual size. A fresh fire is then built, which in continuous operation is usually lighted by the hot bricks in the furnace. As the fire comes up to heat, the crucible, which has been previously warmed by being on top of the furnace, is placed in the fire, and the heavier metal of the charge, which was weighed up in the scraproom is brought out on the casting floor and set behind each furnace. The charge, except spelter, is there laid carefully in the crucible, care being taken that the metal does not tend to wedge the pot apart during melting, when the pot becomes soft. Ordinarily, a ring made from the upper half of an old crucible is placed on top of the crucible to hold the scrap and copper that cannot be put inside. In this case the scrap should be put in the bottom, as it melts faster than the copper.

After all the metal is melted and up to a bright heat, the spelter, which has been warmed by lying on the furnace, is thrust beneath the surface of the metal and is rapidly melted and alloyed with the copper. The brass is then stirred thoroughly with a graphite stirring rod, so as to secure a homogeneous mixture. The graphite stirring rods are expensive, but are the best for high-grade brass, as iron from an iron stirring

rod will alloy with the brass and thus increase the impurities. During the melting, salt and powdered charcoal are thrown on the metal, the charcoal to protect the molten metal from the atmosphere and the salt to act as a flux. After a vigorous stirring, the metal is given a minute or two to allow the impurities and dirt to come to the surface in the form of slag. The crucible tongs are then placed on the crucible, which is raised from the furnace by means of the jib crane. The outside surface of the crucible is cleaned, and it is then lowered on clean sand on the floor. The slag is skimmed off and a block of wood thrown on the clean surface of the metal.

The crucible is then raised and placed over the strainer on the mold and poured, tipping the crucible forward with the tongs, keeping back the residue of slag and charcoal with the skimmer.

The block of wood in burning tends to keep the air away from the metal and is useful in reducing the amount of spelter burned out. The strainer should be kept full of metal so that the slag and dirt passing the skimmer remain on the surface and do not enter the mold. The molds should not stand slanting sidewise, as there is a possibility that impurities and gas pockets will lodge in the corner of the mold instead of coming to the surface, so that one edge of the bar may be defective for the entire length of the mold.

The molds are prepared by scraping with the scraper and brushing down thoroughly with a wire brush, after which they are painted with lard oil. Many substitutes are offered as a mold dressing, but lard oil seems to secure the best results. The molds are then banded and wedged up tight and are ready for use, the strainer being placed on top. After pouring, the metal is soon chilled sufficiently to allow the bands to be knocked off and the mold opened. The bars are raised with the bar tongs, and the burrs are filed off. Then the bars are piled on the floor behind the mold pit and allowed to cool until they can be handled and taken to the shears in the scraproom.

The term "losses" covers the difference between the metal weighed out and melted and the total metal returned. The gross loss includes the metal in the ashes, and the net loss is that determined after the ashes have been put through the recovery plant and a large part of the metal in the ashes reclaimed. The net loss is therefore the difference between metal melted and that returned from all sources.

The melting loss varies with the type of furnace used, size of charge and proportions of mixture. On cartridge brass under the conditions outlined the gross loss varies from 3 to 5 per cent. No figures are available for the net loss, but in other plants it varies from 1 to 3 per cent.

The loss represents a greater money value than the profit in manufacture and therefore should be given the most careful attention.

Metal spilled in handling and pouring is recovered from the mold

pits and floor each day. This is known as floor scrap, and to it is added the solid metal picked from the skimmings and ashes, which contain the metal representing the difference between the gross and the net losses. No figures are available to give proportion by weight of recoverable metal in the ashes in the plant described, but it has been found by other firms to run from 0.25 to 0.5 per cent. by weight of ashes.

This recovery is made by concentrating and refining processes. The quantity of ashes is not sufficient to warrant a recovery installation in any but a large plant. The floor scrap may be melted directly with the charge in small quantities or remelted and sheared before using, as the quality of work may require. Some specifications for cartridge brass permit the use of floor scrap; and if used judiciously, no bad effects will be noticed.

In addition to the tools and equipment mentioned the following materials are required in the approximate quantities given, which are the results of several months' operation:

Coke.....	50 lb. per 100 lb. metal melted
Charcoal (used in lighting fires).....	0.1 bu. per 100 lb. metal melted
Lard oil No. 2.....	0.04 gal. per 100 lb. metal melted
Salt.....	0.25 lb. per 100 lb. metal melted
Phosphorized copper .....	1 oz. per 100 lb. metal melted
Graphite stirring rods, 1½×18 in. long.	30 heats each

For a plant having 40 furnaces, or four sets of fires, there will be required 4 casters, 16 to 20 casters' helpers and 4 laborers. These men will be able to produce from 5 to 7 heats from each furnace in about 9 hr. The casters are paid on a tonnage basis at the rate of 17 to 20c. per 100 lb. of good sheared metal. The casters pay two helpers at 65c. per round, which is one heat from each of the two furnaces comprising a set of fires. The firm supplies additional helpers at the same rate, giving three men if special circumstances require them. A better arrangement is to pay on a tonnage basis for the entire crew about as follows, per 100 lb.: caster, 8c.; floor helpers, 5½c.; pit, 4½c.

In this scheme the bars are marked with the crew number, and a deduction is made for bars scrapped at the overhauling machines in the rolling mill, as metal apparently good at the shears may be poor metal when overhauled—that is, the process of scraping off the surface metal, dirt, etc., preparatory to rolling.

The scraproom requires about 10 men—4 on the shears and 6 on the scales. The pay of these men runs from 20 to 30c. per hr.

The direct cost for producing sheared bars ready for rolling is about ½c. per lb. of metal melted, divided about evenly among labor, supplies, renewals, etc. To this figure must be added the value of metals lost and burden. These items may vary greatly. The distribution of metals between weighed charge and sheared bars is as follows:

	Per Cent.
Metal weighed out .....	100.00
Net loss, volatilization, etc. ....	2.50
Recovered metal, ashes .....	2.00
Floor scrap .....	5.00
Shear scrap .....	10.00
Good sheared bars .....	80.50

These figures represent what may be called fair to good operation, but undoubtedly offer opportunities for further economies. The importance of accurate records will be appreciated in making an estimate. Several of the most necessary are shown.

To many it might seem that the crucible-furnace method of making brass is antiquated and that units of larger capacity should be used. But segregation, gas occlusion, rehandling and consequent cooling in ladles and higher losses are still disadvantages of the large furnace that must be taken into consideration.

### ROLLING CARTRIDGE BRASS

A typical layout of a rolling mill, to which the sheared bars from the casting shop are delivered, is shown in Fig. 407. The building should be well ventilated, of mill construction, free from the dirt and dust-laden air of the other parts of the plant.

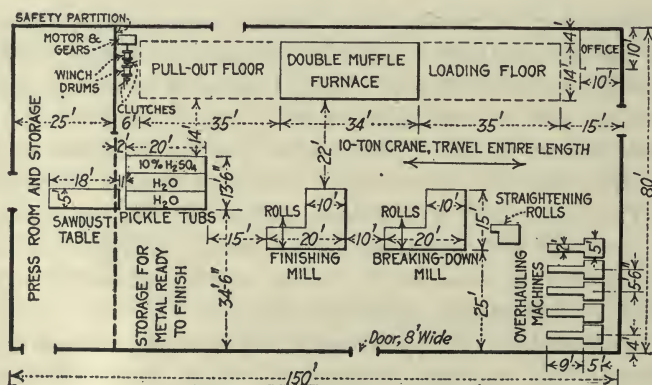

FIG. 407. PLAN OF ROLLING MILL

The standard size of rolls for heavy metal is 20 in. diameter by 30 in. face. The breaking down rolls (mills) are run at about 14 r.p.m., approximately 73 ft. per minute, and the finishing rolls at 18 r.p.m., about 94 ft. per minute. These mills are gear driven and are fitted with positive brakes for quick stopping in case of accident. Lubrication of the rolls is achieved by laying a swab of waste covered with heavy graphite grease against the necks of the rolls. In addition a cold water spray is turned against the necks from each side as shown in Fig. 408.



**First Rolling Operation.**—In the first rolling operation, breaking down, the reduction should be as great as possible without making the bar too long for the table of the overhauling machine. For this reason a gage stick for the maximum allowable length of bar is kept at the rolls and the reduction varied, so that the full-length sheared bar will not come too long and all bars of the same nominal thickness are given the same reduction. In sticking (entering a bar in the rolls), the bottom end of the bar is entered first as it will be square, clean and free from oil, which is not the case with the sheared or top end of the bar. The presence of oil will prevent the rolls biting on the bar and occasionally it is necessary to dust charcoal on the sticking end of the bar in order to make it enter. A dab of kerosene oil is placed on the upper side of the bar a few inches from the sticking end. This helps to lubricate the rolls and tends to keep the metal from turning up. After breaking down the bars are ready for overhauling.

At times bars will come curved and bent in some direction, will gage unevenly or not finish smoothly, and patience must be exercised in finding the cause. Some of the troubles may be owing to bars being cast in old or improperly made molds, and therefore be of uneven thickness; to a difference in diameter of the rolls; to the heating of the necks of the rolls; to incorrect height of the bottom guide above the center of the rolls; to the kind of lubricant used on the metal; to dust and dirt in the atmosphere; to uneven annealing; to improper pickling; to unusual variation in chemical composition of different bars or within the same bar, or other causes.

The fundamental principles to be remembered in any consideration of the action of the rolls on brass bars of uniform thickness are that the rolls spring apart in proportion to the total pressure exerted on the metal; that the amount the metal flows or the bar elongates at any point depends upon the pressure the rolls exert and the hardness of the metal; that the metal may vary in hardness owing to chemical composition and inequality in annealing or previous working; and that, theoretically, the peripheral velocity of both upper and lower rolls should be the same. In addition, a further consideration is that bars are not always of uniform thickness and that variations in thickness may occur in the same bar. From these facts it is evident that unless the metal is uniform and

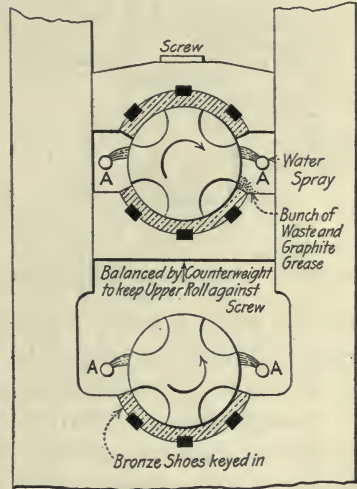

FIG. 408. METHOD OF KEEPING THE BEARINGS COOL

homogeneous in every particular, bars will tend to turn up or down in the rolls, hoop, curve or bend, and it is in handling the metal with usual mill variations from uniformity that the skill of the roller is brought into play.

If there is a small difference in the diameter of the rolls, the larger roll should be placed on the top as this will tend to turn the bar down. In

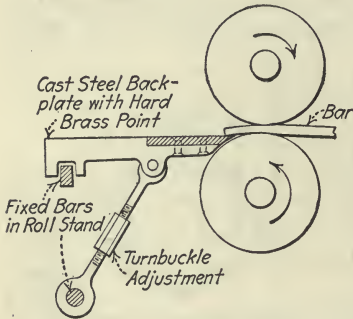

FIG. 409. POSITION OF BACK PLATE

breaking down it is difficult to set the guides so that all the bars will come straight as they are rolled from the rough, and therefore it is the usual practice to make the bars turn down. The curve in the sticking end of the bar will be determined by the setting of the back plate as shown in Fig. 409. The back plate is set up as far as possible, care being taken that the rolled bar does not catch and tear out the plate.

This back plate should have a hard brass wearing plate or point. The front guides should have adjustable bottom guides of bronze so that the metal will not seize or tear. The side guides may be of cast iron or steel with hard steel wearing plates.

**Straightening the Bars.**—Preliminary to overhauling, the bars must be straightened so that they will lie flat on the table of the overhauling machine. The straightening is done with a set of rolls, the upper and lower rolls being staggered as shown in Fig. 410. The number of rolls required depends on the thickness of the metal and degree of flatness required. For many purposes a three-roll straightener is satisfactory, but several passes are needed to bring the bars flat. The principle of straightening is to curve the bar in one direction on the first pass, turn it upside down and remove the curve in the further successive passes required. Obviously, a five- or seven-roll machine is simply a combination of three-roll straighteners in series, and the operation may be done in one pass in such a machine. The rolls are set to remove the greatest kink in the bars, and small variations in thickness have no effect other than increasing the driving power required. Derived from some experience with two different types of machines, the following points should be considered in selecting a straightener. All rolls should be driven—that is, no idler rolls; rolls should be as small in diameter as possible consistent with strength for the work to be done, rolls should be set on close centers horizontally—that is, within  $\frac{1}{8}$  in. of the diameter; the housings should

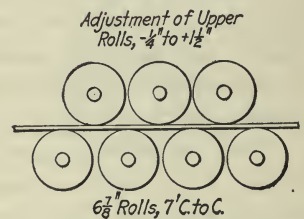

FIG. 410. DIAGRAM OF ROLL POSITIONS

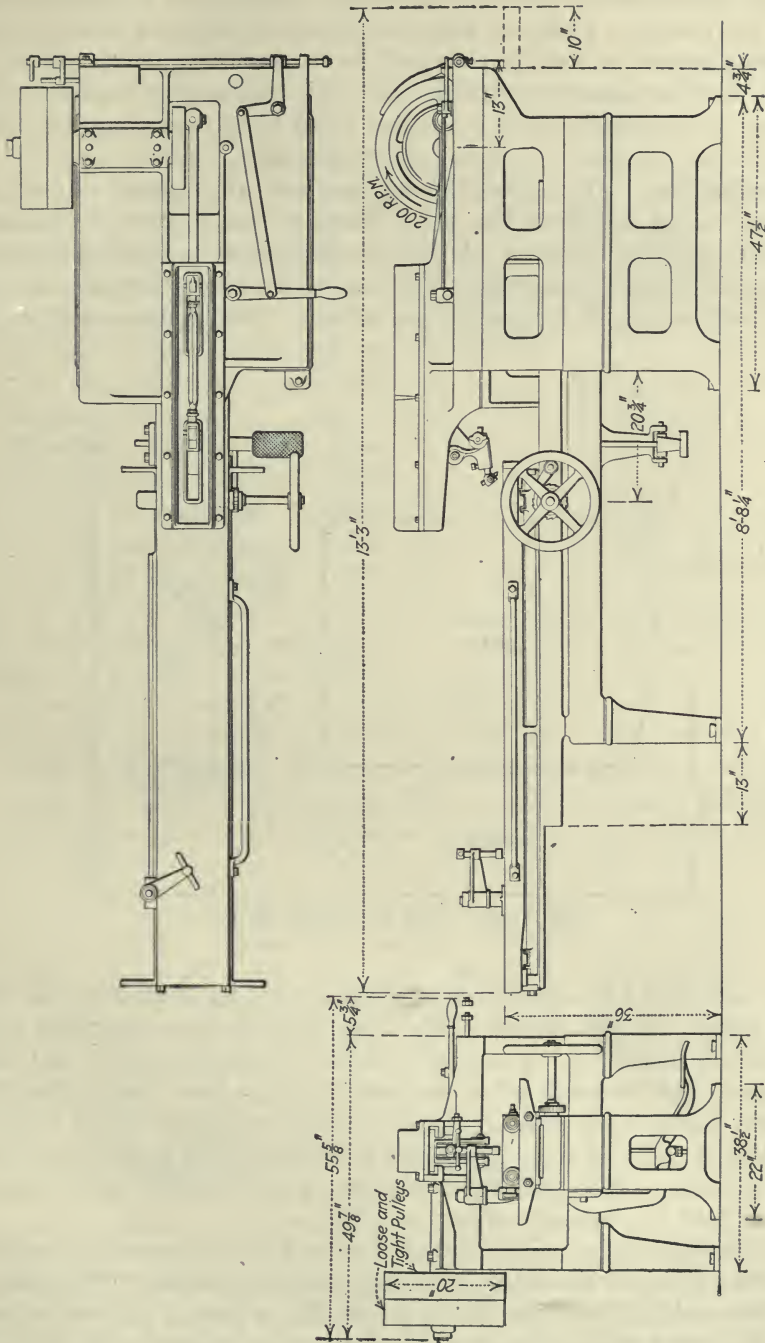

FIG. 411. OVERHAULING MACHINE

be such that a broken roll may be removed and replaced without tearing down the machine; a parallel adjusting device should be attached to the adjusting screws so that the rolls may be set parallel, quickly and accurately; and the power should be ample. On a seven-roll machine with rolls  $6\frac{7}{8}$  in. in diameter on 7-in. centers about 20 hp. was required. The speed of the rolls varies from 40 to 70 ft. per min.

**Overhauling.**—After straightening, the bars are stacked in front of the overhauling machines, Fig. 411. These are simply light, high-speed, draw-cut shaping machines adapted to the special requirements of removing the surface metal from the sides of the bars. The tool is provided with a cam lift for the reverse stroke. The machines run at 200

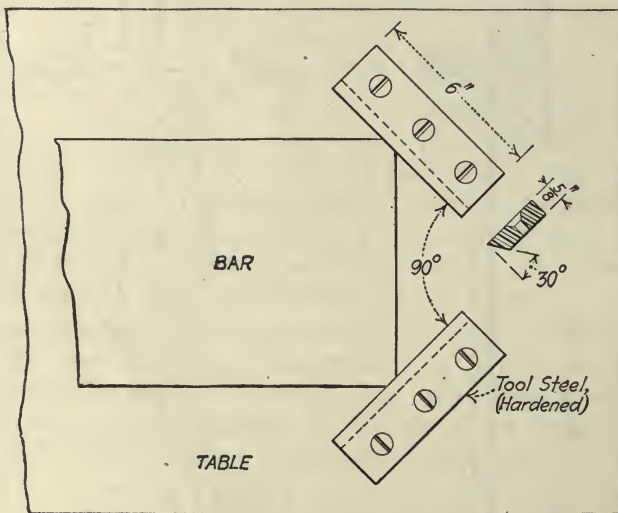

FIG. 412 TYPE OF CLAMPS USED

r.p.m. and have a 9-in. stroke of which about  $7\frac{3}{4}$  in. is effective, the loss being due to the cam action. The table slides in both directions horizontally on rollers, and is moved by hand. The entire table and rails are raised, and the work fed to the tool, by a foot lever that enables the operator to vary the pressure against a stop and thus obtain a slight variation in depth of cut. The metal removed is from 0.020 in. to 0.040 in. in thickness. The tools are of high-speed steel  $\frac{3}{8} \times 1\frac{1}{4}$  in. in section, and are held in a special holder.

The bars should be overhauled all over, and for this reason the method of holding them on the table of the machine is important. The clamps provided with the machines described would not permit the tool to pass over the end of the bar, therefore a special device shown in Fig. 412 was designed. In this the pull of the tool makes the jaws bite into the brass

and holds them more firmly. The bars are then turned end for end to clean up the portion covered by the front clamp.

Inspection follows, after which the bars may be returned to the operator for proper machining, rejected as scrap, or passed to the running-down rolls.

The overhauling-machine operators are paid on a piece-rate basis of from  $2\frac{1}{2}$  to 4c. per bar, depending upon material and size of bar, irrespective of mill variations from nominal length. The output per machine should average ten to fourteen bars per hour, overhauling all over.

**Running Down.**—The bars which have passed inspection are then run through the breaking down rolls and reduced to a suitable thickness for finishing. They are then sorted into loads (lots) of 60, which load is used as a unit quantity of metal until it is finished.

The run-down bars gage to within 0.020 in. of the same size, but may vary somewhat in temper or hardness so that they are annealed in order to facilitate the finishing operation. This annealing is done in order to bring all the metal to the same condition as regards temper rather than because the metal is too hard to allow further reduction without splitting or cracking.

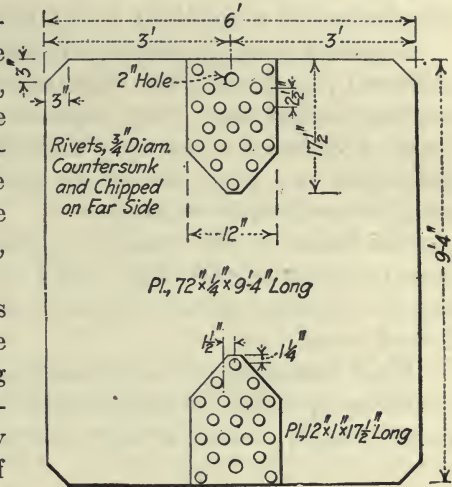

FIG. 413. BAR-ANNEALING PAN

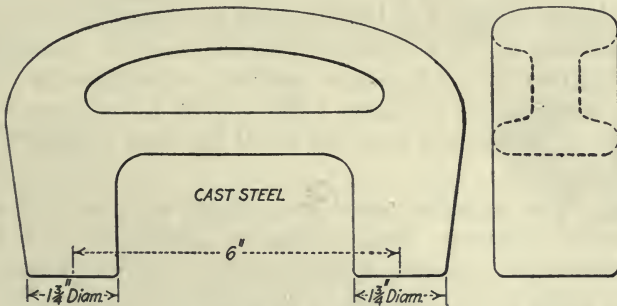

FIG. 414. PAN HOOK

**First Annealing.**—The furnaces generally used for both the first and final annealing operations are of the muffle type, using gas, coal or oil as fuel. A usual size is about 6 ft. 6 in. wide, 32 ft. long and 3 ft. high, allowing three 6 × 10-ft. annealing pans (see Fig. 413) to be used in tandem.

These are coupled together by pan hooks, each as shown in Fig. 414 and are handled by a motor-driven winch.

The bars are kept in the furnace until the metal is brought to an even heat all over. The temperature of the furnace is not as important in the first annealing operation as in the final, but ordinarily about the same temperature is maintained in the furnace, approximately 1,250 deg. F.

**Second Rolling Operation.**—The cleaned bars then go to the finishing mills and pass through the rolls adjusted to deliver bars closely approximating finished size. The bars are then sorted into lots, covering a range of variation of not more than 0.002 in. Each lot is then rolled to finish gage in a final pass on one setting of the rolls, a different setting being determined for each lot.

The finishing rolls require regrinding once or twice a week. This is done by traversing the rolls with a stick fitted to the curve of the rolls, using a mixture of No. 60 emery and oil. This operation consumes 3 or 4 hours.

**Final Annealing.**—The finished bars are then subjected to another annealing operation which must be performed with great care as to the proper temper, tensile strength and elongation of brass depends mainly

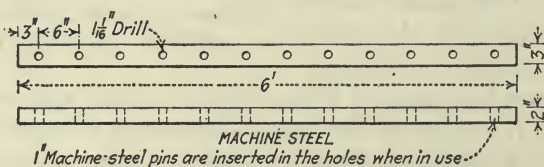

FIG. 41. FIXTURE FOR HOLDING BARS

upon the temperature reached in annealing, and the bars must be uniformly heated. To secure even heating the bars are set on edge on a fixture as shown in Fig. 415 before being put into the annealing pans.

For annealing 67 to 33 per cent. brass to secure minimum tensile strength of 43,000 lb. per in. and a minimum elongation of 57 per cent. in 4 in., a temperature of about 1,250 deg. F. is sufficient. The bars must remain in the furnace until the metal has been brought to the same heat throughout.

**Pickling.**—The annealed metal has a slight scale on it that must be removed before finishing. This is done by dipping the bars in a pickle solution of 10 to 15 per cent. sulphuric acid. Acid and water are added each day to make up the strength of the solution and to replace the drip loss on each bar. The acid acts more quickly and effectively if heated by a steam coil to about 150 deg. F.

The concentration of copper sulphate in the solution should be checked frequently, for when it is high a large amount of acid will be required and there is a tendency under certain conditions to plate out

copper on the bars. This is especially objectionable when pickling the finished metal after final annealing.

Metal is rarely handled in bar form longer than 18 ft. as greater lengths are coiled. Tanks about 4 ft. wide, 30 ft. long and 2 ft. 6 in. deep are standard. Timber such as cedar, yellow pine, etc., in finished planks 3 in. thick mortised and bolted together with  $\frac{1}{2}$ -in. iron stud bolts is usual construction. The acid tank is lined with  $\frac{1}{8}$ -in. sheet lead.

The method of dipping the bars varies with the crane facilities. Excellent work has been done by pickling each load of sixty bars in slings made of brass bars bent up for this purpose. A ten-ton crane picks up the load from the furnace front and carries it directly to the acid tub. An immersion of ten or fifteen minutes should be sufficient to clean the bars to a bright yellow, free from scale or discoloration. Afterward the load is rinsed in two tubs of clear water—the latter preferably hot to assist in drying. The water from the second tub is led through an overflow into the first. The bars are dried by covering with sawdust that is then removed by brushes. This is best determined directly by the color or by a pyrometer working on the radiation principle. The points of thermo-couple pyrometers are not always the same temperature as the metal and each may be affected differently by currents of gases in the furnace. The length of time the metal is exposed to a constant temperature does not seem materially to affect the strength of the metal, at least for small differences of an hour or two. Usually, however, the temperature continues to run up after the firing of the furnace has stopped and thus the condition of constant temperature is not realized. Quenching or cooling slowly does not seem appreciably to affect the strength of the metal. Care should be taken to avoid an excess of air, as the atmosphere of the furnace should be more nearly reducing than oxidizing.

Summarized a scheme of reduction for one grade of cartridge brass is as follows:

	Inches
Cast bar .....	1.000 $\pm$ 0.020
Breaking down .....	0.750 $\pm$ 0.015
Running down .....	0.650 $\pm$ 0.012
Running down .....	0.550 $\pm$ 0.010
Running down .....	0.450 $\pm$ 0.008
Anneal	
Finishing .....	0.384 $\pm$ 0.005
Finishing .....	0.374 $\pm$ 0.003
Finishing .....	0.368 $\pm$ 0.002
Anneal	

## CHAPTER II

### MAKING 1-LB. CARTRIDGE CASES<sup>1</sup>

The manufacture of cartridge cases, almost entirely a punch press undertaking, calls for exceedingly accurate work, on account of the close limits imposed on allowable variations. This is well demonstrated in the methods employed by the New York and Hagerstown Metal Stamping Co., Hagerstown, Md., in producing 1-lb. cartridge cases for the British Government.

These cartridge cases, illustrated in Figs. 416 and 417, are made from sheet brass, analyzing approximately 70 per cent. copper and 30 per cent.

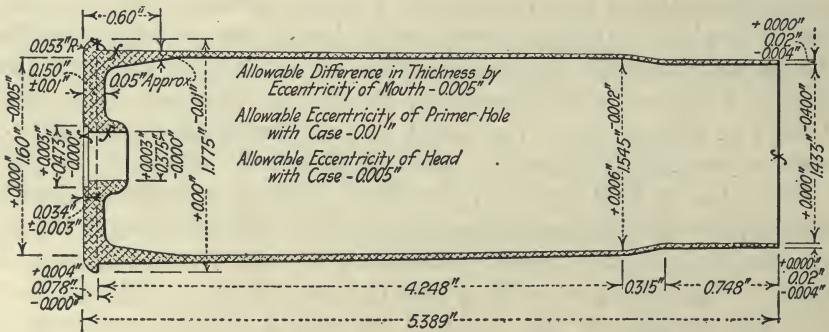

FIG. 416. DETAILS OF 1-LB. CARTRIDGE CASE

spelter, with a variation of about 1 per cent. either way and an allowance of  $\frac{1}{2}$  per cent. for impurities. The stock is purchased in the form of blanks measuring  $2\frac{7}{8}$  in. in diameter and 0.20 in. in thickness. The physical requirements of the completed case are 48,000 to 54,000 lb. per sq. in. tensile strength at the mouth with 58 per cent. minimum local elongation, a minimum tensile strength of 60,000 lb. per sq. in. at the head and under the head a minimum tensile strength of 58,000 lb. per sq. in.

The requirements called for in manufacturing the cartridge cases are as follows:

1. The cases must be cold drawn from brass of the proper quality.
2. The curvature at the neck shall conform to that of the standard gun chambers shown on the drawings, within manufacturing limits.
3. Ten from each lot of 5,000 shall be selected by the inspector to be proved.

<sup>1</sup> Robert Mawson, Associate Editor, *American Machinist*.



4. The proof shall be the firing of each of the selected cartridge cases once with service charge and shell. Two of the fired cases shall then be selected by the inspector; and from each of them three additional service rounds shall be fired without re-forming, but the forward end of the cylindrical part of the neck may be contracted sufficiently to grip the shell at each reloading.

5. The proof cases of accepted lots may be incorporated in the regular lots, provided they are re-formed and again pass inspection.

6. No cases must show signs of weakness or excessive hardness.

The manufacture of the cartridge cases involve some 27 main operations, as given in the following table, some of which are shown in the series of sketches.

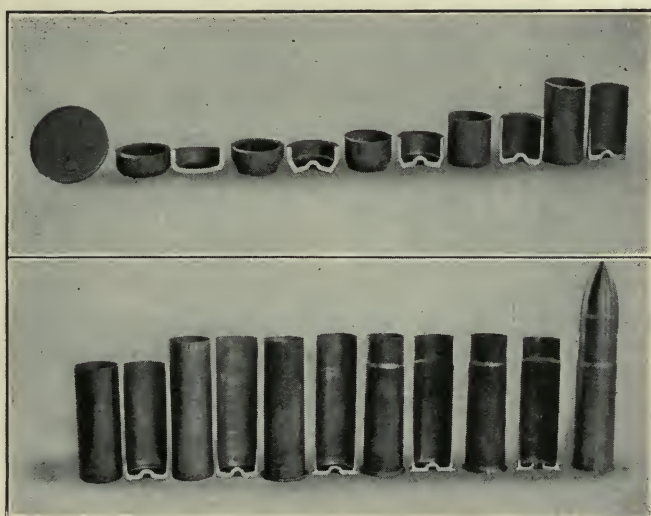
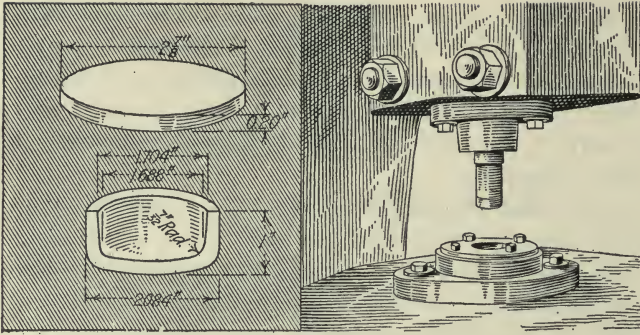

FIG. 417. VARIOUS STAGES OF 1-LB. CASE FROM BLANK TO FINISHED PART

TABLE OF SEQUENCE OF OPERATIONS

- |                       |  |  |
|-----------------------|--|--|
| 1. Blank              | 13. Trim to length   | 21. Machine to length                          |
| 2. Cup                | 14. Anneal and pickle  | 22. Burr inside of primer hole                 |
| 3. Anneal and pickle  | 15. Fifth draw   | 23. Finish-machine primer hole and form recess |
| 4. Indent             | 16. Trim to length   | 24. Wash                                       |
| 5. Anneal and pickle  | 17. Head   | 25. Final inspection                           |
| 6. First draw         | 18. Anneal open end and wash                                 | 26. Stamp                                      |
| 7. Anneal and pickle  | 19. Form taper   | 27. Pack ready for shipping                    |
| 8. Second draw        | 20. Face and finish-machine flange and rough out primer hole |  |
| 9. Anneal and pickle  |  |  |
| 10. Third draw        |  |  |
| 11. Anneal and pickle |  |  |
| 12. Fourth draw       |  |  |

Summarized a scheme of reduction for one grade of cartridge brass is as follows:



OPERATION 2. CUPPING

Machine Used—Ferracute 6-in. stroke press.  
Production—625 per hr.

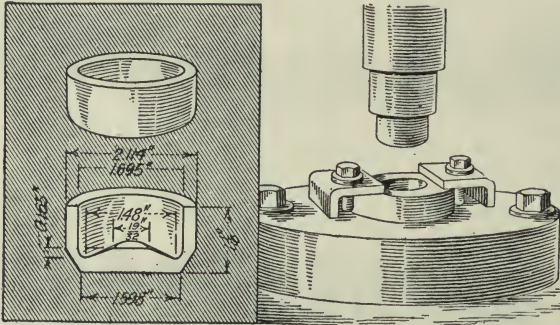

OPERATION 4. INDENTING

Machine Used—Special 2¾-in. stroke press.  
Production—475 per hr.

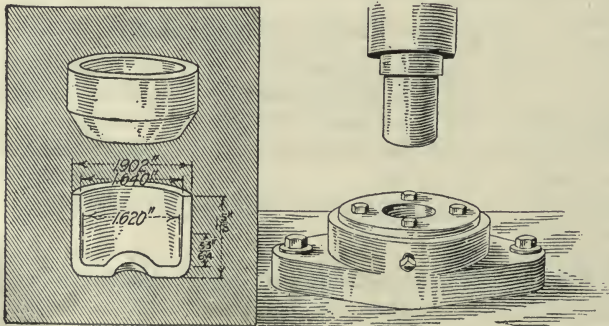

OPERATION 6, FIRST DRAWING

Machine Used—Ferracute 6-in. stroke press.  
Production—550 per hr.

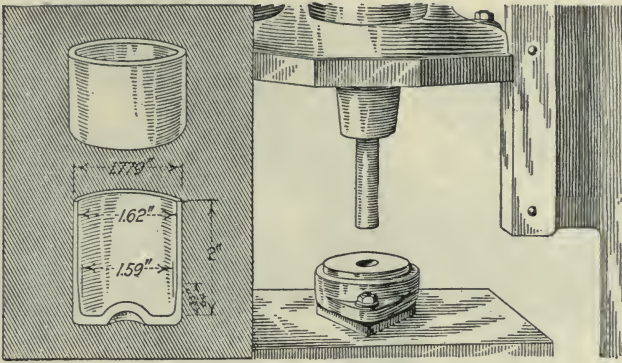

OPERATION 8. SECOND DRAWING

Machine Used—Bliss 8-in. stroke press.  
 Production—550 per hr.

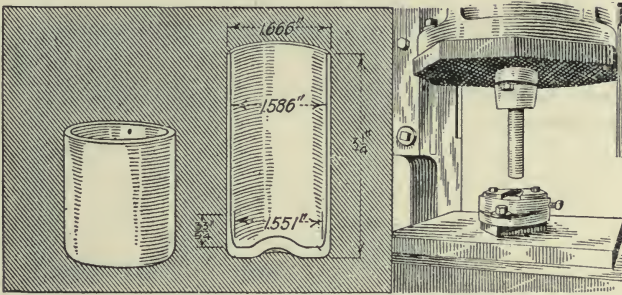

OPERATION 10. THIRD DRAWING

Machine Used—Bliss 8-in. stroke press.  
 Production—550 per hr.

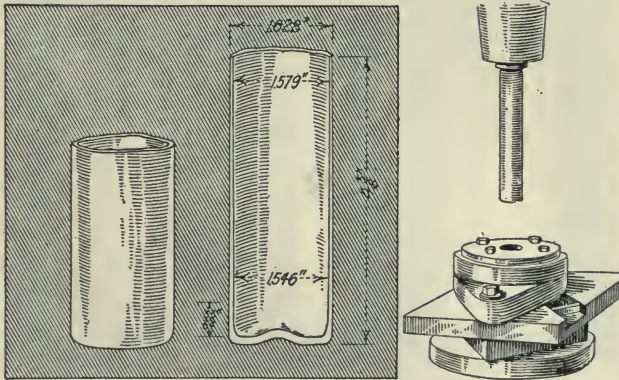

OPERATION 12. FOURTH DRAWING

Machine Used—Bliss 15-in. stroke press.  
 Production—400 per hr.

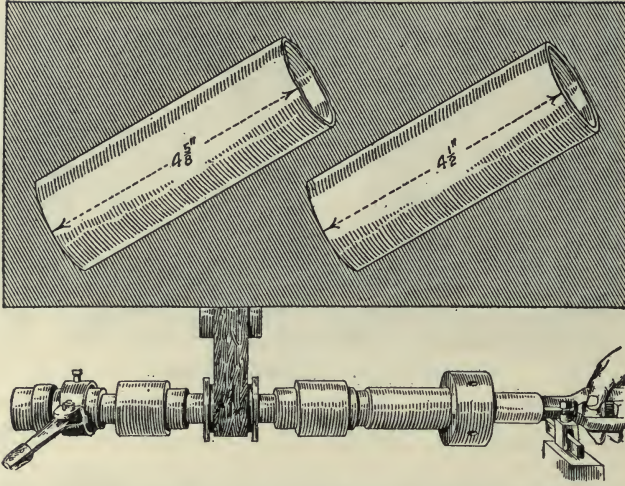

OPERATION 13. TRIMMING TO LENGTH

Machine Used—Special lathe.

Special Tools—Lathe, chuck, wooden tongs and parting tool.

Production—200 per hr.

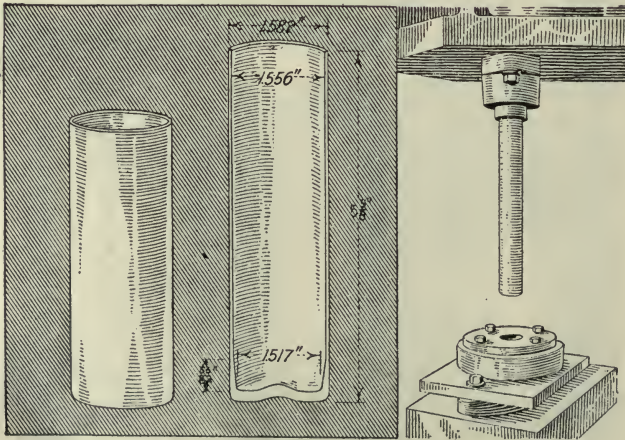

OPERATION 15. FIFTH DRAWING

Machine Used—Bliss 15-in. stroke press.

Production—400 per hr.

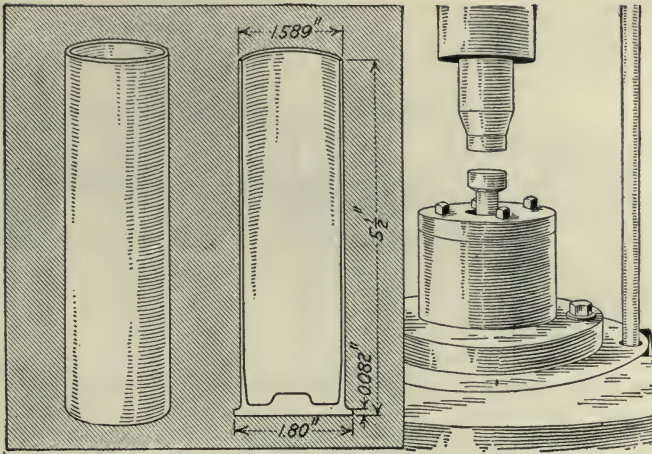

OPERATION 17. HEADING

Machine Used—Bliss 12-in. stroke press.

Production—400 per hr.

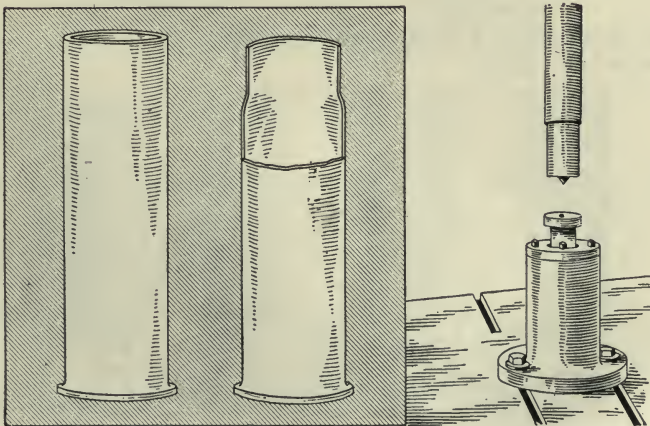

OPERATION 19. TAPERING

Machine Used—Ferracute 20-in. stroke press.

Production—400 per hr.

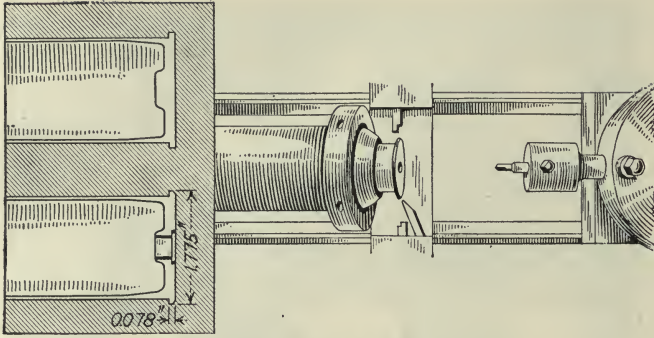

OPERATION 20. MACHINING FLANGE

Machine Used—Dreses & Windsor turret lathe.  
 Production—100 per hr.

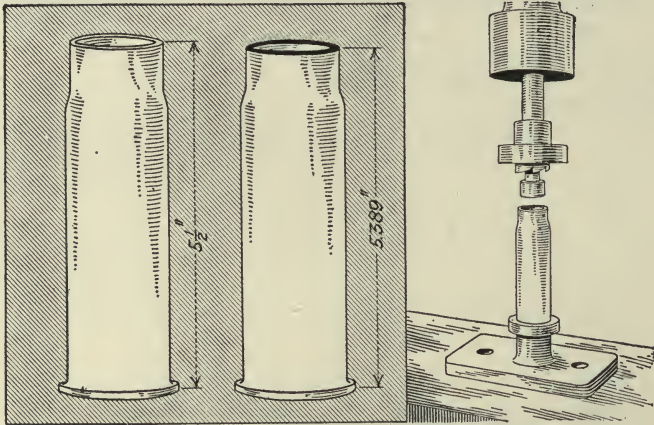

OPERATION 21. MACHINING TO LENGTH

Machine Used—Pratt & Whitney drilling machine.  
 Production—200 per hr.

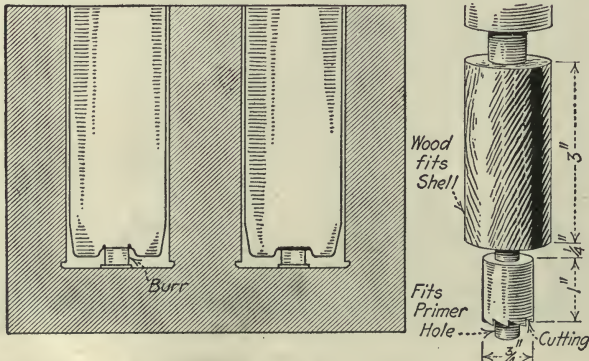

OPERATION 22. BURRING

Machine Used—Pratt & Whitney drilling machine.  
 Production—300 per hr.

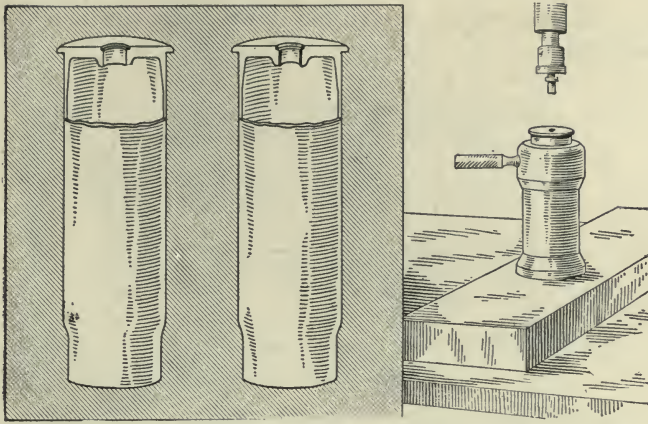

OPERATION 23. FINISH MACHINING PRIMER HOLE AND RECESS

Machine Used—Pratt & Whitney drilling machine.

Production—200 per hr.

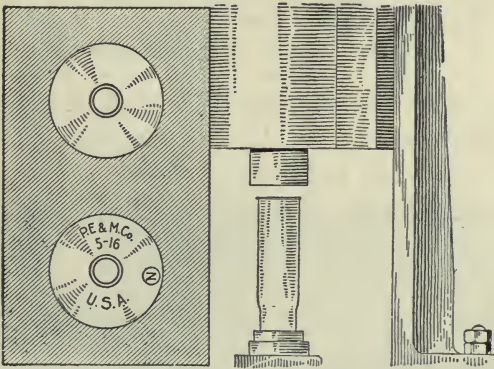

OPERATION 26. STAMPING

Machine Used—Foot-controlled press.

Special Tools—Arbor and steel stamp.

Production—600 per hr.

The first machine operation consists in cupping the blanks in a Ferracute press. The form of the punch and die employed is shown in Fig. 418. The die is supported on a bolster of the style illustrated in Fig. 419 and the punch is held in a special holder, Fig. 420.

The cupped blanks are then annealed in gas-heated ovens in which the temperature is kept at approximately 1,380 deg. F. Here they are allowed to remain 30 min., a sheet of flame playing under the trays holding the parts.

After annealing, the parts are conveyed to the pickling tanks, Fig. 421, and washed in "Edis" compound, to remove the scale. The parts are then transferred to the indenting machine where the cupped shell

is placed in the die and the punch fed down with the machine to form the indentation.

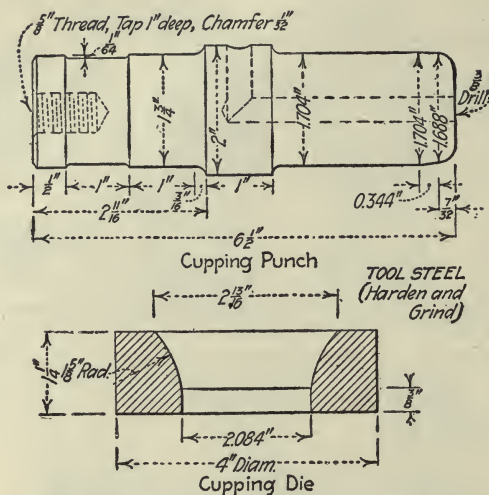

FIG. 418. DETAIL OF PUNCH AND DIE

The retainer plate, Fig. 422, the punch holder, Fig. 420, the punch, Fig. 423, the center section, Fig. 424, the die, Fig. 425, and the bolster, Fig. 426, are used for this indenting operation.

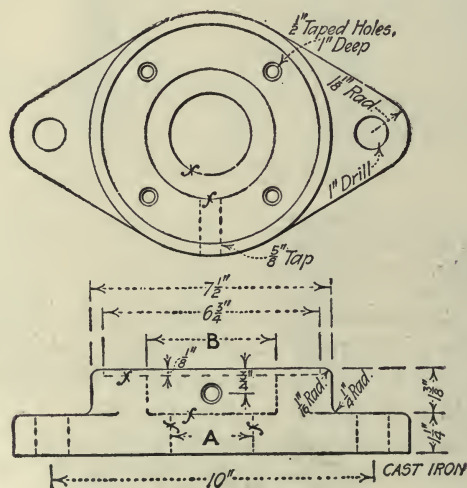

FIG. 419. DETAIL OF BOLSTER

The parts are then annealed and pickled in a similar manner to that described for the previous operation. After the pickling they are returned to the Ferracut press, and the first drawing operation occurs.



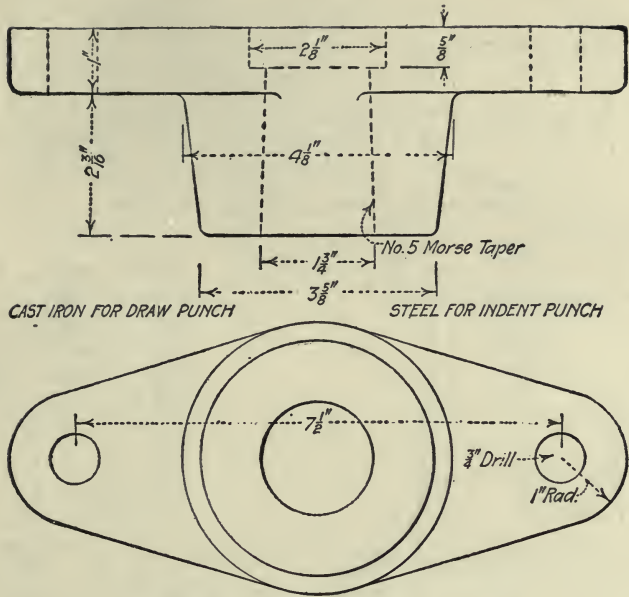

FIG. 420. DETAIL OF PUNCH HOLDER

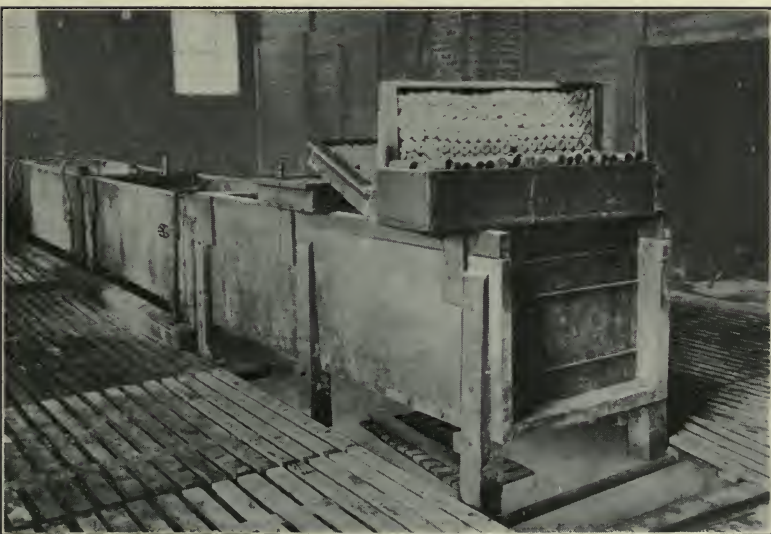

FIG. 421. PICKLING TANKS

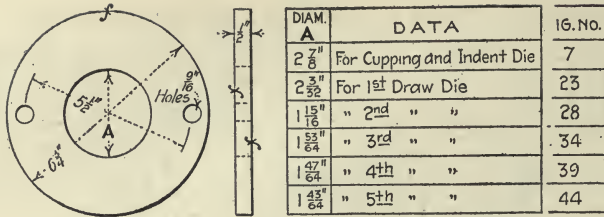

FIG. 422. DETAIL OF RETAINER PLATE

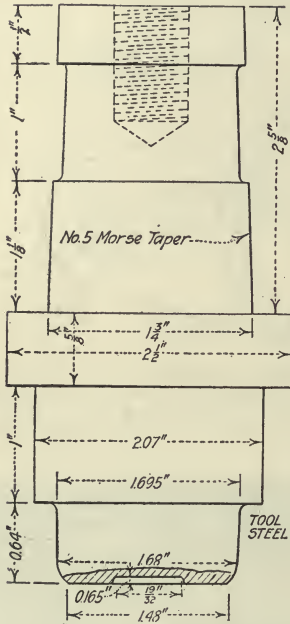

FIG. 423. DETAIL OF INDENT PUNCH

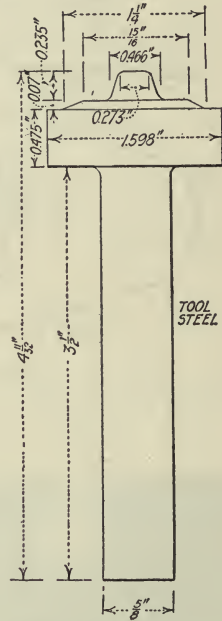

FIG. 424. DETAIL OF CENTER SECTION

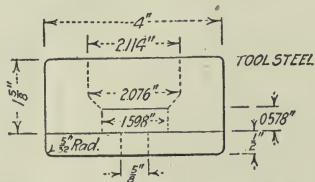

FIG. 425. DETAIL OF INDENT PUNCH

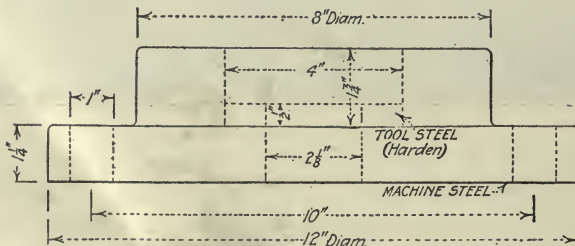

FIG. 426. DETAIL OF INDENT BOLSTER

The punch holder, Fig. 420, punch die of the type shown in Fig. 427, the bolster, Fig. 419, and the retainer plate, Fig. 422, are used for this first drawing operation. The parts are then annealed and pickled in a similar manner to that previously described.

The next operation is the second drawing. The machine used for this work is a Bliss press. The punch holder, Fig. 420, the bolster, Fig.

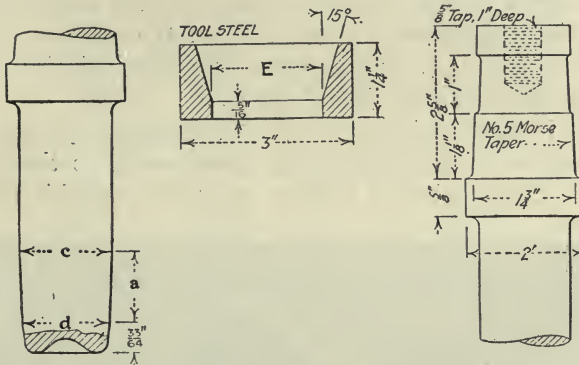

FIG. 427. DETAILS OF DRAWING PUNCHES AND DIES

419, the punch, Fig. 422, the die, Fig. 427, the retainer plate, Fig. 420, and the stripper, Fig. 428, are used in performing this operation.

The cases are again annealed and pickled. Then the next operation on the shell is the third drawing, which is also done on a Bliss press. The punch holder, Fig. 420, the bolster, Fig. 419, the stripper, Fig. 428,

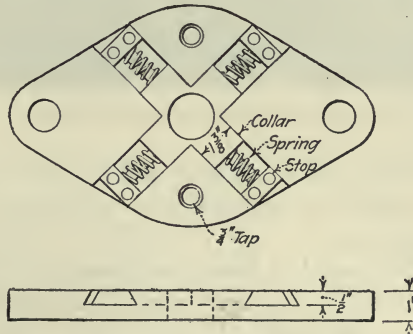

FIG. 428. DETAIL OF STRIPPER

the punch, Fig. 422, the die, Fig. 427, and the retainer plate, Fig. 422, are used for the third drawing operation.

The parts are annealed and pickled once more and are then taken to a larger Bliss press for the fourth drawing operation. The punch holder, Fig. 420, the bolster Fig. 418, the stripper, Fig. 428, the punch and die, Fig. 427, and the retainer plate, Fig. 422, are again employed for this operation.

The case is next taken to the special lathe, Fig. 429, and the open end trimmed so that the overall length is  $4\frac{1}{2}$  in. The case is gripped with the wooden tongs *A* and slipped into the chuck *B* against a stop surface.

The handle *C* is drawn forward, actuating the jaws of the chuck so that they grip the case securely. The parting tool *D* is fed against the revolving case, and the end is trimmed to the correct length.

The handle is pushed back, thus releasing the chuck, and with the aid of the tongs the case is removed from the machine. The case is transferred to the oven, annealed and afterward pickled in a manner similar to that previously described.

The case is then subjected to the last drawing operation, the fifth, which is done on a long stroke Bliss press similar to that used for the fourth draw. The tools and fixtures employed resemble those used for

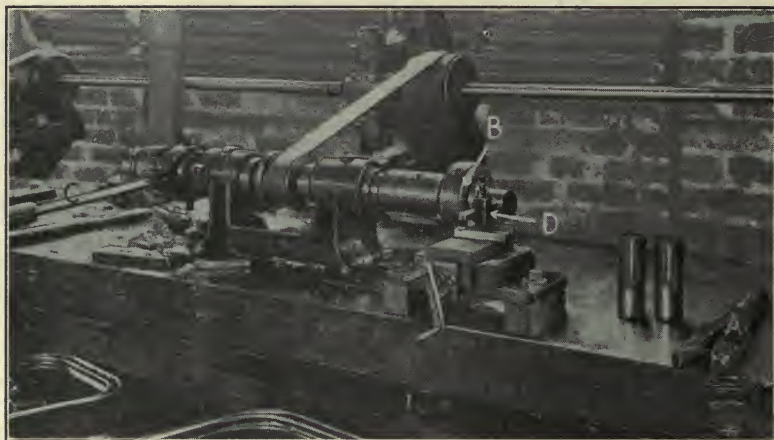

FIG. 429. TRIMMING END OF SHELL

this previous operation, but are of such proportions as to leave the shell, below the section which is subsequently contracted, finished, but for certain minor operations.

The case is then trimmed to length and headed. The latter operation is performed in a 12-in. stroke Bliss press equipped with the tools and fixtures illustrated in Fig. 430.

From the press, the cases go to the washing tank where they are submerged for one minute in a solution of "Carlsrhue" heated to 420 deg. F. to remove any grease. After this they are rinsed, first in hot water and then in cold, and the open end of the shell annealed by dipping in a solution of saltpeter heated to about 760 deg. F. The shells remain in this liquid for 2 min.

The next operation is tapering, which is performed with the tools seen in Fig. 431. The case is slid into the die and the bunter placed on

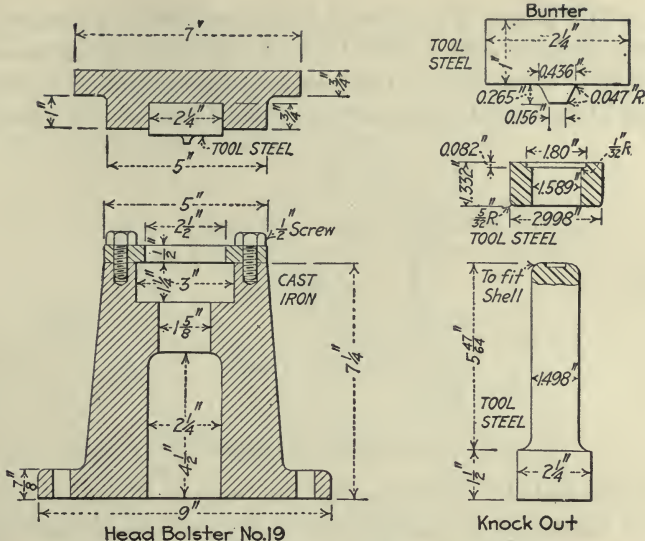

FIG. 430. DETAILS OF PUNCH, DIE, BOLSTER, BUNTER AND KNOCK-OUT FOR HEADING OPERATION

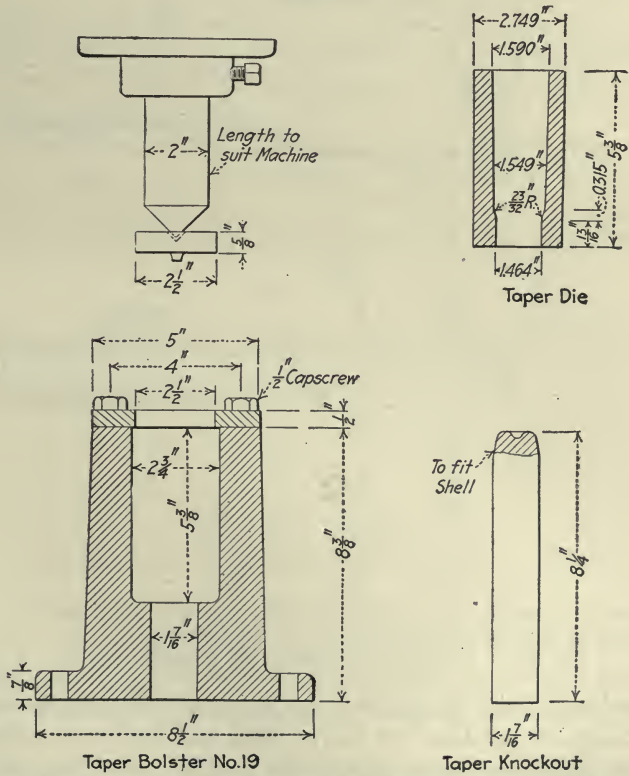

FIG. 431. DETAILS OF PUNCH, BUNTER, DIE, BOLSTER AND KNOCK-OUT FOR TAPERING OPERATION

the head. The punch is fed down by the machine, a Ferracute 20-in. stroke press, and the case is forced into the die, (see operation 19).

The shell is then taken to the small turret lathe, the flange faced and turned to size and the primer hole roughed out. For this operation

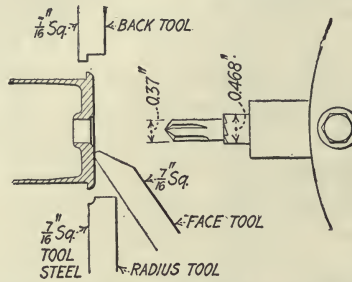

FIG. 432. TOOL SET-UP FOR MACHINING FLANGE

the shell is firmly held in the chuck, being pushed against a stop surface. The tool in the turret is pushed up and the primer hole is rough-drilled and counterbored. The front post carries two tools, one machining the

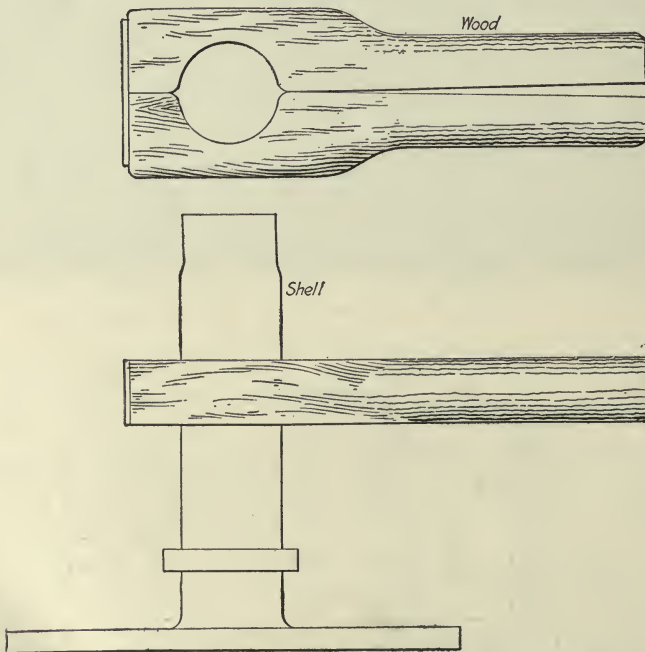

FIG. 433. DETAILS OF CLAMP AND HOLDING FIXTURE

outside surface of the flange and the other forming the radius in the flange. Stops are used on the turret slide and both tool posts, so that the correct dimensions may be obtained. Details of the tools for the operation are given in Fig. 432.

The case is then transferred to a Pratt & Whitney drilling machine, operation 21, and machined to length. The shell is placed on an arbor and, the table being raised to a stop, the revolving tool machines the case to length. It is held by the operator with the wooden clamp, Fig. 433. A detail of the cutter used is shown in Fig. 434.

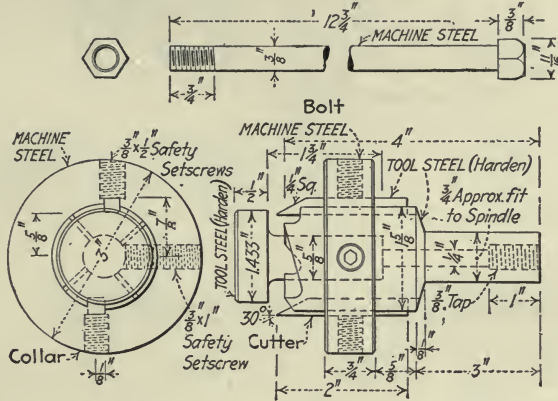

FIG. 434. CUTTER AND FINISHING SHELL

The inside of the primer hole is then burred, see operation 22. For this operation the case is held with the wooden clamp, as for the preceding operation.

The next operation—reaming the primer hole and forming the recess—is also performed on a Pratt & Whitney. The shell is held in a special fixture and the primer hole is reamed and counterbored. The combination tool and holding fixture for the machining is illustrated in Fig. 435.

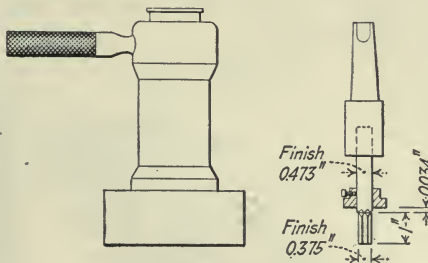
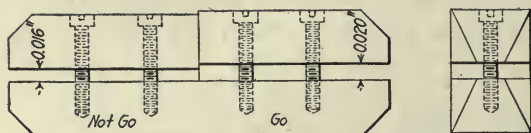

FIG. 435. COMBINATION TOOL AND HOLDING FIXTURE

The cases are then taken to the inspection department for the final examination. The various gages used are shown in detail in Fig. 436.

After the final inspection the cases that have been passed are stamped and then washed to remove the grease. They are then packed ready for shipment.

A novel method of shipping the cartridge cases is employed at this factory. The firm was originally in the business of manufacturing seam-



Limit Snap Gage for Thickness at Mouth

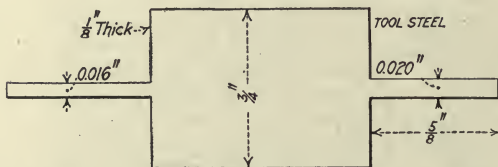

Master for Limit Snap Gage for Thickness of Mouth

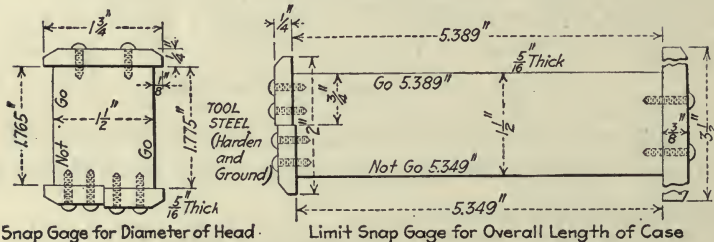

Snap Gage for Diameter of Head

Limit Snap Gage for Overall Length of Case

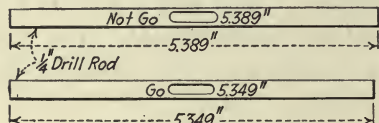

Masters for Length of Shell

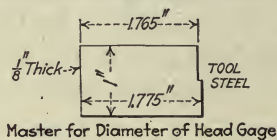

Master for Diameter of Head Gage

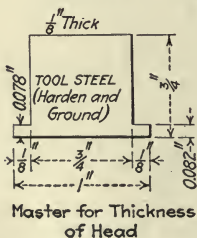

Master for Thickness of Head

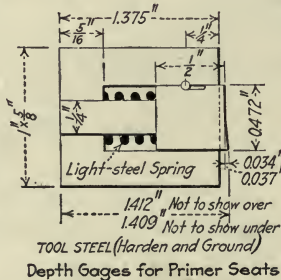

Depth Gages for Primer Seats

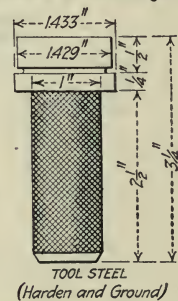

Limit Plug Gage for Mouth of Shell

FIG. 436. GAGES FOR TESTING



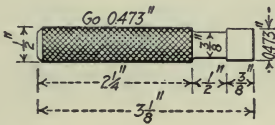
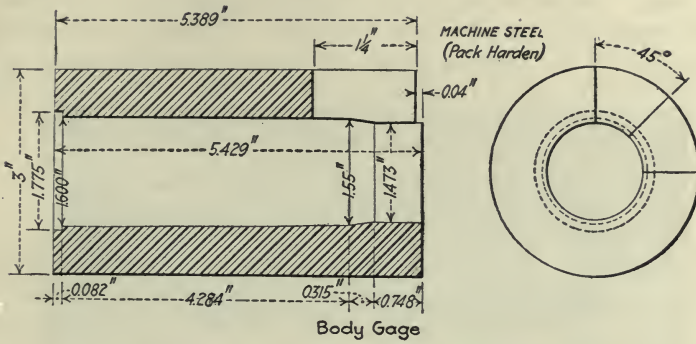

Gages for Primer Counterbore

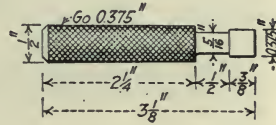

Plug Gages for Primer Hole

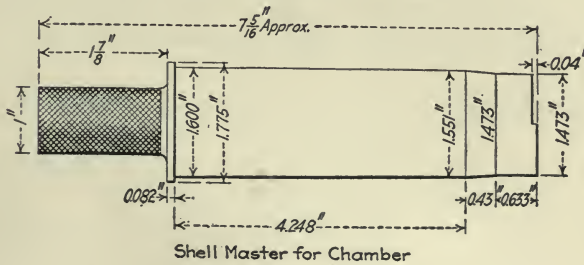
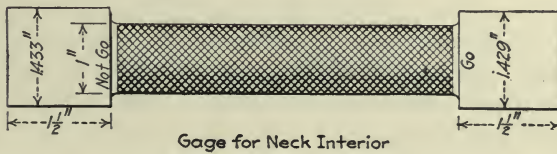

less steel caskets. These are now being used for the finished cartridge cases. Each casket will hold 516 cases, which are placed in two trays. Attached to each tray is a board properly spaced to keep the cartridge cases from moving. The advantage of this method of packing is the ease with which the cases may be placed in the tray. Further, by removing the trays individually and turning them over, the cases will drop out straight



FIG. 437. PACKING CASE FOR CARTRIDGE CASES, WITH CAPACITY FOR 516 CASES

and in a convenient position for forcing the steel projectile in position. Another advantage is that the shipper can readily see when the correct number has been put in, without the necessity of calculation.

One of these caskets is illustrated in Fig. 437 with the upper tray removed, so that the method of packing may be easily observed.

## CHAPTER III

### MAKING THE 18-LB. CARTRIDGE CASE<sup>1</sup>—DRAWING 18-LB. CARTRIDGE CASES ON BULLDOZERS AND FROG PLANERS<sup>2</sup>—CARTRIDGE HEADING PRESSES AND ACCUMULATORS AT THE ANGUS SHOPS<sup>2</sup>

Typical of cartridge case manufacture in general is the task of making cases for the British 18-pounders (see Fig. 438) and a description of the processes employed by the American Locomotive Co., Richmond, Va., and the work performed by that company gives a clear conception of the difficulties encountered in such work. By radical changes in equipment and methods in this plant, an average daily output of about 18,000 cases was attained.

The stock blanks are purchased in the form of brass disks 6.375 in. in diameter by 0.0380 in. thick, analyzing about 70 per cent. copper and 30 per cent. spelter. This composition varies to some extent, the range being approximately as follows:

Copper.....	67 to 72 per cent.	Lead under.....	0.10 per cent.
Zinc .....	33 to 28 per cent.	Iron under.....	0.10 per cent.

The physical properties of the metal are—ultimate tensile strength, 48,000 lb. per sq. in.; elastic limit, 17,000 lb. per sq. in.; elongation, 71 per cent. As the blanks are procured from three different concerns it is found advisable to mark them with a distinguishing symbol. The blanks are therefore marked with a letter, number or character so that the cases may be traced should any defect arise during the machining operations.

The operations followed in the manufacture of the case are:

- |                            |                              |
|----------------------------|------------------------------|
| 1. Blank                   | 12. Fourth draw              |
| 2. Mark for identification | 13. Second indent            |
| 3. Cupping                 | 14. Anneal and pickle        |
| 4. Anneal and pickle       | 15. Fifth draw               |
| 5. First draw              | 16. First trim               |
| 6. Anneal and pickle       | 17. Anneal and wash          |
| 7. Second draw             | 18. Sixth draw               |
| 8. First indent            | 19. Second trim              |
| 9. Anneal and pickle       | 20. Wash                     |
| 10. Third draw             | 21. First and second heading |
| 11. Anneal and pickle      | 22. Flash anneal             |

<sup>1</sup> Robert Mawson, Associate Editor, *American Machinist*.

<sup>2</sup> John H. Van Deventer, Managing Editor, *American Machinist*.



- |                      |                           |
|----------------------|---------------------------|
| 23. First taper      | 28. Hand-tap for primer   |
| 24. Second taper     | 29. Final inspection      |
| 25. Machine head     | 30. Government inspection |
| 26. First inspection | 31. Stamp, box and ship   |
| 27. Stamp and broach |                           |

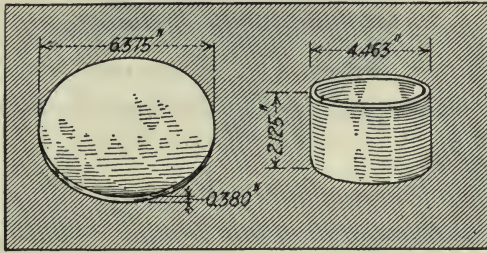

## OPERATION 3. CUPPING

Machine Used—Bliss No. 77½, 12-in. stroke, press operating at 13½ r.p.m.

Production—800 per hr.

Lubricant Used—Lub-a-tone.

Pressure Required—120 tons.

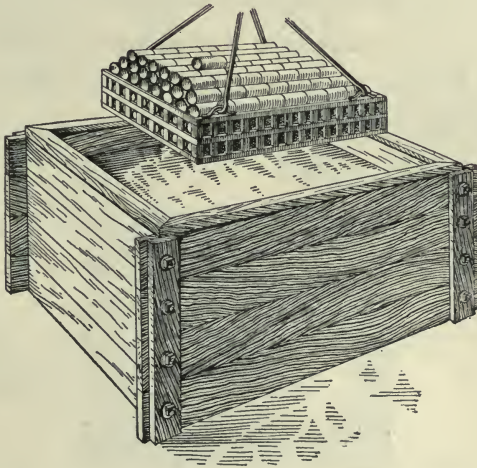

## OPERATION 4. ANNEALING AND PICKLING CONTINUOUS NO. A-258-S

Apparatus Used—Quigley crude-oil furnace and trays, water and “Edis” compound tanks.

Production—1,400 per furnace per hr.

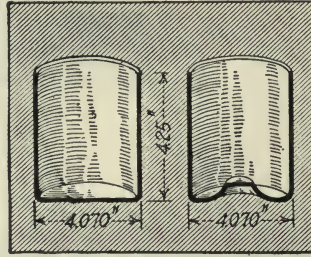

OPERATION 5. FIRST DRAW

Machine Used—Bliss No. 77½, 10-in. stroke, press operating at 13½ r.p.m.  
 Production—800 per hr.  
 Lubricant Used—Lub-a-tone.  
 Pressure Required—75 tons.

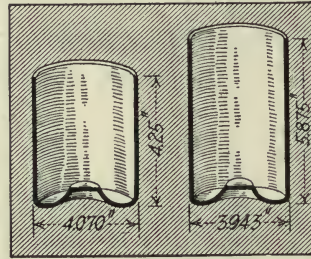

OPERATION 7. SECOND DRAW

Machine Used—Bliss No. 77½, 12-in. stroke, press operating at 13½ r.p.m.  
 Production—800 per hr.  
 Lubricant Used—Lub-a-tone.

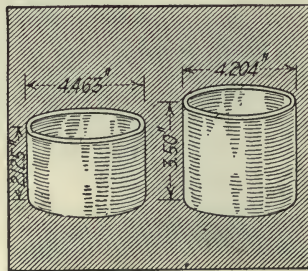

OPERATION 8. FIRST INDENT

Machine Used—Bliss No. 78½, 10-in. stroke, press operating at 12 r.p.m.  
 Production—700 per hr.  
 Lubricant Used—None.  
 Pressure Required—150 tons.

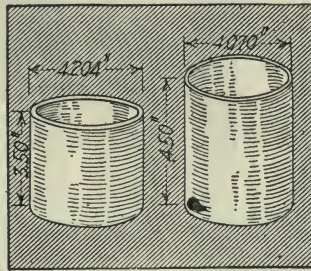

OPERATION 10. THIRD DRAW

Machine Used—Bliss No. 77½, 10-in. stroke, press operating at 13½ r.p.m.  
 Production—800 per hr.  
 Lubricant Used—Lub-a-tone.

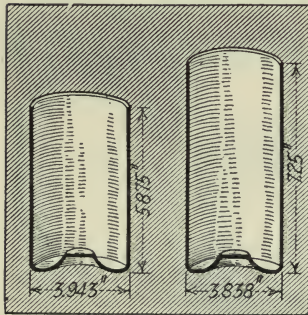

OPERATION 12

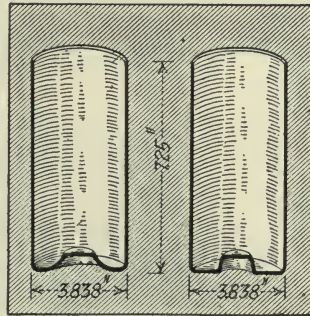

OPERATION 13

OPERATION 12. FOURTH DRAW

Machine Used—Bliss No. 87, 16-in. stroke, press operating at 13½ r.p.m.  
 Production—750 per hr.  
 Lubricant Used—Lub-a-tone.

OPERATION 13. SECOND INDENT

Machine Used—Bliss No. 78½, 10-in. stroke, press operating at 12 r.p.m.  
 Production—700 per hr.  
 Lubricant Used—None.

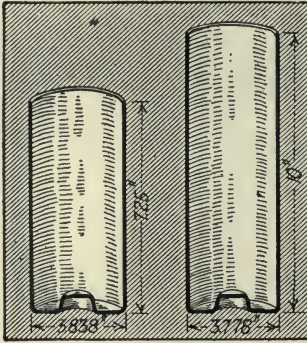

OPERATION 15

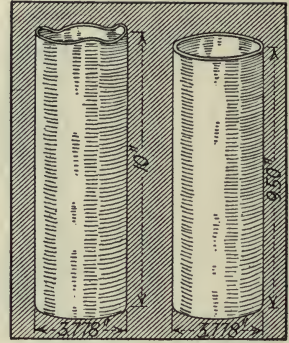

OPERATION 16

## OPERATION 15. FIFTH DRAW

Machine Used—Bliss No. 60½ reducing press.  
 Production—250 per hr.  
 Lubricant Used—Lub-a-tone.

## OPERATION 16. FIRST TRIMMING

Machine Used—Bliss trimmer, speed of spindle 585 r.p.m.  
 Production—800 per hr.  
 Note—Case trimmed dry to 9½ in.

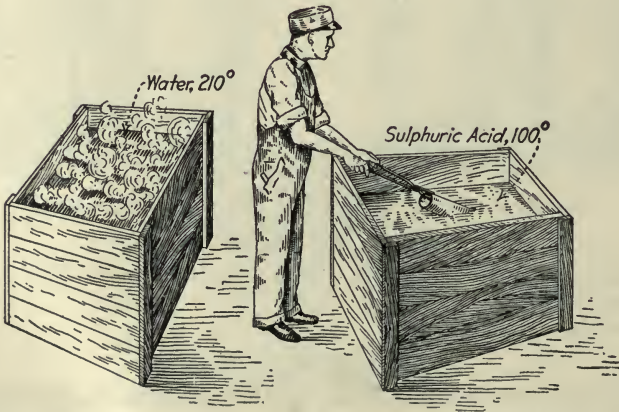

OPERATION 17. WASHING

Apparatus Used—Tanks and tongs.



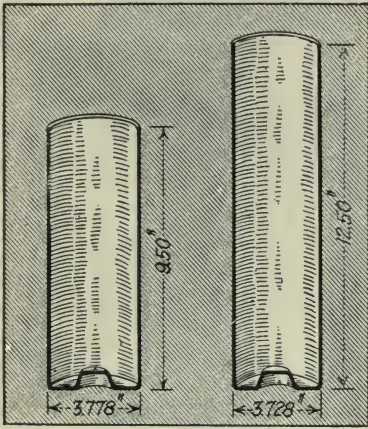

OPERATION 18

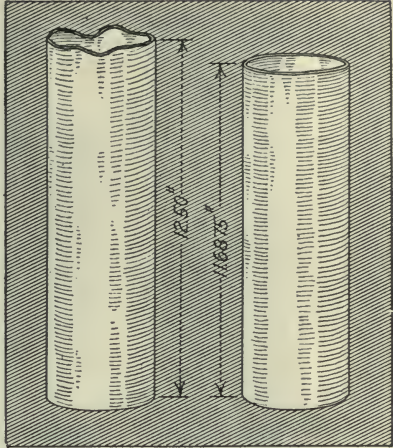

OPERATION 19

OPERATION 18. SIXTH DRAW

Machine Used—Bliss reducing press No. 60½.  
 Production—230 per hr.  
 Lubricant Used—Lub-a-tone.

OPERATION 19. SECOND TRIMMING

Machine Used—Bliss trimmer, speed of spindle 585 r.p.m.  
 Note—Case trimmed dry to 11½⅙ in.

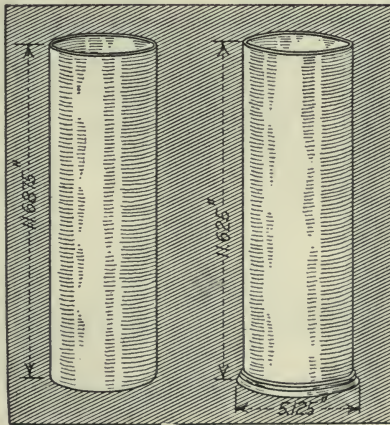

OPERATION 21. FIRST AND SECOND HEADING

Machine Used—Bliss embossing press No. 27.  
 Production—300 per hr.  
 Lubricant Used—Lub-a-tone.  
 Pressure Required—800 tons.

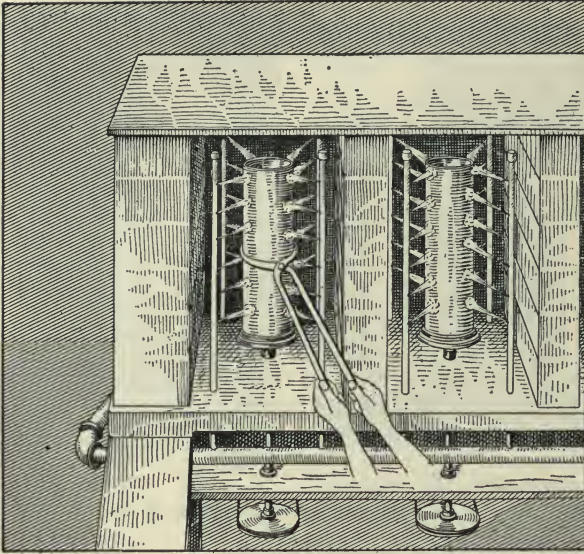

OPERATION 22. FLASH ANNEALING

Machine Used—Special four-burner gas furnace.

Production—200 per hr.

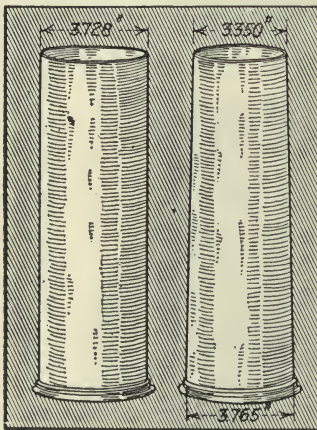

OPERATION 23

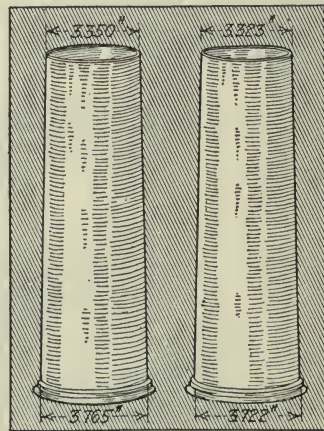

OPERATION 24

OPERATION 23. FIRST TAPER

Machine Used—Bliss wiring press No. 2W, 16-in. stroke, operating at 16 r.p.m.

Production—900 per hr.

Lubricant Used—Neatsfoot oil.

OPERATION 24. SECOND TAPER

Machine Used—Bliss wiring press No. 2W, 16-in. stroke, operating at 16 r.p.m.

Production—900 per hour.

Lubricant Used—Neatsfoot oil.

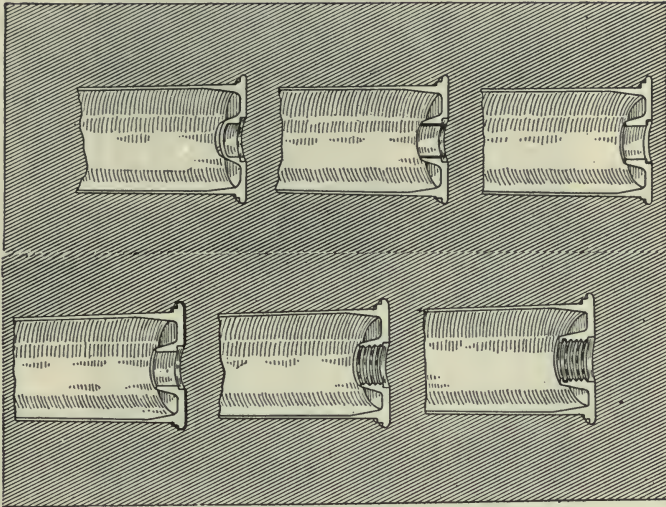

OPERATION 25. MACHINING HEAD

Machine Used—Bullard cartridge lathe operating at 570 r.p.m., for tapping.

Production—55 per hr.

Note—All machine work performed dry except threading, where lard oil is used.

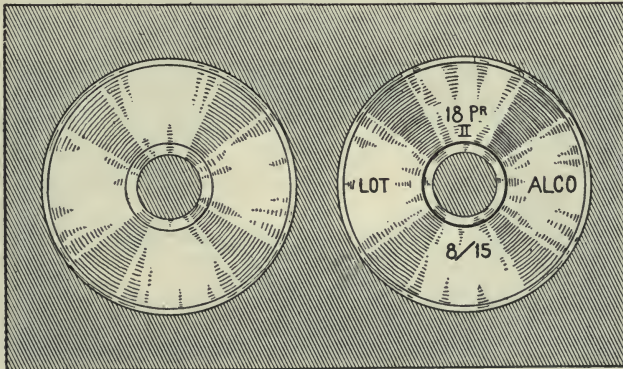

OPERATION 27. STAMP AND BROACH

Machine Used—Bliss No. 39B marking machine.

Production—1,200 per hr.

Lubricant Used—None.

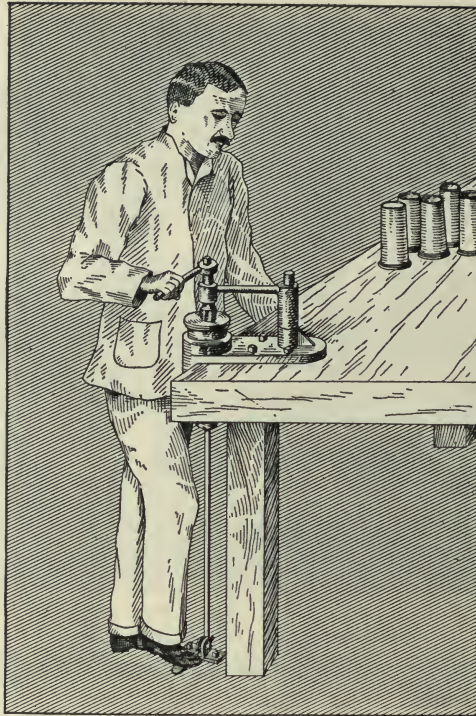

OPERATION 28. HAND-TAPPING FOR PRIMER

Machine Used—Holding fixture with wooden ejector.

Production—150 per hr.

Lubricant Used—Lard oil.

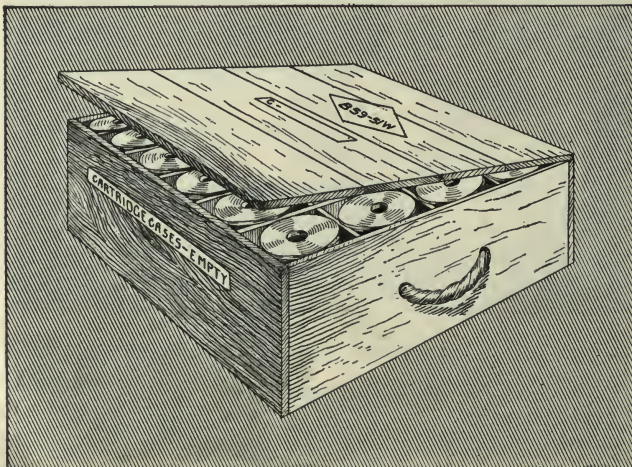

OPERATION 31. PACKING.

Production—Seven men pack and five men fasten boxes together at the rate of 700 in 10 hr.

The first machining operation is that of cupping; the machine used for performing this operation is a 12-in. Bliss press. The punch and die for which are shown in detail in Fig. 439. The cupped blanks are then taken to the oil burning furnaces for annealing; the temperature is kept at from 1,180 to 1,200 deg. F. The average consumption of oil is 15 gal. per hr. per furnace.

When annealing, two men load the trays. The furnace holds nine, one tray accommodating about 150 blanks. Every 6 min. one of these

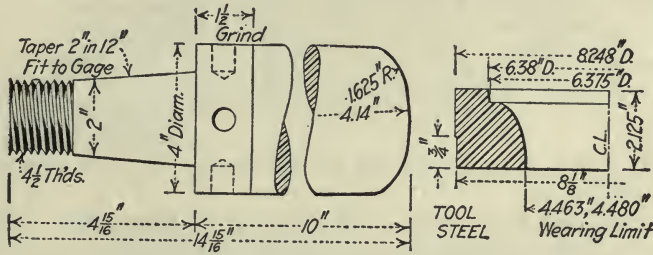

FIG. 439. DETAILS OF CUPPING PUNCH AND DIE

is pushed into the furnace. The cartridge cases are left in the furnace for approximately 45 min. Two men, stationed at the furnace, draw out the trays according to the time noted and lower them by an air hoist into the water tank.

Three furnaces are attended to by another man who watches the pyrometers and regulates the heat. The pickling is done in a bath of "Edis" compound made from 1 lb. of the compound and 1 gal. of water. This mixture is kept at a temperature of from 180 to 210 deg. F. The

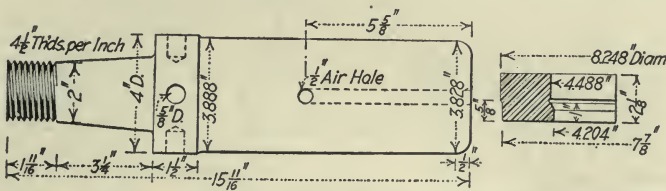

FIG. 440. DETAILS OF PUNCH AND DIE FOR FIRST DRAWING OPERATION

blanks are allowed to remain in the pickling tank for approximately 8 min.

The cases are then washed in hot water in a separate tank. The baskets that are used during this operation are made from copper so as to prevent any discoloration of the cases.

The next operation is the first drawing; the press used for this operation is a 10-in. Bliss press. The punch and die for which are shown in Fig. 440.

The cases are again annealed and pickled after which they are ready

for the second drawing operation, which is performed on a 12-in. Bliss press. Details of the punch and die used for this second drawing are shown in Fig. 441.

The cases are then taken to another Bliss press for the first indenting operation. Details of the punch, die and center post used for this operation are shown in Fig. 442; details of the die holder and punch holder in Fig. 443.

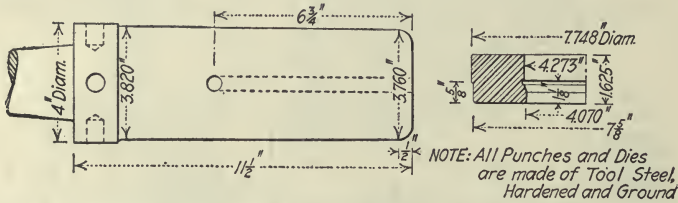

FIG. 441. DETAILS OF PUNCH AND DIE FOR SECOND DRAWING OPERATION

The third draw is performed on a No. 77 1/2 Bliss press. Details of the punch and die used for this third drawing are shown in Fig. 444. The cases are then again annealed and pickled as before.

The next operation is the fourth drawing; the press used is a 16-in. stroke Bliss No. 87. The punch and die used for the drawing operation are shown in detail in Fig. 445.

The case is now ready for the second indenting, which is performed on a Bliss No. 78 1/2. Details of the die and punch holders used in this

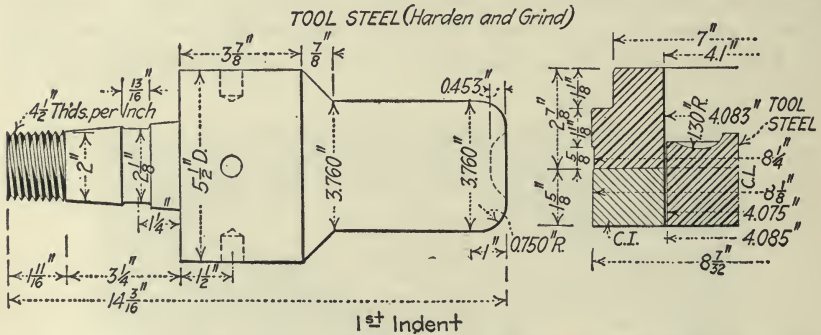

FIG. 442. DETAILS OF THE PUNCH, DIE AND CENTER POST FOR FIRST INDENTING OPERATION

operation are shown in Fig. 443. The punch and die are also shown in detail in Fig. 446. The cases are then annealed as described and pickled by dipping in a bath made in the proportion of 1 part sulphuric acid to 10 parts water, and kept at a temperature of 120 deg. F.

The next operation on the case is the fifth drawing; performed on a Bliss No. 60 1/2 reducing press. Details of the punch and die used for this drawing are shown in Fig. 447.

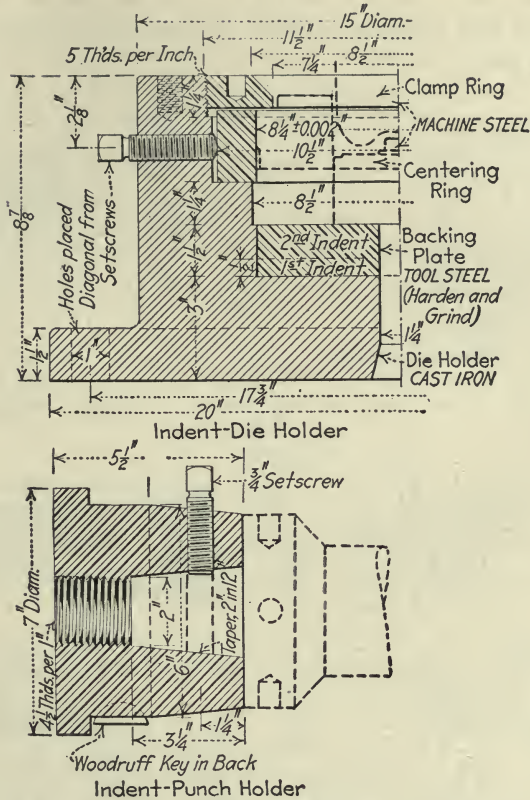

FIG. 443. DETAILS OF DIE AND PUNCH HOLDERS

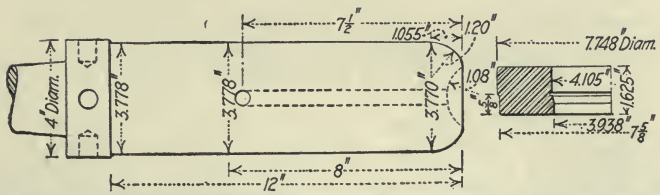

FIG. 444. DETAILS OF PUNCH AND DIE FOR THIRD DRAWING OPERATION

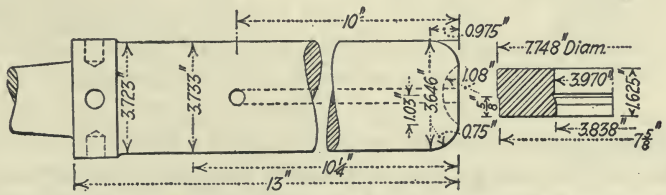

FIG. 445. DETAILS OF PUNCH AND DIE FOR FOURTH DRAWING OPERATION





tongs used to dip the cases in the bath is shown in Fig. 450. It will be noted that this time the cases are only dipped into the bath, whereas before they were allowed to remain in the bath suspended in a basket.

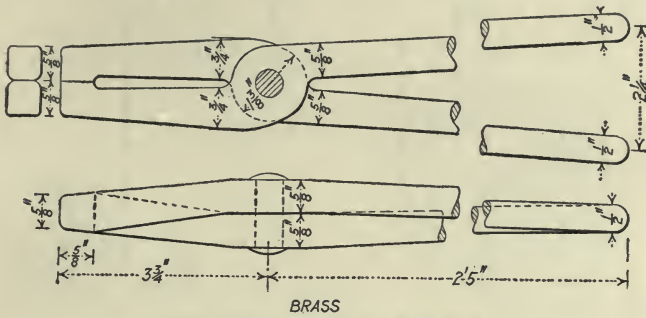

FIG. 450. DETAILS OF TONGS

It will be observed also that the bath mixture is different. After being removed from the bath they are plunged into water at a temperature of 210 deg. F. and then quickly transferred to the air dry.

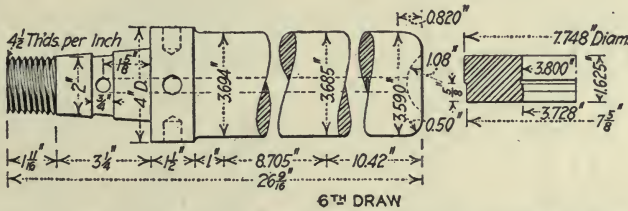

FIG. 451. DETAILS OF PUNCH AND DIE FOR SIXTH DRAWING OPERATION

The next operation, the sixth drawing, is performed in the Bliss reducing press. Details of the punch and die used for this final drawing are shown in Fig. 451.

The case is now transferred to a lathe and trimmed to  $11\frac{1}{16}$  in. in length over all. The tools used for this operation are shown in detail in Figs. 448 and 452. The case is then dipped in a sulphuric-acid bath. The tongs shown in Fig. 450 are used to hold the case. The bath is composed of a mixture of sulphuric acid and water in the proportion of 300 gal. of water to 2 gal. of acid and is kept at a temperature of 210 deg. F.

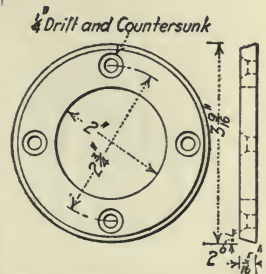

FIG. 452. DETAIL OF TRIMMING CUTTER

The next operations are the first and second headings performed in a Bliss embossing press. This machine carries two sets of heading tools, one set performing the first and the other the second heading operation. In front of the press is the stripper which, by

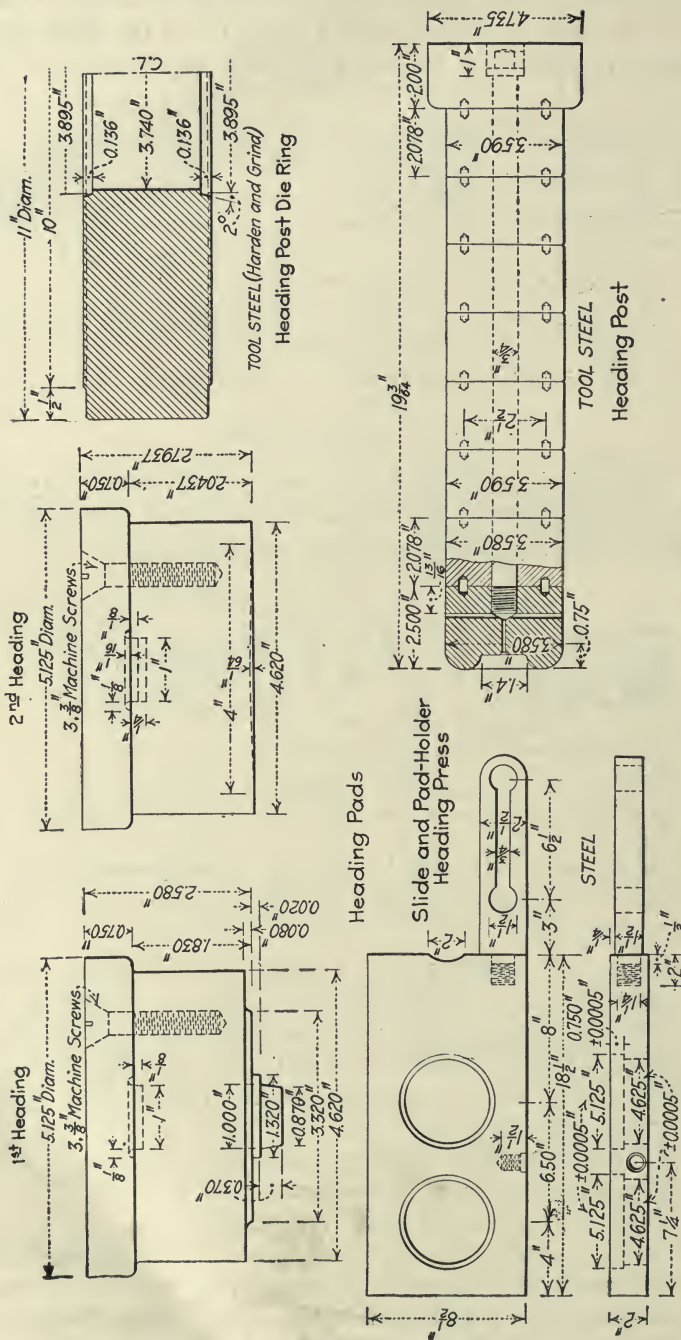

FIG. 453. DETAILS OF HEADING TOOLS

means of two latches, raises the case from the die after it has been headed. Details of the heading post, heading-post die ring, slide and pad holder and heading pads are shown in detail in Fig. 453.

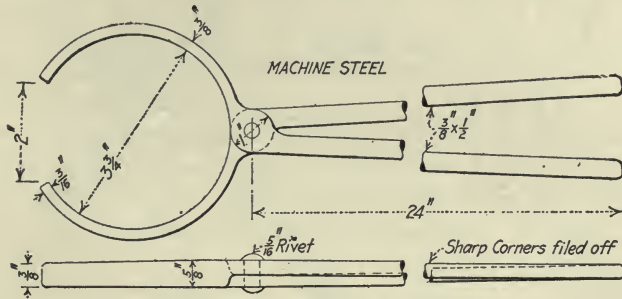

FIG. 454. DETAIL OF TONGS

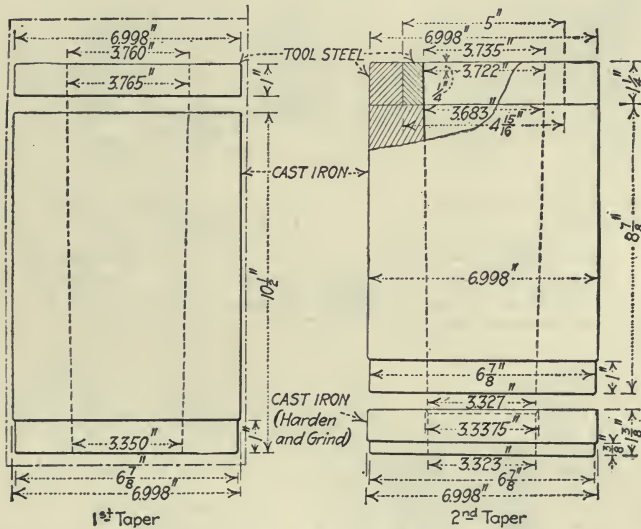

FIG. 455. DETAIL OF FIRST TAPERING DIE

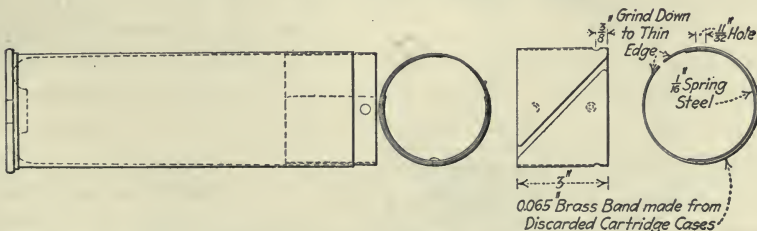

FIG. 456. DETAILS OF DIE HOLDER AND REINFORCING

The case is then taken to a gas furnace and mouth-annealed. The furnace holds four cases, which are kept revolving by means of pulleys driven by belts at the lower end of the device.

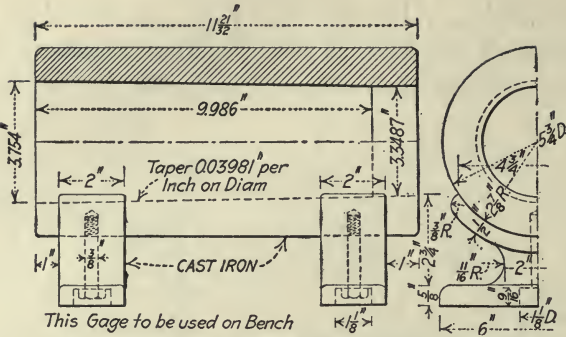

FIG. 457. DETAIL OF GAGE FOR TAPERING OPERATION

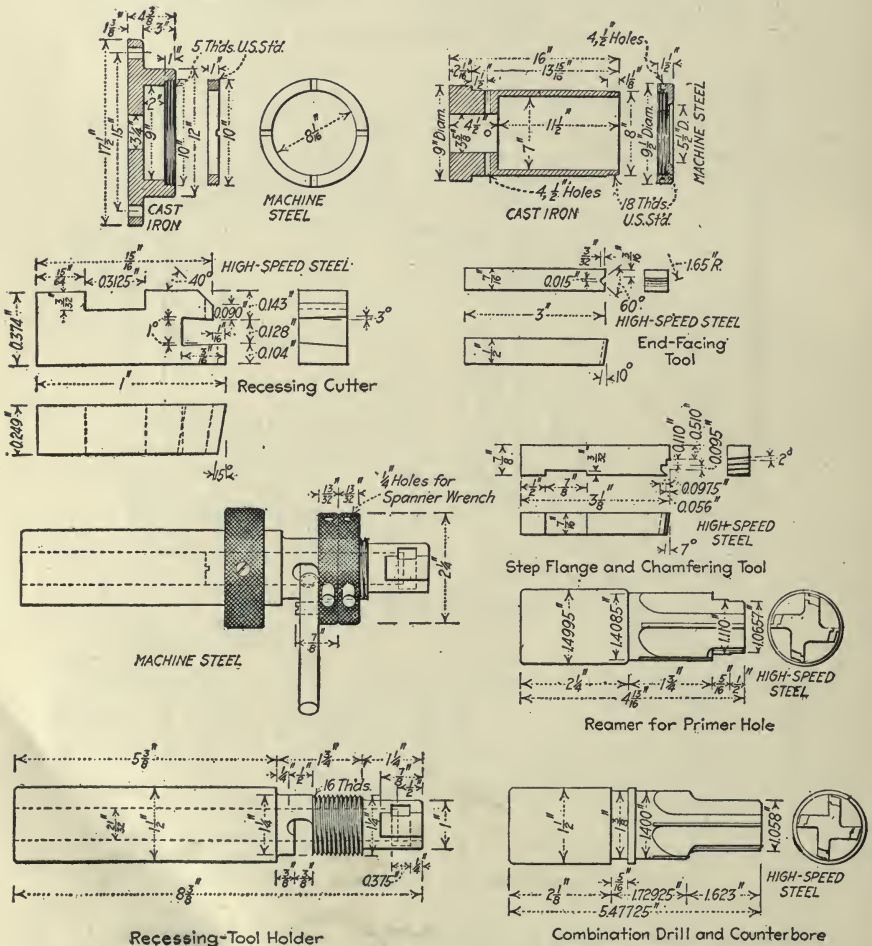

FIG. 458. DETAILS OF MACHINING TOOLS

Jets of gas flame are allowed to play against the outside of the case until it becomes low red hot, after which it is removed with the tongs, Fig. 454, and allowed to cool in air.

The next operation is the first taper, which is performed in a Bliss wiring press. A detail of the tapering die is shown in Fig. 455. The die holder and the reinforcing ring are shown in detail in Fig. 456. The reinforcing ring is placed on the inside of the case to prevent distortion during the tapering operation.

The second tapering, which is the next operation, is performed in a press similar to the one used for the first draw. The die used for this operation is shown in Fig. 455, the other tools being the same as shown

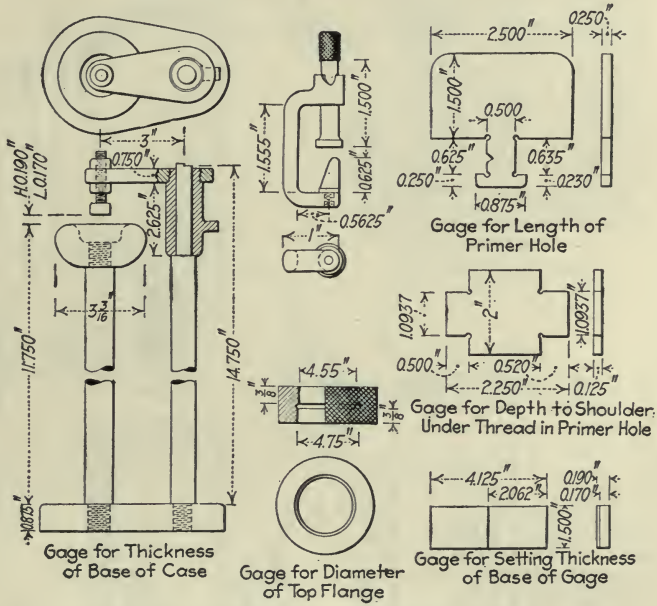

FIG. 459. DETAILS OF INSPECTION GAGES

in detail in Fig. 456. The gage used to test the tapered case at the machine is shown in Fig. 457.

The case is next taken to a Bullard cartridge lathe where the head is machined and the case itself is faced to length. The sequence of operations performed in the lathe are:

- |  |  |
|--|--|
| 1. Drill   | face the shell to length with the cutter |
| 2. Form recess and face boss on inside of case                               | at rear end of the machine               |
| 3. Face flange to diameter and thickness—using cross-slide, at the same time | 4. Tap                                   |
|  | 5. Ream and counterbore                  |

Details of the tools used for these operations are shown in Fig. 458. The case is now given its first inspection, using the gages shown in

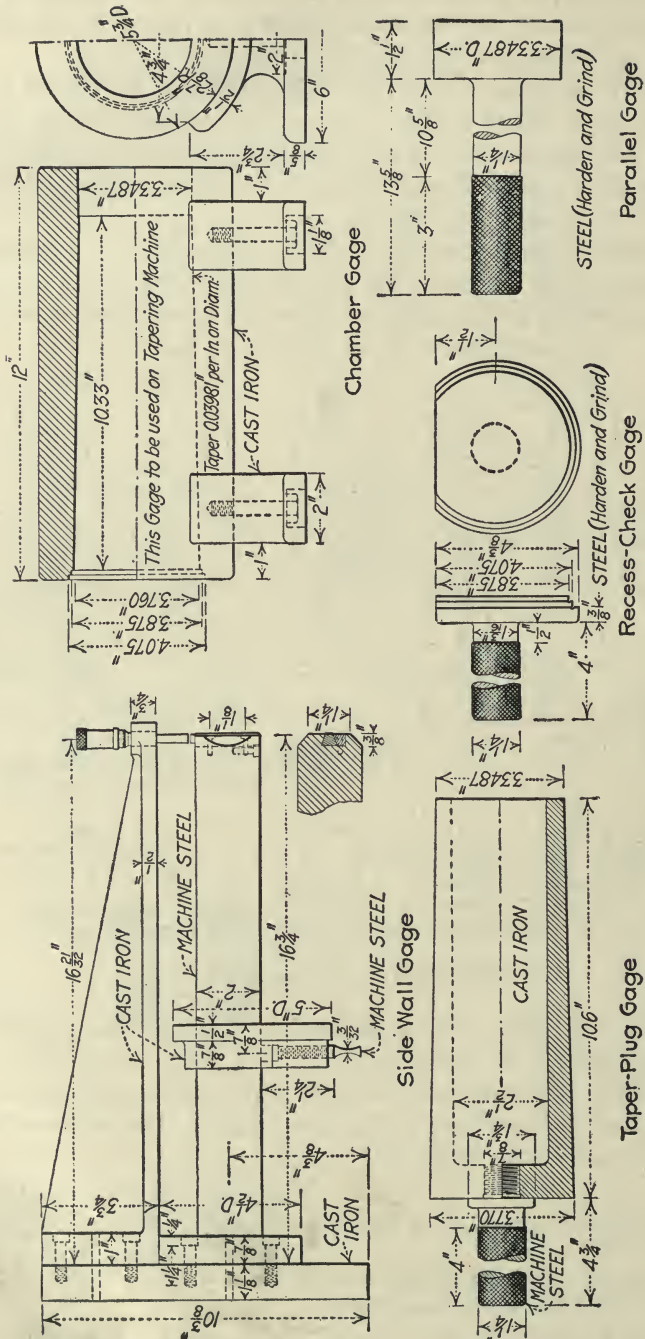

FIG. 459 (a). INSPECTION AND RECEIVING GAGES

Fig. 459. The receiving gage for testing the chamber gage is shown in Fig. 459(a). For the inspection, the case is placed on a long bench and

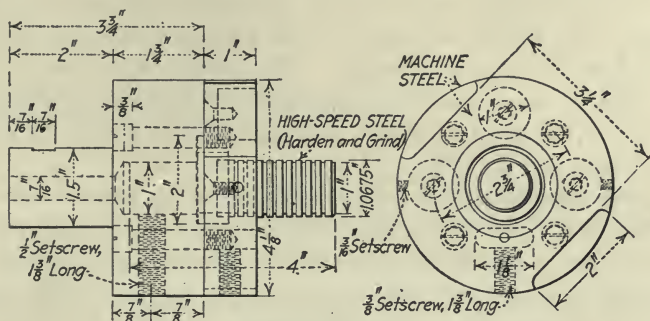

FIG. 460. DETAILS OF BROACH AND STAMP

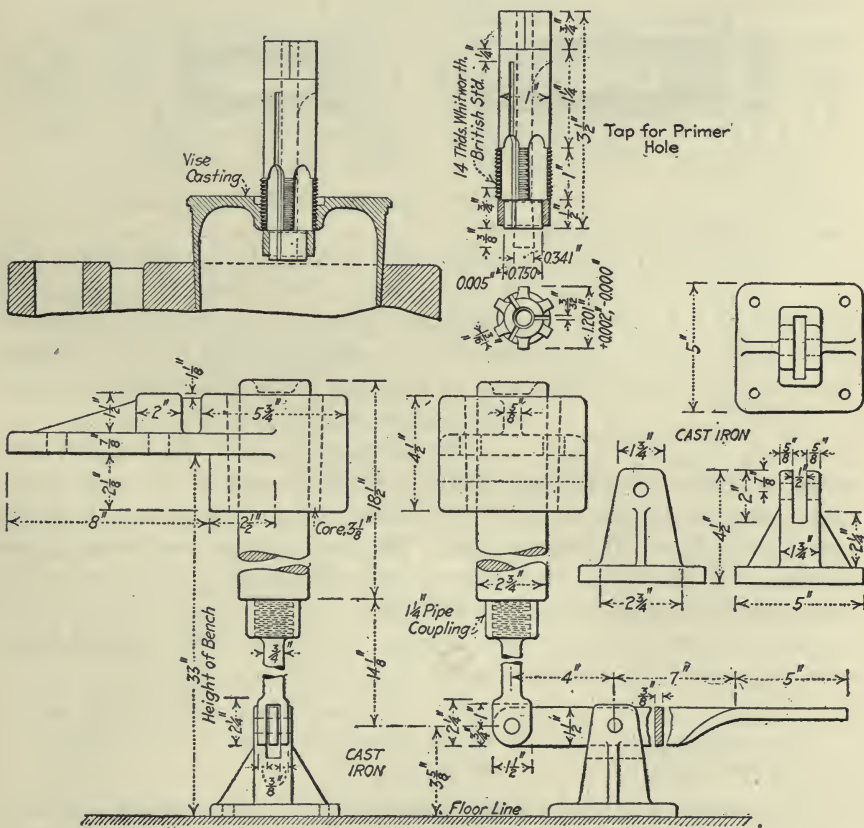

FIG. 461. DETAILS OF TAP AND HOLDING FIXTURE

a gang of seven inspectors test the dimensions, the case being passed along the line until all the surfaces have been examined. With a gang of seven men about 700 cases are inspected per hr.

The case is then conveyed to the Bliss No. 39B marking machine, the hole broached, and the flange stamped. For this operation the case is placed on a steel post which fits on the inside, the case resting on the upper end. The fixture is made to slide forward, enabling the operator easily to place the case in position. The fixture and case are then slid back against a stop, the punch is made to descend, and the hole is broached and the case stamped. Details of the broach and stamping tool are shown in Fig. 460.

The next operation is the hand-tapping of the primer hole. To do this the fixture is fastened to the bench, and after being tapped the operator pushes down a treadle with his foot and forces out the case.

Details of the tap and holding fixture are shown in Fig. 461. The case is then given a final wash through four vats. The first of these

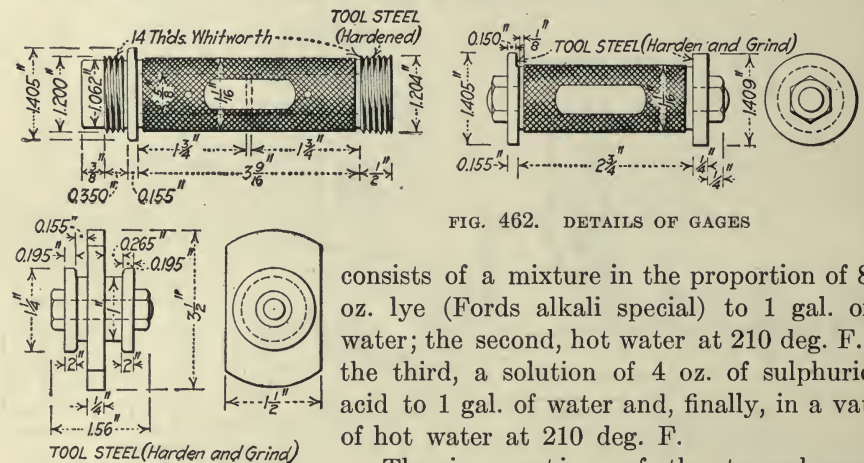

FIG. 462. DETAILS OF GAGES

consists of a mixture in the proportion of 8 oz. lye (Fords alkali special) to 1 gal. of water; the second, hot water at 210 deg. F.; the third, a solution of 4 oz. of sulphuric acid to 1 gal. of water and, finally, in a vat of hot water at 210 deg. F.

The inspection of the tapped and broached holes in the head, and also of the flange, is the next operation, using the gages shown in Fig. 462. The average for this operation is one man 120 cases per hr. The case is then transferred to the Government inspection department where it is again inspected, using gages similar to those shown in Fig. 459.

Several cartridge cases have been tested for hardness with the Shore scleroscope and the average was found to be

At flange.....	45-55	5 in. from flange.....	35-40
1/4 in. from flange.....	40-50	10 in. from flange.....	30-35
2 in. from flange.....	40-50		

The average weight of a finished case is 3 lb. 2 drams, and the contents 94.80 cu. in.

It might be of interest to know what weight is lost by the case while it is passing through the various stages of manufacture. For this purpose the company took about 50 specimens at different times and the average obtained was as follows:



	Lb.	Oz.	Drams
Average weight of disk.....	3	11	8
Average weight before first trim.....	3	11	11¼
Average after first trim.....	3	9	11⅞
Average before second trim.....	3	9	5½
Average after second trim.....	3	7	12
Average before machining head.....	3	7	12
Average after machining head.....	3	0	9½

After the Government inspection, those cases that are accepted are packed into boxes the covers of which are fastened down and marked on the outside. They are now ready for shipping.

**DRAWING 18-LB. CARTRIDGE CASES ON BULLDOZERS AND FROG PLANERS**

The Angus shops of the Canadian Pacific undertook the manufacture of 18-lb. cartridge cases along lines quite dissimilar from those employed by the American Locomotive Co., employing bulldozers and frog planers for all operations other than those of heading and indenting. This unusual use of apparently unsuitable machines for accurate press operations proved highly successful and is one which could be profitably copied by any plant engaged in the production of cartridge cases. The Angus shops attained a production rate of 3,000 cases per day with a work force which had no previous experience in brass drawing or in work of a similar nature.

**Arrangement of the Cartridge Department.**—A truck-shop building was cleaned out and made over into the cartridge department. The arrangement of machines, inspecting room, pickling and washing tanks and other equipment are shown in Fig. 463.

A bit of dust or grit on one of the drawing dies or plungers makes an ugly scratch in the case, and it was considered more advisable to keep this shop free from smoke and dust than to try to avoid transportation. Therefore, as the nearest available building for the annealing furnaces was the blacksmith shop across the midway, this shop was used for the drawing operations, and the indenting and heading presses were also installed there.

**List of Operations.**—The operations as performed on cartridge cases at the Angus shops are as follows:

- |                  |                 |                     |
|------------------|-----------------|---------------------|
| 1. Blank         | 10. Anneal      | 19. Second trim     |
| 2. Cup           | 11. Third draw  | 20. Head            |
| 3. Anneal        | 12. Anneal      | 21. Semi-anneal     |
| 4. First draw    | 13. Fourth draw | 22. First taper     |
| 5. Anneal        | 14. Anneal      | 23. Second taper    |
| 6. Second draw   | 15. Fifth draw  | 24. Head turn       |
| 7. First indent  | 16. First trim  | 25. Parallel cut    |
| 8. Anneal        | 17. Anneal      | 26. Stamp           |
| 9. Second indent | 18. Sixth draw  | 27. Shop inspection |

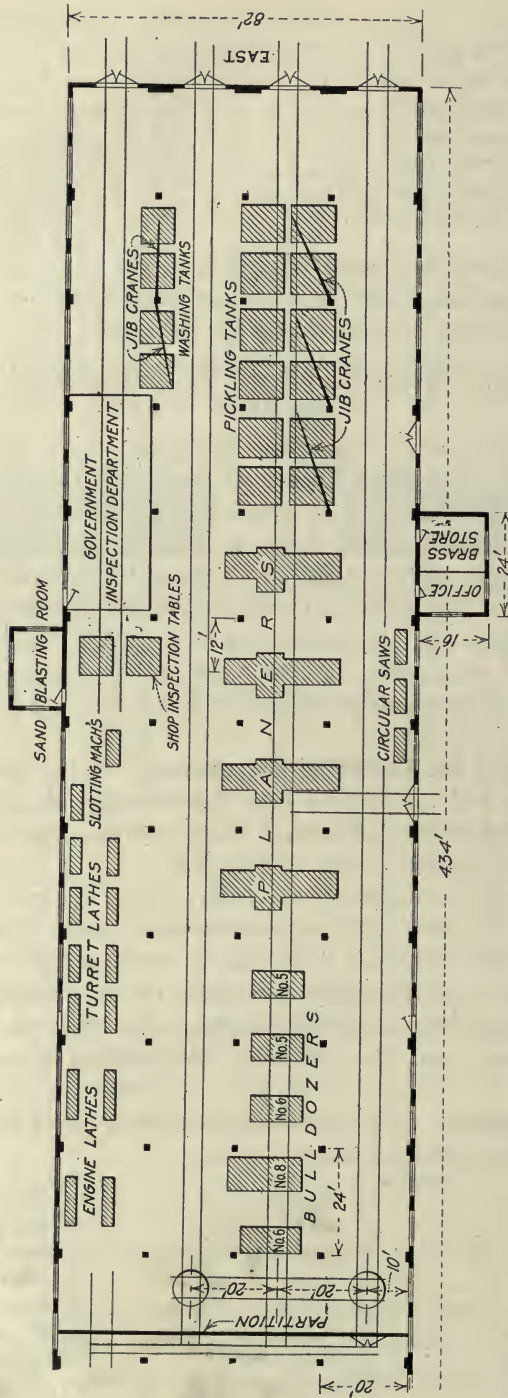

FIG. 463. DIAGRAM SHOWING THE ARRANGEMENT OF CARTRIDGE DEPARTMENT AT THE ANGUS SHOPS

There are six drawing and seven annealing operations; the cupping and first four draws are handled on bulldozers, and the last two draws, on frog planers. The round blank is punched out of strips of sheet brass, and each disk weighs 3 lb. 9½ oz. at the start. By the time it has become a finished case, it has lost 1¼ lb. due to trimming, the finished weight being 2.49 pounds.

All stages in the process are represented in Fig. 464. The round, flat blank punched out of strip brass is shown at *A*; the cup made directly from this is shown at *B*, and *C* and *D* represent the first and second draws respectively. The indented case is shown at *E*, the indenting being performed after the second draw. The third, fourth, fifth and sixth draws are shown at *F*, *G*, *H* and *I*. At *J* is the headed cartridge case, while *K* represents the completely tapered case with its base machined

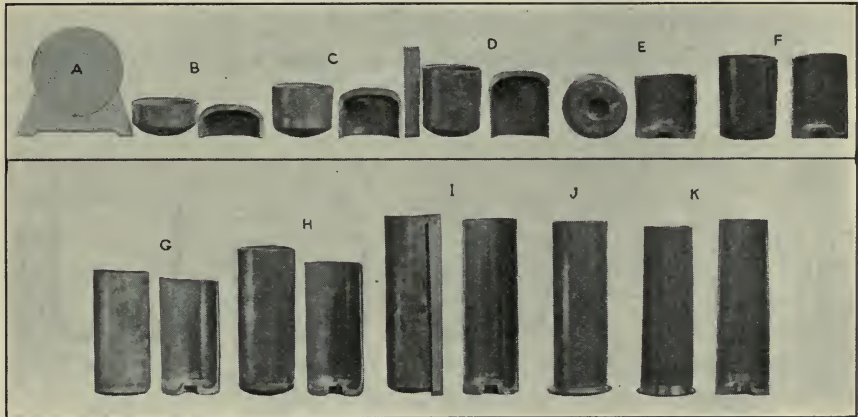

FIG. 464. THE EVOLUTION OF A CARTRIDGE CASE

and ready for the primer, which, of course, is not furnished at this shop nor attached until the complete cartridge is in government hands.

**Motor-driven Machines.**—The bulldozers and planers are all motor-driven. There are four of each of these machines, one of the bulldozers being provided with three sets of plungers and dies and the others having but one set each. On the bulldozers, the die is mounted on a special crosshead, and the plunger, on the rail. On the planers, the punch is mounted on the rail, and the die-holder, on an angle-block on the table.

Little was known at the start about the pressures required to accomplish the various drawing and heading operations. To throw light on this subject, experiments were made with brass disks of the same composition as the cartridge cases, the effect of pressure upon them being studied. The results of these experiments are shown in Fig. 465, and they served as the basis for calculations when the presses were built.

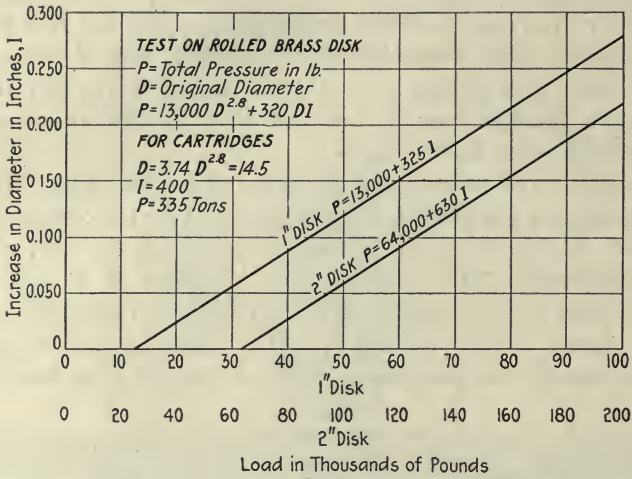

FIG. 465. CURVES SHOWING RELATIONS BETWEEN STRESS AND STRAIN IN CARTRIDGE MATERIAL

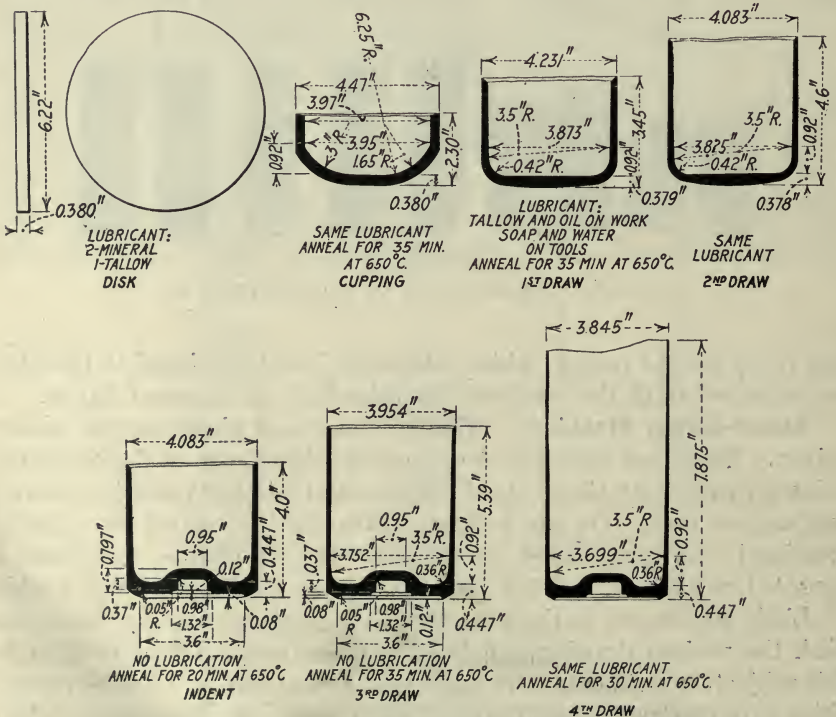

FIG. 466. BULLDOZER OPERATIONS ON CARTRIDGE CASE

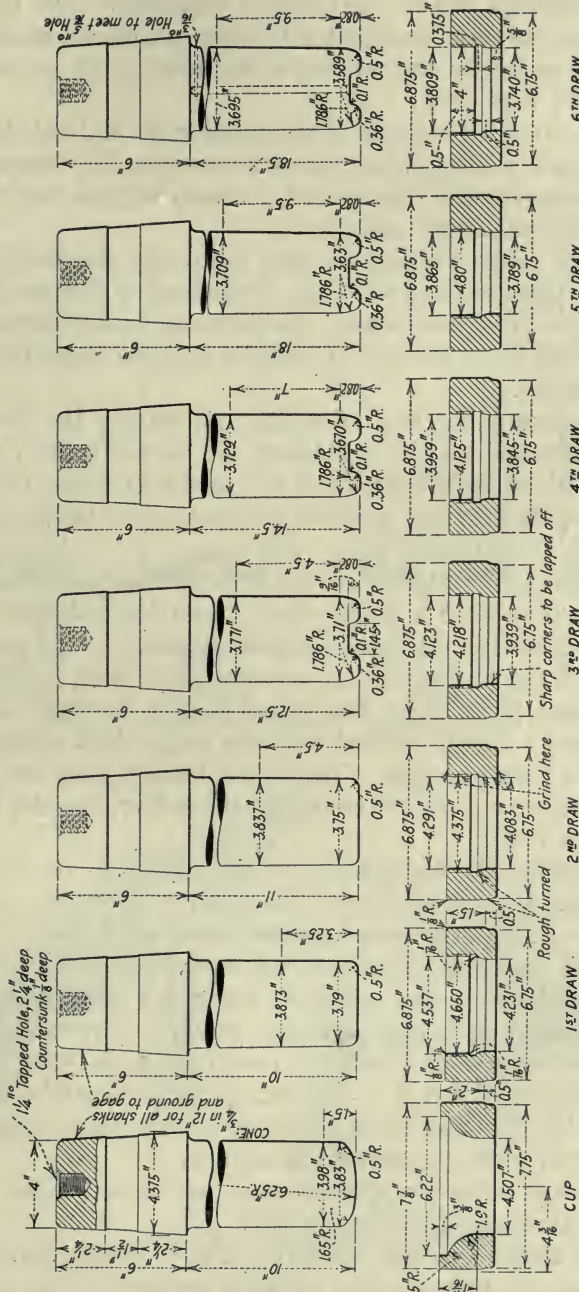

FIG. 467. DETAILS OF THE PLUNGERS AND DIES USED FOR MAKING 18-LB. BRITISH CARTRIDGE CASES

**The Bulldozers.**—Owing to their limited stroke, bulldozers are employed only through the fourth drawing operation. The machine for the cupping operation is equipped with three sets of plungers and dies, the center set caring for the cupping of the disk, while the two outside sets handle the first draw.

A recess is provided in front of the cupping die to hold the flat disk while the plunger advances, but no such provision is necessary for the drawing operations, as the cup, or shell, is simply slipped over the plunger while it is in its withdrawn position.

As the work passes through the dies, the pieces pass into galvanized iron conductor pipes which guide them to the back of the machine, where they roll down a chute into boxes. As each case passes through the die, it pushes forward those ahead of it, causing them to climb the slight incline in the pipes.

Sectional views of the case after the cupping and the four drawing operations performed on the bulldozers are shown in Fig. 466. Fig. 467 shows details of the plungers and dies used for making 18-lb. British cartridge cases, the first five of which are used on the bulldozers and the last two on the frog planers.

**The Planers.**—Frog planers are used for the last two draws for two reasons—first, they have a longer stroke than the bulldozers; second, they are more accurate. A special head is mounted on the planer cross-rail, from which the feed screws are removed, and upon this the plunger holder is secured, the plunger fitting into it on a standard taper. The die is held upon a heavily ribbed cast-iron angle-block which is in one piece with the frame casting. The whole thing weighs some four or five tons and serves not only to secure the die-holder, but also to prevent the table from rising.

At first thought, the natural plan would apparently be to mount the die-holder upon the cross-rail and the plunger upon the angle-block. There is a good reason for the opposite procedure, however, since any lift that occurs during the operation will undoubtedly take place in the planer table and not in the cross-rail, which is a rigid member. The plunger, on account of its long overhang, would be thrown out considerably by a few thousandths of an inch rise of the table; whereas the die, having a thickness of but 2 to  $2\frac{1}{2}$  in., is not perceptibly affected, as evidenced by the fact that the thickness of shell in these cartridge cases does not vary over one-thousandth of an inch.

Sectional views of the case after the two drawing operations performed on the frog planers are shown in Fig. 468.

**Speeds of Bulldozers and Planers.**—The bulldozer which handles the cupping and first draw has a working stroke of 24 in., makes 240 strokes per hour and has a speed on the effective stroke of  $18\frac{1}{2}$  ft. per min. The bulldozer on the third draw has a 20-in. stroke and makes

240 strokes per hour, having an effective speed on the working stroke of 16½ ft. per min. The planer on the fifth draw, with a stroke of 37½ in., runs at an average of 130 strokes per hour and an average speed on the effective working stroke of 11 ft. per min.

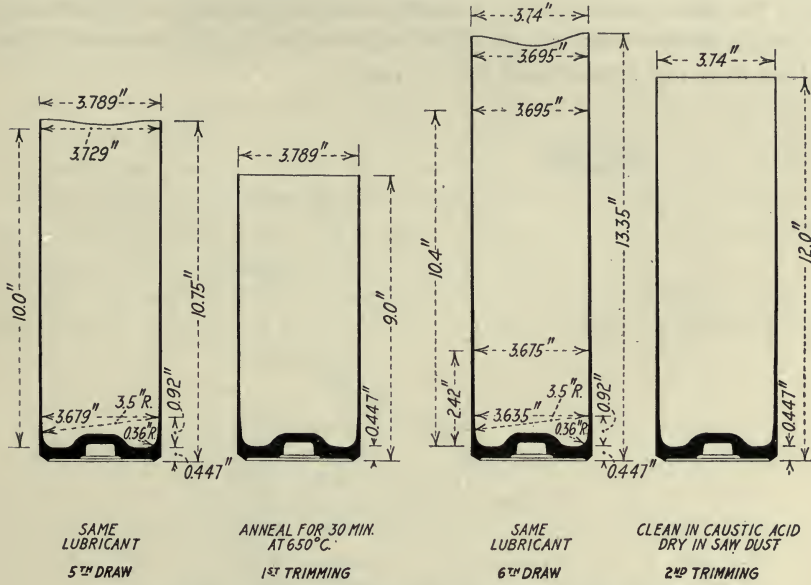

FIG. 468. FROG PLANER AND TRIMMING OPERATIONS

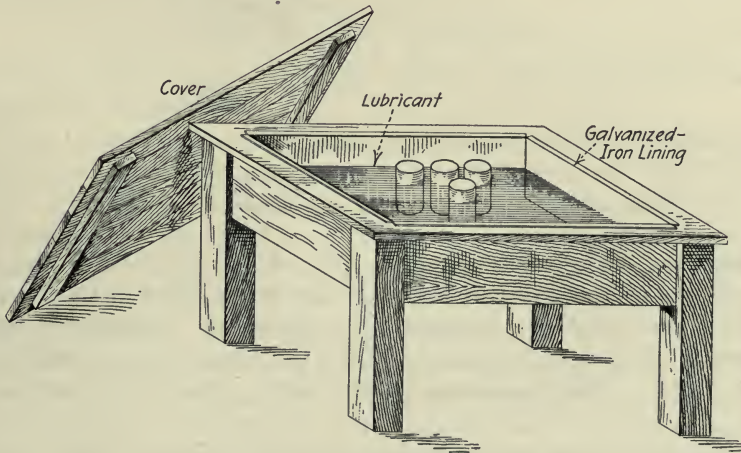

FIG. 469. LUBRICANT TANK-TABLE

**Tote-Boxes and Lubricant Tank-tables.**—The cases are transported in tote boxes holding about 24 cases. Four hundred cases are considered a "lot." To this, 10 per cent. is added as an allowance for loss and two

more cases are added to each lot for the firing and proof tests, so that the total "lot" number as it originally starts through the factory is 442.

A convenient combination of work table and lubricant tank is shown in Fig. 469. It consists of a wooden table, containing a galvanized iron-lined lubricant tank in which the shells are stood until the operator is ready for them, thus insuring a good coating of lubricant. These tables are easily portable and are provided with covers which prevent dirt from getting into the tanks when not in use.

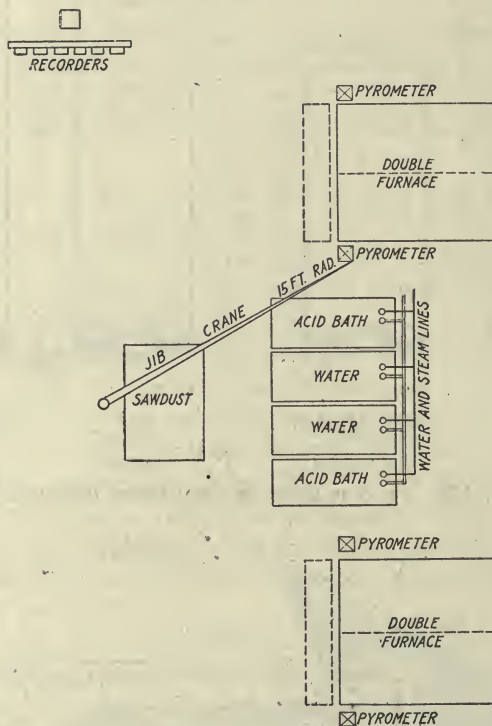

FIG. 470. ARRANGEMENT OF THE HEATING FURNACES

**Annealing and Semi-annealing, Etc.**—After every draw the cases are annealed in order to counteract the hardening effect of the draw and to secure the ductility required for subsequent operations. This is performed in oil-fired furnaces in which the temperature is maintained at 650 deg. F. The arrangement of the heating furnaces is shown in Fig. 470.

For the first seven annealing operations, the cases are placed directly in the furnaces in special annealing baskets constructed of angle iron frames with heavy wire cloth lining on two sides and further reinforced by angle iron struts.

After the cupping, first, second and third drawing operations, the



cases remain in the annealing furnace 35 min.; after the first and second indenting operations, 20 min.; and after the fourth draw, first and second trim, which follow the fifth and sixth draws, 30 min.

A heat treatment, the eighth, known as "semi-annealing," is performed just before the cases are tapered. In this operation, which lasts for but 35 sec., the cases do not come in direct contact with the flames, but are placed inside of incandescent cast-iron tubes extending into the furnace.

After coming from each machine operation in which a lubricant is used, the cartridge cases are washed in boiling lye water to avoid excessive scale and smoke during the annealing. In addition, each batch of cases coming from the annealing ovens must be pickled to remove the scale, which would injure the dies. The acid bath for this purpose consists of  $2\frac{1}{2}$  parts sulphuric acid to 20 parts of water.

For dipping the product in the washing tanks, in which the casts are freed from the lubricant before they go to the annealing ovens, angle-iron

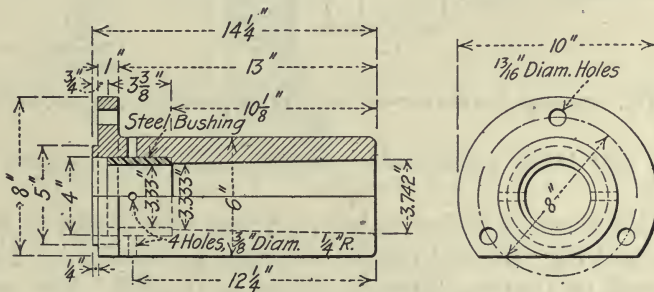

FIG. 471. SECOND TAPERING DIE

washing baskets of a type similar to those employed in the annealing furnaces are employed.

Very substantial wooden dipping boxes are used in the acid tanks. These are made out of 2-in. stock and two of them lengthwise fill one acid tank. They are handled by means of air hoists from swinging jibs.

**Pressing the Taper.**—One of the most interesting operations in the entire process of making cartridge cases is that of tapering. This is done on a bulldozer, and requires two steps, both of which are completed on the same machine. The first taper is given the case in one die, after which it is further tapered and finished in the second die. The case is inserted in each of these dies by hand and is pressed home by means of the cross-head of the bulldozer. It is ejected after the stroke is completed by the return of the cross-head through the medium of the pull-back rods, which actuate the ejector plugs. Correct annealing for this operation is a very important matter, and unless this is assured, there is a tendency for the case to wrinkle. A detail drawing of the second tapering die is shown in Fig. 471.

Some interesting tests have been made upon the pressure required to perform the tapering operations on a bulldozer. For the first operation, to press the cartridge flush with the die requires an average of 7,900 lb. The second tapering operation exceeded this greatly, averaging between 19,000 and 20,000 lb. total thrust. The stripping of the tapered

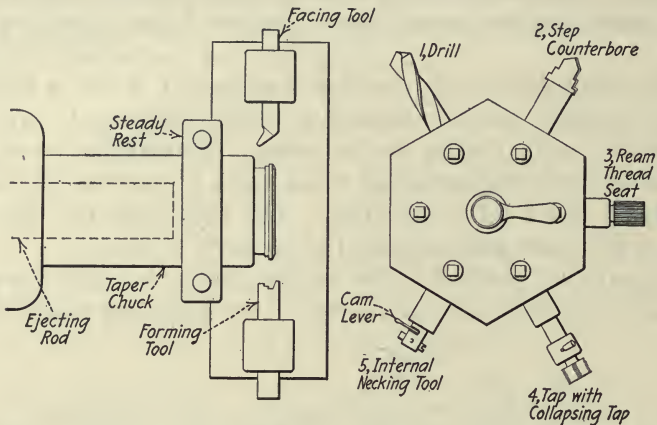

FIG. 472. TURRET LATHE SET-UP FOR FINISHING BASE AND PRIMER HOLE

cartridge also takes considerable pressure, this varying from 5,320 to 11,000 lb.

After the tapering operation, the cartridge case is sent to the turret lathes so that the base and primer hole may be machined. The set-up for this work on Bertram turrets is shown in Fig. 472. The production for this operation on these machines averages eight cases per hr.

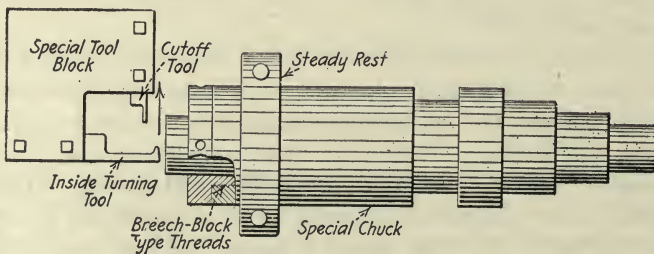

FIG. 473. ENGINE LATHE SET UP FOR CUT-OFF AND PARALLEL TURNING

The next operation is known as "parallel turning." It consists of cutting off the open end of the shell to proper length and also of thinning down the thickness of wall on the inside so that the hole will pass a limit-gage test. This operation is performed at the rate of 30 per hr. on a modified engine lathe equipped with a special tool post and chuck, as shown in Fig. 473. Both the base and open-end turning will be done in

the near future on Bullard cartridge lathes, which handle the two operations simultaneously at the rate of from 20 to 25 cases per hr.

An ingenious and time-saving vise is shown in Fig. 474. It is used at the benches for retapping the primer hole, which is purposely left a little full in size and brought to full standard by means of a hand tap. This vise holds the case on its taper by friction and is fitted with a quick ejector operated by foot power.

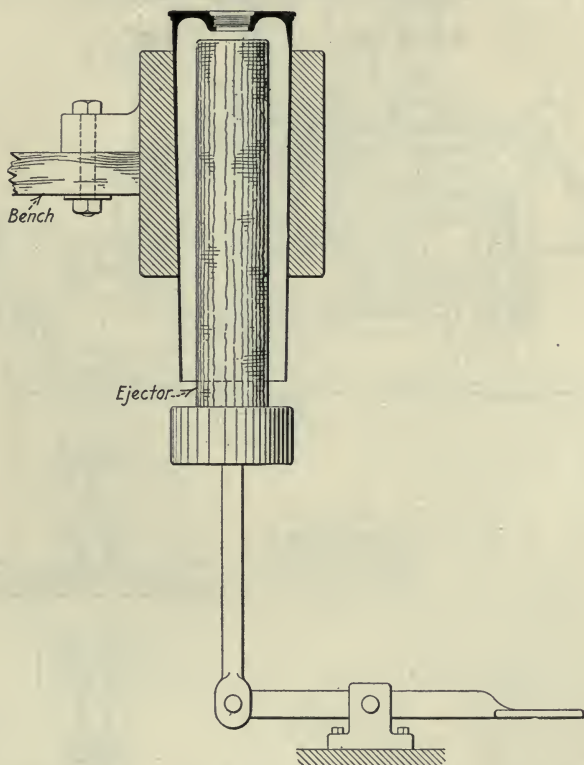

FIG. 474. SPECIAL BENCH VISE FOR HOLDING CARTRIDGE CASES

**Indenting and Heading Operations.**—The indenting operation is performed on a 285-ton station-type hydraulic press, a machine, incidentally, which was designed and built at the Angus shops.

The cartridge cases are headed by means of three 800-ton hydraulic presses, also built at Angus. These are shown in Fig. 475 and are operated by two large hydraulic accumulators working at 1,500 lb. per sq. in. pressure.

**Description of the 800-ton Heading Press.**—The presses used for heading are built according to the design shown in Fig. 475. The cast iron plunger of 37 in. diameter, shown at *A*, works within a steel cylinder casting *R*. Water from the accumulator at a pressure of 1,500 lb. per

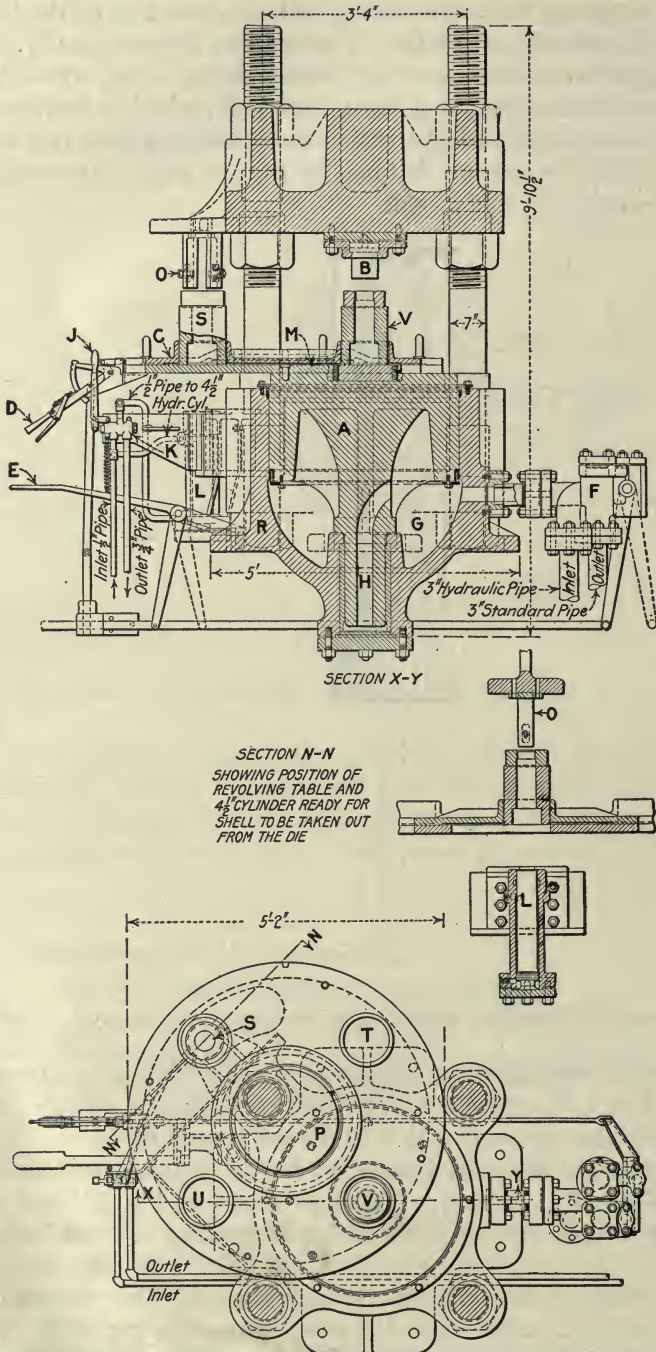

FIG. 475. SECTIONS AND PLAN OF FOUR-STATION 800-TON HEADING PRESS

sq. in. is admitted and discharged through the cylinder space *G* by action of the three-way valve *F*, which is operated by the foot lever *E*. (The press is set partly underground so that this lever is at a convenient height for the operator's foot.) An equalizing passage *H* is cored in the plunger in order to make the area of the 8-in. guide stem effective. A dial table *C*, mounted above a stationary table *M*, is arranged to rotate upon a center pivot *P*. This table carries four "stations," shown at *S*, *T*, *U*

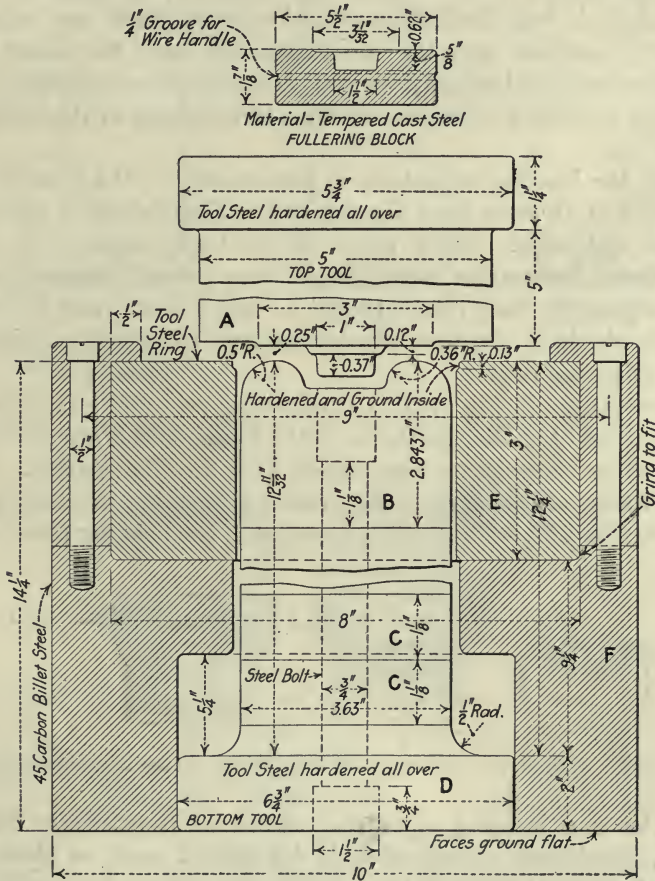

FIG. 476. DETAILS OF HEADING PUNCH AND COMPOSITE DIES SHOWING LAMINATIONS

and *V*. The rotating table is notched for indexing, which is accomplished through the table-operating lever *D*, which forces a hardened-steel wedge into the locating notch on the moving table.

In the main sectional view, the station *V* is shown directly underneath the punch *B* in correct position for heading a case. The station *S* is in the fourth position, in which the headed case is ejected. A 4 1/2-in. hydraulic cylinder *L* (shown more clearly in the minor section) is located

immediately beneath this position. An operating lever *J* actuates the three-way valve *K* which controls the plunger in the ejecting cylinder. When this is caused to rise, it pushes the cartridge case upward until the flange of the case is caught by the spring jaws of the stripping device *O*.

An enlarged view of the station tool-block is shown in Fig. 476, and reference to this will be helpful before taking up the description of the heading operation. The die consists essentially of three parts—the base ring *F*, which is bolted within the table-station block and which does not come in contact with the brass cartridge case; the upper ring *E*, which takes the radial pressure caused by the heading operation; and the internal die *B*, the top of which conforms to the shape of the inside of the cartridge base.

During the heading operation on the station *V*, the base of the die *B*, indicated at *D*, rests upon the top of the 37-in. plunger, which raises the entire dial table. While this is in its high position, the ejecting plunger under the station *S* is brought into action, pushing the die *B* upward within the base ring. It will be noted that there is a possible movement of  $5\frac{1}{4}$  in. for this, which is enough to eject the finished case into the stripping device.

At the station *T*, Fig. 476, is the loading position. Here the cases are inserted into the composite die, being hammered down with a block of wood, when necessary. The station *U* is an idle position.

**The Process of Heading.**—The process of heading as done at Angus, is shown in Fig. 477. The case as it comes to the heading press is shown

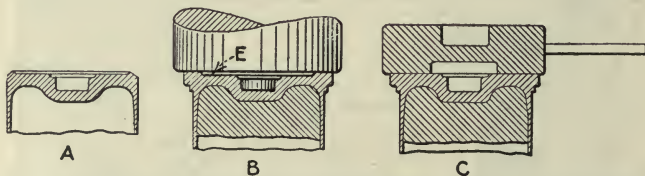

FIG. 477. STAGES IN CASE-HEADING THE 18-LB. BRASS CARTRIDGE CASE

at *A*. The first pressing operation, shown at *B*, partially heads the cartridge, but leaves a depression in its central part, as shown at *E*. This is not the final shape of the headed case, the depression being provided in order to spread the metal and make the operation easier. The third step, in which this top surface is smoothed out with a fullering die, is shown at *C*. After the press has performed the operation *B*, the table is lowered and the fullering die is inserted under the stationary punch, it being provided with a recess that fits the protruding part of the latter and centers the fullering block. It is held here by hand while the work is given another squeeze, which produces the smooth, flat surface shown at *C*.

Four men are required to operate one of these presses—the man in charge of the gang operates the machine levers; one of the others takes care of the loading station; another holds the fullering die in the pressing

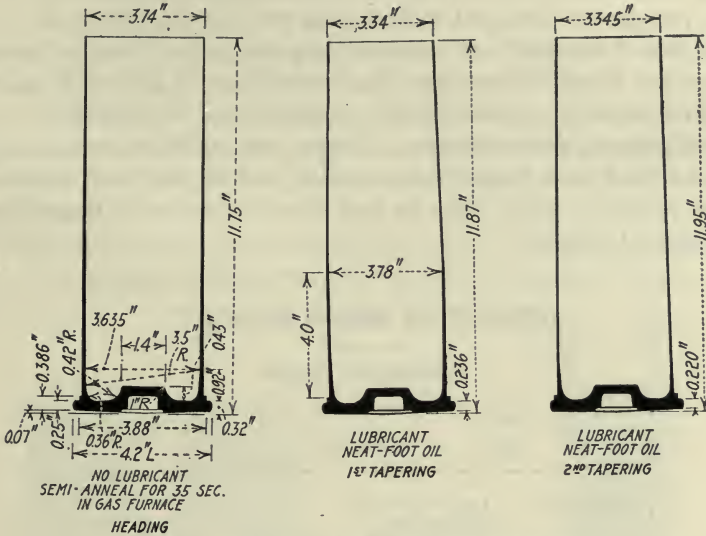

FIG. 478. HEADING AND TAPERING OPERATIONS

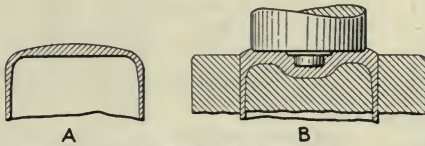

FIG. 479. PUNCH AND DIE USED IN INDENTING

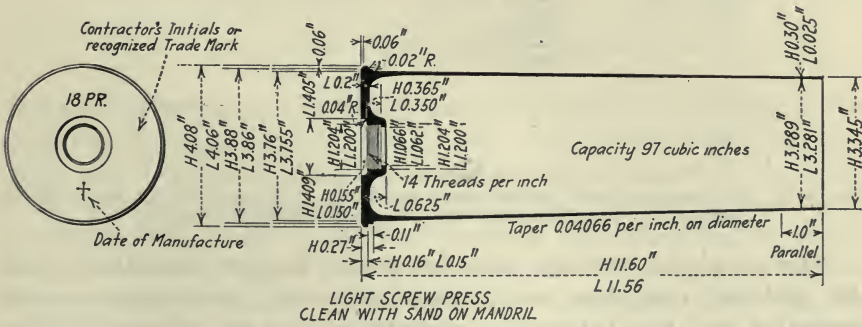

FIG. 480

operation and a third helper takes the extracted shell from the stripper and places it in the tote box. The entire time for the operation is approximately 1½ min.

The full capacity of the press appears to be required to take care of the leading operations.

Details of the cartridge case after the heading operation and after the first and second tapering operations are given in Fig. 478.

The punch and die used in indenting are shown in Fig. 479. At *A* is the section of the shell as it comes to the press, while *B* shows the indenting operation completed and also the construction of the punch and compound die, which are quite similar to those used for heading.

**The Hydraulic Accumulators.**—These accumulators consist of sheet-iron tanks filled with pieces of scrap steel and the like and mounted on cast-iron cylinders which slide up and down on cast-iron rams mounted on substantial bases.

DEFECTIVE WORK REPORT.		FORM C. C. 3.
CARTRIDGE CASES		
Firm.		
LOT	Total Examined	Date.
RECTIFIABLE	High to Chamber gage Low Primer Hole High to Plug Gauge High to Length Low to Horse-Shoe Gauge for body Low to Plug Gauge High Thickness of Metal at mouth High Thickness of flange Toolmarks on body (slight)	_____
	Rectified & Passed	_____
NOT RECTIFIABLE	High Primer Hole High Diameter top of threads Low Thickness of Metal at mouth Low Thickness of flange Low to Length (over .05") Toolmarks in body (deep) Flaws Spilly Metal Spontaneous Splits Damaged threads	_____
	Rejected	Total
		_____
		Examiner.

FIG. 481. WAR DEPARTMENT INSPECTOR'S REPORT. THIS SHOWS THE DIFFERENCE BETWEEN "RECTIFIABLE" AND "NONRECTIFIABLE" ERRORS

The completed cartridge cases (see detail Fig. 480), notwithstanding the rigid shop inspection, must pass an exceedingly severe government inspection and test before final acceptance, and the remarkably few rejected cartridge cases speak volumes for the excellence of the workmanship in the Angus shops and the efficiency of bulldozers and frog planers in precise drawing operations.

**Methods of Inspecting and Testing.**—The government inspectors carefully search for defective shells, as a flaw in one of these would cause



much injury to a field gun. One of the defective work reports is shown in Fig. 481 and will serve to illustrate the nature of the defects as they are classified. Some of them are rectifiable and others cause the immediate and absolute rejection of the case.

Two cases out of every 400 are subjected to government tests, which are known as the proof and firing tests. The former is conducted by subjecting the shell to explosions, the pressures of which are carefully measured. It may be wondered how the intensity of an explosion can be measured. This is very simply done by the arrangement shown in Figs. 482 and 483, which is a device purposely constructed for finding such pressure.

A steel cylinder *A* is provided with a cap *B* in which the piston *C* fits snugly, its top surface being exposed to the air through the cap *B* and

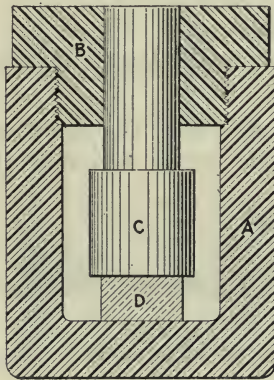

FIG. 482

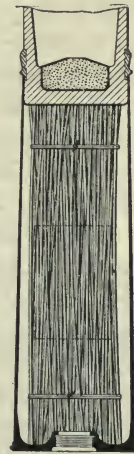

FIG. 483

FIGS. 482 AND 483. PROOF-PRESSURE TESTING DEVICE

its lower surface resting upon the soft copper plug *D*. In making the proof test, this apparatus is placed inside of the cordite within the cartridge case. When the charge is exploded, the gas pressure, being equal in all directions, presses upon the plunger *C*, Fig. 482, with a certain force per square inch, which causes it to compress the copper disk *D*, which has been carefully turned to a definite size and the resistance of which to compression is known. With these factors constant, measuring the increase in the diameter of the disk gives a definite measure of the intensity of the explosion pressure.

**Tensile Strength of the Brass.**—To stand up against this severe service, the material used for making cartridge cases must be selected with great care. Some typical tests of the strength of this annealed brass are given below.

Tensile strength, tons	Yield, tons	Elongation in 2 in., per cent.
20.1	5.45	67.0
20.1	6.38	70.0
20.5	4.37	62.0
20.6	6.02	58.5

**Piece Prices on Machine Operations.**—All of the work on cartridge cases at Angus is done on a piece-work basis. Some of the pieces are reproduced below and show that even with machines far different from those that would be considered suitable for this purpose, an excessive labor cost may be avoided.

**Cupping**—One operator and helper. Helper to fill tank with disks and 13 boxes of 34 at the rear of machine and return empties. Per 100—27c.

**First Draw**—One operator and two helpers. (Double operation.) Helper to fill tanks with cups, 12 boxes of 36, one box of 10 and return empties. Per 100—21c.

**Trimming**—Operator only. Per 100—18c.

**Buffing**—Operator only. Per 100—10c.

**Tapering**—Oil and taper (first and second complete). Operator and helper. Per 100—52c.

**Piece Prices for Handling and Washing.**—Even the operations performed by laborers are worked out and paid for on a piece-work basis, some of the prices being as follows:

**Wash**—In lye or water. Per 100—10c.

**Wash**—In acid. Per 100—20c.

**Trucking**—To or from wash tubs to machine (in cartridge department). Per lot of 442—20c.

**Trucking**—To or from wash tubs to annealing ovens (blacksmith shop). Per lot of 442—45c.

**Annealing Ovens**—Operator and four helpers. Remove from boxes and replace after annealed ready for trucking. Per 100—33c.

## CHAPTER IV

### MAKING THE 4.5-IN. HOWITZER CARTRIDGE CASE<sup>1</sup>

The Worcester Pressed Steel Co., Worcester, Mass., undertook to furnish the British Government with 4.5-in. British howitzer cartridge

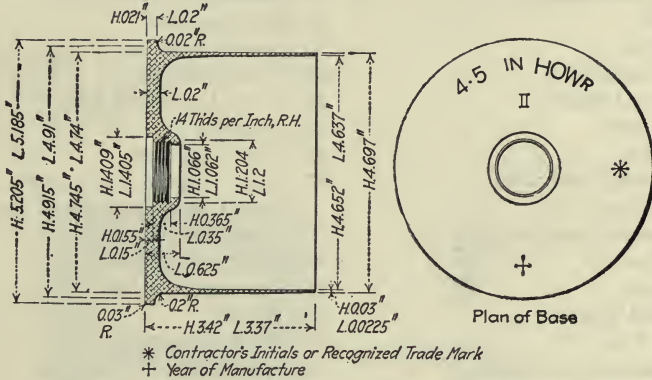

FIG. 484. DETAIL OF 4.5-IN. HOWITZER CARTRIDGE CASE

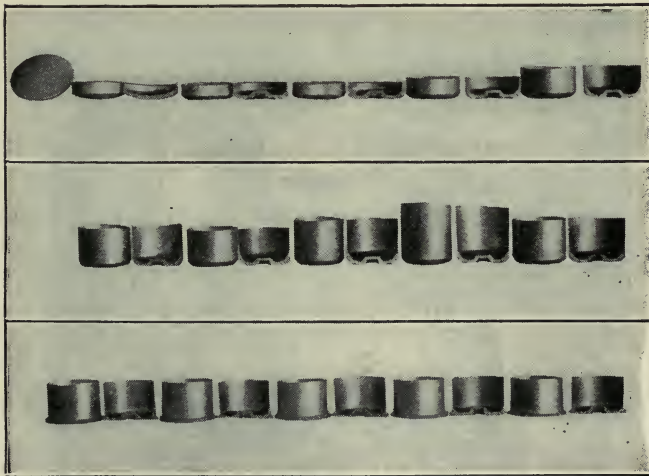

FIG. 485. VARIOUS STAGES OF 4.5-IN. CARTRIDGE CASE FROM BLANK TO FINISHED PART

cases at a rate of some 75,000 per week and in fulfilling this contract developed a highly efficient system of manufacture.

The brass from which these cartridge cases (see Fig. 484) were made—

<sup>1</sup> Robert Mawson, Associate Editor, *American Machinist*.

analyzing 70 per cent. copper and 30 per cent. spelter—was purchased in the form of flat disks measuring  $5\frac{3}{8}$  in. in diameter by 0.30 in. in thickness. Thirty-odd operations converted these disks into completed cartridge cases, see Fig. 485. The sequence of operations is given in the accompanying table, and the principle operations are illustrated by sketches and brief data.

TABLE OF SEQUENCE OF OPERATIONS

1. Blank—purchased	18. Wash
2. Cupping	19. First heading
3. First indent	20. Second heading
4. Second indent	21. Final trimming
5. Anneal and pickle	22. Pierce for primer hole
6. Flatten base	23. Tapering
7. First draw	24. Shop inspection
8. Wash, anneal and pickle	25. Face, square to length, rough-thread and counterbore for primer
9. Second draw	26. Finish-thread
10. Wash, anneal and pickle	27. Finish-counterbore
11. Third draw	28. Face inside of boss
12. Trimming	29. Wash
13. Wash and pickle	30. Final inspection
14. Fourth draw	31. Stamping
15. Wash, anneal and pickle	32. Packing
16. Fifth draw	
17. Trimming	

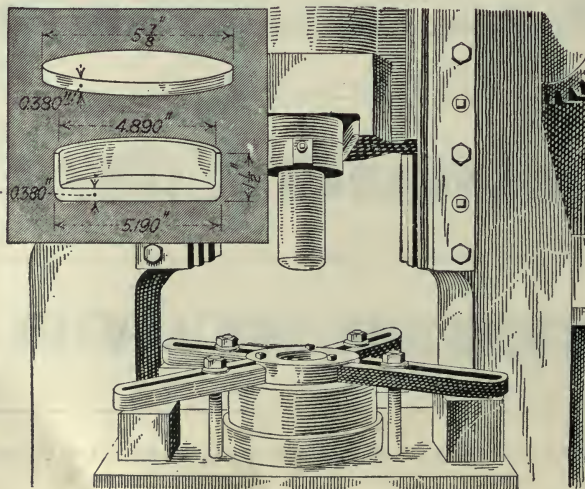

OPERATION 2. CUPPING

Machine Used—12-in. stroke Bliss.

Production—550 per hr.

Pressure—210 tons.

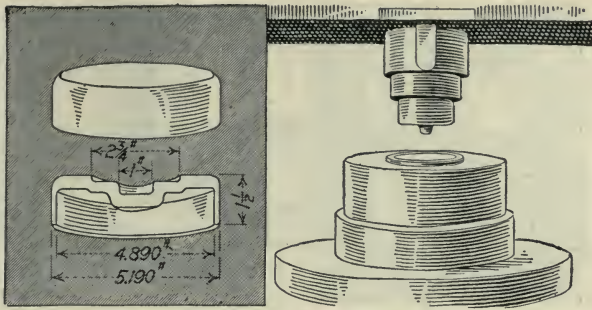

OPERATION 3. FIRST INDENT

Machine Used—Toledo 18-in. stroke.  
 Production—500 per hr.  
 Pressure—400 tons.

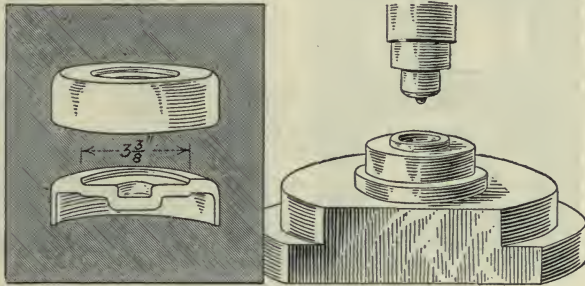

OPERATION 4. SECOND INDENT

Machine Used—Toledo 26-in. stroke.  
 Production—450 per hr.  
 Pressure—400 tons.

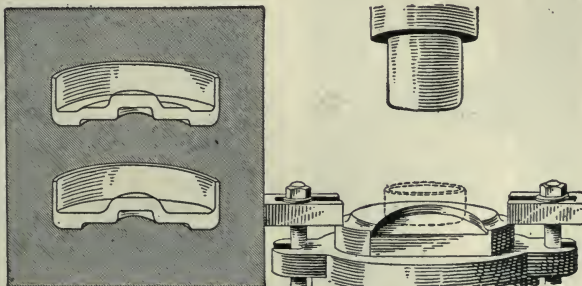

OPERATION 6. FLATTENING BASE

Machine Used—Toledo 8-in. stroke.  
 Production—1,100 per hr.  
 Pressure—100 tons.

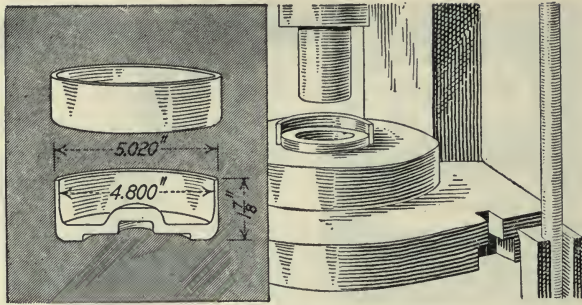

OPERATION 7. FIRST DRAW

Machine Used—Toledo 8-in. stroke.  
 Production—900 per hr.  
 Pressure—100 tons.

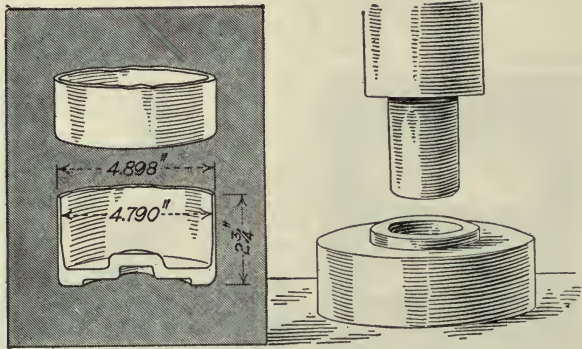

OPERATION 9. SECOND DRAW

Machine Used—Bliss 12-in. stroke.  
 Production—550 per hr.  
 Pressure—75 tons.

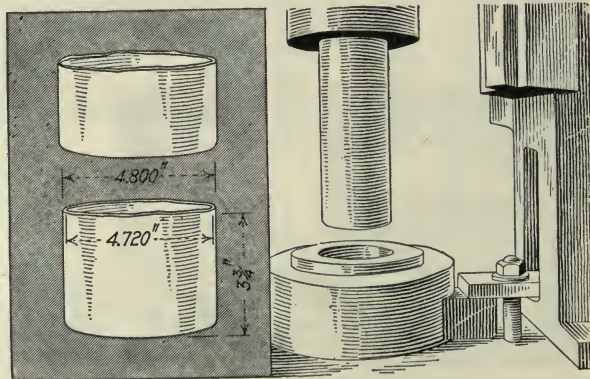

OPERATION 11. THIRD DRAW

Machine Used—Bliss 12-in. stroke.  
 Production—550 per hr.  
 Pressure—75 tons.

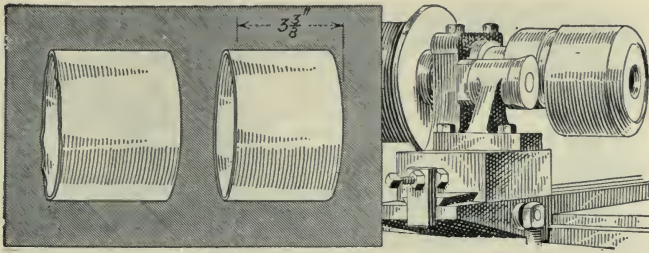

OPERATION 12. TRIMMING

Machine Used—Special high-speed lathe.  
 Production—250 per hr.

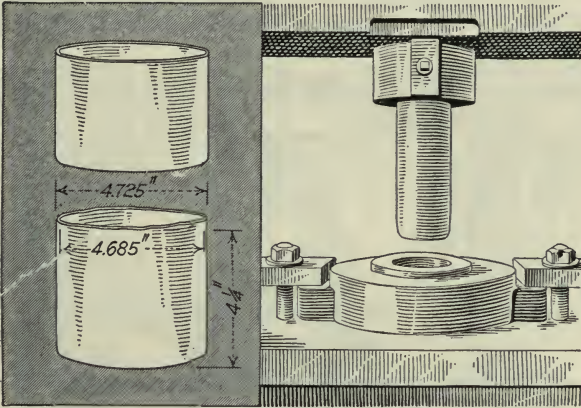

OPERATION 14. FOURTH DRAW

Machine Used—Bliss 12-in. stroke.  
 Production—550 per hr.

Pressure—75 tons.

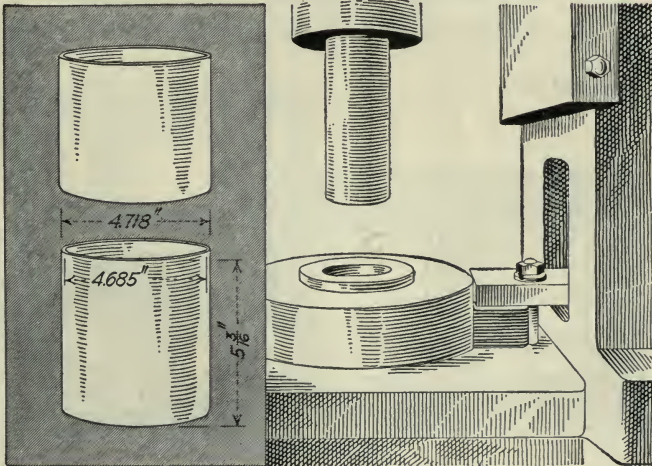

OPERATION 16. FIFTH DRAW

Machine Used—Bliss 12-in. stroke.  
 Production—450 per hr.

Pressure—60 tons.

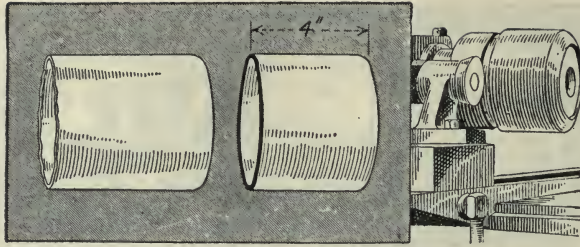

OPERATION 17. TRIMMING

Machine Used—Special high-speed lathe with chuck and trimming attachment.  
Production—270 per hr.

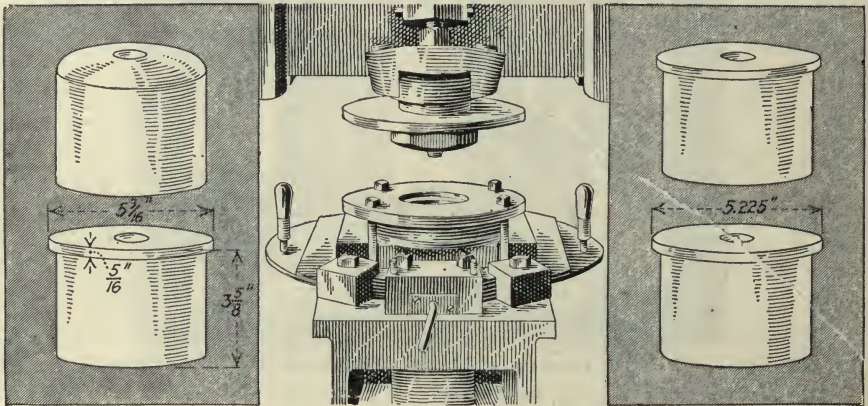

OPERATIONS 19 AND 20. FIRST AND SECOND HEADING

Machines Used—Waterbury Farrell foundry (hydraulic) 6-in. stroke press; Toledo 2½-in. stroke press.

Production—260 per hr.

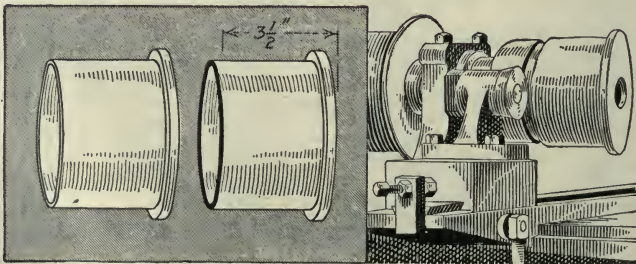

OPERATION 21. FINAL TRIMMING

Machine Used—Special high-speed lathe with chuck and trimming attachment.  
Production—270 per hr.



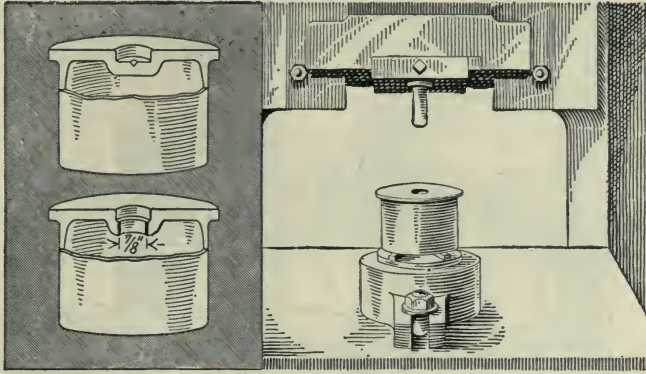

OPERATION 22. PIERCING

Machine Used—Toledo 5-in. stroke press.

Production—500 per hr.

Pressure—5 tons.

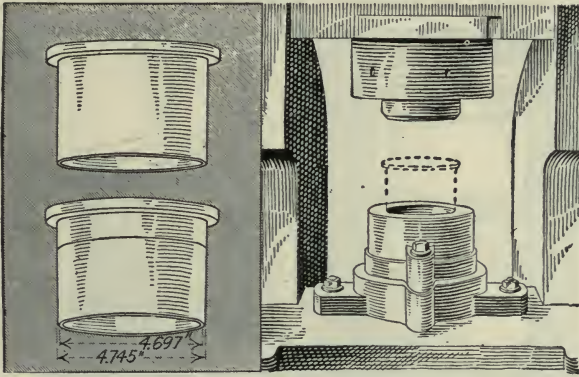

OPERATION 23. TAPERING

Machine Used—Bliss 6-in. stroke press.

Production—400 per hr.

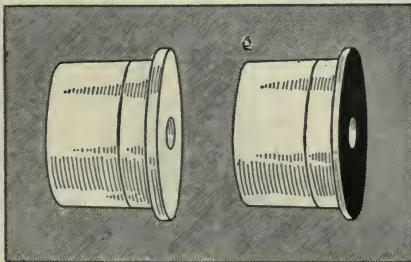

OPERATION 25. FACE, SQUARE TO LENGTH, ROUGH-THREAD AND COUNTER-BORE FOR PRIMER

Machine Used—Warner & Swasey turret lathe.

Production—70 per hr.

Lubricant—All surfaces machined dry except threading, on which lard oil is used.

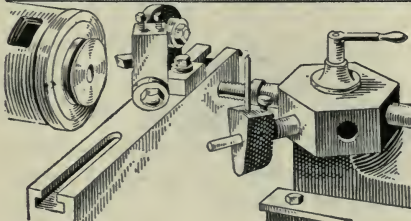

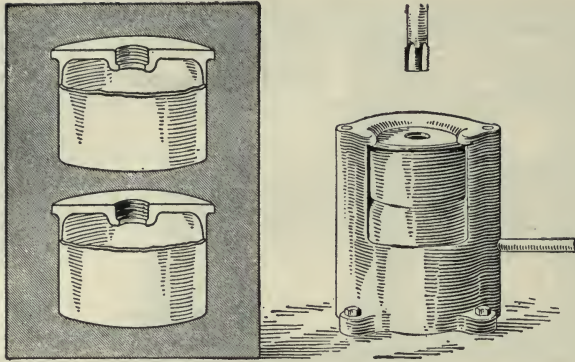

OPERATION 26. FINISH-THREAD

Machine Used—Snyder drilling machine.

Production—380 per hr.

Lubricant—Lard oil.

Note—Pilot used but not shown in the above illustration.

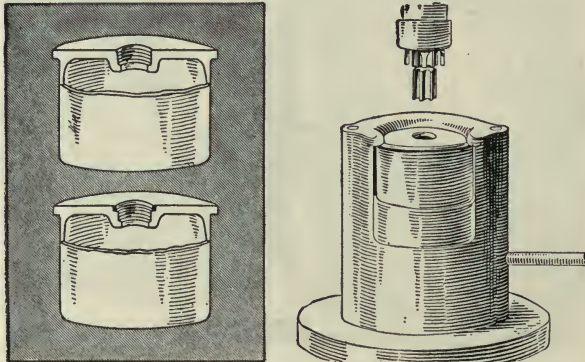

OPERATION 27. FINISH-COUNTERBORE

Machines Used—Leland-Gifford and Barnes drilling machines.

Production—380 per hr.

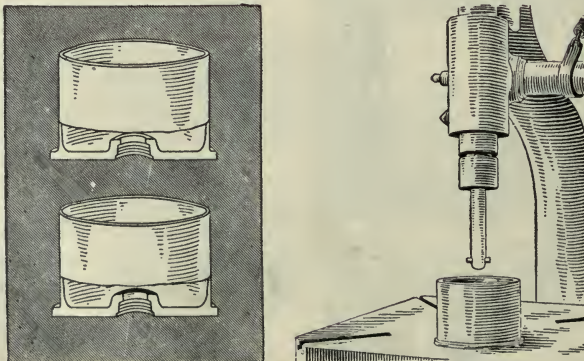

OPERATION 28. FINISH INSIDE BOSS

Machines Used—Barnes and Dwight-Slate drilling machines.

Production—380 per hr.

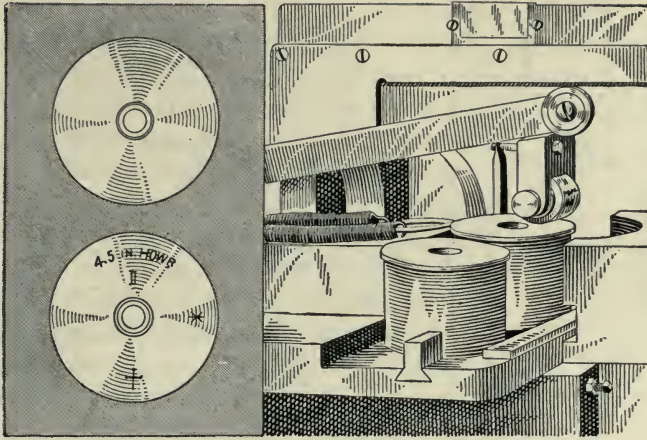

OPERATION 31. STAMPING

Machine Used—Dwight-Slate marking machine.  
 Production—1,200 per hr.

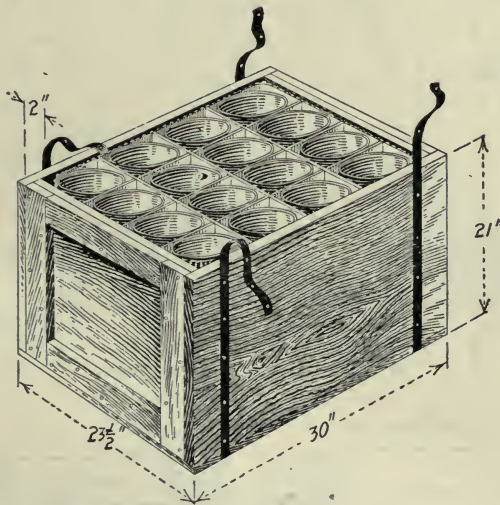

OPERATION 32. PACKING

Production—One man packs 1,200 per hr.; one man fastens up boxes.

The blanks are first subjected to a cupping operation on a Bliss press with 12-in. stroke, the punch shown in Fig. 486 and the die shown in Fig. 487 being used for this work. During this and the subsequent punch press operations the cases are lubricated with Lub-a-Tube made into a solution with the proportions of 30 lb. of the composition to 50 gal. of water.



The next operation is making the first indent. This is done on an 18-in. Toledo press. The punch, Fig. 488, and the die, bolster and center-section knock-out, Fig. 489, are used. The punch is fastened to the punch press with a holder similar to that for the cupping operation.

The part then receives a second indenting on a 26-in. Toledo press. The reason for this second indenting operation is that a better case is produced than if the two operations were performed at one time and, as is obvious, it avoids the use of an extra-large press. For this work, the punch, Fig. 490, the die bolster and the center-section knock-out, Fig. 489, are utilized; also the punch holder, Fig. 486.

The next process is annealing and pickling the parts. They are placed on trays and slid into a crude-oil oven, Fig. 491. Three such ovens are provided at the factory for this work, each one holding four 44-in. square pans, in each of which approximately 110 cartridge cases may be placed. The ovens are kept at a temperature of 1,250 deg. F., and the cases are left in the ovens 36 min. The annealing operation is conducted so that a pan is removed from the rear of the oven every

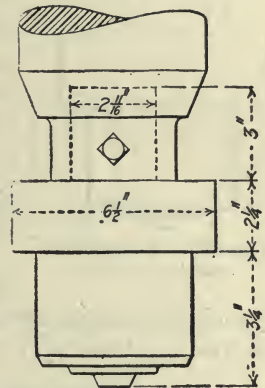

FIG. 488. THE PUNCH

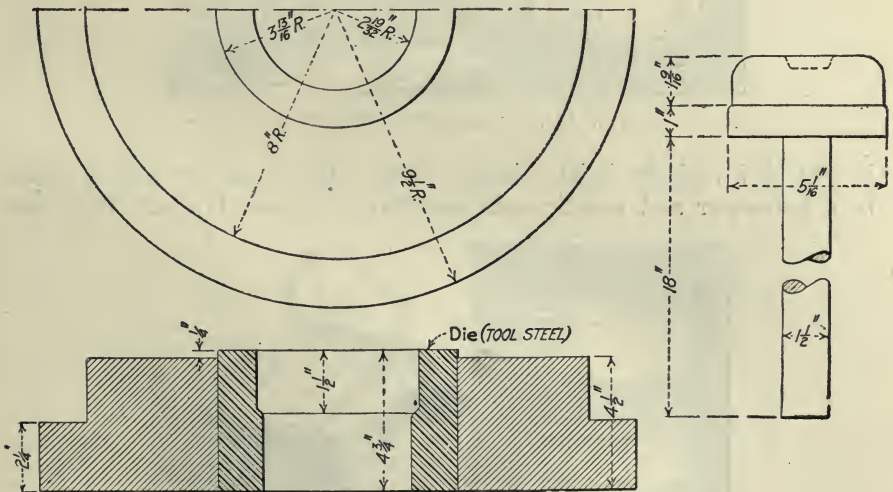

FIG. 489. DIE, BOLSTER AND CENTER-SECTION KNOCK-OUT

9 min. As the pan is removed, another is placed at the front of the oven. This procedure enables the annealing operation to be a continuous one. The three ovens anneal 11,000 cases in 24 hr., requiring 504 gal. of oil.

When the pan has been taken from the oven, the cases are quenched in cold water. They are then conveyed, by means of a 1,000-lb. air hoist, to the pickling tanks, Fig. 492. The solution consists of one part sulphuric acid to ten parts water. The cases remain in the pickling tank about 5 min. The parts are then carried to an 8-in. Toledo punch press where the base is flattened, so that the cases will present a good surface for the first drawing operation, in which the punch and die, Fig. 493, are used. The die is held with bolts on the bolster, Fig. 494. The punch is placed in the holder, Fig. 486.

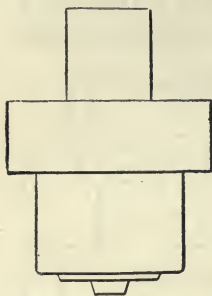

FIG. 490. PUNCH FOR SECOND INDENT

The case is now ready for the drawing operations. The first of these is performed in Toledo punch press, 8-in. stroke. The drawing punches, Fig. 495, are fastened to the machine by the punch holder, Fig. 486. The die is illustrated

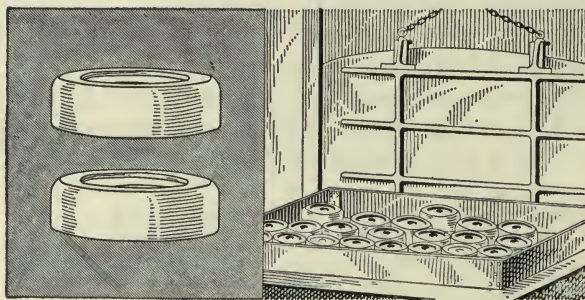

FIG. 491. ANNEALING OPERATION

in Fig. 487 and the bolster in Fig. 494. The cases are then washed in a hot-water and caustic soda solution for about 1 min. They are

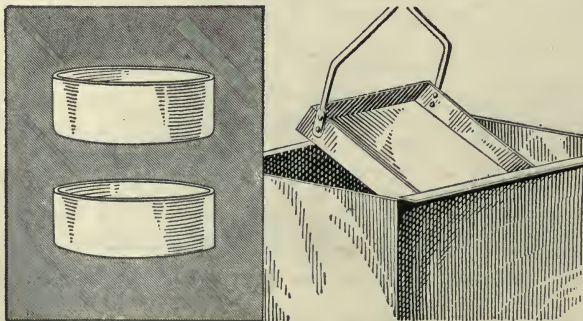

FIG. 492. PICKLING OPERATION

afterward annealed, quenched in cold water and pickled in a similar manner to that described for operation 5.

The parts are then conveyed to a 12-in. Bliss press, for the second drawing. The punch, Fig. 495, inserted in the holder, Fig. 486, and the die, Fig. 487, held in the bolster, Fig. 490, are the tools for this second

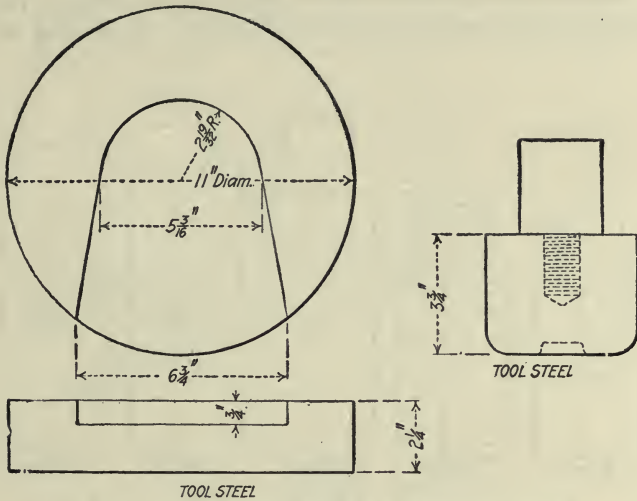

FIG. 493. PUNCH AND DIES FOR FLATTENING BASE

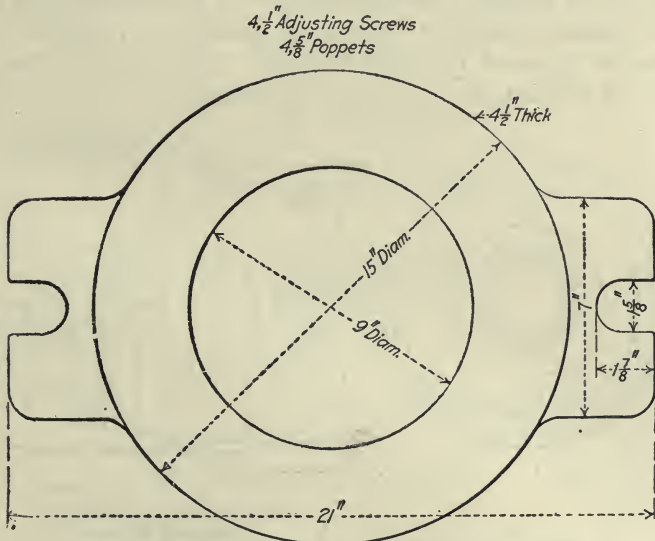

FIG. 494. BOLSTER FOR BASE-FLATTENING DIE

drawing operation. The cases are then washed, annealed and pickled in a manner similar to that described in operations 5 and 8.

The next operation, the third drawing, is performed on a similar Bliss press. The tools are a punch, Fig. 495, a punch holder, Fig. 486, a die, Fig. 487, and a bolster, Fig. 490.







The cases are then ready for the fifth, or final, drawing operation. This is performed on another Bliss punch, 12-in. stroke. Details of the tools for this operation are given in the following illustrations:

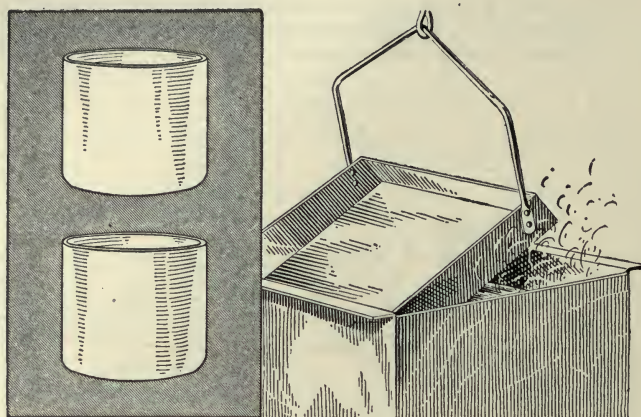

FIG. 498. WASHING OPERATION

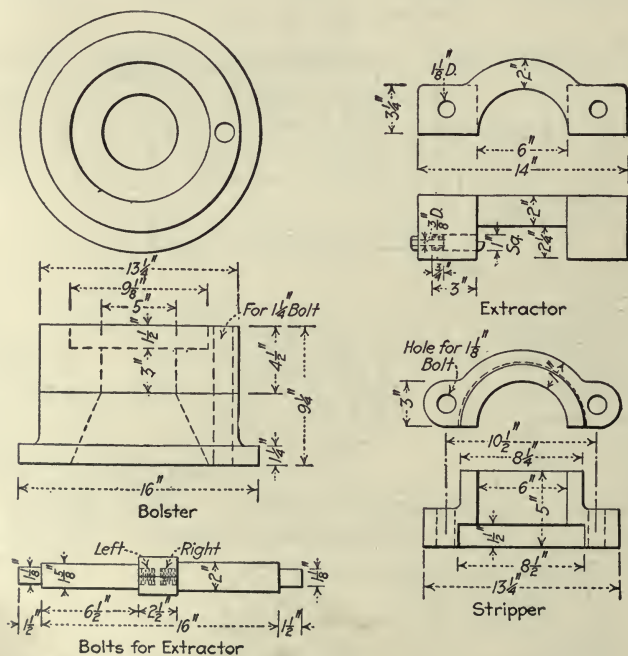

FIG. 499. DETAILS FOR HYDRAULIC PRESS

Punch, Fig. 495; punch holder, Fig. 486; die, Fig. 487, and bolster, Fig. 490. This operation completes the drawing work performed on the cartridge case.

After the final drawing operation the cartridge cases are taken to a special high-speed lathe and trimmed to 4 in. in length. The same tools are again used, as shown in detail in Fig. 496, with the exception that there is another guide chuck to suit the diameter of the case and the

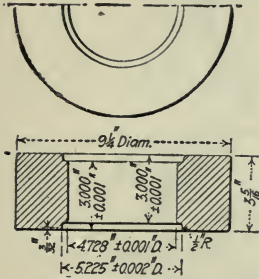

FIG. 500. HEADING DIE FOR HYDRAULIC PRESS

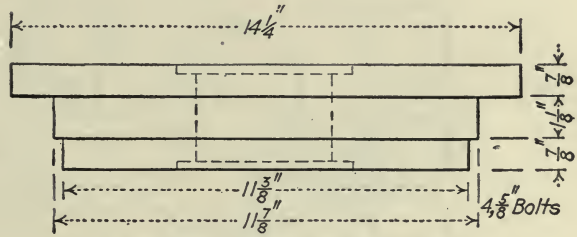

FIG. 501. DIE FOR POWER PRESS

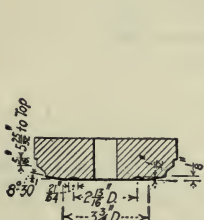

FIG. 502. FIRST HEADING PUNCH

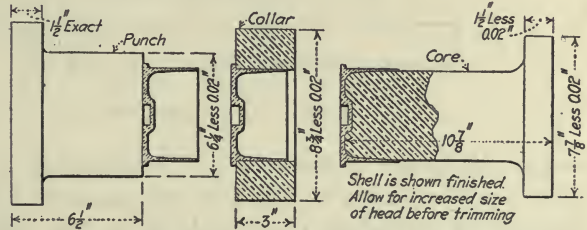

FIG. 503. KNOCK-OUT FOR HYDRAULIC PRESS

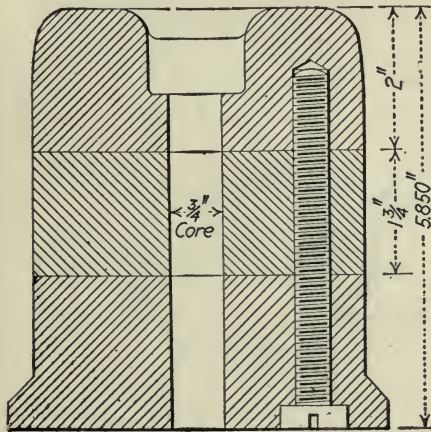

FIG. 504. KNOCK-OUT FOR POWER PRESS

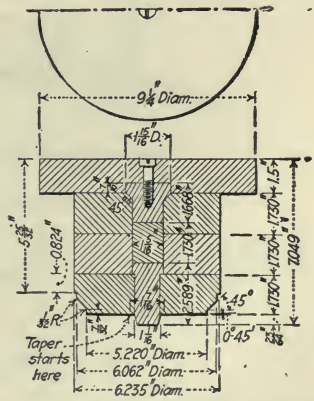

FIG. 505. SECOND HEADING PUNCH

length it is to be trimmed. The rate of production for the operation is 270 per hour. The cartridge cases are washed for about 1 min. in a solution of hot water and caustic soda, to clean them. The tank held

in position ready for receiving shells to be dipped in the solution of hot water and caustic soda is shown in diagrammatical form in Fig. 498.

The next operation is the heading. This work is performed in both hydraulic and power presses. The operation is divided into first and

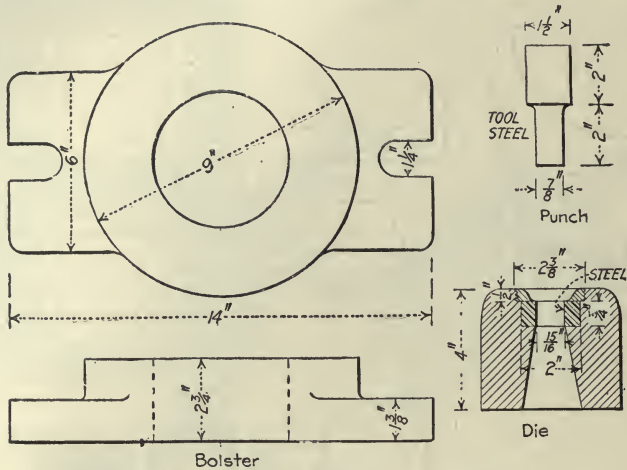

FIG. 506. TOOLS FOR PIERCING OPERATION

second heading. Details of the attachments fitted to the hydraulic press are illustrated in Fig. 499 and die used is illustrated in Fig. 500. The die for the power press is shown in Fig. 501. The punch for both the hydraulic and the power press for the first heading is seen in Fig.

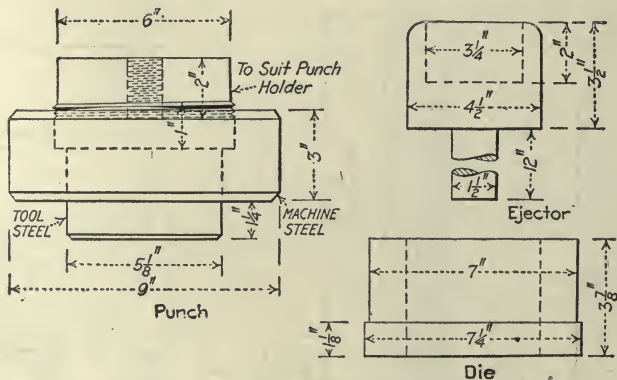

FIG. 507. TOOLS FOR TAPERING

502. The knock-out used in the hydraulic is shown in Fig. 503 and that for the power press in Fig. 504. For the second heading the same tools are employed, with the exception of the punch, which is illustrated in Fig. 505.

The cases are then trimmed to 3 1/2-in. length in a manner similar to

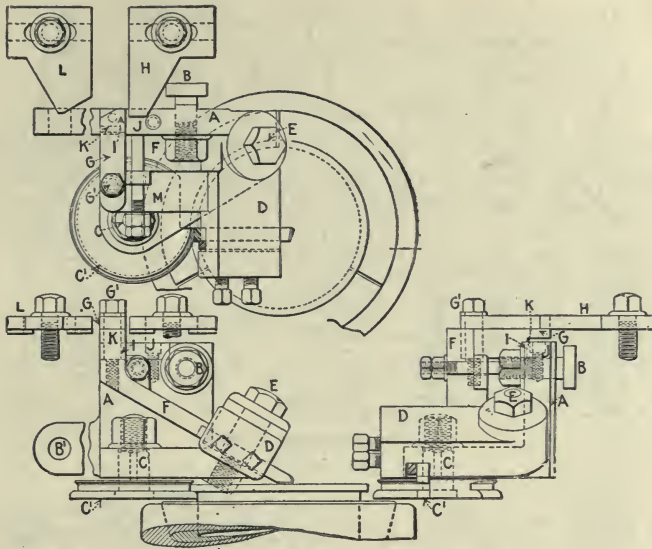

FIG. 508. SET UP OF TOOLS

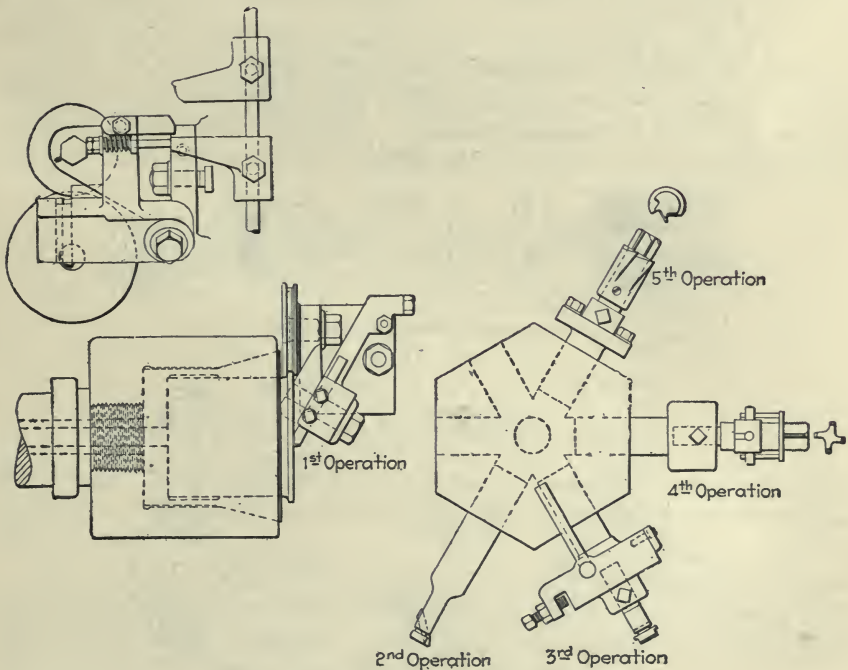

FIG. 509. LAYOUT OF TURRET TOOLS



that previously described. This operation is performed on the special high-speed lathe, with the same tools, substituting a chuck to suit the length of the case being trimmed. The rate of production for this operation is approximately the same as for operation 17.

The next operation is piercing for the primer hole. The punch press for this operation is a Toledo 5-in. stroke press. The punch, die and bolster for the piercing operation are shown in Fig. 506. The cases are then

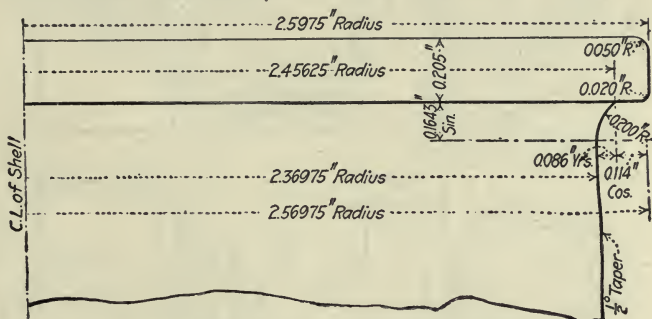

FIG. 511. DETAIL OF HEAD OF CASE

ready for the tapering operation. The machine used on this work is a 6-in. Bliss press. The punch, ejector, die, and bolster, Fig. 507, are employed for the tapering operation.

From the trimming machine to the piercing and then to the tapering presses, the cartridge cases are transferred by means of inclined wooden troughs, down which they slide. After being tapered the cases are slid down a short wooden chute feeding an inclined chain conveyor of the

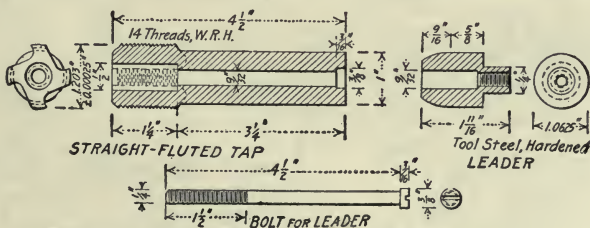

FIG. 512. DETAILS OF TAP AND PILOT

flight type. This conveyor delivers the cartridge cases to an upper floor, where they are given a thorough shop inspection before the remaining operations are undertaken.

The next operation is facing, squaring to length, rough-threading and counterboring for the primer. Details of the tools used are given in Figs. 508, 509 and 510a-d, while a detail of the shape required on the head is presented in Fig. 511.

The next operation is finish tapping the primer hole. This is done in a drill press, with a tap fitted with a pilot, so that the thread will be

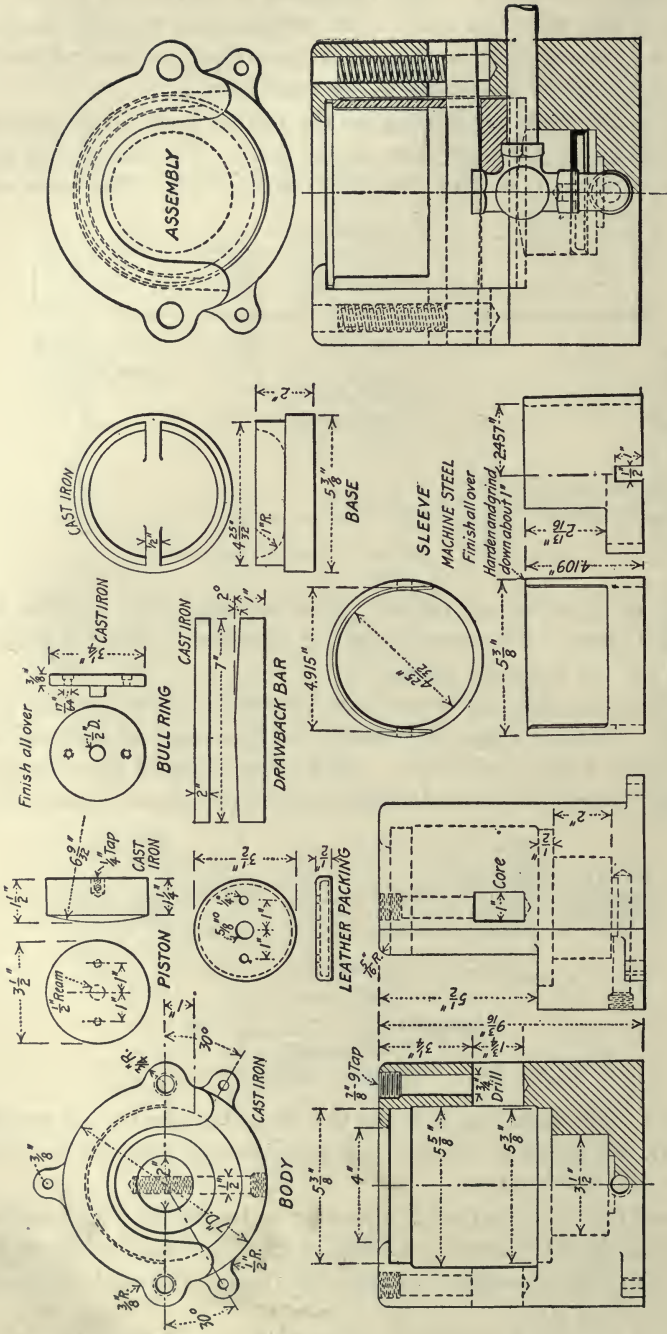

FIG. 513. PNEUMATIC HOLDING CHUCK



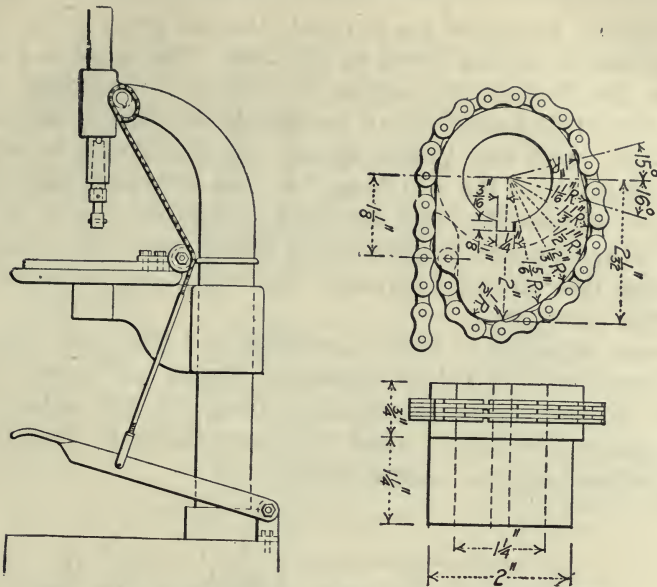

FIG. 514. ASSEMBLY AND DETAIL OF CAM ATTACHMENT

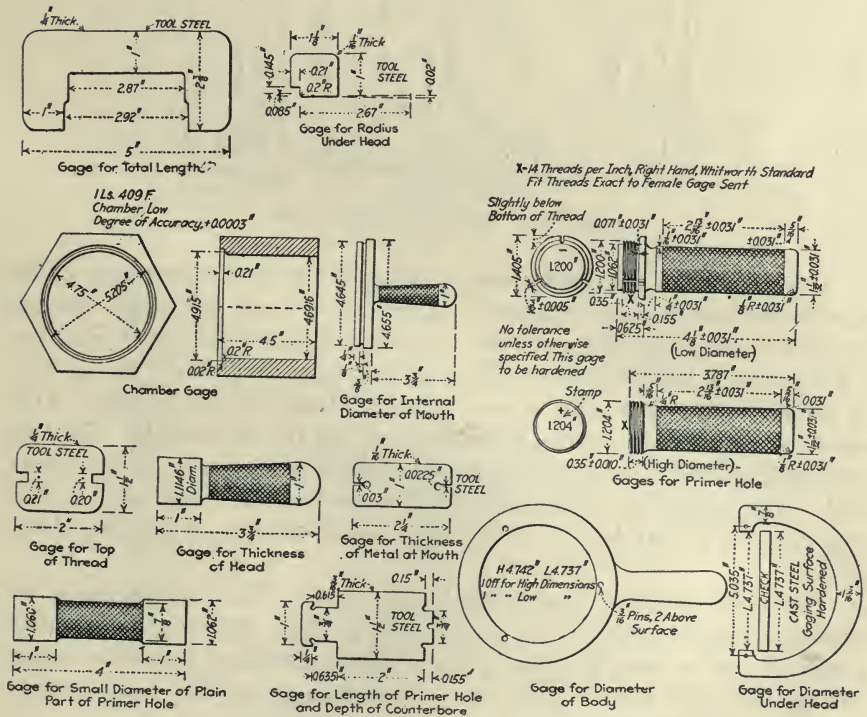

FIG. 515. GAGES FOR 4.5 HOWITZER CASE

tapped square. Details of the tap and pilot are given in Fig. 512 and of the pneumatic holding chuck in Fig. 513. The novel and valuable feature of this chuck is the method of locating the cartridge case. It will be observed that when the air pressure is admitted to the chuck the case is raised. It is then located against a finished flange on the chuck. As the outside face of the case flange has been accurately machined, the hole tapped and counterbored will thus be square with it, as the tap operates at right angles to the locating face of the chuck. Lard oil is used during this tapping operation, also when rough-tapping in the twenty-fifth operation.

The next operation is finish-counterboring. The drill press set up for this operation is a Leland-Gifford or Barnes drill press. For this operation the same pneumatic holding chuck, Fig. 513, holds the case. The counterbore is shown in detail in Fig. 509 and is the same as used in the fifth suboperation of operation 25.

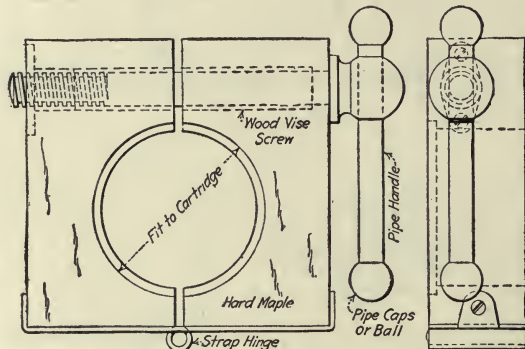

FIG. 516. SPECIAL HOLDING VISE

The surface of the inside boss is faced as the next operation. This is not done to any gage, being only to remove the burr left in the threading and counterboring operations. The machine for this work is either a Barnes or a Dwight-Slate drilling machine (see Fig. 514), the spindle of which is operated with a foot treadle acting through a cam. This revolves a gear that meshes with the rack cut on the spindle. By this arrangement the leverage of the cam is utilized as the force for the facing tool. The cases are then washed in a solution of water and caustic soda, heated to 150 deg. F., where they are allowed to remain for about 10 sec.

The next operation is the final inspection. The various gages for testing the cartridge cases are shown in Fig. 515. In Fig. 516 is shown a special vise to hold the case for any slight operation found necessary during the inspection. The rate of production on the inspection is approximately 65 per hr.

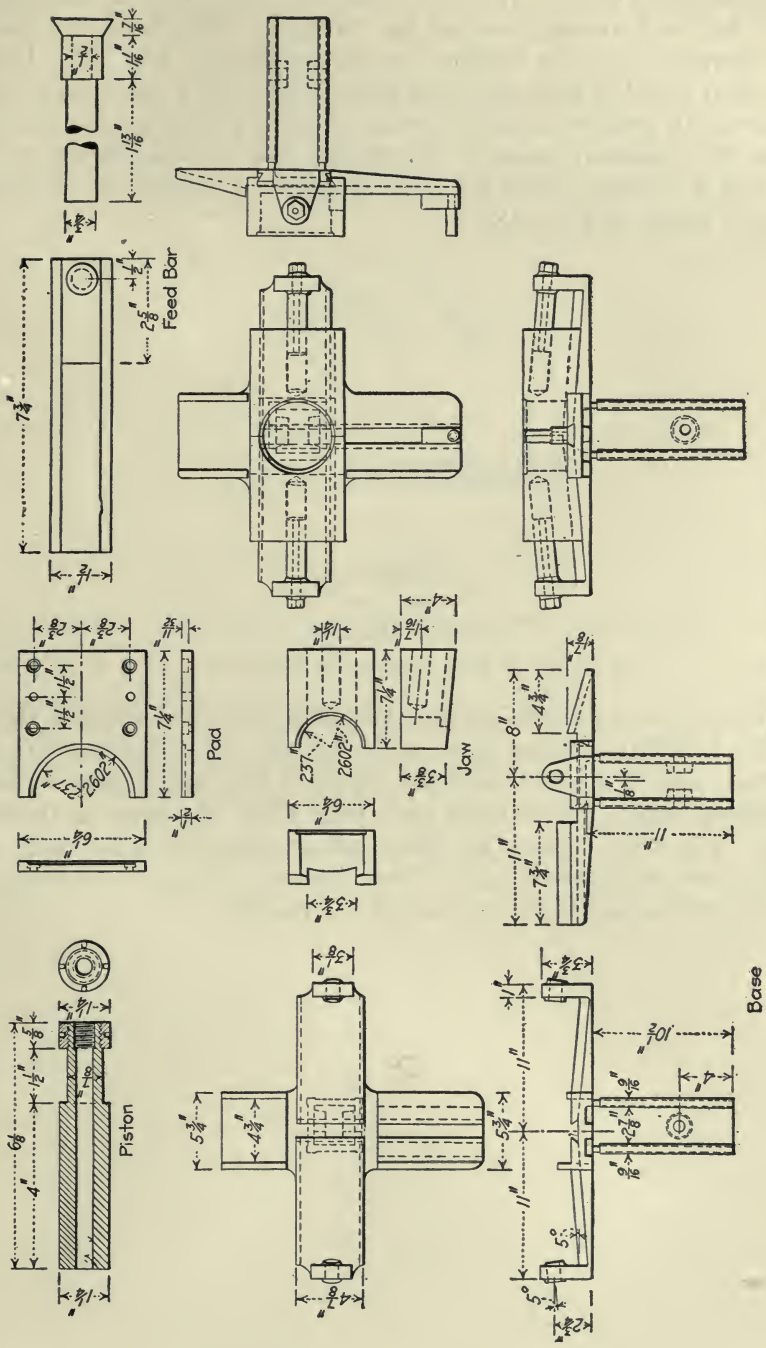

FIG. 517. DETAILS OF HOLDING FIXTURE

The cases are then conveyed, by means of a chute, from the inspection bench to the marking machine for stamping. Details of the special jaws operated by air for holding the case are given in Fig. 517. It will be noticed that the jaws slide on a slight incline. By this means, when the case is in position under the stamp ready for marking, the pressure during the operation comes on the flange, thus avoiding injury to the thin wall of the open end of the cartridge case. A detail of the cartridge stamp is shown in Fig. 518.

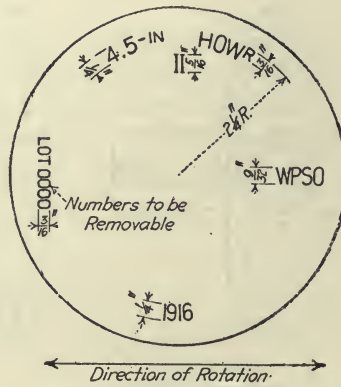

FIG. 518. DETAIL OF STAMP

The final operation is packing for shipment. The wooden case is made to hold 100 cartridge cases, which are placed in 5 layers of 20 each. Between each layer and around the insides of the packing case is placed corrugated paper. After cases have been filled, the cover is fastened down. The wooden cases are then pushed along the roller track and finally down an inclined chute. Such method eliminates any lifting or carrying of the cartridge cases during the packing.

SECTION IV  
FUSES AND PRIMERS

By

FRED H. COLVIN

	PAGE
CHAPTER I. MAKING THE BRITISH DETONATOR FUSE MARK 100.....	623
CHAPTER II. MAKING THE BRITISH TIME FUSE MARK 80-44.....	660
CHAPTER III. MAKING PRIMERS FOR CARTRIDGE CASES.....	705



## CHAPTER I

### THE DETONATOR FUSE—MAKING THE BRITISH DETONATOR MARK 100<sup>1</sup>—MAKING ADAPTERS FOR BRITISH DETONATING FUSE<sup>1</sup>

The function of the detonating head, or fuse, which screws into the nose of the high-explosive shell, is that of exploding the shell when the head strikes any object offering sufficient resistance to set off the explosive material, much in the same way as a cartridge is exploded by the percussion cap in its base. Such an "exploder," known as the British Detonator Mark 100, is shown in Fig. 519.

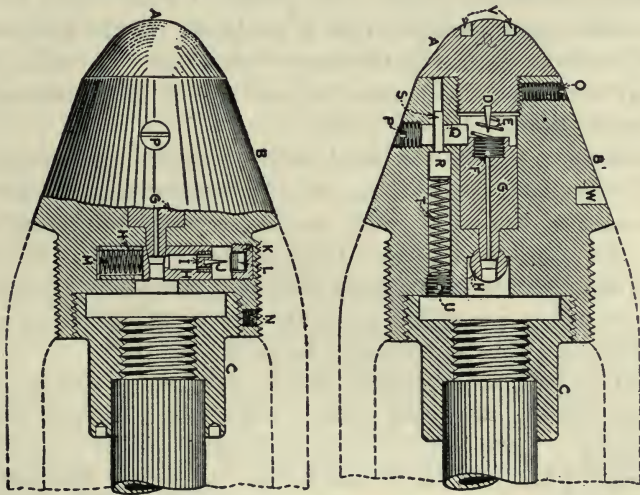

FIG. 519. DETAILS OF BRITISH MARK 100 DETONATING FUSE OR EXPLODER

The percussion or firing material is held at two points, *F* and *L*, the firing mechanism being interlocked so that it is necessary to release the first firing needle before it is possible to fire the second.

In order to make the shells safe to handle, even after the heads *A* and the firing materials are screwed into place, it is necessary to provide a lock so that the graze pellet *G* cannot carry the cap *F* into contact with the needle. This is done by inserting the centrifugal bolt *Q* so that it projects beyond the shoulder of the graze pellet *G* and prevents it being thrown forward toward *D* even if the shell is dropped point downward.

<sup>1</sup> Fred H. Colvin, Associate Editor, *American Machinist*.

The light conical spring *E* is simply to aid in keeping *G* in its place, but is not strong enough to act as a safety in this respect.

When the shell is fired from the gun, however, the acceleration is so great that the inertia of the upper and lower detents *R* and *S*, which are virtually one piece, is enough to compress the spring behind them and allow the centrifugal bolt *Q* to be thrown outward and away from the graze pellet by the centrifugal force set up by the rapid whirling of the shell due to the rifling grooves in the gun. This releases the graze pellet and leaves it free to act as soon as the momentum of the shell is retarded by striking an object.

In order to be sure that the detent does not fly back to lock the centrifugal bolt, the small portion or upper detent is held in a ball joint with a 15-deg. movement. The whirling of the shell throws this out so that when the spring again forces it forward it locks the detent in the large holes.

When this occurs the impact throws the graze pellet forward, forces the percussion material against the needle *D* and shoots the ignition flame down through the center of the graze pellet and the gaine or powder tube to the powder pocket in the base of the shell. To make explosion doubly sure the second percussion device is used, being released by the forward movement of the graze pellet.

The cross or percussion pellet *H* is held against the pressure of the spring *M* by the lower end of the graze pellet fitting into the tapered cross-hole. As soon as the graze pellet shoots forward, the spring forces the percussion pellet needle *J* into the firing material at *L* and sets it off. The fire shoots through the small holes *I* around the needle *J*, through the center of the percussion pellet, and joins the other line of fire on its way to the explosion pocket in the gaine tube.

In addition to the parts mentioned in connection with the operation of the fuse in action, there are several others which present problems in manufacturing. These are the small retaining screws *N*, *O*, *P* and *U*. The wrench-key holes *V* and *W* also require attention, drill jigs for holding and high-speed drilling machines being provided for doing these rapidly and economically. The hole *W* is in reality an oblong slot which must be milled to accommodate the spanner wrench for tightening the head.

Material for these fuses must be approved after being submitted to mechanical test—from test pieces not less than 1 in. in diameter by 7 in. long where practicable. The materials for the fuse are divided into three classes of bronze or copper alloys, with the exception of the adapter, which is made of mild steel of from 28 to 36 tons' tensile strength.

The detents are of phosphor-bronze alloys with a yield point of 20 and a breaking strength of 30 tons. The next class of material must have strength of 12 and 20 tons respectively, while the more unimportant



parts are only required to have a yield point of 8 tons and a breaking point of 20 tons. The elongation demanded is 20 per cent. for the first class, 30 for the second and 20 for the third, while the steel for adapters need elongate but 17 per cent.

These figures, however, are only acceptable if in the test piece furnished the length divided by the square root of the area equals 4. This interpreted into shop language means that the square root of the area of the test piece multiplied by 4 gives the effective length or the distance between grips in the testing machine, and with this setting the piece must give the elongation shown.

The exact composition of these alloys is left to the manufacturer, the only requirement being that they come up to the physical requirement specified.

After completion the outside of the fuse and the inside of the adapter must be coated with a lacquer of specified composition.

All screw threads must be of the British standard fine thread. These have the Whitworth form, but differ in pitch from bolt standards.

Fuses are delivered in lots of 1,000, plus five extra fuses for testing purposes. The five extra fuses are fired with filled shells at 1 deg. elevation over sand, to be sure the fuse acts correctly on impact. Should one of the five test shells be "blind," or fail to explode, a second proof may be taken of five more selected at random from the lot of 1,000. A second blind fuse condemns the lot. This gives some idea of the accuracy required in this work.

#### MAKING THE BRITISH DETONATOR MARK 100

The body of the detonator fuse is made from a forged-brass casting, the cast plug with dimensions being shown in Fig. 520. These castings are an alloy of 60 per cent. copper and approximately 40 per cent. zinc, with traces of antimony, phosphorus and manganese. These slugs are cast  $1\frac{5}{16}$  in. in diameter at the large end and  $3\frac{3}{4}$  in. long, the detailed dimensions being as shown.

In the new Boston plant of the American Steam, Gauge and Valve Manufacturing Co., the brass castings, slugs, are heated in oil furnaces of the Chicago Flexible Shaft Co. to a forging heat of about 1,500 deg. and placed in the screw press, which is rated by the makers, Zeh & Hahne-man, as having a capacity of 150 tons' pressure. Two of these presses are used, each capable of handling 10 to 12 slugs a minute, or 600 to 720 per hr.

The slugs are pressed to a length of  $2\frac{7}{8}$  in., into the shape shown, reducing the volume about 15 per cent. and making the metal much more dense. The straight portion on the nose is for ease in chucking for the first operation.

The dies for this slug are 6 in. square by  $4\frac{1}{2}$  in. thick and best results are obtained with a lubricant made up of water and mineral lard oil in the usual proportions, with the addition of graphite and white soda ash. These are measured in a small wooden box which gives about 13 cu. in.

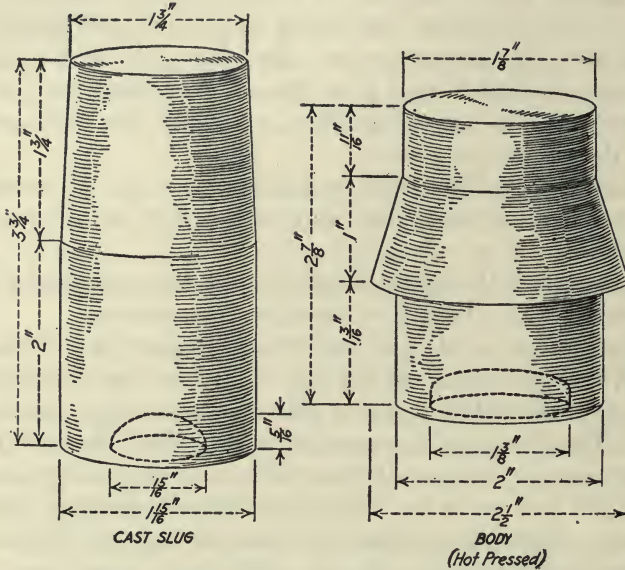

FIG. 520. THE FORGED BRASS SLUG FOR THE BODY

for the graphite and 2 cu. in. for the soda ash. This mixture is applied to the dies with a swab after every forging operation.

After the body slugs have been hot-pressed they are sent to the department, which contains the turret or hand screw machines. These are of the Warner & Swasey, the Bardons & Oliver and Acme Machinery Co. manufacture. An outline of the sequence of these operations is shown in Fig. 521. Those marked 1 are the first operations and those designated by a 2 show the sequence of the operations after the second chucking. The letter after each number shows the order of the sub-operations.

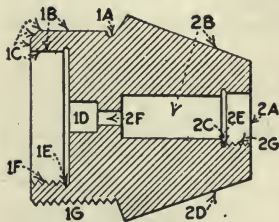

FIG. 521. SEQUENCE OF OPERATION ON BODY

The tooling of the Warner & Swasey turret for operation 1 is shown in Fig. 522. The box tool for the first or roughing cut is shown at A, the holder having three side tools B in addition to the two-lipped center cutter C for counterboring the base for the adapter. The cross-slide tool comes in for the next cut 2, which undercuts beyond the thread and forms the angular shoulder where the fuse body fits against the shell. The next sub-operation—finishing for the die at A and facing at B—is



For the second operation on the Warner & Swasey turret lathes the

body is held by the chuck shown in sub-operation 1, Fig. 523. The body is screwed into the drawing bar *A* and pulled back against the conical seat *B*. The center drill *C* paves the way for the tapped hole which receives the cap. The next sub-operation involves drilling for the graze pellets with *A*, roughing off the straight nose to conform to the taper with tool *B* and facing the end with *C*.

The drilling of the small hole which completes the opening to the powder tube is done in the third sub-operation. This is followed by the counterbore 4, which finishes the hole for the graze pellet. The tolerance here is only 0.002 in. Recessing for the cap thread comes next, sub-operation 5; then the taper is turned by the cross-slide forming tool 6 passing under the work and the facing tool 7, also held in the cross-forming slide. Tapping for the cap completes the body, except for subsequent drilling for the detents and centrifugal bolts and tapping for the small screws.

The production runs from 16 to 20 per hour per machine for the first operation and from 10 to 13 per hour for the second.

The 14 gages for the work done on the turrets are shown in Fig. 524. These explain themselves and give the tolerances allowed. Two gages, *I* and *N*, are for the same purpose, gaging the depth of the turret hole. The last is an improved gage which now supplants the other.

The drilling and tapping of the fuse body, the next operation, is more of a job than might be imagined

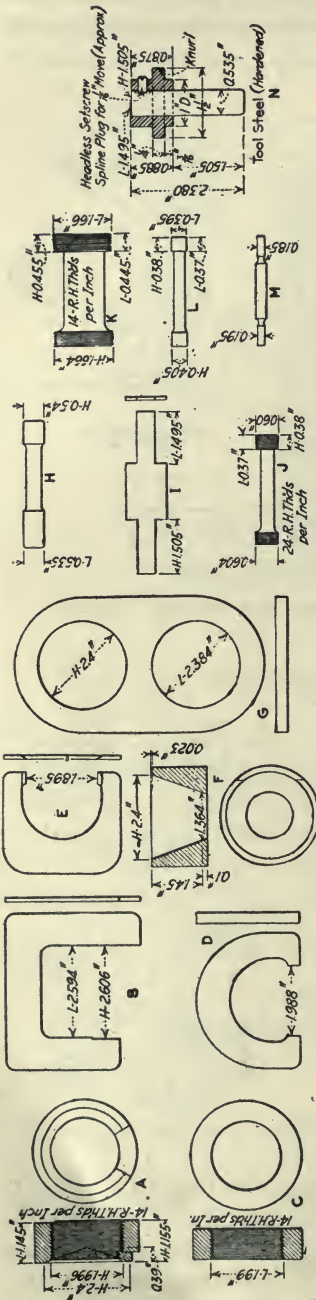

FIG. 524. GAGES FOR TESTING THE MACHINE WORK IN THE FUSE BODY

A—Diameter and angle of cone shoulder. B—Length of body. C—Minimum thread diameter. D—Minimum diameter top of thread. E—Minimum diameter of thread undercut. F—Diameter and length of front cone. G—Diameter of body. H—Diameter of bore for graze pellet. I—Depth of graze-pellet hole. J—Diameter and depth of screw for cap. K—Diameter and depth of recess for adapter. L—Diameter and depth of hole at bottom of recess for adapter. M—Diameter of central hole for graze pellet. N—Depth of graze-pellet hole

and involves the use of the seven special fixtures. In order to see exactly what these drilling operations are and to better appreciate all the problems that present themselves, it is necessary to study the illustra-

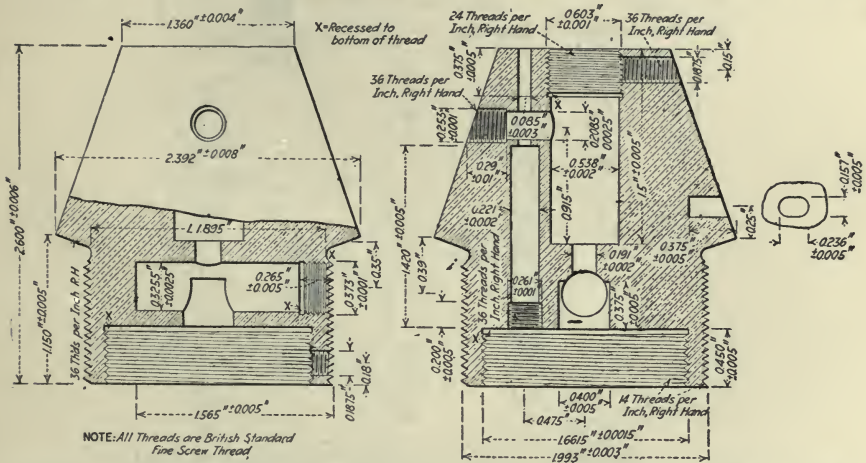

FIG. 525. SECTIONS OF BRITISH DETONATOR HEAD, SHOWING DIMENSIONS AND TOLERANCES OF VARIOUS PARTS

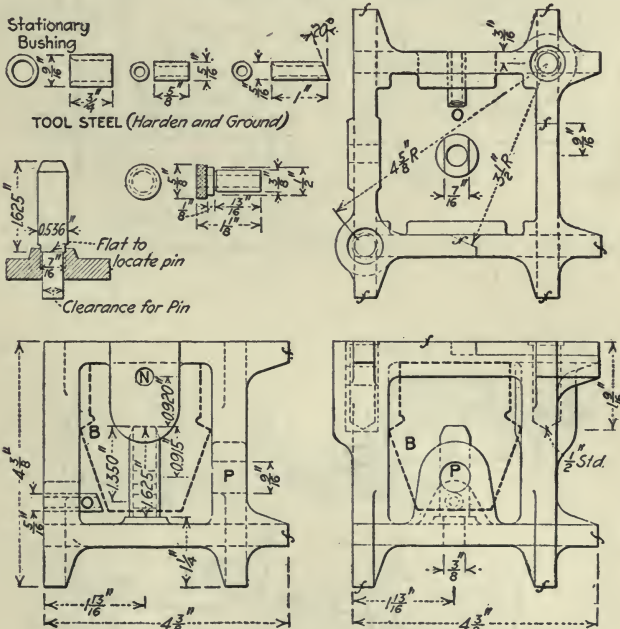
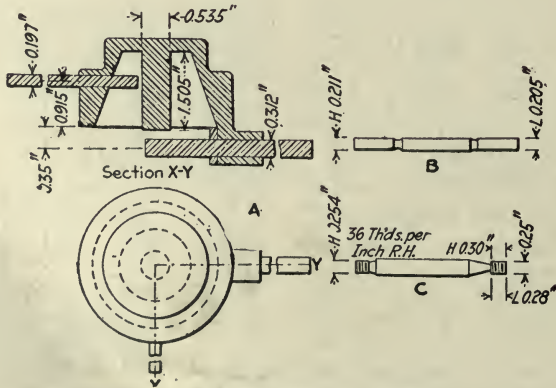
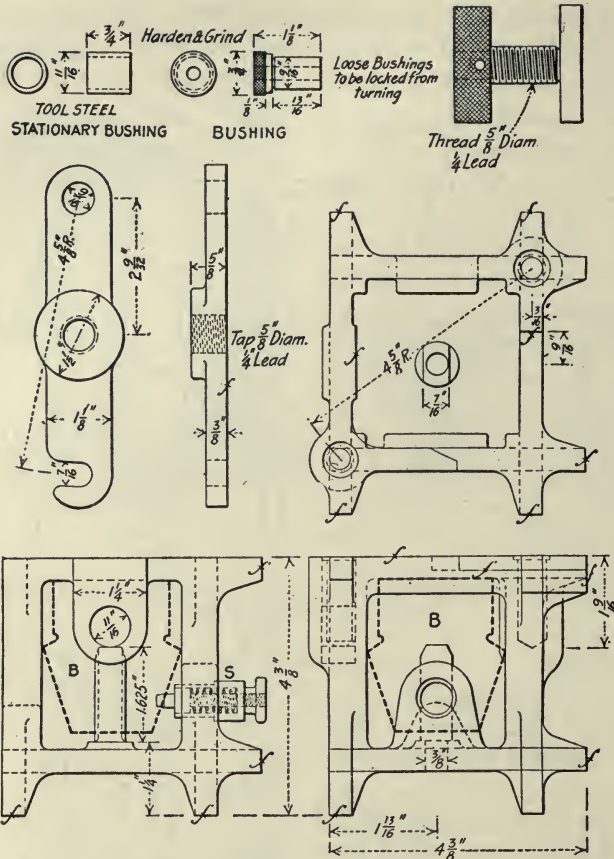

FIG. 526. FIRST DRILLING FIXTURE FOR SIDE HOLES

tions in Fig. 525. The small tolerances allowed, as well as the density and large amount of copper in the metal, make this a particularly difficult job.



A—Relation of hole to top of body and to setscrew hole for cap. B—Diameter of hole. C—Diameter of threaded hole

The fixture shown in Fig. 526 is designed for drilling the three holes *N*, *O* and *P*, the first two being for the grub or headless setscrews for hold-

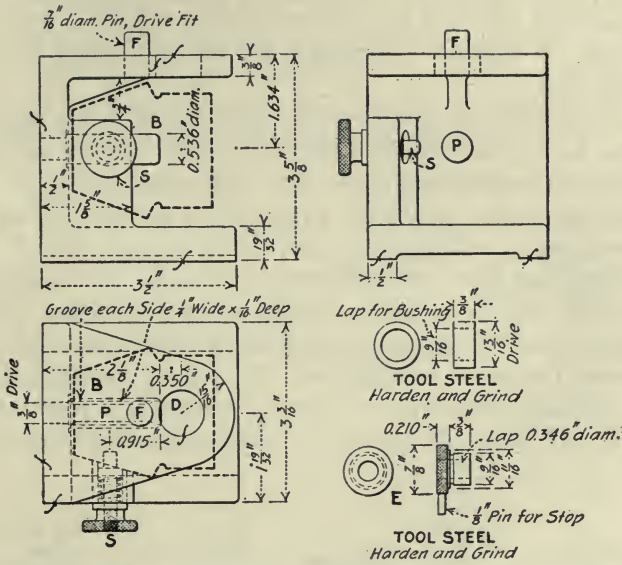

FIG. 529. FIXTURE FOR RECESSING AND TAPPING PERCUSSION-PELLET HOLE

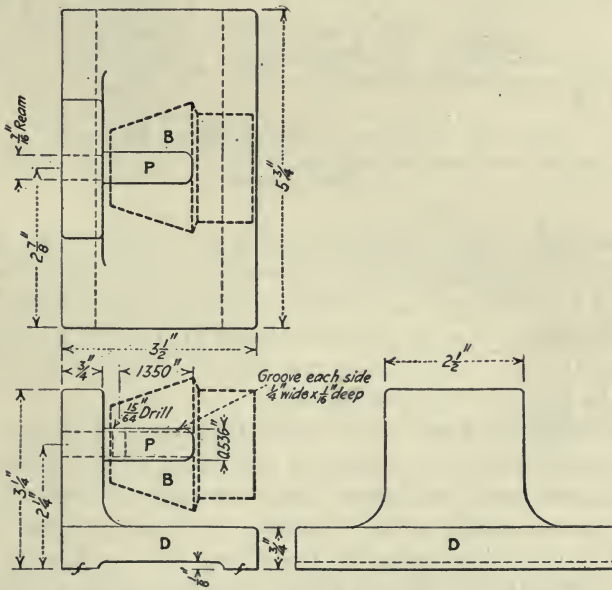

FIG. 530. TAPPING FIXTURE FOR SETSCREW HOLE

ing the cap and adapter in place, while the other drills the hole for the centrifugal bolt. The body *B* is shown in position in the drilling jig,

being located by the central post, which fits the graze pellet hole, the end of the plug bottoming and the clamp of the fixtures holding it in place against this plug. Details of the swinging clamp are shown in Fig. 527. Feet are provided on three sides of the fixture, together with hardened steel bushings, as shown. The gages for the centrifugal-bolt hole are shown in Fig. 528.

With the exception of the operation shown in Fig. 535, which is located by the holes for the percussion pellet, all further drilling operations are located from the centrifugal bolt hole. The second fixture, Fig. 527, drills for the percussion pellet, the fixture being similar to that shown in Fig. 526, with the exception of the spring index pin or stop *S* located in the centrifugal bolt hole. This illustration also shows the details of the swinging clamp, which carries a central screw for holding the body *B* firmly in place after the clamp is swung under the locking bolt.

Next comes the jig for recessing and tapping for the percussion pellet, Fig. 529. The body is located in the same manner as before in the fixture shown in Fig. 527, which illustrates very clearly how the work is done and

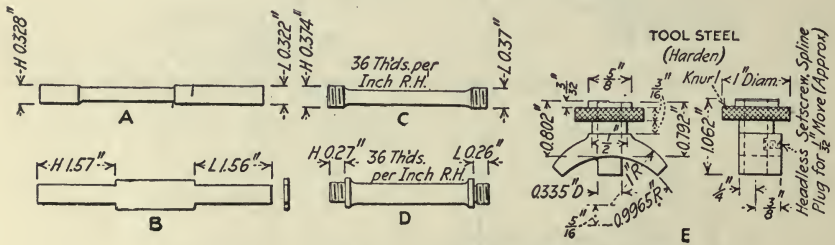

FIG. 531. GAGES FOR PERCUSSION-PELLET HOLE

A—Diameter. B—Depth. C—Diameter of threads. D—Depth of threads.  
E—Depth of recess

the bushing used. The bushing carries a pin which stops against the projection *F* to prevent turning. Each side of the central locating stud is grooved  $\frac{1}{4}$  in. wide and  $\frac{1}{16}$  in. deep, to reduce friction when sliding the body over the stud. The two setscrew holes in the side, for both the cap and the adapter, are tapped with the fixture shown in Fig. 530. Fig. 531 shows the gages for this suboperation.

**Drilling the Detent Hole.**—The next suboperation, Fig. 532, is perhaps one of the most difficult on account of the depth of the detent hole and the fact that the small drill must break through the cross-hole already drilled for the centrifugal bolt. The piece is located by this centrifugal bolt hole, as in the other cases, by the spring pin *S*, while the body fits over the post *P* with its flattened sides. The hinged lid *E* is fastened by a quarter turn of the screw *F* and the body held firmly in place by the jackscrew *G*. The bushing *H* fits into the lid at *C*, the inner end of the bushing projecting down into the adapter recess so as to guide the drill



for the hole, which is 0.221 in. for a depth of 1.420 in., this diameter terminating just before reaching the centrifugal bolt hole.

Then the bushing *I* is put in place, guiding the small drill clear to the end. This drill is 0.085 in. in diameter, but as can be seen, the bushing is relieved so as to guide for only the last  $\frac{5}{16}$  in. and prevent friction in the bushing. As the specifications call for a square-bottom hole, it is necessary to follow the drill with a square-ended reamer.

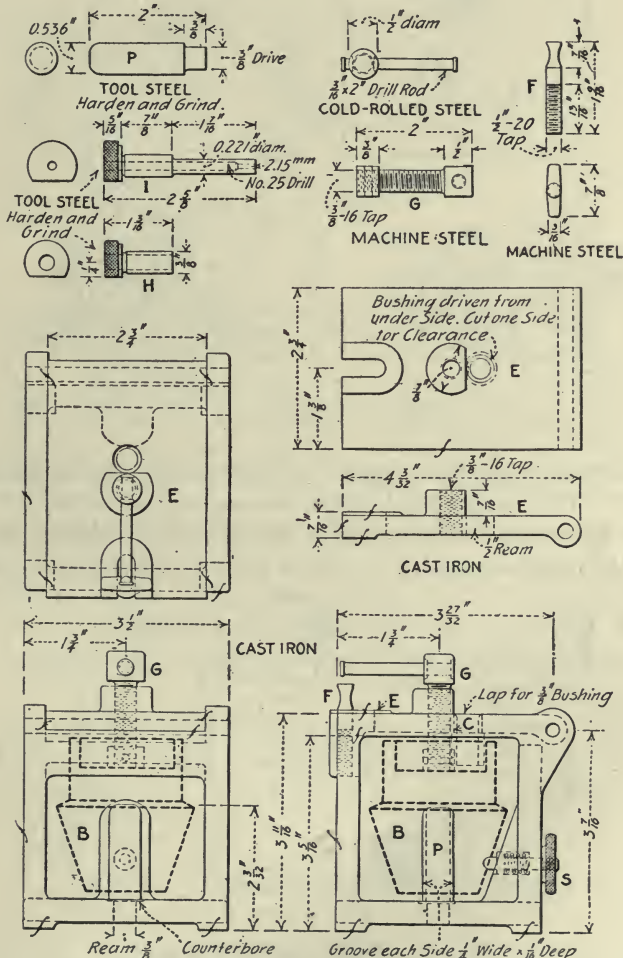

FIG. 532. FIXTURE FOR DRILLING DETENT HOLES

This detent hole is tapped by the simple fixture shown in Fig. 533. This is simply to hold it square while running in the 0.261-in. tap with 36 threads per inch. The index pin *S* prevents any tendency to turn.

The gages are shown in Fig. 534. The gage *E*, which shows the relation between the detent hole and the percussion-pellet hole, is of

interest. The cross-piece of the gage is put into the percussion-pellet hole and the gage body is inserted in the adapter hole so that the side stud enters the detent hole and the center stud goes up and embraces the cross-piece.

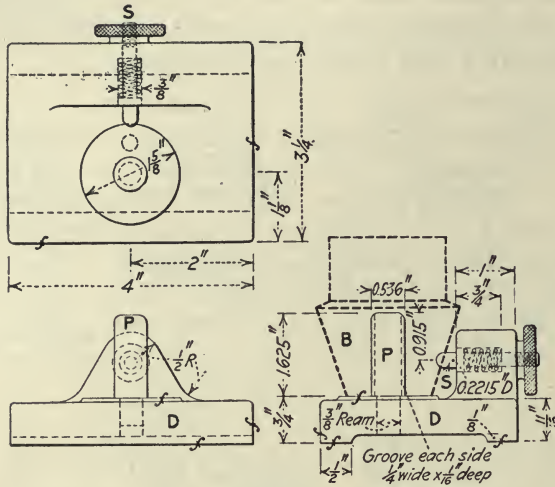

FIG. 533. FIXTURES FOR TAPPING DETENT HOLE

The oblong slot for the spanner wrench is milled in the fixture shown in Fig. 535. This carries the body *B* horizontally on the post *P* and locks it in place by means of the swinging clamp *E*, which has a cross-arm *H* spanning the adapter opening. This is locked in position by the latch *F*.

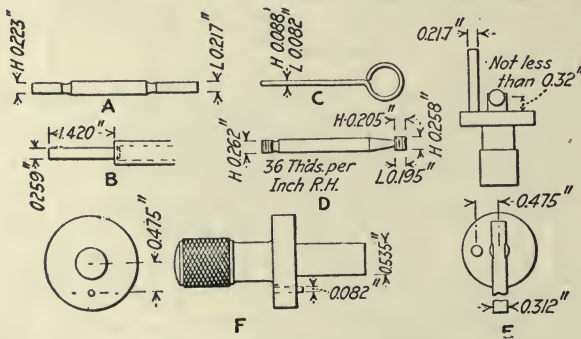

FIG. 534. GAGES FOR DETENT HOLES

A—Diameter bottom detent hole. B—Depth of bottom of detent hole. C—Diameter top detent hole. D—Threaded diameter detent hole. E—Relation of detent and percussion-pellet holes. F—Relation of top detent and graze-pellet holes

The small end mill is located and guided by the hardened bushing *I*, while the body is moved back and forth under it to produce the oblong hole. The body with the post *P* and the indexing stop *S* is mounted on the slide *G*, which is moved back and forth in the body *D* by means of the

lever *L*. The amount of movement is determined by the position of the stop screws *TT*. By feeding the rapidly revolving end mill down at the same time the body is moved back and forth underneath it, the oblong slot is quickly produced.

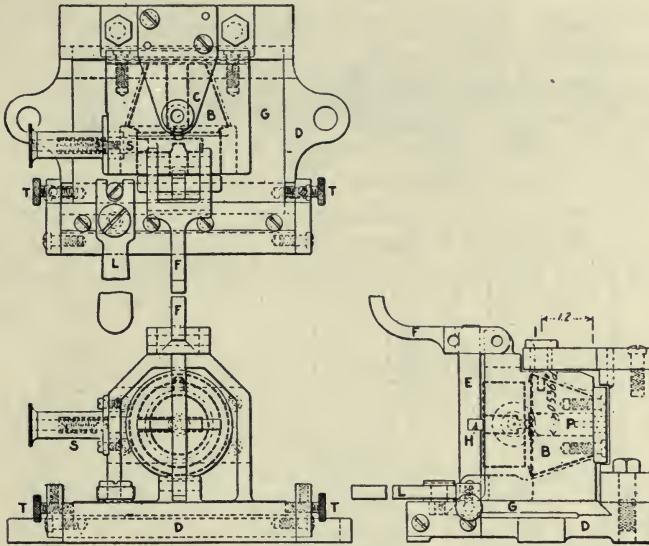

FIG. 535. FIXTURE FOR MILLING OBLONG SPANNER-WRENCH HOLE

The gages are given in Fig. 536. The lines show the proper location of the hole.

**The Working Parts.**—The graze pellet, which fits in the center of the body and carries the explosive material in the upper end, is shown in detail in Fig. 537. This illustration gives the tolerance allowed in the

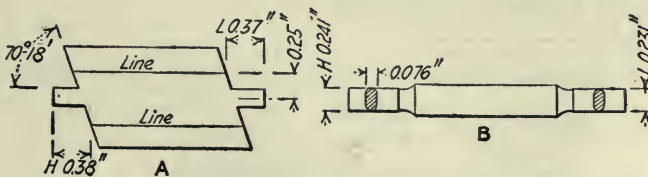

FIG. 536. GAGES FOR SPANNER-WRENCH SLOT

A—Height of hole on body. B—Size of hole

various parts, the largest limit being 0.005 in. The pellet is made from  $\frac{9}{16}$ -in. diameter brass rod and averages about 10 to the pound. The specifications call for a brass having a yield point of 8 tons and a breaking point of 20 tons per sq. in., with an elongation of 20 per cent. These are long tons of 2,240 lb.

This is an automatic screw-machine job, National Acme No. 52 four-spindle machines being used for all the small work. The operation



suboperation, leaving only the long center hole to be drilled. The tools used are shown in Fig. 537. The production is 300 per hr. per machine.

The gages for the graze pellet (nine in number) are shown in Fig. 539. These cover the length, diameters, threads, taper and hole diameter.

This hole is only 0.05 in. in diameter and long in proportion—a trifle over an inch—so that the question of clearing the drill becomes important. A No. 55 high-speed drill is used in a Leland-Gifford drilling machine, which runs at 10,000 r.p.m. The drilling fixture shown in Fig. 538 holds the graze pellet in the V-block *A*, the clamping being done by the hook bolt *B*, which is drawn into place by the threaded lever *C*. This drilling fixture is small and can be easily handled, which secures an output of 120 pieces per hour for each. On account of the length of these holes it is necessary to clear the drill frequently—about 20 times per hole on the average run.

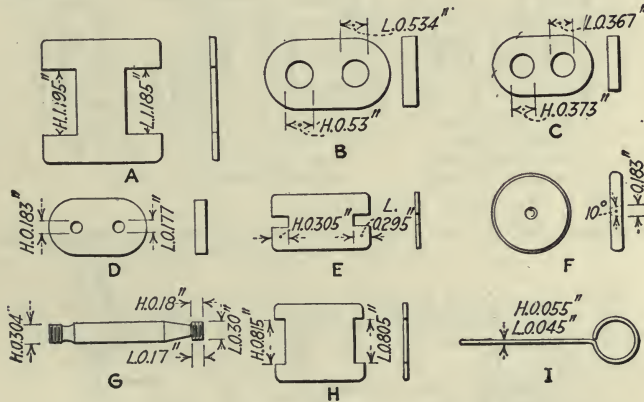

FIG. 539. GAGES FOR THE GRAZE PELLET

A—Total length. B—Diameter of body. C—Diameter at top. D—Diameter of stem. E—Length of stem. F—Angle of end of stem. G—Diameter and depth of screw recess. H—Length of body. I—Diameter of central hole

**Centrifugal Bolt.**—The centrifugal bolt is the simplest piece in the entire fuse, being a cylinder cut from  $\frac{7}{32}$ -in. diameter brass rod, and averages about 232 pieces to the pound. It is made of the same material as the graze pellet. The dimensions and limits are given in Fig. 540. The sequence of the automatic machine operations, shown in Fig. 540, consists of sizing the outside diameter with a circular forming tool, squaring to length, shaving the end and finally cutting off, the second cross-slide operation being omitted. The automatic turns out 1,020 pieces per hr. per machine with single tooling, the tools being shown in Fig. 540.

**Detent-Hole Screw Plug.**—The screw plug for the detent hole is shown in Fig. 541. The screw plugs are made from  $\frac{9}{32}$ -in. brass rod—the same as the graze pellet—and run about 215 to the pound. These

simply form or size, square and thread. The production is 750 per hr. per machine.

**Percussion Detonator Plug.**—The percussion detonator plug shown in Fig. 542 is somewhat similar to the detent-hole screw plug, but re-

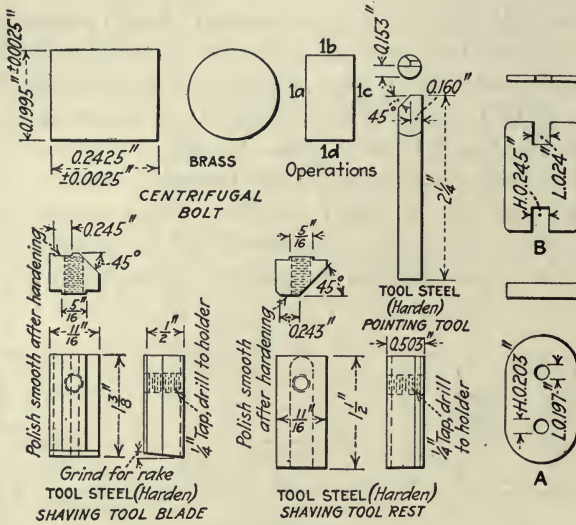

FIG. 540. CENTRIFUGAL-BOLT DETAILS

Details of centrifugal bolt. Sequence of operations. Special tools used in automatic screw machine. A, diameter; B, length

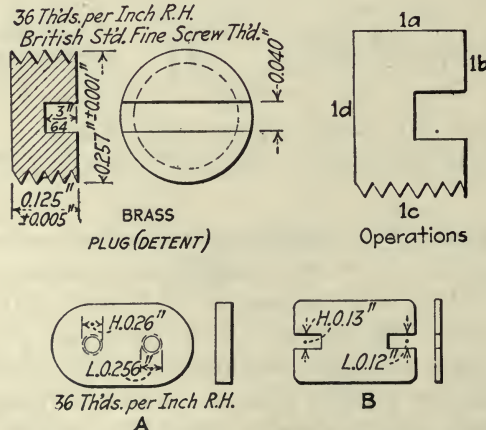

FIG. 541. DETENT SCREW PLUG DETAILS

Details of detent screw plug. Sequence of operation. Gages; A, diameter; B, length

quires the additional operation of drilling the two holes for the double-pin wrench or key, by which it is screwed into place. It is also of the same metal, is  $1\frac{3}{32}$  in. in diameter and runs about 75 to the pound. It requires two turret suboperations and two of the cross-slides as shown

in the operation view, Fig. 542. These form and drill, ream and square the bottom, thread and cut off. The special pointing tool and the circular forming tools are shown in Fig. 542. The production is 720 per hr. per machine.

The drilling is done in the fixture shown in Fig. 543, which has several interesting features. The piece *L* is held in a slotted pocket in the end of the lever *A*, which is pivoted at *I* so as to swing the plug under the jig plate after it has been placed in position. It also swings clear around to bring the different drill bushings under the drill.

In practice the plugs are laid on the plate *E* and slid through the slot *D* into place in the end of the lever when in the dotted position shown.

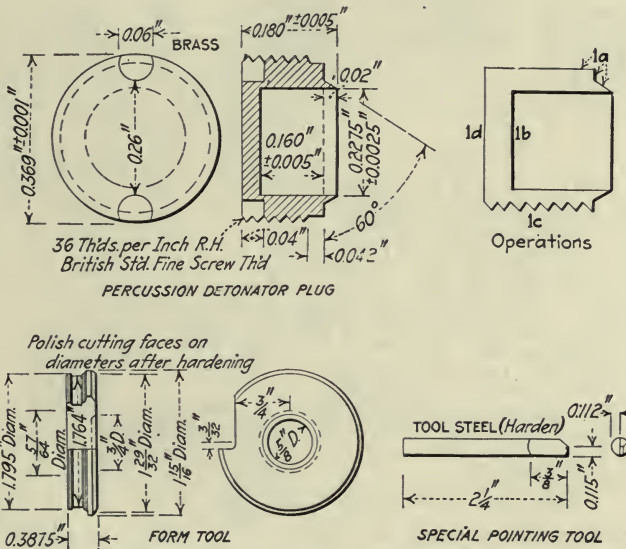

FIG. 542. PERCUSSION DETONATOR PLUGS AND TOOLS

The lever is then swung into the operating position, carrying the piece *L* past the swinging plate *B*, which keeps it from coming out of its pocket and which is controlled by the light spring *C*, so as to help locate and hold the plug for drilling when the lever *A* strikes the stop *G*. This is a somewhat ticklish drilling job, as the drill cuts through the thread on the outside as shown. The depth is also an important feature, owing to the small amount of metal in the head, which is the reason for the flat bottom in the hole. The holes are drilled separately, the work-holding portion swinging through a half circle for locating the holes. The center distance is 0.32 in. The gages are given in Fig. 544.

**The Percussion Needle Plug.**—The percussion needle plug, Fig. 545, is a rather fussy piece to handle because of its small size and the four holes, 0.04 in. in diameter, drilled around it. It is made from  $\frac{9}{32}$ -in.





form and center, drill, thread and cut off. Two of the tools are shown in Fig. 545. The production is 700 per hr. per machine.

The drilling jig, Fig. 546, is almost identical with that shown in Fig. 543. The extremely close center distance prevents the four small holes being drilled at one time. There is also a difference in the slotted pocket

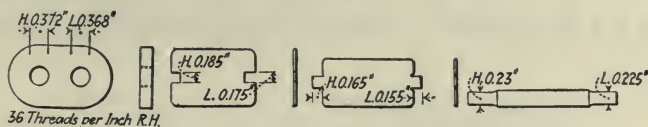

FIG. 544. PERCUSSION DETONATOR PLUG GAGES

at the end of the lever A, owing to the fact that there are several holes to be drilled and that these go clear through the plug. With these exceptions the drilling fixtures are practically the same. The work holder can swing in a complete circle. The gages are shown in Fig. 547.

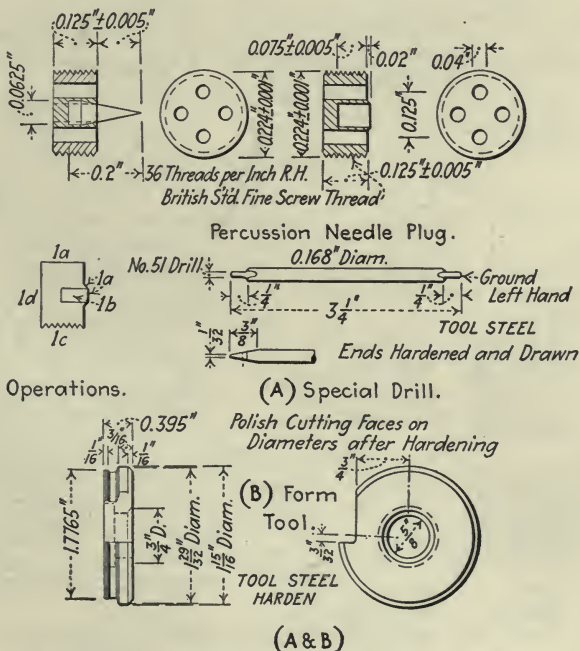

FIG. 545. PERCUSSION NEEDLE-PLUG AND TOOLS

**The Percussion Pellet.**—The percussion pellet is closely related to the graze pellet, the latter being designed to act as soon as the former has been thrown forward by the impact of the shell. The percussion pellets are made from  $1\frac{1}{32}$ -in. diameter brass rod and average 29 pieces to the pound. The other end is jig drilled for the impelling spring. The pellets are shown in detail in Fig. 548, and also the sequence of operations.

The pellets are formed with a box tool, drilled for the tap and centered for the other hole at the first operation. Next comes the recessing for the tap which follows, the fourth suboperation being the drilling of the central hole and the cutting of the piece from the bar. The tools are shown in Fig. 548, the production being 320 per hr. per machine.

The back end of the pellet is drilled for the spring pocket by turning the jig on end and using the necessary drills to produce the square-bottom

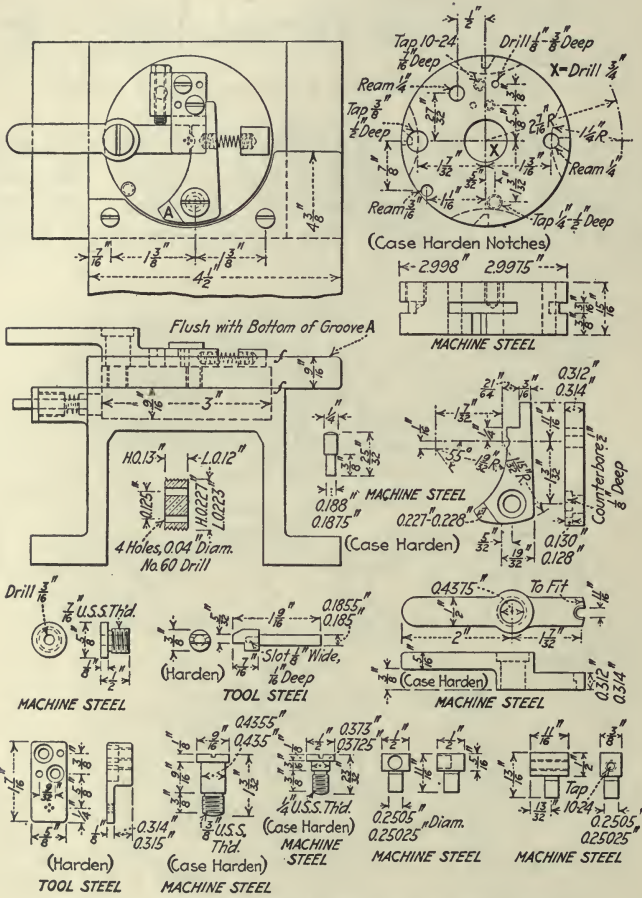

FIG. 546. DRILL JIG FOR PERCUSSION NEEDLE PLUG

hole. The drilling of the cross-holes is done in the fixture shown in Fig. 549. These holes are drilled in two separate operations because of the close center distance. The large hole is drilled and reamed to the 10-deg. taper shown, the small diameter being only 0.15 in., while the other hole through the side of the spring recess is but 0.10 in. The pellet is located by the stop screw A and held in place by the lid B, which clamps it into the V-block C. The lid is locked by the swinging cam lever D.

The gages for the percussion pellet are shown in Fig. 550.

**The Detents.**—The top detent, shown in Fig. 551, is of phosphor bronze or similar metal made from  $\frac{5}{32}$ -in. round stock and run about 235 to the pound of stock.

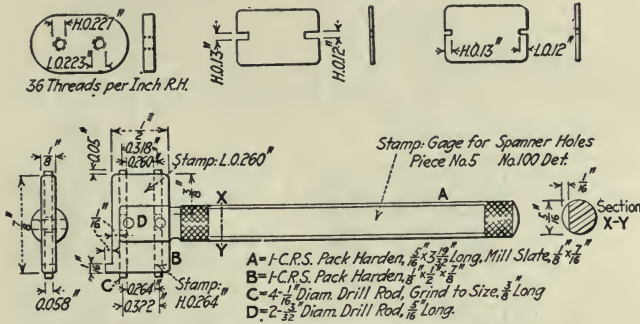

FIG. 547. GAGES FOR PERCUSSION NEEDLE PLUGS

The operations of the automatic are also shown in Fig. 551, the stem being finished in two box-tool suboperations. The round head is formed and shaved by the forming slide for the third suboperation, the fourth suboperation being the cut off. Some of the tools are given in Fig. 551. The production is 300 per hr. per machine.

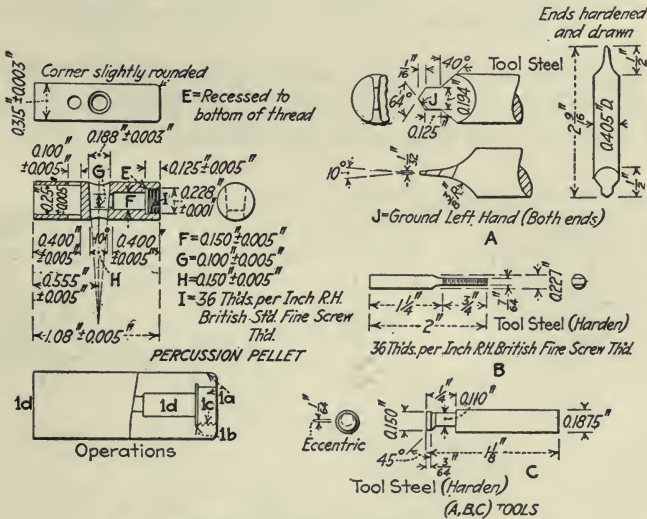

FIG. 548. PERCUSSION PELLET AND TOOLS

The lower detent is shown likewise in Fig. 551 and also the sequence of operations. This detent is also made from the phosphor-bronze rod,  $\frac{1}{32}$  in. in diameter, running something over 200 to the pound. The only subsequent operation is the assembling of these two parts of the

detent by staking down the beveled edge. Two of the tools are shown in Fig. 551, the production being 700 per hr. per machine. The gages of both detents are shown in Fig. 551.

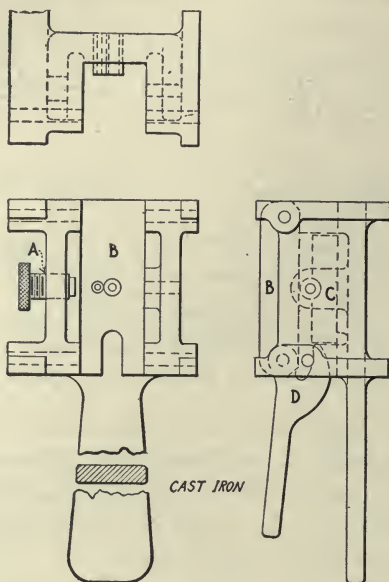

FIG. 549. DRILL FIXTURE FOR PELLET CROSSHOLES

Fig. 552 shows the cap. This gives all necessary details and tolerances and shows the sequence of operation on the screw machines.

These caps are now being made of the same grade of brass as the

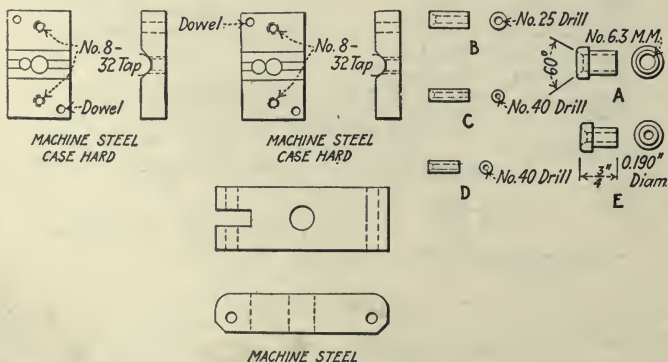

FIG. 550. PERCUSSION PELLET GAGES

graze pellets and other parts mentioned, but later they, as well as the bodies, will be made of steel. They are cut from  $1\frac{3}{8}$ -in. diameter brass rod and require nearly  $\frac{1}{2}$  lb. of stock each. The operations are: Rough-



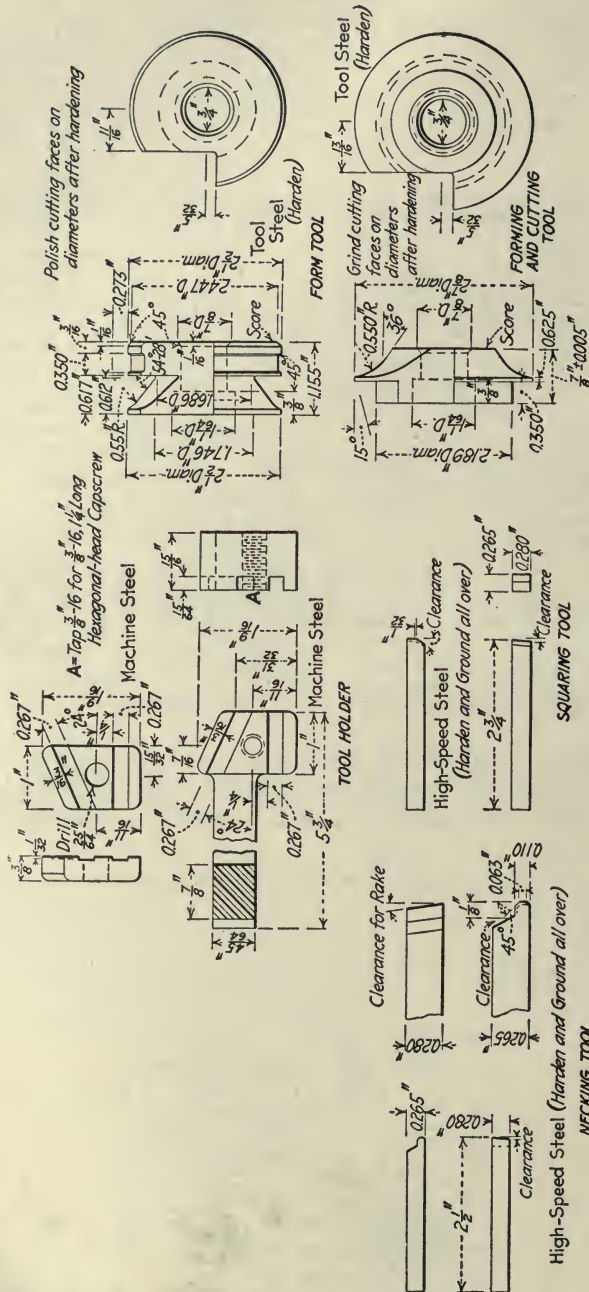

FIG. 553. TOOLS FOR FUSE CAP



forming the rounded end and form the thread, including the recess at the end of the thread, and spot-drilling for the needle. The needle hole is then drilled and both the flat faces are made square. The thread is next cut, and finally the head is finish-formed and cut off. The production is 150 per hr. per machine.

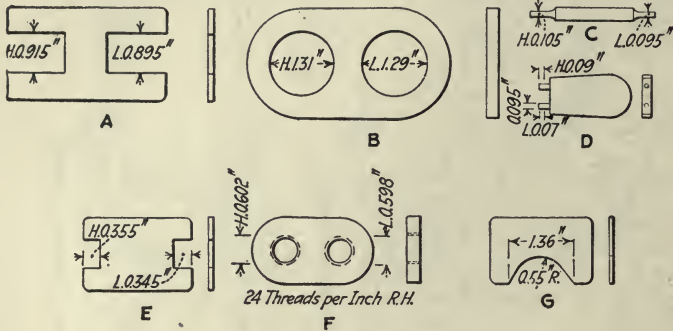

FIG. 555. GAGES FOR THE FUSE CAP

A—Total height. B—Outside diameter. C—Diameter of wrench holes. D—Spacing of wrench holes. E—Length of threaded end. F—Diameter of threads. G—Contour of cap

Fig. 553 shows the tools, which give 150 per hr. per machine, these being done on the No. 55 National Acme.

The drilling fixture for the fuse cap, Fig. 554, is simply an adaptation of that used for the percussion plug cap and the detonator needle plug. It is enlarged and modified to suit the shape of the piece being handled;

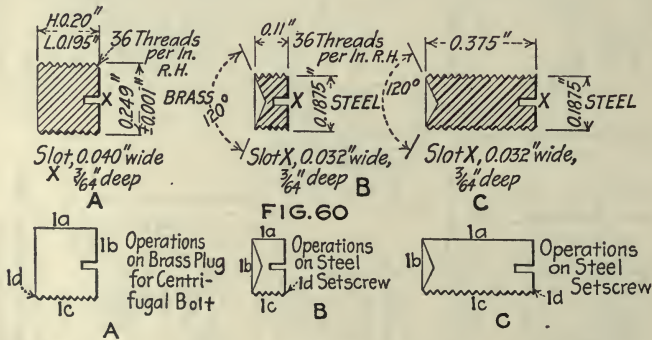

FIG. 60

FIG. 556. DIMENSIONS AND OPERATIONS OF THE THREE SETSCREWS

but the method of holding and indexing is the same. The center distance is 0.413 in., and the holes are drilled one at a time by turning the top of the holder around as with the percussion needle plug and the cap. A slot  $\frac{1}{16}$  in. deep by  $\frac{1}{8}$  in. wide is cut in the under side of the jig plate to allow clearance for the tit which is left when the caps are cut from the



bar in the screw machine. This is afterward removed by grinding. The gages are seen in Fig. 555.

Fig. 556 shows three small screws. The one in brass, *A*, covers the centrifugal bolt holes, while the others are headless steel set or grub screws *B* clamping the adapter and *C* the cap. These are entirely screw-machine jobs, the production being at the rate of 600 per hr. per machine

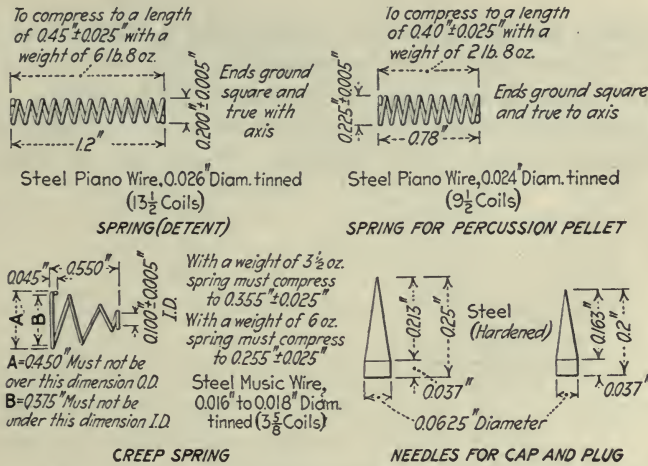

FIG. 557. FUSE SPRINGS AND PERCUSSION NEEDLES

for the short screws and 500 for the long screws. They are slotted on a National Acme rotary screw slotter at the rate of about 1,000 per hr. per machine. The sequence of operations is shown in Fig. 556.

**Fuse Springs and Percussion Needles.**—The balance of the parts entering into a completed detonating fuse head consist of the three springs and the percussion needles, which are made by specialists. Two of the springs are of the plain helical type, while the third is cone shaped,

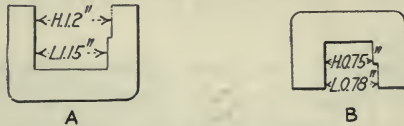

FIG. 558. GAGES FOR SPRINGS

A—Length gage for detent spring. B—Length gage for percussion-pellet spring

and is used to hold the graze pellet away from the percussion needle until it meets with a real obstruction. These springs, with their dimension specifications, are shown in detail in Fig. 557. The material specifications of the springs are:

“The springs are to be made of steel piano wire, tinned, and are to stand the tests laid down on the drawing. The detent spring when compressed till all the coils are in contact for 12 hr. must not set up more

than 0.05 in. The percussion pellet spring when simultaneously compressed for 12 hr. must not set up more than 0.03 in."

The needles for both the cap and the percussion-pellet detonator plug, which are supplied by the Excelsior Needle Co., are swaged and then hardened. They are identical except for a variation of 0.05 in. in length. Fig. 558 shows the gages for the springs and the percussion needles.

The springs are tested by dead weight, the method being shown in Fig. 559. Different springs are tested by the same method, the plungers and weights differing according to the springs to be tested. The high and low limits of the springs, both free and under compression, are shown by the distance between return grooves. The widths of these grooves

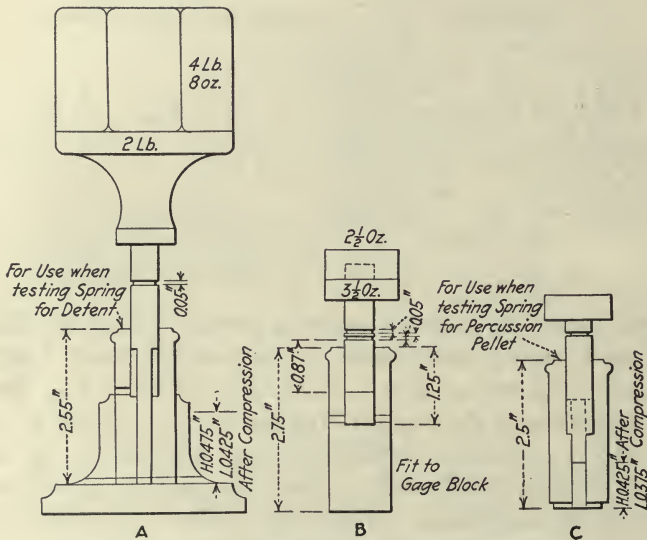

FIG. 559. DEAD WEIGHT FOR TESTING SPRINGS

show the tolerance in both positions. The spring is placed on the reduced portion of the plunger and the whole inserted in the holder, the weight being then placed on top and the compression noticed.

The detent spring must stand a dead weight of 6 lb. and 8 oz., which gives some idea of the shock caused by the acceleration of the projectile. For when it is considered that the detent, which weighs only a fraction of an ounce compresses this spring and locks itself out of the way of the centrifugal bolt, we begin to realize something of the effect of inertia resulting from rapid acceleration of the projectile.

The spring for the percussion pellet must carry 2 lb. 8 oz. and the creep spring, which goes over the graze pellet, 6 oz. The testing apparatus is shown at A, B and C, Fig. 559.

MAKING ADAPTERS FOR BRITISH DETONATING FUSE

The adapter, shown in Fig. 560, is made of machine steel  $1\frac{1}{16}$  in. in diameter and screwed inside the fuse body, making a connection for the gaine, which is screwed inside the adapter.

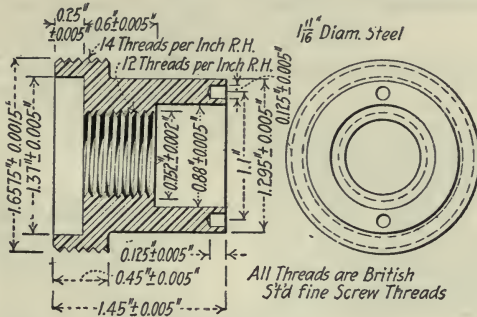
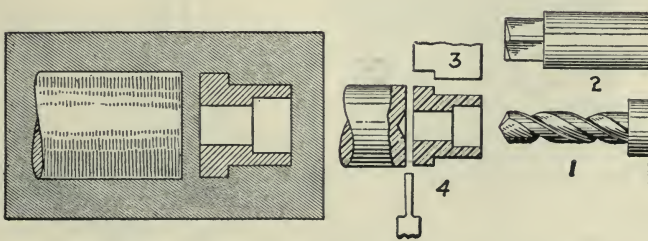

FIG. 560. ADAPTER FOR BRITISH MARK 100 DETONATING FUSE

Five comparatively simple main operations are required in the manufacture of this connecting unit, the sequence of which, together with brief data and descriptive sketches, is as follows:

SEQUENCE OF OPERATIONS

1. Cutting-off, drilling and recessing blanks.
2. Counterboring.
3. Tapping.
4. Threading.
5. Drilling holes for spanner wrench.



OPERATION 1. CUTTING-OFF, DRILLING AND RECESSING

Machine Used—National Acme No. 56.

Special Fixture—None.

Gages—See Fig. 562.

Production—60 per hr. per machine.

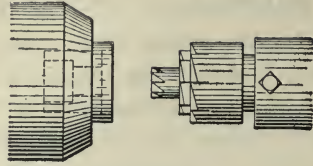
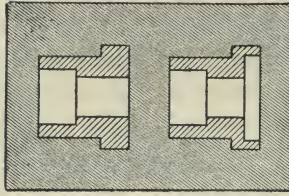

OPERATION 2. COUNTERBORING

Machine Used—Cleveland automatic.  
Gages—See Fig. 562.

Special Fixture—Tilting magazine.  
Production—90 per hr. per machine.

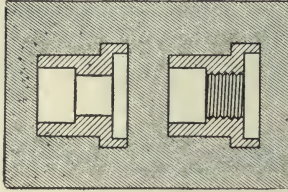

OPERATION 3. TAPPING

Machine Used—Hand turret, Smur & Kammen.  
Special Fixtures—Chuck-in turret and taper tap.  
Gages—See Fig. 562.  
Production—150 per hr. per machine.

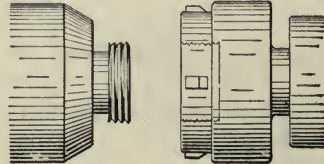
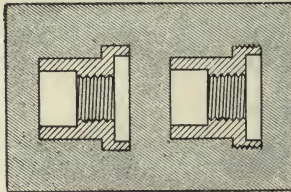

OPERATION 4. THREADING

Machine Used—Hand turret.  
Gages—See Fig. 562.

Special Fixture—Self-opening die head.  
Production—300 per hr. per machine.

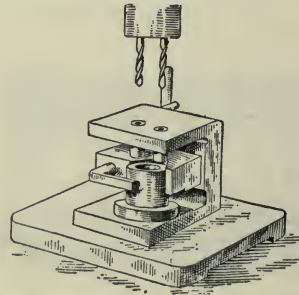
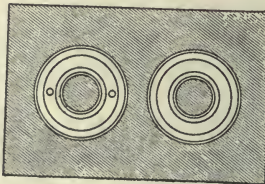

OPERATION 5. DRILLING

Machine Used—Leland-Gifford drilling machine.  
Special Fixtures—Sellew two-spindle drilling head.  
Gages—See Fig. 562.  
Production—400 per hr. per machine.

The first operation is performed on National Acme Automatics No. 56 and consists of four suboperations. The first of these is drilling the bar stock for the hole to be tapped subsequently for the insertion of the gaine; the second, counterboring for the bottom recess; the third, turning the shoulder; and the fourth in cutting-off the formed blank. This most complex of the five main operations consumes but about 1 min., the production from one machine being 60 per hour.

The second operation consists in counterboring the top recess and is done on a Cleveland automatic at a rate of 90 pieces per hour per machine, a tilting magazine being employed.

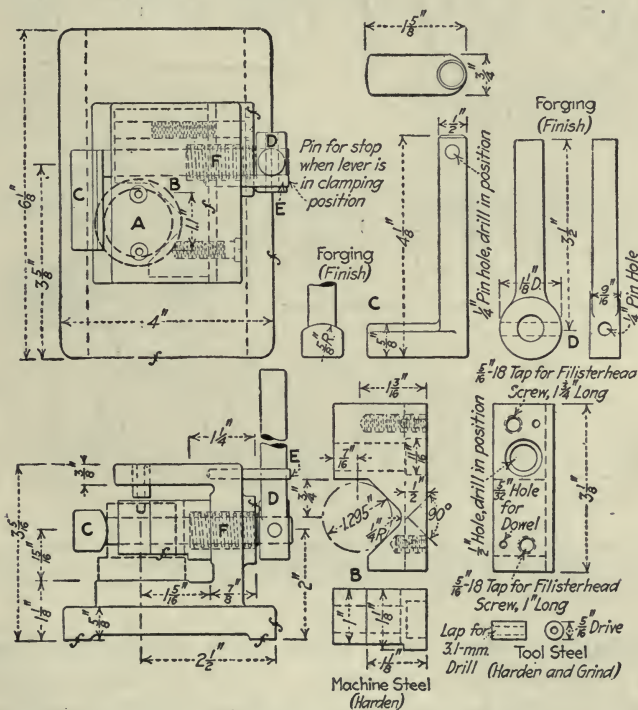

FIG. 561. DRILLING FIXTURE FOR ADAPTER WRENCH HOLES

The third operation is the tapping of the thread for receiving the gaine, this being done in almost any kind of lathe, although a hand turret is preferable. A tapper tap is held in a suitable chuck on the lathe spindle, and the adapter is held in the turret while it is being fed over the tap. When the shank of the tapper tap is full, it is removed from the chuck, the pieces are slid off and the operation is repeated.

The next operation is cutting the threads on the outside of the adapter, this also being done in a plain turret. The work is held in a spring chuck, and a self-opening die is used for the threading. Dies of the Geometric, Modern, and Warner & Swasey types are all used for this work.

A fifth and last operation is drilling the two holes for the side spanner wrench. This is done in a simple drilling jig shown in Fig. 561. The adapter *A* fits into the block *B* and is held in place by the hook bolt *C*, which has a rounded surface on the inside of the hook and a pin handle *D* at the other end. It is held closed by the spring *F*. This hook bolt is swung to an angle of about 90 deg. to release and to lock the adapter. The pin *E* affords a stop for the handle *D* when in a locked position.

The gages used are shown in Fig. 562.

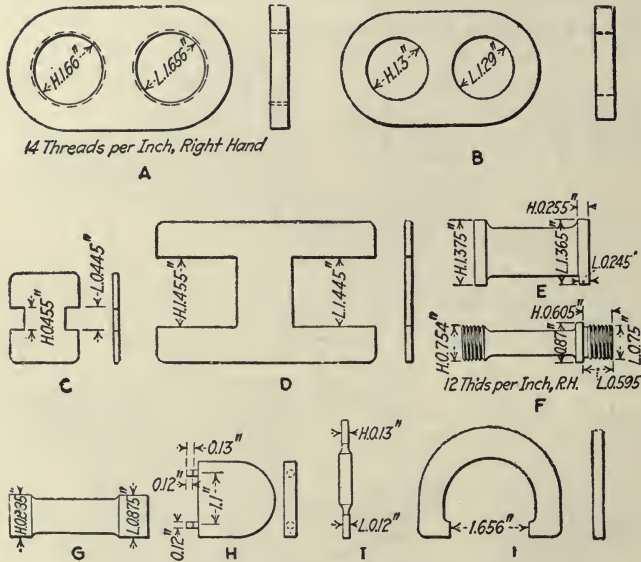

FIG. 562. GAGES USED FOR THE ADAPTERS

A—Diameter of outside screw thread. B—Diameter of plain part. C—Length of screw. D—Total length. E—Diameter and depth of recess at top. F—Diameter and length of internal thread. G—Diameter of small bore. H—Depth and distance of keyholes. I—Diameter of keyholes. J—Low or "not go" diameter of screw threads

**Assembling.**—Bringing the various parts together and assembling fuses at a rate sufficient to insure the desired delivery is an interesting problem, for it is the assembling which shows up the production of the various departments and indicates very clearly where the equipment or labor is insufficient.

The assembling room is so divided as to keep the bodies moving, the various parts of the fuses being put in place by different girls. The small parts are kept in the boxes shown and the girls are expert in putting them together. A compressed-air hose is provided for each operator for blowing out any dirt or dust and assisting in putting the detent in a place where the small stem of the upper detent does not readily find its way into the small hole. Usually, however, this is accomplished by a sort of swinging motion in line with the detent, which seems to centralize the parts so that they drop into place quite readily.



holes are made with a 0.067-in. drill-and-ream taper from one side, as shown. They are spaced 0.375 in. apart to conform to the holder shown in *B*, which acts as a magazine for the percussion-needle plugs.

This magazine consists of a steel bar  $\frac{5}{8}$ -in. wide by  $\frac{1}{2}$ -in. thick, drilled and countersunk as shown in *B*, to receive the hardened drill-rod plugs shown at *C*. These blocks are knurled or roughened at one end in order to act as an anvil against the pressure of the revolving riveter and to prevent the plug from turning under its action. The percussion-needle plugs are easily slipped into the pockets left in the strip *B* and the plate *A* placed over them so that the holes coincide. This is readily located by means of a pin *D* at each end of the strip. The needles are then placed with the large end in the tapered holes, from which they immediately drop into the holes in the percussion-needle plugs. The

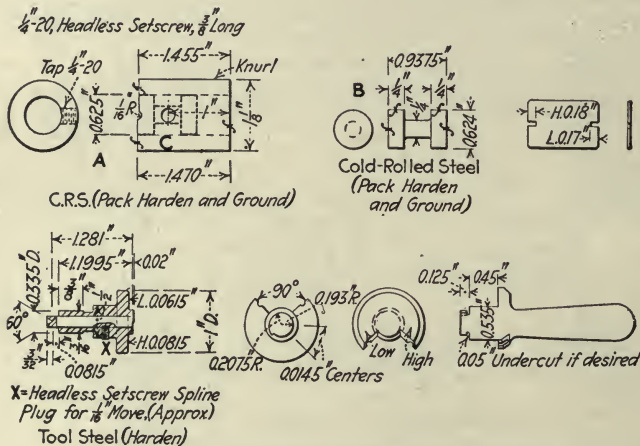

FIG. 564. GAGES FOR PERCUSSION NEEDLES

Gages for length of needle in cap. Distance of needle point from recess in percussion pellet. Protrusion of centrifugal bolt in graze-pellet hole, when assembled

plate *A* is then removed, the strip *B* placed in the holder *E* and the riveting or staking begins.

This holder *E* is fastened to the table of Grant rotary riveters and the holder *B* placed so that the first plug comes under the riveting spindle. Here it is indexed by the cone-pointed plug *F* fitting in the small V-notches shown on *A*, and the spindle of the riveter is brought down to the work. This spins the raised portion firmly around the base of the needle, and the work slide is indexed from one plug to the other very rapidly. When all the plugs held in the slide are riveted it is an easy matter to simply dump them into a box and insert another slide which has been properly loaded by a girl working at the bench. This loading is essentially a bench operation and can be done rapidly.

The caps are riveted in the same way, except that each cap is large



enough to be handled individually, and there is no trouble whatever in staking them in one at a time.

The gage for testing the height of the needle in the cap is shown in Fig. 564. It consists of a cylinder *A* and the spool *B*, which fits inside the cylinder and is held in position by a setscrew at *C* going down in between the heads of the spool. This does not hold the spool in one position but allows it to move back and forth, making it a type of "feel"

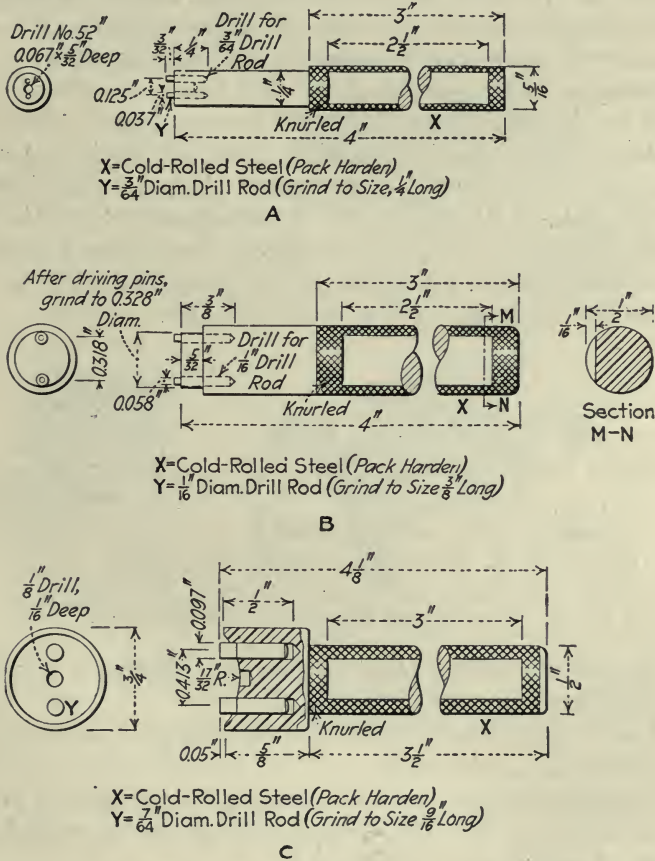

FIG. 565. PIN WRENCHES FOR ASSEMBLING

A—Wrench for percussion-needle plug. B—Wrench for detonator plug. C—Wrench for screwing in cap

gage. The cap is inserted in the end of the gage as shown, and the position of the upper end of the spool with relation to the half-round groove *C* indicates the proper position of the needle.

The gage, Fig. 564, shows the distance of the needle point from the recess in the percussion-plug pellet. Another interesting gage is the one for determining whether the centrifugal bolt projects the proper distance over the end of the graze pellet. This is also shown in Fig.

564. The body fits the upper end of the graze-pellet hole and the lower end is cut to form a cam, the eccentricity of which represents the high and low limits. The 90-deg. sector cut from the flange gives the allowable variation in the setting of the bolt.

Three of the wrenches used in assembling the fuses are shown in Fig. 565 at *A*, *B* and *C*. These are pin wrenches made to fit the parts named. They are made from cold-rolled steel and have pins of drill rod inserted in the end to fit the holes in the pieces to be screwed into place. The handles are knurled, but are flattened on one side so as to be stamped with their proper names for easy identification.

**Lacquering.**—After assembling the fuse heads are placed in a reel oven built by the Meek Oven Co., Newburyport, Mass. This oven has large shelves, which hang horizontally, while the whole reel on which they are supported revolves in the heated chamber, thus heating the fuse so as to take the lacquer. The specifications require the fuses to be heated sufficiently to drive off any excess of methylated spirit, reducing the residual solvent to a minimum. It must be applied to the outside of the fuse and the interior of the adapter.

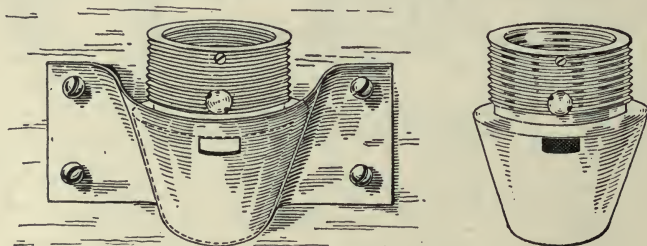

FIG. 566. SHIELD FOR SPRAYING DANGER SPOT

The lacquer specified is made as follows: Shellac, 1 lb.; turmeric, 8 oz.; methylated spirits, 8 lb.

The lacquer must be free from metallic impurity in any form, the following alone being permitted:

A percentage of manganese not exceeding 0.5 per cent.; a percentage of lead calculated as Pb taken from scrapings not to exceed 0.005; a percentage of copper not exceeding 0.1.

The lacquering is done by machines of the rotary table type, which are built especially for this work. The adapter of each fuse is set into one of the 16 sockets located in the outer ring. The whole table revolves and a pinion on the lower end of each holder, meshing into a large ring gear beneath, also turns each socket with its finished fuse while it is passing by the operator who handles the spraying nozzle. The machine is driven by a small electric motor. The compressed air comes from the regular air system of the shop and the lacquer is suspended in the bucket shown. This machine enables the spraying to be done very rapidly and

uniformly, the adapters being previously coated by a dipping process. A spraying shield is shown in Fig. 566.

**Painting the "Red Spot" and Packing.**—An additional operation is the painting of a rectangular red spot on the fuse body just above the percussion detonator plug. This is to warn the artilleryman who puts the fuse head into the shell not to have the grub or setscrew come at this point owing to danger of exploding shells.

This red spot is sprayed on with the air brush, the fuse being dropped in the holder shown in Fig. 566 with the detonator plug at front. The opening through the holder or shield, allows the paint to cover the de-

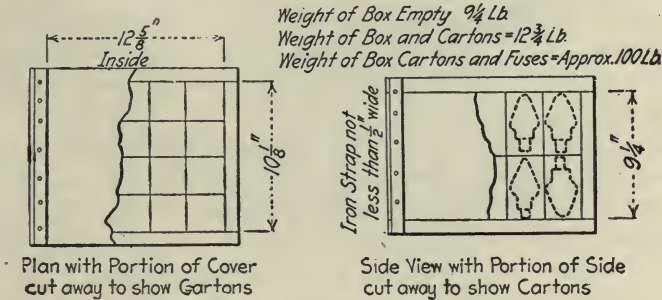

FIG. 567. PACKING BOX FOR FUSES

sired space only, the work being done very rapidly and satisfactorily in this way.

The fuse heads are packed in boxes holding two layers of 20 each, or 40 in all. Each fuse is held in a carton or square cardboard box, the dimensions being 2 1/2 in. by 2 1/2 in. by 4 3/8 in. high. The box is shown in Fig. 567. Each box must be securely fastened with nails and bound at each end by two iron straps not less than 1/2 in. wide and put on to lie flat. The empty box weighs 9 1/4 lb. The cartons add 3 1/2 lb. to this, while the total weight of a filled box is about 100 lb.

## CHAPTER II

### MAKING THE BRITISH TIME FUSE MARK 80-44<sup>1</sup>—CAPS AND FUSE PLUGS FOR TIME FUSE<sup>1</sup>—MAKING THE SMALL PARTS OF THE BRITISH TIME FUSE<sup>1</sup>

The mission of the time fuse is to explode the charge in the projectile, either shrapnel or high-explosive shell, at a predetermined time after leaving the gun, or to explode on impact either before or after the time set. It is in reality a combined time-and-detonating fuse. The principal parts are shown in Fig. 568.

The time element is governed by the burning of a train of standard fine-grained pistol powder, the length of the train being varied by turning the time ring. The detonator works practically the same as in the Mark-100 fuse already described. The safety element of the time portion consists in turning the rings so as to block the passage in the powder train. Safety against explosion by shock is obtained by means of the stirrup springs *J* and *S*. The operation is as follows:

The rapid acceleration of the projectile as it is fired from the gun literally shoots it away from the time pellet *F*, the inertia forcing up the side ears of the spring stirrup *J*, even though it is made of hard-rolled sheet brass. The inertia of the pellet forces the detonator *K* against the steel needle *P* and explodes it in the chamber shown. The fire then shoots through *A'* and ignites the mealed powder in *B'*, which communicates with the powder train in the corrugations *C'* through the hollow stick of black powder *P'* to *D'* and then to the second train *E'*, finally going through the two powder tubes *P'* to *F'* and *G'*. As shown, these passages are directly connected, but in use the fire would have to burn part way around the powder train before it reached the opening through the ring to the next train and to the bottom charge. Should this fail, or should it strike some object in its flight, the detonator end becomes active. The sudden checking of the speed of the shell throws the detonator pellet *H* forward and forces the lower detonator *K* against the bottom needle, exploding the lower charge and sending the fire direct through the detonator plug *I* to the powder *G'* and the shell behind it. The specifications resemble those of the detonator, some of the features being almost identical. Several parts of the British time fuse—including the body, cap, base plate and some of the minor interior parts—are made of aluminum. The specifications call for an aluminum alloy which

<sup>1</sup> Fred H. Colvin, Associate Editor, *American Machinist*.

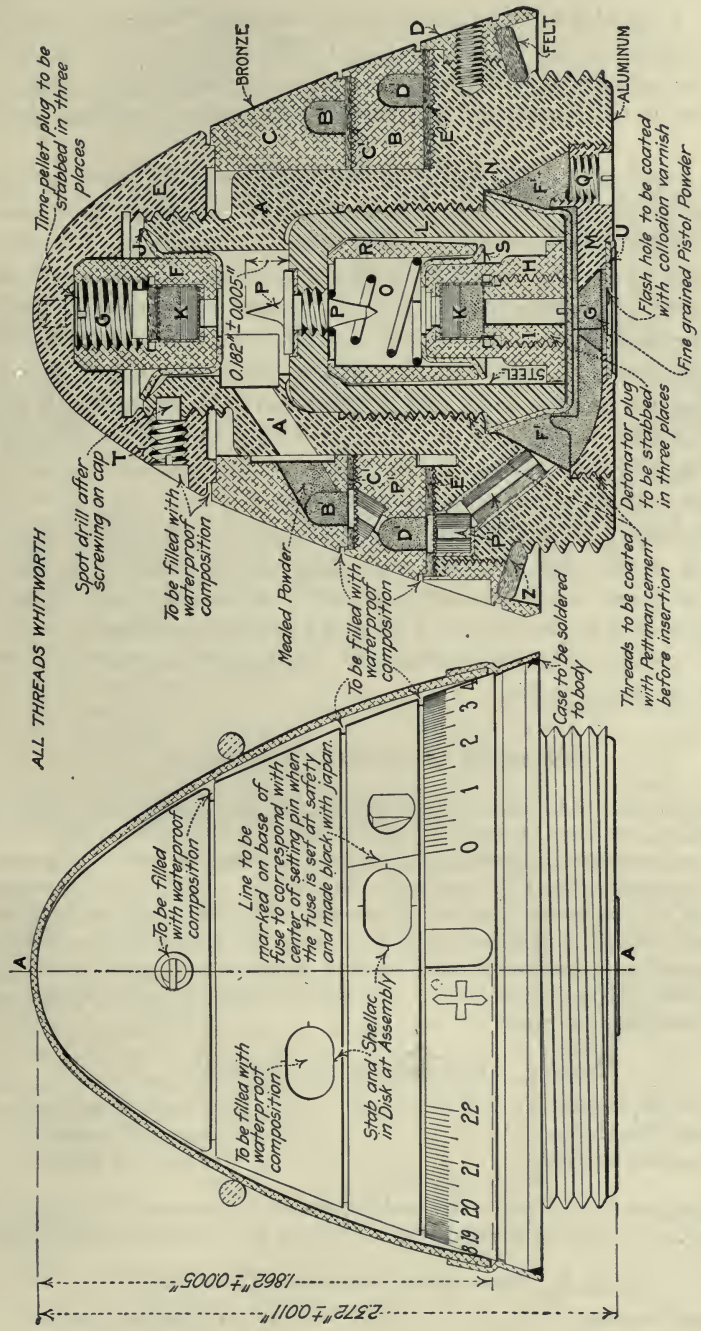

FIG. 568. SECTIONAL VIEW OF BRITISH TIME FUSE MARK 80-44

A, body; B, bottom ring; C, top ring; D, time pellet; E, cap; F, time pellet; G, time pellet screw plug; H, percussion pellet; I, percussion pellet screw plug; J, stirrup spring for time pellet; K, detinator for both time and percussion; L, percussion mechanism holder; M, base plug; N, cap for percussion holder; O, detinator spring; P, needle, for both time and detinator; Q, screw plug for base; R, percussion ferrule; S, stirrup spring for percussion pellet; T, setscrew for cap; U, base plug washer

shall be free from cracks and flaws, with a specific gravity not exceeding 3.5, capable of being satisfactorily machined and free from any ingredient which would be detrimental to the keeping qualities of the metal. The castings for the bodies are to be placed in a die and subjected to a total pressure of 400 tons in order to insure proper density.

The ring and pin on the flange of the body are to be made of brass. The composition rings are to be made of the metal known as Class C, although Class B may be used if preferred by the contract. The ferrule is to be made of an alloy containing 70 parts copper and 30 parts zinc, while the stirrup springs, which hold the time and percussion pellets, are of hard-rolled brass. The spiral spring is of thin steel wire. The time and percussion pellets and the setting pin are of Class A metal. The classification of metals, as well as their physical properties, is given in Table 3. The needle plug and the holder for the percussion device are to be made of steel hardened and tempered; or as an alternative, the needle plugs may be made of a softer steel and blued. The cover was originally specified to be of brass of the best quality and capable of being bent double under the hammer and straightened without a sign of fracture. In some instances, however, these covers are now being replaced with covers made of sheet lead and tinned on each side.

Further specifications, including the detonating compositions, varnishes and cements, follow:

### SUMMARY OF SPECIFICATIONS

The detonators are to be made of sheet copper, having a central hole covered by a copper disk, and are to be charged with the quantity of composition shown below. A pellet of pressed powder weighing 1.78 grain is to be placed on top of the composition and the detonator closed by means of a copper disk. In the time detonator a cardboard disk is to be pressed over the copper disk. The detonators are inserted in the pellets and retained in position by the screw plugs, these being secured by three indents, the plug for the percussion pellet having a disk of paper placed over the axial perforation before being screwed home. The time detonator is to be charged with 1.28 grain of the following composition:

TABLE 1. TIME-DETONATING COMPOUND

Chlorate of potash.....	52.5 parts by weight
Sulphide of antimony.....	36.5 parts by weight
Fulminate of mercury.....	11.0 parts by weight

The composition is to be put in dry and pressed with a pressure of 600 lb. The percussion detonator is to be charged with 1.39 grain of the following composition:

TABLE 2. PERCUSSION-DETONATING COMPOUND

Chlorate of potash.....	45 parts by weight
Sulphide of antimony.....	23 parts by weight
Fulminate of mercury.....	32 parts by weight

The composition is to be put in dry and undergo a pressure of 600 lb. As an alternative, a time detonator containing 0.75 grain of the composition given above for this detonator and a pellet of pressed powder weighing 0.87 grain may be used, in which case the cardboard disk over the copper disk and the sectors of vegetable paper over the lighting points of the rings should be omitted. The lighting hole in the top ring should have a pellet of pressed powder inserted instead of mealed powder.

TABLE 3. PHYSICAL REQUIREMENTS OF METAL .

Metals	Tenacity, Tons of 2,240 Lb. per Sq. In.		Percentage of Elongation in a Test Piece 2 In. Long and 0.564 In. in Diameter or Such Test Piece as Can be Furnished, Provided that Length = $\frac{4}{\sqrt{\text{Area}}}$
	Yield	Breaking	
Aluminum alloy.....	7.75	12	7
Delta metal.....	20	30	20
Hard-rolled brass.....	6	12	10
Class A metal.....	20	30	20
Class B metal.....	12	20	30
Class C metal.....	6	12	10

The stirrup springs are to be made of hard-rolled sheet brass. All the stirrup springs will be subject to the following minimum test: The time-detonator pellet spring will be required to stand a pressure of 100 lb. and the percussion-detonator pellet spring a pressure of 60 lb. The percussion-detonator spring is to be gaged, after having been subjected to a load of 60 lb. in a steel counterpart of the fuse pellet and ferrule to mean dimensions, and the time-detonator pellet spring after having been subjected to a load of 100 lb.

The cloth washers are to be made from waterproofed drab woolen material, weighing 13½ oz. per sq. yd. Holes are to be cut in the washers so as to expose the powder pellets in the body and ring, also a hole to clear the brass pin in the body.

The interior of the fuse, aluminum cap and washer and inside face of base plug are to be coated with shellac varnish consisting of:

TABLE 4. INTERIOR FUSE VARNISH

Shellac, finest orange.....	5 lb.
Spirit, methylated.....	8 lb.

and stoved at a temperature of 170 deg. F. for not less than 3 hr. Spirit lost by evaporation is to be replaced as required.

After the holder for percussion arrangement has been screwed into the body, the holder and inside of cap are to be coated with shellac varnish. The exterior of the time rings and brass ring on body, the time pellet and stirrup, exterior of ferrule for percussion pellet, interior of composition grooves and flash hole in body are to be lacquered with a lacquer consisting of:

TABLE 5. LACQUER FOR FUSES

Shellac.....	1 lb.
Turmeric.....	8 oz.
Spirit, methylated.....	8 lb.

The screw threads must, unless otherwise stated, be of the British Standard Whitworth form, cut full.

Perforated pellets of pressed powder are to be inserted in the fire-escape holes of

the top and bottom composition rings and the holes closed by brass disks. A pellet is also to be inserted in the hole on top of the bottom composition ring and in the flash holes of the body. The lighting hole in the top ring is to be filled with loose mealed powder covered by a patch of silk or tycoon paper. A cloth washer is to be secured on the face of the body and on the top of the bottom ring with shellac varnish containing a small quantity of Venice turpentine. The grooves on the under side of the composition rings are to be charged with the composition pressed into them to give the required time of burning. The under faces of the composition rings are then coated with the varnish previously referred to, and are to be covered with vegetable paper washers secured with shellac varnish consisting of best orange shellac dissolved in methylated spirit containing a small quantity of Venice turpentine, vegetable paper tablets being previously placed over the lighting points.

In assembling, the threads, the percussion-arrangement holder and base plug are to be coated with Pettman cement before being screwed into the body. The cap is to be screwed down so that a turning moment of  $144 \times 12$  in.-oz. will just turn the ring, the cap being secured by means of the setscrew.

The bench or table upon which the tensioning apparatus is fixed is to be jarred by tapping with a mallet to assist the turning of the ring. The fuse cover is to be attached to the fuse in the following manner: Press the fuse cover into position and solder it to the brass ring of the fuse, using pure rosin as a flux, the surplus solder being removed. The fuse is set at safety before the cover is soldered on. The fuse with cover attached is then to be vacuum-tested to insure its air-tightness. After testing, the base plug is to be screwed into the body and the magazine filled with fine grain powder through the filling hole. The hole is to be closed with the screwed plug, the threads of the latter being previously coated with Pettman cement. The bottom of the fuse is to be coated with shellac varnish. A leather washer soaked in melted mineral jelly is to be placed under the flange inside the brass ring. The Pettman cement is to consist of:

TABLE 6. PETTMAN CEMENT

Gum, shellac.....	7 lb. 8 oz.
Spirit, methylated.....	8 lb.
Tar, Stockholm.....	5 lb.
Venetian red.....	20 lb. 12 oz.

The spaces between the cap, time rings and body and setscrew recess in top are to be filled with waterproofing composition consisting of:

TABLE 7. WATERPROOF COATING

Beeswax.....	2 parts by weight
Mineral jelly.....	1 part by weight
French chalk.....	$2\frac{1}{4}$ parts by weight

The escape-hole disks in the time rings are also to be covered with the above composition. The flash hole in the center of the base plug is to be coated with a varnish consisting of:

TABLE 8. FLASH-HOLE VARNISH

Amyl acetate.....	91 parts by weight
Nitrocellulose (soluble in ether alcohol).....	5 parts by weight
Castor oil.....	4 parts by weight

The cap is to be made of brass, formed to shape, with a projection. The strip is to be made of sheet brass, annealed and tinned all over. A ring made of brass wire,



with brazed joint, is to be secured at one end of the strip by turning over the latter and securing with solder. The strip, with ring attached, is to be soldered to the cap and the brass ring is to be held in position by means of a brass strip also soldered to the cap. In addition to the tests previously provided for, a percentage of the covers may be selected during manufacture and tested in the following manner:

The cover will be securely held in a press with the open end against an india rubber pad and tested for airtightness either by immersing the whole apparatus in water at 100 deg. F. or by means of a vacuum process. Any escape of air will entail rejection. The fuse and cover are to be stamped and stenciled.

The fuses are to be delivered into bond in lots of 2,000, with covers complete, to await the results of proof. An additional 40 is to be supplied free for proof with each 2,000 or any less number supplied; in the event of further proof being required the fuses will be taken from the lot supplied. If the results of proof are satisfactory the fuses will then be forwarded as described for final examination and testing.

The fuses selected for proof will be tested as follows: Ten will have the percussion arrangement removed and will be fired in an electrical testing machine to determine the mean time of burning at rest. The mean time of burning, set full, when corrected for barometer will be 22 sec. + 0.2 sec. The constant to be used when correcting for barometer is 0.023 of the mean time of burning. For every inch the barometer reads above or below 30 in. it is + when above and - when below. If the lot fails to pass this test a further proof will be taken while spinning in a lathe at 2,500 r.p.m. The fuse must burn within the limits specified above, otherwise the lot will be rejected. Should the detonator fail to ignite time ring a second proof will be taken; should a similar failure occur at second proof, or should there be more than one such failure at first proof, the lot will be rejected. Twenty fuses will be fired at the same elevation in any of the following guns, with full charges.

The mean difference from the mean time of burning of the 20 fuses is not to exceed:

In 18-pdr. gun	{	If set full.....	0.14 sec.
		If set 16.....	0.11 sec.
In 13-pdr. gun	{	If set full.....	0.20 sec.
		If set 14.....	0.13 sec.

The difference between the longest and shortest fuse is not to exceed:

In 18-pdr. gun	{	If set full.....	0.75 sec.
		Omitting one fuse.....	0.60 sec.
		If set 16.....	0.60 sec.
In 13-pdr. gun	{	Omitting one fuse.....	0.50 sec.
		If set full.....	0.90 sec.
		Omitting one fuse.....	0.70 sec.
		If set 14.....	0.70 sec.
		Omitting one fuse.....	0.50 sec.

If there is one blind fuse, a second proof will be taken. If there is a blind at second proof or more than one such failure at first proof the lot will be rejected.

**The Sequence of Operations.**—Details of the fuse body are shown in Fig. 569 and the sequence of operations is illustrated in Figs. 570-572. These may be listed as follows:

1. Rough-turn outside of stem to fit collet.
2. Bore, recess and tap inside and turn outside for the two threads.
3. Hand-tap inside threads.

4. Mill thread on outside of large end.
5. Finish outside of stem, bore and counterbore small end and serrate upper side of platform.
6. Hand-ream inside for upper and lower shoulders.
7. Mill thread on end of stem.
8. Mill fine thread for graduated ring on large end.
9. Rough-turn outer edge of graduated ring casting to allow easy chucking.
10. Bore and tap graduated ring.
11. Screw ring on body.
12. Drill ring and body for screwed plug.
13. Tap ring and body for screwed plug.

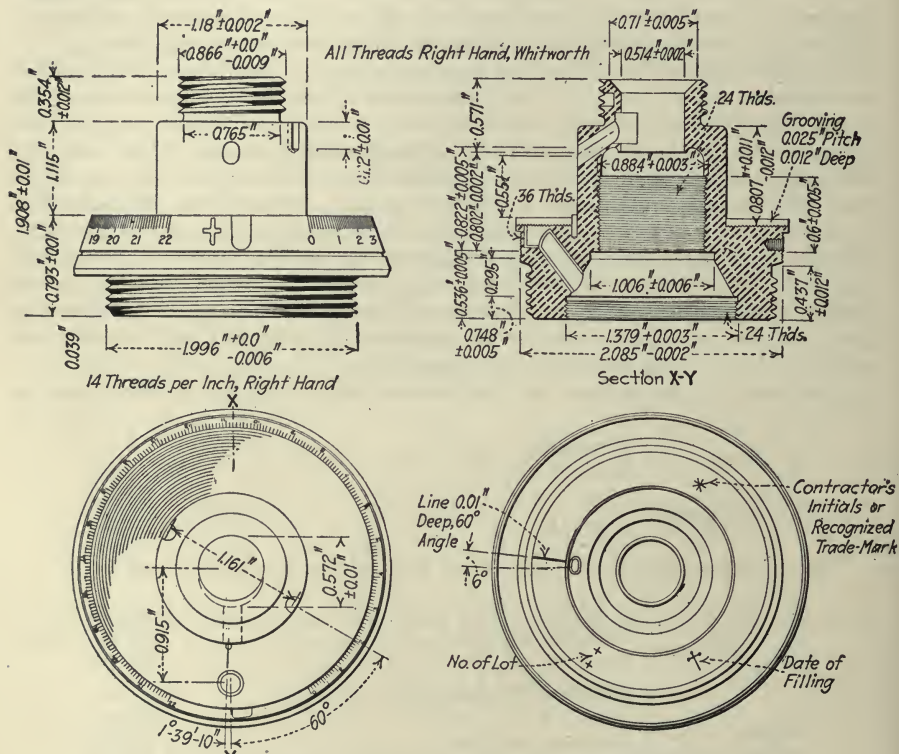
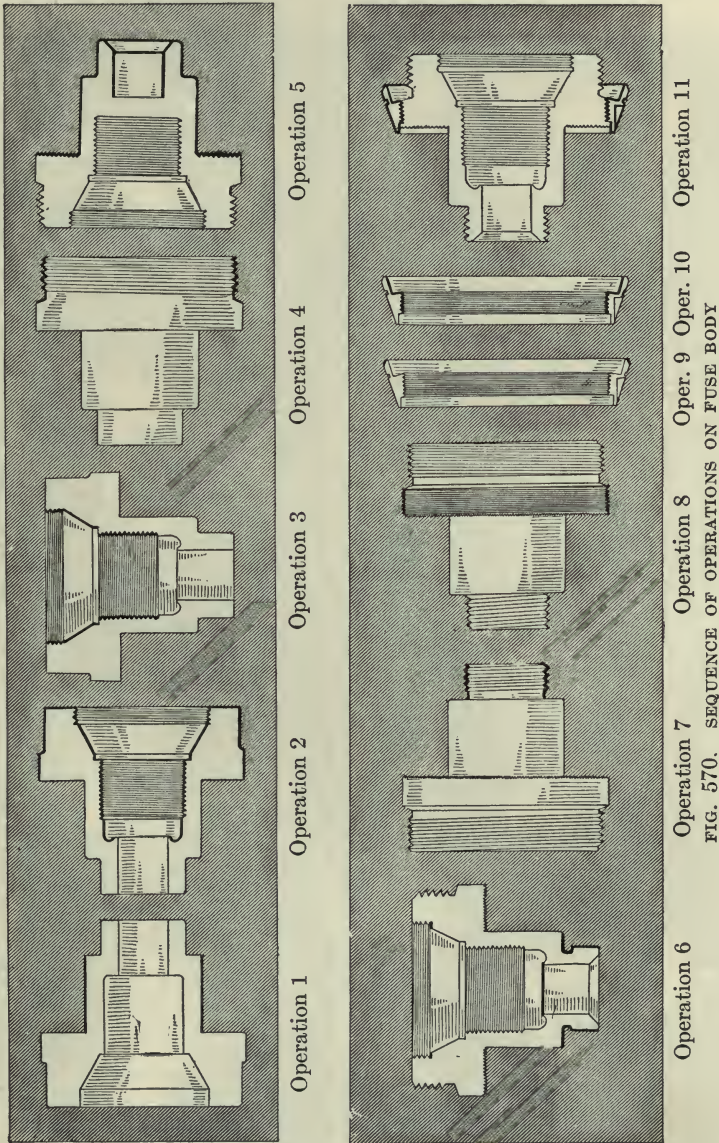

FIG. 569. DETAILS OF TIME-FUSE BODY

14. Turn outside of graduated ring.
15. Face under side of graduated ring.
16. Mill key slot in graduated ring.
17. Mill recess for flash hole.
18. Drill powder hole in platform.
19. Drill magazine hole.
20. Drill flash hole.
21. Roll graduations in ring.
22. Turn neck on small end.
23. Stamp base line on bottom of body.

The bodies are machined for the most part on hand turret machines of various makes. The rough-turning of the stem in operation 1 makes it easy to hold the bodies in spring collets and has been found more satis-



factory than gripping in an ordinary chuck. This is done at the rate of 50 per hr.

The cutting speed for turning tools on the body is about 142 ft. per

min., while a tapping speed of 55 ft. per min. is found very satisfactory. A mixture of kerosene and lard oil is used as a cutting lubricant.

The tools used in operation 2 are shown in Fig. 573. This shows the main dimensions of the various tools, and in some cases, notably in *I*,

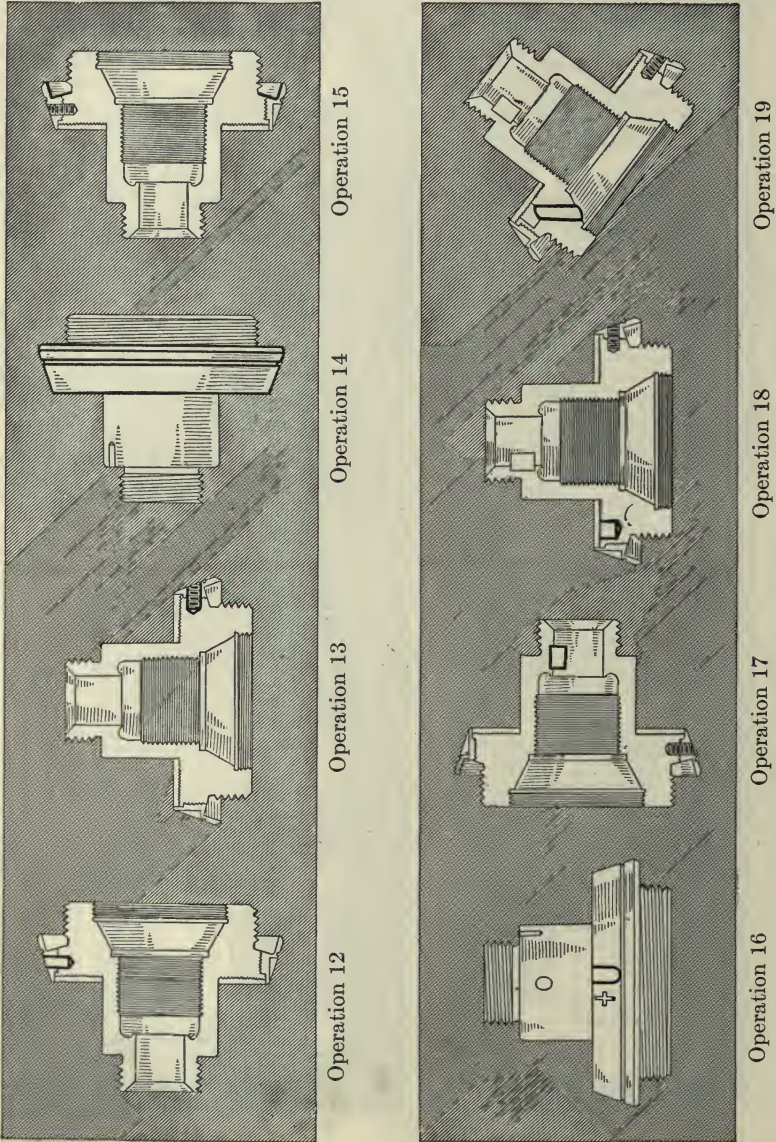
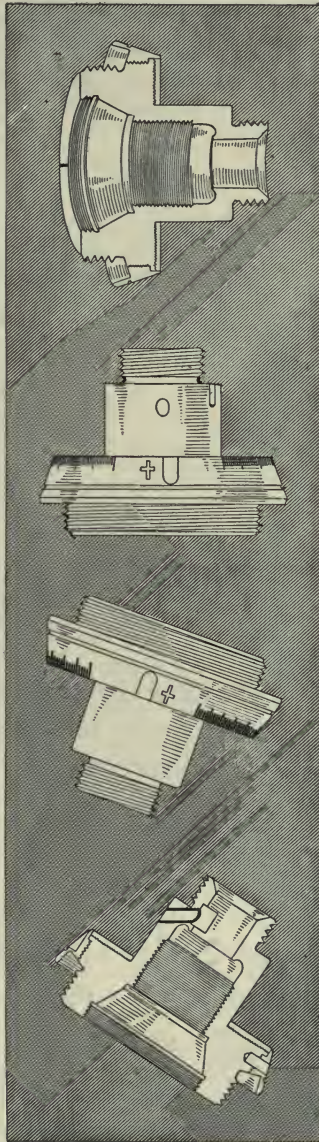

FIG. 571. SEQUENCE OF OPERATIONS ON FUSE BODY

the work they perform. It will be noted in *M* that the circular forming cutter is provided with radial slots. This has been done to prevent the

cutter warping out of shape and has been adopted in nearly all circular cutters.

For hand-tapping the bodies are held in special wooden vise jaws,



Operation 23

Operation 22

Operation 21

Operation 20

FIG. 572. SEQUENCE OF OPERATIONS ON FUSE BODY

these being shown in Fig. 574. These hold the body firmly for tapping and do not crush or mar the stem.

In the fourth operation the body is held in the special milling fixture





similar to the one shown in Fig. 575, and the thread is milled on the large end of the body. This is done in a simple fixture in which the body is held inside of a screw having the same lead as the thread to be milled.

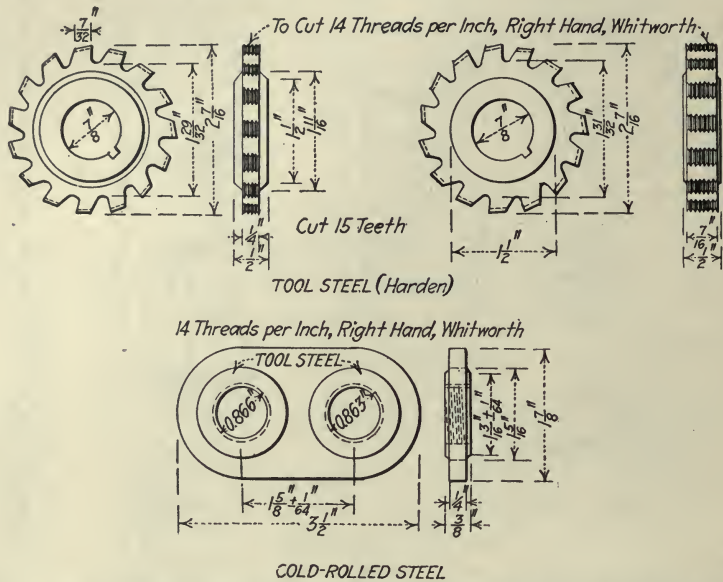

FIG. 575. THREAD-MILLING CUTTERS FOR MILLING THREADS ON ENDS OF TIME-FUSE BODY AND LIMIT GAGES USED FOR OPERATION 7

The milling cutter has no lead, but is simply a cutter, set at the proper angle and having enough teeth to cover the entire length of the thread. In this way one revolution of the body in the hand fixture shown mills

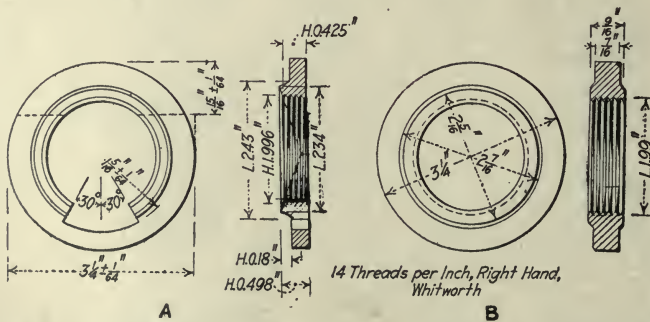

FIG. 576. GAGES FOR OPERATION NO. 4. PRODUCTION, 30 PER HOUR  
 A, main thread on nose, low limit; B, combination high diameter, cone, length of thread and shape of recess under platform

the thread on the entire circumference. A stop for the cross-slide allows the work to be fed in the proper depth, so that the right diameter is easily secured. The gages are shown in Fig. 576.





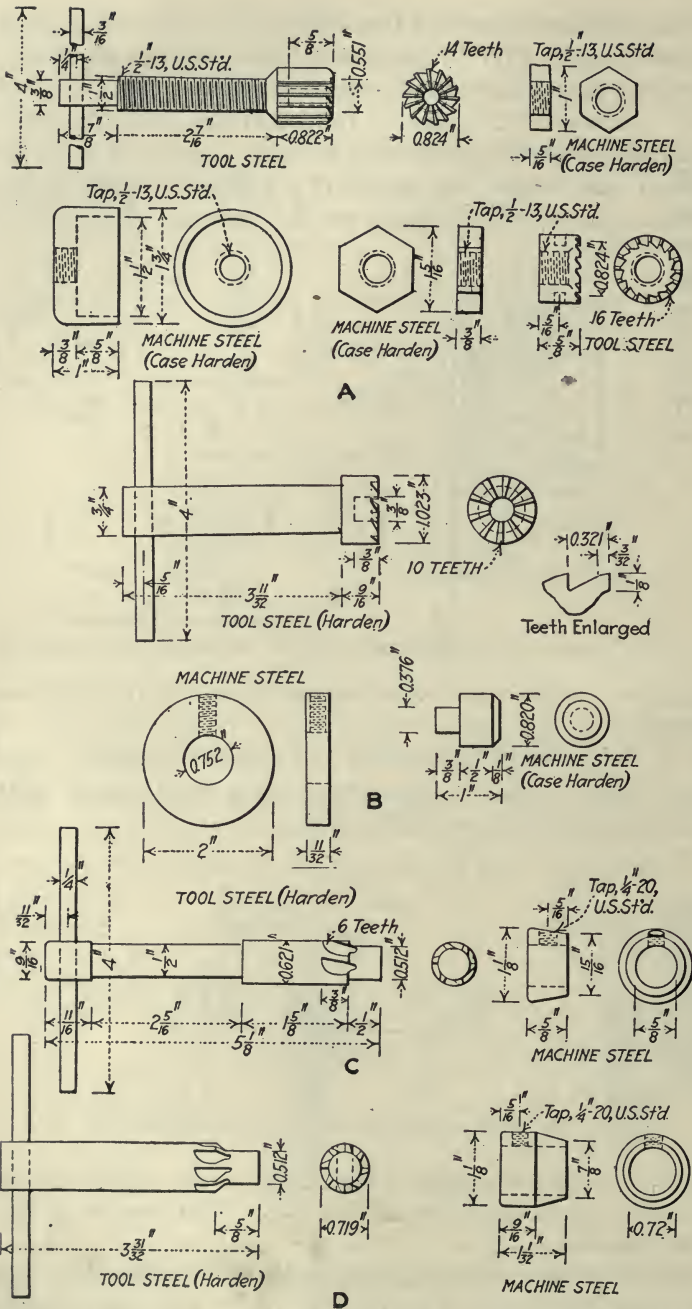

FIG. 579. FACING TOOLS FOR OPERATION NO. 6. PRODUCTION, 45 PER HR.  
 A, hand reamer for inner shoulder; B, hand reamer for outer shoulder; C, hand reamer for inner seat;  
 D, hand reamer for rounding inner corner





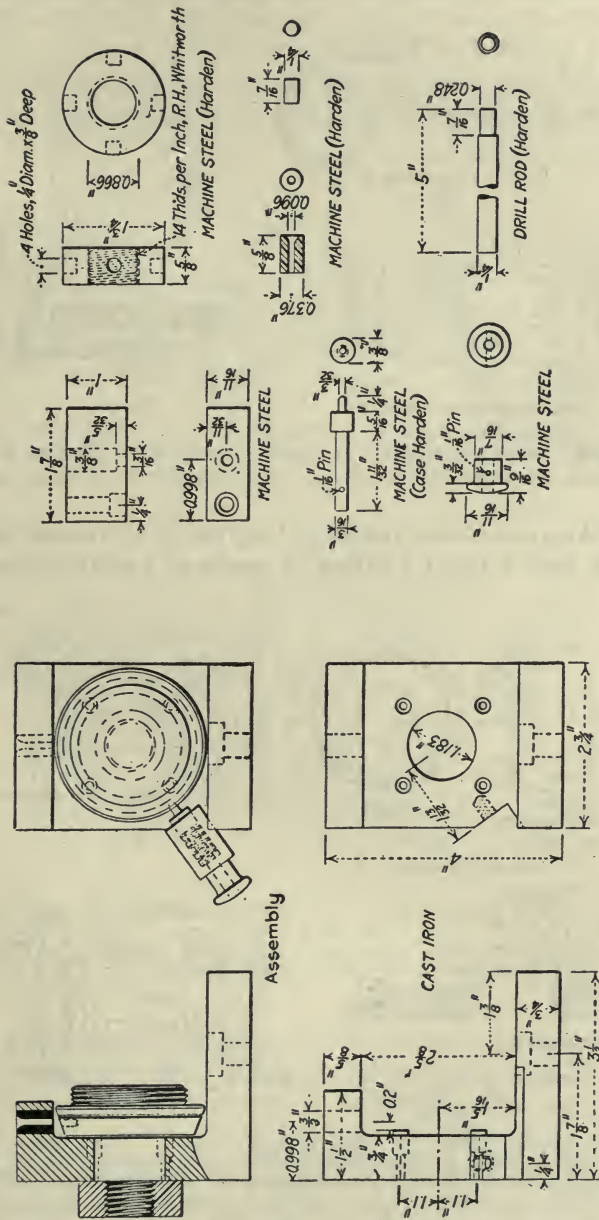

FIG. 583 JIG FOR DRILLING LOCKING-SCREW HOLE

An interesting feature of the jigs for holding the fuse body for drilling is the use of hardened steel pins for locating the body from the serrated platform. Four pins are used, these being assembled in position. These

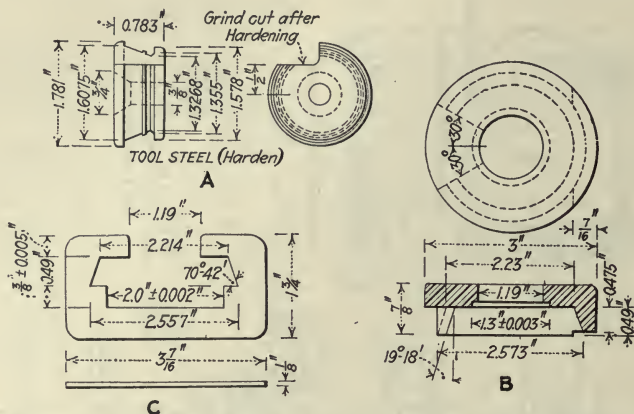

FIG. 584. TURNING OUTSIDE OF RING. PRODUCTION, 30 PER HR.  
A, circular forming tool for graduated ring; B, angle gage; C, low diameter of ring and platform

do not retain chips and make it easier to keep the jig in working condition. The tapping is done without a fixture by means of a small friction tapper

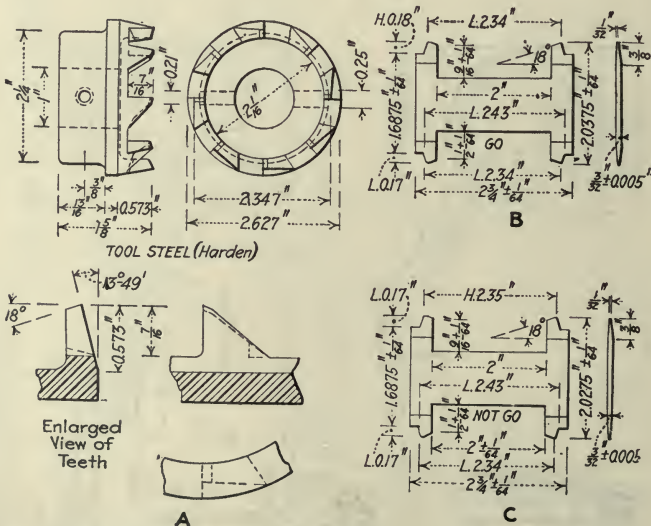

FIG. 585. TOOLS AND GAGES FOR FACING UNDER SIDE OF RING  
A, facing tool for under side of ring; B, depth of recess under brass collar; C, diameter and shape of recess

built by the Rickert-Shafer Co., of Erie, Penn. After the tapping, threaded brass rods are screwed through the ring into the body and twisted off. The body then goes to a hand screw machine or bench

lathe, as the case may be, and has the outside of the ring turned in operation 14, by the tool shown in Fig. 584. Next comes the facing of the under side of the brass rings, Fig. 585 showing the tool and gages used in connection with this, operation 15. This is done on a hand screw machine and is one of the particular jobs in making the fuse. Fig. 586 shows the fixture, the routing tool and the gages used in milling the key slot in the ring, as shown in operation 16. This is later used in deter-

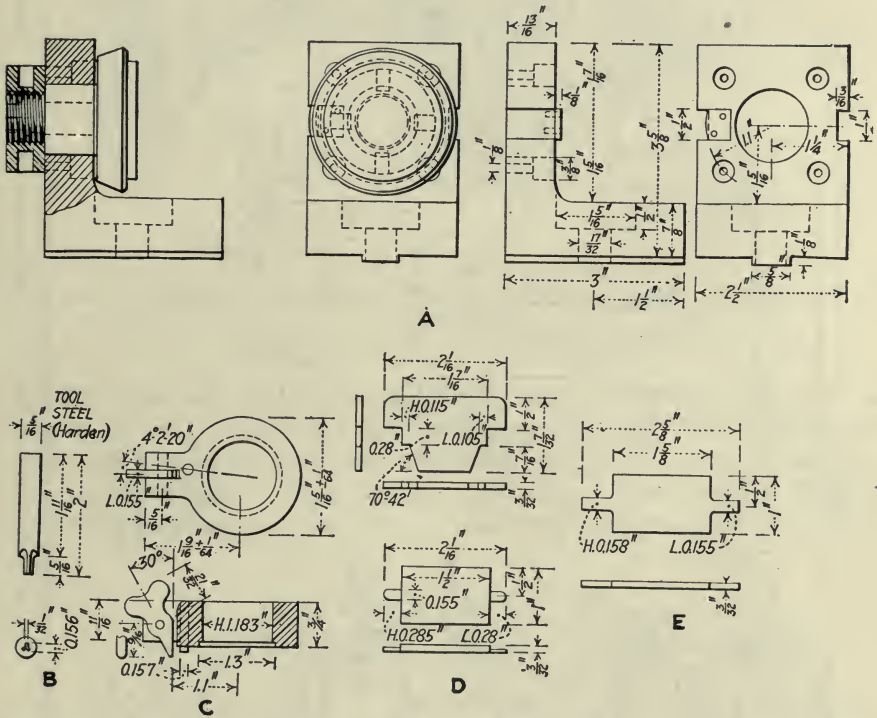

FIG. 586. FIXTURE, TOOLS AND GAGES FOR MILLING KEY SLOTS. PRODUCTION, 100 PER HR.

A, holder for milling ring; B, routing cutter for key slot; C, position of key slot from magazine hole; D, depth of key slot; E, length of key slot

mining the position of the hole through the platform which connects with the magazine inside the large end of the body.

The recess in the stem, which later forms the connecting passage with the flash hole, is cut in a Burke hand miller, as shown in operation 17. The milling cutter and gages for this are illustrated in Fig. 587. These recesses are cut very rapidly and, in common with all operations which follow operation 16, the body is positioned by the key slot already mentioned. This is particularly true in operation 18, in which the platform hole is drilled in the jig shown in Fig. 588. As can be seen, the





center line of the hole is 4 deg. 2 min. 30 sec. from the center of the key slot. The gages are also shown in the same figure.

Drilling the hole through from the side of the platform hole to the magazine is done in operation 19 and in the fixture shown in Fig. 589. The gages are also shown in the same figure.

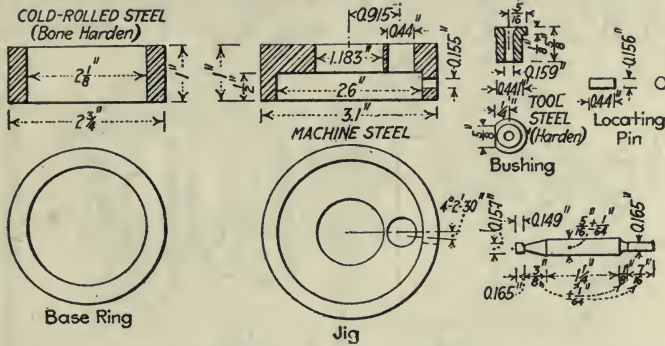

FIG. 588. FIXTURE AND GAGES FOR DRILLING PLATFORM HOLES. PRODUCTION, 100 PER HR.  
Jig for drilling platform hole; diameter and depth gage for platform hole

The flash hole, which is drilled through the stem of the body into the recess shown in Fig. 584, constitutes operation 19. The fixture and gages for this are shown in Fig. 590, these being very similar to those for the magazine hole. It will be noted in several of these fixtures that four small hardened and ground pins are used for locating the fuse body end-

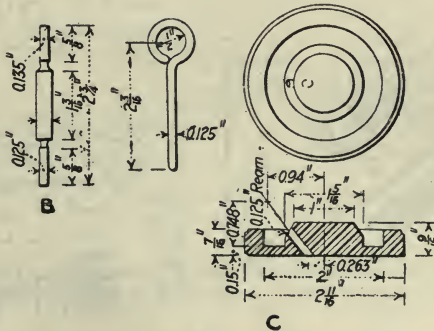

FIG. 589. JIGS AND GAGES FOR DRILLING MAGAZINE HOLES. PRODUCTION, 400 PER HR.  
B, diameter of magazine hole; C, angle of magazine hole

wise. These come in contact with the serrations on the upper side of the platform and inside the raised ring on the outer diameter.

Next comes the graduating of the ring on a rolling machine built by Noble & Westbrook. This is divided into two suboperations—the first rolling in the graduations and the second rolling the numerals in their







the thread in the cap is of the maximum length. The tolerance is 0.002 in. The next operation cuts off the end that is to form the base plug, as shown at *C*, Fig. 592. It will be noted at *A* that the end of the plug is recessed, the exact shape being shown in the base plug details, Fig. 601.

Leaving the base plug for the present and continuing with the completion of the cap, the round end is formed in the usual manner, by either flat or circular forming tools, as shown in Fig. 597. The cap is then easily released from the threaded mandrel *A* by means of the left-hand nut that forms a stop and enables the pressure to be easily relieved.

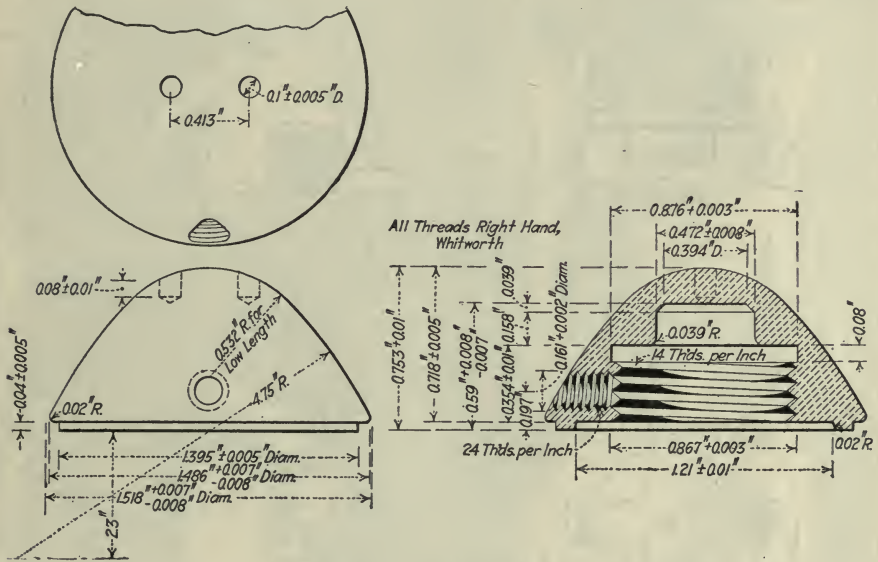

FIG. 594. DETAILS OF CAP

Next comes the drilling of the spanner wrench holes, as shown at *E*, Fig. 595, this being done in a simple jig *A*, Fig. 598, with the aid of a double-spindle drilling head. The spindles have a center distance of 0.413 in. These holes are 0.10 in. in diameter, and both the diameter and the center distance are tested by gages, shown in Fig. 598 at *C*. Then the side hole for the setscrew is drilled as at *F*, and tapped as at *G*, Fig. 595. Tools and gages for these operations are shown in Figs. 599 and 600.

After the plugs have been cut from the cap casting, they are held in a collet and finished on the back side, the sequence of operations being given in Fig. 602. This plug is a rather difficult piece to make, the various shaped recesses on the end not being easy to handle. The thickness of the plug is determined by a hardened steel stop in the center of the facing tool that makes contact with a distance plug in the center of the

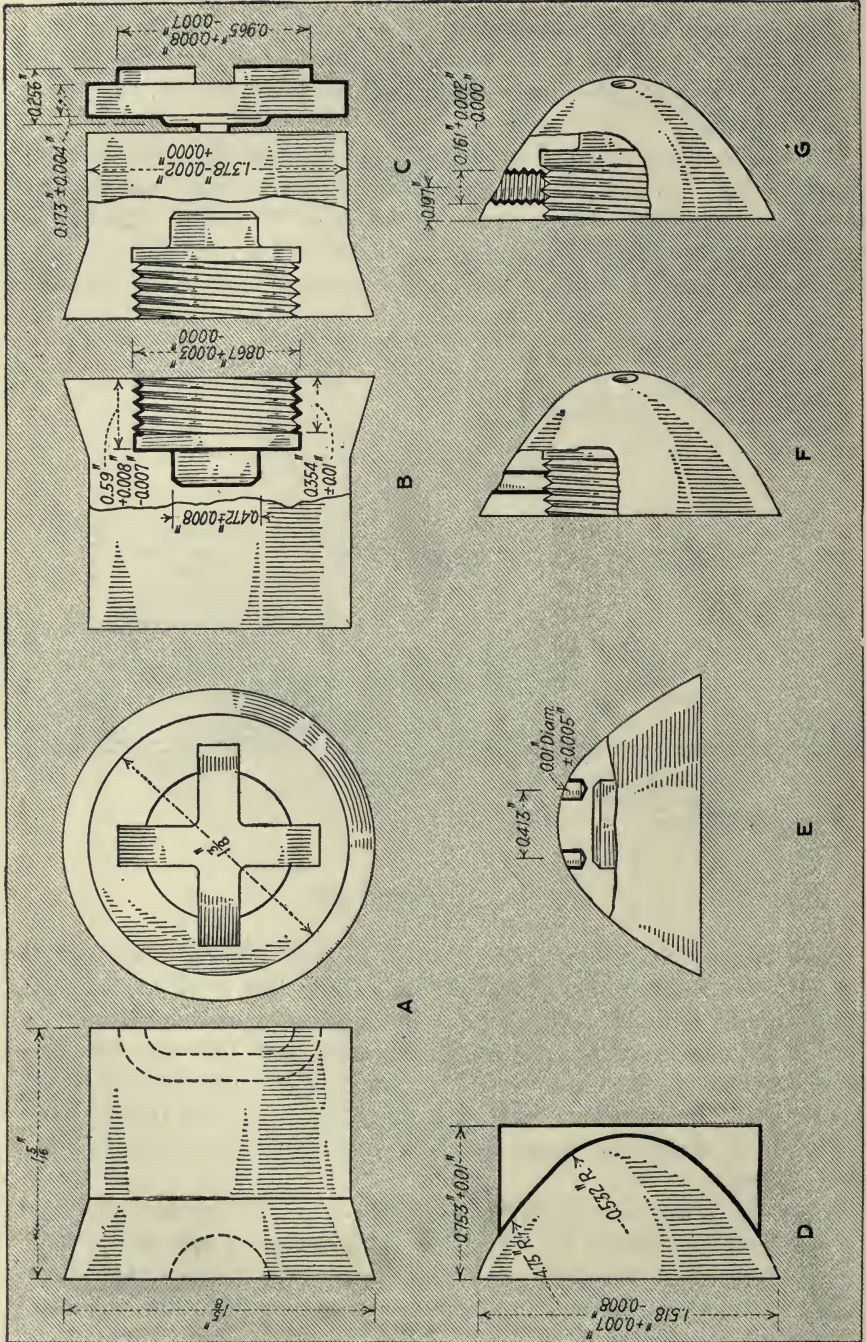

FIG. 595. SEQUENCE OF OPERATIONS ON CAPS

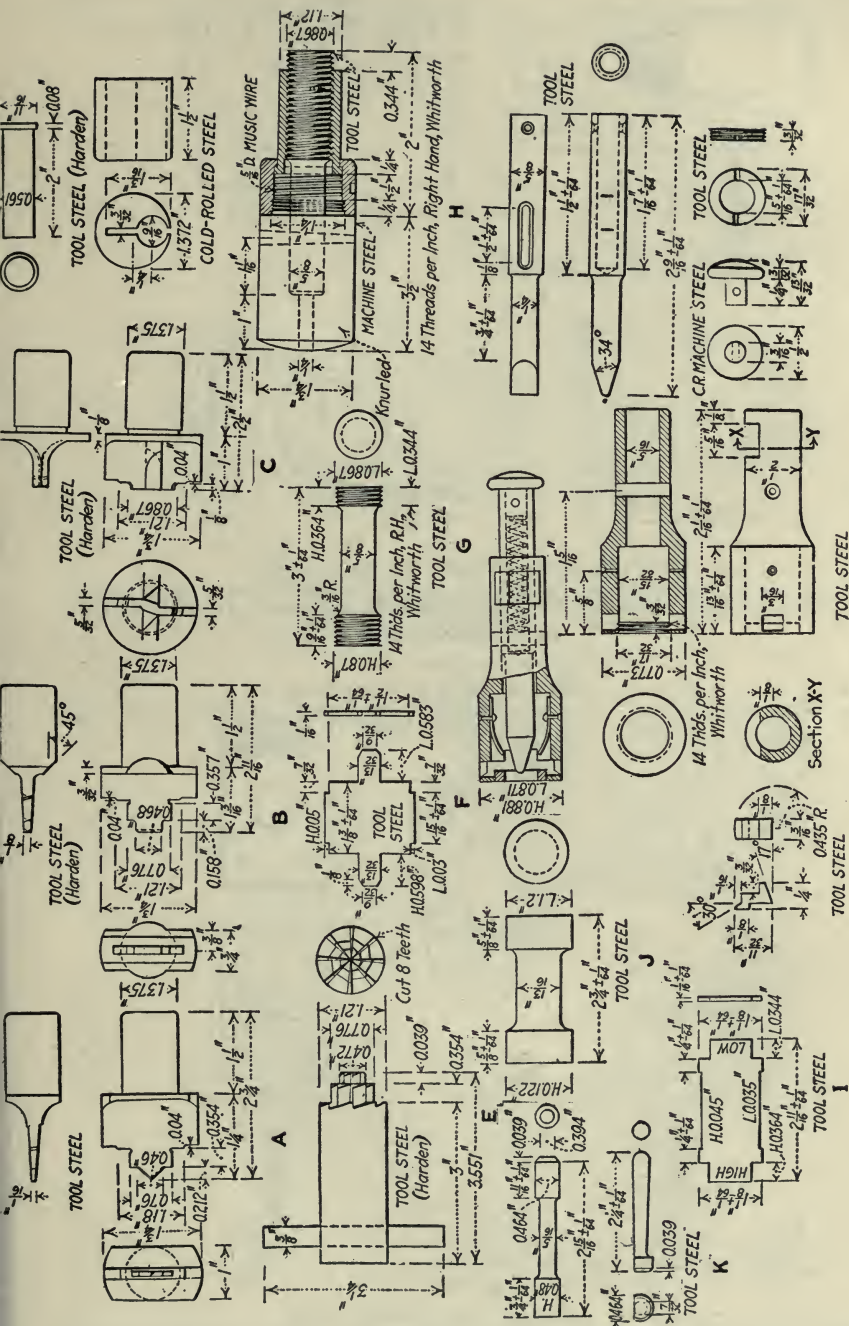

FIG. 596. BORING AND TAPPING CAPS

Tools—A, roughing cutter for inside of cap; B, cutter for inside of cap; C, form-facing tools for other end of cap; D, reaming tools for cap; E, hand reamer for inside of cap; F, depth of recess and depth of bore in cap; G, diameter and depth of screw recess; H, another form of gage for diameter and depth of recess; I, depth of threaded portion and depth of lip; J, diameter of recess in cap; K, form of bore in cap; L, diameter of undercuts in cap

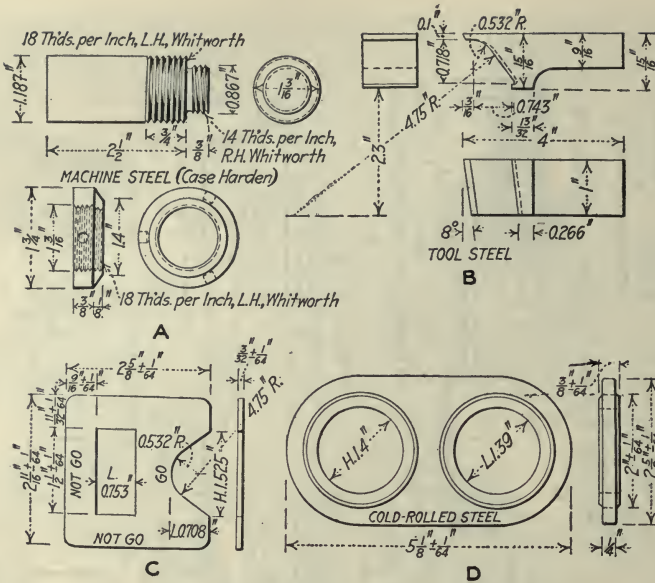

FIG. 597. TURNING THE OUTSIDE OF THE CAP

Tools—A, threaded mandrel for holding cap; B, flat forming tool for outside of cap. Gages—C, low length and shape of cap; D, diameter of cap. A similar gage tests the diameter of the lip on the cap

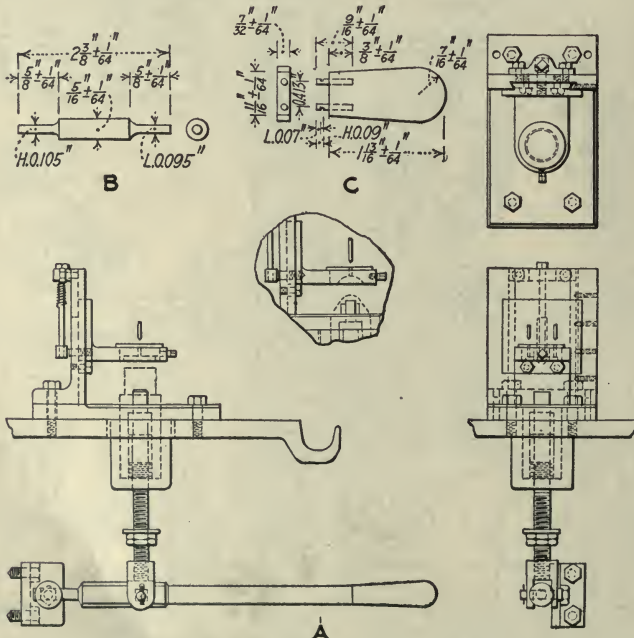

FIG. 598. DRILLING THE WRENCH HOLES

Special Tools—Sellew drilling head with fixed center; A, drilling fixture. Gages—B, diameter of holes; C, center distance of holes





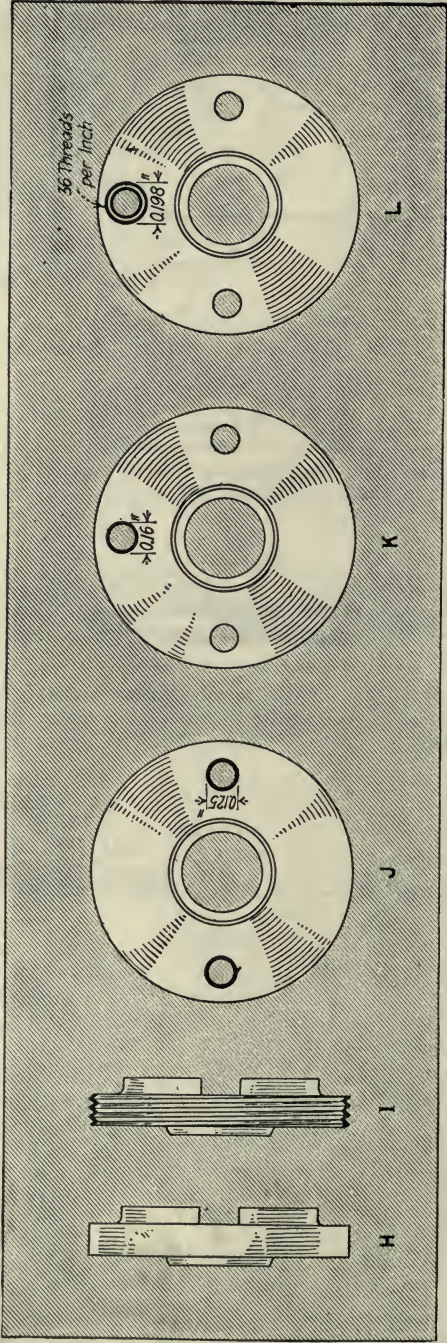

FIG. 602. SEQUENCE OF OPERATIONS ON BASE PLUGS

Here the die *A* is held stationary in the top of the holder *B*, which is fastened to the drilling-machine table. A plunger *C* comes up through the center of the die, and the plug to be threaded is laid on the end of this central plunger at *D*. Then the drill spindle, which carries a driver *E*, is brought down on the plug, the driver fitting the cross-slots on the outer end of the plug and revolving it in the die at the same time it is supported by the plunger, to insure the thread being cut square with the axis of the plug. The plunger recedes as the plug is threaded

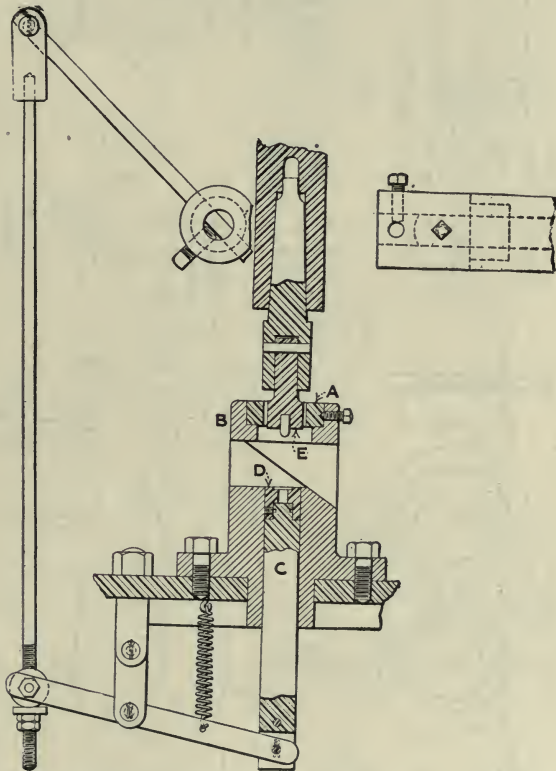

FIG. 603. BASE PLUG THREADER IN POSITION IN DRILLING MACHINES

through the die and allows the finished plug to drop out of a side opening, as can be seen. Details of the connections are shown and the whole device can be readily understood.

Next comes the drilling of the two holes for the spanner wrench and the hole for the loading screw. These operations are shown in *J* and *K*, Fig. 602, the fixtures and tools being shown in Fig. 605. The plug hole is also counterbored for the head of the screw and finally tapped to 0.198 in. with 36 threads per inch, Whitworth form.

The packing of these parts for shipment is also important as being

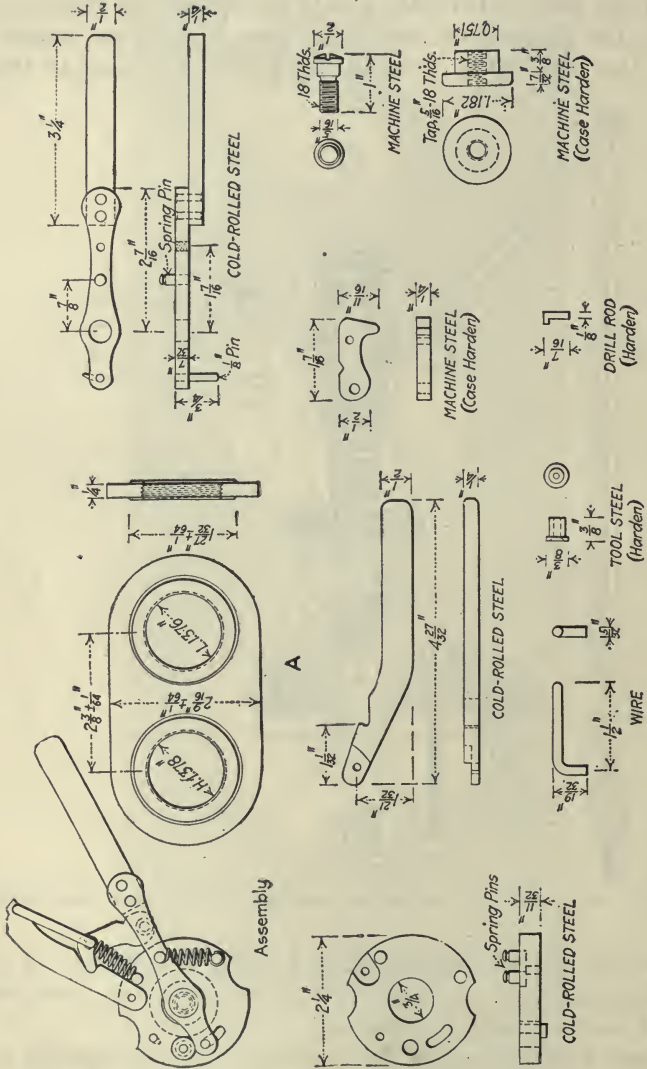

FIG. 604. DETAILS OF THE THREADING DEVICE

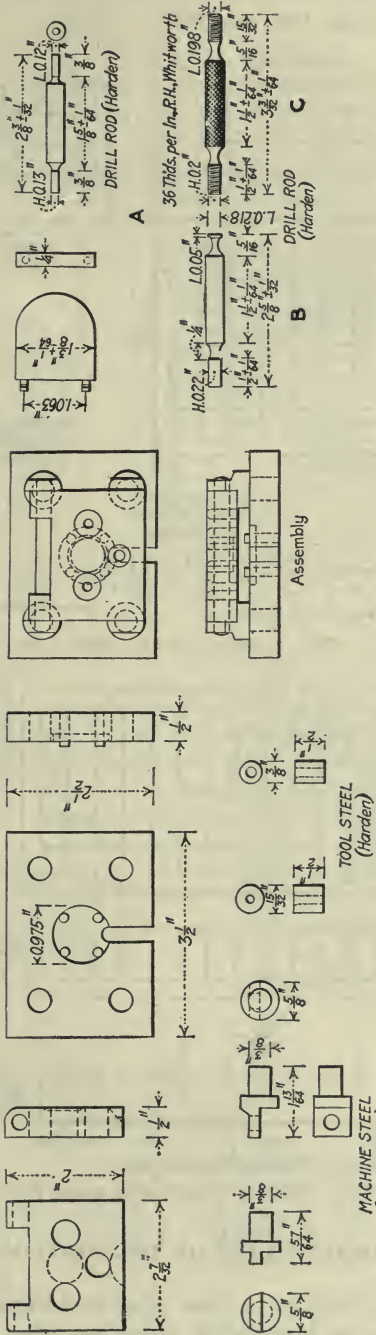

FIG. 605. DRILLING WRENCH HOLES, DRILLING JIGS FOR SPANNER HOLES, AND ALSO POWDER HOLES  
Gages—A, center distance and diameter of wrench hole; B, diameter and depth of powder-hole recess; C, size of tapped powder hole

of aluminum they are easily damaged. The boxes used, with all essential details, are shown in Figs. 606 and 607.

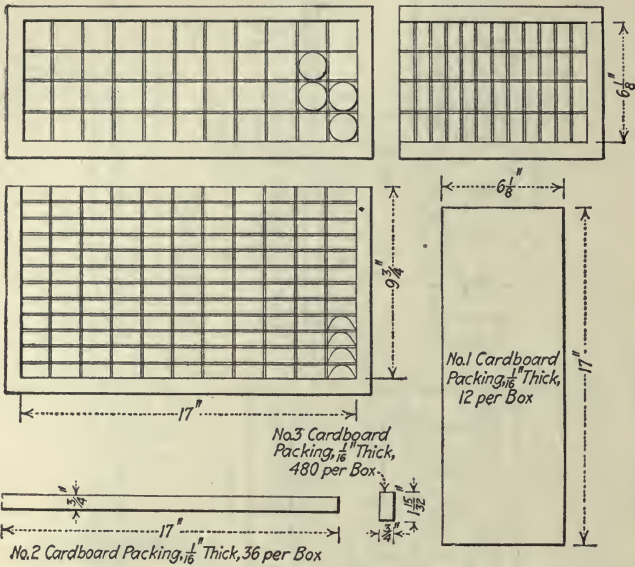

FIG. 606. PACKING BOXES FOR CAPS

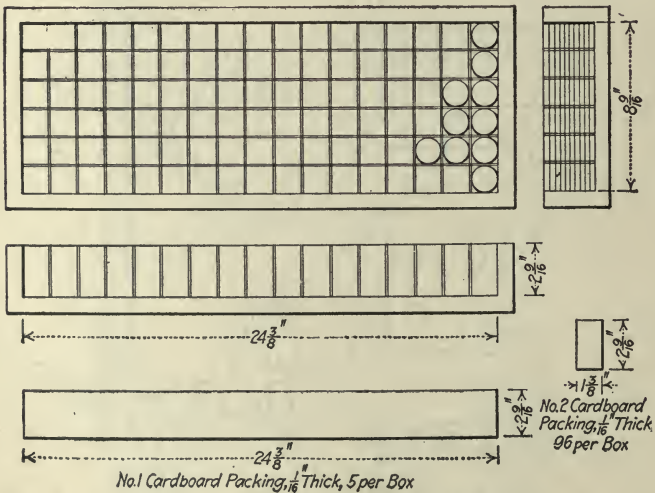

FIG. 607. PACKING BOXES FOR BASE PLUGS

MAKING THE SMALL PARTS OF THE BRITISH TIME FUSE

In addition to the body, cap, base plug and timing rings that have been described in more or less detail, there are also many other parts that are largely made in the automatic screw machine and the punch







press. These are shown in Figs. 608 and 609, the designating letters corresponding to those used in Fig. 568, and for the most part are made on automatic screw-machines. No special methods are employed but

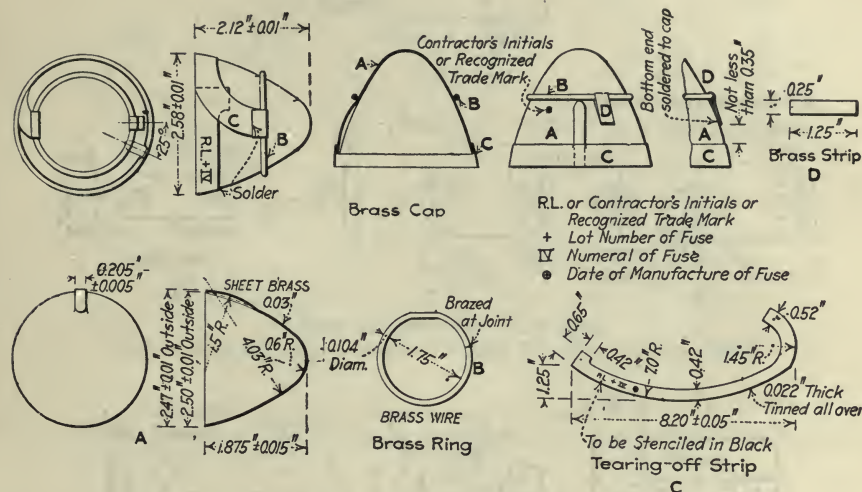

FIG. 610. THE FUSE COVER OR CAP

the collection of gages which are used is particularly complete—see Figs. 611 to 623.

Fig. 610 shows the brass fuse cover as originally called for and gives

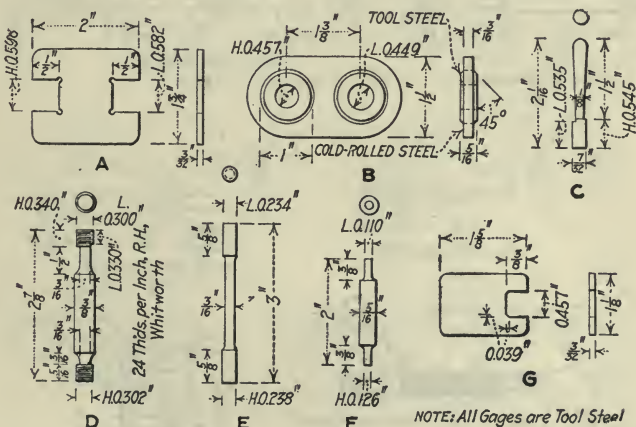

FIG. 611. TIME PELLET

A, total length; B, diameter of body; C, depth of detonator recess; D, diameter and steps of threaded parts; E, diameter of detonator recess; F, diameter of central hole; G, shape of top

some idea of the work that it involved. It consists of the body A, the brass wire ring B, which must be butted together and brazed at the joint, the tearing-off strip C and the short brass strip D. This strip is soldered

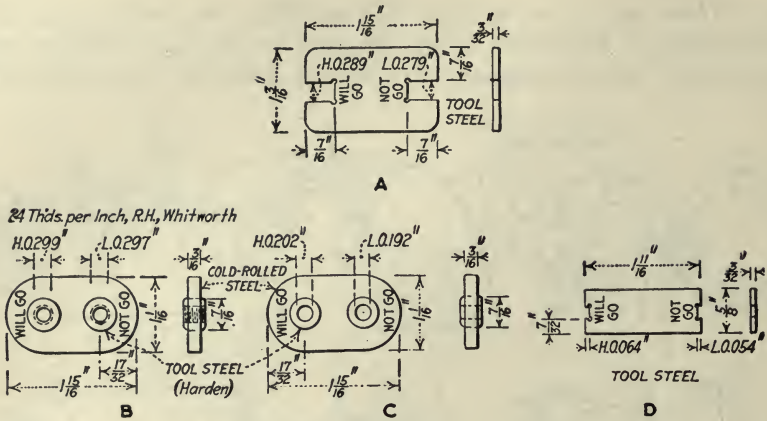

FIG. 612. TIME-PELLET SCREW

A, total length; B, diameter of plug; C, diameter of nipple; D, length of nipple

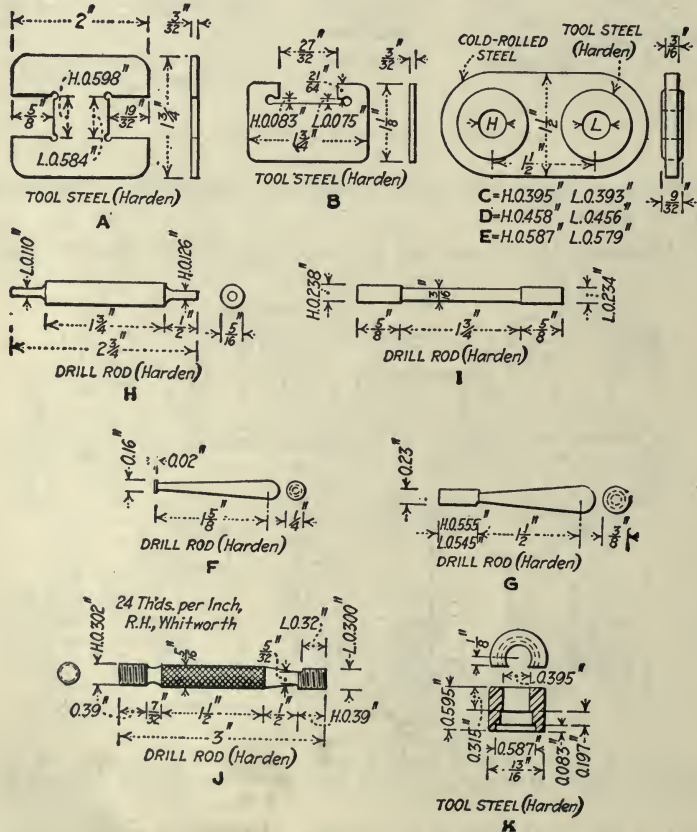

FIG. 613. PERCUSSION PELLET

A, total length; B, thickness of flange; C, diameter of front part; D, diameter of body; E, diameter of plan; F, diameter and recess in top; G, depth of recess detonator in top; H, diameter of central hole; I, diameter of detonator recess; J, diameter and depth of threaded part; K, external forms



to the cap of the body *A* in order to hold the ring *B* on the side opposite the hold of the tearing-off strip.

The object of the fuse cover is to protect the fuse from exposure to dampness and to guard it against mechanical injury. Another form of cap was made of heavy tinfoil, although this later gave place to a cap of lead thoroughly coated with tin in order to prevent any possible contact of the lead and the explosive material, which make a dangerous combination.

The screw-machine work covers everything but the washers, detonating time and percussion body and the stirrup spring. These are all punch-press operations, and while seemingly simple in themselves,

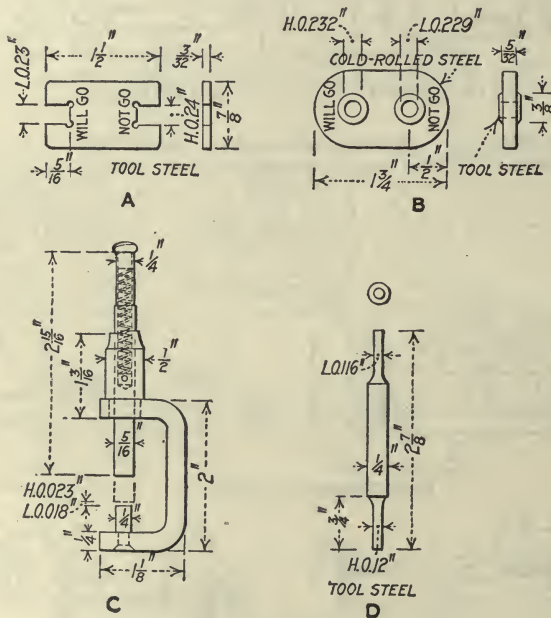

FIG. 616. PERCUSSION BODY

A, total length; B, diameter of outside; C, thickness of base; D, diameter of central hole in base

some of the specifications are not easy of fulfillment. The stirrup springs, for example, are made of hard rolled sheet brass. The spring for the percussion pellet must be gaged after having been subjected to a pressure of 60 lb. in a steel counterpart of the fuse pellet and should return to the mean dimension. It must yield at a load of not less than 77 lb., nor more than 99 lb., these pressures being the limits which the fuse is supposed to be subjected under firing conditions.

The time stirrup spring is made in a similar manner and must withstand a minimum pressure of 100 lb. A certain percentage of those tested must not yield at less than 125 lb. nor more than 165 lb.



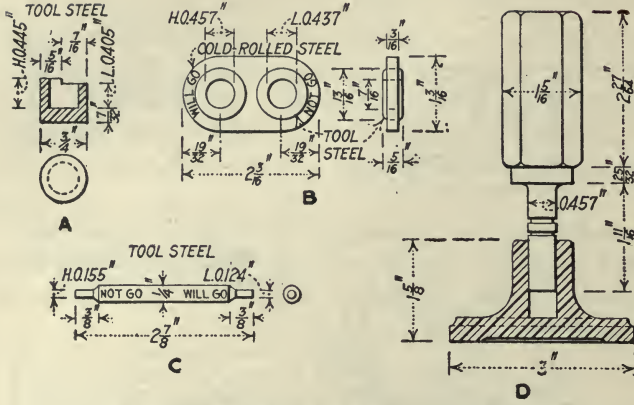

FIG. 619. DETONATOR SPRING GAGES

A, total length; B, diameter of spring; C, inside diameter of top of coil; D, standard weight for testing

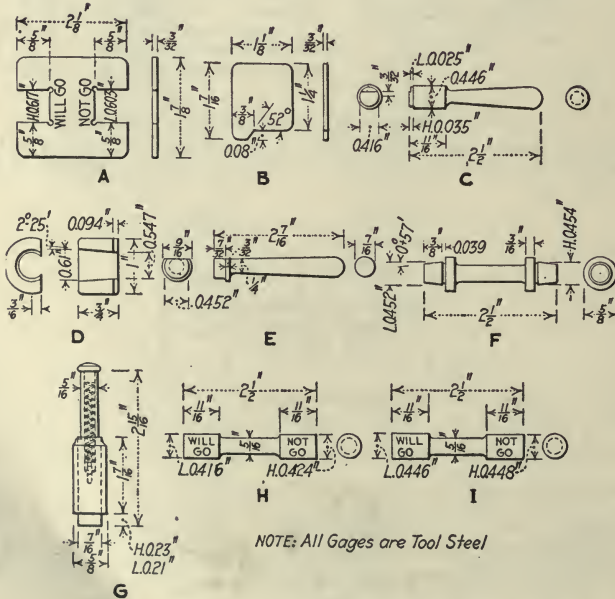

FIG. 620. FERRULE GAGES

A, total length; B, length of chamfer; C, thickness of flange at top; D, cone and diameter; E, radius at bottom; F, depth of to shoulder in bore; G, another form of gage for same purpose; H, diameter of bore at top; I, diameter of bore

NOTE: All Gages are Tool Steel

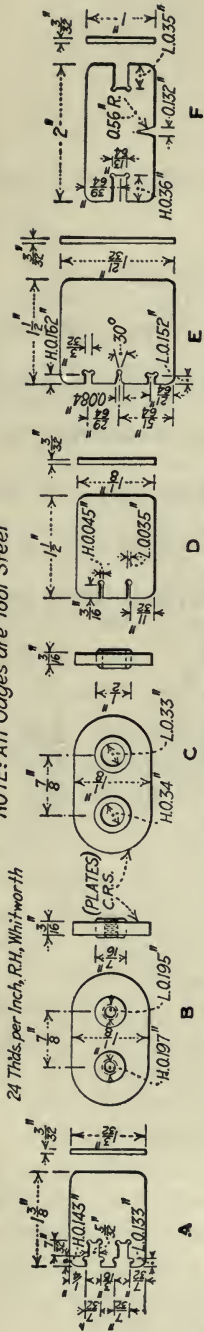

FIG. 621. PERCUSSION NEEDLE

A, length of screw; B, diameter of screw; C, diameter of hole; D, thickness of flange; E, length and cone of time needle from face of flange; F, length and form of percussion needle

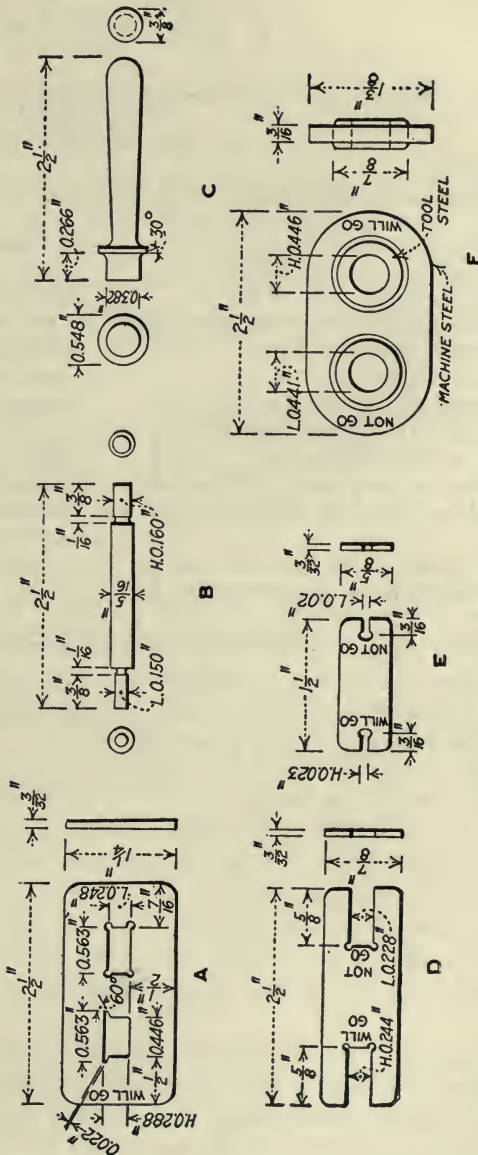

FIG. 622. STIRRUP SPRING FOR PERCUSSION PELLET

A, length and form; B, diameter of hole; C, internal form D, width of lug; E, thickness of brass; F, diameter of circular parts

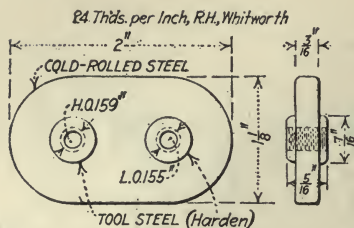

FIG. 623. SETSCREW FOR CAP

Screw-machine times on these parts are:

Time pellet, 140 per hr.	Slotting time-pellet screw plug, 1,200 per hr.
Time-pellet screw, 380 per hr.	Rethreading time-pellet screw plug, 800 per hr.
Percussion pellet, 130 per hr.	Polishing time-pellet screw plug, 1,200 per hr.
Percussion-pellet screw plug, 380 per hr.	Percussion-pellet automatic, 130 per hr.
Base-plug screw, 260 per hr.	Reseating top of percussion-pellet automatic, 800 per hr.
Ferrule, 300 per hr.	Polishing top of percussion-pellet automatic, 2,000 per hr.
Rotating pin, 600 per hr.	
Slotting rotating pins, 1,800 per hr.	
Cap setscrew, 450 per hr.	
Slotting cap setscrews, 2,000 per hr.	
Polishing top of cap setscrews, 1,700 per hr.	
Time pellet, Delta metal, 360 per hr.	
Time-pellet screw plug, 400 per hr.	

The foregoing are the number of pieces the automatics are timed to produce. The actual work turned out, however, is considerably less—as is always the case. In the average shop from 75 to 80 per cent. of the camming time is a good output.



## CHAPTER III

### MAKING PRIMERS FOR CARTRIDGE CASES<sup>1</sup>—LOADING THE PRIMERS

The general appearance of the primer for field artillery and its parts is shown in Fig. 625. They are seen in place in a cartridge case in Fig. 624. While the primer is very simple as compared with the time or even the detonating fuse, it involves more problems than might appear, especially when 5,000,000 are made on one order, as was called for by the contract awarded the American Multigraph Co., Cleveland, Ohio.

These primers fire the charge in the cartridge case that expels the projectile from the gun, just as the percussion cap in the fuse of a shotgun shell fires the powder inside. One of these primers does more, however, for it must not only fire the charge of powder ahead of it but prevent the gases from getting back into the breech of the gun.

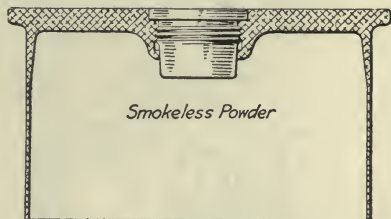

FIG. 624. PRIMER IN PLACE IN CASE

The small exploding charge is contained in the small copper cup that fits into the base of the body. Just above this is the anvil to receive the blow of the firing hammer. Next is the plug, which backs up the anvils and also forms a cover for the safety pocket in the anvil. Surrounding the central stem is a recess for a powder charge that is ignited by the small exploder in the base. The explosion of this charge bursts through the paper cover and the copper closing disk, igniting the main charge in the cartridge case and firing the projectile from the gun. The reaction, however, forces gas backward and bends the points of the closing disk in. It is for this reason that the small copper ball is used as a check valve in the anvil cavity.

This ball normally rests on the lower side of the cavity and allows the flame to shoot through the three small holes in the anvil and out through three similar holes in the plug. The ball is forced against the plug, and to prevent its interfering with the flame reaching the powder in the surrounding cavity, a groove is cut in the inside face of the plug to allow free passage no matter what the position of the ball.

The primer proper, the percussion cap, involves no intricate opera-

<sup>1</sup> Fred H. Colvin, Associate Editor, *American Machinist*.

tions, being a simple punch-press task that simply calls for close limits. But the balance of the primer parts involve a number of more or less complicated operations and these, as performed at the shops of the American Multigraph Co., are of interest.

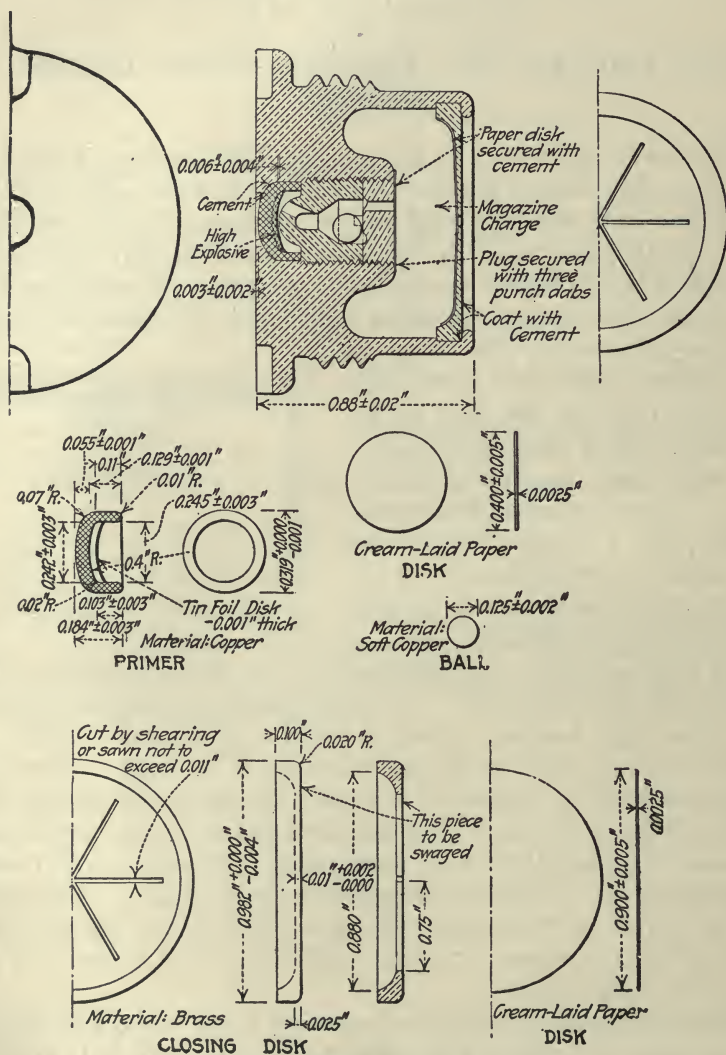

FIG. 625. THE COMPLETE PRIMER

**The Primer Body.**—The primer body is shown in Fig. 626. It is made from bar stock 1.410 in. in diameter. As the outside finish size is 1.4 in. with a tolerance of 0.004 in., this gives from 0.01 to 0.014 in. to clean up, which means a very true running chuck to start with. The

material must have a tensile strength of 26,880 lb. per sq. in., a breaking strength of 44,800 lb. and an elongation of 30 per cent.

Nine main operations on the primer bodies were found necessary to secure maximum output of work. These, together with brief data, are as follows:

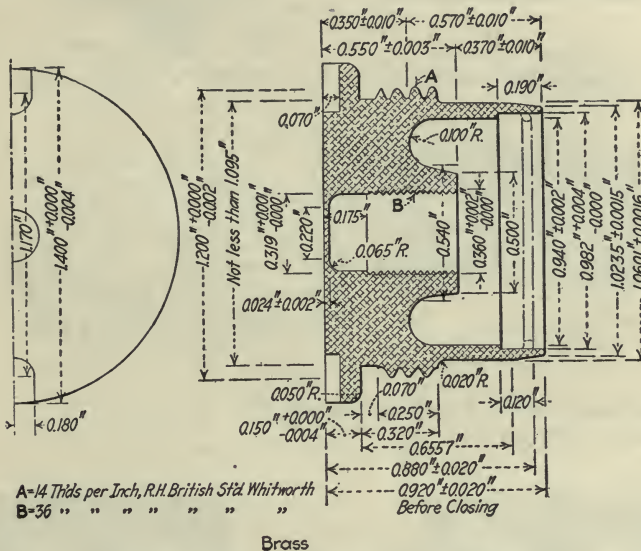

FIG. 626. THE DETAILS OF THE PRIMER BODY

SEQUENCE OF BODY OPERATIONS

1. Turning and boring blanks.
2. Facing the head.
3. Milling thread on primer body.
4. Washing in gasoline.
5. Milling key seats.
6. Tapping for anvil.
7. Finishing counterbore.
8. Washing in gasoline.
9. Final inspection.

BODY OPERATION 1. TURNING AND BORING

Machine Used—Gridley 1¾-in. automatic.  
 Special Fixtures—Tools in automatic.  
 Production—150 per hr. per machine.

BODY OPERATION 2. FACING THE HEAD

Machine Used—Brown & Sharpe vertical miller.  
 Special Fixture—Table for continuous milling.  
 Production—500 per hour.

BODY OPERATION 3. MILLING THREAD ON PRIMER BODY

Machine Used—Special thread miller.  
 Production—450 to 500 per hour.

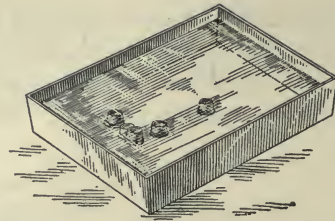
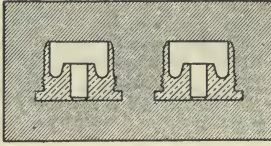

BODY OPERATIONS 4 AND 8. WASHING IN GASOLINE

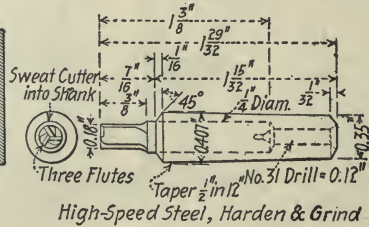
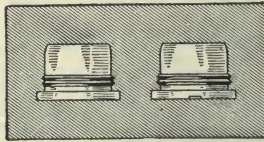

BODY OPERATION 5. MILLING KEY SLOTS

Machine Used—Special five-spindle miller.

Production—2,400 per hr.

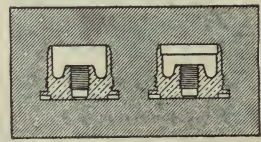
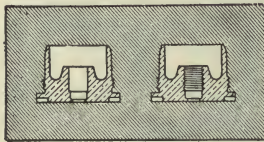

BODY OPERATION 6. TAPPING FOR ANVIL

Machine Used—Vertical drilling machine.

Special Fixtures—Errington tapping head and fixtures.

Production—250 per hr.

BODY OPERATION 7. FINISH COUNTERBORE

Machine Used—Vertical drilling machine.

Special Fixtures—Holding fixture and tools.

Production—600 per hr.

The first operation is performed on  $1\frac{3}{4}$ -in. Gridley four-spindle automatics, the tooling set-up being shown in Fig. 627. The sequence of operations is shown beneath the various views, the outside turning and the counterboring being done simultaneously, in both roughing and finishing. This is made possible by the cross-slide forming tool being run into the flute of the counterbore, although the tool layout indicates an interference, as the counterbore has been turned to show the shape of the cutting edges. The forming tools and counterbores are shown in Fig. 628.

From the Gridley the fuse bodies go to the face-milling attachment, shown in Fig. 629. The table holds 30 bodies, gripping each body in a pair of jaws that are drawn down in a wedge-shaped pocket by the

levers with rollers on the end, these rollers passing under a cam at the proper time. This draws them down against the face of the plate just before they pass under the single-pointed fly cutter which runs at top speed and makes a flat, smooth surface.

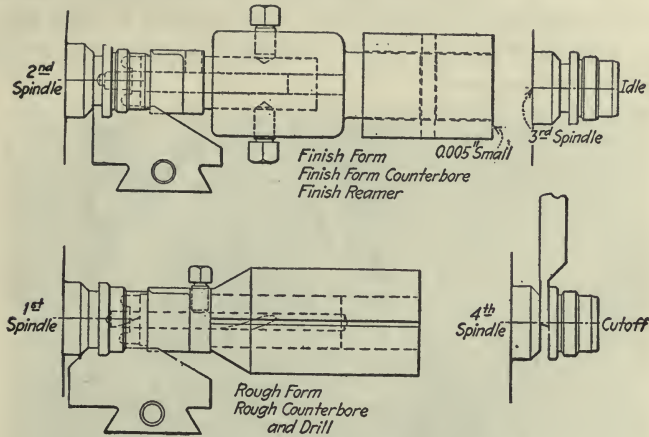

FIG. 627. TOOL SET-UP FOR BODY OPERATION 1

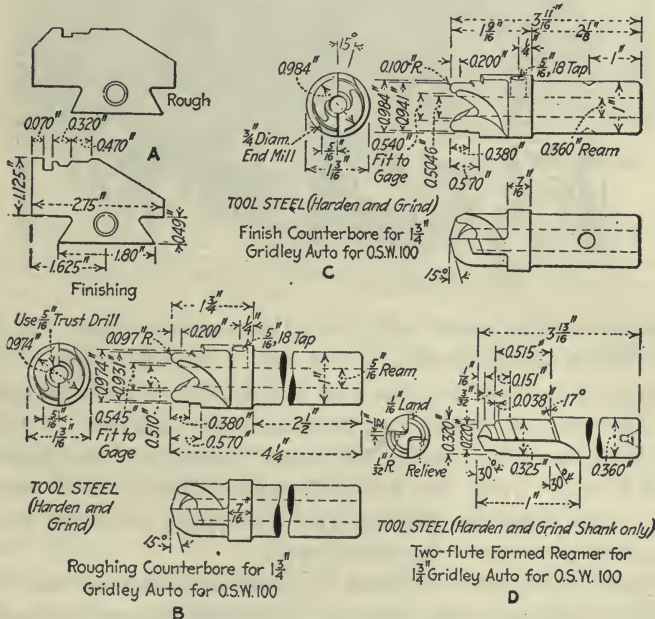

FIG. 628. FORMING TOOLS AND COUNTERBORES

Just behind the milling cutter is an ingenious device that stamps the back of the primer body with the company mark "M," saving one operation. This punch, or stamp, is actuated by the small wedges E

which lift the punch and then release it, a spring behind the punch giving it a quick blow which does the stamping. The milling spindle *A* carries a single point fly cutter. Each set of gripping jaws has a roller *B* on the outer end which is actuated by the cams *C* and *D*. The first draws the jaws down, locking the primer, while the second *D* raises the roller and the jaws for releasing and reloading. The wedges *E* raise the marking stamp and release it for the blow. Air jets keep the chips clear of the work and the holding jaws.

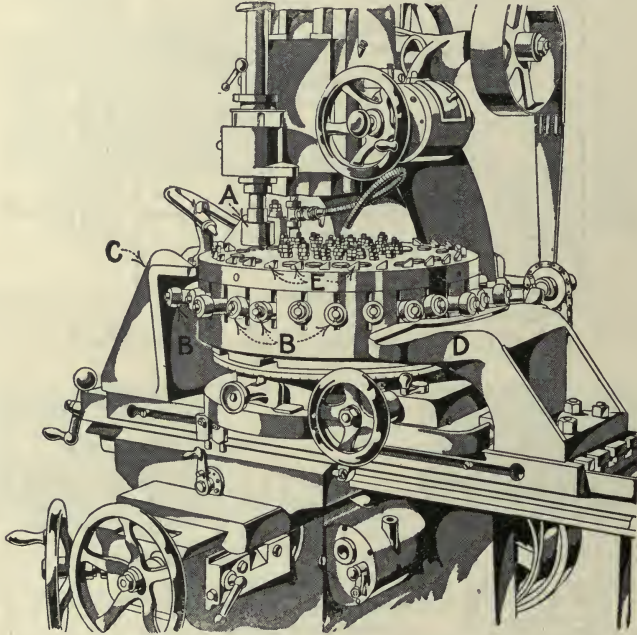

FIG. 629. BROWN AND SHARP VERTICAL MILLER

The thread milling comes next, being done at the rate of 10 per minute on the special machine shown in Fig. 630. This machine has one hob with alternately relieved threads, and two spindles which carry the primer bodies. The primer bodies are automatically gripped by the flange, carried against the hob, rotated and moved endwise at the proper speed, and moved away from the hob, the other spindle then coming into operation. The time for loading and unloading, although there is no lost time, is at the rate of 6 seconds each.

The fourth operation is to wash in gasoline, it having been found the most suitable cleanser. It is used in small quantities only, kept in shallow pans, and every precaution taken to prevent flame from coming anywhere near it.

The fifth operation is to mill the key, or wrench slots, another special machine, Fig. 631, being used for this purpose. This slot-milling machine

carries five horizontal milling spindles, three running in one direction and two in the other, and works on four bodies simultaneously. The bodies are placed in the cylinder of the machine, two operators being kept busy in loading it. The bodies are indexed into position; the five spindles move sidewise, first one way and then the other, and in so doing mill the two slots in all four bodies. The cylinder is turned at a rate of 40 bodies, or 10 movements, per minute, or 2,400 per hour.

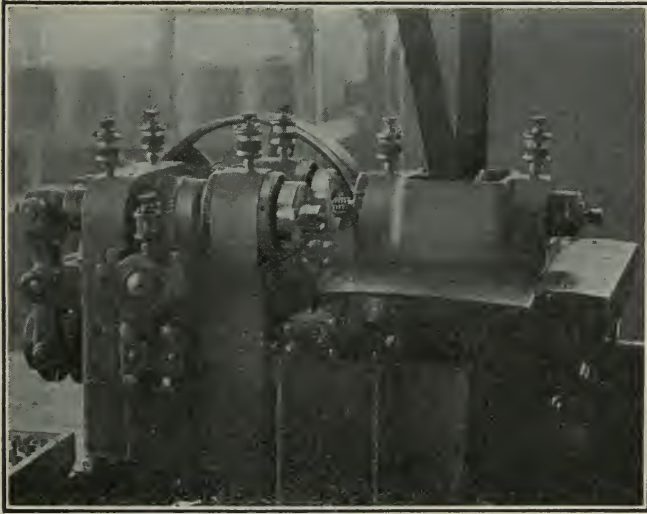

FIG. 630. SPECIAL THREAD MILLER

The illustration shows two views and gives the essential details. The cylinder *G* is removed from the shaft *F* in one view. The five spindles are shown at *A* and the four holding fingers at *B*. The arm *C* carrying the pawl *D* and actuated by the lever *E* indexes the cylinder by means of the ratchet *H*. It is a very compact and very efficient little machine for this kind of work.

Tapping, the sixth operation, is done under a sensitive drill with the aid of Errington tapping devices at the rate of nearly 500 an hour, the body being held in the fixture shown in Fig. 632. The body is set over the two pins, to hold against turning, and the fork is slid over the flange to prevent lifting.

Following the tapping comes the finish counterboring to get the seat for the percussion cap the correct distance from the face of the primer body and also to insure the length of this recess being exactly correct, so as to hold the anvil and plug in proper relation to the tap.

This counterboring is done under a sensitive drilling machine similar to that used for the tapping previously referred to, the fixture and methods

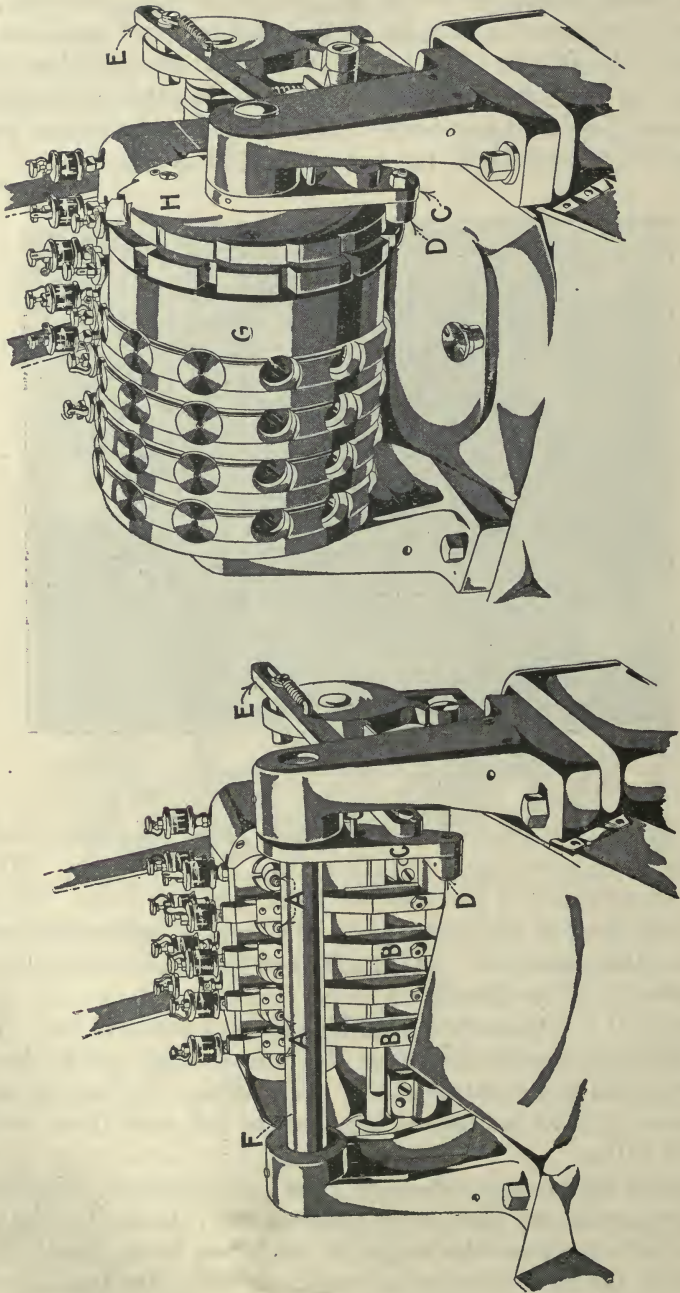

FIG. 631. SPECIAL FIVE-SPINDLE SLOT MILLER



being clearly shown in Fig. 633. The key slots of the fuse body are placed over the two locating pins, and the combined counterbore and spacing cutter, *A* and *B* respectively, are brought down into the recess

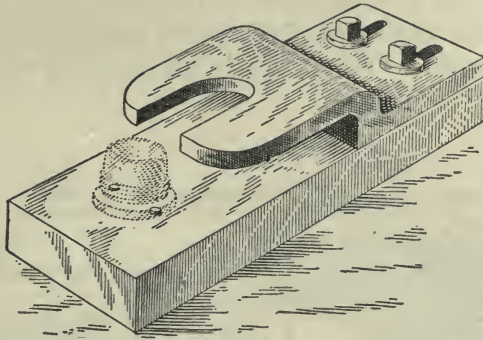

FIG. 632. SPECIAL TAPPING FIXTURE

until the collar *C* rides on the hard-steel bushing *D*. This insures the correct depth and can be handled very rapidly, a production of about 600 an hour being maintained throughout the day.

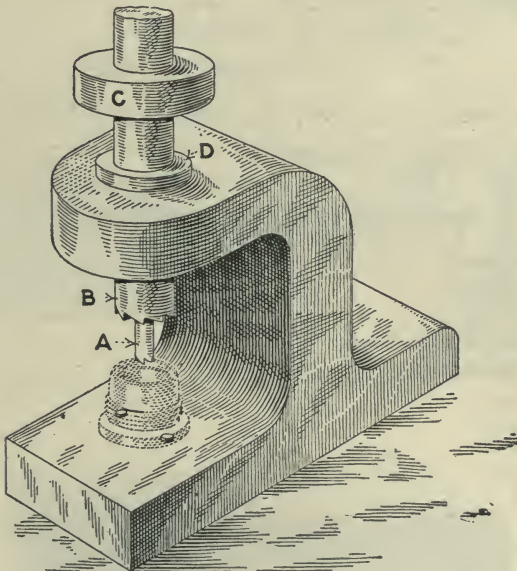

FIG. 633. COUNTERBORING FIXTURE

The eighth operation is to wash again in gasoline, preparatory to the ninth operation, or final inspection.

The finished primer bodies are substantially boxed for shipment to the loading factory. The heavy wooden boxes,  $12\frac{3}{8} \times 14\frac{3}{4} \times 9\frac{5}{8}$ -in.

deep, hold 100 primers per layer—10 layers per box. A sheet of corrugated cardboard is placed between each layer, the primers in each layer being staggered, and also over the top. When packed in this way, the upper layer protrudes beyond the box so that, when the cover is nailed down, the thin edges of the primer bodies force their way into the corrugated paper. This effectively prevents any shifting or injury to the contents.

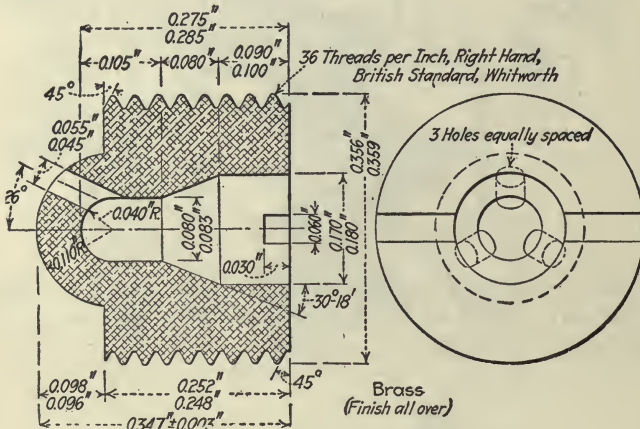
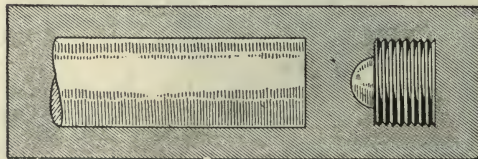

FIG. 634. DETAILS OF THE ANVIL

**The Primer Anvil.**—The anvil, Fig. 634, is made from brass-rod stock in five main operations, which, together with brief data, are as follows:

#### SEQUENCE OF ANVIL OPERATIONS

1. Forming the blank.
2. Drilling the blank.
3. Slotting.
4. Removing the burr by hand.
5. Shaving rounded end.



ANVIL OPERATION 1. FORMING

Machine Used—National Acme automatic No. 515.

Production—550 per hr.

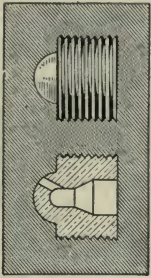

ANVIL OPERATION 2. DRILLING

Machines Used—Langelier and Burke bench machines.  
 Special Fixtures—Drilling fixture.  
 Production—440 per hr.

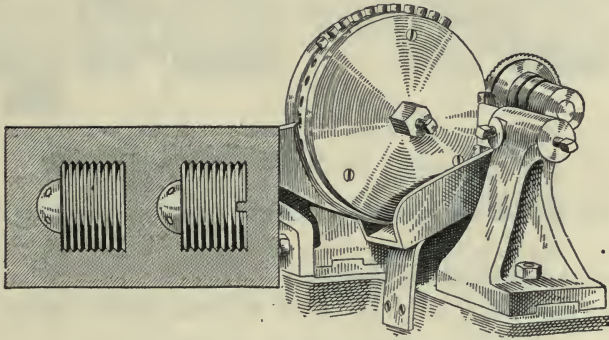

ANVIL OPERATION 3. SLOTTING

Machine Used—National Acme slotter.  
 Production—1,800 per hr.

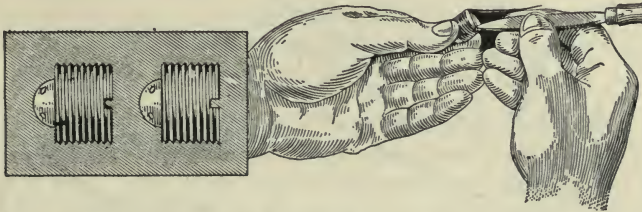

ANVIL OPERATION 4. HAND BURNING THE SLOT OF THE ANVIL

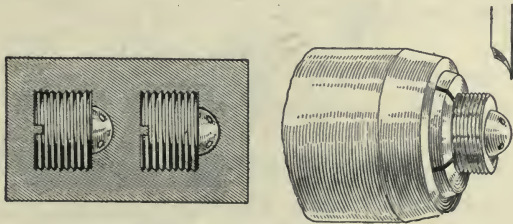

ANVIL OPERATION 5. SHAVE ROUND END

Machine Used—Brown & Sharpe bench machine.  
 Special Fixture—Split chuck.  
 Production—550 per hr.

The first operation, forming the anvil, is done on a National Acme No. 515 and consists of four sub-operations in the order indicated on Fig. 635—*i.e.*, form, counterbore, thread and cut-off. The machines

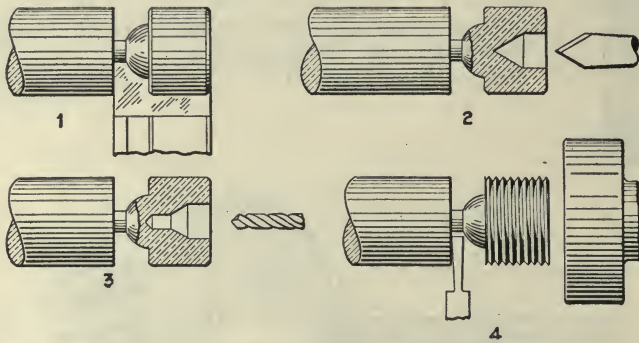

FIG. 635. TOOL LAYOUT FOR ANVIL OPERATION 1

employed for this work are single tooled and average 12,000 pieces in 21½ hours.

The second operation on the anvil consists in drilling the three flash holes in its rounded end. This work is done in the fixture shown in

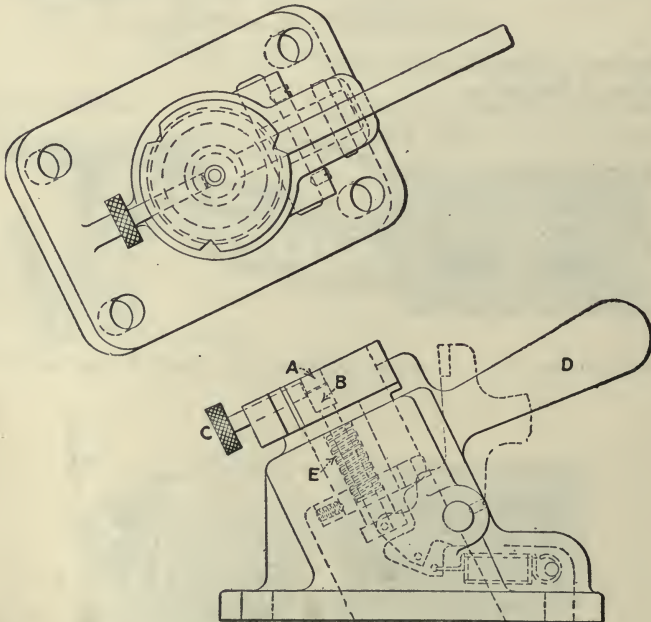

FIG. 636. SPECIAL INDEXING FIXTURE

Fig. 636, the drill being run in either a small Burke bench drilling machine or in one of the new high-speed machines built by Langelier. The latter handle about 4,000 primer anvils in 9 hours.

The base of the indexing fixture, Fig. 636, is inclined so as to give the desired angle to the hole, and no guide bushing is found necessary, as the drill is allowed to project only a short distance from the chuck. The anvil to be drilled is dropped into the opening *A*, resting on the plunger *B*, and held by a slight movement of the knurled setscrew *C*. It is indexed around by hand, from notch to notch; when the last hole is drilled a movement of the lever *D* into the dotted position shown ejects the anvil by means of the plunger *B*. This plunger is normally held in its lower position by the helical springs, and the indexing lever can be moved only far enough to cause ejection when the holder is in one position.

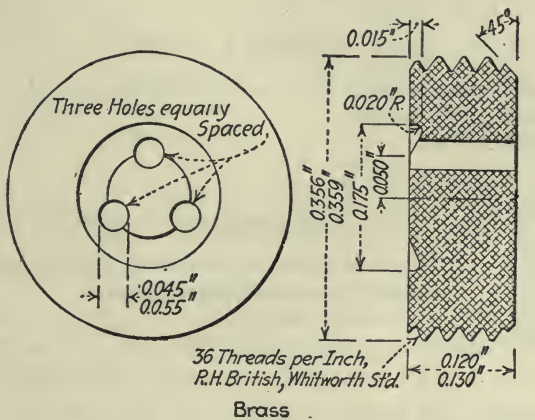
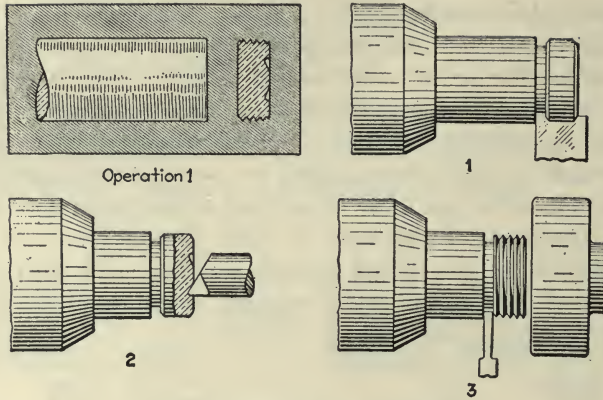

FIG. 637. THE PLUG ENLARGED AND DIMENSIONED

The third operation on the anvil is slotting in a National Acme screw slotter provided with suitable holding plates, and with a production of 17,000 in 9 hours. The burr is then removed from the slot by hand, the fifth and final operation being the shaving of the rounded end on a small Brown & Sharpe bench machine, consisting solely of a bed, headstock and cross-slide. The anvil is held in a grip chuck, the production averaging 5,000 in 9 hours.

**The Primer Plug.**—The plug, Fig. 637, is also made from brass-rod stock, but two main operations being required. These, with brief data, are as follows:

The first operation, consisting of forming the plug, cutting the circular groove in its face and cutting off the plug, is performed on a No. 515 National Acme automatic, the production being about 13,000 during a day's run of  $21\frac{1}{2}$  hr.



PLUG OPERATION 1. FORMING

Machine Used—National Acme automatic No. 515.  
 Special Fixtures—Forming tools.  
 Production—600 per hr.

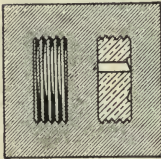

PLUG OPERATION 2. DRILLING HOLES

Machines Used—Langelier and Burke bench machines.  
 Special Fixtures—Holding fixtures.  
 Production—350 per hr.

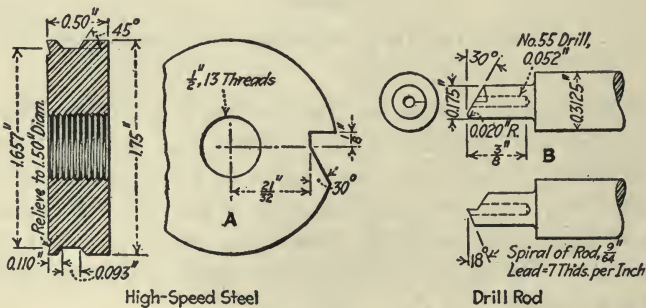

FIG. 638. THE TOOLS USED IN THE AUTOMATIC

The tools are shown in Fig. 638. The circular groove in the face of the plug is cut by the single-lipped tool shown in Fig. 638, which is rather interesting. It has a helix equivalent to a 7-pitch thread cut on the end, so that it can be ground back almost indefinitely, as with a circular forming tool.

The second operation on the plug is to drill the three small flash holes in the fixtures shown in Fig. 639. The operation of this fixture is practically identical with that of the one shown in Fig. 636, the same method

of ejecting the work being employed in this case. The production is practically the same as with the anvil, 3,000 pieces being handled per day of 9 hours. There is no special accuracy required in the spacing of these holes, so that no drill bushing is found necessary.

Both the anvils and the plugs are shipped in lots of about 100 lb., no assembling being done until they reach the loading plant. They are boxed in a substantial manner, no special packing being found necessary to prevent the threads being damaged in transit.

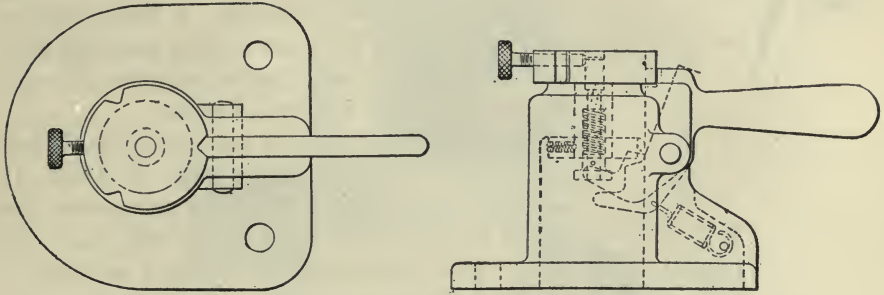

FIG. 639. DRILLING FIXTURE FOR THE PLUG

### LOADING THE PRIMER

The top of the box of 1,000 primer bodies, in 10 layers of 100 each, is removed at the loading factory and the box turned upside down on a broad bench. Raising the inverted box leaves the contents in a pile, the various layers separated by the corrugated cardboard. The primers are then placed open end up in wooden trays, each tray accommodating 50 bodies. This is the unit in which they are handled through the various departments.

The primer bodies are subjected to a visual examination for possible faults, care being taken to see that they are correct in every particular before the assembling and loading are commenced.

The anvil and plugs are also examined particularly for the flash holes, for if these are not clear it is impossible for the fire to reach the powder in the body of the primer. The rounded end on the anvil is carefully inspected, as the distance between this and the explosive in the cap is of great importance if they are to fire properly.

The length of the anvil is tested in a simple multiplying device, as shown in Fig. 640, where the outer face of the anvil rests on the gage plate and the anvil projection touches the feeler that actuates the multiplying lever. Two marks on the scale give the maximum and minimum, which in this case is 0.096 to 0.098 in.

The holes are tested by placing the anvils over a sheet of ground glass having an incandescent bulb beneath, as in Fig. 641. This throws

the light through the holes, so that the operator can easily see light through the three holes in each anvil, even though they are drilled at an angle. The operator is partly inclosed, so as to shut out bright daylight, which might tend to confuse.

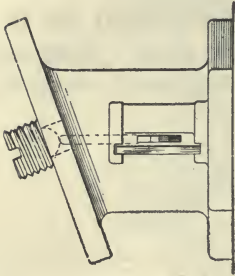

In order to facilitate the handling of these anvils for this inspection a special form of rack has been made, as illustrated in Fig. 642. This is of light sheet metal and holds 81 anvils, 9 on each side. The holder is easily loaded by simply scattering anvils over the top. A little practice enables a girl to fill these holders very quickly, and they are then passed to the inspector through an opening in the side of her cage.

This holder is made in two parts, the lower containing 81 rather sharp pegs *A*, which fit up inside the hole of the anvil and center the anvils so that the rounded end will point upward. The lower part is removed as soon as the holder has been filled, only the upper part being necessary to hold the anvils over the ground glass for the eye test. After the inspection of the primer parts is finished, and the percussion caps, which are shallow, drawn copper cups that have been partly filled with the proper mixture of explosives and covered with a thin disk of tinfoil, have been brought to the operator, everything is ready for assembling.

The first operation is to put the caps in place, which is done while the primer bodies are in the trays previously referred to. The caps are picked up by a ball hand-spring chuck, Fig. 643, and a ring of Pettman's cement is placed on the outer edge to seal the cap into the body. This is done by an ingenious little device seen in Fig. 644, the central portion being practically a hollow tube and bringing a ring of cement up against the cap as it is held in the position shown.

The board of primer bodies with the percussion caps in place goes to a bench, where the anvil is screwed in by the little machine shown in outline in Fig. 645. This is a mechanical screwdriver, operated by a small pair of bevel gears and a handwheel, as shown. The primer body is held under the screwdriver by the yoke, which is operated by a hand

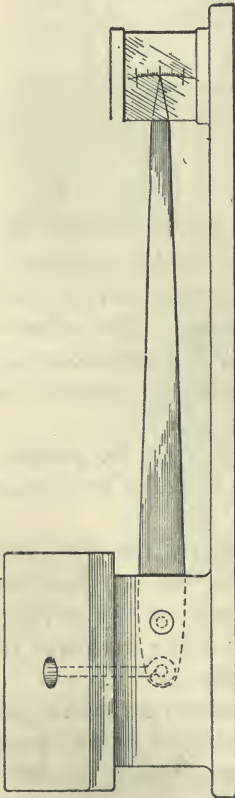

FIG. 640. MEASURING DEVICE FOR PRIMER ANVIL

in outline in Fig. 645.



lever beneath the bench. The anvils are screwed down solidly on their seats; and as both the depth of the cup and the projection on the anvil have been previously gaged, there is practically no danger of their making

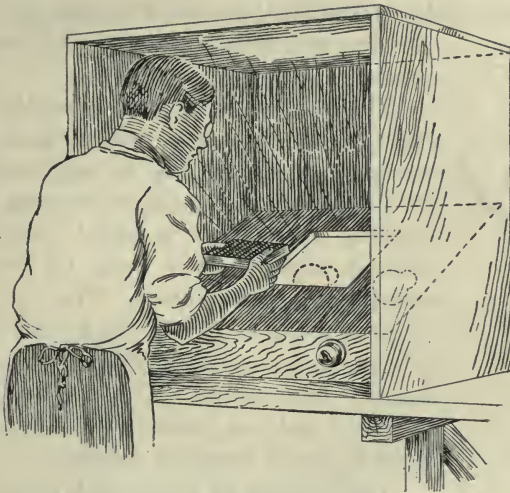

FIG. 641. INSPECTING PRIMER ANVILS

contact. The surplus cement is cleaned out with a soft stick. The caps are all seated in the body by being lightly pounded, using a soft-nosed stick for this purpose.

The assembling fixture, Fig. 645, consists primarily of the frame *A* and the screwdriver spindle *B*. This is driven by the handwheel at the side, through the bevel gear *C*. The handle *D* controls the vertical movement of the screwdriver, which is made solid on the splined shaft and is shown at *E*. The primer body is held in position by the plate *G*, which forms a guide for the screwdriver and is actuated by the cam *J*, shown beneath. This pulls the plate *G* down against the primer body, the spring shown releasing it as soon as the cam is moved in the opposite direction. The hardened-steel plug *I* in the base of the clamping fixture locates the proper distance from the face of the primer body to the rounded or outer surface of the percussion cap above the surface, forcing up the end of the cap, should it be necessary.

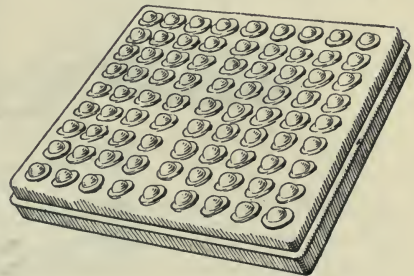

FIG. 642. RACK HOLDER FOR PRIMER ANVILS

The bottom of the primer is then inspected to insure the caps being at the proper distance, this being done in a machine almost identical with that illustrated in Fig. 640. Then the primer bodies are turned over in the tray, and the small copper ball is put into the anvil. The plug is next started in the hole, so that the ball will not come out. These plugs are screwed into place with a three-prong screw-driver.

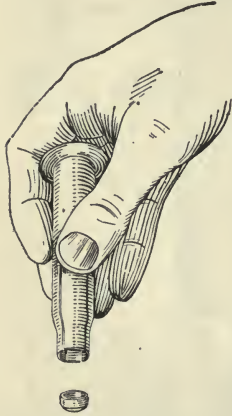

FIG. 643. HAND SPRING CHUCK

The next operation is to close the metal around the plug by forcing a hollow-coned die over the central portion of the primer body, closing the thread so as effectually to prevent the plug from backing out. This is called "dabbing" and is done in a foot-power press on the order of the well-known sprue cutter. The operation is performed about as rapidly as a man can handle the primer, a production of probably 30 a minute being steadily maintained. Men are shifted from this to other and less laborious work every two hours, so as to avoid excessive fatigue.

The surface of the raised portion is then cemented in a machine similar to that seen in Fig. 644, and a small paper washer is put in place to prevent the grains of powder from working down into the flash holes. This is also done very rapidly, the small paper washers being spread on the bench and picked up with the end of a soft wooden stick, which is occasionally moistened on a damp sponge.

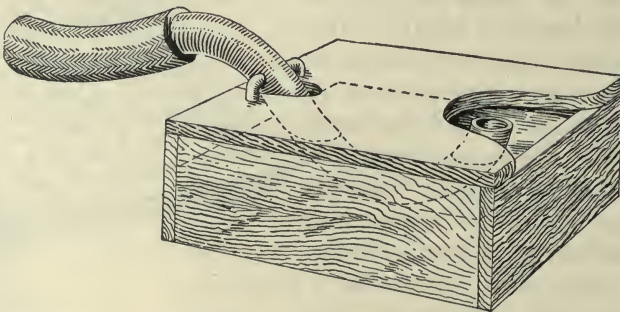

FIG. 644. THE CEMENTER

**Loading the Primers with Powder.**—The bodies are now ready to be loaded with the coarse-grained powder that surrounds the central portion. This powder is already measured in regular 16-page paper shells, which come in cases containing 20 boxes, each box holding 120 paper shells and each shell containing a proper load for the fuse.

The powder is poured into the primer body very rapidly, as there is no danger of its getting into the flash holes. The girls who do the loading become very expert, and by using both hands they fill a tray of 50 primers in remarkably short time.

Then the brass closing disks are put in place, each previously having a paper washer cemented on the inside. A ring of cement is placed around the outer edge of the closing disk, a brass tube of the proper dimension being used for this purpose. It is simply dipped into the cement and placed on the top of the closing disk, which makes a ring around the outer edge. The sharp edge of the primer body is closed on the disk by another foot press.

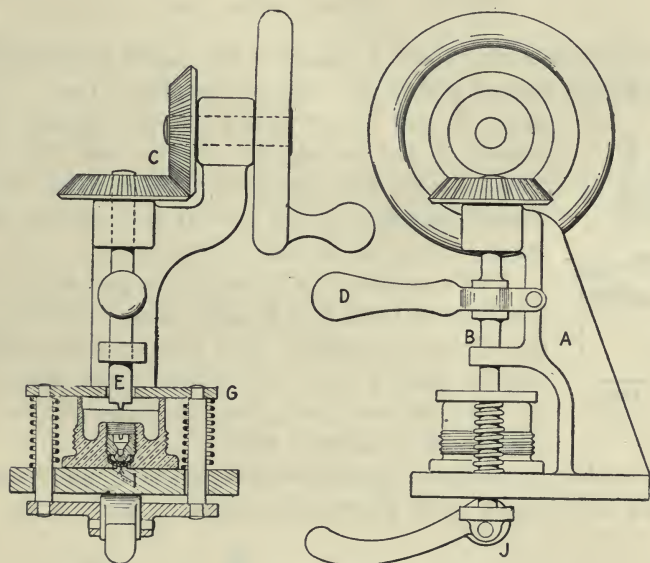

FIG. 645. ASSEMBLING FIXTURE

The primer then goes to a regular crank press, which puts the finishing crimp on the end and at the same time stamps the proper marking on the base of the primer. This handles about 9,000 primer bodies in  $10\frac{1}{2}$  hr.

**Guarding Against Fire.**—All the tables where powder is used are covered with a linoleum or rubber pad and are surrounded by a water trough perhaps 3 in. wide. All loose powder is brushed into the water, so as to avoid any accumulation that might become a source of danger.

The final inspection is primarily for the thread on the body, in order to make sure that it has not become distorted in any of the closing operations. The thread gage is held in a chuck and revolved by a small friction that turns it in either direction. Any large primer body passes

along the bench to the special vise, Fig. 646, which holds it while the hand die is being run over the thread.

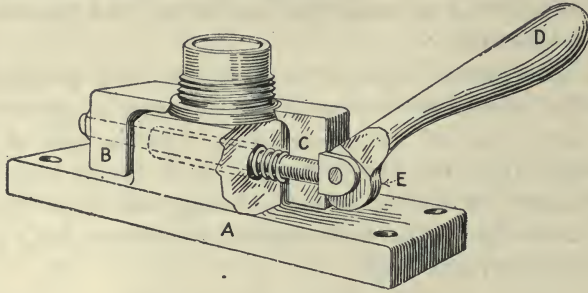

FIG. 646. SPECIAL PRIMER VISE

This vise consists of a body *A*, raised in the center and carrying two studs that fit the wrench slot in the back of the primer body. The two jaws *B* and *C* are closed on the primer body by means of the handle *D* and the cam *E* at the end. This pulls the two jaws toward each other, the spring shown surrounding the central bolt forcing the jaws apart as soon as the lever is released.

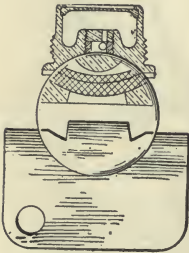

FIG. 647. FINAL TESTING GAGE

The completed primers are lacquered by dipping, this having been found much more satisfactory than the spraying process. The primers are handled very rapidly, placed in a wire basket tray, dipped, lifted out and drained, then placed in front of a fan, which dries them in about 2 min.

After this they go into the trays once more, and the upper side of the closing disk is covered with Pettman's cement. Here again various

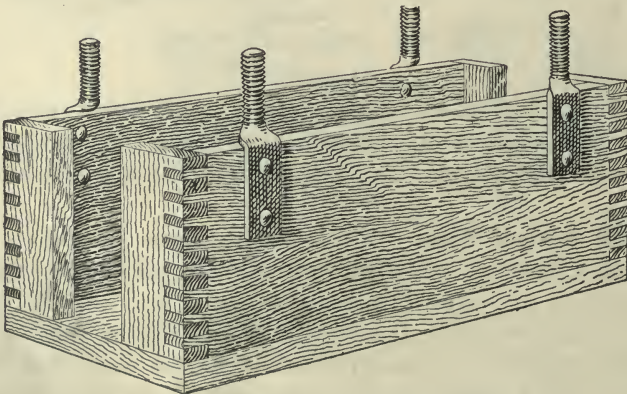

FIG. 648. PACKING BOX FOR PRIMERS

more or less complicated methods have given way to the simple expedient

of flooding the top with the cement on the end of a small round brush. This is done very quickly by hand, after which the primers are set aside to dry as long as necessary. The final gaging is for the cap distance from the bottom, the form of gage shown in Fig. 647 being used for this purpose.

The primer bodies are then packed in a special box that holds 10 trays, the style of box being shown in Fig. 648. It is open at the end to allow the trays to be put in place and removed easily, and is provided with four bolts, so that a cover can be readily and substantially adjusted and held by means of wing nuts. This box holds the trays while the primer bodies are going to the shop, where they are put into the cartridge cases.



## APPENDIX

	PAGE
MACHINE TOOLS FOR MUNITION MANUFACTURE .....	729
COMPOSITION AND PROPERTIES OF SHELL STEEL .....	734
LIGHT SHELLS .....	737
DETAILS OF SOME SHRAPNEL .....	738
DETAILS OF SOME HIGH-EXPLOSIVE SHELLS .....	743
BRITISH REQUIREMENTS FOR PROJECTILE INSPECTION.....	755
BRITISH PRICES FOR HAND-PAINTING SHELLS .....	757
DIAMETER OF BRITISH SHELLS OVER PAINT .....	757
WEIGHTS AND DIMENSIONS OF SOME BRITISH SHELLS.....	758
TEMPERATURES AND DURATION OF HEAT TREATMENT FOR BRITISH SHELLS.....	759





## MACHINE TOOLS FOR MUNITION MANUFACTURE<sup>1</sup>

The importance of machine tools and metal-working machinery in munition manufacture is strikingly shown by the exports of these classes of machines during the first two years of the great European War. Previous to the outbreak of this war, the greatest fiscal year in the export history of the American machine-tool building industry was 1913 when a total of \$16,097,315 worth was sent abroad. The record for the fiscal year 1914 is smaller, although this is the second largest year in our history previous to the European War. Against these, by comparison, modest figures we must put the total for the fiscal year 1915, \$28,162,968, and for the fiscal year 1916, \$61,315,032.

That is, the total American shipments abroad of metal-working machinery for the second year of the war is nearly four times the best pre-war record for the same length of time.

The statistics are even more striking when we appreciate the fact that during the fiscal year 1916 in round figures \$50,000,000 worth of the exports went to the allied nations. It is probable at this time of writing (October, 1916) that the Allies will take at least \$100,000,000 of American machine tools to satisfy their war needs.

The following table gives the total exports of metal-working machine tools from the United States for the fiscal years 1905 to 1916 both inclusive:

EXPORTS OF MACHINE TOOLS FOR TWELVE FISCAL YEARS

1905 .....	\$4,332,665	1911.....	9,626,965
1906 .....	6,445,612	1912.....	12,151,819
1907 .....	9,369,056	1913.....	16,097,315
1908 .....	8,696,235	1914.....	14,011,359
1909 .....	3,640,034	1915.....	28,162,968
1910 .....	5,975,503	1916.....	61,315,032

But these large totals of the exports for 1915 and 1916 do not represent by any means the total of the great demands placed upon American machine-tool builders during that period. It is estimated at the time of this writing that the total of the munition contracts placed in the United States is some \$1,600,000,000. Much machinery had to be produced to manufacture the material to satisfy these huge orders.

It was but natural that the machine-tool industry should be profoundly affected by this huge volume of business. The existing machine-tool building plants could not supply machines fast enough and many

<sup>1</sup>L. P. Alford, Editor-in-Chief, *American Machinist*.

machine firms that had never built such machinery before, turned to it in the emergency. It is estimated that at least thirty concerns built lathes that had never made such a machine before.

Many machines were developed especially for munition manufacture. Of these, lathes for turning shells are the most numerous. In general, these war lathes ranged from 18-in. to 24-in. in swing with comparatively short beds and no attachments. There were also special grinders for shell bodies and bases, millers for surfacing the bases of shells, drilling machines for fuse parts, shell forging and shell banding presses, shell marking and shell painting machines, cutting off machines for shell blanks and copper driving bands, and special machines for rifle manufacture including particularly barrel finishing machinery. These are far too numerous to be mentioned here in detail. The files of the *American Machinist* for 1915 and 1916 present complete information about them.

Many special outfits of munition making machines were designed and built and some of these are shown in the preceding pages. See particularly the turret lathes and forming lathes used on 3-in. Russian shrapnel (Chapter V, Section I), the outfit of hydraulically operated drilling and turning machines used on 3-in. Russian high-explosive shells (Chapter IX, Section II), and the outfit of lathes of most simple and unusual design used on the British 9.2-in. high-explosive shells (Chapter VI, Section II).

Furthermore, fuse-making machinery has been developed to a very high degree, by the use of semiautomatic and automatic mechanism and turret and station-type machines.

A feature of the design of many of the new machines is ruggedness. Very large spindles have been used, wide belts and simple constructions.

As a rule, automatic machines have not been widely used on shells as the preceding pages show. On the other hand, automatics have been the salvation of the manufacturers of fuses, detonators, primers and small parts. Many shops have rigged up munition manufacture on their regular machine-shop equipment and have made a success of the work.

In addition to the application of machine-tools to the specific problems of munition manufacture as shown in the body of this volume, the procuring of the right kind of machine tools, in the shortest possible time, would be of the greatest importance in the emergency of war in the United States. It is, therefore, wise to analyze some of the broader events of the past two years in the machine-tool industry.

Although there has been some scattered buying, the greater number of the machine tools exported from the United States have been taken by Great Britain, France and Russia. Exports have been cut off from Germany and Austria, while the Scandinavian countries, Holland and Italy have increased their buying much beyond the normal amount. But little is known in this country of the method that Germany has

employed to build and maintain the machine tools necessary to produce her munitions of war. On the other hand, there is considerable information available in regard to the methods employed by Great Britain and France. Thus it is with the experiences of these latter-named countries, that we are at the present moment concerned. From their methods we can formulate the principles of action to govern the design, purchase, production and distribution of machine tools in preparing for a national emergency of war.

The events of the past 26 months justified the statement that the machinery-building industry is the backbone of any defensive or offensive warfare at the present day. This statement emphasized anew the need of carefully considering machine tools in any plan for industrial preparedness.

The machine tools shipped abroad within the past 26 months analyze into three general classes: First, simple, plain machines that were either standard with certain manufacturers before the outbreak of war or have been designed and built under the stress of the tremendous foreign demand; second, regular machine tools of a more highly organized grade, particularly automatic machines that were the standard product of some manufacturers prior to the outbreak of war; third, special machine tools developed for some operation or series of operations in the manufacture of some particular detail of munitions. These group into (a) lathes for the outside turning of shells; (b) lathes for boring shells; (c) lathes for waving, grooving and undercutting shells. The first class comprises by far the greater volume of the exports, and simple lathes are the predominating machines. In like manner, lathes predominate in the third class.

The methods adopted by Great Britain, France and Russia in buying these machine tools need brief consideration. The early orders were placed by European machine-tool agents who had handled American machine tools for years. Their knowledge of the business gave them the first entrance into the field.

These dealers' contracts were followed by others given by special agents or government commissions who came over to this country during the first year of the war. These orders brought about a condition of scarcity of machine tools in the United States and at the same time filled all the regular machine-tool building plants with such a volume of business that deliveries in many cases have been seriously delayed. The third class of buying has been by government commissions in shops making high-grade machinery other than machine tools, as printing presses and wood-working machinery, and in general have been for machines of the third class previously mentioned. Their buying has been most ably managed, and the results of their work have been more uniformly successful and satisfactory than that of any of the private buyers.

The private buying—that is, the buying done by machine-tool dealers—can be roughly divided into three periods. During the first period simple lathes and turret machines were bought almost exclusively. The demand during the second period was for grinders, drilling machines and millers. The demand during the third period was for planers, shapers and toolroom machinery.

After learning from the hard school of experience it is now realized that toolroom machinery should have been bought during the first period. The reason is obvious, for such machines are needed to produce the jigs, fixture and gages that are the necessary accompaniment of machine tools for duplicate production.

In case of war with a first-class power, the United States would unquestionably need to add an enormous number of machine tools to the present equipment of her machine shops. Based on the record of the years immediately preceding the outbreak of the war, the normal surplus of machine-tool production of the United States as represented by the amount shipped abroad, has a value of about \$15,000,000. This supply would naturally be kept at home, but in addition thereto, and in addition to the increase of machines that would be turned out by our own manufacturers under war conditions, we would have to draw from the industrial nations of Europe, provided we were not involved in a European war. This buying would have to be done by some organization not now in existence, for the reason that there are only a few agencies in this country that market European machine tools here.

Thus the European buying for the United States would have to be placed in the hands of experienced men, perhaps civilians representing both builders and users. The present British Ministry of Munitions with its subcommittees might well form a model for the American organization charged with the duty of buying machinery abroad. There are facts that tend to prove that the work done by the British commission has been most efficiently handled and has brought excellent results. This is an experience well worth careful weighing.

One of the early acts of the British Ministry of Munitions was the prohibition of the importation of machine tools into Great Britain, except under license of the ministry. A number of reasons led up to this decision. Among them are the necessity of suppressing speculative buying and selling, controlling the kinds of machine tools bought abroad, the effective utilizing of ocean-borne freight, the distributing of machine tools in a manner to best further the manufacture of munitions and the control of quality.

But little is known of the conditions that have surrounded the machine-tool industry in Germany during the war. However, at the outbreak of war edicts of the Ministry of War placed a prohibition upon the exportation of machine tools as one of the items in a list of articles that

might be of value to the enemy. As the war progressed, the ministry formed two committees—one the War Raw-Materials Committee and the other the Industrial Committee. These committees have controlled the machine-tool building industry as well as other German industries. They have directed what machines should be built, where they should be built, have handled the supplies of raw materials for machinery building and have arranged for the distribution of the new machines as well as other machines that could be released from their regular employment.

It is reported that France mobilized the machine tools of the Republic as one of the early war measures. The purpose was to bring together the machine-tool equipment into units of such a size that manufacturing could be carried forward expeditiously and efficiently.

Thus from the experience of Great Britain, Germany and France, the necessity of controlling the supply and distribution of machine tools is evident in case of war between first-class powers.

No exact estimate can be given of the number of machine tools that might be immediately available in Germany in case there should be an emergency demand from the United States. A careful estimate for Great Britain, however, is that under normal conditions there are some 1,200 to 1,500 lathes in the stocks of dealers and builders at any normal time. In any event it is fair to assume that the stock of machine tools in the possession of dealers and builders in Europe would not be very great and in fact would be a very small factor in the number that we should be likely to need. Accepting this situation as a starting point, a decision can be made as to whether the United States should buy standard machines regularly manufactured abroad or order special machines particularly adapted to our own needs. It is conceivable that it might be much better to have machines built to our own drawings and specifications than to attempt to use the regular products of European builders.

It is estimated on reliable authority that plain lathes of say, 16 to 24 inches in swing, could begin to be shipped from British machine shops in 12 weeks from the receipt of detailed drawings of their parts and detailed specifications for their manufacture. Not only could they be procured in this time from machine-tool building shops, but also from other machine shops accustomed to doing high-grade work. Broadly speaking, any machine shops that are accustomed to do accurate planing and scraping can build machine tools under the conditions of demand such as have existed in the United States during the first 26 months of the European war.

Machine tools should be standardized for munition manufacture, and because of the small stocks of machine tools in Europe, it is evident that not many could be obtained during the brief period of waiting for

American standardized construction to be produced. It is of course possible that the essential standardized details could be reduced to a minimum, with the insistence that these should be incorporated in the regular designs of European builders. In this way the essential needs of uniformity with American products would be met, and it is possible that a certain amount of time could be saved over the estimates just given.

From the experience of the Allied nations in purchasing machine tools during the past 26 months it seems justifiable to lay down the following principles for the standardization and procurement of machine tools in organizing for American industrial preparedness.

1. Organize at once in skeleton form an industrial committee of the Council of National Defense to control the standardization, design and preparation of machine tools for the production of American munitions.

2. Through joint action of this committee, the American Society of Mechanical Engineers and the National Machine Tool Builders Association standardize the details of regular machine tools and design whatever additional special machine tools may be necessary for the rapid and economical production of American munitions.

3. Immediately on the outbreak of war prohibit the exportation of any machine tools from the United States.

4. Immediately on the outbreak of war prohibit the importation of any machine tools into the United States except under license and control of the committee mentioned under 1.

5. Order all machines abroad through this committee or its representatives in the capitals of Europe and intrust these men with the responsibility of securing the desired deliveries and quality.

6. Order no machine tools abroad except to standardized American designs either for the complete machine or the essential details, as the committee may determine.

#### COMPOSITION AND PROPERTIES OF SHELL STEEL<sup>1</sup>

The importance of uniformity in the chemical composition of the steel used in shell making is a question which would appear to be viewed from varying angles by different nations. The British specifications, in particular, are exacting in their requirements and unquestionably prohibit the use of much steel of satisfactory physical properties. The French Government demands exceedingly severe hydraulic pressure tests and places importance upon the ballastic properties of the shell—as is evidenced by the test for the eccentricity of the center of gravity described in the chapter devoted to the manufacture of French 120-mm. high-explosive shells.

Notwithstanding the rigid chemical specifications of the British Government, the subsequent physical tests to which every batch of British shells are subjected are more exacting than the French hydraulic pressure test. The accepted British shell, and to almost the same degree the Russian shell, must be made of a particular and comparatively uni-

<sup>1</sup> Reginald Trautscold.

form grade of steel and, in addition, must possess certain physical properties. The French shell, on the other hand, while it must possess certain physical properties, supplemented by exacting requirements in the matter of distribution of weight, may vary to some extent in chemical composition; the sole object being apparently to produce a shell which will have the necessary physical properties, irrespective of composition.

In connection with this question of composition of shell steel, it is interesting to note the results of chemical analyses of 21 high-explosive German shells, published by Dr. J. E. Stead in "The Engineer," Jan. 14, 1916. These analyses, given in Table I, were made from fragments of exploded German shells found on the field of battle—not selected samples—shells which had proved satisfactory in their destructive mission and doubtless illustrate general German practice.

TABLE I.—ELEMENTS FOUND IN 21 GERMAN HIGH-EXPLOSIVE SHELLS

	C.	Mn	Si.	S.	P.	Cu.	N.	Tenacity.
	Per cent.	Per cent.	Per cent.	Per cent.	Per cent.	Per cent.	Per cent.	
1	0.600	0.730	—	0.062	0.085	—	—	—
2	0.700	0.800	0.350	0.027	0.043	—	—	55
3	0.670	0.515	0.336	0.037	0.048	0.083	—	62
4	0.870	1.094	0.252	0.037	0.028	0.080	—	65
5	0.465	0.794	0.324	0.038	0.028	0.090	—	55
6	0.600	0.655	0.597	0.046	0.051	—	—	—
7	0.820	1.266	0.186	0.048	0.052	—	—	—
8	0.765	0.655	0.364	0.030	0.045	—	—	—
9	0.630	0.550	0.400	0.042	0.077	—	—	—
10	0.860	1.030	0.186	0.053	0.045	—	—	—
11	1.120	1.000	0.230	0.054	0.038	—	—	—
12	0.850	1.330	—	0.080	0.105	—	—	—
13	0.600	1.210	0.334	0.071	0.069	—	0.0112	59
14	0.740	1.170	0.261	0.044	0.064	—	—	62
15	0.675	0.380	0.078	0.083	0.043	—	—	—
16	0.700	1.108	0.221	0.041	0.079	—	—	—
17	0.980	1.050	—	0.055	0.086	—	—	—
18	0.930	0.980	—	0.059	0.065	—	—	—
19	0.740	0.980	—	0.054	0.050	—	—	—
20	0.393	1.400	0.210	0.035	0.041	—	—	—
21	0.930	0.970	0.164	0.032	0.048	—	—	—

Most of these German shell fragments were small, and the fractures generally indicated material of very high tenacity. The analyses show a variation of 285 per cent. in carbon content, 368 per cent. in manganese, 766 per cent. in silicon, 307 in sulphur and 375 per cent. in the proportion of phosphorus. Quite obviously no exacting chemical requirements are imposed by the Germans, for shell material high in sulphur and phosphorus was sometimes comparatively high in manganese and carbon and

at others the proportions of these elements was comparatively low. No apparent relationship exists in the proportions of the various elements, as is strikingly shown in the graphic presentation of Table I given as Chart I. Furthermore, there is no reason to assume that the analyses made depict in any way extremes in German practice. They indubitably show the *usual* variation in the chemical composition of German shell steel.

The German shells analyzed were successfully fired and, presumably, were just as destructive as it is possible to make shells, yet many of them would have failed to pass the British specifications, as well as those of many other nations. That they were successfully fired proves that they

CHART I.—VARIATIONS IN THE COMPOSITION OF GERMAN HIGH-EXPLOSIVE SHELL STEEL

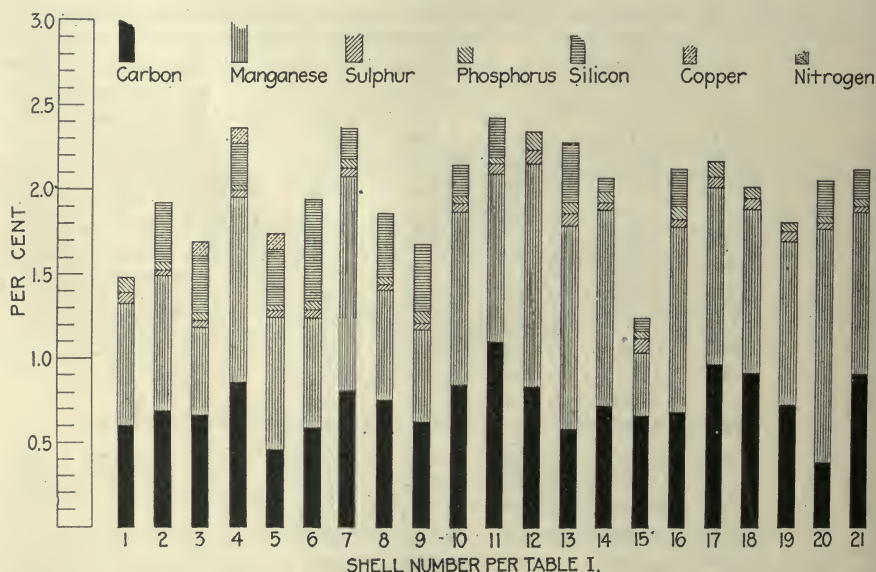

would have passed some such physical examination as the French hydraulic pressure test, and it is probable that some such test was made. The French test may be exacting, probably is, but it would appear to be the logical test, that which definitely establishes the availability of the shell.

The chemical composition of steel indicates what physical properties may be expected but these must invariably be confirmed by actual physical tests. Tests on pieces cut from specified sections of a shell are of interest, but must fail to establish conclusive proof of uniformity of strength. The hydraulic pressure test, on the other hand, does establish uniformity of strength and quite obviously is much more easily performed



than examinations necessitating the cutting of test pieces from sample shells and subjecting these to the various required tests.

Physical tests alone can show up the defects of a shell, for the strains to which the shell is subjected are all physical and their destructive capabilities are also governed by their physical properties. It would then seem that some such test as the French hydraulic pressure test could profitably be incorporated in the specifications of all nations and only such test required, as chemical tests are of value merely in indicating what would be the result of the physical test. The abolishment of the chemical requirements for the steel stock would also have the very desirable result of making available much steel which is at present barred from use by limitations in the allowable percentage of certain component elements. Particularly is this true in regard to the presence of sulphur and phosphorus.

### LIGHT SHELLS

The exacting requirements and small tolerances common to shell specifications have resulted in manufacturers working to the high limits rather than running the danger of shell rejection on account of lightness. A heavy shell can nearly always be brought down to weight but a shell which is deficient in weight has usually to be scrapped. With a tolerance in weight of but 1 per cent. or so, a light shell is apt to represent a dead loss to the manufacturer for the use of lead or any lead compound, the obvious remedy for a shell but slightly under weight, is absolutely prohibited on account of the formation of the destructive compound, picrate of lead, in the loaded shell.

The French Government, realizing that production would be stimulated if it were possible to make use of the few shells which even with the greatest manufacturing care are slightly lacking in weight, permits a certain number to be brought up to weight by tinning on the inside.

This is done by pickling the inside of the shell with a solution of sulphuric acid—one part acid to ten parts water—for about two hours. The shell is then thoroughly washed and afterward filled with muriatic acid. This acid is allowed to remain in the shell for about 10 min., after which the outside of the shell is covered with vaseline and the shell immersed in a bath of molten tin. The first dipping has little effect but the second will add some 20 to 25 grams to the weight of a 120-mm. shell.

The shell is then partly filled with this molten tin, an aluminum plug screwed into the nose and the shell inverted. The tin cools about the plug and the nose can be bored out, leaving a sufficient amount of tin on the inside to give the required weight. But 5 per cent. of the shells in any one shipment, however, may be so tinned.

DETAILS OF SOME SHRAPNEL

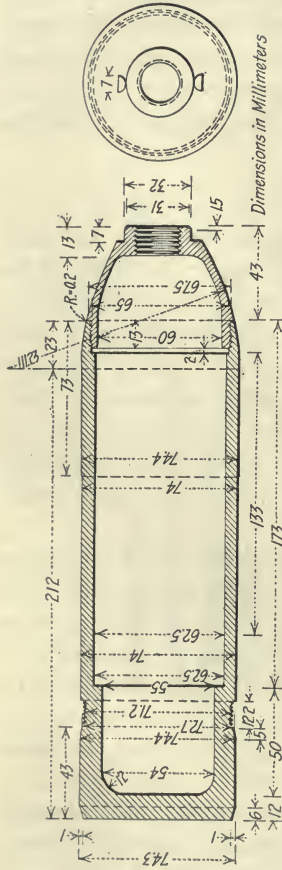

FIG. 649. FRENCH 75-MM. SHRAPNEL

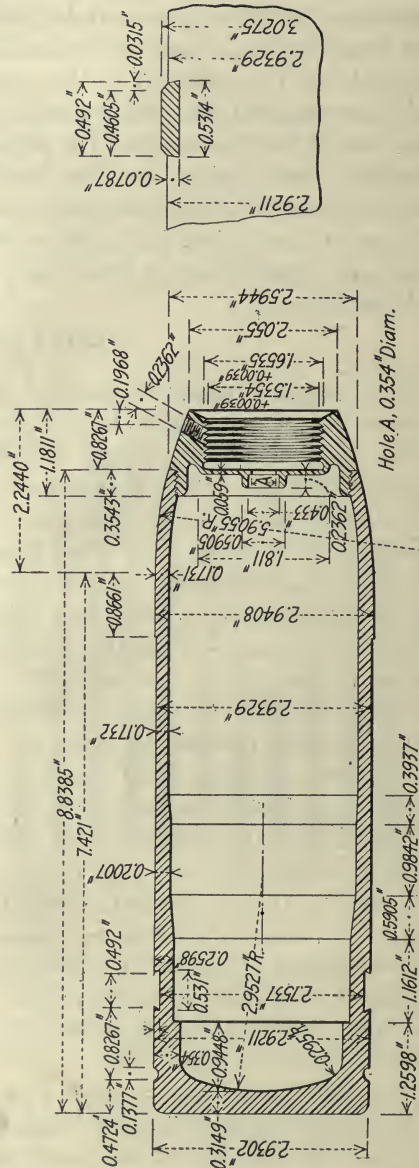

FIG. 650. SPANISH 75-MM. SHRAPNEL





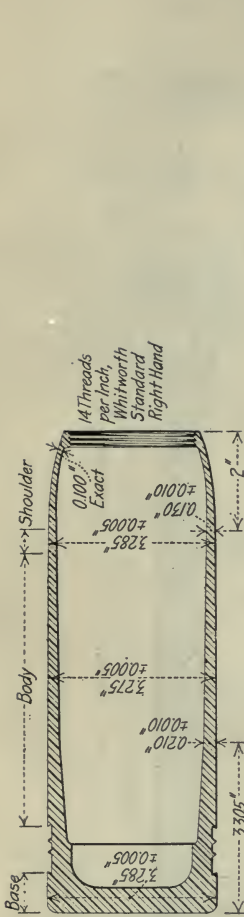

FIG. 653. BRITISH 18-LB. SHRAPNEL

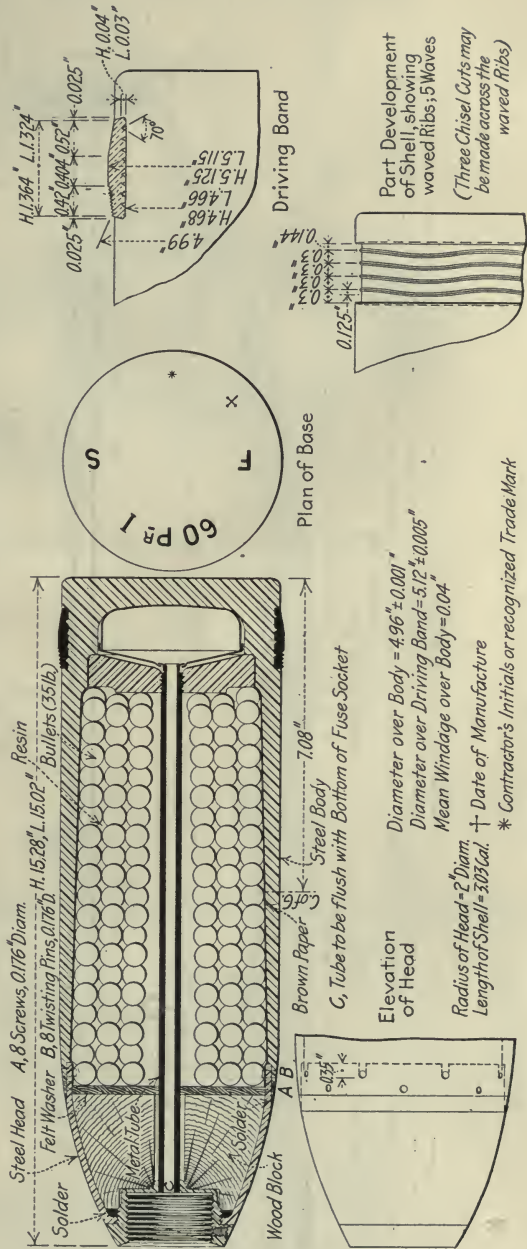

FIG. 654. BRITISH 60-LB. SHRAPNEL MARK I

\* Contractor's Initials or recognized Trade Mark

† Date of Manufacture

Radius of Head = 2" Diam.  
Length of Shell = 3.03 Cal.

Elevation of Head

C, Tube to be flush with Bottom of Fuse Socket

Diameter over Body = 4.96 ± 0.001"

Diameter over Driving Band = 5.12 ± 0.005"

Mean Windage over Body = 0.04"

7.08"

Resin

Bullets (35 lb.)

H. 15.28", L. 15.02"

8 Twisting Pins, 0.176" D.

Steel Head

8 Screws, 0.176" Diam.

Felt Washer

Menzies Tubes

Solder

Wood Block

Steel Body

Brown Paper

Driving Band

Part Development of Shell, showing waved ribs; 5 Waves (Three Chisel Cuts may be made across the waved ribs)

60 PR I

S F

Plan of Base

14 Threads per Inch, Whitworth Standard Right Hand

0.100" Exact

3.785 ± 0.005"

7.275 ± 0.010"

3.305"

2"

0.130 ± 0.005"

0.100 ± 0.010"

0.025"

0.040 ± 0.001"

0.025"

H. 0.004"

L. 0.003"

70°

H. 4.68"

L. 4.66"

H. 5.125"

L. 5.115"

H. 3.64"

L. 1.324"

Base

Body

Shoulder



DETAILS OF SOME HIGH-EXPLOSIVE SHELLS

Gas check must be a tight fit in the shell and must be set home so as to require great force to start out again

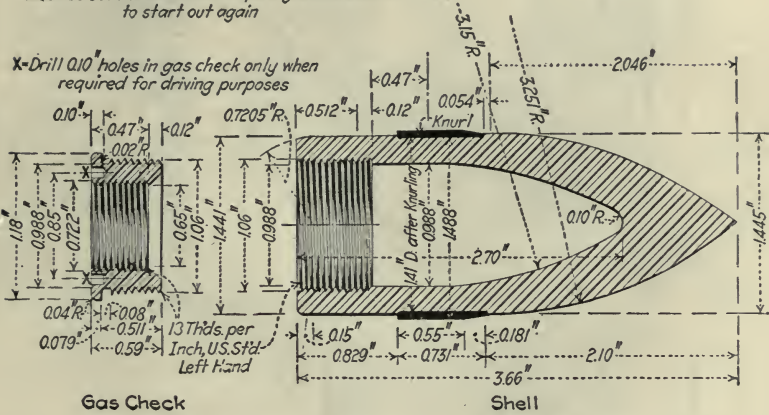

FIG. 656. RUSSIAN 1-LB. HIGH-EXPLOSIVE SHELL

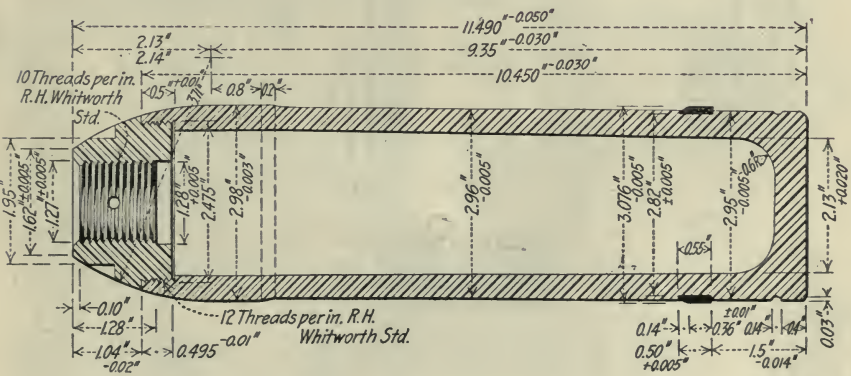

FIG. 657. RUSSIAN 3-IN. HIGH-EXPLOSIVE SHELL





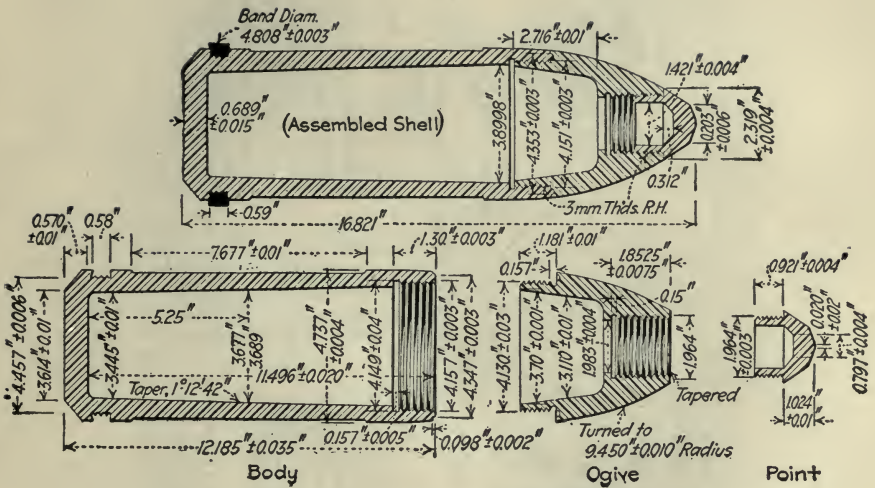

FIG. 659. SERBIAN 120-MM. HIGH-EXPLOSIVE SHELL

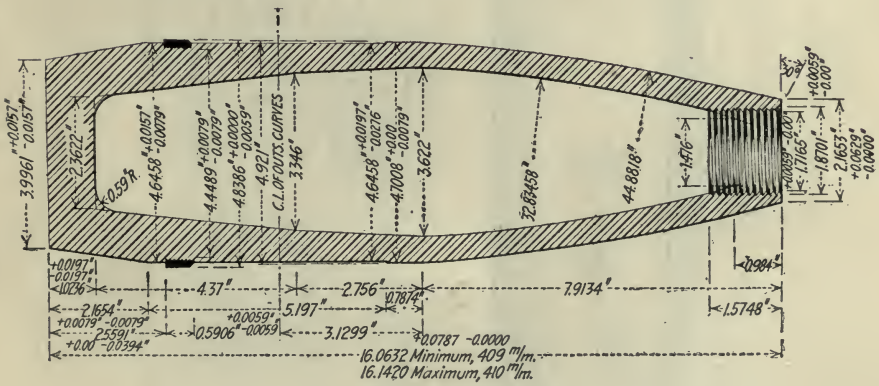

FIG. 660. FRENCH 120-MM. HIGH-EXPLOSIVE SHELL







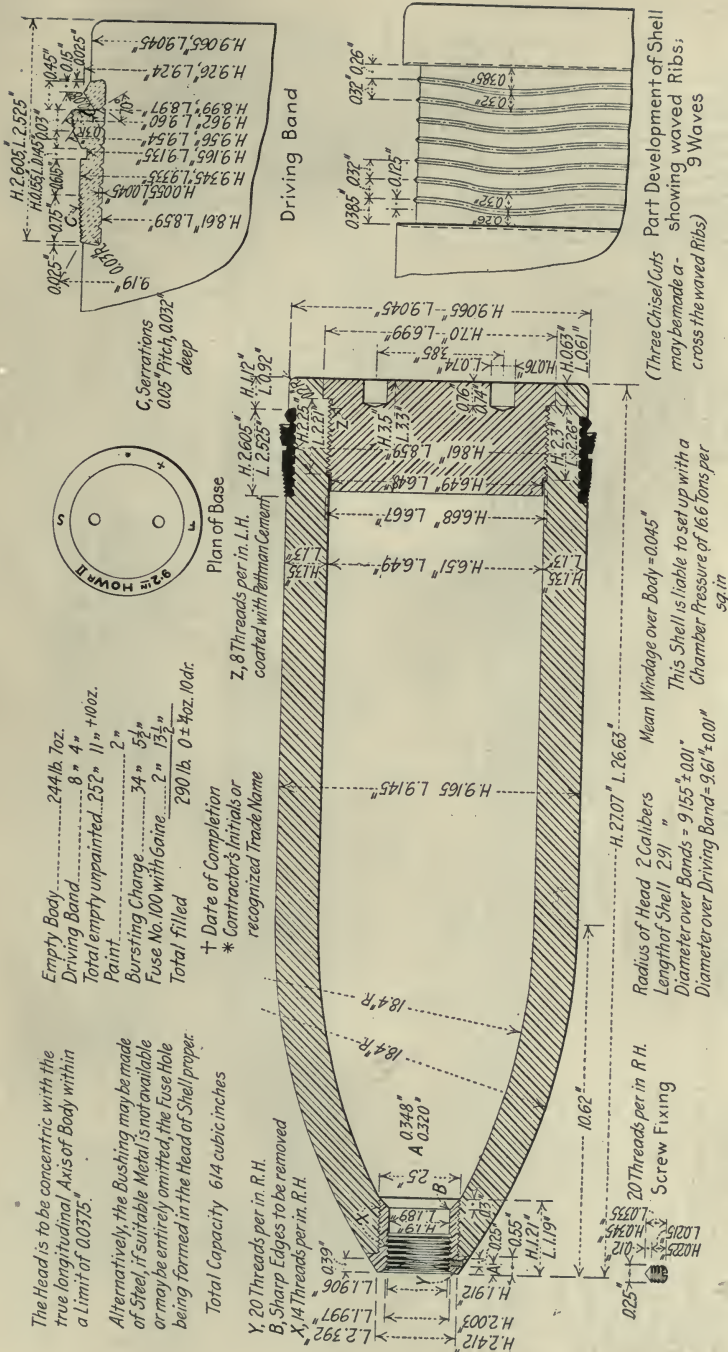

FIG. 664. BRITISH 9.2-IN HIGH EXPLOSIVE HOWITZER SHELL MARK II



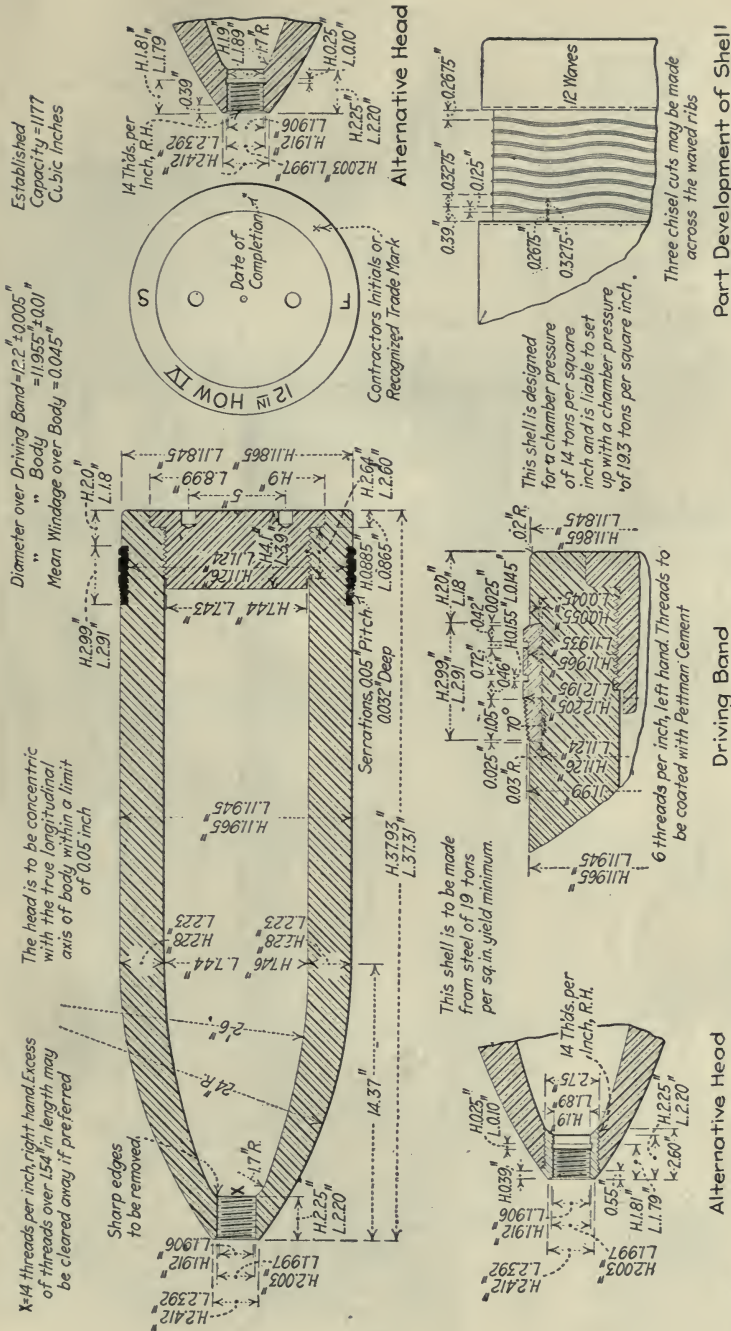

FIG. 666. BRITISH 12-IN. HIGH-EXPLOSIVE HOWITZER SHELL MARK IV

Part Development of Shell Showing Waved Ribs

Driving Band

Alternative Head

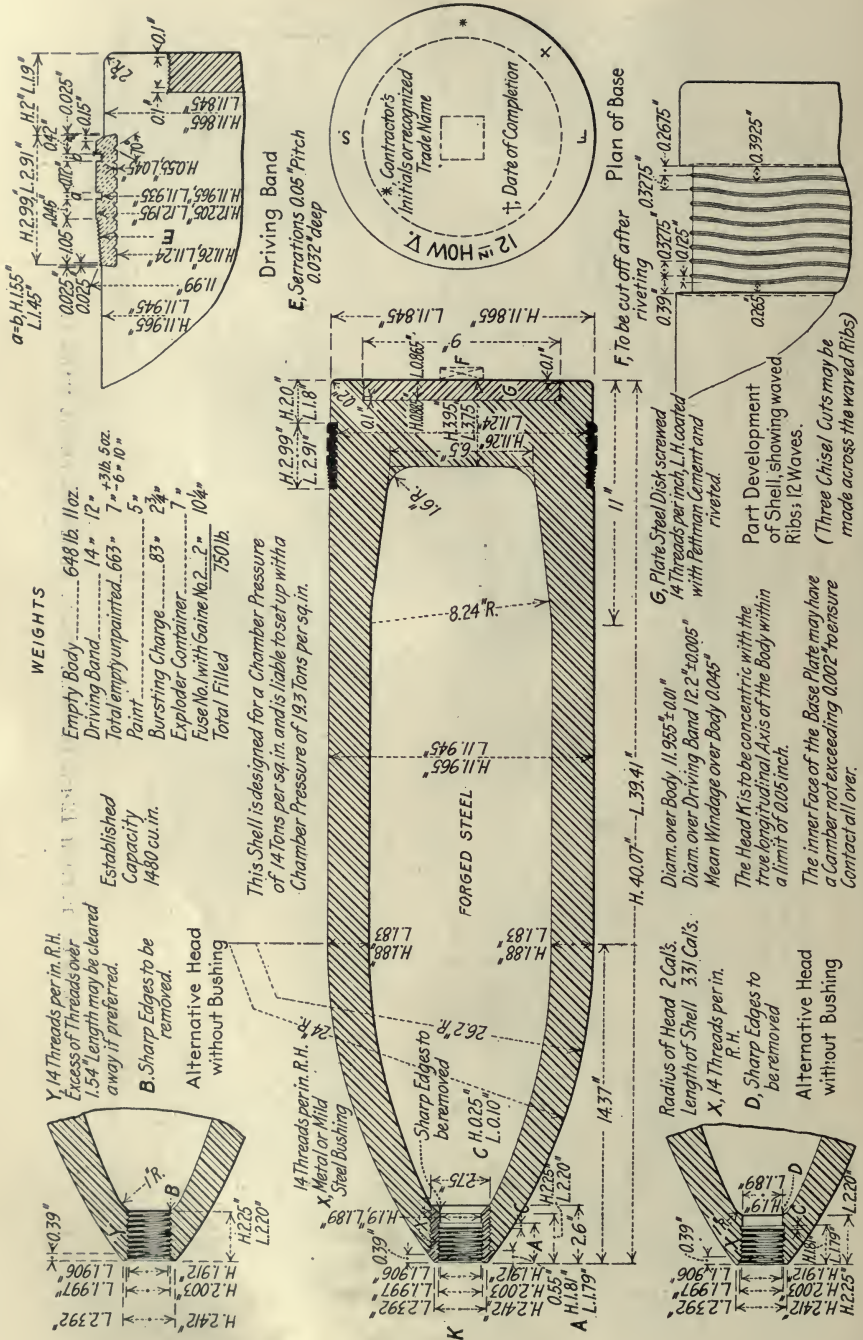

FIG. 667. BRITISH 12-IN HIGH-EXPLOSIVE HOWITZER SHELL MARK V



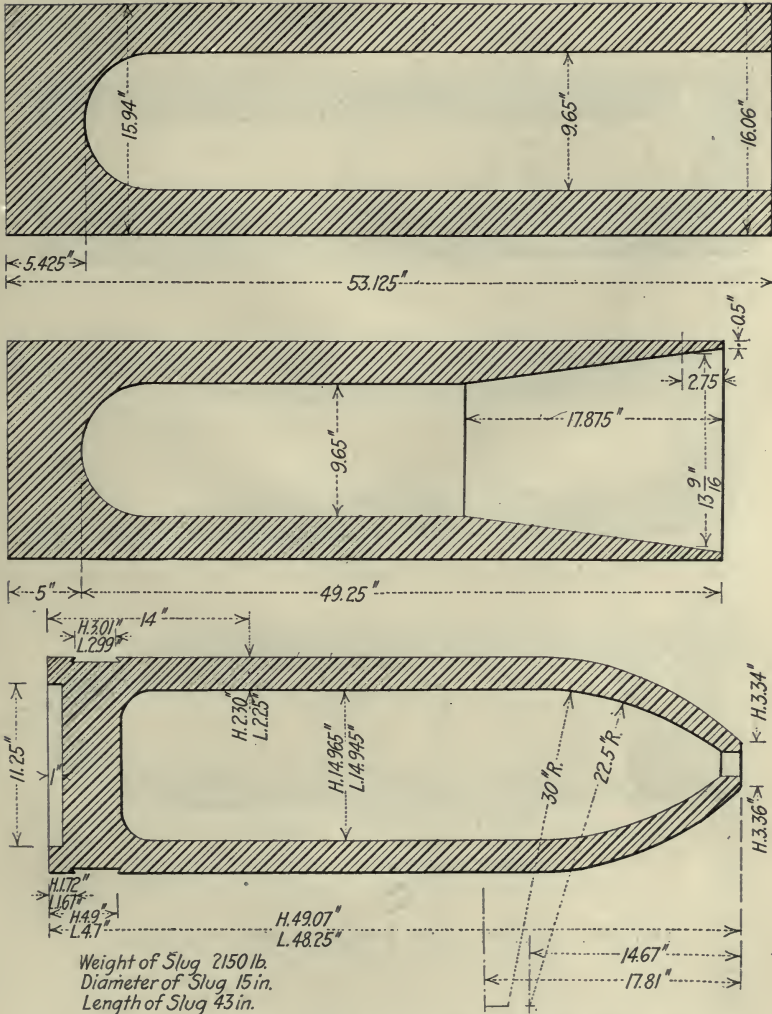

FIG. 668. BRITISH 15-IN. HIGH-EXPLOSIVE HOWITZER SHELL

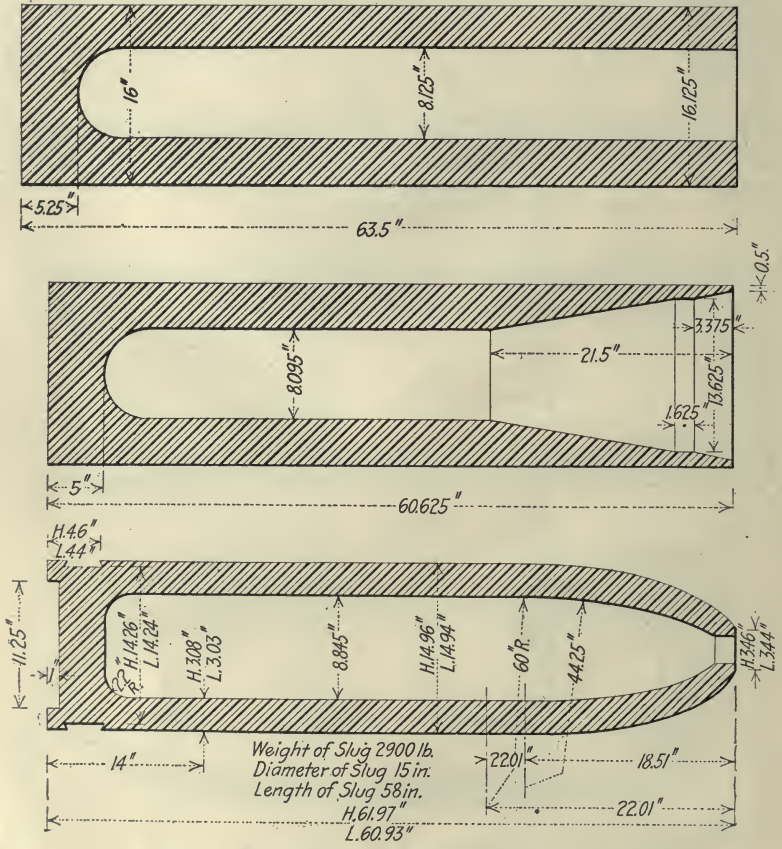

FIG. 669. BRITISH 15-IN. HIGH-EXPLOSIVE GUN SHELL

## BRITISH REQUIREMENTS FOR PROJECTILE INSPECTION

Type	Number to be inspected per man	
	Per hour	Per week
2-in. practice shot.....	.....	1,080
2 Pr. Tracers.....	15.00	720
3 Pr. Shells.....	15.00	720
Annealed.....	18.00	864
With tracers.....	9.00	.....
Shot.....	21.00	1,008
6 Pr. Shells.....	12.00	576
Annealed.....	16.00	768
With tracers.....	8.00	384
Shot.....	18.00	864
With tracers.....	15.00	720
12 & 14 Prs. × 2.75-in.....	.....	.....
Shot.....	15.00	720
Shot with tracers.....	12.00	576
15 & 12 Prs. × 2.95-in.....	.....	.....
12 & 14 Prs. × 2.75-in. shells.....	9.00	432
15 & 12 Prs. × 3-in.....	.....	.....
Shrapnel with tracers.....	8.00	384
13 Pr. Shell.....	8.75	420
With tracers.....	8.00	384
3-in. High-Explosive.....	8.00	384
18 Pr. Shell.....	8.25	398
With tracers.....	7.50	380
4-in. Shell.....	6.30	312
With tracers.....	6.00	288
Shot.....	8.50	408
With tracers.....	7.75	372
4.5-in. Shell.....	7.00	336
With tracers.....	6.25	300
Shot.....	8.75	420
With tracers.....	7.75	372
4.7-in. Shell.....	6.50	312
With tracers.....	6.00	288
Shot.....	8.50	408
With tracers.....	8.00	384
5-in. Shell.....	5.50	264
With tracers.....	5.00	240
Shot.....	7.60	360
With tracers.....	7.00	336
6-in. Shell.....	5.00	240
With tracers.....	4.50	216
Shot.....	6.50	312
With tracers.....	6.00	288

## BRITISH REQUIREMENTS FOR PROJECTILE INSPECTION—(Continued)

Type	Number to be inspected per man	
	Per hour	Per week
7.5-in. Shell.....	3.50	168
With tracers.....	3.25	158
Shot.....	4.50	216
With tracers.....	4.00	192
9.25-in. Shell.....	1.00	48
With tracers.....	0.85	40
Shot.....	2.25	105
With tracers.....	2.00	96
10-in. Shell.....	0.85	40
With tracers.....	.66	32
Shot.....	1.16	56
With tracers.....	1.00	48
12-in. H. Shell.....	0.75	36
With tracers.....	.625	30
Shot.....	1.00	48
With tracers.....	.85	40
13.5-in. I. Shell.....	0.625	30
With tracers.....	.50	25
Shot.....	.85	40
With tracers.....	.75	36
13.5-in. Shell.....	0.50	24
With tracers.....	.40	20
Shot.....	.75	36
With tracers.....	.625	30
15-in. Shell.....	.35	17
With tracers.....	.30	15
Shot.....	.50	24
With tracers.....	.40	20

BRITISH PRICES FOR PAINTING SHELLS  
HAND PAINTING PER 100

Type	Unstacking cleaning 1st coat 2d coat stacking		Unloading		Loading		Stencilling calibre and numeral		Red tip							
	s	d	\$	s	d	\$	s	d	\$	s	d	\$				
2.75-in. Shrap.....	3	10	0.92	7	25	0.145	6	125	0.1225	8	0	16	9	25	0.185	
15-lb. Shrap.....	4	3	1.02	7	25	0.145	6	125	0.1225	8	0	16	9	25	0.185	
18-lb. Shrap.....	4	7	1.10	7	25	0.145	6	125	0.1225	8	0	16	9	25	0.185	
4.5-in. Shrap.....	7	9	1.86	1-0	25	0.245	1-0	25	0.245	9	0	18	10	25	0.205	
60-lb. Shrap.....	9	2	2.20	1-3	25	0.305	1-0	25	0.245	9	0	18	1	1	25	0.265
12 & 14 Pr. H. E..	4	9	1.14	7	25	0.145	6	125	0.1225	8	0	18				
18-lb. H. E.....	4	7	1.10	7	25	0.145	6	125	0.1225	8	0	18				
4.5-in. H. E.....	7	9	1.86	1-0	25	0.245	1-0	25	0.245	9	0	18				
60-lb. H. E.....	9	2	2.20	1-3	25	0.305	1-0	25	0.245	9	0	18				
6-in. H. E.....	11	8	75	2	6	50	0.610	2	0	50	0.490	9	0	18		
8-in. H. E.....	17	4	5	4	13	5-1	1.225	5-1	1.225	1	3	0	30			
9.2-in. H. E.....	25	0	6.00	12-9	3	06	12-9	3	06	1	3	0	30			

NOTES.—In the case of 9.2-in. and 8-in. high-explosive shells no stacking is done, except under exceptional circumstances, but prices are paid for "Rolling during operation" and "Rolling after operation" which are included in the above.

One penny is assumed to be equivalent to two cents.

DIAMETER OF BRITISH SHELLS OVER PAINT

Calibre	Diameter	Calibre	Diameter
1½ & 1-Pdr.....	1.453-in.	4.5-in.	4.490-in.
2-Pdr.....	1.571-in.	4.7-in.	4.709-in.
3-Pdr.....	1.846-in.	60-Pdr. } 5-in. } 80-Pdr. } 6-in. }	4.980-in.
6-Pdr.....	2.240-in.		5.980-in.
10-Pdr. } 2.75-in. }	2.740-in.	7.5-in.	7.480-in.
2.95-in. ....	2.951-in.	8-in.	7.980-in.
12 & 14-Pdr.....	2.990-in.	9.45-in.	9.430-in.
15-Pdr.....	2.990-in.	9.2-in.	9.180-in.
13-Pdr. } 3-in. }	2.995-in.	10-in.	9.980-in.
18-Pdr.....	3.295-in.	12-in.	11.980-in.
30-Pdr. } 4-in. }	3.980-in.	13.5-in.	13.480-in.
		14-in.	13.980-in.
		15-in.	14.980-in.

## WEIGHTS AND DIMENSIONS OF SOME BRITISH SHELLS

	5 in. MK V	6 in. MK XIV	9.2 in. MK II(L)	9.2 in. MK X	12 in. MK III (N)	15 in. MK III	15 in. MK IA
Dimens.....	5"×13½"	6"×17¾"	9"×20½	9"×29"	12"×36¾"	14¾"×44½"	14¾"×60"
Weight.....	73 lbs.	144 lbs.	367 lbs.	512 lbs.	1170 lbs.	2150 lbs.	2900 lbs.
Scale loss.....	2 lbs.	4 lbs.	8 lbs.	12 lbs.	30 lbs.	50 lbs.	60 lbs.
Width of cut...	½"	¾"	½"	½"	¾"	1"	1"
Weight of cut..	2½ lbs.	4 lbs.	9 lbs.	9 lbs.	24 lbs.	50 lbs.	50 lbs.
Mean O. D....	5.250"	6.300"	9.656"	9.650"	12.850"	16.075"	16.075"
Mean I. D....	3.250"	4.300"	6.074"	5.825"	7.585"	9.658"	8.095"
Length overall..	19.57"	24"	29"	36.5"	48.05"	53.125"	63.5"
Length inside...	18.00"	20.77"	26.5"	32.875"	43.625"	47.700"	58.275"
O. D.....	5.70"+	6.80"	10.12"	10.45"	13.70"	15.95"	16.68"
I. D.....	5.00"	6.00"	9.00"	9.20"	11.95"	14.90"	14.90"
Width.....	1½ <sub>6</sub>	1¾ <sub>2</sub>	2.53"	2½"	3¾ <sub>2</sub>	27½"	4.40"
Rough weight...	2 lbs. 12 oz.	3 lb. 4 oz.	13.8 lbs.	15 lb. 8 oz.	36 lbs. 1 oz.	23 lbs.	61 lbs. 8 oz.
Finish weight..	1 lb. 4 oz.	1 lb. 14 oz.	8 lbs. 14 oz.	8 lbs. 12 oz.	17 lbs. 8 oz.	16 lbs. 8 oz.	30 lbs. 10 oz.
Width of cut...	½"	¾"					
Weight of cut..	2½ ozs.	5½ ozs.					
Slug/dimens....			6×5½"×5¾" <sup>10</sup>	3½"×3½"×4½"	4¾"×4½"×5¾"	5¾"×5¾"×5½"	5¾"×5¾"×5½"
Rough weight..	1 lb. 8 oz.	3 lbs. 6 oz.	47 lbs.	12 lbs. 8 oz.	30 lbs.	44 lbs.	44 lbs.
Finish weight..	15 oz	2 lbs. 3 oz.	31 lbs.	6 lb. 4 oz.	15 lbs. 10 oz.	28 lbs.	28 lbs.
Width of cut...			¾"	¾"	¾"	¾"	¾"
Weight of cut..			3 lbs. 8 oz.	1 lb.	2 lbs.	3 lbs.	3 lbs.
Stock dimens....	3"D×2½"	2¾"D×2¼"	3¾"D×2½"	3¾"D×2¼"	3¾"D×2¼"	3¾"D×2¼"	3¾"D×2¼"
Rough weight...	4 lbs. 10 oz.	5 lbs. 4½ oz.	6 lbs. 8 oz.	7 lbs. 1 oz.	6 lbs. 13 oz.	7 lbs. 15 oz.	7 lbs. 15 oz.
Finish weight..	1 lb. 4 oz.	2 lbs. 2½ oz.	2 lbs. 8 oz.	2 lbs. 4¼ oz.	3 lbs. 3 oz.	2 lbs. 7 oz.	3 lbs. 7¼ oz.
Width of cut...	¾"	¾"	¾"	¾"	¾"	¾"	¾"
Weight of cut..	6 oz.	6½ oz.	7 oz.	8 oz.	8 oz.	9 oz.	9 oz.

Sling

Forcing

Copper Ring

Base Plate

Bushing

CHART II.—TEMPERATURES AND DURATION OF HEAT TREATMENT FOR BRITISH SHELLS

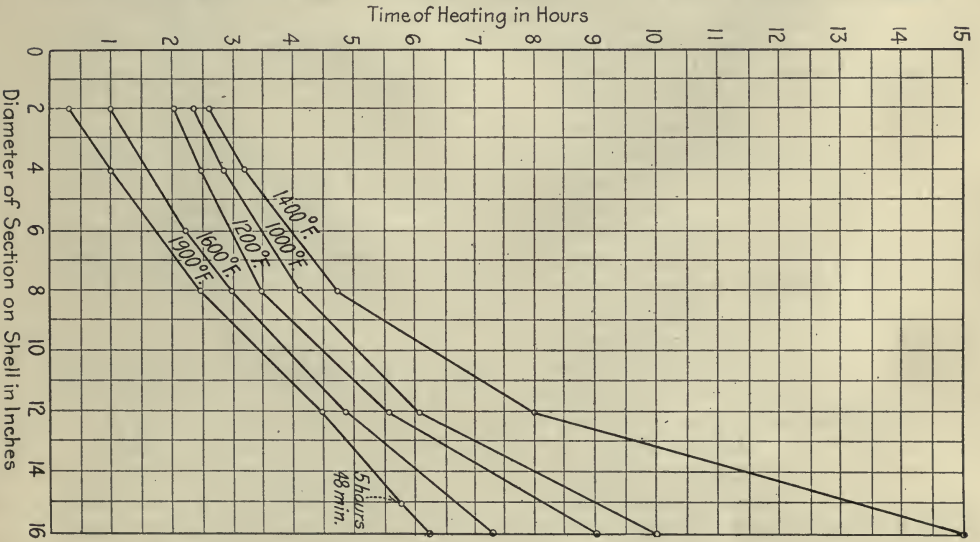





# INDEX

## A

- Adapters for British detonating fuse, 651-659
  - assembling, 654
  - lacquering, 658
  - manufacturing processes and equipment, 653-659
  - operation data, 651-652
  - painting the "Red Spot" and packing, 659
- Amalgamated corporation lathes, 392-395
- American Brake Shoe and Foundry Co., 389-391
- American Locomotive Co., 555
- American Multigraph Co., 705
- American Steam Gauge and Valve Manufacturing Co., 625
- Analysis of machine tool exports, 731
- Automatic production of shrapnel parts, 203-220

## B

- Base-plates for high-explosive shells, 247-250
  - forging operations, 248
  - inspection, 249
  - restricting imperfect work, 250
- Brass, cartridge, 517-528
- Brass casting shop (see *Casting shop*), 519-525
- Brass furnace equipment, 518
- Brass, tensile strength, 593
- British cartridge case (see *Cartridge case*), 555-620
  - detonator Mark IV (see *Detonator*), 625-650
  - detonator fuse adapters (see *Adapters*), 651-659
  - high-explosive shells (see *High-explosive shells*), 251-411
  - prices for painting shells, 757
  - requirements for projectile inspection, 755-756
  - shrapnel (see *Shrapnel*), 8-196
  - time fuse mark 80-44 (see *Time fuse*), 660-683

## C

- Canadian Allis-Chalmers Co., 312
- Canadian Car and Foundry Co., 26
- Canadian Car and Foundry Co. Dominion Works, 242
- Canadian Ingersoll-Rand Co., 31
- Canadian Pacific Angus Shops, 577
- Canadian Steel Foundries, Ltd., 236
- Caps and base plugs for time fuse (see *Time fuse*), 683-694
- Cartridge brass, 517-528
  - manufacturing processes and equipment, 525-528
  - specifications, 517
- Cartridge brass, rolling, 528-535
  - annealing, first, 533
  - final, 534
  - overhauling, 532
  - pickling, 534
  - rolling operation, first, 529
  - second, 534
  - running down, 533
  - straightening bars, 530
- Cartridge cases, 536-554
  - manufacturing processes and equipment, 543-554
  - operation data, 537-543
  - requirements, 536
- Cartridge cases, drawing British 18 lb., 577-594
  - annealing and semi-annealing, 584
  - bulldozers, 582
  - heading operation, 590
  - heading press, 800-ton, 587
  - hydraulic accumulators, 592
  - indenting and heading operations, 587
  - inspecting and testing, 592
  - manufacturing processes and equipment, 579-593
  - planers, 582
  - pressing taper, 585
  - prices on handling and washing, 594
  - prices on machine operations, 594
  - schedule of operations, 577

- Cartridge cases, making British 18 lb.,  
555-577  
chemical composition, 555  
hardness, 576  
manufacturing processes and equip-  
ment, 565-576  
operation data, 555-564  
weights, 577
- Cartridge cases, British 4.5-in. howitzer,  
595-620  
chemical composition, 595-596  
manufacturing processes and equip-  
ment, 603-620  
operation data, 596-603
- Casting shop (brass), 519-525  
crucibles, 523  
fluxes, 524  
fuel, 520  
furnace, 519  
layout and equipment, 519  
molds, 520  
scraproom, 525  
tool equipment, 522
- Composition and properties of shell  
steel, 734-737
- D
- Detonator fuse, 623-625
- Detonator, British Mark-100, 625-650  
centrifugal bolt, 637  
chemical composition, 625  
detents, 643  
detent-hole screw plug, 637  
fuse cap, 644  
fuse spring, 649, 650  
manufacturing processes and equip-  
ment, 625-650  
needles, 650  
percussion detonator plug, 638  
percussion needle plug, 639  
percussion pellet, 641  
working parts, 635
- Diameter of British shells over paint, 757
- Dimensions of British shells, 758
- Dominion Bridge Co., 222, 251
- Drive band, British 18-lb. high-explosive  
shell, 298-301  
18-lb. shrapnel, 59  
4.5-in. high-explosive shell, 358,  
361  
8-in. howitzer shell, 378  
9.2-in. Mark IV howitzer shell, 395  
12-in. Mark IV howitzer shell, 410
- Drive band, French 120-mm. explosive  
shell, 510  
Russian 1-lb. high-explosive shell,  
425  
3-in. high-explosive shell, 458  
Serbian 120-mm. shell, 487-488
- E
- East Jersey drilling machine, 444  
East Jersey Pipe Corporation, 442  
East Jersey turning machine, 446
- Eccentricity test, French 120-mm. explo-  
sive shell, 512
- Explosives used for high-explosive shells,  
233
- Exports of machine tools, 729
- F
- Forging base plates for high-explosive  
shells, 242  
blanks, high-explosive shell, 236-242  
4.5-in. British high-explosive shell  
blanks, 242-247  
operations, British 18-lb. shrapnel  
blanks, 13, 17
- French 75-mm. shrapnel, 6  
120-mm. explosive shell (see *High-  
explosive shells*), 494-514
- Fuse and charge for high-explosive shells,  
232
- Fuse, detonator, 623-625  
Time-Mark 80-44 (see *Time fuse*),  
660-683
- Fuse plug, British 18-lb. shrapnel, 73,  
74-82
- H
- Heat treatment, British 18-lb. shrapnel,  
57  
British 18-lb. shrapnel forgings, 24  
British shells—temperatures, etc.,  
759  
French 120-mm. explosive shell, 506  
Russian 3-in. high-explosive shell,  
454
- High-explosive shell details, 743-754  
British 18-lb., 744  
60-lb., 746  
6-in. Mark XVI, 747  
8-in. howitzer shell, 748

- High-explosive shell details, British  
 9.2-in. howitzer shell Mark II, 749  
 9.2-in. howitzer shell Mark IX, 750  
 12-in. howitzer shell Mark IV, 751  
 12-in. howitzer shell Mark V, 752  
 15-in. howitzer shell, 753  
 15-in. gun shell, 754  
 French 120-mm., 745  
 Russian 1-lb., 743  
 3-in., 743  
 Serbian 120-mm., 745
- High-explosive shells, 231  
 explosive used, 233  
 fuse and charge, 232  
 heads, 207  
 materials of construction and shape, 231  
 steel, 235
- High-explosive-shell manufacture, 236-514  
 British 18-lb., 251-311  
 drive band, 298-301  
 final inspection, 305-308  
 manufacturing processes and equipment, 278-311  
 operation data, 251-278  
 painting, 308-309  
 shop inspection and hospital work, 292-294  
 standard stamps, 311  
 British 4.5-in., 242-247, 312-365  
 drive band, 358, 361  
 forging blanks, 242-247  
 inspection, 247  
 operations, 242-247  
 piercing operation, 242  
 luting and packing, 365  
 manufacturing processes and equipment, 325-365  
 operation data, 312-325  
 shell inspection, 355, 363  
 varnishing inside, 360  
 British 8-in. howitzer, 366-388  
 drive band, 378  
 gages, 384-388  
 inspection, 383-388  
 manufacturing processes and equipment, 374-383  
 operation data, 368-373  
 British 9.2-in. Mark IV howitzer, 389-398  
 drive band, 395
- High-explosive-shell British 9.2-in. Mark IV howitzer, manufacturing processes and equipment, 392-398  
 sequence of operations, 391  
 British 12-in. Mark IV howitzer, 399-411  
 adapter, 408, 410  
 drive band, 410  
 manufacturing processes and equipment, 399-411  
 French 120-mm., 494-514  
 drive band, 510  
 eccentricity test, 512  
 heat treatment, 506  
 hydraulic pressure test, 509  
 inspection, 504, 511, 513  
 manufacturing processes and equipment, 499-514  
 operation data, 494-499  
 packing, 514  
 volumetric test, 505-506  
 Russian 1-lb., 412-441  
 chemical composition, 413  
 drive band, 425  
 gas check, 432  
 inspection, 438  
 loading, 435  
 manufacturing processes and equipment, 423-441  
 operation data, 413-423  
 Russian 3-in., 442-459  
 chemical composition, 453  
 drive band, 458  
 heat treatment, 454  
 inspection, 458-459  
 manufacturing processes and equipment, 453-459  
 operation data, 448-453  
 Serbian 120-mm., 460-493  
 drive band, 487-488  
 gages, 483  
 inside varnishing, 489  
 inspection, 482  
 manufacturing processes and equipment, 471-493  
 ogive, 484-485  
 operation data, 461-471  
 packing, 492-493  
 painting, 490  
 point or cap, 491-492
- High-explosive shell forging blanks, 236-242  
 analysis and tests, 241

- High-explosive-shell manufacturing processes and equipment, 237-241  
mixture, 236
- Hydraulic pressure test, French 120-mm. explosive shell, 509
- I
- Ignition of shrapnel fuse, 5
- Inspection, projectile—British requirements, 755-756
- L
- Light shells, 737
- Loading primers for cartridge cases, 719-725
- M
- Machine tools for munition manufacture, 729-734  
exports, 729
- Manufacturers of cartridge cases:  
American Locomotive Co., 555  
Canadian Pacific Angus Shops, 577  
New York and Hagerstown Metal Stamping Co., 536  
Worcester Pressed Steel Co., 595
- Manufacturers of high-explosive shells:  
American Brake Shoe and Foundry Co., 389-391  
Canadian Allis-Chalmers Co., 312  
Canadian Car & Foundry Dominion Works, 242  
Canadian Steel Foundries, Ltd., 236  
Dominion Bridge Co., Ltd., 251  
East Jersey Pipe Corporation, 442  
Providence Engineering Works, 460
- Manufacturers of detonating fuses:  
American Steam Gauge and Valve Manufacturing Co., 625
- Manufacturers of primers for cartridge cases:  
American Multigraph Co., 705
- Manufacturers of shrapnel:  
Canadian Car & Foundry Co., 26  
Canadian Ingersoll-Rand Co., 31  
Dominion Bridge Co., 222  
Montreal Locomotive Co., 8
- Montreal Locomotive Co., 8
- N
- New York and Hagerstown Metal Stamping Co., 536
- P
- Paint, diameter over—British shells, 757
- Painting shells, British prices, 757
- Piercing operations, British 18-lb. shrapnel, 29  
British 4.5-in. high-explosive blanks, 242
- Powder cups, British 18-lb. shrapnel, 66-67
- Primers for cartridge cases, 705-719  
anvil, 714  
manufacturing processes and equipment, 716-717  
operation data, 714-715  
body, 706  
manufacturing processes and equipment, 708-714  
operation data, 707-708  
loading, 719-725  
plug, 717  
manufacturing processes and equipment, 718  
operation data, 718  
"Productograph," 446
- Projectile inspection, British requirements, 755-756
- Providence Engineering Works, 460
- R
- Rolling cartridge brass (see *Cartridge brass, Rolling*), 528-535
- Russian high-explosive shells (see *High-explosive shells*), 412-459
- Russian shrapnel (see *Shrapnel*), 83-182
- S
- Serbian 120-mm. shells (see *High-explosive shells*), 460-493
- Shrapnel, 3  
details of design, 4
- Shrapnel details, 738-742  
British 3-in., 739  
60-lb. Mark I, 741  
French 75-mm., 738  
Russian 3-in., 740  
12-in., 742  
Spanish 75-mm., 738
- Shrapnel, British 18-lb., 8-82, 183-196  
French 75-mm., 6  
Russian 3-in., 83-145  
Russian 12-in., 146-182

- Shrapnel fuse, ignition of, 5  
 Shrapnel manufacture, 8-228  
   British 18-lb., 8-82, 183-196  
     forging blanks, 8-26  
       base forming stops and strip-  
       pers, 21  
       cutting bars, 8  
       cutting-off blanks, 27  
       drawing operation, 19, 29  
       flanging press, 13  
       forging, 12  
       forging hints, 23  
       forging operations, 13, 17  
       heat treatment, 24  
       piercing operations, 29  
       upsetting blanks, 28  
   making shells, 31-65  
     boxing, 62  
     chucking, 56  
     closing-in, 58  
     double-spindle flat turret lathes,  
       62-65  
       operations, 63  
     drive band, 59  
     filling shell, 60  
     gages, 56  
     grinding operations, 58  
     heat treatment, 57  
     inspection, 57, 58  
     operation data, 32-55  
     painting, 62  
     soldering powder tubes, 62  
   manufacturing with regular shop  
     equipment, 183-196  
     manufacturing processes and  
     equipment, 185-196  
     operation data, 183-185  
   powder cups, discs, sockets and  
     plugs, 66-82  
     fuse plug, 73  
       birch log, 74  
       manufacturing processes  
       and equipment, 79-82  
       operation data, 75-78  
     powder cup, assembling, 67  
     operations, 66  
     sockets, 72  
     steel disc, 68  
   Russian 3-in., 83-145  
     manufacturing processes and  
     equipment, 112-126  
     manufacturing processes in a  
     pump shop, 138-145  
     Shrapnel manufacture, Russian 3-in.,  
       operation data, 85-112  
       operation data in a pump shop,  
       126-138  
       Russian 12-in., 146-182  
       manufacturing processes and  
       equipment, 158-182  
       operation data, 146-158  
     Shrapnel parts, manufacture on auto-  
       matic machines, 196-203  
       case, 196  
       fuse body and caps, 202  
       head, 199  
     Shrapnel production in a bridge shop,  
       222-228  
       flat-turret operations, 223  
       painting, 228  
       production, 228  
       reinforced boring bars, 225  
       turning case, 228  
     Shrapnel shell parts, automatic produc-  
       tion of, 203-220  
       fuse heads, 203  
       priming plug, projectile, 217  
       sockets, 212  
       time fuse bodies, 217  
       nose, 212  
       rings, 218  
     Sockets, British 18-lb. shrapnel, 72  
     Specifications for cartridge brass, 517  
     Steel discs, British 18-lb. shrapnel, 68  
     Steel, high-explosive shell, 235
- T
- Time fuse, British—Mark 80-44, 660-683  
   manufacturing processes and equip-  
   ment, 667-683  
   sequence of operations, 665  
   specifications, 662-665  
 Time fuse caps and base plugs, 683-694  
 Time fuse small parts, British, 694-704  
 production, 704  
 Timing device, shrapnel, 4
- V
- Variations in German high-explosive  
 shell steel, 736  
 Volumetric test, French 120-mm. explo-  
 sive shell, 505-506
- W
- Weights of British shells, 758  
 Worcester Pressed Steel Co., 595













YD 00558

U. C. BERKELEY LIBRARIES



C057095261

349166

Alford

UF 760

A9

UNIVERSITY OF CALIFORNIA LIBRARY

