

ACID-BASE INDICATORS



THE MACMILLAN COMPANY
NEW YORK · BOSTON · CHICAGO · DALLAS
ATLANTA · SAN FRANCISCO

MACMILLAN & CO., LIMITED
LONDON · BOMBAY · CALCUTTA
MELBOURNE

THE MACMILLAN COMPANY
OF CANADA, LIMITED
TORONTO

ACID-BASE INDICATORS

BY

I. M. KOLTHOFF, PH.D.

*Professor of Analytical Chemistry
University of Minnesota*

Translated by

CHARLES ROSENBLUM, PH.D.

*Fellow of the C. R. B. Educational
Foundation, Inc., New York City*

NEW YORK
THE MACMILLAN COMPANY
1937

COPYRIGHT, 1937,
BY THE MACMILLAN COMPANY

All rights reserved—no part of this book
may be reproduced in any form without
permission in writing from the publisher,
except by a reviewer who wishes to quote
brief passages in connection with a review
written for inclusion in magazine or
newspaper.

Published July, 1937

SET UP AND ELECTROTYPED BY
THE LANCASTER PRESS, INC., LANCASTER, PA.

PRINTED IN THE UNITED STATES OF AMERICA

PREFACE TO THE FOURTH GERMAN EDITION

Those substances, the color of which changes with the hydrogen ion concentration of a solution, have been called, until recently, "Color Indicators." Unfortunately, this name is not exact, nor was it logically chosen, since oxidation-reduction, adsorption indicators, etc. are also accompanied by a color change when they function as indicators. Accordingly it is better to designate those substances, the color of which depends upon the acidity or alkalinity of a solution, as Acid-Base Indicators. In this monograph, they will be referred to simply as Indicators.

The contents of this book differ essentially from those of its predecessor. Only the first two chapters dealing with the general concepts and calculations of acidity, and the reaction of ampholytes, have been retained, with minor changes and additions. The remainder of this monograph is newly written.

Although the importance of hydrogen ion concentration in pure and applied chemistry is generally recognized, and though it plays and has played a prominent part in the solution of many problems, one feels constrained to omit such material in this summarizing monograph. Such a compilation is found in the third edition of this book. Furthermore the importance of pH is exhaustively treated in specialized descriptions of various fields (for example, the chemistry of soils, foods, water, sugar, physiological and biochemistry, bacteriology, etc.). There is really no justification for a detailed discussion of this subject in the present monograph.

Still another chapter, concerning the use of indicators in neutralization analyses, is omitted because this topic is thoroughly treated in the author's *Volumetric Analysis*, I and II.

Furthermore, it was necessary to remodel completely the remaining contents. First the theoretical portion had to be extended considerably. In all acid-base equilibria, activities and not concentrations determine the equilibrium conditions. Therefore, from a practical viewpoint, a summarizing description of the modern theory of strong electrolytes and of the activity concept is indispensable, especially since otherwise phenomena such as influence of dilution on the pH of a buffer mixture, or the salt error of indicators, etc. have no quantitative explanation.

The concepts and equations of acid-base dissociation have referred chiefly to aqueous solutions. Recently, interest in the behavior of acids and bases in solvents other than water has increased considerably. The classical definition of an acid and a base, which is satisfactory for water solutions, is too limited for other solvents. Because of the great importance of the general question of the acid-base equilibrium, the clear and fruitful views of Brönsted are exhaustively considered in a special (fourth) chapter.

However, not only in its theoretical portions has the book undergone a marked expansion; the practical portion as well has grown considerably in extent. This is especially true of the description of properties of individual indicators (Chap. 5). The author has attempted to give as complete as possible a compilation of indicators, including those seldom used, in which their purification and preparation are considered in detail. Various new groups of indicators (among them fluorescein and precipitation indicators) are mentioned.

The sixth chapter describes the behavior of indicators in solvents other than water, while the seventh presents the theories which attempt to explain the color change.

The third section of the book is devoted to the colorimetric pH determination. The chapter on preparation and properties of buffer solutions embraces the whole of the author's present knowledge of this field. The ninth chapter deals with the colorimetric determination of pH, in which connection the practical performance as well as the values of indicator constants are discussed at great length. The tenth chapter treats the very important subject of errors in the colorimetric method. Indicator papers are taken up in the final chapter.

The author hopes that he has succeeded, by this extensive revision, in creating a new manual which considers, in a modern fashion, all which is of theoretical and practical importance in this field.

In conclusion, it is my pleasant duty to express heartfelt thanks to Dr. Fischgold (Berlin) for his grammatical revision of the manuscript, proof reading, and further coöperation.

I. M. KOLTHOFF

TRANSLATOR'S PREFACE

The fourth edition *Säure-Basen Indicatoren*, which appeared in 1932, treated the subject in the light of modern views of strong electrolytes. The present volume, prepared recently during the translator's tenure of a C. R. B. Fellowship at the University of Louvain, retains intact the theoretical treatment. A section dealing with neutralization curves, however, has been omitted. A number of minor additions and revisions have been made.

The translator acknowledges his indebtedness to his wife for her help with the mechanics of preparing the manuscript, and to Mr. L. S. Guss of the University of Minnesota for his aid in reading galley proof.

CHARLES ROSENBLUM

LOUVAIN, BELGIUM
May, 1937.

TABLE OF CONTENTS

PART ONE

THE DISSOCIATION OF STRONG AND WEAK ELECTROLYTES

CHAPTER	PAGE
I. THE REACTION (DEGREE OF ACIDITY) OF ACIDS, BASES, AND SALTS.....	3
II. AMPHOTERIC SUBSTANCES.....	32
III. THE ION ACTIVITY THEORY AND ITS APPLICATION TO ACID-BASE EQUILIBRIA.....	48
IV. THE BRÖNSTED DEFINITION OF ACIDITY AND BASICITY, PROPERTIES OF ACIDS AND BASES.....	83

PART TWO

THE PROPERTIES OF ACID-BASE INDICATORS

V. THE COLOR CHANGE AND PROPERTIES OF INDICATORS...	103
VI. THE INFLUENCE OF SOLVENTS ON THE PROPERTIES OF INDICATORS.....	197
VII. THE THEORY OF INDICATORS.....	216

PART THREE

THE COLORIMETRIC DETERMINATION OF HYDROGEN ION CONCENTRATION

VIII. BUFFER SOLUTIONS. PREPARATION AND PROPERTIES...	239
IX. THE COLORIMETRIC DETERMINATION OF HYDROGEN ION CONCENTRATION.....	277
X. SOURCES OF ERROR IN THE COLORIMETRIC METHOD...	322
XI. INDICATOR PAPERS.....	361
APPENDIX.....	379
INDEX.....	391

PART ONE
THE DISSOCIATION OF STRONG AND
WEAK ELECTROLYTES

CHAPTER ONE

THE REACTION (DEGREE OF ACIDITY) OF ACIDS, BASES, AND SALTS

1. The dissociation of water.

In a quantitative neutralization, the concentration of an acid is determined by titration with a base to form a neutral salt. Conversely, the strength of a base is determined by titration with an acid. If we write the acid as HA and the base by the formula BOH, the reaction is represented by the equation:

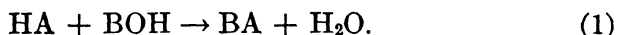

According to the electrolytic dissociation theory, electrolytes in aqueous solution are completely or partially dissociated into ions. Thus the acid HA splits into H^+ ions and A^- ions, BOH into B^+ and OH^- ions, and the salt BA into B^+ ions and A^- ions. Hence equation (1) may be written more appropriately in the following form:

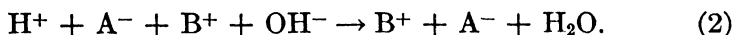

In other words, A^- and B^+ remain unaltered by the reaction. The change, therefore, involves simply the combination of H^+ ions and OH^- ions to form water:



Since the purest water is dissociated into H^+ and OH^- to an extremely slight degree, equation (3) must be written as a reversible reaction. Applying the mass action law to this reaction in equilibrium, we may write:

$$\frac{[\text{H}^+] \times [\text{OH}^-]}{[\text{H}_2\text{O}]} = K. \quad (4)$$

The brackets indicate molar concentrations of the various components.

In dilute aqueous solutions the concentration of water may be regarded as constant. Hence equation (4) becomes:

$$[\text{H}^+] \times [\text{OH}^-] = K' = K_w. \quad (5)$$

Equation (5) is the basis of analytical neutralizations. K_w is the *dissociation constant*, or rather, the *ionization constant* or *ion product* of water. Hydroxyl and hydrogen ions are simultaneously formed as a result of the slight dissociation of water. The ion product of water, though very small, has been determined by various investigators, with excellent agreement. The constant varies considerably with temperature. The following table contains the values given by KOHLRAUSCH and HEYDWEILLER¹ for the dissociation constant of water at various temperatures.

ION PRODUCT OF WATER AT VARIOUS TEMPERATURES

TEMPERATURE	K_w	pK_w
0°	0.12×10^{-14}	14.93
18°	0.59×10^{-14}	14.23
25°	1.04×10^{-14}	13.98
50°	5.66×10^{-14}	13.25
100°	58.2×10^{-14}	12.24

A distinction is usually made between strong and weak electrolytes. Strong electrolytes in aqueous solution are practically completely dissociated into ions. The theory of Arrhenius requires that the "degree of dissociation" decrease with increasing electrolyte concentration. According to modern views (BJERRUM, DEBYE and HÜCKEL, A. A. NOYES et al.), it is assumed that the strong electrolytes are completely ionized; and that it is rather the *activity* of ions which is considered to diminish with increasing concentration. Although the modern concept of ion activity is of prime importance for the development of the theory of strong electrolytes, and must be taken into account in all accurate calculations, we will confine ourselves in this review chapter merely to general remarks and neglect this distinction. The strong acids (the halogen hydracids, the halogen oxyacids, nitric acid), strong bases (alkali and alkaline earth hydroxides), and most salts (except many mercury and several cadmium salts) belong to the strong electrolyte class. We shall assume in our derivations that all strong electrolytes are completely ionized in solution, or in other words,

¹ Kohlrausch and Heydweiller: *Ann. Physik*, (4) 28, 512 (1909). Nernst: *Z. physik. Chem.*, 14, 155 (1894). Sv. Arrhenius: *Z. physik. Chem.*, 11, 827 (1893). Lorenz and Böhi: *Z. physik. Chem.*, 66, 733 (1909). Kanolt: *J. Am. Chem. Soc.*, 29, 1414 (1907). Noyes, Kato and Sosman: *Z. physik. Chem.*, 73, 20 (1910). Lunden: *J. chim. phys.*, 5, 574 (1907). Wijs: *Z. physik. Chem.*, 12, 514 (1893). Löwenherz: *Z. physik. Chem.*, 20, 283 (1896). Fales and Nelson: *J. Am. Chem. Soc.*, 37, 2769 (1915). Beans and Oakes: *J. Am. Chem. Soc.*, 42, 2116 (1920). Lewis, Brighton and Sebastian: *J. Am. Chem. Soc.*, 39, 2245 (1917).

that the degree of electrolytic dissociation (ARRHENIUS) is equal to unity regardless of dilution. We shall assume further that the activity coefficient (modern view) likewise equals unity. We realize that by so doing, we introduce an error. This error, however, is small and of secondary importance in these general considerations.

In accurate calculations, the activity coefficients (f_a) must be taken into account. The *activity* of ions is obtained by multiplying the ion concentration by f_a . In this chapter, ion concentration will be set equal to ion activity. The activity theory will be treated exhaustively in Chapter 3, where exact expressions for equilibrium conditions will be presented.

2. The reaction of a liquid.

The concentration of hydrogen ions in pure water equals that of the hydroxyl ion. Setting $K_w = 10^{-14}$ for the sake of simplicity, we have for pure water:

$$[\text{H}^+]^2 = [\text{OH}^-]^2 = 10^{-14},$$

or

$$[\text{H}^+] = [\text{OH}^-] = 10^{-7}.$$

It is thus evident that 1 g. of hydrogen ion and 17 g. of hydroxyl ion are present in 10,000,000 liters of water. In acid solutions, the hydrogen ion concentration exceeds that of the hydroxyl ion, while the reverse is true in alkaline solutions. The product of the two concentrations remains constant in all cases.

If the value of $[\text{H}^+]$ is greater than 10^{-7} , we say that the solution shows an *acid reaction*. When $[\text{OH}^-]$ exceeds 10^{-7} , we say the solution is *alkaline*. The reaction is *neutral* if $[\text{H}^+] = [\text{OH}^-]$.

We have assumed, for purposes of calculation, that the temperature is 24° , so that $K_w = 10^{-14}$.

It follows from equation (5) that:

$$[\text{H}^+] = \frac{K_w}{[\text{OH}^-]} \quad (6)$$

and

$$[\text{OH}^-] = \frac{K_w}{[\text{H}^+]}. \quad (7)$$

When either $[\text{H}^+]$ or $[\text{OH}^-]$ is known, the other may be calculated. FRIEDENTHAL¹ has suggested that the reaction of a solution be expressed in terms of hydrogen ion concentration, even

¹Friedenthal: Z. Elektrochem., 10, 113 (1904).

though it be alkaline. Equation (7) then permits the calculation of $[\text{OH}^-]$.

For certain purposes, it has been more advantageous not to speak of the hydrogen ion concentration as such, but rather to express it in terms of the negative logarithm (Briggsian) of concentration, or by the logarithm of its reciprocal. This proposal was made by SÖRENSEN,¹ who called the number the *hydrogen exponent* and designated it by the symbol pH. Consequently:

$$\text{pH} = -\log [\text{H}^+] = \log \frac{1}{[\text{H}^+]},$$

and

$$[\text{H}^+] = 10^{-\text{pH}}.$$

For example:

$$[\text{H}^+] = 10^{-5.0}, \quad \text{pH} = 5.0.$$

$$[\text{H}^+] = 3 \times 10^{-5} = 10^{(\log 3) - 5} = 10^{-4.52}, \quad \text{pH} = 4.52.$$

Conversely, pH = 4.3 corresponds to $[\text{H}^+] = 10^{-4.3} = 10^{-5+0.7} = 5.0 \times 10^{-6}$.

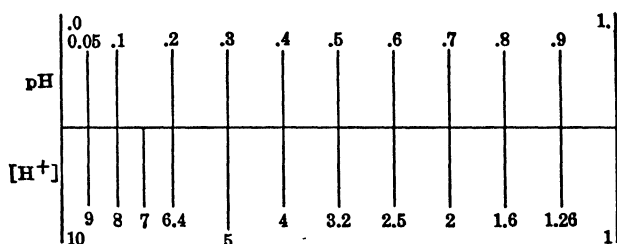

FIG. 1

A simple graphical method of converting $[\text{H}^+]$ into pH, or the reverse, is shown in Fig. 1. The pH scale is divided into ten equal parts from 0.0 to 1.0. Beneath it, the corresponding $[\text{H}^+]$ scale is laid off logarithmically. Each decimal of the hydrogen exponent corresponds to the value given for the hydrogen ion concentration in the lower row (see also Appendix, Table 6).

If the hydroxyl exponent is defined in the same manner as the hydrogen exponent, and the negative logarithm of K_w is designated by pK_w , then equation (5) becomes:

$$\text{pH} + \text{pOH} = pK_w. \quad (8)$$

¹ S. P. L. Sørensen: Compt. rend. trav. lab. Carlsberg, 8, 28 (1909); Biochem. Z. 21, 131, 201 (1909).

For $K_w = 10^{-14}$, $pK_w = 14$. Hence we may write:

$$pH + pOH = 14. \quad (9)$$

In pure water $pH = pOH = 7$. The reaction of a liquid may therefore be defined in the following manner:

$$\begin{array}{ll} pH = pOH = 7 & \text{Neutral reaction.} \\ pH < 7 < pOH & \text{Acid reaction.} \\ pH > 7 > pOH & \text{Alkaline reaction.} \end{array}$$

The smaller the hydrogen exponent, the more acid is the liquid; and the smaller the hydroxyl exponent, the more strongly alkaline is the liquid. A decrease of one unit in hydrogen exponent corresponds to a tenfold increase in hydrogen ion concentration. The use of the hydrogen exponent in preference to ion concentration offers certain advantages, especially as regards graphical representations.

On various occasions, SÖRENSEN'S manner of expressing the reaction of solutions has been criticized. It is naturally rather difficult for a beginner to understand that increasing pH means a diminishing acidity, and that acidity increases with decreasing pH. In spite of this objection, the notation has been accepted quite generally and with good reason. In my opinion, it is impossible to replace this valuable manner of expressing hydrogen ion concentration by one equally satisfactory. Only pH serves as a direct measure of the acidity.

D. GIRIBALDO¹ has proposed that the reaction of a fluid be designated by the ratio $\log \frac{[H^+]}{[OH^-]}$ (i.e. by the value of $-pH + pOH$).

This method gives positive values for acid reactions and negative values for alkaline reactions. The general use of this notation is not recommended, although it is useful in certain cases. The author's remarks on this matter are to be found elsewhere² in the literature.

3. Acids and bases.

Substances which liberate hydrogen ions in aqueous solution are called acids. Bases, on the other hand, split off hydroxyl ions.³ The various acids and bases differ quantitatively in the

¹ D. Giribaldo: *Biochem. Z.*, 163, 8 (1925).

² I. M. Kolthoff: *Biochem. Z.*, 169, 490 (1926).

³ This definition is too restricted, as will be seen in Chapter 4. The important ideas of J. N. Brönsted will be considered there, and a more general definition given.

strength of their acidic or basic characteristics. The greater the degree of dissociation, the stronger is the acid or base in question.

Again denoting an acid by HA, its dissociation may be represented by:



According to the mass action law, we have

$$\frac{[\text{H}^+] \times [\text{A}^-]}{[\text{HA}]} = K_{\text{HA}}, \quad (11)$$

where K_{HA} is the *dissociation constant* of the acid, and $[\text{HA}]$ the concentration of unionized acid. For an acid in a pure water solution $[\text{H}^+] = [\text{A}^-]$. Therefore:

$$\frac{[\text{H}^+]^2}{[\text{HA}]} = \frac{[\text{A}^-]^2}{[\text{HA}]} = K_{\text{HA}},$$

or

$$[\text{H}^+] = \sqrt{K_{\text{HA}}[\text{HA}]}. \quad (12)$$

This equation is not valid for very strong acids, but holds only for those which are weak or of medium strength. If the degree of dissociation α ¹ is calculated with the aid of equation (11), it is usually found that αc (which is equivalent to the hydrogen ion concentration in a pure acid solution) is so very much smaller than the total concentration c as to be negligible in comparison with $[\text{HA}]$. Hence the total acid concentration c may be substituted for $[\text{HA}]$ without great error. Equation (12) then becomes

$$[\text{H}^+] = \sqrt{K_{\text{HA}} \times c}. \quad (13)$$

If we wish to compute pH, we find

$$\text{pH} = \frac{1}{2}\text{pHA} - \frac{1}{2}\log c, \quad (14)$$

¹ α is that fraction of a mole which has dissociated into ions. Since according to modern views, all strong electrolytes are completely ionized in aqueous solution, then the equations derived in these paragraphs apply only to medium strong and weak electrolytes.

Reference to the more exact expressions, in which activity coefficients are introduced, will be reserved for the third chapter.

According to the definition of α , its value in a solution of a weak acid is

$$\alpha = \frac{[\text{H}^+]}{[\text{H}^+] + [\text{HA}]} = \frac{[\text{A}^-]}{[\text{A}^-] + [\text{HA}]} = \frac{[\text{H}^+]}{c} = \frac{[\text{A}^-]}{c}$$

and

$$[\text{H}^+] = [\text{A}^-] = \alpha c,$$

where c stands for the analytical concentration of the acid.

where pH_A represents the *acid exponent*, the negative logarithm of K_{HA} .

That we are justified in replacing $[HA]$ by c in many cases is shown readily.

The dissociation constant of acetic acid is 1.8×10^{-5} at 18° . Ostwald's dilution law, which may be derived without difficulty, states:

$$\frac{\alpha^2 c}{1 - \alpha} = \frac{\alpha^2}{(1 - \alpha)V} = K_{HA}, \quad (15)$$

where c is the total acid concentration, α the degree of dissociation, V represents the dilution and is the reciprocal of the concentration c , and K_{HA} is the dissociation constant.

In the following table, α has been calculated for various concentrations (c) and expressed as per cent of c .

$$K_{HA} = 1.8 \times 10^{-5}$$

c	100α	$[H^+]$ CALC'D BY EQUATION (15)	$[H^+]$ CALC'D BY EQUATION (13)	Δ IN PER CENT
1/8	1.2	1.50×10^{-3}	1.50×10^{-3}	0
1/16	1.7	1.06×10^{-3}	1.06×10^{-3}	0
1/32	2.4	0.75×10^{-3}	0.75×10^{-3}	0
1/128	4.7	0.37×10^{-3}	0.376×10^{-3}	1.5
1/1024	12.7	0.12×10^{-3}	0.135×10^{-3}	10

Since $[H^+]$ equals αc , it can be calculated readily if α is known.

It is seen from this table that 0.1 N acetic acid is approximately 1 per cent dissociated into ions. In calculating the hydrogen ion concentration in this solution, it may be assumed without appreciable error that the undissociated acid concentration equals the total concentration. Whether the calculation is simplified by neglecting α (equation (13)), or whether α is taken into account as in the exact computation (equation (15)), the same value of $[H^+]$ ($= 1.35 \times 10^{-3}$) is obtained for the 0.1 N solution.

Equation (13) applies only to cases in which K_{HA} is small and the dilution is not too great. If the degree of dissociation may no longer be neglected, the $[H^+]$ can be found by using equation (12) written in the following form:

$$[H^+] = \sqrt{K_{HA}(c - [H^+])}, \quad (16)$$

or simply,

$$[\text{H}^+] = -\frac{K_{\text{HA}}}{2} + \sqrt{\frac{K_{\text{HA}}^2}{4} + K_{\text{HA}} \cdot c}. \quad (17)$$

In the case of a dibasic acid two dissociation constants must be considered:

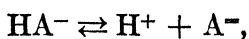
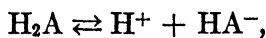

$$K_1 = \frac{[\text{H}^+] \times [\text{HA}^-]}{[\text{H}_2\text{A}]}, \quad (18)$$

$$K_2 = \frac{[\text{H}^+] \times [\text{A}^-]}{[\text{HA}^-]}. \quad (19)$$

To calculate the $[\text{H}^+]$ in a solution of a dibasic acid only the value of K_1 need be employed, so that the entire discussion of monobasic acids applies equally well to this case. This is especially true in most instances where the two constants differ considerably, for then the second dissociation is probably small enough to be neglected.

When the second step in the ionization of the acid must be considered, the hydrogen ion concentration in such an acid solution may be calculated by means of a more complicated equation.

The concentration of positive ions equals that of the negative ions since the solution is electrically neutral. From this it follows that:

$$[\text{H}^+] = [\text{HA}^-] + 2[\text{A}^-] \quad (20)$$

and

$$[\text{H}_2\text{A}] = c - [\text{H}^+] + [\text{A}^-], \quad (21)$$

where c is the total concentration of acid.

Equations (18) and (19) are readily rearranged to yield:

$$[\text{H}^+] = \frac{[\text{H}_2\text{A}]}{[\text{HA}^-]} K_1 = \frac{[\text{HA}^-]}{[\text{A}^-]} K_2$$

or

$$\frac{[\text{H}_2\text{A}][\text{A}^-]}{[\text{HA}^-]^2} = \frac{K_2}{K_1}. \quad (22)$$

By substituting the value of $[\text{H}_2\text{A}]$ (equation 21) in equation (18) we arrive at:

$$[\text{HA}^-] = \frac{c - [\text{H}^+] + [\text{A}^-]}{[\text{H}^+]} K_1. \quad (23)$$

The following relation is obtained by solving the above four simultaneous equations (20), (21), (22), and (23) for $[H^+]$:

$$[H^+]^3 + [H^+]^2K_1 - [H^+](K_1c - K_1K_2) = 2K_1K_2c. \quad (24)$$

This equation has a number of uses. If $[H^+]$ is determined in two solutions of different concentrations of a given dibasic acid, two equations are obtained in which K_1 and K_2 are the only unknowns and from which the values of these dissociation constants are found very simply.

Conversely, if both constants of a dibasic acid are known, the concentration of hydrogen ions in aqueous solution can be calculated. Although it is difficult to solve an equation of the third degree, the correct value can be found by the method of trial and error. The labor involved can be materially reduced by the simple procedure described below.

In a solution of a dibasic acid,

$$[H^+] = [HA^-]$$

as a first approximation, because the degree of the first dissociation is always much greater than that of the second. Then equation (19) may be rewritten:

$$K_2 = [A^-].$$

Thus if $[H^+]$ is calculated under the assumption that the acid in pure solution behaves as a monobasic acid, and if K_2 is known, it can be seen immediately whether the second dissociation may be neglected. For example, if K_2 equals 10^{-6} and $[H^+]$ is calculated to be 10^{-3} , the second dissociation need not be considered. On the other hand, if K_2 is 10^{-5} and the calculated value of $[H^+]$ is 10^{-4} , then $[A^-]$ likewise equals 10^{-5} so that the roughly corrected value of $[H^+]$ is

$$[H^+] = 10^{-4} + 10^{-5} = 1.1 \times 10^{-4},$$

whereas

$$[HA^-] = 10^{-4} - 10^{-5} = 0.9 \times 10^{-4}.$$

We have assumed in this calculation that $[H^+] = [HA^-]$, which is not strictly true. Actually the correction is smaller as can be shown by substituting these corrected values in equation (19). In this way we find that now $[A^-] = 0.8 \times 10^{-5}$. By a second approximation we have $[H^+] = 10^{-4} + 0.8 \times 10^{-5} = 1.08 \times 10^{-4}$,

which does not differ materially from the result of the first approximation.

Once the approximate value of $[H^+]$ has been calculated in the manner just described, the exact value can be found rapidly from equation (24) after several trials.

ILLUSTRATIONS. *Phthalic acid*:

$$K_1 = 10^{-3}, \quad K_2 = 3 \times 10^{-6}, \quad c = 0.1:$$

$$[H^+] = 9.5 \times 10^{-3}$$

(the hydrogen ion concentration is calculated assuming that phthalic acid behaves as a monobasic acid),

$$[A^-] = 3 \times 10^{-6}.$$

The second dissociation step can be neglected here, just as in the following case where $c = 0.001$:

$$[H^+] = 6.2 \times 10^{-4}, \quad [A^-] = 3 \times 10^{-6}.$$

$$\textit{Tartaric acid:} \quad K_1 = 10^{-3}, \quad K_2 = 9 \times 10^{-5}:$$

$$\text{For } c = 0.1, \quad [H^+] = 9.5 \times 10^{-3}, \quad [A^-] = 9 \times 10^{-5}.$$

Here the second dissociation is negligible.

$$\text{For } c = 0.001, \quad [H^+] = 6.2 \times 10^{-4} \text{ (as a monobasic acid),}$$

$$[A^-] = 9 \times 10^{-5}.$$

The $[H^+]$ corrected approximately for the second dissociation is:

$$[H^+] = 6.2 \times 10^{-4} + 9 \times 10^{-5} = 7.1 \times 10^{-4}.$$

The exact value according to equation (24) is

$$[H^+] = 6.9 \times 10^{-4}.$$

Succinic acid ($K_1 = 6.55 \times 10^{-5}$; $K_2 = 6 \times 10^{-6}$) behaves very much like phthalic acid although the first constant of succinic acid is only ten times greater than its second.

Whatever has been said about acids applies equally well to bases except that in the latter case it is the hydroxyl ion concentration which is sought. Knowing $[OH^-]$, the $[H^+]$ may be derived directly from equation (5).

Let us consider the dissociation constants of a number of frequently used acids and bases, from which the hydrogen ion

THE REACTION OF ACIDS, BASES, AND SALTS 13

concentration and the exponent pH have been calculated for 0.1 N solutions. K_w was assumed ¹ to be $10^{-14.23}$ at 18°.

The great difference between the *actual* or *true acidity*, which corresponds to the hydrogen ion concentration, and the *titration acidity* is clearly seen in the following table. *The acidity found by titration is equal to the total acid concentration, and is determined by the quantity of alkali required to titrate the acid to the equivalence point.* In the following table, the titration acidity or alkalinity is the same for all substances, whereas the true acidities are decidedly different.

DISSOCIATION CONSTANTS OF SOME ACIDS AND BASES AT 18°
[H⁺] in 0.1 N Solution

SUBSTANCE	K_1	K_2	K_3	[H ⁺] IN 0.1 N SOLUTION	pH
Strong acids	Can not be stated	—	—	9×10^{-2}	1.05
Carbonic acid	3.04×10^{-7} $= 10^{-6.52}$	6×10^{-11} $= 10^{-10.22}$	—	1.23×10^{-4} (saturated)	3.91
Phosphoric acid	9×10^{-3} $= 10^{-2.05}$	1.95×10^{-7} $= 10^{-6.7}$	3.6×10^{-13} $= 10^{-12.44}$	3.04×10^{-2}	1.52
Hydrogen sulfide	6×10^{-8} $= 10^{-7.22}$	8×10^{-15} $= 10^{-14.1}$	—	7.76×10^{-5}	4.11
Boric acid	5.5×10^{-10} $= 10^{-9.26}$	—	—	7.41×10^{-6}	5.13
Acetic acid	1.8×10^{-5} $= 10^{-4.75}$	—	—	1.35×10^{-3}	2.87
Oxalic acid	3.8×10^{-2} $= 10^{-1.42}$	4.9×10^{-5} $= 10^{-4.31}$	—	6.55×10^{-2}	1.18
Phenol	1.0×10^{-10} $= 10^{-10}$	—	—	3.16×10^{-6}	5.50
Strong bases	Can not be stated	—	—	6.6×10^{-14}	13.18
Ammonia	1.7×10^{-5} $= 10^{-4.77}$	—	—	4.42×10^{-12}	11.35
Pyridine	1.6×10^{-9} $= 10^{-8.80}$	—	—	4.68×10^{-10}	9.33
Aniline	3.5×10^{-10} $= 10^{-9.46}$	—	—	1.0×10^{-9}	9.00

4. Hydrolysis of salts.

When a salt is dissolved in water it reacts partially with water to form an acid and a base. This change is described by the

¹ See Appendix, Table 2.

equation:

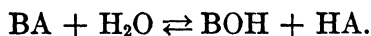

In this equation BA denotes the salt, and BOH and HA stand for the base and acid respectively. The reaction is reversible since BOH and HA react to form BA and H₂O.

It is more appropriate to consider hydrolysis as a reaction between the ions of salt BA and water. This may be represented as follows:

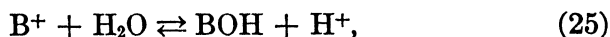

The hydrolysis of a salt of a very strong acid and base may be entirely neglected, since both BOH and HA are ionized completely at great dilutions. The equilibria shown in equations (25) and (26) are displaced far to the left; and as a result the solution has a neutral reaction.

On the other hand, if we are dealing with the salt of a strong acid and a weak base, or of a weak acid with a strong base, the salt is considerably hydrolyzed in water. In the first case, the change denoted by equation (26) may be ignored. One may conclude from equation (25) that the solution will have an acid reaction, and will contain a definite quantity of undissociated base equivalent in concentration to the hydrogen ion. An aqueous solution of the second type of salt will be alkaline and will contain, aside from an excess of hydroxyl ions, an equal concentration of undissociated acid HA.

Finally, if we consider a salt of a weak acid with a weak base, we find that both reactions (25) and (26) occur simultaneously in aqueous solution. Although the solution of a salt of this type, such as ammonium acetate, may react exactly neutral, it contains nevertheless a definite concentration of undissociated free acid and base.

5. Calculation of hydrogen ion concentration in hydrolyzed salt solutions.

(a) A salt formed from a strong acid and a strong base is not hydrolyzed appreciably. The hydrogen ion concentration of such a solution equals that in pure water, i.e. 10^{-7} at 24°; pH = 7. This is strictly true, of course, only if the salt is dissolved in exactly neutral water. It is really more precise to say that a

“neutral salt” is one which does not alter the reaction of the water in which it is dissolved.

(b) *Hydrolysis of a salt of a weak acid and strong base at room temperature.* It has already been stated that the solution of such a salt has an alkaline reaction and contains an excess of hydroxyl ions. Equation (26) shows that equal amounts of HA and OH⁻ are formed as a result of the hydrolysis of this type of salt. This is true only when we are justified in assuming that the base formed is so strong as to be completely ionized. Applying the mass action law to the equilibrium involved in equation (26), we find that:

$$\frac{[\text{HA}] \times [\text{OH}^-]}{[\text{A}^-] \times [\text{H}_2\text{O}]} = K'. \quad (27)$$

Considering the concentration of water as constant, we obtain:

$$\frac{[\text{HA}] \times [\text{OH}^-]}{[\text{A}^-]} = K_{\text{hydr.}} \quad (28)$$

The quantity $K_{\text{hydr.}}$ is called the *hydrolysis constant*. Since K_{HA} has been defined as:

$$\frac{[\text{H}^+] \times [\text{A}^-]}{[\text{HA}]} = K_{\text{HA}}, \quad (11)$$

it follows that

$$\frac{[\text{H}^+] \times [\text{OH}^-]}{K_{\text{HA}}} = K_{\text{hydr.}}$$

Recalling the definition of K_w :

$$[\text{H}^+] \times [\text{OH}^-] = K_w, \quad (5)$$

we may write

$$K_{\text{hydr.}} = \frac{K_w}{K_{\text{HA}}}. \quad (29)$$

We have already stated that in the salt solution $[\text{HA}]$ is equal to $[\text{OH}^-]$. If the salt in solution is completely ionized, and its hydrolysis may be disregarded, then $[\text{A}^-] = c$ where c is the salt concentration. From (28) and (29) it follows that:

$$\frac{[\text{OH}^-]^2}{c} = \frac{K_w}{K_{\text{HA}}},$$

$$[\text{OH}^-] = \sqrt{\frac{K_w \times c}{K_{\text{HA}}}} \quad (30)$$

and

$$[\text{H}^+] = \sqrt{\frac{K_w \times K_{\text{HA}}}{c}}, \quad (31)$$

$$\text{pOH} = 7 - \frac{1}{2}\text{pHA} - \frac{1}{2} \log c. \quad (32)$$

Since $\text{pH} = 14 - \text{pOH}$, we find for the same solution:

$$\text{pH} = 7 + \frac{1}{2}\text{pHA} + \frac{1}{2} \log c. \quad (33)$$

(c) *Hydrolysis of a salt of a strong acid and weak base.* When we calculate the degree of hydrolysis of a salt of a strong acid and weak base, we obtain the following equation instead of (30):

$$[\text{H}^+] = \sqrt{\frac{K_w \times c}{K_{\text{BOH}}}} \quad (34)$$

and

$$\text{pH} = 7 - \frac{1}{2}\text{pBOH} - \frac{1}{2} \log c. \quad (35)$$

ILLUSTRATION. Let us calculate the hydrogen ion concentration of a normal solution of ammonium chloride. In this problem $c = 1$ and $\text{pBOH} = 4.75$. Hence

$$\text{pH} = 7 - 2.38 = 4.62,$$

i.e. $[\text{H}^+] = 2.40 \times 10^{-5}$, a value which has been confirmed by measurement.

Expressed in per cent, the degree of hydrolysis β of a salt of a strong acid and a weak base is:

$$\beta = \frac{100[\text{H}^+]}{c}. \quad (36)$$

When, however, the degree of hydrolysis is very small ($\beta < 0.01\%$), we are no longer justified in assuming that $[\text{BOH}] = [\text{H}^+]$ (or in the preceding case, $[\text{HA}] = [\text{OH}^-]$), because now the hydrogen ions and hydroxyl ions from water must also be taken into account. The equation which permits one to calculate the pH of such a solution is too complicated to discuss here (cf. BJERRUM 1914; also below).

(d) *Hydrolysis of salts of weak acids and weak bases.* The reactions represented by both equations (25) and (26) must be considered in this instance. Equal quantities of undissociated

BOH and HA are formed by hydrolysis if the reaction of the solution remains unchanged.

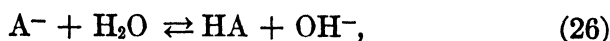
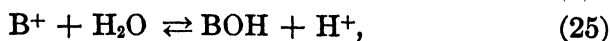

From (25) and (26) respectively we can derive:

$$K_{1 \text{ hydr.}} = \frac{K_w}{K_{BOH}} \quad (29)$$

and

$$K_{2 \text{ hydr.}} = \frac{K_w}{K_{HA}}. \quad (29)$$

Thus the hydrolysis constants are inversely proportional to the dissociation constants of the acid or base.

An aqueous solution of a salt of the weak acid-weak base type, for which K_{HA} is much larger than K_{BOH} , should show an acid reaction. We can not conclude, however, that $[H^+] = [BOH]$ as equation (25) would indicate, because most of the hydrogen ions unite with A^- ions to form HA. It is only when the hydrogen ion concentration does not deviate much from 10^{-7} , i.e. when it does not exceed 10^{-6} , that we may assume $[BOH] = [HA]$. According to equation (25), $[H^+]$ and $[BOH]$ should always be equal. This is not true, however, since the hydrogen ions which are produced are used up in the formation of HA. Only when the initial hydrogen ion concentration remains undisturbed does $[BOH]$ exactly equal $[HA]$, for then the hydroxyl ions produced by hydrolysis are removed as a result of the formation of BOH.

Since the final hydrogen ion concentration is usually small (between 10^{-6} and 10^{-8}), we may assume without appreciable error that the acid and base are formed in equivalent quantities, i.e. $[BOH] = [HA]$. We are now in a position to calculate the hydrogen exponent and the degree of hydrolysis from the equations already derived. We have shown above that:

$$\frac{[HA] \times [OH^-]}{[A^-]} = \frac{K_w}{K_{HA}} \quad (29)$$

and

$$\frac{[\text{BOH}] \times [\text{H}^+]}{[\text{B}^+]} = \frac{K_w}{K_{\text{BOH}}}. \quad (34)$$

By multiplying (29) and (34) we obtain

$$\frac{[\text{BOH}] \times [\text{HA}]}{[\text{B}^+] \times [\text{A}^-]} = \frac{K_w}{K_{\text{HA}} \times K_{\text{BOH}}}.$$

If the salt is completely ionized and its concentration is c , we have $[\text{B}^+] = [\text{A}^-] = c$. Let us assume that the concentrations of HA and BOH are negligible as compared with c . Furthermore, we have already shown that $[\text{BOH}]$ usually may be set equal to $[\text{HA}]$. Accordingly

$$\frac{[\text{BOH}]^2}{c^2} = \frac{[\text{HA}]^2}{c^2} = \frac{K_w}{K_{\text{HA}} \times K_{\text{BOH}}}, \quad (37)$$

$$[\text{BOH}] = [\text{HA}] = c \sqrt{\frac{K_w}{K_{\text{HA}} \times K_{\text{BOH}}}}, \quad (38)$$

$$\begin{aligned} -\log [\text{BOH}] &= -\log [\text{HA}] \\ &= -\log c + 7 - \frac{1}{2}\text{pHA} - \frac{1}{2}\text{pBOH}. \end{aligned} \quad (39)$$

If we let β represent the degree of hydrolysis in per cent, then

$$\beta = \frac{100[\text{BOH}]}{c} = 100 \sqrt{\frac{K_w}{K_{\text{HA}} \times K_{\text{BOH}}}}. \quad (40)$$

The $[\text{H}^+]$ can be calculated simply from equation (34) since $[\text{BOH}]$ is known. Thus:

$$\begin{aligned} [\text{H}^+] &= \frac{c}{[\text{BOH}]} \times \frac{K_w}{K_{\text{BOH}}} = \frac{c}{c \sqrt{\frac{K_w}{K_{\text{HA}} \times K_{\text{BOH}}}}} \times \frac{K_w}{K_{\text{BOH}}} \\ &= \sqrt{\frac{K_w \times K_{\text{HA}}}{K_{\text{BOH}}}}, \end{aligned} \quad (41)$$

and

$$\text{pH} = 7 + \frac{1}{2}\text{pHA} - \frac{1}{2}\text{pBOH}. \quad (42)$$

Expressions for $[\text{OH}^-]$ and pOH may be derived in a similar manner.

From (40) and (41) it follows that the degree of hydrolysis and the hydrogen exponent are independent of the concentration of the salt, provided that its dissociation is complete. If this

condition is not fulfilled, and the degree of ionization is α , the above equations assume the form:

$$[\text{BOH}] = [\text{HA}] = \alpha c \sqrt{\frac{K_w}{K_{\text{HA}} \times K_{\text{BOH}}}} \quad (38a)$$

$$\beta = 100\alpha \sqrt{\frac{K_w}{K_{\text{HA}} \times K_{\text{BOH}}}} \quad (40a)^1$$

ILLUSTRATIONS. The simplest example is the case of *ammonium acetate*. The dissociation constants of both acetic acid and ammonia equal $10^{-4.75}$. From (42) it follows that in a solution of ammonium acetate

$$\text{pH} = 7 + 2.38 - 2.38 = 7.$$

Evidently a solution of this salt reacts *exactly neutral*. The degree of hydrolysis expressed as per cent of salt concentration is:

$$\beta = 100 \sqrt{\frac{10^{-14}}{10^{-9.5}}} = 10^{-0.25} = 0.562\%.$$

In a 0.1 N ammonium acetate solution the concentration of undissociated acetic acid and ammonium hydroxide is approximately 0.0006 N.

The hydrolysis of *ammonium formate* will be considered next. A solution of this salt will have an acid reaction since formic acid is a stronger acid than ammonia is a base. The dissociation constants are:

$$K_{\text{Formic acid}} = 10^{-3.67}; \quad K_{\text{NH}_3} = 10^{-4.75}.$$

Hence the hydrogen exponent is

$$\text{pH} = 7 + 1.84 - 2.38 = 6.46.$$

Since the hydrogen exponent of a solution of such a salt is easily measured by means of indicators, we can determine rapidly whether the salt contains an excess of free acid or base. The hydrolysis of ammonium carbonate² is much more complicated than either of the preceding cases.

(e) *Hydrolysis of acid salts*. We may think of the acid salt BHA as a dibasic acid. In aqueous solution it is almost com-

¹ According to modern concepts, it is the activity and activity coefficient, f , rather than the degree of dissociation which must be considered. Analogous formulae may be developed in which the activity coefficient f replaces α .

² R. Wegscheider: *Monatsh.*, 37, 425 (1916).

pletely ionized according to the following equation:

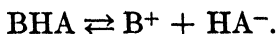

The ion HA^- also behaves as an acid. Hence:



In this instance, however, $[\text{H}^+]$ does not equal $[\text{A}^-]$, since part of the hydrogen ions is used up in the following reaction:



It is immediately evident from the last two equations that

$$[\text{A}^-] = [\text{H}^+] + [\text{H}_2\text{A}]. \quad (45)$$

According to (18) and (19):

$$[\text{H}_2\text{A}] = \frac{[\text{H}^+][\text{HA}^-]}{K_1} \quad (18)$$

and

$$[\text{A}^-] = \frac{[\text{HA}^-]}{[\text{H}^+]} K_2. \quad (19)$$

If now we assume that the salt BHA is completely dissociated and that both $[\text{A}^-]$ and $[\text{H}_2\text{A}]$ are very much less than $[\text{HA}^-]$, then we may set $[\text{HA}^-]$ equal to the total salt concentration c . (If the assumption of complete ionization is unjustified, then $[\text{HA}^-]$ becomes equal to αc ; or if the activity is being considered, $[\text{HA}^-] = fc$.)

Combining equations (18), (19) and (45), we deduce:

$$[\text{H}^+] = \sqrt{\frac{K_1 K_2 c}{K_1 + c}}. \quad (46)$$

NOYES¹ was the first to derive an equation of this sort.

We may conclude from the latter equation that the concentration of an acid salt has but little influence on the hydrogen ion concentration of its solutions. This is especially true if K_1

¹ Literature on the hydrolysis of acid salts: A. A. Noyes: *Z. physik. Chem.*, *11*, 495 (1893). Trevor: *Z. physik. Chem.*, *10*, 321 (1892). Walker: *J. Chem. Soc.*, *61*, 696 (1892). Smith: *Z. physik. Chem.*, *25*, 144, 193 (1898). Tower: *Z. physik. Chem.*, *18*, 17 (1895). McCoy: *J. Am. Chem. Soc.*, *30*, 688 (1908). Chandler: *J. Am. Chem. Soc.*, *30*, 694 (1908). Enklaar: *Chem. Weekblad*, *8*, 824 (1911). Dhatta and Dhar: *J. Chem. Soc.*, *107*, 824 (1915). Thoms and Sabalitschka: *Ber.*, *50*, 1227 (1917). Th. Sabalitschka: *Ber.*, *52*, 567, 1378 (1919).

is small compared with c , for in this case $K_1 + c$ equals c for all practical purposes, and equation (46) is simplified to

$$[\text{H}^+] = \sqrt{K_1 K_2}. \quad (47)$$

This expression always permits an approximate calculation of the hydrogen ion concentration in a solution of an acid salt. It yields correct values as long as c is more than 100 times greater than K_1 . Only in special cases is it necessary to employ equation (46).

ILLUSTRATIONS. *Sodium bicarbonate:*

$$K_1 = 3 \times 10^{-7}, \quad K_2 = 6 \times 10^{-11}.$$

If $c = 0.1$ molar, $[\text{H}^+] = \sqrt{K_1 K_2} = 4.25 \times 10^{-9}$, pH = 8.37. The same value is found for a 0.001 molar solution.

Sodium bitartrate:

$$K_1 = 1 \times 10^{-3}, \quad K_2 = 9 \times 10^{-6}.$$

In 0.1 molar solutions, $[\text{H}^+] = \sqrt{K_1 K_2} = 3 \times 10^{-4}$, pH = 3.52;

but if $c = 0.001$ molar, $[\text{H}^+] = \sqrt{\frac{K_1 K_2 c}{K_1 + c}} = 2.12 \times 10^{-4} = 3.68$.

In this example the concentration has an appreciable influence on the hydrogen ion concentration in solution.

6. Hydrolysis at higher temperatures.

The equations describing hydrolysis equilibria apply as well at higher temperatures. It has been shown that the degree of hydrolysis and pH are determined by K_w and by K_{HA} or K_{BOH} . The effect of heat on the dissociation constants of many acids and bases is slight. NOYES¹ has determined the variation in the dissociation constants of acetic acid and ammonium hydroxide with temperature.

t	0°	18°	25°	50°	100°
Acetic acid K_{HA}	—	18.2×10^{-6}	—	—	11.1×10^{-6}
Ammonium hydroxide K_{BOH}	13.9×10^{-6}	17.2×10^{-6}	18.0×10^{-6}	18.1×10^{-6}	13.5×10^{-6}

¹ A. A. Noyes: J. Am. Chem. Soc., 50, 349 (1909).

If the effect of increasing temperature on the dissociation constants of acids and bases may be disregarded, then the degree of hydrolysis will change only because the *ion product* of water, K_w , increases with increasing temperature. Thus the ion product of water at 100° is about one hundred times its value at room temperature.

It has been shown that the pH of a solution of a salt of the strong acid-weak base type may be calculated in the following manner:

$$\text{pH} = \frac{1}{2}\text{p}K_w - \frac{1}{2}\text{pBOH} - \frac{1}{2}\log c. \quad (35)$$

At ordinary temperatures $\frac{1}{2}\text{p}K_w$ equals 7, whereas at 100° it is equal to 6. Evidently the pH at 100° is smaller by one unit, and the reaction of the solution at this temperature is correspondingly more acid.

Conversely, in a solution of a salt of a strong base and weak acid, the hydroxyl ion exponent at 100° is likewise lowered to the same extent.

In solutions of salts of the weak acid-weak base type, both pH and pOH diminish equally with increasing temperature.

7. The reaction in a mixture of a weak acid and its salt, or a weak base and its salt. Buffer mixtures or regulators.

A weak acid is split only partially into ions. In the presence of one of its salts, the dissociation of the acid is repressed still further by the common ion. Since the degree of ionization of the salt is very large, we may assume without appreciable error that, in a mixture of a weak acid and its salt, practically all of the acid HA is in the undissociated form, and that the salt is completely ionized. According to equation (11):

$$\frac{[\text{H}^+] \times [\text{A}^-]}{[\text{HA}]} = K_{\text{HA}}. \quad (11)$$

It follows from this that

$$[\text{H}^+] = \frac{[\text{HA}]}{[\text{A}^-]} K_{\text{HA}}. \quad (48)$$

If the mixture contains equivalent amounts of acid and salt, $[\text{HA}] = [\text{A}^-]$ and the hydrogen ion concentration equals the

dissociation constant of the acid. More generally, however, (48) shows that

$$\text{pH} = \log C_{\text{salt}} - \log C_{\text{acid}} + \text{pHA}, \quad (49)$$

where C_{salt} and C_{acid} are the concentrations of salt and acid respectively, and pHA is again the negative logarithm of the dissociation constant.

Similar calculations can be performed to find the pOH, and therefore pH, for mixtures of a base and one of its salts.

If we wish to prepare a strongly acid solution, we have but to dilute a more concentrated solution of the acid. Solutions with a pH of 2 (0.01 N) may be prepared from hydrochloric acid. On the other hand, when it is a matter of preparing solutions in which the pH varies between 3 and 7, this simple dilution method is no longer sufficiently accurate. When we prepare, for example, a hydrochloric acid solution of pH = 6, we subject a normal solution to a millionfold dilution. Naturally such a solution can not be used with confidence. Even a trace of alkali, such as may easily come from glass containers, is sufficient to change the pH from 6 to 8. On the other hand, the small quantity of atmospheric carbon dioxide dissolved in distilled water produces a greater acidity than corresponds to a pH of 6.

The same applies to bases. Only strongly alkaline solutions may be made by diluting concentrated solutions of strong bases. Other procedures must be adopted in order to obtain weakly alkaline solutions in which the pH lies between 11 and 7.

Solutions of any desired pH may be obtained simply by mixing a weak acid or base with one of its salts in various proportions. It is evident from equation (48) that even small amounts of strong acids and bases have only a slight effect on the pH of such mixtures. Certainly the small quantities of alkali from glass and carbon dioxide from the atmosphere can exert no perceptible influence. Such mixtures which are resistant to a change in reaction were called *Buffer Mixtures* by S. P. L. SÖRENSEN.¹ L. MICHAELIS² coined the term *Regulators*. They may also be referred to as *Ampholytes* because of the amphoteric character of such mixtures. *All mixtures of weak acids and their salts,*

¹ S. P. L. Sørensen: *Compt. rend. trav. lab. Carlsberg*, 8, 1 (1909).

² L. Michaelis: *Die Wasserstoffionenkonzentration*, Berlin, Julius Springer (1914).

or of weak bases with their salts, are therefore buffer mixtures (or regulators, or ampholytes).

FELS¹ was the first to take advantage of such buffer mixtures. They were frequently employed by SÖRENSEN. In the colorimetric determination of hydrogen ion concentration they are almost indispensable. We see that the hydrogen or hydroxyl ion concentration always lies in the neighborhood of the dissociation constant of the acid or base used. When the acid and salt concentrations are equal,

$$\text{pH} = \text{pHA}.$$

If the ratio of acid to salt is 100,

$$\text{pH} = \text{pHA} - 2.$$

However, when the ratio is 1/100,

$$\text{pH} = \text{pHA} + 2.$$

The ratio of acid to salt should never exceed 100 or fall below 1/100, for then the buffer action of these mixtures is lost. We may say quite generally that buffer mixtures, in which the pH lies between $\text{pHA} - 1.7$ and $\text{pHA} + 1.7$, can be prepared from a salt and its acid.

The best buffer mixtures are obtained by mixing equivalent amounts of acid and salt. The application of buffer mixtures will be taken up later under the discussion of the colorimetric determination of hydrogen ion concentration.

8. Buffer capacity and buffer index.

It is important for different purposes to be able to express quantitatively the buffer capacity of a liquid. In this connection, a paper by DONALD D. VAN SLYKE² "On the Measurements of Buffer-values and on the Relationship of Buffer-value to the Dissociation Constant of the Buffer and the Concentration and Reaction of the Buffer Solution" will be summarized briefly in the following paragraphs.

Not all mixtures of a weak acid with its salt have the same buffer capacity or intensity. The best buffer action is displayed at the hydrogen ion concentration of the half-neutralized acid.

¹ Fels: Z. Elektrochem., 10, 208 (1904).

² D. D. van Slyke: J. Biol. Chem., 52, 525 (1922).

We can measure buffer action in terms of a definite unit called *buffer capacity* or *buffer index* π , where

$$\pi = \frac{dB}{dpH}, \quad (50)$$

i.e. π is the differential quotient of the increase in amount of added base B (expressed in equivalents per liter) with respect to the corresponding change in pH . A solution has a buffer capacity of 1 if its pH changes by 1 upon addition of one equivalent of acid or base per liter of liquid.

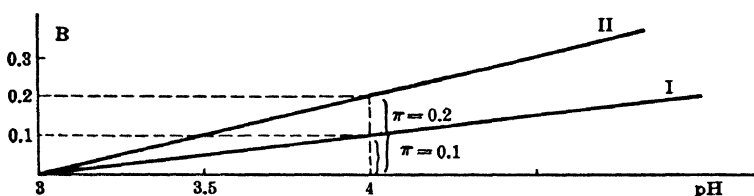

FIG. 2

In Fig. 2, the quantity B is plotted on the ordinate axis while the abscissa represents pH values. It is evident from this figure that at a $pH = 4$, the buffer capacities of curves I and II are 0.1 and 0.2 respectively.

If the B versus pH line is curved, we determine the buffer index at a given point by drawing a line tangent to the curve at this point and determining the slope of this straight line.

It is important to know how the buffer capacity varies for solutions of the different types of salts.

(a) *Buffer capacity of water, strong acids, and strong bases.* If we add a solution of a completely ionized base to water, then dB equals $d[OH^-]$. We may write, therefore,

$$\pi = \frac{dB}{dpH} = \frac{d[OH^-]}{dpH}.$$

Since

$$pH = pK_w - pOH, \quad (8)$$

and

$$dpH = d \log [OH^-],$$

then

$$\pi = \frac{dB}{dpH} = \frac{d[OH^-]}{d \log [OH^-]} = \frac{[OH^-]}{0.4343} = 2.3[OH^-]. \quad (51)$$

Conversely, upon addition of a very strong acid, the buffer capacity of water is:

$$\pi = \frac{dB}{dpH} = 2.3[H^+]. \quad (52)$$

The total buffer capacity of water containing a strong acid or strong base is therefore:

$$\pi = 2.3([H^+] + [OH^-]). \quad (53)$$

If we wish to take into account in this calculation the ion activities of the strong acid or base, then:

$$\pi = 2.3 \left(\frac{[H^+]}{f_{HA}} + \frac{[OH^-]}{f_{BOH}} \right), \quad (53a)$$

where f is the activity coefficient.

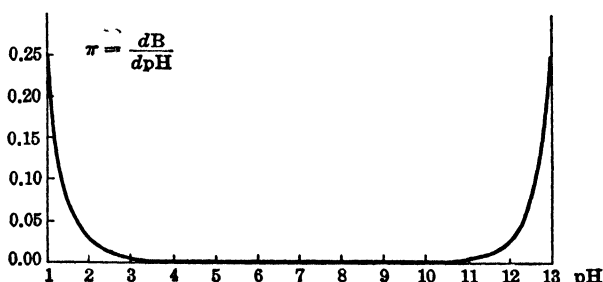

FIG. 3

Equation (53) permits us calculate in simple fashion the buffer capacity of solutions of strong acids and bases at different pH values. Between $pH = 2.4$ and $pOH = 2.4$, π is less than 0.01 and may be neglected. Figure 3 is a graphical representation of the buffer capacity of water plus strong acids and bases. Along the abscissa is plotted pH while π -values constitute the ordinate axis.

(b) *Buffer capacity of a solution of a weak acid and its salt.* Equation (48) tells us that in a mixture of a weak acid with one of its salts

$$pH = pHA + \log \frac{[A^-]}{[HA]}. \quad (54)$$

We may set $[A^-]$ equal to the total salt concentration¹ C_s , so that

$$\text{pH} = \text{pHA} + \log \frac{C_s}{C_{\text{HA}}} \quad (55)$$

where C_{HA} is the concentration of acid. Since the quantity of base B added to neutralize the acid forms salt, then $[A^-] = C_s = [B]$.

If the initial acid concentration were c , then, after addition of the quantity $[B]$ of base, its concentration would become $c - [B]$. Hence from equation (48) we derive:

$$[B] = \frac{K_{\text{HA}} \times c}{K_{\text{HA}} + [H^+]}$$

Therefore

$$\begin{aligned} \pi = \frac{dB}{d\text{pH}} &= - \frac{dB}{d \log [H^+]} = - \frac{[H^+]}{0.4343} \times \frac{dB}{d[H^+]} \\ &= - 2.3[H^+] \frac{dB}{d[H^+]} \end{aligned} \quad (56)$$

Differentiating $[B]$ with respect to $[H^+]$, and substituting in (56), we arrive at

$$\pi = \frac{dB}{d\text{pH}} = \frac{2.3[B]\{c - [B]\}}{c} \quad (57)$$

A simplified expression for π in terms of concentration is:

$$\pi = \frac{2.3K_{\text{HA}}[H^+]c}{\{K_{\text{HA}} + [H^+]\}^2} \quad (58)$$

It follows that the buffer capacity increases with increasing acid concentration. Thus a 0.1 molar acetate mixture has a buffer capacity which is ten times greater than the capacity of a 0.01 molar solution of the same components.

Combining (58) and (53), we find that the total buffer capacity of a weak acid mixed with any desired quantities of strong acid or base is given by:

$$\pi = 2.3 \left\{ \frac{K_{\text{HA}}[H^+]c}{(K_{\text{HA}} + [H^+])^2} + [H^+] + [OH^-] \right\} \quad (59)$$

¹ According to modern concepts,

$$\text{pH} = \text{p}'\text{HA} + \log \frac{C_s}{C_{\text{HA}}}, \quad (55a)$$

in which

$$\text{p}'\text{HA} = \text{pHA} - \log f_a, \quad (55b)$$

where f_a is the activity coefficient of the anion.

In Fig. 4 is shown the buffer capacity of mixtures of 0.1 N and 0.2 N acetic acid solutions with a strong acid or with alkali. We see that between pH's of 2 and 3.5 the total buffer capacity is obtained by adding the ordinates of the two dotted lines which represent the buffer capacities of the strong and weak acid. Outside this pH-region, we have to deal only with the buffer index of the individual weak acid, strong acid, or base, without having to consider their mutual buffering action.

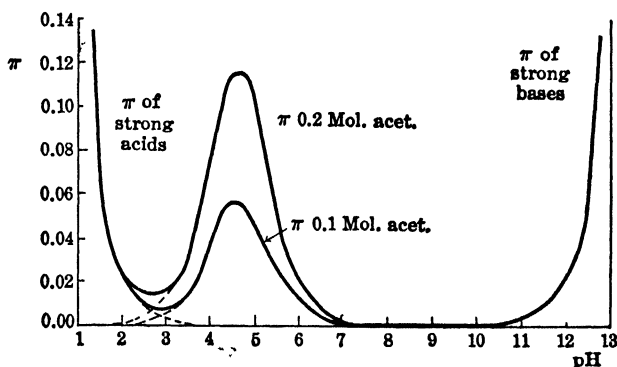

FIG. 4

In a number of cases it is of advantage to express buffer intensity as molar buffer capacity π_m , which may be defined as

$$\pi_m = \frac{\pi}{c} \quad (60)$$

Figure 4 shows that both the 0.1 N and 0.2 N acetate-acetic acid mixtures have their maximum buffer capacity at the same pH, namely, where $\text{pH} = \text{pH}_A$. This result is predicted by equation (58). If $[\text{H}^+] = K_{\text{HA}}$, we find

$$\pi = \frac{2.3}{4} c = 0.575 \times c$$

and

$$\pi_m = 0.575.$$

The buffer action of mixtures of acids or of polybasic acids is given by the expression:

$$\sum \pi = 2.3[\text{H}^+] \left\{ \frac{K_{\text{H}_1\text{A}_1} c_1}{(K_{\text{H}_1\text{A}_1} + [\text{H}^+])^2} + \frac{K_{\text{H}_2\text{A}_2} c_2}{(K_{\text{H}_2\text{A}_2} + [\text{H}^+])^2} + \dots \right\} + 2.3\{[\text{H}^+] + [\text{OH}^-]\}. \quad (61)$$

If we assume that the concentrations of the different acids are equal, and when the dissociation constants differ greatly, it follows that the components have but little reciprocal influence on

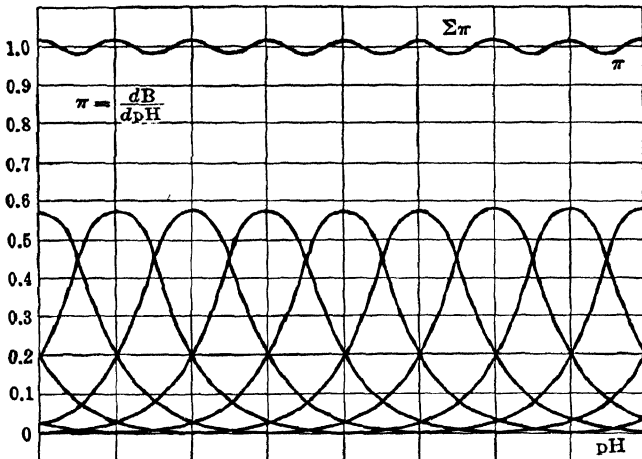

FIG. 5

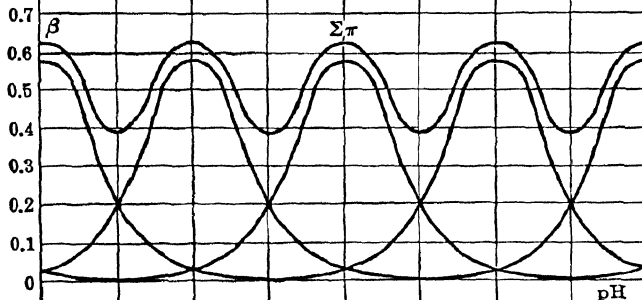

FIG. 6

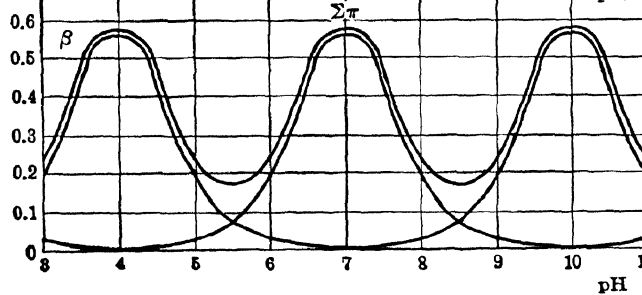

FIG. 7

their buffer capacities. This mutual influence grows as the difference between dissociation constants becomes smaller. Figures 5, 6 and 7, as well as the following table, illustrate this point.

Instead of (61) it is more convenient to write

$$\sum \pi = \pi_1 + \pi_2 + \pi_3 \dots$$

$pH_2A_2 - pH_1A_1$	$\sum \pi_m$ AT $pH = pH_1A_1$	$\sum \pi_m$ AT $pH = \frac{pH_1A_1 + pH_2A_2}{2}$
3.0	0.577	0.138
2.0	0.598	0.384
1.6	0.684	0.552
1.4	0.749	0.673
1.3	0.784	0.738
1.2	0.848	0.813
1.1	0.919	0.899
1.0	1.003	0.998

These ideas of VAN SLYKE have a number of important applications. In the first place, they tell us how to prepare buffer solutions (see Chapter Eight) with a high buffer capacity. Thus the best buffers are obtained by taking a series of acids whose dissociation constants differ little from one another, so that addition of alkali produces a solution whose buffer capacity is practically independent of the quantity of base added (cf. Fig. 5).

Furthermore, the author believes that buffer capacity curves, which may be established from neutralization curves, are of value in estimating the composition of liquids containing a mixture of various acids and bases. Examples of such liquids are soil infusions, beer, milk, fruit juices, foodstuffs, etc. A detailed discussion of the subject is beyond the scope of this monograph.¹

GÜNTHER LEHMANN² expresses the buffer capacity p_g by the equation:

$$p_g = \frac{b}{pH_1 - pH_2} \quad \text{or} \quad \frac{c}{pH_1 - pH_2},$$

in which b (and c) denotes the amount of added acid (or alkali) which is required to change the pH of a solution from pH_1 to pH_2 .

This method of evaluating buffer capacity is only approximate, and is less exact than the equations of VAN SLYKE and his collaborators.

¹ Consult K. Täufel and C. Wagner: *Kolloid-Z.*, 40, 174 (1926); *Biochem. Z.*, 177, 389 (1926). Koppel and Spiro: *Biochem. Z.*, 65, 409 (1914). F. Leuthardt: *Kolloidchem. Beihefte*, 25, 1 (1927). H. Moser: *Kolloidchem. Beihefte*, 25, 69 (1927). K. Maiwald: *Kolloidchem. Beihefte*, 37, 251 (1928).

² G. Lehmann: *Biochem. Z.*, 133, 30 (1922).

The molar buffer capacity as defined by VAN SLYKE is determined only by the ratio acid/salt, and is independent of the total concentration of either component. C. MORTON¹ has proposed a measure of buffer capacity in terms of the dilution effect. He defined capacity β as

$$\beta = \frac{d\text{pH}}{d\sqrt{\mu}}.$$

In this equation μ is a measure of the total electrolyte concentration expressed as "total ionic strength" (cf. p. 56). In very dilute solutions we find that

$$\beta = 0.5 - z$$

where z is the valence of the anion (z is 1 in acetate mixtures, 2 in mono-diphthalate mixtures, and 3 in solutions containing di- and tricitrate). If μ exceeds 0.01, the equation becomes more involved, and we find

$$\beta = 2B\sqrt{\mu} + (0.5 - z).$$

B is a constant determined by the nature of the particular mixture employed.

In Chapter Eight, the effect of dilution on the pH of buffer mixtures will be considered in detail.

¹ C. Morton: J. Chem. Soc., 1928, 1401.

CHAPTER TWO

AMPHOTERIC SUBSTANCES

1. Characteristics of amphoteric substances.

When an acid is dissolved in water, it splits off hydrogen ions. This change may be attributed to the ability of acids to bind hydroxyl ions. Conversely we may say that bases liberate hydroxyl ions or bind hydrogen ions.

Many compounds possess both acidic and basic properties, although sometimes one or the other property predominates. Such substances which behave both as acids and bases by combining with hydroxyl ions as well as hydrogen ions are called *amphoteric* substances or *ampholytes*. The reaction of a solution of an ampholyte is neither strongly acid nor strongly basic as a rule, because of the dual nature of these compounds. Typical inorganic ampholytes are arsenic trioxide, and the hydroxides of tin, aluminum, and zinc. Organic ampholytes such as amino acids, proteins, and peptides are of much greater biological importance.

The general formula of an amphoteric compound may be written HXOH .¹ Its amphoteric properties may be described by the equations:

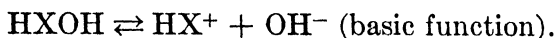

Applying the mass action law to these reactions, we find:

$$\frac{[\text{H}^+][\text{XOH}^-]}{[\text{HXOH}]} = K_a,$$

$$\frac{[\text{HX}^+][\text{OH}^-]}{[\text{HXOH}]} = K_b.$$

¹ In Chapter Four we shall see that it is more in accord with modern concepts to write this formula HX , and to describe the behavior of ampholytes by

and $\text{HX} \rightleftharpoons \text{H}^+ + \text{X}^-$ (acid function),

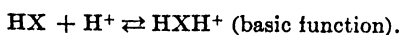

Aside from the undissociated portion HXOH , a solution of an amphoteric compound contains hydrogen and hydroxyl ions, ampholyte anions XOH^- , and cations HX^+ .

2. Reaction of a solution of an ampholyte.

We have shown in the section on hydrolysis included in the first chapter that the reaction of salts derived from weak acids and weak bases is never strongly acidic or strongly alkaline, unless the difference between the acidic and basic dissociation constants is too large. The same explanation, applied to the acidic and basic functions of ampholytes, accounts for the fact that solutions of amphoteric compounds never react very strongly acid or alkaline.

We shall not consider the case of ampholytes which contain an excess of acid or basic groups, for such compounds behave simply as acids or bases and have been treated in the preceding chapter.

For the sake of simplicity we shall refer to the undissociated ampholyte as A , to the ampholyte cations as A^+ , and to the anions as A^- . We shall designate the dissociation constant of the acidic group by K_a , the basic dissociation constant by K_b , and the constant of water by K_w . The total ampholyte concentration will be taken as equal to c .

We obtain for an ampholyte solution:

$$\frac{[\text{H}^+][\text{A}^-]}{[\text{A}]} = K_a, \quad (1)$$

$$\frac{[\text{OH}^-][\text{A}^+]}{[\text{A}]} = K_b, \quad (2)$$

$$[\text{H}^+] \times [\text{OH}^-] = K_w, \quad (3)$$

$$[\text{A}^+] + [\text{H}^+] = [\text{A}^-] + [\text{OH}^-], \quad (4)$$

$$[\text{A}] + [\text{A}^+] + [\text{A}^-] = c. \quad (5)$$

From (1) and (2) we have:

$$[\text{A}^-] = K_a \frac{[\text{A}]}{[\text{H}^+]}, \quad (6)$$

$$[\text{A}^+] = K_b \frac{[\text{A}]}{[\text{OH}^-]} = \frac{K_b}{K_w} [\text{A}][\text{H}^+]. \quad (7)$$

Substituting these values in (4):

$$\frac{K_b}{K_w} [A][H^+] + [H^+] = K_a \frac{[A]}{[H^+]} + \frac{K_w}{[H^+]}$$

and

$$[H^+] = \sqrt{\frac{K_a[A] + K_w}{\frac{K_b}{K_w}[A] + 1}}. \quad (8)$$

J. WALKER¹ derived this equation in a similar manner. There are two unknowns, $[H^+]$ and $[A]$, in equation (8); and a direct solution is not possible.

S. P. L. SÖRENSEN² has eliminated the unknown $[A]$ and obtained the expression:

$$[H^+]^4 + [H^+]^3 \left(\frac{K_w}{K_b} + c \right) + [H^+]^2 \frac{K_w}{K_b} (K_a - K_b) - [H^+] \frac{K_w}{K_b} (K_a c - K_w) - \frac{K_w}{K_b} K_a K_w = 0. \quad (9)$$

This equation is too inconvenient for practical use. Its general solution can not be given.

The author, therefore, suggests that equation (8) be used in calculations, assuming as a first approximation that the concentration of undissociated ampholyte, $[A]$, is equal to the total concentration c . We thus neglect the dissociation of the amphoteric compound into cations and anions. This procedure permits us to approximate a value of $[H^+]$ which, when substituted in (6) and (7), yields corresponding values of $[A^+]$ and $[A^-]$. We are now able to make the following correction:

$$[A] = c - [A^+] - [A^-].$$

The same calculation may be repeated with the new $[A]$ value. Usually the first approximation is sufficient to yield the correct $[H^+]$, although the calculation may be made any required number of times.

From equation (8) we see that:

(a) The error in the approximate calculation becomes smaller as the concentration c increases.

(b) The error becomes smaller, the smaller K_b and K_a are (cf. the example of phenylalanine).

¹ J. Walker and Aston: *J. Chem. Soc.*, 67, 576 (1895).

² S. P. L. Sørensen and Coworkers: *Compt. rend. trav. lab. Carlsberg*, 12 (1917)

(c) If c is very small and K_a is more than 10^5 times greater than K_b , so that $K_b[A] \ll K_w \ll K_a[A]$, the ampholyte behaves practically as a monobasic acid. Conversely, the ampholyte may be regarded as a monoacid base when K_b exceeds K_a to the same extent.

ILLUSTRATIONS. *Phenylalanine*:

$$K_a = 2.5 \times 10^{-9}, \quad K_b = 1.3 \times 10^{-12}, \quad K_w = 10^{-14}, \quad c = 10^{-2}.$$

According to equation (8),

$$[H^+] = 3.3 \times 10^{-6},$$

if $[A]$ is taken as c . The corresponding values of

$$\begin{aligned} [A^+] &= 4 \times 10^{-6}, \\ [A^-] &= 7.3 \times 10^{-6}. \end{aligned}$$

Therefore the correct value of $[A]$ is $10^{-2} - 7.3 \times 10^{-6} - 4 \times 10^{-6}$, which is practically identical with $c = 10^{-2}$.

Similar calculations made for $c = 10^{-4}$ yield:

$$\begin{aligned} [H^+] &= 5.1 \times 10^{-7}, \\ [A^+] &= 0.1 \times 10^{-7}, \\ [A^-] &= 5 \times 10^{-7}. \end{aligned}$$

Here too $[A]$ is practically the same as c .

m-Aminobenzoic acid:

$$K_a = 1.6 \times 10^{-5}, \quad K_b = 1.2 \times 10^{-12}, \quad K_w = 10^{-14}, \quad c = 10^{-2}.$$

Equation (8) gives as a first approximation:

$$\begin{aligned} [H^+] &= 2.7 \times 10^{-4}, \\ [A^+] &= 3.3 \times 10^{-4}, \\ [A^-] &= 6 \times 10^{-4}, \\ [A^+] + [A^-] &= 9.3 \times 10^{-4}. \end{aligned}$$

In this instance it is evident that the sum $[A^+] + [A^-]$ may not be neglected in comparison with $c = 10^{-2}$.

When the proper correction is made, recalculation results in the following figures:

$$\begin{aligned} [H^+] &= 2.5 \times 10^{-4}, \\ [A^+] &= 2.8 \times 10^{-4}, \\ [A^-] &= 5.3 \times 10^{-4}. \end{aligned}$$

When $c = 10^{-4}$, the first approximation gives:

$$\begin{aligned} [\text{H}^+] &= 4 \times 10^{-5}, \\ [\text{A}^-] &= 4 \times 10^{-5}, \\ [\text{A}^+] &\text{ is negligibly small.} \end{aligned}$$

Using the corrected $[\text{A}]$ and recalculating, we find the correct values

$$\begin{aligned} [\text{H}^+] &= 3.2 \times 10^{-5}, \\ [\text{A}^-] &= 3.2 \times 10^{-5}. \end{aligned}$$

Since K_b is so much smaller than K_a , the ampholyte may be considered as a monobasic acid at this dilution. Thus the same $[\text{H}^+]$ is obtained if the simple equation for a monobasic acid is used.

The hydrogen ion exponents of a number of aspartic acid solutions are given in the following table. The $[\text{H}^+]$ values were calculated in three ways: by the simple equation (8), by the second approximation method, and by the complicated equation (9) of SÖRENSEN.

Aspartic acid: $K_a = 1.5 \times 10^{-4}$, $K_b = 1.2 \times 10^{-12}$, $K_w = 10^{-14}$.

CONCENTRATION	PH ACCORDING TO EQUATION (8)	PH CORRECTED	PH ACCORDING TO SÖRENSEN
~	2.952	2.952	2.952
1	2.953	2.953	2.954
10^{-1}	2.969	2.973	2.973
10^{-2}	3.083	3.110	3.110
10^{-3}	3.437	3.521	3.521
10^{-4}	3.914	4.165	4.166

It is evident that the application of the simple equation (8), followed by correcting the value of $[\text{A}]$, always yields correct results.

3. The isoelectric point of an ampholyte.

From the foregoing discussion we see that every ampholyte solution contains definite concentrations of $[\text{A}]$, $[\text{A}^-]$, and $[\text{A}^+]$. In strong acid solutions, $[\text{A}^-]$ is negligible beside $[\text{A}^+]$, whereas in strongly alkaline solution, $[\text{A}^+]$ is much smaller than $[\text{A}^-]$.

In a pure aqueous solution of an ampholyte, the concentration of A exceeds by far the $[\text{A}^+]$ and $[\text{A}^-]$. Thus there must exist

a certain hydrogen ion concentration at which the concentration of the undissociated portion A is at a maximum, and at which the sum of $[A^+] + [A^-]$ is minimal. This point is called the *isoelectric point* because at this hydrogen ion concentration, an electric current will cause as many ampholyte cations to move towards a cathode as there are ampholyte anions migrating towards an anode.

From (5), (6), and (7), it follows that:

$$\frac{c}{[A]} = 1 + \frac{K_a}{[H^+]} + \frac{K_b}{K_w} [H^+]. \quad (10)$$

According to L. MICHAELIS,¹ we then have:

$$\frac{d \frac{c}{[A]}}{d[H^+]} = -\frac{K_a}{[H^+]^2} + \frac{K_b}{K_w}.$$

$[A]$ is at a maximum when:

$$-\frac{K_a}{[H^+]^2} + \frac{K_b}{K_w} = 0,$$

or

$$[H^+]_{I.P.} = \sqrt{\frac{K_a}{K_b} K_w}. \quad (11)$$

$[H^+]_{I.P.}$ stands for the hydrogen ion concentration at the isoelectric point. In equation (11) is given a simple relationship between $[H^+]_{I.P.}$ and the various constants involved. (Cf. also H. ECKWEILLER, H. M. NOYES, and K. G. FALK;² P. A. LEVENE and H. S. SIMMS;³ for methods of determining the isoelectric point, see L. MICHAELIS,¹ S. P. L. SÖRENSEN (l.c.), and W. R. ATKIN.⁴)

If the substance contains m acid groups and n basic groups, then according to Levene and Simms:³

$$[H^+]_{I.P.} = \sqrt{\frac{K_{a_1} + K_{a_2} \cdots + K_{a_m}}{K_{b_1} + K_{b_2} \cdots + K_{b_n}} K_w}.$$

¹ L. Michaelis: Die Wasserstoffionenkonzentration. 2 ed. Julius Springer, Berlin, 1922.

² H. Eckweiller, H. M. Noyes, and K. G. Falk: J. Gen. Physiol., 3, 291 (1921).

³ P. A. Levene and H. S. Simms: J. Biol. Chem., 55, 801 (1923).

⁴ W. R. Atkin: Proc. Leeds Phil. Lit. Soc., 1, 165 (1927); Chemical Abstracts, 21, 2210 (1927).

VALUES OF K_a AND K_b FOR A NUMBER OF AMPHOLYTES

AMPHOLYTE	K_a	TEMP.	INVESTIGATOR ^a	K_b	TEMP.	INVESTIGATOR ^a
Alanine	1.9×10^{-10}	25°	Winkelblech	5.1×10^{-12}	25°	Winkelblech
Alanylglycine	1.8×10^{-10}	—	L. J. Harris	2.5×10^{-12}	—	L. J. Harris
Alanylalanine	1.8×10^{-8}	25°	H. von Euler	2.0×10^{-11}	25°	H. von Euler
Arginine, 2nd step	0.66×10^{-8}	—	L. J. Harris	1.3×10^{-11}	—	L. J. Harris
1st step	0.66×10^{-8}	—	L. J. Harris	1.0×10^{-11}	—	L. J. Harris
Arginine, 2nd step	$< 1.1 \times 10^{-14}$	25°	Kanitz	2.2×10^{-13}	25°	L. J. Harris
1st step	4×10^{-13}	25°	Hunter and Borsook	1.0×10^{-7}	25°	Kanitz
1st step	8.8×10^{-10}	18°	Lunden	1.3×10^{-12}	25°	Lunden
Asparagine	1.35×10^{-9}	25°	Lunden	8.8×10^{-13}	18°	Lunden
	3.2×10^{-9}	40°	Lunden	1.5×10^{-13}	25°	Lunden
Aspartic acid, 1st step	1.5×10^{-4}	25°	Winkelblech	1.9×10^{-11}	60°	Walker and Aston
1st step	2.35×10^{-4}	30°	Levene and Simms	1.2×10^{-12}	25°	Winkelblech
2nd step	4×10^{-10}	30°	Levene and Simms	1.5×10^{-12}	30°	Levene and Simms
Betaine	3.4×10^{-10}	25°	Winkelblech	7.6×10^{-13}	25°	Winkelblech
Glycine	1.2×10^{-10}	17.5°	Michaelis and Rona	2.7×10^{-12}	25°	Winkelblech
	1.05×10^{-10}	18°	Derby	1.93×10^{-12}	17.5°	Michaelis and Rona
	1.8×10^{-10}	25°	Harris	1.7×10^{-12}	18°	Derby
	1.8×10^{-10}	18°	Tague	2.6×10^{-12}	25°	Harris
	1.8×10^{-8}	25°	Euler	2.8×10^{-11}	25°	Walker and Aston
	3.3×10^{-9}	18°	Derby	2×10^{-11}	25°	Euler
	5.3×10^{-9}	25°	Harris	0.95×10^{-11}	18°	Derby
	1.6×10^{-10}	25°	Harris	1.4×10^{-11}	25°	Harris
	6.3×10^{-5}	25°	Harris			
	6×10^{-5}	18°	Holmberg Tague			
Glycylglycine						
Glutamic acid, 2nd step						
1st step						

^a See page 40 for References.

VALUES OF K_a AND K_b FOR A NUMBER OF AMPHOLYTES—Continued

AMPHOLYTE	K_a	TEMP.	INVESTIGATOR	K_b	TEMP.	INVESTIGATOR
Histidine, 2nd step						
1st step	2.2×10^{-9}	25°	Kanitz	5.0×10^{-13}	25°	Kanitz
Leucine	1.8×10^{-10}	25°	Winkelblech	5.7×10^{-9}	25°	Kanitz
	2.5×10^{-10}	25°	Harris	2.3×10^{-12}	25°	Winkelblech
	1.5×10^{-8}	25°	Euler	2.3×10^{-12}	25°	Harris
Leucylglycine						
Lysine, 1st step						
2nd step	1.2×10^{-11}	25°	Kanitz	3.0×10^{-11}	25°	Euler
1st step	2×10^{-11}	25°	Harris	1.1×10^{-12}	25°	Kanitz
2nd step				$> 1.1 \times 10^{-7}$	25°	Kanitz
Phenylalanine						
	2.5×10^{-9}	25°	Kanitz	3.2×10^{-5}	25°	Harris
	7.5×10^{-10}	25°	Harris	1.0×10^{-12}	25°	Harris
	7.5×10^{-10}	25°	Tague	1.3×10^{-12}	25°	Kanitz
	4.0×10^{-9}	25°	Kanitz			
	4.0×10^{-11}	25°	Harris			
	4.0×10^{-10}	25°	Harris			
	7.0×10^{-10}	18°	Tague			
Tyrosine						
2nd step				2.6×10^{-12}	25°	Kanitz
1st step						
Valine						
Arsenious acid	6×10^{-10}	25°	Wood	2.0×10^{-12}	25°	Harris
Caffeine	$< 1 \times 10^{-14}$	25°	Wood	1×10^{-14}	25°	Wood
Cacodylic acid	6.4×10^{-7}	25°	Johnston	4.0×10^{-14}	25°	Wood
	7.5×10^{-7}		Holmberg	3×10^{-13}		Zawidski
Theobromine						
	1.3×10^{-8}	18°	Paul	3.6×10^{-13}	25°	Holmberg
	1.1×10^{-10}	25°	Wood	1.3×10^{-14}	18°	Paul
Theophylline	1.7×10^{-9}	25°	Wood	4.8×10^{-14}	40°	Wood
<i>m</i> -aminobenzoic acid	1.6×10^{-5}	25°	Michaelis and Davidsohn	1.9×10^{-14}	20°	Wood
	1.6×10^{-5}	18°	Winkelblech	1.2×10^{-11}	25°	Michaelis and Davidsohn
	1.06×10^{-5}	18°	Lunden	1.2×10^{-11}	25°	Winkelblech
<i>o</i> -aminobenzoic acid						
	1.35×10^{-5}	40°	Lunden	1.37×10^{-12}	18°	Lunden
	1.2×10^{-5}	25°	Winkelblech	3.15×10^{-12}	40°	Lunden
	1.2×10^{-5}	25°	Michaelis and Davidsohn	2.3×10^{-12}	25°	Winkelblech
<i>p</i> -aminobenzoic acid						
	1.2×10^{-5}	25°	Michaelis and Davidsohn	2.3×10^{-12}	20°	Michaelis and Davidsohn

LITERATURE REFERENCES FOR TABLE

- Winkelblech: *Z. physik. Chem.*, *36*, 546 (1901).
 L. J. Harris: *Proc. Roy. Soc. (London)*, *95*, 440 (1923).
 H. v. Euler: *Z. physiol. Chem.*, *51*, 213 (1907).
 A. Hunter and A. Borsook: *Biochem. J.*, *18*, 883 (1924).
 H. Lunden: *Z. physik. Chem.*, *54*, 532 (1906); *J. chim. phys.*, *5*, 145 (1907).
 Cf. also Affinitätsmessungen an schwachen Säuren und Basen, Sammlung chem.-tech. Vorträge, Vol. 14 (1908), Enke, Stuttgart.
 Walker and Aston: *J. Chem. Soc.*, *67*, 576 (1895).
 P. A. Levene and H. Simms: *J. Gen. Physiol.*, *4*, 801 (1923).
 L. Michaelis and P. Rona: *Biochem. Z.*, *49*, 248 (1913).
 Dernby: *Compt. rend. trav. lab. Carlsberg*, *11*, 265 (1916).
 Tague: *J. Am. Chem. Soc.*, *42*, 173 (1920). Calculated by author.
 Holmberg: *Z. physik. Chem.*, *70*, 157 (1910).
 Wood: *J. Chem. Soc.*, *93*, 411 (1908).
 Johnston: *Ber.*, *36*, 1625 (1903).
 Zawidski: *Ber.*, *36*, 3325 (1903); *37*, 153, 2289 (1904).
 Th. Paul: *Arch. Pharm.*, *239*, 48 (1901).
 Michaelis and Davidsohn: *Biochem. Z.*, *47*, 250 (1912).
 A. Bork: *Z. physik. Chem.*, *129*, 58 (1927).
 S. Andrews and C. L. A. Schmidt: *J. Biol. Chem.*, *73*, 651 (1927).
 For more recent literature, cf. Landolt-Börnstein-Roth, *Physikalisch-Chemische Tabellen*, Vol. 2 (1931).

If we make use of the simple equation (8) to calculate the $[H^+]$ in a solution of pure ampholyte, in which the $[A]$ is extremely large, and if K_a and K_b are at least 10,000 times as great as K_w , then we find:

$$[H^+] = \sqrt{\frac{K_a[A] + K_w}{\frac{K_b}{K_w}[A] + 1}} = \sqrt{\frac{K_a}{K_b} K_w}. \quad (12)$$

This simplification thus leads to the same expression which Michaelis derived for $[H^+]$ at the isoelectric point.

At the isoelectric point therefore:

(a) $[A]$ is at a maximum, and the sum of $[A^+]$ and $[A^-]$ is minimal.

(b) $[A^+]$ is equal to $[A^-]$. (Shown by substituting equation (11) in (6) and (7).) It is for this reason that the ampholyte is considered from an electrochemical standpoint to be isoelectric. If K_a and K_b are known, the $[H^+]_{I.P.}$ may be easily calculated with the aid of Michaelis' equation.

In the preceding table is compiled a number of K_a and K_b values found in the literature.

4. Neutralization curves of ampholytes.

When a strong acid is added to a solution of an ampholyte, the concentration of A^+ ions increases while the $[A^-]$ diminishes.

If a large enough excess of acid is present, the $[A^-]$ becomes so small as to be insignificant compared with the ampholyte cation concentration. In such a case, we may regard the ampholyte merely as a weak base, and can calculate the remainder of the neutralization curve on this basis.

Similarly, when the excess of added alkali is sufficiently great to make the concentration of the cations $[A^+]$ very much less than $[A^-]$, then the basic properties of the ampholyte may be disregarded and it may be thought of simply as a weak acid.

In the neighborhood of the isoelectric point the calculation becomes much more complicated since both acidic and basic properties must be considered.

Let us first treat the usual case in which the K_a of the ampholyte is larger than its K_b . We shall designate the total ampholyte concentration by c , and the concentration of added hydrochloric acid by a . The salt formed will be considered to be completely ionized.

Since the sum of the cations equals that of the anions, we find:

$$[H^+] + [A^+] = [A^-] + [Cl^-] + [OH^-]$$

$$= [A^-] + [Cl^-] = [A^-] + a$$

or

$$[A^+] = [A^-] + a - [H^+]. \quad (13)$$

We know also that

$$[A^-] = \frac{[A]}{[H^+]} K_a \quad (6)$$

and

$$[A^+] = \frac{[A]}{[OH^-]} K_b = \frac{K_b}{K_w} [A][H^+]. \quad (7)$$

By combining these equations, we obtain:

$$\frac{K_b}{K_w} [A][H^+] = a - [H^+] + \frac{[A]}{[H^+]} K_a,$$

$$[H^+]^2 - [H^+] \frac{a}{\frac{K_b}{K_w} [A] + 1} - \frac{[A]K_a}{\frac{K_b}{K_w} [A] + 1} = 0,$$

$$[H^+] = \frac{a}{2 \frac{K_b}{K_w} [A] + 1} + \sqrt{\left\{ \frac{a}{2 \frac{K_b}{K_w} [A] + 1} \right\}^2 + \frac{[A]K_a}{\frac{K_b}{K_w} [A] + 1}}. \quad (14)$$

In order to solve this equation, it is necessary to assume as a first approximation that $[A]$ is equal to $c - a$, just as was done in calculating the $[H^+]$ of a pure ampholyte solution. Should the error introduced by this approximation prove to be too large, the calculation can be repeated using for $[A]$ the value $c - a - [A^-]$.

The form of the above equation is rather complicated. For many practical applications it can be reduced to a more convenient form. Unfortunately the limited confines of this book do not permit a more detailed discussion.

An equation corresponding to (14) likewise may be derived for the case in which a base is added to a solution of an ampholyte. The complicated expression (14) need be used only in the neighborhood of the isoelectric point. The simple equations for monovalent acids and bases (cf. Chapter One) may be employed at other hydrogen ion concentrations.

Equation (13) tells us the quantity of acid (or base) required to bring an ampholyte solution to the isoelectric point. *This quantity is equal to the difference between the hydrogen ion concentration at the isoelectric point and the $[H^+]$ of the solution.*¹

5. Hybrid ions (Zwitterionen). Theory of N. Bjerrum.

BREDIG² was the first to assume that an amphoteric compound really was an inner salt, and that its molecules therefore contained both a negative and a positive charge. A similar explanation was advanced to account for the behavior of methyl orange when F. W. KÜSTER³ suggested that the free indicator acid be regarded as a "Zwitterion" (cf. Chapter Five, section four).

It has usually been assumed in the literature that the formation of hybrid ions takes place only to a small degree. As regards the hybrid ions of the amino acids, MICHAELIS actually states, "Their concentrations are undoubtedly always vanishingly small." N. BJERRUM⁴ has advanced considerably our knowledge of the behavior of amino acids by assuming that these ampholytes are present in aqueous solutions for the most part

¹ A. E. Stearn: J. Gen. Physiol., 10, 313 (1926).

² Bredig: Z. physik. Chem., 13, 323 (1894); Z. Elektrochem., 6, 35 (1894).

³ F. W. Küster: Z. anorg. allgem. Chem., 13, 135 (1897).

⁴ N. Bjerrum: Z. physik. Chem., 104, 147 (1923); E. Q. Adams: J. Am. Chem. Soc., 33, 1503 (1916).

as hybrid ions. We shall see that this assumption has enabled us to explain a number of properties of the amino acids.

In order to illustrate the hybrid ion theory, we shall compare ammonium acetate with an amino acid of which the acid and basic dissociation constants are respectively the same as those of acetic acid and ammonium hydroxide. We know that in 0.1 molar solution, ammonium acetate is 0.5% hydrolyzed and the salt is 99.5% ionized. If we employ the same equation (40 in Chapter One) to calculate the degree of hydrolysis of the amino acid, we find that it too is 0.5% hydrolyzed. Thus it appears logical to assume that the remainder of the ampholyte is present in the ionogenic form.

The inner salt, however, can not dissociate into ions because the charges are bound to special groups within the molecules. According to the theory only a small part of the amino acid, NH_2RCOOH , is hydrolyzed into the cations, $^+\text{NH}_3\text{RCOOH}$, and anions, NH_2RCOO^- . The largest portion exists as an inner salt,

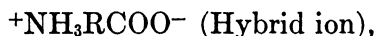

instead of neutral molecules, NH_2RCOOH , as required by the older conception. The calculations in the preceding section were based upon the latter concept, although it is not valid. We shall see later that these calculations yield correct results, although the significance attributed to the acidic and basic dissociation constants was incorrect.

If we let A denote the amino acid NH_2RCOOH , $^+\text{A}^-$ the hybrid ion, A^+ the cation, and A^- the anion, then according to the older view

$$\frac{[\text{H}^+][\text{A}^-]}{[\text{A}]} = K_a, \quad (1)$$

$$\frac{[\text{A}^+][\text{OH}^-]}{[\text{A}]} = K_b. \quad (2)$$

According to the modern concept, we have to deal with the following equilibria:

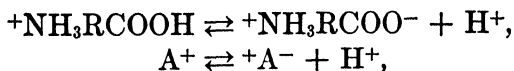

and

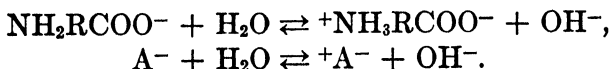

The equilibrium constants are

$$\frac{[{}^+A^-][H^+]}{[A^+]} = K_a', \quad (15)$$

and

$$\frac{[{}^+A^-][OH^-]}{[A^-]} = K_b'. \quad (16)$$

K_a' and K_b' are the true acidic and basic dissociation constants of the ampholyte whereas K_a and K_b are merely the apparent dissociation constants.

A simple relation exists between K_a , K_b , K_a' , and K_b' . Since the $[A]$ of the older theory is equal to the $[{}^+A^-]$ of the more recent conception, we find by combining (2) and (15)

$$K_a' = \frac{K_w}{K_b}; \quad (17)$$

and from (1) and (16) we obtain

$$K_b' = \frac{K_w}{K_a}. \quad (18)$$

The true acidic dissociation constant of the amino acid is evidently identical with the hydrolysis constant of the basic group with an apparent dissociation constant K_b ; the true basic dissociation constant corresponds to the value of the hydrolysis constant for the acid group on the older basis.

The radical difference between the classical and modern views is readily seen from equations (17) and (18). The *basic character*, as defined by the older theory, actually *is determined by the true acidic dissociation constant* based on the hybrid ion conception. Conversely, the acidic nature is governed by the true basic dissociation constant.

On the classical basis, the reaction between a strong acid and an amino acid would be written:

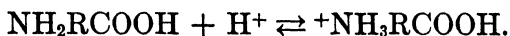

According to the theory of BJERRUM, however:

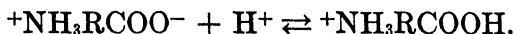

The classical view holds that the basic NH_2 -group is neutralized by the strong acid, whereas the modern theory regards the effect of acid on an ampholyte as a liberation of the weak

acid $+NH_3RCOOH$ from the "salt" $+NH_3RCOO^-$. In this respect, the behavior of amino acids is strictly analogous to that of ammonium acetate

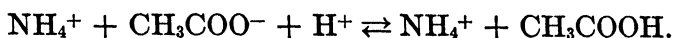

When an amino acid is treated with a strong base, the weak base NH_2RCOO^- is liberated, just as ammonia is liberated upon addition of alkali to ammonium acetate

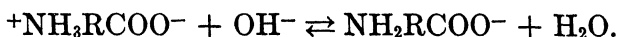

A complete analogy exists between the behavior of an amino acid towards acids and bases and that of a salt of the ammonium acetate type, with the restriction that hybrid ions do not conduct an electric current. The ammonium and acetate ions, of course, do conduct because of their free charge.

In the following table are given the values of K_a and K_b of amino acids at 25° , together with values of K_a' and K_b' as calculated by BJERRUM.

DISSOCIATION CONSTANTS OF AMINO ACIDS (N. BJERRUM)

	K_a	K_b	K_a'	K_b'
Glycine	$10^{-9.75}$	$10^{-11.57}$	$10^{-2.33}$	$10^{-4.15}$
Methylglycine	$10^{-9.89}$	$10^{-11.75}$	$10^{-2.15}$	$10^{-4.01}$
Dimethylglycine	$10^{-9.85}$	$10^{-11.97}$	$10^{-1.93}$	$10^{-4.05}$
Betaine	About 10^{-14}	$10^{-12.66}$	$10^{-1.34}$	About 1
Alanine	$10^{-9.72}$	$10^{-11.29}$	$10^{-2.61}$	$10^{-4.18}$
Leucine	$10^{-9.75}$	$10^{-11.64}$	$10^{-2.26}$	$10^{-4.15}$
Phenylalanine	$10^{-8.60}$	$10^{-11.89}$	$10^{-2.01}$	$10^{-5.30}$
Tyrosine	$10^{-8.40}$	$10^{-11.39}$	$10^{-2.51}$	$10^{-5.50}$
Glycylglycine	$10^{-7.74}$	$10^{-10.70}$	$10^{-3.20}$	$10^{-6.16}$
Alanylglycine	$10^{-7.74}$	$10^{-10.70}$	$10^{-3.20}$	$10^{-6.16}$
Leucylglycine	$10^{-7.82}$	$10^{-10.52}$	$10^{-3.38}$	$10^{-6.08}$
Taurine	$10^{-8.8}$	About 10^{-14}	About 1	$10^{-5.1}$
Asparagine	$10^{-8.87}$	$10^{-11.82}$	$10^{-2.08}$	$10^{-5.08}$
Lysine, 1st step	10^{-12}	$<10^{-6.96}$	$10^{-1.94}$	$10^{-1.9}$
2nd step	—	$10^{-11.96}$	—	$10^{-6.96}$
Arginine, 1st step	$<10^{-13.96}$	$10^{-7.0}$	$10^{-2.24}$	>1
2nd step	—	$10^{-11.66}$	—	$10^{-6.9}$
Histidine, 1st step	$10^{-8.66}$	$10^{-8.24}$	$10^{-1.60}$	$10^{-5.24}$
2nd step	—	$10^{-12.30}$	—	$10^{-8.24}$
Aspartic acid, 1st step	$10^{-3.82}$	$10^{-11.92}$	$10^{-1.98}$	$10^{-1.8}$
2nd step	$10^{-12.1}$	—	$10^{-3.82}$	—

6. Advantages of the hybrid ion concept.

The K_a values of amino acids usually lie between 10^{-8} and 10^{-10} . Such small constants appear improbable since, except for taurine, all the amino acids listed above are carboxylic acids, which usually have dissociation constants of 10^{-5} to 10^{-2} . If the classical conception is correct, then we must conclude that the introduction of an NH_2 -group lowers the dissociation constant of a carboxylic acid enormously. This is not to be expected, however, since the positive NH_2 -group rather favors the separation of hydrogen ions from the acid group. According to the hybrid ion hypothesis, the true dissociation constants lie between $10^{-1.5}$ and $10^{-3.5}$, which is much more probable. Greater proximity of the amino and carboxyl groups corresponds to more pronounced acidic properties of the latter. Thus for glycine K_a' is $10^{-2.33}$, whereas for glycylglycine, in which the amino and carboxylic groups are further removed, the constant is only $10^{-3.20}$. Similar considerations apply to the magnitude of the dissociation constant of the basic group, which is equal to $10^{-4.15}$ for glycine and $10^{-6.16}$ for glycylglycine.

The behavior of sulfonic acids also has been explained by the new theory. These compounds are strong acids comparable with sulfuric acid. It is not clear therefore why taurine should have a K_a value equal to $10^{-8.8}$. On the new basis, however, the true acidic dissociation constant is approximately equal to unity, which is completely in accord with the nature of this substance as a sulfonic acid.

The theory of BJERRUM is sufficient also to elucidate the behavior of methyl orange as an indicator (cf. Chapter Five, section four).

The fact that WALBLUM¹ found a large temperature coefficient for the K_a of glycine supports the hybrid ion theory. The dissociation constants of carboxylic acids and of ammonia show small temperature coefficients. If WALBLUM's data are recalculated to yield the true basic dissociation constant, we find only a twofold increase in this constant between 10° and 70° .

The behavior of amino acids in other instances, as in the mustard oil reaction, the formaldehyde titration, etc. is comprehensible only on the new basis.

¹ Walblum: *Compt. rend. soc. biol.*, 83, 707 (1920).

7. The equilibrium between amino acids and hybrid ions.

The solution of an amino acid contains hybrid ions and the residual amino acid. This equilibrium may be described by:

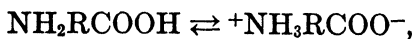

$$\frac{[+A^-]}{[A]} = n.$$

The value of n can be determined only approximately. For dimethylglycine, glycine, and phenylalanine, $n = 10^4$; and for glycyglycine, n equals 10^2 . It is safe to assume that the undissociated portion of these amino acids is present as the hybrid ion.

This is no longer true when the aromatic amino acids, such as benzoic acid derivatives, are concerned. Further information may be obtained from the paper of BJERRUM (l.c.).

CHAPTER THREE

THE ION ACTIVITY THEORY AND ITS APPLICATION TO ACID-BASE EQUILIBRIA

1. Historical review. Classification of electrolytes.

As early as 1805 the theory of GROTHUS concerning the electrical conductivity of solutions proposed that the positive and negative parts of the electrolyte molecules were transferred from molecule to molecule by a chain mechanism. Consequently these portions must have an independent existence for at least a short time during the electrolysis.

These dynamic considerations led R. CLAUSIUS (1857), fifty years later, to conclude that in an electrolyte solution, even in the absence of a current, there must be present a number of free "electrical partial molecules" possessing an irregular heat motion. The effect of an electric current is to constrain these particles to move in a definite direction. Simultaneously, W. HITTORF wrote in reports of his classical investigations of the migration of ions, "The ions of electrolytes can not be firmly bound to the electrolyte molecule."

Unfortunately a clear picture of the state of a dissolved electrolyte was not available at the time. Eighty years after GROTHUS' proposal was made, physical chemistry received its tremendous impetus; and not until then was it possible to account for the physical properties of electrolyte solutions.

At that time VAN'T HOFF made his famous comparison between solutions and gases. He stated that solutes in dilute solution were governed by the same equation of state which applies to gases: $pv = RT$, where p represents the osmotic pressure of the solution instead of the gas pressure. The behavior of non-electrolytes is well described by this rule. The measurements of RAOULT have shown that the lowering in freezing point of solvents is independent of the nature of the solute, and is determined only by the molecular concentration of the solute. Further investigations by PFEFFER, M. TRAUBE, and HUGO DE

VRIES on the "isotonic coefficient" of solutions also confirmed the VAN'T HOFF rule.

When electrolyte solutions are involved, however, the osmotic effects such as freezing point lowering, osmotic pressure increase, and rise in boiling point are much greater than corresponds to the total electrolyte concentration. Accordingly, VAN'T HOFF introduced the *irrationality factor* i (VAN'T HOFF factor) by which the particular osmotic effect could be divided to yield a number which satisfied the equation of state (i is always greater than 1). The VAN'T HOFF factor is purely empirical and does not account for the anomalous behavior of strong electrolyte solutions.

During this period, Sv. ARRHENIUS wrote his Doctor's thesis (1884) in which were outlined his ideas concerning solutions of strong electrolytes. It had been known previously that the increase in electrical conductivity of these strong electrolyte solutions diminishes with increasing concentration. ARRHENIUS assumed that the dissolved electrolyte is composed of "active" or conducting, and "inactive" or nonconducting molecules present in varying proportions. ARRHENIUS identified the active molecules with ions in his classical publication (1887).

In terms of the ARRHENIUS theory, sodium chloride in solution partially dissociates according to the equation:



That fraction of a gram molecular weight which splits into ions is called the *degree of electrolytic dissociation* α . For example, in a 0.01 N sodium chloride solution α equals 0.9. Then the concentration of undissociated salt is $0.1 \times 0.01 = 0.001$, and the concentration of chloride and sodium ions is $0.9 \times 0.01 = 0.009$.

Not only was it possible to explain, by the new theory, the anomalous osmotic behavior of strong electrolytes, but intensive quantitative studies indicated clearly the existence of a simple relationship between the *irrationality factor* i and the *degree of electrolytic dissociation* α . In a solution of a uni-univalent electrolyte of concentration c , the sum of concentrations of all particles evidently exceeds c . This summation is equal to $(1 - \alpha)c + 2\alpha c = c(1 + \alpha)$. From the definition of irrationality factor, i equals the ratio $\frac{c(1 + \alpha)}{c}$, or

$$i = 1 + \alpha.$$

Should the electrolyte dissociate into n ions, then $i = 1 + (n - 1)\alpha$.

Since i could be determined from freezing point and boiling point measurements, it was possible to calculate α . Other methods, such as determining the electrical conductivity of solutions, likewise permit the calculation of the degree of dissociation α . The equivalent conductance Λ of a solution is a function of the concentration. It is greatest in infinitely dilute solution where the electrolyte is completely dissociated into ions, and diminishes with increasing concentration due to the decrease in electrolytic dissociation. If we assume provisionally that the conductivity is determined only by the concentration of ions, it follows that

$$\alpha = \frac{\Lambda_c}{\Lambda_\infty},$$

where Λ_c is the equivalent conductance at the concentration c , and Λ_∞ is the value at infinite dilution.

In addition to this method of calculating α , a number of other procedures have been proposed.

(a) The Nernst Equation states that the potential difference between an electrode and a solution of ions of the electrode material is determined, as a first approximation, by the concentration of these ions.

(b) When ions exert a catalytic effect, such as the hydrogen ions in the inversion of sucrose, or the hydroxyl ions in the saponification of esters, the reaction velocity is proportional to the concentration of these ions.

(c) The solubility of slightly soluble strong electrolytes is markedly lowered by the addition of an electrolyte containing a common ion. The solubility decrease is determined approximately by the concentration of the common ion.

Electrolytes may be divided into two general groups, with a number of intermediate examples.

(a) The "*strong electrolytes*" are very strongly dissociated into ions in dilute aqueous solutions. To this group belong most neutral salts as well as the so-called strong mineral acids and bases as HCl, HNO₃, HClO₄, KOH, and Ba(OH)₂.

(b) The degree of dissociation of the "*weak electrolytes*" in-

creases with greater dilution, although the dissociation, even at great dilution, is practically always far from complete. Most organic acids and bases, ammonia, hydrogen sulfide, etc., belong to this class.

Actually these groups (a) and (b) represent two extremes; the ideal strong electrolytes in solution are completely dissociated into ions, whereas the ideal weak electrolytes show no appreciable dissociation. Of course there are many intermediate cases. Electrolytes may be described as strong, medium strong, or weak, but it is questionable whether either of the extreme cases really is encountered.

The modern theory of strong electrolytes does not exclude entirely the presence of undissociated molecules. The concentration of these molecules, however, is so small as to be negligible. Hydrogen chloride is considered a strong electrolyte in aqueous solution, although this is no longer the case in solvents in which the dissociation constant of HCl is smaller. The dissociation constant in water can be calculated approximately from the acid strength in ethyl alcohol. The order of magnitude of this constant is found to be 10^{+2} . Hence in a normal aqueous solution of hydrochloric acid, the undissociated portion constitutes about 1% of the total concentration. In more dilute solutions the dissociation is still more pronounced, so that here the concentration of undissociated molecules may be disregarded. Hydrogen bromide and iodide, though stronger than the chloride, behave similarly.

The halogen hydracids are all weaker than perchloric acid. Actually they are not ideal strong electrolytes, although they approach this behavior when water is used as the solvent. Certainly, these compounds differ distinctly from typical strong electrolytes such as potassium chloride and other neutral salts. The difference probably originates in the structure of the solid form. Neutral salts in the solid crystalline state possess a coordination lattice. Simple molecules do not exist in this type of lattice since the constituents of the salt are present solely in the ionic form. Each ion is surrounded in a uniform manner by a definite number of other ions of opposite charge. Indeed it is no longer correct to speak of "undissociated molecules" in the solid state.

The picture is different for weak electrolytes which include most organic acids. A. HANTZSCH has demonstrated spectroscopically that an organic acid in water exists in two forms. One has the same structure as the ester of the acid (undissociated form), while the other has the salt structure (ionogenic form). The latter probably dissociates completely into ions, as do strong electrolytes, and it is really unnecessary even to speak of an ionogenic form.

It is very likely that *in solutions of weak electrolytes a reversible equilibrium exists between the two molecular types, one of which behaves as a strong electrolyte while the other has practically no electrolyte properties. These forms may be called respectively the "Electro-" and "Pseudo-form."*

On this basis, the dissociation of weak electrolytes may be written:¹



The mass action law is applicable to the equilibrium between "Pseudo \rightleftharpoons Electro," but not to the dissociation of the strong electrolyte "Electro" into the cations B^+ and anions A^- . The less "Pseudo" and more "Electro" present in solution, the stronger is the electrolyte. When the solution contains practically no "pseudo-form," the transition from group (b) of weak electrolytes to group (a), which includes the strong electrolytes, is complete. By assuming an equilibrium between the two forms, we make our picture of the behavior of weak electrolytes dependent upon our knowledge of the properties of strong electrolytes.

The mass action law applied to weak electrolytes leads to:

$$\frac{[\text{Electro}]}{[\text{Pseudo}]} = K.$$

If the concentration of the pseudoform equals c , then $[\text{Electro}] = Kc$. *Such a solution behaves as though it contained a strong electrolyte of concentration Kc . Any change in the total concentration of weak electrolyte produces a corresponding variation in the concentration of the "strong" electrolyte portion (Electro) as required by the mass action law.*

¹ K. Schaeffer: *Z. anorg. allgem. Chem.*, 97, 285 (1916); 98, 70 (1916); *Z. physik. Chem.*, 93, 312 (1918). A. Hantzsch: *Ber.*, 59, 1096 (1926); *Z. anorg. allgem. Chem.*, 160, 5 (1927).

2. Objections to the theory of Sv. Arrhenius.

(a) The Arrhenius theory assumes that strong electrolytes in solution dissociate into ions. This reaction is reversible and may be represented, in the case of sodium chloride, by the following equation:



The mass action law should be valid for this equilibrium, so that

$$\frac{[\text{Na}^+][\text{Cl}^-]}{[\text{NaCl}]} = K,$$

where K stands for the dissociation constant of the strong electrolyte. Soon after the publication of the ARRHENIUS theory it was realized that K was by no means constant, but rather increases markedly with increasing concentration. This *anomalous action of strong electrolytes* could not be explained by the theory. As a matter of fact it was necessary to represent the dissociation equilibrium by the following empirical expression:¹

$$K = \frac{(\alpha c)^n}{(1 - \alpha)c},$$

in which n had an approximate value of 1.4 for uni-univalent electrolytes. The fact that n deviated so markedly from the theoretical value of 2 could not be accounted for.

(b) When the degree of electrolytic dissociation, α , is calculated by different methods, very poor agreement is obtained. The deviations are much greater than the experimental errors involved.

In the following table are included data found by A. A. NOYES and McINNES² for potassium chloride. Here f_λ indicates the degree of electrolytic dissociation, calculated from conductivity measurements:

$$f_\lambda = \frac{\Lambda_c \mu_c}{\Lambda_\infty \mu_\infty},$$

in which μ is the viscosity. The degree of dissociation calculated from electromotive force data is f_a , and f_0 denotes the dissociation found from freezing point lowering.

¹ Storch: Z. physik. Chem., 19, 13 (1896). Van't Hoff: Z. physik. Chem., 18, 300 (1895).

² Noyes and McInnes: J. Am. Chem. Soc., 42, 239 (1920).

CONCENTRATION OF KCl	f_{λ} (CONDUCTIVITY)	f_e (E.M.F.)	f_0 (FREEZING POINT)
0.001 molar	0.979	0.979	0.977
0.005 "	0.956	0.923	0.946
0.01 "	0.941	0.890	
0.05 "	0.889	0.790	
0.1 "	0.861	0.745	

(c) A. A. NOYES has pointed out a number of other objections to the theory of ARRHENIUS. It is difficult to understand, for example, why a normal hydrochloric acid solution should show an inappreciable vapor pressure of hydrogen chloride, in spite of the fact that conductivity measurements show 15% of the electrolyte to remain undissociated.

Other phenomena, such as the influence of electrolytes on the solubility of slightly soluble salts, the so-called neutral salt effect in catalytic phenomena, and the light absorption by strong electrolytes, are not elucidated by the classical theory of ARRHENIUS.

(d) It is known that the crystals of most electrolytes are constructed of ions (i.e., ionic lattice). With this in mind, it is not easy to devise a mechanism by which these ions can unite to form undissociated molecules when the crystals are dissolved in water.

3. The theory of complete dissociation of strong electrolytes.

In spite of the various obvious objections to the ARRHENIUS theory, it remained the basis for the electrochemistry of solutions until 1923, simply because no better theory had replaced it. At the end of the preceding century a number of authors, among them O. JAHN,¹ had demonstrated indeed that the theory did not represent the facts in a satisfactory manner. As early as 1894, J. J. VAN LAAR² had begun to lead the way to the modern theory by stating that the extremely strong electrostatic fields surrounding ions certainly must exert a profound influence on the dissociation processes. Later on he came to the conclusion that, in fairly dilute solutions, the degree of dissociation of all strong electrolytes equals unity.

¹ O. Jahn: *Z. physik. Chem.*, *27*, 354 (1898); *33*, 545 (1900); *35*, 1 (1900); *36*, 443 (1901); *37*, 490 (1901).

² J. J. van Laar: *Z. physik. Chem.*, *15*, 457 (1894); *17*, 245 (1895); *Arch. Teyler*, (2) *7*, 1 (1900); *Z. anorg. allgem. Chem.*, *139*, 108 (1924).

SUTHERLAND¹ went a step further by expressing the opinion that all strong electrolytes in aqueous solution were completely dissociated into ions. N. BJERRUM² arrived at similar conclusions on the basis of experimental investigations. The mathematical treatment (cf. MILNER³) of the problem of interionic forces proved to be extremely difficult, and therefore BJERRUM⁴ had to be satisfied temporarily with expressing the effects produced by the electrostatic influence of ions by means of empirical "deviation coefficients." These coefficients gave the ratio of the observed value to that which should be obtained in the absence of interionic forces. He proposed the three following factors:

f_0 is the *osmotic coefficient*, which stands for the ratio of the observed osmotic pressure of a salt solution to the pressure exerted when the salt is completely dissociated into free ions;

f_λ , the *conductivity coefficient*, is equal to Λ_c/Λ_∞ . This coefficient is evidently identical with the classical degree of electrolytic dissociation α as defined by ARRHENIUS;

f_a , the *activity coefficient*, is the ratio of the "active mass" or *activity* of the ions (i.e., their chemical or electrochemical effectiveness) referred to their total concentration. In other words, f_a is the proportionality constant relating concentrations with activities. It is these ion activities which govern chemical equilibria and potential measurements.

P. DEBYE and E. HÜCKEL⁵ succeeded, in 1923, in deriving the relationship between the different coefficients, on the one hand, and the concentration, valence, and specific nature (diameter) of the ions on the other. At present, this very complicated problem is not yet completely solved. DEBYE and HÜCKEL found it necessary to make certain approximations in order to simplify their complicated mathematical expressions. These simplifications were shown by GRONWALL, LA MER and SANDVED⁶ to introduce rather large deviations, especially for polyvalent ions. The equations of DEBYE and

¹ Sutherland: *Phil. Mag.*, **3**, 161 (1902); **7**, 1 (1906).

² N. Bjerrum: *7. Intern. Kongress Angew. Chem.*, **10**, 59 (1909).

³ Milner: *Phil. Mag.*, **23**, 551 (1912); **25**, 742 (1913); **35**, 214, 352 (1918).

⁴ N. Bjerrum: *Z. Elektrochem.*, **24**, 321 (1918); *Z. anorg. allgem. Chem.*, **109**, 280 (1920); *Z. physik. Chem.*, **104**, 406 (1923).

⁵ P. Debye and E. Hückel: *Physik. Z.*, **24**, 185 (1923). E. Hückel: *Physik. Z.*, **26**, 93 (1925); *Ergebn. Naturwiss.*, **3**, 199 (1924). H. Falkenhagen: *Elektrolyte*, Leipzig, S. Hirzel, 1932.

⁶ Gronwall, La Mer and Sandved: *Physik. Z.*, **29**, 358 (1928).

HÜCKEL, however, agree well with experiment when dilute solutions of uni- and bivalent ions are concerned. It would be out of place to repeat the complicated derivations in this monograph; and we must limit our discussion to a mere statement of calculations which can be performed with their aid.

The activity coefficient f_a of an ion of a strong electrolyte in dilute solution can be calculated from the equation:

$$-\log f_a = Az_i^2\sqrt{\mu}. \quad (1)$$

A is a constant approximately equal to 0.5 (0.495 at 15°; 0.498 at 18°; 0.501 at 25°) at room temperature and in aqueous solutions. This constant is *inversely proportional to the dielectric constant of the solvent*, and is of course entirely different in alcohol solutions than when water is used as the solvent. z_i stands for the valence of the ion. Since z_i occurs in the equation as a squared term, it is clear that the valence of an ion has a marked influence in determining its activity coefficient.

μ denotes the "total ionic strength," a term proposed by G. N. LEWIS,¹ which also depends upon the valence of the ions, and which may be calculated from the following equation:

$$\mu = \frac{\gamma_1 z_1^2 + \gamma_2 z_2^2 \cdots + \gamma_n z_n^2}{2} = \sum \frac{\gamma z^2}{2}.$$

γ denotes the molar concentration of a given ion, and z is its valence. In a 0.01 M potassium chloride solution, for instance, $\gamma_1 = \gamma_2 = 0.01$, $z_1 = z_2 = 1$, and $\mu = \frac{0.01 + 0.01}{2} = 0.01$. Only for a uni-univalent electrolyte does the ionic strength equal the analytical concentration.

In a 0.01 molar solution of barium chloride: $\gamma_1 = 0.02$, $z_1 = 1$, $\gamma_2 = 0.01$, $z_2 = 2$, and $\mu = \frac{0.02 + 0.04}{2} = 0.03$.

In 0.01 molar aluminum chloride solution: $\gamma_1 = 0.03$, $z_1 = 1$, $\gamma_2 = 0.01$, $z_2 = 3$, and $\mu = \frac{0.03 + 0.09}{2} = 0.06$.

For a solution which is 0.01 molar in magnesium sulfate: $\gamma_1 = \gamma_2 = 0.01$, $z_1 = z_2 = 2$, and $\mu = \frac{0.04 + 0.04}{2} = 0.04$.

¹ G. N. Lewis and M. Randall: Thermodynamics and the free energy of chemical substances, New York, McGraw Hill Book Co., 1923.

We see from equation (1) that, *in very dilute solutions of a strong electrolyte, the activity coefficient is determined only by the concentration and valence of ions, the specific nature of the ions having no appreciable influence.*

In dilute solution, the activity coefficients of the anion and cation of a uni-univalent electrolyte are equal. For a uni-bivalent electrolyte, however, the activity coefficient of the univalent ion is larger than that of the bivalent ion. We may write, for all types of electrolytes, the *mean activity coefficient* of all ions as follows:

Uni-univalent electrolyte:

$$-\log f_a = -\frac{1}{2}(\log f_{\text{cation}} + \log f_{\text{anion}}) = 0.5\sqrt{\mu}.$$

Uni-bivalent electrolyte:

$$-\log f = -\frac{1}{3}(2\log f_1 + \log f_2) = \frac{1}{3} \times 0.5(2 + 4)\sqrt{\mu} = 2 \times 0.5\sqrt{\mu}.$$

Uni-trivalent electrolyte:

$$-\log f = -\frac{1}{4}(3\log f_1 + \log f_2) = \frac{1}{4} \times 0.5(3 + 9)\sqrt{\mu} = 3 \times 0.5\sqrt{\mu}.$$

Bi-bivalent electrolyte:

$$-\log f = -\frac{1}{2}(\log f_1 + \log f_2) = \frac{1}{2} \times 0.5(4 + 4)\sqrt{\mu} = 4 \times 0.5\sqrt{\mu}.$$

Values of $-\log f$, calculated for various types of electrolytes in concentrations ranging from 0.001 to 0.01 normal, are found in the following table. Normality is defined in the usual way; i.e. a 0.005 molar barium chloride solution (bi-univalent) is 0.01 normal.

CALCULATED VALUES OF $-\text{Log } f$ FOR VARIOUS ELECTROLYTE TYPES

NORMALITY OF SALT SOLUTION	VALUES OF μ FOR				VALUES OF $-\text{Log } f$ FOR			
	uni-uni	uni-bi	uni-tri	bi-bi	uni-uni	uni-bi	uni-tri	bi-bi
0.001	0.001	0.0015	0.002	0.002	0.016	0.040	0.067	0.090
0.002	0.002	0.003	0.004	0.004	0.022 ₅	0.055	0.094	0.128
0.005	0.005	0.0075	0.010	0.010	0.027 ₅	0.086	0.150	0.200
0.008	0.008	0.012	0.016	0.016	0.035	0.110	0.192	0.254
0.01	0.01	0.015	0.020	0.020	0.050	0.123	0.213	0.284

The $-\log f_a$ value for a 0.01 molar copper sulfate solution, calculated by means of the above equation, is 0.40, yielding $f_a = 0.40$. The experimental value found by LEWIS was $f_a = 0.404$.

It should be emphasized that equation (1) is valid only for extremely dilute electrolyte solutions. When the electrolyte concentration exceeds 0.01 N (uni-univalent electrolyte), the specific nature of the ions becomes a determining factor. Differences in ionic diameter will influence the coefficients. Appreciable deviations from the simple equation (1) occur at still lower concentrations if the electrolyte consists of polyvalent ions.

DEBYE and HÜCKEL propose the following expression for more concentrated solutions:

$$-\log f_a = 0.5z_i^2 \frac{\sqrt{\mu}}{1 + 0.329 \times 10^8 \times b\sqrt{\mu}} \quad (2)$$

In this equation b represents the average ionic diameter. HÜCKEL has calculated b values for the following salts in aqueous solution:

KCl	$b = 3.76 \times 10^{-8}$ cm.	La(NO ₃) ₃	$b = 4.97 \times 10^{-8}$ cm.
K ₂ SO ₄	$b = 2.69 \times 10^{-8}$ cm.	MgSO ₄	$b = 3.55 \times 10^{-8}$ cm.

Equation (2) may be written

$$-\log f_a = 0.5z_i^2 \frac{\sqrt{\mu}}{1 + C\sqrt{\mu}} \quad (2a)$$

in which C is constant.

Equation (2a) has only a limited applicability since the ionic diameter b does not remain truly constant with varying ionic strength. The factor A introduced in equation (1) is a function of the dielectric constant of the solution. As yet there are insufficient data available concerning the dielectric constant of electrolyte solutions, so that the effect of variation in dielectric constant can not be taken into account with great accuracy.

Another complication which enters in more concentrated solutions is the *salting-out effect* (cf. p. 68). The activity coefficients of nonelectrolytes also depend upon the ionic strength of the solution:

$$\log f = B \times \mu.$$

B is a constant which is determined by the nature of the nonelectrolyte and of the electrolyte in solution.

If we assume that a similar "salting-out effect" is being exerted on the ions in more concentrated solutions, we may replace

equation (2) by:

$$-\log f_a = 0.5z_a^2 \frac{\sqrt{\mu}}{1 + 0.329 \times 10^8 \times b \times \sqrt{\mu}} - B\mu. \quad (3)$$

Equation (3) is presumably a quantitative representation of the variation of f_a within a wide range of concentrations. The fact still remains, however, that the equation has no exact significance, since factors A and B depend upon the dielectric constant, and the third "constant" b is not really a constant. BJERRUM¹ maintains furthermore that association of ions must be reckoned with.

In view of these uncertainties, it may prove more advantageous provisionally to work with an *empirical* relationship between *activity coefficients* and *ionic strength* of more concentrated solutions, instead of the DEBYE-HÜCKEL equation. BJERRUM has found from experience that the following equation holds within wide limits:

$$-\log f_a = A'\sqrt[3]{\mu} - B'\mu. \quad (4)$$

A' and B' are constants determinable from experimental data. He has demonstrated likewise that at smaller ionic strengths the expression

$$-\log f_a = 0.5\sqrt{\mu} - B\mu,$$

which is very similar to the simple DEBYE-HÜCKEL equation, may be employed.

Although the theory of activity coefficients, especially in concentrated solutions, is still rather incomplete, one must remember that in the quantitative treatment of all chemical equilibrium problems, it is the *activity and not the concentration of the participating components* which must be used in calculations.

We must bear in mind the various methods of expressing concentration:

(a) *Liter concentration or liter molarity* is the number of moles of a substance dissolved in one liter of solution.

(b) *Weight molarity* is the number of moles of a substance dissolved in 1000 grams of solution.

(c) *Molality* is the number of moles dissolved in 1000 grams of solvent.

¹ N. Bjerrum: *Ergebn. Naturwiss.*, 5, 125 (1926).

(d) *Mole fraction*, γ , is the ratio of the number of moles of a dissolved substance over the total number of moles in the solution.

$$\gamma = \frac{n}{n + N}.$$

The number of moles of dissolved substance is n , and N denotes the number of moles of solvent. Thermodynamically speaking, it is most proper to express concentrations in terms of mole fraction. Actually, however, this method is used but little in studies of equilibria in solution.

It makes little difference whether concentrations in dilute solutions are expressed by method (a), (b), or (c); but in stronger solutions the difference becomes significant.

DEBYE and HÜCKEL used liter molarity in deriving their equations. Molarity and molality are the expressions favored in American publications. A proper representation of concentration can not be decided upon until the so-called "hydration effect" shall have been studied quantitatively.

A large number of activity coefficients have been determined empirically by G. N. LEWIS and M. RANDALL,¹ and by G. SCATCHARD.² These data will be tabulated because of their great practical importance.

ACTIVITY COEFFICIENTS IN ELECTROLYTE SOLUTIONS, ACCORDING TO LEWIS AND RANDALL, AND SCATCHARD

CONCENTRATION OF ELECTROLYTE (MOLALITY)	0.01	0.02	0.05	0.1	0.2	0.5	1.0
HCl	0.91	0.881	0.836	0.801	0.783	0.762	0.823
LiCl	0.901	0.869	0.819	0.779	0.774	0.736	0.776
NaCl	0.903	0.871	0.821	0.778	0.752	0.671	0.650
KCl	0.899	0.865	0.809	0.762	0.749	0.654	0.634
KOH	0.92	0.89	0.84	0.80	0.75	0.73	0.75
AgNO ₃	0.902	0.857	0.783	0.723	0.655	0.526	0.396
H ₂ SO ₄	0.617	0.519	0.397	0.313	0.244	0.178	0.150
CuSO ₄	0.404	0.320	0.216	0.158	0.110	0.067	—

4. The activity concept.

When we speak of the activity of a dissolved substance, we usually mean the *relative activity in the particular solvent involved*.

¹ G. N. Lewis and M. Randall: J. Am. Chem. Soc., 43, 1112 (1921).

² G. Scatchard: J. Am. Chem. Soc., 47, 641, 648, 696 (1925).

The activity generally is set equal to concentration in dilute solutions of a nonelectrolyte. The activity of urea in a 0.01 molar water solution is said to be 0.01; and we assume the same activity for urea in an alcoholic solution of the same concentration. The "*absolute activity*" of the solute, however, is decidedly different for different solvents.

The same is true for ions. The *conventional* unit of activity is determined for a specified solvent. The ion activity equals the ion concentration in infinitely dilute solution. However, *when we speak of equal ion activities in different solvents, we do not mean that the absolute ion activities are equal.*

Let us consider the concept of "*activity*" in greater detail. G. N. LEWIS¹ first formulated the activity concept in the following manner:

$$A = - RT \ln a + i.$$

In this equation, R is the gas constant, T the absolute temperature, a is the activity of the dissolved substance, and i is an arbitrarily chosen constant. A may be termed the work of separation, i.e. the work which must be performed to remove a mole of solute from the solution isothermally, reversibly, and without a change of volume. By assuming that i is zero, we set up an activity scale based upon the activity of the free solute taken as unity.

In sufficiently dilute solutions, the activity of a nonelectrolyte is *directly proportional* to its concentration, whereas, according to the DEBYE-HÜCKEL equation (1), the activity of ions in electrolyte solutions is an *exponential function* of the ionic strength. This proportionality factor, which is different for each substance and ion, changes also with the solvent. The state of a solute (ion or nonelectrolyte molecule) is different in each solvent. A reaction with the solvent takes place, this change usually being termed solvation (or hydration in aqueous medium). The term "solvation" has no stoichiometric significance, but rather indicates a physical process (polarization).

If we arbitrarily set the proportionality constant equal to unity for a given solvent, then the activity equals the concentration, and the activity scale is established for the particular solvent in the conventional manner. Equal activities in various solvents,

¹ G. N. Lewis: Z. physik. Chem., 61, 129 (1908).

however, does not mean that the absolute activities are equal. It is necessary to bear this distinction in mind when comparing solubility and dissociation data for a group of solvents. Otherwise, gross errors may enter into the interpretation of the various equations.

Let us consider, for example, an insoluble salt such as silver chloride. We know from thermodynamics that in aqueous solution the product of the activities of the chloride and silver ions equals a constant (activity product L)

$$[a\text{Ag}^+][a\text{Cl}^-] = L.$$

In this formulation, a stands for the activity (conventional) of the particular ion, and L is the constant which varies with temperature but is independent of the electrolyte content.

Similar relationships may be written for other solvents, but the L values will be different since the *absolute activities* of ions will not be equal for the same concentrations in the various solvents. Were the ratio of the absolute activities known for equal relative activities in these solvents, we could calculate, from the activity product in water, the value of this constant in other media such as alcohol. If the ratios for these solvents are

$$a'\text{Ag} \left(\frac{\text{Water}}{\text{Alcohol}} \right) \quad \text{and} \quad a'\text{Cl} \left(\frac{\text{Water}}{\text{Alcohol}} \right),$$

then

$$L_{\text{Alcohol}} = L_{\text{Water}} a'\text{Ag} \left(\frac{\text{Water}}{\text{Alcohol}} \right) a'\text{Cl} \left(\frac{\text{Water}}{\text{Alcohol}} \right).$$

These ratios may be determined approximately for various ions by a number of experimental methods. Unfortunately this subject is beyond the scope of this volume, and the "distribution coefficients" of ions between different solvents will not be considered further.

5. The activity coefficient of hydrogen and hydroxyl ions in hydrochloric acid, sodium chloride, and potassium chloride solutions.

Individual ion activities may be obtained from electromotive force measurements using suitable concentration cells. The potential difference between an electrode and a solution containing ions of the electrode material is determined, according to the

Nernst Equation, by the activity of the ions:

$$E = -\frac{RT}{nF} \ln [a_{\text{ion}}] + C.$$

The potential of the hydrogen electrode, in a given solvent and at constant temperature and pressure, is governed only by the activity of the hydrogen ions. Thus the hydrogen ion activity in solution can be calculated from this potential measured against any standard electrode. Only the potentiometric method permits the determination of individual ion activities. It is not extremely accurate since a diffusion potential is always set up at the junction between the solution in the standard electrode and the solution being measured. Experiments seeking to eliminate this liquid junction potential by interposing a saturated potassium chloride solution have not been conclusive. Attempts to calculate this diffusion potential likewise have been unsatisfactory. It is very unfortunate that as yet we have no way of measuring individual ion activities.¹ We could, of course, attempt to minimize the junction potential by a proper choice of a system; or we could determine it as accurately as possible. Since a knowledge of the activities of the hydrogen and hydroxyl ions is of greatest importance in problems of acidity and basicity, we must learn as much as possible concerning the activities of both these ions, even though as yet no exact thermodynamic meaning can be attributed to such activities. The significance of these factors will be demonstrated by the following example.

Let us assume that, in a 0.01 N solution of an average strong acid in a medium which is also 1 N in potassium chloride, the hydrogen ion activity is 0.001. To find the concentration of undissociated acid, we must reduce the total concentration by the hydrogen ion concentration (and not the activity):

$$[\text{HA}] = 0.01 - [\text{cH}^+]$$

or

$$[\text{HA}] = 0.01 - \frac{[a\text{H}^+]}{f_{\text{H}}},$$

because

$$[a\text{H}^+] = f_{\text{H}}[\text{cH}^+].$$

In this formulation, f_{H} is the activity coefficient of the hydrogen

¹ E. A. Guggenheim: *J. Phys. Chem.*, **33**, 842 (1929).

ions, which depends upon the ionic strength and the kind of ions in solution.

NIELS BJERRUM and A. UNMACK,¹ in a thorough and reliable investigation, have determined the activity coefficients of the hydrogen and hydroxyl ions in sodium and potassium chloride solutions at various temperatures. These values are summarized in the two following tables. Instead of $-\log f$, pf (activity coefficient exponent) is written. The first table contains the data for small ionic strengths, where the nature of the ions present is unimportant. The second table applies to higher ionic strengths, in which region the particular character of the electrolytes involved becomes a determinative factor.

pf_H AND pf_{OH} AT SMALL IONIC STRENGTHS (BJERRUM AND UNMACK)

	0°	18°	25°	37°
pf_H	$0.486\sqrt{c} - 1.25c$	$0.499\sqrt{c} - 1.32c$	$0.504\sqrt{c} - 1.64c$	$0.515\sqrt{c} - 2.02c$
	(in HCl, KCl, NaCl to $c = 0.03$)			
pf_{OH}	$0.486\sqrt{c} - 0.54c$	$0.499\sqrt{c} - 0.56c$	$0.504\sqrt{c} - 0.56c$	$0.512\sqrt{c} - 0.56c$
	(in NaOH, KOH; NaCl, KCl to $c = 0.03$)			

pf_H AND pf_{OH} IN NaCl AND KCl SOLUTIONS AT GREATER IONIC STRENGTHS
(c BETWEEN 0.001 AND 1.5)

	0°	18°
pf_H in NaCl	$0.192\sqrt[3]{c} - 0.207c - 0.007$	$0.166\sqrt[3]{c} - 0.185c - 0.003$
pf_H in KCl	$0.225\sqrt[3]{c} - 0.187c - 0.007$	$0.196\sqrt[3]{c} - 0.166c - 0.003$
pf_{OH} in NaCl	$0.263\sqrt[3]{c} + 0.008c - 0.011$	$0.295\sqrt[3]{c} - 0.031c - 0.017$
pf_{OH} in KCl	$0.230\sqrt[3]{c} - 0.069c - 0.011$	$0.270\sqrt[3]{c} - 0.100c - 0.017$
	25°	37°
pf_H in NaCl	$0.161\sqrt[3]{c} - 0.178c - 0.003$	$0.143\sqrt[3]{c} - 0.158c - 0.005$
pf_H in KCl	$0.178\sqrt[3]{c} - 0.154c - 0.003$	$0.156\sqrt[3]{c} - 0.140c - 0.005$
pf_{OH} in NaCl	$0.290\sqrt[3]{c} - 0.024c - 0.019$	$0.320\sqrt[3]{c} - 0.051c - 0.025$
pf_{OH} in KCl	$0.275\sqrt[3]{c} - 0.096c - 0.019$	$0.310\sqrt[3]{c} - 0.124c - 0.025$

It would be desirable to have similar data for other salt solutions. The average activity coefficient ($= \sqrt{f_c f_A}$) has been determined very accurately for various electrolytes, especially by American investigators. For our purposes, however, it is of greater importance to know individual activity coefficients of ions,

¹ N. Bjerrum and A. Unmack: Kgl. Danske Videnskab. Selskab. Biol. Med., 9, 1 (1929). Cf. also I. M. Kolthoff and W. Bosch: Rec. trav. chim., 24, 430 (1927).

although it is impossible ever to obtain their exact values. (Cf. section 8(a).)

6. Ion product and ion activity product of water.

Applying the mass action law to the equilibrium between hydrogen and hydroxyl ions

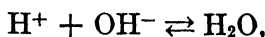

we arrive at

$$\frac{[a\text{H}^+][a\text{OH}^-]}{[a\text{H}_2\text{O}]} = K.$$

In the absence of solute, the activity of water $[a\text{H}_2\text{O}]$ may be set equal to unity in the conventional manner; and even in dilute solutions, the activity is not far removed from this value. The activity of water in more concentrated solutions can be calculated from water vapor pressure measurements:

$$[a\text{H}_2\text{O}] = \frac{p}{p_0},$$

where p is the vapor pressure of the solution and p_0 is that of pure water at the same temperature.

Taking $[a\text{H}_2\text{O}] = 1$, then:

$$[a\text{H}^+][a\text{OH}^-] = K_w,$$

in which K_w may be called the *ion activity product* of water. K is constant at a given temperature, and is independent of the ionic strength of the solution (with this one limitation, that in concentrated solutions a correction must be made for the variation in $[a\text{H}_2\text{O}]$).

The calculation usually made on the classical basis is simply

$$[c\text{H}^+][c\text{OH}^-] = K_{c\text{H}_2\text{O}},$$

wherein the product is supposed to remain constant. We may refer to $K_{c\text{H}_2\text{O}}$ as the *stoichiometric ion product*; but it may be readily demonstrated that *this quantity is not a true constant*.

We know that

$$K_w = [a\text{H}^+][a\text{OH}^-] = [c\text{H}^+][c\text{OH}^-]f_{\text{H}}f_{\text{OH}}$$

or

$$\frac{K_{c\text{H}_2\text{O}}}{K_w} = \frac{1}{f_{\text{H}}f_{\text{OH}}}.$$

It is evident that the dissociation of water increases with higher

electrolyte content, whereas the ion activity product remains constant.

Under certain circumstances it is useful to employ the product

$$[aH^+][cOH^-] = K.$$

This permits us to calculate the *hydroxyl ion concentration* $[cOH^-]$ if the values of $[aH^+]$ and K are known. The K value is less than K_{cH_2O} , and of course varies with the electrolyte content of the solution.

N. BJERRUM and A. UNMACK (l.c.) have performed accurate measurements of the ion activity product of water. They find between 0° and 37° that:

$$pK_w = paH + paOH = 14.926 - 0.0420t + 0.00016t^2.$$

The values of K_w and pK_w between 10° and 30° found in Table 2 of the Appendix are calculated by means of this equation.

The value of $K_{cH_2O} = [cH^+][cOH^-]$ may be derived for various electrolyte concentrations from the values of f_H and f_{OH} which are presented in the tables on page 64. This information is of practical importance, and is collected in the following table.

$$pK_{cH_2O} = pcH - pcOH.$$

For solutions with an ionic strength between 0 and 0.03:

$$\begin{array}{ll} t = 0^\circ, & pK_{cH_2O} = 14.926 - 0.972\sqrt{c} + 1.81c \\ t = 18^\circ, & = 14.222 - 0.998\sqrt{c} + 1.90c \\ t = 25^\circ, & = 13.980 - 1.008\sqrt{c} + 2.22c \\ t = 37^\circ, & = 13.590 - 1.030\sqrt{c} + 2.60c. \end{array}$$

For more concentrated solutions of potassium and sodium chloride ($c = 0.001$ to 1.5):

$$\begin{array}{ll} t = 0^\circ \text{ NaCl,} & pK_{cH_2O} = 14.944 - 0.455\sqrt[3]{c} + 0.215c \\ & \text{KCl,} & = 14.944 - 0.455\sqrt[3]{c} + 0.272c \\ t = 18^\circ \text{ NaCl,} & = 14.242 - 0.461\sqrt[3]{c} + 0.232c \\ & \text{KCl,} & = 14.242 - 0.466\sqrt[3]{c} + 0.282c \\ t = 25^\circ \text{ NaCl,} & = 14.002 - 0.451\sqrt[3]{c} + 0.218c \\ & \text{KCl,} & = 14.002 - 0.453\sqrt[3]{c} + 0.266c \\ t = 37^\circ \text{ NaCl,} & = 13.620 - 0.463\sqrt[3]{c} + 0.225c \\ & \text{KCl,} & = 13.620 - 0.466\sqrt[3]{c} + 0.280c. \end{array}$$

In the following tables are given also values of

$$pK = paH + pcOH$$

at various concentrations of potassium and sodium chloride. In the presence of NaOH, KOH, NaCl, and KCl, at an ionic strength (or normality) between 0 and 0.1:

$$\begin{aligned} t = 0^\circ, & \quad pK = 14.926 - 0.486\sqrt{c} + 0.56c \\ t = 18^\circ, & \quad = 14.222 - 0.499\sqrt{c} + 0.58c \\ t = 25^\circ, & \quad = 13.980 - 0.504\sqrt{c} + 0.58c \\ t = 37^\circ, & \quad = 13.590 - 0.515\sqrt{c} + 0.58c. \end{aligned}$$

In more concentrated solutions of potassium and sodium chloride ($c = 0.001$ to 1.5):

$$\begin{aligned} t = 0^\circ \text{ NaCl}, & \quad pK = 14.937 - 0.263\sqrt[3]{c} + 0.008c \\ & \quad \text{KCl}, & \quad 14.937 - 0.230\sqrt[3]{c} + 0.085c \\ t = 18^\circ \text{ NaCl}, & \quad 14.239 - 0.295\sqrt[3]{c} + 0.047c \\ & \quad \text{KCl}, & \quad 14.239 - 0.270\sqrt[3]{c} + 0.116c \\ t = 25^\circ \text{ NaCl}, & \quad 13.999 - 0.290\sqrt[3]{c} + 0.040c \\ & \quad \text{KCl}, & \quad 13.999 - 0.275\sqrt[3]{c} + 0.112c \\ t = 37^\circ \text{ NaCl}, & \quad 13.615 - 0.320\sqrt[3]{c} + 0.067c \\ & \quad \text{KCl}, & \quad 13.615 - 0.310\sqrt[3]{c} + 0.140c. \end{aligned}$$

7. Ion activity constants (thermodynamic dissociation constants) and stoichiometric dissociation constants of acids.

Monobasic acids. For the equilibrium



we may write

$$\frac{[a\text{H}^+][a\text{A}^-]}{[a\text{HA}]} = K_a. \quad (5)$$

K_a is the *true dissociation* or *ionization constant* as distinguished from the *stoichiometric dissociation constant*

$$\frac{[c\text{H}^+][c\text{A}^-]}{[c\text{HA}]} = K_c. \quad (6)$$

K_a is independent of the ionic strength of the solution, and its value changes only with the solvent. \blacktriangle The relationship between

K_a and K_c is found to be:

$$K_a = \frac{[cH^+]f_{H^+}[cA^-]f_{A^-}}{[cHA]f_{HA}} = K_c \frac{f_{H^+}f_{A^-}}{f_{HA}}. \quad (7)$$

K_c increases with rising electrolyte concentration, since f_{H^+} and f_{A^-} are smaller in higher concentrations and K_a remains constant. It follows, therefore, that the dissociation of a weak acid (or of weak electrolytes in general) increases with increasing ionic strength of solution. SV. ARRHENIUS was cognizant of this fact more than thirty years ago, although naturally his interpretation differed from that accepted to-day. It should be stated that the activity coefficients of most ions pass through a minimum at a definite electrolyte content (depending upon the ion and electrolyte involved), after which they increase with growing ionic strength. Accordingly K_c will pass through a maximum, and then decrease at very large electrolyte concentrations.

From equations (5) and (6) we may conclude that K_a and K_c will be equal only when the ionic strength of the solution is zero, for in such a medium all activity coefficients are equal to unity. The activity coefficient of an undissociated acid becomes larger with increasing ionic strength ($f_{HA} > 1$), and is given by

$$+ \log f_{HA} = B\mu.$$

The rising values of activity coefficients which accompany the increase in electrolyte content are parallel to the "salting-out effect" and can be calculated from the solubility in water and salt solution, after correcting for the dissociated portion. Thus

$$f_{HA} = \frac{s_0}{s},$$

where s_0 is the solubility in pure water, and s that in the electrolyte. In the presence of neutral salts, f usually increases with increasing ionic strength. When organic salts are involved, however, often the reverse effect is found. The activity coefficient of benzoic acid, for example, is 1.18 in 0.5 N KCl and 1.23 in 0.5 N NaCl, but only 0.78 in a 0.5 N solution of sodium benzoate.¹

The above considerations are of importance in explaining the behavior of buffer solutions. The colorimetric method of deter-

¹ I. M. Kolthoff and W. Bosch: *J. Phys. Chem.*, **36**, 1685 (1932).

mining pH is based upon the potentiometric method; and in the latter procedure it is the hydrogen ion *activity* rather than *concentration* which is measured. Consequently the degree of acidity of our standard solutions also is known in terms of activities.

Equation (5) tells us that for a buffer solution

$$[aH^+] = \frac{[aHA]}{[aA^-]} K_a = \frac{[cHA]}{[cA^-]} K_a f_{HA} f_{A^-}^{-1}. \quad (8)$$

Any variation in the activity coefficients of undissociated acid and of the anions will also change $[aH^+]$. In most buffer solutions f_{HA} may be set equal to unity, whereas f_{A^-} is appreciably smaller. When such a mixture is diluted with water, f_{A^-} becomes larger and therefore $[aH^+]$ diminishes. If a neutral salt is added to the buffer solution, f_{HA} increases and f_{A^-} decreases, so that $[aH^+]$ is larger in the presence of a neutral salt than in the original buffer solution. The influence of dilution on the pH of a buffer solution will be treated exhaustively in Chapter Eight, section eight. A rational treatment of the salt error for indicators, on the basis of the activity theory, will be presented in Chapter Ten, section two.

Polybasic acids. The second dissociation step of a polybasic acid may be described in the following manner:

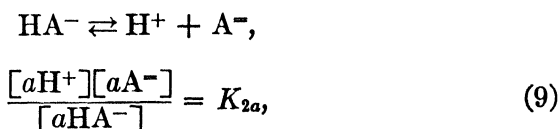

in which $[aA^{2-}]$ is the activity of the bivalent ion, and $[aHA^-]$ the activity of the monovalent anion. K_{2a} is again a constant independent of the ionic strength of the solution.

The relationship between the *stoichiometric second dissociation constant* K_{2c} and the *thermodynamic constant* K_{2a} is given by

$$K_{2a} = K_{2c} \frac{f_{H^+} f_{A^{2-}}}{f_{HA^-}}, \quad (10)$$

where $f_{A^{2-}}$ stands for the activity coefficient of the bivalent anion and f_{HA^-} represents the activity coefficient of the univalent anion. The value of K_{2c} increases with ionic strength more markedly than does K_c (equation 7), because the activity coefficient of the

bivalent ion diminishes (exponentially) with the ionic strength much more rapidly than does the coefficient of the univalent ions.

The effect of dilution on the pH of a mixture of uni- and bivalent anions of a weak acid also is more pronounced than on a mixture of a weak acid with its univalent anion. From equation (9) we see that

$$[aH^+] = K_{2a} \frac{[aHA^-]}{[aA^-]} = K_{2a} \frac{[cHA^-] f_{HA^-}}{[cA^-] f_{A^-}} \quad (11)$$

or

$$paH = -\log K_{2a} + \log \frac{[cA^-]}{[cHA^-]} - \log \frac{f_{HA^-}}{f_{A^-}}. \quad (12)$$

$\log K_{2a}$ and $\log \frac{[cA^-]}{[cHA^-]}$ do not vary, and therefore paH changes only with $\log \frac{f_{HA^-}}{f_{A^-}}$.

In a mixture of a weak acid and its univalent anion, we find from equation (8) that

$$paH = -\log K_a + \log \frac{[cA^-]}{[cHA^-]} - \log \frac{f_{HA}}{f_{A^-}}. \quad (13)$$

If we assume for the latter case that f_{HA} is equal to unity, and that the simple DEBYE-HÜCKEL expression

$$-\log f = 0.5z^2\sqrt{\mu}$$

may be used at the various ionic strengths, we may conclude from equation (13) that paH will change with the value of $-0.5\sqrt{\mu}$.

For a mixture of uni- and bivalent anions of a weak acid the situation is different. Equation (12) informs us that in this case paH varies with the values of $-\log \frac{f_{HA^-}}{f_{A^-}}$, or in other words with $(0.5\sqrt{\mu} - 2\sqrt{\mu}) = -1.5\sqrt{\mu}$. Evidently the dilution effect in such a mixture is three times as large as in a medium containing an acid with its univalent anion.

By a similar procedure it is possible to demonstrate that when bi- and trivalent anions of a weak acid are involved, the change in paH with dilution is governed by $(+2\sqrt{\mu} - 4.5\sqrt{\mu}) = -2.5\sqrt{\mu}$; and in a mixture of tri- and quadrivalent anions the paH varies with $(+4.5\sqrt{\mu} - 8\sqrt{\mu}) = -3.5\sqrt{\mu}$. The dilution

effect therefore grows with increasing number of dissociation steps. Quantitatively these relationships are not so simple as described because, especially in systems containing polyvalent ions, the DEBYE-HÜCKEL equation employed applies only to very small ionic strengths. As an approximation, however, these considerations are valid. This is shown by the investigations of I. M. KOLTHOFF and W. BOSCH¹ from which the following examples have been borrowed.

EQUIMOLECULAR MIXTURES OF CITRIC ACID AND MONOPOTASSIUM CITRATE (18°)

CITRATE CONCENTRATION	pH (MEASURED)	pH (CORRECTED) ^a	[H ⁺] (CORR.) × 10 ⁸
2.5 × 10 ⁻¹ Molar	2.861	2.857	1.39
1.25 × 10 ⁻¹	2.912	2.905	1.25
0.5 × 10 ⁻¹	2.969	2.952	1.12
0.25 × 10 ⁻¹	3.009	2.975	1.06
0.125 × 10 ⁻¹	3.050	2.988	1.03
0.05 × 10 ⁻¹	3.131	3.001	1.00
0.025 × 10 ⁻¹	3.222	3.009	0.98
0.0125 × 10 ⁻¹	3.345	3.018	0.96

^a "pH measured" stands for the pH determined at 18° with the hydrogen electrode. "pH corrected" gives the value corrected for the dissociation of the acid itself in the mixture, and is the hydrogen exponent for the case in which the concentration of undissociated acid is equal to that of the monovalent citrate. The quantity so obtained is equivalent to the theoretical dilution effect.

EQUIMOLECULAR MIXTURES OF MONO- AND DIPOTASSIUM CITRATE (18°)

TOTAL POTASSIUM CONCENTRATION	CONCENTRATION OF MONO- AND DIHYDROGEN CITRATE IONS	TOTAL IONIC STRENGTH μ	pH (MEASURED)	pH (CORRECTED)
0.5 Molar	0.167 Molar	0.667	4.293	4.301
0.2	0.0668	0.267	4.343	4.350
0.1	0.0334	0.133	4.405	4.408
0.05	0.0167	0.0667	4.485	4.484
0.02	0.00668	0.0267	4.554	4.555
0.01	0.00334	0.0133	4.602	4.600
0.005	0.00167	0.00667	4.622	4.613
0.0025	0.000835	0.00334	4.643	4.621
0.001	0.000334	0.00133	4.606	4.661

¹ Concerning citric acid, cf. *Rec. trav. chim.*, 47, 558 (1928). Concerning carbonic acid, cf. *Rec. trav. chim.*, 47, 819 (1928). Concerning pyrophosphoric acid, cf. *Rec. trav. chim.*, 47, 826 (1928). Concerning succinic, tartaric, and adipic acids, cf. *Rec. trav. chim.*, 47, 861 (1928). Concerning acetic, caproic, and benzoic acids, cf. *Rec. trav. chim.*, 47, 873 (1928). Concerning pyridine, pyrimidon, and *p*-phenylenediamine, cf. *Rec. trav. chim.*, 48, 37 (1929).

EQUIMOLECULAR MIXTURES OF DI- AND TRIPOTASSIUM CITRATE (18°)

TOTAL POTASSIUM CONCENTRATION	CONCENTRATION OF CITRATE AND MONOHYDROGEN CITRATE	TOTAL IONIC STRENGTH μ	pH (MEASURED)	pH (CORRECTED)
0.5 Molar	0.1 Molar	0.9	5.612	5.590
0.25	0.05	0.45	5.681	5.662
0.1	0.02	0.18	5.811	5.793
0.05	0.01	0.09	5.911	5.894
0.025	0.005	0.045	6.012	5.998
0.01	0.002	0.018	6.125	6.112
0.005	0.001	0.009	6.187	6.175
0.002	0.0004	0.0036	6.249	6.238
0.001	0.0002	0.0018	6.274	6.264

MIXTURE OF 0.1 MOLE OF SODIUM PYROPHOSPHATE AND 0.05 MOLE OF HYDROCHLORIC ACID AT VARIOUS DILUTIONS (18°)

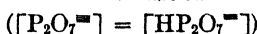

TOTAL SALT NORMALITY	IONIC STRENGTH μ	pH	$-\log \frac{f_4}{f_3}$
0.4	0.85	8.015	1.339
0.2	0.425	8.232	1.122
0.08	0.17	8.504	0.850
0.04	0.085	8.683	0.671
0.02	0.0425	8.856	0.498
0.008	0.017	8.976	0.378

The dilution effect is very pronounced in the last case due to the presence of ions of higher valence. The effect was less when acid anions of smaller charge were present in the system. Thus the theoretical considerations presented above appear to be justified by experimental observations.

The influence of a neutral salt on the pH of a dilute buffer solution also becomes more marked as the valence of the acid anions increases. In the following table, taken from the papers of Kolthoff and Bosch, are given examples of mixtures in which the cation influence predominates and where the nature of the anion does not enter.

It should be remembered that in all chemical reactions at equilibrium we must deal with activities rather than concentration of reactants. All the equations developed in Chapter One (Dissociation and Hydrolysis) are therefore merely approximations. In order to treat these subjects quantitatively we must

EFFECT OF NEUTRAL SALTS ON BUFFER SOLUTIONS CONTAINING ACID ANIONS OF VARIOUS VALENCES

BUFFER MIXTURE	SALT	SALT CONCENTRATION (MOLARITY)	pH AT 18°
0.005 Mole citric acid and 0.005 mole monopotassium citrate	—	—	3.130
	KCl	0.1	3.042
	"	0.5	2.976
	NaCl	0.1	2.989
	"	0.5	2.884
	LiCl	0.1	3.001
Equimolecular mixture of mono- and divalent citrate; total ionic strength 0.0133	"	0.5	2.832
	—	—	4.601
	KCl	0.1	4.386
	"	0.5	4.197
	NaCl	0.1	4.329
	"	0.5	4.069
Mixture of 0.002 molar di- and 0.002 molar tricitrate	LiCl	0.1	4.307
	"	0.5	3.986
	—	—	6.118
	KCl	0.1	5.755
	"	0.5	5.470
	NaCl	0.1	5.697
Mixture of 0.001 molar quadrivalent and 0.001 molar trivalent pyrophosphate	"	0.5	5.284
	LiCl	0.1	5.636
	"	0.5	5.111
	—	—	8.974
	KCl	0.1	8.356
	"	0.5	7.903
	NaCl	0.1	8.229
	"	0.5	7.640
	LiCl	0.1	7.405
	"	0.5	6.753

replace concentrations by activities. We found on page 21, for example, that the hydrogen ion concentration in a solution of an acid salt BHA was

$$[H^+] = \sqrt{K_1 K_2},$$

and in a solution of a salt of the type B₂HA the hydrogen ion concentration was

$$[H^+] = \sqrt{K_2 K_3}.$$

The constants in these expressions stand for the stoichiometric dissociation constants which, as we have seen, increase at first until a given ionic strength is attained, and then diminish. They would indicate that the pH of a solution of an acid salt is not independent of dilution, thus contradicting the conclusion of in-

dependence to be drawn from the above equations. Rather are we led to expect that the pH increases quite generally with greater dilution. That the pH actually does depend upon dilution is illustrated below.

P_H OF MONOPOTASSIUM CITRATE SOLUTIONS AT 18°

SALT CONCENTRATION	P _H (MEASURED)	P _H (CALCULATED)
0.25 Molar	3.59	3.60
0.1	3.67	3.66
0.05	3.73	3.72
0.01	3.83	3.80

P_H OF DIPOTASSIUM CITRATE SOLUTIONS AT 18°

0.25 Molar	4.965	4.945
0.1	5.026	5.020
0.05	5.085	5.100
0.025	5.178	5.189
0.01	5.275	5.288
0.005	5.338	5.356

We must state, however, that the thermodynamic dissociation constants have a relatively small practical importance. It is true that they remain constant with changing ionic strength; but to use them it is necessary to know the activity coefficients of the several components at different electrolyte concentrations. The simple DEBYE-HÜCKEL equation for computing activity coefficients is valid only at very small ionic strengths. At larger ionic strengths it is preferable to determine empirically the stoichiometric dissociation constants for various types of electrolytes.

8. The determination of dissociation constants.

Most dissociation constants recorded in the literature ¹ have been calculated on the basis of the old dissociation theory of ARRHENIUS. It is therefore of great practical interest to evaluate these data critically and to see how the thermodynamic dissociation constants may be calculated from them. Only the three most important methods for determining dissociation constants will be discussed. Sufficient information has been given

¹ For a summary, cf. Landolt-Börnstein-Roth: Physikalische-chemische Tabellen.

in the last paragraphs to indicate how the calculation is to be carried out in other cases. We shall see that the calculated dissociation constants and those determined by the classical methods need not be the same.

(a) *The potentiometric method.* The *hydrogen ion activity* of a solution of known composition is measured by means of the hydrogen or quinhydrone electrode. It is customary to employ a buffer solution for this purpose. The hydrogen ion activity of such a solution diminishes with increasing dilution.

In order to calculate the thermodynamic dissociation constant from the paH and the known composition of the solution, the activity coefficients of the various components must be known. Unfortunately the simple DEBYE-HÜCKEL equation is valid only at small ionic strengths; and in concentrated solutions, the values of the different factors (A , b , B) needed to calculate activity coefficients are unknown. Hence the calculation of these coefficients is at best an uncertain practice.

By far a better procedure is to measure the paH of a buffer solution at increasing dilution, and then to plot paH against $\sqrt{\mu}$. The simple form of the DEBYE-HÜCKEL equation: $-\log f = 0.5z^2\sqrt{\mu}$ holds at great dilution, so that in this region paH is a linear function of $\sqrt{\mu}$. Thus for a very dilute mixture of an undissociated acid and its univalent anion, paH will be a linear function of $0.5\sqrt{\mu}$; and for a mixture of uni- and bivalent anions of a weak acid, it will vary with $1.5\sqrt{\mu}$. After correcting for dissociation and association of the several components, it is possible to know, from the limiting linear relationship, the value of K at zero ionic strength.

Naturally the precision depends upon the reliability of the experimental procedure. The liquid junction potential must also be taken into account. It has been assumed that the hydrogen electrode permits the measurement of the hydrogen ion activity $aH^+ = cH^+f_{H^+}$. Actually a thermodynamic analysis by GUGGENHEIM¹ has revealed that the quantity measured is not $cH^+f_{H^+}$, but rather $cH^+f_?$. The coefficient $f_?$ is a complicated function of the mean activity coefficients of all electrolytes and of the transport numbers of all ions present not merely in the electrode solution, but also in the bridge solution and at each

¹ E. A. Guggenheim: *J. Phys. Chem.*, 34, 1758 (1930).

part of the transition layer between the electrode solution and the bridge solution. Only when the diffusion potential is negligible can the thermodynamic constant be known to within about 2%.

As a matter of fact, GUGGENHEIM and SCHINDLER¹ conclude that any computation of the salt effect on an indicator equilibrium, which is dependent upon electrometric measurements of cells with liquid junctions, is likely to be uncertain by about 4%. Although it is granted that to measure very accurately a single ion activity is a physical impossibility, the true value from a practical viewpoint may be approached closely enough, under proper conditions, to justify the measurement of αH^+ by means of the hydrogen electrode. It should be realized, however, that such values have no theoretical significance and that only measurements of cells without liquid junction yield exact data.

Regardless of these difficulties, the fact remains that the thermodynamic dissociation constant is truly a constant, and that the quantity calculated on the basis of "degree of dissociation" does not yield a true constant.

(b) *The conductivity method.* The greater number of dissociation constants of monobasic acids have been determined by the conductivity method. Values calculated in the classical manner are somewhat larger than the thermodynamic dissociation constants. Fortunately deviations from the thermodynamic constant are quite small in the case of medium weak and very weak acids, though somewhat larger differences are shown by stronger acids. When strong acids are involved, the classical method no longer yields a constant, the values increasing in more concentrated solutions. The thermodynamic constant, on the other hand, is independent of the ionic strength.

It is possible to derive the true dissociation constant from the equivalent conductivity. The classical calculation of the dissociation constant is based upon the Ostwald Dilution Law,

$$K = \frac{\alpha^2 c}{(1 - \alpha)}$$

α denotes the degree of electrolytic dissociation according to the ARRHENIUS concept, and is equal to Λ_c/Λ_∞ in which Λ_c is the

¹ E. A. Guggenheim and T. D. Schindler: *J. Phys. Chem.*, **38**, 543 (1934).

equivalent conductivity at concentration c and Λ_∞ is the equivalent conductivity at infinite dilution. The degree of dissociation found in this way is misleading, since αc does not represent the true concentration of ions. We may illustrate this statement by considering a 0.1 N solution of hydrochloric acid, for which the measured value of $f_\lambda = \Lambda_c/\Lambda_\infty$ is 0.923. On the classical basis we should expect the degree of dissociation α also to equal 0.923, and therefore $[cH^+]$ would become 0.0923. In reality, however, the acid is completely dissociated and $[cH^+]$ equals the analytical concentration of the acid, i.e. 0.1 N in this case. Thus it appears that the classical ion concentration (αc) must be divided by a properly chosen f_λ (conductivity coefficient) value to yield the true concentration of ions.

Suppose now that a solution of an incompletely ionized acid is involved, and that the classical ion concentration αc is 0.01 N. We can obtain the true ion concentration simply by dividing this quantity by the f_λ corresponding to the particular ionic strength involved. In other words, for a solution of an incompletely dissociated acid,

$$[cH^+] = \frac{\alpha c}{f_\lambda},$$

where f_λ is the conductivity coefficient of hydrochloric acid at the given ionic strength. We assume of course that f_λ is the same for different acids at the same concentration of ions, an assumption which is permissible at very small ionic strengths. Another approximation is introduced by using f_λ as though it corresponded to an ion concentration αc instead of to $\alpha c/f_\lambda$. The error, nevertheless, is small, and can be remedied by repeating the calculation using an f_λ' value which corresponds to the $\alpha c/f_\lambda$ calculated at first.

From the preceding discussion it follows that

$$K_c = \frac{[cH^+][cA^-]}{[cHA]} = \frac{\left(\frac{\alpha c}{f_\lambda}\right)^2}{\left(1 - \frac{\alpha}{f_\lambda}\right)c}, \quad (14)$$

whereas the quantity we desire to evaluate is

$$K_a = \frac{[aH^+][aA^-]}{[aHA]} = K_c \frac{f_H f_A}{f_{HA}}.$$

At small ionic strengths f_{HA} may be set equal to unity, and we have already tacitly assumed that f_{H} equals f_{A} , and that both coefficients have the same value as f_{H} and f_{Cl} in hydrochloric acid of the same ionic strength. Actually some uncertainty is introduced by so doing, but this will not be discussed at this point. In solutions with an ionic strength less than 0.01 the error does not exceed 0.5%, although the uncertainty grows with larger ionic strengths. We see that K_a can be calculated from values of electrical conductivity by the following expression:

$$K_a = \frac{\frac{\alpha^2 c}{f_\lambda^2} f_{\text{H}} f_{\text{A}}}{1 - \frac{\alpha}{f_\lambda}} \quad (15)$$

The thermodynamic dissociation constants were calculated from the classical constants in a similar manner and independently of each other by D. A. MACINNES,¹ M. S. SHERILL and A. A. NOYES,² and I. M. KOLTHOFF.³

Values of $f_\lambda = \Lambda_c/\Lambda_\infty$ may be calculated from Kohlrausch's measurements of electrical conductivity of hydrochloric acid solutions. f_{H} and f_{Cl} can be evaluated from the potentiometric measurements on hydrochloric acid solutions performed by SCATCHARD.⁴ These data are very reliable since the concentration chain was so arranged as to eliminate diffusion potentials. In this way, SCATCHARD determined the mean activity coefficient $\sqrt{f_{\text{H}} f_{\text{Cl}}}$ instead of the individual ion activities. If we assume that in a potassium chloride solution $f_{\text{K}} = f_{\text{Cl}}$ —which is plausible when we recall that both ions have the same structure—and that f_{Cl} is the same in hydrochloric acid solutions and potassium chloride solutions of the same concentration, then we can calculate f_{H} and f_{Cl} in hydrochloric acid solutions. Naturally these values are not strictly correct since the effect of the potassium ions on the activity of the chloride ions probably is different from that of the hydrogen ions at the same ionic strength. In the succeeding table are given values of f_λ , f_{H} , and f_{Cl} calculated by the above method.

¹ D. A. MacInnes: *J. Am. Chem. Soc.*, *48*, 2068 (1926).

² M. S. Sherill and A. A. Noyes: *J. Am. Chem. Soc.*, *43*, 1861 (1926).

³ I. M. Kolthoff: *Rec. trav. chim.*, *46*, 350 (1927).

⁴ G. Scatchard: *J. Am. Chem. Soc.*, *47*, 651 (1925).

f_{λ} , f_H , AND f_{Cl} IN HYDROCHLORIC ACID

CONCENTRATION	$f = \frac{\Lambda_c}{\Lambda_{\infty}}$ (KOHLRAUSCH)	$\sqrt{f_H f_{Cl}}$ (SCATCHARD)	f_H (SCATCHARD)	f_{Cl}
0.001	0.992	0.966	0.965	0.966
0.002	0.990	0.954	0.951	0.957
0.005	0.981	0.932	0.926	0.938
0.01	0.974	0.910	0.899	0.921
0.02	0.966	0.881	0.865	0.895
0.03	0.958	—	—	—
0.05	0.947	0.836	0.809	0.864
0.1	0.923	0.801	0.762	0.842

In solutions with an ionic strength less than 0.001, f_H and f_{Cl} can be calculated with the aid of the simple DEBYE-HÜCKEL equation; and by so doing we find $f_H = f_{Cl} = 0.975$ in 0.0005 N HCl, and equal to 0.982 in 0.00025 N HCl.

By way of illustration we present the two following tables which include the thermodynamic dissociation constants of acetic acid and *o*-nitrobenzoic acid calculated from conductivity measurements by J. KENDALL.¹ The first column contains the acid concentration, the second contains the classical degree of dissociation α multiplied by 100, in the third is found the dissociation constant calculated by the classical method, the fourth gives αc (classical ion concentration), the fifth column shows the true ion concentration $\alpha c/f_{\lambda}$, the sixth contains the concentration of undissociated acid $[cHA] = c - (\alpha c/f_{\lambda})$, and in the last column is found K_a calculated by equation (15).

For K_a of acetic acid an average value of 1.76×10^{-5} is found (25°), whereas I. M. KOLTHOFF and W. BOSCH² obtained a value of 1.70×10^{-5} at 18°.

The K_a found for *o*-nitrobenzoic acid is constant at ionic strengths varying between 0.0115 and 0.00046, and is equal to $6.0(\pm 0.1) \times 10^{-3}$. This acid is already fairly strong, and we see that the classical dissociation constant increases with concentration.

(c) *The kinetic (catalytic) method.* We should naturally expect the velocity of a reaction to be proportional to the activity of reactants. Experimental investigations, unfortunately, have failed to

¹ J. Kendall: J. Chem. Soc., 101, 1275 (1912).

² I. M. Kolthoff and W. Bosch: Rec. trav. chim., 47, 873 (1928).

THERMODYNAMIC DISSOCIATION CONSTANTS OF ACETIC ACID AND *o*-NITROBENZOIC ACIDS CALCULATED FROM CONDUCTIVITY DATA

CONCENTRATION	$100\alpha \left(= \frac{\Lambda_c}{\Lambda_\infty} \times 100 \right)$	$K = \frac{c^2 c}{1 - \alpha}$	αc	$\frac{\alpha c}{f\lambda}$	$\sqrt{[cHA]}$	$K_a = \frac{[oH^+][cA^-]}{[cHA]}$
<i>Acetic Acid</i>						
7.37×10^{-2}	1.57	1.845×10^{-5}	1.157×10^{-3}	1.165×10^{-3}	7.254×10^{-2}	1.788×10^{-5}
3.685×10^{-2}	2.216	1.851×10^{-5}	8.17×10^{-4}	8.22×10^{-4}	3.603×10^{-2}	1.759×10^{-5}
1.842×10^{-2}	3.118	1.849×10^{-5}	5.74×10^{-4}	5.76×10^{-4}	1.784×10^{-2}	1.754×10^{-5}
9.21×10^{-3}	4.380	1.849×10^{-5}	4.03×10^{-4}	4.05×10^{-4}	8.805×10^{-3}	1.759×10^{-5}
4.606×10^{-3}	6.141	1.851×10^{-5}	2.83×10^{-4}	2.83×10^{-4}	4.323×10^{-3}	1.770×10^{-5}
2.303×10^{-3}	8.568	1.849×10^{-5}	1.97×10^{-4}	1.97×10^{-4}	2.106×10^{-3}	1.787×10^{-5}
<i>o-Nitrobenzoic Acid</i>						
3.125×10^{-2}	36.85	6.72×10^{-3}	1.152×10^{-2}	1.184×10^{-2}	1.941×10^{-2}	5.92×10^{-3}
1.562×10^{-2}	47.22	6.60×10^{-3}	7.38×10^{-3}	7.55×10^{-3}	8.07×10^{-3}	6.00×10^{-3}
7.81×10^{-3}	58.22	6.45×10^{-3}	4.57×10^{-3}	4.66×10^{-3}	3.15×10^{-3}	6.00×10^{-3}
3.91×10^{-3}	69.88	6.33×10^{-3}	2.73×10^{-3}	2.76×10^{-3}	1.15×10^{-3}	5.95×10^{-3}
1.95×10^{-3}	80.07	6.28×10^{-3}	1.56×10^{-3}	1.58×10^{-3}	3.7×10^{-4}	6.20×10^{-3}
9.77×10^{-4}	87.94	6.27×10^{-3}	8.59×10^{-4}	8.65×10^{-4}	1.12×10^{-4}	6.26×10^{-3}
4.88×10^{-4}	93.26	6.29×10^{-3}	4.55×10^{-4}	4.57×10^{-4}	3.1×10^{-5}	6.34×10^{-3}

support this expectation. The activity theory appeared for a time to have been invalidated until J. N. BRÖNSTED proposed his revolutionizing theory of acid-base catalysis. The limited confines of this monograph unfortunately prohibit an extensive description of this theory. Nevertheless a short and admittedly incomplete review will be offered. For further information, the publications of BRÖNSTED¹ and his collaborators must be consulted.

The velocity of a reaction between two components A and B, according to the activity theory, is proportional to the activities of these reactants:

$$v = k[c_A]f_A[c_B]f_B = k[a_A][a_B].$$

According to BRÖNSTED (as well as CHRISTIANSEN and KRAMERS) the immediate result of a collision between molecules is the formation of a *critical complex* AB, which in turn decomposes instantaneously into C and D.



The velocity of this reaction is given by

$$v = k \frac{[c_A]f_A[c_B]f_B}{f_x} = k[c_A][c_B] \frac{f_A f_B}{f_x},$$

where f_x is the activity coefficient of the critical complex. It is evident that the influence of neutral salt on the reaction velocity results from the change in the "*kinetic activity factor*" $f_A f_B / f_x$. This was termed the *primary salt effect* by BRÖNSTED.

The charge of the critical complex AB naturally is equal to the algebraic sum of the charges of A and B. If, for example, A is a univalent ion and B is a neutral molecule, the critical complex will have a valence of 1. The kinetic activity factor therefore will be independent of the electrolyte content between rather wide limits since f_A and f_x will vary approximately in the same manner. At larger ionic strengths a more distinct salt effect will be observed since individual differences between A and AB will enter and because f_B will no longer be equal to unity.

When hydrogen ion concentration is determined by the catalytic method, the hydrogen ions are permitted to react with a neutral molecule (inversion of sugar; cleavage of diazoacetic acid

¹ J. N. Brönsted: Chem. Reviews, 5, 231 (1928).

ester), and the critical complex formed has the same valence as the hydrogen ions. The kinetic activity factor $f_A f_B / f_x$ therefore is influenced but little by the presence of electrolytes. At larger ionic strengths of course a more pronounced effect is shown, the reaction velocity usually increasing with increasing quantities of electrolyte present during the hydrogen ion catalysis. This is explained by saying that f_A / f_x exceeds unity and f_B grows larger (salting out effect) with increasing ionic strength. It is approximately true that at small ionic strengths the electrolyte effect is small, so that the *reaction velocity is governed by the hydrogen ion concentration and not by the hydrogen ion activity*.

Thus it is clear that when the hydrogen ion concentration in a dilute solution of an average strong or weak acid (in the absence of salts) is measured by the catalytic method, it is actually the *concentration of hydrogen ions* which is determined and not their activity. The potentiometric method, on the other hand, yields the *hydrogen ion activity*.

The *stoichiometric dissociation constant* and not the thermodynamic constant is calculated from the results of the kinetic method. The thermodynamic constant can then be computed from the stoichiometric constant by the method described in connection with the conductivity method (sub *b*).

Whatever has been said regarding the catalytic effects of hydrogen ions applies equally to catalysis by hydroxyl ions.

It should be mentioned that acid catalysis is not a specific property of hydrogen ions. According to BRÖNSTED, all substances possessing an acid character will exert a similar influence, although to a much smaller degree than is shown by hydrogen ions. The same is true of basic catalysis, which is by no means restricted to hydroxyl ions. All substances with basic properties show qualitatively the same effect. The papers of BRÖNSTED should be studied for more detailed information.

CHAPTER FOUR

THE BRÖNSTED DEFINITION OF ACIDITY AND BASICITY. PROPERTIES OF ACIDS AND BASES

1. Definition of an acid and base.

Acids are defined classically as substances which liberate hydrogen ions in aqueous solutions, while bases are substances which dissociate in water with the formation of hydroxyl ions. This formulation of the concept of "acids" and "bases" had developed chiefly on the basis of acidic and basic properties displayed in *aqueous solutions*. When an attempt was made to establish a more general theory of acids and bases, the old formulation appeared in many ways to be one-sided and incomplete.

In contrast with the classical view, BRÖNSTED'S definition¹ is based on the fundamental principle that *any substance may be considered an acid if it can split off a proton* (hydrogen ion; hydrogen nucleus), *and a base if it is able to add a proton*.

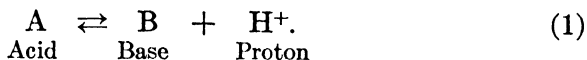

Thus when a compound behaves as an acid, it is transformed into a corresponding base B; and conversely, a base is converted into a corresponding acid.

Evidently A and B constitute a *corresponding* system, comparable with the oxidation-reduction system:

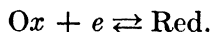

A reductor is such a substance as can split off electrons, while an oxidant can take up electrons. When a compound exerts its reducing action, it is transformed into a corresponding oxidized form, and conversely. Since electrons can not exist in solution in the free state, a substance can exert a reducing action only when at the same time an oxidant is present in solution to take

¹ J. N. Brönsted: *Rec. trav. chim.*, **42**, 718 (1923); *J. Phys. Chem.*, **30**, 777 (1926); *Chem. Reviews*, **5**, 232 (1928); *Ber.*, **61**, 2049 (1928).

up the liberated electrons. Conversely, a substance will behave as an oxidizing agent only when, simultaneously, a reducing agent is present in solution to supply the needed electrons.

Similar considerations apply to an acid-base system. It is as unlikely that hydrogen nuclei (protons) exist independently in solution as it is that free electrons be present. Hence, in order for a substance to display its acidic properties, a base must also be available to take up the protons. The solvent itself can usually function as such a base, as will be seen in the succeeding discussion.

One especially significant consequence of the new acid-base concept is that the hydrogen ions and hydroxyl ions are deprived of their roles as carriers of the acidity and basicity characteristics. They become merely examples of acids and bases, and play an important part only when water is employed as a solvent.

It is evident from equation (1) that the acidic and basic properties are independent of the electric charge of the molecule of the acid or base. Whereas formerly only electrically neutral molecules could be regarded as acids and bases, BRÖNSTED' definition admits that molecules which bear an electric charge may also behave as acids and bases.

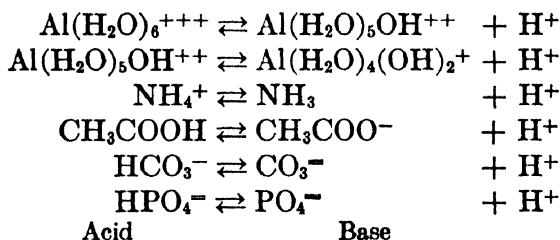

2. General significance of the new acid-base concept.

The dissociation of acids and bases. The basic properties of solvents. Since free protons are not present in solution, a dissolved acid will be dissociated electrolytically to an appreciable degree only if the solvent possesses the power of accepting protons, or in other words, if the solvent has basic properties. Hence the dissociation of an acid is determined quantitatively not only by its own acid strength but also by the basic strength of the solvent.

When an acid is dissolved in water, the latter develops its basic characteristics with the formation of hydroxonium or hy

dronium ions (H_3O^+):

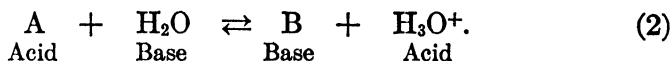

In water, therefore, the dissociation is controlled by the basic properties of water, regardless of the nature of the acid concerned. The basic nature of water is designated by

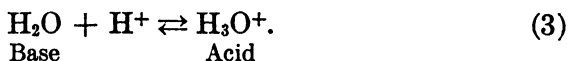

It may be shown easily that free protons do not exist in water. The author¹ has calculated that in a normal solution of a strong acid, in which the $[\text{H}_3\text{O}^+]$ is 1, the concentration of protons is of the order of 10^{-130} N, which of course has no real significance.

Whenever we speak of the hydrogen ion concentration, we refer really to the *solvated* proton concentration. The state of the hydrogen ions in water differs from that in alcohol. In the latter solvent, $\text{C}_2\text{H}_5\text{OHH}^+$ (Ethylhydrolium ions) are formed:

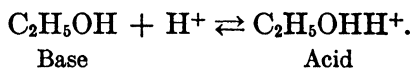

By the hydrogen ion concentration in an ammonia solution we mean the concentration of ammonium ion NH_4^+ :

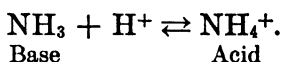

Qualitatively, therefore, the ammonium ion should have the same properties as the hydroxonium ion. Actually A. VOLMER² has shown by Röntgen analysis a striking crystallographic similarity between the ammonium ion in ammonium perchlorate NH_4ClO_4 and the hydroxonium ion in hydroxonium perchlorate H_3OClO_4 . Almost thirty years ago A. HANTZSCH³ had demonstrated that the cryoscopic effect of various substances was analogous in water, ammonia, and sulfuric acid; and from this he concluded correctly that the proton in these different solvents was present in a state of solvation.

In the event that the solvent possesses no basic properties whatsoever, as in the case of ligroin, benzene, etc., a dissolved

¹ I. M. Kolthoff: Rec. trav. chim., 49, 407 (1930).

² A. Volmer: Liebig's Ann. Chem., 440, 200 (1924).

³ A. Hantzsch: Z. physik. Chem., 65, 41 (1908).

acid will remain electrically undissociated, and the conductivity of the acid solution will be identical with that of the solvent. One may not conclude from this that the dissolved substance no longer behaves as an acid in this particular solvent. We must remember that acid properties are developed only when a substance (base) is present which is capable of taking up protons. Paradoxical though it may seem, it is possible, and in many cases likely, that a strong acid undissociated in a hydrocarbon medium will display stronger acid properties than are shown by an acid in aqueous solution and completely dissociated.

The dissociation of an acid in water, hitherto thought to be a simple process, is thus found to be quite complicated. However, the reaction

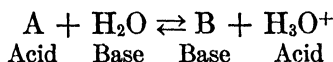

supplies us with much more accurate information concerning the mechanism than did the classical representation.

The dissociation of an acid in a given solvent (such as water) is comparable with the process usually called "neutralization" or "salt formation." The base, water, neutralizes the acid A. In the case of perchloric acid the substance which is produced actually resembles the customary salt:

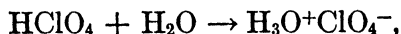

which is analogous to

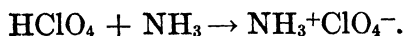

If the aqueous solution contains a substance more basic than water, a competition for the proton takes place between both bases. Let us consider the ammonium ion which, according to the BRÖNSTED definition, behaves as an acid:

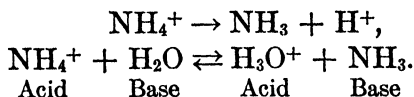

This reaction, usually called hydrolysis, is in reality a distribution of protons between the bases NH_3 and H_2O .

The old definition of an acid, which states that its reaction with a base forms a salt and water, is misleading. Indeed no

salt formation occurs even in the simplest example of a reaction between a strong acid and strong base:

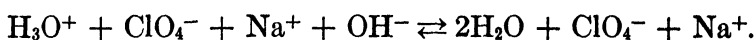

Both the sodium and the perchlorate are present as ions before and after "neutralization," and the process is governed solely by the reaction between hydroxonium and hydroxyl ions.

The shortcomings of the classical definition are illustrated still more clearly by the following acid-base reactions:

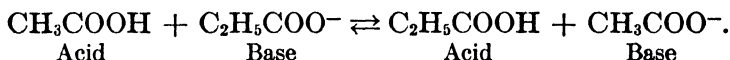
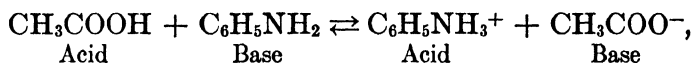

In neither of these cases is water produced by the "neutralization," and not even "salt" is formed in the last reaction. The formation of "salt" occurs only in reactions between neutral acids and bases.

It seems surprising at first to refer to water as a base. This is probably due to the fact that we have always considered the hydrogen ion concentration in water identical with the hydroxonium concentration, and because the dissociation constant of water as well as of other solvents is exceedingly small. Alcohol is about five hundred times weaker than water as a base. Were we to add water to an alcoholic solution of an acid, the water would act qualitatively as does ammonia when it is added to an aqueous acid solution:

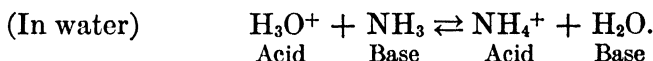
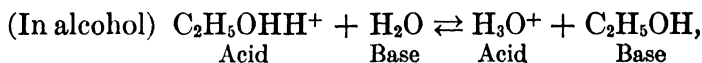

If we add ammonia to an aqueous solution of a slightly dissociated acid, the degree of dissociation of the acid will increase due to the "salt formation." Water acts in exactly the same manner when it is added to an alcoholic solution of a weak acid, the dissociation of the latter increasing considerably upon addition of water. We shall take up this effect quantitatively later on (page 99).

The *hydroxyl ion* occupies a special position among bases. If we restrict our considerations to water as a solvent, then any substance which produces hydroxyl ions in solution will be a base. The classical definition of a base is unsatisfactory when solvents other than water are involved, since in such media hydroxyl ions can no longer be formed. Let us take the dissociation of ammonia in alcohol as an example:

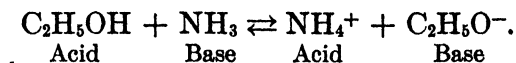

In this case ethylate ions are formed instead of hydroxyl ions. Evidently we limit ourselves to water as a solvent when we define a base as a substance which yields hydroxyl ions in solution. Furthermore we should need a separate definition for each solvent. This difficulty is eliminated by the terminology of BRÖNSTED, for his method of expression is more general. Thus the dissociation of ammonia in water is the analogue of the process in alcohol, as is shown by

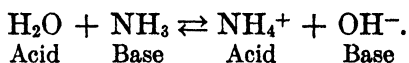

We see that in this instance water acts like an acid, and that, therefore, it is able to split off protons as well as to take them up. This *amphoteric nature* characterizes a number of other solvents such as alcohol, ammonia, acetic acid, formic acid, pyridine, aniline, and sulfuric acid. The dual nature of water may be described as follows:

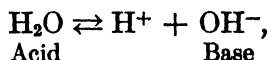

and

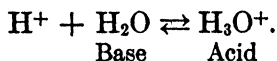

It is clear that the dissociation of water and the equilibria involved will be determined quantitatively by the acid and basic strength of water:



We have seen already that an acid is electrolytically dissociated only when present in a solvent which has a basic nature. Conversely we may say that bases will dissociate exclusively in

solvents which are able to supply protons, i.e. solvents which possess acid properties. Only acids will dissociate in solvents which are strictly basic in nature; and in purely acid solvents, bases alone will dissociate. If the solvent has amphoteric properties, both acids and bases will undergo dissociation.

The degree of dissociation depends quantitatively not solely upon the acid (or base) itself, but as well upon the basic (or acidic) properties of the solvent. The classical dissociation constant therefore fails to give us the real measure of acid and basic strength. When we compare the behavior of acids in ammonia, water, and acetic acid, we find that the basic character of the media diminishes in the order as they are named. Acids which are "medium strong" in water become very strong acids in ammonia, and behave as very weak acids in acetic acid. It is a fact that formic acid, an average strong acid in water, acts as though it were a very strong acid in ammonia and as a very weak one in acetic acid.

The strengths of dissolved bases will be in the reverse order since the acid nature of the solvents mentioned becomes more marked in the series ammonia, water, acetic acid. An amine will thus appear to be a very weak base in ammonia, of medium strength in water, and extremely basic in acetic acid.

We realize from the above discussion that care must be exercised in deciding whether a substance has acidic or basic properties. Usually we are limited to the behavior of the substance in water. The fact that, in water, a compound develops neither acidic nor basic properties signifies merely that its acidic and basic properties are weaker than those of water, and does not prove that the substance is unable to supply or accept protons. Monovalent alcohols for example are weaker bases and (except for methyl alcohol) weaker acids than water. Addition of a small quantity (about 1%) of alcohol to an aqueous solution of an acid or base accordingly will effect scarcely any change.

On the other hand, adding alcohol to a solution of an acid or base in a solvent possessing acidic or basic characteristics less pronounced than those of the alcohol will disturb the acid-base equilibrium radically.

As yet but little quantitative information is available concerning the strengths of acids and bases in various solvents. A number of laboratories are studying the problem, and it is expected

that our knowledge¹ will be enriched materially before many years have elapsed.

3. Quantitative treatment of the acid-base equilibrium.

The dissociation constant of an acid is not the proper criterion for judging its strength in various solvents since the value of the constant in a given medium depends partially on the basic strength of the solvent. BRÖNSTED therefore has proposed another method of expressing the strength of an acid.

From the equation

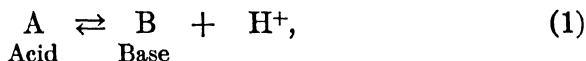

we may write

$$\frac{c_B}{c_A} [a\text{H}^+] = K_{\text{Acid}} \quad (4)$$

and

$$\frac{1}{[a\text{H}^+]} \frac{c_A}{c_B} = K_{\text{Base}}. \quad (5)$$

K_{Acid} is the *acidity constant of the acid* and K_{Base} is the *basicity constant of the base*. For a corresponding acid-base system, K_{Acid} is the reciprocal of K_{Base} . In equations (4) and (5) $[a\text{H}^+]$ denotes the proton activity, and c_A and c_B are respectively the conventional activities of the acid and the base and are set equal to the concentration c in very dilute solutions. The hydrogen ion activity on the contrary is expressed in *absolute units*; and at first glance it seems rather arbitrary to make the distinction. We shall see, however, that (4) and (5) give us practical and serviceable expressions for the acidity and basicity constants which now permit comparisons between different solvents.

It is true that we can not know the absolute proton activity since protons in solution are in a state of solvation. We can,

¹ Concerning acetic acid as a solvent:

J. B. Conant and N. F. Hall: *J. Am. Chem. Soc.*, *49*, 3047 (1929). J. B. Conant and T. H. Werner: *J. Am. Chem. Soc.*, *52*, 4436 (1930). N. F. Hall: *J. Am. Chem. Soc.*, *52*, 5115 (1930); *Chem. Reviews*, *8*, 191 (1930).

Formic acid as a solvent:

L. P. Hammett and N. Dietz, Jr.: *J. Am. Chem. Soc.*, *52*, 4795 (1930).

Ether as a solvent:

G. Schwarzenbach: *Helv. Chim. Acta*, *13*, 870, 897 (1930); *14*, 1069, 1071 (1931).

Benzene as a solvent:

J. N. Brönsted: *Ber.*, *61*, 2049 (1928). V. K. La Mer and H. C. Downes: *J. Am. Chem. Soc.*, *53*, 888 (1931).

Alcohol as a solvent: §§ 3, 4, and 5 of this chapter.

however, determine the *ratio* of proton activities in various media, and then agree upon some solvent in which to set the proton activity equal to the activity of the solvated protons. We may choose water as the comparison solvent. By arbitrarily setting the hydroxonium ion activity in water equal to the proton activity (which is far from correct), we introduce an enormous error; but this error is the same for all solvents since the proportionality constant k in

$$[aH^+] = k[aH_3O^+]$$

will be the same in each case.

The ratio of the proton activity at an equal activity of solvated protons can be measured potentiometrically with the hydrogen electrode. The potential of the hydrogen electrode is determined by the following processes:

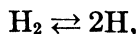

and



Then

$$E_H = \frac{RT}{F} \ln \frac{K\sqrt{P_{H_2}}}{[aH^+]}, \quad (6)$$

where P_{H_2} is the hydrogen pressure. The potential will depend only upon the proton activity if the hydrogen pressure and activity of solvated protons are kept constant. Suppose we compare alcohol and water solutions which are 0.01 N with respect to some completely dissociated strong acid. If we place hydrogen electrodes in each solution and connect both half cells, an electromotive force will be developed due to the fact that the proton activity will be different in each solution. Neglecting the junction potential between water and alcohol, the electromotive force is determined by the ratio of the basic strengths of water and alcohol.

In BRÖNSTED'S notation, the equilibrium constant for

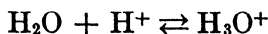

is written

$$\frac{C_{H_3O^+}}{C_{H_2O}} \times \frac{1}{[aH^+]} = K_{\text{Base Water}}. \quad (7)$$

$K_{\text{Base Water}}$ is the basicity constant of water. If we consider that the conventional activity of water is constant in dilute aqueous solutions, we may replace equation (7) by

$$C_{\text{H}_3\text{O}^+} \times \frac{1}{[a\text{H}^+]} = K_{\text{Conv. Base Water}}, \quad (8)$$

in which $K_{\text{Conv. Base Water}}$ is the conventional basicity constant of water.

In a similar manner we may write for alcohol:

$$\frac{C_{(\text{C}_2\text{H}_5\text{OHH})^+}}{C_{\text{C}_2\text{H}_5\text{OH}}} \times \frac{1}{[a\text{H}^+]} = K_{\text{Base Alcohol}} \quad (9)$$

and

$$C_{(\text{C}_2\text{H}_5\text{OHH})^+} \times \frac{1}{[a\text{H}^+]} = K_{\text{Conv. Base Alcohol}}. \quad (10)$$

From equation (6) it follows that the potential of the water-alcohol cell constructed above is given by:

$$\begin{aligned} \text{E.M.F.} &= E_{\text{H}(\text{Water})} - E_{\text{H}(\text{Alcohol})} \\ &= \left. \begin{aligned} &= \frac{RT}{F} \ln \frac{K\sqrt{P_{\text{H}_2}}}{[a\text{H}^+]_{\text{W}}} - \frac{RT}{F} \ln \frac{K\sqrt{P_{\text{H}_2}}}{[a\text{H}^+]_{\text{A}}} \\ &= \frac{RT}{F} \ln \frac{[a\text{H}^+]_{\text{A}}}{[a\text{H}^+]_{\text{W}}}. \end{aligned} \right\} \quad (11) \end{aligned}$$

Since in our illustration $C_{(\text{C}_2\text{H}_5\text{OHH})^+} = C_{\text{H}_3\text{O}^+}$, it follows from (8), (10), and (11) that

$$\begin{aligned} \text{E.M.F.} &= \left. \begin{aligned} &= \frac{RT}{F} \ln \frac{C_{(\text{C}_2\text{H}_5\text{OHH})^+}}{C_{\text{H}_3\text{O}^+}} \times \frac{K_{\text{Conv. Base Water}}}{K_{\text{Conv. Base Alcohol}}} \\ &= \frac{RT}{F} \ln \frac{K_{\text{Conv. Base Water}}}{K_{\text{Conv. Base Alcohol}}}. \end{aligned} \right\} \quad (12) \end{aligned}$$

It thus appears to be a very simple matter to determine potentiometrically the ratio of conventional basicity constants of solvents. Unfortunately, however, we meet with the fundamental difficulty arising from the fact that the work required to transfer protons from one solvent to the other depends upon the electrical state (potential; charge) of both phases; and suitable means are

not yet available for distinguishing the electrical from the chemical work. As we shall see below (next section), still another method may serve to determine the distribution coefficient of protons between alcohol and water, thus permitting a comparison with the results of the potentiometric procedure.

Let us now return to expressions (4) and (5). It appeared rather arbitrary to employ the conventional activities of A and B while expressing $[aH^+]$ in absolute units. The fact is that absolute activities of protons in various solvents can be compared experimentally, whereas this is not yet generally possible for aB and aA . As was emphasized in the discussion of the activity theory (Chapter Three, section four), the activity of a substance is set equal to its concentration in very dilute solutions. In reality no equality but a proportionality exists between activity and concentration,

$$aA = f \times cA,$$

although it is conventional to set the proportionality constant in the given solvent equal to unity. This factor f is not known with any degree of certainty, and is determined by the interaction between solvent and the chemical individual. Hence the value of the coefficient will vary with the medium. When we say that the activity of urea is 0.01 in 0.01 molar aqueous and alcoholic solutions, we refer to conventional and not to the absolute activities of the compound. The absolute activity will be different in each solvent even though the concentration of urea is the same in both media.

It is possible to determine approximately the ratio of absolute activities of different substances and ions present in various solvents in which their conventional activities are the same. Even were this ratio known accurately, certain difficulties would still remain. It would still be impossible to compare acetic acid and benzoic acid in the same solvent (say water) since we do not know the ratio of the *true* activities of the undissociated acids and of the acetate and benzoate ions.

From the foregoing discussion we see that constant $K_{A \text{ Act.}}$ is given by

$$\frac{[aB]}{[aA]} [aH^+] = K_{A \text{ Act.}} = \frac{c_B}{c_A} [aH^+] \frac{f_B}{f_A} = K_{A \text{ acid}} \frac{f_B}{f_A}, \quad (13)$$

in which $[aB]$, $[aA]$, and $[aH^+]$ are the true activities, and f_B and f_A represent the true activity coefficients. Thus $K_{A \text{ Act.}}$ is an absolute thermodynamic constant which is independent of ionic strength and solvent. This constant has little practical value since we are ignorant of the relationship between conventional and true activities. If, however, we make use of the acidity constant K_{Acid} and the basicity constant K_{Base}

$$\frac{c_B}{c_A} [aH^+] = K_{\text{Acid}} \quad (4)$$

and

$$\frac{c_A}{c_B} \times \frac{1}{[aH^+]} = K_{\text{Base}}, \quad (5)$$

we are able to compare the "constant" of an acid in different solvents or the constants of a number of acids in the same solvent since c_B and c_A are determinable quantities.

K_{Acid} and K_{Base} will change in passing from one solvent to another because the absolute activities of A and B vary. The effect is governed for the most part by the dielectric constant of the solvent. In going from a solvent with a high dielectric constant to one with a lower constant, the increase in f is greater the higher the charge of the ions. The resultant change in K_{Acid} may be predicted from (13) which tells us that

$$K_{\text{Acid}} = K_{A \text{ Act.}} \frac{f_A}{f_B}.$$

If we assume that the activity coefficient of a neutral molecule does not vary with the solvent (which is not strictly true, though permissible for the following qualitative considerations; the effect is generally smaller than for ions), then we can predict the direction in which the acidity constant of an acid will change in passing from water to a solvent with a smaller dielectric constant. In the following table, a + sign signifies an increase and a - sign denotes a diminution.

The acidity constants of electrically neutral acids (HA) and of acid anions (HA^- , HA^{2-} , etc.) diminish in going from water to alcohol, whereas cation acids (ammonium ion, quinine ion, aluminum ion) show an increased acidity constant. These qualitative conclusions have been substantiated by experiment.

INCREASE (+) OR DECREASE (-) OF ACIDITY CONSTANT IN PASSING FROM A SOLVENT WITH A HIGHER TO ONE WITH A LOWER DIELECTRIC CONSTANT

CHARGE TYPE		f_A	f_B	$\frac{f_A}{f_B}$	K_{Acid}
Acid	Base				
A ⁻	B ⁻	+	++	-	-
A ^o	B ⁻	0 (?)	+	-	-
A ⁺	B ^o	+	0 (?)	+	+
A ⁺⁺	B ⁺	++	+	+	+

Before leaving this section it would be desirable to discuss the relationship between the acidity constant and the classical dissociation constant.

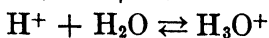

From the equations

$$c_{H_3O^+} \frac{1}{[aH^+]} = K_{\text{Conv. Base Water}} \quad (8)$$

and

$$\frac{c_B}{c_A} [aH^+] = K_{\text{Acid}}, \quad (4)$$

we find that the *dissociation constant* $K_{\text{Diss.}}$ of an acid in water is

$$K_{\text{Diss.}} = \frac{c_{H_3O^+} \times c_B}{c_A} = K_{\text{Acid (Water)}} \times K_{\text{Conv. Base Water}}. \quad (14)$$

The classical dissociation constant is thus equal to the product of the acidity constant of the acid in water and the conventional basicity constant of water.

In analogous fashion we find that the dissociation constant in alcohol is

$$K_{\text{Diss. (Alcohol)}} = K_{\text{Acid (Alcohol)}} \times K_{\text{Conv. Base Alcohol}}. \quad (15)$$

It is easy to see from this that the dissociation constant of an acid in alcohol, even though $K_{\text{Acid (Water)}}$ and $K_{\text{Acid (Alcohol)}}$ may be equal, will be smaller than in water due to the fact that the conventional basicity constant of alcohol is less than that of water.

Finally, let us discuss the acid-base properties of the solvent itself. Water is an amphoteric substance and behaves both like an acid and a base.

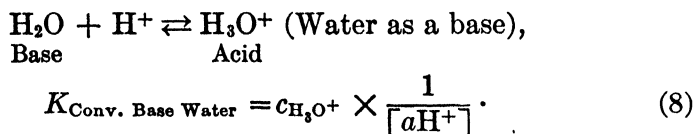
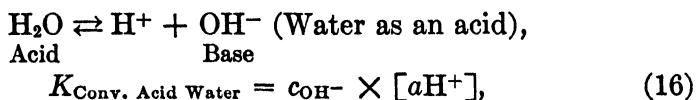

The dissociation of water itself is governed by both these constants in



and it is easy to see that

$$\begin{aligned} c_{\text{H}_3\text{O}^+} \times c_{\text{OH}^-} &= K_w \\ &= K_{\text{Conv. Base Water}} \times K_{\text{Conv. Acid Water}} = 10^{-14} \text{ (25}^\circ\text{)}. \end{aligned} \quad (17)$$

We may write in similar manner for alcohol:

$$\left. \begin{aligned} K_{\text{Alcohol}} &= c_{(\text{C}_2\text{H}_5\text{OHH})^+} \times c_{\text{C}_2\text{H}_5\text{O}^-} \\ &= K_{\text{Conv. Base Alcohol}} \times K_{\text{Conv. Acid Alcohol}} \\ &= \text{approx. } 10^{-20} \text{ (25}^\circ\text{)}. \end{aligned} \right\} \quad (18)$$

4. The dissociation of acids in alcohol.

It is of interest to study further the dissociation of acids in alcohol. H. GOLDSCHMIDT¹ and his collaborators have used the conductivity method to study the dissociation of a number of acids in absolute alcohol at 25°, and have computed the dissociation constants of these acids in the classical manner. E. LARSSON² has corrected certain of these values for the difference between the ion concentration and the conventional activity; and in addition he has measured the constants of several other acids potentiometrically.

L. MICHAELIS and M. MIZUTANI³ have determined the *acidity constant* (and not the dissociation constant) of different acids in

¹ H. Goldschmidt: *Z. physik. Chem.* *89*, 129 (1914); *91*, 46 (1916); *99*, 116 (1921). E. Mathiesen: *Z. physik. Chem.*, *119*, 439 (1926). Goldschmidt and F. Aas: *Z. physik. Chem.*, *112*, 423 (1924).

² E. Larsson: *Untersuchungen über die elektrolytische Dissoziation einiger Elektrolyte in äthylalkoholischer Lösung*, Inaug.-Diss., Kopenhagen, 1924.

³ L. Michaelis and M. Mizutani: *Biochem. Z.*, *147*, 7 (1924); *Z. physik. Chem.*, *116*, 135 (1925). Mizutani: *Z. physik. Chem.*, *116*, 350 (1925).

water-alcohol mixtures with the aid of the hydrogen electrode. Graphical extrapolation of their data leads to a value for the acidity constant in absolute alcohol. If we arbitrarily set the acidity and dissociation constants in water equal to each other, then we see from equations (14) and (15) that

$$pK_{\text{Diss. Alcohol}} - pK_{\text{Acid Alcohol}} = pK_{\text{Conv. Base Alcohol}} - pK_{\text{Conv. Base Water}} \quad (19)$$

where p again signifies the negative logarithm.

Certain of the data of GOLDSCHMIDT, LARSSON, and MICHAELIS and MIZUTANI (extrapolated) are compared in the following table. $pK_{\text{Diss. Water}}$ is the negative logarithm of the dissociation constants in water, $pK_{\text{Diss. Alc. Goldschmidt}}$ the same in alcohol as determined by GOLDSCHMIDT, $pK_{\text{Diss. Alc. Corr.}}$ is the latter corrected by LARSSON for the ionic strength effect, $pK_{\text{Diss. Alc. Larsson}}$ is the quantity determined potentiometrically by LARSSON, and finally $pK_{\text{Diss. Alc. Average}}$ is the mean of all values. In the column headed $pK_{\text{Diss. Water}} - pK_{\text{Diss. Alc.}}$ is given the difference between the negative logarithms of dissociation constants in water and in alcohol. $pK_{\text{Acid M. M.}}$ contains the extrapolated values for acidity constants in alcohol found by MICHAELIS and MIZUTANI, and $pK_{\text{Diss. Alc.}} - pK_{\text{Acid Alc.}}$ gives the corresponding difference between the negative logarithms of the dissociation and acidity constants in alcohol. The last column gives the average value of this difference for uncharged acids and monovalent cation acids.

It is plain from this table that the ratio of the dissociation constants in water and alcohol is not constant. Uncharged acids possess dissociation constants which in alcohol are 10^4 to 10^6 times smaller than in water; the difference is much less for monovalent cation acids.

The values which are found in the last column should be constant for all acids regardless of type since these figures represent differences between the logarithms of the conventional basicity constants of alcohol and water (equation 19). For uncharged acids, however, the average value was 3.05, whereas the univalent cation acids gave an average of 2.27. It must be noted in this connection that MICHAELIS and MIZUTANI did not correct for the difference between ion activities and ion concentrations, and that their data were based on ion concentrations. These authors have worked mostly with a system which was 0.01 N with respect to

DISSOCIATION OF UNCHARGED ACIDS AND MONOVALENT CATION ACIDS IN WATER AND ALCOHOL

Acid	$pK_{\text{Diss. W.}}$	$pK_{\text{Diss. Alc.}}$ (GOLDSCHMIDT)	$pK_{\text{Diss. Alc.}}$ (CORR.)	$pK_{\text{Diss. Alc.}}$ (LARSSON)	$pK_{\text{Diss. Alc.}}$ (AVERAGE)	$pK_{\text{Diss. Alc.}}$ $- pK_{\text{Acid Alc.}}$	$pK_{\text{Acid Alc.}}$ M.M.	$pK_{\text{Diss. Alc.}}$ $- pK_{\text{Acid Alc.}}$	AVERAGE DIFFER- ENCE
------	------------------------	---	-------------------------------------	---------------------------------------	---------------------------------------	---	---------------------------------	---	----------------------------

Uncharged Acids

Acetic acid	4.73		10.8	10.26	10.6 ?		7.5	3.1	} 3.05
Formic acid	3.70	9.15	5.96	5.68	9.15	5.9	5.95	3.2	
Trichloroacetic acid	0.88	5.83	7.08	7.05	5.8	4.9			
Trichlorobutyric acid		6.98		10.13	7.05	6.05	7.4	3.05	
Benzoic acid	4.2	10.43	10.4	8.73	8.7	5.7	5.8	2.9	
Salicylic acid	3.0	8.67	8.73	11.2	11.2	4.1	8.2	3.0	
<i>p</i> -Nitrophenol	7.1								

98

Monovalent Cation Acids

Ammonium	9.4			10.5			8.35	2.15	} 2.27
Anilinium	4.7	5.7				1.1	3.6 ± 0.1	2.1	
Methylanilinium	4.86	} 4.9				} 0.6	} 2.4	} 2.5	
	4.3 ^a								
Dimethylanilinium	4.0 ^a	} 4.4				} +0.4	} 2.2	} 2.2	
	5.17								
<i>o</i> -Toluidinium	4.50	5.6				1.1	3.2	2.4	
<i>m</i> -Toluidinium	4.8	5.9				1.1	3.5	2.4	
Pyridinium	5.2	4.7				-0.5	2.6	2.1	

^a M. Bourgeaud and A. Dondelinger: Bull. soc. chim., 57/58, 277 (1925).

a uni-univalent salt. LARSSON (l.c.) has calculated the activity coefficient f of the univalent cation acid or of the univalent anion of the uncharged acid in alcohol by means of the following equation:

$$-\log f = 2\sqrt[3]{c}.$$

For $c = 0.01$,

$$-\log f = 0.43.$$

Correcting the values of MICHAELIS and MIZUTANI for the difference between ion concentration and ion activity, the difference $pK_{\text{Diss. Alc.}} - pK_{\text{Acid Alc.}}$ (last column) diminishes by 0.43 for uncharged acids, and increases by 0.43 for the cation acids. After correction, therefore, the figures in the last column become $3.05 - 0.43 = 2.62$, and $2.27 + 0.43 = 2.70$, in very close agreement with each other. From the average value of $pK_{\text{Conv. Base Alc.}} - pK_{\text{Conv. Base Water}} = 2.66$, we may conclude that *water is about 400 times stronger as a base than is alcohol.*

5. The effect of traces of water on the dissociation of acids in alcohol.

Since water is a much stronger base than alcohol, the addition of a small amount of water to an alcoholic solution of a weak acid will increase the dissociation of the latter considerably. The extent of the water effect is determined by the respective capacities of water and alcohol for taking up protons:

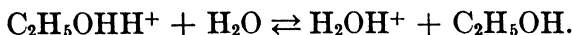

Hence

$$\frac{[\text{C}_2\text{H}_5\text{OHH}^+][\text{H}_2\text{O}]}{[\text{H}_2\text{OH}^+]} = K. \quad (20)$$

(The concentration of alcohol in the alcoholic solution may be considered constant.) In equation (20), K is really the distribution coefficient of protons between alcohol and water.

H. GOLDSCHMIDT (l.c.) found from conductivity measurements that at 25°

$$\frac{[\text{C}_2\text{H}_5\text{OHH}^+] \times n}{[\text{H}_2\text{OH}^+]} = K(25^\circ) = 0.0583, \quad (21)$$

where n is the molar concentration of water in the alcoholic solution.

The dissociation constant $K_{\text{Diss. o}}$ of a weak acid in pure alcohol is

$$K_{\text{Diss. o}} = \frac{[\text{C}_2\text{H}_5\text{OHH}^+][\text{B}]}{[\text{A}]} = \frac{[\text{C}_2\text{H}_5\text{OHH}^+]^2}{[\text{A}]} \quad (22)$$

If the dissociation constant remains unchanged by the addition of small quantities of water, then from (21) and (22) we find that the dissociation constant of the acid in an n molar solution of water in alcohol is K_n :

$$\begin{aligned} K_n &= \frac{\{[\text{C}_2\text{H}_5\text{OHH}^+] + [\text{H}_2\text{OH}^+]\}[\text{B}]}{[\text{A}]} \\ &= \frac{[\text{C}_2\text{H}_5\text{OHH}^+][\text{B}]}{[\text{A}]} \frac{(K + n)}{K} \quad (23) \end{aligned}$$

or

$$K_n = K_{\text{Diss. o}} \frac{(K + n)}{K} = K_{\text{Diss. o}} \frac{(0.0583 + n)}{0.0583} \quad (25^\circ). \quad (24)$$

The acid is assumed above to be so weak that the total water concentration may be set equal to n . According to GOLDSCHMIDT, equation (24) is valid up to a water concentration of 0.1 molar. The following empirical expression holds for more concentrated solutions:

$$K_n = K_{\text{Diss. o}} \frac{K + n}{K} (1 + 0.9n + 0.3n^2). \quad (25)$$

Were the concentration of water expressed in terms of activity instead of molarity, equation (24) probably would be satisfactory up to much higher concentrations.

PART TWO

THE PROPERTIES OF ACID-BASE INDICATORS

CHAPTER FIVE

THE COLOR CHANGE AND PROPERTIES OF INDICATORS

1. Definition.

According to WILHELM OSTWALD, acid-base indicators are weak acids or bases which, when undissociated, exhibit a color different from that of their ionic forms. HANTZSCH and others have shown that the color change is not due to ionization, but rather results from a structural change. The explanation of OSTWALD, however, is most suitable for purposes of elucidating the behavior of indicators at various hydrogen ion concentrations. We shall return in Chapter Seven to a comparison of the views of OSTWALD and HANTZSCH. It will then be found advisable to revise the definition of OSTWALD as follows: *Indicators are weak acids and bases of which the ionogenic form possesses a color and constitution different from the color and structure of the pseudo or normal form.*

2. Color change and interval.

When we say that an indicator is an acid, we expect that in aqueous solution a definite fraction of it will be dissociated into ions. If we denote the indicator acid by HI, then the ionization will proceed in accordance with the following equation:



where I^- represents the alkaline form. The succeeding expressions¹ apply to this equilibrium:

$$\frac{[\text{H}^+] \times [\text{I}^-]}{[\text{HI}]} = K_{\text{HI}} \quad (2)$$

and

$$\frac{[\text{I}^-]}{[\text{HI}]} = \frac{K_{\text{HI}}}{[\text{H}^+]}. \quad (3)$$

¹ It would be more appropriate to write equation (2) in the form:

$$\frac{[a\text{H}^+] \times [a\text{I}^-]}{[a\text{HI}]} = K_{\text{HI}}.$$

We shall return to this expression in Chapter Ten.

When $[H^+] = K_{HI}$, it follows that $[I^-] = [HI]$, which means that half of the indicator has been converted into its alkaline form. We may conclude from equation (3) that the ratio of concentrations of the acid and alkaline forms is a function of the hydrogen ion concentration. Evidently it is not correct to speak of a *point* at which the color indicator undergoes a transformation, since the change of the indicator from one form to the other is not associated with any particular hydrogen ion concentration. The color change occurs gradually, once the hydrogen ion concentration is of the same order of magnitude as the dissociation constant of the indicator. Definite ratios exist between the acid and alkaline forms at each hydrogen ion concentration. Since we perceive a difference in color only between certain limiting ratios, we see that the "transformation" of the indicator takes place between certain limiting hydrogen ion concentrations. If we express these limits, between which the change is perceptible, in terms of pH, then we have a range of hydrogen ion exponents which constitutes the *transformation interval or region*. The width of this interval is not the same for all indicators because these compounds differ in the sensitivity with which the color of one form may be detected in the presence of the other.

Assuming that the concentration of the alkaline form, to be visible, must be 10% that of the acid form, we have:

$$\frac{[I^-]}{[HI]} = \frac{K_{HI}}{[H^+]} = \frac{1}{10}.$$

Then

$$[H^+] = 10 \times K_{HI},$$

and

$$pH = pK_I - 1, \tag{4}$$

wherein pK_I is the negative logarithm of K_{HI} .

If we make the further assumption that the transformation of the indicator to the alkaline structure is no longer observable when about 91% has been so changed, then:

$$\frac{[I^-]}{[HI]} = \frac{K_{HI}}{[H^+]} = 10,$$

or

$$[H^+] = \frac{1}{10} K_{HI}$$

and

$$pH = pK_I + 1. \tag{5}$$

According to (4) and (5), the change commences at a pH less than pK_1 by one unit, and is practically complete at a pH in excess of pK_1 by the same amount. The transformation range of this indicator thus includes two units of hydrogen exponent. This range of two pH units happens to be characteristic of most indicators. As regards the visibility of the acid form in the presence of the alkaline, similar relationships obtain; and the production of the colored form in visible quantities starts at a certain pH value above pK_1 and is virtually complete at a hydrogen exponent less than pK_1 by the same amount. A plot of the quantity of indicator present in the alkaline form versus the corresponding hydrogen exponent is a bilogarithmic curve with symmetrical branches above and below the 50% mark. Figure 8

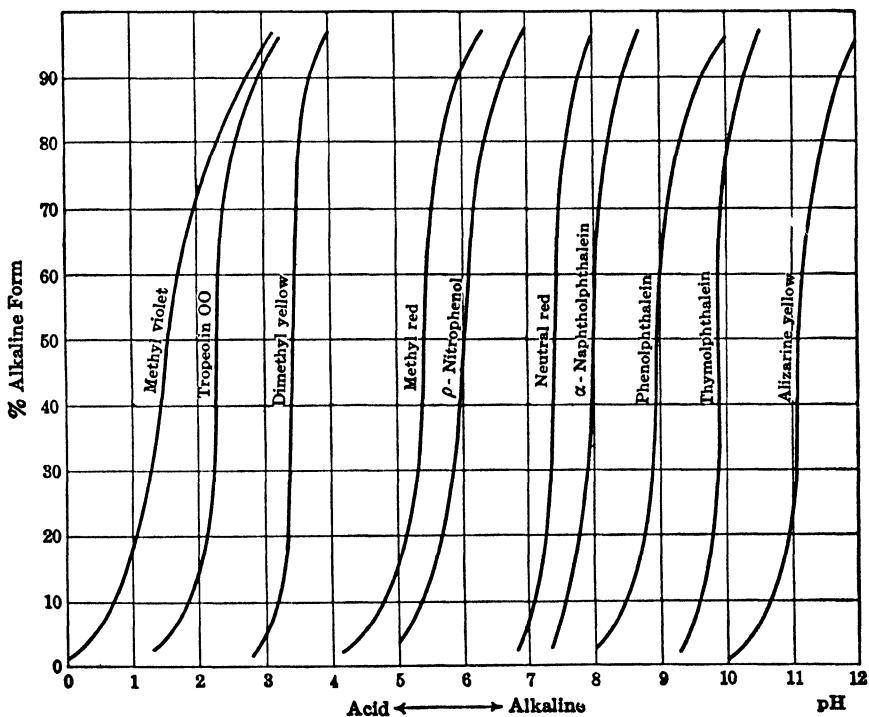

FIG. 8

illustrates such curves for a series of indicators. The pH values are plotted as abscissas and the concentration of alkaline form in per cent as ordinates. The curves approach the abscissa asymptotically, since at each pH there is present a definite ratio

of acid to alkaline form (cf. Table 5 of Appendix for color changes and intervals).

BJERRUM¹ was the first to use such a curve to represent graphically the transformation of a given indicator. CLARK and LUBS² have shown, also graphically, the manner in which the dissociation (α) varies with pH. The latter method, however, is apt to be confusing since the curves so drawn run from the lower left to the upper right or from the lower right to the upper left of a coordinate system, depending on whether the indicator is an acid or a base. In Fig. 8, on the other hand, all curves run in the same direction; and the value of pK_I can be obtained directly from them because pK_I is equal to pH when 50% of the indicator is present in the acid and alkaline form.

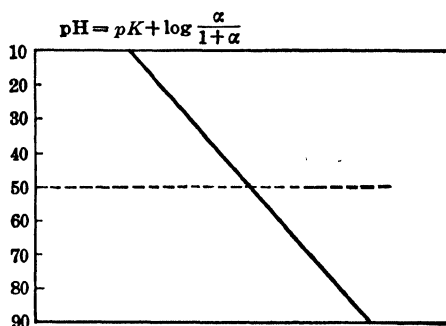

FIG. 9

In Fig. 9, the per cent of indicator converted into the alkaline form is plotted as the ordinate (10–90%), while the abscissa axis shows corresponding values of pH ($= pK + \log \frac{\alpha}{1-\alpha}$). The 50% point corresponds to a pH = pK .

3. Selected list of useful indicators.

A compilation of indicators useful for pH determinations was made available first by the laboratory of W. NERNST. Simultaneous reports by W. SALESSKY,⁴ H. FRIEDENTHAL,⁵ and B. FELS⁶ appeared in 1904. SALM⁷ made a noteworthy contribution by

¹ N. Bjerrum: Die Theorie der alkalimetrischen und acidimetrischen Indicatoren, Sammlung Herz, 1914, 30.

² W. M. Clark and Lubs: J. Bact., 2, 110 (1917); J. Biol. Chem., 25, 479 (1916).

³ J. F. McClendon: J. Biol. Chem., 54, 647 (1922).

⁴ W. Salessky: Z. Elektrochem., 10, 204 (1904).

⁵ H. Friedenthal: Z. Elektrochem., 10, 113 (1904).

⁶ B. Fels: Z. Elektrochem., 10, 208 (1904).

⁷ E. Salm: Z. Elektrochem., 10, 341 (1904); 12, 99 (1906); Z. physik. Chem., 63, 83 (1908).

J. F. McClendon³ represents the interval of an indicator graphically as a linear function. From the equation

$$[H^+] = \frac{[HI]}{[I^-]} K = \frac{1-\alpha}{\alpha} K$$

we may derive:

$$pH = pK + \log \frac{\alpha}{1-\alpha}.$$

In Fig. 9, the per cent of indicator converted into the alkaline

tabulating all available information. Then appeared the classical and pioneer investigations of S. P. L. SÖRENSEN¹ dealing with the colorimetric and potentiometric determination of pH and with the importance of hydrogen ion concentration in biochemistry. To SÖRENSEN belongs the credit for introducing the concept of transformation interval. Various other indicators were described later on, from which methyl red² and the sulfophthaleins³ have been adopted for general use. In all about 200 dyes which have acid-base indicator properties are known at present.

The properties of most of these indicators are known only incompletely (purity, salt error, protein error), and they must be employed with great care. It is advisable for practical purposes to select a list of indicators which have proven to be most useful. Such a list is found in the accompanying table.

One should realize, however, that the selection of these indicators is somewhat arbitrary. A great number of other indicators is to be examined in the following section. Among the numerous indicators described in this section (4) are included many dyes which very likely would serve equally well as indicators. It is doubtful, though, that they would prove to be materially superior to the substances chosen.

The indicators in the following list are arranged according to color-change interval. In the first column is given the customary trade name, in the second the scientific designation, the third column shows the transformation interval expressed in pH, the fourth the colors involved in the change, and in the fifth column are found the names of the investigators who have studied the properties of the indicator.

Indicator concentration. Usually it is best to prepare a stock solution containing 0.05–0.1% of the indicator. Water or alcohol may be used as solvent.

Water as the solvent. Water may be used to dissolve tropeolin 00, methyl orange, *p*-nitrophenol, sodium alizarine sulfonate, propyl- α -naphthol orange, nile blue, alizarine yellow, diazo violet, and tropeolin 0.

Alcohol as the solvent. Certain dyestuffs are not directly

¹ S. P. L. Sørensen: Comptes rend. trav. lab. Carlsberg, 8, 1, 396 (1909); Biochem. Z., 21, 131, 231 (1909); Biochem. Z., 22, 352 (1910). Sørensen and S. Palitzsch: Biochem. Z., 24, 381 (1910).

² E. Rupp and R. Loose: Ber., 41, 3905 (1908); Arch. Pharm., 253, 367 (1915).

³ W. M. Clark and H. A. Lubs: J. Bact., 2, 1, 109, 191 (1916).

LIST OF RECOMMENDED INDICATORS

TRADE NAME	SCIENTIFIC NAME	TRANSFORMA- TION INTERVAL	COLOR CHANGE		INVESTIGATOR
			Acid	Alkaline	
<i>o</i> -Cresol red	<i>o</i> -Cresolsulfonephthalein	0.2-1.8	red - yellow	red - yellow	McCrumb and Kenny
<i>m</i> -Cresol purple	<i>m</i> -Cresolsulfonephthalein	1.2-2.8	red - yellow	red - yellow	Clark and Lubs
Thymol blue	Thymolsulfonephthalein	1.2-2.8	red - yellow	red - yellow	Clark and Lubs
Pentamethoxy red	2,4,2',4',2'',4''-Pentamethoxytriphenyl- carbinol	1.2-3.2	red violet - color- less	red violet - color- less	Kolthoff
Quinaldine red	Cf. page 156	1.4-3.2	colorless - red	colorless - red	McClendon, Kolthoff
Tropeolin 00	Sodium diphenylamino-azo- <i>p</i> -benzene sulfonate	1.3-3.2	red - yellow	red - yellow	Sörensen
Hexamethoxy red	2,4,2',4',2'',4''-Hexamethoxytri- phenylcarbinol	2.6-4.6	rose red - colorless	rose red - colorless	Kolthoff
Dimethyl yellow	Dimethylamino-azo-benzene	2.9-4.1	red - yellow	red - yellow	Sörensen
Tetrabromphenol blue	Tetrabromophenoltetrabromo- sulfonephthalein	3.0-4.6	yellow - blue	yellow - blue	Harden and Drake
Bromphenol blue	Tetrabromophenolsulfonephthalein	3.0-4.6	yellow - purple	yellow - purple	Clark and Lubs
Methyl orange	Sodium dimethylamino-azo-benzene sulfonate	3.1-4.5	red - yellow	red - yellow	Sörensen
Bromcresol green	Tetrabromo- <i>m</i> -cresolsulfonephthalein	3.8-5.4	orange	orange	B. Cohen
Naphthyl red	α -Naphthylamino-azo-benzene	3.7-5.0	yellow - blue	yellow - blue	K. Linderström-Lang
Methyl red	Dimethylamino-azo-benzene car- boxylic acid	4.4-6.3	red - yellow	red - yellow	Rupp and Loose
Chlorphenol red	Dichlorophenolsulfonephthalein	4.8-6.4	yellow - red	yellow - red	B. Cohen
<i>p</i> -Nitrophenol	—	5.0-7.0	colorless - yellow	colorless - yellow	Sörensen
Heptamethoxy red	2,4,6,2',4',2'',4''-Heptamethoxytri- phenylcarbinol	5.0-7.0	red - colorless	red - colorless	Kolthoff
Bromcresol purple	Dibromo- <i>o</i> -cresolsulfonephthalein	5.2-6.8	yellow - purple	yellow - purple	Clark and Lubs
Sodium alizarine sulfonate	Sodium 1,2-dihydroxyanthraquinone sulfonate	5.5-6.8	yellow - red	yellow - red	Sörensen
Bromthymol blue	Dibromothymolsulfonephthalein	6.0-7.6	yellow - blue	yellow - blue	Clark and Lubs

LIST OF RECOMMENDED INDICATORS—Continued

Pinachrome (M) (Höchst)	<i>p</i> -Ethoxyquinaldine- <i>p</i> -ethoxyquinolineethylocyanin	5.8-7.6	colorless - violet	Kolthoff
Aurin	Phenolbenzein	6.0-7.6	yellow - red	Kolthoff
Phenol red	Phenolsulfonephthalein	6.4-8.2	yellow - red	Clark and Lubs
Neutral red	as. Dimethyldiaminophenasin-chloride	6.8-8.0	red - brown yellow	Sörensen
Cresol red	<i>o</i> -Cresolsulfonephthalein	7.0-8.8	yellow - red	Clark and Lubs
Cresolbenzein	<i>o</i> -Cresolbenzein	7.2-8.6	yellow - red	Kolthoff
<i>m</i> -Cresol purple	<i>m</i> -Cresolsulfonephthalein	7.4-9.0	yellow - purple	Clark and Lubs
Propyl- α -naphthol orange	Cf. page 148	7.4-8.9	yellow - red	Slotta and Franke
α -Naphtholphthalein	—	7.8-9.0	pale rose brown - blue green	Sörensen
Thymol blue	Thymolsulfonephthalein	8.0-9.6	yellow - blue	Clark and Lubs
Phenolphthalein	—	8.0-9.8	colorless - red violet	Sörensen
Xylenolphthalein	—	9.0-10.5	colorless - blue	Thiel
Thymolphthalein	—	9.3-10.5	colorless - blue	Sörensen
Nile blue	Diethylaminonaphthophenazoxonium sulfate	9.0-10.4	blue - red	Kolthoff
Alizarine yellow	Cf. page 148	10.1-11.1	yellow - lilac	Sörensen
Diazo violet	<i>o-p</i> -Dihydroxy-azo- <i>p</i> -nitrobenzene	10.1-12.0	yellow - violet	Kolthoff
Nitramine	Pierylmethylnitramine	10.8-12.8	colorless - orange brown	Kolthoff
Tropeolin O	Resorcine-azo-benzene sulfonic acid	11.1-12.7	yellow - orange brown	Sörensen
Trinitrobenzene	—	12.0-14.0	colorless - orange (fades)	Hegge
Sodium trinitrobenzoate	—	12.0-13.4	colorless - orange-red (turns yellow)	Kolthoff

soluble in water. Hence weighed quantities of such an indicator may be dissolved first in alcohol and then diluted with water and alcohol to the desired concentration. The recommended alcohol content for solutions of a number of frequently used indicators follows: Pentamethoxy red (70% A), quinaldine red (70% A), hexamethoxy red (70% A), dimethyl yellow (80% A), methyl red (60% A), heptamethoxy red (70% A), pinachrome (80% A), cresolbenzein (60% A), aurin (60% A), neutral red (70% A), α -naphtholphthalein (70% A), phenolphthalein (60% A), thymolphthalein (80% A), nitramine (70% A), trinitrobenzoic acid (70% A), and trinitrobenzene (70% A).

Water as a solvent after neutralization of the acid group. The *sulfonephthaleins* dissolve in water with difficulty, although they are readily soluble in dilute alcohol solutions (first dissolving in strong alcohol, then diluting with water to give a solution which is 20% in alcohol). Although such solutions are satisfactory for most purposes, they must not be used to determine the pH of a poorly buffered system since the sulfonephthalein may contain a strong acid group which can shift the pH of the solution under investigation slightly towards the acid side. For this reason W. M. CLARK recommends that the sulfonic acid group be neutralized with alkali before use.

It should be emphasized that even after indicator solutions have been neutralized they may still change the pH of poorly buffered solutions to a small extent. This point will be discussed in Chapter Ten. In most instances it is sufficient to prepare the

QUANTITY OF ALKALI REQUIRED TO NEUTRALIZE INDICATORS IN AQUEOUS SOLUTIONS

INDICATOR	MOLECULAR WEIGHT	c c. 0.1 N NaOH PER 100 MG.
Cresol red	382	2.65
<i>m</i> -Cresol purple	382	2.65
Thymol blue	466	2.15
Tetrabromphenol blue	986	1.01
Bromphenol blue	669	1.5
Methyl red	269	3.7
Chlorphenol red	423	2.35
Bromcresol purple	540	1.85
Bromthymol blue	624	1.6
Phenol red	354	2.85
Bromcresol green	698	1.45

indicator solution in the following manner: 100 mg. of indicator are triturated in an agate mortar with the volume of 0.1 N NaOH given in the preceding table. After the solid has dissolved, the solution of the neutralized indicator is diluted to 100 or 200 c.c. Likewise, when aqueous solutions of methyl red and trinitrobenzoic acid are employed, their carboxyl groups should be neutralized. The sodium salt of methyl red is sold by Eastman Kodak Co.

4. Description of Various Indicators. Classification.

The Phthaleins. All phthaleins are rather insoluble in water but very soluble in alcohol. Most of them are colorless in acid medium (lactone form), while the alkaline form is colored (red, violet, blue, green) and possesses the quinone phenolate structure. In strongly alkaline medium the color gradually fades due to the transformation of the quinone phenolate into the colorless carbinol form. These structural changes will be discussed in detail in Chapter Seven. The velocity with which the colors of various phthaleins fade in alkaline medium has been measured by A. THIEL¹ and coworkers, and the velocity constants determined.

The phthaleins are transformed also into the colored quinoid structure in very strong acid media (concentrated hydrochloric acid or sulfuric acid). *Phenolphthalein* becomes rose-colored, *thymolphthalein* violet, and *α-naphtholphthalein* green. The explanation of this phenomenon too will be postponed until Chapter Seven.

The most important compounds in this group of indicators are those mentioned in the preceding paragraph. Their properties, as well as the characteristics of certain other phthaleins, will now be described.

Phenolphthalein.

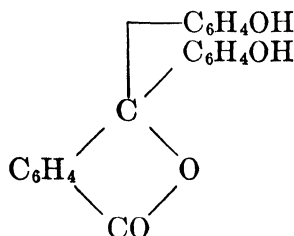

Melting point 250°. Lactone form colorless.

¹ A. Thiel and R. Diehl: Sitzb. Ges. Naturw. Marburg, 62, 471 (1927). A. Thiel and L. Jungfer: Z. anorg. allgem. Chem., 178, 49 (1929). A. Thiel: Monatsh., 53/54, 1008 (1929).

The commercial product may be purified by recrystallization from methyl or ethyl alcohol. The stock solution should contain 0.1% of the indicator in a 60% alcohol solution. As is the case with all single-color indicators, the transformation interval will depend upon the concentration of the indicator (cf. section eleven, below). The interval lies between pH 8.0 and 9.8 (colorless to violet-red) when 1-2 drops of the 0.1% indicator solution are added per 10 c.c. of solution under investigation. The color fades in strongly alkaline solutions.

Phenolphthalein behaves as a dibasic indicator in a titration with alkali. First the lactone group is transformed into the carboxylic group anion (the monovalent ions are colorless), and then the second equivalent of base changes the indicator into the red-violet quinone phenolate which acts like a bivalent anion. The first and second dissociation constants lie very close to each other, and therefore the relation between pH and color intensity of phenolphthalein (as well as other phthaleins) is rather complex.

Phenolphthalein is a very useful indicator. Its protein error is quite small.

Thymolphthalein. The structure of this indicator is like that of phenolphthalein, with the exception that the phenol groups are replaced by two thymol groups. It melts at 253°. A convenient stock solution may contain 0.1% of the indicator in an 80% alcohol solution. Its color change interval lies between pH 9.3 and 10.5, the color changing from colorless to blue.

The colorless form is very insoluble in water. Consequently, if the indicator is added to a solution with a pH of 10, a fading of the blue color will be perceptible after a short time of standing. The separation of the colorless form of the indicator will thus displace the customary equilibrium towards the acid side. The more indicator employed and the longer one waits for the appearance of this phenomenon, the more pronounced will be the effect. For this reason thymolphthalein is not very satisfactory for use in the colorimetric determination of pH. The indicator is suitable, however, for titrimetric purposes.

Xylenolphthalein. A. THIEL¹ has found that the interval of xylenolphthalein is approximately the same as that of thymolphthalein. Since the solubility of the former is about thirty-five

¹ A. Thiel: Z. angew. Chem., 44, 863 (1931).

times greater than that of the latter, it is rather advantageous to use it in preference to thymolphthalein. THIEL has shown that $K_1 = 10^{-9.07}$ and $K_2 = 10^{-9.55}$. A 0.01% solution of the indicator in 70% alcohol constitutes a satisfactory stock solution.

α -Naphtholphthalein.

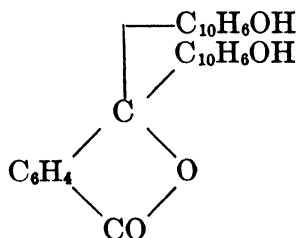

S. P. L. SÖRENSEN and S. PALITZSCH¹ first introduced this indicator which they prepared according to the directions of GRABOWSKI. A. THIEL² states that the compound possesses a more or less distinct rose color, depending upon the degree of its purity. Hence the color change has been described as either from rose to blue or from a faint yellow-rose to green. After considerable purification, THIEL finally succeeded in obtaining a practically white product. He concluded from this that commercial preparations are extremely impure, and that the rose color is associated with the presence of impurities which are difficult to remove. Commercial preparations always yield a brown solution in alcohol, whereas THIEL's product gave a colorless solution. Thus in this respect, α -naphtholphthalein resembles other phthaleins.

SÖRENSEN and PALITZSCH report the melting point of the compound as 253–255°. The stock solution should be a 0.1% solution in 50% alcohol. The interval lies between 7.4 and 8.8, the color changing from colorless to green-blue.

THIEL gives no particulars concerning his pure preparation. He merely mentions that a sample prepared according to W. SCHULENBERG,³ which the author has shown to be identical with the product of SÖRENSEN, behaves differently. SCHULENBERG's sample appears to be a dibasic indicator, changing from colorless

¹ S. P. L. Sørensen and S. Palitzsch: *Compt. rend. trav. Lab. Carlsberg*, 9 (1910).

² A. Thiel: *Z. physik. Chem., Bodenst.-Festband*, 352 (1931).

³ W. Schulenberg: *Ber.*, 53, 1445 (1920).

(acid form) to yellow at a pH near 5.7, and then from yellow to blue in the region where ordinary α -naphtholphthalein undergoes its color change. It would be desirable to have available more detailed information concerning the behavior of both samples of α -naphtholphthalein because the data recorded in the literature refer to the impure preparation.

A number of other phthaleins such as *o*-cresolphthalein, pyrogallolphthalein, etc., as well as halogen substitution products of certain of the above-mentioned compounds have been prepared and partially investigated. In general, however, these additional indicators offer few advantages over the compounds described in detail.

The transformation interval of *o*-cresolphthalein is between 8.2 and 9.8 (colorless to red). The colors of the pyrogallolphthalein in alkaline media are not very stable.

A. THIEL and L. JUNGFER¹ have studied the characteristics of various chlorine substitution products of phenolphthalein. R. T. K. CORNWALL and A. J. ESSELSTEYN² have described thymoltetrachlorophthalein,

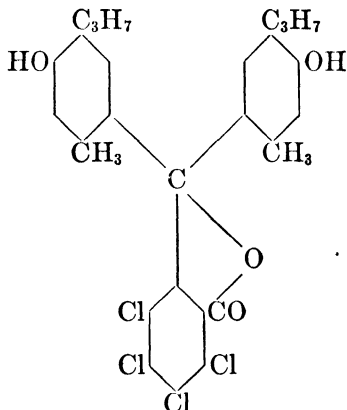

with a transformation interval from 9.2 (colorless) to 10.0 (blue). These authors have reported also that the dibromo derivative possesses an interval in the neighborhood of pH 8.6 (from colorless at 8.4 to blue at 8.8; this variation in pH seems to be much too small).

Information pertaining to several other halogenated phenolphthaleins has been summarized below.

Phenoltetraiodophthalein. Yellow powder; slightly soluble in 95% alcohol. Interval from 8.2 (colorless) to about 10 (blue-violet).

¹ A. Thiel and L. Jungfer: *Z. anorg. allgem. Chem.*, 178, 49 (1929).

² R. T. K. Cornwall and A. J. Esselsteyn: *J. Am. Chem. Soc.*, 49, 826 (1927).

Tetraiodophenoltetraiodophthalein. White powder; insoluble in alcohol. Transformation region from 7.6 (colorless) to 9.4 (blue).

Tetrabromophenolphthalein. White powder; soluble in alcohol. Interval between 7.6 (colorless) and 9.4 (violet).

Tetrabromophenoltetraiodophthalein. Yellowish powder; difficultly soluble in alcohol. Color-change interval from about 7.2 (colorless) to 9.0 (blue).

Chlorophenolphthalein (Grübler). A 0.1% solution in alcohol is colored yellow to yellow-orange. Use 1-2 drops of indicator solution per 10 cc. Acid color is a faint yellow-orange; the alkaline color is red-violet. The alkaline coloration is very unstable, and one should never wait longer than ten to fifteen minutes because the color fades rather rapidly. Interval, about 9.8-11.4.

Azo derivatives of phenolphthalein. H. EICHLER¹ has described the preparation and use of several azo derivatives of phenolphthalein without, however, mentioning their transformation intervals. It is also uncertain whether these new indicators are any better than the classical indicators. These compounds are:

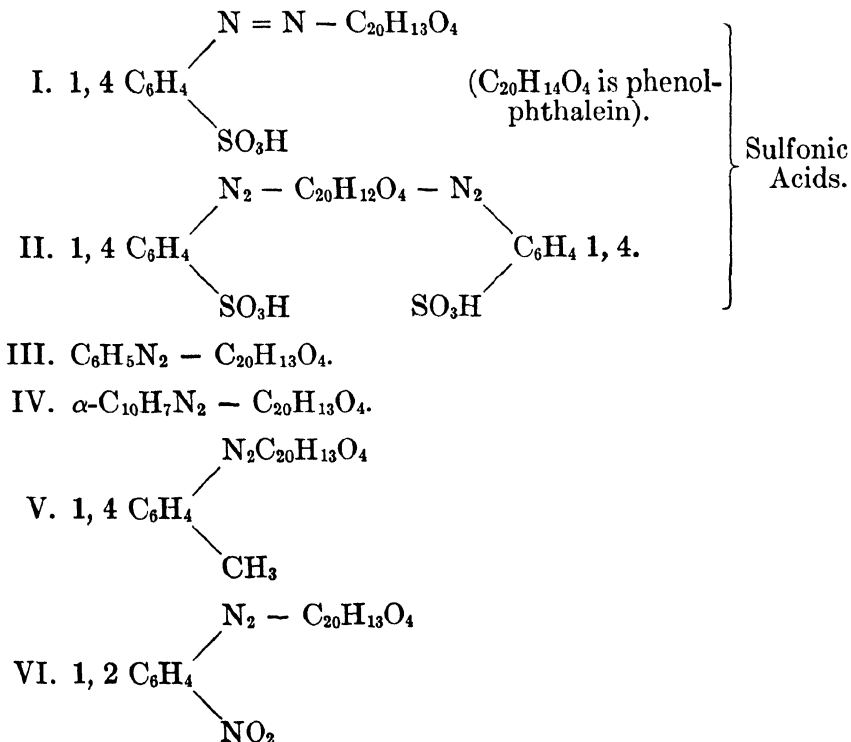

¹H. Eichler: Z. anal. Chem., 79, 81 (1929).

The free sulfonic acid II is a viscous substance. The remaining compounds may be obtained as solids. They are all soluble in alcohol. Compound II is soluble also in water. The properties of these substances are summarized in the table on page 117.

DR. EICHLER has kindly sent the following samples to the author who has established their transformation intervals:

- I. 8.0–9.6, light yellow to deep red,
- III. 9.4 to about 10.6, yellow to red-brown,
- IV. 8.2–9.6, light yellow to deep red,
- V. 8.8–10.6, faint yellow to red.

Although compounds I and IV are satisfactory, they offer no advantages over phenolphthalein. Substances III and V may perhaps be used in place of thymolphthalein. Unfortunately the color transition in the case of the compounds III and V is not especially pronounced.

The Sulfonephthaleins.

The two transformation regions of the sulfonephthaleins and of the phthaleins. The sulfonephthaleins are not colorless in weakly acid solutions, but are present in the form of a yellow quinoid compound. The color alteration results from the following structural changes:

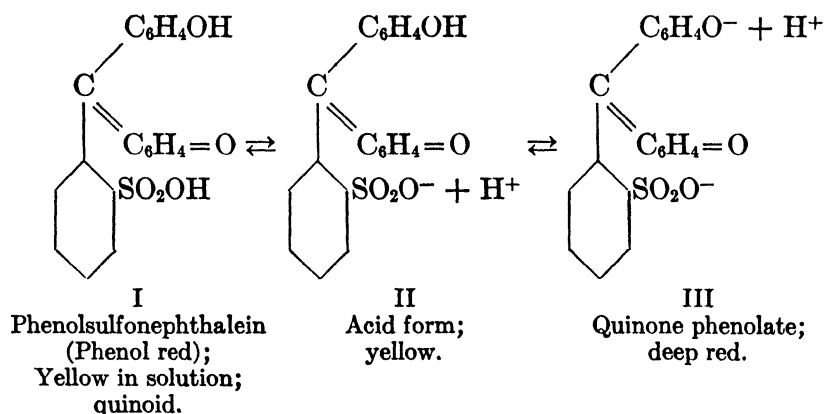

The proportion of the yellow to the red form is determined by the dissociation equilibrium $\text{II} \rightleftharpoons \text{III}$.

The sulfonephthaleins are much more stable towards alkali than the corresponding phthaleins. Accordingly, their decolorization in strongly alkaline solutions proceeds slowly. This was

AZO DERIVATIVES OF PHENOLPHTHALEIN (H. EICHLER¹; SEE PAGE 115)

	I	II	III	IV	V	VI
Color of solid	orange	red-brown	yellow	dark red	brown	red
Indicator content of stock solution, %	0.2%	0.2%	0.1-0.2%	0.2%	0.5%	0.5%
Color of solution	light yellow	deep yellow	light brown	red	red	golden yellow
Solvent	alcohol	water	alcohol	alcohol	alcohol	alcohol
Color change	→colorless →red	→deep yellow-brown →light yellow	→deep yellow →brown-red	colorless intense red	colorless red	red light yellow or colorless

¹ H. Eichler: Z. anal. Chem., 79, 81 (1929).

first observed by W. R. ORNDORFF,¹ and then studied more quantitatively by A. THIEL.² The structural changes involved in the fading of the color will be discussed in greater detail in Chapter Seven.

The indicators thymol blue, cresol red, and cresol purple have two transformation regions, one in rather strongly acid medium and another from yellow to blue, red or purple in the neighborhood of pH 7-8. I. M. KOLTHOFF³ has shown that the "acid" transformation range is not limited to the three sulfonephthaleins mentioned, but that all compounds of this class exhibit a color in strongly acid media. The quinoid group is weakly basic,⁴ and in the presence of strong acids may form a cation. It is difficult to decide whether the strong acid form is an oxonium or carbonium compound. The work of M. GOMBERG and CONE⁵ would indicate that the quinocarbiniol configuration is more probable. (See, however, Lund's explanation, Chapter Seven, section three.)

The color change of thymol blue in strong acid solutions has been described by KOLTHOFF (l.c.) in the following manner:

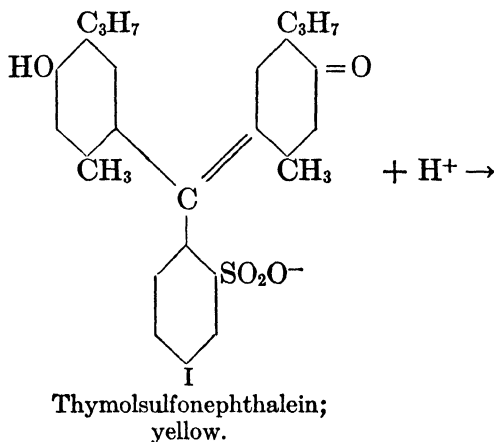

¹ W. R. Orndorff, R. C. Gibbs, and S. A. McNulty: *J. Am. Chem. Soc.*, *47*, 2767 (1925); *49*, 992 (1927).

² A. Thiel: *Monatsh.* *53/54*, 1008 (1929).

³ I. M. Kolthoff: *J. Phys. Chem.*, *35*, 1433 (1931).

⁴ A. v. Bayer and R. Hallensleben: *Ber.*, *36*, 2791 (1903). W. R. Orndorff and H. T. Lacey: *J. Am. Chem. Soc.*, *49*, 818 (1927).

⁵ M. Gomberg and Cone: *Liebig's Ann. Chem.*, *370*, 192 (1909). H. Lund: *J. Am. Chem. Soc.*, *49*, 1346 (1927). L. C. Anderson and M. Gomberg: *J. Am. Chem. Soc.*, *50*, 203 (1928). Anderson: *J. Am. Chem. Soc.*, *51*, 1889 (1929); *52*, 4567 (1930).

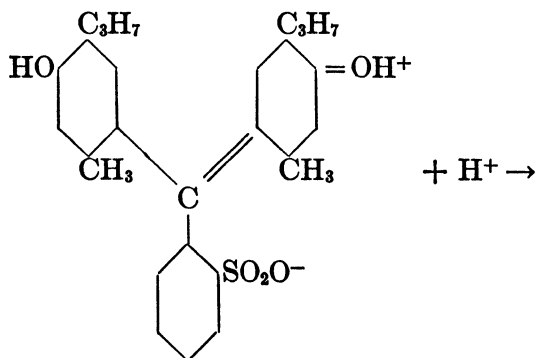

II
Hybrid ion; red.

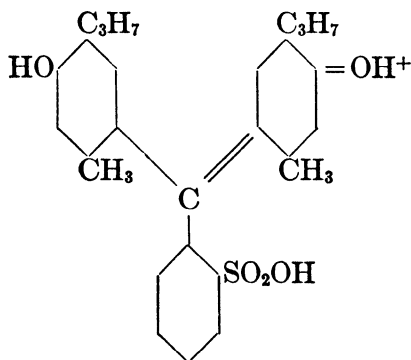

III
Cation; red.

The strong acid form II appears to be a hybrid ion (cf. also methyl orange and methyl red, page 145). It is possible that in the presence of large amounts of mineral acid, the dissociation of the sulfonic acid group is repressed so that the indicator exists as a cation (form III).

In the following table are recorded the colors of the various sulfonephthaleins in strongly acid solution as observed by KOLTHOFF.¹ The change in color of phenol red (P.R.) and of its dichloro- derivative should be observed in reflected light.

It is peculiar that the ionization of the quinone group should influence the color so profoundly. The free quinone compound is yellow while the color of its corresponding cation is red to red-violet. The alkaline form (quinone phenolate) on the con-

¹ I. M. Kolthoff: *J. Phys. Chem.*, 35, 1433 (1931).

COLOR OF SULFONEPHTHALEINS IN STRONGLY ACID SOLUTION

HYDROCHLORIC ACID CONCENTRATION	T.B.	P.R.	C.P.	C.R.	E.T.B.	C.P.R.	B.P.B.	T.B.P.B.	B.C.P.	B.C.G.
0.001 N	yellow	yellow	yellow	yellow	yellow	yellow	yellow	yellow	yellow	yellow
0.01	orange- red	yellow- orange	orange	orange	"	"	"	"	"	"
0.1	red-violet	orange	rose-red	orange- rose	"	"	"	"	"	"
1	"	"	"	rose-red	"	"	"	"	"	"
4	"	"	"	"	orange- red	orange- red	"	"	orange	orange
6	"	"	"	"	violet	orange	"	"	orange- red	"
12	"	"	"	"	"	"	orange- rose	faint	violet- red	violet
Concentrated sulfuric acid	"	"	"	"	purple	"	violet- red	faint yellow	red "	intense violet

T.B. is thymol blue.
P.R. is phenol red.
C.P. is cresol purple.
C.R. is cresol red.
B.T.B. is bromthymol blue.

C.P.R. is chlorphenol red.
B.P.B. is bromphenol blue.
T.B.P.B. is tetrabromphenol blue.
B.C.P. is bromcresol purple.
B.C.G. is bromcresol green.

trary possesses a much more intense color. When the color changes from yellow to that of the quinone phenolate or that of the hybrid ion (or cation), the maximum in the light absorption is displaced towards longer wave lengths. The investigations of W. R. ORNDORFF¹ and his coworkers indicate that the maximum absorption by the strong acid form lies at shorter wave lengths than in the case of the strong alkali form. The absorption coefficient of the latter is larger than that of the strong acid form, showing that the alkaline color is more intense.

The following general conclusions may be drawn from the studies of ORNDORFF and others:

1. The basic nature of the quinone group becomes less marked when halogens are substituted in the phenol group. For example,

$K_{\text{Bas.}}$ of phenol red $>$ $K_{\text{Bas.}}$ of chlorphenol red $>$ $K_{\text{Bas.}}$ of bromphenol blue $>$ $K_{\text{Bas.}}$ of tetrabromphenol blue.

2. The introduction of halogen causes a shift in the maximum of light absorption towards higher wave lengths (phenol red is orange in strongly acid solutions, while chlorphenol red is orange-red; bromphenol blue is violet-red in sulfuric acid). The effect of a halogen substitution on the color of the quinone phenolate (strong alkali form) is qualitatively similar to the effect on the quinoid cations.

3. The absorption of light by the strong acid forms of phenol-, thymol- and cresolsulfonephthaleins runs parallel with the absorption by the alkaline forms.

The phthaleins too assume a color in strong acid solutions. In aqueous solution, these compounds exist almost entirely as lactones, although here too we must assume that a small fraction is present in the quinoid form. The acid form, however, does not become visible until the acidity attained is much greater than that required by the corresponding sulfonephthalein. We find for example that thymolphthalein is still colorless in 6 N hydrochloric acid, but pale rose in 9 N and dark violet in concentrated hydrochloric or sulfuric acid. Phenolphthalein is weakly rose-colored in 9 N and 12 N hydrochloric acid, but orange-brown in concentrated sulfuric acid. α -naphtholphthalein also is colorless

¹ W. R. Orndorff and coworkers: *J. Am. Chem. Soc.*, 45, 486, 495 (1923); 47, 290 (1925); 48, 981, 2212 (1926); 49, 826, 1284, 1730 (1927); 50, 1416 (1928); 51, 1466 (1929).

in 6 N HCl, but weak green in 9 N acid and dark green in concentrated HCl or H₂SO₄. A green precipitate separates on standing.

Dichromatism of certain sulfonephthaleins. The color of the sulfonephthaleins depends of course upon the quantity and kind of light which they absorb. It should be noted in this connection that the alkaline form of a number of these indicators, especially bromphenol blue and bromcresol purple, exhibit the phenomenon of "dichromatism." Thin films appear to be blue while greater thicknesses are colored red. CLARK has advanced the following explanation for this effect. In alkaline solution, the predominant absorption bands are in the yellow and green, so that chiefly red and blue light is transmitted. Suppose the intensity of the incident light is I . After passing through unit depth of the liquid, the intensity becomes Ia , where a is the "transmission coefficient." The value of a is determined by the nature of the absorbing medium and by the wave length of the incident light. The intensity of light is Ia^ϵ after passage through a depth ϵ . Thus the transmitted blue light has an intensity $Ia^\epsilon_{\text{blue}}$ and the red light Ia^ϵ_{red} .

Let us assume now that the intensity of the blue light in arbitrary units is 100 and that of the red light is 30. Taking certain of CLARK'S figures, we have:

$$a_{\text{blue}} = 0.5 \quad \text{and} \quad a_{\text{red}} = 0.8.$$

For $\epsilon = 1$: $Ia^\epsilon_{\text{blue}} = 50$ and $Ia^\epsilon_{\text{red}} = 24$; therefore
blue color is more intense than red.

$\epsilon = 10$: $Ia^\epsilon_{\text{blue}} = 0.1$ and $Ia^\epsilon_{\text{red}} = 3.0$; therefore
blue is less intense than red.

Hence if we observe a thin layer of the liquid, it appears to be blue, whereas thicker layers are red. Should the intensity of the incident colors change, the color of the solution will also be different. Thus if $I_{\text{red}} = 100$ and $I_{\text{blue}} = 30$, then for $\epsilon = 1$, $Ia_{\text{blue}} = 15$ and $Ia_{\text{red}} = 80$. Therefore the red color predominates, and the solution is colored red. Actually when we observe the solution in a room illuminated by a carbon filament lamp instead of by daylight (much blue light), the color changes from blue to red.

These considerations are useful also in explaining phenomena which are in evidence when certain phenolsulfonephthaleins are

employed in turbid solution, such as in suspensions of bacteria cultures. When a great depth of liquid is involved, very little light reaches the eye from the bottom of the tube. Most of the light is reflected sidewise by the suspended particles and will pass through only a small layer of liquid. Hence the color appears to be blue. A comparison of the color with that of the indicator in a clear buffer solution is impossible unless very little liquid is used; and even then the results are only approximations.

It is possible to eliminate this error by filtering out either the red or the blue. Which of these two colors is to be removed depends upon the absorption spectrum of the indicator solution.

The author wishes to point out the fact that sulfonephthaleins in solutions of certain substances may exhibit a color entirely different from their color in the buffer solutions serving for purposes of comparison. When the solution under investigation has a "transmission coefficient" for red or blue light which differs from that of the aqueous buffer solutions, the colors of both solutions are no longer comparable. Thus the author has observed that in the presence of various substances such as alcohol, acetone, and certain alkaloid salts which absorb one form of the transmitted light, the dichromatism of bromphenol blue and other sulfonephthaleins is completely eliminated. For example, bromphenol blue in alcoholic medium or in a dilute alcohol solution changes from yellow to a pure blue. In aqueous solution, the intermediate colors are totally different. These facts must be borne in mind in connection with the colorimetric determination of hydrogen ion concentration.

Fortunately we are able to replace bromphenol blue and bromcresol purple with other sulfonephthaleins which do not show dichromatism. W. C. HARDEN and N. L. DRAKE¹ have prepared tetrabromophenoltetrabromosulfonephthalein (tetrabromophenol blue) which may be used in place of bromphenol blue. Both indicators have the same transformation range (pH 3.0–4.6) with a color change from pure yellow to pure blue. Chlorphenol red, with a color change from yellow to red, is a good substitute for bromcresol purple.

The sulfonephthaleins are very valuable indicators because their colors change very distinctly from yellow to red, blue, or purple.

¹ W. C. Harden and N. L. Drake: *J. Am. Chem. Soc.*, 51, 562 (1929).

Preparation, purity, and properties of the sulfonephthaleins. The preparation of the various sulfonephthaleins from *o*-sulfobenzoic acid, molten zinc chloride, and a phenol (which may be halogen substituted) has been described by CLARK and LUBS.¹ A. COHEN² has reported his method of obtaining xylenolsulfonephthalein, while a number of other valuable sulfonephthaleins have become available through the work of Barnett Cohen.³

Since the publications of B. COHEN are not readily accessible, details of the preparation of the three most important of his indicators, tetrabromo-*m*-cresolsulfonephthalein (bromocresol green), *m*-cresolsulfonephthalein (cresol purple), and dichlorophenolsulfonephthalein, will be given here.

Metacresolsulfonephthalein is obtained from *o*-sulfobenzoic acid and distilled metacresol. 36.2 g. of freshly distilled metacresol are heated to 110° and mixed with 30.8 g. of *o*-sulfobenzoic acid. The mixture is stirred for six hours in a bath at 106°. The progress of the reaction is tested by noting the color produced by a drop of reaction mixture in a ten per cent soda solution and in a dilute acid solution. The heating may be discontinued when the maximum color intensity is attained. The mixture is steam distilled to remove metacresol and then, while still warm, treated carefully with sodium carbonate until the solution assumes a deep purple color. After standing over night, the solution is filtered, and concentrated hydrochloric acid is added to the filtrate which turns a deep red color. Crystallization is induced by evaporating the solution in vacuum. Small green crystals of the sulfonephthalein separate out, and may be washed with water to remove salt and acid. This product as it stands is pure enough for use as an indicator. The yield is 12 g.

Bromocresol green (tetrabromo-*m*-cresolsulfonephthalein). A solution of 25 g. bromine in 150 c.c. of glacial acetic acid is added slowly to a suspension of 15 g. metacresolsulfonephthalein in 150 c.c. of glacial acetic acid. The stirred mixture is maintained at a temperature below 30°. The progress of the reaction is followed by observing the color produced by a drop of the solution in a buffer mixture with a pH of 7. When a maximum color

¹ W. M. Clark and Lubs: *J. Wash. Acad. Sci.*, 5, 610 (1915); 6, 481 (1916); *J. Bact.*, 2, 110 (1917).

² A. Cohen: *Biochem. J.*, 16, 31 (1922); 17, 535 (1923).

³ Barnett Cohen: *Public Health Reports Reprint*, 38, 814 (1923); 41, 3051 (1926); *Proc. Soc. Exptl. Biol. Med.*, 20, 124 (1922).

intensity is produced, the excess bromine is removed by aeration. The remaining mixture is poured into 300 c.c. of water and treated with sodium carbonate sufficient to turn the solution a permanent green. This solution is filtered after having stood over night, and the filtrate is treated with hydrochloric acid and then evaporated. As acetic acid is removed, the bromocresol green separates out as a dark red-brown mass. A light yellow product with a melting point of 217–218° (corr.) is obtained after recrystallization from glacial acetic acid.

Chlorphenol red (dichlorophenolsulfonephthalein, $C_{19}H_{12}O_5SCl_2$) was prepared by B. COHEN in the following manner. 32 g. of dry *o*-chlorophenol were heated to 130° and treated with 23 g. of crystalline *o*-sulfobenzoic acid while stirring. The mixture is kept at this temperature for about six hours until the color intensity is at a maximum. Water is then added, and the excess *o*-chlorophenol removed by steam distillation. Sodium carbonate is added slowly to the residue in the flask until the solution becomes deep blue-red. The solution is permitted to stand over night before filtering. Concentrated hydrochloric acid is added to the filtrate until a precipitate is formed. This solid is filtered off and washed with dilute hydrochloric acid. The dilute acid wash solution is used instead of water because chlorphenol red is appreciably soluble in water. More of the indicator may be crystallized out of the mother liquor simply by evaporation. The water and hydrochloric acid adhering to the crystals are removed by drying in a warm enclosure. The crystals are very small, and are colored a dark green with a reddish luster. The product obtained after recrystallization from glacial acetic acid has a melting point of 261–262° (corr.).

The common sulfonephthaleins may be procured from a number of manufacturers,¹ although *their purity leaves much to be desired*. Several authors² have observed that preparations from various sources differ greatly in the color intensities of their solutions. Although the degree of purity of an indicator is of secondary importance in many colorimetric pH measurements,

¹ The author has found that the purest preparations are to be obtained from Hynson, Westcott and Dunning (Baltimore, Md.).

² B. Collins: *J. Ind. Eng. Chem.*, 12, 800 (1920). Schlegel and Streuber: *Ind. Eng. Chem.*, 19, 631 (1927). M. G. Mellon and G. W. Ferner: *J. Phys. Chem.*, 35, 1925 (1931).

impurities may give rise to serious errors especially when measurements are being made in slightly buffered solutions (cf. Chapter Nine, section seven; for example, in distilled water or drinking water). Hence the reliability of a sample should be tested whenever possible by determining its melting point.

I. M. KOLTHOFF and T. KAMEDA¹ have preferred to examine the purity by titrating the indicator solution conductometrically. The sulfonic acid group in sulfonephthaleins behaves as a strong acid; and in a titration with alkali, the conductivity diminishes just as in the case of a strong acid. A break occurs in the titration curve when the sulfonic acid group is neutralized, and thereafter the conductivity increases until the phenol group is neutralized. A second break occurs at this point and from there on the conductivity increase is due to the free alkali added. Thus two breaks are obtained; and for pure preparations the quantity of alkali required to reach the first point should equal the quantity used up between the first and second. Relatively few of the samples investigated by the author fulfilled this requirement.

DR. GERHARD KLOTZ (Chemisches Laboratorium, Leipzig N 22), who is engaged in the commercial preparation of indicators, was kind enough to impart to the author much valuable information concerning these compounds. Frequently commercial samples are merely resinous condensation products purified only by washing with water. Although the resins themselves are insoluble, they dissolve in soda solution in the presence of excess sulfonephthalein. Obviously it is difficult to attain a very high degree of purity simply by precipitation from alkali solution upon addition of acid.

DR. KLOTZ has found furthermore that the unbrominated sulfonephthaleins such as phenol red, cresol purple, thymol blue, etc., possess a marked tendency to form molecular compounds with their corresponding phenols. Apparently the stability of the indicator solutions depends upon this phenol content.

There are no general rules for the purification of these compounds.

The properties of the most important of the sulfonephthaleins will be discussed in greater detail in the following pages.

¹ I. M. Kolthoff and T. Kameda: *J. Am. Chem. Soc.*, *53*, 825 (1931).

Thymolsulfonephthalein, Thymol blue, $C_{27}H_{35}O_5S$.

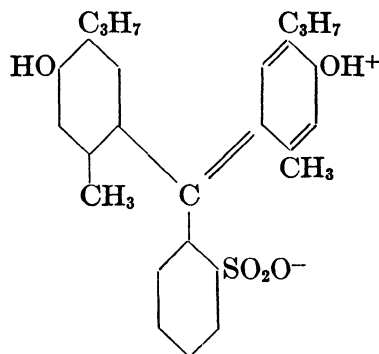

Inner salt; hybrid ion.

The crystals are dark colored and contain about one molecule of water of crystallization (quinoid hydrate). W. R. ORNDORFF and T. K. CORNWELL¹ have described a method of preparation which is superior to that of CLARK and LUBS. The indicator shows two transformation regions: red to yellow at pH 1.2–2.8, and yellow to blue between 8.0 and 9.6.

The indicator dissolves in a saturated aqueous sodium bicarbonate solution yielding a red color. It imparts a purple color to a 10% caustic soda solution which, after dilution with water, changes to blue. Acidification of an alkaline solution at room temperature produces an amorphous red precipitate, whereas acidification of a boiling solution yields greenish crystals.

Thymol blue is only slightly soluble in water (yellow-orange). At 25° the solubility is 110 mg. per liter (2.3×10^{-4} M), and diminishes in dilute hydrochloric acid (7.2 mg. per l. in 0.01 N HCl; 2.6 mg. per l. in 0.05 N HCl; 1.8 mg. per l. in 0.1 N HCl; 1.6 mg. per l. in 0.5 N HCl; 1.8 mg. per l. in 1 N HCl; 5.0 mg. per l. in 6 N HCl). The slight solubility at pH values between 2.5 and 1 accounts for the fading of the indicator color in solutions of this acidity.

ORNDORFF and CORNWELL state that thymol blue can be recrystallized from ether or glacial acetic acid. Its solubility in acetone, chloroform, carbon tetrachloride, benzene, toluene, xylene, and ethyl acetate is too small.

¹ W. R. Orndorff and T. K. Cornwell: *J. Am. Chem. Soc.*, 48, 981 (1926).

Pulverizing the crystals produces a chocolate brown powder which loses water at 59° and turns red at 195°. Carbonization occurs between 200° and 220°, and the powder melts forming a dark red opaque liquid.

Thymol blue itself is known only in the quinoid form although esters showing the lactone structure have been prepared. ORNDORFF and CORNWELL have obtained two forms of the dimethyl ether. One substance, derived from the lactone form, was colorless and insoluble in water and 10% alkali, while the other compound (derived from the quinone form) was colored and unstable.

Dibromothymolsulfonephthalein, Bromthymol blue, $C_{27}H_{28}O_5SBr_2$. This compound was isolated by ORNDORFF and CORNWELL (l. c.) in the colorless form, and was thought by them to be a derivative of the lactone (sultone) form. It forms a colored quinoid hydrate from which the colorless compound is recovered upon heating. The crystalline hydrate contains two molecules of water of crystallization. It is obtained in the form of dark colored crystals which yield a red powder upon being pulverized.

The indicator dissolves in water forming an orange-red solution. It is readily soluble in ether, methyl alcohol, and ethyl alcohol, much less soluble in benzene, toluene, and xylene, and insoluble in ligroin. Its transformation interval is from pH 6.0 to 7.6 (yellow to blue).

Phenolsulfonephthalein, Phenol red, $C_{19}H_{14}O_5S$. W. R. ORNDORFF and F. W. SHERWOOD¹ state that phenol red usually contains a red colored impurity possessing weakly acid properties and which is insoluble in water and sodium bicarbonate solutions although readily soluble in sodium hydroxide. They recommend that this indicator be purified by dissolving the sample in sodium bicarbonate and acidifying the filtrate. The air dried product always contains about 1–1.5% of water which may be removed completely by heating at 120–140°. Water is reabsorbed from the atmosphere by the dry powder.

Phenol red has a structure similar to that of thymol blue, and is known only in the deeply colored form. ORNDORFF and SHERWOOD, however, have succeeded in preparing a colorless mono-

¹ Orndorff and Sherwood: J. Am. Chem. Soc., 45, 486 (1923).

methyl ether (needles; melting point 178°). The solution of this ether in water is yellow and remains yellow upon addition of alkali. The colored monomethyl ether is obtained simply by heating the colorless form for a half hour at 170° .

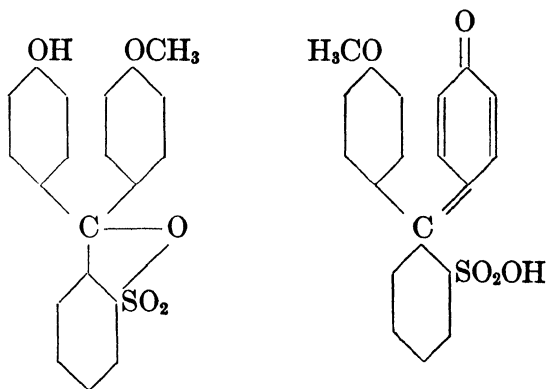

Colorless (lactone = sultone).

Colored (quinoid).

The color change interval of phenol red is from pH 6.4 to 8.2, the color going from yellow to red.

Tetrabromophenolsulfonephthalein, Bromphenol blue, $C_{19}H_{12}O_6Br_4S$ (carbinol form). According to ORNDORFF and SHERWOOD,¹ bromphenol blue usually has an orange or brown color (partially hydrated?). Colorless crystals, which decompose while melting at 279° , are obtained by recrystallizing from glacial acetic acid and drying over solid sodium hydroxide. It is noteworthy that bromphenol blue exists in the solid state as the colorless lactone whereas phenol red is known only as a quinoid compound. The author believes that the bromine atoms, which reduce markedly the basicity of the quinone group, are responsible for this difference. The indicator forms a colored hydrate. The properties of the monomethyl ether have been described by ORNDORFF and SHERWOOD.

The transformation interval of bromphenol blue is pH 3.0–4.6, yellow to purple. The indicator is not well suited for colorimetric pH determinations because of the disturbing effect of dichromatism. Tetrabromophenoltetrabromosulfonephthalein is more suitable for this purpose.

¹ Orndorff and Sherwood: J. Am. Chem. Soc., 45, 495 (1923).

Metacresolsulfonephthalein, Cresol purple. Its structural formula is

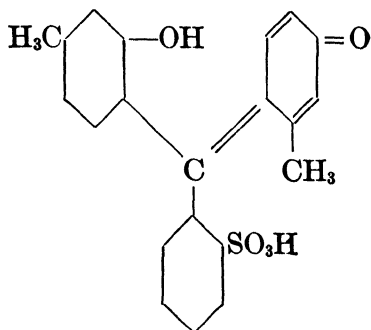

or the corresponding hybrid ion.

Cresol purple always has a dark color which indicates the presence of the quinoid structure. W. R. ORNDORFF and A. C. PURDY¹ find that the crystalline material contains about 1% of water. The crystals appear to reflect a dark green light, and yield a dark red powder when pulverized. It is slightly soluble in water (yellow), dissolves readily in methyl alcohol, ethyl alcohol, and glacial acetic acid, but is insoluble in benzene, ether, carbon tetrachloride, petroleum ether, and ethyl acetate. Its melting point is not clearly defined.

The indicator has two transformation regions: red to yellow between pH 1.2–2.8 and yellow to purple between pH 7.4–9.0.

The strong acid form of this indicator is more soluble than that of thymol blue.

Tetrabromocresolsulfonephthalein, Bromcresol green. W. R. ORNDORFF and A. C. PURDY² produced this compound in the colorless lactone form. It exists also as a colored hydrate with a quinoid structure. The latter compound loses its water when heated and is transformed to the uncolored compound. The melting point of the colorless compound is 218–219° (B. COHEN, 217–218° corr.).

The dark red amorphous hydrate turns orange at about 90°, becomes colorless at about 190°, and melts at 218–219°, the melting point being sharp. It is slightly soluble in water, very soluble in ether, ethyl acetate, and ethyl alcohol, but much less soluble in glacial acetic acid and benzene.

¹ W. R. Orndorff and A. C. Purdy: *J. Am. Chem. Soc.*, 48, 2212 (1926).

² W. R. Orndorff and A. C. Purdy: *J. Am. Chem. Soc.*, 48, 2216 (1926).

The color changes from yellow to blue at pH 3.8–5.6.

Aside from the sulfonephthaleins listed in the table on page 108, several others have been reported. Although they offer no practical advantage over the compounds described in detail, their properties will be summarized for the sake of completeness.

Xylenol blue or *p-Xylenolsulfonephthalein* was prepared and proposed by A. COHEN.¹ This indicator changes color in the same ranges as shown by thymol blue, namely, from red to yellow between pH 1.2 and 2.8, and yellow to blue at pH 8.0–9.6. Cohen states that the color intensity of this dye is twice that of thymol blue, although the author has never been able to verify this observation using commercial preparations.

Catecholsulfonephthalein shows the following colors in solution: rose at pH 0.2, orange at 0.8, yellow at 4.0, green at 7.0, violet at 8.5, blue² at 10.2.

C. B. WOOD³ reports that the indicator is a dark red, amorphous substance. The intensity of its aqueous solutions is only 1/10 that of other sulfonephthaleins. The same investigator finds a satisfactory color change in the pH range 0 to 1.5. Its use in alkaline solutions is not recommended because the color is unstable.

Diiodophenolsulfonephthalein (CLARK, COHEN, and ELVOVE, l.c.). pH 5.7 (yellow) to 7.3 (purple).

Phenolnitrosulfonephthalein (CLARK, COHEN, and ELVOVE). pH 6.6 (yellow) to 8.4 (purple).

Dibromodichlorophenolsulfonephthalein (Bromchlorphenol blue) (B. COHEN 1926). pH 3.2 (yellow) to 4.8 (purple).

Dibromophenolsulfonephthalein (Bromphenol red) (B. COHEN 1924). pH 5.4 (yellow) to 7.0 (red).

α -Naphtholsulfonephthalein (Naphthol blue) (CLARK and LUBS 1916). pH 7.6 (yellow) to 9.0 (blue).

Salicylsulfonephthalein (Salicyl red) $C_{21}H_{14}O_9S$ (W. C. HARDEN⁴). pH 6.6 (yellow) to 8.2 (violet-red).

Tetrabromosalicylsulfonephthalein (Salicyl purple) $C_{21}H_{10}O_9SBr_4$ (W. C. HARDEN⁴). pH 3.2 (yellow) to 4.6 (purple).

Hydroquinonesulfonephthalein, $C_{19}H_{12}O_6S$. This substance was prepared and studied by W. R. ORNDORFF and C. V. SHAPIRO.⁵ The solid has the quinoid structure, and exists as dark red, thin plates which

¹ A. Cohen: *Biochem. J.*, 16, 31 (1922); 17, 535 (1923).

² W. M. Clark, B. Cohen, and Elvove: *Intern. Crit. Tables*, 1 (1927).

³ C. B. Wood: *J. Am. Chem. Soc.*, 52, 3463 (1930).

⁴ W. C. Harden: *J. Am. Chem. Soc.*, 49, 3139 (1927).

⁵ W. R. Orndorff and C. V. Shapiro: *J. Am. Chem. Soc.*, 50, 1730 (1928).

yield a red powder when ground. This sulfonephthalein contains a pyrone ring.

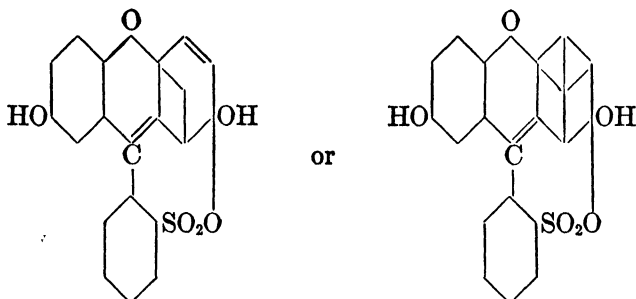

The indicator may be recrystallized from a hot, weakly acid aqueous solution. Its solubility at 22° is 117 mg. per liter of water and 120 mg. per liter of absolute alcohol. It is practically insoluble in organic solvents. The indicator properties of the compound were investigated by B. COHEN. He found that the color of the indicator changes in the following manner: pH 1-5 brown-yellow; 5-6 yellow; 6.4-8 yellow-green to olive green; 8-10 purplish. The alkaline, blue-violet color changes rapidly to brown. Accordingly the indicator has little practical usefulness.

Hydroxyhydroquinonesulfonephthalein, $C_{19}H_{12}O_8S\frac{1}{2}H_2O$.

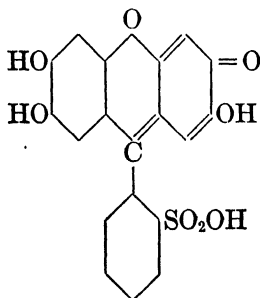

The properties of this substance were studied by W. R. ORNDORFF and M. L. WILLARD.¹ The solid is obtained in the form of green crystals which contain a half molecule of water of crystallization and which are converted into an orange-red powder upon grinding.

It is slightly soluble in water, forming a red solution with a marked *green fluorescence*. The compound dissolves in methyl alcohol, ethyl alcohol, acetone, and glacial acetic acid, but is insoluble in benzene, toluene, ether, and petroleum ether. In concentrated sulfuric acid it yields a yellow solution which does not fluoresce. ORNDORFF and

¹ W. R. Orndorff and M. L. Willard: *J. Am. Chem. Soc.*, 51, 1466 (1929).

WILLARD believe that there is formed some sulfonevioletin ($C_{19}H_{10}O_7S$), which is violet-red as a solid.

Little is known about its indicator properties. ORNDORFF and WILLARD mention only that in aqueous solution its color at pH 7.2 is orange-yellow to red, and at pH 12.0 the color is violet-red.

Dibromohydroxyhydroquinonesulfonephthalein. ORNDORFF and WILLARD prepared this compound in the form of green crystals which are soluble in water. The color changes from orange-red to violet-red in the neighborhood of pH 6.4. Its color is blue in a concentrated sodium hydroxide solution.

W. C. BOYD and A. W. ROWE¹ have described the properties of a new series of halogenated sulfonephthaleins.

1. *Phenoltetraiodosulfonephthalein* ($C_{19}H_{10}O_5I_4S$) exists as small red-black crystals, containing 8–10% water, which melt (water-free) at 180°. It decomposes at 210°. The indicator is soluble in methyl alcohol, ethyl alcohol, acetone, glacial acetic acid, and ethyl acetate, is less soluble in benzene, carbon tetrachloride, and $C_2Cl_4H_2$, and very insoluble in water. Its interval is pH 7.0 (brown-yellow) to 8.2 (red-purple).

2. *o-Cresoltetraiodosulfonephthalein* ($C_{21}H_{14}O_5I_4S$) possesses the same properties as the preceding compound. Its interval is from pH 8.8 (brown-yellow) to 9.6 (purple). HARDEN and DRAKE (cf. below) report the interval to be pH 7.0–8.6! Apparently the samples of BOYD and ROWE were impure.

3. *Phenoltetrabromosulfonephthalein* ($C_{19}H_{10}O_5Br_4S$) also has the same properties as compound 1. Its interval is pH 7.2 (brown-yellow) to 8.0 (purple). (HARDEN and DRAKE report 6.6–8.2.)

4. *Tetrabromophenoltetrabromosulfonephthalein* ($C_{19}H_6O_5Br_8S$). Its interval is 5.6–7.0. All colors are more or less green. (HARDEN and DRAKE report 3.0–4.6.)

The earlier investigations of W. C. HARDEN and N. L. DRAKE² indicate that the samples of BOYD and ROWE were not pure.

These new indicators as well as those of CLARK and LUBS and of B. COHEN are halogenated sulfonephthaleins. Except for tetrabromophenoltetrabromosulfonephthalein, these compounds offer no special advantages over the indicators originally recommended. The properties of these new substances are summarized in the following table.

It has already been stated that tetrabromophenoltetrabromosulfonephthalein (tetrabromophenol blue) is a good substitute for bromphenol blue because it changes from yellow to pure blue and exhibits no dichromatism.

¹ W. C. Boyd and A. W. Rowe: J. Am. Chem. Soc., 52, 4954 (1930).

² W. C. Harden and N. L. Drake: J. Am. Chem. Soc., 51, 562 (1929).

SULFONEPHTHALEINS ACCORDING TO HARDEN AND DRAKE

NAME OF INDICATOR	INTERVAL IN PH	ACID-ALKALINE COLOR	C.C. 0.1 N NaOH SOLUTION PER 100 MG. INDICATOR
Tetrabromophenoltetrabromosulfonephthalein $C_{19}H_6O_5Br_8S$ M = 986	3.0-4.6	yellow-blue	1.01
Tetrabromophenoltetrachlorosulfonephthalein $C_{19}H_6O_5Cl_4Br_4S$ M = 808	3.0-4.6	yellow-blue	1.24
Dibromo- <i>o</i> -cresoltetrabromophenolsulfonephthalein $C_{21}H_{12}O_5Br_6S$ M = 856	5.2-6.8	yellow-violet	1.17
Dibromo- <i>o</i> -cresoltetrachlorosulfonephthalein $C_{21}H_{12}O_5Br_2Cl_4S$ M = 688	5.2-6.8	yellow-violet	1.45
Dibromophenoltetrabromophenolsulfonephthalein $C_{19}H_8O_5Br_6S$ M = 828	5.6-7.2	yellow-purple	1.21
Phenoltetrabromosulfonephthalein $C_{19}H_{10}O_5Br_4S$ M = 670	6.6-8.2	yellow-purple	1.49
Phenoltetrachlorosulfonephthalein $C_{19}H_{10}O_5Cl_4S$ M = 492	6.6-8.2	yellow-purple	2.03
<i>o</i> -Cresoltetraiodosulfonephthalein $C_{21}H_{14}O_5I_4S$ M = 886	7.0-8.6	yellow-purple	1.13
<i>o</i> -Cresoltetrabromosulfonephthalein $C_{21}H_{14}O_5Br_4S$ M = 698	7.2-8.8	yellow-purple	1.43
<i>o</i> -Cresoltetrachlorosulfonephthalein $C_{21}H_{14}O_5Cl_4S$ M = 520	7.2-8.8	yellow-purple	1.93

The Benzeins. In connection with the phthaleins and sulfonephthaleins, the properties of certain benzeins should also be discussed. The benzeins contain neither a carboxyl nor a sulfonic acid group, although their properties resemble those of the sulfonephthaleins. They are usually strongly colored in the solid state (quinoid structure), and change color in the same pH range as the sulfonephthaleins. Since the benzeins contain no polar group, they behave differently from the sulfonephthaleins in that they dissolve in water with greater difficulty than do the latter compounds. For this reason thymolbenzein and α -naphtholbenzein can not be used as indicators for determining pH. The other benzeins, however, are very valuable for this purpose because their salt error is much less than that of the corresponding sulfonephthaleins.¹

The benzeins also have two transformation ranges, one in strongly acid solution (cation formation by the weakly basic

¹ I. M. Kolthoff: J. Phys. Chem., 35, 1433 (1931).

quinoid group) and the other in weakly acid, neutral, or alkaline solution (quinone phenolate). The structures in question are illustrated below in the case of thymolbenzein.

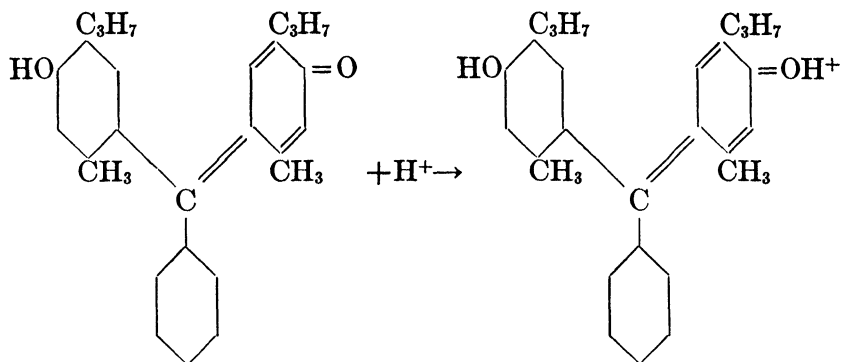

Thymolbenzein; quinoid; yellow.

Strong acid form; cation; red.

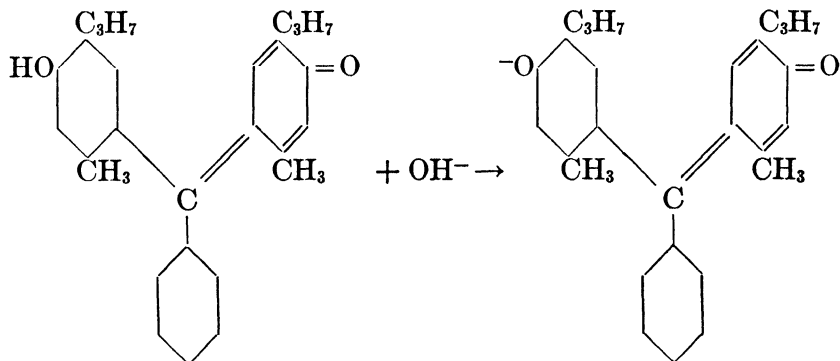

Thymolbenzein; quinoid;
yellow.

Alkaline form; red, violet, or
blue; quinone phenolate.

The succeeding table gives the color variation of these compounds in strong acid solutions as found by KOLTHOFF (l.c. 1931).

COLOR CHANGE OF BENZEINS IN STRONGLY ACID SOLUTION

CONCENTRATION OF HYDROCHLORIC ACID	T.Bz.	P.Bz.	<i>o</i> -C.Bz.	B.T.Bz.	B.C.Bz.
0.01 N	yellowish	yellow	yellow	yellow	yellow
0.1	rose	"	orange-rose	"	"
1	rose-red	"	rose	"	"
4	"	"	"	"	orange
6	"	"	"	orange	rose
12	"	"	"	red	red
H ₂ SO ₄	"	"	"	violet	violet-red

T.Bz. is thymolbenzein; P.Bz. is phenolbenzein (Aurin); *o*-C.Bz. is *o*-cresolbenzein; B.T.Bz. is dibromothymolbenzein; B.C.Bz. is dibromocresolbenzein.

The following transformations have been established on the alkaline side:

INDICATOR	RANGE	ACID-BASE COLOR
Dibromo- <i>o</i> -cresolbenzein	5.2-6.8	yellow-purple
Phenolbenzein (Aurin)	6.0-7.6	yellow-red
<i>o</i> -Cresolbenzein	7.2-8.6	yellow-red

All of these indicators are made up in 0.1% alcohol solutions. One or two drops of indicator solution are used per 10 c.c. of unknown solution.

The behavior of thymolbenzein, dibromothymolbenzein, and α -naphtholbenzein is somewhat abnormal because of their very slight solubility in water. In alcoholic solution they resemble the corresponding sulfonephthaleins.

Thymolbenzein (in water). At pH 9.0, the solution is brown-yellow and opalescent due to the precipitation of the indicator. The color at pH 10.2 is bluish, the color intensity increasing with higher pH.

Dibromothymolbenzein (in water). The color of its solution is yellow-brown at a pH of 9.0, a weak green at 9.2, distinct green at 9.8, bluish at 10.2, and deep blue at 10.6.

α -Naphtholbenzein (in water) is brownish at pH 9.8 and green-blue at 11.6.

Because of their insolubility, these three indicators are not very useful in aqueous media.

The properties of a number of benzeins have been described by ORNDORFF and coworkers. They recommend certain derivatives as being very useful in colorimetric pH determinations.

Phenolbenzein (Aurin, benzaurin, or rosolic acid) was prepared by W. R. ORNDORFF, R. C. GIBBS, and S. A. McNULTY.¹ In 33% potassium hydroxide, the compound forms a colorless solution (carbinol compound like the phthaleins).

Thymolbenzein, $C_{27}H_{30}O_2$, was prepared by W. R. ORNDORFF and H. T. LACEY.² It is a red powder, may be recrystallized from alcohol, and melts at 184°. It is soluble in ether, very

¹ W. R. Orndorff, R. C. Gibbs, and S. A. McNulty: *J. Am. Chem. Soc.*, *47*, 2767 (1925).

² W. R. Orndorff and H. T. Lacey: *J. Am. Chem. Soc.*, *49*, 818 (1927).

soluble in formic acid, acetic acid, methyl alcohol, and acetone, and insoluble in water and ligroin.

Dibromothymolbenzein, $C_{27}H_{28}O_2Br_2$, exists as large red crystals with a melting point at $96-97^\circ$. It is soluble in acetone, ether, methyl alcohol, and ethyl alcohol, less soluble in ligroin, and insoluble in water.

o-Cresolbenzein, $C_{21}H_{18}O_2$, was described by W. R. ORNDORFF and S. A. McNULTY.¹ It is an orange-red powder which melts at $260-262^\circ$.

Dibromo-o-cresolbenzein, $C_{21}H_{16}Br_2O_2$, ORNDORFF and McNULTY.
Pyrogallolbenzein, $C_{19}H_{12}O_5$?, ORNDORFF and WANG.²

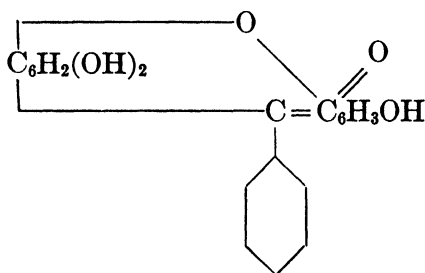

This compound is insoluble in water, but dissolves in sulfuric acid with a dark red color, and in concentrated hydrochloric acid with an orange-yellow color. In alkaline solution it is blue. ORNDORFF and WANG have prepared the crystalline hydrochloride, sulfate, and perchlorate of this substance.

The Methoxytriphenylcarbinols. The methoxytriphenylcarbinols are derivatives of triphenylcarbinol,

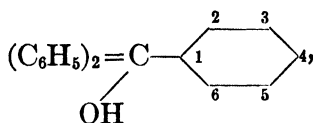

which behaves as a weak base. Hakon Lund³ has prepared and studied intensively a number of such derivatives. His experiments were performed in a mixture of acetone and water. I. M. KOLTHOFF⁴ also has determined the properties of these com-

¹ W. R. Orndorff and S. A. McNulty: *J. Am. Chem. Soc.*, *49*, 992 (1927).

² W. R. Orndorff and Ch. Wang: *J. Am. Chem. Soc.*, *49*, 1284 (1927).

³ H. Lund: *J. Am. Chem. Soc.*, *49*, 1346 (1927).

⁴ I. M. Kolthoff: *J. Am. Chem. Soc.*, *49*, 1218 (1927).

pounds in aqueous solutions, and has found that the hepta-, hexa-, and pentamethoxytriphenylcarbinols are especially valuable. These indicators differ from phenolphthalein in that their acid color is red whereas their alkaline solutions are colorless.

2,4,6,2',4',2'',4''-Heptamethoxytriphenylcarbinol (Heptamethoxy red), $C_{26}H_{30}O_8$, is prepared from 2,4-dimethoxyiodobenzene and the ethyl ester of 2,4,6-trimethoxybenzoic acid with a yield of 40%. Its melting point is 147° . The stock solutions should contain 0.1% of the indicator in alcohol. Appreciable time is required for the appearance of its color; and in a colorimetric determination, solutions should be permitted to stand for a half hour before color comparisons are performed. The color change interval lies between pH 5.0 and pH 7.0. The indicator is of little use in titrations because of the time effect mentioned. H. LUND (l.c.) has studied the absorption spectrum of the indicator.

2,4,2',4',2'',4''-Hexamethoxytriphenylcarbinol (Hexamethoxy red), $C_{25}H_{28}O_7$, melts at 184° . A stock solution should contain 0.1% of the indicator in alcohol. Its transformation interval is pH 2.6–4.6, and the compound is very useful both for colorimetric and titrimetric purposes.

2,4,2',4',2''-Pentamethoxytriphenylcarbinol (Pentamethoxy red) was prepared by H. LUND from 2,4-dimethoxyiodobenzene and the methyl ester of *o*-methoxybenzoic acid, the yield being 40%. The compound melts at 146 – 147° . The alcoholic stock solution contains 0.1% of the indicator. This substance is very satisfactory, with a color change interval at pH 1.2–3.2 (red-violet to colorless).

The methoxytriphenylcarbinols behave like weak bases. The properties of the above three indicators are summarized in the following table.

Cyclohexanone derivatives. B. SANDAHL¹ has prepared and studied the indicator properties of products obtained by condensing cyclohexanone and its derivatives with vanillin. These compounds are crystalline, and change color from yellow (acid) to red or orange-red in alkaline media. They dissolve in concentrated sulfuric or hydrochloric acid with an intense red color.

¹ B. Sandahl: *J. pharm. chim.*, (8) 7, 162 (1928); 11, 8 (1930).

INTERVALS OF THE METHOXY-TRIPHENYL CARBINOLS ACCORDING TO KOLTHOFF-LUND

INDICATOR	COMMON NAME	CONCENTRATION IN ALCOHOL	INTERVAL IN pH	ACID-BASE COLOR
2,4,6,2',4',2'',4''-Heptamethoxy-triphenylcarbinol	Heptamethoxy red	0.1%	5.0-7.0	red-colorless
2,4,2',4',2'',4''-Hexamethoxy-triphenylcarbinol	Hexamethoxy red	0.1%	2.6-4.6	rose red-colorless
2,4,2',4',2''-Pentamethoxy-triphenylcarbinol	Pentamethoxy red	0.1%	1.2-3.2	red violet-colorless

Stock solutions should contain 0.1% of the indicator in alcoholic solution.

The most representative members of the different groups will be briefly described. The reports of SANDAHL should be consulted for information concerning the preparation and properties of these substances.

DR. SANDAHL was kind enough to supply the author with samples of his new indicators in order to permit an independent judgment of their value. The findings of SANDAHL were substantiated quite generally, although the author considers the new indicators of little practical value, especially in pH determinations. The acid (yellow) form is so extremely insoluble in water that it precipitates out almost completely in a very short time.

I. Di-5-bromo-vanillidene-cyclohexanone, $C_{22}H_{20}Br_2O_5$,

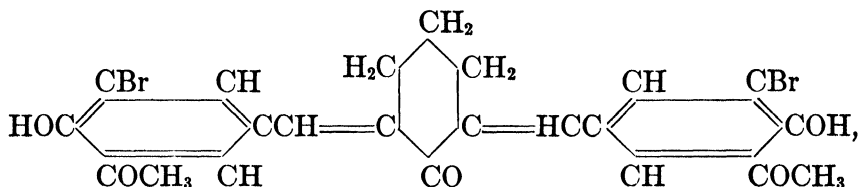

is prepared from cyclohexanone and bromvanillin. The crystalline product is a light yellow and decomposes while melting at 222-224°.

Di-5-bromo-vanillidene-*p*-methylcyclohexanone, $C_{23}H_{22}Br_2O_5$, melts at 189° . Di-5-bromo-vanillidene-*m*-methylcyclohexanone, $C_{23}H_{22}Br_2O_5$, melts at $165-170^\circ$. These compounds resemble I in their indicator properties.

II. Di-5-nitro-vanillidene-cyclohexanone, $C_{22}H_{20}N_2O_9$,

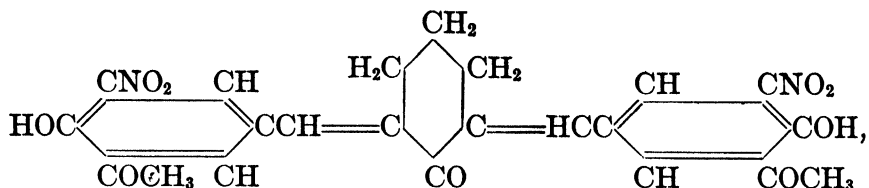

is insoluble in both water and alcohol and therefore not suited for use as an indicator. It melts at $241-242^\circ$.

III. Di-4-oxy-3-ethoxybenzylidene-cyclohexanone, $C_{24}H_{26}O_5$,

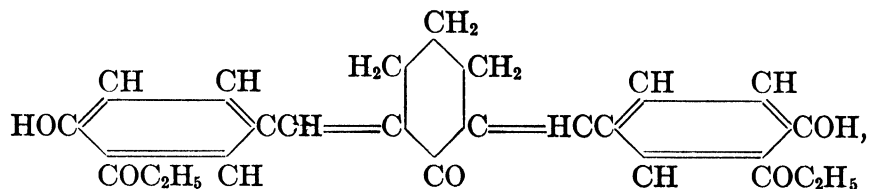

may be obtained as yellow platelets with a melting point of 158° . It dissolves but little in alcohol, and is completely insoluble in water.

Di-4-oxy-3-ethoxybenzylidene-*p*-methylcyclohexanone, $C_{25}H_{28}O_5$, also obtainable in the form of yellow platelets, melts at $148-149^\circ$. Di-oxy-3-ethoxybenzylidene-*m*-methylcyclohexanone is colored lemon-yellow and melts at 153° .

IV. Di-3,4-dioxybenzylidene-cyclohexanone, $C_{20}H_{18}O_5$,

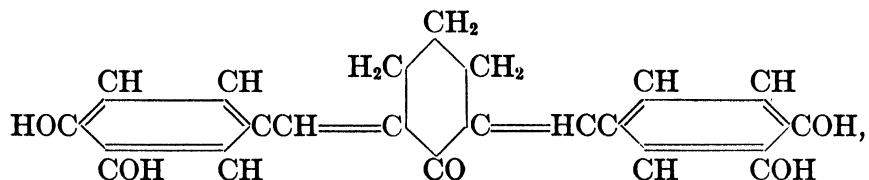

is obtained as yellow platelets which melt at $242-245^\circ$.

Di-3,4-dioxybenzylidene-*m*-methylcyclohexanone, $C_{21}H_{20}O_5$, melts at $221-223^\circ$.

The transformation intervals of the most typical of the above compounds are as follows:

I. Di-5-bromo-vanillidene-cyclohexanone. pH 7.2–8.6 from yellow-green to orange-red.

III. Di-4-oxy-3-ethoxybenzylidene-cyclohexanone. pH 8.0–10.2 from yellow to red.

IV. Di-3,4-dioxybenzylidene-cyclohexanone. This substance contains two hydroxy groups and therefore reacts with borate buffers as though it were a polyvalent phenol. The color in phosphate or glycine-sodium hydroxide buffer mixtures changes from yellow to orange at pH 6.8–7.0, becomes more reddish at higher pH's, and is violet at pH 11.8. The red color is stable up to a pH of 10.9, but between 10.9 and 11.8 it changes to violet after several minutes. The violet solutions begin to fade after fifteen minutes. If some borate is added to the red indicator solution, the color changes to yellow. Borates do not affect the violet solutions appreciably.

In all probability the new cyclohexanone derivatives will not become very important indicators.

The azo indicators.

Azobenzene.

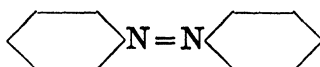

is yellow-orange in the solid state and forms yellow solutions in organic solvents. Its derivatives likewise produce yellow solutions, which turn red in the presence of acids.

Alkylaminoazobenzene.

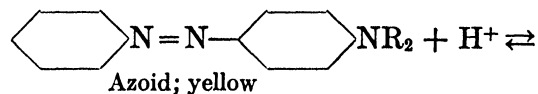

Azoid; yellow

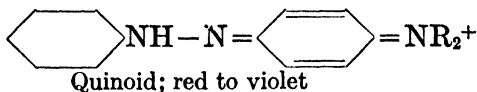

Quinoid; red to violet

The azo indicators, such as dimethylaminoazobenzene (butter yellow, methyl or dimethyl yellow), are usually but slightly soluble in water and therefore unsuited for the quantitative determination of pH. If several drops of a 0.1% alcoholic

methyl yellow solution are added to 5–10 c.c. of an aqueous medium, an opalescence or turbidity is observable almost instantly.

The introduction of polar groups, such as the sulfonic acid or carboxyl group, increases the solubility sufficiently to yield rather useful indicators. We shall see in Chapter Ten that these water-soluble azo dyes are especially valuable because their salt error is negligible.

The azo dyes are indicator bases which change from yellow to red (or red-violet) accompanied by the formation of cations (see above equation). When the compound contains a sulfonic acid or carboxyl group (methyl orange, methyl red), the color change is governed by the basic group. The transformation interval depends upon the strength of the basic group. The pioneer investigations of S. P. L. SÖRENSEN¹ will serve to illustrate the influence of various groups on the basic strength of the azo indicators. His results are reviewed briefly.

Azo indicators of Sørensen.

I. Anilinoazoparabenzene sulfonic acid: $\text{HOO}_2\text{SC}_6\text{H}_4\text{N} = \text{NC}_6\text{H}_4\text{NR}_1\text{R}_2$.

II. Anilinoazobenzene: $\text{C}_6\text{H}_5\text{N} = \text{NC}_6\text{H}_4\text{NR}_1\text{R}_2$ (unsuitable because of its small solubility).

III. Anilinoazoparatoluene: $\text{CH}_3\text{C}_6\text{H}_4\text{N} = \text{NC}_6\text{H}_4\text{NR}_1\text{R}_2$ (unsuitable because of insolubility).

IV. α -Naphthylaminoazoparabenzenesulfonic acid:

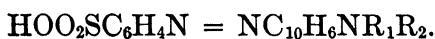

V. α -Naphthylaminoazobenzene: $\text{C}_6\text{H}_5\text{N} = \text{NC}_{10}\text{H}_6\text{NR}_1\text{R}_2$ (unsuitable because of insolubility).

VI. α -Naphthylaminoazoparatoluene:

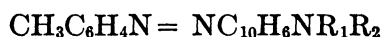

(unsuitable because of insolubility).

The transformation intervals of the compounds derived by varying R_1 and R_2 in the above six types of azo indicators are listed in the following table.

¹ S. P. L. Sørensen: *Compt. rend. trav. lab. Carlsberg*, 8, 28 (1909); *Biochem. Z.*, 21, 159 (1909).

TYPE	R ₁	R ₂	TRANSFORMATION INTERVAL
I	H	C ₆ H ₅	pH 1.4-2.6
II	H	"	1.2-2.1
III	H	"	1.0-2.0
V	H	"	1.4-2.6
VI	H	"	1.1-1.9
I	H	C ₆ H ₅ CH ₂	1.9-3.3
II	H	"	2.3-3.3
III	H	"	1.6-2.8
V	H	"	1.9-2.9
VI	H	"	1.6-2.6
I	H	H	1.9-3.3
II	H	H	1.9-3.3
IV	H	H	3.5-5.7
V	H	H	3.7-5.0
VI	H	H	3.7-5.0
I	H	CH ₃	3.1-4.2
I	H	C ₂ H ₅	3.1-4.4
I	CH ₃	CH ₃	3.1-4.4
I	CH ₃	"	3.5-4.5
I	CH ₃	"	2.9-4.0
IV	CH ₃	"	5.0-5.7
V	CH ₃	"	4.8-5.5

The following indicators were added to this list by SÖRENSEN:

Diphenylaminoazometabenzenesulfonic acid	Interval 1.2-2.3
<i>o</i> -Toluene-azo- <i>o</i> -toluidine	1.4-2.9
Metadiethylanilino-azo-parabenzenesulfonic acid	2.6-4.0

A. THIEL and W. SPRINGEMANN¹ have studied the light sensitivity of the various azo indicators dissolved in organic solvents. In this connection, THIEL² and his collaborators prepared a number of additional azo derivatives. The author has determined the transformation intervals of certain of these compounds prepared by THIEL. His findings are summarized below.

p-Ethyl orange (0.1% solution in water). pH 3.4-4.8, rose-red to yellow.

m-Ethyl orange (0.1% solution in water). pH 2.8-4.3, rose-red to yellow.

Ethyl red (0.1% solution in 70% alcohol). pH 2.9-4.0 (rose-

¹ A. Thiel and W. Springemann: Z. anorg. allgem. Chem., 176, 112 (1928).

² A. Thiel, A. Dassler, and F. Wülken: Fortschritte Chem., Physik, physik. Chem., 18, 83 (1924).

red to yellow-orange). This indicator is insoluble in water and precipitates out of solution.

The following dye is added by the author to the preceding list.

*Dimethyl- α -naphthylaminoazo-*o*-methoxybenzeneparasulfonic acid* (Eastman Kodak product). Sodium salt, 0.1% in water; pH 3.4-4.8, purple to yellow-orange.

Among the azo dyes we may include *o*-methyl red, naphthol orange, curcumin, *o-p*-dioxyazo-*p*-nitrobenzene, and tropeolin 0 (sodium salt of resorcin-azo-benzenesulfonic acid).

The properties of the most important azo indicators will be considered below.

Tropeolin 00 (also called orange IV, aniline yellow, or diphenyl orange): Schultz No. 97. Sodium salt of diphenylaminoazo-*p*-benzenesulfonic acid,

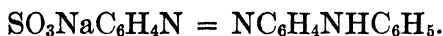

The commercial preparation may be recrystallized from water. Stock solutions should contain 0.1% of the indicator in water, and two drops of the indicator solution are required per 10 c.c. The transformation interval is between pH 1.3 and 3.0, the color changing from red to yellow-orange. This indicator is very useful, possessing a small salt error.

Metanil yellow (also called victoria yellow, metanil extra, and tropeolin G): Schultz No. 91. Sodium salt of diphenylamino-azo-*m*-benzenesulfonic acid,

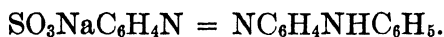

The commercial preparation may be recrystallized from water. The aqueous stock solution should contain 0.1% of indicator. Two drops of this solution should be used per 10 c.c. The interval is between pH 1.2-2.3, from red to yellow. This compound has a small salt error and is thus a very useful indicator.

Dimethylaminoazobenzene (also called dimethyl yellow, methyl yellow, or butter yellow),



The commercial preparation should be recrystallized from dilute alcohol, and a 0.1% stock solution prepared in 90% alcohol.

The interval is from pH 2.9 to 4.0, from red to yellow. One to four drops of indicator solution should be used per 10 c.c. This substance is admirably suited for the titration of weak bases, and of alkali bound by weak acids. It is not so useful for colorimetric determinations because the indicator separates out rapidly.

Methyl orange (helianthin B, or orange III): Schultz No. 96. Sodium salt of dimethylaminoazobenzenesulfonic acid,

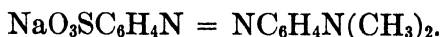

Commercial preparations should be recrystallized from water. The aqueous stock solution should contain 0.1% of the indicator. Use 1–4 drops of stock solution per 10 c.c. The color change is from red to yellow-orange at pH 3.0–4.4. This compound too has a small salt error. It is very useful for colorimetric determinations.

The investigations of A. THIEL¹ and coworkers, and of I. M. KOLTHOFF² indicate that the free acid form of methyl orange is a hybrid ion (cf. Chapter Two):

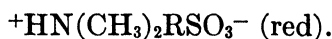

The behavior of methyl orange as an indicator is governed by the reaction

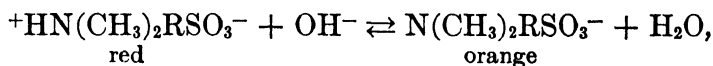

equilibrium being represented by

$$\frac{[+\text{NH}(\text{CH}_3)_2\text{RSO}_3^-][\text{OH}^-]}{[\text{N}(\text{CH}_3)_2\text{RSO}_3^-]} = K_b.$$

Methyl orange acts as an indicator base with $K_b = 2 \times 10^{-11}$ (18°). $K_a = 9 \times 10^{-2}$ (18°).

Methyl red: dimethylaminoazobenzene-*o*-carboxylic acid,

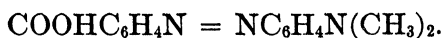

This indicator was introduced by E. RUPP and R. LOOSE.³

¹ A. Thiel, A. Dassler, and F. Wülken: Fortschritte Chem., Physik, physik. Chem., 18, 83 (1924); Ber., 56, 1667 (1923).

² I. M. Kolthoff: Rec. trav. chim., 44, 68 (1925).

³ E. Rupp and R. Loose: Ber., 41, 3905 (1908).

SVEN PALITZSCH¹ suggests the following method of purifying commercial preparations: Heat 4 g. of methyl red with 30 c.c. of glacial acetic acid. After filtration, add sufficient water to produce a slight turbidity. Warm until the turbidity disappears, and then cool rapidly. If the quantity of water added is not too great, methyl red will separate out in the form of well-defined crystals. H. WALES² finds it more satisfactory to recrystallize the compound from toluene.

A stock solution is prepared by dissolving 1 g. of methyl red in 300 c.c. of alcohol, and then diluting to 500 c.c. with water. It is more advisable to use a 0.1% solution of the sodium salt in water. Each 10 c.c. portion of solution requires 1-4 drops of indicator solution. The transformation interval is pH 4.4 to 6.2, the color changing from red to yellow. This indicator is very useful, possessing a small salt error.

Methyl red resembles methyl orange in that it acts like a base in the pH region 4.4-6.2. Writing the free methyl red as a hybrid ion³

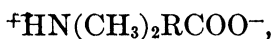

we may describe its indicator action by the reaction

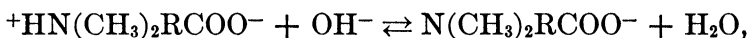

where $K_b = 7 \times 10^{-10}$ (18°; KOLTHOFF⁴). The hybrid ion can react also with acids to form ${}^+\text{HN}(\text{CH}_3)_2\text{RCOOH}$ which is red. The color intensity of this compound differs from that of the hybrid ion.

Naphthyl red: α -Naphthylaminoazobenzene, $\text{C}_6\text{H}_5\text{N} = \text{NC}_{10}\text{H}_6\text{NH}_2$. The method of synthesizing this compound has been reported by K. LINDERSTRÖM-LANG.⁵ A 0.1% stock solution should be prepared in 96% alcohol. The interval lies at pH 3.7-5.0, the color going from red to yellow. Use 1-2 drops of indicator per 10 c.c. of solution.

¹ S. Palitzsch: Compt. rend. trav. lab. Carlsberg, 10, 162 (1911).

² H. Wales: Ind. Eng. Chem., 18, 876 (1926).

³ H. Baggesgaard-Rasmussen and F. Reimers: Dansk Tidsskr. Farmaci, 7, 225 (1933) present convincing evidence that not the hybrid ion but the undissociated form $(\text{CH}_3)_2\text{NRCOOH}$ is the acid form of methyl red.

⁴ I. M. Kolthoff: Rec. trav. chim., 44, 68 (1925).

⁵ K. Linderström-Lang: Z. physiol. Chem., 173, 44 (1927).

p-Methyl red: ¹ Dimethylaminoazobenzene-*p*-carboxylic acid. The color changes from red to yellow between pH 1.0 and 3.0. Its extremely small solubility in water minimizes its usefulness as an indicator.

Naphthol orange and its derivatives. The behavior of naphthol orange and its derivatives differs from that of the azo indicators already discussed, in that the color of the former compounds is yellow or brown-yellow in acid solutions and rose or red in the presence of alkali. K. H. SLOTTA and W. FRANKE ² recently have elucidated the structural rearrangements accompanying the color change of α -naphthol orange. The acid form is considered to have hybrid ion properties. Upon addition of hydroxyl ions, a hydrogen nucleus is detached from an azo nitrogen atom with the result that the naphthalene group assumes a quinoid structure:

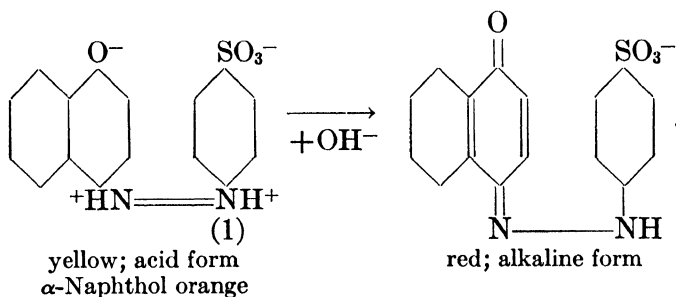

The hydrogen attached to the nitrogen atom (1) has no effect on the indicator properties, and may be replaced by alkyl groups. SLOTTA and FRANKE have determined the indicator characteristics of such substituted α -naphthol orange derivatives. Their findings are summarized in the following table. The color intensity of the alkaline form increases with the atomic weight of the

INDICATOR PROPERTIES OF SUBSTITUTED α -NAPHTHOL ORANGE DERIVATIVES

	α -NAPHTHOL ORANGE	METHYL	ETHYL	PROPYL	BUTYL	HEXYL
Transformation range	pH 7.4-8.8	7.4-9.0	7.3-3.9	7.4-8.9	7.3-9.0	7.4-8.9
50% Transformation	8.28	8.25	8.23	8.26	8.33	8.27
Alkaline color	gray-rose	pale rose	rose-carmine	→ carmine red ←		
Acid color	pale yellow-green	yellow-green	yellow	→ golden-yellow ←		

¹ Thiel, Dassler, and Wulfken: Fortschritte Chem., Physik, physik. Chem., 18, 83 (1924).

² K. H. Slotta and W. Franke: Ber., 64, 86 (1931).

alkyl radical. The hexyl- α -naphthol orange, for example, has a color intensity which is about twice that of the unsubstituted indicator.

α -Naphthol orange (tropeolin 000, α -naphtholazobenzene-*p*-sulfonic acid):

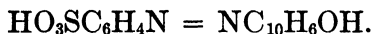

This indicator was used as early as 1909 by SÖRENSEN. Commercial preparations may be employed after recrystallizing from water. A 0.1% aqueous solution serves as a stock supply, 2–4 drops being needed per 10 c.c. The author has confirmed the findings of SLOTTA and FRANKE that the color change of propyl-, butyl-, and hexylnaphthol orange is much more pronounced than that of tropeolin 000.

Propyl- α -naphthol orange has already been included in the list of recommended indicators. More exhaustive studies with this new indicator are still desirable however. It remains yet to be shown that the color intensity of the red form is less than that of cresol red which possesses a similar transformation range.

Curcumin (brilliant yellow): Schultz No. 100, Sulfanilic acid-azodiphenylaminosulfonic acid. Stock solutions should contain 0.1% of the indicator in 50% alcohol. The color changes from yellow to red-brown in the pH range 7.4 to 8.6. Use 1–3 drops of indicator solution per 10 c.c.

In strongly alkaline solutions, the color again becomes yellowish, the extent of the change being proportional to the hydroxyl ion concentration. This is not a salt effect, but one produced solely by the hydroxyl ions. The indicator is not very useful.

Alizarine yellow R: Sodium salt of *p*-nitranilineazosalicyclic acid,

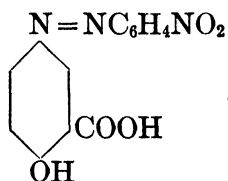

Aqueous stock solutions may contain 0.1% of the indicator, 1–3 drops being required per 10 c.c. The transformation is from yellow to violet in the region 10.2–12.0. This compound is well suited for colorimetric determinations.

Azo violet: *o-p*-Dihydroxyazo-*p*-nitrobenzene,

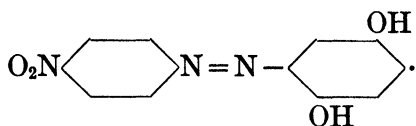

This substance was prepared by K. SUITSU and K. OKUMA¹ who recommended its use as a reagent for magnesium. I. M. KOLTHOFF² demonstrated the acid-base indicator properties of the compound. Stock solutions should contain 0.1% of the sodium salt in water. The color change is from yellow to violet in the pH interval 11.0–13. In strongly alkaline solutions containing magnesium, its color is a corn-flower blue.

Tropeolin O (also golden yellow or chrysoine): Schultz No. 101, Sodium salt of resorcinol-azo-benzenesulfonic acid,

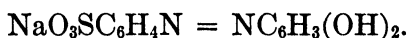

A 0.1% aqueous stock solution should be used, 1–3 drops being needed per 10 c.c. The color transformation is from yellow to orange-brown in the interval 11.0–13.0. The color change is not, however, very marked.

Disazo indicators. In this group of indicators are included congo red, benzopurpurin B, and benzopurpurin 4B, none of which are recommended for use as indicators for the determination of pH. Though the red alkaline form is soluble in water, the blue or violet acid form is insoluble.

Benzopurpurin B was known to SALM³ as early as 1908. Its color is blue at a pH of 0.3, violet at 1.0, yellow in the range 5.0–12.0, and red at a pH of 14.0.

Benzopurpurin 4B (also cotton red 4B or sultan 4B): Schultz No. 268, sodium salt of *o*-toluidinedisazo-bi-1-naphthylamine-4-sulfonic acid,

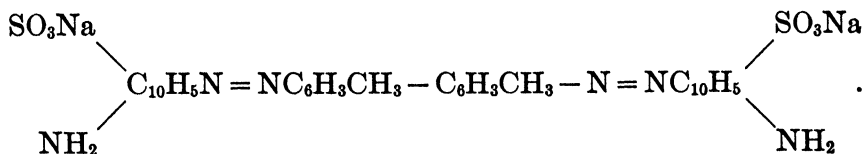

¹ K. Suitsu and K. Okuma: J. Soc. Chem. Ind. (Japan), *29*, 132 (1926); Chem. Abstracts, *20*, 3000 (1926). Also W. L. Ruigh: J. Am. Chem. Soc., *51*, 1456 (1929).

² I. M. Kolthoff: Mikrochemie, Emich-Festschrift, 1930, 180.

³ E. Salm: Z. Physik. Chem., *63*, 83 (1908).

Commercial preparations may be purified by adding hydrochloric acid to an aqueous solution in order to precipitate the indicator, which is then washed and dried. A small quantity of alkali, insufficient to dissolve all of the indicator, is added and the solution evaporated to yield the sodium salt. A 0.1% aqueous stock solution is prepared, and 1-3 drops used per 10 c.c. of solution under investigation. The interval occurs at pH 1.3-4, the color going from blue-violet to red. This substance has a high salt error and protein error, and is not recommended for use as an indicator.

Congo red (congo G.R.): Schultz No. 148, sodium salt of benzidine-disazo-*m*-amidobenzenesulfonic acid-1-naphthylamine-4-sulfonic acid,

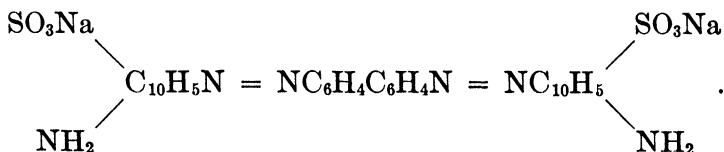

The purification of commercial samples and preparation of a stock solution is the same as for benzopurpurin. The interval lies between pH 3.0 and 5.2, the color changing from blue-violet to red. This compound likewise has high salt and protein errors, and thus is not a very desirable indicator.

The triphenylmethane dyes. The most important representatives of this group of compounds are crystal violet, methyl violet 6B, methyl green, malachite green, and gentian violet.

These compounds behave like very weak polyacidic bases which change from violet or green to yellow in strong acid solutions. H. C. BIDDLE¹ has studied the velocity of this color change, and E. Q. ADAMS and L. ROSENSTEIN² have investigated thoroughly the color and ionization of crystal violet. The triphenylmethane dyes have no special practical value as indicators because of certain undesirable properties. In the first place, their color change is not very pronounced. Furthermore their acid forms are rather unstable. In addition, since they yield polyvalent cations in acid solution, their salt error is very large (cf. Chapter Ten, section two).

¹ H. C. Biddle: J. Am. Chem. Soc., 36, 101 (1914).

² E. Q. Adams and L. Rosenstein: J. Am. Chem. Soc., 36, 1452 (1914).

*Crystal violet.*¹

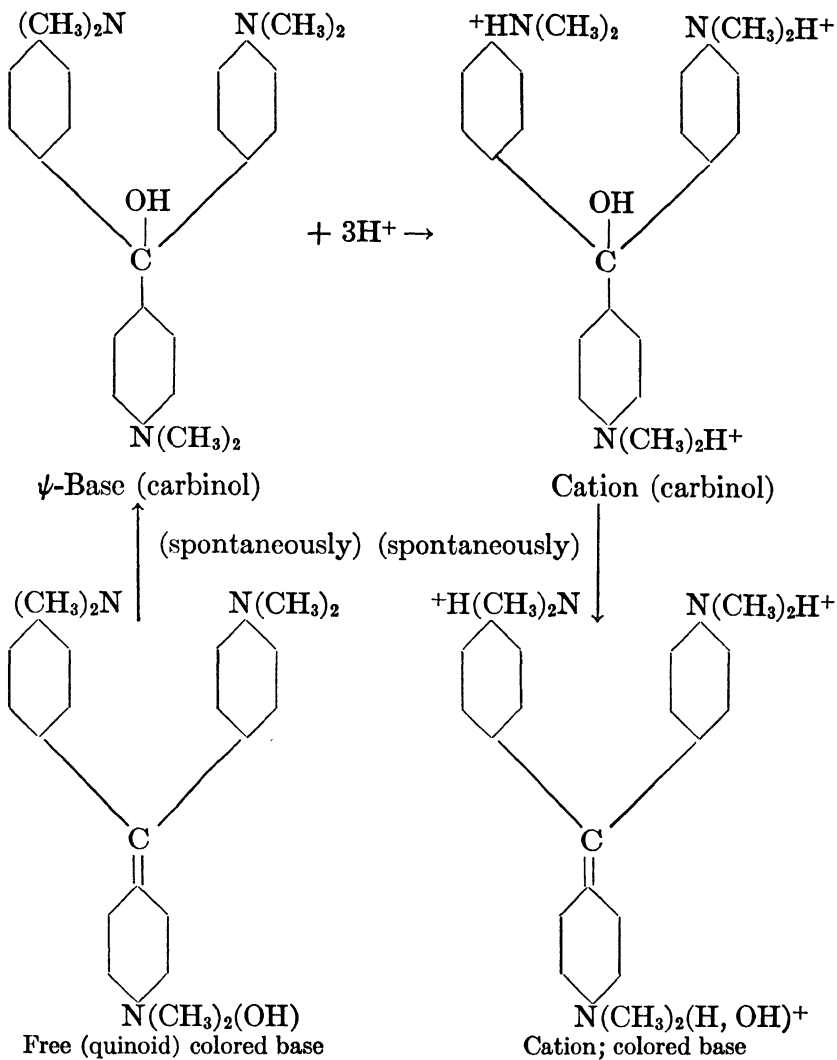

This substance is practically never used for determining pH.

¹ H. Lund: Danske Videnskab. Selskab., 11, No. 6 (1931), represents the transformation of crystal violet as follows:

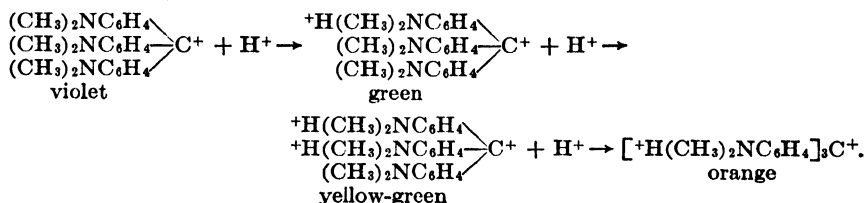

Methyl violet 6B: Schultz No. 430 (5th Ed. No. 517). Penta-methylbenzylpararosanilinehydrochloride (with varying quantities of the tetra- and hexa-derivatives),

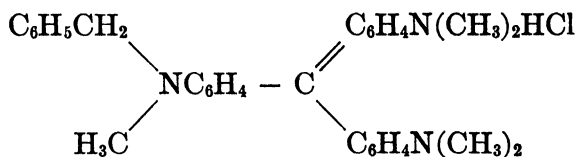

Use 1–2 drops of a 0.1% aqueous stock solution per 10 c.c. The color at a pH of 0.1 is yellow, green at 1.5, and violet at pH 3.2.

Gentian violet turns from yellow to violet in the pH range 0.4–2.7. A 0.1% aqueous stock solution should be employed.

Methyl green: Schultz No. 456 (5th Ed. No. 519).

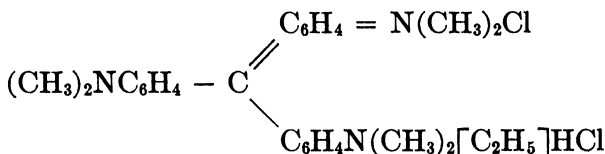

A 0.1% aqueous stock solution should be used. The interval is between pH's 0.1 and 2.3, with a change in color from yellow to green-blue.

Mauveine: Schultz No. 625. 0.1–2.9.

Crystal violet. 0.8–2.6 (green to blue-violet).

The nitro indicators. Nitro indicators as a rule possess a colorless acid form whereas, in alkaline solutions, they exhibit a more or less intense yellow color. One of the best known examples of this group is *p*-nitrophenol, the color change of which may be described in the following manner:

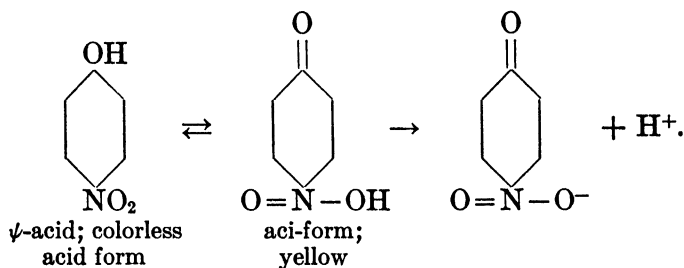

L. MICHAELIS¹ and his coworkers have extended the number

¹ L. Michaelis and A. Gyemant: *Biochem. Z.*, 109, 165 (1920). L. Michaelis and A. Krüger: *Biochem. Z.*, 119, 307 (1921).

of valuable nitrophenols. These indicators are extremely useful for determining the pH of unbuffered solutions. The preparation of these substances is described in detail in the original publications of MICHAELIS and GYEMANT¹ and of MICHAELIS and KRÜGER. The paper of I. W. KULIKOW and S. W. PANOWA² should be consulted for information regarding the preparation and purity of β -dinitrophenol.

TRANSFORMATION INTERVALS OF INDICATORS ACCORDING TO
MICHAELIS AND GYEMANT

INDICATOR	COMMON NAME	CONCENTRATION	INTERVAL IN PH	ACID-ALKALI COLOR
2,4-Dinitrophenol	α -Dinitrophenol	0.1%	2.0-4.7	colorless-yellow
2,6- "	β - "	0.1%	1.7-4.4	colorless-yellow
2,5- "	γ - "	0.1%	4.0-6.0	colorless-yellow
<i>p</i> -Nitrophenol		0.1-0.5%	5-7.6	colorless-yellow
<i>m</i> -		0.1-0.5%	6.5-8.5	colorless-yellow orange
Alizarine yellow G-G	Salicyl yellow	0.1%	10.0-12.0	weak yellow-orange

The author has learned through private correspondence with DR. GERHARD KLOTZ (Leipzig) that β -dinitrophenol is likely to be contaminated with α -dinitrophenol, and γ -dinitrophenol with δ - and ϵ -dinitrophenols. DR. KLOTZ claims also that but a single recrystallization is necessary to yield the pure meta- and para-nitrophenols. The purity of samples may be tested by noting the melting point or the temperature at which the crystalline compound begins to sinter. KLOTZ reports his observations as follows:

α -Dinitrophenol. Golden yellow leaflets; melting point 114°; sintering at 111°. Indicator solution: 0.05-0.1% in 70% alcohol; 1-4 drops per 10 c.c.

β -Dinitrophenol. Bright lemon yellow crystalline needles; melting point 64.5°; sintering at 62.5°. Indicator solution: same as for the α -preparation.

γ -Dinitrophenol. Bright lemon yellow; very fine crystals; melting point 107.8°; sintering at 106.5°. Indicator solution: same as for the α -preparation.

Meta-nitrophenol. Whitish, dense crystals; melting point 98-99°; sintering at 96°. Indicator solution: 0.1-0.5% in water.

¹ *Ibid.*

² I. W. Kulikow and S. W. Panowa: Trans. Inst. Pure Chem. Reagents (Moscow), 102, No. 8 (1929); Biochem. Z., 246, 87 (1932).

MICHAELIS and GYEMANT suggest the following directions for testing the reliability of a sample of *m*-nitrophenol. An initial 0.3% indicator solution is diluted 5–10 times with water. A sample of this diluted solution must be completely decolorized by several drops of 1/15 molar primary potassium phosphate (KH_2PO_4). A second sample, treated with several drops of 1/15 molar secondary sodium phosphate (Na_2HPO_4), should turn yellowish green. The addition of a few drops of sodium hydroxide solution to a third sample of the dilute solution should give it a still stronger brownish yellow color.

Para-nitrophenol. Whitish, spongy, light crystals; melting point 114.5° ; sintering at 112° . Indicator solution: 0.1–0.5% in water.

Nitro derivatives of other phenols may also show pronounced indicator properties. F. L. GILBERT, F. C. LAXTON, and E. B. R. PRIDEAUX¹ have measured the dissociation constants of a number of such substances. These values are arranged in the following table together with the negative logarithms of these constants. The range of usefulness of the indicators will lie approximately at $\text{pH} = \text{p}K_1 \pm 1$.

DISSOCIATION CONSTANTS OF A NUMBER OF NITRO COMPOUNDS DETERMINED BY GILBERT, LAXTON, AND PRIDEAUX AT 25°

SUBSTANCE	DISSOCIATION CONSTANT K	$\text{p}K_1 = -\log K$
2,6-Dinitrohydroquinone	1×10^{-4}	4.00
3,5-Dinitropyrocatechol	2.9×10^{-4}	3.54
2,4-Dinitroresorcinol	8.85×10^{-4}	3.05
4,6-Dinitroresorcinol	1.05×10^{-4}	3.98
Nitrohydroquinone	1×10^{-6}	6.00
3-Nitropyrocatechol, 1st step	1.88×10^{-6}	5.73
2nd step	9.3×10^{-12}	11.03
4-Nitropyrocatechol, 1st step	3.5×10^{-7}	6.45
2nd step	1.1×10^{-11}	10.96
2-Nitroresorcinol	1.6×10^{-6}	5.80
4-Nitroresorcinol, 1st step	1.04×10^{-6}	5.98
2nd step	1.55×10^{-9}	8.81

The following compounds may likewise be included with the nitro indicators: 2,5-dinitrohydroquinone, dinitrobenzoylurea, isopicramic acid, nitramine, trinitrobenzene, trinitrobenzoic acid, and trinitrotoluene.

¹ F. L. Gilbert, F. C. Laxton, and E. B. R. Prideaux: *J. Chem. Soc.*, 1927, 2164.

2,5-Dinitrohydroquinone (cf. L. J. HENDERSON and A. FORBES¹). This substance has a green-yellow color at a pH of 2, orange-yellow at pH 4, orange at 6, brown-red at pH 8, reddish purple at 10, and purple at 12. It appears to have the characteristics of a "universal" indicator (cf. section 6 of this chapter).

Dinitrobenzoylurea. Interval at pH 6–8 (cf. M. T. BOGERT and G. SCATCHARD²).

Isopicramic acid (2,6-dinitro-4-aminophenol). This indicator was proposed by MELDOLA and HALE.³ A stock solution should contain 0.1% of the indicator in water. The color change is from rose to yellow between pH 4.0 and 5.6.

Nitramine (Picrylmethylnitramine). 2,4,6-trinitrophenylmethylnitramine (tetryl).

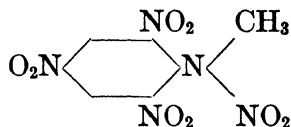

Melting point: 127° (P. VAN ROMBURGH⁴), 129° (REVERDIN), 132° (FRANCHIMONT). VAN ROMBURGH obtained nitramine by heating dimethylaniline with fuming nitric acid. The formation of picrylmethylnitramine is accompanied by a vigorous evolution of gases. In addition to a nitration of the benzene ring, one of the methyl groups is oxidized away and replaced by a nitro group:



A 0.1% indicator solution may be prepared by dissolving 500 mg. in 300 c.c. alcohol and diluting with water to 500 c.c. The transformation occurs at pH 10.8 to 13, from colorless to red-brown. One should use 1–5 drops of stock solution per 10 c.c. The indicator solution should be stored in the dark, and freshly prepared every 3–6 months. The brown-red alkaline color is unstable, and consequently permanent solutions of the alkaline form can not be prepared. The color changes are much more distinct than in the case of tropeolin 0.

¹ L. J. Henderson and A. Forbes: *J. Am. Chem. Soc.*, **32**, 687 (1910).

² M. T. Bogert and G. Scatchard: *J. Am. Chem. Soc.*, **33**, 1606 (1916).

³ Meldola and Hale: *Chem. World*, **1**, 327 (1912).

⁴ P. van Romburgh: *Rec. trav. chim.*, **2**, 31 (1883).

Trinitrobenzene. Symmetrical 1,3,5-trinitrobenzene. Melting point 122°. Indicator solution: 0.1% in alcohol.

The transformation from colorless to red-brown takes place between pH 11.8–14. The alkaline form is unstable, and the red-brown color fades on standing. The speed of this reaction increases with alkalinity.

Trinitrobenzoic acid. A 0.1% aqueous solution of the sodium salt serves as a stock solution. A change from colorless to orange-red occurs between pH's 11.6 and 13.5. The red color changes to yellow on standing, and the substance loses its indicator properties.

2,4,6-Trinitrotoluene behaves like trinitrobenzene.

Quinoline group. The following indicators belong to this group:

INDICATOR	INTERVAL	ACID-ALKALINE COLOR
Quinaldine red	1.4–3.2	Colorless-red
Pinachrome	5.6–8.0	Colorless-red violet
Quinoline blue (Cyanin)	6.6–8.6	Colorless-blue

Quinaldine red. Quinaldine red has the structural formula:

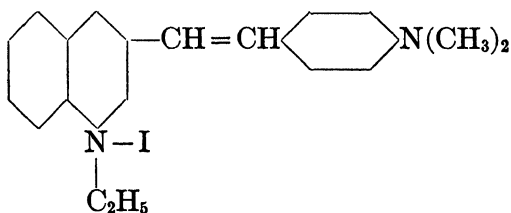

J. F. McCLENDON¹ used it for determining the pH of gastric juice. The properties of the substance were studied later on in greater detail by I. M. KOLTHOFF.² Commercial preparations are available in the form of a dark red-black powder. The indicator is insoluble in water but dissolves in alcohol producing a dark red solution. A stock solution, containing 0.1% of indicator in 95% alcohol, should be stored in dark containers. Aside from having a rather large salt error, the indicator is satisfactory.

Pinachrome (M). *p*-Ethoxyquinaldine-*p*-ethoxyquinoline ethyl-

¹ J. F. McClendon: *J. Biol. Chem.*, 59, 437 (1924).

² I. M. Kolthoff: *Biochem. Z.*, 194, 78 (1928).

cyanin. Mol. Wt. = 518. Probable formula:

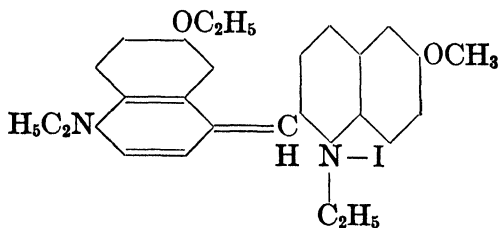

This substance behaves like a weak base, is insoluble in water, and dissolves in dilute hydrochloric acid as a colorless salt. The indicator properties were investigated by I. M. KOLTHOFF.¹

Stock solution *a*: 0.1% in 70% alcohol (red solution).

Stock solution *b*: 0.1% neutralized solution prepared by dissolving 100 mg. of indicator in 40 c.c. of alcohol, adding 1.9 c.c. of 0.1 N hydrochloric acid, and diluting to 100 c.c. with water. This solution has a weak violet color and is stored in Jena or Pyrex glass containers. The color change is from a weak rose to red-violet between pH's 5.6 and 8.0. The color equilibrium does not set in instantaneously, and it is necessary to wait two minutes after adding the indicator before judging its color.

The indicator behaves in a peculiar manner in alkaline solutions, and care must be exercised when pinachrome is used in pH measurements. The free red indicator base is very slightly soluble in water, and separates out on standing. If the indicator is shaken violently in a solution containing alkali, a red-violet foam is produced and the solution becomes almost completely decolorized. Shaking favors the decolorization process. Evidently the indicator base is strongly capillary active, and collects at the air-water interface when the solution is agitated. Consequently, when pinachrome is used in basic solutions, the tubes must be rotated carefully and the color estimated soon after addition of the indicator.

Cyanin or *Quinoline blue*, $C_{19}H_{35}N_2I$, is not a very satisfactory indicator because its blue alkaline form is unstable. Its color intensity diminishes appreciably in a very short time. The blue color turns violet in strongly alkaline solutions. The stock solution can not be stored for long, and must be freshly prepared at frequent intervals.

¹ I. M. Kolthoff: J. Am. Chem. Soc., 50, 1604 (1928).

The indophenols. The indophenols were examined thoroughly for *oxidation-reduction indicator properties* by W. M. CLARK¹ and his collaborators, who observed also that they behaved as acid-base indicators. All indophenols show a color change from dark red or brownish red (in acid) to a deep blue. Unfortunately these colors do not endure. In the following table are found the values of the indicator constants (50% transformation) determined at 30° by CLARK and coworkers. $pK_I = -\log K_I = \text{pH}$ when $[\text{HI}] = [\text{I}^-]$.

Indicator constants of the indophenols.

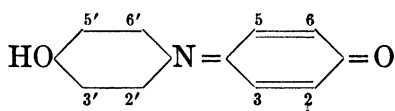

Indophenol

INDOPHENOL	pK_I AT 30°
Indophenol	8.1
2,6,3'-Tribromoindophenol	5.1
2,6-Dichloroindophenol	5.7
2-Chloroindophenol	7.0 (Interval 6.5-8.5, red to blue)
2-Methoxyindophenol	8.7
2,6-Dibromo-2'-bromoindophenol	6.3

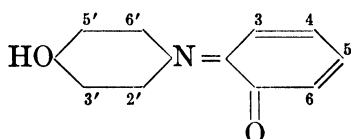

Orthoindophenol

Orthoindophenol	8.4
3'-Bromorthoindophenol	7.1
2'-Methylorthoindophenol	8.8
o-Cresolindophenol	8.4 (Interval 8.0-9.6, red to blue)

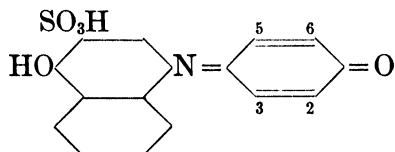

Indonaphthol-3'-sulfonic acid

Indonaphthol-3'-sulfonic acid	8.7
2,6-Dichloroindonaphthol-3'-sulfonic acid	6.1
2-Methylindonaphthol-3'-sulfonic acid	9.0

¹ B. Cohen, M. X. Gibbs, and W. M. Clark: Public Health Reports, 39, 381, 804 (1924); 40, 649 (1925).

Various other substitution compounds are referred to by COHEN, GIBBS, and CLARK (loc. cit.).

Anthraquinone group.

Alizarine. 1,2-Dioxyanthraquinone,

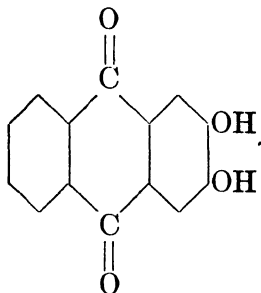

Stock solution: 0.1% in 90% alcohol; 1-4 drops per 10 c.c. Intervals: pH 5.5 to 6.8, from yellow to violet; pH 10.1-12.1, violet to purple.

It is better to use the water soluble *sodium salt of alizarine sulfonic acid*,

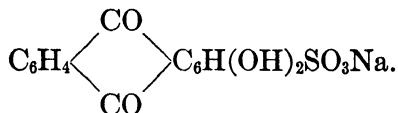

Stock solution: 0.1% in water.

Alizarine blue: Schultz No. 528. Dioxyanthraquinonequinoline,

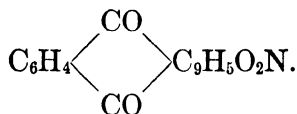

This compound melts at 270°. An alcoholic stock solution should be saturated with the indicator. The color changes from yellow-red to blue in the interval 11.0-13.0. This compound is not a very useful indicator.

1,2,6-Trioxanthraquinone. An alcoholic stock solution should be saturated with respect to the indicator; 0.2 c.c. of this solution is required per 10 c.c. The compound is insoluble in water but soluble in the presence of alkali. Its color in 0.005 N NaOH is brown, in 0.01 N NaOH the color is orange, orange-red in 0.1 N NaOH, and cherry red in 0.5 N NaOH. The red color-

tion appears at a much smaller alkalinity if salts are present. This indicator is not very satisfactory.

Other indicators. A number of dyes which belong to none of the groups already considered is tabulated below:

INDICATOR	STOCK SOLUTION W = WATER A = ALCOHOL	INTERVAL	COLOR	
			Acid	Alkaline
Phenacetolin	A 0.1%	{ 3.0- 6.0 10.0-13.0	yellow red	red colorless
Galleine	A 0.1%	{ 3.8- 6.6 10.6-13.0	light brown- yellow	rose violet
Resazurin	A 0.1%	3.8- 5.6	orange	violet
Lacmoid	A 0.2%	4.4- 6.4	red	blue
Litmus	W 0.5%	5.0- 8.0	red	blue
<i>Azolitmin</i>	W 0.5%	5.0- 8.0	red	blue
<i>Rosolic acid</i>	A 0.1%	6.6- 8.0	yellow	red
<i>Neutral red</i>	A 0.1%	6.8- 8.0	red	yellow-orange
Diorthohydroxystyrylketone	A 0.05%	7.3- 8.7	yellow	green
<i>Fast Green</i>	W	7.4- 8.8	green	blue
<i>Nile blue</i>	W	9.0-10.4	blue	red
Alkali blue	W	9.4-13.0	light blue	rose
Poirrier's blue	W	10.0-13.0	blue	purple

Resazurin. Dissolve 0.1 g. of the dye in 2 c.c. of 0.1 N sodium hydroxide and dilute to 500 c.c. with water. Use 1-5 drops per 10 c.c. The transformation is from orange to a dark violet at pH 3.8 to 5.6. This indicator is not very satisfactory.

Lacmoid (also resorcin blue), $C_{12}H_9O_3N$. FR. GLASER¹ tests the reliability of commercial samples by determining their solubility in water. The preparation should not be used if little or none of the blue dye dissolves; but it may be used if it colors boiling water an intense blue. Alcoholic solutions of the dye are also blue (with a violet tinge), whereas a poorer quality of lacmoid colors alcohol a brownish violet. The blue dye may be extracted from commercial preparations by treating the pulverized product with boiling water. The extraction should not be too thorough, in order to prevent the red fluorescent dyes, which are the usual impurities in trade lacmoid, from going into solution. After cooling and filtering the blue solution, the dye is precipi-

¹ Fr. Glaser: *Indicatoren der Acidimetrie und Alkalimetrie*, Wiesbaden, 1901, p. 6.

tated by acidifying slightly, filtered, and washed with water. The solid then is dried either by direct heating or by dissolving in alcohol and evaporating this solution on a water bath. About 40% of a good commercial product may be recovered in this way. Very pure samples may be obtained also by digesting a good trade preparation in 96% alcohol, filtering, and evaporating the filtrate over sulfuric acid in vacuum. A 0.2% alcoholic solution of such a pure product serves as a stock solution, 1–5 drops being used per 10 c.c. The color change is from red to blue between pH's 4.4 and 6.4. HOTTINGER¹ recommends the use of lacmosol instead of lacmoid.

Litmus is procured by fermentation of ammoniacal extracts of various lichens, especially of the species *ROCELLA* and *LECANORE*. The commercial product is a mixture of various substances, many of which are totally devoid of indicator properties. From such a preparation have been isolated azolitmin, erythrolitmin, erythrolein, and spaniolitmin. Only the first of these compounds has any practical value. P. SCHEITZ² claims that even azolitmin is a mixture.

Litmus (azolitmin) is the classical indicator for acid-base titrations, although by now it has been supplanted by much better indicators. Neither litmus nor azolitmin should be used in colorimetric determinations of pH because of their salt and protein errors. Litmus is of value only in the form of indicator paper (cf. Chapter Eleven).

Azolitmin. Commercial litmus contains varying quantities of azolitmin, usually 4–5%. The azolitmin may be extracted from such samples with cold water, after which the solution is evaporated with sand, and sufficient hydrochloric acid added to produce a deep red solution. The residue, left after the acid solution is evaporated, is pulverized, placed on a large flat filter, washed successively with hot and cold water, and finally dried on a water bath. The azolitmin at this stage is found adsorbed by the sand. Suitable indicator solutions may be obtained by pouring hot water, containing several drops of ammonia, over the fine sand. The filtrate is acidified with several drops of sulfuric acid, and again neutralized to yield a very good indicator solution. When the solution is greatly diluted and several drops of sulfuric acid

¹ R. Hottinger: *Biochem. Z.*, 65, 177 (1914).

² P. Scheitz: *Z. anal. Chem.*, 49, 735 (1910).

added, very pure azolitmin separates out as a brown-red precipitate, leaving in solution a small amount of impurities. An uncommonly bright blue solution is obtained by treating this purified azolitmin with water containing a trace of ammonia. The indicator solution may be prepared by dissolving 1 g. of azolitmin in 100 c.c. of weakly alkaline water and neutralizing carefully with acid until the appearance of a violet tint. The transformation occurs between pH 5.0 and 8.0, from red to blue. One should use 1–10 drops per 10 c.c. The salt error and protein error of this substance is rather large. It is unsuited for colorimetric determinations.

Rosolic acid (also aurin and yellow corallin). This indicator is a mixture of aurin, oxidized aurin, methyl aurin, and pseudo rosolic acid or corallinphthalein. The structure of the principal constituent is

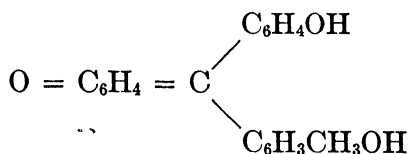

(compare with phenolbenzein, page 136). A 50% alcohol stock solution should contain 0.2% of indicator. About 1–4 drops should be used per 10 c.c. The color changes from yellow to red in the range 6.6–8.0. This indicator is very useful for the titration of alcoholic solutions.

Neutral red:¹ Schultz, 5th Ed., No. 670. Amino-dimethyl-amino-tolphenazin-hydrochloride,

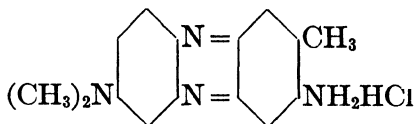

Stock solution: 0.1% in 70% alcohol; store in dark colored containers, and prepare anew every three months. The transformation range is 6.8–8.0, from red to yellow-orange. About 1–3 drops of indicator solution may be used per 10 c.c. The salt error is small, and the compound is a satisfactory indicator.

Diorthohydroxystyrylketone, $\text{OC} = (\text{CH} = \text{CHC}_6\text{H}_4\text{OH})_2$. This substance was proposed as an indicator by ARON. Stock solu-

¹ Bernthsen and Schweitzer: Liebig's Ann. Chem., 236, 332 (1886).

tion: 0.05% in alcohol. Transformation range 7.3–8.7, from yellow to green. This compound is not very useful because the green color fades on standing.

Fast green F.C.F. or *p*-Hydroxyerioglucine is available as a synthetic dyestuff. The tetrasodium salt is colorless, the trisodium salt is blue (absorption line 611 $\mu\mu$), and the disodium salt green (absorption line 628 $\mu\mu$).

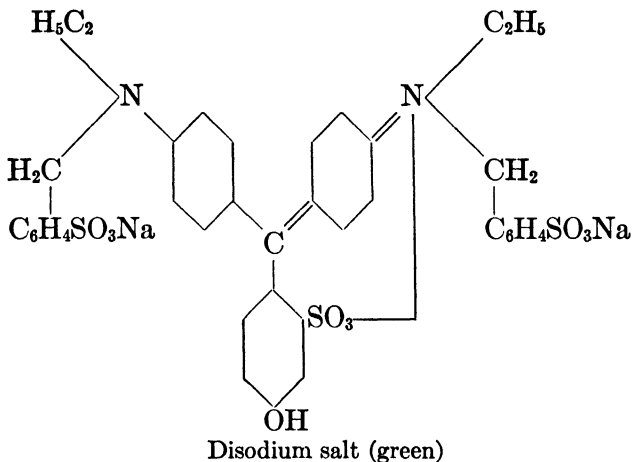
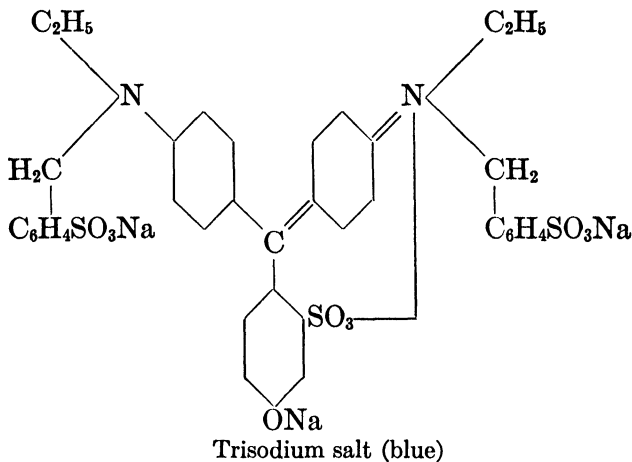

It is evident that the constant of the phenol group governs the color change from green to blue. The spectrophotometric measurements of W. C. HOLMES and E. F. SNYDER¹ show that

¹ W. C. Holmes and E. F. Snyder: *J. Am. Chem. Soc.*, 50, 1907 (1928).

at 29° pK_I is 8.1. The green color changes to yellow in strong acid solutions.

Nile blue. Diethylaminonaphthophenazoniumchloride,

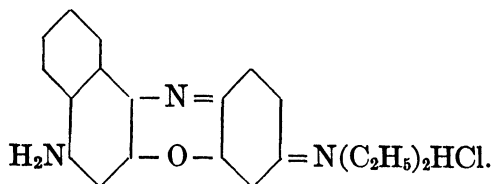

Stock solution: 0.1% in water (blue; maximum absorption in dilute solution at 630 $\mu\mu$). Transformation occurs from blue to red at 9.0–10.4. The free indicator base is red, and exceedingly insoluble in water. The red form separates out on standing, leaving a colorless solution. This characteristic makes it rather unsatisfactory for use in pH determinations, although it may be used for titrations. The dissociation constant (indicator constant) of the substance is 10^{-10} .

Alkali blue and *Poirrier's blue* have no practical importance, and therefore will not be described.

Plant extracts. Various plants contain natural dyes which resemble acid-base indicators. Actually such extracts have little practical value because the dyes as a rule are very impure and their alkaline forms usually undergo decomposition. L. E. WALBUM¹ has recommended the use of red cabbage extract, which possesses an interval at 2.4 to 4.5, from red to green.

T. MILOBEDZSKI and S. JAJTI² have studied the alcoholic blue cabbage extract—which they name “cop.” This extract exhibits the following colors: red at pH 2.0, pale red at 3.0, rose at 4–5, rose-violet at 6, violet at 6.5, blue at 7, blue-green at 7.5, green at 8, greenish yellow at 9, yellow-green at 10, and yellow at 11. Durable “cop” solutions are obtained by extracting blue cabbage with 50–60% alcohol. They should be stored in orange colored glass flasks with glass stoppers.

K. HARRISON³ has described the indicator properties of *sinalbin* extracted from white mustard (*sinapis alba*). This glucoside has a transformation range between pH 6.2 (colorless) and 8.4 (yellow).

¹ L. E. Walbum: Compt. rend. trav. lab. Carlsberg, 10, 227 (1913).

² T. Milobedzski and S. Jajti: Chem. Zentr., 1927, 1, 329.

³ K. Harrison: Biochem. J., 26, 88 (1932).

O. B. PRATT and H. O. SWARTOUT¹ have investigated the indicator properties of various fruit and vegetable extracts. Their results are summarized in the following table. Alcoholic solutions of these substances are permanent and may be employed in titrations, especially when one titrates from the acid to the alkaline side. They can not be used for alkaline solutions because in such media they decompose rapidly. These indicators are of little importance in pH determinations.

EXTRACT	INTERVAL	COLOR	
		Acid	Alkaline
Apple	6.2- 7.4	red	yellow-green
Blackberry	6.0- 7.4	red	gray-blue
Blueberry	6.2- 7.2	red-purple	green-purple
Cactus	9.0-12.0	red	weak purple
Cactus	12.0-13.0	weak purple	red-brown
Cherry	6.0- 7.2	red	blue-purple
Mountain Cranberry	6.2- 7.2	red	yellow-green
Grape	5.0- 6.6	red	purple
Grape	6.6- 7.6	purple	green
Plum	6.2- 7.2	red	yellow-green
Pomegranate	6.0- 6.8	red	purple
Pomegranate	6.8- 7.6	purple	green
Raspberry	6.2- 7.2	red	yellow-green

5. Indicators for use in very strongly acid media.

Indicators which change color in extremely strongly acid media are not generally in demand. It rarely happens that the pH must be determined for solutions of strong acids so concentrated that the indicators usually employed in volumetric analysis are completely useless. From a theoretical viewpoint, however, it is desirable to have available indicators which undergo transformation at very high acidities. One profitable use for such substances would be to determine the true degree of acidity of mineral acids in aqueous solutions of different concentrations. Another application could be the determination of the acidity of strong acids in various solvents to permit comparison with the acidity in aqueous solutions. The latter problem has assumed great importance of late.

¹ O. B. Pratt and H. O. Swartout: *Science*, 71, 486 (1930).

The fact that the sulfonephthaleins and the benzeins change color in the strong acid region has been mentioned earlier in this chapter. The following indicators were employed by J. B. CONANT and N. F. HALL¹ in their splendid studies of "super-acidity" in glacial acetic acid: benzalacetophenone, triphenylcarbinol, diphenyl- α -naphthylcarbinol, piperonalacetophenone, dianisylcarbinol, anisalacinnamalacetone, dipiperonalacetone, dianisalacetone, diphenylanisylcarbinol, and phenylxanthidrol.

This question was first studied systematically by L. P. HAMMETT and A. J. DEYRUP.² We referred, in Chapters Three and Four, to the difficulties encountered in measuring hydrogen ion activities in various solvents. When water is the solvent, we measure the activity of hydrated protons (hydronium ions) instead of the real proton activity; and in other solvents too, it is the activity of the solvated protons which is determined. Accordingly, HAMMETT and DEYRUP have proposed to express acidity in terms of an *acidity function* H_0 which is measured with *monoacidic indicator bases*.

Let us first consider the meaning of this term which otherwise might lead to considerable confusion. The acidity function H_0 is defined by the following equation:

$$H_0 = \log \frac{c_B}{c_{BH^+}} + pK_B'. \quad (a)$$

In this expression c_B is the concentration of the undissociated indicator base, c_{BH^+} is the concentration of its cation, and pK_B' is the negative logarithm of its basic strength in water. It is immediately evident that H_0 is a measure of the degree to which a base of $pK_B' = 0$ reacts with hydrogen ions. We may say also that H_0 is a measure of the strength of a monoacidic indicator base half of which is present in the form of ions.

From Chapters Three and Four we know that

$$pK_B' = -\log \frac{a_{H^+}a_B}{a_{BH^+}} = -\log \frac{c_{H^+}c_B}{c_{BH^+}} - \log \frac{f_{H^+}f_B}{f_{BH^+}}, \quad (b)$$

in which a stands for activity, c is concentration, and f is the activity coefficient. Furthermore it is conventional to set the activity coefficients in aqueous solutions equal to unity, which

¹ J. B. Conant and N. F. Hall: *J. Am. Chem. Soc.*, 49, 3062 (1927).

² L. P. Hammett and A. J. Deyrup: *J. Am. Chem. Soc.*, 54, 2721 (1932).

permits us to write

$$pK_B' = -\log \frac{c_{H_3O^+} c_B}{c_{BH^+}}. \quad (c)$$

If now we compare the ionization relationship between two monoacidic indicator bases *in the same medium*, we see from (b) that

$$pK_{B_1}' - pK_{B_2}' = -\log \frac{c_{B_1} c_{B_2 H^+}}{c_{B_2} c_{B_1 H^+}} - \log \frac{f_{B_1} f_{B_2 H^+}}{f_{B_2} f_{B_1 H^+}}. \quad (d)$$

Since both bases belong to the same charge type, the ratio of the activity coefficients which constitutes the second member of equation (d) may be set equal to unity, thus leading to:

$$pK_{B_1}' - pK_{B_2}' = -\log \frac{c_{B_1} c_{B_2 H^+}}{c_{B_2} c_{B_1 H^+}}. \quad (e)$$

This ratio can be determined either colorimetrically or spectrophotometrically. Starting with an indicator base of known pK_B' , we can determine the pK_B' of other monoacidic indicator bases (referred to water) in a great number of solutions of increasing acidity. The pK_B' permits in turn an evaluation of H_0 for a given solution.

Equations (a) and (b) indicate that

$$H_0 = -\log a_{H^+} \frac{f_B}{f_{BH^+}}.$$

In aqueous solution, H_0 corresponds to the conventional hydrogen ion concentration (or rather pH), whereas in other solvents it represents the *acidity referred to water*. As long as only monoacidic indicator bases of similar nature are employed, the measured H_0 value is independent of the specific character of the indicator. For such bases, the f_B/f_{BH^+} ratios are the same in a given solvent.

It should be noticed that this procedure yields a large number of acidity functions which depend upon the charge type of the indicators involved. If we consider, for example, a monobasic indicator acid,

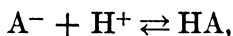

we obtain the acidity function H_- (instead of H_0 , because in this

case the base is a monovalent anion):

$$H_- = \log \frac{c_{A^-}}{c_{HA}} + pK_{HA},$$

where

$$pK_{HA} = - \log \frac{a_{H^+} + a_{A^-}}{a_{HA}}$$

or, as in the conventional manner,

$$pK_{HA} = - \log \frac{c_{H_3O^+} + c_{A^-}}{c_{HA}}.$$

A different acidity function (H_+ , H_{++} , H_-) is obtained for indicators of other charge types:

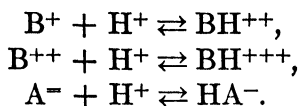

Hence only monoacidic indicator bases should be employed for the determination of the acidity function H_0 . Confusion may result from the use of indicators belonging to other charge types.

HAMMETT and DEYRUP have measured the pK_B' of various monoacidic indicator bases in mixtures of sulfuric acid and water and of perchloric acid and water. All of their indicators showed a transformation from yellow to colorless or the reverse. A summary of this work is found in the following table.

MONOACIDIC INDICATOR BASES ACCORDING TO HAMMETT AND DEYRUP

SUBSTANCE	COLOR		pK_B'
	Alkaline	Acid	
<i>p</i> -Nitroaniline	yellow	colorless	(+1.40)
<i>o</i> -Nitroaniline	yellow	colorless	+0.16
<i>p</i> -Chloro- <i>o</i> -nitroaniline	yellow	colorless	-0.56
<i>p</i> -Nitrodiphenylamine	yellow	colorless	-2.09
2,4-Dichloro-6-Nitroaniline	yellow	colorless	-2.93
<i>p</i> -Nitroazobenzene	colorless	yellow	-3.06
2,6-Dinitro-4-methylaniline	yellow	colorless	-4.03
2,4-Dinitroaniline	yellow	colorless	-4.09
<i>N,N</i> -Dimethyl-2,4,6-trinitroaniline	yellow	colorless	-4.40
Benzalacetophenone	colorless	yellow	-5.32
β -Benzoylnaphthalene	colorless	yellow	-5.63
<i>p</i> -Benzoyldiphenyl	colorless	yellow	-5.90
6-Bromo-2,4-Dinitroaniline	yellow	colorless	-6.30
Anthraquinone	colorless	yellow	-7.86
2,4,6-Trinitroaniline	yellow	colorless	-9.0

It is a very simple matter to determine $B : BH^+$ ratios for, with one-color indicators, it is necessary to measure only the intensity of a color (cf. Chapter Nine on the determination of pH with one-color indicators in unbuffered solutions). One must remember that the solvent may have an effect upon the absorption spectrum and upon the color intensity (absorption coefficient). Such uncertainties may be avoided by the use of comparison solutions having the same composition as the solutions under investigation, or by applying a correction, for the influence of solvent, ascertained by comparing the color of the experimental solutions with that of aqueous solutions.

Several of the values for acidity function H_0 measured by HAMMETT and DEYRUP for water-sulfuric acid mixtures are recorded below. The acidity function of concentrated sulfuric acid is seen to be 10.6; and therefore this compound is $(10.6 + 7.0) = 17.6$ units more acid than water (pH of water at 25° is 7.0).

STRENGTH OF SULFURIC ACID IN %	H_0	STRENGTH OF SULFURIC ACID IN %	H_0	STRENGTH OF SULFURIC ACID IN %	H_0
0.939	+1.28	31.85	-1.39	76.9	- 6.07
3.08	+0.73	35.41	-1.68	85.4	- 7.35
5.96	+0.44	41.6	-2.16	91.5	- 8.03
10.59	+0.08	48.2	-2.67	96.1	- 8.57
15.92	-0.33	56.8	-3.74	98.95	- 9.31
19.12	-0.54	64.3	-4.55	99.86	-10.02
23.90	-0.85	71.2	-5.40	100.00	-10.60

Properties of the indicator bases of Hammett and Deyrup.

p-Nitroaniline (KAHLBAUM). Melting point 48.9° .

o-Nitroaniline (KAHLBAUM). Recrystallized from alcohol. Melted at 71.7° .

p-Chloro-*o*-nitroaniline. Obtained by neutralization of the hydrochloride. Recrystallized from water. Melting point 116.1° .

p-Nitrodiphenylamine (Eastman Kodak Co.). Recrystallized from alcohol. Melting point 133° .

2,4-Dichloro-6-nitroaniline. Prepared by method of WITT,¹ by chlorination of 4-chloro-2-nitroaniline. Recrystallized from alcohol and acetone. Melting point 101.1° .

¹ Witt: Ber., 8, 820 (1875).

p-Nitroazobenzene. Prepared according to the method of JANOWSKY.¹ Recrystallized from acetone. Melting point 130.8°.

2,6-Dinitro-4-methylaniline. Prepared by nitration of acetone-*p*-toluidine and saponifying the acetyl derivative (BEILSTEIN and KUHLEBERG;² JACKSON and ITTNER³). Recrystallized from alcohol and acetone. Melting point 169°.

2,4-Dinitroaniline (Eastman Kodak Co.). Recrystallized from alcohol and acetone. Melting point 180°.

N-N-Dimethyl-2,4,6-trinitroaniline. Obtained from picryl chloride and dimethylamine (P. VAN ROMBURGH⁴). Recrystallized from glacial acetic acid. Melting point 141°.

Benzalacetophenone (Eastman Kodak Co.). Recrystallized from alcohol. Melting point 55.5°.

β-Benzoylnaphthalene. Prepared according to the directions of P. MONTAGNE.⁵ Recrystallized from alcohol. Melting point 82.7°.

p-Benzoyldiphenyl. Directions of MONTAGNE.⁶ Recrystallized from alcohol. Melting point 101.6°.

6-Bromo-2,4-dinitroaniline. According to KÖRNER,⁷ by bromination of 2,4-dinitroaniline. Recrystallized from glacial acetic acid. Melting point 150.5–152°.

Anthraquinone (KAHLBAUM). Recrystallized from alcohol.

2,4,6-Trinitroaniline (KAHLBAUM). Recrystallized from alcohol.

6. Universal indicators.

Mixtures of various dyes have been used often to permit a preliminary determination of pH. The components of such mixtures are chosen so that different color tints appear over a wide range of pH (3 to 11), making it possible to obtain an *approximate* value for the acidity of a solution. These *universal indicators* are not intended for accurate pH determinations because the color difference attending a given pH increment is much less than for single unmixed indicators. The author himself has never considered such universal indicators very important because pH

¹ Janowsky: Monatsh., 7, 124 (1886).

² Beilstein and Kuhlberg: Liebig's Ann. Chem., 158, 341 (1871).

³ Jackson and Ittner: Am. Chem. J., 19, 6 (1897).

⁴ P. van Romburgh: Rec. trav. chim., 2, 105 (1883).

⁵ P. Montagne: Rec. trav. chim., 26, 281 (1907). Rousset: Bull. soc. chim., (3) 15, 71 (1896).

⁶ Montagne: Rec. trav. chim., 27, 357 (1908).

⁷ Körner: Jahresber., 1875, 350.

can be determined approximately merely by using indicator papers or single indicator solutions. They are discussed, however, because a number of mixtures of this type have been described in the literature.

FELTON (1921) has employed a mixture of equal quantities of methyl red and bromthymol blue for the range 4.6–7.6; of methyl red and bromcresol purple for the range 4.6–7.0; methyl red and thymol blue for 1.2–9.0. LIZIUS and EVERS (1922) used one part of methyl red and three of thymol blue for the region 4–10; one of phenolphthalein with six of thymol blue for the range 8–10; one of phenolphthalein and six of thymolphthalein for 8.3–11.0; one part of tropeolin 0 with four of thymolphthalein between pH's 9–13.

J. MOIR¹ prepared a universal indicator of a wider range by using a mixture of methyl red, α -naphtholphthalein and phenolphthalein. F. H. CARR² added bromthymol blue and thymolphthalein to this mixture. The relative amounts of the various indicators were not reported by these authors. A useful "universal indicator" may be prepared³ by mixing equal volumes of 0.1% solutions of the five indicators named above. This indicator solution is red at a pH of 4.0, orange-red at 5, yellow at 6, green-yellow at 7, green at 8, blue-green at 9, blue-violet at 10, and red-violet at 11.

E. B. R. PRIDEAUX and A. T. WARD⁴ have described a commercial universal indicator prepared by the British Drug Houses (London). Although its composition is not disclosed, its color changes are identical with those of the Carr mixture.

E. BOGEN⁵ proposes the following solution: 100 mg. of phenolphthalein, 200 mg. of methyl red, 300 mg. of dimethylaminoazobenzene, 400 mg. bromthymol blue, and 500 mg. of thymol blue in 500 c.c. of alcohol, with sufficient 0.1 N alkali added to produce a yellow color (pH = 6). At a pH of 1, the color is cherry red; at 2, rose; red-orange at 3; orange-red at 4; orange at 5; yellow at 6; yellow-green at 7; green at 8; blue-green at 9; blue at 10. This indicator is satisfactory in the pH range 4 to 10.

¹ J. Moir: *J. Chem. Met. Mining Soc. S. Africa*, 1917, 129.

² F. H. Carr: *Analyst*, 47, 196 (1922).

³ I. M. Kolthoff: *Pharm. Weekblad*, 66, 67 (1929).

⁴ E. B. R. Prideaux and A. T. Ward: *J. Chem. Soc.*, 125, 423 (1924).

⁵ E. Bogen: *J. Am. Med. Assoc.*, 89, 199 (1927).

H. W. VAN URK¹ has varied the composition of this mixture somewhat to obtain more pronounced color differences.

Of the other universal indicators which have been suggested, the following should be mentioned:

KOLTHOFF (1929): 15 c.c. 0.1% dimethylaminoazobenzene, 5 c.c. 0.1% methyl red, 20 c.c. 0.1% bromthymol blue, 20 c.c. 0.1% phenolphthalein, and 20 c.c. 0.1% thymolphthalein. The colors obtained upon addition of 0.1 c.c. to 10 c.c. of solution under investigation are: rose at pH of 2.0, red-orange at 3.0, orange at 4.0, yellow-orange at 5.0, lemon yellow at 6.0, yellow-green at 7.0, green at 8.0, blue-green at 9.0, and violet at 10.0.

E. L. SMITH:² 0.02% bromcresol green, 0.0045% neutral red, 0.05% *p*-nitrophenol, and 0.6% phenolphthalein in alcohol. The color of this solution is orange at a pH of 4.5, changes through gray to blue, then to green, and at 8.5 it passes through gray to red (see next section).

7. Mixed indicators.

It is more advantageous for certain purposes to use dyes which change color very sharply at a given pH. Such indicators with a "transformation point" are especially important in volumetric analysis, although less useful for the colorimetric determination of pH. Even in colorimetric determinations, however, such an indicator offers certain advantages, especially when it is desirable to determine small changes in pH in the neighborhood of the "transformation point" of the indicator.

As was shown in the very beginning of this chapter, a single indicator always possesses a "transformation interval" rather than a "transformation point." By combining two suitable indicators it is often possible to prepare mixtures which change color rather sharply at a given pH. This can be done in the following manner:

(a) To an indicator is added a dye the color of which is the complement of one of the indicator colors. Thus methyl green has a color which is complementary to the red-violet alkaline form of phenolphthalein. A solution which is 1% in phenolphthalein and 0.2% in methyl green constitutes a "mixed indicator" with a green color in acid medium. The transformation of phenolphthalein starts at pH 8.4, the color turning gray. At

¹ H. W. van Urk: Pharm. Weekblad, 65, 1246 (1928).

² E. L. Smith: Pharm. J., 71 (4), 101 (1930).

TRANSFORMATION POINTS OF CERTAIN USEFUL MIXED INDICATORS

COMPOSITION OF INDICATOR SOLUTION	PT	ACID COLOR	ALKALINE COLOR	REMARKS
1 Part dimethyl yellow 0.1% in alcohol	3.28	blue-violet	green	Still green at pH = 3.4; blue-violet at 3.2; excellent indicator
1 " methylene blue 0.1% " " Store in dark container				
1 Part methyl orange 0.1% in water	4.1	violet	"	Good indicator, especially under artificial illumination
1 " indigocarmine 0.25% " " Store in dark container				
1 Part hexamethoxytriphenylcarbinol 0.1% in alcohol	4.0	"	"	Blue-violet color at pH = 4.0
1 " methyl green 0.1%				
1 Part methyl orange 0.1% in water	4.3	"	"	
1 " aniline blue 0.1% " " "				
3 Parts bromeresol green 0.1% in alcohol	5.1	wine-red	"	Very sharp color change; excellent indicator
1 Part methyl red 0.2% " " " Store in dark container				
1 Part methyl red 0.2% in alcohol	5.4	red-violet	"	Dirty blue color at pH = 5.4; dirty green at pH = 5.6; red-violet at pH 5.2
1 " methylene blue 0.1% " " " Store in dark container				
1 Part bromeresol green (sodium salt) 0.1% in water	5.6	violet	yellow-green	Red-brown at pH = 5.6; very good indicator
1 " sodium alizarine sulfonate 0.1% in water				
1 Part chlorphenol red (sodium salt) 0.1% in water	5.8	green	violet	Pale violet at pH = 5.8
1 " aniline blue 0.1% in water				

TRANSFORMATION POINTS OF CERTAIN USEFUL MIXED INDICATORS—Continued

COMPOSITION OF INDICATOR SOLUTION	pT	ACID COLOR	ALKALINE COLOR	REMARKS
1 Part bromocresol green (sodium salt) 0.1% in water	6.1	yellow-green	blue-violet	Blue-green at pH = 5.4; blue with violet tinge at 5.8; blue-violet at 6.2
1 " chlorphenol red (sodium salt) 0.1% in water				
1 Part bromocresol purple (sodium salt) 0.1% in water	6.7	yellow	violet-blue	Yellow-violet at pH = 6.2; violet at 6.6; blue-violet at 6.8
1 " bromthymol blue (sodium salt) 0.1% in water				
2 Parts bromthymol blue (sodium salt) 0.1% in water	6.9	violet	blue	
1 Part azolitmin 0.1% in water				
1 Part neutral red 0.1% in alcohol	7.0	violet-blue	green	Violet-blue at pH = 7.0; excellent indicator
1 " methylene blue 0.1% " " " Store in dark container				
1 Part neutral red 0.1% in alcohol	7.2	rose	"	Dirty green at pH > 7.2; pale rose at 7.2; distinct rose at 7.0
1 " bromthymol blue 0.1% " " "				
2 Parts cyanin 0.1% in 50% alcohol	7.3	yellow	violet	Orange at pH = 7.2; violet at 7.4; color fades on standing
1 Part phenol red 0.1% " " " Decomposes on standing				
1 Part bromthymol blue (sodium salt) 0.1% in water	7.5	"	"	Dirty green at 7.2; pale violet at 7.4; intense violet at 7.6; excellent indicator
1 " phenol red (sodium salt) 0.1% in water				

TRANSFORMATION POINTS OF CERTAIN USEFUL MIXED INDICATORS—Continued

COMPOSITION OF INDICATOR SOLUTION	p _T	ACID COLOR	ALKALINE COLOR	REMARKS
1 Part cresol red (sodium salt) 0.1% in water	} 8.3	"	"	Rose at pH = 8.2; distinct violet at 8.4; excellent indicator
3 Parts thymol blue (") 0.1% " "				
2 Parts α-naphtholphthalein 0.1% in alcohol	} 8.3	pale rose	"	Pale violet at pH = 8.2; intense violet at 8.4
1 Part cresol red 0.1% " "				
1 Part α-naphtholphthalein 0.1% in alcohol	} 8.9	"	"	Pale green at pH = 8.6; distinct violet at 9.0
3 Parts phenolphthalein 0.1% " "				
1 Part phenolphthalein 0.1% in alcohol	} 8.9	green	"	Pale yellow-blue at pH = 8.8; violet at 9.0
2 Parts methyl green 0.1% " "				
1 Part thymolblue 0.1% in 50% alcohol	} 9.0	yellow	"	Color changes from yellow through green to violet; excellent indicator
3 Parts phenolphthalein 0.1% " "				
2 Parts phenolphthalein 0.1% in 50% alcohol	} 9.6	pale rose	"	Color changes through green to violet; excellent indicator
1 Part naphtholphthalein 0.1% " "				
1 Part phenolphthalein 0.1% in alcohol	} 9.9	colorless	"	Rose at pH = 9.6; violet appears at 10.0
1 " thymolphthalein 0.1% " "				
1 Part phenolphthalein 0.1% in alcohol	} 10.0	blue	red	Violet at pH = 10.0; excellent indicator
2 Parts Nile blue 0.2% " "				
2 Parts thymolphthalein 0.1% in alcohol	} 10.2	yellow	violet	Sharp color change
1 Part alizarine yellow 0.1% " "				
2 Parts Nile blue 0.1% in water	} 10.8	green	red-brown	
1 Part alizarine yellow 0.1% " "				

pH 8.8, the color is a pale blue. In this case both colors almost completely compensate one another. In still stronger alkaline solutions the red-violet form of phenolphthalein predominates, and at pH 9.0 the color becomes violet. It is evident that the phenolphthalein-methyl green mixture has a transformation point at pH 8.8.

(b) The components of such indicator mixtures are substances which exhibit their indicator action at approximately the same pH and which show contrasting colors. When the extinction or transmission coefficients of the individual indicators are known at various wave lengths and pH values, suitable combinations may be decided upon very easily. In this connection, the publications of E. B. R. PRIDEAUX¹ and of A. THIEL and R. DIEHL² are of interest.

More than thirty years ago M. SCHOLTZ³ proposed a large number of mixed indicators which, however, have been little used. Well known is the methyl orange-indigocarmine mixture which has been recommended also by LUTHER⁴ and KIRSCHNIK.⁵ K. C. D. HICKMAN and R. P. LINSTEAD⁶ used xylene-cyanol (F.T.) instead of indigocarmine, their indicator solution containing one part of methyl orange and 1.4 of xylene-cyanol in 500 c.c. of 50% alcohol. The color is green in alkaline solution and magenta red in acid solution. The mixture is a neutral gray at a pH of 3.8. The methyl orange-indigocarmine mixture shows similar colors. It must be stored in dark containers.

A. COHEN⁷ has made use of mixtures of sulfonephthaleins. For example, a mixture of bromcresol purple and bromthymol blue is green-yellow at pH 6.0 and blue at 6.8. He recommends also solutions of bromcresol purple with bromphenol blue and of bromphenol blue and cresol red. Other combinations⁸ have also been proposed. I. M. KOLTHOFF⁹ has investigated a large

¹ E. B. R. Prideaux: *J. Soc. Chem. Ind.*, 55, 664, 678, 697 (1926).

² A. Thiel and R. Diehl: *Sitzb. Ges. Naturw. Marburg*, 64, 79 (1929).

³ M. Scholtz: *Z. Elektrochem.*, 10, 549 (1904).

⁴ Luther: *Chem.-Zeit.*, 31, 1172 (1904).

⁵ Kirschnik: *Chem.-Zeit.*, 31, 960 (1907).

⁶ Hickman and Linstead: *J. Chem. Soc.* 121, 2502 (1922). F. X. Moerk: *Am. J. Pharm.*, 93, 675 (1921).

⁷ A. Cohen: *J. Am. Chem. Soc.*, 44, 185 (1922).

⁸ Lizius: *Analyst*, 46, 355 (1921). F. H. Carr, *Analyst*, 47, 196 (1922). G. Chabot: *Chem. Zentr.*, 96, 1375 (1922). G. Simpson: *J. Ind. Eng. Chem.*, 16, 709 (1924).

⁹ I. M. Kolthoff: *Biochem. Z.*, 189, 26 (1927).

number of combinations which are included in the preceding table. It is found generally advisable to store mixed indicators in brown vessels because of the tendency of many dyes to decompose photochemically. In the second column of the table, under p_T , the transformation point of the indicator is given.

8. Turbidity indicators.

The appearance of a turbidity due to the formation of a precipitate has been used on many an occasion to detect the end-point of a reaction. L. KIEFFER¹ took advantage of precipitate formation to indicate the equivalence point in acidimetry and alkalimetry. This he did with the aid of an ammoniacal copper sulfate solution. Other less useful indicators of this type have been suggested (cf. K. JELLINEK²). KARL NAEGELI³ has investigated thoroughly the possible use of colloidal ampholytes as turbidity indicators, and has found certain of them to be fairly valuable. Many ampholytes are distinguished by their great insolubility at the isoelectric point (cf. Chapter Two). Their solubility increases on both sides of this critical point due to the formation of cations in more acid media and anions on the alkaline side. Addition of a solution of such an ampholyte (anion or cation salt) to a liquid will produce a perceptible turbidity only if the pH of the liquid is very close to the isoelectric point of the ampholyte. Turbidity indicators have practically no value in determining pH. There is some use for them in volumetric analysis. Details should be sought in the original paper of NAEGELI and the author's book, *Maszanalyse II* 2d Ed. 1931, p. 54.

9. Fluorescence indicators.

The technique and the interest in measurements of ultraviolet light have grown to such an extent in the last few years that a brief discussion of fluorescence indicators is in order. These compounds are weak acids or bases whose acid or alkaline forms exhibit a marked fluorescence. The phenomenon of fluorescence involves the absorption of light of a given wave length by a substance, and the subsequent emission of the absorbed energy as light of another wave length (usually longer than the absorbed).

¹ L. Kieffer: *Liebig's Ann.*, **93**, 386 (1855).

² K. Jellinek: *Z. anorg. allgem. Chem.*, **130**, 263 (1923).

³ K. Naegeli: *Kolloidchem. Beihefte*, **21**, 306 (1925).

It should be possible to determine the pH of a solution with fluorescence indicators just as with one-color indicators. If the dissociation constant of the indicator is known, and if a measured quantity of the indicator is added, then, from the intensity of fluorescence, it is possible to obtain the concentration of the fluorescing form and therefore the ratio $[HI]/[I^-]$ or $[IOH]/[I^+]$ (cf. the method of MICHAELIS, Chapter Nine, section 5).

Great care must be exercised when applying this method. J. EISENBRAND¹ has demonstrated a significant relationship between the light absorption and fluorescence of quinine sulfate solutions in sulfuric acid. He finds that a logarithmic expression relates light absorption and intensity of fluorescence. Dilute solutions constitute a limiting case in which the extinction of the fluorescing field is infinitely small; and for such solutions, *concentration is directly proportional to the intensity of fluorescence*. It should be remembered, however, that this rule holds only for very dilute solutions, in which the absorption of fluorescence radiation by the solution is infinitely small.

This rule has a very decided bearing on the application of fluorescence indicators to pH measurements. It is, obviously, imperative that the indicator exhibit a decided fluorescence in extremely small concentrations (as do bivalent quinine ions), so that one may work in the region of direct proportionality. Addition of larger amounts of indicator is to be avoided because, just as color indicators possess acid or basic properties, fluorescence indicators may change the pH of a solution (cf. especially Chapter Ten, section 1, unbuffered liquids).

When the fluorescence method becomes more generally adopted, it will be necessary to study not only those factors (neutral salt, temperature) which alter the equilibrium relationships, but also those which influence fluorescence (deformation effect, influence of solvent, etc.; cf. P. W. DANCKWORTT, *Luminescence Analysis*, 2 Ed., Leipzig 1929; F. WEIGERT, *Optical Methods in Chemistry*, 1927). The interesting publication of L. J. DESHA² should be consulted regarding the quantitative aspects of fluorometry. In quantitative work it is best to use the filtered monochromatic ultraviolet radiation ($\lambda = 366 \mu\mu$) from a quartz lamp. Con-

¹ J. Eisenbrand: *Z. physik. Chem.*, 144, 441 (1929).

² L. J. Desha: *J. Am. Chem. Soc.*, 42, 1350 (1920).

tainers made of ordinary glass may then be used since they are transparent to the longer wave lengths in the ultraviolet.

A connection between fluorescence and pH was recognized even in the earlier technical literature (cf. KRÜGER,¹ BUCKINGHAM,¹ KNOBLAUCH,¹ WADDEL,¹ ZELLNER¹). O. STARK² had recommended 2-methyl-3-aminoquinoline for use in titrations. The ions of this compound show a marked fluorescence whereas the free base is inactive. The fluorescence interval, like the color change range, is not defined very precisely. The region depends, of course, also upon the sensitivity of the instruments employed.

*Dichlorfluorescein.*³ Interval, 4.0–6.6; fluoresces in alkaline solution. Use 2 c.c. of a 1% indicator solution per 100 c.c.

*Fluorescein.*⁴ Interval between pH's 3.8 (weak blue-green fluorescence) and 4.3 (intensive green fluorescence). H. LINSER advises the use of this substance between 3.4 and 4.1.

*Salicylic Acid.*⁵ Interval, 2.0 (colorless) to 3.5 (intensive blue fluorescence).

*Acridine.*⁴ Intensive green fluorescence at pH < 4.85, and violet-blue fluorescence at pH > 4.85.

*β-Methylumbelliferon.*⁶ (0.3% in alcohol.) Anhydride form:

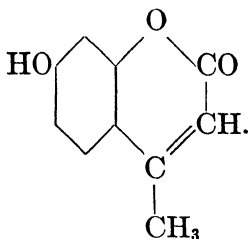

Interval, 5.8 (colorless) to 7.5 (blue fluorescence).

*Umbelliferon.*⁷ Interval, pH 6.5 (weak blue fluorescence) to

¹ Krüger: Ber., 9, 1572 (1876). Buckingham: Z. physik. Chem., 14, 129 (1894). Knoblauch: Wied. Ann., 54, 193 (1895). Waddel: J. Phys. Chem., 2, 171 (1898). Zellner: Pharm. Zeit., 46, 100 (1901), also Kummerer: Inaug.-Diss., Berlin (1914).

² O. Stark: Ber., 40, 3434 (1907).

³ G. A. Bravo: Chimie & industrie, 22, 481 (1929). Y. Volmar: Anales soc. españ. ffs. quím., 29, 247 (1931).

⁴ Y. Volmar and E. Widder: Chimie & industrie, 21, 160 (Special issue) (1929). Y. Volmar: Arch. phys. biol., 6, 61 (1928).

⁵ J. Eisenbrand: Pharm. Zeit., 74, 249 (1929).

⁶ C. Bülow and W. Dick: Z. anal. Chem., 75, 81 (1928).

⁷ Robl: Ber., 59, 1725 (1926). R. Mellit and M. A. Bischoff: Compt. rend., 182, 1616 (1926). Y. Volmar: Anales soc. españ. ffs. quím., 29, 247 (1931).

7.6 (intense blue fluorescence). According to LINSER,¹ the intervals fall between 6.25 and 7.0, and from 7.0 to 8.0.

Esculin. Interval from 3.4 to 4.1 (H. LINSER).

Quinine was studied most thoroughly by J. EISENBRAND (l.c.). It has two transformation intervals: pH 5.8 (forget-me-not blue fluorescence) to 6.5 (bluish violet fluorescence), and pH 9.0 (violet fluorescence) to 10.0 (colorless).

The fact that chlorides influence the intensity of fluorescence greatly detracts from the general usefulness of this indicator.

β -Naphthol (EISENBRAND). Colorless at pH < 8.6 and blue at pH > 8.6.

Cotarnine (EISENBRAND). At pH 12.5, the fluorescence changes from yellow to white.

Naphtholsulfonic acids. The sodium salts of the following naphtholsulfonic acids were studied quantitatively by L. J. DESHA, R. E. SHERILL, and L. M. HARRISON.²

Sodium salt of 1-naphthol-4-sulfonic acid ($K_a = 6.3 \times 10^{-9}$). Acid form colorless; alkaline form fluoresces. Approximate interval, from pH 7.0 (12.7% fluorescence) to 9.6 (93.1% fluorescence).

Sodium salt of 2-naphthol-3,6-disulfonic acid ($K_a = 3.2 \times 10^{-10}$). Interval, approximately from pH 8.6 (colorless) to 10.6 (fluorescent).

Sodium salt of 1-naphthol-2-sulfonic acid. Interval, between 8.5 (colorless) to 10.5 (fluorescent).

DESHA and his collaborators have studied also resorcinol- and hydroquinonesulfonic acids. The fluorescence of these compounds is much less marked than that of the naphtholsulfonic acids. Their rapid decomposition in alkaline solutions renders them valueless.

This brief and necessarily incomplete review of fluorescence indicators must suffice. A more quantitative discussion of the subject would be premature at present because too many factors, such as salt error, effect of indicator concentration, etc., remain yet to be studied exhaustively. Chlorides, for example, diminish considerably the fluorescence of the quinine cations and of the naphtholsulfonic acid anions. Fluorescence indicators are as yet

¹ H. Linser: *Biochem. Z.*, 244, 157 (1932).

² L. J. Desha, R. E. Sherill, and L. M. Harrison: *J. Am. Chem. Soc.*, 48, 1493 (1926).

more important for volumetric analytical determinations in colored solutions than in the quantitative measurement of pH.

10. Classification of indicators.

SCHOORL¹ has pointed out a simple way of classifying the various indicators. An indicator possessing a transformation range which lies in the neighborhood of $\text{pH} = 7$, is equally sensitive to hydrogen ions and to hydroxyl ions, and may be described as *neutral*. If, however, the indicator exponent pK_I (the negative logarithm of the indicator constant; equal to the pH at 50% transformation of the indicator) is less than 7, the transformation starts in an acid medium, and the indicator is *alkali sensitive*. On the other hand, an indicator exponent greater than 7 means that the transformation begins in an alkaline medium and that the indicator is *acid sensitive*.

CLASSIFICATION OF INDICATORS

1. Transformation range about $\text{pH} = 7$, neutral indicator.
Examples: neutral red, phenol red, azolitmin.

2. Transformation range at $\text{pH} > 7$, acid sensitive indicator.
Examples: phenolphthalein, thymolphthalein.

3. Transformation range at $\text{pH} < 7$, alkali sensitive indicator.
Examples: dimethyl yellow, methyl red.

Thus if a neutral solution, such as most samples of tap water, is treated with different indicators, the following behavior will be observed:

Neutral red or phenol red will show an intermediate color,
Phenolphthalein will show its acid color (colorless),
Dimethyl yellow will show its yellow alkaline color.

It is evident that the effect of a solution on an indicator does not determine its *true reaction* as defined in the first chapter. The fact that a liquid reacts acid to phenolphthalein means simply that its pH is less than 8; and when a medium is alkaline towards methyl yellow, we know merely that its pH exceeds 4.2. It is only when we determine the gradation of color, assumed by neutral red for instance, in the particular liquid that the acid or alkaline coloration corresponds to the true acid or alkaline reaction.

¹ N. Schoorl: Chem. Weekblad, 3, 719, 771, 807 (1906).

So far we have always spoken of indicator acids. Exactly the same theoretical treatment may be applied to the indicator bases IOH. Thus for

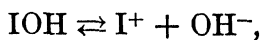

we have

$$\frac{[\text{I}^+]}{[\text{IOH}]} = \frac{K_{\text{IOH}}}{[\text{OH}^-]}, \quad (6)$$

where I^+ denotes the acid form and IOH the basic form. Since the $[\text{OH}^-]$ is equal to $\frac{K_w}{[\text{H}^+]}$, equation (6) may be rearranged to yield the expression

$$\frac{[\text{IOH}]}{[\text{I}^+]} = \frac{K_w}{K_{\text{IOH}} \times [\text{H}^+]}. \quad (7)$$

Substituting ¹ a new constant K' for $\frac{K_w}{K_{\text{IOH}}}$, equation (7) becomes

$$\frac{[\text{IOH}]}{[\text{I}^+]} = \frac{K'}{[\text{H}^+]}. \quad (8)$$

This expression corresponds to the one derived for the acid indicators. The entire discussion concerning the transformation interval applies equally well to the basic indicators.

The transformation range is different for each indicator. Apart from the personal element involved in making observations, the interval depends upon the depth of the liquid layer being observed, the indicator concentration, and the temperature. The influence of indicator concentration especially has never been sufficiently considered. Since this effect is of utmost importance in the colorimetric determination of hydrogen ion concentration as well as in many titrations, it will be discussed thoroughly in the next section.

11. The influence of indicator concentration on the transformation range.

We shall find that a fundamental difference in behavior exists between the one- and poly-colored indicators. The former group will be considered first.

¹The negative logarithm of K' ($= pK_1$) is called the indicator exponent. $\text{pH} = pK_1$ corresponds to the half way point between pure acid and alkali forms.

(a) **One-color indicators.** Assuming again that the indicator is an acid with the formula HI, it follows from equation (2) that

$$\frac{[\text{I}^-]}{[\text{HI}]} = \frac{K_{\text{HI}}}{[\text{H}^+]},$$

and

$$[\text{I}^-] = \frac{K_{\text{HI}}}{[\text{H}^+]} \times [\text{HI}], \quad (9)$$

where $[\text{I}^-]$ is the concentration of the colored form and $[\text{HI}]$ that of the uncolored form. By taking a solution, the $[\text{H}^+]$ of which is regulated by a buffer mixture of known composition, the ratio $\frac{K_{\text{HI}}}{[\text{H}^]}$ in equation (9) is a constant K' , with the consequence that

$$[\text{I}^-] = K' \times [\text{HI}]. \quad (10)$$

We see from this that the quantity of the colored form is proportional to the concentration of undissociated indicator. An increase in $[\text{HI}]$ at a constant hydrogen ion concentration intensifies the color to the same extent. Since, however, most indicators are but slightly soluble, the solution is soon saturated with respect to HI, with the result that the color intensity can not increase beyond a certain maximum. If L is the solubility of the indicator, then at a given $[\text{H}^+]$ this maximum intensity $[\text{I}^-]$ is expressed by

$$[\text{I}^-] = L \times K'. \quad (11)$$

In other words, when a one-color indicator is added to a given buffer mixture, the color intensity will increase to a limit attained when the solution is saturated with respect to the indicator.

Naturally there is also a minimum color intensity which is at the limit of visibility of the colored form; and a definite quantity of the colored form must be present before the indicator can be perceived. This concentration can not be stated exactly since it will vary with the observer and with depth of solution. Denoting this smallest amount of colored form required to produce a visible coloration by $[\text{I}^-_{\text{min.}}]$, we have

$$[\text{I}^-_{\text{min.}}] = [\text{HI}_{\text{min.}}] \times K'. \quad (12)$$

At any given hydrogen ion concentration, the quantity $[\text{I}^-]$,

i.e. the degree of coloration, varies between $[\text{HI}_{\text{min.}}] \times K'$ and $L \times K'$. The important connection between the above consideration and the colorimetric determination of hydrogen ion concentration is apparent. We shall return to this point in Chapter Nine.

The concentration of indicator will influence also the extent of the transformation range. Suppose we have two single-color indicators possessing colored forms perceptible at the same concentration (i.e. the same $[\text{I}^-_{\text{min.}}]$) and having equal dissociation constants! If we always use saturated solutions of the indicator (i.e. $[\text{HI}] = L$), then it follows from equation (9) that the transformation interval begins at a hydrogen ion concentration given by

$$[\text{H}^+] = \frac{L}{[\text{I}^-_{\text{min.}}]} \times K_{\text{HI}}. \quad (13)$$

If the solubilities of the indicators differ one hundred fold, then the concentration of the colored form of the more soluble indicator will, at the same hydrogen ion content of solution, be one hundred times as great as the corresponding value for the second indicator. Hence, when saturated solutions of these indicators are used, the transformation region of the first indicator will start at a hydrogen ion concentration which is one hundred times greater than that at which the color of the second indicator appears. The pH at the start of the transformation of the more soluble indicator is less by two units than when the second indicator is employed. In spite of the similarity of dissociation constants, the transformation of the more soluble indicator takes place over a wider pH range.

The termination of the interval of the more soluble compound appears slightly ahead of that of the other indicator. This difference, however, is negligible. Since the indicator salt is readily soluble, it would be difficult, when the color change is complete, to maintain the solution saturated with respect to indicator. The production of the salt form will already have required the addition of a large quantity of the indicator.

Assuming that the end of the interval is reached when 91% of the indicator is present in the alkaline form, the transformation range of an indicator in saturated solution lies between the hydro-

gen ion concentrations:

$$[H^+] = \frac{L}{[I^-_{\text{min.}}]} \times K_{HI} \quad \text{and} \quad [H^+] = \frac{9}{91} \times K_{HI} = \frac{1}{10} K_{HI}$$

or between

$$\text{pH} = \text{p}K_I + \log \frac{[I^-_{\text{min.}}]}{L} \quad \text{and} \quad \text{pH} = \text{p}K_I + 1.$$

It will be seen from the investigations which are to be described that the above considerations are not without practical significance. It has already been mentioned that the solubility of phenolphthalein is much larger than that of thymolphthalein, so that the width of the interval of phenolphthalein exceeds that of thymolphthalein. The solubility of *p*-nitrophenol is in turn still larger than that of phenolphthalein, so that the *p*-nitrophenol interval is very broad and greatly dependent upon the indicator concentration.

Phenolphthalein. The solubility is about 1/4000 molar, although McCoy¹ has reported as small a value as 1/12,000 molar.

The author has sought to determine the smallest perceptible concentration of the red form ($[I^-_{\text{min.}}]$) of the indicator. He employed Nessler colorimetric tubes containing an 8 cm. depth of liquid viewed against a white background. Solutions of different concentrations were made by diluting a stock solution containing one part of indicator per thousand. To 50 c.c. samples of these solutions was added 1 c.c. 4 N NaOH, and the concentration of indicator at which the red color disappeared was noted. The red coloration was still apparent in a 2×10^{-6} molar indicator solution, while the color of a 1×10^{-6} molar solution was uncertain. Hence the author felt justified in assuming that, for his experimental conditions, $[I^-_{\text{min.}}]$ was equal to 2×10^{-6} molar. This value is of course larger in ordinary titrations since usually the conditions which prevail are unfavorable for observing faint colors.

The study was continued to determine the concentration of the colored form at which further addition to the Nessler tube no longer produced any change observable with the naked eye. This was the case when 5–6 c.c. of the 0.1% stock solution was added to 50 c.c. Other experiments indicated the point to be reached when 1.5 c.c. of a 0.5% solution was added.

¹ McCoy: Am. Chem. J., 31, 563 (1904).

The beginning of the transformation range of phenolphthalein in a saturated solution may be calculated from the above information. It lies at:

$$[\text{H}^+] = \frac{L}{[\text{I}^-_{\text{min.}}]} \times K_{\text{HI}},$$

where $L = \frac{1}{4000} = 2.5 \times 10^{-4}$ molar, and $[\text{I}^-_{\text{min.}}] = 2 \times 10^{-6}$ molar; and on the basis of $pK_{\text{I}} = 9.7$, the point lies at

$$\text{pH} = 9.7 + \log \frac{2 \times 10^{-6}}{2.5 \times 10^{-4}} = 7.6.$$

Actually a boric acid-borax mixture saturated with phenolphthalein shows a rose color at a $\text{pH} = 7.8$.

In our case, the end of the interval lies at a pH which is less than 10.0, coming at $\text{pH} = 9.4$ when a saturated solution of phenolphthalein is used. This is partially due, however, to the fact that pK_{I} is not strictly constant.

Thymolphthalein. This study was performed exactly as was the preceding, so that only data need be presented. The solubility is much less than that of phenolphthalein, since turbidity resulted from the addition of 12.5 c.c. of a 0.1% solution per liter. The solubility of the indicator is thus 1.25×10^{-6} g. per liter. It was shown in addition that $[\text{I}^-_{\text{min.}}] = 1 \times 10^{-6}$ g. per liter.

The simple calculation places the start of the transformation range at

$$\text{pH} = pK_{\text{I}} + \log \frac{1 \times 10^{-6}}{1.25 \times 10^{-6}}.$$

The pH at which the range begins is therefore of the same magnitude as pK_{I} . SÖRENSEN places the interval of thymolphthalein between pH 's 9.3 and 10.5. The author found that the interval begins at $\text{pH} = 9.2$. This and other experiments indicate that the value of pK_{I} is 9.2 instead of $\frac{9.3 + 10.5}{2} = 9.9$. It is evi-

dent from the foregoing that it is not always correct to take pK_{I} from the point at which 50% of the indicator has been converted into the alkaline form (cf. ROSENSTEIN, 1912; also figure 8).

Paranitrophenol. The solubility is an especially important factor in determining the transformation of this substance. A

1% solution is prepared from a product melting at 112–113°, and secondary solutions of various concentrations are prepared by dilution of the stock mixture. Observation of the yellow coloration in Nessler tubes shows

$$[I^-_{\text{min.}}] = 10^{-7} \text{ molar.}$$

$[I^-_{\text{max.}}]$ is of course difficult to determine. The alkaline color of *p*-nitrophenol in dilute solutions is green-yellow, whereas it is golden yellow in higher concentrations. When 1 c.c. of a 1% *p*-nitrophenol solution has been added to 50 c.c. of a very dilute alkali solution, continued addition of indicator produces practically no further perceptible color change. This would place $[I^-_{\text{max.}}]$ at about 2×10^{-4} g. per liter. SÖRENSEN has reported the transformation region of *p*-nitrophenol to lie between pH 5.0 and 7.0, pointing to a dissociation constant of 10^{-6} .

Since *p*-nitrophenol is rather easily soluble, it is to be expected that, when much indicator is used, the yellow coloration will appear in solution at a much smaller pH. This was demonstrated in the following experiments with 0.1 *N* acetic acid, a solution which has a pH of 2.87. The following observations were recorded:

- 10 c.c. of acetic acid solution plus 1 c.c. of 1% *p*-nitrophenol gave a faint blue color.
- 10 c.c. of acid solution plus 2 c.c. of 1% indicator gave a faint yellow-blue color.
- 10 c.c. plus 3 c.c. of the 1% *p*-nitrophenol solution produced a distinct yellow color.

Similar experiments were also performed using 1/15 molar NaH_2PO_4 . Enough 0.1% *p*-nitrophenol solution was added to 10 c.c. of an aqueous solution to produce a visible yellow coloration. Addition of 1.7–1.8 c.c. yielded a very faint color; but in the presence of 2 c.c. the color was unmistakable. These operations were repeated using a 1% solution, with the following results:

- Addition of 0.14 c.c. of the 1% solution occasioned no change.
- Addition of 0.18 c.c. of the 1% solution produced a weak yellow tint.
- Addition of 0.20 c.c. of the 1% solution produced a rather distinct yellow color.

We may conclude from these experiments that if sufficient indicator is present, *p*-nitrophenol may begin its transformation at a pH of 3.0.

It need not be emphasized again that these considerations are of utmost importance in connection with the colorimetric determination of hydrogen ion concentration. The concentration error is most likely to occur when *p*-nitrophenol is employed as the indicator, appreciably less when phenolphthalein is involved, and least important when the very insoluble thymolphthalein is used.

(b) **Two-color indicators.** The effect of concentration on the transformation interval is much more complicated than when the indicator shows but a single color. For these indicators also, the branches of the transformation curve (Fig. 8) are not located symmetrically because the sensitivity with which the acid form may be determined in the presence of the alkaline form usually differs from the ease of determining the alkaline in the presence of the acid modification. The red cation of dimethyl yellow, for example, has a greater color intensity than that of an equal concentration of the alkaline modification. Consequently the former is observable in concentrations much below the quantities of the free indicator base (yellow) which may be detected in the presence of the acid form (red).

A second difficulty enters when one of the two forms is insoluble. This must be guarded against, especially in the colorimetric determination of hydrogen ion concentration. The azo dye dimethylamino-azo-benzene (dimethyl yellow) will serve to illustrate this difficulty. Dimethyl yellow is a weak base with a $pBOH = 10$. It is very insoluble and shows a yellow color. The red colored salt, on the other hand, is much more soluble in water. In the equation

$$\frac{[IOH]}{[I^+]} = \frac{K'}{[H^+]}, \quad (8)$$

$[IOH]$ is the concentration of the yellow form and $[I^+]$ the concentration of the red form. There is a definite ratio of yellow to red modification at each hydrogen ion concentration. If we add increasing amounts of indicator to a given solution, the values of $[IOH]$ and $[I^+]$ would increase proportionately until the solution is saturated with IOH. Beyond this point, $[IOH]$

and $[I^+]$ remain constant. The excess indicator remains suspended in solution as a colloid which possesses the same yellow color as does the alkaline form. One would expect from its color that such a solution had a much higher pH than actually pertains. On this basis, it is more appropriate to use for colorimetric determinations in acid or alkaline solutions the rather easily soluble methyl orange in place of dimethyl yellow which is too insoluble in water.

Dimethyl yellow. The product employed in preparing the saturated solutions was purified by digesting several times in fresh water. The following saturated solutions were prepared:

1. One portion was shaken with water.
2. A second portion was digested in water and then let stand several days.
3. A third solution was prepared by adding an alcoholic solution to water and letting it stand for several days. The supernatant liquids of all three solutions were carefully siphoned off, and compared in Nessler tubes with dimethyl yellow solutions of known concentrations. The solubility of dimethyl yellow was found to be 5 mg. per liter. Therefore, if the hydrogen ion concentration of 10 c.c. of sample is to be determined colorimetrically using a 0.1% alcoholic dimethyl yellow solution, not more than 0.05 c.c. (about one drop) should be used.

12. Influence of temperature on transformation region.

SCHOORL¹ has already pointed out the influence of heat on the color of an indicator. He found that boiling a solution of an alkali sensitive indicator shifted the color to the basic side, while the color of acid sensitive indicators was displaced towards the acid side. He explained this on the basis of an increase in the dissociation constant of water. This interpretation is illustrated by the following discussion.

The color of an indicator possessing acid properties is governed by the following equation:

$$\frac{[I^-]}{[HI]} = \frac{K_{HI}}{[H^+]}. \quad (3)$$

Suppose we consider an acid sensitive indicator the transformation of which starts at a hydrogen ion concentration of 10^{-10} .

¹ N. Schoorl: Chem. Weekblad, 3, 719, 771, 807 (1903).

At room temperature the corresponding hydroxyl ion concentration is about 10^{-4} . The increased dissociation of water at higher temperatures will not affect the $[\text{OH}^-]$ of a solution which is already 1/10,000 normal with respect to this ion (at least if we work with not too dilute alkali solution). The $[\text{OH}^-]$ will thus remain approximately 10^{-4} . The dissociation constant of water at 100° , however, is about 100 times as large as at 18° , so that the hydrogen ion concentration at 100° will be 100 times as great since $[\text{H}^+] = \frac{K_w}{[\text{OH}^-]}$. The change in dissociation constant of most acids and bases with temperature is usually small. Assuming that the dissociation constants of indicators are invariable with temperature, we may conclude from equation (3) that the ratio $\frac{[\text{I}^-]}{[\text{HI}]}$ at 100° is 100 times smaller than the value at 18° since $[\text{H}^+]$ has become 100 times as large. The result is that too little of the alkaline form is present to produce a perceptible color change. Consequently, when a boiling aqueous solution is being examined, it is necessary to add sufficient alkali to diminish the $[\text{H}^+]$ 100 times to simulate conditions at room temperature. This in turn increases the hydroxyl ion concentration considerably, so that at 100° the ratio $\frac{[\text{OH}^-]}{[\text{H}^+]}$ at the start of the transformation interval is much greater than at room temperature.

For a basic indicator we have from equations (7) and (8):

$$\frac{[\text{IOH}]}{[\text{I}^-]} = \frac{K'}{[\text{H}^+]} = \frac{K_w}{K_{\text{IOH}}} \times \frac{1}{[\text{H}^+]}$$

If now, at room temperature, the transformation of such an indicator begins at an $[\text{H}^+] = 10^{-4}$ (as in 1/10,000 N HCl), then the increased dissociation of water at its boiling point will leave the $[\text{H}^+]$ practically unchanged. K_w , however, increases 100 fold while K_{IOH} presumably remains constant. Hence the right hand side of the above equation becomes 100 times larger, and the indicator will not begin to transform until enough acid has been added to raise the $[\text{H}^+]$ 100 times. The start of the interval at higher temperatures, therefore, lies at a much smaller pH although at the same pOH.

Hydrolysis considerations also lead to the conclusion that warming acid indicator solutions displaces their color towards the acid side. The hydrolysis of an indicator salt BI in water solution may be written as:

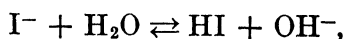

$$\frac{[HI][OH^-]}{[I^-]} = \frac{K_w}{K_{HI}}.$$

If K_w increases 100 times¹ at the boiling point of water, and if K_{HI} remains unaltered, the ratio $[HI]/[I^-]$ becomes 100 times larger. Accordingly 100 times as much of the acid form is present.

From the following experimental studies it is seen that the color change interval of any acid indicator may shift as much as two units on the pOH axis, and that the range of any alkaline indicator may be displaced two units on the pH axis.

Nitramine. The sensitivity of this indicator to hydroxyl ions does not change at higher temperatures. It may be concluded from this that nitramine acts as a basic indicator.

Thymolphthalein. Into a frequently used Erlenmeyer flask of Jena glass was placed 250 c.c. of distilled water and 10 drops of a 0.1% thymolphthalein solution, the contents heated to boiling, and 0.1 N NaOH added until a faint blue color appeared. This required 0.7–0.8 c.c. of alkali solution, the average of five experiments. The maximum coloration was attained after addition of 5 c.c. of 0.1 N alkali. Evidently the indicator begins to transform in the presence of 3 c.c. 0.1 N NaOH per liter, i.e. at an $[OH^-] = 3 \times 10^{-4}$ or pOH = 3.53. Since pK_w at 100° is 12.2, we see that the color change of the indicator starts at a pH of 12.2 minus 3.53 or 8.67. The indicator is completely converted at $[OH^-] = 2 \times 10^{-3}$ or pOH = 2.70, i.e. at pH = 9.50. At 100°, therefore, thymolphthalein changes its color at a much higher $[OH^-]/[H^+]$ ratio than at 18°. This illustrates SCHOORL's contention admirably.

It is striking that the indicator at 100° starts to change its color at a smaller pH than at room temperature. This does not

¹ According to the investigations of Kohlrausch and Heydweiller: *Ann. Physik*, (4) 28, 512 (1909), pK_w at 100° is 12.24; according to Lorenz and Böhl: *Z. physik. Chem.*, 66, 733 (1909), it is 12.13. The author uses the average value of 12.2 in his computations.

mean that the dissociation constant of thymolphthalein has increased. It may, however, be due to the fact that the solubility of the indicator is much greater at higher temperatures. It has already been stated that solubility is an especially important factor regarding the transformation range of thymolphthalein. It was shown that although the thymolphthalein in the 10 drops of 0.1% solution added at room temperature did not dissolve, it was readily soluble at the boiling point of water. Very likely, therefore, the fact that thymolphthalein at 100° begins to change color at a lower pH than at room temperature is due in part to its greater solubility, hence greater concentration, at higher temperatures.

Phenolphthalein. Similar experiments were performed using phenolphthalein as the indicator. Addition of between 0.20 and 0.21 c.c. of 0.1 N NaOH to 250 c.c. of boiling water containing 5 drops of a 1% phenolphthalein solution produces a weak rose color. At this point $[\text{OH}^-] = 8 \times 10^{-5}$ or pOH is 4.1, and pH 8.1. The greatest color intensity is attained upon addition of 1.5 c.c. of 0.1 N NaOH per 250 c.c., i.e. at a pOH of 3.21 or pH of about 9.0.

The color change of the indicator begins at about the same pH as at room temperature, though at a much smaller pOH. This conclusion was tested by boiling a 0.2 N sodium acetate (KAHLBAUM product) solution containing phenolphthalein. Such a solution at room temperature reacts very weakly alkaline towards the indicator. It has already been stated that, according to NOYES,¹ the dissociation constant of acetic acid changes but little with temperature (K_{HAc} is 18.2×10^{-6} at 18° and 11.1×10^{-6} at 100°). The diminution in dissociation constant is too small to allow a very great increase in the degree of hydrolysis. On the other hand, hydrolysis will be markedly favored by the 100-fold increase in K_w . Therefore, whereas the pH remains sensibly the same, pOH will decrease by at least a unit. This would require the color of the boiling solution to be only slightly more basic than at room temperature, which was confirmed experimentally.

Thymol blue. It is necessary to add 2.5 c.c. of 0.01 N NaOH per 250 c.c. of yellow indicator solution at 100° before a greenish

¹ A. A. Noyes: J. Am. Chem. Soc., 30, 349 (1908).

tinge appears. This is equivalent to an $[\text{OH}^-] = 10^{-4}$ or pOH of 4.0, and pH = 8.2. The maximum coloration appears after addition of 1.5 c.c. of 0.1 N NaOH, which is equivalent to a pOH of 3.2 and a pH of 9.0. This indicator behaves exactly as does phenolphthalein.

Cresol red. A weak rose color appears when 0.6 c.c. of 0.01 N NaOH is added to 250 c.c. of indicator solution. This corresponds to an $[\text{OH}^-] = 2.4 \times 10^{-5}$ or pOH = 4.6, and a pH of 7.6. The transformation of the indicator at room temperature starts at pH = 7.2.

Phenol red. 0.35 c.c. of 0.01 N NaOH must be added to 250 c.c. of indicator solution at 100° to produce a faint rose color. At this point, $[\text{OH}^-] = 1.2 \times 10^{-5}$, pOH is 4.9, and pH = 7.3. The transformation range at room temperature begins at a pH = 6.6. It follows from all these experiments that the dissociation constants of the phthaleins and sulfonephthaleins are little changed by boiling.

Methyl red. Boiling solutions of this indicator shifts the color very slightly towards the alkaline side, as can be simply demonstrated. Some methyl red was added to a very dilute acetic acid solution in previously boiled water, and the resulting mixture divided into two parts. Half was warmed and compared with the unheated portion. It was found that heating made the color slightly more alkaline. Analogous experiments with dilute hydrochloric acid or boric acid solutions led to the same conclusion, although the difference in color obtained with the latter compound was not as distinct as with the others.

The slight temperature effect was confirmed further by observing the behavior of methyl red in ammonium chloride solutions. NOYES (p. 21) has reported that the dissociation constant of ammonia is independent of temperature. Since K_w increases 100 times, the pH of the boiling solution must be considerably decreased, and the color of solution must of necessity be shifted to the acid side. This was confirmed experimentally as follows. Several drops of methyl red added to a 0.2 N ammonium chloride solution showed an intermediate color (pH = 5.1). Boiling produced a much more intense red, although not quite the color of methyl red at a pH of 4.2. After cooling, the color corresponded to the original pH.

It is reasonable to conclude from these experiments that the

color change interval, expressed in pH, is almost entirely free of any temperature influence.

p-Nitrophenol. Here too a slight shift of color to the basic side is observed at higher temperatures. This, however, contradicts the behavior expected of an acid indicator when it is assumed that the dissociation constant of the indicator varies little with temperature. Actually such is the case with the dissociation of the indicator in question. One is then led to the belief that the color of the *p*-nitrophenolate ions becomes more intense with rising temperature.

HANTZSCH has already reported that the color of a *p*-nitrophenol solution in organic solvents becomes deeper when heated. The following experiment demonstrates this change for water solutions as well. A strongly alkaline solution containing a small quantity of *p*-nitrophenol is pale yellow when cold but dark yellow when heated. Upon cooling, the solution assumes its original shade.

The color change of *p*-nitrophenol in heated aqueous solutions is demonstrated likewise by the following experiment. Heating a pale yellow boric acid solution of *p*-nitrophenol produces a green-yellow color. The original color returns upon cooling.

All of these experiments indicate that the color change interval of *p*-nitrophenol is displaced only slightly by heating. By extrapolating from the experiments of L. MICHAELIS and A. GYEMANT,¹ it can be estimated that the constant of *p*-nitrophenol at 100° is ten times as large as at room temperature.

Dimethyl yellow. In a Jena flask were placed 250 c.c. of distilled water and five drops of a 0.2% dimethyl yellow solution. The contents were heated to boiling and titrated with 0.1 N hydrochloric acid until comparison with a blank showed a visible color change. This required 0.8–0.9 c.c. of acid, corresponding to an $[H^+] = 3.4 \times 10^{-4}$ or pH = 3.47, and a pOH of 8.73. The maximum acid color appeared after the addition of 12.5 c.c. of 0.1 N HCl. This is equivalent to an $[H^+] = 5 \times 10^{-3}$, a pH of 2.30, and a pOH equal to 9.90.

Were the dissociation constant of dimethyl yellow to remain unchanged by heating, then at the boiling point of water this indicator should undergo transformation at two pH units less

¹ L. Michaelis and A. Gyemant: *Biochem. Z.*, 109, 165 (1920).

than at 18°, i.e. at pH about 2.0. Actually the conversion begins at pH 3.47, pointing to a strong increase in dissociation constant of dimethylamino-azo-benzene with temperature. The following data of A. RICHTER¹ concerning the dissociation of dimethyl yellow corroborates this conclusion.

TEMPERATURE	pK
20°	10.91
40°	10.47
60°	10.15
75°	9.92

Methyl orange. Similar studies were made with the sodium salt of dimethylamino-azo-benzene sulfonic acid. The transformation started after the addition of 0.5–0.6 c.c. of 0.1 N HCl. $[H^+] = 2.2 \times 10^{-4}$ or pH 3.66, and pOH of 8.54. The dissociation of this indicator too increases with temperature.

Thymol blue. It is necessary to add 2.5 c.c. of 0.1 N HCl to 100 c.c. of a yellow solution before a faint rose color appears. $[H^+] = 2.5 \times 10^{-3}$, pH = 2.6, and pOH = 9.6. The conversion at 100° begins at about the same pH as at room temperature (pH 2.8).

Tropeolin 00. 45 c.c. of water was boiled with three drops of 0.1% tropeolin solution, and titrated with 0.1 N hydrochloric acid. The interval began after 5 c.c. of acid had been added, or at $[H^+] = 10^{-2}$, pH = 2, and pOH = 10.2. The end of the region was too difficult to observe. The dissociation constant of tropeolin 00 also increases with temperature since, at 18°, the initial color appears at a pH of 3.1.

Methyl violet. 250 c.c. of water was boiled after the addition of methyl violet, and the whole titrated with 0.5 N and 4 N hydrochloric acid. The blue color appeared after the addition of 10 c.c. of 0.5 N acid, or after 1.2 c.c. of 4 N HCl had been added. This corresponds to an $[H^+] = 1.8 - 2.0 \times 10^{-2}$, to a pH = 1.70, and a pOH of 10.50. The difficult determination of the end of the interval was carried out with 4 N hydrochloric acid. It appears to lie in a 0.5 N solution where the color is yellow.

¹ A. Richter: Z. anal. Chem., 65, 224 (1925).

All of the preceding studies demonstrate the fact that the position of the color change interval of most indicators will be displaced appreciably as temperature increases. Only the sulfonephthaleins and the phthaleins experience a negligible variation in their sensitivity towards hydrogen ions. The effect of warming solutions of the various indicators is summarized in the following table.

DISPLACEMENT OF TRANSFORMATION INTERVALS OF INDICATORS BY HEATING
($pK_w = 14.2$ AT 18° AND 12.2 AT 100°)

INDICATORS	18°		100°	
	pH	pOH	pH	pOH
Methyl violet	0.1- 3.2	14.1-11.0	0.5- 1.7	11.7-10.5
Thymolsulfonephthalein	1.2- 2.8	13.0-11.4	1.2- 2.6	11.0- 9.6
Tropeolin 00	1.3- 3.3	12.9-10.9	0.8- 2.2	11.2-10.0
Dimethyl yellow	2.9- 4.0	11.3-10.2	2.3- 3.5	9.9- 8.7
Methyl orange	3.1- 4.4	11.1- 9.8	2.5- 3.7	9.7- 8.5
Methyl red	4.2- 6.3	10.0- 7.9	4.0- 6.0	8.2- 6.2
<i>p</i> -Nitrophenol	5.0- 7.0	9.2- 7.2	5.0- 6.5	7.2- 5.7
Phenolsulfonephthalein	6.4- 8.4	7.4- 5.8	7.3- 8.3	4.9- 3.9
<i>o</i> -Cresolsulfonephthalein	7.2- 8.8	7.0- 5.4	7.6- 8.8	4.6- 3.4
Phenolphthalein	8.3-10.0	5.9- 4.2	8.1- 9.0	4.1- 3.2
Thymolsulfonephthalein	8.0- 9.6	6.2- 4.6	8.2- 9.2	4.0- 3.0
Thymolphthalein	9.3-10.5	4.9- 3.7	8.7- 9.5	3.5- 2.7
Nitramine	11.0-12.5	3.2- 1.7	9.0-10.5	3.2- 1.7

CHAPTER SIX

THE INFLUENCE OF SOLVENTS ON THE PROPERTIES OF INDICATORS

1. General.

The manner in which various solvents affect the properties of acid-base indicators has not as yet been formulated quantitatively. A more exact treatment of these properties in ethyl alcohol and in alcohol-water mixtures will be attempted in the next two sections. First, however, the literature bearing on this subject will be reviewed.

In his book "Der Stand der Indicatorenfrage," A. THIEL¹ emphasizes the perplexing nature of the subject. WADDELL,² endeavoring to test the validity of the indicator theory of W. OSTWALD, had occasion to investigate the effect of weakly ionizing solvents such as alcohol, acetone, ether, chloroform, and benzene upon the following substances: fluorescein, cyanin, *p*-nitrophenol, phenolphthalein, methyl orange, corallin, phenacetolin, lacmoid, and curcumin (cf. section 3, this chapter). SCHOLTZ³ has reported several qualitative experiments of which the following is typical. When alcohol is added to a weak alkaline solution of phenolphthalein, the rose color disappears; but the coloration returns when the solution is warmed. The experiments of SCHOLTZ have been confirmed by COHN,⁴ who observed in addition that, whereas a cold neutral alcoholic soap solution does not show a color with phenolphthalein, it will do so at more elevated temperatures (cf. also BRAUN,⁵ F. GOLDSCHMIDT,⁶ R. MEYER and O. SPRENGLER,⁷ and O. SCHMATOLLA⁸). R. HIRSCH⁹ found that the action of methyl alcohol in repressing the color of a weakly

¹ A. Thiel: Der Stand der Indicatorenfrage, Stuttgart, 1911, pp. 28, 30.

² Waddell: J. Phys. Chem., *2*, 171 (1898); also W. D. Bancroft and H. L. Davis: J. Phys. Chem., *34*, 1797 (1930).

³ Scholtz: Ber., *14*, 348 (1904).

⁴ Cohn: Z. angew. Chem., *19*, 1389 (1906).

⁵ Braun: Z. angew. Chem., *18*, 573 (1905).

⁶ F. Goldschmidt: Chem.-Zeit., *28*, 302 (1904).

⁷ R. Meyer and O. Sprengler: Ber., *36*, 2591 (1903).

⁸ O. Schmatolla: Ber., *35*, 3905 (1902).

⁹ R. Hirsch: Ber., *35*, 2874 (1902).

alkaline aqueous phenolphthalein solution was ten times as strong as that of ethyl alcohol. McCoy¹ performed some experiments with a 1/20,000 N barium hydroxide solution containing an equivalent amount of phenolphthalein. The addition of 2 c.c. of alcohol to 100 c.c. of this solution shifted the color to half intensity. As little as 0.4 c.c. was found to have an appreciable effect. Too much importance, however, should not be attached to the data of McCoy because he worked in extreme dilutions, and probably had a solution of barium carbonate instead of the hydroxide. Alcohol also exerts an appreciable effect upon the degree of hydrolysis of the carbonate.

According to J. H. HILDEBRAND,² the influence of alcohol upon phenolphthalein was much greater than upon a number of other indicators examined by him. His principal results are incorporated in the succeeding table.

INFLUENCE OF ALCOHOL ON INDICATORS (HILDEBRAND)

INDICATOR	% DISSOCIATED		DIMINUTION IN COLOR INTENSITY %
	Without Alcohol	In 13% Alcohol	
Phenolphthalein	67	30	37
Litmus	76	80	-4
Rosolic Acid	57	57	0
<i>p</i> -Nitrophenol	80	81	0

HILDEBRAND's experiments on the effect of alcohol on phenolphthalein were performed with a dilute ammonia solution; and the reduction in degree of dissociation of the ammonia was disregarded.

A significant investigation of titrations in ethyl alcohol solutions is that reported by E. R. BISHOP, E. B. KITTRIDGE, and J. H. HILDEBRAND.³ These workers determined neutralization curves for various acids and bases in ethyl alcohol solutions, using the hydrogen electrode. They observed, in addition, the electromotive force readings between which the interval of the indicator was located. Unfortunately, the constant of the hydro-

¹ McCoy: *Am. Chem. J.*, **31**, 508 (1904).

² J. H. Hildebrand: *J. Am. Chem. Soc.*, **30**, 1914 (1908).

³ E. R. Bishop, E. B. Kittredge, and J. H. Hildebrand: *J. Am. Chem. Soc.*, **44**, 135 (1922).

gen electrode in ethyl alcohol solutions is not known with sufficient certainty to permit them to express the transformation range in pH units.

2. The dissociation constants of a number of indicators in pure ethyl alcohol.

The dissociation of acids in ethyl alcohol was discussed in a general manner in the third section of Chapter Four. The following statements were made at that time: The dissociation constants of indicators which behaved like uncharged acids or anion acids were much smaller in alcohol than in water. This difference is much less marked if the acid form of the indicator is a cation.

The author ¹ has actually determined the dissociation constants of certain indicators in water-free alcohol. Alcoholic buffer solutions were employed as comparison solutions in this work. The constants were calculated from the following equation:

$$K_{\text{Diss. Alc. I}} = \frac{[\text{basic form}][A]}{[\text{acid form}][B]} K_{\text{Diss. Alc. Acid}}$$

$K_{\text{Diss. Alc. I}}$ is the dissociation constant of the indicator in alcohol. The factor $[\text{basic form}]/[\text{acid form}]$ is the experimentally determined ratio of the quantities of both forms of the indicator present in the buffer solution, while $[A]/[B]$ is the ratio of the concentration of the acid and its sodium salt in a reference buffer solution. $K_{\text{Diss. Alc. Acid}}$ is the dissociation constant of the buffer acid in alcohol (cf. accompanying table).

ILLUSTRATION. A certain alcoholic solution was 0.05 molar in salicylic acid and 0.05 molar in sodium salicylate. The dissociation constant of salicylic acid in alcohol is 2×10^{-9} . The indicator used was bromphenol blue.

$$\text{The ratio } \frac{[\text{basic form}]}{[\text{acid form}]} = \frac{\text{blue}}{\text{yellow}} = \frac{31}{69},$$

so that

$$K_{\text{Diss. Alc. B.P.B.}} = \frac{31}{69} \times 2 \times 10^{-9} = 9 \times 10^{-10}$$

and

$$pK_{\text{Diss. B.P.B.}} = 9.05.$$

¹ I. M. Kolthoff: *J. Phys. Chem.*, *35*, 2732 (1931).

The above buffer mixture was diluted to one-tenth its concentration and the experiment repeated. The $pK_{\text{Diss. B.P.B.}}$ was found to be 9.09.

In the last column of the following table, Δ represents the difference between the indicator constant in alcohol and in water ($pK_{\text{Diss. Alc.}} - pK_{\text{Diss. Water}}$). We see from the table that, in changing from the yellow to the acid color, the dissociation constants of the sulfonephthaleins in alcohol are 10^{-5} – 10^{-6} times smaller than in water. This is of the same order of magnitude as the difference exhibited by benzoic acid, salicylic acid, and phenol.

The variation in the dissociation constants of the cation acids methyl orange and methyl yellow, in passing from water to alcohol, is much less than for uncharged or anion acids. This is in accord with the views of BRÖNSTED.

3. Influence of water on the properties of indicators in alcohol.

Small amounts of water. We have already seen in Chapter Four (§ 5) that the dissociation constant of an acid in alcohol is increased strikingly when water is added. It is of equal interest to know how a trace of water will change the color of an indicator which is exhibiting an intermediate color in a given acid-base solution in pure alcohol. *The influence of water is determined by the nature of the particular acid-base system contained in the alcoholic solution.*

(a) Suppose that an indicator has an intermediate color in a dilute solution of a strong acid:

$$K_{0 \text{ Diss. Ind.}} = \frac{[\text{basic form}][\text{C}_2\text{H}_5\text{OHH}^+]}{[\text{acid form}]} \quad (1)$$

When the water concentration in the alcohol solution is n molar, we know from equation (23) of Chapter Four that the dissociation constant $K_{n \text{ Diss. Ind.}}$ is:

$$\left. \begin{aligned} K_{n \text{ Diss. Ind.}} &= \frac{[\text{basic form}]\{[\text{C}_2\text{H}_5\text{OHH}^+] + [\text{H}_2\text{OH}^+]\}}{[\text{acid form}]} \\ &= K_{0 \text{ Diss. Ind.}} \frac{(0.0583 + n)}{0.0583} (1 + 0.9n + 0.3n^2). \end{aligned} \right\} \quad (2)$$

Since the original solution contained a strong acid, the sum of $[\text{C}_2\text{H}_5\text{OHH}^+] + [\text{H}_2\text{OH}^+]$ is constant and the analytical con-

DISSOCIATION CONSTANTS OF THE ACID FORMS OF CERTAIN INDICATORS IN ALCOHOL

INDICATOR	TYPE OF BUFFER SOLUTION	[A]/[B] IN BUFFER	$K_{\text{Diss. Alc. of BUFFER ACID}}$	$K_{\text{Diss. Alc. INDICATOR}}$	$pK_{\text{Ind. Alc.}}$	$pK_{\text{Ind. WATER}}$	Δ
Thymol blue	trichloroacetic acid	0.05 : 0.05 0.02 : 0.08	1.6×10^{-9}	1.8×10^{-6} 2.4×10^{-6}	5.7	1.65	4.05
2,4,2',4'-Pentamethoxytri-phenylcarbinol	"	0.05 : 0.05	"	8.7×10^{-7} 10.1×10^{-7}	6.0	1.86	4.1
Dimethylamino-azo-benzene	"	0.02 : 0.08 0.095 : 0.005 0.09 : 0.01	"	6.5×10^{-6} 6×10^{-6}	(5.20)	3.25	(1.95)
Methyl orange	"	0.0975 : 0.0025 0.095 : 0.005	"	1.4×10^{-3} 1×10^{-3}	2.9-3.0	3.46	-0.45
Bromphenol blue	salicylic acid	0.05 : 0.05	2×10^{-9}	9×10^{-10} 8×10^{-10}	9.1	4.10	5.0
Bromcresol green	benzoic acid	0.02 : 0.08 0.09 : 0.01	5.6×10^{-11}	6×10^{-11} 4.5×10^{-11}	10.3	4.90	5.4
Bromcresol purple	"	0.05 : 0.05	"	3×10^{-12}	11.5	6.4	5.1
Bromthymol blue	veronal	0.01 : 0.09 0.09 : 0.01	4×10^{-14}	1.5×10^{-13}	12.8	7.3	5.5
Phenol red	"	0.05 : 0.05	"	6×10^{-14}	13.4	8.0	5.4
α -Naphtholphthalein	"	0.05 : 0.05	"	1.5×10^{-14}	13.8	8.3	5.5
Thymol blue (acid region)	"	0.005 : 0.095	"	7×10^{-16}	15.15	9.2	5.9
Phenolphthalein	"	0.005 : 0.095	"	(5×10^{-16})	(15.3)	(9.3)	(6.0?)

centration of acid remains the same. Hence, from (1) and (2) we have:

$$\left\{ \frac{[\text{basic form}]}{[\text{acid form}]} \right\}_n : \left\{ \frac{[\text{basic form}]}{[\text{acid form}]} \right\}_0 = \frac{K_n}{K_0} \\ = \frac{0.0583 + n}{0.0583} (1 + 0.9n + 0.3n^2), \quad (3)$$

or if the water content is very small:

$$\left\{ \frac{[\text{basic form}]}{[\text{acid form}]} \right\}_n : \left\{ \frac{[\text{basic form}]}{[\text{acid form}]} \right\}_0 = 1 + 17n. \quad (4)$$

We see from this that the *sensitivity of an acid-base indicator for strong acids in alcohol diminishes strongly when traces of water are present*, regardless of whether the indicator happens to be an acid or a base. A simple calculation will disclose the fact that an indicator in 98.2% alcohol ($n = 1$) is 40 times less sensitive to strong acids than in pure alcohol.

These conclusions are supported by experiment.¹ In the case of pentamethoxy red, a still more pronounced diminution in sensitivity in the presence of water is found, which can be explained by the pseudo basic nature of the indicator.

(b) Let us suppose that *the original solution in pure alcohol contains a weak acid*. We may derive from the above and from the discussion in Chapter Four (p. 99) that in this case the water effect is smaller:

$$\left\{ \frac{[\text{basic form}]}{[\text{acid form}]} \right\}_n : \left\{ \frac{[\text{basic form}]}{[\text{acid form}]} \right\}_0 = \sqrt{\frac{K_n}{K_0}} \\ = \text{approximately } \sqrt{1 + 17n}. \quad (5)$$

(c) *The original solution in pure alcohol contains a buffer mixture.* (Mixture of a weak acid and one of its salts.) The indicator equilibrium, and consequently the color, remain unaltered by the addition of water in this case. *When the effect of water on the color of any dye in a particular solvent is being studied, one must always bear in mind that the magnitude of the effect is determined by the nature of the acid-base system present in the medium.*

The conclusions drawn from (a), (b), and (c) may be verified experimentally. The discussion under (c) is especially useful because it removes the necessity of employing completely water

¹ I. M. Kolthoff: J. Phys. Chem., 35, 2732 (1931).

free alcohol when determining the dissociation constants of indicators in pure alcohol. Identical values are obtained even though the alcohol contains a trace of water, as long as the indicator equilibrium is investigated in a buffer mixture composed of a weak acid and its salt.

The fact that water alters markedly the color of an indicator in an alcoholic solution of a strong acid may be utilized for the determination of the quantity of water present in absolute alcohol. The author originally used methyl orange in very dilute hydrochloric acid for this purpose, although more recently he has found pentamethoxytriphenylcarbinol to be more satisfactory.

4. Influence of alcohol on the indicator equilibrium in aqueous solutions.

Since water is a much stronger base than alcohol, all hydrogen ions remain in the form of H_2OH^+ even after the addition of alcohol to an aqueous solution. Alcohol can, however, displace the acid-base equilibrium in aqueous solutions; and this influence which alcohol exerts upon the color of an indicator depends not only upon the nature of the indicator but also upon the kind of acid-base system found in the solution.

The dissociation of strong acids is not altered by the presence of alcohol, whereas that of weak acids and bases, due to a lowering of the dielectric constant, is decreased appreciably.

(a) *Indicators in a solution of a strong acid.* The addition of alcohol shifts the color of an indicator towards the acid side, as may be seen from

$$\frac{[\text{I}^-]}{[\text{HI}]} = \frac{[\text{basic form}]}{[\text{acid form}]} = \frac{K_{\text{Ind.}}}{[\text{H}_2\text{OH}^+]}. \quad (6)$$

The presence of alcohol lowers $K_{\text{Ind.}}$ and, since $[\text{H}_2\text{OH}^+]$ remains constant, the ratio $[\text{basic form}]/[\text{acid form}]$ also diminishes.

The color of an indicator base (as methyl orange or methyl yellow), on the other hand, will shift towards the alkaline side when alcohol is added, because the dissociation constant of the acid form diminishes (cf. Chapter Four, p. 94).

(b) *Indicators in a solution of a weak acid.* The alcohol effect is less than in the presence of a strong acid, at least as far as indicator acids are concerned. The dissociation constants of the weak acid and the indicator acid change in the same direction

when alcohol is added :

$$[\text{H}_2\text{OH}^+] = K_{\text{acid}} \frac{[\text{A}]}{[\text{B}]} = \sqrt{K_{\text{acid}}[\text{A}]} = K_{\text{Ind.}} \frac{[\text{HI}]}{[\text{I}^-]}, \quad (7)$$

$$\frac{[\text{I}^-]}{[\text{HI}]} = \frac{K_{\text{Ind.}}}{\sqrt{K_{\text{acid}}[\text{A}]}}. \quad (8)$$

When it happens that the dissociation constant of the uncharged weak acid and the indicator acid change to the same relative extent upon addition of alcohol, it follows from (8) that the ratio of basic to acid form of the indicator varies with the square root of $K_{\text{Ind.}}$. In strong acid solutions, the ratio is directly proportional to $K_{\text{Ind.}}$.

We can show in a similar manner that the color of an indicator base changes more drastically in a solution of a weak acid than in the presence of a strong acid when alcohol is added to the solution :

$$\frac{[\text{IH}^+]}{[\text{I}]} \rightleftharpoons \frac{[\text{acid form}]}{[\text{alkaline form}]} = \frac{\sqrt{K_{\text{acid}}[\text{A}]}}{K_{\text{Ind.}}}. \quad (9)$$

If $K_{\text{Ind.}}$ decreases to the same degree as does K_{acid} , we find in the solution of a weak acid that

$$\left\{ \frac{[\text{IH}^+]}{[\text{I}]} \right\}_{\text{Water}} : \left\{ \frac{[\text{IH}^+]}{[\text{I}]} \right\}_{\text{Water+Alc.}} \text{ is proportional to } \left(\sqrt{\frac{K_{\text{Ind. Water}}}{K_{\text{Ind. Water+Alc.}}}} \right)^3, \quad (10)$$

and that, in the presence of a strong acid, the ratio varies only with

$$\left(\frac{K_{\text{Ind. Water}}}{K_{\text{Ind. Water+Alc.}}} \right). \quad (11)$$

(c) *Indicators in a solution of a weak uncharged acid with its salt.* More noteworthy is the behavior of indicator acids and indicator bases in a buffer solution. Assuming again that $K_{\text{Ind.}}$ and K_{acid} vary to the same extent, we find that the color of an indicator acid in a solution of a weak uncharged acid and its salt is unchanged by alcohol :

$$\frac{[\text{HI}]}{[\text{I}^-]} = \frac{K_{\text{acid}}}{K_{\text{Ind.}}} \frac{[\text{A}]}{[\text{B}]} = \frac{K_{\text{acid}}}{K_{\text{Ind.}}} \times \text{Constant}. \quad (12)$$

For an indicator base, however, we find:

$$\frac{[\text{IH}^+]}{[\text{I}]} = \frac{K_{\text{acid}}}{K_{\text{Ind.}}} \times \text{Constant}, \quad (13)$$

and by making the same assumption as above, that

$$\left\{ \frac{[\text{IH}^+]}{[\text{I}]} \right\}_{\text{Water}} : \left\{ \frac{[\text{IH}^+]}{[\text{I}]} \right\}_{\text{Water+Alc.}}$$

is proportional to the ratio

$$\left(\frac{K_{\text{Ind. Water}}}{K_{\text{Ind. Water+Alc.}}} \right)^2. \quad (14)$$

We may summarize the above discussion by saying that the color of an indicator acid in a solution of a strong acid changes towards the acid side when alcohol is added. The effect is smaller in a solution of a weak uncharged acid, and inappreciable in a buffer solution of a weak uncharged acid with one of its salts. The reverse is found with an indicator base. Its color in a strong acid solution shifts to the alkaline side upon addition of alcohol. The change is more marked in a solution of a weak uncharged acid, and greatest in a buffer mixture of a weak uncharged acid with one of its salts.

The influence of alcohol offers a simple means of deciding whether the electrically neutral form of the indicator is an acid or base.

The semi-quantitative derivations may be tested experimentally. In 0.01 N acetic acid, methyl orange has a red-orange color which, upon addition of 40% alcohol, changes to a pure yellow (alkaline). The color of tetrabromophenoltetrabromosulfonephthalein, on the other hand, changes slightly towards the acid side under the same conditions.

The colors of methyl orange, methyl yellow, and hexamethoxytriphenylcarbinol in an acetate buffer (pH = 3.8) change strongly towards the alkaline side upon addition of alcohol. The color of tetrabromophenoltetrabromosulfonephthalein, however, is altered very little (deep green). Bromocresol green in an acetate buffer (pH = 5.0) behaves like the latter indicator, its color shifting slightly to the alkaline side in 50% alcohol.

5. The sensitivity of indicators in water-alcohol mixtures.

The sensitivity of indicators to acids and bases was studied by I. M. KOLTHOFF.¹ To a given volume of an alcohol-water solution of an indicator was added alkali or acid until a perceptible color change was observed. The alcohol concentration in the following tables is expressed as volume per cent.

THYMOLPHTHALEIN		PHENOLPHTHALEIN	
Alcohol Content in Per Cent	Sensitivity for Alkali	Alcohol Content in Per Cent	Sensitivity for Alkali
0	0.002 N	0	0.0002 N
17	0.004 N	17	0.0004 N
20	0.0065 N	28	0.0008 N
48	0.012 N	48	0.0010 N
80	0.025 N	69	0.0013 N
96	0.032 N	80	0.0015 N
		96	0.002 N

It is clear from these tables that the figures have no theoretical significance, because actually thymolphthalein and phenolphthalein are much more sensitive to hydroxyl ions than is indicated above. The true sensitivity can be determined only by using buffer solutions. It should be remembered, furthermore, that alcohol not only changes the color intensity but the color as well. Phenolphthalein in aqueous alkaline solution is cherry red, assumes a violet tint in dilute alcoholic solution, and is bluish violet in concentrated alcohol. Furthermore the color intensity of an alkaline phenolphthalein solution is much less in alcohol than in water.²

Experiments with methyl alcohol instead of ethyl alcohol have also been performed. It was found that the influence of methyl alcohol is less than that of ethyl alcohol, which is to be expected.

It is not possible to determine the sensitivity of neutral indicators (which have a transformation interval in water in the neighborhood of $\text{pH} = 7$) in the above manner, because traces of impurities in water have too great an influence upon the

¹ I. M. Kolthoff: *Rec. trav. chim.*, *42*, 25 (1923).

² For the influence of alcohol upon the absorption spectrum of both forms of the indicator, cf. A. Thiel, F. Wulfken, and A. Dassler: *Z. anorg. allgem. Chem.*, *136*, 406 (1924).

results. Consequently it is necessary to employ buffer mixtures. Even then, exact experiments can not be performed as yet, since the hydrogen exponents of such mixtures in alcoholic solutions are unknown.

The following experiments permit us to decide which indicators show a sharp transformation in concentrated alcohol.

α -Naphtholphthalein. Transformation in water between pH 7.3 and 8.7 (rose to blue). To 25 c.c. of neutral 96% ethyl alcohol were added 15 drops of a 0.2% α -naphtholphthalein solution, and then the color produced by varying amounts of 0.01 N alkali was estimated in Nessler tubes.

α -NAPHTHOLPHTHALEIN IN 96% ALCOHOL

C C. OF 0.01 N ALKALI ADDED	COLOR OF SOLUTION
0	light brown
0.2	change to yellow
0.4	pure yellow
0.4-0.7	straw-yellow
0.8	yellow-green
1.0	green
Much alkali	blue

The dibasic nature of α -naphtholphthalein explains its peculiar behavior in alcoholic solutions.¹

Rosolic acid. Transformation in water between pH 6.9 and 8.0 (yellow to red). The indicator imparts a pure yellow color to a 96% or 99.7% alcohol solution. The color turns rose red after addition of 0.1 c.c. of 0.01 N alkali per 50 c.c. The color intensity is at a maximum when 0.2-0.3 c.c. has been added. The transformation in alcohol therefore is very sharp.

Phenolsulfonephthalein. Transformation in water between pH 6.4-8.0. Its behavior in the presence of alcohol is similar to that of rosolic acid.

Neutral red. Transformation between pH's 6.8 and 8.0 in aqueous solutions. The indicator is yellow in 99.7% alcohol (therefore alkaline, in contrast to both preceding indicators). A rose red color appears after addition of 0.1 c.c. of 0.01 N acid to 25 c.c. of a 99.7% alcohol solution containing the indicator,

¹ A. Thiel: Z. physik. Chem., *Bodenstein-Festband*, 352 (1931).

the most intense color being shown after adding 0.25 c.c. of the 0.01 N acid solution. The change in alcohol is thus very distinct.

Azolitmin. The transformation is from red to blue in aqueous solutions, in the pH range 5.0–8.0. The indicator has an intermediate violet color in 99.7% and 96% alcohol. The color changes produced by acid or alkali are not very sharp. Azolitmin is not a good indicator for use in alcoholic solutions.

Curcumin. Transformation in water between pH 7.8–8.2. About the same quantity of alkali is required to produce the change in alcohol as is needed in water.

Lacmoid. Transformation in water in the interval 4.4–6.4 (red to blue). It shows its alkaline (blue) color in 99.7 and 96% alcohol solutions. A rose red color appears when 0.15 c.c. of 0.01 N acid is added to 25 c.c. of a 96% alcohol solution of the indicator. The transformation is very distinct.

Bromcresol purple. Transformation in water between pH 5.2 and 6.8 (yellow to purple). A 99.7% alcohol solution of the indicator is green-yellow. Treating 25 c.c. of the alcohol solution with 0.1 c.c. of 0.01 N hydrochloric acid produces a pure yellow color, whereas 0.1 c.c. of 0.01 N alkali turns the solution blue-green, and 0.2 c.c. of 0.01 N alkali yields a blue color. The color change is sharp.

p-Nitrophenol. Alcoholic and aqueous solutions of this indicator behave very much alike.

Sodium alizarine sulfonate. The interval in water is in the range 3.7–5.2 (yellow to violet). The indicator has a brown color in a 99.7% alcohol solution. In the presence of alkali, the color is red-brown instead of violet as in water.

Methyl red. The transformation range in water lies between pH's 4.2–6.3 (red to yellow). The indicator is pure yellow in a 99.7% alcohol solution. The color becomes orange-yellow when 0.1 c.c. of 0.01 N hydrochloric acid is added to 10 c.c. of the alcoholic solution. Further addition of acid causes a very gradual shift towards the red side. The change is not very pronounced.

The sensitivity of alkali sensitive indicators for acids may be determined in a manner analogous to that used for estimating the sensitivity of acid sensitive indicators towards alkali.

ALCOHOL CONTENT IN %	SENSITIVITY TOWARDS HYDROCHLORIC ACID	
	Methyl Orange	Dimethyl Yellow
0	0.00002 N	0.00007 N
17	0.00006 N	0.00010 N (indistinct)
28	0.00014 N	0.00022 N “
48	0.00034 N	0.0008 N “
96	0.0024 N	0.006 N “

ALCOHOL CONTENT IN %	SENSITIVITY TOWARDS HYDROCHLORIC ACID	
	Tropeolin 00	Methyl Violet
0	0.0009 N	0.002 N
17	0.0013 N	0.0027 N
28	0.0025 N	—
48	0.012 N (indistinct)	0.03 N
69	0.026 N “	—
96	0.012 N “	0.08 N

Congo red. This indicator is unsuitable for use in alcoholic solutions because of its slow reactivity.

The variation of the sensitivity of indicators induced by the presence of alcohol has been studied more quantitatively in the following manner. Into separate beakers were pipetted 25 c.c. of conductivity water and of the alcohol solution under investigation. The same quantity of indicator solution was added to both solutions. The aqueous medium was treated with a known volume of acid or alkali which was sufficient to produce a distinct intermediate coloration. Then, from a microburette, enough acid or alkali was pipetted into the alcoholic solution to produce a color of equal intensity. These experiments were performed at 11–12°.

The following tables report the sensitivity ratio (S.R.) of the indicator in water and in alcohol. A ratio less than 1 signifies that the indicator is more sensitive to alkali or acid in alcohol than in water; and when the ratio exceeds unity, the indicator is less sensitive than in water. It would be desirable to repeat these experiments in buffer mixtures.¹ These data are only approximate because of the difficulties involved.

¹ Cf. end of Chapter Ten, where the results of experiments by L. Michaelis and Mizutani are discussed.

ACID SENSITIVE INDICATORS

VOLUME % ALCOHOL IN SOLUTION	S.R. (SENSITIVITY RATIO) FOR NITRAMINE	S R. FOR TROPEOLIN O
10	0.55	1.6
20	0.25	—
30	0.13	2.0
40	0.11	3.6
50	0.09	4.8
60	0.08	6.2
70	0.07	8.0
80	0.055	9.0
90	0.055	8.5
95.6	0.06	6.0
99.7	0.06	3.0

VOLUME % ALCOHOL	S R FOR THYMOL- PHTHALEIN	S R. FOR PHENOL- PHTHALEIN	S R. FOR THYMOL BLUE	S R FOR CURCUMIN
10	1.3	1.15	—	—
20	2.0	—	2	0.5
30	4	1.5	—	—
39	9	2.7	5	0.3
46.5	18	7.5	—	—
51	24	—	—	0.27
59	—	25	7.5	—
68	70	100	—	0.3
78	125	380	13	—
87	200	1000	15	0.4
93.5	200	3000	24	0.4
99	200	3200	24	0.4

ALKALI SENSITIVE INDICATORS

VOLUME % ALCOHOL	S R FOR METHYL ORANGE	S R. FOR DIMETHYL YELLOW	S R. FOR TROPEOLIN OO	S R. FOR METHYL VIOLET
10	1.25	1.3	1.15	—
19.5	1.55	1.7	1.7	1.75
28.5	2.7	2.8	3.2	4.6
37	4.8	5.0	9	6.8
42	10	—	—	—
49	16	13.5	25	16
57	28.5	23	47	—
65	45	37	69	—
72	64	—	78	—
78	—	70	86	—
87	118	96	82	—
92	140	98	—	—
99.4	23	20	54	—

ALKALI SENSITIVE INDICATORS—*Continued*

VOLUME % ALCOHOL	S. R. FOR BROMPHENOL BLUE	S. R. FOR HEXAMETHOXYTRI- PHENYLCARBINOL	S. R. FOR THYMOL BLUE (ACID SOLUTION)
10	0.87		1.0
20	0.62		0.95
30	0.45	4.7	0.85
40	0.42		0.70
50	0.42	4.1	0.64
60	0.17		0.57
70	0.10	2.7	0.5
80	0.08		0.4
90	0.02	1.1	0.15
95.5	acid color	0.2	0.024
99.7	“ “		0.011

The significance of these data is brought out more clearly by plotting sensitivity ratios versus alcohol content (Figs. 10, 11, 12, p. 212). We observe the following:

(a) The curves are uniform and contain no discontinuities. As the alcohol content increases, the sensitivity ratio may grow smaller or larger continually as in the case of phenolphthalein, or it may approach a maximum or minimum constant value at a certain alcohol concentration. Nitramine, thymol blue (in acid or alkaline solution), and curcumin behave in the latter fashion.

(b) At a given alcohol concentration, a maximum or minimum constant S.R. value occurs, as in the case of tropeolin 0, methyl orange, dimethyl yellow, and tropeolin 00. The maximum is extremely pronounced for azo indicators. The sensitivity of methyl orange towards acid rises strikingly between 95% and 96% alcohol. This property furnishes a simple means of determining the water content of alcohol (see § 3 of this chapter).

We see from the experiments which have been described and from the figures that tropeolin 0, phenolphthalein, thymolphthalein, thymol blue, and bromphenol blue become more sensitive towards strong acids when present in alcohol-water mixtures. Nitramine, curcumin, methyl orange, dimethyl yellow, tropeolin 00, and methyl violet, on the other hand, become more alkali sensitive.

We may therefore conclude that *indicators which act like acids become more sensitive towards strong acids in the presence of alcohol, regardless of whether the indicator is acid or alkali sensitive.* Con-

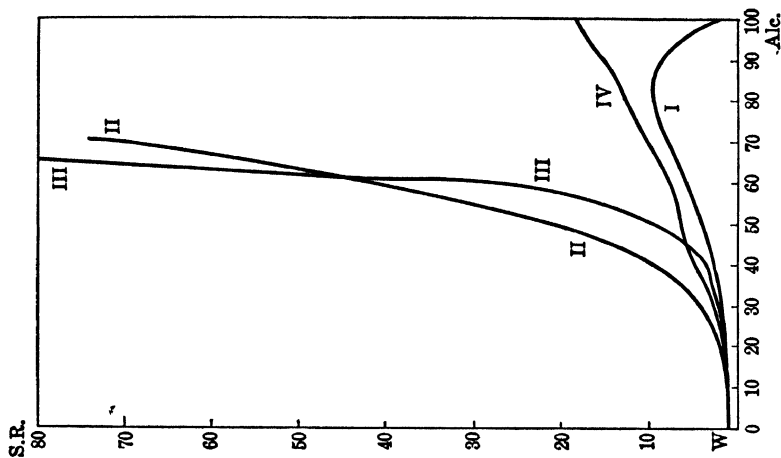

Fig. 12. I, tropeolin O; II, thymolphthalein; III, phenolphthalein; IV, thymol blue.

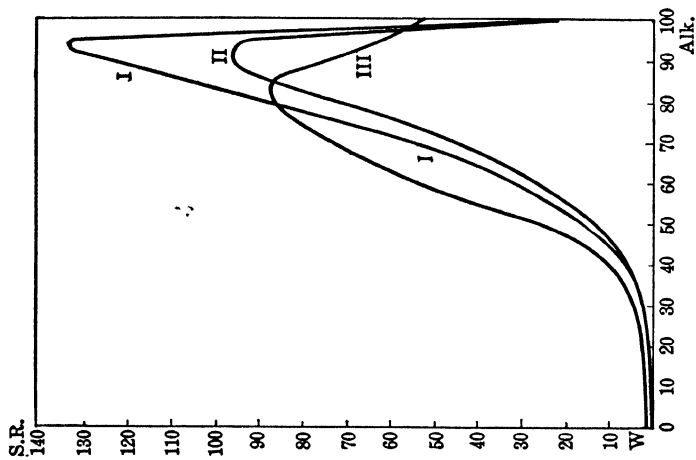

Fig. 11. I, methyl orange; II, dimethyl yellow; III, tropeolin OO.

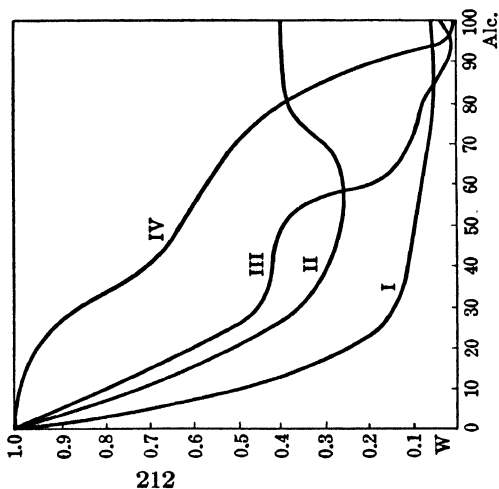

Fig. 10. I, nitramine; II, curcumin; III, bromphenol blue; IV, thymol blue (pH < 3).

versely, indicators which are weak bases become less sensitive towards hydrogen ions in the presence of alcohol.

It is peculiar that the effect of increasing temperature on the color of an indicator in alcoholic solution is the opposite of that found in aqueous solutions. Whereas in aqueous solution an acid indicator like phenolphthalein becomes more acid sensitive when warmed, we find also that a weakly alkaline alcoholic solution of the indicator assumes a more intense red color at a higher temperature. This reversal is observed also with methyl orange. Thus an aqueous solution of the latter indicator, previously treated with strong acid to obtain an intermediate color, turns yellow upon being warmed, whereas an alcoholic solution similarly prepared becomes a more intense red.

The influence of neutral salts and proteins on the transformation range will be considered in great detail in connection with the colorimetric determination of hydrogen ion concentration (Chapter Ten). In the same chapter will be reported the results of L. MICHAELIS and M. MIZUTANI,¹ who have measured the dissociation constants of the nitro indicators in solutions of differing alcohol concentrations.

6. The influence of other solvents on the properties of acid-base indicators.

F. M. CRAY and G. M. WESTRIP² have determined the influence of acetone upon the transformation interval of a number of indicators. They worked with acetone containing 10% by volume of water. They prepared various buffer mixtures, the pH's of which were measured potentiometrically by means of the quinhydrone electrode. The following table shows how large an effect acetone has upon the magnitude of the dissociation constant.

DISSOCIATION CONSTANTS OF ACIDS IN ACETONE CONTAINING 10% WATER

ACIDS	$pK = -\log K_{HA}$
Phthalic acid, 1st step	6.10
2nd step	11.5
Acetic acid	9.75
Glycine	8.35
Monochloroacetic acid	7.60

¹ L. Michaelis M. and Mizutani: *Biochem. Z.*, 147, 7 (1924).

² F. M. Cray and G. M. Westrip: *Trans. Faraday Soc.*, 21, 326 (1925).

The ion product of water also is influenced, diminishing considerably in the presence of acetone. J. N. PRING¹ showed that K_w in acetone, containing 10% water by volume, is 3.3×10^{-20} at 15°.

The transformation ranges and indicator exponents of the most important of the indicators studied by CRAY and WESTRIP are found in the succeeding table.

TRANSFORMATION INTERVAL AND pK_I OF SEVERAL INDICATORS IN ACETONE CONTAINING 10% OF WATER

INDICATOR	TRANSFORMATION INTERVAL	pK_I
Phenol red	13.0-11.0	—
Bromthymol blue	12.8-11.4	12.4
Rosolic acid	12.5-10.5	—
Bromcresol purple	11.1- 9.6	10.8
Alizarine	11.0- 9.5	10.4
Bromcresol blue	9.8- 8.3	9.0
Bromphenol blue	8.3- 6.5	8.0
<i>m</i> -Cresol purple	4.5- 2.8	—
Thymol blue	4.0- 2.4	—
Methyl red	3.7- 1.7	3.6
Methyl orange	2.7- 1.0	2.4
Dimethyl yellow	2.5- 0.5	1.8

J. B. CONANT and N. F. HALL² have measured the acid sensitivity of various unsaturated keto- and carbinol indicators in glacial acetic acid. The acid sensitivity grows in the following order: Benzalacetophenone (from yellow [acid] to colorless), triphenylcarbinol (from yellow [acid] to colorless), diphenyl- α -naphthylcarbinol (from green-blue [acid] to colorless), piperonalacetophenone (from red-orange [acid] through yellow to weak yellow), disanisylcarbinol (from rose-orange to colorless), anisal-cinnamalacetone (red to yellow), dipiperonalacetone (purple-red to yellow), dianisalacetone (rose-red to weak yellow), diphenyl-anisylcarbinol (orange to colorless), phenylxanthidrol (fluorescent green to colorless).

J. N. BRÖNSTED³ has undertaken to examine qualitatively the acid nature of different types of indicators (uncharged acids, anion acids, and cation acids) as compared with the acid strength

¹ J. N. Pring: *Trans. Faraday Soc.*, 19, 705 (1924).

² J. B. Conant and N. F. Hall: *J. Am. Chem. Soc.*, 49, 3062 (1927).

³ J. N. Brönsted: *Ber.*, 61, 2049 (1928); also V. K. La Mer and H. C. Downes: *J. Am. Chem. Soc.*, 53, 883 (1931).

of other substances in benzene. The acid strength decreases in the following order :

- | | |
|----------------------------------|----------------------------------|
| 1. Hydrogen chloride | 13. Neutral red |
| 2. Methyl red | 14. <i>m</i> -Chlorobenzoic acid |
| 3. Methyl yellow | 15. Bromcresol green |
| 4. Trichloroacetic acid | 16. Benzylammonium ion |
| 5. Dichloroacetic acid | 17. Formic acid |
| 6. Picric acid | 18. Phenylacetic acid |
| 7. <i>o</i> -Nitrobenzoic acid | 19. Benzoic acid |
| 8. Monochloroacetic acid | 20. Acetic acid |
| 9. Salicylic acid | 21. Isoamylammonium ion |
| 10. Bromphenol blue | 22. Bromcresol purple |
| 11. β -Dinitrophenol | 23. Piperidinium ion |
| 12. <i>o</i> -Chlorobenzoic acid | 24. Bromthymol blue |

CHAPTER SEVEN

THE THEORY OF INDICATORS

1. The theory of the color change.

Of the various attempts which have been made to elucidate the mechanism of the color change of an indicator, two concepts have appeared most plausible. They are the *Ion Theory* or the theory of WILHELM OSTWALD,¹ and the chromophore or *Chemical Theory* which is usually referred to as the theory of HANTZSCH. In addition, WOLFGANG OSTWALD² has proposed a new viewpoint. He maintains that the color change is accompanied by a variation in the degree of dispersion of the indicator. The theory of WOLFGANG OSTWALD, however, is not of general validity because, as was shown by the researches of KRUYT and KOLTHOFF³ among others, very often the indicator is molecularly dispersed. The bare fact that the degree of dispersion varied with the color would not necessarily signify that the variation in degree of dispersion caused the color change. It is difficult to understand, furthermore, why only hydrogen and hydroxyl ions should exhibit such striking effects upon color and degree of dispersion. It is true that in certain cases a complete parallelism exists between color change and dispersion. This relationship is shown to a marked degree by congorubin which, judging from the investigations of Wo. OSTWALD,⁴ appears to be a typical colloid. This, however, is an exceptional case for, as a rule, dyes which behave as typical colloids are unsuited for use as indicators because of their large salt and protein errors. The views of WOLFGANG OSTWALD, therefore, need not be considered in a discussion of the theory of indicators.

Only the theories of WILHELM OSTWALD and of HANTZSCH remain for consideration. According to W. OSTWALD, indicators

¹ Wilhelm Ostwald: Die wissenschaftlichen Grundlagen der analytische Chemie.

² Wo. Ostwald: Kolloid-Z., 10, 97, 132 (1912); 24, 67 (1919).

³ H. R. Kruyt and I. M. Kolthoff: Kolloid-Z., 21, 22 (1917).

⁴ Wo. Ostwald: Kolloidchem. Beihefte, 10, 179; 11, No. 1-2 (1919); 12, 92 (1920). Also, Lüers: Kolloid-Z., 27, 123 (1920); Wiegner: Mitt. Lebensm. Hyg., 11, 216 (1920); W. Pauli and E. Weiss: Biochem. Z., 203, 103 (1928).

are weak acids or weak bases the undissociated forms of which possess colors differing from those of the ions. OSTWALD evidently attributes the color change of an indicator to a transition into ions. Thus an indicator acid HI in aqueous solution dissociates as follows:

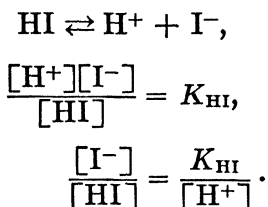

The term $\frac{[\text{I}^-]}{[\text{HI}]}$ represents the ratio of concentrations of alkaline and acid forms.

The above expressions tell us how the color changes with $[\text{H}^+]$. The chief advantage of OSTWALD'S concept lies in the fact that it permits a quantitative study of the color transformation of an indicator. Even though the original views of OSTWALD should not prove to be entirely correct, the expression derived above still applies to an indicator which behaves like a monobasic acid. OSTWALD himself found it difficult to formulate his theory in a more acceptable form. He pointed out that all members of a series of salts consisting of a common colored anion and different colorless cations, or the reverse, possess the same color (i.e. permanganates, chromates, etc.). Deviations were found, however, in a number of instances. Such anomalous behavior was characteristic of copper and cobalt salts, although deviations became less pronounced at great dilutions. Probably the complex ions present in concentrated solutions dissociate into simple ions when the solutions are diluted. A careful study performed by OSTWALD, and involving 300 salts, appeared to be in complete harmony with his theory. The importance of electric charge in determining color was adduced as evidence in favor of "ion isomerism." This kind of isomerism includes those compounds which differ only in the valence of a given constituent element, such as ferro and ferri salts, or manganate and permanganate, and yet which possess distinctly different colors.

In spite of this evidence, a large number of objections have been advanced against the theory of OSTWALD. These criticisms

have been reviewed in the monograph of THIEL.¹ Several of them will be mentioned briefly.

(a) When a small quantity of alkali is added to phenolphthalein, the solution turns red. Addition of more alkali, however, yields a colorless solution. This anomalous behavior may be explained simply by the formation of other ions (see § 3).

(b) The solid salt of phenolphthalein is red. It had been maintained that the color does not necessarily indicate the salt to be dissociated in the solid state. If this be true, then according to the OSTWALD view it should be colorless. The same is true of the solid salt of *p*-nitrophenol. This indicator is colorless in acid solution and yellow in the presence of alkali. The solid salt should be colorless, since it is undissociated, whereas actually it is yellow. Modern views of the structure of salts remove this objection.

(c) The most serious criticism is based on the fact that certain color changes are distinctly time reactions, as in the cases of tropeolin 000 (MANDA²), hematein (SALM and FRIEDENTHAL³), and phenolphthalein⁴ (WEGSCHEIDER⁵). If the transformation is due solely to the transition of undissociated acid into the ionic forms, then it must always take place immediately since ionic reactions are instantaneous. The slow process points to the occurrence of molecular reactions.

(d) HANTZSCH⁶ and HANTZSCH and ROBERTSON⁷ investigated the applicability of BEER'S law to solutions of colored electrolytes and found it to hold for colored salts through the widest possible range of concentrations. A number of these compounds were examined in non-aqueous media such as methyl alcohol, ethyl alcohol, pyridine, acetone, amyl alcohol, and concentrated sulfuric acid; and for these solutions too the rule was found to apply. This should not be true if the ions have a color different from that of the undissociated compound because, especially in non-aqueous solutions, the dissociation varies greatly with con-

¹ A. Thiel: Der Stand der Indicatorenfrage, Herz Collection, 1911, p. 43.

² Manda: Ber., 42, 3182 (1909).

³ Salm and Friedenthal: Z. Elektrochem., 13, 127 (1907).

⁴ The slow color change of phenolphthalein is attributable to the carbonic acid content of solution. In a carbon dioxide free solution, the transformation is distinct and the color no longer disappears on standing.

⁵ R. Wegscheider: Z. Elektrochem., 14, 512 (1908).

⁶ A. Hantzsch: Z. physik. Chem., 72, 362 (1910).

⁷ Hantzsch and Robertson: Ber., 41, 4328 (1908).

centration. Accordingly, they inferred that the ions and the undissociated compound had the same color. This conclusion, however, is not substantiated by the studies of H. C. JONES and his collaborators.

Actually we should expect BEER'S law to be valid for dilute solutions since, on the basis of modern views, strong electrolytes are completely dissociated. As early as 1909, N. BJERRUM had concluded from the behavior of complex chromic salt solutions that these salts dissociated completely into ions.

That the color is dependent upon the ionization state likewise is in accord with the existing physical representation of light absorption. The external electron shell governs the light absorption; and a variation in the ionized state is accompanied by a parallel shift in absorption.

Although it appears possible to explain away the objections to the Ostwald theory, and though it is exceedingly useful, one must admit that the *chromophore* theory has given us a much deeper insight into the behavior of indicators. Actually a proper understanding of indicator properties is impossible without the latter theory, which will be discussed in the next section.

2. The chromophore theory.

The chromophore theory originated with BERNTHSEN¹ and FRIEDLÄNDER,² who proposed, simultaneously and independently, that the colorless form of phenolphthalein present in acid solutions possessed a lactone structure, and that the red salt formed by alkalis contained a chromophore quinone group. Hence the color transformation was accompanied by a change in constitution. Later, HANTZSCH and his students extended the theory, and ascertained that unless a structural change occurred, the color remained the same. They stated, however, that in many cases the demonstration of a structural change was too difficult to be decisive.

HANTZSCH and his students demonstrated the relationship between color and constitution most clearly with the nitroparaffins and the nitrophenols. These substances are yellow in alkaline solution and colorless in the presence of acids. HANTZSCH showed

¹ Bernthsen: Chem.-Zeit., 1892, 1596.

² Friedländer: Ber., 32, 575 (1899). Also, A. Thiel: Z. physik. Chem., 100, 479 (1923); A. F. Birge and S. F. Acree: J. Am. Chem. Soc., 41, 1031 (1919).

for phenylnitromethane that the formation of salt from the acid, and conversely the formation of the acid from the salt, was a slow reaction. Treating the solution of the salt with an equivalent quantity of acid leaves the solution colored a deep yellow, and the conductivity increases considerably. The high conductivity is evidence for the presence of a strong acid in solution. After longer periods of standing, the yellow color becomes less intense and, simultaneously, the conductivity diminishes until a constant color is attained at which point the conductivity remains constant. The strong acid appears to have been converted into a neutral compound (or possibly into a weak acid). In other words, we are dealing with an example of the formation of a *pseudo-acid* from the *aci*-compound. By an *aci*-compound we mean a strong acid resulting from the molecular rearrangement of a substance which itself is not an acid or only a very weak acid. The salts and esters derived from such a compound are called *aci*-salts and *aci*-esters. The substance from which the *aci*-compound originates is referred to as a *pseudo-acid*. In an analogous manner, we speak of *pseudo-bases* and *baso*-compounds.

The *aci*-compound of phenylnitromethane in acid solution slowly changes into the pseudo-compound. At the same time its color goes from yellow to almost colorless. HANTZSCH showed that the *aci*- and pseudo-compounds of the nitrophenols had the following general structures:

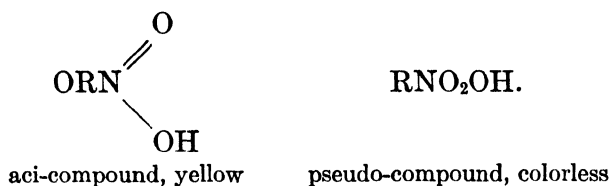

He suggested that in acid solution the *aci*-compound is not completely converted into the pseudo-compound, but that these substances are in equilibrium with each other:

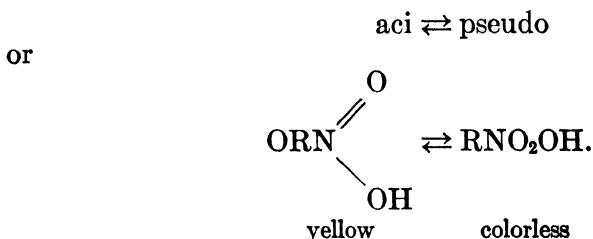

Addition of alkali increases the quantity of aci-salt formed, thereby displacing the equilibrium towards the left and increasing the intensity of the yellow color. No ions of the colorless pseudo-compound are supposed to be formed during the transformation into the salt form, the pseudo-form first rearranging into the aci-compound which then produces colored ions.

HANTZSCH has adduced as further evidence for the existence of these aci- and pseudo-compounds the fact that he has prepared esters of both types of substances, the aci-ester being yellow and the other being colorless.

The same investigator has proposed a similar explanation for the relationship between *pseudo-bases* and *baso-compounds*. A salt of crystal violet is colored violet in alkaline solution, and its conductivity is high. The solution becomes colorless after standing for some time, and the conductivity diminishes to a minimum value. The baso-compound, which is a strong base and is colored violet, possesses a structure different from that of the colorless pseudo-compound:

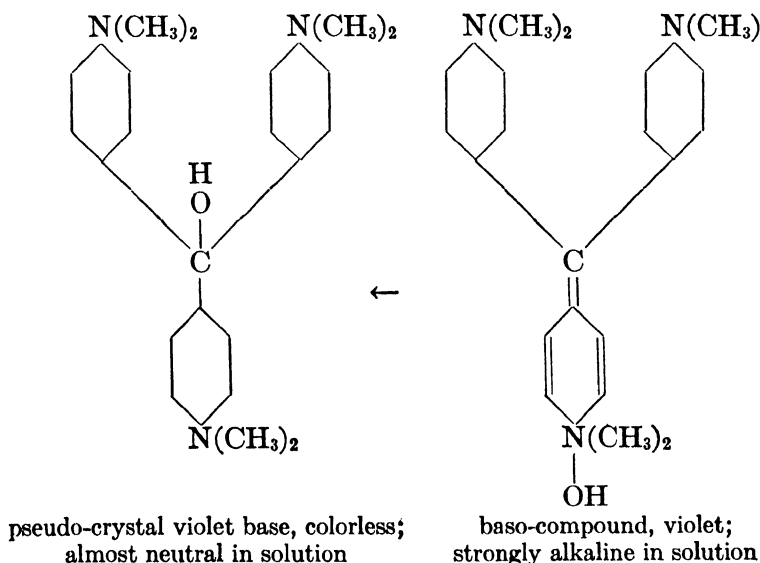

3. The color change of the most important indicators.

The phthaleins. The equilibrium conditions for the phthaleins are extremely complex. Taking phenolphthalein as typical of the group, the following reversible changes must be considered in any quantitative interpretation of the color transformation

towards the alkaline side:

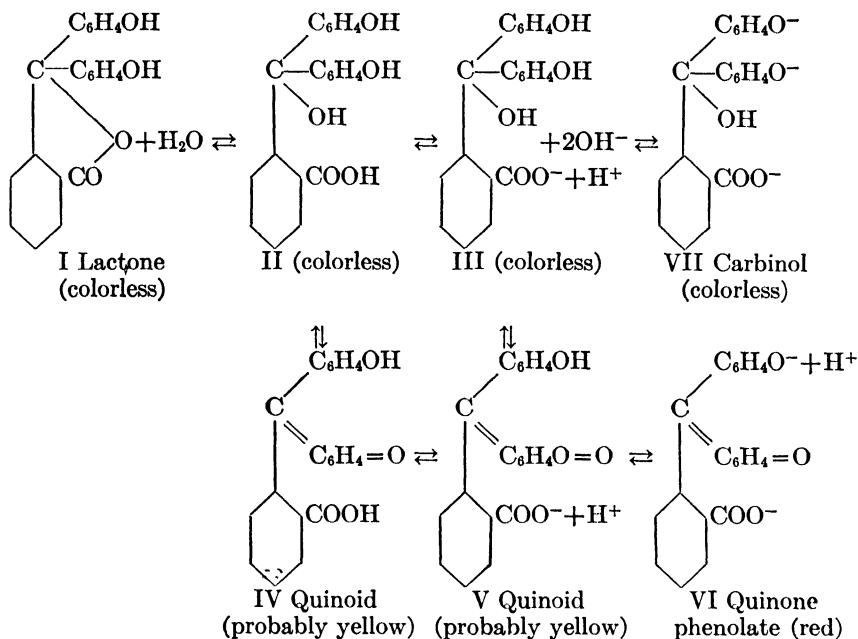

The monovalent ions of phenolphthalein (form III) are known to be colorless. In a titration of an alcoholic phenolphthalein solution, for example, almost an equivalent amount of alkali is added before the red-violet color appears. ROSENSTEIN¹ reports that the "apparent" first dissociation constant of phenolphthalein is 1.15×10^{-9} , whereas $K_2 = 2.8 \times 10^{-10}$. Accordingly

$$\frac{[\text{H}^+][\text{III}]}{[\text{I}]} = K_1 = 1.15 \times 10^{-9}.$$

The equilibrium between forms I and II is reversible. Therefore

$$\frac{[\text{I}]}{[\text{II}]} = K,$$

and

$$\frac{[\text{H}^+][\text{III}]}{[\text{II}]K} = K_1.$$

Form II represents an ordinary carboxylic acid. Such acids, like benzoic acid, have dissociation constants of the order of 10^{-5} or larger. Assuming that the dissociation constant of II is 10^{-5} ,

¹ L. Rosenstein: J. Am. Chem. Soc., 34, 1117 (1912).

we see from the last equation that

$$\frac{[\text{H}^+][\text{III}]}{[\text{II}]} = KK_1 = 10^{-5},$$

and that K is of the order of magnitude of 10^{-4} .

In an aqueous solution of phenolphthalein the concentration of the lactone form is about 10,000 times greater than that of the hydrate form II.¹ The concentration of the quinoid forms IV and V must be exceedingly small as compared with that of I because the solution is colorless. Addition of hydroxyl ions displaces the equilibrium of II and III through V to the quinone phenolate VI. The equilibrium relationships for phenolphthalein are represented quantitatively by the following expressions:

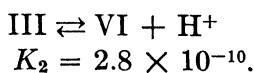
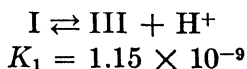

The decolorizing action of excess alkali can be explained only by assuming very little III is present in strongly alkaline solutions. Form III is converted into the colorless configuration VII (equilibrium $\text{III} \rightleftharpoons \text{VII}$). It is seen readily from the above that the processes which control the color change of phenolphthalein and of other phthaleins are extremely complicated. A number of investigators have concerned themselves with the velocity of fading of the color of the phthaleins. A. THIEL² and H. LUND³ have contributed interesting investigations. A. THIEL and R. DIEHL⁴ and E. VOGT⁵ were able to conclude from spectrophotometric examinations that the central carbon atom in conjunction with two meriquinoid side chains could be regarded as chromophoric in the colored compounds of the phthaleins. The quinone phenolate theory of S. F. ACREE (cf. form VI) is confirmed inasmuch as the salts of the phthaleins contain only the secondary type of the chromophore mentioned.

H. LUND⁶ doubts the plausibility of the quinone phenolate and assumes that the colored ion of phenolphthalein contains a posi-

¹ I. M. Kolthoff: *J. Phys. Chem.*, *35*, 1433 (1931); also, R. T. Birge and S. F. Acree: *J. Am. Chem. Soc.*, *41*, 1031 (1919).

² A. Thiel and Jungfer: *Z. anorg. allgem. Chem.*, *178*, 62 (1929).

³ H. Lund: *J. Chem. Soc.*, *1930*, 1844.

⁴ A. Thiel and R. Diehl: *Sitzungsber. Ges. Naturwiss. Marburg*, *62*, 427 (1927).

⁵ Eckhardt Vogt: *Z. physik. Chem.*, *132*, 101 (1928).

⁶ H. Lund: *Kgl. Danske Videnskab. Selskab.*, *11*, No. 6 (1931).

tively charged methane carbon atom:

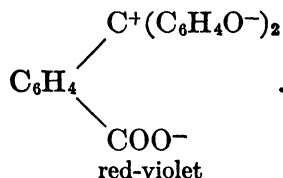

The fading of the color he attributes to the following reaction:

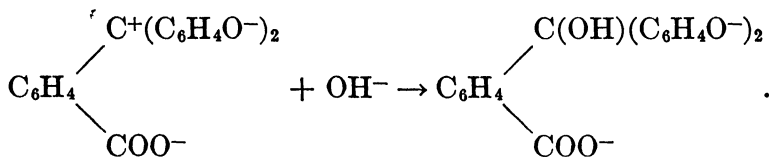

LUND's proposal explains the behavior of phenolphthalein better than does the quinone phenolate theory. More exhaustive researches are required before a choice between these theories is possible.

The coloration of phenolphthalein in strong acid media is relatively unimportant. It is well known that phenolphthalein, in a solution of a strong acid (concentrated hydrochloric acid, sulfuric acid), turns a pale rose color, while thymolphthalein becomes violet and α -naphtholphthalein green. These changes occur at acidities much greater than for the corresponding sulfonephthaleins or benzeins (cf. Chapter Five, § 4). The difference is explained by assuming that the equilibrium between the lactone and quinone modifications of the phthaleins lies further towards the former whereas the color change in acid is regulated by the basic quinoid group:

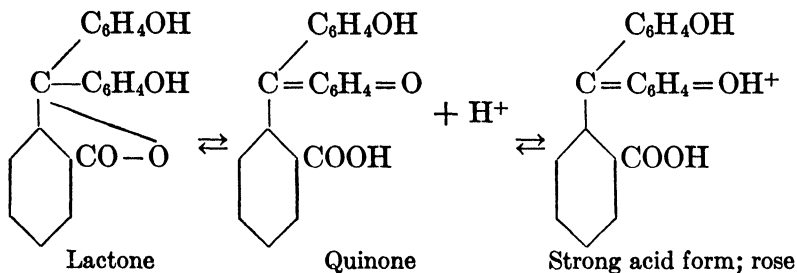

The sulfonephthaleins. Although the weak acid form of most phthaleins is colorless, that of the sulfonephthaleins is colored

yellow. H. A. LUBS and S. F. ACREE ¹ believe that the structure of all sulfonephthaleins is the same as that of phenolsulfonephthalein. The various tautomers of this compound are given below: ²

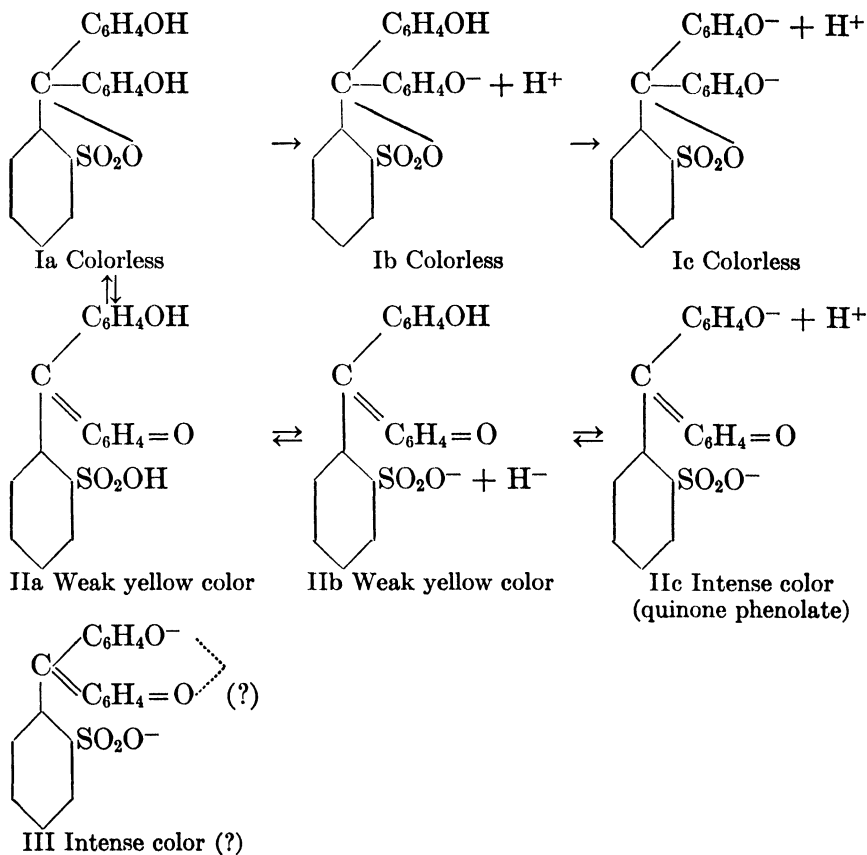

¹ H. A. Lubs and S. F. Acree: *J. Am. Chem. Soc.*, **38**, 2772 (1916). E. C. White and S. F. Acree: *J. Am. Chem. Soc.*, **39**, 648 (1917); **40**, 1092 (1918).

² According to Lund (l.c.), it is necessary to assume that in the yellow solution the sulfonephthalein has the following structure:

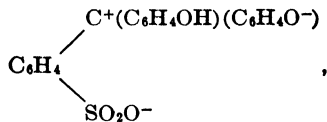

while in the presence of alkali the following red colored ion is present:

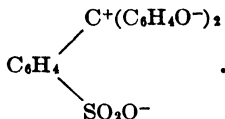

I. M. KOLTHOFF¹ expresses doubt as to whether the sultone forms (Ia, Ib, and Ic) actually are present in solution. In any case, they need not be considered in quantitative studies of the color change of sulfonephthaleins. On the other hand, A. THIEL² has shown that the sulfonephthaleins, although much more stable than the corresponding phthaleins, are also decolorized by an excess of alkali. The ions are derived from the colorless carbinol modification.

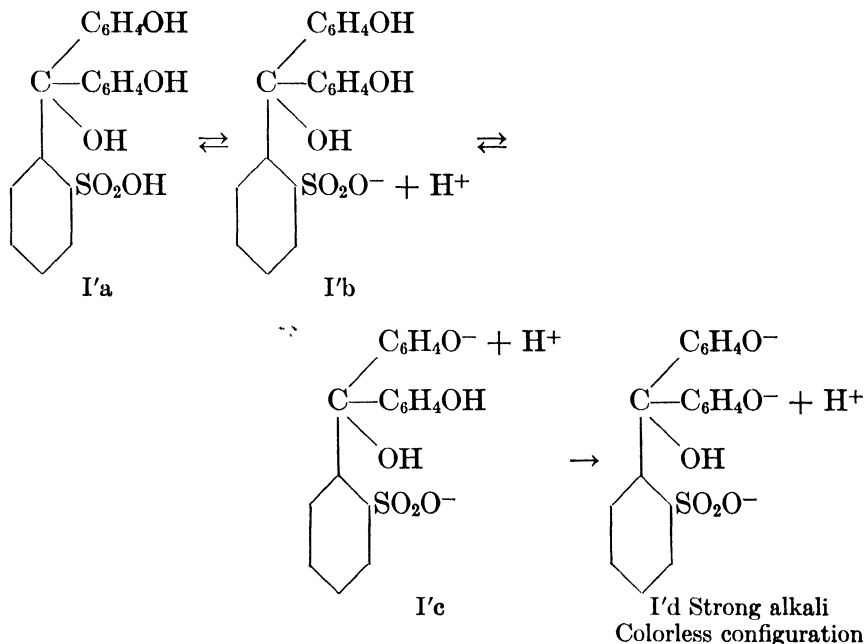

These forms correspond to those of phenolphthalein. Their concentration in the case of sulfonephthaleins is so small, however, that it may be neglected in the quantitative treatment of the color change. The conversion of the weak acid (yellow) form to the alkaline form is therefore governed by the expression:

$$\frac{[\text{II}_b][\text{H}^+]}{[\text{II}_c]} = K_1.$$

It appears doubtful whether configuration III hypothesized by ACREE and LUBS actually exists. Certainly it plays an insignificant part in the color change.

¹ I. M. Kolthoff: *J. Phys. Chem.*, *35*, 1433 (1931).

² A. Thiel: *Monatsh.*, *53/54*, 1008 (1929).

The color transformation of the sulfonephthaleins in strongly acid media is attributable to the formation of a cation involving the quinoid group; see, however, LUND (l.c.):

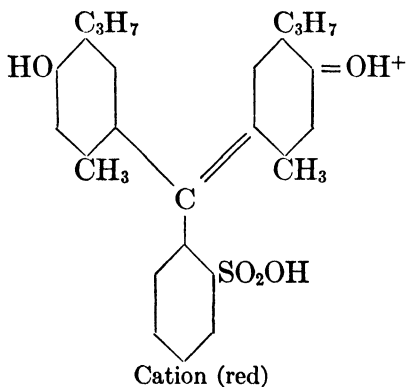
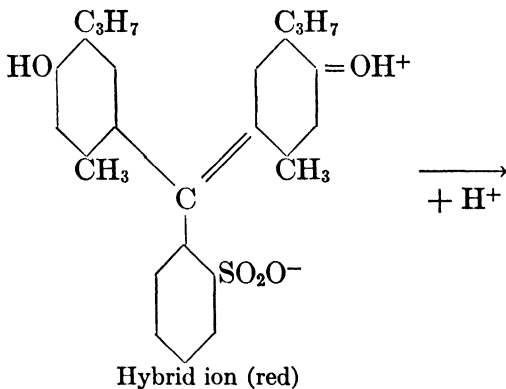
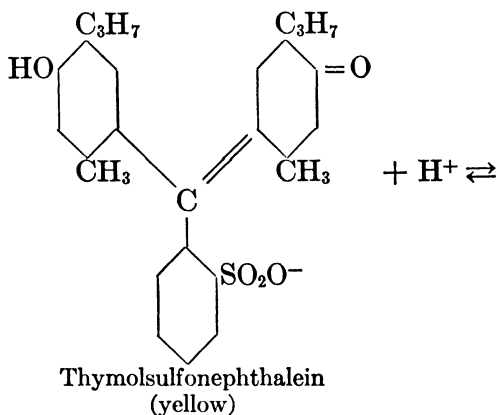

Azo indicators. The behavior of this group of compounds is extremely complex and not completely understood.

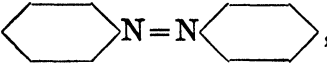
Azobenzene, , is yellow in the solid state. Solutions in organic solvents are yellow but turn red in the presence of strong acids.

Dialkylaminoazobenzene.

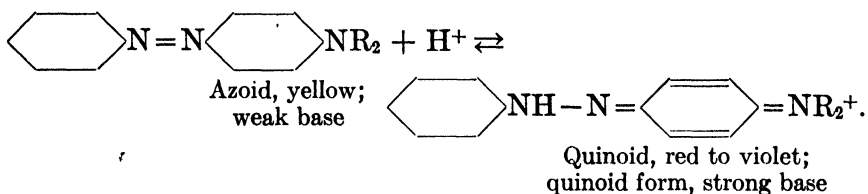

The structural changes in methyl orange may be represented by the following equations:

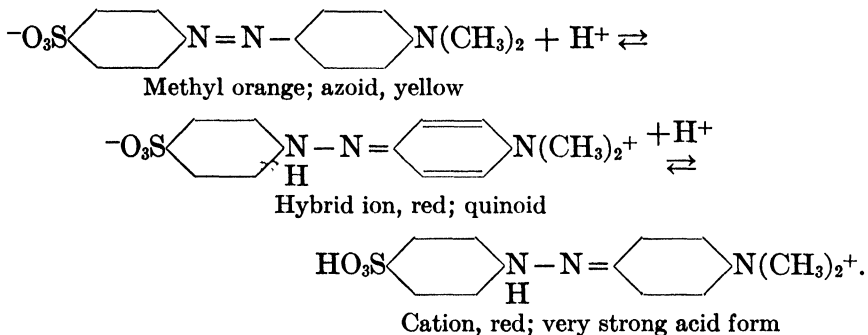

Various other acid forms of methyl orange are known, but will be omitted from this discussion.

Nitro indicators. *p*-Nitrophenol.

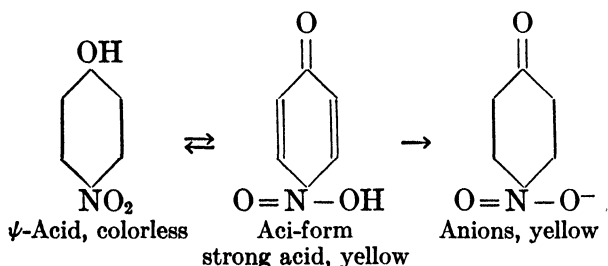

4. A new definition of an indicator.

It is evident from the above discussion that the simple explanation of OSTWALD is far from complete. It is likewise true that structural changes alone do not account for the relationship between color (the ratio of the acid to the alkaline form) and

hydrogen ion concentration. STIEGLITZ¹ has combined the ionic and chromophore theories in such a manner that the relationship between color and hydrogen ion concentration can be calculated with the aid of the equation of OSTWALD. However, he discards the theory of OSTWALD as an explanation of the transformation because it really does not explain the *color change*. The chromophore theory is adopted to account for this change.

The author finds himself at variance with these views. He feels that the *chromophore theory fails to explain the transformation satisfactorily, and that it merely considers a phenomenon which occurs simultaneously with the color change. The fact that color and constitution vary at the same time does not necessarily indicate that constitutional rearrangements are the cause of the color change.*

These statements are not intended to discredit the beautiful investigations of HANTZSCH, which are of utmost importance to the organic chemist. The fact remains, however, that constitutional changes need not be regarded as the cause of the alteration in color. The readily observed color change and the structural variations which are difficult to prove are phenomena which occur side by side. If, conversely, the constitutional variations were easily explained and the color change difficult to observe, we should not be forced to conclude that the latter causes the indicator to modify its structure. HANTZSCH's picture, furthermore, does not suggest why the hydrogen ions should control the transformation of an indicator.

Thus we approach the question: *What determines the color change of an indicator?* The following answer may be formulated: *The transformation is determined by the equilibrium which is set up between the aci- or ionogen form and the pseudo- or normal form.*

Again taking *p*-nitrophenol by way of illustration, this equilibrium in aqueous solutions is described by

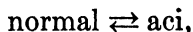

and is characterized by the expressions:

$$\frac{[\text{aci}]}{[\text{normal}]} = K, \quad (1)$$

or

$$[\text{aci}] = K \times [\text{normal}]. \quad (2)$$

¹ J. Stieglitz: J. Am. Chem. Soc., 25, 1112 (1903).

The aci-compound acts like a strong acid and is converted into its salt by alkali:

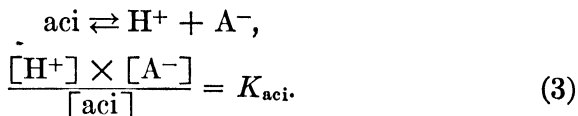

The K_{aci} denotes the dissociation constant of the aci-acid. From equations (2) and (3) we have:

$$\frac{[\text{H}^+] \times [\text{A}^-]}{[\text{normal}]} = K_{\text{aci}} \times K = K_{\text{HI}}, \quad (4)$$

or

$$\frac{[\text{A}^-]}{[\text{normal}]} = \frac{K_{\text{HI}}}{[\text{H}^]}.$$

The ratio $\frac{[\text{A}^-]}{[\text{normal}]}$ for *p*-nitrophenol does not refer to the final concentration of the yellow or the alkaline form since the free undissociated acid (aci) also is yellow. Thus the total concentration of the yellow form is $[\text{A}^-] + K \times [\text{normal}]$. If the total concentration of the indicator is $[\text{HI}]$, then $[\text{normal}] = [\text{HI}] - [\text{A}^-] - [\text{aci}]$. At a specified $[\text{H}^+]$ the ratio of the yellow to the colorless form is

$$\frac{[\text{A}^-] + K[\text{normal}]}{[\text{normal}]} = \frac{[\text{A}^-] + K\{[\text{HI}] - [\text{A}^-] - [\text{aci}]\}}{[\text{HI}] - [\text{A}^-] - [\text{aci}]} = \frac{K_{\text{HI}}}{[\text{H}^]}.$$

In the event that the aci-acid is strong enough to justify the assumption of complete dissociation, we may make use of the familiar equilibrium equation

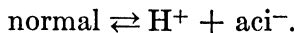

The equation derived to describe the coloration then becomes rather simple.

The situation becomes more complicated when the acid properties of the normal form itself are sufficiently pronounced to permit salt formation. In this case we have two acids to deal with:

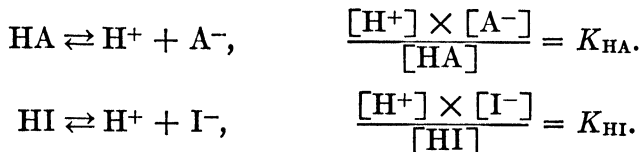

These equations lead to the following expression referred to a particular $[H^+]$:

$$\frac{[A^-]}{[HA]} \times K_{HI} = \frac{[I^-]}{[HI]} \times K_{HA}.$$

If now $[HI]$ represents the concentration of the aci-form and $[HA]$ the concentration of the pseudo-form, then the concentration of the yellow form becomes $[I^-] + [HI]$. The colorless form is given by $[A^-] + [HA]$. Since $[HI] = K[HA]$ (equation 2),

$$[I^-] = \frac{K \times [HA] \times K_{HI}}{[H^+]}$$

Therefore the total concentration of the yellow form is

$$\frac{K[HA] \times K_{HI}}{[H^+]} + K[HA].$$

The simpler equation (4) embodies the OSTWALD conception with the difference that K_{HI} is not the *true* dissociation constant but the *apparent* constant of the indicator since it represents the product of the true dissociation constant and the equilibrium constant for the normal and aci-forms. The latter equilibrium favors the normal compound in the case of *p*-nitrophenol so that this substance appears to be a very weak acid. With *o*-nitrophenol, however, the existence of the aci-form is favored so that this compound behaves as a stronger acid. The ratio of aci to normal is so large in the case of picric acid that relatively much of the aci- or ionogen form, as compared with the pseudo-compound, is present in aqueous solution. Consequently this substance is a rather strong acid. As the apparent dissociation constant increases, the intensity of the yellow color of aqueous solutions must likewise grow because more of the aci-form will be found in solution. This statement can be confirmed easily. Picric acid in water solutions is yellow, but colorless in organic solvents due to the predominance of the pseudo-form.

The relationships between the concentration of hydrogen ions and the color of phenolphthalein and similar indicators may be derived just as for *p*-nitrophenol. The equilibrium in aqueous

solutions will now be set up between the lactone compound (L) and the quinone form (Q).

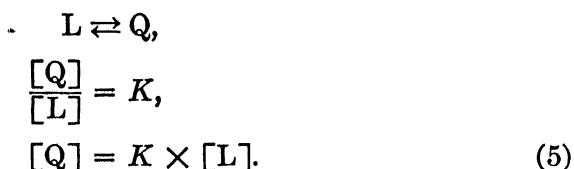

The quinone form, in its turn, dissociates into ions :

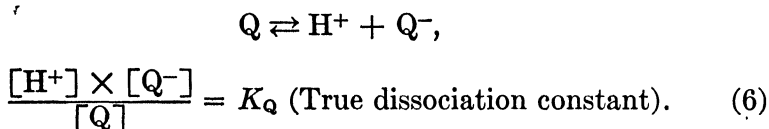

It follows directly from (5) and (6) that :

$$\frac{[H^+] \times [Q^-]}{K \times [L]} = K_Q,$$

or

$$\frac{[H^+] \times [Q^-]}{[L]} = K_Q \times K = K_{HI}. \quad (7)$$

We see that here too the dissociation constant of the indicator is merely an *apparent* value which is composed of the true dissociation constant and the equilibrium constant between the aci- and pseudo-compounds. The equilibrium between Q and L in water solutions is such that the liquid appears to be colorless. Displacement of the equilibrium by addition of alkali produces a red color.

The transformation of dimethyl yellow and related substances is governed by the following equilibrium :

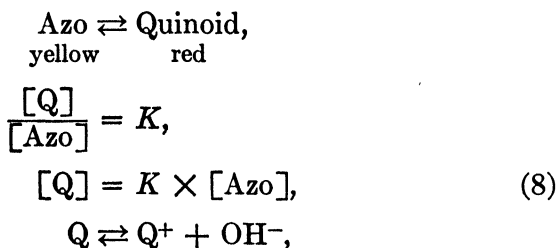

$$\frac{[Q^+] \times [OH^-]}{[Q]} = K_Q \text{ (True dissociation constant)}. \quad (9)$$

It follows from (8) and (9) that:

$$\frac{[Q^+] \times [OH^-]}{K \times [Azo]} = K_Q,$$

or

$$\frac{[Q^+] \times [OH^-]}{[Azo]} = K_Q \times K = K_I \text{ (Apparent dissociation constant).}$$

The equations derived above are in complete accord with the Ostwald expression for all practical purposes. They differ, however, in certain fundamental respects.

(a) The derived dissociation constants are the products of the true dissociation constants and the equilibrium constants between the aci- (or baso-) and the pseudo-compounds. Nevertheless it is still permissible to regard the apparent dissociation constants as a measure of the strength of the indicator acid or base. Indeed the investigations of recent years have made it appear probable that most of the dissociation constants of organic acids and bases are not true constants but only apparent.

This point is clearly illustrated by the dissociation constant of carbonic acid:

$$\frac{[H^+] \times [HCO_3^-]}{[H_2CO_3]} = K_{H_2CO_3}. \quad (10)$$

Usually one assumes that $[H_2CO_3]$ is equal to the total carbon dioxide concentration. This is obviously incorrect since the major portion of the dissolved substance is present as the anhydride CO_2 , which is in equilibrium with H_2CO_3 so that

$$[H_2CO_3] = K \times [CO_2].$$

Substituting this value in equation (10), we obtain:

$$\frac{[H^+] \times [HCO_3^-]}{[CO_2]} = K_{H_2CO_3} \times K = K' = 3 \times 10^{-7}.$$

The quantity $K' = 3 \times 10^{-7}$ is commonly called the dissociation constant of carbonic acid. In reality it is the apparent dissociation constant. The true dissociation constant is much greater, for the equilibrium between CO_2 and H_2CO_3 favors the former substance by far. The ratio $\frac{[CO_2]}{[H_2CO_3]}$ is about 1000, so

that the true dissociation constant of carbonic acid is approximately 1000 times greater than the apparent constant, or about 3×10^{-4} .

The same applies to ammonia, although to a much lesser degree. Here too we have been dealing with an apparent dissociation constant since we overlook the equilibrium

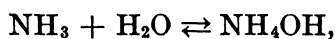

and assume that all undissociated ammonia is present as NH_4OH . Hence the true dissociation constant of ammonia will be far greater than the constant customarily employed.

The views of SNETHLAGE¹ and of A. HANTZSCH² suggest that perhaps all dissociation constants are apparent and determined by the true dissociation constant and the equilibrium constant between ionogenic and pseudo-forms. This supposition finds support from several sources, including HANTZSCH'S investigation of acetic acid and its derivatives. It was shown in this study that the esters differ structurally from salts, which led to the conclusion that, very probably, acetic acid in aqueous solutions consists of two forms in equilibrium, one compound having the typical ester structure and the other the salt structure. The equilibrium constant for this case would be:

$$\frac{\text{ionogen}}{\text{pseudo}} = K.$$

The assumption that all undissociated acetic acid in aqueous solutions is present only in a single form is erroneous because the equilibrium between the ionogen- and pseudo-forms is disregarded. Hence the true dissociation constant of acetic acid is much larger than that usually employed.

(b) The views of the author differ from OSTWALD'S explanation also in that the ions need not have the same structure as that of the undissociated acid. This leads us to the following new definition of an indicator:

Indicators are (apparent) weak acids or bases of which the ionogenic (aci- or baso- respectively) form possesses a color and constitution different from the color and structure of the pseudo- or normal compound.

¹ Snethlage: Chem. Weekblad, 15, 168 (1918).

² A. Hantzsch: Ber., 50, 1413 (1917).

With this definition in mind, we may proceed without hesitation to describe the reactions of indicators as follows:

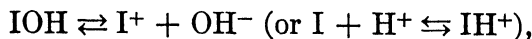
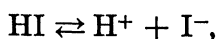

in which the structures of I^- and I^+ differ from HI and IOH .

It is assumed in the above equations that the aci- or baso-compound is so strong that it is completely dissociated,

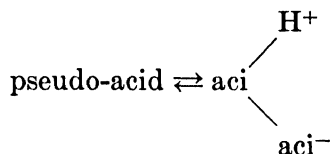

Recalling that the dissociation constant is an apparent value, we may write:

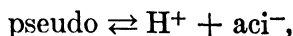

and

$$\frac{[\text{H}^+] \times [\text{aci}^-]}{[\text{pseudo}]} = K_{\text{HI}}.$$

The above treatment is valid also for indicator bases.

The new definition provides for the fact that the transformation of indicators is a time-consuming reaction. The theory supposes the existence of an equilibrium between an ionogen- and normal form. It is not unreasonable to expect that the equilibrium between these two forms sets in slowly.

The definition furthermore explains why the solid salt of phenolphthalein is red and that of *p*-nitrophenol is yellow. The salts have the constitution and, therefore, also the color of the ionogenic form, whether it be completely or only partially dissociated. This is in accord with the findings of HANTZSCH (l.c.) and HANTZSCH and ROBERTSON (l.c.) mentioned early in this chapter, namely, that BEER'S law holds for colored salts as long as the concentration is not too great. This is to be expected if the undissociated salt molecules are ionogenic and possess the same structure and color as do the ions.

The observation that phenolphthalein again becomes colorless in the presence of excess alkali is not surprising since we are really

dealing with two equilibria :

$$\frac{[\text{Lactone}]}{[\text{Quinone}]} = K_1, \quad \frac{[\text{Quinone}]}{[\text{Carboxylic acid}]} = K_2.$$

Excess alkali slowly displaces the equilibrium towards the carboxylic acid.

The chief point of departure from the explanation of OSTWALD consists in not having to say that the color of the ions differs from that of the pseudo-compounds. It is the ionogenic form which is differently colored. We see here the connection with the chromophore theory which states that the ionogen form and the normal form have different structures.

Of primary importance in the conception is the equilibrium,

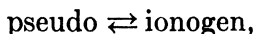

which regulates the transformation of indicators. The equations in Chapter Five, derived on the basis of the new definition, are still valid and in no way contradictory to the views of HANTZSCH.

PART THREE

**THE COLORIMETRIC DETERMINATION
OF HYDROGEN ION CONCENTRATION**

CHAPTER EIGHT

BUFFER SOLUTIONS. PREPARATION AND PROPERTIES

1. General.

Buffer solutions are liquids of such composition as to resist appreciable changes in hydrogen ion concentration. Addition of traces of acids or bases leaves their pH practically unaltered. For this reason they are indispensable as comparison media in colorimetric pH determinations. Buffer mixtures can be retained unchanged for two months if stored in closed flasks made of good glass and containing a disinfectant (a minute thymol crystal). It is preferable, however, to prepare fresh solutions each month.

Most buffer solutions are composed of a weak acid and one of its alkali salts. Usually such mixtures of an acid and its salt may be prepared to extend over a range of two pH units, between $pK + 1$ and $pK - 1$ where pK is the negative logarithm of the dissociation constant (K_A) of the acid. Buffer solutions made with acetic acid, which has a dissociation constant of 1.86×10^{-5} or a pK of 4.73, are useful in the pH range between 3.7 and 5.7. It should be recalled that the intensity of buffer action¹ (*buffer capacity*) in a series of

buffer solutions is greatest in the mixture of pH equal to pK , in which the ratio of acid to salt is unity (cf. Fig. 13). The greater the difference between pH and pK , the less pronounced becomes the buffer action. A solution in which the acid to salt ratio exceeds 10 : 1 or is lower than 1 : 10 can no longer be stored unchanged.

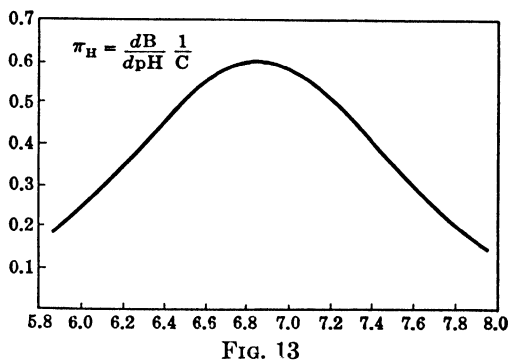

FIG. 13

Buffer solutions which are useful over a longer pH range may be prepared from polybasic acids instead of monobasic acids.

¹ Donald D. van Slyke: J. Biol. Chem., 52, 525 (1922); also Chapter One, § 8.

A range of pH from 2 to 6 is possible with citric acid and sodium hydroxide. In order to obtain mixtures which have a high buffer capacity over a wide variation in composition, it is advisable to start with a mixture of acids of approximately similar dissociation constants.

Fluctuations in temperature affect the hydrogen ion concentration of most useful buffers but slightly. This is true of solutions composed of a weak acid and its salt. The boric acid-metaborate mixtures are an exception. The pH of these solutions diminishes appreciably with increasing temperature (see tables). The influence of temperature must always be considered in accurate investigations.

Mixtures of a weak base with one of its salts have just as good a buffer action as mixtures of an acid and its salt. The hydroxyl ion concentration of such solutions is determined by the dissociation constant of the base and by the ratio base : salt. The concentration of hydroxyl ions varies but little with temperature. Since the ion product of water increases considerably with temperature, and

$$[\text{H}^+] = \frac{K_w}{[\text{OH}^-]},$$

we see that the pH of buffers composed of a base and a salt becomes much larger at higher temperatures. Consequently the use of such solutions for accurate pH measurements at fluctuating room temperature should be discouraged.

The pH values of the known buffer mixtures have all been determined by careful measurements with the hydrogen electrode.¹ Generally the standard values of S. P. L. SÖRENSEN² are used in calculating the pH from potentiometric measurements. These values are based upon a standard hydrochloric acid buffer containing 0.01 N acid and 0.09 N potassium chloride, for which a pH of 2.038 is assumed. This figure is calculated from conductivity data according to the isohydric principle of ARRHENIUS. This manner of calculating is not in accord with the modern views regarding strong electrolytes.

¹ It is generally assumed that measurements with the hydrogen electrode yield the hydrogen ion activity. That this is only approximately true can be seen from the discussion of the potentiometric method of determining dissociation constants (cf. pages 75 and 76).

² S. P. L. Sörensen: *Biochem. Z.*, *21*, 131 (1909); *22*, 352 (1909); *Ergebnisse Physiol.*, *12*, 393 (1912).

Nowadays it is assumed that strong electrolytes in aqueous solutions are completely dissociated into their ions. The *activities* of these ions decrease initially with growing electrolyte content. In most biological processes where the acidity plays a part it is the *activity of the hydrogen ions* aH^+ which is of primary importance. Unfortunately the activity of the hydrogen ions in the standard hydrochloric acid mixture is not known with sufficient accuracy. It appears probable from recent measurements that pH and paH are related in the following manner: $paH = pH + 0.04$, where paH is the negative logarithm of the hydrogen ion activity. As long as the value of paH in the standard acid mixture is not known accurately, *it is better to retain the pH values of SÖRENSEN. The data reported in tables all refer back to his determinations.*

A number of experimenters have described various series of buffer solutions. Those which have proven of greatest practical service will be considered in detail.

2. The buffer solutions of W. M. Clark and Lubs¹ (1916).

These solutions include the pH range from 1.0 to 10.0 (Fig. 14). CLARK and LUBS have arranged their mixtures to cover the range from 2.0 to 10.0 in jumps of 0.2 unit of pH. Their buffers were prepared from the following solutions:

SOLUTIONS	pH RANGE
0.2 N Hydrochloric acid and 0.2 N potassium chloride in water	1.0- 2.4
0.1 N Hydrochloric acid and 0.1 N potassium biphthalate in water	2.2- 4.0
0.1 N Sodium hydroxide and 0.1 N potassium biphthalate in water	4.0- 6.2
0.1 N Sodium hydroxide and 0.1 N monopotassium phosphate in water	6.0 -8.0
0.1 N Sodium hydroxide and 0.1 N boric acid in 0.1 N potassium chloride and water	8.0-10.2

The mixtures of CLARK and LUBS are very easy to prepare. The starting materials are readily obtained in the pure state, and the arrangement of solutions at pH intervals of 0.2 unit is very convenient. The biphthalate-hydrochloric acid buffers, however, have two disadvantages which detract somewhat from its usefulness.

1. The author has observed repeatedly that, in such mixtures with pH less than 3.0, phthalic acid crystals separate out. This difficulty is encountered especially during the winter months when the temperature drops below 15°.

¹ W. M. Clark and Lubs: *J. Bact.*, 2, 1, 109, 191 (1917). Also W. M. Clark: *The determination of hydrogen ions*, 3rd ed., Baltimore, 1928.

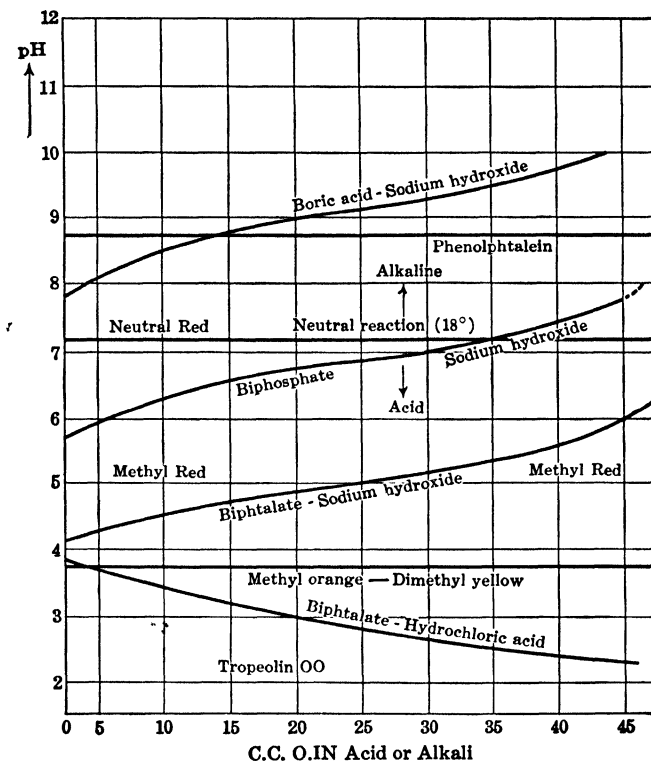

FIG. 14

2. Biphthalate buffer mixtures have been shown¹ to be unsatisfactory for measurements involving methyl orange. This indicator imparts to the buffer solution a color which is too acid, with the consequence that colorimetric determinations yield pH's which are about 0.2 unit too high.

Instead of the biphthalate mixtures it is better to use the buffers prepared from monopotassium citrate and acid or alkali, as suggested by KOLTHOFF and VLEESCHHOUWER (see § 4).

Purity of Materials. 0.2 N hydrochloric acid and 0.1 N carbonate free sodium hydroxide are prepared by the methods usually employed in volumetric analysis.

Potassium biphthalate is obtained in the manner described by DODGE,² but modified slightly by CLARK and LUBS (l.c.). Sixty grams of pure potassium hydroxide (containing a minimum of carbonate) are dissolved in 400 c.c. water, and 85 g. of ortho-

¹ I. M. Kolthoff: *Rec. trav. chim.*, 45, 433 (1926).

² Dodge: *J. Ind. Eng. Chem.*, 7, 29 (1915).

phthalic acid or the corresponding amount of twice sublimed phthalic anhydride added. The solution is then treated with phthalic acid until it becomes faintly alkaline towards phenolphthalein, after which an equal quantity of the phthalic acid is again added. The biphthalate can be prepared also from equivalent amounts of potassium bicarbonate and phthalic acid. Care must be taken to add precisely an equal quantity of phthalic acid to the phthalate solution or else the biphthalate will contain an excess of acid or phthalate. It is difficult to remove this excess simply by recrystallizing from water. The boiling solution is filtered while hot and the potassium biphthalate separates out on cooling. The salt is sucked dry, recrystallized at least twice from water, and dried at 110–120°.

S. B. SMITH,¹ who has made a thorough examination of the phthalic acid-potassium biphthalate system, found that the recrystallization must not be carried out below 35°. When the preparation is pure or contaminated only with potassium phthalate, the crystallization may take place at 25°. If it is too acid, however, the impurity can be eliminated only by recrystallizing above 35°, for otherwise a small portion of the salt 1 potassium phthalate · 4 phthalic acid · 4H₂O separates out. In any event it is advisable to test the composition of the final recrystallized product by titrating with alkali in the presence of phenolphthalein as indicator. The *molecular weight* of potassium biphthalate is 204.2.

Monopotassium phosphate, KH₂PO₄. Molecular weight 136.1. A commercial product, recrystallized three times from water and dried to constant weight at 110°, will serve. The sample should not lose more than 0.1% water at 100°. The loss on ignition should be 13.23% ± 0.1%.

R. HOLCOMB and R. R. MCKIBBIN² report that after long standing a precipitate of iron and/or aluminum phosphate frequently settles out of solutions of potassium dihydrogen phosphate. These impurities are not removed easily by recrystallization from water because they remain suspended as colloids in the concentrated salt solution. For this reason HOLCOMB and MCKIBBIN recommend that a 1/5 molar solution of the salt be stored for 24 hours at 85° and then filtered through a thick filter. The filtrate is evaporated and the salt recrystallized in the usual manner.

¹ S. B. Smith: J. Am. Chem. Soc., 53, 3711 (1931).

² R. Holcomb and R. R. McKibbin: J. Am. Chem. Soc., 50, 1695 (1928).

The monosodium phosphate is more difficult to obtain pure than the potassium salt because of the water of recrystallization which it contains. Therefore its use in buffer solutions is less satisfactory.

Boric acid, H_3BO_3 . *Molecular weight* 62.0.

The trade preparation is purified by two or three recrystallizations from water, after which it is spread in a thin layer between sheets of filter paper and dried at room temperature in a vacuum desiccator. Boric acid at higher temperatures loses also part of its water of constitution to yield a small quantity of metaboric acid HBO_2 . Samples dried at a higher temperature rapidly take up this water again when exposed to air at room temperature, thus returning to the orthoboric acid form. In the presence of sufficient quantities of mannitol or invert sugar, boric acid may be titrated accurately as though it were a monobasic acid, using sodium hydroxide in the presence of phenolphthalein as the indicator. A 0.1 molar solution produces an intermediate color with methyl red.

Potassium chloride. Commercial products should be recrystallized several times from water and dried at 120–150°.

The buffer mixtures of CLARK and LUBS are described in the following table. All data refer to 20° C.

BUFFER SOLUTIONS OF CLARK AND LUBS (20°)
0.2 N HCl with 0.2 N KCl (14.92 g. KCl per Liter)

COMPOSITION (PER 200 c.c. SOLUTION)	pH	INDICATOR
97.0 c.c. HCl + 50 c.c. KCl	1.0	Thymol blue Tropeolin 00 Quinaldine red Pentamethoxy red
64.5 " HCl + 50 " KCl	1.2	
41.5 " HCl + 50 " KCl	1.4	
26.3 " HCl + 50 " KCl	1.6	
16.6 " HCl + 50 " KCl	1.8	
10.6 " HCl + 50 " KCl	2.0	
6.7 " HCl + 50 " KCl	2.2	

0.1 N HCl with 0.1 Molar Potassium Biphthalate (20.42 g. per Liter)

COMPOSITION (PER 100 c.c. SOLUTION)	pH	INDICATOR
46.70 c.c. HCl + 50 c.c. Biphthalate	2.2	Quinaldine red Thymol blue Tropeolin 00 Azonaphthylaminebenzene sulfonic acid Bromphenol blue Hexamethoxy red (Methyl orange not satisfactory)
39.60 " HCl + 50 " "	2.4	
32.95 " HCl + 50 " "	2.6	
26.42 " HCl + 50 " "	2.8	
20.32 " HCl + 50 " "	3.0	
14.70 " HCl + 50 " "	3.2	
9.90 " HCl + 50 " "	3.4	
5.97 " HCl + 50 " "	3.6	
2.63 " HCl + 50 " "	3.8	

0.1 N NaOH with 0.1 Molar Potassium Biphthalate (20.42 g. per Liter)

COMPOSITION (PER 100 c.c. SOLUTION)	pH	INDICATOR
0.40 c.c. NaOH + 50 c.c. Biphthalate	4.0	Bromophenol blue
3.70 " NaOH + 50 " "	4.2	
7.50 " NaOH + 50 " "	4.4	
12.15 " NaOH + 50 " "	4.6	
17.70 " NaOH + 50 " "	4.8	Bromocresol green
23.85 " NaOH + 50 " "	5.0	Methyl red
29.95 " NaOH + 50 " "	5.2	Sodium alizarine sul- fonate
35.45 " NaOH + 50 " "	5.4	
39.85 " NaOH + 50 " "	5.6	Chlorphenol red
43.00 " NaOH + 50 " "	5.8	Bromocresol purple
45.45 " NaOH + 50 " "	6.0	

0.1 N NaOH with 0.1 Molar Monopotassium Phosphate (13.62 g. per Liter)

COMPOSITION (PER 100 c.c. SOLUTION)	pH	INDICATOR
5.70 c.c. NaOH + 50 c.c. Phosphate	6.0	Chlorphenol red
8.60 " NaOH + 50 " "	6.2	
12.60 " NaOH + 50 " "	6.4	Pinachrome
17.80 " NaOH + 50 " "	6.6	
23.65 " NaOH + 50 " "	6.8	
29.63 " NaOH + 50 " "	7.0	
35.00 " NaOH + 50 " "	7.2	Bromthymol blue
39.50 " NaOH + 50 " "	7.4	
42.80 " NaOH + 50 " "	7.6	Phenol red
45.20 " NaOH + 50 " "	7.8	
46.80 " NaOH + 50 " "	8.0	
		Neutral red or Cresol red

0.1 N NaOH with 0.1 Molar Boric Acid in 0.1 Molar KCl (6.2 g. Boric Acid and 7.46 g. KCl per Liter)

COMPOSITION (PER 100 c.c. SOLUTION)	pH	INDICATOR
(2.61 c.c. NaOH + 50 c.c. Boric acid-KCl)	7.8	Cresol red
3.97 " NaOH + 50 " " " "	8.0	
5.90 " NaOH + 50 " " " "	8.2	
8.50 " NaOH + 50 " " " "	8.4	
12.00 " NaOH + 50 " " " "	8.6	Thymol blue
16.30 " NaOH + 50 " " " "	8.8	
21.30 " NaOH + 50 " " " "	9.0	Phenolphthalein
26.70 " NaOH + 50 " " " "	9.2	
32.00 " NaOH + 50 " " " "	9.4	Thymolphthalein
36.85 " NaOH + 50 " " " "	9.6	
40.80 " NaOH + 50 " " " "	9.8	
43.90 " NaOH + 50 " " " "	10.0	
		Nile blue

E. H. FAWCETT and S. F. ACREE¹ pointed out that the alkaline buffers were not stable in air due to the absorption of carbon

¹ E. H. Fawcett and S. F. Acree: Bur. Standards J. Research (1931).

dioxide. They recommend that the borate-boric acid mixtures of CLARK and LUBS (pH 8-10) be saturated with ordinary air to insure their further stability in air. Bubbling atmospheric air through a borate buffer with a pH of 8 produces a change to 7.95 after two days. A buffer with a pH 8.63 changes to 8.55 in two days, an initial pH of 9.03 becomes 8.84 in four days, 9.64 becomes 9.10 in five days, and a pH of 10.0 changes to 9.24 in eight days. More strongly alkaline solutions require longer periods before coming into equilibrium with the air. After a sufficient time interval, the mixtures referred to become stable towards air.

The author does not consider the proposal of FAWCETT and ACREE of great practical importance. It is true that the carbon dioxide content of the atmosphere is *approximately* constant throughout the world. In any given locality, however, the amount of dioxide in the air will vary with the season. Hence it becomes necessary always to check the pH electrometrically after equilibrium is established. It is much simpler to store the buffer mixtures in tightly stoppered flasks and prepare fresh solutions every 4-6 weeks. Since the solutions have a good buffer capacity, the influence of carbon dioxide in the air due to an occasional opening of containers can scarcely be appreciable.

3. The buffer solutions of S. P. L. Sørensen (l.c.) and S. Palitzsch.¹

The starting materials needed for these solutions are frequently more difficult to prepare than those of CLARK and LUBS. The pure substances can be ordered from Kahlbaum, although there is really no definite assurance of their purity. One must be especially careful with disodium phosphate.

The hydrogen exponents of the mixtures recommended by SØRENSEN were determined by him with greatest accuracy at 13°. WALBUM² has measured the pH change in several ranges between 10° and 70°, so that we now possess data concerning the pH of comparison solutions at temperatures other than 18° and 20°. The course of the pH variation with temperature is very uniform; and it is possible, by a linear interpolation, to determine the pH value at any desired temperature between 10° and

¹ S. Palitzsch: *Biochem. Z.*, 70, 333 (1915).

² Walbum: *Compt. rend. soc. biol.*, 83, 707 (1920).

70°. On the other hand it has been found in the author's laboratory that the pH's of various citrate mixtures show practically no variation between 10° and 70° (cf. also page 266).

The solutions of SÖRENSEN and PALITZSCH are summarized below.

SOLUTIONS	pH RANGE
0.1 N Hydrochloric acid with 0.1 N Glycine in 0.1 N NaCl.....	1.04- 4.0
0.1 N Sodium hydroxide with 0.1 N Glycine in 0.1 N NaCl.....	8.24-10.48
1/15 Molar KH_2PO_4 with 1/15 molar $\text{Na}_2\text{HPO}_4 \cdot 2\text{H}_2\text{O}$	6.0 - 8.0
0.1 N Disodium citrate with 0.1 N HCl.....	2.97- 4.96
0.1 N Disodium citrate with 0.1 N NaOH.....	4.96- 6.3
0.1 N Borax with 0.1 N HCl.....	8.0 - 9.24
0.1 N Borax with 0.1 N NaOH.....	9.24-10.0
0.1 N Borax with 0.2 N Boric acid in 0.05 N NaCl (PALITZSCH)...	7.60- 9.24

The glycine-sodium hydroxide mixtures are less useful than the others because of the marked variation of hydrogen ion concentration with temperature.

Purity of materials. (See also the preceding section.)

Disodium phosphate. Molecular weight 268.2. SÖRENSEN employed the Kahlbaum salt $\text{Na}_2\text{HPO}_4 \cdot 2\text{H}_2\text{O}$. It frequently happens that commercial preparations do not contain precisely two molecules of water because of the instability of the hydrate in air. Such a sample of salt can be recrystallized several times from water and stored in a desiccator containing deliquescent calcium chloride until its weight becomes constant. N. SCHOORL¹ suggests the following more rapid procedure: The recrystallized sample (12 molecules of water of crystallization) is warmed in an open dish on a water bath until the salt dissolves in its own water of crystallization. The solution is stirred continuously until the whole mass has evaporated to dryness. The residual salt, which has the approximate composition $\text{Na}_2\text{HPO}_4 \cdot 2\text{H}_2\text{O}$, is then kept over deliquescent calcium chloride until its weight becomes constant. Exposure to moist air permits a transition of the dihydrate to the heptahydrate. This occurs in air of a relative humidity of 55%. The final product must be stored in tightly stoppered flasks. The loss in weight after drying at 100° and 20-30 mm. pressure is $25.28 \pm 0.1\%$. The phosphate is converted to the pyrophosphate at 300°. The salt can be titrated with hydrochloric acid

¹ N. Schoorl: Pharm. Weekblad, 61, 971 (1924).

to the monosodium phosphate, using dimethyl yellow, methyl orange, or bromphenol blue as indicator ($pT = 4.4$).

Borax, $\text{Na}_2\text{B}_4\text{O}_7 \cdot 10\text{H}_2\text{O}$. *Molecular weight* 382.0. A commercial preparation may be recrystallized three times from water (below 50°) and dried to constant weight in a desiccator containing deliquescent sodium chloride. The purity of samples is easily tested by titrating against methyl red ($pT = 5.0$) or methyl yellow.

Glycine (Kahlbaum). *Molecular weight* 75.05. A solution of 2 g. of glycine per 20 c.c. water should be clear. It should give no precipitate with barium nitrate, and should show only the slightest opalescence with silver nitrate. The ash content of 5 g. of glycine ought not exceed 2 mg. The nitrogen content, as indicated by the Kjeldahl method, must be $18.67\% \pm 0.1\%$.

BUFFER SOLUTIONS OF SÖRENSEN (18°)

0.1 N HCl WITH 0.1 MOLAR GLYCINE IN 0.1 N SODIUM CHLORIDE
(7.505 G. GLYCINE AND 5.85 G. NaCl PER LITER)

COMPOSITION		PH AT 18°
0.0 c.c. Glycine and	10.0 c.c. HCl	1.04
1.0 " " "	9.0 " "	1.15
2.0 " " "	8.0 " "	1.25
3.0 " " "	7.0 " "	1.42
4.0 " " "	6.0 " "	1.64
5.0 " " "	5.0 " "	1.93
6.0 " " "	4.0 " "	2.28
7.0 " " "	3.0 " "	2.61
8.0 " " "	2.0 " "	2.92
9.0 " " "	1.0 " "	3.34
9.5 " " "	0.5 " "	3.68

Citric acid (Kahlbaum), $\text{C}_6\text{H}_8\text{O}_7 \cdot \text{H}_2\text{O}$. *Molecular weight* 210.0. Commercial samples may be recrystallized twice from water and then dried to constant weight over deliquescent sodium bromide. The acid contains one molecule of water of crystallization. SÖRENSEN specifies that solutions of the acid should be clear and give no reaction with barium and silver nitrates. The ash content of 5 g. should be less than 1 mg. Drying at 70° and 20–30 mm. pressure removes the water of crystallization, which corresponds to an $8.58\% \pm 0.1\%$ loss in weight.

A solution of the secondary citrate may be prepared by dissolving 21.01 g. of citric acid in 200 c.c. of normal sodium hydroxide and diluting to 1 liter with water. I. M. KOLTHOFF and

F. TEKELENBURG¹ found that the variation of the pH of these solutions with temperature is negligible.

0.1 N HCl WITH 0.1 MOLAR DISODIUM CITRATE

COMPOSITION				P _H
3.33	c.c. Citrate	+ 6.67	c.c. HCl	2.27
4.0	" "	+ 6.0	" HCl	2.97
4.5	" "	+ 5.5	" HCl	3.36
4.75	" "	+ 5.25	" HCl	3.53
5.0	" "	+ 5.0	" HCl	3.69
5.5	" "	+ 4.5	" HCl	3.95
6.0	" "	+ 4.0	" HCl	4.16
7.0	" "	+ 3.0	" HCl	4.45
8.0	" "	+ 2.0	" HCl	4.65
9.0	" "	+ 1.0	" HCl	4.83
9.5	" "	+ 0.5	" HCl	4.89
10.0	" "	+ 0.0	" HCl	4.96

0.1 N NaOH WITH 0.1 MOLAR DISODIUM CITRATE

COMPOSITION	P _H AT			
	18° ^a	10° ^b	40° ^b	70° ^b
10.0 c.c. Citrate + 0.0 c.c. NaOH	4.96	4.93	5.04	5.14
9.5 " " + 0.5 " NaOH	5.02	4.99	5.10	5.20
9.0 " " + 1.0 " NaOH	5.11	5.08	5.19	5.29
8.0 " " + 2.0 " NaOH	5.31	5.27	5.39	5.49
7.0 " " + 3.0 " NaOH	5.57	5.53	5.64	5.75
6.0 " " + 4.0 " NaOH	5.97	5.94	6.04	6.15
5.5 " " + 4.5 " NaOH	6.33	6.30	6.41	6.51

^a Sørensen. ^b Walbum: Compt. rend. soc. biol., 83, 707 (1920).

1/15 MOLAR KH₂PO₄ (9.078 G. PER LITER) WITH 1/15 MOLAR Na₂HPO₄·2H₂O (11.88 G. PER LITER)

COMPOSITION	P _H AT 18°
9.5 c.c. KH ₂ PO ₄ + 0.5 c.c. Na ₂ HPO ₄	5.59
9.0 " KH ₂ PO ₄ + 1.0 " Na ₂ HPO ₄	5.91
8.0 " KH ₂ PO ₄ + 2.0 " Na ₂ HPO ₄	6.24
7.0 " KH ₂ PO ₄ + 3.0 " Na ₂ HPO ₄	6.47
6.0 " KH ₂ PO ₄ + 4.0 " Na ₂ HPO ₄	6.64
5.0 " KH ₂ PO ₄ + 5.0 " Na ₂ HPO ₄	6.81
4.0 " KH ₂ PO ₄ + 6.0 " Na ₂ HPO ₄	6.98
3.0 " KH ₂ PO ₄ + 7.0 " Na ₂ HPO ₄	7.17
2.0 " KH ₂ PO ₄ + 8.0 " Na ₂ HPO ₄	7.38
1.0 " KH ₂ PO ₄ + 9.0 " Na ₂ HPO ₄	7.73
0.5 " KH ₂ PO ₄ + 9.5 " Na ₂ HPO ₄	8.04

¹ I. M. Kolthoff and F. Tekelenburg: Rec. trav. chim., 46, 33 (1927).

0.1 N HCl WITH 0.05 MOLAR BORAX (19.10 G. PER LITER)

COMPOSITION	PH AT			
	18° ^a	10° ^b	40° ^b	70° ^b
5.25 c.c. Borax + 4.75 c.c. HCl	7.62	7.66	7.55	7.47
5.5 " " + 4.5 " HCl	7.94	7.96	7.86	7.76
5.75 " " + 4.25 " HCl	8.14	8.17	8.06	7.95
6.0 " " + 4.0 " HCl	8.29	8.32	8.19	8.08
6.5 " " + 3.5 " HCl	8.51	8.54	8.40	8.26
7.0 " " + 3.0 " HCl	8.68	8.72	8.56	8.40
7.5 " " + 2.5 " HCl	8.80	8.84	8.67	8.50
8.0 " " + 2.0 " HCl	8.91	8.96	8.77	8.59
8.5 " " + 1.5 " HCl	9.01	9.06	8.86	8.67
9.0 " " + 1.0 " HCl	9.09	9.14	8.94	8.74
9.5 " " + 0.5 " HCl	9.17	9.22	9.01	8.80
10.0 " " + 0.0 " HCl	9.24	9.30	9.08	8.86

^a Sorensen. ^b Walbum.

0.1 N NaOH WITH 0.05 MOLAR BORAX (19.10 G. PER LITER)

COMPOSITION	PH AT			
	18° ^a	10° ^b	40° ^b	70° ^b
10.0 c.c. Borax + 0.0 c.c. NaOH	9.24	9.30	9.08	8.86
9.0 " " + 1.0 " NaOH	9.36	9.42	9.18	8.94
8.0 " " + 2.0 " NaOH	9.50	9.57	9.30	9.02
7.0 " " + 3.0 " NaOH	9.68	9.76	9.44	9.12
6.0 " " + 4.0 " NaOH	9.97	10.06	9.67	9.28
5.0 " " + 5.0 " NaOH	11.07	11.24	10.61	9.95

^a Sorensen. ^b Walbum.0.1 N NaOH WITH 0.1 MOLAR GLYCINE IN 0.1 N NaCl
(7.505 G. GLYCINE AND 5.85 G. NaCl PER LITER)

COMPOSITION	PH AT			
	18° ^a	10° ^b	40° ^b	70° ^b
9.75 c.c. Glycine + 0.25 c.c. NaOH	8.24	—	—	—
9.5 " " + 0.5 " NaOH	8.57	8.75	8.12	7.48
9.0 " " + 1.0 " NaOH	8.93	9.10	8.45	7.79
8.0 " " + 2.0 " NaOH	9.36	9.54	8.85	8.16
7.0 " " + 3.0 " NaOH	9.71	9.90	9.18	8.45
6.0 " " + 4.0 " NaOH	10.14	10.34	9.58	8.82

^a Sorensen. ^b Walbum.

The buffer mixtures of PALITZSCH (l.c.) prepared from boric acid and borax are listed in the following table. The data refer to a temperature of 18°.

THE BUFFER MIXTURES OF SVEN PALITZSCH (18°)

0.2 MOLAR BORIC ACID AND 0.05 N SODIUM CHLORIDE (12.40 g. H_3BO_3 AND 2.925 g. NaCl PER LITER) WITH 0.05 MOLAR BORAX (19.10 g. $Na_2B_4O_7 \cdot 10H_2O$ PER LITER)

COMPOSITION		pH
1.0 c.c. Borax	+ 9.0 c.c. Boric acid	7.36
1.5 " "	+ 8.5 " "	7.60
2.0 " "	+ 8.0 " "	7.78
2.5 " "	+ 7.5 " "	7.94
3.0 " "	+ 7.0 " "	8.08
3.5 " "	+ 6.5 " "	8.20
4.5 " "	+ 5.5 " "	8.41
5.5 " "	+ 4.5 " "	8.60
6.0 " "	+ 4.0 " "	8.69
7.0 " "	+ 3.0 " "	8.84
8.0 " "	+ 2.0 " "	8.98
9.0 " "	+ 1.0 " "	9.11
10.0 " "	+ 0.0 " "	9.24

4. The buffer solutions of Kolthoff and of Koltkoff and Vleeschhouwer.

These buffers cover the pH range 2.0–12.0 at 18°. The difficulties which accompany the use of the biphthalate mixtures of CLARK and LUBS have already been mentioned. Hence another series of solutions have been prepared by I. M. KOLTHOFF and J. J. VLEESCHHOUSER,¹ from monopotassium citrate and acid or alkali, to extend over the range between 2.2 and 6.0.

Buffers hitherto proposed have not exceeded a pH of 10.0. Accordingly the same authors have prepared a series of mixtures for strongly alkaline media. Sodium carbonate-borax mixtures are used for the range 9.20–11.0, whereas between 11.0 and 12.2 mixtures of disodium phosphate and sodium hydroxide are employed. When buffers with a still higher pH are needed, they may be obtained conveniently by diluting 0.1 N NaOH with carbonate free water.

The preparation of buffer mixtures in many bacteriological and physiological laboratories is frequently hampered by the

¹ I. M. Kolthoff and J. J. Vleeschhouwer: *Biochem. Z.*, 179, 410 (1926), 183, 444 (1922).

absence of standard acid or alkali. To overcome this difficulty, the author¹ has proposed a number of buffer solutions which require neither hydrochloric acid nor sodium hydroxide. The initial materials are pure crystalline substances from which solutions of known composition may be obtained by weighing the desired amount of solid. Mixtures for the range 2.2–3.8 may be prepared from 0.1 molar monopotassium citrate and 0.1 molar citric acid solutions, pH's between 3.8 and 6.2 may be covered with mixtures of monopotassium citrate and borax, and 0.1 molar monopotassium phosphate plus 0.05 molar borax solutions yield buffers with pH's between 5.8 and 9.2. SÖRENSEN'S phosphate mixtures and the boric acid-borax solutions of PALITZSCH, as well as the borax-soda buffers of KOLTHOFF and VLEESCHHOUWER, also belong to this group. The composition of the buffer solutions of KOLTHOFF and VLEESCHHOUWER is given below.

	pH RANGE
0.1 Molar monopotassium citrate with 0.1 N HCl.	2.2- 3.8
0.1 " " " " 0.1 N NaOH.	3.8- 6.2
0.1 " " " " 0.1 molar citric acid.	2.2- 3.8
0.1 " " " " 0.1 molar borax.	3.8- 6.2
0.1 " monopotassium phosphate with 0.1 molar borax.	5.8- 9.2
0.1 " sodium carbonate with 0.1 molar borax.	9.2-11.2
0.1 " disodium phosphate with 0.1 N NaOH.	11.2-12.2

The original report of KOLTHOFF (l.c. 1925) contained also a description of a series of mixtures obtained from 0.05 molar succinic acid and 0.05 molar borax, the pH of which varies between 3.0 and 5.8. They will not be discussed since they offer no advantage over the monocitrate mixtures. A minute crystal of thymol prevents the growth of fungi in the citrate mixtures during storage.

Strongly alkaline buffer solutions (pH > 9.0) must of course be stored in tightly stoppered flasks of a glass of good quality.

Buffer tablets with a pH range of 3.0–11.2 have been made available with the coöperation of J. SLIS (Nachtegaalstraat, Utrecht, Holland). These tablets have the advantage of eliminating the use of various solutions, it being necessary only to dissolve one tablet in 20 c.c. of water. The buffer mixture obtained in this

¹ I. M. Kolthoff: J. Biol. Chem., 63, 135 (1925).

way will have the pH marked on the container for the tablets. All of the tablet buffers have been tested with the hydrogen electrode at 18°. The deviation is usually less than 0.02 pH units. Buffer tablets save a worker considerable time. In America they are put on the market, together with appropriate apparatus for colorimetric measurements, by Pfaltz and Bauer, Inc., New York.

The purity of materials.

Monopotassium citrate, $C_8H_7O_7K \cdot H_2O$. *Molecular weight* 248. The citrate is prepared by dissolving 420 g. of ordinary citric acid in 150 c.c. of warm water and adding to it in small portions 138.2 g. of potassium carbonate which has been freed of water by ignition. After the evolution of carbon dioxide has ceased, the solution is heated to boiling and filtered rapidly. The monopotassium salt separates out in the form of fine crystals. These crystals are sucked dry, washed with a little ice-cold water, and recrystallized from water. About half the weight of the wet salt is due to water. At room temperature this salt dissolves in about two parts of water, and is four times as soluble at the boiling point of water. The crystals are filtered by suction and dried in air or over deliquescent sodium bromide. Drying at 80° produces a water-free salt which may be kept in tightly stoppered flasks. The molecular weight of this product is 230. Its composition may be tested by titrating with alkali against phenolphthalein as indicator. The pH of a 0.1 molar solution is 3.68, and of a 0.05 molar solution 3.73.

Sodium carbonate. *Molecular weight* 106.0. The chemically pure salt may be prepared simply by heating sodium bicarbonate or sodium oxalate (SÖRENSEN) for a half hour at 360°. The water-free salt takes up water readily, and must be stored in a tightly stoppered flask provided with a soda lime tube. The loss in weight when heated at 300–360° should not exceed 0.1%. Its purity is checked easily by titrating with hydrochloric acid against dimethyl yellow as indicator.

The following tables give the pH values for the buffer solutions of KOLTHOFF and VLEESCHHOUWER. All measurements have been made at 18°.

0.1 N HCl with 0.1 Molar Monopotassium Citrate (24.8 g. of the Monohydrate or 23.0 g. of the Anhydrous Salt per Liter)

COMPOSITION		pH
49.7 c.c.	0.1 N HCl + 50 c.c. Citrate per 100 c.c.	2.2
43.4 "	0.1 N HCl + 50 " " " 100 "	2.4
36.8 "	0.1 N HCl + 50 " " " 100 "	2.6
30.2 "	0.1 N HCl + 50 " " " 100 "	2.8
23.6 "	0.1 N HCl + 50 " " " 100 "	3.0
17.2 "	0.1 N HCl + 50 " " " 100 "	3.2
10.7 "	0.1 N HCl + 50 " " " 100 "	3.4
4.2 "	0.1 N HCl + 50 " " " 100 "	3.6

0.1 N NaOH with 0.1 Molar Monopotassium Citrate

COMPOSITION		pH
2.0 c.c.	0.1 N NaOH + 50 c.c. Citrate per 100 c.c.	3.8
9.0 "	0.1 N NaOH + 50 " " " 100 "	4.0
16.3 "	0.1 N NaOH + 50 " " " 100 "	4.2
23.7 "	0.1 N NaOH + 50 " " " 100 "	4.4
31.5 "	0.1 N NaOH + 50 " " " 100 "	4.6
39.2 "	0.1 N NaOH + 50 " " " 100 "	4.8
46.7 "	0.1 N NaOH + 50 " " " 100 "	5.0
54.2 "	0.1 N NaOH + 50 " " "	5.2
61.0 "	0.1 N NaOH + 50 " " "	5.4
68.0 "	0.1 N NaOH + 50 " " "	5.6
74.4 "	0.1 N NaOH + 50 " " "	5.8
81.2 "	0.1 N NaOH + 50 " " "	6.0

0.1 Molar Citric Acid (21.0 g. per Liter) with 0.1 Molar Monopotassium Citrate (24.8 g. of the Monohydrate or 23.0 g. Anhydrous Salt per Liter)

COMPOSITION		pH
9.11 c.c.	Citric acid + 0.89 c.c. Citrate.	2.2
8.15 "	" " + 1.85 " "	2.4
7.15 "	" " + 2.85 " "	2.6
5.96 "	" " + 4.04 " "	2.8
4.64 "	" " + 5.36 " "	3.0
3.16 "	" " + 6.84 " "	3.2
1.80 "	" " + 8.20 " "	3.4
0.43 "	" " + 9.57 " "	3.6

0.05 Molar Borax (19.10 g. per Liter) with 0.1 Molar Monopotassium Citrate

COMPOSITION		pH
1.3 c.c.	Borax + 50 c.c. Citrate per 100 c.c.	3.8
8.8 "	" + 50 " " " 100 "	4.0
17.2 "	" + 50 " " " 100 "	4.2
27.0 "	" + 50 " " " 100 "	4.4
36.0 "	" + 50 " " " 100 "	4.6
45.6 "	" + 50 " " " 100 "	4.8
54.8 "	" + 50 " " "	5.0
62.4 "	" + 50 " " "	5.2

0.05 MOLAR BORAX (19.10 g. PER LITER) WITH 0.1 MOLAR MONOPOTASSIUM CITRATE—Continued

COMPOSITION		pH
69.8 c.c. Borax	+ 50 c.c. Citrate	5.4
76.6 " "	+ 50 " "	5.6
83.4 " "	+ 50 " "	5.8
88.2 " "	+ 50 " "	6.0

0.1 MOLAR MONOPOTASSIUM PHOSPHATE (13.62 g. KH_2PO_4 PER LITER) WITH 0.05 MOLAR BORAX (19.10 g. $\text{Na}_2\text{B}_4\text{O}_7 \cdot 10\text{H}_2\text{O}$ PER LITER)

c.c. PHOSPHATE	c.c. BORAX	pH	c.c. PHOSPHATE	c.c. BORAX	pH
8.77	1.23	6.0	4.80	5.20	7.8
8.30	1.70	6.2	4.50	5.50	8.0
7.70	2.30	6.4	4.24	5.76	8.2
7.12	2.88	6.6	3.80	6.20	8.4
6.58	3.42	6.8	3.20	6.80	8.6
6.10	3.90	7.0	2.48	7.52	8.8
5.66	4.34	7.2	1.32	8.68	9.0
5.36	4.64	7.4	0.00	10.00	9.2
5.08	4.92	7.6			

0.05 MOLAR SODA (5.3 g. Na_2CO_3 PER LITER) WITH 0.05 MOLAR BORAX (19.10 g. $\text{Na}_2\text{B}_4\text{O}_7 \cdot 10\text{H}_2\text{O}$ PER LITER)

COMPOSITION		pH
100.0 c.c. Borax	+ 0.0 c.c. Soda	9.2
64.3 " "	+ 35.7 " "	9.4
44.5 " "	+ 55.5 " "	9.6
33.3 " "	+ 66.7 " "	9.8
24.6 " "	+ 75.4 " "	10.0
17.85 " "	+ 82.15 " "	10.2
13.1 " "	+ 86.9 " "	10.4
8.5 " "	+ 91.5 " "	10.6
5.25 " "	+ 94.75 " "	10.8
2.7 " "	+ 97.3 " "	11.0

0.1 MOLAR DISODIUM PHOSPHATE (17.81 g. $\text{Na}_2\text{HPO}_4 \cdot 2\text{H}_2\text{O}$ PER LITER) WITH 0.1 N NaOH

COMPOSITION		pH
8.26 c.c. 0.1 N NaOH	+ 50 c.c. Phosphate per 100 c.c.	11.0
12.00 " 0.1 N NaOH	+ 50 " " " 100 "	11.2
17.34 " 0.1 N NaOH	+ 50 " " " 100 "	11.4
24.50 " 0.1 N NaOH	+ 50 " " " 100 "	11.6
33.3 " 0.1 N NaOH	+ 50 " " " 100 "	11.8
43.2 " 0.1 N NaOH	+ 50 " " " 100 "	12.0

5. Other buffer mixtures.

Data concerning other buffer mixtures are to be found in the

literature. The composition of a number of these solutions will be reported below.

WALPOLE¹ has examined acetic acid-acetate mixtures with a total acetate content of 0.2 molar.

ACETIC ACID-ACETATE MIXTURES OF WALPOLE (TOTAL ACETATE CONCENTRATION 0.2 MOLAR)

COMPOSITION		P _H
18.5 c.c. 0.2 Molar acetic acid +	1.5 c.c. 0.2 Molar sodium acetate.	3.6
17.6 " 0.2 " " " +	2.4 " 0.2 " " " "	3.8
16.4 " 0.2 " " " +	3.6 " 0.2 " " " "	4.0
14.7 " 0.2 " " " +	5.3 " 0.2 " " " "	4.2
12.6 " 0.2 " " " +	7.4 " 0.2 " " " "	4.4
10.2 " 0.2 " " " +	9.8 " 0.2 " " " "	4.6
8.0 " 0.2 " " " +	12.0 " 0.2 " " " "	4.8
5.9 " 0.2 " " " +	14.1 " 0.2 " " " "	5.0
4.2 " 0.2 " " " +	15.8 " 0.2 " " " "	5.2
2.9 " 0.2 " " " +	17.1 " 0.2 " " " "	5.4
1.9 " 0.2 " " " +	18.1 " 0.2 " " " "	5.6

KOLTHOFF and TEKELENBURG (l.c.) have found that the pH change of acetate buffer mixtures between 10° and 60° is negligible.

MIXTURES OF McILVAINE,² 0.1 MOLAR CITRIC ACID WITH 0.2 MOLAR DISODIUM PHOSPHATE

COMPOSITION	P _H (McILVAINE)	P _H (SLOTTA AND FRANKE)
19.60 c.c. Citric acid + 0.40 c.c. Phosphate	2.2	
18.76 " " " + 1.24 " "	2.4	
17.82 " " " + 2.18 " "	2.6	
16.83 " " " + 3.17 " "	2.8	2.88
15.89 " " " + 4.11 " "	3.0	
15.06 " " " + 4.94 " "	3.2	3.20
14.30 " " " + 5.70 " "	3.4	
13.56 " " " + 6.44 " "	3.6	3.57
12.90 " " " + 7.10 " "	3.8	
12.29 " " " + 7.71 " "	4.0	3.92
11.72 " " " + 8.28 " "	4.2	
11.18 " " " + 8.82 " "	4.4	4.27
10.65 " " " + 9.35 " "	4.6	
10.14 " " " + 9.86 " "	4.8	4.66
9.70 " " " + 10.30 " "	5.0	
9.28 " " " + 10.72 " "	5.2	5.01
8.85 " " " + 11.15 " "	5.4	

¹ G. S. Walpole: *J. Chem. Soc.*, 105, 2501 (1914).

² McIlvaine: *J. Biol. Chem.*, 49, 183 (1921).

MIXTURES OF McILVAINE, 0.1 MOLAR CITRIC ACID WITH 0.2 MOLAR DISODIUM PHOSPHATE—*Continued*

COMPOSITION	pH (McILVAINE)	pH (SLOTTA AND FRANKE)
8.40 c.c. Citric Acid + 11.60 c.c. Phosphate	5.6	5.43
7.91 " " " + 12.09 " "	5.8	
7.37 " " " + 12.63 " "	6.0	5.88
6.78 " " " + 13.22 " "	6.2	
6.15 " " " + 13.85 " "	6.4	6.32
5.45 " " " + 14.55 " "	6.6	
4.55 " " " + 15.45 " "	6.8	
3.63 " " " + 16.47 " "	7.0	6.97
2.61 " " " + 17.39 " "	7.2	
1.83 " " " + 18.17 " "	7.4	
1.27 " " " + 18.73 " "	7.6	7.60
0.86 " " " + 19.15 " "	7.8	
0.55 " " " + 19.45 " "	8.0	8.00

The salt content of the buffer solutions of McILVAINE is rather high, and therefore the salt error of the indicator in these solutions will be much different from the error in other mixtures.

K. H. SLOTTA and W. FRANKE¹ have repeated the measurements at 21°, and have found deviations as large as 0.19 pH unit in the region 4.0–7.0. A more thorough investigation appears desirable. The purity of the phosphate is open to suspicion.

It is often preferable for physiological purposes to use buffer systems other than the boric acid-borate mixtures. L. MICHAELIS² has found that mixtures of veronal (diethylbarbituric acid) with its sodium salt show a satisfactory buffer action in the neighborhood of pH = 8.0. Pure commercial samples of the sodium salt of veronal are readily available, and may be used frequently without previous recrystallization. Buffer mixtures can be prepared by adding hydrochloric acid to the salt. This compound is water-free, and should suffer no loss in weight when dried at 100°. A 0.1 N solution in water requires exactly an equivalent quantity of 0.1 N hydrochloric acid when neutralized against methyl red. A stock solution should contain 10.30 g. of the sodium salt per 500 c.c. Only carbon dioxide free water should be used.

¹ K. H. Slotta and W. Franke: *Ber.*, 64, 452 (1931).

² L. Michaelis: *J. Biol. Chem.*, 87, 33 (1930).

VERONAL-SODIUM SALT BUFFER MIXTURES (MICHAELIS). pH 7.00-9.20

c.c. OF 0.1 N SODIUM SALT SOLUTION	c.c. 0.1 N HCl	pH	c.c. OF 0.1 N SODIUM SALT SOLUTION	c.c. 0.1 N HCl	pH
5.36	4.64	7.00	7.69	2.31	8.20
5.54	4.46	7.20	8.23	1.77	8.40
5.81	4.19	7.40	8.71	1.29	8.60
6.15	3.85	7.60	9.08	0.92	8.80
6.62	3.38	7.80	9.36	0.64	9.00
7.16	2.84	8.00	9.52	0.48	9.20

L. MICHAELIS¹ has reported also a combination of veronal and acetate buffers which, due to the addition of an appropriate amount of sodium chloride, have the same ionic strength as a salt solution isotonic with blood. The original solution is 1/7 molar with respect to sodium acetate and the sodium salt of veronal, 500 c.c. of solution (in carbon dioxide-free water) containing 9.714 g. of sodium acetate ($\text{CH}_3\text{COONa} \cdot 3\text{H}_2\text{O}$) and 14.714 g. of the veronal salt. Five c.c. portions of this solution are treated with 2 c.c. of an 8.5% NaCl solution, with a c.c. 0.1 N HCl, and with $(18 - a)$ c.c. of water. The following table shows how a and pH (hydrogen electrode 25°) are related.

The buffer action is very slight in the pH range between 5.5 and 7. The added sodium chloride has but little influence upon the pH. MICHAELIS finds that it may be omitted without altering the pH appreciably.

VERONAL-ACETATE BUFFERS OF MICHAELIS (25°)

a	pH	a	pH
(0)	9.64)	6.5	6.75
0.25	9.16	7	6.12
0.5	8.90	8	5.32
0.75	8.68	9	4.93
1.0	8.55	10	4.66
2.0	8.18	11	4.33
3.0	7.90	12	4.13
4.0	7.66	13	3.88
5.0	7.42	14	3.62
5.5	7.25	15	3.20
6.0	6.99	16	2.62

¹ L. Michaelis: Biochem. Z., 234, 139 (1931).

The composition of some buffer mixtures prepared from crystalline substances without the use of standard acid or alkali is recorded in the following tables.

BUFFER MIXTURES PREPARED WITHOUT THE USE OF HYDROCHLORIC ACID OR ALKALI (18° C)

0.05 Molar Succinic Acid with 0.05 Molar Borax (Kolthoff¹)

SUCCINIC ACID C.C.	BORAX C.C.	pH	SUCCINIC ACID C.C.	BORAX C.C.	pH
9.86	0.14	3.0	7.00	3.00	4.6
9.65	0.35	3.2	6.65	3.35	4.8
9.40	0.60	3.4	6.32	3.68	5.0
9.05	0.95	3.6	6.05	3.95	5.2
8.63	1.37	3.8	5.79	4.21	5.4
8.22	1.78	4.0	5.57	4.43	5.6
7.78	2.22	4.2	5.40	4.60	5.8
7.38	2.62	4.4			

0.1 Molar KH₂PO₄ + 0.05 Molar Borax (Kolthoff)

KH ₂ PO ₄ C.C.	BORAX C.C.	pH	KH ₂ PO ₄ C.C.	BORAX C.C.	pH
9.21	0.79	5.8	5.17	4.83	7.6
8.77	1.23	6.0	4.92	5.08	7.8
8.30	1.70	6.2	4.65	5.35	8.0
7.78	2.22	6.4	4.30	5.70	8.2
7.22	2.78	6.6	3.87	6.13	8.4
6.67	3.33	6.8	3.40	6.60	8.6
6.23	3.77	7.0	2.76	7.24	8.8
5.81	4.19	7.2	1.75	8.25	9.0
5.50	4.50	7.4	0.50	9.50	9.2

MIXTURES OF SODIUM CARBONATE AND SODIUM BICARBONATE (H. MENZEL²).
18°

PARTS OF SODA	PARTS OF BICARBONATE	pH	PARTS OF SODA	PARTS OF BICARBONATE	pH
2.4	7.5	9.47	7.5	2.5	10.35
4	6	9.73	9	1	10.77
5	5	9.90	10	0	11.54
6	4	10.08			

Mixtures of 0.2 Molar Bicarbonate and 0.2 Molar Soda

¹ I. M. Kolthoff: J. Biol. Chem., 63, 135 (1925).

² H. Menzel: Z. physik. Chem., 100, 276 (1921).

MIXTURES OF SODIUM CARBONATE AND SODIUM BICARBONATE (M. MENZEL).
 18°—Continued

PARTS OF SODA	PARTS OF BICARBONATE	P _H	PARTS OF SODA	PARTS OF BICARBONATE	P _H
<i>Mixtures of 0.1 Molar Bicarbonate and 0.05 Molar Soda</i>					
1	9	8.94	6	4	9.95
2.5	7.5	9.37	7.5	2.5	10.18
4	6	9.62	9	1	10.58
5	5	9.80	10	0	11.37
<i>Mixtures of 0.1 Molar Bicarbonate and 0.1 Molar Soda</i>					
4	6	9.83	6.25	3.75	10.16
5	5	9.97			
<i>Mixtures of 0.02 Molar Bicarbonate and 0.02 Molar Soda</i>					
2	8	9.50	6.7	3.3	10.33
3.3	6.7	9.79	8	2	10.54
4	6	9.94	10	0	11.23
5	5	10.10			

Sodium bimalate ($\text{NaHC}_4\text{H}_2\text{O}_4 \cdot 3\text{H}_2\text{O}$) and sodium hydroxide mixtures have been proposed by J. W. TEMPLE¹ as buffers for use in the pH region 5.2–6.8. The acid sodium salt is prepared from maleic acid and sodium hydroxide just as in the case of potassium biphthalate. The salt is ready for use after recrystallization and drying. No details are given by the author.

0.1 Molar Sodium Bimalate and 0.1 N Sodium Hydroxide

	P _H
50 c.c. Bimalate + 7.2 c.c. 0.1 N NaOH per 100 c.c.	5.2
50 " " + 10.5 " " " " 100 "	5.4
50 " " + 15.3 " " " " 100 "	5.6
50 " " + 20.8 " " " " 100 "	5.8
50 " " + 26.9 " " " " 100 "	6.0
50 " " + 33.0 " " " " 100 "	6.2
50 " " + 38.0 " " " " 100 "	6.4
50 " " + 41.6 " " " " 100 "	6.6
50 " " + 44.4 " " " " 100 "	6.8

¹ J. W. Temple: J. Am. Chem. Soc., 51, 1754 (1929).

CACODYLIC ACID-SODIUM CACODYLATE (pH 5.2-6.5) ¹

C.C. OF 0.2 N CACODYLIC ACID	C.C. OF 0.2 N SODIUM CACODYLATE	TEMPERATURE	pH
(10)	(0)	(14°)	(3.86)
9	1	18°	5.20
7	3	16°	5.76
5	5	16°	6.11
3	7	16°	6.48

W. R. G. ATKINS and C. F. A. PANTIN ² have prepared buffer solutions from 0.1 molar soda and 0.1 molar boric acid in 0.1 N potassium chloride.

MIXTURES OF 0.1 MOLAR SODA (10.6 G. PER LITER) AND 0.1 MOLAR BORIC ACID IN 0.1 N KCl (6.2 G. BORIC ACID AND 7.45 G. KCl PER LITER)

COMPOSITION	pH AT 16°
9.17 c.c. Boric acid + 0.83 c.c. Soda.....	7.8
8.88 " " " + 1.12 " "	8.0
8.50 " " " + 1.50 " "	8.2
8.07 " " " + 1.93 " "	8.4
7.57 " " " + 2.43 " "	8.6
6.95 " " " + 3.05 " "	8.8
6.30 " " " + 3.70 " "	9.0
5.64 " " " + 4.36 " "	9.2
4.97 " " " + 5.03 " "	9.4
4.29 " " " + 5.71 " "	9.6
3.60 " " " + 6.40 " "	9.8
2.91 " " " + 7.09 " "	10.0
2.21 " " " + 7.79 " "	10.2
1.54 " " " + 8.46 " "	10.4
0.98 " " " + 9.02 " "	10.6
0.57 " " " + 9.43 " "	10.8
0.35 " " " + 9.65 " "	11.0

It should be stated that those solutions with a pH less than about 9.6 lose carbon dioxide to the air, whereas the strongly alkaline solutions tend to absorb this gas. Mixtures with a pH of about 8.0 are especially difficult to store due to the escape of the dioxide.

For strongly alkaline solutions E. B. R. PRIDEAUX and F. L. GILBERT ³ recommend the use of 0.1 N piperidine solutions 15%-55% neutralized with 0.1 N hydrochloric acid. The pH of

¹ G. S. Walpole: *Biochem. J.*, 8, 6, 635 (1914).

² W. R. G. Atkins and C. F. A. Pantin: *Biochem. J.*, 20, 102 (1926).

³ E. B. R. Prideaux and F. L. Gilbert: *J. Chem. Soc.*, 1927, 2164.

such mixtures is given by the equation:

$$\text{pH} = 11.10(\pm 0.05) + \log \frac{1 - \alpha}{\alpha},$$

in which α is the amount of base neutralized and $1 - \alpha$ is the amount of free base. These buffers probably have a considerable temperature coefficient.

6. Universal buffer solutions.

E. B. R. PRIDEAUX and A. T. WARD¹ have employed a mixture of several acids in order to obtain buffer solutions with a general applicability between pH's 2.0 and 12.0. The mixture used is 0.04 molar with respect to the following acids: phosphoric, phenylacetic, and boric. The solution is neutralized with 0.2 N sodium hydroxide. The relatively small buffer action of such a universal solution decreases its general usefulness.

H. T. S. BRITTON and R. A. ROBINSON² have measured the same solutions without, however, diluting to 100 c.c. after addition of alkali. Their values deviate by 0.05–0.2 pH unit from the data of PRIDEAUX and WARD.

UNIVERSAL SOLUTIONS OF PRIDEAUX AND WARD, 50 C.C. SOLUTION WITH THE CALCULATED QUANTITY OF ALKALI, DILUTED TO 100 C.C. WITH WATER

% NEUTRALIZED	pH	% NEUTRALIZED	pH
0	1.99	45	6.30
5	2.13	50	6.84
15	2.65	60	7.91
20	3.10	65	8.62
25	3.73	70	9.11
30	4.21	80	10.21
35	4.80	90	11.41(?)
40	5.43	100	11.94(?)

H. T. S. BRITTON and R. A. ROBINSON³ have introduced several new universal buffer solutions. The following solutions are prepared by addition of 0.2 N sodium hydroxide to a solution which is 0.04 molar with respect to phosphoric, acetic, and boric acids.

¹ E. B. R. Prideaux and A. T. Ward: *J. Chem. Soc.*, 125, 426 (1924).

² H. T. S. Britton and R. A. Robinson: *J. Chem. Soc.*, 1931, 458.

³ H. T. S. Britton and R. A. Robinson: *J. Chem. Soc.*, 1931, 1456.

100 C.C. OF "ACID SOLUTION" WITH 0.2 N ALKALI AT 18° (BRITTON AND ROBINSON)

c.c. NaOH	pH	c.c. NaOH	pH	c.c. NaOH	pH	c.c. NaOH	pH
0	1.81	27.5	4.35	52.5	7.00	77.5	9.91
2.5	1.89	30.0	4.56	55.0	7.24	80.0	10.38
5.0	1.98	32.5	4.78	57.5	7.54	82.5	10.88
7.5	2.09	35.0	5.02	60.0	7.96	85.0	11.20
10.0	2.21	37.5	5.33	62.5	8.36	87.5	11.40
12.5	2.36	40.0	5.72	65.0	8.69	90.0	11.58
15.0	2.56	42.5	6.09	67.5	8.95	92.5	11.70
17.5	2.87	45.0	6.37	70.0	9.15	95.0	11.82
20.0	3.29	47.5	6.59	72.5	9.37	97.5	11.92
22.5	3.78	50.0	6.80	75.0	9.62	100.0	11.98
25.0	4.10						

Another series of solutions was made by adding 0.2 N sodium hydroxide to a solution of the following composition: 0.0286 molar in citric acid, 0.0286 molar in monopotassium phosphate, 0.0286 molar in boric acid, 0.0286 molar with respect to veronal, and 0.0286 N in hydrochloric acid.

100 C.C. SOLUTION WITH 0.2 N ALKALI AT 18°

(a = without addition of water; b = dilution to 200 c.c. after addition of alkali)

c.c. NaOH	0	2	4	6	8	10	12	14	16	18	20	22	24	26	28
a	2.40	2.55	2.73	2.92	3.12	3.35	3.57	3.80	4.02	4.21	4.40	4.57	4.75	4.91	5.08
b	2.58	2.72	2.86	3.02	3.21	3.43	3.66	3.87	4.09	4.26	4.42	—	—	—	5.08
c.c. NaOH	30	32	34	36	38	40	42	44	46	48	50	52	54	56	58
a	5.25	5.40	5.57	5.70	5.91	6.10	6.28	6.45	6.62	6.79	6.94	7.12	7.30	7.45	7.63
b	5.25	5.40	5.59	5.70	5.91	6.10	6.28	6.45	6.62	6.79	6.94	7.12	7.30	7.45	7.63
c.c. NaOH	60	62	64	66	68	70	72	74	76	78	80	82	84	86	88
a	7.79	7.98	8.15	8.35	8.55	8.76	8.97	9.20	9.41	9.65	9.88	10.21	10.63	11.00	11.23
b	7.79	7.98	8.15	8.35	8.55	8.76	8.97	9.20	9.41	9.65	9.88	10.21	10.63	11.00	11.23
c.c. NaOH	90	92	94	96	98	100									
a	11.44	11.60	11.75	11.85	11.94	12.02									
b	11.44	11.60	11.75	11.85	11.94	12.02									

It should be mentioned that ACREE, MILLON, AVORY, and SLAGLE¹ have used a complicated mixture of monopotassium phosphate, sodium formate, sodium acetate, sodium phenolsulfonate, disodium phosphate, and thymol. The desired pH is

¹ Acree, Millon, Avory, and Slagle: J. Infectious Diseases, 29, 7 (1921).

produced by addition of the proper amount of hydrochloric acid or sodium hydroxide as indicated graphically.

7. The influence of temperature on the pH of buffer solutions.

The dissociation constants of most acids used in buffer mixtures vary but little with temperature.¹ This leads us to expect that the pH of most acid-sodium salt buffer solutions will be independent of temperature within wide limits. The measurements of WALBUM² (cf. table on page 249) show this to be true of the citrate buffers. I. M. KOLTHOFF and F. TEKELENBURG³ have determined the temperature coefficient of the pH of a great number of buffer mixtures. Their results are summarized in the following table.

The marked influence of temperature on the pH of sodium hydroxide solutions is due of course to the large increase of the ionization constant of water. The pH of glycine-hydrochloric acid mixtures is unaffected by temperature variation, whereas glycine-sodium hydroxide solutions are extremely temperature-sensitive. Such behavior is to be expected on the basis of the hybrid ion structure of amino acids.

SVERRE STENE⁴ has measured the pH of a number of phosphate buffer mixtures, biphthalate solutions, and borate buffers with the hydrogen electrode at 150°. He found that the pH of biphthalate-hydrochloric acid solutions at 150° was about 0.2 unit greater than at 20°, the pH of biphthalate-sodium hydroxide mixtures was 0.7 greater than at 20°, while that of boric acid-borate buffers diminished with increasing temperature. Solutions of the latter system with pH's up to 9.0 were 0.5 unit less at 150°, 0.6 unit less for pH 9.2, 0.8 unit less for 9.6, and a whole unit for pH 10.0. Because certain assumptions introduced in his calculations were not entirely justified, these data must be accepted with reserve. Thus the boric acid-borate solutions behave differently from other buffers consisting of a weak acid and one of its salts. WALBUM (table, page 250) also has found this diminution of pH with temperature.

¹ Cf. H. Jahn and E. Schmidt: *Z. physik. Chem.*, *16*, 72 (1895); A. A. Noyes: *J. Am. Chem. Soc.*, *30*, 349 (1909).

² Walbum: *Compt. rend. soc. biol.*, *83*, 707 (1920).

³ I. M. Kolthoff and F. Tekelenburg: *Rec. trav. chim.*, *46*, 33 (1925).

⁴ Sverre Stene: *Rec. trav. chim.*, *49*, 1133 (1930).

THE VARIATION OF PH OF BUFFER SOLUTIONS WITH TEMPERATURE
(DATA OF KOLTHOFF AND TEKELEBURG)

COMPOSITION OF SOLUTIONS	TEMPER- ATURE	PH
0.1 Molar formic acid and 0.1 molar sodium formate	20°	3.66
	30°	3.65
	40°	3.65
	50°	3.66
	60°	3.66
0.1 Molar acetic acid and 0.1 molar sodium acetate	25°	4.60
	40°	4.61
	50°	4.63
	60°	4.65
0.1 Molar oxalic acid and 0.1 molar sodium bioxalate	20°	1.39
	30°	1.41
	40°	1.41
	50°	1.42
	60°	1.43
0.1 Molar sodium bioxalate	18°	2.58
	30°	2.62
	40°	2.66
	50°	2.69
	60°	2.72
0.1 Molar malonic acid and 0.1 molar sodium bimalonate	18°	2.71
	30°	2.71
	40°	2.72
0.1 Molar succinic acid and 0.1 molar sodium bisuccinate	20°	3.96
	30°	3.98
	40°	3.96
	50°	3.95
	60°	3.97
0.1 Molar sodium bisuccinate	18°	4.71
	30°	4.69
	40°	4.69
	50°	4.71
	60°	4.74
0.1 Molar glycolic acid and 0.1 molar sodium glycolate	25°	3.65
	40°	3.66
	50°	3.65
	60°	3.66
0.1 Molar lactic acid and 0.1 molar sodium lactate	18°	3.67
	30°	3.68
	40°	3.69
	50°	3.70
	60°	3.73

THE VARIATION OF PH OF BUFFER SOLUTIONS WITH TEMPERATURE

(Continued)

(DATA OF KOLTHOFF AND TEKELENBURG)

COMPOSITION OF SOLUTIONS	TEMPERATURE	PH
0.1 Molar tartaric acid and 0.1 molar sodium bitartrate	18°	2.79
	40°	2.77
	50°	2.75
	60°	2.76
0.1 Molar sodium bitartrate	18°	3.48
	30°	3.48
	40°	3.46
	50°	3.45
	60°	3.44
0.1 Molar sodium bitartrate and 0.01 molar sodium tartrate	18°	4.16
	30°	4.14
	40°	4.16
	50°	4.16
	60°	4.17
0.1 Molar monosodium citrate	18°	3.66
	30°	3.65
	40°	3.65
	50°	3.66
	60°	3.65
Sørensen citrate buffer (cf. page 249), citric acid and monosodium citrate	20°	3.51
	30°	3.49
	40°	3.47
	50°	3.48
Sørensen citrate buffer, mono- and disodium citrate	18°	4.45
	30°	4.43
	40°	4.41
	50°	4.40
	60°	4.40
0.1 Molar disodium citrate	20°	4.96
	30°	4.96
	40°	4.96
	50°	4.97
0.01 Molar β -hydroxybutyric acid and 0.01 molar sodium β -hydroxybutyrate	18°	4.42
	30°	4.42
	40°	4.43
0.1 Molar fumaric acid and 0.01 molar monosodium fumarate	18°	3.00
	30°	3.01
	40°	3.02

THE VARIATION OF pH OF BUFFER SOLUTIONS WITH TEMPERATURE

(Continued)

(DATA OF KOLTHOFF AND TEKELENBURG)

COMPOSITION OF SOLUTIONS	TEMPERATURE	pH
0.01 Molar monosodium fumarate	18°	4.30
	30°	4.32
	40°	4.34
0.01 Molar monosodium fumarate and 0.02 molar disodium fumarate	18°	3.66
	30°	3.66
	40°	3.67
0.1 Molar maleic acid and 0.1 molar monosodium maleate	18°	1.90
	30°	1.90
	40°	1.91
0.1 Molar monosodium maleate	20°	4.18
	30°	4.18
	40°	4.19
0.1 Molar monosodium maleate and 0.1 molar disodium maleate	18°	5.75
	30°	5.79
	40°	5.82
0.05 Molar potassium biphthalate and 0.025 molar hydrochloric acid	18°	2.85
	30°	2.87
	40°	2.88
	50°	2.89
	60°	2.91
0.05 Molar potassium biphthalate	18°	3.94
	30°	3.96
	40°	3.99
	50°	4.02
	60°	4.05
0.05 Molar potassium biphthalate and 0.025 molar sodium hydroxide	18°	5.02
	30°	5.05
	40°	5.08
	50°	5.12
	60°	5.16
Glycine-hydrochloric acid (Sørensen, cf. page 248)	18°	3.68
	30°	3.64
	40°	3.64
	50°	3.64

THE VARIATION OF PH OF BUFFER SOLUTIONS WITH TEMPERATURE

(Continued)

(DATA OF KOLTHOFF AND TEKELENBURG)

COMPOSITION OF SOLUTIONS	TEMPERATURE	pH
<i>Alkaline Solutions</i>		
0.1 Molar sodium hydroxide	18°	12.99
	30°	12.62
	40°	12.32
	50°	12.06
	60°	11.81
0.01 Molar sodium hydroxide	18°	12.06
	30°	11.67
	40°	11.38
	50°	11.12
	60°	10.87
0.1 Molar glycine and 0.05 molar NaOH	18°	9.31
	30°	9.00
	40°	8.77
	50°	8.54
	60°	8.33
Glycine-sodium hydroxide (Sørensen, cf. page 250)	18°	10.01
	30°	9.71
	40°	9.45
	50°	9.27
	60°	9.03
0.05 Molar sodium carbonate	18°	11.27
	30°	11.02
	40°	10.85
	50°	10.69
	60°	10.55
0.1 Molar sodium carbonate and 0.05 molar hydrochloric acid	18°	10.01
	30°	9.91
	40°	9.84
	50°	9.77
	60°	9.70
0.15 Molar disodium phosphate and sodium hydroxide	25°	11.29
	40°	11.08
	18°	11.72
	30°	11.52
	40°	11.36
	50°	11.19
	60°	11.03

8. The influence of dilution on the pH of buffer mixtures.

We have already seen in the general discussion of the properties of buffer solutions that the pH of a solution of known composition can be calculated *approximately* from the equation (cf. Chapter One, § 7):

$$[\text{H}^+] = \frac{[\text{HA}]}{[\text{A}^-]} K_1 \quad \text{or} \quad \frac{[\text{HA}^-]}{[\text{A}^-]} K_2, \text{ etc.,}$$

or quite generally from the equation

$$[\text{H}^+] = \frac{[a]}{[b]} K,$$

where $[a]$ is the concentration of the acid form and $[b]$ the concentration of the basic form of each charge type, and K is the corresponding constant.

This equation would lead us to expect that the pH of a buffer solution does not change with dilution. However, such is not the case since, as we shall see, the expression is not exact.

(a) The quantities $[\text{HA}]$ and $[\text{A}^-]$, etc., are not the analytical concentrations $[a]$ and $[b]$ of the acid and basic forms but the concentrations after dissociation equilibrium is established. Let us consider by way of illustration a mixture of a normal and an acid salt (such as a biphthalate-phthalate buffer):

$$[\text{H}^+] = \frac{[\text{HA}^-]}{[\text{A}^-]} K_2.$$

Setting the analytical concentration of the biphthalate equal to a , and that of the phthalate equal to b , we see that $[\text{HA}^-]$ is somewhat less than a and $[\text{A}^-]$ is greater than b due to the dissociation $\text{HA}^- \rightleftharpoons \text{H}^+ + \text{A}^-$. We may write as approximations:

$$[\text{HA}^-] = a - [\text{H}^+],$$

and

$$[\text{A}^-] = b + [\text{H}^+],$$

so that in the buffer solution

$$[\text{H}^+] = -\frac{b + K_2}{2} + \sqrt{\left(\frac{b + K_2}{2}\right)^2 + K_2 a}. \quad (1)$$

Even this equation is not entirely correct because the dissociation of water is not taken into account. This need not be considered, however, unless the pH of the solution is approximately 7 and the dilution is very great.

The more exact expression may be derived by introducing the rule of electro-neutrality. Assuming that sodium salts are involved, we have:

$$[\text{Na}^+] + [\text{H}^+] = [\text{HA}^-] + 2[\text{A}^-] + [\text{OH}^-]$$

or

$$a + 2b + [\text{H}^+] = [\text{HA}^-] + 2[\text{A}^-] + [\text{OH}^-].$$

We know also that

$$[\text{HA}^-] + [\text{A}^-] = a + b.$$

Therefore

$$[\text{A}^-] = b + [\text{H}^+] - [\text{OH}^-],$$

and

$$[\text{HA}^-] = a - [\text{H}^+] + [\text{OH}^-],$$

or

$$[\text{H}^+] = \frac{a - [\text{H}^+] + [\text{OH}^-]}{b + [\text{H}^+] - [\text{OH}^-]} K_2,$$

which leads to

$$[\text{H}^+] = -\frac{b + K_2}{2} + \sqrt{\left(\frac{b + K_2}{2}\right)^2 + aK_2 + K_w + \frac{K_w K_2}{[\text{H}^+]}}. \quad (2)$$

It is rather difficult to solve this third degree equation. Fortunately it is possible to manage without a rigorous solution by first obtaining an approximate $[\text{H}^+]$ value from equation (1) and then calculating the quotient $\frac{K_w K_2}{[\text{H}^+]}$ from equation (2). This in turn yields a more correct value of $[\text{H}^+]$. A closer approximation can be obtained by repeating the calculation with this value instead of the less accurate $[\text{H}^+]$ obtained from equation (1).

In the event that the buffer solution has an alkaline reaction (carbonate-bicarbonate), we find that at great dilution

$$[\text{HA}^-] = a + [\text{OH}^-],$$

$$[\text{A}^-] = b - [\text{OH}^-],$$

and approximately

$$[\text{H}^+] = \frac{K_w + K_2 a}{2b} + \sqrt{\left(\frac{K_w + K_2 a}{2b}\right)^2 + \frac{K_2 K_w}{b}}. \quad (3)$$

Equations (1), (2), and (3) need be employed only at extreme dilutions. Let us take, by way of illustration, a mixture of 0.001 molar normal salt and 0.001 molar acid with $K_2 = 10^{-5}$. The general equation states that

$$[\text{H}^+] = \frac{a}{b} K_2 = 10^{-5}.$$

The true value of a , however, is not 10^{-3} but $10^{-3} - [\text{H}^+]$, and b equals $10^{-3} + [\text{H}^+]$, so that

$$[\text{H}^+] = \frac{10^{-3} - 10^{-5}}{10^{-3} + 10^{-5}} K_2 = \text{approximately } 10^{-5}.$$

In this case the general expression is sufficiently accurate. Only when the extent of dissociation is such that $[\text{H}^+]$ is no longer negligible in comparison with a and b is it necessary to employ the more complicated equations.

(b) The expressions

$$[\text{H}^+] = \frac{[\text{HA}]}{[\text{A}^-]} K_1 \quad \text{or} \quad \frac{[\text{HA}^-]}{[\text{A}^-]} K_2, \text{ etc.}$$

are incorrect from the standpoint of thermodynamics. We have seen in the third chapter that, according to the activity theory,

$$[a\text{H}^+] = \frac{[a\text{HA}]}{[a\text{A}^-]} K_1 = \dots, \text{ etc.}, \quad (4)$$

where the symbol a stands for the activity of the component involved.

We may write for a mixture of an undissociated acid and its salt:

$$[a\text{H}^+] = \frac{f_0[\text{HA}]}{f_1[\text{A}^-]} K_1, \quad (5)$$

where f is the activity coefficient. In a dilute buffer solution (without addition of neutral salt) f_0 may be set equal to unity, or in other words, the activity of the acid is equal to its concentration. The activity coefficient of the ions f_1 , however, varies

with the ionic strength of the solution, and is equal to unity only in infinitely dilute solutions.

Rewriting equation (5) as a function of pH, we find

$$paH = \log f_1 + pK_1 - \log \frac{[HA]}{[A^-]}. \quad (6)$$

The term pK_1 is a thermodynamic constant, and f_0 is set equal to unity. The ratio of the analytical concentrations of the acid and its salt is given by $\frac{[HA]}{[A^-]}$, and is independent of dilution.

(See sub a for the correction at extreme dilutions.) Thus equation (6) informs us that paH changes to the same extent as does $\log f_1$ upon dilution. Since f_1 is larger for smaller concentrations of electrolyte, tending to approach a final value of unity, we see that paH increases with dilution and the solution becomes more alkaline. It is a simple matter to compare the reactions of a buffer mixture of a weak acid with one of its salts at two different dilutions (1) and (2). Equation (6) leads immediately to

$$paH_1 - paH_2 = \log f_1 - \log f_1'. \quad (7)$$

When we are dealing with a mixture of an acid and a normal salt (HA^- and A^{2-}), the following expression holds:

$$paH = \log \frac{f_2}{f_1} + pK_2 - \log \frac{[HA^-]}{[A^{2-}]}, \quad (8)$$

where f_2 denotes the activity coefficient of the bivalent anion A^{2-} and f_1 that of the univalent anion HA^- . For a salt mixture of bi- and trivalent anions (bi- and trivalent citrate) we have

$$paH = \log \frac{f_3}{f_2} + pK_3 - \log \frac{[HA^{2-}]}{[A^{3-}]}, \text{ etc.} \quad (9)$$

It was shown in the third chapter that the variation of f with ionic strength could be calculated from the DEBYE-HÜCKEL equation

$$-\log f = \frac{0.5z^2\sqrt{\mu}}{1 + 0.329 \times a \times 10^8\sqrt{\mu}}, \quad (10)$$

where z is the valence of the ion, μ the ionic strength, and a the (apparent) ion size. Returning now to equation (7), it follows that, upon diluting a buffer mixture of a weak acid and its salt,

the paH change may be calculated from

$$paH_1 - paH_2 = \Delta paH \\ = \frac{0.5\sqrt{\mu_1'}}{1 + 0.329 \times a \times 10^8 \sqrt{\mu_1'}} - \frac{0.5\sqrt{\mu_1}}{1 + 0.329 \times a \times 10^8 \sqrt{\mu_1}}. \quad (11)$$

Thus paH varies approximately with the difference

$$0.5(\sqrt{\mu_1'} - \sqrt{\mu_1}). \quad (12)$$

Let us consider next a buffer mixture consisting of a uni- and bivalent anion. From equations (8) and (10) we have

$$paH = - \frac{1.5\sqrt{\mu}}{1 + 0.329 \times a \times 10^8 \sqrt{\mu}} + pK_2 - \log \frac{[HA^-]}{[A^{=}]} \quad (13)$$

The approximate paH change with dilution is given by the difference

$$1.5(\sqrt{\mu_1'} - \sqrt{\mu_1}). \quad (14)$$

Equations (9) and (10) tell us also that for a mixture of a bi- and trivalent anion

$$paH = - \frac{2.5\sqrt{\mu}}{1 + 0.329 \times a \times 10^8 \sqrt{\mu}} + pK_3 - \log \frac{[HA^{=}]}{[A^{=}]} \quad (15)$$

Hence upon dilution of such a solution the paH will vary approximately with the difference

$$2.5(\sqrt{\mu_1'} - \sqrt{\mu_1}). \quad (16)$$

The higher the valence of the pH determining ions in the buffer, the more marked will be the change in paH with dilution. For equal dilutions this variation in a citrate-mono-hydrogen citrate mixture is five times as great as in an acetic acid-acetate solution, and for a phosphate- or biphthalate-alkali buffer the change is about three times as great as in the acetate mixture.

The effect of dilution can be calculated quantitatively if the ionic diameter is known. When the customary buffer solutions with an ionic strength less than 0.1 are employed, we may assume an average ionic diameter $a = 4 \times 10^{-8}$ cm., and then calculate the variations in $-\log f_1$, $-\log \frac{f_2}{f_1}$, or $-\log \frac{f_3}{f_2}$ as the case may require. It must be understood that the assumption of a con-

stant ionic diameter for the various types of ions is not substantiated by experiment, although for all practical purposes the approximation is permissible when $\mu < 0.1$. The values of $-\log f_1$, $-\log \frac{f_2}{f_1}$, and $-\log \frac{f_3}{f_2}$ calculated for various ionic strengths on the basis of $a = 4 \times 10^{-8}$ cm. are to be found in the following table.

μ	$\sqrt{\mu}$	$-\log f_1$	$-\log \frac{f_2}{f_1}$	$-\log \frac{f_3}{f_2}$
0.5	0.707	0.20	0.60	1.00
0.2	0.45	0.14	0.42	0.70
0.15	0.39	0.13	0.38	0.63
0.1	0.32	0.11	0.34	0.57
0.05	0.224	0.09	0.26	0.43
0.025	0.158	0.07	0.20	0.33
0.01	0.100	0.04	0.13	0.22
0.005	0.071	0.03	0.11	0.18
0.0025	0.050	0.025	0.07	0.11
0.001	0.032	0.016	0.05	0.08

These figures permit us to calculate easily the influence of dilution upon the pH of a buffer mixture. For example, if we dilute ten-fold a mixture which is 0.1 normal with respect to both acetic acid and sodium acetate, the value of μ will change from 0.1 to 0.01 and $-\log f_1$ will change from 0.11 to 0.04. This variation corresponds to a pH increase of 0.07. The influence of dilution upon the pH of a number of different buffer solutions is illustrated in the tables which follow. The calculated values¹ of pH were checked by actual measurements with the hydrogen electrode (18°).

0.1 N ACETIC ACID AND 0.1 N SODIUM ACETATE

DILUTION	μ	pH (EXP)	pH (CALC)
—	0.1	4.61	(4.61)
2-fold	0.05	4.63	4.63
4 “	0.025	4.65	4.65
10 “	0.01	4.68	4.68
20 “	0.005	4.69	4.69
40 “	0.0025	4.70	4.695

¹ I. M. Kolthoff: *Biochem. Z.*, 195, 239 (1928).

BIPHthalate-PHthalate BUFFER OF CLARK (Cf. SECTION 2 ABOVE). 50 C.C.
0.1 Molar POTASSIUM BIPHthalate + 29.95 C.C. 0.1 NORMAL NaOH
DILUTED TO 100 C.C. WITH WATER. pH = 5.20 (CLARK)

DILUTION	μ	pH (EXP)	pH (CALC.)
—	0.110	5.21	(5.21)
2-fold	0.055	5.28	5.28
5 “	0.022	5.35	5.36
10 “	0.011	5.40	5.42
25 “	0.0044	5.46	5.45
50 “	0.0022	5.48	5.48

MONOPHOSPHATE-DIPHOSPHATE BUFFER OF CLARK (Cf. SECTION 2 ABOVE).
50 C.C. 0.1 Molar MONOPOTASSIUM PHOSPHATE + 29.63 C.C. 0.1
NORMAL NaOH PER 100 C.C. pH = 7.00 (CLARK)

DILUTION	μ	pH (EXP)	pH (CALC)
—	0.109	6.99	(6.99)
2-fold	0.055	7.06	7.06
5 “	0.022	7.14	7.14
10 “	0.011	7.17	7.20
20 “	0.0055	7.18	7.22
(50 “	0.0022	7.20	7.26)

The last dilution is probably influenced slightly by the carbon dioxide present in air.

The agreement between the experimental and calculated values for citrate buffers is not as close as in the preceding cases, presumably due to the fact that the value taken for the ionic diameter ($a = 4 \times 10^{-8}$ cm.) is too small. The agreement is satisfactory if a is assumed to be 6×10^{-8} .

MONO-BIPOTASSIUM CITRATE MIXTURE. THE SOLUTION CONTAINS 0.0334
MOLES OF MONO- AND 0.0334 MOLES OF DIPOTASSIUM CITRATE
PER LITER

DILUTION	μ	pH (EXP)	pH (CALC)
—	0.133	4.405	(4.405)
2-fold	0.0667	4.48	4.48
5 “	0.0267	4.55	4.57
10 “	0.0133	4.60	4.63
20 “	0.0067	4.62	4.66
40 “	0.0033	4.64	4.69

DI-TRIPOTASSIUM CITRATE MIXTURE. THE SOLUTION IS 0.01 MOLAR WITH RESPECT TO DI- AND TRIPOTASSIUM CITRATE

DILUTION	μ	pH (EXP.)	pH (CALC.)
—	0.09	5.91	—
2-fold	0.045	6.01	6.04
5 “	0.018	6.13	6.17
10 “	0.009	6.19	6.24
25 “	0.0036	6.25	6.31
50 “	0.0018	6.27	6.35

The calculation of the dilution effect does not apply to boric acid-sodium hydroxide mixtures. The behavior of these buffer solutions is complicated by the formation of a complex between boric acid and borate ions. The dissociation constant of boric acid in aqueous solution increases with higher concentrations of the acid because the complex polyboric acid formed is more strongly acid than the orthoboric acid.¹ The influence of dilution upon boric acid-sodium hydroxide mixtures has been studied in detail by KOLTHOFF and W. BOSCH.²

¹ I. M. Kolthoff: *Rec. trav. chim.*, 45, 501 (1926).

² I. M. Kolthoff and W. Bosch: *Rec. trav. chim.*, 46, 180 (1927).

CHAPTER NINE

THE COLORIMETRIC DETERMINATION OF HYDROGEN ION CONCENTRATION

1. Principle of the method.

The procedure is based upon the assumption that two different solutions have the same concentration of hydrogen ions if they produce equal color intensities of a given indicator. The simple dissociation theory of indicators provides that

$$[\text{H}^+] = \frac{[\text{HI}]}{[\text{I}^-]} K_{\text{I}},$$

which demands that the hydrogen ion concentrations of two solutions be equal when the ratio $\frac{[\text{HI}]}{[\text{I}^-]}$ is the same for both solutions. We shall find later that the above equation is not entirely correct since we have expressed the equilibrium conditions in terms of concentrations instead of activities of constituents which participate in the reaction. For the present we shall disregard this distinction and assume that equal color intensities signify identical hydrogen ion activities.

In the colorimetric determination of pH we always make use of a comparison solution of known acidity. The accuracy of such a comparison method evidently is limited by the reliability of the comparison solution. As has been mentioned in the preceding chapter, the pH of the comparison or buffer solution is measured by means of the hydrogen electrode. Hence the colorimetric procedure is based ultimately upon the potentiometric method. It is the hydrogen ion *activity*¹ rather than the *concentration* which is determined by the latter method. Thus when it is stated that an unknown and a buffer solution have the same pH on the basis of equal color intensities, it is really the hydrogen ion activity which is implied.

¹That this is only approximately true can be seen from the discussion of the potentiometric method of determining dissociation constants (cf. pages 75 and 76).

The reader must bear in mind that, although the experimental error in colorimetric measurements may be reduced to a very small quantity (about 0.01 unit of pH) by a suitable choice of instruments and experimental conditions, the results are less reliable than measurements by the potentiometric method. This is due to the uncertainty introduced by assuming that equal colorations indicate the same hydrogen ion activity. The potentiometric procedure must always be considered as the standard method in accurate work. Colorimetric measurements, however, are of great service because they are rapidly performed, results are reproducible, and because no special equipment is required. The technique is so very simple that it can be mastered by persons without chemical training or understanding of the theoretical basis of the procedure. Paradoxically enough, its very simplicity frequently may cause many of the possible sources of error to be overlooked. Each worker, therefore, should be required to make a thorough study of the sources of error in colorimetric determinations (see Chapter Ten).

2. The determination with buffer solutions.

Measurements should be carried out with two different indicators, unless routine analyses are involved. When nothing at all is known of the acidity of the solution, the approximate pH must first be found in order to permit a choice of proper indicators. Of course only those indicators may be used which impart a distinct intermediate color to the unknown solution. An indicator is of no value if its color in the unknown solution is due to the pure acid or pure basic form. The preliminary examination for acidity may be performed with the use of various indicator papers such as congo, litmus, phenolphthalein, and turmeric papers, or by treating small portions of liquid (on a spot plate) with various indicators. If it happens, for example, that a solution remains colorless in the presence of phenolphthalein and is alkaline towards methyl orange, its pH must lie between 8 and 4.5. Should further tests show the unknown to be alkaline also to methyl red, we would know that the pH being measured lies between 6 and 8, and that a suitable indicator could be chosen from the group which includes bromthymol blue, phenol red, neutral red, and cresol red. Universal indicators are especially useful for making such estimates of pH values.

Actual determinations are made in ordinary resistance glass (Jena, Pyrex, etc.) test tubes of *very small diameter*. To 3–10 c.c. portions of solution is added 0.03–0.10 c.c. of indicator solution of concentration prescribed in Chapter Five. The comparison solution is treated in the same way. To compare colors, one makes use of a test tube rack constructed so that the tubes are inclined towards a white (milk glass or paper) background at an angle of 35–40° from the vertical. Colors may be judged in two ways. The solutions may be observed through the tube against the white background, or the color of the whole column may be noted.

A sufficient number of comparison solutions must be prepared so that the color of the liquid being investigated always falls between two comparison solutions. Furthermore, exactly the *same volume of the same indicator solution must be added to the comparison and unknown solutions*. The concentration of one-color indicators is of very great importance. In the case of two-color indicators, concentration plays a minor role since the relationship between the concentrations of the acid and alkaline form determines the color. Here too, however, it is advisable to add the indicator from a small pipette rather than a dropper. Duplicate colorimetric measurements with phenolphthalein (also thymolphthalein, *p*-nitrophenol, nitramine, etc.) may differ appreciably unless the specified quantity of indicator solution is measured out accurately.

Choice of suitable indicators. An indicator suitable for the colorimetric determination of pH should have acid and alkaline forms which are rather stable and which are sufficiently soluble in water to exclude the possibility of separation of solid indicator. The most important properties of indicators have been discussed exhaustively in Chapter Five, and the reader is referred to these details when choosing an indicator.

Certain of these indicators will again be considered by way of illustration of desirable properties. Methyl violet is green in 0.05 N hydrochloric acid, but the color fades appreciably even in fifteen minutes and disappears entirely after a longer interval. Evidently methyl violet can not be recommended for pH determinations, and cresol red or thymol blue must be used in its stead. In order to obtain stable acid solutions (red) of the latter indicators, no more than 0.1 c.c. of 0.1% solution should be used

per 10 c.c. Otherwise the acid form of the indicators will settle out on standing.

Azo indicators are all weak bases which are very insoluble in water. Their solubility is raised by the introduction of a polar group in the molecule (sulfonic acid group in methyl orange; carboxyl group in methyl red). Although methyl yellow (dimethylaminoazobenzene) is satisfactory as an indicator in neutralization analyses, it can hardly be used for exact colorimetric determinations. Methyl orange, on the other hand, has nearly the same transformation interval and is quite suitable for such measurements. When 0.1 c.c. of a 0.05% alcoholic dimethylaminoazobenzene solution is added to 10 c.c. of a solution of pH 3.6, it will be observed that the color fades appreciably in fifteen minutes, and that a large part of the indicator separates out. Buffer solutions containing methyl orange (and also tropeolin 00) can be kept for several days without changing color. Although the acid form of methyl red is not as stable as that of methyl orange, it also is a very satisfactory indicator for colorimetric measurements.

Bromeresol green is to be preferred to methyl red when measurements are made over longer periods of time (as frequently is necessary in bacteriology). Although neutral red is a very good indicator, it is necessary to work rapidly with it because the alkaline form is somewhat unstable. Solutions of phenolphthalein stable over short periods of time may be prepared since its acid form is sufficiently soluble. Unfortunately the red alkaline form is not stable and is converted partially into the colorless carbinol compound on standing. The change is so slow, especially within the transformation range of the indicator, that the comparison colors of buffer solutions will remain unaltered for at least a half day.

Thymolphthalein is not especially suitable for the determination of pH. The acid form is insoluble in water and fading of the color is nearly always observed. When 0.1 c.c. of a 0.1% indicator solution is added to 10 c.c. of a carbonate buffer of pH 10, there appears a light blue color which fades rapidly on standing, due to the flocculation of the acid form. Indicator must be added simultaneously to the buffer and unknown solution and the colors compared immediately if thymolphthalein is used. Even so, results are not always reliable.

The red alkaline form of nile blue is extremely insoluble in water and separates out quantitatively on standing. Great care must be exercised when using this substance. The red-brown color of the acid-sensitive nitramines turns colorless or light yellow on standing in alkaline solution due to decomposition of the indicator.

The sulfonephthaleins are characterized by pronounced color changes and by the stability of both forms. Bromphenol blue and bromcresol purple are less satisfactory for pH determinations since they show a marked dichromatism during transformation. Fortunately these indicators may be replaced by tetrabromophenoltetrabromosulfonephthalein, bromcresol green, and chlorphenol red.

Best results in colorimetric measurements are obtained usually with indicators which possess short transformation intervals. Small variations in hydrogen ion concentration produce more distinct color differences with such indicators than when the color change occurs over a wider range. Indicators with short ranges are to be preferred in spite of the fact that, if indicators with long intervals are employed, a smaller number of the latter are needed for each pH determination. Although more indicators of short range are required for a given measurement, the accuracy of the result is greater. Litmus or azolitmin changes color from pH 5 to 8, neutral red from 6.8 to 8, and phenol red between 6.4 and 8.0. All three indicators may be used to determine pH values between 6.8 and 8.0. The transformation of neutral red and phenol red is much more distinct than in the case of litmus. In this connection we see that the use of "universal indicators" for accurate measurements is to be discouraged.

Accuracy of colorimetric measurements. An accuracy of 0.05–0.1 pH unit is possible in routine work when buffer solutions differing by 0.2 pH are employed. Estimates to 0.01 unit, as is customary when measuring the pH of blood serum, are significant only if the pH difference between comparison solutions is 0.05–0.1 pH unit. The attainment of such precision is facilitated by the colorimeter or spectrophotometer, although an experienced worker may obtain equal precision with the naked eye. In no event should the accuracy of the measurement be exaggerated, for a number of other factors influence the results (differences in ionic strengths of unknown solution and buffer). An accuracy

greater than 0.05 unit is difficult to realize since the electrolytes present in solution will affect the coloration itself.

We saw in Fig. 8 (Chapter Five) that the absolute color change of an indicator occasioned by a slight variation in hydrogen ion concentration is greatest when the pH approximates pK_I . Hence, in colorimetric determinations, that indicator of which the pK_I approximates the pH of the unknown solution will yield the most accurate result. In other words, the pH being measured should lie in the middle of the transformation region of the indicator. If this pH lies towards the end of the interval, the color changes are usually less marked for equal pH differences. This is especially true of two-color indicators for which it is necessary to estimate relative values instead of absolute quantities of a single form as in the case of one-color indicators. Maximum accuracy with the sulfonephthaleins is not obtained at $pH = pK_I$, but at the beginning of the acid side of the interval because of the large difference in color intensity between the acid and alkali forms.

J. T. SAUNDERS¹ stated that a precision of 0.01 to 0.02 pH unit is obtainable with the following indicators.

INDICATOR	BEST RANGE
Bromocresol purple.....	5.80-6.40
Bromthymol blue.....	6.40-7.20
Phenol red.....	7.10-7.90
Cresol red.....	7.65-8.45
Thymol blue.....	8.40-9.20

Micro determination of pH. The same principle applies to the determination of the pH in small quantities of liquid except that capillary tubes² are used instead of the usual test tubes. F. VLÈS³ has described a microcolorimeter designed for the measurement. L. D. FELTON⁴ adds several drops of indicator to several drops of unknown solution on a porcelain spotplate and compares the color so obtained with the color of buffer mixtures similarly treated. Great care must be exercised in the application of the micro determination, especially when the solution being studied is poorly buffered. Large errors may be introduced because the ratio of indicator concentration to buffer

¹ J. T. Saunders: Proc. Cambridge Phil. Soc., 1, 30 (1923); cf. also Wells: J. Am. Chem. Soc., 42, 2160 (1920).

² O. A. Walther and J. Ulrich: Bull. soc. chim. biol., 8, 1106 (1926).

³ F. Vlès: Compt. rend. soc. biol., 94, 879 (1926).

⁴ L. D. Felton: J. Biol. Chem., 46, 299 (1921).

capacity is very high, and the added indicator will alter the pH of solution unless an isohydric indicator is employed (cf. Chapter Ten, § 1). Details of the microcolorimetric pH measurement are available in the literature.¹

3. pH Determination without buffer solutions.

Principle of the method. Dissociation constants of indicators. The relationship between the hydrogen ion activity and color of a solution is given by the equation

$$[aH^+] = \frac{[HI]}{[I^-]} K_I, \quad (1)$$

where $[HI]$ is the concentration of the acid form, $[I^-]$ that of the alkaline form, and K_I the dissociation constant of the indicator. This may be rewritten:

$$p_aH = \log \frac{[I^-]}{[HI]} + pK_I. \quad (2)$$

If K_I or pK_I is known and the ratio $\frac{[HI]}{[I^-]}$ determined experimentally, then aH and p_aH can be calculated readily. It is possible, on this basis, to determine the pH of a solution without the use of buffer solutions.

It should be realized that K_I is not an absolute constant. The dissociation constant, as defined above, is a function of the concentrations of the various components which participate in the reaction and, as such, will vary with the ionic strength of the solution. The true constant is K_I' defined as follows:

$$[aH^+] = \frac{[aHI]}{[aI^-]} K_I' = \frac{[HI]}{[I^-]} K_I' \times \frac{f_{HI}}{f_I^-}. \quad (3)$$

The symbol a again denotes the activity of a given component, and f the activity coefficients.

It is obvious from (1), (2), and (3) that

$$pK_I = pK_I' - \log \frac{f_{HI}}{f_I^-}. \quad (4)$$

The term pK_I' is constant, but pK_I diminishes with increasing electrolyte content of solution because $-\log \frac{f_{HI}}{f_I^-}$ for indicator

¹ V. C. Myers, H. W. Schmitz, and L. L. Booher: *J. Biol. Chem.*, 57, 209 (1923); J. H. Brown: *J. Lab. Clin. Med.*, 9, 239 (1924); Smith: *Chem. Abstracts*, 19, 1722 (1925).

acids first assumes negative values as the ionic strength increases. A minimum is reached at a rather high ionic strength, usually above 0.5 N although it varies with the electrolyte, after which pK_I increases with higher electrolyte concentration. It is only at very small electrolyte concentrations (below 0.01 N) that the specific influence of individual ions upon the activity coefficients of both forms of an indicator may be neglected. For practical purposes it is permissible to consider the electrolyte effect below a certain ionic strength to be the same for various ions, without occasioning a large error. At larger concentrations of electrolyte, however, it is necessary to determine the specific effect of each salt on the ratio of the activity coefficients of both forms of the indicator (and also on the light absorption; cf. § 6).

The indicator constant varies also with the temperature, and this temperature effect should be considered when using this method without buffers. I. M. KOLTHOFF¹ has summarized and examined the pertinent data reported in the literature in order to ascertain the extent to which pK_I depends upon ionic strength and temperature. Since the knowledge of indicator constants is of prime importance in the application of the colorimetric method without buffer solutions, his findings will be considered in detail.

Equation (2) allows us to calculate the pK_I if the paH which governs the indicator equilibrium is known. It has been customary to determine paH (pH) with the aid of the hydrogen electrode by calculating it from the E.M.F. according to the standard equations of S. P. L. SÖRENSEN² (SÖRENSEN value). This SÖRENSEN value has no special significance when regarded in the light of our modern views of the dissociation of strong electrolytes. SÖRENSEN (1909) based his calculations upon the dissociation theory of ARRHENIUS, assuming that the pH of a 0.1 N hydrochloric acid solution is 1.038. In reality this pH is equal to 1.00, whereas the paH is 1.08 ± 0.01 . Most authors use SÖRENSEN'S equations for calculating pH, although J. SENDROY and A. B. HASTINGS,³ as well as K. BUCH,⁴ employ the paH value of 1.08 for 0.1 N hydrochloric acid and 2.08 for a mixture of 0.01 N HCl and 0.01 N KCl.

¹ I. M. Kolthoff: *J. Phys. Chem.*, **34**, 1466 (1930).

² S. P. L. Sørensen: *Compt. rend. trav. lab. Carlsberg*, **8**, 23 (1909); cf. also W. M. Clark: *The determination of hydrogen ions*, 3 ed., 1928.

³ J. Sendroy and A. B. Hastings: *J. Biol. Chem.*, **82**, 198 (1929).

⁴ K. Buch: *Soc. Sci. Fennica*, **2**, 29 (1926).

Although the SÖRENSEN value is erroneous, it appears preferable, at least for the time being, to retain it because the pH of most buffer solutions described in the literature is calculated by SÖRENSEN'S equations. All SÖRENSEN values will be readily convertible into paH , once the constant difference between pH (SÖRENSEN) and paH has been established. At present, such a recalculation would merely add to the confusion already encountered, for various authors do not agree upon the value of this difference between pH (SÖRENSEN) and paH .

The following table is a review of the pK_I values found in the literature. The temperature is given in the first column, the method by which pK_I was determined is given in the second, the third column shows the buffer solution in which the ratio of both forms of the indicator was determined, the fourth contains the pK_I calculated in this buffer solution, and the author is recorded in the last column. This review is concluded with a summarizing table in which are found the most authentic pK_I values at various temperatures and ionic strengths.

Bromphenol Blue

TEMPERATURE	METHOD	BUFFER SOLUTION	pK_I	AUTHOR
(Approx. 25°?)	spectrophotometric	Clark and Lubs	4.05	Brode ¹
(Approx. 18°?)	"	Sörensen	4.0	Prideaux ²
(Approx. 18°?)	"	acetate	4.10	Vlès ³
20°	colorimetric	Clark and Lubs	4.1	Clark and Lubs ⁴
15°	"	" " "	4.00 ± 0.05	Kolthoff ⁵
30°	"	" " "	4.10 ± 0.1	Gillespie ⁶
30°	"	" " "	4.1	van Alstine ⁷
18°	"	very dil. HCl	4.09	Güntelberg and Schiödt ⁸
18°	"	same + 0.05 N KCl	4.10	Kolthoff ⁹
18°	"	" + 0.1 N KCl	3.84	Güntelberg and Schiödt
18°	"	" + 0.5 N KCl	3.77	" " "
18°	"	" + 1 N KCl	3.71	" " "

¹ W. C. Brode: *J. Am. Chem. Soc.*, *46*, 481 (1924).

² E. B. R. Prideaux: *J. Soc. Chem. Ind.*, *45*, 664, 678, 697 (1926).

³ F. Vlès: *Arch. phys. biol.*, *4*, 285 (1926).

⁴ W. M. Clark and H. A. Lubs: *J. Bact.*, *2*, 1, 109, 191 (1917).

⁵ I. M. Kolthoff: *Rec. trav. chim.*, *43*, 144 (1924).

⁶ L. J. Gillespie: *J. Am. Chem. Soc.*, *42*, 742 (1920); *Soil Science*, *9*, 115 (1920).

⁷ E. van Alstine: *Soil Science*, *10*, 467 (1920).

⁸ E. Güntelberg and E. Schiödt: *Z. physikal. Chem.*, *135*, 393 (1928).

⁹ I. M. Kolthoff: *J. Phys. Chem.*, *32*, 1820 (1928).

The buffer solutions of CLARK and LUBS (biphthalate buffers) have an ionic strength of about 0.05–0.06, while the citrate mixtures of SÖRENSEN have an ionic strength of 0.2.

TEMPERATURE	METHOD	BUFFER SOLUTION	pK_I	AUTHOR
<i>Bromcresol Green</i>				
27°	spectrophotometric	Clark and Lubs	4.68	Holmes and Snyder ¹
30°	"	" "	4.67	B. Cohen ²
Room temp.	"	citrate	4.7	Prideaux (l.c.)
20°	colorimetric	acetate	4.64	Hastings, Sendroy, and Robson ³
38°	"	"	4.68	Hastings, Sendroy, and Robson
<i>Chlorphenol Red</i>				
30°	spectrophotometric	Clark and Lubs	5.98	B. Cohen (l.c.)
20°	colorimetric	acetate and citrate	5.98	Hastings, et al. (l.c.)
38°	"	citrate	5.98	" " "
<i>Bromcresol Purple</i>				
18°	spectrophotometric	citrate (Sorensen)	6.15	Buch ⁴
Room temp. (18°?)	"	" "	6.3	Prideaux (l.c.)
Room temp. (25°?)	"	Clark and Lubs	6.3	Brode (l.c.)
20°	colorimetric	" " "	6.3	Clark and Lubs (l.c.)
30°	"	" " "	6.20	Gillespie (l.c.)
20°	"	" " "	6.28	Barnett and Barnett ⁵
Room temp. (25°?)	"	" " "	6.3	van Alstine (l.c.)
15°	"	" " "	6.07	Kolthoff (l.c.)
20°	"	acetate, citrate	6.15	Hastings, Sendroy, and Robson (l.c.)
38°	"	" "	6.05	Hastings, Sendroy, and Robson (l.c.)
<i>Bromthymol Blue</i>				
18°	spectrophotometric	phosphate (Sorensen)	7.06	Buch (l.c.)
Room temp. (18°?)	"	" "	7.1	Prideaux (l.c.)
Room temp. (25°?)	"	Clark and Lubs	7.10	Brode (l.c.)

¹ W. C. Holmes and E. F. Snyder: *J. Am. Chem. Soc.*, **47**, 221, 226, 2232 (1925).

² B. Cohen: *Public Health Reports*, **42**, 3051 (1927).

³ A. B. Hastings, J. Sendroy, and W. Robson: *J. Biol. Chem.*, **65**, 381 (1925).

⁴ K. Buch: *Soc. Scient. Fennica*, **2**, 29 (1926).

⁵ G. D. Barnett and C. W. Barnett: *Proc. Soc. Exp. Biol. Med.*, **18**, 127 (1920/21).

TEMPERATURE	METHOD	BUFFER SOLUTION	pK _I	AUTHOR
-------------	--------	-----------------	-----------------	--------

Bromthymol Blue—Continued

Room temp (18°?)	spectrophotometric	boric acid—borax	7.0	Vlès (l. c.)
20°			7.1	Clark and Lubs (l. c.)
15°	colorimetric	Clark and Lubs	7.08	Kolthoff (l. c.)
20°			7.10	Gillespie (l. c.)
Room temp. (25°?)			7.10	van Alstine (l. c.)

Phenol Red

18°	spectrophotometric	phosphate (Sorensen)	7.86	Buch (l. c.)
Room temp. (18°?)			7.9	Prideaux (l. c.)
Room temp. (25°?)	colorimetric	Clark and Lubs	7.90	Brode (l. c.)
20°			7.87	Barnett and Chapman ¹
20°			7.78	Barnett and Barnett (l. c.)
20°			7.9	Clark and Lubs (l. c.)
Room temp. (25°?)			7.9	van Alstine (l. c.)
29°	"	" " "	7.72	Gillespie (l. c.)
25°			7.76	Wu ²
15°			7.85	Kolthoff
20°			7.74	Hastings, Sendroy, and Robson (l. c.)
38°			7.61	Hastings, Sendroy, and Robson (l. c.)

o-Cresol Red

Room temp. (25°?)	spectrophotometric	Clark and Lubs	8.20	Brode (l. c.)
Room temp. (18°?)			8.2	Prideaux (l. c.)
Room temp. (18°?)	colorimetric	borate (Palitzsch)	8.30	Vlès (l. c.)
20°			8.3	Clark and Lubs (l. c.)
24°			8.08	Gillespie (l. c.)
15°			8.17	Kolthoff (l. c.)
Room temp. (25°?)			8.3	van Alstine

m-Cresol Purple

ACID RANGE

30°	spectrophotometric	Clark and Lubs	1.51	B. Cohen (l. c.)
-----	--------------------	----------------	------	------------------

¹ G. D. Barnett and H. S. Chapman: J. Am. Med. Assoc., 70, 1062 (1918).² H. Wu: Proc. Soc. Exp. Biol. Med., 21, 111 (1923/24).

TEMPERATURE	METHOD	BUFFER SOLUTION	pK_I	AUTHOR
ALKALINE RANGE				
30°	"	Clark and Lubs	8.32	B. Cohen (l. c.)
<i>Thymol Blue</i> ACID RANGE				
Room temp. (25°?)	spectrophotometric	Clark and Lubs	1.75	Brode (l. c.)
Room temp. (18°?)	"	—	1.75	Prideaux (l. c.)
Room temp. (25°?)	"	Clark and Lubs	1.5	Holmes and Snyder (l. c.)
20°	colorimetric	" " "	1.7	Clark and Lubs (l. c.)
15°	"	HCl + 0.05 N NaCl	1.64 ± 0.03	Kolthoff (l. c.)
Room temp. (25°?)	"	—	1.7	van Alstine (l. c.)
ALKALINE RANGE				
Room temp. (25°?)	spectrophotometric	Clark and Lubs	8.90	Brode (l. c.)
Room temp. (25°?)	"	" " "	8.91	Holmes and Snyder (l. c.)
Room temp. (18°?)	"	" " "	8.91	Prideaux (l. c.)
20°	colorimetric	" " "	8.9	Clark and Lubs (l. c.)
25-30°	"	" " "	8.82	Gillespie (l. c.)
15°	"	" " "	8.96	Kolthoff (l. c.)
Room temp. (25°?)	"	" " "	(9.0)	van Alstine (l. c.)

Additional pK_I values for bromcresol green, bromcresol purple, and phenol red, as determined by SENDROY and HASTINGS¹ at various ionic strengths, are to be found in the following tables. These investigators have based their calculations upon a paH value of 1.08 in 0.1 N hydrochloric acid, whereas all other tables assume the SÖRENSEN figure of 1.04 for the pH of this acid solution. Although the latter value does not take into consideration our more recent ideas concerning the nature of strong electrolytes, it has been employed so widely in the literature that the author has preferred to retain it in compiling these tables.

¹ J. Sendroy and A. B. Hastings: J. Biol. Chem., 82, 198 (1920).

In order to compare the data of SENDROY and HASTINGS with those in other tables, it is necessary first to deduct 0.04 from the former. We must, however, keep in mind that this difference is only approximate.

pK_I VALUES AT 20°, IN THE PRESENCE OF VARIOUS SALTS AT INCREASING IONIC STRENGTHS (J. SENDROY AND A. B. HASTINGS)

Bromcresol Green

IONIC STRENGTH	NaCl	KCl	Na ₂ SO ₄	K ₂ SO ₄	CaCl ₂	MgCl ₂	ACETATE MIXTURE
0.025	4.77	4.77	4.78	4.79	4.75	4.73	4.78
0.050	4.72	4.71	4.74	4.74	4.69	4.67	4.73
0.075	4.68	4.67	4.70	4.70	4.65	4.63	4.71
0.100	4.65	4.65	4.68	4.68	4.62	4.60	4.69
0.125	4.63	4.63	4.66	4.66	4.59	4.58	4.67
0.150	4.61	4.62	4.64	4.64	4.57	4.56	
0.175	4.59	4.61	4.62	4.63	4.56	4.55	
0.200	4.57	4.59	4.60	4.61	4.53	4.52	
0.225	4.56	4.59	4.59	4.60	4.52	4.50	
0.250	4.55	4.58	4.57	4.59	4.51	4.49	

Bromcresol Purple

IONIC STRENGTH	NaCl	KCl	Na ₂ SO ₄	K ₂ SO ₄	MgCl ₂	MgSO ₄	PHOSPHATE MIXTURE
0.025	6.28	6.29	6.30	6.31	6.30	6.32	6.30
0.050	6.22	6.23	6.24	6.26	6.23	6.28	6.25
0.075	6.18	6.19	6.20	6.23	6.19	6.25	6.22
0.100	6.15	6.17	6.18	6.21	6.16	6.23	6.20
0.125	6.14	6.15	6.16	6.19	6.14	6.21	6.19
0.150	6.13	6.14	6.14	6.17	6.12	6.19	6.18
0.175	6.12	6.13	6.13	6.16	6.11	6.18	
0.200	6.11	6.12	6.12	6.15	6.11	6.17	

Phenol Red

IONIC STRENGTH	NaCl	KCl	Na ₂ SO ₄	K ₂ SO ₄	MgCl ₂	MgSO ₄	PHOSPHATE MIXTURE
0.025	7.91	7.93	7.92	7.93	7.93	7.94	7.93
0.050	7.86	7.87	7.87	7.88	7.89	7.91	7.90
0.075	7.84	7.86	7.85	7.85	7.86	7.89	7.87
0.100	7.82	7.84	7.82	7.83	7.84	7.88	7.86
0.125	7.80	7.81	7.80	7.81	7.82	7.87	7.84
0.150	7.79	7.79	7.78	7.79	7.81	7.86	7.81
0.175	7.78	7.78	7.77	7.78	7.79	7.85	7.80
0.200	7.78	7.77	7.76	7.78	7.77	7.84	7.79
0.225		7.76		7.77	7.77	7.84	

Azo indicators.

TEMPERATURE	METHOD	BUFFER SOLUTION	pK_1	AUTHOR		
<i>Methyl Orange</i>						
Room temp. (18°?)	spectrophotometric	citrate (?)	3.18	Prideaux (l.c.)		
Room temp. (18°?)		"	"	3.53	Vlès (l.c.)	
25°		"	—	3.37	Thiel and Dassler ¹	
25°		"	HCl + 0.1 N Alkali chloride	3.52	Sidgwick, Worboys, and Woodward ²	
25°		"	HCl + 0.5 N KCl	3.53	Sidgwick, Worboys, and Woodward	
25°		"	HCl + 0.5 N KBr	3.54	Sidgwick, Worboys, and Woodward	
25°		conductometric colorimetric	HCl + 0.5 N NaCl (NaBr, NaNO ₃ , NaClO ₃)	3.54		
25°			acetate	(4.82)	Winkelblech ³	
25°			"	"	3.37	Tizard ⁴
15°			"	"	3.34	Salm ⁵
24°	"		"	3.57	Tizard and Whiston ⁶	
37°	"		"	3.43	" " "	
18°	"		"	3.28	" " "	
18°	"		citrate	3.52	Kolthoff ⁷	
18°	"		HCl (0.0001)	3.45	Güntelberg and Schiodt ⁸	
18°	"		HCl + 0.1 N KCl	3.41	" " "	
18°	"	HCl + 0.2 N KCl	3.41	" " "		
18°	"	HCl + 0.5 N KCl	3.46	" " "		
18°	"	HCl + 1 N KCl	3.57	" " "		
<i>Dimethylaminoazo Benzene (Methyl Yellow)</i>						
18°	colorimetric	HCl (0.0001 N)	3.25	Güntelberg and Schiodt		
18°		"	3.34	" " "		
18°		"	3.40	" " "		
18°		"	3.39	" " "		
<i>Methyl Red</i>						
Room temp. (25°?)	spectrophotometric	Clark and Lubs	5.05	Brode (l.c.)		
Room temp. (18°?)		"	citrate	4.95	Prideaux (l.c.)	
25°	colorimetric	—	4.92	Thiel and Dassler (l.c.)		
30°		Clark and Lubs	4.96-5.0	Gillespie (l.c.)		
20°		"	"	5.1	Clark and Lubs (l.c.)	
20°		"	"	"	"	

¹ A. Thiel and A. Dassler: *Ber.*, *56*, 1667 (1923); Thiel, Dassler, and F. Wülken: *Fortschritte Chem., Physik, physik. Chem.*, *18*, 83 (1924).

² N. V. Sidgwick, W. J. Worboys, and L. A. Woodward: *Proc. Roy. Soc. Lond.*, *129*, 537 (1930).

³ K. Winkelblech: *Z. physik. Chem.*, *36*, 569 (1901).

⁴ H. T. Tizard: *J. Chem. Soc.*, *97*, 2477 (1910).

⁵ Salm: *Z. physik. Chem.*, *57*, 471 (1906).

⁶ W. T. Tizard and J. R. Whiston: *J. Chem. Soc.*, *117*, 150 (1920).

⁷ I. M. Kolthoff: *Rec. trav. chim.*, *44*, 68 (1925).

⁸ E. Güntelberg and E. Schiodt: *Z. physik. Chem.*, *135*, 393 (1928).

TEMPERATURE	METHOD	BUFFER SOLUTION	pK _I	AUTHOR
<i>Methyl Red—Continued</i>				
15°	colorimetric	" " "	5.05	Kolthoff ¹
Room temp. (25°?)	"	" " "	5.1	van Alstine (l.c.)
18°	"	acetate	4.98	Tizard (l.c.)
15°	"	"	5.13	"
20°	"	"	5.10	"
30°	"	"	5.05	"
40°	"	"	4.98	"
50°	"	"	4.93	"

One-color indicators.

Nitrophenols. The values in the following tables have been recalculated to 20° with the aid of the temperature modulus of L. MICHAELIS and A. GYEMANT.² In the second column are reported the nature of the solution and its ionic strength.

BUFFER SOLUTION	IONIC STRENGTH AND TYPE OF SALT	METHOD	pK _I	AUTHOR
-----------------	---------------------------------	--------	-----------------	--------

β-Dinitrophenol (1-oxy-2,6-Dinitrobenzene) (20°)

Acetic acid	approx. 0.001	colorimetric	3.68	Michaelis and Gyemant (l.c.)
Acetate	0.025	"	3.72(?)	" " "
"	0.15 (NaCl)	"	3.56	" " "
"	0.5 (NaCl)	"	3.38 or 3.57?	" " "
"	0.5 (KCl)	"	3.34	" " "
HCl	0.001	"	3.66	" " "
Clark and Lubs	0.005-0.08	"	3.54	Kolthoff ³
Monopotassium citrate	0.1	"	3.46	"
—	0.25	"	3.03	"
—	—	conductivity	3.79	Bader ⁴
—	—	"	3.60	Holleman ⁵

α-Dinitrophenol (1:2:4) (20°)

Acetate	0.005-0.05	colorimetric	4.05	Michaelis and Gyemant
"	0.5 (KCl)	"	3.84	" " "
"	0.15 (NaCl)	"	3.95	" " "
"	0.5 (NaCl)	"	3.85	" " "
—	0	"	4.11	Kolthoff (l.c.)
Clark and Lubs	0.05-0.08	"	3.92	"
"	0.5 (KCl)	"	3.80	"
—	0.001	conductivity	4.13	Bader (l.c.)
—	0.001	"	4.03	Holleman (l.c.)

¹ I. M. Kolthoff: *Rec. trav. chim.*, 43, 144 (1924); 44, 75 (1925).

² L. Michaelis and A. Gyemant: *Biochem. Z.*, 109, 165 (1920).

³ I. M. Kolthoff: *Pharm. Weekblad*, 60, 949 (1923).

⁴ R. Bader: *Z. physik. Chem.*, 6, 289 (1890).

⁵ A. F. Holleman: *Rec. trav. chim.*, 24, 428 (1902).

BUFFER SOLUTION	IONIC STRENGTH AND TYPE OF SALT	METHOD	pK _I	AUTHOR
<i>γ-Dinitrophenol (1:2:5) (20°)</i>				
Acetate	0.03	colorimetric	5.14	Michaelis and Krüger ¹
"	0.15 (NaCl)	"	5.06	" " "
"	0.5 (NaCl)	"	5.00	" " "
Clark and Lub ²	0.07	"	5.12	Kolthoff (l.c.)
—	0.001	conductivity	5.19	Bader (l.c.)
—	0.001	"	5.19	Holleman (l.c.)
<i>p-Nitrophenol</i>				
Acetate	approx. 0.05	colorimetric	7.13	Michaelis and Gyemant (l.c.)
Phosphate	0.006-0.05	"	7.15	" " "
"	0.08-0.10	"	7.00	Kolthoff (l.c.)
"	0.5 (NaCl)	"	7.08	Michaelis and Krüger (l.c.)
—	0.001	conductivity	7.22	Euler and Bolin ³
—	0.001	"	7.24	Holleman (l.c.)
—	0.001	"	7.22	Lundén ³
—	0.001	"	6.98	Bader (l.c.)
—	0.001	"	7.08	Hantzsch ⁴
<i>m-Nitrophenol</i>				
Phosphate	0.01-0.03	colorimetric	8.33 ± 0.05	Michaelis and Gyemant (l.c.)
Borate	0.01-0.03	"	8.33	" " "
Phosphate	0.003-0.01	"	8.31	Michaelis and Krüger (l.c.)
"	0.05-0.1	"	8.29	Kolthoff (l.c.)
—	0	"	8.31	Michaelis and Krüger (l.c.)
Phosphate	0.05 (NaCl)	"	8.26	" " "
"	0.1 (NaCl)	"	8.21	" " "
"	0.2 (NaCl)	"	8.16	" " "
"	0.5 (NaCl)	"	8.15	" " "
"	1 (NaCl)	"	8.13	" " "
—	0.001	conductivity	8.04	Holleman (l.c.)
—	0.001	"	7.99	Bader (l.c.)
—	0.001	"	8.35	Lundén (l.c.)

The presence of free chlorine and bromine will vitiate pH measurements with most indicators. The nitrophenols appear to constitute an exception,⁵ and may be used if the chlorine concentration is not too high.⁴

KOLTHOFF has introduced a number of new one-color indicators for use in the colorimetric pH determination. They differ from the nitrophenols in that they exhibit a very marked color change to the red. Their properties are summarized in the following table.

¹ L. Michaelis and Krüger: *Biochem. Z.*, 119, 307 (1921).

² H. v. Euler and Bolin: *Z. physik. Chem.*, 66, 71 (1909).

³ H. Lundén: *J. chim. phys.*, 6, 574 (1907); *Z. physik. Chem.*, 70, 253 (1910).

⁴ A. Hantzsch: *Ber.*, 33, 3066 (1899).

⁵ H. F. Lewis and S. I. Kukulich: *Paper Trade J.*, 95, 28 (1932).

ONE-COLOR INDICATORS OF KOLTHOFF

INDICATOR	pK_I AND TEMPERATURE VARIATION	IONIC STRENGTH
2,4,2',4',2''-Pentamethoxytriphenylcarbinol ¹	1.86 ± 0.05 + 0.008(<i>t</i> - 20°)	0-0.1
2,4,2',4',2'',4'''-Hexamethoxytriphenylcarbinol ¹	3.32 ± 0.03 + 0.007(<i>t</i> - 20°)	0-0.1
2,4,6,2',4',2'',4'''-Heptamethoxytriphenylcarbinol ¹	5.90 (20°)	0.05-0.1
Quinaldine red ²	2.63 - 0.007(<i>t</i> - 20°)	0
"	2.73	0.005
"	2.90	0.1
"	3.10	0.5 (KCl)
Pinachrome ³	7.34 - 0.013(<i>t</i> - 20°)	0.014

The following table has been constructed after a critical study of all pK_I values of indicators published in the literature. The reader must realize that *these values are based upon the SÖRENSEN value of pH 1.04 in 0.1 N hydrochloric acid or 2.04 in a mixture of 0.01 N HCl and 0.09 N KCl.*

INDICATOR CONSTANTS (pK_I) AT 20° AND OTHER TEMPERATURES

INDICATOR	pK_I AT THE FOLLOWING IONIC STRENGTHS				
	0	0.01	0.05	0.1	0.5
<i>m</i> -Cresol purple	(1.5 ?)			1.51	
Thymol blue	1.65 (15-30°)		1.65	1.65	1.65
Bromphenol blue	4.10 (15-25°)	4.06	4.00	3.85	3.75(KCl)
Bromcresol green	4.90 (15-30°)	4.80	4.70	4.66	4.5(KCl)
Chlorphenol red	6.26 - 0.005(<i>t</i> - 20°)	6.15	6.05	6.00	4.42(NaCl)
Bromcresol purple	6.40 - 0.005(<i>t</i> - 20°)	6.23	6.21	6.12	5.9 (KCl)
Bromthymol blue	7.30 (15-30°)	7.19	7.13	7.10	5.8 (NaCl)
Phenol red	8.00 - 0.007(<i>t</i> - 20°)	7.92	7.84	7.81	6.8 (NaCl)
<i>o</i> -Cresol red	8.46 (30°)		8.30	8.25	7.5 (NaCl)
<i>m</i> -Cresol purple				8.32(30°)	
Thymol blue	9.20 (15-30°)	9.01	8.95	8.90	
Methyl orange	3.46 - 0.014(<i>t</i> - 20°)	3.46	3.46	3.46	3.46
Methyl yellow	3.25 (18°)			3.34	3.40(KCl)
Methyl red	5.00 - 0.006(<i>t</i> - 20°)			5.00	5.00
β -Dinitrophenol(1 : 2 : 6)	3.70 - 0.006(<i>t</i> - 20°)			3.50	
α -Dinitrophenol(1 : 2 : 4)	4.10 - 0.006(<i>t</i> - 20°)		3.95	3.90	3.80(KCl)
γ -Dinitrophenol(1 : 2 : 5)	5.20 - 0.0045(<i>t</i> - 20°)		5.12	5.10	5.00(NaCl)
<i>p</i> -Nitrophenol	(7.00 or 7.15) - 0.011(<i>t</i> - 20°)				
<i>m</i> -Nitrophenol	8.35 - 0.01(<i>t</i> - 20°)		8.30	8.25	8.15(NaCl)
2,4,2',4',2''-Pentamethoxytriphenylcarbinol	1.86 + 0.008(<i>t</i> - 20°)		1.86	1.86	
2,4,2',4',2'',4'''-Hexamethoxytriphenylcarbinol	3.32 + 0.007(<i>t</i> - 20°)		3.32	3.32	
2,4,6,2',4',2'',4'''-Heptamethoxytriphenylcarbinol			5.90	5.90	
Quinaldine red	2.63 - 0.007(<i>t</i> - 20°)	2.80		2.90	3.10(KCl)
Pinachrome	7.34 - 0.013(<i>t</i> - 20°)			7.34	

¹ I. M. Kolthoff: J. Am. Chem. Soc., 49, 1218 (1927).

² I. M. Kolthoff: Biochem. Z., 194, 78 (1928).

³ I. M. Kolthoff: J. Am. Chem. Soc., 50, 1604 (1928).

The above values are correct to at least 0.05 unit and in certain cases to 0.01–0.02.

4. Determination of pH with two-color indicators without the use of buffer solutions.

Having considered the theoretical aspects of the method, let us turn next to the practical applications. Even before the theory of the procedure had been developed, L. J. GILLESPIE¹ evolved a simple technique for their use. He added a given number of drops of pure indicator acid to one of a pair of test tubes of equal diameter and containing equal volumes of liquid, and to the other he added a sufficient quantity of the alkaline form so as to make a total of ten drops in both tubes. A series of comparison tubes is obtained in this manner. The unknown substance is treated with ten drops of the same indicator, and the resulting color is compared with that of the other tubes held one behind the other. It is advisable for purposes of comparison to place a tube containing an equal volume of water behind the solution being examined. The author prefers to use small cylinders which can be placed one on top of the other. Each color intermediate between the acid and alkaline forms corresponds to a definite pH. By varying the number of drops in each of a pair of tubes, the whole transformation range may be covered. For the case of methyl red, we have:

1 drop alkaline and 9 drops acid corresponds to pH = 4.05,
 5 drops " " 5 " " " pH = 5.0,
 9 " " " 1 drop " " " pH = 5.95.

In a second report GILLESPIE¹ described in detail his procedure, to which the following equation applies: $pH = pK_I + \log$ "Drop Ratio." By using aqueous indicator solutions, he found the following pK_I values:

INDICATOR	B P.B	M R.	B.C P	P.R	C R	T.B.
Room temperature	31°	30°	30°	29°	24°	24°
pK_I	4.06	4.96	6.26	7.72	8.08	8.82
Strength of indicator: solutions %	0.008	0.003	0.012	0.004	0.008	0.008

¹ L. J. Gillespie: J. Am. Chem. Soc., 42, 742 (1920); Soil Science, 9, 115 (1920).

The following table will be found useful when the pH is being determined by the GILLESPIE method:

DROP RATIO [ACID] : [ALKALI]	PH FOR EACH PAIR OF TUBES						
	B.P.B.	M.R.	B.C.P.	B.T.B.	P.R.	C.R.	T.B.
1 : 9	3.1	4.05	5.3	6.15	6.75	7.15	7.85
1.5 : 8.5	3.3	4.24	5.5	6.35	6.95	7.35	8.05
2 : 8	3.5	4.4	5.7	6.5	7.1	7.5	8.2
3 : 7	3.7	4.6	5.9	6.7	7.3	7.7	8.4
4 : 6	3.9	4.8	6.1	6.9	7.5	7.9	8.6
5 : 5	4.1	5.0	6.3	7.1	7.7	8.1	8.8
6 : 4	4.3	5.2	6.5	7.3	7.9	8.3	9.0
7 : 3	4.5	5.4	6.7	7.5	8.1	8.5	9.2
8 : 2	4.7	5.6	6.9	7.7	8.3	8.7	9.4
8.5 : 1.5	4.8	5.75	7.0	7.85	8.45	8.85	9.55
9 : 1	5.0	5.95	7.2	8.05	8.65	9.05	9.75
% Indicator solution	0.008	0.008	0.012	0.008	0.004	0.008	0.008
c.c. 0.1N NaOH per 0.1 g. indicator	1.64	—	2.78	1.77	3.10	2.88	2.38
Acid color prepared with HCl	0.05N	0.05N	0.05N	0.05N	0.05N	2% KH ₂ PO ₄	2% KH ₂ PO ₄
Amount of acid per 10 c.c. to produce acid color	1 c.c.	1 drop	1 drop	1 drop	1 drop	1 drop	1 drop

B.P.B. = Bromphenol blue. M.R. = Methyl red. B.C.P. = Bromeresol purple. B.T.B. = Bromthymol blue. P.R. = Phenol red. C.R. = Cresol red. T.B. = Thymol blue.

The tubes employed by GILLESPIE were always 15 cm. long, with a diameter of 1.5 cm. Each pair of tubes always contains 10 drops of indicator solution, and is observed in tandem arrangement. The indicator exhibits its complete acid color in one tube, and the full alkaline color in the other. The same volume of solution, i.e., 5–6 c.c., is placed in each tube. Ten drops of indicator solution are added to the unknown solution, and the tube is placed in a so-called comparator (cf. Fig. 21, § 7). W. D. HATFIELD¹ has suggested a modification of the GILLESPIE method.

In another publication, GILLESPIE² has described a simple

¹ W. D. Hatfield: *J. Am. Chem. Soc.*, 45, 930 (1923).

² L. J. Gillespie: *Pub. Mass. Inst. Technol. Ser.*, 135, 399 (1921).

colorimeter (cf. Fig. 15). In Fig. 15, *A* and *C* remain stationary, while *B* is moved along a scale, its position being indicated by a pointer attached to it. The reading may be between 0 and 100. The acidified indicator solution of suitable strength may be placed in *B*, and the alkaline solution of the same strength in *C*. Tube *A* is used to hold some

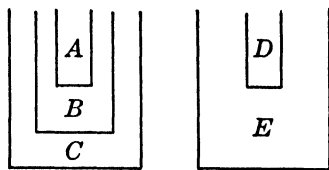

FIG. 15

of the unknown when this solution is colored or turbid. In this case, it is advisable to add to tube *D* a volume of water equal to the volume of unknown solution placed in *A*. In *E* is placed the solution being investigated, containing an indicator concentration equal to that in *B* and *C* together. *B* is then adjusted until the color is the same on both sides, and the ratio of acid to alkaline form is read directly from the scale.

Although the principle of the GILLESPIE device is rather simple, the arrangement is less satisfactory in practice. Today there are available on the market a number of *Bicolorimeters* which are very suitable for measuring the ratio of the two colored forms of an indicator. For example, there are the colorimeter of Bausch and Lomb, Rochester, N. Y., and the Beaver¹ colorimeter of the Klett Mfr. Co. The mixed color colorimeter of A. THIEL,² constructed by the firm of Dr. Carl Leitz of Steglitz, may also be used for colored solutions, and makes it possible to measure acid intervals accurately to 0.01 pH unit if appropriate indicators are selected and if suitable color filters are employed when necessary. A diagrammatic representation of THIEL'S "*Bathmometer*" is shown in Fig. 16.

It consists of three pairs of cylindrical containers T_1 and T_1' , T_2 and T_2' , and T_3 and T_3' , which dip successively one into another. Each pair is narrower than the pair of cups beneath it. T_1 and T_1' are closed at the bottom, ground-glass plates being kept in place by screw-caps. The other pairs of cylinders likewise have glass plates cemented (preferably with Canada balsam) to the lower ends. The total height of the liquid column is determined by the distance from the bottom of the ground glass plates of T_3 and T_3' to the top of the plates which close cups

¹ J. J. Beaver: *J. Optical Soc. Am.*, 18, 41 (1929).

² A. Thiel: *Sitzb. Ges. Naturwiss. Marburg*, 65, 159 (1930).

T_1 and T_1' . The verniers N_2 and N_2' are attached to the front wall of the instrument, while two others, N_1 and N_1' , are attached to T_3 and T_3' and move with it. The double scales (divided into millimeters) which move with containers T_2 and T_2' serve with the aid of the vernier readings to determine the heights of a liquid column, and permit these heights to be read after the colors on both sides have been equalized.

The manipulation of the instrument is described below. First of all, containers T_2 and T_2' are lowered by means of a knob (not shown in Fig. 16) until they touch the bottom of cups T_1 and T_1' . By so doing, the zero readings of the verniers N_2 and N_2' are brought opposite the zero marks of the scales S_2 and S_2' . Cups T_3 and T_3' are raised until the position of the verniers N_1 and N_1' with respect to scales S_1 and S_1' shows the desired total height of liquid (identical on both sides). Usually a column of 100 mm. is taken, and containers T_3 and T_3' are fixed in this position by means of lock screws. It is now possible, simply by moving T_2 or T_2' upward, to divide the total 100 mm. depth of the liquid at will between one of cylin-

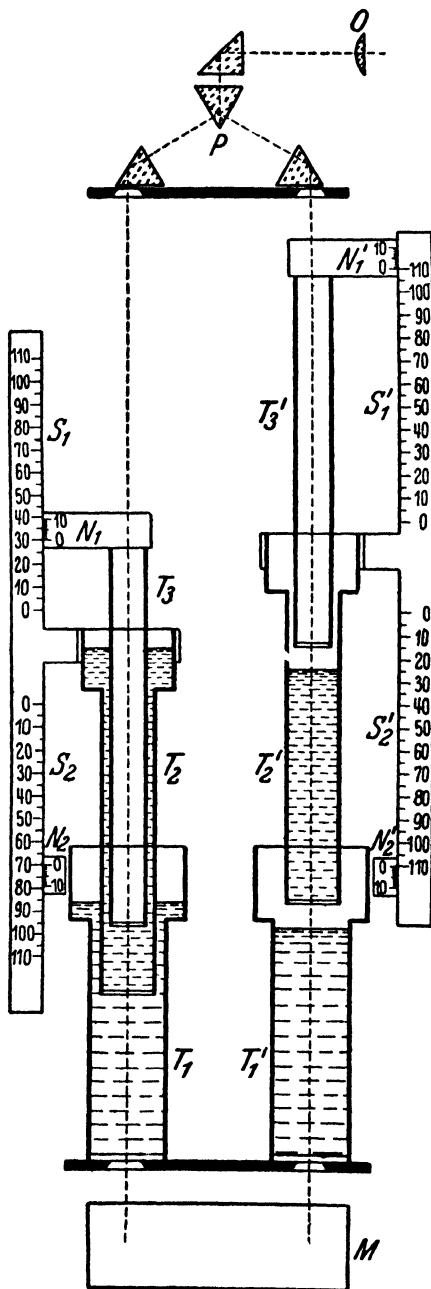

FIG. 16

ders 2 containing, let us say, the acid modification, and the corresponding tube 1 containing a solution of the limiting alkaline form. The complete transformation from one limiting color to the other can be reproduced in this manner.

The arrangement pictured in Fig. 16 shows on the left a total column of 100 mm. divided between the alkaline form (lower cup) and the limiting acid solution (upper cup) in the ratio of 70 to 30. It is especially convenient to use a total depth of 100 mm. because the scale readings indicate directly the percentage transformation of the indicator (from acid to alkaline). Denoting the percentage transformation by α , we see that the acidity of the unknown solution, when it exhibits a color identical with that of the comparison system, is

$$\text{pH} = \text{p}K_1 + \log \frac{\alpha}{1 - \alpha}.$$

After addition of indicator, the solution under investigation is placed on the other side either in T_1' and T_2' (as shown in Fig. 16), or to conserve the liquid, solely in the narrower container T_2' . If the first manner of operating is adopted, the position of T_2' between T_1' and T_3' is immaterial; but in the latter procedure T_2' must be lowered until it touches the bottom of T_1' , "optical contact" being assured by placing a small quantity of water (when aqueous solutions are involved) in T_1' .

Cups T_3 and T_3' serve to compensate for possible turbidity or color of the solution being examined. In such an event, the solution in question, without added indicator solution, is placed in cup T_3 (above the comparison solution) to a height identical with that of the unknown solution containing indicator which is the same as the combined height of both limiting solutions. Cup T_3' contains pure water. Millimeter scales are etched on both T_3 and T_3' .

Uniform illumination is obtained by means of a milk-glass plate (M) in conjunction with a Soffit lamp and reflector. The lighting arrangement is placed so as to give equal illumination on both sides when the cups are filled with pure water. Greatest precision is realized when the instrument is illuminated artificially and measurements are made in a dark room. The ability of the eye to distinguish colors in daylight is considerably reduced because of the dazzling effect of bright light.

The light passes from *M* through the successive cups, through a lens (omitted in Fig. 16) of large focal length, into the prism system (*P*), where it is reflected horizontally into the eyepiece (*O*). The portion of the colorimeter between *M* and *P* may be rotated on a vertical axis, the horizontal motion permitting the elimination of small inequalities of illumination on both sides of the instrument. A cup with parallel plane sides (10 mm. apart) and containing a suitable dye solution as a light filter may be inserted between *P* and *O*.

N. BJERRUM¹ was the first to make use of a bicolorimeter. Two wedges cemented together served his purpose. The author² himself has employed a similar device to determine the hydrogen exponent of drinking water, with neutral red as indicator. Two wedge-shaped glass containers were cemented together with Canada balsam. In one was placed a solution 0.1 N in acetic acid and with 1 : 100,000 of neutral red, while in the other wedge was placed a 1 : 100,000 solution of the indicator in 50% glycerine, this solution being also about 0.1 N with respect to NH_3 . Glycerine is needed to avoid the gradual flocculation of the indicator. A scale and screen are placed beside this arrangement to permit an accurate observation of the contents over a small distance. The solutions being tested were placed in a small flat-bottomed cylinder and treated with indicator sufficient to produce a color intensity equal to that in the apparatus described. Colors were estimated against a white background.

The screen was displaced until the color in the field of vision was equal to that in the glass cylinder. Previous calibration of the scale with buffer solutions of known hydrogen exponent permitted the pH value to be read directly. This arrangement is very useful for determining pH of water at the location where the sample is collected, since no auxiliary instruments are required. It is evident that this instrument may be used also with other indicators, such as methyl red, methyl orange, etc. Phenolphthalein may not be used because of the instability of its alkaline solutions. Physiological solutions, such as urine, may be examined rapidly with this instrument.

Another apparatus, more suitable for use with all indicators,

¹ N. Bjerrum: Die Theorie der alkalimetrischen und acidimetrischen Titrierungen. Stuttgart, 1914.

² I. M. Kolthoff: Z. Nahr. Genussm., 41, 141 (1921).

was proposed later by the author.¹ The essential part of this instrument consists of two wedges held together by Canada balsam along the border (Fig. 17). One wedge contains the completely alkaline form while the other contains the pure acid form of the indicator. To one wedge-shaped container is attached a scale of twenty equal divisions, which can be read through the telescope (*g*). A reading of 0.2 signifies that the ratio of the concentrations of both forms of indicator at this point in the wedges is 2 : 8. The wedges are housed in a metal case (*kl*), and can be moved vertically between *e* and *f* by means of a lock screw

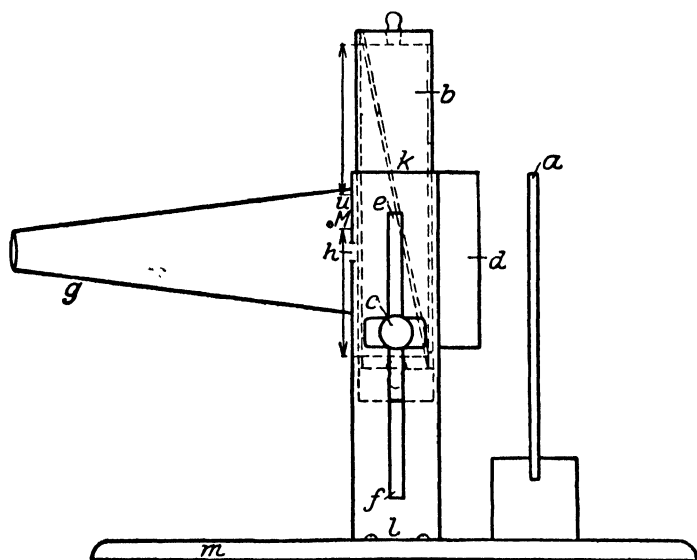

FIG. 17

(c). Near the casing is found a copper holder in which is placed the container with unknown solution plus indicator. This cup (or "cuvette") is not shown in the diagram, which is a side view of the colorimeter. The amount of indicator in the cylindrical cup is regulated so that it equals the total concentration in the wedges. The colors in both the wedges and the cylinder are observed through *g* focused on a small round opening *h*, and the wedge system moved until the color is the same on both sides.

¹ I. M. Kolthoff: *Rec. trav. chim.*, *43*, 144 (1924). Cf. also Ramann and H. Sallinger: *Z. anal. Chem.*, *63*, 292 (1923); W. D. Ramage and R. C. Miller: *J. Am. Chem. Soc.*, *47*, 1230 (1925); G. D. Barnett and C. W. Barnett, *Proc. Soc. Exptl. Biol. Med.*, *18*, 127 (1921); J. McCrae: *Analyst*, *51*, 287 (1926).

The ratio of concentrations of both indicator forms then may be read on the scale. Behind the colored solutions is placed a wooden stand carrying a milk-glass screen (*a*), which permits more accurate comparisons. The whole system is mounted on a wood base (*m*). Colored solutions may also be studied with this instrument simply by placing a "cuvette" (*d*), filled with the colored liquid behind the wedges, and a similar container filled with water behind unknown solution plus indicator.

Directions for preparing solutions of the acid and alkaline forms of indicators follow.

Thymol blue (acid range). Acid solution in 0.25 N hydrochloric acid (red); alkaline solution in a liquid with pH between 3 and 7 (yellow).

Tropeolin OO. Acid solution in 0.25 N hydrochloric acid; alkaline solution in water.

Methyl orange, *Bromphenol blue*, and *Tetrabromphenol blue*. Acid solution in about 0.01 N hydrochloric acid; alkaline solution in a liquid with pH > 5.

Bromcresol green, *Chlorphenol red*, *Methyl red*, *Bromcresol purple*, *Bromthymol blue*, *Phenol red*, *Neutral red*, *Cresol red*, and *Thymol blue* (alkaline region). Acid solution in very dilute acetic acid (about 0.1 N); alkaline solution in dilute sodium carbonate (about 0.01 N–0.1 N).

Empirical methods. It is possible to measure the pH of a solution in the absence of buffers even when indicator constants are not known provided that a series of stable comparison solutions are available, the colors of which correspond to the transformation range of the indicator in question. Each mixture of acid and basic form of indicator corresponds to a definite pH. By adding indicator to buffer mixtures of known pH, the resulting colors may be considered as standard, and an empirical color scale established. This procedure is advantageous for routine work, although it is advisable to test the empirical color scale frequently. Insufficient purity of the indicator and changes in temperature may influence the results greatly under certain conditions. Accordingly the procedure with buffer solutions is to be preferred quite generally, especially when only occasional measurements are made.

Since most organic dye stuffs are sensitive to light, mixtures of colored inorganic salts must be used to obtain stable comparison

solutions. Mixtures of ferric chloride and cobalt nitrate or chloride are satisfactory for the indicators neutral red, methyl orange, tropeolin 00, and for the alkaline intermediate colors of methyl red. The ferric chloride solution (Fe) employed should contain 11.262 g. of $\text{FeCl}_3 \cdot 6\text{H}_2\text{O}$ per 250 c.c. of 1% hydrochloric acid solution, and cobalt solution (Co) 18.2 g. of recrystallized cobalt nitrate per 250 c.c. of 1% hydrochloric acid. In the determinations with neutral red, methyl red, and methyl orange, 0.2 c.c. of 0.05% indicator solutions is added to 10 c.c. of liquid, whereas 0.2 c.c. of a 0.1% tropeolin 00 solution is employed.

TABLE OF KOLTHOFF ¹

FERRIC CHLORIDE (Fe), COBALT NITRATE (Co) MIXTURES, WITH pH'S
CORRESPONDING TO COLORS OF MIXTURES

RATIO Fe : Co	pH NEUTRAL RED	pH METHYL RED	pH METHYL ORANGE	pH TROPEOLIN 00
0	—	5.19	3.05	1.98
0.1	6.98	—	3.22	—
0.3	7.12	5.29	3.52	2.13
0.5	7.24	5.50	3.72	2.22
0.75	7.37	5.57	3.92	2.29
1.0	7.60	5.62	4.00	2.31
1.5	7.80	5.70	4.19	2.41
2.0	7.93	5.75	4.30	2.46
3.0	—	5.81	4.50	2.52

A. TAUB ² has extended the method to various other indicators. The colored comparison solutions were prepared from the standard solutions of H. V. ARNY: ³

STANDARD SOLUTION

Co - Fe - Cu SOLUTIONS⁴

Co	0.5N Cobalt chloride (59.5 g. CoCl_2 in 1 l. of 1% HCl)
Fe	0.5N Ferric chloride (45.05 g. $\text{FeCl}_3 \cdot 6\text{H}_2\text{O}$ in 1 l. of 1% HCl)
Cu	0.5N Cupric chloride (42.63 g. $\text{CuCl}_2 \cdot 2\text{H}_2\text{O}$ in 1 l. of 1% HCl)

These solutions and their mixtures may be kept indefinitely. The accuracy usually attained is 0.1–0.2 pH. The following data refer to 20°.

¹ I. M. Kolthoff: Pharm. Weekblad, 59, 104 (1922).

² A. Taub: J. Am. Pharm. Assoc., 16, 116 (1927).

³ H. V. Arny and A. Taub: J. Am. Pharm. Assoc., 12, 839 (1923).

⁴ Concerning the absorption of light by indicators and inorganic comparison solutions (Fe^{+++} , Co^{++} , Cu^{++} , Dichromate), cf. J. P. Mehlig and M. G. Mellon: J. Phys. Chem., 35, 3397 (1931).

<i>Metacresol Purple (Acid Region)</i> 0.12 c.c. 0.1% Indicator per 10 c.c.					<i>Thymol Blue (Acid Region)</i> 0.2 c.c. 0.1% Indicator per 10 c.c.				
pH	Co	Fe	Cu	H ₂ O	pH	Co	Fe	Cu	H ₂ O
1.2	9.0	—	1.0	—	1.6	5.3	—	—	4.7
1.4	6.5	0.1	—	3.4	1.8	3.9	0.3	—	5.8
1.6	5.5	0.2	—	4.3	2.0	3.2	0.8	—	6.0
1.8	4.4	0.5	—	5.1	2.2	2.2	1.8	—	6.0
2.0	4.1	1.3	—	4.6	2.4	1.9	2.2	—	5.9
2.2	2.8	2.1	—	2.6	2.6	1.6	2.7	—	5.7
2.4	2.3	2.7	—	5.0	2.8	1.3	3.0	—	5.7
2.6	1.7	3.3	—	5.0					
<i>Methyl Orange</i> 0.12 c.c. 0.1% Indicator per 10 c.c.					<i>Bromcresol Green</i> 0.12 c.c. 0.1% Indicator per 10 c.c.				
pH	Co	Fe	Cu	H ₂ O	pH	Co	Fe	Cu	H ₂ O
3.0	8.1	0.3	—	1.6	3.8	0.3	2.2	0.5	7.0
3.2	7.5	0.6	—	1.9	4.0	0.6	1.8	1.8	5.8
3.4	6.5	1.0	—	2.5	4.2	0.7	1.6	3.0	4.7
3.6	5.8	1.9	—	2.3	4.4	0.9	0.8	5.1	3.2
3.8	4.8	2.9	—	2.3	4.6	1.1	0.5	7.0	1.4
4.0	4.0	4.0	—	2.0	4.8	0.9	0.3	8.8	—
4.2	3.4	5.0	—	1.6	5.0	0.5	0.2	9.3	—
4.4	2.8	5.8	—	1.4					
<i>Methyl Red</i> 0.08 c.c. 0.1% Indicator per 10 c.c.					<i>Chlorphenol Red</i> 0.2 c.c. 0.1% Indicator in 10 c.c.				
pH	Co	Fe	Cu	H ₂ O	pH	Co	Fe	Cu	H ₂ O
4.8	9.8	—	0.2	—	5.0	0.8	3.8	—	5.4
5.0	5.9	0.3	—	3.8	5.2	0.9	3.3	—	5.8
5.2	5.0	0.7	—	4.3	5.4	1.1	2.4	—	6.5
5.4	3.7	2.3	—	4.0	5.6	1.4	1.9	—	6.7
5.6	2.9	2.8	—	4.3	5.8	1.8	1.0	0.1	7.1
5.8	1.9	4.0	—	4.1	6.0	2.1	0.2	0.4	7.3
6.0	1.4	5.3	—	3.3	6.2	5.0	—	5.0	—
<i>Bromthymol Blue</i> 0.12 c.c. 0.1% Indicator per 10 c.c.					<i>Phenol Red</i> 0.12 c.c. 0.1% Indicator in 10 c.c.				
pH	Co	Fe	Cu	H ₂ O	pH	Co	Fe	Cu	H ₂ O
6.0	0.2	3.1	0.3	6.4	6.6	1.8	6.5	—	1.7
6.2	0.3	2.7	1.0	6.0	6.8	2.4	5.4	—	2.2
6.4	0.3	2.1	1.8	5.8	7.0	3.5	2.9	—	3.6
6.6	0.3	1.7	2.6	5.4	7.2	5.0	1.3	—	3.7
6.8	0.4	0.7	4.4	4.5	7.4	7.2	0.3	—	2.5
7.0	0.8	0.3	8.9	—					
7.2	0.7	0.1	9.2	—					

<i>o</i> -Cresol Red 0.08 c.c. 0.1% Indicator per 10 c.c.					<i>Metacresol Purple</i> 0.08 c.c. 0.1% Indicator per 10 c.c.				
pH	Co	Fe	Cu	H ₂ O	pH	Co	Fe	Cu	H ₂ O
7.2	1.0	2.8	—	6.2	7.6	1.3	1.5	1.2	6.0
7.4	1.4	2.2	—	6.4	7.8	1.2	1.0	1.1	6.7
7.6	2.1	1.2	0.7	6.0	8.0	1.5	0.4	2.0	6.1
7.8	3.0	0.1	1.7	5.2	8.2	1.8	0.1	2.4	5.7
8.0	4.6	—	3.7	1.7	8.4	2.5	—	4.0	3.5
8.2	5.6	—	4.4	—	8.6	3.5	—	6.5	—

Thymol Blue
0.16 c.c. Indicator per 10 c.c.

pH	Co	Fe	Cu	H ₂ O
8.2	0.6	1.8	1.2	6.4
8.4	0.8	1.2	2.3	5.7
8.6	1.0	0.4	4.8	3.8
8.8	1.4	0.1	7.0	1.5
9.0	1.5	—	8.5	—

P. BRUÈRE¹ has recommended solutions of cobalt nitrate, potassium dichromate, and copper sulfate.

Approximate pH determinations may be made by comparisons with a suitable color chart. In the first edition of his book, CLARK² included a very good color table. The "spot apparatus" of DR. TÖDT³ is based upon this chart. A similar principle is involved in the Foil Colorimeter of P. WULFF.⁴ Great care must be exercised in the use of this type of "colorimeter," especially when working in slightly buffered solutions.⁵

Colored glasses may be used instead of stable comparison solutions of colored inorganic salts. SONDÉN⁶ has made use of such a device. A method of obtaining permanent colored glass plates

¹ P. Bruère: *J. pharm. chim.*, (8) 3, 377 (1926), 4, 241 (1926).

² W. M. Clark: *The determination of hydrogen ions*, Baltimore, Williams and Wilkins Co., 1920, pp. 39, 40.

³ Ströhlein & Co. G.m.b.H., Dusseldorf, 39.

⁴ P. Wulff: *Kolloid-Z.*, 40, 341 (1926). Cf. also A. Diem: *Chem. Zentr.*, 1927 I, 2111; H. Kroepelin: *Kolloid-Z.*, 44, 188 (1928); P. Hanson: *Dansk Tids. Farm.*, 2, 139 (1928), *Chem. Abstracts*, 23, 1352 (1929).

⁵ I. M. Kolthoff: *Chem. Weekblad*, 28, 78 (1931). Cf. also E. Larsson: *Svensk. Kem. Tid.*, 43, 122 (1930).

⁶ K. Sondén: *Arkiv. Kemi, Mineral. Geol.*, 8, No. 7 (1921).

was patented in 1924 by BADOLLET, HAMILTON, and WALTON.¹ The "Hellige Comparator" (Fig. 18) takes advantage of this procedure for various indicators.

Before concluding this section, we shall consider the ingenious method in which the hydrogen ion concentration of a solution is estimated from its effect on the reaction velocity between malonic nitrile and α -naphthoquinone. W. KESTING² observed that these com-

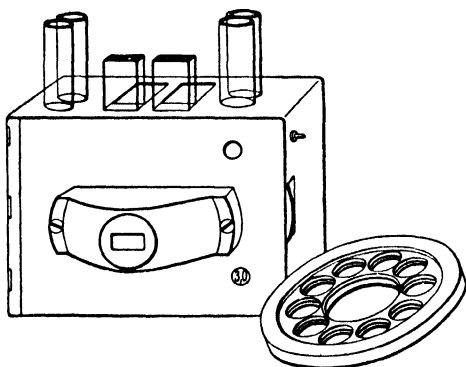

FIG. 18

pounds reacted to form a colored solution. The velocity of appearance of the blue coloration depends upon the hydrogen ion concentration and increases with rising alkalinity. By adding equal quantities of reagents to a buffer solution and to the liquid being examined, and observing the time elapsing before the appearance of equal color intensities, it is possible to determine the unknown pH. The accuracy obtained by KESTING is 0.1 unit.

Usually 5 drops of a 0.2% alcoholic malonic nitrile solution and 5 drops of a 0.3% alcoholic solution of α -naphthoquinone are added to 5 c.c. of the solution being studied. Both reacting solutions remain unaltered for a long period. Their volumes should be measured carefully, the use of a micro burette being recommended in certain cases. The range of applicability is pH 4.5–11.5.

It is better to add larger amounts (20 drops) of the reagents to the more acid solutions since otherwise the color appears too slowly. Too large quantities, however, must not be employed because of the possible difference in influence of the alcoholic solutions on the unknown liquid and the buffer. Any change of the pH of the solutions being investigated by the alcohol must be avoided.

Less than 5 drops of reagents are added in more alkaline solutions to slow down the appearance of the color.

¹ M. S. Badollet, J. Hamilton, and C. F. Walton, Jr.: U. S. A. Patent 1,505,185 (19 VIII 1924).

² W. Kesting: Z. angew. Chem., 41, 358 (1928).

The method is of value in orientating measurements. For greater accuracy, details of temperature, salt, and alcohol content must be worked out.

The blue color changes to green at a pH greater than 11.5, due to the decomposition of the blue compound (cf. KESTING¹ as to composition). Other quinones such as *p*-benzoquinone and β -naphthoquinone may be used in the reaction instead of α -naphthoquinone. The range for *p*-benzoquinone is pH = 4–9. Above 9, a red-brown color appears, which is analogous to the green color of α -naphthoquinone at a pH above 11.5. Solutions of β -naphthoquinone are colored a light brown. The quinone reacts with malonic nitrile to form an intensive red-colored compound. The β -naphthoquinone may be used at a pH greater than 11.5.

5. The determination of pH with one-color indicators in unbuffered solutions.

L. MICHAELIS,² in collaboration with A. GYEMANT and R. KRÜGER, developed the procedure by means of which acidity can be determined, using one-color indicators, without the aid of buffer solutions. Since one of the two forms of the indicator is colored, the pH can be computed rather simply when the total quantity of indicator added and the indicator constant are known, and if the color intensity is measured experimentally. By way of illustration, let us suppose that when 1 c.c. of indicator is added per 10 c.c. of solution, the color is the same as that of a completely alkaline solution containing 0.5 c.c. of indicator. Evidently half of the indicator in the solution being investigated is present in the alkaline form and half as the acid form. Con-

sequently $\text{pH} = \log \frac{[\text{I}^-]}{[\text{HI}]} + \text{p}K_{\text{I}} = \text{p}K_{\text{I}}$.

Only the I-ions, however, determine the extent of coloration *F* of the solution. Knowing the amount of indicator added to

¹ W. Kesting: *Z. angew. Chem.*, *41*, 745 (1928).

² L. Michaelis and A. Gyemant: *Biochem. Z.*, *109*, 165 (1920); Michaelis and R. Krüger: *Biochem. Z.*, *119*, 307 (1921).

Concerning practical applications of the method, cf. L. Michaelis: *Z. ges. exptl. Med.*, *26*, 149 (1922); *Deut. med. Wochschr.*, *46*, 1238 (1920); *47*, 465, 673 (1921); *Z. Nahr. Genussm.*, *42*, 75 (1921); *Z. Immunitäts.*, *32*, 194 (1921); *Wochschr. Brau.*, *38*, 107 (1921); E. Schröder: *Compt. rend. soc. biol.*, *89*, 205 (1923); E. Richard: *J. pharm. chim.*, (8) *1*, 328 (1929); C. Risch: *Biochem. Z.*, *148*, 147 (1924); R. H. Hamälaines, E. E. Leikola, and Y. Airila: *Chem. Zentr.*, *94 II*, 942 (1923).

the liquid, and measuring F , we see that $[HI] = 1 - F$. Quite generally, therefore, we may write

$$\text{pH} = \text{p}K_{\text{I}} + \log \frac{F}{1 - F},$$

or

$$\text{pH} = \text{p}K_{\text{I}} + \phi,$$

where $\phi = \log \frac{F}{1 - F}$.

The values of ϕ have been calculated for varying values of F , and are recorded below.

FUNCTION ϕ OF THE EXTENT OF COLORATION F (ACCORDING TO MICHAELIS AND GYEMANT)

F	ϕ	F	ϕ	F	ϕ	F	ϕ
0.002	-2.69	0.01	-2.00	0.10	-0.95	0.50	+0.00
0.004	-2.40	0.015	-1.80	0.14	-0.79	0.60	+0.20
0.006	-2.22	0.025	-1.60	0.18	-0.65	0.70	+0.38
0.008	-2.07	0.04	-1.38	0.20	-0.59	0.80	+0.60
0.010	-2.00	0.06	-1.20	0.25	-0.47	0.85	+0.75
		0.08	-1.06	0.35	-0.25		
		0.10	-0.95	0.40	-0.18		
				0.50	-0.00		

The following indicators were employed: *β -Dinitrophenol* 1 : 2 : 6 in saturated water solution. The author finds it better to use a 0.04% aqueous solution of the sodium salt (one equivalent of NaOH). According to the experience of the writer, the region in which the indicator may be used to the best advantage is pH 1.7-4.4. The alkaline color is yellow.

α -Dinitrophenol 1 : 2 : 4. Saturated aqueous solution (MICHAELIS); 0.04% solution of the sodium salt (KOLTHOFF). The best range is 2.0-4.7 (MICHAELIS) or 2.6-4.4 (KOLTHOFF).

γ -Dinitrophenol 1 : 2 : 5. Saturated water solution (MICHAELIS) or 0.04% solution of the sodium salt (KOLTHOFF). The best range is between pH 4.0-5.8.

p-Nitrophenol. 0.1% aqueous solution of the indicator or its sodium salt. The best range is pH 4.7-7.9 (MICHAELIS) or 5.6-7.6 (KOLTHOFF).

m-Nitrophenol. 0.1% water solution of the indicator or its sodium salt. The best range is pH 6.3–9.0 (MICHAELIS) or 6.6–8.6 (KOLTHOFF).

Phenolphthalein. 0.04% solution in 30% alcohol. Best range is between pH's 8.5–10.5 (MICHAELIS) or 8.2–9.8 (KOLTHOFF).

m-Nitrobenzene-azo-salicylic acid (*Salicyl yellow*). The author makes use of two solutions, a 0.1% alcohol solution between pH's 10 and 11, and a 0.025% solution between 11 and 12.

KOLTHOFF has added to those recommended by MICHAELIS the following indicators which display a marked color change from colorless toward red to violet (or the reverse):

Quinaldine red.¹ 0.025% solution in 50% alcohol. The range is 1.4–3.2 (colorless to red).

2,4,2',4',2'',4'' Pentamethoxytriphenylcarbinol (Pentamethoxy red ²). 0.02% solution in 40% alcohol. Range is pH 1.2–3.2 (red to colorless).

2,4,2',4',2'',4'' Hexamethoxytriphenylcarbinol (Hexamethoxy red). 0.02% solution in 30% alcohol. Range between 2.6 and 4.6 (red to colorless).

2,4,6,2',4',2'',4'' Heptamethoxytriphenylcarbinol (Heptamethoxy red). 0.02% solution in 30% alcohol. Range between pH's 5.0 and 7.0 (red to colorless).

Pinachrome.³ 0.02% solution of the indicator in 40% alcohol, or a solution of the hydrochloric acid salt in water (20 mg. indicator in 10 c.c. alcohol, plus 3.8 c.c. 0.01 N HCl, diluted to 100 c.c. with water). The solution should be stored in resistance glass. The range of applicability is 5.8–7.8 (colorless to red). Because the color equilibrium is not established instantaneously, the solutions should be allowed to stand for two minutes after addition of indicator and before measurements are made. The alkaline comparison solutions cannot be kept for more than about an hour because the free base is too insoluble. Such solutions must be prepared carefully in 0.01 N sodium carbonate solutions, the content of the tubes being mixed by gentle rotation. Vigorous shaking causes the indicator to separate out at the surface.

Procedure. A measured volume (5 or 10 c.c.) of the liquid

¹ I. M. Kolthoff: *Biochem. Z.*, 194, 78 (1928).

² I. M. Kolthoff: *J. Am. Chem. Soc.*, 49, 1218 (1927).

³ I. M. Kolthoff: *J. Am. Chem. Soc.*, 50, 1604 (1928).

being studied is treated with enough of a suitable indicator to produce a distinct color. As much as 1 c.c. of indicator solution may be employed if necessary, although it is better not to exceed 0.5 c.c. if possible. The quantity of indicator employed must be noted accurately. The indicator chosen must impart a color which is neither too weak nor too intense. Between 0.2 c.c. and 1 c.c. (at the most) is used.

Into a second test tube is placed 4–9 c.c. of a sodium hydroxide solution approximately 0.01 N. The author has found that ordinary tap water may be used for α -, β -, and γ -dinitrophenol and for quinaldine red. Comparison solutions of the methoxytriphenylcarbinols are prepared in 0.1–0.5 N hydrochloric acid. A quantity of the same indicator, sufficient to produce a color approximately the same as that in the first tube, is then added. As a rule the stock solution of indicator will thus be diluted ten or twenty fold. It is best to employ for this purpose a burette graduated to 0.01 c.c. Then the solution is diluted with solvent (0.01 N NaOH, water, sodium carbonate, or hydrochloric acid, as the case may be) to the total volume of the first tube. The ratio of the quantity of indicator in the comparison solution and in the solution being studied is equal to the degree of coloration F.

The determination with the indicators of MICHAELIS may be simplified considerably by preparing a series of indicator solutions which, according to MICHAELIS, are stable for many months. The pH difference from tube to tube is 0.2 unit. The quantity of completely alkaline indicator solution to be added to the comparison tubes, when the liquids under investigation are treated with a constant amount of indicator, can be calculated readily for each indicator and each pH from the expression:

$$\text{pH} = \text{p}K_{\text{I}} + \log \frac{F}{1 - F}.$$

Colors may be compared in a comparator (cf. Fig. 21).

W. WINDISCH, W. DIETRICH, and P. KOLBACH,¹ as well as the author, find however that the alkaline comparison solutions of the indicators are not permanent. WINDISCH proposed the use of potassium chromate, bichromate, or mixtures of these salts as

¹ W. Windisch, W. Dietrich, and P. Kolbach: *Wochschr. Brau.*, 39, 79 (1922).

color standards instead of the indicators themselves. The best practice, however, is still to prepare fresh comparison solutions for each series of measurements, as was done by MICHAELIS himself in his original report.

E. BRESSLAU¹ has improved the procedure to permit good results with small quantities of liquid and in weakly buffered solutions. To eliminate the salt error (Chapter Ten) as much as possible, BRESSLAU employed indicator solutions which were more dilute than those prescribed by MICHAELIS. Because the colors of the various alkaline indicators are the same, it is possible to use 15 to 18 permanent comparison solutions to include the pH range 2.6–8.9. The indicators mentioned in the following tables have the same colors at the pH's recorded.

INDICATOR	SOLUTION	PH OF THE PERMANENT SOLUTIONS											
		2.6	2.8	3.0	3.2	3.4	3.6	3.8	4.0	4.2	4.4	4.6	—
α -Dinitrophenol	0.1 : 200	2.6	2.8	3.0	3.2	3.4	3.6	3.8	4.0	4.2	4.4	4.6	—
β -Nitrophenol	0.1 : 100	—	5.2	5.4	5.6	5.75	5.9	6.05	6.2	6.35	6.5	6.6	6.67
<i>p</i> -Nitrophenol	0.1 : 300	5.6	5.7	5.9	6.1	6.25	6.4	6.6	6.8	7.0	7.2	7.4	7.65
<i>p</i> -Nitrophenol	0.1 : 600	5.9	6.0	6.2	6.45	6.6	6.8	7.05	7.35	7.75	—	—	—
<i>m</i> -Nitrophenol	0.3 : 100	6.7	6.8	7.0	7.1	7.3	—	—	—	—	—	—	—
<i>m</i> -Nitrophenol	0.1 : 150	7.4	7.45	7.7	7.9	8.15	—	—	—	—	—	—	—
<i>m</i> -Nitrophenol	0.1 : 300	7.75	7.8	8.1	8.4	—	—	—	—	—	—	—	—
<i>m</i> -Nitrophenol	0.1 : 600	8.17	8.35	8.9	—	—	—	—	—	—	—	—	—

The interval 4.6–5.2 is not included among these solutions. The gap can be filled best by using varying concentrations of γ -dinitrophenol.

INDICATOR	SOLUTION	PH OF PERMANENT SOLUTIONS		
		4.6	4.8	5.0
γ -Dinitrophenol	0.1 : 400	4.6	4.8	5.0
“	0.1 : 600	4.85	5.1	5.37
“	0.1 : 700	4.95	5.2	5.58

Instructions for preparing certain of the permanent solutions are given by the following table, which is based upon the work of Bresslau. They are prepared from alkaline indicator solutions by dilution to 100 c.c. with 0.1 N sodium carbonate. The volumes of indicator solution needed to yield a permanent solution of the corresponding pH are given for *m*- and *p*-nitrophenol and for γ -dinitrophenol.

¹ E. Bresslau: Deut. Med. Wochschr., 1924, No. 6; Arch. Hydrobiologie, 15, 585 (1922).

PREPARATION OF PERMANENT SOLUTIONS ACCORDING TO BRESSLAU

pH FOR <i>p</i> -NITROPHENOL 0.1 : 300	ALKALINE INDICATOR SOLUTION DILUTED 18 TIMES	pH FOR γ -DINITROPHENOL 0.1 : 400	UNDILUTED INDICATOR SOLUTION
5.6 5.7 5.9 6.1 6.25	2.31 c.c. 2.91 " 4.5 " 7.0 " 9.6 "	4.6 4.8 5.0	2.0 c.c. } Diluted to 2.8 " } 100 c.c. with 3.8 " } 0.1 N sodium carbonate
6.4 6.6 6.8 7.0 7.2 7.4 7.6	UNDILUTED INDICATOR SOLUTION 1.3 c.c. 1.9 " 2.67 " 3.6 " 4.56 " 5.67 " 6.6 "	pH FOR <i>m</i> -NITROPHENOL 0.1 : 150 8.3 8.5 8.7	UNDILUTED INDICATOR SOLUTION 4.4 c.c. } Diluted to 5.4 " } 100 c.c. with 6.4 " } 0.1 N sodium carbonate

The sodium carbonate solution need not be exactly 0.1 N. The stability of the solutions was excellent since they were sealed in tubes which contained but little air. It was because of their stability that BRESSLAU preferred permanent tubes of dichromate-chromate mixtures.

To determine the hydrogen ion concentration, a mixture of one part of indicator solution (say 0.1 c.c.) and 10 c.c. of unknown solution is placed in a 5 cm. tube. Then the color is compared with that of the permanent tubes, and the pH estimated. BRESSLAU used a *hydrionometer*, which was a slightly inclined wood wedge carrying a plate of milk glass on top and a channel below in which fit two adjacent blocks. The permanent tubes, when placed in these blocks, lie against the milk glass plate. The decision as to which of the tubes has the same color as the unknown solution is made by covering with a screen. The clamp screen can be used also for colored or turbid liquids (comparator). An accuracy of 0.1–0.05 pH unit is possible. The hydrionometer is very good for rapid determinations.

Comparison with permanent chromate or dichromate solutions. Tubes of colorless glass and with flat bottoms are used for the comparisons. Aspirin tubes, for example, are satisfactory for this purpose. After filling the tubes with chromate or dichro-

TABLE FOR 15°

c.c. of 0.1% K_2CrO_4	0.3	0.45	0.7	1.1	1.5	1.8	2.3	3.1	3.7	4.0
Corresponds with the pH measured with α -dinitrophenol (0.2 c.c. of 0.1% indicator per 10 c.c.)	2.95	3.18	3.35	3.55	3.75	3.95	4.15	4.35	4.60	—
Corresponds with the pH measured with p-nitrophenol (0.2 c.c. of 0.3% indicator per 10 c.c.)	(5.62)	5.70	5.78	5.93	6.1	6.24	6.45	6.8	7.05	7.15
(0.1 c.c. of 0.3% indicator per 10 c.c.)	—	—	—	—	—	7.13	7.36	7.55	—	—

Temperature correction for α -dinitrophenol 0.006 ($t - 15^\circ$)
 " " " p -nitrophenol 0.011 ($t - 15^\circ$)

c.c. of 0.1% $K_2Cr_2O_7$	0.23	0.35	0.55	0.72	1.1	1.55	1.8	2.2	3.0
Corresponds with the pH measured with γ -dinitrophenol (0.2 c.c. of 0.1% indicator per 10 c.c.)	3.95	4.05	4.25	4.45	4.65	4.85	5.05	5.25	5.45
Corresponds with the pH measured with m -nitrophenol (0.4 c.c. of 0.3% indicator per 10 c.c.)	7.0	7.2	7.5	7.7	7.9	8.1	8.3	8.5	—
Corresponds with the pH measured with salicyl yellow (0.2 c.c. of 0.05% indicator per 10 c.c.)	—	—	—	(9.8)	10.20	10.46	10.6	10.84	11.28
(0.2 c.c. of 0.025% indicator per 10 c.c.)	—	—	10.2	10.40	10.80	—	—	—	—

Temperature correction for γ -dinitrophenol 0.004 ($t - 15^\circ$)
 " " " m -nitrophenol 0.008 ($t - 15^\circ$)
 " " " salicyl yellow 0.013 ($t - 15^\circ$)

mate, they are stoppered, numbered, and stored in a small wooden box, the inside of which is blackened, and which contains a number of holes to fit the tubes. A piece of white paper or a plate of milk glass will serve as a white base. Color intensities are judged by observing the whole column of liquid in the tubes.

Identical tubes are employed in measuring the pH of an unknown solution. Ten c.c. of liquid are pipetted into the tubes and the quantity of indicator shown in the table is added. In the same table is given the volume (c.c.) of 0.1% potassium chromate (Kahlbaum) or of 0.1% potassium dichromate needed for a given comparison tube. The latter is then diluted with water to 10 c.c.

The pH can not be calculated simply from the color intensity F for phenolphthalein and salicyl yellow. MICHAELIS and GYEMANT have presented a table of empirical F values for these substances. The values for phenolphthalein, determined somewhat earlier by the author,¹ do not agree with these figures.

EMPIRICAL F VALUES FOR PHENOLPHTHALEIN AT 18° (MICHAELIS)

F	pH	F	pH	F	pH
0.01	8.45	0.21	9.20	0.65	10.0
0.030	8.60	0.34	9.40	0.75	10.2
0.069	8.80	0.45	9.60	0.845	10.4
0.120	9.00	0.55	9.80	0.873	10.5

VALUES OF KOLTHOFF²

F	pH	F	pH
0.0076	8.2	0.16	9.0
0.019	8.4	0.25	9.2
0.039	8.6	0.39	9.4
0.079	8.8	0.54	9.6
—	—	0.7	9.8

Phenolphthalein acts as though it were a dibasic acid within its indicator range. The free acid and the monovalent anions are colorless whereas the divalent anion, possessing the quinone phenolate structure, is colored a deep violet-red (cf. page 222).

¹ I. M. Kolthoff: Pharm. Weekblad, 59, 104 (1922).

² I. M. Kolthoff: Pharm. Weekblad, 59, 104 (1922).

ROSENSTEIN has found from colorimetric measurements that the two dissociation constants of phenolphthalein are $K_1 = 1.5 \times 10^{-10}$, and $K_2 = 2.82 \times 10^{-10}$. In the accompanying table, x denotes the concentration of the colored form and $(1 - x)$ the sum of the concentrations of both uncolored forms (free acid and monovalent anions).

$$\frac{x}{(1-x)} \text{ ACCORDING TO ROSENSTEIN }^1$$

pH	$\frac{x}{(1-x)}$ EXPERIMENTAL	$\frac{x}{(1-x)}$ CALCULATED
9.95	2.22-2.36	2.28
9.65	1.03	1.03
9.53	0.774-0.766	0.76
9.47	0.691	0.64
9.36	0.474	0.46
9.33	0.449	0.43
9.17	0.277	0.266
9.09	0.218	0.207
9.05	0.184	0.182
8.96	0.111	0.133

MICHAELIS and GYEMANT give the temperature correction as $0.0110(t - 18^\circ)$.

V. AIRILA ² states that mixtures of fuchsine and methyl violet have the same color as phenolphthalein in its transformation region, and may therefore be used as comparison solutions. The latter can be prepared from a 0.0125% aqueous fuchsine solution and a saturated solution of methyl violet.

The following table applies to salicyl yellow at 20° .

EMPIRICAL F VALUES FOR SALICYL YELLOW AT 20°

F	pH	F	pH
0.13	10.00	0.56	11.20
0.16	10.20	0.66	11.40
0.22	10.40	0.75	11.60
0.29	10.60	0.83	11.80
0.36	10.80	0.88	12.00
0.46	11.00	—	—

¹ L. Rosenstein: J. Am. Chem. Soc., *34*, 1117 (1912).

² V. Airila: Chem. Zentr., *93 IV*, 105 (1922).

6. pH determination by spectrophotometric method.

BRODE¹ found that the positions of the absorption bands of various indicators do not change as the hydrogen ion concentration is varied, but rather that the intensity of the transmitted light diminishes or increases. If the same concentration of indicator is used in all solutions being examined, it is possible to determine the degree of acidity by comparing the height of the characteristic absorption band of an unknown solution with that of solutions of known pH. For colored solutions, the solution itself can be used in the comparison measurements, determining of course only the maximum and the minimum of the band. Indicators best suited for this method are those possessing a very sharp absorption band in the middle of the spectrum, with the second band sufficiently removed from the first so as to preclude any masking influence, yet still in the visible portion (cf. below).

Thymol blue is the indicator which fulfills best all requirements. A mixture of methyl red and bromphenol blue may be used in the region between the transformation intervals of thymol blue. It is thus possible to cover the range between 1.0–10.0 using only two indicator solutions. Methyl red, however, is less satisfactory for this purpose than the indicators of CLARK and LUBS, so that it is probably better to replace it by bromcresol green.

BRODE employed a simple spectrophotometer which permitted direct readings. The wave lengths at which the absorption maxima for a number of indicators occur are listed below.

INDICATOR	WAVE LENGTH m μ	INDICATOR	WAVE LENGTH m μ
Thymol blue (acid)	544	Cresol red	572
Bromphenol blue	592	Phenol red	558
Methyl red	530	Thymol blue (alkaline)	596
Chlorphenol red ²	573	<i>m</i> -Cresol purple ²	580
Bromcresol purple	591	Neutral red	533
Bromcresol green ²	617	Phenolphthalein	553
Bromthymol blue	617	Thymolphthalein	598

¹ W. R. Brode: *J. Am. Chem. Soc.*, 46, 581 (1924).

² B. Cohen: *Public Health Reports*, 41, 3051 (1926).

Kurt Buch¹ has found the following values at 18°:

INDICATOR	ALKALINE SOLUTION	MOLAR EXTINCTION	ACID SOLUTION	MOLAR EXTINCTION
α -Naphtholphthalein	649 m μ	2.63×10^4	474 m μ	0.0171×10^4
Phenol red	554 "	3.32×10^4	504 "	1.28×10^4
Bromthymol blue	614 "	4.45×10^4		
Bromcresol purple	585 "	7.63×10^4		

Figure 19 illustrates the manner in which the intensity of the transmitted light varies with pH. Wave lengths in m μ are plotted as abscissae against intensity of transmitted light (on the right) and the logarithm of intensity (on the left) as ordinates. When the ratio of the quantity of transmitted light to the maxi-

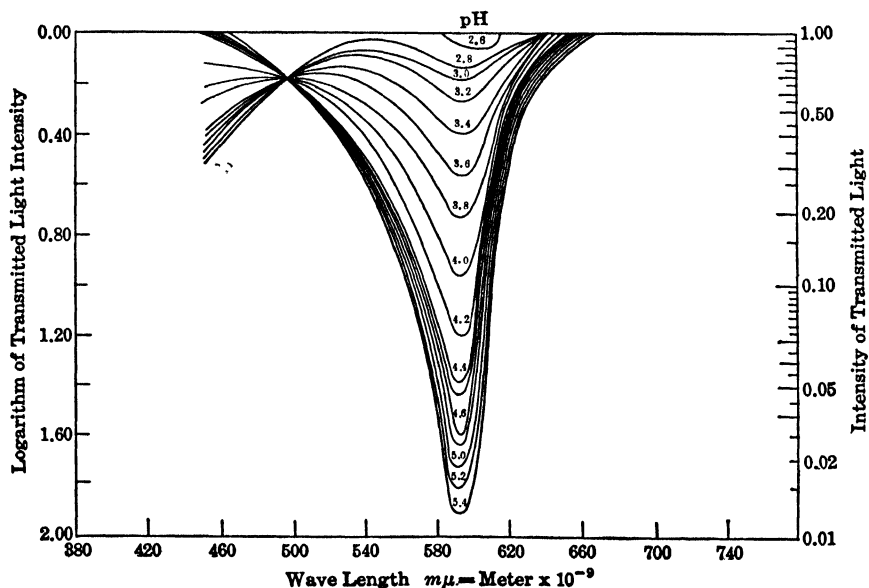

FIG. 19

mum (or minimum) quantity is plotted as a function of the pH, a dissociation curve results which yields the constant of the indicator.

The spectrophotometric method is very well suited to the measurement of pH. The accuracy naturally is greater than when comparisons are made with the eye. The method may be

¹ K. Buch: Soc. Sci. Fennica, Commentationes Phys.-Math., 2, 29 (1926). (German.)

applied also to turbid and colored liquids. It is of course susceptible to all the usual errors incidental to the colorimetric method (salt error, protein error, etc.).

W. C. HOLMES¹ recommends a method similar to that of BRODE for pH determinations involving two-color indicators. In such measurements a given variation in pH will occasion two changes in the visible spectrum. Thus it is possible to determine ratios R_2 of light transmitted at two wave lengths which are near or at the maximum absorption value. As the pH changes, the quantity of one kind of light transmitted increases while that of the other diminishes. An indicator suited for this purpose in the pH range 8-10 is 1-naphthol-2-sodium sulfonate indophenol (W. M. CLARK, 1923; cf. page 158).

pH	10.19	8.69	7.74
R_2	0.146	0.60	10.40

HOLMES believes that other indophenols also may be used, and hopes to make a detailed report at a later date. Certain biological applications of the method have been made by E. J. HIRSCH.²

FERD. VLÈS³ states that in order to determine spectrophotometrically the pH of a solution by means of a two-color indicator, the concentration of the indicator must be known before comparison with the reference solution is possible. VLÈS avoids this difficulty by measuring the absorption coefficient for two wave lengths. Their ratio is

$$\phi = \frac{k_1c_1 + k_2c_2}{k_1'c_1 + k_2'c_2},$$

where c_1 and c_2 are the concentrations of the alkaline and acid forms of the indicator, and the k 's stand for the corresponding specific absorption coefficients. For the case in which $c_1 + c_2$ is kept constant, it is possible to show from the classical expression involving c_1 and c_2 that

$$[\text{H}^+] = K \frac{k_1 - \phi k_1'}{\phi k_2' - k_2},$$

where K is the apparent dissociation constant of the indicator.

¹ W. C. Holmes: *J. Am. Chem. Soc.*, *46*, 627 (1924).

² E. J. Hirsch: *J. Biol. Chem.*, *63*, 55 (1925).

³ F. Vlès: *Compt. rend.*, *180*, 584 (1925); *Chem. Zentr.*, *1925 I*, 2248.

The formula is valid for cresol red and bromthymol blue, but does not apply to crystal violet and *o*-methyl red. The spectra of the latter seem to consist of three distinct bands.

A. THIEL¹ and his coworkers have studied spectrophotometrically the dissociation constants and the behavior of various azo indicators in pure water and in alcoholic solution. Original sources must be consulted for details.

7. Colored solutions.

When the solution under investigation happens to be colored, the reference solution must be treated with a coloring agent possessing a color which resembles that of the unknown solution as closely as possible. It is evident that those indicators which are already completely transformed at the pH being investigated may be used for this purpose. For example, methyl orange can be added to a reference solution without hesitation to match the yellow-brown color of a liquid with a pH = 7. SÖRENSEN² has made a list of frequently used colorants.

- a. Bismarck bröwn—0.2 g. per liter of water.
- b. Helianthin—0.1 g. in 800 c.c. of alcohol and 200 c.c. of water or Methyl orange—0.1 g. per liter of water.
- c. Tropeolin 0—0.2 g. per liter of water.
- d. Tropeolin 00—0.2 g. per liter of water.
- e. Curcumin—0.2 g. in 600 c.c. of 93% alcohol and 400 c.c. of water.
- f. Methyl violet—0.2 g. per liter of water.

The following have also been found useful:

- g. Methylene blue—0.1 g. per liter of water.
- h. Safranine—0.1 g. per liter of water.

In the event that the investigated solution is turbid, the comparison solution must be made equally turbid. To produce this condition, SÖRENSEN suggests the addition of a suspension of

¹ A. Thiel, A. Dassler, and F. Wulfken: *Fortschritte Chem. Physik, physik. Chem.*, 18, No. 3 (1924); A. Thiel and F. Wulfken: *Z. anorg. allgem. chem.*, 136, 393, 406 (1924); A. Thiel: *Physikochemisches Praktikum*, Berlin: Gebr. Borntraeger, 1926, p. 163. Cf. also, Holmes and Snyder: *J. Am. Chem. Soc.*, 47, 221 (1925); Holmes: *Ind. Eng. Chem.*, 15, 833 (1923); 16, 35 (1924); E. B. R. Prideaux: *J. Soc. Chem. Ind.*, 45, 664, 678, 697 (1926); R. A. Morton and A. H. Tipping: *J. Chem. Soc.*, 1398 (1926); M. G. Mellon and F. D. Martin: *J. Phys. Chem.*, 31, 161 (1927).

² S. P. L. Sørensen: *Biochem. Z.*, 21, 131 (1909); *Ergebnisse Physiol.*, 12, 393 (1912).

fresh barium sulfate by treating a small quantity of 0.1 N barium chloride with an equal quantity of potassium sulfate solution. A suspension of talc or kaolin will serve equally well provided that these materials are first boiled in acid and then washed by shaking with water until the filtrate no longer gives an acid reaction with methyl red.

HENDERSON¹ adopted the practice of diluting colored solutions to an extent such that its color no longer interfered. Although in buffer solutions the hydrogen ion concentration depends but little upon the total electrolyte content, the activity coefficient nevertheless changes at higher dilutions. Accordingly, this procedure is to be recommended only if the accuracy desired is not too great.

Obviously colorimetric determinations of pH in colored or turbid solutions are not very reliable. The color of the indicator should never be the same as the color of the liquid. For example, one should employ phenolsulfonephthalein for yellow solutions, and not *p*-nitrophenol.

Frequently it is of advantage to resort to the artifice of removing one form of the indicator by dissolving it in a solvent like ether. The amount of indicator form extracted depends both upon its distribution coefficient and upon the concentration of hydrogen ions. This must be kept in mind when a colored ether layer is compared with the color of the ether layer from a comparison solution. Iodoeosine is well suited for this procedure, its colored form being very soluble in ether. However, there remains still to be developed a list of indicators which would permit of accurate measurements over the whole pH range. It is obvious also that addition of a solvent will change the transformation range.

G. PICHARD and R. CHAMINADE² have studied the behavior of methyl red and various sulfonephthaleins when shaken with organic solvents. They added ten drops of a 0.1% methyl red solution or of a 0.04% solution of a sulfonephthalein to 10 c.c. of aqueous solutions at different pH's, and noted the color of isobutyl alcohol extracts. They made the following observations with isobutyl alcohol as solvent:

¹ L. J. Henderson: *Biochem. Z.*, *24*, 40 (1910).

² G. Pichard and R. Chaminade: *Bull. soc. chem.*, (4) *51*, 90 (1932).

Thymol blue: Isobutyl alcohol red at pH = 1; yellow at pH = 4; intermediate colors between pH's 1-4.

Bromphenol blue: Solvent yellow at pH = 3; blue at pH = 6; intermediate colors between 3 and 6.

Methyl red: Solvent red at pH = 5; yellow at pH = 8.

Bromcresol purple: Solvent yellow at pH = 7; green at pH = 9 to 10.

Bromthymol blue: Solvent yellow at pH = 8; blue at pH = 11.

The extraction method should be used only for rough estimates of the pH. It is especially useful in approximating the pH of very turbid or dark solutions, or of colored suspensions.

WALPOLE ¹ has described for use in connection with colored or very turbid liquids the device shown in Fig. 20 (cf. also W. BIEHLER ²).

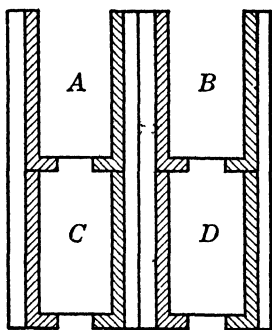

FIG. 20

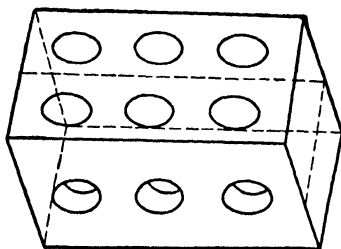

FIG. 21

A, B, C, and D are small cylinders, with flat bottoms, which rest in a frame lined with black paper. The base of the frame is illuminated. In A is placed 10 c.c. of the investigated solution plus the indicator. C contains 10 c.c. of water. Ten c.c. of the solution being examined, without indicator, are placed in D, while to B are added 10 c.c. of the comparison solution with indicator. Thus the color of the solution is balanced out.

Figure 21 is a diagram of the comparator ³ which fulfills most practical needs. It consists simply of a block of hard wood with holes bored so as to permit a view of the colors of two solutions placed one in front of the other. A measured quantity of indi-

¹ G. S. Walpole: *Biochem. J.*, 5, 207 (1910), 7, 260 (1913), 8, 628 (1914).

² W. Biehler: *Z. physiol. Chem.*, 110, 298 (1920).

³ S. H. Hurwitz, K. F. Meyer, and Z. Ostenberg: *Proc. Soc. Exptl. Biol. Med.*, 113, 24 (1915).

cator is added to the solution being examined, and a tube with this liquid is placed in one of the holes. Behind it is inserted a tube containing only water. A third tube containing the buffer solution with the same amount of indicator, and a fourth containing the solution being examined are placed in two other holes. A plate of milk glass or a plate of pale blue glass (as for nitro indicators) may be used as a background if desired.

The colorimetric method fails in solutions which are very darkly colored or extremely turbid. Frequently this difficulty may be overcome by the dialysis method, especially when the colored substance is colloidal. The investigated solution is placed in a thimble of pure parchment or in a collodion membrane set in a little pure water. After it has been ascertained that the pH of the external water no longer varies, its acidity is measured colorimetrically. The time required is usually twelve hours or less, and must be determined for each case. The author has obtained good results by this method when used to measure the pH of soil extracts, milk, emulsions, etc.

Actually this procedure does not give exact results because the Donnan equilibrium which is set up through the membrane is neglected. Because of this equilibrium, an unequal distribution of ions between the internal and external water occurs in the presence of colloids. Usually, however, this error is small.

CHAPTER TEN

SOURCES OF ERROR IN THE COLORIMETRIC METHOD

1. The acid-base error of indicators. Isohydric indicators. The measurement of pH in unbuffered or slightly buffered solutions.

Acid-base indicators are weakly acid or basic substances. Consequently, their addition to an unbuffered solution will produce a pH change. The indicator concentration is always very small in colorimetric work, about 10^{-5} molar or less, so that the effect of the indicator on the reaction of a liquid is noticeable only in very slightly buffered media such as pure water, ordinary distilled water, neutral salt solutions, solutions of slightly hydrolyzed salts, solutions of very weak acids and bases, and very dilute solutions of strong acids and bases. Very large errors may be introduced by neglecting the acidity change due to added indicator. The following examples will illustrate the nature of the error.

Let us consider first the case of an indicator acid HI in pure water. The indicator dissociates as follows:

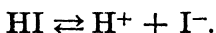

Taking into account the equilibrium

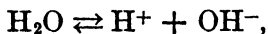

we see that

$$[\text{I}^-] = [\text{H}^+] - [\text{OH}^-],$$

since the liquid is electrically neutral. Hence it follows from the equation for the dissociation constant of an acid that

$$\frac{[\text{H}^+]\{[\text{H}^+] - [\text{OH}^-]\}}{[\text{HI}]} = K_{\text{HI}}$$

or

$$[\text{H}^+]^2 = K_{\text{HI}}[\text{HI}] + K_w.$$

By means of the last expression, it is possible to calculate the values of $[\text{H}^+]$ in pure water solutions of indicators with different

dissociation constants. The results of such calculations, assuming $K_w = 10^{-14}$, are compiled in the following table where c denotes the molar concentration of indicator.

c	K_{HI}	$[H^+]$	pH
10^{-6}	10^{-8}	1.4×10^{-7}	6.85
5×10^{-6}	10^{-8}	2.45×10^{-7}	6.41
10^{-5}	10^{-8}	3.3×10^{-7}	6.48
10^{-6}	10^{-7}	2.8×10^{-7}	6.55
5×10^{-6}	10^{-7}	6.6×10^{-7}	6.18
10^{-5}	10^{-7}	9.6×10^{-7}	6.02
10^{-6}	10^{-6}	6.3×10^{-7}	6.20
5×10^{-6}	10^{-6}	1.9×10^{-6}	5.72
10^{-5}	10^{-6}	2.6×10^{-6}	5.59
10^{-6}	10^{-5}	9.2×10^{-7}	6.04
5×10^{-6}	10^{-5}	1.8×10^{-6}	5.75
10^{-5}	10^{-5}	6.5×10^{-6}	5.19

It is seen readily that the error occasioned by measuring colorimetrically the pH of pure water increases with higher indicator concentrations and with increasing value of dissociation constant. The author¹ has determined experimentally the error introduced by employing methyl red ($K_{HI} = 9 \times 10^{-6}$).

HYDROGEN ION CONCENTRATION IN VERY DILUTE METHYL RED SOLUTIONS

VOLUME OF 0.2% INDICATOR SOLUTION PER 5 c.c. H ₂ O	MOLAR CONCENTRATION OF METHYL RED	pH (CALCULATED)	pH (MEASURED)
0.05 c.c.	7.4×10^{-5}	4.7	4.9
0.02 "	3×10^{-5}	4.92	5.0
0.01 "	1.5×10^{-5}	5.1	5.3
0.005 "	7.5×10^{-6}	5.32	5.7

Evidently unneutralized methyl red cannot be used to determine the pH of pure water.

The discrepancy is not so great when a solution of the neutral salt of the indicator acid is employed, although even the neutralized indicator does not permit an accurate measurement of pH because of the hydrolysis

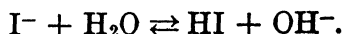

¹ I. M. Kolthoff: *Biochem. Z.*, 168, 110 (1926).

Let us calculate the extent to which the pH of water is changed by addition of a hydrolyzed indicator salt.

For most purposes we assume that the amount of HI produced is equal to the hydroxyl ion concentration (Chapter One). When hydrolysis is very slight, however, this assumption is no longer permissible because the hydroxyl ions formed from water may no longer be neglected. Accordingly $[\text{HI}] = [\text{OH}^-] - [\text{H}^+]$.

Quite generally we may write for the hydrolysis equilibrium

$$\frac{[\text{HI}][\text{OH}^-]}{[\text{I}^-]} = K_{\text{Hydr.}} = \frac{K_w}{K_{\text{HI}}}$$

Denoting the concentration of the indicator salt by c , substituting the correct value of $[\text{HI}]$, and making the approximation¹ $[\text{I}^-] = c$, we find that

$$[\text{OH}^-]^2 - K_w = c \frac{K_w}{K_{\text{HI}}}; \quad \text{or} \quad [\text{OH}^-] = \sqrt{c \frac{K_w}{K_{\text{HI}}} + K_w}$$

The "hydrolysis error" becomes smaller for smaller c and larger K_{HI} values. It is very small for neutralized methyl red solutions, but much greater for neutralized solutions of bromthymol blue. Evidently one obtains a correct measure of the reaction of pure water with neither the pure indicator solution nor with the neutralized solution.

Incorrect results are found also in very dilute acid or basic solutions which are not buffered. When phenolphthalein is added to a very dilute alkali solution, hydroxyl ions are bound to an extent equivalent to the quantity of the red form of the indicator produced. In analogous fashion, methyl orange binds hydrogen ions when this indicator is added to dilute acid solutions. The following illustrations will show clearly that large errors can be encountered when, for example, the acid properties of phenolphthalein are neglected in very dilute alkali solutions.

For the sake of simplicity we shall assume that phenolphthalein behaves as a monobasic acid with a dissociation constant of 10^{-9} . Let us calculate the hydroxyl ion concentration resulting from the addition of 0.1 c.c. of 1% phenolphthalein to 10 c.c. of 0.0001 N sodium hydroxide solution. This corresponds to a con-

¹ In reality, $[\text{I}^-] = c - [\text{HI}] = c - [\text{OH}^-] + \frac{K_w}{[\text{OH}^-]}$, which leads to a quadratic equation.

centration of 100 mg. of indicator per liter, or to an approximately 3×10^{-4} molar solution. The indicator reacts as follows with alkali:

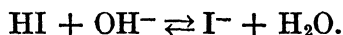

The initial alkali concentration is equal to the sum of $[\text{OH}^-]$ and $[\text{I}^-]$, or

$$[\text{OH}^-] + [\text{I}^-] = 10^{-4}.$$

Since the total concentration of indicator acid is 3×10^{-4} , the concentration of the undissociated portion HI is:

$$[\text{HI}] = 3 \times 10^{-4} - [\text{I}^-] = 3 \times 10^{-4} - 10^{-4} + [\text{OH}^-] \\ = 2 \times 10^{-4} + [\text{OH}^-].$$

Therefore

$$K_{\text{HI}} = 10^{-9} = \frac{[\text{H}^+][\text{I}^-]}{[\text{HI}]} = \frac{K_w\{10^{-4} - [\text{OH}^-]\}}{[\text{OH}^-]\{2 \times 10^{-4} + [\text{OH}^-]\}}.$$

Solving, we find that $[\text{OH}^-]$ is about 5×10^{-6} , whereas the original was actually 10^{-4} M with respect to OH^- . Evidently the error is very large.

Erroneous results are obtained also in the colorimetric determination of the pH of solutions of very weak acids (or bases). When an indicator acid is employed, the acid error of the indicator itself must be taken into account; and when the indicator salt is used, allowance must be made for the following reaction between the salt and the acid present:

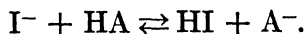

Isohydric indicator solutions. Reliable information concerning unbuffered solutions is obtained only when the pH of the liquid is unaffected by the added indicator. Actually the indicator solution should have a composition such that its pH equals that of the solution being investigated.¹ Indicator solutions of this kind have been called *isohydric* by E. H. FAWCETT and S. F. ACREE.²

Given a large series of solutions of known pH containing various proportions of the acid and alkaline forms of a certain indicator, there arises the problem of deciding upon the proper mixture with pH equal to that of the unknown. *By adding*

¹ I. M. Kolthoff: *Biochem. Z.*, 168, 110 (1926).

² E. H. Fawcett and S. F. Acree: *J. Bact.*, 17, 163 (1929); *Ind. Eng. Chem., Analyt. Ed.*, 2, 78 (1930).

gradually increasing quantities of indicator to the solution being examined, and measuring the pH after each addition by comparing with buffer solutions containing the same amount of indicator, constant values are obtained only when the indicator solution involved is isohydric¹ with the unknown. If the indicator solution has a hydrogen ion concentration greater than that of the solution being examined, then the measured pH values diminish with increasing indicator concentration. For an indicator mixture which is too alkaline, increasing pH's are found under similar conditions.

This conclusion can be tested theoretically. It is of general interest to know how the pH of an indicator mixture or of a buffer mixture changes when subjected to extreme dilution. At infinite dilution, of course, the pH of the solution is that of the pure solvent. Let us consider an indicator which consists of a mixture of a monovalent (acid form) anion and a divalent (alkaline form) sulfonephthalein anion. The equilibrium involved is:



$$[a\text{H}^+] = \frac{[a\text{HI}^-]}{[a\text{I}^-]} K_{\text{I}}. \quad (2)$$

The first dissociation constant of the sulfonephthalein is very large so that the hydrolysis of the HI^- ions may be neglected. If we add to pure water an indicator solution for which the ratio $[\text{HI}^-]/[\text{I}^-]$ and the total amount of indicator are known, we should find that the ratio has changed due to the variation of pH with dilution. The $[\text{HI}^-]$ value diminishes with dilution and $[\text{I}^-]$ increases if the indicator mixture has an acid reaction.

Designating the original molar concentration of HI^- as a and that of I^- as b , it follows from the electroneutrality of the solution that

$$[\text{Na}^+] + [\text{H}^+] = [\text{HI}^-] + 2[\text{I}^-] + [\text{OH}^-] \quad (3)$$

or

$$a + 2b + [\text{H}^+] = [\text{HI}^-] + 2[\text{I}^-] + [\text{OH}^-]. \quad (4)$$

It has been assumed that the indicator acid was neutralized with sodium hydroxide. Furthermore, concentrations are employed instead of activities since the activity coefficients have values in the neighborhood of unity at the great dilutions involved.

¹ Cf. also W. H. Pierre and J. F. Fudge: *J. Am. Chem. Soc.*, 50, 1254 (1928).

We see further that

$$[\text{HI}^-] + [\text{I}^-] = a + b, \quad (5)$$

and

$$[\text{HI}^-] = a - [\text{H}^+] + [\text{OH}^-], \quad (6)$$

$$[\text{I}^-] = b + [\text{H}^+] - [\text{OH}^-]. \quad (7)$$

It follows from equations (2), (6), and (7) that

$$[\text{H}^+] = \frac{a - [\text{H}^+] + [\text{OH}^-]}{b + [\text{H}^+] - [\text{OH}^-]} K_{\text{I}} \quad (8)$$

or

$$[\text{H}^+] = -\frac{b + K_{\text{I}}}{2} + \sqrt{\left(\frac{b + K_{\text{I}}}{2}\right)^2 + aK_{\text{I}} + K_w + \frac{K_w K_{\text{I}}}{[\text{H}^+]}}. \quad (9)$$

This cubic equation cannot be solved very simply although an approximate value of $[\text{H}^+]$ can be obtained by making certain simplifying assumptions. In case the indicator mixture has an acid reaction, then the rigid expressions (6) and (7) may be replaced by

$$[\text{HI}^-] = a - [\text{H}^+] \quad (6')$$

and

$$[\text{I}^-] = b + [\text{H}^+], \quad (7')$$

so that *approximately*

$$[\text{H}^+] = -\frac{b + K_{\text{I}}}{2} + \sqrt{\left(\frac{b + K_{\text{I}}}{2}\right)^2 + aK_{\text{I}}}. \quad (10)$$

In extremely diluted solutions where the pH is very close to 7, the $[\text{H}^+]$ can be obtained using first the approximate formula (10) and substituting this $[\text{H}^+]$ value in the $K_w K_{\text{I}}/[\text{H}^+]$ term of equation (9).

In the event that the indicator mixture is alkaline, equations (6) and (7) may be used modified as follows:

$$[\text{HI}^-] = a + [\text{OH}^-]$$

and

$$[\text{I}^-] = b - [\text{OH}^-],$$

which leads to the following expression instead of (10):

$$[\text{H}^+] = \frac{K_w + K_{\text{I}}a}{2b} + \sqrt{\left(\frac{K_w + K_{\text{I}}a}{2b}\right)^2 + \frac{K_{\text{I}}K_w}{b}}. \quad (11)$$

The following table contains the pH values calculated for the case where varying quantities of a 0.1% bromthymol blue solution, containing the acid (yellow; HI^-) and alkaline (blue; I^-)

forms in different proportions, are added to 15 c.c. of pure water (pH 7.00). Here $K_I = 5.5 \times 10^{-8}$ and $K_w = 1.00 \times 10^{-14}$, both at 25°.

VARIATION IN pH OF WATER DUE TO ADDITION OF BROMTHYMOL BLUE

C.C. OF 0.1% INDICATOR PER 15 C.C. WATER	TOTAL INDICATOR CONCENTRATION IN WATER	RATIO [HI ⁻]/[I ⁻]	pH CALCULATED FROM (9) AND (10)
0.1	1.07×10^{-5}	98 : 2	6.20
0.3	$3.21 \times "$	98 : 2	6.00
0.5	$5.35 \times "$	98 : 2	5.92
0.1	$1.07 \times "$	90 : 10	6.45
0.3	$3.21 \times "$	90 : 10	6.37
0.5	$5.35 \times "$	90 : 10	6.35
0.1	$1.07 \times "$	10 : 5.5	7.00
0.3	$3.21 \times "$	10 : 5.5	7.00
0.5	$5.35 \times "$	10 : 5.5	7.00

The indicator mixture with the [HI⁻] : [I⁻] ratio equal to 10 : 5.5 is isohydric with water.

Preparation of suitable indicator solutions. The preparation of indicator solutions for use in the colorimetric pH determination has already been described in detail in Chapter Five (§ 3). These solutions, however, were suited only for measurements of buffered solutions. Isohydric indicator solutions have to be prepared in another manner. H. T. STERN¹ titrates the indicator with sodium hydroxide and measures the pH during neutralization with the quinhydrone electrode. A similar procedure has been described by PIERRE and FUDGE.² FAWCETT and ACREE³ keep in stock a large series of neutralized indicator solutions and determine their pH approximately by colorimetric means.

A knowledge of the degree of acidity of the indicator solution is not, however, of great practical value since the pH of the solution being examined is unknown. For this reason I. M. KOLTHOFF and T. KAMEDA⁴ recommend that only two solutions of each indicator be kept in storage, one containing solely the acid form and the other only the alkaline. For the sulfonephthaleins, the monosodium salt is the acid, and the disodium salt is the alkaline form. These authors emphasize especially the use of

¹ H. T. Stern: J. Biol. Chem., 65, 675 (1925).

² W. H. Pierre and J. F. Fudge: J. Am. Chem. Soc., 50, 1254 (1928).

³ E. H. Fawcett and S. F. Acree: J. Bact., 17, 163 (1929).

⁴ I. M. Kolthoff and T. Kameda: J. Am. Chem. Soc., 53, 825 (1931).

very pure indicators and suggest that their purity be tested by conductimetric titration or by a melting point determination (cf. Chapter Five, page 124).

Sulfonephthaleins. (a) 100 mg. of indicator are dissolved in an equivalent amount of sodium hydroxide and diluted to 100 c.c. with water (cf. table on page 110; solution of monosodium salt; acid form).

(b) To 100 mg. of indicator are added double the equivalent quantity of sodium hydroxide and the solution diluted to 100 c.c. (alkaline form).

Methyl red. (a) 0.1% solution in 70% alcohol (acid form).

(b) 0.1% solution in 50% alcohol, to which is added an equivalent amount of alkali (cf. table, page 110; alkaline form).

Phenolphthalein. (a) 0.1% solution in 50% alcohol, to which is added one equivalent of alkali (acid form).

(b) 0.1% solution in 50% alcohol, to which is added twice the equivalent amount of alkali (alkaline form; to be prepared fresh).

Stability of indicator mixtures. Mixtures of the two forms of an indicator show a pH variation with time of standing. It is advisable, therefore, to prepare new solutions every two or three days, especially when they are to be used for unbuffered solutions. The mixtures may be kept for fourteen days if the solution under investigation has even a very slight buffer action.

Choosing a suitable indicator mixture. A mixture containing 50% of both alkaline and acid forms is prepared and the pH is determined in the usual manner after addition of 0.05, 0.2, and 0.4 c.c. of indicator. If the pH's are found to decrease as the indicator concentration grows, it is evident that the indicator mixture is too acid and a new mixture is prepared to contain 25% of the acid form and 75% of the alkaline. Had the first indicator preparation turned out to be too alkaline, the second mixture would have contained 75% of the acid and only 25% of the alkaline form. Usually the correct mixture is found after two series of measurements.

Measurement of the pH of pure water and of neutral salt solutions. I. M. KOLTHOFF and T. KAMEDA¹ have developed a simple technique for measuring the pH of pure water and of neutral salt solutions. Conductivity water was distilled in a quartz apparatus, first over dilute sulfuric acid to remove volatile bases and

¹ I. M. Kolthoff and T. Kameda: J. Am. Chem. Soc., 53, 825 (1931).

then twice in the absence of reagents. The first and last fractions (a fourth each) of distillate were discarded and the main body of liquid was protected against acid and alkaline gases present in air. The water was siphoned into glass-stoppered

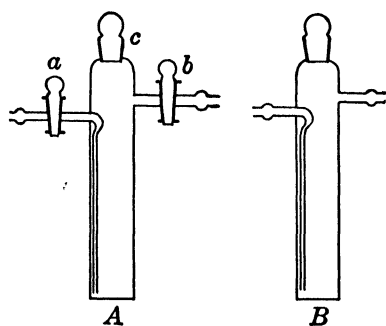

FIG. 22

pyrex glass cylinders constructed as shown in Fig. 22A. By means of stopcocks *a* and *b*, carbon dioxide free air was drawn for a time through the liquid; thereupon a definite volume of water or neutral salt solution was introduced through *c*, and the flow of carbon dioxide free air continued until the liquid was completely free of dioxide. A measured quantity of

indicator was added through *c*, the stopper replaced, and the stopcocks *a* and *b* closed. An equal volume of buffer solution was treated with the same amount of indicator and the colorimetric measurement performed in the usual manner. The buffer solution need not be protected against atmospheric air so that, as shown in Fig. 22B, the glass cylinder used for the buffers was not provided with stopcocks. The proper indicator mixture was found as already described.

The reliability of the method is illustrated by results taken from the report of KOLTHOFF and KAMEDA. It is clear from the table that a 100 : 55 bromthymol mixture and a 100 : 10 phenol red mixture are isohydric with pure water.

COLORIMETRIC DETERMINATION OF pH IN 15 C.C. OF WATER (25°)

INDICATOR	RATIO [HI ⁻]/[I ⁻]	pH FOUND WITH DIFFERENT AMOUNTS OF INDICATOR ^a		
		0.1 c.c.	0.3 c.c.	0.5 c.c.
Bromthymol blue	96 : 4	6.62	6.50	6.20
“ “	100 : 55	7.03	7.00	7.01
“ “	4 : 96	7.93	8.05	8.25
Phenol red	99 : 1	6.70	6.60	6.50
“ “	100 : 10	7.03	7.05	7.07
“ “	1 : 99	8.55	8.55	9.00

^a The quantity 0.25 is added to the experimentally determined pH values as a correction for the difference in ionic strength between water and the buffer solution (cf. the next section).

It should be noted that pure water and neutral salt solutions are very sensitive to traces of carbon dioxide present in the air. Removal of the stopper for a minute after the water is freed of carbon dioxide will result in a pH of 6.85 instead of 7.00. The pH changes from 7.00 to 6.35 when the water is poured from one container into another.

Several determinations of the pH of a 0.05 molar potassium chloride solution in pure water are reported in the table below.

COLORIMETRIC DETERMINATION OF pH IN 15 C.C. OF 0.05 MOLAR POTASSIUM CHLORIDE SOLUTION (25°)

INDICATOR	RATIO [HI ⁻]/[I ⁻]	pH FOUND WITH DIFFERENT AMOUNTS OF INDICATOR ^a		
		0.1 c.c.	0.3 c.c.	0.5 c.c.
Bromthymol blue	100 : 55	6.77	6.77	6.77
Phenol red	100 : 10	6.78	6.75	6.75

Hydrogen electrode^b 6.70–6.77.

^a No correction for the "salt error."

^b Adapted for unbuffered solutions; cf. I. M. Kolthoff and T. Kameda: *J. Am. Chem. Soc.*, 53, 821 (1931).

Measurements of pH in extremely dilute solutions of strong bases are extremely difficult because of the sensitivity of such solutions to carbon dioxide. Obviously one must employ isohydric indicator solutions. The author has proceeded in the following manner. To carbon dioxide free water in the cylinder shown in Fig. 22 were added in rapid succession dilute alkali from a micro burette and then the indicator mixture. The pH was calculated from the known hydroxyl ion concentration by

$$\text{pH} = 14.00 - \text{pOH}. \quad (24^\circ \text{C.})$$

The measurements were carried out with thymol blue and phenolphthalein as indicators.

The following table indicates that with phenolphthalein and thymol blue the pH of extremely dilute solutions of bases can be determined to within 0.1 unit. From their extensive researches, J. W. McBAIN, O. E. DUBOIS, and K. G. HAY,¹ and J. W. McBAIN, M. E. LAING, and O. E. CLARK² concluded that

¹ J. W. McBain, O. E. Dubois, and K. G. Hay: *J. Gen. Physiol.*, 9, 461 (1926).

² J. W. McBain, M. E. Laing, and O. E. Clark: *J. Gen. Physiol.*, 12, 695 (1929).

COLORIMETRIC pH DETERMINATION IN 15 C.C. OF EXTREMELY DILUTE SODIUM HYDROXIDE SOLUTIONS (25°)

INDICATOR	RATIO [III ⁻]/[I ⁻]	pH FOUND WITH DIFFERENT AMOUNTS OF INDICATOR ^a			
		0.1	0.3	0.5	pH Calculated
Phenolphthalein	99 : 1	9.30	9.30	9.30	9.22
"	70 : 30	9.32	9.42	9.50	9.22
"	60 : 40	9.40	9.50	9.60	9.22
Thymol blue	30 : 70	9.25	9.25	9.25	9.22
" "	50 : 50	9.25	9.15	9.10	9.22
Phenolphthalein		9.30	9.28		9.22
"		9.45			9.47
"		9.73			9.82
"		9.87			10.00
"		10.05			10.12

^a The quantity 0.25 is added to the experimental pH's as a correction for the difference in the ionic strengths of the liquid and the buffer solution.

phenol red, *o*-cresol red, phenolphthalein, and thymol blue were not suited for the measurement of pH of exceedingly dilute electrolyte solutions because they permit errors as great as 1-2 pH units. The results reported in the above table, however, show that the indicators may be used if the *proper ratio* is employed.

Results of measurements of the pH of slightly hydrolyzed zinc sulfate solutions are contained in the accompanying table. The determinations were made both with the hydrogen electrode and with isohydric methyl red solutions.¹

pH OF ZINC SULFATE SOLUTIONS AT 25°

MOLAR CONCENTRATION OF ZnSO ₄	pH H ₂ -ELECTRODE	pH ISOHYDRIC METHYL RED
0.01	6.00	6.00
0.02	5.89	5.90
0.05	5.76	5.77
0.1	5.67	5.66

Distilled water. Distilled water in equilibrium with air contains a small amount of atmospheric carbon dioxide and has therefore an acid reaction. Normal air contains approximately 0.03 volume per cent of carbon dioxide. The distribution coeffi-

¹ I. M. Kolthoff and T. Kameda: J. Am. Chem. Soc., 53, 832 (1931).

cient of carbon dioxide between a gas space and water is about 1. Consequently water in equilibrium with air contains 0.03% of the dioxide by volume, or 0.0000135 mole of acid per liter. Since the first dissociation constant of carbonic acid is 3×10^{-7} , then the concentration of hydrogen ions in "equilibrium water" is

$$[\text{H}^+] = \sqrt{1.35 \times 10^{-6} \times 3 \times 10^{-7}} = 2 \times 10^{-6},$$

or

$$\text{pH} = 5.7.$$

A value between 5.7 and 5.8 actually was found with isohydric methyl red.

Ordinary distilled water is apt to contain more carbon dioxide than corresponds to equilibrium with air, frequently as much as 2.5×10^{-4} molar. If water is allowed to stand exposed to air but protected against dust for longer than a week, equilibrium is practically attained. This condition is realized more quickly by bubbling through the water for ten hours air washed by acid and water. If the water so obtained shows a pH less than 5.7 with isohydric methyl red, acid impurities other than carbonic acid are responsible. A pH greater than 5.9 indicates the presence of basic contamination.

2. The salt or electrolyte effect. The salt error.

Whereas the acid or base error of indicators can be eliminated by proper experimental conditions, the influence of electrolytes can not be avoided experimentally. The effect of electrolytes can be traced in general to two causes:

1. The salt *changes the optical absorption* of one or both indicator forms. Not only is the color intensity affected but also the color itself is altered due to a displacement of the absorption maximum to longer or shorter wavelengths. It is frequently impossible to compare the color of an indicator in an ordinary buffer mixture with its color in a solution containing considerable salt. This phenomenon is observable even with the naked eye in the case of nitrophenols. When increasing quantities of a neutral salt are added to a completely alkaline solution of *p*- or *m*-nitrophenol, the color intensity of the solutions increases. This interfering action of salt is evident likewise with thymol blue in the acid transformation region. Addition of increasing

amounts of salt is accompanied by a diminution in color intensity and produces a shift of the color towards pure red. The color intensity of thymol blue (red) and tropeolin 00 (red) in 0.1 N salt solutions is about 20–30 per cent less than in very dilute acid solution free from salt. The relative decrease in intensity is no longer so great at higher salt concentrations. THIEL¹ has already shown that the effect of salt upon the absorption spectrum must be taken into account. The investigations of VON HALBAN and EBERT² and of J. EISENBRAND³ concerning the behavior of the nitrophenols are especially noteworthy.

For ordinary colorimetric pH measurements it has been ascertained that the effect of salt upon the absorption of light by indicators is negligible in many cases at electrolyte concentrations below 0.5 N. In order to determine the indicator color equilibrium at higher salt concentrations, one must resort to the spectrophotometric method by means of which the absorption curve is compared with that of the completely acid and alkaline form of the indicator in an equal electrolyte concentration. It is also feasible to prepare buffer mixtures which contain the same salt concentration and composition which characterizes the solution being studied. Since the pH of the buffers themselves changes with addition of salt (cf. pages 67 and 269), it is necessary to determine the degree of acidity of each mixture independently with the hydrogen electrode. The bicolorimeter (Chapter Nine, § 4) may also be used for this determination, the completely acid and alkaline comparison solutions being prepared with the same salt content as the unknown solution.

2. *Displacement of the equilibrium between both indicator forms by addition of electrolyte.* It is usually assumed in colorimetric determinations of pH that two solutions containing the same indicator will have the same color if the hydrogen ion activity is equal. S. P. L. SÖRENSEN⁴ reported long ago that indicator acids and bases in solutions with a very high electrolyte content

¹ A. Thiel, A. Dassler, and F. Wülfken: *Fortschritte Chem., Physik, physik. Chem.*, 18, 3 (1924). Cf. also Günther Coch: *Diss. Marburg*, 1930.

² H. von Halban and L. Ebert: *Z. physik. Chem.*, 112, 321 (esp. 352, 359) (1924).

³ H. von Halban and J. Eisenbrand: *Z. physik. Chem.*, 132, 401, 433 (1928), 133, 476 (1928), 134, 334 (1928). J. Eisenbrand and H. von Halban: *Z. physik. Chem.*, A146, 30, 101, 111 (1930); see also F. Vlès and M. Gex: *Compt. rend.*, 185, 946 (1927).

⁴ S. P. L. Sørensen: *Biochem. Z.*, 21, 159 (1909).

yield erroneous results when compared with buffers containing but little salt. Thus indicator acids give too basic a reaction while indicator bases appear to be too acid.

This puzzling salt effect is explained readily by the activity theory, which may even be used to calculate the effect quantitatively at very low electrolyte concentrations.¹ The color of an indicator is governed by the ratio of the *concentrations* of the acid and alkaline forms whereas the indicator equilibrium is determined by a ratio of *activities* of these forms. Let us consider the case of a monobasic indicator acid HI.

The following expression is valid for a given hydrogen ion activity:²

$$\frac{[a\text{HI}]}{[a\text{I}^-]} = \frac{f_0[\text{HI}]}{f_1[\text{I}^-]} = \frac{[a\text{H}^+]}{K_I'}, \quad (12)$$

where f_0 is the activity coefficient of the undissociated acid and f_1 that of the indicator anion, while $[a\text{H}^+]$ is the hydrogen ion activity and K_I' is the dissociation constant of the indicator. Equation (12) may be rearranged to show clearly the factors which determine the color of the indicator:

$$\frac{[\text{HI}]}{[\text{I}^-]} = \frac{[a\text{H}^+]}{K_I'} \frac{f_1}{f_0}. \quad (12a)$$

It was seen in Chapter Three that the activity coefficient (f_1) of a monovalent ion first diminishes as electrolyte concentration increases until, at a certain ionic strength, it reaches a minimum the position of which depends upon the nature of the monovalent ion itself as well as upon the nature of other ions present. The value of f_0 rises slowly with increasing electrolyte concentration, but we shall disregard this effect for the present.

Let us assume next that a monobasic indicator acid has been added to two different buffer solutions characterized by the same hydrogen ion activity but having ionic strengths of 0.001 and 0.1 respectively. In the latter solution f_1 is smaller than in the buffer mixture of ionic strength 0.001, with the consequence

¹ J. N. Brönsted: J. Chem. Soc., 119, 574 (1921).

² It is generally assumed that measurements with the hydrogen electrode yield the hydrogen ion activity. That this is only approximately true can be seen from pages 75 and 76.

that the ratio $[\text{HI}]/[\text{I}^-]$ in (12) is smaller at an ionic strength of 0.1 than at 0.001 although both solutions have the same hydrogen ion activity. Evidently the color of the indicator is not the same in both solutions, being shifted towards the acid side of the transformation interval in media with small ionic strengths. The opposite effect is found with indicator bases.

It is customary in colorimetric pH determinations to use as comparison solutions buffer mixtures with an ionic strength of 0.05–0.1. When the color of an indicator in a solution being investigated is identical with that of a buffer mixture, both liquids will have the same $pa\text{H}$ if they have also the same ionic strength (and really also the same kind of ions). Should the unknown solution have an ionic strength less than that of the buffer mixture, colorimetric measurements with an indicator acid will yield too low a $pa\text{H}$. A correction corresponding to the difference in the ionic strengths of both solutions must be added to this experimentally determined value. The quantity added is called the *salt correction*, and depends as a first approximation upon the difference in ionic strengths of the experimental and comparison solutions.

The correction can be calculated approximately from the Debye-Hückel theory. Considering again a monobasic indicator acid in two solutions having the same hydrogen ion activity but differing in ionic strength, we have from (12) that

$$\left(\frac{f_0}{f_1}\right)_1 \left(\frac{[\text{HI}]}{[\text{I}^-]}\right)_1 = \left(\frac{f_0}{f_1}\right)_2 \left(\frac{[\text{HI}]}{[\text{I}^-]}\right)_2. \quad (13)$$

It can be shown from (12) and (13) that the difference in $[\text{HI}]/[\text{I}^-]$ ratios between the solutions corresponds to a difference of

$$\Delta p\text{H} = + \log \left(\frac{f_0}{f_1}\right)_1 - \log \left(\frac{f_0}{f_1}\right)_2. \quad (14)$$

The above calculations may be repeated for dibasic indicator acids such as phenolphthalein and the sulfonephthaleins. For these substances we have

$$\frac{[\text{HI}^-]}{[\text{I}^-]} = \frac{[a\text{H}^+] f_2}{K_1 f_1}, \quad (15)$$

in which f_2 is the activity coefficient of the divalent and f_1 that of the monovalent indicator anion. We see here that

$$\Delta\text{pH} = + \log \left(\frac{f_1}{f_2} \right)_1 - \log \left(\frac{f_1}{f_2} \right)_2. \quad (16)$$

The ratio $f_1 : f_2$ in (16) increases with larger salt concentrations much more rapidly than the corresponding $f_0 : f_1$ ratio in (14). Hence the *salt error* of dibasic indicator acids is much greater than of monobasic acids (such as the nitrophenols). Indicator bases may be treated in analogous fashion.

The above discussion leads us to expect that the benzeins will have a smaller salt error than the corresponding sulfonephthaleins.

For solutions in which the salt content is not too high, the activity coefficient can be computed from the DEBYE-HÜCKEL expression:

$$- \log f = \frac{0.5z^2\sqrt{\mu}}{1 + 0.329 \times a \times 10^8\sqrt{\mu}},$$

in which z denotes the valence of the indicator form under consideration, a the ionic diameter, and μ the total ionic strength (cf. page 56). If we assume that f_0 of all indicator acids increases in the same manner with growing electrolyte content, and that all of these substances have the same ionic diameter, then the same salt error should be expected at not too high a concentration of electrolyte. The salt error of dibasic indicator acids is about three times as great since

$$- \log \frac{f_1}{f_2} = \frac{1.5\sqrt{\mu}}{1 + 0.329 \times a \times 10^8\sqrt{\mu}}.$$

At smaller ionic strengths ($\mu < 0.05$) the influence of the ionic diameter may be neglected for all practical purposes. Thus we may expect all dibasic indicator acids to have the same salt error in dilute electrolyte solutions *provided that the buffers used in the pH measurement all have the same ionic strength and contain the same kind of ions*. The buffer solutions in colorimetric pH determinations are, however, always considered as standards, and the pH of the buffer solution is taken as a standard value. Hence it follows immediately that the *sign* of the *salt correction* will be

changed by the ionic strength of the buffer. If the sign happens to be positive for an indicator acid at smaller ionic strengths, it will be negative (up to a maximum value) at greater ionic strengths.

The salt correction may be calculated quantitatively with the help of the DEBYE-HÜCKEL expression. However, certain factors operating especially at higher ionic strengths tend to produce deviations between the calculated and experimentally determined values. These factors are enumerated below.

(a) The ionic diameter a is unknown.

(b) The specific interaction between the anions and cations¹ as well as the salting out effect of electrolytes upon the indicator ions must be considered.

(c) It is uncertain whether the indicator salt behaves as an ideal electrolyte, i.e. whether it is completely dissociated into ions. N. BJERRUM² had attempted to explain the salt error on the basis of incomplete dissociation, before the development of the modern theory of strong electrolytes.

(d) As has already been discussed, the absorption spectrum of the indicator forms may be changed at higher ionic strengths.

For these reasons the calculated salt error is erroneous especially at high ionic strengths, and we must content ourselves with the results of empirical measurements. The agreement between the calculated and experimentally determined values, however, is satisfactory at low ionic strengths. One should always remember that *the salt correction depends not only upon the ionic strength but upon the nature of the buffer solution used for comparison as well. Workers in this field should make it a point to mention in their reports the kind and composition of the buffers they employ.*

The indicator corrections. The author³ has determined experimentally indicator corrections under various conditions. In the following tables a positive sign indicates that the correction must be added to the experimentally determined value while a minus sign means that the correction must be subtracted.

¹ J. N. Brönsted: Trans. Faraday Soc., 77, 416 (1927).

² N. Bjerrum: Die Theorie der alkalimetrischen und acidimetrischen Titrierungen, Stuttgart, 1914.

³ I. M. Kolthoff: J. Phys. Chem., 32, 1820 (1928).

In these tables are to be found a description of the particular electrolyte media employed as well as the ionic strengths at which salt errors were determined.

Methyl orange. The citrate buffers of KOLTHOFF and VLEESCHOUWER were used as comparison solutions instead of the biphthalate buffer mixtures which exert ¹ a specific influence on methyl orange.

SALT CORRECTION OF METHYL ORANGE IN CITRATE SOLUTIONS

CONCENTRATION OF MONOPOTASSIUM CITRATE	IONIC STRENGTH	SALT CORRECTION
0.25 Molar	0.25	+0.02
0.1 "	0.1	-0.03
0.05 "	0.05	-0.02
0.01 "	0.01	-0.02
0.002 "	0.002	-0.04
0.001 "	0.001	-0.04

SALT CORRECTION OF METHYL RED IN CITRATE SOLUTIONS, ALSO IN THE PRESENCE OF NEUTRAL SALTS (COMPARED WITH THE BUFFER SOLUTIONS OF CLARK)

NORMALITY OF THE CITRATE MIXTURE (ALKALI CONCENTRATION)	IONIC STRENGTH	SALT CORRECTION
0.5	0.9	+0.04
0.1	0.18	-0.03
0.05	0.090	-0.03
0.025	0.045	-0.01
0.01	0.018	+0.02
0.005	0.009	-0.02
0.01+0.5 N KCl	0.52	+0.05
0.01+0.5 N NaCl	0.52	-0.08
0.01+0.5 N KI	0.52	+0.13
0.01+0.5 N KNO ₃	0.52	+0.08

Aside from methyl orange and methyl red, thymol blue (in the acid region pH 1.3-2.8) and tropeolin 00 also have negligible salt errors. Clearly the indicators *thymol blue* (pH 1.3-2.8), *tropeolin 00*, *methyl orange*, and *methyl red* are unusually well suited for the colorimetric determination of *paH* because they yield reliable results, at not too high ionic strengths, which need not be corrected.

¹ I. M. Kolthoff: *Rec. trav. chim.*, 45, 433 (1926).

SALT CORRECTION OF SODIUM ALIZARINE SULFONATE, BROMCHLORPHENOL BLUE, BROMPHENOL BLUE, BROMCRESOL GREEN, AND α -DINITROPHENOL. MEASURED IN SODIUM-POTASSIUM CITRATE MIXTURES (COMPARED WITH THE BUFFER SOLUTIONS OF CLARK)

NORMALITY OF THE CITRATE SOLUTION	IONIC STRENGTH	SALT CORRECTION FOR				
		Alizarine Sulfonate	Bromchlorphenol Blue	Bromphenol Blue	Bromcresol Green	α -Dinitrophenol
0.5	0.667	-0.26	-0.13	-0.11	-0.04	-0.15
0.1	0.133	-0.12	-0.02	-0.10	-0.05	
0.05	0.0667	0.00	0.00	0.00	+0.01	
0.025	0.0333	+0.03	+0.03	+0.03	0.00	0.00
0.01	0.0133	+0.12	+0.10	+0.08	+0.10	
0.005	0.0067	+0.11	+0.15	+0.08	+0.10	+0.17
0.0025	0.0033	+0.15	+0.20	+0.07	+0.15	
0.01+0.5 N KCl	0.51	-0.35	-0.18	-0.15	-0.17	-0.15
0.01+0.5 N NaCl	0.51	-0.43	-0.23	-0.23	-0.21	-0.23
0.01+0.5 N KNO ₃	0.51	-0.34	-0.14	-0.14	-0.11	
0.01+0.5 N KI	0.51	—	-0.12	-0.12	-0.08	

SALT CORRECTION OF CHLORPHENOL RED, BROMCRESOL PURPLE, AND *p*-NITROPHENOL IN CITRATE SOLUTIONS (COMPARED WITH THE BUFFER SOLUTIONS OF CLARK)

NORMALITY OF THE CITRATE SOLUTION	IONIC STRENGTH	SALT CORRECTION FOR		
		Chlorphenol Red	Bromcresol Purple	<i>p</i> -Nitrophenol
0.5	0.9	-0.06	-0.21	+0.06
0.1	0.18	-0.02	-0.05	-0.03
0.05	0.09	+0.03	+0.03	+0.01
0.025	0.045	+0.09	+0.09	+0.03
0.01	0.018	+0.15	+0.17	+0.02
0.005	0.009	+0.17	+0.17	0.00
0.0025	0.0045	+0.18	+0.18	+0.05
0.01+0.5 N KCl	0.52	-0.11	-0.23	-0.13
0.01+0.5 N NaCl	0.52	-0.16	-0.31	-0.16
0.01+0.5 N KI	0.52	-0.09	-0.22	—
0.01+0.5 N KNO ₃	0.52	-0.04	-0.17	-0.12

SALT CORRECTION OF β -DINITROPHENOL, HEXAMETHOXYTRIPHENYLCARBINOL, AND BROMPHENOL BLUE IN MONOPOTASSIUM CITRATE (COMPARED WITH THE BUFFER SOLUTIONS OF CLARK)

CONCENTRATION OF MONOPOTASSIUM CITRATE	IONIC STRENGTH	SALT CORRECTION FOR		
		β -Dinitrophenol	Hexamethoxy Red	Bromphenol Blue
0.25	0.25	-0.51	+0.19	-0.13
0.1	0.1	-0.08	+0.12	-0.07
0.05	0.05	-0.07	+0.03	-0.02
0.01	0.01	-0.02	-0.07	+0.05
0.002	0.002	+0.01	-0.04	+0.07
0.001	0.001	+0.09	-0.05	+0.06

SALT CORRECTION OF BROMTHYMOL BLUE, PHENOL RED, AND NEUTRAL RED IN PHOSPHATE SOLUTIONS (WITH OR WITHOUT NEUTRAL SALT). (COMPARED WITH PHOSPHATE BUFFERS OF CLARK)

COMPOSITION OF SOLUTION (CLARK'S PHOSPHATE BUFFER pH = 7.00)	IONIC STRENGTH	SALT CORRECTION FOR		
		Bromthymol Blue	Phenol Red	Neutral Red
2-fold dilution	0.055	+0.04	+0.02	-0.02
5 " "	0.022	+0.07	+0.08	-0.04
10 " "	0.011	+0.11	+0.11	-0.05
20 " "	0.0055	+0.12	+0.13	-0.06
50 " "	0.0022	+0.14	+0.14	-0.06
5 " " +0.25 N KCl	0.27	-0.17	+0.17	
5 " " +0.5 N KCl	0.52	-0.20	-0.20	+0.07
5 " " +0.5 N KBr	0.52	-0.20	-0.21	+0.13
5 " " +0.5 N KI	0.52	-0.29	-0.19	
5 " " +0.25 N NaCl	0.27	-0.19	-0.20	+0.05
5 " " +0.5 N NaCl	0.52	-0.28	-0.29	

It is evident from the preceding table that the salt correction of neutral red is very small.

SALT CORRECTION OF PHENOLPHTHALEIN AND THYMOL BLUE IN 0.25 MOLAR BORAX SOLUTIONS AND AT GREATER DILUTIONS (COMPARED WITH THE BORATE BUFFER SOLUTIONS OF CLARK)

BORAX CONCENTRATION. MOLAR	IONIC STRENGTH	SALT CORRECTION FOR	
		Phenolphthalein	Thymol Blue
0.25	0.5	-0.24	-0.22
0.1	0.2	-0.07	-0.05
0.05	0.1	-0.05	-0.03
0.01	0.02	+0.06	+0.05
0.005	0.01	+0.08	+0.08
0.0025	0.005	+0.14	+0.11

SALT CORRECTION OF THYMOLPHTHALEIN, ALIZARINE YELLOW, AND SALICYL YELLOW IN AN EQUIMOLECULAR MIXTURE OF SODIUM CARBONATE AND SODIUM BICARBONATE (COMPARED WITH SODIUM CARBONATE-BORATE BUFFER SOLUTIONS)

IONIC STRENGTH OF THE CARBONATE SOLUTION	SALT CORRECTION FOR		
	Thymolphthalein ^a	Alizarine Yellow	Salicyl Yellow
1.0	(+0.15)	-0.43	-0.40
0.5	(+0.07)	-0.28	-0.26
0.2	-0.03	-0.19	-0.18
0.1	+0.04	-0.10	-0.16
0.05	+0.04	-0.02	-0.06
0.02	+0.12	+0.02	+0.02
0.01	+0.14	+0.10	+0.06
0.02+0.1 N KCl	-0.01	-0.16	—
0.02+0.5 N KCl	-0.16	-0.57	-0.52
0.02+0.5 N NaCl	—	-0.58	-0.54

^a Measure rapidly; indicator separates out; not especially suited for colorimetric measurements.

Alizarine yellow and salicyl yellow must be used with discretion because they show a very large salt error. It would be exceedingly desirable to have available better indicators for measuring the pH in the alkaline region (10-13).

The salt errors of the most important indicators are summarized in the succeeding table. It is assumed here that the comparisons were all made with buffer solutions having an ionic strength of 0.1, as is usually the condition obtaining in practice. If the ionic strength deviates considerably from this value, the

SALT CORRECTION OF INDICATORS AT VARIOUS IONIC STRENGTHS, DETERMINED BY COMPARISON WITH BUFFERS HAVING AN IONIC STRENGTH OF 0.1

IONIC STRENGTH	T B ^a	Trop. 00	M.O.	B P B	B C G	M.R.	C.P.R.	p-N.P.	B T B	P R.	N.R.	Phpht.	T.B. ^b
0.0025			-0.04	+0.15	+0.21	0.00	+0.15	+0.06	+0.14	+0.14	-0.07		
0.005			-0.04	+0.14	+0.18	0.00	+0.15	+0.05	+0.12	+0.12	-0.06	+0.18	+0.16
0.01	0.00	0.00	-0.02	+0.14	+0.16	0.00	+0.18	+0.03	+0.11	+0.11	-0.05	+0.12	+0.12
0.02	0.00	0.00	0.00	+0.13	+0.14	0.00	+0.12	+0.02	+0.07	+0.07	-0.04	+0.10	+0.09
0.05	0.00	0.00	0.00	+0.10	+0.05	0.00	+0.05	+0.01	+0.04	+0.04	-0.02	+0.05	+0.05
0.1	0.00	0.00	0.00	0.00	0.00	0.00	0.00	0.00	0.00	0.00	0.00	0.00	0.00
0.5 (KCl)	0.00	0.00	0.00	-0.10	-0.12	0.00	-0.16	-0.18	-0.20	-0.20	+0.07	-0.26	-0.12
0.5 (NaCl)	0.00	0.00	0.00	-0.18	-0.16	0.00	-0.19	-0.19	-0.28	-0.29	-0.12	-0.21	-0.19

T.B. = Thymol blue
Trop. 00 = Tropoeolin 00
M.O. = Methyl orange
B.P.B. = Bromphenol blue
B.C.G. = Bromeresol green
M.R. = Methyl red
C.P.R. = Chlorphenol red
p-N.P. = p-Nitrophenol
B.T.B. = Bromthymol blue
P.R. = Phenol red
N.R. = Neutral red
Phpht. = Phenolphthalein

^a In acid range.
^b In alkaline range.

DEBYE-HÜCKEL equation may be used to apply ¹ a corresponding correction for the deviation.

J. B. SENDROY and A. B. HASTINGS ² have determined systematically the influence of KCl, NaCl, K₂SO₄, Na₂SO₄, CaCl₂, and MgCl₂ on the color of bromcresol green, bromcresol purple, and phenol red at ionic strengths up to 0.2 (and from these observations derived the pK_I values reported on page 289). Thorough and beautiful experiments dealing with the salt error of methyl orange and methyl yellow at high salt concentrations have been reported by E. GÜNTEMBERG and E. SCHIÖDT.³

The use of the table. Suppose that the pH of an acetic acid-acetate mixture with a total salt concentration of 0.005 is found colorimetrically to be 4.8, using ordinary buffer solutions and bromcresol green as indicator. Accordingly the corrected pH is $4.8 + 0.18 = 4.98$. Next let us consider a very dilute acetate mixture which is treated with NaCl to make it 0.5 N with respect to salt. Suppose that again a pH of 4.8 is found colorimetrically (with B.C.G.). In this instance the corrected value is $4.8 - 0.16 = 4.64$.

Congo red, azolitmin, and litmus must be rejected as indicators for colorimetric pH determinations because of their very large salt error. The author has found, for example, that the salt error of congo red in 0.5 N sodium chloride is -0.5 , and -1.0 in 1 N NaCl solutions. Azolitmin in 0.5 N NaCl has an error of -0.55 .

SÖRENSEN ⁴ states that the triphenylmethane dyes also show a pronounced salt error. However, metanil yellow extra (diazosulfonic acid indicator) is serviceable. SÖRENSEN examined three 0.01 N hydrochloric acid solutions with methyl violet, mauveine, methyl green, and metanil yellow extra. Solution A contained only acid, B contained in addition 0.1 N KCl, whereas C was 0.3 N with respect to this salt. The pH's measured colorimetrically with each of these four indicators are compared with those determined electrometrically and with the values calculated from the nature of the three solutions. These findings are summarized in the following table.

¹ I. M. Kolthoff: J. Phys. Chem., *32*, 1820 (1928).

² J. B. Sendroy and A. B. Hastings: J. Biol. Chem., *82*, 197 (1929).

³ E. Güntelberg and E. Schiödt: Z. physik. Chem., *135*, 393 (1928).

⁴ S. P. L. Sørensen: Biochem. Z., *21*, 131 (1909).

	pH IN		
	A	B	C
Calculated	2.02	2.04	2.06
Electrometrically	2.01	2.01	2.05
Colorimetrically with methyl violet	2.22	2.04	1.91
" " mauveine	2.22	2.04	1.91
" " methyl green	2.28	2.05	1.89
" " metanil yellow extra	1.99	2.04	2.04

SÖRENSEN and PALITZSCH¹ have determined the pH of sea water both colorimetrically and with a hydrogen electrode. They find that the following corrections must be applied to the colorimetric method:

(a) *p*-Nitrophenol: Comparison solution phosphate mixture (SÖRENSEN).

3.5% salt.....	-0.12
2.0% "	-0.08

(b) Neutral red: Comparison solution phosphate mixture (SÖRENSEN).

3.5% salt.....	+0.10
2.0% "	+0.05

(c) α -Naphtholphthalein: Comparison solution phosphate mixture (SÖRENSEN).

3.5% salt.....	-0.16
2.0% "	-0.11

(d) Phenolphthalein: Comparison solution borax mixture (SÖRENSEN).

3.5% salt.....	-0.21
2.0% "	-0.16

These figures constitute the necessary corrections. If a solution containing 3.5% of salt is found to have a pH = 8.4 with phenolphthalein as indicator, the true value is 8.19.

The same investigators have determined also the salt error at very small salt concentrations. In this case the error may be positive and negative (cf. page 338). In judging their data, one

¹S. P. L. Sørensen and S. Palitzsch: Compt. rend. trav. lab. Carlsberg, 10, 252 (1911).

should remember that the salt error refers to the particular SÖRENSEN buffer mixtures employed.

The salt error of neutral red in salt concentrations less than 2.0% was found to be negligible, in contrast to the case of phenolphthalein and α -naphtholphthalein. The following corrections were derived graphically from the results of SÖRENSEN and PALITZSCH.

SALT CONTENT %	CORRECTION FOR	
	α -Naphtholphthalein	Phenolphthalein
0	+0.22	+0.22
0.2	+0.10 (phosphate buffer) +0.04 (borax buffer)	0.00
0.4	+0.06 (phosphate buffer) -0.02 (borax buffer)	-0.04
1.0	-0.03 (phosphate buffer) -0.09 (borax buffer)	-0.10
2.0	-0.17 (phosphate buffer) -0.10 (borax buffer)	-0.16

McCLENDON¹ determined the salt error of *o*-cresolsulfonephthalein and α -naphtholphthalein in mixtures of boric acid and borax with total salt concentrations as high as 0.6 N. When the salt content reaches 0.5 N, the salt correction amounts to about -0.05, and at 0.6 N salt the correction is -0.1.

The salt error of cresol red as determined by W. D. RAMAGE and R. C. MILLER² agrees with the values of WELLS.³ They present the accompanying table. These data refer to measurements with ordinary buffer mixtures which are 0.06-0.1 N with respect to salt.

SALT ERROR OF CRESOL RED (RAMAGE AND MILLER)

SALT CONTENT IN GRAMS PER LITER	SALT ERROR
5.0	-0.11
10.0	-0.16
15.0	-0.22
25.0	-0.25
30.0	-0.26
35.0	-0.27

¹ J. F. McClendon: J. Biol. Chem., 30, 265 (1917).

² W. D. Ramage and R. C. Miller: J. Am. Chem. Soc., 47, 1230 (1925).

³ R. C. Wells: J. Am. Chem. Soc., 42, 2160 (1920).

C. L. BRIGHTMAN, M. R. MEACHEM, and S. F. ACREE¹ have measured the salt error of phenol red spectrophotometrically. Their results do not agree with the measurements of the author, especially at a low salt content. They appear to have neglected the acid error of the indicator.

L. B. PARSONS and W. F. DOUGLAS² have determined the salt error of various indicators in very high salt concentrations. Comparisons were made with Clark buffers.

SALT ERROR IN CONCENTRATED SODIUM CHLORIDE SOLUTIONS (PARSONS AND DOUGLAS)

	CONCENTRATION OF SODIUM CHLORIDE		
	1 Molar	2 Molar	3 Molar
Thymol blue (acid region)	-0.10	-0.13	-0.12
Methyl red	-0.04	-0.01	+0.12
Bromphenol blue	-0.28	-0.37	-0.43
Bromcresol green	-0.26	-0.31	-0.29
Bromcresol purple	-0.26	-0.33	-0.31
Bromthymol blue	-0.19	-0.27	-0.29
Phenol red	-0.21	-0.26	-0.29
Cresol red	-0.28	-0.32	-0.37
Thymol blue (alkaline region)	-0.22	-0.29	-0.34

For bromthymol blue, J. T. SAUNDERS³ finds, by comparison with Sørensen buffers, a salt error of -0.19 when the medium is 0.6 N with respect to NaCl . The error becomes $+0.20$ at a total electrolyte concentration of 0.003 N . The errors which SAUNDERS finds for thymol blue, phenol red, cresol red, bromthymol blue, and bromcresol purple in salt concentrations below 0.1 N are in accord with the measurements of the author (cf. above pages 340 to 342).

The following figure shows a curve which SAUNDERS uses to obtain the salt error of cresol red. The curve is a plot of the pH variation with change in salt content, the *color of the indicator remaining unaltered*. The correction is found from this curve quite simply if the salt contents of the unknown and of the buffer mixture are known. By way of illustration we may consider a

¹ C. L. Brightman, M. R. Meachem, and S. F. Acree: *J. Bact.*, *5*, 169 (1920).

² L. B. Parsons and W. F. Douglas: *J. Bact.*, *12*, 263 (1926).

³ J. T. Saunders: *Proc. Cambridge Phil. Soc.*, *1*, 30 (1923).

buffer mixture with a salt concentration of 0.1 N, and a solution being examined with a salt content of 0.6 N (sea water). We see from the logarithms of these salt concentrations that the correction is $7.82 - 7.96 = -0.14$. When the salt concentration of the solutions under investigation is 0.01 N, the correction

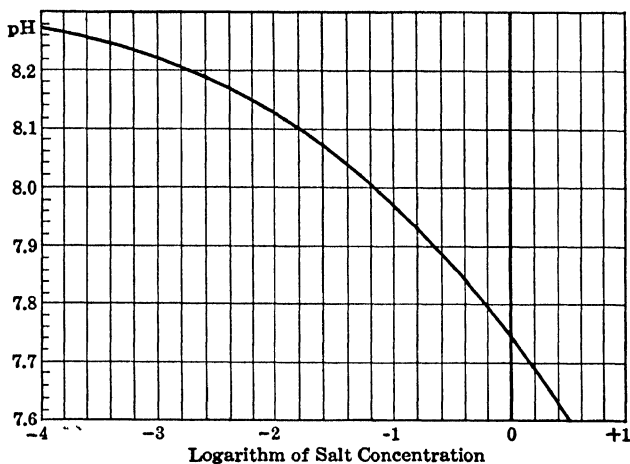

FIG. 23

becomes $8.12 - 7.96 = +0.16$ (the author found $+0.12$, which agrees satisfactorily).

SAUNDERS finds the following salt errors for the Clark indicators if comparisons are always made with buffers which have a salt concentration of 0.08 N. These values are in agreement with earlier measurements of KOLTHOFF¹ (page 343) and may be considered as correct.

	SALT CONTENT	SALT ERROR
Bromcresol purple	0.6 N	-0.25
Bromthymol blue	"	-0.19
Phenol red	"	-0.15
Cresol red	"	-0.18
Thymol blue	"	-0.18

Further reliable data have been obtained by B. COHEN² who employed Clark buffers for comparison.

¹ I. M. Kolthoff: *Rec. trav. chim.*, 41, 54 (1922), 42, 904 (1923).

² B. Cohen: *Public Health Reports*, 41, 3051 (1926).

SALT CORRECTIONS (B. COHEN)

MOLAR SALT CONCENTRATION	<i>m</i> -CRESOL PURPLE		B.C.G.	B.P.R.	C.P.R.	B.C.P.B.
	Acid Range	Alkaline Range				
1.0	-0.14	-0.29	-0.32	-0.26	-0.26	-0.33
0.5	-0.09	-0.22	-0.26	-0.22	-0.20	-0.28
0.2	-0.02	-0.16	-0.16	-0.12	-0.10	-0.16
0.005	+0.11	+0.09	+0.09	+0.25	+0.23	+0.14

B.C.G. = Bromeresol green

C.P.R. = Chlorphenol red

B.P.R. = Bromphenol red

B.C.P.B. = Bromchlorphenol blue

E. B. R. PRIDEAUX¹ has determined the salt correction for a number of seldom used indicators. He employed SÖRENSEN buffers for comparison.

SALT ERROR OF CERTAIN INDICATORS (PRIDEAUX)

INDICATOR	CORRECTION IN SOLUTION WITH 0.5 N NaCl
Naphthylamino-azo- <i>p</i> -benzene sulfonic acid	+0.10
<i>p</i> -Nitrophenol	-0.15 (?)
Alizarine sulfonic acid	-0.26
Neutral red	+0.09
Rosolic acid	-0.06
<i>p</i> -Benzenesulfonic acid-azo- α -naphthol	-0.12
Phenolphthalein	-0.12

L. MICHAELIS and coworkers² have given corrections for the indicators they recommend. It appears to the author that their results are based on comparison solutions with too small an ionic strength. These data do not agree with the measurements of KOLTHOFF who employed buffers with a μ of 0.1.

SALT ERROR OF INDICATORS (MICHAELIS)

INDICATOR	0.5 N SALT	0.15 N SALT	0.1 N SALT	0.05 N SALT
α -Dinitrophenol	-0.20	-0.10	—	—
β - " "	-0.30	-0.12	—	—
γ - " "	-0.13	-0.07	—	—
<i>p</i> -Nitrophenol	-0.05	0.00	—	—
<i>m</i> - " "	-0.16	-0.11	-0.10	-0.05
Phenolphthalein	-0.20	-0.08	—	—

¹ E. B. R. Prideaux: The theory and use of indicators. London, 1917.² L. Michaelis and A. Gyemant: Biochem. Z., 109, 165 (1920); L. Michaelis and R. Krüger: Biochem. Z., 119, 317 (1921).

3. The "protein error."

It was SÖRENSEN (1909) who pointed out that proteins and their decomposition products are capable in many instances of disturbing the colorimetric pH determination. The influence of proteins lies in their amphoteric character which enables them to bind (adsorb) both acid and basic dyes. Although the effect of proteins on different indicators can not be predicted specifically, the disturbing influence generally seems to be strongest on the acid side of the isoelectric point. The effect of decomposition products is much less marked than that of the true proteins themselves.

The protein error depends also upon the indicator involved. According to SÖRENSEN the error is smaller the simpler the composition of the indicator. Whenever a given indicator is used in protein-containing solutions, it is advisable to check several of the results with a hydrogen electrode. Reliable data may be expected if the agreement is good.

SÖRENSEN showed by special experiments that the union between the azo indicators and proteins takes place spontaneously and rather slowly. The color of tropeolin 00 changed gradually from red to yellow when added to a mixture of 10 c.c. of 1 N hydrochloric acid and 40 c.c. of a 0.5% solution of egg white. Simultaneous measurements with the hydrogen electrode failed to disclose a variation in the hydrogen ion concentration. The protein error can be illustrated rather clearly in the following manner. When dimethyl yellow or methyl orange is added dropwise to milk which has been made 0.01 N with respect to hydrochloric acid, the drops become red before diffusing throughout the liquid. Stirring, however, results in a yellow color.

Further examples from the work of SÖRENSEN¹ have been collected below. Column *a* refers to an invertase solution containing 6 c.c. of citrate and 4 c.c. of alkali as buffer mixture. Column *b* refers to a somewhat acidified 2% glue solution. Column *c* concerns a 2% Witte peptone solution, slightly acidified with hydrochloric acid. Column *d* deals with a 2% egg white solution. It is evident that in every case here recorded, the pH's determined colorimetrically exceed those measured electrometrically.

¹ S. P. L. Sørensen: *Biochem. Z.*, 21, 131 (1909).

	pH IN			
	a	b	c	d
Electrometrically	5.69	4.98	4.92	5.34
Colorimetrically with sodium alizarine sulfonate	5.85	5.97	5.75	5.61
“ “ lacmoid	5.75	—	—	—
“ “ <i>p</i> -nitrophenol	5.75	—	—	5.39

SVEN PALITZSCH¹ showed that the protein error of methyl red was very small. This conclusion was drawn from the following experiments with a 2% solution of natural egg white in dilute hydrochloric acid solution.

pH ELECTROMETRIC	pH COLORIMETRIC	Δ ELECTR.-COLOR.
4.99	4.75	+0.24
5.16	4.90	0.18
5.53	5.27	0.26
5.60	5.39	0.21
5.68	5.41	0.27
5.70	5.48	0.22

The error of methyl red is small in the following protein solutions as well.

SOLUTION	pH ELECTR.	pH COLOR	Δ ELECTR.-COLOR.
1% Hydrochloric acid solution of casein + phosphate	5.66	5.58	+0.08
Hydrochloric acid solution of hydrolyzed serum + phosphate	4.73	5.83	-1.1
Preceding solution with more HCl	3.96	4.75	-0.79
2% HCl solution of casein, partially decomposed by pepsin	5.57	5.48	+0.09
2% Witte peptone solution in hydrochloric acid which is 0.1 N with respect to NaCl	4.88	4.91	-0.03
Preceding solution	4.83	4.83	0.00
2% Egg white, partially decomposed by pepsin	5.63	5.58	+0.05
Preceding solution	5.27	5.19	+0.08
Preceding solution, decomposition more advanced	5.27	5.24	+0.03
2% Gelatine solution + primary phosphate	5.57	5.51	+0.06
Preceding solution	5.17	5.17	0.00

SÖRENSEN found in 1909 that the deviations of methyl violet, *p*-nitrophenol, neutral red, rosolic acid, phenolphthalein, and

¹ Sven Palitzsch: Compt. rend. trav. lab. Carlsberg, 10, 162 (1911).

thymolphthalein in a 2% peptone solution were negligible, as contrasted with the appreciable deviations shown in 2% egg white solution by methyl violet, tropeolin 00, metanil yellow, neutral red, rosolic acid, phenolphthalein, thymolphthalein, alizarine yellow, and tropeolin 0. Tropeolin 000 and *p*-nitrophenol may be used in the latter solution.

The following table of "protein corrections" is due to W. M. CLARK and H. A. LUBS.¹ They made their comparisons with Clark buffers.

PROTEIN CORRECTIONS (CLARK AND LUBS)

INDICATOR	CORRECTIONS IN		
	Peptone (Meat Broth)	10% Gelatine	2% Egg Albumin
Bromphenol blue	+0.05	—	—
Methyl red	-0.10	—	+0.24
Bromcresol purple	+0.01	+0.04	—
Bromthymol blue	+0.10	+0.04	—
Phenol red	+0.04	+0.20	—
Cresol red	+0.03	+0.20	—
Thymol blue	+0.04	+0.20	—
Cresolphthalein	-0.03	+0.20	—

BARNETT COHEN² found the following values in 5% Witte peptone.

PROTEIN CORRECTIONS IN 5% WITTE PEPTONE (B. COHEN)

INDICATOR	CORRECTION	INDICATOR	CORRECTION
<i>m</i> -Cresol purple (acid range)	-0.20	Bromphenol red	+0.11 to -0.10
Thymol blue (acid range)	-0.20	Bromcresol purple	+0.11 to -0.10
Bromphenol blue	-0.35	Bromthymol blue	+0.34 to +0.07
Bromchlorphenol blue	-0.35	Phenol red	+0.24 to -0.01
Bromcresol green	-0.12	Cresol red	0.0
Chlorphenol red	+0.09 to -0.07	<i>m</i> -Cresol purple (alk.)	0.0
		Thymol blue (alk.)	+0.09 to -0.03

E. H. LEPPER and C. J. MARTIN³ found that the effect of pseudoglobulin on phenol red and neutral red is the reverse of the effect of serum albumin from horses. The sign of the correction for neutral red is opposite to that for phenol red (neutral red is an indicator base and phenol red an indicator acid).

¹ W. M. Clark and H. A. Lubs: *J. Bact.*, **2**, 1, 109, 191 (1917).

² B. Cohen: *Public Health Reports*, **41**, 3051 (1926). Cf. D. Jaumain: *Compt. rend. soc. biol.*, **93**, 860 (1925), regarding the protein error of bromthymol blue.

³ E. H. Lepper and C. J. Martin: *Biochem. J.*, **21**, 356 (1927).

In cases where the protein error is not known in advance, it is advisable to determine the pH both with an indicator acid and an indicator base. The result may be considered reliable if both measurements agree.

PROTEIN CORRECTIONS (LEPPER AND MARTIN)

PSEUDOGLOBULIN CONCENTRATION IN %	NEUTRAL RED CORRECTION	ALBUMIN CONCENTRATION IN %	NEUTRAL RED CORRECTION
0.33	0.00	0.19	-0.20
0.67	+0.05	0.38	-0.30
1.35	+0.15	0.75	-0.40
2.70	+0.25	1.5	-0.51
4.09	+0.45	3.0	-0.58
5.40	+0.60		
8.17	+0.73		
10.80	+0.83		
16.35	+0.85		
	PHENOL RED CORRECTION		PHENOL RED CORRECTION
2	0.00	0.00	0.00
4	-0.02	0.03	0.00
8	-0.03	0.06	+0.02
12	-0.04	0.13	+0.03

4. The colloid error.

When we are no longer dealing with an indicator in true solution, certain additional difficulties enter due to the difference in behavior of the two indicator forms at an interface. The protein error results in part from a colloidal behavior.

That the forms of an indicator behave differently at an interface was demonstrated for the air-water boundary by DEUTSCH.¹ Vigorous shaking of a 0.01 N hydrochloric acid solution containing thymol blue produces a red color in the air-solution emulsion which is much deeper than that of the original solution. The red form is thus enriched in the froth. The indicator appears also to have a larger dissociation constant than in water. Shaking water solutions with benzene or ligroin instead of air results in the formation of a beautiful red emulsion, whereas the indicator left in the aqueous phase assumes an intermediate color. Settling permits reestablishment of the original conditions. Similar experiments can be performed with several other indicators.

¹ B. Deutsch: Z. physik. Chem., 136, 353 (1928); Ber., 60, 1036 (1927).

It is always necessary to exercise great care when applying the colorimetric method to colloidal solutions because there is always the possibility that one of the indicator forms will be preferentially adsorbed at the solid-liquid interface. The charge of the colloid probably exerts a tremendous influence on the phenomenon. A. JARISCH¹ found that a soap solution with a pH of 9.2 is turned red by neutral red whereas the same indicator in pure water solution is already orange-yellow at a pH of 8.2. This apparent anomaly is produced by the colloidal fatty acids contained in the strongly hydrolyzed soap solution. These acids adsorb the basic neutral red in its red form. The fatty acid particles act like negatively charged colloids and the neutral red as a positively charged ion.

Proof of this explanation is seen in the fact that a soap solution colored red with neutral red turns yellow upon addition of alcohol. The alcohol dissolves the colloidal fatty acid particles, thus allowing the neutral red to react in a normal manner. We may expect in general that, in colorimetric pH determinations, it is preferable to employ basic indicators in the presence of positive colloids and indicator acids when negative colloids are present. For example phenolphthalein shows approximately its normal reaction in a soap solution while the basic neutral red deviates considerably in the same medium.

Finely divided particles in suspension can also interfere with colorimetric measurements if one of the indicator forms happens to be preferentially adsorbed. Lanthanum hydroxide is a very striking example of such interference. This compound is a strong base which is very slightly soluble in water. A saturated solution in water at 25° has a pH of 9.0. If the pH of a suspension (turbid solution) of the solid hydroxide is measured with thymolphthalein, the result obtained is 10.5. The suspension is colored a dark blue, although thymolphthalein is colorless at pH 9.0. The precipitate settles after a time, leaving a colorless supernatant solution although the solid itself is dark blue. Because of the strong basic properties of solid lanthanum hydroxide, it forms on its surface a salt with the indicator acid. In other words, the adsorption of the colored indicator anion predominates, and the presence of the solid phase favors a displacement of the indicator equilibrium towards the alkaline form. Phenol-

¹ A. Jarisch: *Biochem. Z.*, 134, 177 (1922).

phthalein, thymol blue, and other indicators behave in like fashion.

A. GUTBIER and H. BRINTZINGER¹ investigated the transformation of various indicators in the presence of certain lyophilic colloids such as gelatine, gum arabic, and erythro-dextrine. Aside from congo, these colloids appear to affect indicators but little. It is rather simple to explain deviations observed with other indicators in terms of the binding of acids or bases by a colloid.

Quite generally, when the colorimetric procedure is being applied to solutions containing substances of which the influence on the color of the indicator is unknown (for example, colloids, organic compounds, etc.), the results must always be checked electrometrically. The hydrogen ion measurement with the hydrogen electrode must always be considered as exact.

5. The influence of temperature.

The influence of temperature upon the sensitivity of indicators has been discussed in detail on pages 189 and 293. The variation of indicator constant values with temperatures ranging from 18° to 70° (approximate determinations) will be found below.

CHANGE OF INDICATOR CONSTANTS BETWEEN 18° AND 70° (KOLTHOFF)

INDICATOR	CHANGE EXPRESSED IN		RATIO OF CONSTANT AT 70° TO THAT AT 18°
	pH	pOH	
Nitramine	-1.45	0.0	1
Phenolphthalein	-0.9 to -0.4	-0.55 to -1.05	Approx. 5
Thymol blue	-0.4	-1.05	2.5
α -Naphtholphthalein	-0.4	-1.05	2.5
Curcumin	-0.4	-1.05	2.5
Phenol red	-0.3	-1.15	2
Neutral red	-0.7	-0.75	—
Bromcresol purple	0.0	-1.45	1
Azolitmin	0.0	-1.45	1
Methyl red	-0.2	-1.25	—
Lacmoid	-0.4	-1.05	2.5
<i>p</i> -Nitrophenol	-0.5	-0.95	3.2
Methyl orange	-0.3	-1.15	14
Dimethyl yellow	-0.28	-1.17	15
Bromphenol blue	0.0	-1.45	1
Tropeolin 00	-0.45	-1.0	10
Thymol blue	0.0	-1.45	1

¹ A. Gutbier and H. Brintzinger: *Kolloid-Z.*, 41, 1 (1927).

MICHAELIS and his coworkers have determined the indicator exponents pK_I at various temperatures for the indicators which they have employed. Their data are summarized in the table which follows.

INDICATOR EXPONENTS AT VARIOUS TEMPERATURES
(INDICATORS OF MICHAELIS)

TEMPERATURE	α -DINITRO-PHENOL	β -DINITRO-PHENOL	γ -DINITRO-PHENOL	p -NITRO-PHENOL	m -NITRO-PHENOL
5°	4.13	3.76	5.21	7.33	8.43
10	4.11	3.74	5.18	7.27	8.39
15	4.08	3.71	5.15	7.22	8.35
20	4.05	3.68	5.14	7.16	8.31
30	3.99	3.62	5.09	7.04	8.22
40	3.93	3.56	5.04	6.93	8.15
50	3.88	3.51	4.99	6.81	8.07

The temperature coefficient for phenolphthalein is 0.011 per 1°, and the correction must be taken into account at temperatures above 18°. For salicyl yellow the temperature coefficient is 0.013, and this correction must be made above 20°.

6. The influence of the solvent. The alcohol error.

A change of solvent will occasion a displacement of the acid-base equilibrium, accompanied by corresponding changes in the values of indicator constants. When the color of an indicator in a solution containing alcohol is compared with the color in an aqueous buffer solution, equal color intensities no longer signify the same pH. The influence of alcohol on the sensitivity of various indicators has already been discussed in Chapter Six. The author has calculated from experimental data the corrections for alcohol contents varying between 0 and 70% by volume. These data are combined in the following table. They refer to a temperature of 11–12°. Although the temperature coefficient is rather large, the table may be used for temperatures between 10° and 20° up to an alcohol content of 70% by volume. The values given for phenolphthalein, thymol blue, and thymolphthalein are rather uncertain because of the difficulty in determining the sensitivity ratio of acid sensitive indicators.

The corrections are recorded in the same manner as for the salt error. A positive sign signifies that the correct pH is obtained by adding the proper correction to the pH found colorimetrically. For example, the correction for methyl orange in

50% alcohol is - 1.2, which means that 1.2 must be subtracted from the measured pH to obtain the correct value.

ALCOHOL ERROR OF INDICATORS, EXPRESSED IN pH AT 12°

ALCOHOL CON- TENT VOL. %	T.B. ^a	Tr. 00	B.P.B.	D.Y.	M.O.	Curc.	Phph.	T.B. ^b	Thph.	Tr. 0	Nitr.
10	0.00	-0.06	+0.06	-0.11	-0.10	-0.1	+0.06	+0.15	+0.1	+0.2	-0.25
20	+0.02	-0.23	+0.21	-0.24	-0.20	-0.3	+0.10	+0.3	+0.3	+0.52	-0.6
30	+0.07	-0.6	+0.35	-0.48	-0.47	-0.4	+0.15	+0.5	+0.6	+0.3	-0.9
40	+0.15	-1.0	+0.38	-0.8	-0.9	-0.5	+0.45	+0.7	+1.0	+0.5	-1.05
50	+0.21	-1.4	+0.38	-1.1	-1.2	-0.6	+1.0	+0.8	+1.3	+0.65	-1.1
60	+0.25	-1.7	+0.77	-1.4	-1.5	-0.5	+1.6	+0.9	+1.6	+0.8	-1.15
70	+0.30	-1.9	+1.0	-1.7	-1.8	-0.5	+2.2	+1.0	+1.9	+0.9	-1.25

T.B. = Thymol blue

Curc. = Curcumin

Tr. 00 = Tropeolin 00

Phph. = Phenolphthalein

B.P.B. = Bromphenol blue

Thph. = Thymolphthalein

D.Y. = Dimethyl yellow

Tr. 0 = Tropeolin 0

M.O. = Methyl orange

Nitr. = Nitramine

^a Acid range.^b Alkaline range.

In order to determine the alcohol error of semisensitive indicators, it is necessary to have available buffer solutions of varying alcohol concentrations. The optical properties of indicators in non-aqueous solutions are not strictly comparable with their behavior in aqueous solutions.¹

L. MICHAELIS and M. MIZUTANI,² and later MIZUTANI³ alone, have measured with the hydrogen electrode the pH of solutions of weak acids with their salts in the presence of varying amounts of alcohol. They assumed in their calculations that the constant of the hydrogen electrode remained unchanged by the addition of alcohol. Probably, only a small error enters when solutions with higher alcohol concentrations are involved. MICHAELIS and MIZUTANI were unable to calculate the *true* dissociation constants of the particular acids from their measurements because the activity of the anions was not known with sufficient accuracy. The quantity which they determined was the acidity constant (cf. page 90).

We are familiar with the following equation:

$$K = \frac{[H^+][A^-]}{[HA]}$$

¹ A. Thiel: Z. anorg. allgem. Chem., 136, 406 (1927).² L. Michaelis and M. Mizutani: Biochem. Z., 147, 7 (1924); Z. physik. Chem., 116, 135, 350 (1925).³ M. Mizutani: Z. physik. Chem., 116, 350 (1925).

The hydrogen ion concentration $[H_3O^+]$ or its activity is measured with the hydrogen electrode whereas the activity of the undissociated acid is set equal to the total acid concentration. The activity of the anions is unknown. The conventional activity of the anions in alcoholic solutions is much less than in pure water solutions with the same salt concentration.

If we assume in the calculation of K that $[A^-]$ is equal to the total salt concentration—which implies that the activity coefficient is unity—then the value of K so obtained will be too large and will increase with increasing salt content. Thus MICHAELIS and MIZUTANI found for a 70% alcohol solution which was 0.1 molar with respect to acetic acid and 0.1 molar to sodium acetate that the apparent K value was 6.6×10^{-7} . The value was 3.6×10^{-7} for a 0.01 molar solution of these constituents.

Since the activity coefficients of salts in alcoholic solutions are unknown, it is simplest to refer the value of the dissociation constant of an acid to the particular salt concentration concerned by assuming that the activity of the salt is equal to its concentration (cf. page 67). In the following table will be found values of pK ($= -\log K$) for solutions which are 0.01 molar with respect to both acid and sodium salt.

In these solutions $pH = pK$. If the acid concentration were

DISSOCIATION CONSTANTS OF ACIDS IN ALCOHOL SOLUTIONS (MICHAELIS AND MIZUTANI). CONCENTRATION OF SALTS AND ACIDS 0.01 MOLAR
($t = 15 - 20^\circ$)

$$K = \frac{[H^+][Salt]}{[Acid]}, \quad pK = -\log K.$$

ALCOHOL VOL. %	pK FOR						
	Formic Acid	Acetic Acid	Lactic Acid	Salicylic Acid	Benzoic Acid	Phosphoric Acid K ₂	Carbonic Acid K ₂
0	3.66	4.70	3.71	3.06	4.23	7.08	10.03
10		4.79	3.82	3.13	4.31	7.26	
20	3.80	4.94	3.96	3.28	4.52	7.46	10.31
30		5.12	4.18	3.52	4.83	7.71	
40	4.13	5.38	4.37	3.80	5.23	7.95	10.80
50		5.68	4.70	4.09	5.62	8.22	
60	4.68	6.00	5.04	4.43	5.94	8.50	11.41
70		6.34	5.30	4.72	6.30	8.82	
80	5.30	6.69	5.64	5.05	6.65		
90		7.10	5.96	5.42	7.03		
95	5.83						

ten times as large, $\text{pH} = \text{p}K - 1$, and if ten times less, $\text{pH} = \text{p}K + 1$.

The same investigators have measured the pH of mixtures of weak bases and their salts. The following table contains certain of their data. Because the ion product of water in alcoholic solutions is not known accurately, the hydrolysis constants (cf. page 14) will be reported instead of the dissociation constants. The hydrolysis constant is

$$K' = \frac{[\text{H}^+][\text{Base}]}{[\text{Salt}]}, \quad \text{p}K' = -\log K'.$$

In terms of the Brönsted concept of acidity and basicity the acidity constants of the cations are reported.

ALCOHOL VOL. %	pK' OF BASES				
	NH ₃	Methylamine	Aniline	Pyridine	Glycine
0	9.37	10.80	4.76	5.13	9.81
20	9.18	10.59	4.61	4.89	9.26
40	9.07	10.40	4.47	4.56	9.76
60	9.03	10.23	4.36	4.25	9.90
80	8.89	9.95	4.24	3.86	10.01
95	8.55	9.55	4.02	3.11	

Only values for the most important acids and bases have been included. The original publication should be consulted for further details.

Thanks to the measurements of MICHAELIS and MIZUTANI, we have available a series of buffer mixtures with which it is possible to determine the alcohol error of various indicators. Investigations in this connection are now in progress.¹

The case is simpler when the pH of an alcoholic solution is measured with one-color indicators, because no buffer mixtures need be employed. We saw on page 307 that

$$\text{pH} = \text{p}K_{\text{I}} + \log \frac{F}{1 - F}.$$

L. MICHAELIS and M. MIZUTANI² have measured $\text{p}K_{\text{I}}$ for a number of indicators in solutions of different alcohol concentrations.

¹ Extensive studies have been made by H. Baggesgaard-Rasmussen and F. Reimers: *Dansk Tidsskr. farmaci* 7, 164, 225 (1933), 9, 253 (1935); *Z. anal. Chem.* 105, 269 (1936).

² L. Michaelis and Mizutani: *Biochem. Z.*, 147, 7 (1924).

Directions for measuring the pH of alcoholic solutions. These determinations are as reliable as the procedure described by MICHAELIS and GYEMANT for aqueous solutions. The following precaution, however, must be observed. The alcoholic comparison solution must have the same alcohol content as the solution under examination. The alkalinity necessary to permit the maximum color intensity must always be produced by addition of sodium hydroxide. The hydroxide concentration best suited for alcohol concentrations from 0 to 70% is 0.01 N, and for higher alcohol concentrations, 0.1 N. The pH calculation is made just as for aqueous solutions with the difference that the pK value for the particular alcohol concentration must be employed. A special table is available for phenolphthalein.

This method is not especially accurate. Reliable values may be obtained potentiometrically.

TABLE OF pK VALUES OF THE NITROPHENOL INDICATORS AT VARIOUS ALCOHOL CONCENTRATIONS (MICHAELIS AND MIZUTANI)

INDICATOR	pK AT THE FOLLOWING ALCOHOL CONCENTRATIONS (VOL. %)									
	0	10	20	30	40	50	60	70	80	90
<i>m</i> -Nitrophenol	8.37	8.56	8.75	8.97	9.15	9.40	9.64	9.92	10.24	10.73
<i>p</i> -Nitrophenol	7.17	7.17	7.28	7.38	7.63	7.85	8.11	8.34	8.59	8.90
γ -Dinitrophenol	5.15	5.20	5.23	5.39	5.45	5.58	5.70	5.95	6.08	9.46
α -Dinitrophenol	4.00	4.00	4.00	4.00	4.00	4.15	—	—	—	—

THE DEGREE OF COLORATION F OF PHENOLPHTHALEIN VERSUS pH AT VARIOUS ALCOHOL CONCENTRATIONS

F	pH AT THE FOLLOWING ALCOHOL CONCENTRATIONS (VOL. %)										
	0	10	20	30	40	50	60	70	80	90	95
0.01	8.5	8.7	8.9	9.2	9.5	9.8	10.2	10.6	10.8	11.1	11.3
0.02	8.6	8.8	9.0	9.3	9.7	10.0	10.4	10.7	11.0	11.2	11.5
0.04	8.8	8.9	9.2	9.5	9.9	10.2	10.6	10.9	11.2	11.4	11.7
0.06	8.9	9.0	9.4	9.7	10.0	10.3	10.7	11.0	11.3	11.6	11.8
0.08	8.98	9.1	9.5	9.8	10.1	10.4	10.8	11.1	11.4	11.7	11.9
0.1	9.04	9.2	9.6	9.9	10.2	10.5	10.9	11.2	11.5	11.8	12.0
0.2	9.22	9.4	9.8	10.1	10.5	10.8	11.1	11.5	11.9	12.1	12.3
0.3	9.38	9.6	9.9	10.2	10.6	10.9	11.3	11.7	12.1	12.3	12.4
0.4	9.54	9.7	10.1	10.4	10.8	11.1	11.4	11.8	12.2	12.4	12.6
0.5	9.80	9.9	10.2	10.5	10.9	11.2	11.5	12.0	12.4	12.6	12.7

CHAPTER ELEVEN

INDICATOR PAPERS

1. The use of indicator papers.

Indicator papers serve the same purpose as do indicator solutions in that they reveal the reaction of a liquid. As we shall see farther on, the sensitivity of the papers depends on so many conditions that as a rule they do not permit a very precise measurement of the hydrogen ion concentration. It is true that the pH of buffer mixtures can be measured approximately with indicator papers. They may be employed to greater advantage, however, for qualitative purposes such as the testing of gases for acidic or basic constituents (ammonia, acetic acid, etc.).

Reagent papers are made use of in the qualitative analysis of metal ions. Frequently it is necessary to know the $[H^+]$ between rather wide limits. In the precipitation of the copper group, the hydrogen ion concentration must be about 0.05–0.2 N in order to precipitate lead and cadmium and yet keep zinc in solution. This degree of acidity can be regulated with methyl violet paper. Another case is the precipitation of iron, aluminum, and chromium as basic acetates and formates at a hydrogen ion concentration of 10^{-5} to 10^{-6} . This condition is realized by neutralizing the solution being investigated until it no longer reacts with congo paper but is still acid towards litmus.

Indicator papers frequently aid in the identification of chemicals. Strong mineral acids are acid towards methyl violet or thymol blue papers, moderately strong acids react acid towards congo paper, and very weak acids are acid towards litmus and azolitmin paper. Strong bases show an alkaline reaction with turmeric or tropeolin 0 paper, medium strong bases with phenolphthalein, and very weak bases with litmus or azolitmin paper. These papers are not recommended for use in quantitative analysis.¹

¹ Gillespie and Hurst: *Soil Science*, 6, 219 (1918); Gillespie and Wise: *J. Am. Chem. Soc.*, 40, 796 (1918).

Indicator solutions can not be used in titrating colored liquids such as fruit juices, wines, etc. Frequently even the papers show an indistinct color change. This is especially so if the solution being titrated still exerts a buffering action when the paper begins to change color. In such cases it is better to perform the titration by other methods such as conductometrically, with the hydrogen electrode, or spectroscopically.¹ Furthermore, indicator papers are not recommended for the determination of weak acids, such as acetic acid, in the presence of strong acids. Glaser² reports that an indistinct endpoint is obtained.

2. Sensitivity of indicator papers.

The sensitivity of indicator papers depends upon a number of factors which will be discussed below. Suffice it to say that this sensitivity is always smaller than that of the indicator solution when determined with strong acids or bases. When buffer mixtures are used, however, the sensitivity of the paper towards hydrogen or hydroxyl ions is the same as that of the solution of the corresponding indicator.

(a) *Type of paper.* Sized paper usually shows the reaction more distinctly than does filter paper because the drop of liquid does not spread so extensively and the color change is more localized. On the other hand filter paper is to be preferred if colored solutions are being examined, especially if the color of the liquid is the same as that of one of the indicator modifications. The capillary action of the paper causes a separation into dye and colorless solution which is especially pronounced when a basic dye is concerned. In this case the reaction occurs more sharply at the edge of the drop. KOLTHOFF³ has shown that the sensitivity of sized paper is less than that of filter paper. The probable explanation for this difference is that the sized paper takes up little dye. The sensitivity of sized paper is treated in the following table (+ signifies a weak reaction and - no reaction). Comparing the sized congo red paper with unsized papers of the same indicator (page 364) shows the latter type to be more sensitive.

¹ Concerning the various physico-chemical methods for determining an endpoint, see I. M. Kolthoff: *Die Massanalyse I. Die theoretischen Grundlagen der Massanalyse*, 2 ed., Berlin, Julius Springer, 1930.

² Fritz Glaser: *Indicatoren der Acidimetrie und Alkalimetrie*. Wiesbaden, 1901.

³ I. M. Kolthoff: *Pharm. Weekblad*, 56, 175 (1919).

SENSITIVITY OF SIZED PAPER

INDICATOR	10 ⁻³ N HCl	5 × 10 ⁻⁴ N HCl
Congo red	+	-
Dimethylamino-azo-benzene	-	-
Litmus (very weakly colored)	+	-

(b) *Nature and preliminary treatment of filter paper.* Because of the colloidal nature of many indicators, the effect of pre-treating paper with various reagents such as hydrochloric acid, aluminum chloride, sodium hydroxide, etc., upon its subsequent sensitivity as an indicator paper has been investigated. After treatment with hydrochloric acid or aluminum chloride, the paper was washed until the water no longer reacted acid towards methyl red. Paper soaked in alkali was washed until the wash water was no longer alkaline towards phenolphthalein. The paper obtained in this fashion was then immersed in a solution of congo, dimethyl yellow, azolitmin, or phenolphthalein. It was found that the sensitivity remained unchanged by the previous treatment when pure paper was used. If this is not the case treatment with hydrochloric acid will suffice.

The nature of the filter paper itself proved to be of but little importance. The paper of SCHLEICHER and SCHÜLL "for capillary analysis" appeared to be the most sensitive. However, the difference was negligible.

(c) *The concentration of indicator in the paper.* Just as in the case of indicator solutions, the concentration of the indicator in the paper has a great influence on the sensitivity of the indicator paper. We know from Chapter Five that for an indicator acid HI,

$$[H^+] = \frac{[HI]}{[I^-]} K_{HI}.$$

For the acid indicator congo, [HI] represents the concentration of the blue form and [I⁻] that of the red. When we compare two congo papers at the same [H⁺], one paper containing ten times as much congo red as the other, the first will contain also ten times as much [HI]. If the acid or blue form is clearly discernible in the presence of I⁻, then the concentrated congo

paper will be more sensitive towards acid than the dilute. Naturally this illustration can not be generalized. It is a question of the sensitivity with which the acid form is demonstrable in the presence of the basic form. The same considerations apply to indicator bases.

The above discussion is valid only if the papers are prepared from solutions of pure indicators. This condition is not fulfilled by blue and red litmus paper. Blue litmus paper contains an excess of base and red litmus paper an excess of acid. Thus it is easy to see that, up to a certain concentration of the indicator, litmus paper will be more sensitive towards H^+ or OH^- the more dilute is the original litmus solution from which it is prepared. To a lesser degree, this is true also of violet litmus paper because it always contains small quantities of ampholytes.

The influence of the concentration of congo red on the sensitivity of congo paper is illustrated below. It appears from the table that the most sensitive paper is obtained when filter paper is soaked in a 0.1 or 1% congo red solution. A solution of HCl as dilute as 0.0002 N can then be detected. The 0.1% paper is to be preferred because the color change is more distinct. The use of filter paper permits of greater sensitivity than does a sized indicator paper.

CONCENTRATION OF CONGO SOLUTION WITH WHICH THE PAPER IS SATURATED	0.01 N HCl	0.005 N HCl	0.001 N HCl	0.0005 N HCl	0.0002 N HCl	0.0001 N HCl
1% Congo	+++ deep blue spot	+++ deep blue spot	+++ spot	+	+	+
0.1% "	+++ deep blue spot	+++	++ blue circle, red in center	+	+ weak	-
0.01%	+	+	+	-	-	-
0.001%	-	-	-	-	-	-

The sensitivity of litmus and azolitmin papers increases as the indicator concentration diminishes. The usual paper is prepared from 1% solutions.

INFLUENCE OF CONCENTRATION OF LITMUS OR AZOLITMIN ON THE SENSITIVITY
OF THESE PAPERS

KIND OF PAPER	HCl CONCENTRATION				
	10^{-3} N	5×10^{-4} N	2×10^{-4} N	10^{-4} N	5×10^{-5} N
Blue litmus paper 1%	++	-	-	-	-
“ “ “ 0.1%	+++	++	+	-	-
Violet litmus paper	+++	++	±	-	-
Azolitmin 1%	+++	+++	++	+	-
“ 0.1%	+++	+++	++	+	-

KIND OF PAPER	NaOH CONCENTRATION			
	10^{-3} N	4×10^{-4} N	2×10^{-4} N	10^{-4} N
Red litmus paper 1%	++	++	+	-
“ “ “ 0.1%	++	++	+	+
Violet litmus paper	++	++	+	-
Azolitmin 1%	+++	+++	++	+
“ 0.1%	+++	+++	++	+

When determining sensitivity with alkali, the water used for diluting should be completely free from carbon dioxide. Otherwise too low a sensitivity is found. It is obvious from the above data that *azolitmin paper prepared from 0.1% indicator solution is the most sensitive reagent paper for strong acids and bases*. The presence of 10^{-4} N hydrochloric acid and sodium hydroxide can be demonstrated readily with this paper. It is best also for weaker acids and bases.

Whatever has been said about litmus paper applies as well to methyl violet paper. However, the latter paper can not be used if a too concentrated solution is used in its preparation. The color of the paper should be distinctly violet, as is obtained when a 0.04% methyl violet solution is employed. The paper is turned a deep violet-blue by 0.01 N hydrochloric acid, blue green by 0.1 N HCl, and yellow green by the 1 N acid.

The action of phenolphthalein paper differs from that of other papers. Regardless of previous treatment, a drop of liquid placed upon it will diffuse either very slowly or not at all. A 0.1 or 1% solution of phenolphthalein in alcohol is employed in the preparation of the paper. These concentrations appear to be

large enough to allow the indicator to crystallize out in the capillaries of the paper when dried. Since some time is required before a drop of liquid soaks into the paper, the alkaline reaction does not appear immediately. The color change may be produced more rapidly by means of a small rod to improve the contact between liquid and paper. The phenolphthalein is made to dissolve in the liquid by so doing.

The reaction of phenolphthalein probably takes place in the drop itself rather than in the paper. It can occur also in a capillary tube. We see of course that the sensitivity of phenolphthalein paper is the same as that of the indicator solution. The paper will show a weak rose coloration even with 0.001 N sodium hydroxide solution. Phenolphthalein paper offers the advantage that no capillary effects enter, which favors a closer estimation of color differences. The liquid will diffuse after considerable time until finally the red or rose color of the indicator disappears.

The concentration of indicator is important for other papers as well. The table at the end of this chapter gives, for a number of indicators, the concentrations best suited for the preparation of indicator papers.

(d) *Manner of producing the reaction.* Usually a drop of the unknown solution is placed upon the reagent paper. It is also permissible to suspend the paper in the body of the liquid. Neither procedure is especially advantageous. The author finds a somewhat higher sensitivity when the drop method is used. Too long immersion in the solution will result in a partial solution of the dye, an effect which is promoted by electrolytes (WALPOLE¹).

(e) *Nature of the solution.* So far the sensitivities of the indicator papers have been estimated from their behavior in solutions of strong acids and bases. Except in the case of phenolphthalein, the sensitivity of papers is smaller than that of the corresponding indicator solutions. Approximately the same color is obtained when methyl orange is added to a 0.0001 N hydrochloric acid solution and to a mixture of 90 c.c. of 0.1 N acetic acid with 10 c.c. of 0.1 N acetate. Azolitmin paper, on the other hand, makes it appear that the acetate-acetic acid solution is much

¹ H. Walpole: J. Biol. Chem., 7, 260 (1913).

more strongly acid than the solution of hydrochloric acid. Thus an *indicator paper does not report properly the actual acidity or hydrogen ion concentration.*

It frequently happens that hydrogen ions are removed from solution by impurities in the indicator or in the paper, or as a result of adsorption by the paper. In other words, the solution apparently is neutralized. The use of a buffer mixture, however, counteracts the influence of traces of impurities. The sensitivity of indicator papers is found to be the same as that of the corresponding indicator solutions when measured in the presence of buffer solutions. *For strong electrolytes, the indicator papers measure the titration acidity rather than the hydrogen ion concentration.*

To some extent the potassium iodide-iodate paper reveals the hydrogen ion concentration as well as the titration acidity. The reaction between iodide and iodate is described by the equation:



This is a time reaction and is very much influenced by the hydrogen ion concentration. The equation shows that H^+ ions are removed from solution. Comparing the behavior of iodide-iodate paper in 0.0001 N HCl and in the acetic acid-acetate mixture, both reactions seem to be the same at first sight. The same brown or blue color appears. However, the paper treated with the buffer mixture gradually turns a deeper color because the hydrogen ions removed initially are replaced. This is not true of the hydrochloric acid.

3. Determination of hydrogen ion concentration with indicator papers.

We have already stated that, in buffer solutions, indicator papers will show approximately the same transformation intervals as do the corresponding indicator solutions. The hydrogen exponent can be estimated rather closely if a sufficient number of comparison solutions are at hand. HEMPLE¹ found that the use of lacmoid paper was practical between pH's 3.8–6.0. A drop of the solution under investigation was placed on the paper, and the color compared with papers containing drops of a series of buffer mixtures. The accuracy of the measurement was about 0.2–0.5 pH unit.

¹ Hemple: Compt. rend. trav. Lab. Carlsberg, 13, 1 (1917).

HAAS¹ has extended the procedure to include other indicators. He describes a method for preparing blue and red lacmoid papers to be used in the determination. A drop of unknown solution is placed on several strips of indicator paper. At the same time a series of comparison papers is made from buffer mixtures of known $[H^+]$. All the strips are then dried slowly over soda lime (to exclude carbon dioxide), and the colors compared from time to time during drying. The final match is made with the papers completely dried. The color at the center of the drop is considered in making these comparisons because, at the border, the color is blurred due to diffusion. Permanent standards may be prepared by coating the papers with paraffin.

HAAS has used the following indicator papers as well:

Methyl orange paper.....	for pH = 2.4-3.8
Bromphenol blue paper.....	3.4-4.6
Alizarine paper.....	4.0-6.0
Azolitmin paper.....	6.2-8.0
Neutral red paper.....	7.0-9.0

The accuracy obtainable is 0.2 to 0.4 pH unit. The method is useful when only small quantities of liquid are available. However, *care should always be exercised in its application.*

The writer also has investigated the reliability of the determination of pH by means of indicator papers. These results will be summarized briefly. Contrary to the directions of HAAS, the drop should not be permitted to dry. The color of the dried paper is not so distinct, and small differences may be overlooked. Instead of a glass rod, it is better to use a capillary tube in transporting the liquid to the paper. By so doing, 10-20 mm.³ will be sufficient for a determination. Hardened paper is best as a rule. SCHLEICHER and SCHÜLL "for capillary analysis" filter paper is also satisfactory.

Of great importance is the "intensity" of the buffer action. When a phosphate mixture of pH = 7.0 is diluted ten-fold and the color of red litmus paper noted, the undiluted solution appears to be much more strongly alkaline than the diluted buffer. Thus it is recommended that the buffer mixtures used for comparison always have about the same buffer action as has the solution being studied. By so doing, the procedure has an accuracy of approximately 0.2 pH unit. The method is extremely useful for

¹ Haas: J. Biol. Chem., 33, 49 (1919).

the rapid investigation of blood serum and urine. It is unreliable when the solution under investigation contains chiefly a volatile acid such as carbonic acid.

KIND OF PAPER	CONCENTRATION OF INDICATOR SOLUTION	APPLICABLE BETWEEN	TO BE OBSERVED AT FOLLOWING TIMES AFTER PLACING DROP ON PAPER	ACCURACY AND REMARKS
Congo red (hardened paper)	0.1%	pH = 2.5-4.0	Within 5 min	Approximately 0.2 pH. Upon drying, blue spot turns red again About 0.2 pH, rapid estimation. Congo paper usually better. Great influence of dilution About 0.2-0.3 pH
Methyl orange	0.2%	pH = 2.6-4.0	After 2 min.	
Alizarine (hardened paper)	0.1%	pH = 4.6-5.8	" 5 min.	0.2-0.3 pH 0.2 pH. When boric acid (buffer mixture) is present, should not dry 0.2 pH. When boric acid present, do not let paper dry
Blue lacmoid paper	0.1%	pH = 4.6-6.0	" 5-10 min.	
Brilliant yellow paper	0.2%	pH = 6.8-8.5	" 5-60 min.	0.2 pH 0.2 pH 0.2 pH
Red litmus paper	1%	pH = 6.6-8.0	" 5-60 min.	
Blue litmus paper		pH = 6.0-8.0		
Azolitmin paper	0.1%	pH = 5.5-8.0	" 2-30 min.	0.2 pH 0.2 pH
Phenol red paper	0.1%	pH = 7.0-8.2	" 2-30 min.	
Cresol red paper	0.1%	pH = 7.6-9.0	" 5 min.	0.2 pH 0.2 pH
α -Naphtholphthalein (capillary paper)	0.2%	pH = 8.2-9.5	" 10 min.	
Turmeric paper	0.1%	pH = 7.5-9.5	" 10 min.	0.2 pH. Do not let dry in presence of boric acid
Curcumin paper	0.1%	pH = 7.0-9.0	" 10 min.	
Thymolphthalein paper	0.1%	pH = 10-11	" 2 min.	

The indicator papers listed in the accompanying table were found by KOLTHOFF¹ to be satisfactory.

4. Papers of mixed indicators.

We have already seen (cf. page 172) that a mixture of two indicators frequently shows a sudden color change from the acid to the alkaline side at a given pH. W. N. BEHRENS² takes advantage of this effect in preparing indicator papers for measuring hydrogen ion concentration. The need for buffer mixtures is eliminated if papers of different composition (different pH sensitivity) are kept in stock. Of course these papers may be used for investigating well-buffered solutions.

Preparation of the papers. Filter paper (Schleicher and Schüll, No. 602, hard) is immersed several times in the dye solution and hung away to dry. The edge of the dried paper is discarded and the remainder cut into strips which are stored in a moisture-

¹ I. M. Kolthoff: Pharm. Weekblad, 58, 962 (1921).

² W. N. Behrens: Z. anal. chem., 73, 129 (1923).

free atmosphere. BEHRENS employs freshly prepared solutions of the following dyes:

Bordeaux red	(0.1% solution in water)
Brilliant green	(0.1% " " ")
Metanil yellow	(0.1% " " alcohol)
Methylene blue	(0.1% " " water)

Metanil yellow papers (pH = 1.5 and pH = 2.0).

I. 40 c.c. metanil yellow, 5 c.c. brilliant green, 10 c.c. methylene blue, 5 c.c. concentrated hydrochloric acid, 10 c.c. alcohol, 5 c.c. water. Color is lilac at pH < 1.5 and green at pH > 1.5.

II. 40 c.c. metanil yellow, 20 c.c. bordeaux red, 20 c.c. methylene blue, 5 c.c. concentrated hydrochloric acid, 10 c.c. alcohol, 5 c.c. water. Color is lilac at pH < 2.0 and blue green at pH > 2.0.

Methyl orange papers (pH = 2.5, 3.0, and 3.5).

I. 75 c.c. methyl orange solution (0.05% in 50% alcohol), 18 c.c. brilliant green, 12 c.c. methylene blue. Color is violet at pH < 2.5 and blue green at pH > 2.5.

II. 75 c.c. methyl orange, 12 c.c. methylene blue. Color is lilac at pH < 3.0 and green at pH > 3.0.

III. 75 c.c. methyl orange, 4.5 c.c. bordeaux red, 12 c.c. methylene blue. Color is red at pH < 3.5 and yellow-green at pH > 3.5.

Bromphenol blue paper (pH = 4.0).

50 c.c. bromphenol blue (0.1% in alcohol), 20 c.c. metanil yellow, 30 c.c. water. Color is yellow-green at pH < 4.0 and violet at pH > 4.0.

Bromcresol green papers (pH = 4.5 and 5.0).

I. 50 c.c. bromcresol green (0.1% in alcohol), 17.5 c.c. bordeaux red, 32.5 c.c. water. Color is yellowish rose at pH < 4.5 and blue at pH > 4.5.

II. 50 c.c. bromcresol green, 30 c.c. bordeaux red, 15 c.c. metanil yellow. Color is yellowish rose at pH < 5.0 and green-blue at pH > 5.0.

Bromcresol purple papers (pH = 5.5 and 6.0).

I. 50 c.c. bromcresol purple (0.1% in alcohol), 14 c.c. bordeaux red and 4.5 c.c. methylene blue, 32 c.c. water. Color is dirty yellow at pH < 5.5 and violet at pH > 5.5.

II. 50 c.c. bromcresol purple, 2 c.c. bordeaux red, 6 c.c. metanil yellow, 54 c.c. water. Color at pH < 6.0 is a dirty yellow and lilac at pH > 6.0.

Methyl red paper (pH = 6.5).

50 c.c. methyl red (0.1% in alcohol), 8 c.c. bordeaux red, 15 c.c. methylene blue, 27 c.c. water + 1 drop alkali to give a green color. The color is red at pH < 6.5 and green at pH > 6.5.

Phenol red papers (pH = 7.0 and 7.5).

I. 50 c.c. phenol red (0.1% in alcohol), 7.5 c.c. methylene blue, 42 c.c. water. Color is yellow-green at pH < 7.0 and red at pH > 7.0.

II. 50 c.c. phenol red, 30 c.c. brilliant green, 20 c.c. water. Color is green at pH < 7.5 and lilac at pH > 7.5.

The experience of the author leads him to believe that the papers described above are valuable chiefly in pH measurements of an orientating nature, because the color changes at the various acidities are not especially pronounced. The following observations have been made in his laboratory with certain of the indicator papers.

Paper for pH = 2.5. Greenish color. With buffer of pH 2.2, violet; diffusion gives blue circle; violet ring. Buffer of pH 2.4 acts the same as 2.2. Buffer of pH 2.6 produces only a blue circle, no violet. pH 2.8 produces a pale blue circle, no violet. pH 3.0 leaves color unchanged. *Very satisfactory paper.*

Paper for pH = 3.0. Light green color. Buffer of pH 2.6 produces a brown-violet color; diffusion sets in after 30 seconds. pH 2.8, brown-violet. pH 3.0, brownish; violet not distinct. pH 3.2 similar to 3.0; blue-violet color on standing. pH 3.4 like 3.2. Difference not sharp, but paper is useful.

Paper for pH = 3.5. Light green color. Buffer of pH 3.0 produces a violet color; diffusion results in the formation of concentric circles, the innermost blue, then orange, and finally green. pH 3.2 same as 3.0, except less pronounced. pH 3.4, blue circle still visible, but orange-red is weak. At pH 3.6, weaker blue circle, no red-violet. No color change at pH 3.8 or 4.0.

Paper for pH = 4.0. Color not uniform, partly yellow and partly green. Weak violet color at pH 4.4, especially the edge of the circle. At pH 4.2, interior of circle more yellowish, but still distinctly violet. At 4.0 inner circle is yellow and outer ring a weak violet. Color is yellow at pH 3.8. The transformation is not sharp.

Paper for pH = 4.5. Faint yellow color. Violet in pH range

4.0 to 4.4. At 4.6, pale violet circle with green ring. At 4.8, faint violet circle with green-blue rim. At pH 5.0, inner circle still more faintly violet, blue green rim.

Paper for pH = 5.0. Brownish yellow color. No change at a pH of 4.6. Violet circle with green border at 4.8. Same at 5.0; green rim more marked. At pH 5.2, same as 5.0.

Paper for pH = 5.5. Greenish yellow color. Unchanged at pH 5.2; faint violet circle appears after a half minute. At pH 5.4, same as 5.2. Violet circle at 5.6. Blue-violet circle at pH 5.8. Very useful paper.

Paper for pH = 6.0. Light yellow color. Unchanged at pH 5.8. Violet circle at 6.0. More pronounced violet at pH 6.2.

Paper for pH = 6.5. Red-brown color. Unchanged between pH's 6.2 and 6.4. At 6.6, interior of circle unaltered; blue ring. More marked blue at 6.8. Color transition not very striking.

Paper for pH = 7.0. Green-yellow color. Bluish circle at pH 6.6. Deeper blue at 6.8. Blue-violet circle at pH 7.0. Violet-brown circle at 7.2. Color change not sharp, though paper may be used.

The author has prepared papers from a mixture of 0.1% cresol red with 0.25% thymol blue and from 0.1% cresol red with 0.1% thymol blue. The first paper has an indistinct bluish gray color from 7.4 to 8.4. The color is rose at a pH of 8.4 and red-violet at 8.6. The second paper is definitely rose at a pH of 7.6. Neither transformation is very distinct.

Cresol red paper (pH = 8.0).

50 c.c. cresol red (0.1% in alcohol), 10 c.c. brilliant green, 40 c.c. water. The color is green at pH < 8.0, blue-gray at pH = 8.0, and lilac at pH > 8.0. It is best to color only a half sheet with 100 c.c. of dye solution.

Procedure according to Behrens. The indicator paper is drawn for 30 seconds through the solution being examined, and the liquid allowed to drain off. The color of the moist paper is then observed on a white background. A black background is better for bromphenol blue paper. A gray coloration corresponds to the pH sensitivity of the list given above. A sensitivity of 0.2 pH unit may be assumed.

I. M. KOLTHOFF¹ also has employed papers prepared from

¹ I. M. Kolthoff: *Biochem. Z.*, 189, 26 (1927).

various mixed indicators (cf. page 172). Most of them are not satisfactory because of the disturbing capillary phenomena. The papers of *phenolphthalein- α -naphtholphthalein* may be recommended.

Paper I (pH = 9.3). Hardened filter paper is immersed in a mixture of 0.3% phenolphthalein and 0.1% naphtholphthalein solution in 70% alcohol, and then allowed to dry. The paper is colored a pale rose. Buffer solutions of varying pH will produce the following reactions: pale green at 9.2; a rose circle with a green zone appears at 9.4; paper turns violet with a green zone at 9.6; at 9.8 the color is a deep red violet, capillary effects producing a green rim. The paper is very useful in controlling neutralizations to a pH of 9.2–9.4. An example of the application of this paper is the determination of morphine in opium. In this analysis it is necessary to bring the solution to a pH of 9.2, which happens to be the isoelectric point of the morphine and corresponds to the point of minimum solubility of the alkaloid.

Paper II (pH = 9.7). The paper is prepared from 0.1% phenolphthalein and 0.1% α -naphtholphthalein. It has a pure green color at pH = 9.4, faint rose-violet with a green ring at 9.6, and red-violet at 9.8.

We see from the foregoing that mixed indicator papers are available for the following acidities: pH = 1.5, 2.0, 2.5, 3.0, 3.5, 4.0, 4.5, 5.0, 5.5, 6.0, 6.5, 7.0, 7.5, 8.0, 9.3, and 9.7.

5. Capillary phenomena in indicator papers.

The capillary phenomena in filter paper have been the subject of numerous investigations. It is possible to tell when the sensitivity limit of an indicator paper is being approached simply from the appearance of the reactions taking place. A drop of 0.001 N HCl placed upon congo paper will, of course, diffuse radially. The center of this region shows the red alkaline color of the indicator. This is surrounded by a circle showing the acid reaction, which is followed in turn by a water circle. Other indicator papers such as dimethyl yellow, azolitmin, litmus papers, etc., behave in similar fashion.

The relationship between the radii of the water and acid circles depends upon the hydrogen ion concentration (consult HOLM-

GREN and others¹). The following explanation has been offered to account for the formation of circular regions. The entire paper is considered as being acid up to the rim of the acid circle. In the center, however, the acidity is so slight that the $[H^+]$ is insufficient to produce the blue congo acid (if congo paper is involved). When a drop of acid solution is placed on the paper, water diffuses quite rapidly, to be followed by the extremely mobile hydrogen ions. As a consequence of the diffusion process, there is a definite distance from the center at which the quantity of adsorbed hydrogen ion is great enough to produce the acid form of the indicator. The result is an acid circle which acts as a chemical filter, permitting only water molecules to pass.

Capillary phenomena may arise from other causes. Thus a solution of ammonium acetate turns both red and blue litmus papers violet. The drops are more bluish in the center and more red at the edge. It appears that the paper hinders the diffusion of ammonium hydroxide to a greater extent than it does the diffusion of the acetic acid. The effect is even more evident when the reaction is produced with lead acetate. Around the center of the drop is found a blue region (adsorption of lead hydroxide) which is surrounded by a red region due to the diffusion of the acetic acid. These observations account for the discrepancy found in medical books regarding the reaction of lead acetate. It is impossible to determine accurately the reaction of this salt with litmus paper. It can be done, however, with methyl red solutions. The reaction resulting from the hydrolysis of salts such as sodium acetate and ammonium chloride is demonstrated readily by means of indicator papers.

6. Preparation of papers.

The method of GLASER is satisfactory. Strong, white filter paper is purified with hydrochloric acid and ammonium hydroxide, washed with distilled water, and dried. Paper number 595 of SCHLEICHER and SCHÜLL is best for this purpose (GLASER). If white, sized paper is to be employed, a good writing paper is

¹ Goppelsroeder: *Neue Capillar- und Capillaranalytische Untersuchungen*. Verh. Ges. Dtsch. Naturf. u. Ärzte, Basel 1907. Wo. Ostwald: *Kolloid-Z.*, **2**, Suppl.-Heft, 20 (1908). H. Freundlich: *Capillarchemie*, 1 ed., p. 156. Lucas: *Kolloid-Z.*, **23**, 15 (1918). H. Schmidt: *Kolloid-Z.*, **13**, 146 (1913); *J. Biol. Chem.*, **7**, 231 (1913), **24**, 49 (1919). Holmgren: *Biochem. Z.*, **14**, 181 (1908). Krulla: *Z. physik. Chem.*, **66**, 307 (1909). Skraup: *Monatsh.*, **30**, 773 (1909), **31**, 754, 1607 (1910), **32**, 353 (1911). Malarski: *Kolloid-Z.*, **23**, 113 (1918).

as serviceable as any. The dried paper is then saturated with indicator solution. The moist paper is dried by hanging across a string. This assures a uniform distribution of the coloring matter. Alkaline and acid vapors must be excluded from the drying space.

Blue litmus paper can be prepared best by following the directions of GLASER (l.c. page 112). A cake of litmus is first digested with alcohol. The residue is dried and extracted with cold water. The blue paper is obtained simply by saturating filter paper with the aqueous solution, and drying. Free alkali may be removed by washing with water on a glass plate. It is better to remove excess alkali with acid before immersing the paper in the solution.

GLASER prepares red litmus paper from the acid tincture or by dipping blue paper into dilute sulfuric acid and washing with distilled water. It is better, however, to prepare it directly from the aqueous solution from which the blue paper was obtained. This has been suggested also by FRESSENIUS and GRÜNHUT.¹ The blue solution is treated with sulfuric acid until it is entirely red. Paper is then immersed in it. FRESSENIUS and GRÜNHUT boil the acidified solution for a quarter of an hour before preparing the indicator paper. If the red color turns violet or blue again, more sulfuric acid must be added and the process repeated until the desired color is attained.

It is even better to use the violet paper than either the red or blue litmus papers, for either an acid or alkaline reaction will be revealed. The aqueous solution of the purified litmus is treated with acid until the proper hue results, and the paper saturated with this solution. Other indicator papers are prepared from solutions of the pure indicators.

F. W. HORST² gives these directions for preparing a sensitive congo paper. First the dye must be purified. A gram of the crude product is dissolved in 30–35 c. c. of hot water, and permitted to stand while insoluble components such as calcium and magnesium salts settle out. The solution is filtered through glass wool, again heated, and small portions of a saturated sodium chloride solution added slowly while stirring. The addition of salt is continued until the dye begins to crystallize (about 20 c. c.

¹ Fresenius and Grünhut: *Z. anal. Chem.*, 59, 233 (1920).

² F. W. Horst: *Z. angew. Chem.*, 33, 947 (1925).

of salt solution). The crystals are sucked dry while hot, and washed with hot 10% salt solution.

The purified dye again is dissolved in hot water (about 0.3% solution) and the indicator acid precipitated with hydrochloric acid. The solid is filtered, sucked dry, and dissolved in hot water to which ammonium hydroxide is added. The resulting solution (about 0.1%) is maintained near the boiling point while strips of paper of good quality are dipped in it. The strips are washed with cold distilled water as soon as they are removed from the solution. They are sensitive to 1/4000 N HCl.

All indicator papers should be protected against air and light.

O. B. PRATT and H. O. SWARTOUT¹ have prepared indicator papers from fruit and vegetable extracts (cf. page 165) but mention no sensitivity limits. Filter paper was soaked in the aqueous extracts, dried, moistened with ammonium hydroxide, and again dried in air. The paper then has a neutral color. These natural indicator papers are listed below.

KIND OF EXTRACT	NEUTRAL COLOR	COLOR	
		Acid	Alkaline
Apple	gray-purple	red	green
Blackberry	purple	"	blue-green
Blueberry	purple	"	blue
Cherry	red-purple	"	blue-green
Mountain cranberry	pale purple	"	pale green
Grape	purple	"	blue-green
Plum	pale purple	"	pale green
Pomegranate	purple	"	blue-green
Raspberry	red-purple	"	pale green

7. The limits of sensitivity of indicator papers towards strong acids and bases.

The sensitivity will be given only for those indicators which have practical usefulness. The writer has investigated papers made with lacmoid, 1% and 0.1% *p*-nitrophenol, neutral red, methyl red, and a number of other substances, and found that the color was not sufficiently sharp.

Tests were made with indicator papers prepared from ordinary filter paper. In the following table is to be found the concen-

¹ O. B. Pratt and H. O. Swartout: *Am. J. Sci.*, 71, 486 (1930).

trations of the indicator solutions into which the papers were dipped.

TABLE OF SENSITIVITY OF INDICATOR PAPERS

KIND OF INDICATOR	CONCENTRATION OF INDICATOR SOLUTION FROM WHICH PAPER WAS MADE	SENSITIVITY TOWARDS		REMARKS
		HCl	NaOH	
Hematoxylin	0.2%	0.1-0.2 N		From yellow to cherry red. Blue with 10 ⁻² N HCl; blue-green with 10 ⁻¹ N HCl; green-yellow with 1 N HCl
Methyl violet	0.04%	10 ⁻² N		
Metanil yellow	0.2%	5 × 10 ⁻³ N		Yellow (alkaline); red (acid)
Tropeolin 00	0.2%	4 × 10 ⁻³ N		
Dimethyl yellow	0.2% (alcohol)	4 × 10 ⁻⁴ N		
Congo	0.1% (water)	2 × 10 ⁻⁴ N		
Blue litmus	1%	10 ⁻³ N		
" "	0.1%	2 × 10 ⁻⁴ N		
Violet "	1%	4 × 10 ⁻⁴ N	5 × 10 ⁻⁵ N	
Azolitmin	1%	10 ⁻⁴ N	5 × 10 ⁻⁵ N	
Red litmus	1%		2 × 10 ⁻⁴ N	
Red litmus	0.1%		10 ⁻⁴ N	
α-Naphtholphthalein	0.1%		5 × 10 ⁻⁵ N	
Brilliant yellow	1%		10 ⁻⁵ N	yellow — red-brown acid alkaline yellow — red
Phenol red	0.1%		5 × 10 ⁻⁵ N	acid alkaline yellow — purple-red
Cresol red	0.1%		5 × 10 ⁻⁵ N	
Phenolphthalein	1%		5 × 10 ⁻⁵ N	
" "	0.1%		10 ⁻⁴ N	
Nile blue ^a	0.2% (water)		2.5 × 10 ⁻⁴ N	blue — red acid alkaline yellow — red-brown
Turmeric	0.2%		10 ⁻³ N	acid alkaline colorless — blue yellow — red-brown
Thymolphthalein	0.1%		10 ⁻³ N	
Tropeolin 0	0.2%		3 × 10 ⁻³ N	acid alkaline

^a The blue Nile blue paper is colored yellow in strongly acid solution. The color is green in 2 N hydrochloric acid and yellow in 4 N acid.

APPENDIX

TABLE 1. ION PRODUCT (DISSOCIATION CONSTANT) OF WATER AT VARIOUS TEMPERATURES

TEMPERATURE	<i>a</i>	<i>b</i>	<i>c</i>	<i>d</i>
0°	0.12×10^{-14}	0.14×10^{-14}	—	0.089×10^{-14}
18°	0.59×10^{-14}	0.72×10^{-14}	0.74×10^{-14}	0.46×10^{-14}
25°	1.04×10^{-14}	1.22×10^{-14}	1.27×10^{-14}	0.82×10^{-14}
50°	5.66×10^{-14}	8.7×10^{-14}	—	—
100°	58.2×10^{-14}	74×10^{-14}	—	48.0×10^{-14}

^a Kohlrausch and Heydweiller: *Ann. Physik* (4) 28, 512 (1909).

^b Lorenz and Bohi: *Z. physik. Chem.*, 66, 733 (1909).

^c Michaelis: *Die Wasserstoffionenkonzentration*, 1914, p. 8.

^d Noyes and Coworkers: Noyes, *The electrical conductivity of aqueous solutions*, Carnegie Inst. Wash. Pub., 1907; Kanolt, *J. Am. Chem. Soc.*, 29, 1414 (1907); S. P. L. Sørensen: *Compt. rend. trav. lab. Carlsberg*, 3, 31 (1909); Noyes, Kato and Sosmann, *Z. physik. Chem.*, 73, 20 (1910); Fales and Nelson, *J. Am. Chem. Soc.*, 37, 2769 (1915); Beans and Oakes, *J. Am. Chem. Soc.*, 42, 2116 (1920).

TABLE 2. ION ACTIVITY PRODUCT OF WATER:

The most accurate determinations of the activity product of water,

$$aK_w = [aH^+][aOH^-],$$

at temperatures between 0° and 37° have been made by NIELS BJERRUM and A. UNMACK.¹ They found the following values for $paK_w = paH + paOH$: (cf. page 66):

$$14.926 \text{ at } 0^\circ; \quad 14.222 \text{ at } 18^\circ; \quad 13.980 \text{ at } 25^\circ; \quad 13.590 \text{ at } 37^\circ.$$

The variation between 0° and 37° is represented by

$$paK_w = 14.926 - 0.0420t + 0.00016t^2.$$

The values of aK_w and paK_w in the succeeding table were calculated by means of this equation.

This information is useful in predicting how the electrolyte content of a solution will influence the product

$$K_w' = [aH^+][OH^-], \quad \text{or} \quad pK_w' = paH + pOH.$$

The activity of the hydrogen ions is designated by $[aH^+]$, whereas $[OH^-]$ is the total hydroxyl ion concentration. For solutions of electrolytes consisting of univalent ions up to an ionic strength (*c*) of 0.1, pK_w' may be calculated from the expression

$$pK_w' = paK_w - 0.5\sqrt{c} + 0.58c.$$

The table furnishes the appropriate value of paK_w .

Of equal interest is the variation of $[H^+][OH^-]$ with changing electrolyte

¹ N. Bjerrum and A. Unmack: *Kgl. Danske Videnskab. Selskab.*, 9, 1 (1929).

content. From

$$K_w'' = [\text{H}^+][\text{OH}^-],$$

we have

$$pK_w'' = \text{pH} + \text{pOH}.$$

For electrolyte solutions with univalent ions up to an ionic strength of 0.03,

$$pK_w'' = pK_w - \sqrt{c} + 2c.$$

t	$\frac{aK_w \times 10^{15}}{[\text{aH}^+][\text{aOH}^-] \times 10^{15}}$	pK_w	t	$\frac{aK_w \times 10^{15}}{[\text{aH}^+][\text{aOH}^-] \times 10^{15}}$	pK_w
10°	3.0	14.52	21°	7.8	14.11
11°	3.3	14.48	22°	8.3	14.08
12°	3.6	14.45	23°	9.0	14.05
13°	3.9	14.41	24°	9.8	14.01
14°	4.3	14.37	25°	10.5	13.98
15°	4.7	14.33	26°	11.4	13.94
16°	5.1	14.29	27°	12.3	13.91
17°	5.6	14.25	28°	13.2	13.88
18°	6.1	14.22	29°	14.5	13.84
19°	6.6	14.18	30°	15.5	13.81
20°	7.2	14.14			

TABLE 3. AVERAGE ION ACTIVITY COEFFICIENTS f OF SEVERAL ELECTROLYTES IN AQUEOUS SOLUTION AT 25°

m = moles of electrolyte per 1000 g. of solvent.

For electrolyte BA: $f = \sqrt{f_A f_B}$.

For electrolyte B₂A: $f = \sqrt[3]{f_B^2 f_A}$.

$m =$	0.001	0.002	0.005	0.01	0.02	0.05	0.1	0.2	0.5	1.0
HCl ^a	0.965	0.935	0.928	0.904	0.874	0.829	0.795	0.766	0.757	0.810
H ₂ SO ₄ ^b	—	—	—	—	—	—	0.343	0.268	0.193	0.161
KCl ^c	—	—	0.926	0.899	0.865	0.809	0.762	0.715	0.654	0.605
NaCl ^d	—	—	—	—	—	0.833	0.789	0.742	0.683	0.659
LiCl ^d	—	—	—	—	—	0.838	0.797	0.774	0.742	0.775
KOH ^e	—	—	—	—	—	0.799	0.759	0.711	0.686	0.705
Na ₂ SO ₄ ^f	—	—	—	—	—	—	0.599	0.506	—	0.327
BaCl ₂ ^g	—	—	—	0.725	0.659	0.556	0.496	0.440	0.396	0.399
CaCl ₂ ^h	0.888	0.850	0.785	0.725	0.658	0.570	0.515	0.481	0.519	0.715
CuSO ₄ ⁱ	—	—	—	0.444	—	0.230	0.163	0.114	0.0686	—
ZnCl ₂ ^h	0.881	0.838	0.767	0.708	0.642	0.556	0.502	0.448	0.376	0.290
ZnSO ₄ ⁱ	0.734	0.650	0.519	0.421	0.324	0.220	0.161	0.113	0.069	0.048

^a L. E. Young: J. Am. Chem. Soc., 50, 898 (1928).

^b G. N. Lewis and M. Randall: Thermodynamics, McGraw-Hill Book Co., 1923, N. Y.

^c G. Scatchard: J. Am. Chem. Soc., 47, 648 (1925).

^d H. S. Harned: J. Am. Chem. Soc., 51, 416 (1929).

^e M. Knobel: J. Am. Chem. Soc., 45, 70 (1923).

^f H. S. Harned and G. Åkerlöf: Physik. Z., 27, 411 (1926).

^g R. W. Lucasse: J. Am. Chem. Soc., 47, 743 (1925).

^h G. Scatchard and R. E. Teft: J. Am. Chem. Soc., 52, 2265, 2272 (1930).

ⁱ R. F. Nielsen and D. J. Brown: J. Am. Chem. Soc., 49, 2423 (1927).

^j U. B. Bray: J. Am. Chem. Soc., 49, 2372 (1927).

TABLE 4. DISSOCIATION CONSTANTS OF THE MOST IMPORTANT ACIDS AND BASES ¹

SUBSTANCE	TEMPERATURE	CONSTANT	ACID EXPONENT pK
<i>Inorganic Acids</i>			
Arsenic acid, 1st step	25°	5×10^{-3}	2.30
2nd step	25°	8.3×10^{-8}	7.08
Arsenious acid	25°	6.0×10^{-10}	9.22
Boric acid	18°	5.5×10^{-10}	9.26
Carbonic acid, 1st step	0°	2.24×10^{-7}	6.65
1st step	18°	3.12×10^{-7}	6.51
1st step	25°	3.50×10^{-7}	6.46
2nd step	25°	4.4×10^{-11}	10.36
Chromic acid, 2nd step	25°	1.0×10^{-7}	7.00
Hydrazoic acid	25°	2.6×10^{-5}	4.59
Hydrofluoric acid	25°	1.67×10^{-5}	4.78
Hydrogen peroxide	20°	2×10^{-12}	11.7
Hydrogen sulfide, 1st step	18°	5.7×10^{-8}	7.24
2nd step		1.2×10^{-15}	14.92
Hypochlorous acid	18–20°	3.7×10^{-8}	7.43
Hypophosphorous acid, 1st step	20°	(6.4×10^{-3})	2.19
2nd step	20°	1.55×10^{-3}	2.81
3rd step	20°	5.4×10^{-8}	7.27
4th step	20°	9.4×10^{-11}	10.03
Nitrous acid	25°	4×10^{-4}	3.40
Phosphoric acid, 1st step	18°	7.6×10^{-3}	2.12
1st step	25°	7.0×10^{-3}	2.16
2nd step	18°	7.5×10^{-8}	7.13
2nd step	25°	7.4×10^{-8}	7.13
3rd step	18°	3.5×10^{-13}	12.46
3rd step	25°	4.8×10^{-13}	12.32
3rd step	37.5°	6.6×10^{-13}	12.18
Phosphorous acid, 2nd step	18°	2×10^{-7}	6.70
Pyrophosphoric acid, 1st step	25°	1.4×10^{-1}	0.85
2nd step	25°	1.1×10^{-2}	1.96
3rd step	18°	2.1×10^{-7}	6.68
4th step	18°	4.06×10^{-10}	9.39
Silicic acid, 1st step	25°	Approx. 2×10^{-10}	9.7
Sulfuric acid, 2nd step	25°	3.2×10^{-2}	1.50
Sulfurous acid, 1st step	18°	1.7×10^{-2}	1.77
2nd step	15°	1.0×10^{-7}	7.00

¹ As has been stated in Chapter Three, the ionization constant will be truly constant only when equilibrium conditions are expressed in terms of activities rather than concentrations. The "activity constants" are printed in the following tables in heavy type. Consult Landolt-Börnstein-Roth: Erg.-Bd., 2, 1079 (1931), for details.

TABLE 4 (Continued)

SUBSTANCE	TEMPERATURE	CONSTANT	ACID EXPONENT pK
<i>Organic Acids</i>			
ALIPHATIC ACIDS			
Acetic acid	18°	1.73×10^{-5}	4.76
	25°	1.74×10^{-5}	4.76
Capric acid	18°	1.44×10^{-5}	4.84
Citric acid, 1st step	18°	8.4×10^{-4}	3.08
1st step	25°	8.7×10^{-4}	3.06
1st step	37°	9.1×10^{-4}	3.04
2nd step	18°	1.77×10^{-5}	4.75
2nd step	25°	1.8×10^{-5}	4.74
3rd step	18°	3.9×10^{-6}	5.41
3rd step	25°	4.0×10^{-6}	5.40
3rd step	37°	3.8×10^{-6}	5.42
Formic acid	18°	2×10^{-5}	4.70
<i>d</i> -Fructose	25°	1.0×10^{-12}	12.00
Fumaric acid, 1st step	18°	9.3×10^{-4}	3.03
1st step	37°	9.1×10^{-4}	3.04
2nd step	18°	3.4×10^{-5}	4.47
2nd step	37°	3.1×10^{-5}	4.51
<i>d</i> -Glucose	25°	5.9×10^{-13}	12.23
Glycerophosphoric acid	20°	1.8×10^{-7}	6.74
Glycine	25°	3.4×10^{-10}	9.37
Glycolic acid	25°	1.52×10^{-4}	3.82
Hydrocyanic acid	25°	7.2×10^{-10}	9.14
Isobutyric acid	25°	1.48×10^{-5}	4.83
Lactic acid	25°	1.55×10^{-4}	3.81
Lactose	25°	1.05×10^{-12}	11.98
Maleic acid, 1st step	18°	1.0×10^{-2}	2.00
1st step	37°	1.05×10^{-2}	1.98
2nd step	18°	5.5×10^{-7}	6.26
2nd step	37°	4.8×10^{-7}	6.32
Malic acid, 1st step	25°	4×10^{-4}	3.46
2nd step	18°	9×10^{-6}	5.05
Malonic acid, 1st step	25°	1.63×10^{-3}	2.79
2nd step	18°	8×10^{-7}	6.10
Monochloroacetic acid	25°	1.51×10^{-3}	2.82
Oxalic acid, 1st step	25°	6.5×10^{-2}	1.19
2nd step	25°	6.1×10^{-5}	4.21
Propionic acid	25°	1.4×10^{-5}	4.85
Pyrotartaric acid	25°	8.7×10^{-5}	4.06
Racemic acid	25°	1×10^{-3}	3.00
Succinic acid, 1st step	18°	6.6×10^{-5}	4.18
1st step	25°	6.4×10^{-5}	4.19
2nd step	18°	2.7×10^{-6}	5.57
2nd step	25°	2.7×10^{-6}	5.57

TABLE 4 (Continued)

SUBSTANCE	TEMPERATURE	CONSTANT	ACID EXPONENT pK
ALIPHATIC ACIDS (Continued)			
Tartaric acid, 1st step	18°	9.6×10^{-4}	3.02
2nd step	18°	2.8×10^{-5}	4.55
2nd step	25°	2.9×10^{-5}	4.54
Tricarballic acid, 1st step	25°	9.2×10^{-4}	3.04
2nd step	25°	2.7×10^{-5}	4.57
3rd step	25°	1.3×10^{-6}	5.89
Trichloroacetic acid	18°	1.3×10^{-1}	0.89
Valeric acid	25°	1.6×10^{-5}	4.80
AROMATIC ACIDS			
Benzoic acid	25°	6.67×10^{-5}	4.18
Camphoric acid, 1st step	25°	2.95×10^{-4}	3.53
2nd step	25°	1.05×10^{-5}	4.98
3rd step	25°	3.7×10^{-8}	7.43
Cinnamic acid	25°	3.68×10^{-5}	4.43
Diethylbarbituric acid	25°	3.7×10^{-8}	7.43
Hippuric acid	25°	2.38×10^{-4}	3.62
Hydroquinone, 1st step	20°	4.5×10^{-11}	10.35
<i>o</i> -Hydroxybenzoic acid, 1st step	25°	1.06×10^{-3}	2.97
2nd step	20°	3.6×10^{-14}	13.44
<i>m</i> -Hydroxybenzoic acid, 1st step	19°	8.7×10^{-5}	4.06
2nd step	18°	1.0×10^{-10}	10.00
<i>p</i> -Hydroxybenzoic acid, 1st step	19°	3.3×10^{-5}	4.48
2nd step	18°	4.0×10^{-10}	9.40
<i>o</i> -Cresol	25°	6.3×10^{-11}	10.20
<i>m</i> -Cresol	25°	9.8×10^{-11}	10.01
<i>p</i> -Cresol	25°	6.7×10^{-11}	10.17
Phenol	25°	1.3×10^{-10}	9.89
<i>o</i> -Phthalic acid, 1st step	25°	1.3×10^{-3}	2.89
2nd step	18°	3.9×10^{-6}	5.41
Picric acid	25°	1.6×10^{-1}	0.80
Resorcinol	25°	1.55×10^{-10}	9.81
Saccharine, 1st step	18°	2.5×10^{-2}	1.40
Sulfanilic acid	25°	6.5×10^{-4}	3.18
<i>o</i> -Sulfonebenzoic acid	—	1.9×10^{-4}	3.72
Thymol	25°	3.2×10^{-11}	10.50
Uric acid	12–14°	1.3×10^{-4}	3.89

TABLE 4 (Continued)

SUBSTANCE	TEMPERATURE	CONSTANT	BASE EXPO- NENT pK
<i>Inorganic Bases</i>			
Ammonium hydroxide	18°	1.75×10^{-5}	4.76
Lead hydroxide	25°	9.6×10^{-4}	3.02
Hydrazine	25°	3×10^{-6}	5.52
Hydroxylamine	20°	1.07×10^{-8}	7.97
<i>Organic Bases</i>			
ALIPHATIC BASES			
Diethylamine	25°	1.26×10^{-3}	2.90
Dimethylaminoantipyrine (Pyramidon)	18°	6.9×10^{-10}	9.16
Dimethylamine	25°	7.4×10^{-4}	3.13
“	25°	5.12×10^{-4}	3.29
Ethylamine	25°	5.6×10^{-4}	3.25
“		(1.3×10^{-3})	2.89)
Methylamine	25°	5.0×10^{-4}	3.30
“	25°	4.4×10^{-4}	3.36
Triethylamine	25°	6.4×10^{-4}	3.19
Trimethylamine	25°	7.4×10^{-5}	4.13
“	25°	5.27×10^{-5}	4.28
AROMATIC BASES			
Aniline	25°	4×10^{-10}	9.40
α -Naphthylamine	25°	9.9×10^{-11}	10.00
β -Naphthylamine	25°	2×10^{-11}	10.70
<i>o</i> -Phenetidine	20°	4.6×10^{-11}	10.34
<i>p</i> -Phenetidine	15°	2.2×10^{-9}	8.66
<i>o</i> -Phenylenediamine, 1st step	25°	3×10^{-10}	9.52
<i>p</i> -Phenylenediamine, 1st step	18°	1.1×10^{-8}	7.96
2nd step	18°	3.5×10^{-12}	11.46
Pyridine	18°	1.4×10^{-9}	8.85
HETEROCYCLIC BASES			
Aconitine	15°	1.3×10^{-6}	5.88
Apomorphine	15°	1.0×10^{-7}	7.0
Atropine	15°	4.5×10^{-5}	4.35
Brucine, 1st step	15°	9.2×10^{-7}	6.04
2nd step	15°	2.52×10^{-11}	10.60
2nd step	25°	2×10^{-12}	11.7
Caffeine	40°	4.1×10^{-14}	13.39
Cevadine	15°	7.2×10^{-6}	5.15

TABLE 4 (Continued)

SUBSTANCE	TEMPERATURE	CONSTANT	BASE EXPONENT pK
HETEROCYCLIC BASES (Continued)			
Cinchonine, 1st step	15°	1.4×10^{-6}	5.85
2nd step	15°	1.1×10^{-10}	9.92
2nd step	15°	3.3×10^{-10}	9.48
2nd step	15°	5.1×10^{-10}	9.29
Cinchonidine, 1st step	15°	1.6×10^{-6}	5.80
2nd step	15°	8.4×10^{-11}	10.08
Cocaine	15°	2.6×10^{-6}	5.59
Codeine	15°	9×10^{-7}	6.05
Colchicine	15°	4.5×10^{-13}	12.35
Coniine	25°	1.3×10^{-3}	2.89
"	15°	8×10^{-4}	3.1
Ecgonine	15°	6×10^{-12}	11.22
Emetine, 1st step	15°	1.98×10^{-6}	5.70
1st step	15°	1.7×10^{-6}	5.77
2nd step		5×10^{-7}	6.30
2nd step	15°	2.3×10^{-7}	6.64
Hydrastine	15°	1.7×10^{-8}	7.77
Isoquinoline	15°	3.6×10^{-10}	9.44
Morphine	15°	6.8×10^{-7}	6.17
Narceine	15°	2×10^{-11}	10.7
Narcotine	15°	7.9×10^{-8}	7.10
"	15°	1.5×10^{-8}	7.83
Nicotine, 1st step	15°	7×10^{-7}	6.16
2nd step	15°	1.4×10^{-11}	10.86
Papaverine	15°	9×10^{-8}	7.05
"	15°	8.15×10^{-9}	8.09
Physostigmine, 1st step	15°	7.6×10^{-7}	6.12
2nd step	15°	5.7×10^{-13}	12.24
Pilocarpine, 1st step	15°	1.0×10^{-7}	7.00
1st step	15°	7×10^{-8}	7.15
2nd step	15°	2×10^{-13}	12.7
Piperazine, 1st step	25°	6.4×10^{-5}	4.19
2nd step	15°	3.7×10^{-9}	8.43
Piperidine	25°	1.6×10^{-3}	2.80
Piperine	18°	5.8×10^{-13}	12.22
Quinoline	15°	3.2×10^{-10}	9.5
Quinidine, 1st step	15°	(2.4×10^{-7})	(6.62)
1st step	15°	3.7×10^{-6}	5.43
2nd step	15°	3.2×10^{-10}	9.50
2nd step	15°	1.0×10^{-10}	10.0
Quinine, 1st step	15°	1.08×10^{-6}	5.97
2nd step	15°	3.3×10^{-10}	9.48
2nd step		1.3×10^{-10}	9.89
2nd step	15°	1.35×10^{-10}	9.88

TABLE 4 (Continued)

SUBSTANCE	TEMPERATURE	CONSTANT	BASE EXPONENT pK
HETEROCYCLIC BASES (Continued)			
Solanine	15°	2.2×10^{-7}	6.66
Sparteine, 1st step		1.0×10^{-2}	2.00
1st step	15°	5.7×10^{-3}	2.24
2nd step	15°	3.1×10^{-10}	9.5
Strychnine, 1st step	15°	1.0×10^{-6}	6.0
2nd step	15°	2×10^{-12}	11.7
Thebaine	15°	9×10^{-7}	6.05
Theobromine	40°	4.8×10^{-14}	13.32
Theophylline	25°	1.9×10^{-14}	13.72
"		1.2×10^{-14}	13.92

TABLE 5. TRANSFORMATION RANGES OF THE MOST IMPORTANT INDICATORS

INDICATOR	RANGE IN pH	ACID-ALKALINE COLOR
<i>o</i> -Cresol red	0.2- 1.8	red—yellow
<i>m</i> -Cresol red	1.2- 2.8	red—yellow
Thymol blue	1.2- 2.8	red—yellow
Pentamethoxy red	1.2- 3.2	red-violet—colorless
Metanil yellow	1.2- 2.3	red—yellow
Tropeolin 00	1.3- 3.2	red—yellow
Quinaldine red	1.4- 3.2	colorless—red
β -Dinitrophenol	2.4- 4.0	colorless—yellow
Hexamethoxy red	2.6- 4.6	red-violet—colorless
α -Dinitrophenol	2.8- 4.4	colorless—yellow
Dimethyl yellow	2.9- 4.0	red—yellow
Methyl orange	3.1- 4.4	red—orange-yellow
Tetrabromphenol blue	3.0- 4.6	yellow—blue
Bromphenol blue	3.0- 4.6	yellow—purple
Congo red	3.0- 5.2	blue-violet—red
<i>p</i> -Ethyl orange	3.4- 4.8	rose-red—yellow
Dimethyl- α -naphthylamino-azo- <i>o</i> -methoxybenzene- <i>para</i> sul- fonic acid	3.4- 4.8	purple—orange-yellow
Resazurin	3.8- 6.5	orange—dark violet
α -Naphthyl red	3.7- 5.0	red—yellow
Bromcresol green	3.8- 5.4	yellow—blue
γ -Dinitrophenol	4.0- 5.4	colorless—yellow
Isopicramic acid	4.1- 5.6	rose—yellow
Methyl red	4.4- 6.2	red—yellow
Lacmoid	4.4- 6.4	red—blue
Chlorphenol red	4.8- 6.4	yellow—red

TABLE 5 (Continued)

INDICATOR	RANGE IN PH	ACID-ALKALI COLOR
<i>p</i> -Nitrophenol	5.0- 7.0	colorless—red
Heptamethoxy red	5.0- 7.0	red—colorless
Bromocresol purple	5.2- 6.8	yellow—purple
Sodium alizarine sulfonate	5.5- 6.8	yellow—red
Pinachrome	5.8- 7.8	colorless—red
Bromthymol blue	6.0- 7.6	yellow—blue
Aurin (Rosolic acid)	6.0- 7.6	yellow—red
Phenol red	6.4- 8.2	yellow—red
Neutral red	6.8- 8.0	red—yellow
<i>m</i> -Nitrophenol	6.8- 8.4	colorless—yellow
Azolitmin (Litmus)	5.0- 8.0	red—blue
<i>o</i> -Cresol red	7.0- 8.8	yellow—red
<i>o</i> -Cresolbenzein	7.2- 8.6	yellow—red
Di-5-bromovanillidene-cyclo- hexanone	7.2- 8.6	yellow-green—orange-red
Diorthohydroxystyrylketone	7.3- 8.7	yellow—green
Propyl- α -naphthol orange	7.4- 8.9	yellow—red
<i>m</i> -Cresol purple	7.6- 9.2	yellow—purple-red
α -Naphtholphthalein	7.8- 9.0	pale rose-yellow—green
Curcumin	7.8- 9.2	yellow—red-brown
Di-4-oxy-3-ethoxybenzylidene- cyclohexanone	8.0-10.2	yellow—red
Thymol blue	8.0- 9.6	yellow—blue
Phenolphthalein	8.0- 9.8	colorless—red-violet
Thymolphthalein	9.3-10.5	colorless—blue
Nile blue	9.0-10.4	blue—red
Alizarine yellow	10.1-11.1	yellow—lilac
Diazo violet	10.1-12.0	yellow—violet
Salicyl yellow	10.0-12.0	pale yellow—orange-brown
Nitramine	10.8-12.8	colorless—orange-brown
Tropolin 0	11.1-12.7	yellow—orange-brown
Poirrier's blue	11.0-13.0	blue—violet-rose
Trinitrobenzene	12.0-14.0	colorless—orange
Trinitrobenzoic acid	12.0-13.4	colorless—orange-red

TABLE 6. THE RELATION BETWEEN pH AND $[H^+]$

pH	$[H^+]$	pH	$[H^+]$	pH	$[H^+]$
<i>x.00</i>	1.00×10^{-2}	<i>x.34</i>	0.46×10^{-2}	<i>x.68</i>	0.21×10^{-2}
<i>x.02</i>	0.98×10^{-2}	<i>x.36</i>	0.44×10^{-2}	<i>x.70</i>	0.20×10^{-2}
<i>x.04</i>	0.91×10^{-2}	<i>x.38</i>	0.42×10^{-2}	<i>x.72</i>	0.19×10^{-2}
<i>x.06</i>	0.87×10^{-2}	<i>x.40</i>	0.40×10^{-2}	<i>x.74</i>	0.18×10^{-2}
<i>x.08</i>	0.83×10^{-2}	<i>x.42</i>	0.38×10^{-2}	<i>x.76</i>	0.17×10^{-2}
<i>x.10</i>	0.79×10^{-2}	<i>x.44</i>	0.36×10^{-2}	<i>x.78</i>	0.17×10^{-2}
<i>x.12</i>	0.76×10^{-2}	<i>x.46</i>	0.35×10^{-2}	<i>x.80</i>	0.16×10^{-2}
<i>x.14</i>	0.72×10^{-2}	<i>x.48</i>	0.33×10^{-2}	<i>x.82</i>	0.15×10^{-2}
<i>x.16</i>	0.69×10^{-2}	<i>x.50</i>	0.32×10^{-2}	<i>x.84</i>	0.14×10^{-2}
<i>x.18</i>	0.66×10^{-2}	<i>x.52</i>	0.30×10^{-2}	<i>x.86</i>	0.14×10^{-2}
<i>x.20</i>	0.63×10^{-2}	<i>x.54</i>	0.29×10^{-2}	<i>x.88</i>	0.132×10^{-2}
<i>x.22</i>	0.60×10^{-2}	<i>x.56</i>	0.27×10^{-2}	<i>x.90</i>	0.126×10^{-2}
<i>x.24</i>	0.57×10^{-2}	<i>x.58</i>	0.26×10^{-2}	<i>x.92</i>	0.120×10^{-2}
<i>x.26</i>	0.55×10^{-2}	<i>x.60</i>	0.25×10^{-2}	<i>x.94</i>	0.115×10^{-2}
<i>x.28</i>	0.52×10^{-2}	<i>x.62</i>	0.24×10^{-2}	<i>x.96</i>	0.110×10^{-2}
<i>x.30</i>	0.50×10^{-2}	<i>x.64</i>	0.23×10^{-2}	<i>x.98</i>	0.105×10^{-2}
<i>x.32</i>	0.48×10^{-2}	<i>x.66</i>	0.22×10^{-2}	1 + <i>x.00</i>	0.100×10^{-2}

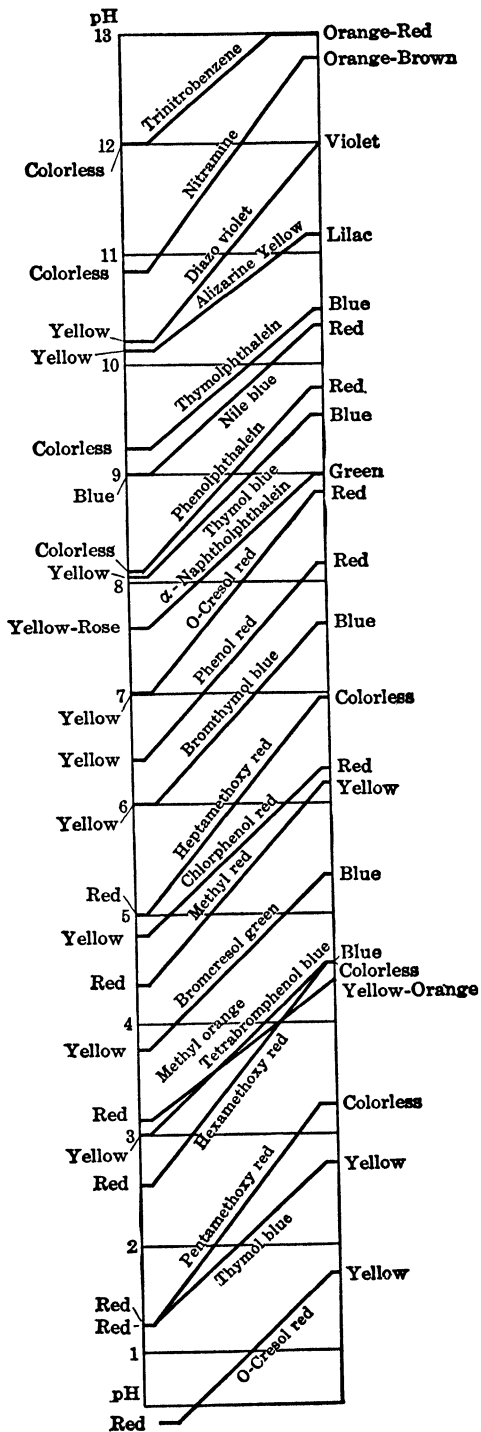

AUTHOR INDEX

- Aas, F. See H. Goldschmidt
 Acree, S. F., 223. See Birge, Brightman, Fawcett, Lubs, White
 Acree, S. F., Millon, Ivory and Slagle, 263
 Adams, E. Q. and L. Rosenstein, 150
 Airila, Y., 314. See Hamälaines
 Åkerlof, G. See Harned
 Anderson, L. C., 118
 Anderson, L. C. and M. Gomberg, 118
 Andrews, S. and C. L. A. Schmidt, 40
 Arny, H. V. and A. Taub, 302
 Arrhenius, S., 4, 5, 49, 53, 54, 55, 68, 74, 76, 240, 284
 Aston. See Walker
 Atkins, W. R., 37
 Atkins, W. R. G. and C. F. A. Pantin, 261
 Avory. See Acree

 Bader, R., 291, 292
 Badollet, M. S., J. Hamilton and C. F. Walton Jr., 305
 Baggesgaard-Rasmussen, H. and F. Reimers, 146, 359
 Bancroft, W. D. and H. L. Davis, 197
 Barnett, C. W. See G. D. Barnett
 Barnett, G. D. and C. W. Barnett, 286, 287, 300
 Barnett, G. D. and H. S. Chapman, 287
 Beans and Oakes, 4, 379
 Beaver, J. J., 296
 Behrens, W. N., 369, 370, 372
 Beilstein and Kuhlberg, 170
 Bernthsen, 219
 Bernthsen and Schweitzer, 162
 Biddle, H. C., 150
 Biehler, W., 320
 Birge, A. F. and S. F. Acree, 219, 223
 Bischoff, M. A. See Mellit
 Bishop, E. R., E. B. Kittredge and J. H. Hildebrand, 198
 Bjerrum, N., 4, 16, 42, 44, 45, 46, 47, 55, 59, 106, 219, 299, 338
 Bjerrum, N. and A. Unmack, 64, 66, 379
 Bogen, E., 171
 Bogert, M. T. and G. Scatchard, 155
 Böhi. See Lorenz
 Bolin. See von Euler
 Booher, L. L. See Myers
 Bork, A., 40
 Borsook, A. See Hunter
 Bosch, W. See Kolthoff
 Bourgeaud, M. and A. Dondelinger, 98
 Boyd, W. C. and A. W. Rowe, 133
 Braun, 197
 Bravo, G. A., 179
 Bray, U. B., 380
 Bredig, 42
 Bresslau, E., 310, 311
 Brightman, C. L., M^r R. Meachem and S. F. Acree, 347
 Brighton. See G. N. Lewis
 Brintzinger, H. See Gutbier
 Britton, H. T. S. and R. A. Robinson, 262, 263
 Brode, W. C., 285, 286, 287, 288, 290, 315, 317
 Brønsted, J. N., 7, 81, 82, 83, 88, 90, 91, 214, 335, 338
 Brown, D. J. See Nielsen
 Brown, J. H., 283
 Bruère, P., 304
 Buch, K., 284, 286, 287, 316
 Buckingham, 179
 Bulow, C. and W. Dick, 179

 Carr, F. H., 171, 176
 Chabot, G., 176
 Chaminade, R. See Pichard
 Chandler, 20
 Chapman, H. S. See G. D. Barnett
 Christiansen, 81
 Clark, O. E. See McBain
 Clark, W. M., 110, 122, 158, 241, 275, 284, 304, 317, 339, 340, 341, 342, 347, 348, 352. See B. Cohen

- Clark, W. M., B. Cohen and Elvove, 131
- Clark, W. M. and Lubs, 106, 107, 108, 109, 124, 127, 131, 133, 241, 242, 244, 246, 251, 284, 285, 286, 287, 288, 290, 315, 352
- Clausius, R., 48
- Coch, G., 334
- Cohen, A., 124, 131, 176
- Cohen, B., 108, 124, 125, 130, 131, 132, 133, 286, 287, 288, 315, 348, 349, 352. See W. M. Clark
- Cohen, B., M. X. Gibbs and W. M. Clark, 158, 159
- Cohn, 197
- Collins, 125
- Conant, J. B. and N. F. Hall, 90, 166, 214
- Conant, J. B. and T. H. Werner, 90
- Cone. See Gomberg
- Cornwall, R. T. K. and A. J. Esselsteyn, 114
- Cornwell, T. K. See Orndorff
- Cray, F. M. and G. M. Westrip, 213, 214
- Dankwortt, P. W., 178
- Dassler, A. See Thiel
- Davidsohn. See Michaelis
- Davis, H. L. See Bancroft
- Debye, P. and E. Hückel, 4, 55, 58, 59, 60, 61, 70, 71, 74, 75, 79, 272, 336, 337, 338, 344
- Dernby, 38, 40
- Desha, L. J., 178, 180
- Desha, L. J., R. E. Sherill, and L. M. Harrison, 180
- Deutsch, 353
- de Vries, H., 49
- Deyrup, A. J. See Hammett
- Dhar. See Dhatta
- Dhatta and Dhar, 20
- Dick, W. See Bulow
- Diehl, R. See Thiel
- Diêm, A., 304
- Dietrich, W. See Windisch
- Dietz, N. Jr. See Hammett
- Dodge, 242
- Dondelinger, A. See Bourgeaud
- Douglas, W. F. See Parsons
- Downes, H. C. See La Mer
- Drake, N. L. See Harden
- DuBois, O. E. See McBain
- Ebert, L. See von Halban
- Eckweiller, H., H. M. Noyes, and K. G. Falk, 37
- Eichler, H., 115, 116, 117
- Eisenbrand, J., 178, 179, 180. See von Halban
- Eisenbrand, J. and H. von Halban, 334
- Elvove. See W. M. Clark
- Enklaar, 20
- Esselsteyn, A. J. See Cornwall
- Evers. See Lizius
- Fales and Nelson, 4, 379
- Falk, K. G. See Eckweiller
- Falkenhagen, H., 55
- Fawcett, E. H. and S. F. Acree, 245, 246, 325, 328
- Fels, B., 24, 106
- Felton, L. D., 171, 282
- Ferner, G. W. See Mellon
- Forbes, A. See Henderson
- Franchimont, 155
- Franke, W. See Slotta
- Fresenius and Grunhut, 375
- Freundlich, H., 374
- Friedenthal, H., 5, 106. See Salm
- Friedländer, 219
- Fudge, J. F. See Pierre
- Gex, M. See Vlès
- Gibbs, M. X. See B. Cohen
- Gibbs, R. C. See Orndorff
- Gilbert, F. L. See Prideaux
- Gilbert, F. L., F. C. Laxton, and E. B. R. Prideaux, 154
- Gillespie, L. J., 285, 286, 287, 288, 290, 294, 295, 296
- Gillespie, L. J. and Hurst, 361
- Gillespie, L. J. and Wise, 361
- Giribaldo, D., 7
- Glaser, F., 160, 362, 374, 375
- Goldschmidt, F., 197
- Goldschmidt, H., 96, 97, 98, 99, 100
- Goldschmidt, H. and F. Aas, 96
- Gomberg, M. See Anderson
- Gomberg, M. and Cone, 118
- Goppelsroeder, 374
- Grabowski, 113
- Gronwall, La Mer, and Sandved, 55
- Grotthus, 48
- Grünhut. See Fresenius
- Guggenheim, E. A., 63, 75

- Guggenheim, E. A. and T. D. Schindler, 76
- Güntelberg, E. and E. Schiodt, 285, 290, 344
- Gutbier, A. and H. Brintzinger, 355
- Gyemant, A. See Michaelis
- Haas, 368
- Hale. See Meldola
- Hall, N. F., 90. See Conant
- Hallensleben, R. See von Bayer
- Hamalaines, R. H., E. E. Leikola, and Y. Airila, 306
- Hamilton, J. See Badollet
- Hammett, L. P. and A. J. Deyrup, 166, 168, 169
- Hammett, L. P. and N. Dietz, Jr., 90
- Hanson, P., 304
- Hantzsch, A., 52, 85, 103, 194, 216, 218, 219, 220, 221, 229, 234, 235, 292
- Hantzsch, A. and Robertson, 218, 235
- Harden, W. C., 131
- Harden, W. C. and N. L. Drake, 108, 123, 133, 134
- Harned, H. S., 380
- Harned, H. S. and G. Åkerlof, 380
- Harris, L. J., 38, 39, 40
- Harrison, K., 164
- Harrison, L. M. See Desha
- Hastings, A. B. See Sendroy
- Hastings, A. B., J. Sendroy, and W. Robson, 286, 287
- Hatfield, W. D., 295
- Hay, K. G. See McBain
- Hegge, 109
- Hemple, C., 367
- Henderson, L. J., 319
- Henderson, L. J. and A. Forbes, 155
- Heydweiller. See Kohlrausch
- Hickmann, K. C. D. and R. P. Linstead, 176
- Hildebrand, J. H., 198. See Bishop
- Hirsch, E. J., 317
- Hirsch, R., 197
- Hittorf, W., 48
- Holcomb, R. and R. R. McKibbin, 243
- Holleman, A. F., 291, 292
- Holmberg, 38, 39, 40
- Holmes, W. C., 317, 318
- Holmes, W. C. and E. F. Snyder, 163, 286, 288, 318
- Holmgren, 374
- Horst, F. W., 375
- Hottinger, R., 161
- Huckel, 58. See Debye
- Hunter, A. and A. Borsook, 38, 40
- Hurst. See Gillespie
- Hurwitz, S. H., K. F. Meyer, and Z. Ostenberg, 309, 320
- Ittner. See Jackson
- Jackson and Ittner, 170
- Jahn, H. and E. Schmidt, 264
- Jahn, O., 54
- Jajti, S. See Milobedzki
- Janowsky, 170
- Jarisch, A., 354
- Jaumain, D., 352
- Jellinek, K., 177
- Johnston, 39, 40
- Jones, H. C., 219
- Jungfer, L. See Thiel
- Kameda, T. See Kolthoff
- Kanitz, 38, 39
- Kanolt, 4, 379
- Kato. See A. A. Noyes
- Kendall, J., 79
- Kenny. See McCrumb
- Kesting, W., 305, 306
- Kieffer, L., 177
- Kirschnik, 176
- Kittredge, E. B. See Bishop
- Klotz, G., 126, 153
- Knobel, M., 380
- Knoblauch, 179
- Kohlrausch, 78, 79
- Kohlrausch and Heydweiller, 4, 191, 379
- Kolbach, P. See Windisch
- Kolthoff, I. M., 7, 78, 85, 108, 109, 118, 119, 134, 135, 137, 139, 145, 146, 149, 156, 157, 171, 172, 176, 199, 202, 206, 223, 226, 242, 252, 259, 274, 276, 284, 285, 286, 287, 288, 290, 291, 292, 293, 299, 300, 302, 304, 307, 308, 313, 323, 325, 338, 339, 344, 348, 355, 362, 369, 372. See Kruyt
- Kolthoff, I. M. and W. Bosch, 64, 68, 71, 72, 79, 276
- Kolthoff, I. M. and T. Kameda, 126, 328, 329, 330, 331, 332

- Kolthoff, I. M. and F. Tekelenburg, 249, 256, 264, 265
 Kolthoff, I. M. and J. J. Vleesch-
 hower, 242, 251, 253, 339
 Koppel and Spiro, 30
 Körner, 170
 Kramers, 81
 Kroepelin, H., 304
 Krüger, 179
 Krüger, A. See Michaelis
 Krulla, 374
 Kruyt, H. R. and I. M. Kolthoff, 216
 Kuhlberg. See Beilstein
 Kukolich, S. I. See H. F. Lewis
 Kulikow, I. W. and S. W. Panowa,
 153
 Kummerer, 179
 Küster, F. W., 42

 Lacey, H. T. See Orndorff
 Laing, M. E. See McBain
 La Mer, V. K. See Gronwall
 La Mer, V. K. and H. C. Downes, 90,
 214
 Larsson, E., 96, 97, 98, 99, 304
 Laxton, F. C. See Gilbert
 Lehmann, G., 30
 Leikola, E. E. See Hamälaines
 Lepper, E. H. and C. J. Martin, 352,
 353
 Leuthardt, F., 30
 Levene, P. A. and H. S. Simms, 37,
 38, 40, 45
 Lewis, G. N., 61
 Lewis, G. N., Brighton, and Sebas-
 tian, 4
 Lewis, G. N. and M. Randall, 56, 60,
 380
 Lewis, H. F. and S. I. Kukolich, 292
 Linderström-Lang, K., 108, 146
 Linsler, H., 179, 180
 Linstead, R. P. See Hickmann
 Lizius, 176
 Lizius and Evers, 171
 Loose, R. See Rupp
 Lorenz and Böhi, 4, 191, 379
 Löwenherz, 4
 Lubs. See W. M. Clark
 Lubs, H. A. and S. F. Acree, 225, 226,
 229
 Lucas, 374
 Lucasse, R. W., 380
 Lüers, 216

 Lund, H., 118, 137, 138, 139, 151,
 223, 224, 225, 227
 Lundén, H., 4, 38, 39, 40, 292
 Luther, 176

 McBain, J. W., O. E. Dubois, and
 K. G. Hay, 331
 McBain, J. W., M. E. Laing, and
 O. E. Clark, 331
 McClendon, J. F., 106, 108, 156, 346
 McCoy, 20, 185, 198
 McCrae, J., 300
 McCrumb and Kenny, 108
 McIlvaine, 256, 257
 McInnes, D. A., 78. See A. A.
 Noyes
 McKibbin, R. R. See Holcomb
 McNulty, S. A. See Orndorff
 Maiwald, K., 30
 Malarski, 374
 Manda, 218
 Martin, C. J. See Lepper
 Martin, F. D. See Mellon
 Mathiesen, E., 96
 Meachem, M. R. See Brightman
 Mehlig, J. P. and M. G. Mellon, 302
 Meldola and Hale, 155
 Mellit, R. and M. A. Bischoff, 179
 Mellon, M. G. See Mehlig
 Mellon, M. G. and G. W. Ferner, 125
 Mellon, M. G. and F. D. Martin, 318
 Menzel, H., 259, 260
 Meyer, K. F. See Hurwitz
 Meyer, R. and O. Sprengler, 197
 Michaelis, L., 23, 37, 42, 152, 178,
 257, 258, 306, 307, 308, 309, 310,
 313, 349, 356, 379
 Michaelis, L. and Davidsohn, 39, 40
 Michaelis, L. and A. Gyemant, 152,
 153, 154, 194, 291, 292, 306, 307,
 313, 314, 349, 360
 Michaelis, L. and A. Krüger, 152, 153,
 154, 292, 306, 349
 Michaelis, L. and M. Mizutani, 96,
 97, 98, 99, 209, 213, 357, 358, 359,
 360
 Michaelis, L. and P. Rona, 38, 40
 Miller, R. C. See Ramage
 Millon. See Acree
 Milner, 55
 Milobedzki, T. and S. Jajti, 164
 Mizutani, M., 96, 357. See Michaelis
 Moerk, F. X., 176

- Moir, J., 171
 Montagne, P., 170
 Morton, C., 31
 Morton, R. A. and A. H. Tipping, 318
 Moser, H., 30
 Myers, V. C., H. W. Schmitz, and
 L. L. Booher, 283
- Naegeli, K., 177
 Nernst, W., 4, 106
 Nelson. See Fales
 Nielsen, R. F. and D. J. Brown, 380
 Noyes, A. A., 4, 20, 21, 54, 192, 193,
 264, 379. See Sherill
 Noyes, A. A. and D. A. McInnes,
 53
 Noyes, Kato, and Sosman, 4, 379
 Noyes, H. M. See Eckweiller
- Oakes. See Beans
 Okuma. See Suitsu
 Orndorff, W. R., 121
 Orndorff, W. R. and T. K. Cornwell,
 127, 128
 Orndorff, W. R., R. C. Gibbs, and
 S. A. McNulty, 118, 136
 Orndorff, R. W. and H. T. Lacey, 118,
 136
 Orndorff, W. R. and S. A. McNulty,
 137
 Orndorff, W. R. and A. C. Purdy, 130
 Orndorff, W. R. and C. V. Shapiro,
 131
 Orndorff, W. R. and F. W. Sherwood,
 128, 129
 Orndorff, W. R. and Ch. Wang, 137
 Orndorff, W. R. and M. L. Willard,
 132, 133
 Ostenberg, Z. See Hurwitz
 Ostwald, Wilhelm, 9, 76, 103, 197,
 216, 217, 218, 219, 228, 229, 231,
 233, 234
 Ostwald, Wolfgang, 216, 374
- Palitzsch, S., 146, 246, 247, 251, 351.
 See Sörensen
 Panowa, S. W. See Kulikow
 Pantin, C. F. A. See Atkins
 Parsons, L. B. and W. F. Douglas, 347
 Paul, T., 39, 40
 Pauli, W. and E. Weiss, 216
 Pfeffer, 48
 Pichard, G. and R. Chaminade, 319
- Pierre, W. H. and J. F. Fudge, 326,
 328
 Pratt, O. B. and H. O. Swartout, 165,
 376
 Prideaux, E. B. R., 176, 285, 286, 287,
 288, 290, 318, 349. See Gilbert
 Prideaux, E. B. R. and F. L. Gilbert,
 261
 Prideaux, E. B. R. and A. T. Ward,
 171, 262
 Pring, J. N., 214
 Purdy, A. C. See Orndorff
- Ramage, W. D. and R. C. Miller, 300,
 346
 Ramann and H. Sallinger, 300
 Randall, M. See G. N. Lewis
 Raoult, 48
 Reimers, F. See Baggesgaard-Ras-
 mussen
 Reverdin, 155
 Richard, E., 306
 Richter, A., 195
 Risch, C., 306
 Robertson. See Hantzsch
 Robinson, R. A. See Britton
 Robl, 179
 Robson, W. See Hastings
 Rona, P. See Michaelis
 Rosenstein, L., 186, 222, 314. See
 Adams
 Rowe, A. W. See Boyd
 Ruigh, W. L., 149
 Rupp, E. and R. Loose, 107, 108, 145
- Sabalitschka, T., 20. See Thoms
 Salessky, W., 106
 Salm, E., 106, 149, 290
 Salm and Friedenthal, 218
 Sallinger, H. See Ramann
 Sandahl, B., 138, 139
 Sandved. See Gronwall
 Saunders, J. T., 282, 347, 348
 Scatchard, G., 60, 78, 79, 380. See
 Bogert
 Scatchard, G. and R. E. Teft, 380
 Schaeffer, K., 52
 Scheitz, P., 161
 Schindler, T. D. See Guggenheim
 Schiodt, E. See Güntelberg
 Schlegel and Streuber, 125
 Schmatolla, O., 197
 Schmidt, C. L. A. See Andrews

- Schmidt, E. See H. Jahn
 Schmidt, H., 374
 Schmitz, H. W. See Myers
 Scholtz, M., 176, 197
 Schoorl, N., 181, 189, 191, 247
 Schröder, E., 306
 Schulenburg, W., 113
 Schwarzenbach, G., 90
 Schweitzer. See Bernthsen
 Sebastian. See G. N. Lewis
 Sendroy, J. See Hastings
 Sendroy, J. and A. B. Hastings, 284, 288, 289, 344
 Shapiro, C. V. See Orndorff
 Sherill, R. E. See Desha
 Sherill, R. E. and A. A. Noyes, 78
 Sherwood, F. W. See Orndorff
 Sidgwick, N. V., W. J. Worboys, and L. A. Woodward, 290
 Simms, H. S. See Levene
 Simpson, G., 176
 Skraup, 374
 Slagle. See Acree
 Slotta, K. H. and W. Franke, 109, 147, 148, 256, 257
 Smith, 20, 283
 Smith, E. L., 172
 Smith, S. B., 243
 Snethlage, 234
 Snyder, E. F. See Holmes
 Söndén, K., 304
 Sörensen, S. P. L., 6, 7, 23, 24, 34, 36, 37, 107, 108, 109, 142, 143, 148, 186, 187, 240, 241, 246, 247, 248, 249, 250, 253, 266, 267, 268, 284, 285, 286, 288, 293, 318, 334, 344, 345, 346, 349, 350, 351, 379
 Sörensen, S. P. L. and S. Palitzsch, 107, 113, 247, 345, 346
 Sosman. See Noyes
 Spiro. See Koppel
 Sprengler, O. See R. Meyer
 Springemann, W. See Thiel
 Stark, O., 179
 Stearn, A. E., 42
 Stene, Sverre, 264
 Stern, H. T., 328
 Stieglitz, J., 229
 Storch, 53
 Streuber. See Schlegel
 Suitsu, K. and Okuma, 149
 Sutherland, 55
 Swartout, H. O. See Pratt
 Tague, 38, 39, 40
 Taube, A., 302. See Army
 Täufel, K. and C. Wagner, 30
 Teft, R. E. See Scatchard
 Tekelenburg, F. See Kolthoff
 Temple, J. W., 260
 Thiel, A., 109, 111, 112, 113, 118, 197, 207, 218, 219, 226, 296, 318, 357
 Thiel, A. and A. Dassler, 290
 Thiel, A., A. Dassler, and F. Wulfken, 143, 145, 147, 290, 318, 334
 Thiel, A. and R. Diehl, 111, 176, 223
 Thiel, A. and L. Jungfer, 111, 114, 223
 Thiel, A. and W. Springemann, 143
 Thiel, A. and F. Wulfken, 318
 Thiel, A., F. Wulfken, and A. Dassler, 206
 Thoms and Sabalitschka, 20
 Tipping, A. H. See R. A. Morton
 Tizard, H. T., 290, 291
 Tizard, W. T. and J. R. Whiston, 290
 Tödt, 304
 Tower, 20
 Traube, M., 48
 Trevor, 20
 Ulrich, J. See Walther
 Unmack, A. See Bjerrum
 van Alstine, E., 285, 286, 287, 288, 291
 van Laar, J. J., 54
 van Romburgh, P., 155, 170
 van Slyke, D. D., 24, 30, 31, 239
 van't Hoff, 48, 49, 53
 van Urk, H. W., 172
 Vleeschhouwer, J. J. See Kolthoff
 Vlès, F., 282, 285, 287, 290, 317
 Vlès, F. and M. Gex, 334
 Vogt, E., 223
 Volmar, Y., 179
 Volmar, Y. and E. Widder, 179
 Volmer, A., 85
 von Bayer, A. and R. Hallensleben, 118
 von Euler, H., 38, 39, 40
 von Euler, H. and Bolin, 292
 von Halban, H. and L. Ebert, 334.
 See Eisenbrand
 von Halban, H. and J. Eisenbrand, 334
 Waddell, 179, 197
 Wagner, C. See Täufel

- Walbum, L. E., 46, 54, 164, 246, 249,
250, 264
Wales, H., 146
Walker, J., 20, 34
Walker, J. and Aston, 34, 38, 40
Walpole, G. S., 256, 261, 320, 366
Walther, O. A. and J. Ulrich, 282
Walton Jr., C. F. See Badollet
Wang, Ch. See Orndorff
Ward, A. T. See Prideaux
Wegscheider, R., 19, 218
Weigert, F., 178
Weiss, E. See Pauli
Wells, R. C., 282, 346
Werner, T. H. See Conant
Westrip, G. M. See Cray
Whiston, J. R. See W. T. Tizard
White, E. C. and S. F. Acree, 225
Widder, E. See Volmar
Wiegner, 216
Willard, M. L. See Orndorff
Windisch, W., W. Dietrich, and P.
Kolbach, 309
Winkelblech, K., 38, 39, 40, 290
Wise. See Gillespie
Witt, 169
Wood, 39, 40
Wood, C. B., 131
Woodward, L. A. See Sidgwick
Worboys, W. J. See Sidgwick
Wu, H., 287
Wulff, P., 304
Wulfken, F. See Thiel
Wys, 4

Young, L. E., 380

Zawidski, 39, 40
Zellner, 179

SUBJECT INDEX

- Absorption of light by indicators, 315, 316
influence of salt on, 333
- Acetate buffer (Walpole), 256
effect of dilution on, 274
- Acetic acid, dissociation constant, 9, 13
dissociation constant in acetone, 213
- Acetone, dissociation constants of acids in, 213
ion product of water in, 214
indicators in, 214
- Acid-base error of indicators, 322
- Acid exponent, 9
- Acidity constant, 90, 95
in alcohol, 97, 357
variation with solvent, 94, 95
- Acidity function, 166-169
- Acidity, titration, 13
- Acidity, true, 13
- Acids, acid strength in benzene, 214, 215
buffer capacity, 25
definition of Brönsted, 83
classical, 7, 83
dissociation constants, 13
in acetone, 213, 214
in alcohol solutions, 358
thermodynamic and stoichiometric, 67
dissociation in ethyl alcohol, 96, 98, 99
pseudo- and aci-forms, 220
- Acid strength in benzene, 214, 215
- Aci-form, 220, 228, 229, 230
- Acridine, 179
- Activity, 4, 5, 61
in alcohol, 62
of hydrogen ions, 241
relative and absolute, 60, 61
- Activity coefficient, 5, 55, 56, 57
average, 57, 78, 79, 380
in electrolyte solutions, 60
exponent, 64
of hydrogen and hydroxyl ions, 64
- Alcohol, acidity constants in, 97
activities in, 62
basic properties, 85, 99
dissociation of acids in, 96, 99
indicator constants in, 199
properties of indicators in, 198, 356
- Alizarine (1,2-Dioxanthraquinone), indicator paper, 368
properties, 159
transformation interval in acetone, 214
- Alizarine blue (dioxyanthraquinone-quinoline), 159
- Alizarine sulfonate (sodium salt), 159
behavior in alcohol-water mixtures, 208
in mixed indicators, 173
salt error, 340, 349
stock solution, 107, 159
transformation interval, 108, 387
- Alizarine yellow G—G, *see* Salicyl yellow
- Alizarine yellow R, in mixed indicators, 175
properties, 148
protein error, 352
salt error, 342
stock solution, 107
transformation interval, 109, 387
- Alkali blue, 160, 164
- m*-Aminobenzoic acid, reaction, 35
- Ammonium acetate, hydrolysis of, 19
- Ammonium chloride, hydrolysis of, 16
- Ammonium formate, hydrolysis of, 19
- Ampholytes, 23, 32
dissociation constants, 38, 39, 45
isoelectric point, 36
reaction, 33
- Aniline blue, in mixed indicators, 173
- Aniline yellow, *see* Tropeolin 00
- Anisalcinamalacetone, 166
acid sensitivity in glacial acetic acid, 214
- Anthraquinone, 168, 170
- Apple extract, 165
indicator paper, 376

- Aspartic acid,
dissociation constant, 36, 38
reaction, 36
- Aurin (Phenolbenzein), properties,
136
stock solution, 110
in strongly acid media, 135
transformation interval, 109, 136,
387
- Azobenzene, 141, 228
- Azo indicators, 141
of Sørensen, 142
spectrophotometry of, 318
structure and color change, 227
- Azolitmin (*see* Litmus), indicator
papers of, 361, 365, 366, 368, 369,
373, 377
in mixed indicators, 174
properties, 161
purification, 161
salt error, 344
sensitivity in water-alcohol mix-
tures, 208
stock solution, 160
temperature effect, 355
transformation interval, 160, 387
- Azo violet (*o-p*-Dihydroxyazo-*p*-ni-
trobenzene), 149
- Bases, Brønsted's definition, 83
classical definition, 7, 83
dissociation constants, 13
in alcohol, 359
- Basicity constant, 90, 95
- Baso-form, 220
- Bathmometer (Thiel), 296
see colorimeter
- Benzalacetophenone, 168, 170
Acid sensitivity in glacial acetic
acid, 166, 214
- Benzaurin, *see* Aurin
- Benzeins, 134
salt error, 337
in strongly acid medium, 135
- Bensopurpurin B, 149
- Benzopurpurin 4B, 149
- p*-Benzoquinone, reaction with ma-
lonic nitrile, 306
- p*-Benzoyldiphenyl, 168, 170
- p*-Benzoylnaphthalene, 168, 170
- Bicarbonate-carbonate buffer (Men-
zel), 259
- Bicolorimeter, 296
see Colorimeter
- Bimaleate-alkali buffer (Temple), 260
- Biphtalate-alkali buffer (Clark and
Lubs), 241, 245
dilution effect, 275
error with methyl orange, 242
purity of biphtalate, 242
temperature effect, 264
- Biphtalate-hydrochloric acid buffer
(Clark and Lubs), 241, 244
dilution effect, 275
error with methyl orange, 242
purity of biphtalate, 242
temperature effect, 264
- Blackberry extract, 165
indicator paper, 376
- Blueberry extract, 165
indicator paper, 376
- Blue cabbage extract ("Cop"), 164
- Borax-alkali buffer (Sørensen), 247,
250
temperature effect, 250
- Borax-boric acid buffer (Palitzsch),
247, 251
purity of constituents, 244, 248
temperature effect, 264
- Borax-hydrochloric acid buffer (Sör-
ensen), 246, 250
temperature effect, 250, 264
- Bordeaux red, in mixed indicator
papers, 370, 371
- Boric acid-alkali buffers (Clark and
Lubs), 241, 245
effect of carbon dioxide from air,
246
dilution effect, 276
temperature effect, 240
- Brilliant green, in mixed indicator
papers, 370, 371, 372
- Brilliant yellow, *see* Curcumin
- Bromchlorphenol blue (dibromodi-
chlorophenolsulfonephthalein),
protein error, 352
salt error, 340, 349
transformation interval, 131
- Bromcresol green (tetrabromo-*m*-cre-
solsulfonephthalein), absorption
maximum, 315
behavior in benzene, 215
dissociation constant in alcohol, 201
empirical comparison solutions, 303
indicator exponent, 286, 289, 293

- in mixed indicators, 173, 174
- mixed indicator papers, 370
- neutralized indicator solution, 110
- preparation, 124
- properties, 130
- protein error, 352
- salt error, 340-344, 347, 349
- stock solution, 108, 301
- in strongly acid medium, 120
- suitability in $[H^+]$ determinations, 280, 281, 301
- transformation interval, 108, 131, 386
- in universal indicators, 172
- Bromcresol purple (dibromo-*o*-cresol-sulfonephthalein), absorption maximum, 315, 316
- behavior in acetone, 214
- behavior in benzene, 215
- behavior in water-alcohol mixtures, 208
- dichromatism, 123
- dissociation constant in alcohol, 201
- extraction method, 320
- indicator exponent, 286, 289, 293-295
- mixed indicator papers, 370
- in mixed indicators, 174, 176
- neutralized indicator solution, 110
- protein error, 352
- salt error, 340, 344, 347, 348
- stock solution, 301
- in strongly acid medium, 120
- suitability in $[H^+]$ determinations, 281, 282
- temperature effect, 355
- transformation interval, 108, 282, 387
- in universal indicators, 171
- 6-Bromo-2,4-dinitroaniline, 168, 170
- Bromphenol blue (tetrabromophenol-sulfonephthalein), absorption maximum, 315
- behavior in acetone, 214
- behavior in benzene, 215
- behavior in alcohol-water mixtures, 211, 357
- dichromatism, 123
- dissociation constant in alcohol, 199, 201
- extraction method, 320
- indicator exponent, 285, 293, 294
- indicator paper, 368
- mixed indicator papers, 370, 372
- in mixed indicators, 176
- neutralized indicator solution, 110
- properties, 129
- protein error, 352
- salt error, 340, 341, 343, 347
- stock solution, 301
- in strongly acid media, 120
- suitability in $[H^+]$ determinations, 281
- temperature effect, 355
- transformation interval, 108, 386
- Bromphenol red (dibromophenolsulfonephthalein), salt error, 348
- transformation interval, 131
- Bromthymol blue (dibromothymolsulfonephthalein), absorption maximum, 315, 316
- acid-base error, 328
- behavior in acetone, 214
- behavior in benzene, 215
- dissociation constant in alcohol, 201
- empirical comparison solutions, 303
- extraction method, 320
- indicator exponent, 286, 293
- in mixed indicators, 174
- neutralized indicator solution, 110
- properties, 128
- protein error, 352
- salt error, 341, 343, 347, 348
- stock solution, 107
- in strongly acid solution, 120
- suitability in $[H^+]$ determinations, 282
- transformation interval, 108, 128, 282, 387
- in universal indicators, 171, 172
- Buffer capacity, 24, 239
- Buffer index, 25
- Buffer mixtures, acetic acid-acetate (Walpole), 256
- bicarbonate-carbonate (Menzel), 259
- bimaleate-alkali (Temple), 260
- bipthalate-alkali (Clark and Lubs), 241, 245
- bipthalate-hydrochloric acid (Clark and Lubs), 241, 244
- borax-alkali (Sørensen), 247, 250
- borax-boric acid (Palitzsch), 247, 251
- borax-hydrochloric acid (Sørensen), 247, 250

- boric acid-alkali (Clark and Lubs), 241, 245
- cacodylic acid-cacodylate (Walpole), 261
- chloride-hydrochloric acid (Clark and Lubs), 241, 244
- citric acid-diphosphate (McIlvaine), 258
- dicitrate-alkali (Sørensen), 247, 249
- dicitrate-hydrochloric acid (Sørensen), 247, 249
- diphosphate-alkali (Kolthoff and Vleeschhouwer), 252, 255
- effect of dilution on pH, 269
- general properties, 22, 239
- glycine-alkali (Sørensen), 247, 250
- glycine-hydrochloric acid (Sørensen), 247, 248
- monocitrate-alkali (Kolthoff and Vleeschhouwer), 242, 252, 254
- monocitrate-borax (Kolthoff and Vleeschhouwer), 252, 254
- monocitrate-citric acid (Kolthoff and Vleeschhouwer), 252, 255
- monocitrate-hydrochloric acid (Kolthoff and Vleeschhouwer), 242, 252, 254
- monophosphate-alkali (Clark and Lubs), 241, 245
- monophosphate-borax (Kolthoff), 259
- monophosphate-borax (Kolthoff and Vleeschhouwer), 252, 255
- piperidine-hydrochloric acid (Priedaux and Gilbert), 261
- primary-secondary phosphate (Sørensen), 247, 249
- soda-borax (Kolthoff and Vleeschhouwer), 252, 255
- soda-boric acid (Atkins and Pantin), 261
- succinic acid-borax (Kolthoff), 259
- temperature effect, 240, 264
- veronal (Michaelis), 258
- veronal-acetate (Michaelis), 258
- universal buffer solutions, 262
- Butter yellow, *see* Dimethyl yellow
- Cacodylic acid buffer (Walpole), 261
- Cactus extract, 165
- Capillary phenomena in indicator papers, 373
- Catecholsulfonephthalein, 131
- Cherry extract, 165
- indicator paper, 376
- Chloride-hydrochloric acid buffer (Clark and Lubs), 241, 244
- purification of potassium chloride, 244
- p*-Chloro-*o*-nitroaniline, 168, 169
- Chlorophenolphthalein, 115
- Chlorphenol red (dichlorophenolsulfonephthalein), absorption maximum, 315
- empirical comparison solutions, 303
- indicator exponent, 286, 293
- in mixed indicators, 173, 174
- neutralized indicator solution, 110
- preparation, 125
- properties, 125
- protein error, 352
- salt error, 340, 343, 349
- stock solution, 301
- in strongly acid solution, 120
- suitability in $[H^+]$ determinations, 123, 281
- transformation interval, 108, 386
- Chromate solutions, *see* Comparison solutions
- Chromophore (chemical) theory of indicators (Hantzsch), 216, 219
- Citric acid-diphosphate buffer (McIlvaine), 256
- Classification of indicators, 181
- Cobalt salts, *see* Comparison solutions
- Colloid error of indicators, 353
- Color change of indicators, azo indicators, 228
- fast green, 160, 163
- nitro indicators, 228
- phthaleins, 221
- sulfonephthaleins, 224
- Colored solutions, determination of pH in, 318
- Colorimeter, foil colorimeter, 304
- Gillespie, 296
- Hellige comparator, 305
- hydrionometer, 311
- Kolthoff, 300
- Thiel, 297
- Walpole, 320
- Colorimetric determination of pH, 277 (*see* Colorimeter)

- with empirical comparison solutions, 301, 311
- Gillespie method, 294
- Color tables, 304
- Comparator, 320
- Comparison solutions (empirical) of colored inorganic salts, 301, 312
- Concentration, means of expressing, 59
- Conductivity coefficient, 63, 77
- Conductivity method, determination of the degree of dissociation, 50
- determination of dissociation constants, 76, 80
- Congo red, behavior in alcohol solutions, 209
- colloid error, 355
- indicator papers, 361, 363-365, 369, 373-377
- purification, 150
- salt error, 344
- stock solution, 150
- transformation interval, 150, 386
- Congorubin, 216
- "Cop" solution, 164
- Corallin, 162 (*see* Rosolic acid)
- Cotarnine, 180
- o*-Cresolbenzein, properties, 137
- stock solution, 110
- in strongly acid solutions, 135
- transformation interval, 109, 136, 187
- o*-Cresolphthalein, 114
- protein error, 352
- m*-Cresol purple (*m*-cresolsulfonephthalein), absorption maximum, 315
- behavior in acetone, 214
- empirical comparison solutions, 303, 304
- indicator exponent, 287, 293
- preparation, 124
- properties, 130
- protein error, 352
- stock solution, 110
- in strongly acid solutions, 118, 120
- transformation interval, 108, 109, 118, 130, 387
- o*-Cresol red (*o*-cresolsulfonephthalein), absorption maximum, 315
- empirical comparison solutions, 304
- indicator exponent, 287, 293, 295
- indicator paper, 369, 377
- in mixed indicators, 175, 176
- mixed indicator papers, 372
- protein error, 352
- salt error, 346-348
- stock solution, 110, 301
- in strongly acid solution, 118, 120
- suitability in $[H^+]$ determinations, 279, 282
- temperature effect, 193, 196
- transformation interval, 108, 109, 118, 282, 386
- m*-Cresolsulfonephthalein, *see m*-Cresol purple
- o*-Cresolsulfonephthalein, *see* Cresol red
- o*-Cresoltetrabromosulfonephthalein, 134
- o*-Cresoltetrachlorosulfonephthalein, 134
- o*-Cresoltetraiodosulfonephthalein, 133, 134
- Critical complex, 90
- Crystal violet, 150-152
- structure, 151, 221
- Cupric chloride, *see* Comparison solutions
- Curcumin (Brilliant yellow), 148
- behavior in water-alcohol mixtures, 208-211, 357
- indicator paper, 369, 377
- temperature effect, 355
- transformation interval, 148, 387
- Cyanin, *see* Quinoline blue
- Cyclohexanone derivatives, 138
- Degree of dissociation, 8, 49, 50, 51, 53, 54
- Degree of hydrolysis, 16
- Deviation coefficient, 55
- Dialysis method of determining pH, 321
- Dianisalacetone, 166
- acid Sensitivity in glacial acetic acid, 214
- Dianisylcarbinol, 166
- acid Sensitivity in glacial acetic acid, 214
- Diazo violet,
- stock solution, 107
- transformation interval, 109, 387
- Dibromo-*o*-cresolbenzein, 136, 137
- in strongly acid solution, 135
- transformation interval, 136

- Dibromo-*o*-cresolsulfonephthalein,
see Bromcresol purple
- Dibromo-*o*-cresoltetrabromophenol-
sulfonephthalein, 134
- Dibromo-*o*-cresoltetrachlorosulfone-
phthalein, 134
- Dibromodichlorophenolsulfone-
phthalein, *see* Bromchlorphenol
blue
- Dibromohydroxyhydroquinonesul-
fonephthalein, 133
- Dibromophenolsulfonephthalein, *see*
Bromphenol red
- Dibromophenoltetrabromophenol-
sulfonephthalein, 134
- Dibromothymolbenzein, 136
in strongly acid solution, 135
- Dibromothymolsulfonephthalein, *see*
Bromthymol blue
- Di-5-bromovanillidene-cyclohex-
anone, 139
transformation interval, 387
- Dichlorofluorescèin, 179
- Dichloronitroaniline, 168, 169
- Dichlorophenolsulfonephthalein, *see*
Chlorphenol red
- Dichromate solutions, *see* Comparison
solutions
- Dichromatism, 122
- Dicitrate-alkali buffer (Sørensen),
247, 249
dilution effect, 276
temperature effect, 249, 266
- Dicitrate-hydrochloric acid buffer
(Sørensen), 247, 249
dilution effect, 275
temperature effect, 266
- m*-Diethylanilino-azo-*p*-benzenesul-
fonic acid, 143
- o*-*p*-Dihydroxyazo-*p*-nitrobenzene,
see Azo violet
- Diiodophenolsulfonephthalein, 131
- Dilution effect, 31, 69-72
in buffer mixtures, 269, 271
- Dimethylaminoazobenzene, *see* Di-
methyl yellow
- Dimethylaminoazobenzenecarboxylic
acid, *see* Methyl red
- Dimethylaminoazobenzenesulfonic
acid (sodium salt), *see* Methyl
orange
- Dimethyl- α -naphthylaminoazo-*o*-
methoxybenzene-*p*-sulfonic acid,
144
transformation interval, 386
- Dimethyltrinitroaniline, 168, 170
- Dinitroaniline, 168, 170
- Dimethyl yellow (dimethylaminoazo-
benzene; methyl yellow; butter
yellow)
behavior in acetone, 214
behavior in benzene, 215
behavior in water-alcohol mixtures,
209, 357
dissociation constant in alcohol,
200, 201
indicator exponent, 290, 293
indicator paper, 363, 373, 377
in mixed indicators, 173
properties, 141, 144
salt error, 344
solubility, 141, 188, 189
stock solution, 110
structure and color change, 141,
228
suitability in $[H^+]$ determinations,
280
temperature effect, 194, 196, 355
transformation interval, 108, 386
in universal indicators, 171
- Dinitrobenzoylurea, 154, 155
- Dinitrohydroquinone, 154, 155
- 2, 6-Dinitro-4-methylaniline, 168, 170
- α -Dinitrophenol, empirical compari-
son solutions, 312
indicator exponent, 291, 293, 356
in alcohol solutions, 360
properties, 153
salt error, 340, 349
stock solution, 307
temperature effect, 356
transformation interval, 153, 386
- β -Dinitrophenol, behavior in benzene,
215
indicator exponent, 291, 293, 356
properties, 153
salt error, 341, 349
stock solution, 307
temperature effect, 356
transformation interval, 153, 386
- γ -Dinitrophenol, empirical compari-
son solutions, 312
indicator exponent, 292, 293, 355
in alcohol solutions, 360

- properties, 153
- salt error, 349
- stock solution, 307
- temperature effect, 356
- transformation interval, 153, 386
- Dinitropyrocatechol, 154
- Dinitroresorcinol, 154
- Diorthohydroxystyrylketone, 162
 - transformation interval, 160, 387
- 1,2-Dioxyanthraquinone, *see* Alizarine
- Dioxyanthraquinonequinoline, *see* Alizarine blue
- Di-4-oxy-3-ethoxybenzylidene-cyclohexanone, 140
 - transformation interval, 387
- Diphenylaminoazo-*m*-benzenesulfonic acid (metanil yellow), 144
- Diphenylanisylcarbinol, 166
 - acid sensitivity in glacial acetic acid, 214
- Diphenyl- α -naphthylcarbinol, 166
 - acid sensitivity in glacial acetic acid, 214
- Diphenyl orange, *see* Tropeolin 00
- Diphosphate-alkali buffer (Kolthoff and Vleeschhouwer), 252, 255
 - purity of disodium phosphate, 247
- Dipiperonalacetone, 166
 - acid sensitivity in glacial acetic acid, 214
- Disazo indicators, 149
- Dissociation constants, acetic acid, 80
 - acids, 7, 381
 - acids in acetone, 213
 - acids in alcohol solutions, 358
 - ampholytes, 35, 36, 38, 39, 45
 - bases, 7, 12, 384
 - bases in alcohol solutions, 359
 - dibasic acids, 10
 - indicators, 201, 285-293, 355
 - in acetone, 214
 - in alcohol solutions, 199
 - methods of determination, 75
 - o*-nitrobenzoic acid, 80
 - strong electrolytes, 53
 - thermodynamic vs. stoichiometric, 67
 - true vs. apparent, 44, 231
 - water, 4, 96, 379
- Dissociation (Electrolytic). 3. 48. 84
 - complete dissociation of strong electrolytes, 54
 - in ethyl alcohol, 96
- Donnan equilibrium, 321
- Electro-form of electrolytes, 52
- Electrolytes, 3
 - electro- and pseudo-forms, 52
 - strong electrolytes, 48, 50
 - weak vs. strong electrolytes, 4, 50
- Equilibrium water, 333
- Erythrolein, 161
- Erythrolitmin, 161
- Esculin, 180
- Ethylhydrolium ion, 85
- m*-Ethyl orange, 143
- p*-Ethyl orange, 143
 - transformation interval, 143, 386
- Ethyl red, 143
- Extent of coloration, 307
 - pH as function of extent of coloration, for phenolphthalein, 313
 - for phenolphthalein, in water-alcohol mixtures, 361
 - for salicyl yellow, 314
- Extraction method, 313
- Ferric chloride, *see* Comparison solutions
- Fluorescein, 179
- Fluorescence indicators, 177
- Foil colorimeter, 304
- Galleine, 160
- Gentian violet, 152
- Glycine, dissociation constant, 38
 - dissociation constant in alcohol, 213
- Glycine-alkali buffer (Sorensen), 247, 250
 - purity of glycine, 248
 - temperature effect, 250, 264, 268
- Glycine-hydrochloric acid buffer (Sorensen), 247, 248
 - temperature effect, 264, 267
- Gold yellow, *see* Tropeolin 0
- Grape extract, 165
 - indicator paper, 376
- Helianthin B, *see* Methyl orange
- Hellige comparator, 305
- Hematein, 218
- Hematoxylin paper, 377

- Heptamethoxy red (heptamethoxytriphenylcarbinol), indicator exponent, 293
 properties, 138
 stock solution, 110, 138, 139, 308
 transformation interval, 108, 138, 139, 387
- Hexamethoxy red (hexamethoxytriphenylcarbinol), indicator exponent, 293
 in mixed indicators, 173
 properties, 138
 salt error, 341
 stock solution, 110, 138, 139, 308
 transformation interval, 108, 138, 139, 386
 in water-alcohol mixtures, 211
- Hybrid ions, 42
 in equilibrium with undissociated molecules, 47
- Hydration effect, 60
- Hydrionometer, 311
- Hydrogen exponent, 6
 relation between pH and $[H^+]$, 388
- Hydrogen ion concentration (*see* Reaction), acids and bases, 7
 ampholytes, 33
 buffer mixtures, *see* Buffer mixtures
 determination of, in colored solutions, 318
 colorimetrically (*see* Colorimeter), 277
 colorimetrically with buffers, 278
 colorimetrically without buffers, 283
 dialysis method, 321
 extraction method, 319
 Gillespie method, 294
 with indicator papers, 367
 micro determinations, 282
 with one-color indicators, 306, 308
 in pure water, 329
 by reaction velocity measurement, 305
 in sea water, 345
 spectrophotometrically, 315
 in turbid solutions, 318
 with two-color indicators, 294
 Walpole method, 320
 relation between pH and $[H^+]$, 388
 salts, 13 (*see* Hydrolysis)
 0.1 N acid solutions, 13
- Hydrolysis, 13, 86
 acid salts, 19
 error of indicators, 324
 salts of weak acids with a strong base, 15
 salts of weak acids and bases, 16
 salts of weak bases with a strong acid, 16
 temperature effect, 21
 Hydrolysis constants, 15
 bases in alcohol solutions, 359
 Hydrolysis error of indicators, 324
 Hydronium ion, 84, 85, 91
 Hydroquinonesulfonephthalein, 131
 Hydroquinonesulfonic acid, 180
 Hydroxonium ion, 84, 85, 91
 Hydroxyhydroquinonesulfonephthalein, 132
- Hydroxyl exponent, 6
- Indicator concentration, effect on transformation interval, *see* Transformation interval
- Indicator exponent, in Alcohol solutions, 201, 360
 definition, 182
 tables, 154, 158, 201, 285-293, 360
 temperature dependence, 293, 356
- Indicator papers, 361
 capillary phenomena, 373
 mixed indicators, 369
 from plant extracts, 376
 preparation, 374
 sensitivity, 362, 377
- Indicators, absorption maxima, 315, 316
 acid-base error, 322
 acid and alkali sensitive indicators, 181, 189
 behavior in acetone, 213, 214
 behavior in alcohol solutions, 206, 356
 behavior in benzene, 215
 behavior in glacial acetic acid, 214
 classification, 181
 colloid error, 353
 color change, 221
 definition, 103, 216, 228, 234
 dissociation constants in alcohol, 201
 fluorescence indicators, 177
 indicator exponent, *see* Indicator exponent

- indicator papers, 278, 361
isohydric indicator solutions, 325
mixed indicators, 172, 369
neutralized indicator solutions, 110
one-color indicators, 183, 306
plant extracts as indicators, 164
protein error, 350
recommended indicators, 106, 108, 109
salt error, 333
stock solutions, 107, 301, 307, 308
in strongly acid media, 165
temperature effect, 189, 293, 355, 356
theories, 216
 chemical or chromophore theory, 216, 219
 ion theory, 216
transformation interval, 104, *see* Transformation interval
transformation point, 172
turbidity indicators, 177
two-color indicators, 188, 294
universal indicators, 170
- Indigocarmine,
 in mixed indicators, 173, 176
- Indonaphthol-3'-sulfonic acid, 158
- Indophenols, 158, 317
- Iodide-iodate paper, 367
- Ion activity constant, 67
- Ion activity product of water, 65, 379
- Ionic diameter, 58
- Ionic strength (total), 31, 56, 59
 effect on activity coefficients, 64
- Ion product (stoichiometric), of water, 4, 22, 65, 190, 379
 of water in acetone, 214
- Ion theory of indicators (W. Ostwald), 216
- Irrationality factor (van't Hoff factor), 49
- Isoelectric point, 36
- Isohydric indicator solutions, 325
- Isopicramic acid, 154, 155
 transformation interval, 386
- Isotonic coefficient, 49
- Kinetic activity factor, 81
- Kinetic (catalytic) method for determining dissociation constants, 79
- Lacmoid (resorcin blue), 160
 in alcohol solutions, 208
 indicator paper, 367-369, 376
 purification, 160
 stock solution, 161
 temperature effect, 355
 transformation interval, 160, 161, 386
- Liter molarity (definition), 59
- Litmus (*see* azolitmin), effect of alcohol, 198
 indicator paper, 361, 363-365, 369, 373, 375, 377
 preparation of paper, 374
 properties, 161
 salt error, 344
 transformation interval, 160, 387
- Malonic nitrile, reaction with α -naphthoquinone as a measure of pH, 305
- Mauveine, 152
 salt error, 345
- Metanil extra, *see* Metanil yellow
- Metanil yellow, indicator paper, 377
 in mixed indicator papers, 370
 properties, 144
 protein error, 352
 salt error, 345
 transformation interval, 144, 386
- Methoxytriphenylcarbinols, 137
- Methyl alcohol, effect on phenolphthalein, 197
 effect on sensitivity of indicators, 206
- 2-Methyl-3-aminoquinoline, 179
- Methylene blue, in mixed indicators, 173, 174
 mixed indicator papers, 370, 371
- Methyl green, 152
 in mixed indicators, 172, 173, 175, 176
 salt error, 345
- Methyl orange (helianthin B; orange III), behavior in acetone, 214
 behavior in water-alcohol mixtures, 209, 357
 determination of water in alcohol, 203, 211
 dissociation constant in alcohol, 200, 201
 empirical comparison solutions, 302, 303

- error in biphthalate buffers, 241
 indicator exponent, 290, 293
 indicator paper, 368, 369
 in mixed indicators, 173, 176
 mixed indicator paper, 370
 properties, 145
 salt error, 339, 343, 344
 stock solution, 107, 145, 301
 structure and color change, 228
 suitability in $[H^+]$ determinations, 142, 280
 temperature effect, 195, 196, 355
 transformation interval, 108, 145, 386
- o*-methyl red (dimethylaminoazobenzene-*o*-carboxylic acid), 145
 absorption maximum, 315
 acid-base error, 323
 behavior in acetone, 214
 behavior in benzene, 215
 behavior in water-alcohol mixtures, 208
 empirical comparison solutions, 301-303
 extraction method, 320
 indicator exponent, 290, 293, 295
 indicator paper, 376
 isohydric solution, 329
 in mixed indicators, 173
 mixed indicator paper, 371
 properties, 145
 protein error, 351, 352
 salt error, 339, 343, 347
 stock solution, 110, 301, 329
 suitability in $[H^+]$ determinations, 280
 temperature effect, 193, 196, 353
 transformation interval, 108, 142, 386
 in universal indicators, 171
- p*-Methyl red (dimethylaminoazobenzene-*p*-carboxylic acid), 147
- β -Methylumbelliferon, 179
- Methyl violet 6B, 150, 152
 indicator paper, 361, 365, 377
 properties, 152
 protein error, 351
 salt error, 345
 structure, 152
 suitability in $[H^+]$ determinations, 279
 temperature effect, 196
 in water-alcohol mixtures, 209
- Methyl yellow, *see* dimethyl yellow
- Micro determination of pH, 282
- Mixed indicator papers, 369
- Mixed indicators, 172
- Molality (definition), 59
- Molarity (definition), 59
- Mole fraction (definition), 60
- Monochloroacetic acid, dissociation constant in acetone, 213
- Monocitrate-alkali buffer (Kolthoff and Vleeschhouwer), 242, 252, 254
 purity of citrate, 253
- Monocitrate-borax buffer (Kolthoff and Vleeschhouwer), 252, 254
 purity of constituents, 248, 253
- Monocitrate-citric acid buffer (Kolthoff and Vleeschhouwer), 252, 254
 purity of constituents, 248, 253
- Monocitrate-hydrochloric acid buffer (Kolthoff and Vleeschhouwer), 242, 252, 254
 purity of citrate, 253
- Monophosphate-alkali buffer (Clark and Lubs), 241, 245
 effect of dilution, 275
 purification of phosphate, 243
- Monophosphate-borax buffer (Kolthoff), 259
- Monophosphate-borax buffer (Kolthoff and Vleeschhouwer), 252, 255
 purity of constituents, 243, 248
- Mountain cranberry extract, 165
 indicator paper, 376
- β -Naphthol, 180
- α -Naphtholbenzein, 134, 136
- Naphthol blue (α -naphtholsulfonephthalein), 131
- α -Naphthol orange (tropeolin 000; α -naphtholbenzene-*p*-sulfonic acid), color change, 147, 218
 properties, 147
 protein error, 352
- Naphthol orange derivatives, 147
- α -Naphtholphthalein, absorption maximum, 316
 dissociation constant, 201
 in alcohol, 201
 indicator paper, 369, 377
 in mixed indicators, 175
 mixed indicator paper, 373

- properties, 113
- salt error, 345, 346
- stock solution, 110, 113
- in strongly acid solution, 121
- temperature effect, 355
- transformation interval, 109, 113, 387
 - in universal indicators, 171
 - in water-alcohol mixtures, 207
- 1-Naphthol-2-sodium sulfonate indo-phenol, spectrophotometric determination of pH, 317
- α -Naphtholsulfonephthalein, *see* Naphthol blue
- Naphtholsulfonic acids, 180
- α -Naphthoquinone (reaction with malonic nitrile), 305, 306
- Naphthyl red (α -naphthylaminoazobenzene), properties, 146
 - transformation interval, 108, 146, 386
- Neutralization curves, in alcohol, 198
 - of ampholytes, 40
- Neutral red, absorption maximum, 315
 - behavior in alcohol solutions, 207
 - behavior in benzene, 215
 - colloid error, 354
 - empirical comparison solutions, 302
 - indicator paper, 368, 376
 - in mixed indicators, 174
 - properties, 162
 - protein error, 352, 353
 - salt error, 341, 343, 345, 349
 - stock solution, 110, 160, 162, 301
 - suitability in $[H^+]$ determinations, 278
 - temperature effect, 355
 - transformation interval, 109, 160, 162, 387
 - in universal indicators, 172
- Neutral salt effect, 72, 73, 81
- Nile blue, indicator paper, 377
 - in mixed indicators, 175
 - properties, 164
 - stock solutions, 107, 160, 164
 - suitability in $[H^+]$ determinations, 164, 281
 - transformation interval, 109, 160, 164, 387
- Nitramine (picrylmethylnitramine), 154, 155
 - in alkaline solutions, 281
 - properties, 155
 - stock solution, 110
 - structure, 155
 - temperature effect, 191, 196, 355
 - transformation interval, 109, 155, 387
 - in water-alcohol mixtures, 210, 357
- o*-Nitroaniline, 168, 169
- p*-Nitroaniline, 168, 169
- p*-Nitroazobenzene, 168, 169
- p*-Nitrobenzeneazosalicylic acid, *see* Salicyl yellow
- p*-Nitrodiphenylamine, 168, 169
- Nitrohydroquinone, 154
- Nitro indicators, 152
 - indicator exponent, 356
 - in alcohol solutions, 360
 - properties, 153
 - stock solutions, 153
 - structure and color change, 152, 228
 - transformation interval, 153
- m*-Nitrophenol, empirical comparison solutions, 312
 - indicator exponent, 292, 293, 356
 - in alcohol solutions, 360
 - properties, 153
 - salt error, 333, 337, 349
 - stock solution, 153, 308
 - temperature effect, 356
 - transformation interval, 153, 308, 387
- p*-Nitrophenol, effect of alcohol, 198, 360
 - empirical comparison solutions, 312
 - indicator exponent, 292, 293, 355, 356
 - in alcohol solutions, 360
 - indicator paper, 370
 - properties, 154
 - protein error, 351, 352
 - salt error, 333, 337, 340, 343, 345, 349
 - sensitivity in water-alcohol mixtures, 208
 - solubility, 187
 - stock solutions, 107, 154, 307
 - temperature effect, 194, 196, 355, 356
 - theory of the color change, 218, 228
 - transformation interval, 108, 154, 307, 387
 - effect of concentration on interval, 187
 - in universal indicators, 172

- Nitropyrocatechol, 154
 Nitroresorcinol, 154
- Orange III, *see* Methyl orange
 Orange IV, *see* Tropeolin 00
 Osmotic coefficient, 55
- Pentamethoxy red (pentamethoxytri-phenylcarbinol), behavior in alcohol solutions, 202
 determination of water in alcohol, 203
 dissociation constant in alcohol, 201
 indicator exponent, 293
 properties, 138
 stock solutions, 110, 138, 139, 308
 transformation interval, 108, 138, 139, 308, 386
- Permanent standards for pH determinations, 310, 311
- Phenacetolin, 160
 Phenolbenzein, *see* Aurin
 Phenolnitrosulfonephthalein, 131
 Phenolphthalein, absorption maximum, 315
 acid-base error, 324
 azo derivatives, 115
 colloid error, 354
 dissociation constant in alcohol, 201
 halogen substitution products, 114, 115
 indicator exponent, 201
 indicator paper, 361, 365, 366, 377
 influence of alcohol, 198
 isohydric solution, 329
 in mixed indicators, 172, 175
 mixed indicator papers, 373
 pH as a function of the extent of coloration, 313
 in alcohol, 360
 properties, 111
 protein error, 112, 352
 salt error, 342, 343, 345, 349
 sensitivity in alcohol solutions, 206, 210-213, 356
 solubility, 185
 stock solution, 110, 112, 308
 in strongly acid solution, 121, 224
 structure, 111, 221
 suitability in $[H^+]$ determinations, 280
 temperature effect, 192, 196, 197, 355
 theory of the color change, 218, 221
 transformation interval, 109, 112, 186, 308, 387
 effect of concentration on the interval, 185
 in universal indicators, 171, 172
- Phenol red (phenolsulfonephthalein), absorption maximum, 315
 behavior in acetone, 214
 dissociation constant in alcohol, 201
 empirical comparison solutions, 303
 indicator exponent, 287, 289, 293, 294
 indicator paper, 369, 377
 in mixed indicators, 174
 mixed indicator papers, 371
 properties, 128
 protein error, 352, 353
 salt error, 341-344, 347, 348
 sensitivity in alcohol solutions, 207
 stock solution, 110, 301
 in strongly acid solution, 120
 structure, 116, 129, 225
 suitability in $[H^+]$ determinations, 281, 282
 temperature effect, 193, 196, 355
 theory of the color change, 119, 225
 transformation interval, 109, 129, 282, 387
- Phenolsulfonephthalein, *see* Phenol red
- Phenoltetrabromosulfonephthalein, 133, 134
- Phenoltetrachlorosulfonephthalein, 134
- Phenoltetraiodophthalein, 114
- Phenoltetraiodosulfonephthalein, 133
- Phenylalanine, reaction, 35
- Phenylxanthidrol, 166
 acid sensitivity in glacial acetic acid, 214
- Phthaleins, general, 111, 116
 in strongly acid solution, 121
 structure and color change, 221
- Phthalic acid, dissociation constant in acetone, 213
 reaction, 12
- Picrylmethylnitramine, *see* Nitramine
- Pinachrome (M), indicator exponent, 293
 properties, 156
 stock solution, 110, 157, 308

- transformation interval, 109, 156, 157, 308, 387
- Piperidine-hydrochloric acid buffer (Prideaux and Gilbert), 261
- Piperonalacetophenone, 166
acid sensitivity in glacial acetic acid, 214
- Plant extracts, 164
indicator papers, 376
- Plum extract, 165
indicator paper, 376
- Poirrier's blue, 160, 164, 387
- Pomegranate extract, 165
indicator paper, 376
- Potentiometric method for the determination of dissociation constants, 75
- Primary-secondary phosphate buffer (Sørensen), 247, 249
- Propyl- α -naphthol orange, 147, 148
stock solution, 107
transformation interval, 109, 147, 387
- Protein correction of indicators, 352, 353
- Protein error of indicators, 350
- Proton, 83, 90, 91
concentration in water, 85
solvation, 85
- Pseudo-form of electrolytes, 52, 220
- Pyrogallolbenzein, 137
- Pyrogallolphthalein, 114
- Quinaldine red, indicator exponent, 293
properties, 156
stock solution, 110
transformation interval, 108, 156, 386
use in determining pH without buffers, 308
- Quinine, 180
- Quinoline blue (cyanin), 157
in mixed indicators, 174
transformation interval, 156
- Raspberry extract, 165
indicator paper, 376
- Reaction (*see* Hydrogen ion concentration), acids and bases, 7
ampholytes, 33
buffer mixtures, 22
definition, 5, 7
salts (hydrolysis), 13
towards indicators, 181
- Red cabbage extract, 164
- Regulators (*see* Buffer mixtures), 23
- Resazurin, 160, 386
- Resorcine-azo-benzenesulfonic acid, *see* Tropeolin O
- Resorcine blue, *see* Lacmoid
- Resoreinolsulfonic acid, 180
- Rosolic acid (*see* Aurin), behavior in acetone, 214
influence of alcohol, 198
properties, 162
protein error, 351, 352
salt error, 349
sensitivity in water-alcohol mixtures, 207
stock solution, 160
transformation interval, 160
- Salicylic acid, 179
- Salicyl purple (tetrabromosalicylsulfonephthalein), 131
- Salicyl red (salicylsulfonephthalein), 131
- Salicylsulfonephthalein, *see* Salicyl red
- Salicyl yellow (alizarine yellow G—G; *m*-nitrobenzeneazosalicylic acid), 153
empirical comparison solutions, 312
pH as a function of extent of coloration, 314
salt error, 342
stock solution, 153, 308
temperature effect, 356
transformation interval, 153, 308, 387
- Salt correction of indicators, 336, 339–349
- Salt error of indicators, 333, 334
- Salting out effect, 58, 82, 338
- Salts, hydrolysis, 13
inner salt (*see* Hybrid ion), 42
salt formation, 86
- Sensitivity of indicators, indicator papers, 363, 377
sensitivity ratio, 209
temperature effect, 189, 293, 355
in water-alcohol mixtures, 206
- Sensitivity ratio, 209

- Sinalbin, 164
 Soda-borax buffer (Atkins and Pantin), 261
 Soda-borax buffer (Kolthoff and Vleeschhouwer), 252, 255
 purity of constituents, 248, 253
 Solubility product, 62
 Solvation, 61
 of protons, 85
 Solvent, 197
 acetic acid (glacial), 214
 acetone, 213
 alcohol, 199
 benzene, 215
 Sørensen value, *see* Standard hydrochloric acid-salt mixture
 Spaniolitmin, 161
 Spectrophotometry, 167, 315
 determination of pH, 315
 salt error of indicators, 333
 Spot apparatus, 304
 Standard hydrochloric acid-salt mixture (Sørensen), 240, 284
 Succinic acid-borax buffer (Kolthoff), 259
 Sulfonephthaleins, 116
 behavior in alcohol, 199
 dichromatism, 122
 extraction method, 319
 indicators of Harden and Drake, 134
 isohydric solutions, 329
 preparation, 124
 properties, 124
 salt error, 329
 stock solutions, 110
 in strongly acid solutions, 120, 127
 theory of the color change, 224
 use in $[H^+]$ determinations, 281
 Tartaric acid, reaction, 12
 Temperature effect on indicators, 189, 293, 355, 356
 Tetrabromophenol blue (tetrabromophenoltetrabromosulfonephthalein), 133
 stock solutions, 110, 134, 301
 in strongly acid solution, 120
 suitability in $[H^+]$ determinations, 123, 281
 transformation interval, 108, 123, 133, 134, 386
 Tetrabromophenolphthalein, 115
 Tetrabromophenolsulfonephthalein, *see* Bromophenol blue
 Tetrabromophenoltetrabromosulfonephthalein, *see* Tetrabromophenol blue
 Tetrabromophenoltetrachlorosulfonephthalein, 134
 Tetrabromophenoltetraiodophthalein, 115
 Tetrabromosalicylsulfonephthalein, *see* Salicyl purple
 Tetraiodophenoltetraiodophthalein, 115
 Thermodynamic dissociation constant, 67
 Thymolbenzein, 134, 135, 136
 Thymol blue (thymolsulfonephthalein), absorption maximum, 315
 behavior in acetone, 214
 behavior in alcohol solutions, 210-212, 357
 colloid error, 354
 dissociation constants in alcohol, 201
 empirical comparison solutions, 303, 304
 extraction method, 320
 indicator exponent, 288, 293, 294
 indicator paper, 361
 in mixed indicator paper, 372
 in mixed indicators, 175
 properties, 127
 protein error, 352
 salt error, 333, 334, 339, 342, 343, 347, 348
 stock solution, 110, 301
 in strongly acid solution, 120, 227
 structure, 118, 127, 227
 suitability in $[H^+]$ determinations, 279, 282
 temperature effect, 192, 195, 196, 355
 transformation interval, 108, 109, 118, 127, 282, 386, 387
 in universal indicators, 171
 Thymolphthalein, absorption maximum, 315
 colloid error, 354
 indicator paper, 369, 377
 in mixed indicators, 175
 properties, 112
 protein error, 350
 salt error, 342

- solubility, 112, 185, 186
stock solution, 110, 112
in strongly acid solution, 121
suitability in $[H^+]$ determinations, 112, 280
temperature effect, 191, 196
transformation interval, 109, 112, 387
 effect of concentration on interval, 186, 192
in universal indicators, 171, 172
in water-alcohol mixtures, 206, 210-212, 357
- Thymolsulfonephthalein, *see* Thymol blue
- Thymoltetrachlorophthalein, 114
- Titration acidity, 13, 367
- p*-Tolueneazo-*o*-toluidine, 143
- Transformation interval of indicators, 103, 172, 281
 in acetone, 213, 214
 in alcohol, 206
 effect of indicator concentration, 182
 graphical representation, 105, 106, 389
 tables, 108, 109, 134, 136, 139, 143, 147, 153, 156, 160, 165, 196, 214, 282, 369 (papers), 386, 387
 temperature effect, 189, 196
- Transformation point, 172
- Trinitroaniline, 168, 170
- Trinitrobenzene, properties, 156
 stock solution, 110, 156
 transformation interval, 109, 156, 387
- Trinitrobenzoic acid, properties, 156
 stock solution, 110, 156
 transformation interval, 109, 156, 387
- Trinitrotoluene, 154, 156
- Trioxyanthraquinone, 159
- Triphenylcarbinol, 166
 acid sensitivity in glacial acetic acid, 214
- Triphenylmethane dyes, 150
 salt error, 344
- Tropeolin G, *see* Metanil yellow
- Tropeolin O (resorcine-azo-benzenesulfonic acid; sodium salt), indicator paper, 361, 377
 protein error, 352
 stock solution, 107
 transformation interval, 109, 387
 in water-alcohol mixtures, 210, 357
- Tropeolin OO (diphenylaminoazo-*p*-benzenesulfonic acid; sodium salt), empirical comparison solutions, 302
 indicator paper, 377
 properties, 144
 protein error, 352
 salt error, 144, 334, 339, 343
 stock solution, 144, 301
 suitability in $[H^+]$ determinations, 280
 temperature effect, 195, 196, 355
 transformation interval, 108, 144, 386
 in water-alcohol mixtures, 209, 357
- Tropeolin OOO, *see* α -Naphthol orange
- Turbidity indicators, 177
- Turbid solutions, determination of pH in turbid solutions, 318
- Umbelliferon, 179
- Universal buffer solutions, 262
- Universal indicators, 170, 278, 281
- Veronal-acetate buffer (Michaelis), 258
- Veronal buffer (Michaelis), 257, 258
- Victoria yellow, *see* Metanil yellow
- Water, as an acid (Brönsted), 88
 as a base (Brönsted), 85, 99
 basicity constant, 92
 determination of the pH of sea water, 345
 determination of the pH of water, 329
 equilibrium water, 333
 ion activity product, 65, 379
 ion product, 4, 22, 65, 190, 379
 ion product in acetone, 214
 temperature effect, 190, 191
- Water-alcohol mixtures, acidity constant, 357
 dissociation of acids, 99, 358
 dissociation of bases, 359

- indicator properties in water-alcohol mixtures, 200, 203, 206, 356
- Weight molarity (definition), 59
- Xylene-cyanol (mixed indicator), 176
- Xylenol blue, 131
- Xylenolphthalein, 109, 112, 114
- p*-Xylenolsulfonephthalein, *see* Xylenol blue
- “Zwitterionen,” *see* Hybrid ions

