

UD
333
.A5
1918b
c.3

SMALL ARMS FIRING MANUAL

1913

CORRECTED TO MARCH 15, 1918

(CHANGES Nos. 1 TO 20)

Jr. E. Pulvly
2nd Lt. U.S.A.

8th Co. 1st Repl. Regt.

WAR DEPARTMENT : OFFICE OF THE CHIEF OF STAFF

SMALL ARMS FIRING MANUAL

1913

CORRECTED TO MARCH 15 1918

(Changes Nos. 1 to 20)



WASHINGTON
GOVERNMENT PRINTING OFFICE

1918

PROPERTY OF US ARMY

2651835
C.B

WAR DEPARTMENT

DOCUMENT NO. 442.

OFFICE OF THE CHIEF OF STAFF.

2

95-91

**WAR DEPARTMENT,
OFFICE OF THE CHIEF OF STAFF,
WASHINGTON, February 28, 1913.**

The following "Small Arms Firing Manual" is approved and published for the information and guidance of the Regular Army and the Organized Militia of the United States. Its provisions will take effect January 1, 1914.

By order of the Secretary of War:

**LEONARD WOOD,
Major General, Chief of Staff.**

TABLE OF CONTENTS.

	Page.
DEFINITIONS.....	9
Part I.—GENERAL SCHEME.....	19
Part II.—INDIVIDUAL INSTRUCTION.....	25
CHAPTER I.—Preliminary instruction on sighting drills for the rifle.....	25
CHAPTER II.—Position and aiming drills.....	36
CHAPTER III.—Deflection and elevation correction drills.....	48
CHAPTER IV.—Gallery practice.....	52
CHAPTER V.—Estimating distance test.....	54
CHAPTER VI.—Known distance practice.....	59
Long-distance practice.....	76
Summary of practice.....	77
CHAPTER VII.—Special course.....	78
Special Course A.....	78
CHAPTER VIII.—Advice to riflemen.....	80
CHAPTER IX.—Pistol or revolver practice.....	90
Preliminary drills.....	90
Position and aiming drills, dismounted.....	96
Position and aiming drills, mounted.....	99
CHAPTER X.—Revolver and pistol range practice.....	100
Who will fire.....	102
Record practice.....	103
Expert test.....	104
CHAPTER XI.—Dismounted course.....	106
Record practice.....	107
Expert test.....	107
CHAPTER XII.—Mounted course.....	110
Instruction practice.....	112
Record practice.....	117
Expert test.....	119
Part III.—COMBAT PRACTICE.....	125
General scheme.....	125
CHAPTER I.—Effect of fire.....	127
Cone of dispersion and the probabilities of hitting.....	128
Table of dispersion; average shots.....	132
Effectiveness of fire.....	133
CHAPTER II.—Influence of the ground.....	135
Rising and falling ground.....	136
Occupation of ground.....	141
CHAPTER III.—The adjustment of fire.....	142
Combined sights.....	147
Auxiliary aiming points and target designation.....	149
Fire at moving targets.....	150
Indirect fire.....	151

	Page.
Part III.—COMBAT PRACTICE—Continued.	
CHAPTER IV.—Instruction combat practice.....	152
Rules.....	153
Preparation of exercises.....	154
Records.....	156
CHAPTER V.—Proficiency test.....	157
Responsibility for deficiency in firing.....	159
CHAPTER VI.—Examples of exercises, with suggestions as to targets.....	160
Part IV.—MISCELLANEOUS.....	173
CHAPTER I.—Classification, extra compensation, insignia, and telescopic sights.....	173
Insignia.....	176
Telescopic sights.....	178
CHAPTER II.—Records and reports.....	178
CHAPTER III.—Targets and ranges.....	181
Ranges.....	195
Class "B" ranges.....	198
CHAPTER IV.—Competitions.....	199
Department rifle competitions.....	199
Department pistol competitions.....	203
Post competitions.....	212
Part V.—COURSES FOR ORGANIZED MILITIA.....	215
CHAPTER I.—Preliminary drills and instruction.....	215
CHAPTER II.—Known-distance firing.....	217
Qualification table.....	222
Combat practice.....	224
CHAPTER III.—Pistol practice.....	225

LIST OF PLATES.

PART II.

- Plate I. Sighting apparatus.
- Plate II. Sighting rest for rifle.
- Plate III. Normal sight ; peep sight.
- Plate IV. Fine sight ; triangles ; trigger finger.
- Plate V. Illustrating focusing on bull's-eye, front sight and rear sight, respectively.
- Plate VI. Sighting rest for pistol ; normal sight.
- Plate VII. Score board, Mounted course.
- Plate VIII. Pistol track.
- Plate IX. Expert test, Halt.
- Plate X. Pistol track, Expert test, Gallop.
- Plate XI. Sections, Pistol track.

PART III.

- Plate XII. Intersection of cone of dispersion with surface.
- Plate XIII. Defiladed space.
- Plate XIV. Rising and falling ground.
- Plate XV. Rising and falling ground.
- Plate XVI. Adjustment of fire.

PART IV.

- Plate XVII. Targets A, B, and C.
- Plate XVIII. Target D.
- Plate XIX. Targets E and F.
- Plate XX. Target G.
- Plate XXI. Targets H and I.
- Plate XXII. Target I, detail.
- Plate XXIII. Target K.
- Plate XXIV. Target M, Bobbing.
- Plate XXV. Targets L and M.
- Plate XXVI. Falling target, detail.
- Plate XXVII. Class B range.

SMALL ARMS FIRING MANUAL.

Definitions.

Aiming device:

A device to be attached to the rifle by which the instructor, standing on one side and facing the rear sight on the rifle, when the soldier is in the act of aiming, can see the reflection of both sights and the object aimed at, and can therefore judge of the accuracy of the soldier's aim and the steadiness of his trigger squeeze.

Anemometer:

An instrument for measuring the velocity of the wind.

Battle sight:

The position of the rear sight in which the leaf is laid down.

Beaten zone:

The intersection of the cone of dispersion with the surface on which the objective of the fire stands, or the space on the ground in which the bullets strike, in a series of shots fired by a body of soldiers with the same aiming point and the same rear sight setting.

Bore:

The cylindrical cavity in the small-arms barrel.

Bull's-eye:

The black circular division in the center of the bull's-eye target.

Butt:

The embankment or other means used to stop bullets in rear of the target. The plural "butts" is used to designate collectively the parapet, pit, and back stop of a group of targets.

Caliber:

The interior diameter of the small-arms barrel, measured between the lands.

Cant:

To revolve the barrel of the piece on its axis to the right or left while aiming.

Center:

The annular division of the bulls-eye targets A, B, and C embraced between the bull's-eye and the circumference of the next larger circular division of the target. Shots in this space have a value of 4.

Classification:

The arranging of the individuals of an organization in groups or classes according to the degree of skill displayed in record practice on the range with the rifle or pistol.

Coach:

A special instructor charged with the duty of giving advice and information to the firer.

Combat practice:

The prescribed firing at targets which simulate the appearance of an enemy under conditions approaching those found in war, and the application of this class of fire to tactical exercises.

Cone of dispersion:

A term applied to the figure formed in space by the trajectories considered together of a series of shots fired by a body of soldiers at a common objective and with the same rear sight setting.

Danger space:

The sum of the distances in the path of the bullet in which an object of given height will be struck. At long ranges the danger space at the farther end of the range alone is considered.

Deflade:

An obstacle either natural or artificial of sufficient thickness to intercept projectiles and afford shelter from fire delivered from a given point.

Disappearing target:

A target which is temporarily exposed to view.

Disk, marking:

A staff, with a disk at each end, used by the marker in the pit in signaling the results of hits on the target.

Distinguished marksman:

An officer or enlisted man who has won three of the authorized medals in department, departmental, division, and Army rifle or carbine competitions or as a member actually firing on a prize-winning team in the national team match.

Distinguished pistol shot:

An officer or enlisted man who has won three of the authorized medals in department, departmental, division, and Army pistol competitions.

Drift:

The lateral deviation of the bullet caused by the resistance of the air and the rotation of the bullet on its longer axis.

Echelon, order in:

In the order in echelon the targets or firing stands are placed one behind another to the right or left and unmasking one another.

Emplacement:

The space on the target range allotted for the position of the target.

Estimating distance:

Judgment by the eye of the distance of an object from the observer. Distance may also be judged by sound.

Expert pistol shot:

The highest grade or classification for skill displayed in record practice with the pistol. (See "Classification," par. 243.)

Expert rifleman:

The highest grade or classification for skill displayed in record practice on the range with the rifle. (See "Classification," par. 240.)

Fire at will:

That class of fire in which, within the restrictions of the command for firing, the individuals deliver their fire independently of the commander and of each other.

Fire control:

Or conduct of fire, is the exercise by a commander, over his unit or units, of that power which enables him to regulate the fire in obedience to his will. It pertains especially to the technicalities immediately involved in delivery of fire.

Fire direction:

Or employment of fire, is a general term embracing the various steps, including tactical disposition, which enable the commander of one or more fire units to bring an effective fire to bear upon the desired target at the proper time. It pertains especially to preparation of fire.

Fire discipline:

Is that condition of the personnel of a fire unit, resulting from training and practice, which enables the commander to obtain an orderly and efficient delivery of fire.

First-class man:

A grade of rifleman just below that of marksman. (See "Classification," par. 240.)

First-class pistol shot:

A grade of pistol shot just below that of expert pistol shot. (See "Classification," par. 243.)

Gallery practice:

Firing at reduced targets at short ranges with small-caliber rifles.

Gallery, shooting:

A room or inclosure in which gallery practice can be conducted.

Grooves:

The spiral channels within the bore of the rifle barrel.

Individual practice:

The firing on the range by which the individual soldier receives his instruction and by which his classification is determined.

Inner:

The annular division of the bull's-eye targets A, B, and C outside the center. Shots in this space have a value of 3.

Insignia:

Badges or distinguishing marks issued for expertness with the rifle or pistol.

Instruction practice:

The prescribed firing on the range which precedes record practice and which is devoted to the instruction of the soldier.

Lands:

Spaces in the bore of the rifle barrel between the grooves.

Line of aim:

The imaginary right line joining the middle point of the horizontal line of the open sight, or the center of the peep sight, and the point of aim.

Long range:

From 800 to 1,200 yards.

Marksman:

A grade of rifleman just below that of sharpshooter. (See "Classification," par. 240.)

Midrange:

From 500 to 800 yards.

Mirage:

A word used to designate the heat waves observed on the target range on warm days. The waves indicate the direction in which the air is moving.

O'clock:

A term employed to indicate, by means of the divisions on the dial of the clock, the location of a hit on the target or the direction from which the wind may be blowing, as a 7 o'clock, 4 or 5 o'clock, wind. In speaking of the position of a hit, the dial is supposed to occupy the front of the target facing the firer, with 12 at the top of the target. In speaking of wind, the dial is supposed to lie on the ground, with the 12 toward the target and the center at the firing point.

Outer:

The space on the bull's-eye targets A, B, and C outside the inner. Shots in this space have a value of 2.

Parapet:

An elevation of earth or other material thrown up in front of the targets to protect the markers.

Pit:

The space between the parapet and the butt or bullet stop occupied by the markers.

Practice season:

Those portions of the target year devoted to firing with the service cartridge. They include the regular season and the supplementary season.

Preliminary drills:

Consist of sighting drills, position and aiming drills, gallery practice, deflection and elevation correction drills.

Preliminary practice:

The prescribed firing on the range which precedes competitions.

Proficiency test:

The annual test conducted to determine the proficiency of organizations in collective marksmanship.

Prone:

Lying flat on the belly. The only position with the body extended on the ground authorized in known distance firing.

Protest:

A formal objection against some act or decision.

Qualification:

The grade attained in known distance practice depending upon the scores made by individuals in the qualification course, record practice.

Qualification course, record practice:

The course in slow and rapid fire designed as the test of the soldier's ability as a rifleman and which determines his classification. It immediately follows the soldier's instruction practice in the qualification course.

Quick fire:

The class of fire employed in instruction and record practice for pistol and revolver when bobbing targets are specified.

Range:

Any tract of land over which firing with small arms is conducted. This term is also used to signify the distance of the objective from the firer.

Range determination:

Finding the range to an object by the use of instrumental range finders, measurement, calculation, or trial shots or volleys.

Range officer:

A commissioned officer charged with the care, police, etc., of a target range and its accessories.

Rapid fire:

The class of fire employed in instruction and qualification practice in which a time limit is set for completing a score or scores.

Regular season:

Comprises two months, not necessarily consecutive, of the target year, selected by the department commander, in which the prescribed course of known distance and combat firing is pursued.

Ricochet shots:

Bullets which rebound after striking the ground or any other obstacle and continue their flight are said to ricochet.

Score book:

A book containing forms for recording scores as well as data concerning conditions affecting firing and instructions for the rifleman.

Score cards:

Pasteboard cards issued to competitors at competitions, giving the number of the target of each competitor firing, with his order of firing, and containing a blank space for the record of the shots fired and for the signature of the scorer.

Score:

A string of consecutive shots fired in individual practice. The term "score" is also used to express the record or register of number of points made in one or more scores, the value of sighting shots being excluded. In record practice with rifle, scores consist of 5 shots in slow fire and 10 shots in rapid fire; with the automatic pistol, 5 shots. In instruction practice with rifle, 10 shots or 5 shots may constitute a score.

Second-class man:

The lowest grade of those who are given a classification in rifle practice. (See "Classification," par. 240.)

Second-class pistol shot:

The lowest grade of those who are given a classification in pistol practice. (See "Classification," par. 243.)

Sharpshooter:

A grade of rifleman just below that of expert rifleman. (See "Classification," par. 240.)

Short range:

0 to 500 yards.

Shot marks:

Disks of thin material, 3 inches, 5 inches, and 10 inches in diameter, respectively, with a wire spring of two branches secured to the disk near its center. They are white on one side and black on the other, and are used to mark on the bull's-eye target the position of the last shot.

Sighting shots:

The trial shots which precede scores in the qualification test firing to enable the soldier to determine the proper sight setting or point of aim.

Slow fire:

The class of fire employed in instruction and record practice in which no time limit is imposed for completing a score.

Special course A:

Special course A is a course of rifle practice provided for the Coast Artillery Corps. It is also the course provided for posts where a complete rifle range is not available, but where a range of 200 and 300 yards can be had. Recruits fire a portion of this course in the practice held during the supplementary season.

Spotter:

One who, in team practice, announces the value of shots and indicates on a wooden target, by means of pins, the position of hits on the range target.

Supplementary season:

A period of the target year designated by the department commander, in which all recruits who have joined too late to participate in the regular practice season will fire a prescribed course.

Target:

An object presenting a mark to be fired at. (See description of targets. Part IV.)

Telescopic sight:

A telescope or other magnifying device attached to the barrel of the rifle for getting, while aiming, a better definition of a distant objective, provision being made for adjustments in elevation and for windage.

Trajectory:

The path described by a bullet in the air moving under the combined influences of the force of propulsion, the force of gravity, and the resistance of the air.

Twist:

The spiral formed by the grooves in the barrel of a rifled piece. In the United States magazine rifle, model 1903, this twist is uniform, one turn in 10 inches.

Unqualified:

Those who in the last practice season failed to qualify as a second-class shot or better, and those who for any reason did not fire the course and are not otherwise classified.

Windage:

The influence of the wind in deflecting the bullet from the point at which it is aimed; also applied to the amount of change made on the wind gauge.

Wind gauge:

A graduated attachment on the rear sight of the rifle by which allowance may be made in aiming for the effect of the wind upon the bullet and for drift.

PART I.

GENERAL SCHEME.

1. OBJECT OF INSTRUCTION.—The sole purpose of rifle training for the soldier is to make of him a good shot under war conditions, and a scheme of instruction will be effective in so far as it tends to produce that result. The soldier should therefore be so trained at known distances in the various kinds of fire employed in actual service as to bring his skill as a rifleman up to the capabilities of his weapon, after which he should be so trained in firing as part of tactical units as to utilize his individual skill to the best advantage in operations simulating those of the battle field. The scheme of instruction is prescribed with a view to attaining these objects. By means of preliminary drills and gallery practice the soldier is trained in the fundamental principles of marksmanship; by means of range practice he is taught to apply these principles in firing, at fixed distances, at clearly defined targets. This training is merely preparatory to combat firing in which individuals learn cooperation and commanders and leaders learn how to obtain the maximum efficiency of fire by a judicious coordination of the skill and the efforts of all the individuals of the group or fire unit.

In all preliminary practice and in range firing the soldier is taught to reduce the size of his shot group as much as possible and to place the center of the shot group at the center of his target. In combat firing this principle should be utilized in securing superiority of fire.

In actual combat, individual targets will not, in general, be visible, but if individual shot groups be so combined as to produce a grazing fire uniformly distributed along the hostile line, a large number of hits will necessarily result and shots which

miss will have the approximate value of hits in determining superiority of fire.

“In a decisive battle success depends on gaining and maintaining superiority of fire. Every effort must be made to gain it early and then to keep it.” (Par. 400, Infantry Drill Regulations.)

“The purpose of fire superiority is to get hits whenever possible, but at all events to keep down the enemy's fire and render it harmless.” (Par. 413, Infantry Drill Regulations.) The ultimate object of all instruction is, therefore, to enable troop commanders to deliver a heavy volume of close, accurate fire upon any designated objective. With a given extent of front, however, there is a limit to the number of men who can use their rifles effectively. When the maximum number of rifles has been brought into action, a further increase in the volume of fire can be obtained only by increasing the rate of fire. The rate of fire to be employed will always be dependent upon the tactical situation; as conditions are never the same, no fixed rules concerning rates of fire can be prescribed, but “In unexpected, close encounters a great advantage accrues to the side which first opens rapid and accurate fire with battle sight.” (Par. 405, Infantry Drill Regulations.) Within such ranges a high degree of proficiency in rapid fire is deemed necessary. The course of instruction in rapid fire is therefore drawn with a view to enabling troop commanders to deliver the most rapid fire possible, consistent with accuracy, upon targets exposed within the ordinary ranges of the battle sight.

2. SCHEME OF INSTRUCTION.—The course herein prescribed has been arranged as follows:

- (a) Nomenclature and care of the rifle.
- (b) Sighting drills.
- (c) Position and aiming drills.
- (d) Deflection and elevation correction drills.
- (e) Gallery practice.
- (f) Estimating distance drill.
- (g) Individual known distance firing, instruction practice.
- (h) Individual known distance firing, record practice.
- (i) Long-distance practice.
- (j) Practice with telescopic sights.

(k) Instruction combat practice.

(l) Combat practice.

(m) Proficiency test.

The course of pistol firing includes the following:

(a) Nomenclature and care of the pistol, general facts and principles.

(b) Position and aiming drills and rapid-fire drills; dismounted and mounted.

(c) Individual firing, instruction practice.

(d) Individual firing, record practice.

3. GRADES OF SHOTS AND BASIS OF QUALIFICATION.—Soldiers are graded according to proficiency exhibited in the record practice as experts, sharpshooters, marksmen, first-class men, second-class men, and unqualified. The grades of first and second class men, corresponding to certain percentages made in the qualification course, are intended to give encouragement to the poorer grades of shots and to provide the soldier, who has been unable to qualify as marksman or better, with a more definite record of marksmanship. The class unqualified is made to include those men borne on the rolls of an organization who have fired and failed to qualify as second class or better and all others who for any reason have not been classified.

As a test of individual proficiency the single course in slow and rapid fire has been devised, qualifications for the various grades being on a percentage basis, as hereinafter shown. The targets used in this test are such that equal conditions as to visibility are provided for all. The time limits chosen after experience and special trials are such that with care and practice the average soldier will be able to deliver without great difficulty the prescribed number of shots in well-aimed fire at targets which are plainly visible.

4. PERIOD OF PRELIMINARY INSTRUCTION.—The portion of the year which immediately precedes the instruction of the soldier upon the target ground will be utilized in laying, by a thorough course of the preliminary drills and gallery practice, a good foundation for future proficiency. This applies especially to recruits and those who in the last season failed to qualify as marksman or better. The instructors will also improve this opportunity for explaining the different theoretical principles, as far as the capacity and interest of the men appear to render

it advantageous. Recruits will also receive preliminary instruction during the month after joining their commands.

The purpose in the training of a company should be to produce uniform proficiency rather than expertness on the part of a comparatively few men. A man who has once learned to shoot will seldom lose his ability. The attention of the instructor should therefore be concentrated on the poorer shots. The prescribed course in firing admits a saving of ammunition on the best shots, which saving should be applied to the better instruction of recruits and those who in the last season's practice were unable to attain the grade of marksman or better. Particular care should be taken to avoid discouraging the poor shots.

5. SUPPLEMENTARY PRACTICE SEASON.—A supplementary course of instruction is prescribed for the benefit of recruits. This practice is for the purpose of preventing an accumulation of recruits totally uninstructed.

6. DISCRETION ALLOWED INSTRUCTORS.—Standards of proficiency being set for the individual by the established grades of riflemen, and the purposes of target instruction being understood, it is expected that as far as practicable instructors will be given some latitude in methods to suit peculiarities of individuals and special conditions. Accordingly, while the methods laid down for the preliminary work and instruction courses are given in some detail, these need not necessarily be followed implicitly when departures therefrom appear to be justifiable or advantageous. Improvements in methods of instruction and in target appliances should constantly be sought for and reported upon.

7. DUTIES OF COMPANY OFFICERS.—The training of the men in small arms firing will be under the immediate supervision of the company commander, who will be held responsible that a suitable standard of proficiency is reached. He will be assisted by his lieutenants, noncommissioned officers, and expert shots, and these assistants should be given the theoretical instruction necessary to fit them to be coaches and instructors.

As good teaching requires a practical as well as a theoretical knowledge of the subject taught, all company officers will be required to fire with the men, subject to the exceptions given in paragraph 89.

8. DUTIES OF THE BATTALION COMMANDER.—The battalion commander is the supervisor and inspector of firing instruction for the organizations under his command. He will give such theoretical instruction to the officers as may be necessary, and, through proper supervision of the preliminary drills and exercises and of the range practice, assure himself that the company commanders and their assistants are thoroughly conversant with the details of the course and that suitable methods within the meaning and intent of those herein prescribed are being followed. He should not attempt to fix definite lines of procedure, but should endeavor to leave some room for initiative and ingenuity on the part of his subordinates, subject to such restrictions as circumstances and the necessities of other troops may impose.

He will also supervise the combat-firing exercises of his command, endeavoring by every means to realize to the fullest extent the instructional value of these exercises.

In combat-firing exercises designed for a company, the battalion commander will supervise the firing and judge the results according to the prescribed standard, and he will also supervise and judge the annual proficiency test of the organizations of his command unless some other officer has been specially designated.

Each battalion commander will, at the end of the target-practice season, make a written report to the regimental commander of the state of instruction in target practice in the organizations of his command, basing the opinions expressed both on the individual qualifications attained in record firing and upon the results obtained in the combat firing and in the annual proficiency test.

9. DUTIES OF THE REGIMENTAL COMMANDER.—The regimental commander will exercise general supervision over the organizations of his command and will endeavor to maintain the highest possible standard of efficiency in his regiment. Upon receipt of the company and the battalion commanders' reports, he will submit, with the regimental consolidated report of classification (see par. 255) a brief report, through the brigade commander, to the department commander on the state of instruction of his command.

10. The post commander will exercise a general supervision over the target practice of troops at his post and direct supervision over the target practice of troops pertaining to the tactical unit to which he belongs. When troops of different brigades are serving at the same post he will see that the approved programs with reference to target practice prescribed in accordance with instruction orders of the War Department are faithfully complied with.

The post commander will recommend the months of the year most suitable for target practice, including the supplementary practice season, for his post, and when combat-firing facilities do not exist on the reservation, should use every effort to procure suitable firing grounds in the vicinity so that the advantage of this training may not be lost.

11. DUTIES OF THE DEPARTMENT COMMANDER.—The department commander will supervise instruction in small arms for the troops in his department and will make every effort to have complete facilities for this instruction at every post. He will satisfy himself that the purposes of instruction in firing are fully understood and carried out, and to this end he will make the necessary examination of the firing records and order such test firings at the time of his annual inspection as he may deem advisable and of which the ammunition available will admit.

PART II.

INDIVIDUAL INSTRUCTION.

CHAPTER I.

PRELIMINARY INSTRUCTION AND SIGHTING DRILLS FOR THE RIFLE.

12. NOMENCLATURE AND CARE OF THE RIFLE.—Although each recruit is required to be instructed in the nomenclature, care, use, and preservation of the rifle, this instruction will be repeated as the initial step for each season's known distance practice.

The precautions necessary to avoid accidents will also be thoroughly impressed upon the soldier at this time.

SIGHTING DRILLS.

13. VALUE.—The value of the sighting drills and the position and aiming drills can not be too strongly emphasized. By means of them the fundamental principles of shooting may be inculcated before the soldier fires a shot.

14. TO WHOM GIVEN.—The sighting drills will be given to all soldiers who have not qualified as "marksman" or better in the preceding target year.

15. PURPOSE:

- (a) To show how to align the sights properly on the mark.
- (b) To discover and demonstrate errors in sighting.
- (c) To teach uniformity in sighting.

16. APPARATUS AND ITS USE—SIGHTING BAR.—(See Pl. I.) To consist of:

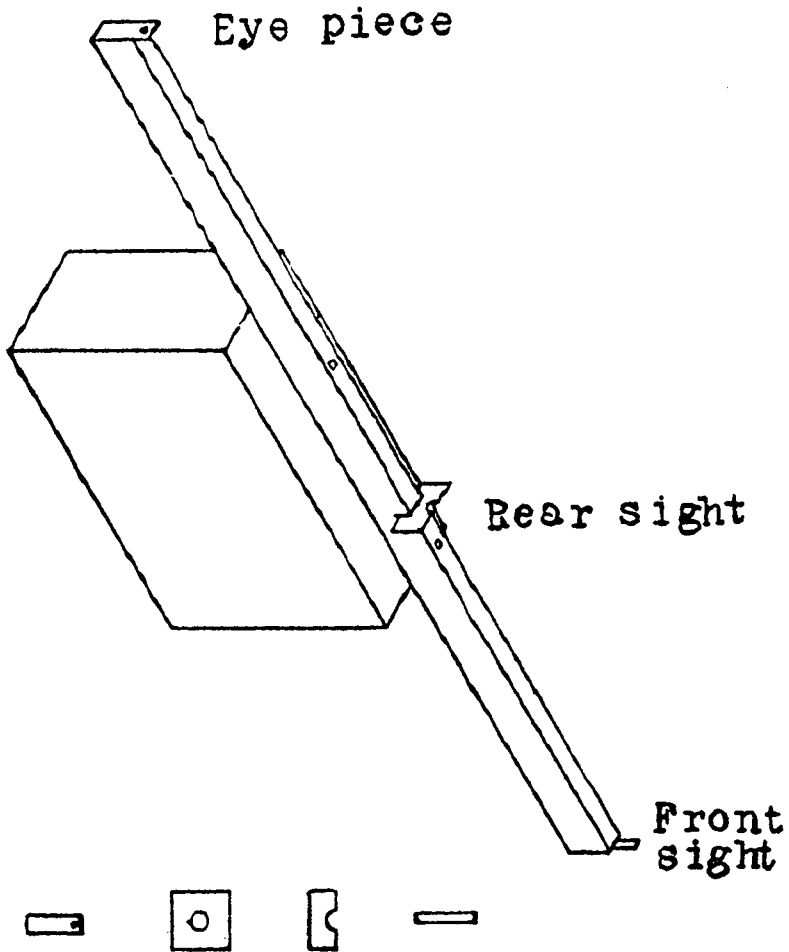

PLATE I.

(a) A bar of wood about 1 by 2 inches by 4 feet, with a thin slot 1 inch deep cut across the edge about 20 inches from one end.

(b) A front sight of tin or cardboard $\frac{1}{2}$ by 3 inches tacked to the end nearer the slot and projecting 1 inch above bar.

(c) An eyepiece of tin or cardboard 1 by 3 inches tacked to the other end of, and projecting 1 inch above, the bar, with a very small hole (0.03 inch) $\frac{1}{2}$ inch from top of part projecting above the bar.

(d) An open rear sight of tin or cardboard $1\frac{1}{2}$ by 3 inches, with a U-shaped notch $\frac{3}{4}$ inch wide cut in the middle of one of the long edges. This is placed in the slot on the bar. A slight bend of the part of the tin fitting in the slot will give enough friction to hold the sight in any part of slot in which it is placed.

(e) A peep rear sight of tin or cardboard 3 by 3 inches, with a peep hole $\frac{3}{4}$ inch in diameter cut in the center. This replaces the open sight when the peep sight is shown.

Carefully blacken all pieces of tin or cardboard and the top of the bar. Nail the bar to a box about 1 foot high and place on the ground, table, or other suitable place. Then adjust the open or peep rear sight in the slot and direct the bar upon a bull's-eye (preferably a Y target) placed about 5 yards from the bar. No other than the sight desired can be seen. Errors, etc., are shown by manipulating the open and peep rear sights.

17. SIGHTING REST FOR RIFLE.—(See Pl. II.) Take an empty pistol ammunition box or a similar well-made box, remove the top and cut notches in the ends to fit the rifle closely. Place the rifle in these notches with the trigger guard close to and outside one end. (The stock may be removed from the rifle so as to bring the eye as near the rear sight as in shooting.) Nail a plank (top of box will do) to a stake or wall about 12 inches from the ground. Fasten a blank sheet of paper to the plank. Place the rest firmly on the ground, 20 or 30 feet from the plank, so that the rifle is canted neither to the right nor left—weight the box with sand if necessary—and without touching the rifle or rest, sight the rifle near the center of the blank sheet of paper. Changes in the line of sight are made by changing the elevation and windage. Take the prone position with elbows on the ground, hands supporting the head. A soldier acting as marker is provided with a pencil and a small rod bearing a disk of white cardboard about 3 inches in diameter, with a black bull's-eye (a black paster is best) pierced in the center with a hole just large enough to admit the point of a lead pencil. The soldier sighting

directs the marker to move the disk to the right, left, higher, or lower, until the line of aim is established, when he commands "Mark" or "Hold." At the command "Mark," being careful not to move the disk, the marker records through the hole in its center the position of the disk and then withdraws it. At the command "Hold," the marker holds the disk carefully in place without marking until the position is verified by the instructor, and the disk is not withdrawn until so directed.

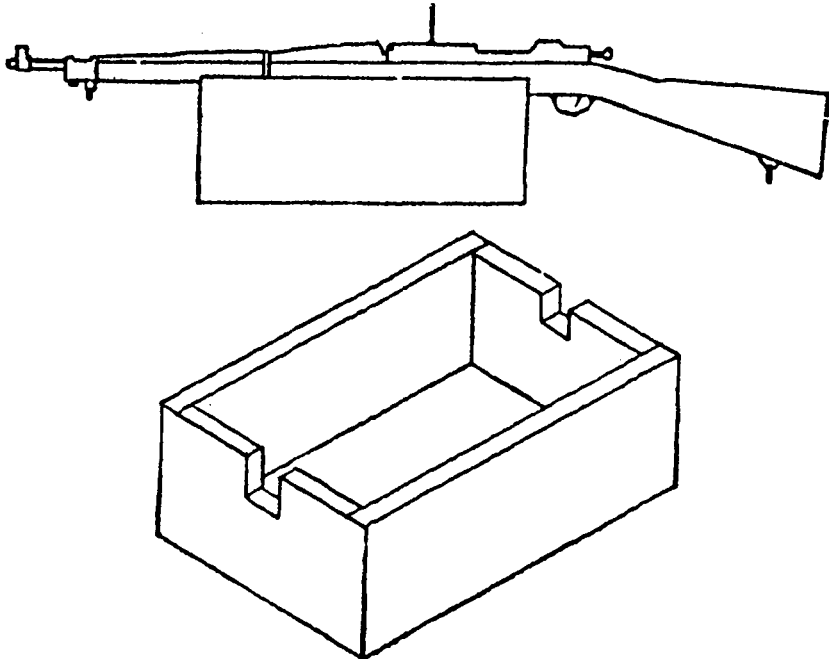

PLATE II.

18. LINE OF SIGHT.—With the open sight the line of sight is determined by a point on the middle line of the notch of the rear sight and the top of the front sight. With the peep sight, the line of sight is determined by the *center* of the peep and the top of the front sight.

19. POINT OF AIM.—The soldier will be informed that to give the greatest uniformity a point just below the mark, and not the

mark, is taken as *the point of aim*, as it is impossible to always know, if touching the mark with the top of the front sight, how much of the front sight is seen; that the term "on the mark or bull's-eye" will be understood to mean an aim, taken just below the mark, showing a fine line of light between the mark and the top of the front sight.

20. THE NORMAL SIGHT.—Look through the rear-sight notch at the bull's-eye or mark and bring the top of the front sight on a line with the top of and in the center of the rear-sight notch and aligned upon the point of aim. (See fig. 1, Pl. III.)

21. THE PEEP SIGHT.—Look through the peep hole at the bull's-eye or mark and bring the top of the front sight to the center of the aperture and aligned upon the point of aim. (See fig. 2, Pl. III.)

The soldier should be informed that regular results in firing can be obtained only when the same amount of front sight is taken each time, and that this can be done only by using the normal sight with the open notch or the peep sight in the manner described above. He should understand that the effect of taking less than the normal amount of sight is to cause a point lower than that aimed at to be struck, and that taking too much of the front sight causes a higher point to be struck.

Although men will be found occasionally who can get excellent results by using the fine sight (fig. 1, Pl. IV), the average man can not, and this form of sighting is not recommended. The so-called full sight should not be taught under any circumstances. If shown to the men at all, it should be for the purpose of pointing out a fault to be carefully avoided.

REMARKS.—The eye can be focused accurately upon objects at but one distance at a time; all other objects in the field of view will appear more or less blurred, depending on their distance from the eye. This can readily be seen if a pencil is placed in the field of view near the eye while looking at some distant object. The pencil will appear blurred. This is the condition met with by the normal eye in sighting a rifle. If the eye is focused on one of the three points—the bull's-eye, the front sight, or the rear sight—the other two will appear blurred. This blurring effect is best overcome by using the "peep sight," as though looking through a window, and focusing the eye on

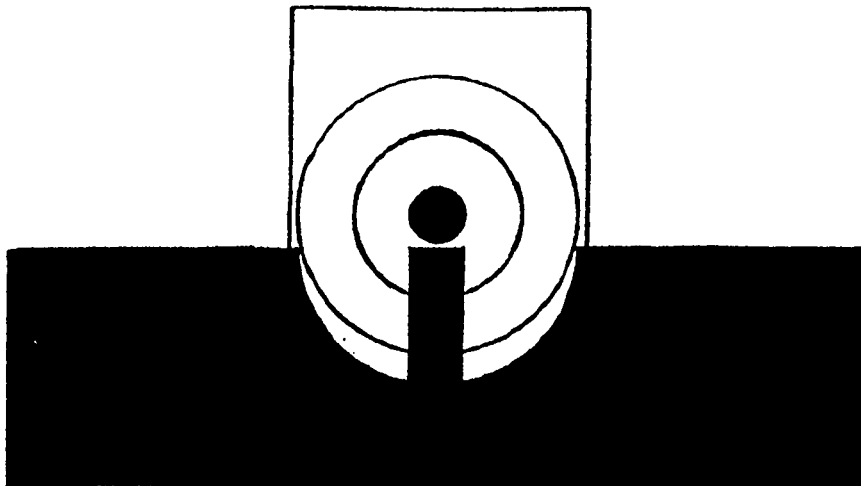

FIG. 1.



FIG 2
PLATE III.

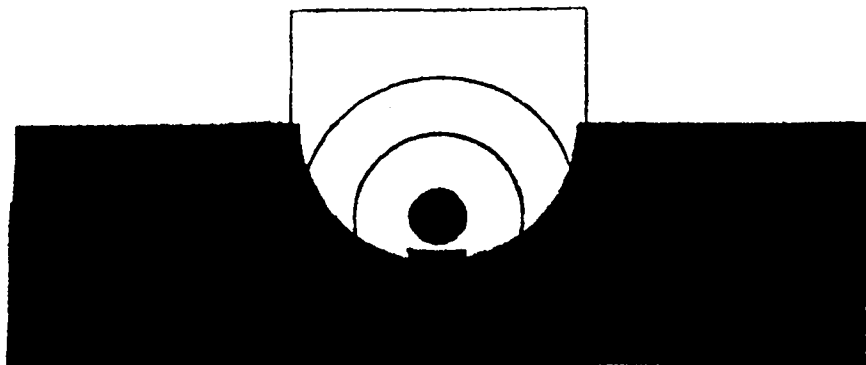

FIG. 1.



FIG. 2.



FIG. 3.

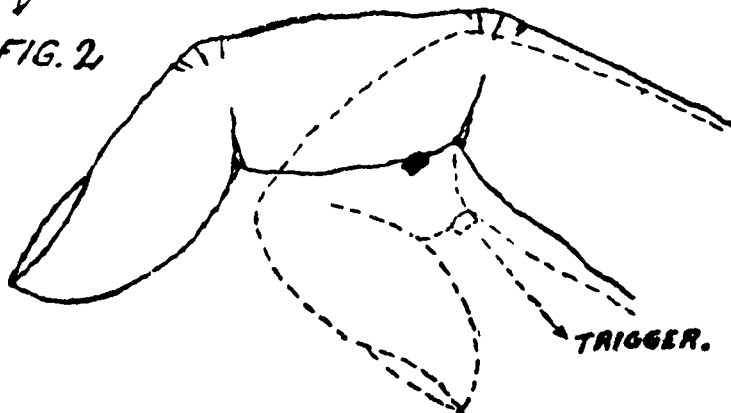

FIG. 4.

the bull's-eye. The blurring of the peep hole will be concentric, giving a clear and easily defined center. The blurring of the front sight will be less, but symmetrical on both sides with very little blur on the top. It can be readily and naturally brought to the center of the peep hole. Variations in light have less effect on the peep than on the open sight.

But the limited field of view and lack of readiness in getting a quick aim with the peep sight limit its use to those stages of the combat when comparative deliberation will be possible. In the later stages of battle—especially when a rapid fire is to be delivered—the open sight will, in most cases, be used. In this case the normal sight should be used, as the horizontal line at the top of the notch of the rear sight affords a good guide for regularity.

Whatever sight is used, the eye must be focused on the bull's-eye, or mark, not on the front or rear sight.

FIRST SIGHTING EXERCISE.

22. Using illustrations, describe the normal sight and the peep sight.

23. Using the sighting bar, represent the normal sight and the peep sight and require each man in the squad to look at them.

24. Using the sighting bar, describe and represent the usual errors of sighting and require each man in the squad to look at them.

SECOND SIGHTING EXERCISE.

25. Using the sighting rest for the rifle, require each man to direct the marker to move the disk until the rifle is directed on the bull's-eye with the normal sight and command "Hold." The instructor will verify this line of sight. Errors, if any, will be explained to the soldier and another trial made. If he is still unable to sight correctly, the first exercise will be repeated.

Soldiers will sometimes be found who do not know how to place the eye in the line of sight; they often look over or along one side of the notch of the rear sight and believe that they

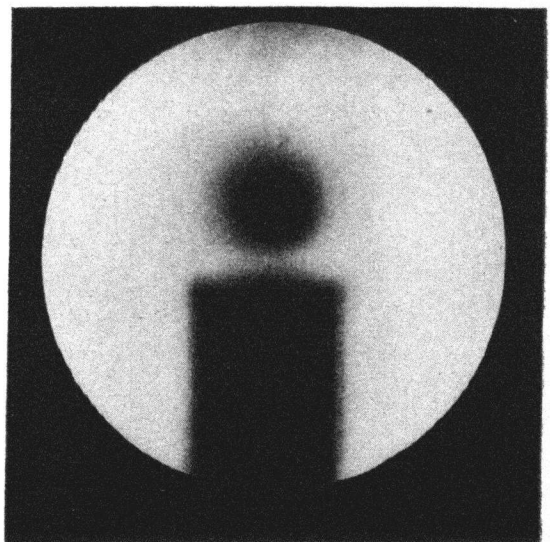
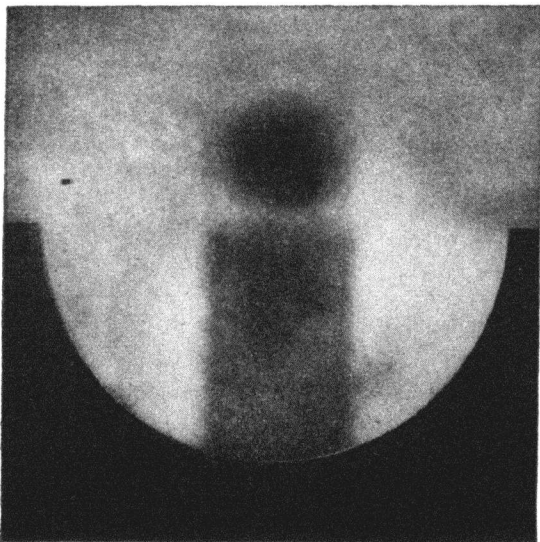
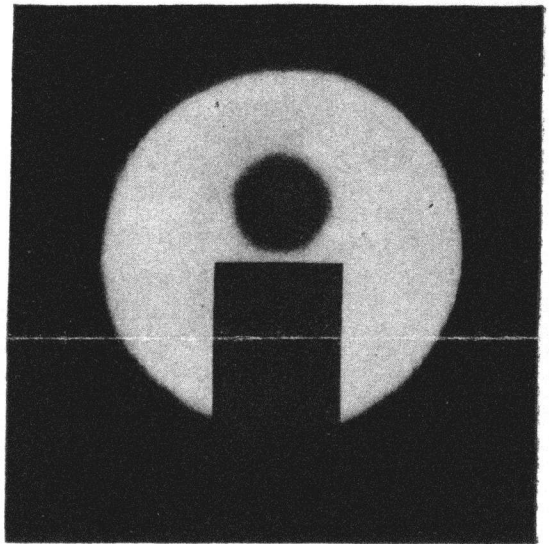
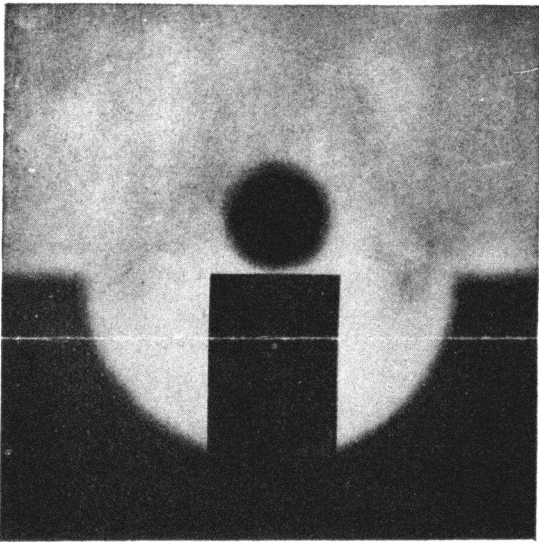
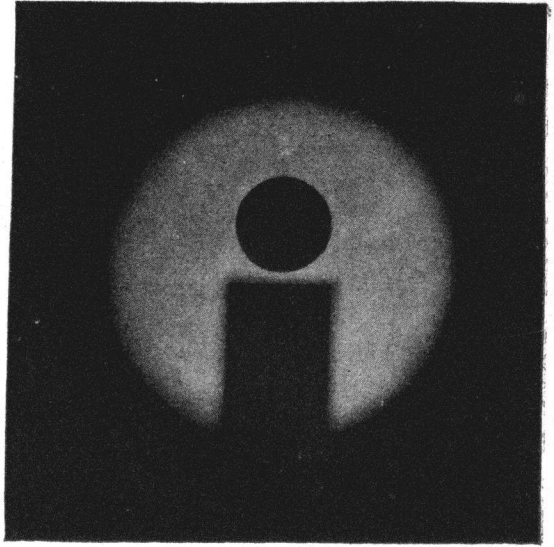
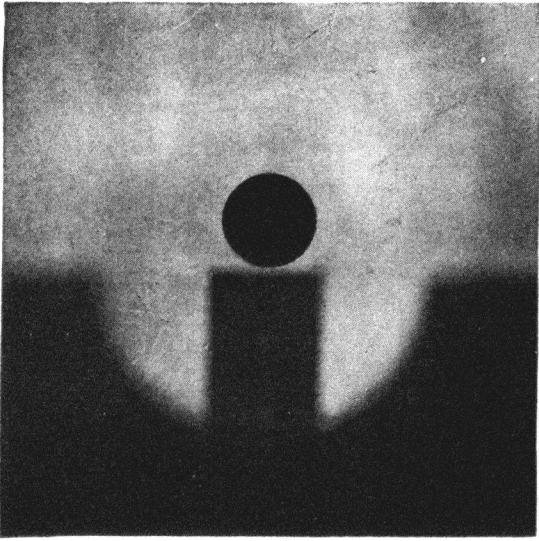

PLATE V.

are aiming through the notch because they see it at the same time that they do the front sight. This error will probably be made evident by the preceding exercise. Some men in sighting will look at the front sight and not at the object. As this often occasions a blur, which prevents the object from being distinctly seen and increases both the difficulties and inaccuracies of sighting, it should be corrected.

26. Repeat the above, using the peep sight.

THIRD SIGHTING EXERCISE.

27. Using the sighting rest for the rifle, require each man to direct the marker to move the disk until the rifle is directed on the bull's-eye with the normal sight and command "Mark;" then, being careful not to move the rifle or sights, repeat the operation until three marks have been made.

(a) THE TRIANGLE OF SIGHTING.—Join the three points determined as above by straight lines, mark with the soldier's name, and call his attention to the triangle thus formed. The shape and size of this triangle will indicate the nature of the variations made in aiming.

(b) ABNORMAL SHAPE, CAUSES.—If the triangle is obtuse angled, with its sides approaching the vertical (see fig. 2, Pl. IV), the soldier has not taken a uniform amount of front sight. If the sides of the triangle are more nearly horizontal (see fig. 3, Pl. IV) the errors were probably caused by not looking through the middle of the notch or not over the top of the front sight. If any one of the sides of the triangle is longer than one-half inch, the instructor directs the exercise to be repeated, verifying each sight and calling the soldier's attention to his errors. The instructor will explain that the sighting gains in regularity as the triangle becomes smaller.

(c) VERIFYING THE TRIANGLE.—If the sides of the triangle are so small as to indicate regularity in sighting, the instructor will mark the center of the triangle and then place the center of the bull's-eye on this mark. The instructor will then examine the position of the bull's-eye with reference to the line of sight. If the bull's-eye is properly placed, with reference to the line of sight, the soldier aims correctly and with uni-

formity. If not so placed, he aims in a regular manner but with a constant error.

(d) CAUSES OF ERRORS.—If the bull's-eye is directly above its proper position, the soldier has taken in aiming too little front sight, or if directly below too much front sight. If directly to the right or left, the soldier has not sighted through the center of the rear-sight notch and over the top of the front sight. If to the right, he has probably either sighted along the left of the rear sight notch or the right side of the front sight, or has committed both of these errors. If the bull's-eye is too far to the left, he has probably sighted along the right of the rear sight notch or to the left of the front sight, or has combined both of these errors.

If the bull's-eye is placed with reference to its proper position diagonally above and to the right, the soldier has probably combined the errors which placed it too high and too far to the right. Any other diagonal position would be produced by a similar combination of vertical and horizontal errors.

As the errors thus shown are committed when the rifle is fixed in position, while that of the bull's-eye or target is altered, the effect will be directly opposite to the changes in the location of a hit in actual fire, occasioned by the same errors, when the target will be fixed and the rifle moved in aiming.

After the above instruction has been given to one man, the line of sight will be slightly changed by moving the sighting rest or by changing the elevation and windage, and the exercises similarly repeated with the other men in the squad.

28. Repeat the third sighting exercise, using the peep sight.

FOURTH SIGHTING EXERCISE.

29. This exercise is a demonstration of the effect of canting the piece. The soldier must be impressed with the necessity of keeping the sights vertical when aiming, and not canting the piece to the right or left. Explain to the soldier that if the piece is canted to the right, the bullet will strike to the right and below the point aimed at, even though the rifle be otherwise correctly aimed and the sights correctly set. Similarly, if the piece is canted to the left, the bullet will strike to the left and low. This can be explained by showing that the elevation

fixes the height of the point where the bullet will hit the target, and that the windage fixes the point to the right or left; i. e. the elevation gives vertical effects and the windage horizontal effects. Let a pencil (or rod) held vertical represent the elevation; now if the pencil is turned to the right 90° , or horizontal, all of the elevation has been taken off, causing the shot to strike low and changed into windage, causing the shot to strike to the right.

30. This effect may be demonstrated as follows: Use the sighting rest with the rifle firmly held in the notches, the bolt removed. Paste a black paster near the center of the bottom line of the target. Sight the rifle on this mark, using about 2,000 yards elevation, then, being careful not to move the rifle, look through the bore and direct the marker to move the disk until the bull's-eye is in the center of the field of view and command "Mark." Next turn the rest with the rifle on its side, and with the same elevation sight on the same paster as above, then, being careful not to move the rifle, look through the bore and again direct the marker to move the disk until the bull's-eye is in the center of the field of view and command "Mark." Not considering the fall of the bullet, the first mark represents the point struck with the sight vertical, the second mark represents the point struck, low and to the right, using the same elevation and the same point of aim, when the piece is canted 90° to the right.

Different degrees of canting the piece can be represented by drawing an arc of a circle through the two marks with the paster as a center. The second mark will be at a point on this arc corresponding to the degree of canting the piece. Emphasis will be laid upon the fact that this effect of canting increases with the distance from the target.

31. OTHER EXERCISES.—If time permits, the instructor may devise other exercises which suggest themselves as useful and beneficial to his men. The following are examples:

(a) In strong sunlight, make a triangle of sighting, using a rifle having sights worn bright. Then, being careful not to move the rifle, blacken sights and make another triangle. Use dotted lines for the triangle made with bright sights and full lines for the triangle made with blackened sights. The position

and size of the two triangles will plainly show the advantage of the blackened sights.

(b) In strong sunlight make a triangle of sighting; then, being careful not to move the rifle, make another triangle, having first shaded the target and the man sighting. The relative position of the triangles will show the importance of knowing the effects of varying degrees of light.

CHAPTER II.

POSITION AND AIMING DRILLS.

32. PURPOSE.—These drills are intended to so educate the muscles of the arm and body that the piece, during the act of aiming, shall be held without restraint, and during the operation of firing shall not be deflected from the target by any convulsive or improper movement of the trigger finger or of the body, arms, or hands. They also establish between the hand and eye such prompt and intimate connection as will insure that the finger shall act upon the trigger, giving the final pressure at the exact moment when the top of the front sight is seen to be directed upon the mark.

The fact, though simple, can not be too strongly impressed upon the recruit that if, at the moment of discharge, the piece is properly supported and correctly aimed, the mark will surely be hit. Since any intelligent man can be taught to aim correctly and to hold the sights aligned upon the mark with a fair amount of steadiness, it follows that bad shooting must necessarily arise from causes other than bad aiming. The chief of these causes is known to be the deflection given to the rifle when it is discharged, due to the fact that the soldier, at the moment of firing, instead of squeezing the trigger, jerks it. This convulsive action is largely due to lack of familiarity with the methods of firing and to a constrained position of the muscles of the body, arm, and hands, which constrained position it is the purpose of the position and aiming drills to correct.

To become a good shot, constant, careful, and patient practice is required. Systematic aiming and squeezing the trigger

will do much to make a rifleman. The men will be taught to take advantage of every opportunity for practicing aiming and squeezing the trigger. For this purpose the barracks and ground in the vicinity of the barracks should be furnished with aiming targets, which the men will be encouraged to use at odd moments, as when waiting for a formation or during a rest. At drill the soldier will be cautioned never to squeeze the trigger without selecting an object and taking careful aim. When on the range waiting for his turn to fire, the soldier should use part of his time in position and aiming exercises, aiming at the target or at objects outside of the range, and he should be made to understand that this practice previous to firing will tend to prevent nervousness and will have a marked effect upon his score.

33. To WHOM GIVEN.—The position and aiming drills will be given to all soldiers who have not qualified as "marksman" or better in the preceding target year. Some practice in these drills (especially in the trigger-squeeze exercise) is recommended for those who have qualified as "marksman" or better. The amount to be given is left to the discretion of the company commander.

34. DRILLS; GENERAL INSTRUCTIONS.—These drills are divided into four progressive exercises. The first exercise teaches the position; the second exercise teaches the position and the aim; the third exercise teaches the aim and the manner of squeezing the trigger; and the fourth exercise teaches the methods of rapid fire. The exercises should be taught by the numbers at first; when fully understood, without numbers.

To correct any tendency to cant the piece, the rear sight will be raised. A black paster at which to aim will be placed on the wall opposite each man. The squad being formed in single rank, with an interval of 1 yard between files, the instructor directs the men to take the position of "Ready," except that the position of the feet will be such as to insure the greatest firmness and steadiness of the body. The instructor then cautions "Position and aiming drill."

The exercise which is being taught should be repeated frequently and made continuous. The instructor prefaces the preparatory command by "Continue the motion," or "At will,"

and gives the command "Halt" at the conclusion of the exercise, when the soldier will return to the position of "Ready." Or the soldier may be made to repeat the first and second motions by the command "One," "Two," the exercise concluding with the command "Halt."

Care should be taken by the instructor not to make the position and aiming drills tedious. Thirty minutes daily should be spent in this practice during the period of preliminary instruction. After gallery practice is taken up, however, five or ten minutes daily should be sufficient for these exercises.

In order that the instructor may readily detect and correct errors, the squads for these drills should not consist of more than eight men.

The instructor should avoid holding the squad in tiresome positions while making explanations or correcting errors.

POSITION EXERCISE.

35. The instructor commands: 1. *Position.* 2. EXERCISE. At the last command, without moving the body or eyes, raise the rifle smartly to the front of the right shoulder to the full extent of the left arm, elbow inclined downward, the barrel nearly horizontal, muzzle slightly depressed, heel of the butt on a line with the top of the shoulder.

(Two.) Bring the piece smartly against the hollow of the shoulder, without permitting the shoulder to give way, and press the rifle against it, mainly with the right hand, only slightly with the left, the forefinger of the right hand resting lightly against the trigger, the rifle inclined neither to the right nor left.

(Three.) Resume the position of "Ready."

36. REMARKS.—The instructor should especially notice the position of each soldier in this exercise, endeavoring to give to each man an easy and natural position. He should see that the men avoid drawing in the stomach, raising the breast, or bending the small of the back.

The butt of the piece must be pressed firmly, but not too tightly, into the hollow of the shoulder and not against the muscles of the upper arm. If held too tightly, the pulsations of the body will be communicated to the piece; if too loosely, the recoil will bruise the shoulder. If only the heel or toe

touches the hollow of the shoulder, the recoil may throw the muzzle down or up, affecting the position of the hit. While both arms are used to press the piece to the shoulder, the left arm should be used to direct the piece and the right forefinger must be left free to squeeze the trigger.

AIMING EXERCISE.

37. The instructor will first direct the sights to be adjusted for the lowest elevation and subsequently for the different longer ranges.

The instructor commands: 1. *Aiming.* 2. EXERCISE.

At the last command execute the first and second motion of the position exercise.

(Two.) Bend the head a little to the right, the cheek resting against the stock, the left eye closed, the right eye looking through the notch of the rear sight at a point slightly below the mark.

(Three.) Draw a moderately long breath, let a portion of it escape; then, with the lungs in a state of rest, slowly raise the rifle with the left hand, being careful not to incline the sight to either side, until the line of sight is directly on the mark; hold the rifle steadily directed on the mark for a moment; then, without command and just before the power to hold the rifle steadily is lost, drop the rifle to the position of "Ready" and resume the breathing.

38. REMARKS.—Some riflemen prefer to extend the left arm. Such a position gives greater control over the rifle when firing in a strong wind or at moving objects. It also possesses advantages when a rapid as well as accurate delivery of fire is desired. Whatever the position, whether standing, kneeling, sitting, or prone, the piece should rest on the palm of the left hand, never on the tips of the fingers, and should be firmly grasped by all the fingers and the thumb.

The eye may be brought to the line of sight either by lowering the head or by raising the shoulder; it is best to combine somewhat these methods; the shoulder to be well raised by raising the right elbow and holding it well to the front and at right angles to the body.

If the shoulder is not raised, it will be necessary for the soldier to lower the head to the front in order to bring the eye in to the line of sight. Lowering the head too far to the front brings it near the right hand, which grasps the stock. When the piece is discharged, this hand is carried by the recoil to the rear and, when the head is in this position, may strike against the nose or mouth. This often happens in practice, and as a result of this blow often repeated many men become gun-shy, or flinch, or close their eyes at the moment of firing. Much bad shooting, ascribed to other causes, is really due to this fault. Raising the right elbow at right angles to the body elevates the right shoulder, and lifts the piece so that it is no longer necessary to incline the head materially to the front in order to look along the sights.

As the length of the soldier's neck determines greatly the exact method of taking the proper position, the instructor will be careful to see that the position is taken without restraint.

39. As changes in the elevation of the rear sight will necessitate a corresponding change in the position of the soldier's head when aiming, the exercise should not be held with the sight adjusted for the longer ranges until the men have been practiced with the sights as the latter would generally be employed for offhand firing.

40. The soldier must be cautioned that while raising the line of sight to the mark he must fix his eyes on the mark and not on the front sight; the latter can then be readily brought into the line joining the rear-sight notch and mark. If this plan be not followed, when firing is held on the range at long distances the mark will generally appear blurred and indistinct. The front sight will always be plainly seen, even though the eye is not directed particularly upon it.

41. The rifle must be raised slowly, without jerk, and its motion stopped gradually. In retaining it directed at the mark, care must be taken not to continue the aim after steadiness is lost; this period will probably be found to be short at first, but will quickly lengthen with practice. No effort should be made to prolong it beyond the time that breathing can be easily restrained. Each soldier will determine for himself the proper time for discontinuing the aim.

42. The men must be cautioned not to hold the breath too long, as a trembling of the body will result in many cases.

43. Some riflemen prefer, in aiming, to keep both eyes open but unless the habit is fixed, the soldier should be instructed to close the left eye.

TRIGGER-SQUEEZE EXERCISE.

44. The instructor commands: 1. *Trigger squeeze.* 2. EXERCISE. At the command EXERCISE, the soldier will execute the first motion of the aiming exercise.

(Two.) The second motion of the aiming exercise.

(Three.) Draw a moderately long breath, let a portion of it escape, hold the breath and slowly raise the rifle with the left hand until the line of sight is on the mark, being careful not to incline the sights to either side. Contract the trigger finger gradually, slowly and steadily increasing the pressure on the trigger, while the aim is being perfected; continue the gradual increase of pressure so that when the aim has become exact the additional pressure required to release the point of the sear can be given almost insensibly and without causing any deflection of the rifle. Continue the aim a moment after the release of the firing pin, observe if any change has been made in the direction of the line of sight, and then resume the position of "Ready," cocking the piece by raising and lowering the bolt handle.

45. REMARKS.—Poor shooting is often the result of lack of proper coordination of holding the breath, the maximum steadiness of aim, and the squeeze of the trigger. By frequent practice in this exercise, each man may come to know the exact instant his firing pin will be released. He must be taught to hold the breath, bring the sights to bear upon the mark, and squeeze the trigger all at the same time.

46. THE TRIGGER SQUEEZE.—The trigger should be squeezed, not pulled, the hand being closed upon itself as a sponge is squeezed, the forefinger sharing in this movement. The forefinger should be placed as far around the trigger as to press it with the second joint. (See fig. 4, Pl. IV.) By practice the soldier becomes familiar with the trigger squeeze of his rifle, and knowing this, he is able to judge at any time, within limits, what additional pressure is required for its discharge. By constant repetition of this exercise he should be able finally to

squeeze the trigger to a certain point beyond which the slightest movement will release the sear. Having squeezed the trigger to this point, the aim is corrected and, when true, the additional pressure is applied and the discharge follows.

RAPID-FIRE EXERCISE.

47. OBJECT.—The object of this exercise is to teach the soldier to aim quickly and at the same time accurately in all the positions he will be called upon to assume in range practice.

48. The instructor commands: 1. *Rapid-fire exercise.* 2. **COMMENCE FIRING.** At the first command the first and second motions of the trigger-squeeze exercise are performed. At the second command the soldier performs the third motion of the trigger-squeeze exercise, squeezing the trigger without disturbing the aim or the position of the piece, but at the same time without undue deliberation. He then, without removing the rifle from the shoulder, holding the piece in position with the left hand, grasps the handle of the bolt with the right hand, rapidly draws back the bolt, closes the chamber, aims, and again squeezes the trigger. This movement is repeated until the trigger has been squeezed five times, when, without command, the piece is brought back to the position of "Ready."

When the soldier has acquired some facility in this exercise, he will be required to repeat the movement ten times, and finally, by using dummy cartridges, he may, by degrees, gain the necessary quickness and dexterity for the execution of the rapid fire required in range firing.

49. METHODS.—The methods of taking position, of aiming, and of squeezing the trigger, taught in the preceding exercises, should be carried out in the rapid-fire exercise, with due attention to all details taught therein; the details being carried out as prescribed except that greater promptness is necessary. In order that any tendency on the part of the recruit to slight the movements of aiming and of trigger squeeze shall be avoided, the rapid-fire exercise will not be taught until the recruit is thoroughly drilled and familiar with the preceding exercises. The recruit will be instructed that with practice in this class of fire the trigger can be squeezed promptly without deranging the piece.

50. REPETITION.—If the recruit seems to execute the exercise hurriedly or carelessly, the instructor will require him to repeat it at a slower rate.

51. MANIPULATION OF THE BREECH MECHANISM.—To hold the piece to the shoulder and, at the same time, manipulate the breech mechanism with the proper facility, are learned only after much practice. Some riflemen, especially men who shoot from the left shoulder, find it easier, in rapid firing, to drop the piece to the position of load after each shot. While at first trial this method may seem easier, it is believed that with practice, the advantage of the former method will be apparent.

POSITION AND AIMING DRILL, KNEELING.

52. These exercises will be repeated in the kneeling position by causing the squad to kneel by the commands prescribed in the Drill Regulations. The exercises will be executed as prescribed for standing, except that at the command "Two" in the position exercise, the soldier will rest the left elbow on the left knee, the point of the elbow in front of the kneecap. The paces for the kneeling exercise should be at $2\frac{1}{2}$ feet from the floor or ground.

53. REMARKS.—Frequent rests will be given during practice in these exercises kneeling, as the position, if long continued, becomes constrained and fatigues the soldier unnecessarily.

In raising the rifle to the mark in the second and third exercises, the position of the left hand should not be changed, but the left forearm should be brought toward the body and at the same time the body bent slightly to the rear.

When aiming kneeling there is, from the nature of the position, a tendency to press the butt of the rifle against the upper arm instead of against the hollow of the shoulder; this will necessitate inclining the head considerably to the right to get the line of sight, and by bringing the rifle so far to the rear will, if the thumb is placed across the stock, cause it to give by the recoil a blow upon the nose or mouth.

These difficulties may be avoided by advancing the right elbow well to the front, at the same time raising it so that the arm is about parallel with the ground. The hollow of the shoulder will

then be the natural place for the rifle butt, and the right thumb will be brought too far from the face to strike it in the recoil.

Some riflemen prefer, by bending the ankle, to rest the instep flat on the ground, the weight of the body coming more on the upper part of the heel; this obviates any tendency of the right knee to slip; or, by resting the right side of the foot on the ground, toe pointing to the front, to bring the weight of the body on the left side of the foot. These positions are authorized.

54. CHOICE OF POSITION.—In firing kneeling, the steadiness obtained depends greatly upon the position adopted. The peculiarities of conformation of the individual soldier exert when firing kneeling a greater influence than when firing either standing, sitting, or prone; the instructor should, therefore, carefully endeavor, noticing the build of each soldier, to place him in the position for which he is best adapted and which will exert the least tension or strain upon the muscles and nerves. It should be remembered, however, that without the rest of the left elbow on the knee this position possesses no advantage of steadiness over the standing position.

55. KNEELING POSITION; WHEN TAKEN.—The kneeling position can be taken more quickly than either the sitting or the prone position. It is, therefore, the position naturally assumed when a soldier, who is standing or advancing, has to make a quick shot at a moving or disappearing object and desires more steadiness than can be obtained standing.

POSITION AND AIMING DRILL, SITTING DOWN.

56. In many cases the men, while able to kneel and hold the piece moderately steady, can obtain in a sitting position much better results. All should, therefore, be instructed in aiming sitting down as well as kneeling.

To practice the soldier in the preceding exercises in a sitting position, the squad being formed in a single rank, with an interval of one pace between files, the rifle should first be brought to "Order arms"; the instructor then commands: **SIT DOWN.**

At this command make a half face to the right and, assisted by the left hand on the ground, sit down, facing slightly to the right, the left leg directed toward the front, right leg inclined toward the right, both heels, but not necessarily the bottoms of

the feet, on the ground, the right knee slightly higher than the left; body erect and carried naturally from the hips; at the same time drop the muzzle of the piece to the front, and to the position of the first motion of load, right hand upon the thigh, just in front of the body, the left hand slightly above, but not resting upon, the left leg.

The exercise will be executed as heretofore prescribed, except that at the command "Two" (position exercise) the soldier will rest the left elbow on the left knee, the point of the elbow in front of the kneecap, and the right elbow against the left or inside of the right knee, at the same time inclining the body from the hips slightly forward.

For the aiming and trigger-squeeze exercises the pasters, used as aiming points, will be $2\frac{1}{2}$ feet from the floor or the ground.

To afford the men rest or on the completion of the kneeling or sitting down exercises the instructor will command Rise, when the men rise, face to the front, and resume the "Order arms."

57. REMARKS.—If the preceding position is carefully practiced, steadiness is quickly attained. The right leg should not be carried so far to the right as not to afford a good support or brace for the right elbow.

This position may be modified, but, in general, not without impairing the steadiness of the man, by crossing the legs at the ankle, the outside of each foot resting upon the ground, body more erect, and the knees slightly more raised than in the previous position.

POSITION AND AIMING DRILL, PRONE.

58. From the nature of the position it is not practicable to execute these exercises according to the method followed when standing or kneeling. Instruction will, however, always be given with reference to the position, to the manner of assuming it, and to aiming and squeezing the trigger.

For this purpose the squad being formed as specified in paragraph 56 (the black pasters therein mentioned being about 12 inches from the ground), the squad will be brought to "Order arms."

Then (the squad either standing or kneeling), the instructor commands: **LIE DOWN**, which will be executed as prescribed in

the Drill Regulations; the legs may be spread apart and the toes turned out if found to give a steadier position.

After the squad has taken the position as prescribed above, the legs should be inclined well to the left, and either crossed or separated as the soldier prefers or as his particular conformation appears to render most desirable, and the body at the same time inclined slightly to the right.

With care and practice the soldier may acquire an easy position which he is able to assume with great facility.

Being at "Ready," the instructor then commands: 1. *Trigger squeeze*. 2. EXERCISE.

At the latter command carry the left elbow to the front and slightly to the right, the left hand under the barrel at the balance, weight of the body mainly supported by the left elbow, the right resting lightly on the floor or ground.

(Two.) Slide the rifle with the right hand through the left hand to the front until the left hand is a little in front of the trigger guard; at the same time raise the rifle with both hands and press it against the hollow of the shoulder.

(THREE.) Direct the rifle upon the mark and carry out the further details of aiming and squeezing the trigger as prescribed in paragraph 44.

Then resume the position, lying down.

As soon as the men have acquired with accuracy the details of the position they will be practiced, without the numbers, in aiming and squeezing the trigger at will; after which the rapid-fire exercise in the prone position will be practiced, the necessary skill and dexterity being acquired by degrees.

To afford the men rest, or on completion of the exercise, the instructor will command: *Rise*, which is executed as prescribed in the Drill Regulations.

59. REMARKS.—The preceding position for firing lying down possesses in a greater degree than any other position the merit of adaptability to the configuration of the ground; it enables the soldier to deliver fire over low parapets or improvised shelters, thus making the best use of cover. The importance of training the soldier in firing from the other positions should not, however, be lost sight of, since from the prone position it will frequently be impossible to see the objective.

Back positions are not authorized.

In the prone position, when aiming, the left elbow should be well under the barrel, the other elbow somewhat to the right, but not so far as to induce any tendency to slip on the floor or ground.

The greater changes in elevation required in first directing the rifle on the object should be given by altering the position of the left hand under the barrel, the slighter changes only by advancing or withdrawing the shoulder.

As the body does not yield to the recoil, as when firing standing or kneeling, the force of recoil, if the rifle is not properly held, may severely bruise the soldier. It is one of the objects of this exercise to so teach him that this will be prevented by assuming a correct position. Care must be exercised that the butt is not brought against the collar bone. By moving the shoulder slightly to the front or rear, and by moving the right elbow from the body or toward it, each soldier may determine the position in which the shoulder gives to the butt of the rifle the easiest rest. This will probably be the one in which the force of the recoil will be least felt.

The soldier should persist in this exercise until he obtains a position in which he feels no constraint, which will not subject him to bruises from the recoil, and from which the mark appears plainly through the sights. Having secured such a position, he must not change it when firing, as a variation in the points of support of the rifle, the distance of the eye from the rear sight, or the tension of the hold has a decided effect, especially at the longer ranges, upon the location of the point struck.

60. USE OF SLING.—After the soldier has been drilled in the proper standing, kneeling, sitting, and prone positions in the foregoing exercises, the use of the sling will be taught. Its use is described in paragraph 91. Adjustments and their advantages will be taught with the idea of noninterference with quickness and freedom of action. The trigger-squeeze exercises will then be continued in the different positions, using the sling.

GENERAL REMARKS ON THE PRECEDING DRILLS.

61. The importance of sighting and position and aiming drills can not be too persistently impressed upon the soldier. If these

exercises are carefully practiced, the soldier, before firing a shot at a target, will have learned to correctly aim his piece, to hold his rifle steadily, to squeeze the trigger properly, to assume that position best adapted to the particular conformation of his body, and will have acquired the quickness and manual dexterity required for handling the piece in rapid fire. This knowledge can not be successfully acquired upon the target ground. At that place the time that can be given to instruction is limited and should be devoted to the higher branches of the subject. Even, if the desired amount of attention could be given to each soldier, nevertheless, from the circumstances of the firing, his errors can not be readily determined. It is more than likely that the soldier would never discover the reasons for his failures and would, therefore, be unable to properly correct them.

Under such conditions the knowledge that he may have of the many other requisites for good marksmanship can not be utilized to full advantage, and, in fact, can but in a limited degree compensate for the neglect of these first principles and for the failure to lay, by assiduously practicing them, the only firm foundation for future proficiency.

If, in the instruction practice on the range, it is found that the soldier makes errors in his position, he should be required to stop firing and to practice the third exercise for 10 or 15 minutes. He should be encouraged to go through these exercises frequently at other than drill hours, care being taken that, in the aiming and trigger-squeeze exercises, he always has some definite object for a mark.

CHAPTER III.

DEFLECTION AND ELEVATION CORRECTION DRILLS.

62. SIGHT CORRECTION.—The soldier may find when firing at a target that the first shot has missed the bull's-eye or figure, and in order to cause the second to hit, two methods may be used: The point of aim may be changed or the sights may be moved and the same point be aimed at. In order to do accurate shooting it is essential to have a well-defined mark at which to aim; con-

sequently, except for very slight corrections, the method of moving the sights, involving changes in elevation and windage, is devised.

63. ELEVATION.—The instructor will show the men the graduations on the rear-sight leaf, and will explain to them the value of the different divisions. He will explain how to adjust their sights for different distances. He will make it clear that raising or lowering the slide on the rear-sight leaf has the effect of raising or lowering the point struck. The amount of change which a given amount of elevation will cause in the point struck varies with the range and with the rifle and the ammunition used.

64. DEFLECTION.—The instructor will explain how to move the movable base by use of the windage screw; that the graduations on the rear end of the movable base are for convenience in setting the sights and applying corrections; that each division is called a point of windage; that turning the movable base of the rear sight to the right or left changes the point struck to the right or left; that, to overcome the drifting effect of a wind from the right, the movable base must be moved to the right, and, if the wind be from the left, the movable sight base must be moved to the left.

65. ADJUSTING THE SIGHTS.—(a) *Elevation*.—The graduations on the rear sight will be found correct for but few rifles. This is due to slight variations in the parts of the rifle, especially the barrel, which occur under the most exact methods of fabrication. Not all rifles are tested at the arsenal, and when the graduations for the rear sight have been experimentally determined, they are correct only for the particular conditions existing when they were so determined. The correction necessary for each particular rifle at any range is found by shooting it at that range, and is constant with the same ammunition and when firing under the same conditions. If no correction is necessary, the rifle is said to "shoot on the mark."

(b) *The zero of a rifle*.—That reading of the wind gauge necessary to overcome the drift of a rifle at a particular range is called the "zero" of that rifle for that range, and all allowances for wind should be calculated from this reading.

The "zero" of a rifle is found by shooting it on a perfectly calm day.

66. The following table gives the approximate corrections on the rear-sight leaf and the wind gauge necessary to move the point struck 1 foot at ranges from 100 to 1,000 yards:

Range.	Correction on wind gauge necessary to move the point struck 1 foot.	Correction in elevation necessary to change the point struck 1 foot.
<i>Yards.</i>	<i>Points.</i>	<i>Yards.</i>
100	3	415
200	1.5	185
300	1	105
400	.75	70
500	.6	48
600	.5	35
700	.43	25
800	.375	20
900	.333	15
1,000	.3	12

67. EXERCISE.—To give the soldier practice in correcting elevation and windage, a target should be placed on the wall facing the squad and a blank paster attached a foot or more from the bull's-eye, at first directly above or below the bull's-eye, then on a horizontal line with it, and finally in an oblique direction.

For this drill the rifle of each soldier who has not determined by actual firing the "zero" and the correct elevations for the different ranges will be assumed; to shoot on the mark and to require no windage.

Announce the range and tell the men that the paster represents the position of an assumed hit and require each man to correct his sight so as to bring the next hit into the bull's-eye. This exercise should be repeated daily during gallery practice, using the A, B, C, and D targets, until the men have acquired accuracy in making corrections for all ranges up to 1,000 yards.

When the men have learned how to adjust their sights, this exercise should be carried on in connection with gallery practice. The rear sight on each rifle is given an incorrect setting in elevation and windage by the instructor, and the soldier required to find the correct adjustment by firing.

68. THE EFFECT OF WIND.—It is important that before going on the range the soldier should be taught to estimate the force and direction of the wind and the amount of correction necessary to apply to the movable rear-sight base to overcome the effect of the wind on the bullet in its flight.

The direction of the wind, for convenience, is expressed by a clock-face notation, the clock being supposed to lie on the ground with the hour XII toward the target or mark and the hour III at the firer's right hand. A wind blowing from the front (that is, from the direction of the target) is called a "XII-o'clock wind," one directly from the left and across the field of fire is called a "IX-o'clock wind," and so on. The direction of the wind can be obtained by observing its effect upon smoke, on trees, or grass, or dust, or by wetting the finger and holding it up.

The force of the wind is designated in miles per hour. An anemometer should be placed near the barracks, where it will not be exposed to cross currents, and so that the dial can be readily seen. The force of the wind can then be read from the dial and at the same time the effect of the wind on the boughs of trees, flags, and streamers, and the smoke from chimneys should be observed. The soldier should be required to estimate the force of the wind and then verify his estimation by anemometer readings. This exercise should be repeated frequently until the soldier has learned to estimate roughly the force of the wind without the aid of an anemometer.

Heat waves, when present, are an important aid in estimating the force of the wind.

69. In the following table are shown the points of windage necessary to correct for a 10-mile-an-hour wind:

Range.	III or IX.	II, IV, VIII, X.	I, V, VII, XI.
<i>Yards.</i>	<i>Points.</i>	<i>Points.</i>	<i>Points.</i>
100	0.23	0.2	0.1
200	.34	.31	.17
300	.61	.53	.30
400	.86	.75	.43
500	1.11	.96	.55
600	1.39	1.2	.69
700	1.68	1.45	.84
800	2.00	1.73	1.00
900	2.34	2.03	1.17
1,000	2.67	2.30	1.33

Winds blowing from XII and VI o'clock directions have no deviating influence on the flight of the bullet, but these winds have the effect of shortening (in the case of XII-o'clock wind) or lengthening the range (in the case of VI-o'clock wind). The correction necessary to apply in the case of such winds is inappreciable.

70. REMARKS.—If the soldier is well drilled in applying the windage and elevation corrections necessary to bring an assumed hit into the bull's-eye or figure, using in turn each of the targets at which he fires on the range, he will need very little further instruction in applying the necessary corrections. The instructor should assure himself that the men understand the reasons for these corrections, and they should never forget that they must move the rear-sight movable base *into the wind and in the same direction* they wish to move the point struck.

CHAPTER IV.

GALLERY PRACTICE.

71. After the soldier has been thoroughly instructed in sighting, and in the position, aiming, deflection, and elevation-correction drills, he will be exercised in firing at short ranges with reduced charges.

72. VALUE OF GALLERY PRACTICE.—Notwithstanding the value of the position and aiming drills, it is impossible to keep up the soldier's interest if these exercises are unduly prolonged. By gallery practice, however, the interest is easily maintained and further progress, especially in teaching the trigger squeeze, is made. Many of the external influences, which on the range affect the firing, being absent, the soldier is not puzzled by results for which, at this stage of his education, he could not account were he advanced to firing with full charges. Furthermore, as there is no recoil to induce nervousness or flinching, the soldier soon finds that he can make good scores, and this success is the surest stimulus to interest.

Not only to the beginner is gallery practice of value; to the good shot it is a means of keeping, to a certain extent, in practice, and practice in shooting, as much as in anything else, is essential. Since it can be carried on throughout the year, gallery practice is of much value in fixing in the men the *habît* of aimed fire, than which nothing in his training is of more importance.

73. GALLERY PRACTICE.—During the month preceding range practice the minimum number of scores given in the following table must be fired by all who are required to fire under the provisions of paragraph 89:

Range (feet).	Target.	Position.	Scores.
50	The iron gallery target issued by the Ordnance Department, or one similar thereto, or the paper "X" target.	Kneeling.	A minimum of four (4) at each range in each of the positions prescribed.
50		Standing.	
75		Prono.	
75		Sitting.	

74. SCORES.—Gallery practice will be conducted in scores of five shots. The number of scores to be fired by any man at a single practice is determined by the company commander.

No reports of the results of the firing will be required, although a record of it should be kept in the company for the instruction and guidance of the soldier.

75. ADDITIONAL PRACTICE.—In addition to the minimum number of scores prescribed in paragraph 73, practice in this class of firing should be carried on throughout the year when practicable, the amount and details of the practice being left to the discretion of the company commander. The practice should be varied as much as possible. It should include exercises in slow and rapid fire, in assuming the various firing positions and opening fire quickly, and in finding the correct adjustment of the rear sight without unnecessary loss of time. Moving or disappearing targets can easily be improvised and the instruction made as interesting as possible.

76. MATCHES.—Matches in gallery firing between the men, particularly the recruits, and between teams of the same or different companies, should be promoted and encouraged. While such matches increase the interest of the men in their practice, they at the same time afford experience in the conditions of competitive firing.

CHAPTER V.

ESTIMATING-DISTANCE TEST.

77. IMPORTANCE.—Ability to estimate distances correctly is an important element in the education of the soldier.

While it is true that fire on the battle field will usually be by groups and the ranges given by officers or noncommissioned officers, the battle field is reached only after a long series of experiences in scout, patrol, and outpost duty, in which the soldier is frequently placed in positions where it is essential that he shall determine for himself the range to be used in order that the fire may be effective. It is, therefore, here made a prerequisite to qualification that the soldier shall be proficient in estimating distances by eye.

During the estimating-distance drills advantage should be taken of every opportunity to train the soldier in observing his surroundings from positions and when on the march. He should be practiced in pointing out and naming different features of the

ground; in discovering and describing different objects; in counting different objects or beings. Especially should noncommissioned officers be trained in describing the location, with reference to other objects, of objects difficult to see and in imparting information of this kind quickly and accurately.

78. Distances can be estimated by the eye or by sound; they can be determined by range-finding instruments, by trial shots or volleys, or from maps.

79. ESTIMATION OF DISTANCE BY EYE.—To estimate distance by the eye with accuracy, it is necessary to be familiar with the appearance, as to length, of a unit of measure which can be compared mentally with the distance which is to be estimated. The most convenient unit of length is 100 yards. To impress upon the soldier the extent of a stretch of 100 yards two posts 100 yards apart, with short stakes between to mark each 25 yards, should be placed near the barracks, or on the drill ground, and the soldier required to pace off the marked distance several times, counting his steps. He will thus learn how many of his steps make 100 yards and will become familiar with the appearance of the whole distance and of its fractional parts.

Next a distance of more than 100 yards will be shown him and he will be required to compare this distance with the 100-yard unit and to estimate it. Having made this estimate, he will be required to verify its accuracy by pacing the distance.

A few minutes each day should be spent in this practice, the soldier often being required to make his estimate by raising his rear-sight leaf and showing it to the instructor. After the first drills the soldier should be required to pace the distance only when the estimate is unusually inaccurate.

The soldier should be taught that, in judging the distance from the enemy, his estimate may be corrected by a careful observation of the clearness with which details of dress, the movements of limbs or of the files in a line may be seen. In order to derive the benefit of this method, the soldier will be required to observe closely all the details noted above in single men or squads of men posted at varying distances, which will be measured and announced.

Although the standing and kneeling silhouettes used in field practice afford good objects upon which to estimate distances,

the instructor should make frequent use of living figures and natural objects, as this is the class of targets from which the soldier will be compelled to estimate his range in active service.

80. METHODS OF ESTIMATING LONG DISTANCES BY THE EYE.—The following methods are found useful:

(a) The soldier may decide that the object can not be more than a certain distance away nor less than a certain distance; his estimates must be kept within the closest possible limits and the mean of the two taken as the range.

(b) The soldier selects a point which he considers the middle point of the whole distance, estimates this half distance and doubles it, or he similarly divides the distance into a certain number of lengths which are familiar to him.

(c) The soldier estimates the distance along a parallel line, as a road on one side, having on it well-defined objects.

(d) The soldier takes the mean of several estimates made by different persons. This method is not applicable to instruction.

81. APPEARANCE OF OBJECTS: HOW MODIFIED BY VARYING CONDITIONS OF LIGHT, DIFFERENCE OF LEVEL, ETC.—During instruction the men should be taught the effect of varying conditions of light and terrain upon the apparent distance of an object.

Objects seem nearer—

(a) When the object is in a bright light.

(b) When the color of the object contrasts sharply with the color of the background.

(c) When looking over water, snow, or a uniform surface like a wheat field.

(d) When looking from a height downward.

(e) In the clear atmosphere of high altitudes.

Objects seem more distant—

(a) When looking over a depression in the ground.

(b) When there is a poor light or a fog.

(c) When only a small part of the object can be seen.

(d) When looking from low ground upward toward higher ground.

82. ESTIMATING DISTANCE BY SOUND.—Sound travels at the rate of about 1,100 feet, or 366 yards, per second. If a gun is fired at a distance, a certain time elapses before the sound is heard. If the number of seconds or parts of seconds between the

flash and the report be carefully taken and multiplied by 366, the product will be approximately the distance in yards to the gun. This method will be of doubtful use on the battle field, owing to the difficulty of distinguishing the sound of the gun, whose flash is seen, from that of any other. It will probably be useful in determining the range to a hostile battery when it first opens fire.

83. DETERMINING DISTANCE BY RANGE-FINDING INSTRUMENTS.—Accuracy in determining distance by range-finding instruments depends upon care and facility in use of the instrument and clearness of definition of the objective. Knowledge of the use of the instrument issued is essential to all company officers and should be imparted to sergeants when time is available.

84. DETERMINATION OF DISTANCE BY TRIAL SHOTS OR VOLLEYS.—If the ground is so dry and dusty that the fall of the bullets is visible through a glass or with the naked eye, a method of determining the distance is afforded by using a number of trial shots or volleys.

The method of using trial volleys is as follows:

The sights are raised for the estimated range and one volley is fired. If this appears to hit but little short of the mark an increase of elevation of 100 yards will be used for the next volley. When the object is inclosed between two volleys, a mean of the elevations will be adopted as the correct range.

The range may be obtained from a near-by battery or machine gun. This is the best method where available.

85. ESTIMATING DISTANCE TEST.—When instruction shall, in the opinion of the company commander, have progressed to such an extent as to enable the soldier to judge distances with the eye with fair accuracy, he will be tested for proficiency.

As the danger space is continuous for a man kneeling within a range of 547 yards (battle-sight range), and as individual fire and the fire of small squads will ordinarily be limited to 1,200 yards, the soldier will be tested for proficiency at distances between these two ranges.

The rules governing this test are as follows:

- (a) The test will be supervised by an officer.
- (b) Each soldier will be tested separately.
- (c) The ground shall be other than that over which he fired or has previously estimated distances.

(d) The use of any device to mark the limits within which distances are tested (550 and 1,200 yards), at the time the test is given, so that this device can be seen from the estimating point, is prohibited.

(e) The objectives will be natural objects, men standing, kneeling, or prone, or silhouettes.

(f) For objectives, five or more natural objects will be selected, or single men or groups of men stationed or silhouettes placed within the ranges indicated above. The distances of the objectives will not be measured until all who are to estimate on them have made their estimates.

The men to be tested are conducted to a point near that from which the estimates are to be made, and remain facing away from the objectives or hidden therefrom by some feature of the ground. They are not permitted to know what objects are to be used in the test until they are called up to the estimating point.

The officer conducting the test calls up one man at a time, points out to him an objective and causes him to estimate the distance thereto. This is continued until the soldier's estimates on five objectives have been obtained. When the test for the day is completed by any man, he will not be allowed to join the squad awaiting test. After all the men have made estimates of distances to a given series of objectives, ranges thereto will be measured.

(g) Proficiency for the expert rifleman and for the sharpshooter shall consist in making in five consecutive estimates an average degree of accuracy of 90 per cent.

Similarly for proficiency, marksmen, first-class men, and second-class men are required to make in five consecutive estimates an average degree of accuracy of 85 per cent.

Not more than three trials will be given, and should the soldier fail three times to make the required percentage, his final qualification will be reduced one grade below that obtained in firing.

86. RANGE ESTIMATORS.—The estimating test having been completed, five or six enlisted men, selected by the company commander from the most accurate estimators, will be designated as "Range estimators." These men will be given practice in estimating distances throughout the year. The practice will be on varied ground and at distances up to 2,000 yards. (C. S. A. F. M. No. 18.)

CHAPTER VI.

KNOWN DISTANCE PRACTICE.

87. GENERAL DESCRIPTION.—When gallery practice has been completed as required, the soldier is advanced to known-distance firing. The general scheme for firing is as follows:

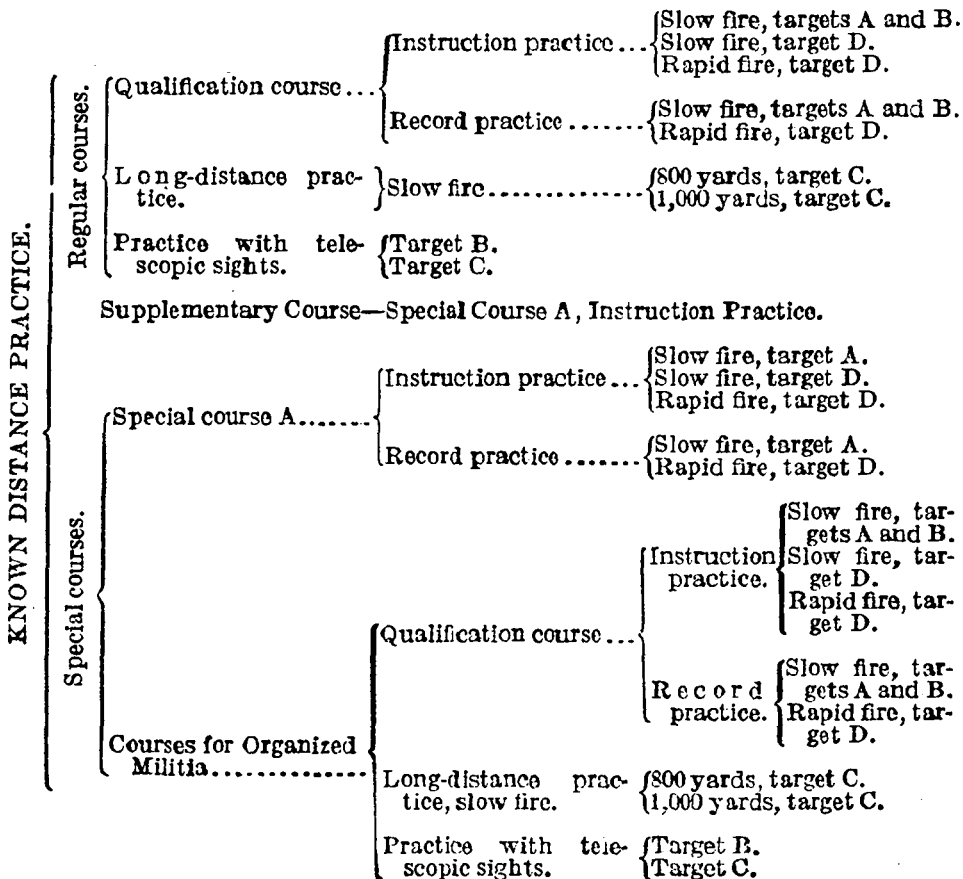

1. The instruction practice, qualification course, embraces slow fire at targets A, B, and D at 200, 300, 500, and 600 yards, and rapid fire at target D at 200, 300, and 500 yards.

2. Record practice, qualification course, consists of slow fire at targets A and B at 300, 500, and 600 yards, and rapid fire at target D at 200, 300, and 500 yards.

3. Long-distance practice is for experts and sharpshooters only. It is for instruction and is not a factor in qualification.

4. Practice with telescopic sights is for instruction of specially selected men in the use of this device, these to be experts or otherwise, four of the best shots among the enlisted men of the company. It is not a factor in qualification.

5. The supplementary course is designed for recruits and others who have joined after the practice season or so late in the season that it has been impracticable for them to fire.

6. Special course A is designed for the Coast Artillery Corps, for bandsmen when required to fire, and for posts where ranges not greater than 300 yards can be obtained.

88. TARGET YEAR AND PRACTICE SEASON.—The target year, being the period for which reports are rendered and which includes the practice season, will commence January 1 and terminate December 31.

The practice season will consist of two months, called the regular season, and a period, not to exceed one month, called the supplementary season. All to be designated by the department commander upon the recommendation of subordinate commanders.

During the period designated as the practice season, known-distance firing will be carried on in such manner that, while record firing should take place on favorable days and under the most favorable circumstances, the men should be required to practice under variable conditions of weather, care being taken that the shooting is not held under such adverse conditions as to make it unprofitable.

As far as practicable, organizations actually firing will be excused from all post duties during this time, the usual duties being performed by the remainder of the garrison.

It shall be the duty of the post commander to see that, as far as the exigencies of the service permit, all men on extra and

special duty who are required to fire be given as much preliminary instruction and range practice as is given to other men.

All range work will be performed by the troops firing, except that during record practice, qualification course, such officers as may be required for range duty will be detailed from troops not firing.

In the regular season, the known distance firing will be carried to completion, all officers and men who are required to fire taking part.

Recruits who join in the last month of the regular season will fire in the supplementary season only.

80. WHO WILL FIRE.—Known-distance practice.

REQUIRED TO FIRE.

All officers and enlisted men of regiments of Infantry, Cavalry, and Engineers, and of mounted battalions of Engineers and of Engineer Trains, except those authorized but not required to fire, and except bandsmen, who will not fire (except in the Philippine Islands, when required to do so by the department commander).

All officers and enlisted men of companies of Coast Artillery will fire special course A.

AUTHORIZED BUT NOT REQUIRED TO FIRE.

Staff departments, except medical and chaplains, all officers and enlisted men.

Staff Corps, all officers and enlisted men.

Field and staff officers of regiments of Infantry, Cavalry, and Engineers, of mounted battalions of Engineers, and of the Coast Artillery Corps.

Enlisted men of headquarters, supply, and machine-gun troops and companies of Infantry and Cavalry. Enlisted men of regiments and mounted battalions of Engineers who do not belong to companies. Noncommissioned staff officers of the Coast Artillery Corps.

All officers enumerated above of over 15 years' commissioned or commissioned and enlisted service, except officers of the Medical Department and chaplains, are authorized but not required to fire.

Cooks may be excused from firing.

Upon the recommendation of the surgeon, the post commander may excuse officers and men from practice.

A soldier who has completed the qualification course, record practice, and who is transferred or who is discharged and re-enlists, will not fire the qualification course a second time in the same year.

A soldier will begin his regular practice each target practice season with the instruction practice, qualification course (Tables 1, 2, and 3). Having completed this, he will fire the record practice, same course (Tables 4 and 5).

Officers and enlisted men authorized but not required to fire, and who are not on duty with a company or troop which takes target practice, will, if they fire, be attached to organizations for practice and will be classified on the report of the organization to which so attached.

(*C. S. A. F. M. Nos. 14 and 19.*)

90. RESTRICTIONS AS TO THE ARM.—The rifle or pistol shall be used as issued by the Ordnance Department, except that wood of the upper band may be worked down. This change must be made under the supervision of the company commander. The use of additional appliances, such as temporary shades for sights, spirit levels, orthoptic eyepieces, etc., is prohibited. The front-sight cover may be left on the rifle during firing, and the sights may be blackened if desired. Telescopic sights may be used in combat practice. Troops will use, in small-arms practice, the weapon with which they are armed.

Small arms and appliances issued by the Ordnance Department for test and report will not be used in determining classifications. (*C. S. A. F. M. No. 1.*)

91. USE OF GUN SLING.—The gun sling may be used at all ranges as an auxiliary to steady the piece, in connection with one arm only, provided that for the purposes of adjustment for shooting, neither end shall have been passed through either sling swivel. No knot will be tied in the sling and the sling itself will not be added to nor modified in any manner.

92. USE OF RESTS—POSITIONS.—In known distance practice a rest will not be allowed for the rifle or any part of the body except as prescribed in these regulations.

In combat firing such rests as are available will be permitted.

Within the limits of these regulations, the soldier should be allowed to take the position giving him the greatest ease and steadiness.

93. USE OF DEVICES FOR DETERMINING FORCE AND DIRECTION OF WIND.—Anemometers, wind clocks, and other instruments, and flags, vanes, or streamers for determining the force or direction of the wind will be allowed on the range during instruction practice but not during record firing for qualification.

94. DRESS AND EQUIPMENT.—In all classes of firing the service uniform and service hat will be worn. In all known distance practice the soldier will be equipped with the rifle and cartridge belt; for infantry and troops equipped as infantry, who are provided with the model 1910 equipment, the garrison belt, or the cartridge belt, model 1910, when the garrison belt is not available;¹ for cavalry provided with the new equipment, the field belt; for other troops, the cartridge belt stripped; cartridge belt suspenders will not be worn in known distance firing; the coat may be omitted when authorized by the post commander.

For combat practice, the service uniform "for field duty" will be worn (see Table of Occasions, Uniform Regulations), together with that field equipment prescribed as one of the conditions of the exercise (see paragraph 223 (*d*) and paragraph 224), and may be any one of the following:

(a) The full field equipment; with or without rations as may be prescribed for the exercise.

(b) The full field equipment less pack (or blanket roll); with or without rations as may be prescribed for the exercise.

Officers will, when firing, wear the same uniform and equipment as the men. In conducting combat firing exercises officers will be equipped with field glasses and pistols; sabers will not be worn. (*C. S. A. F. M. No. 3.*)

95. INSTRUCTION PRACTICE.—Instruction practice, qualification course, should carry out the purposes which the term im-

¹The last sentence of paragraph 7, page 6, Instructions for Assembling the Infantry Equipment, model of 1910, is not intended to prohibit the detaching of the cartridge belt from the equipment for known distance practice when the garrison belt is not available.

plies, and hence the amount of ammunition to be expended in this practice should be in proportion to the instruction needed. For recruits and those who in the last season's practice failed to qualify as marksman or better, not less than that prescribed in Tables 1, 2, and 3 should be fired, and, in special cases, considerably more, so that the inexperienced shot may be given ample opportunity to determine the nature of his errors and the best methods of correcting them.

For those who have qualified as marksman or better and who have learned the principles of shooting, not so much practice is required to keep in condition for retaining the qualification or for improving it; hence for them, in one season of practice, this expenditure per man will not exceed the minimum number of rounds prescribed in the tables.

Subject to these restrictions, the expenditure of ammunition and the procedure as to order of practice and details followed in the instruction practice, qualification course, will be at the discretion of the company commander. Scores of five shots are permitted in rapid fire, instruction practice, and, in some instances, it may be found advantageous to begin instruction at 100 yards. The firing in this practice by a recruit of more than 50 rounds in one day is prohibited.

(*C. S. A. P. M. No. 19.*)

96. RECORD PRACTICE.—Record practice is for two purposes: First, to afford the soldier an object lesson of his progress; second, to obtain a record by means of which the soldier may be graded in awarding insignia and increased pay.

The rules for record practice must be fixed and be applicable to all alike. These rules must be strictly observed by all; scores must be recorded accurately; the work in the pit must be conducted with great efficiency.

In this practice "coaching" of any nature is prohibited. Each firer must observe the location of his own hit as indicated by the marking disk or spotter. After a soldier has taken his place at the firing point, no person shall render or attempt to render him any assistance whatever.

This practice will be conducted according to the regulations governing competitions, except that in a continuous pit there will be one officer to every two targets or less, and in each single target pit there will be an officer.

Scores will be kept in the pit and compared with the record made at the firing point.

97. FIELD GLASSES.—Officers and enlisted men will be allowed and encouraged to use field glasses, subject to the restrictions concerning coaching contained in paragraph 96.

98. ORDER OF PROCEDURE.—The practice season opens with instruction practice, qualification course. This is carried to completion for each soldier before he proceeds to record practice. When the instruction practice, qualification course, is completed, the soldier proceeds to record practice (same course) and follows this to completion.

No individual will fire record practice, qualification course, on the same day as any part of instruction practice. Record practice having begun for any individual will be finished before any other firing is taken up.

While record practice is being conducted at any distance, there will be no other firing on the range at that distance.

A record practice score for any individual once begun at a range will be carried to completion at that range without interruption.

99. SIGHTING SHOTS.—Sighting shots form no part of the score and are not recorded as such. When sighting shots are prescribed they must be taken. If, through no fault of his own, a soldier's record score is not completed at a range where sighting shots are prescribed and has to be repeated, he must be given sighting shots with the new score.

100. INSTRUCTION SHOTS fired by an officer or enlisted man will be permitted only in instruction practice.

101. SCORING.—The record of the score, from which classification will be made, will be kept at each firing point by a non-commissioned officer, who will be assigned, unless at a one-company post, to a point where his own company is not firing. The scoring will be closely supervised and the record verified by a company officer. Scores will be recorded on the range with pencil on sheets prepared for that purpose.

A separate sheet will be kept for each man firing, and as soon as the man's score at any range is completed the scorer will sign the sheet and the company commander will take it up, initial it,

and keep it in his personal possession until the soldier is again called upon to fire. The record scores will be transferred from these sheets to the company target record by the company commander. The company target record will be kept in the personal possession of the company commander and not allowed in the hands of an enlisted man from the beginning of record practice until the required reports for range practice have been rendered. All entries in the company target record will be made in ink and no corrections or alterations will be made except by the company commander, who will initial each correction.

102. SCORING SLOW FIRE.—The scorer, as each shot is signaled, will announce in a tone loud enough to be heard by the firer the name of the firer and the value of the hit, and will record it on a sheet assigned to that soldier.

A shot upon the wrong target will be entered upon the score of the man firing as a miss, no matter what the value of the hit upon the wrong target.

If two shots strike a target at the same or nearly the same time both will be signaled; and if a shot was just fired from the firing point assigned to that target, the hit having the higher value of the two will be entered in the score of the soldier firing from that target point and no record made of the other hit.

103. SCORING RAPID FIRE.—In rapid fire as each shot is signaled it is announced as follows: One five, two fives, three fives, one four, two fours, three fours, four fours, one three, one miss, two misses, and jotted down on a pad as called, the scorer watching the target as he calls the shot. After the marking is finished the scorer counts the number of shots marked and, if more or less than 10, calls: "Re-mark No. —." If 10 shots have been marked, he then enters the score on the soldier's score card and totals it as follows: 5 5 5 4 4 4 4 8 0 0=34.

In record practice, in case of two men firing on the same target, the resulting score will be rejected, the soldier at fault being credited with only such hits, if any, as he may have made on his own target, the other soldier repeating his score. In case of more than 10 hits on a target the score will not be recorded, and the soldier assigned to that target will repeat the score.

104. OFFICER IN CHARGE OF FIRING.—At stations where the range is provided with several targets and practice is usually held simultaneously by two or more companies and successively by others, an officer in charge of the firing will be appointed.

The officer in charge of the firing, who should be, when practicable, a field officer, will have general supervision of the firing and of the target range during the practice season. He will not supervise the details of the instruction of the companies practicing on the range, but will maintain order, regulate the distribution of ranges and targets to organizations, prevent infractions of regulations, and in general assist by every proper means to secure efficient and accurate service from the working force of the range.

He will see that all necessary precautions are taken for the safety of the markers and such spectators as may be present.

When ranges are not provided with butts and the surroundings are such that persons or animals might attempt to cross the range, the officer in charge of firing, before firing is begun, will post lookouts, in positions to be seen from the pit, whose duty it will be to prevent any attempt to cross the line of fire. Whenever the lookouts can not prevent the line of fire being crossed they should display a danger signal, when the markers will withdraw the targets.

105. RANGE OFFICER.—At all ranges a range officer will be appointed who will be charged with the care and police of the range and with the necessary repairs to targets, shelters, butts, and firing points. He will be assisted by a noncommissioned officer and such fatigue parties as may be required. He will make timely estimates for material and labor to place the range in proper condition for the practice season, and all necessary repairs will be made under his direction and the supervision of the post commander. He will be responsible for the accurate measuring of the range and the correct location of the different firing points, for the condition of the telephone system, and for the arrangement and efficiency of the personnel at the butts. During the practice season he will act as assistant to the officer in charge of the firing.

106. NONCOMMISSIONED OFFICER IN CHARGE OF PIT.—A competent noncommissioned officer, with such assistants as the post

commander deems necessary, will be detailed permanently during the target season in charge of arrangements at the butts. He will be under the direction of the range officer and will be responsible for the efficiency and discipline of the target details. It will be his duty to see that targets are ready for the firing desired and that all targets are serviceable; also to see that as the target details report they are provided with the proper flags, marking disks, paste, pasters, etc.

107. TARGET DETAILS.—The detail for marking each target will consist of two privates belonging to the company firing at that target, and one noncommissioned officer, always selected, except at a one-company post, from some other company. The noncommissioned officer will be held responsible that order is kept at his target and should be familiar with the regulations governing the markers and with the method of marking. Upon arriving at the pit the noncommissioned officer in charge of the target will see that his detail procures from the noncommissioned officer in charge of the pit the necessary ricochet and danger flags, spotters, marking disks, pasters, and paste. He will display the danger flag in front of his target, examine the target carefully to see that it is in good working order and that all old shot holes are pasted up. In case any target is, or becomes, so badly mutilated as to be unserviceable, he will procure a new one from the noncommissioned officer in charge of the pit. Upon completion of the firing he will take down the target and return it, with the disks, flags, etc., to the pit house. He will also report to the noncommissioned officer in charge of the pit such repairs as that target and its accessories may require for a subsequent practice.

If it should become necessary before the completion of the firing for the markers to leave or for other persons to enter a target pit not provided with a continuous shelter or covered approach, the target should first be turned or withdrawn from the firing position and the danger signal displayed. After the signal "Cease firing" has been sounded, or if there is no musician present at the firing point after a few seconds' delay, the target pit may be entered or left, the target turned back to the firing position, the danger signal removed, and the firing resumed.

In case of a disabled target the danger signal should be displayed and not withdrawn until the target is in working order.

108. MARKING.—When a post is garrisoned by a single company and it is impossible to detail noncommissioned officers of other companies to supervise the marking and scoring, those duties will be performed by the noncommissioned officers of the firing company. In record firing, qualification course, when only one company is firing, new paper targets will be used for each day's firing, and upon its completion the company commander or one of his lieutenants will count the number of hits made in each division of the target and compare the totals with the recorded scores.

As in some cases the markers may inadvertently make errors in signaling hits, whenever an examination of the target gives results very closely agreeing with the recorded scores, the record should be permitted to stand, but the markers cautioned to exercise greater care in the future.

Any shot cutting the edge of the figure or bull's-eye will be signaled and recorded as a hit in the figure or bull's-eye, and as the limiting line of each division of the target is the outer edge of the line separating it from the exterior division, whenever this line is touched by a shot, it will be signaled and recorded as a hit in the higher division.

In record firing the officers in the pit will verify every miss before it is signaled, and will closely observe the marking on the targets to which they are assigned to prevent fraud or errors on the part of the markers.

109. MARKING, SLOW FIRE.—In slow fire with the rifle, as each shot is fired the noncommissioned officer indicates to one of the markers the value and position of the hit, if any is made, and supervises this marker while he signals the result of the shot to the firing point. The center of the disk should be placed over the shot hole. When double sliding targets are used the target hit will be withdrawn and the location of the hit indicated with the proper disk on the other target. After the result of the shot has been signaled, if a direct or ricochet hit has been made, the other marker will cover the shot hole with the proper paster. When spotters are used the shot hole will not be pasted up, but

the spotter hung in the hole. When the exposed target is hit it is withdrawn and the other target run up, the spotter showing the exact location of the preceding hit on that target. When another hit is made on that target it is withdrawn, the spotter changed from the first shot hole to the second, and the first shot hole pasted up. When spotters are used care must be taken to paste up a shot hole as soon as the spotter is removed and also to paste up any shot hole in the spotter itself.

The value of a shot will be indicated to the firing point as follows:

If a bull's-eye, with a white disk.

If a center (four), with a red disk.

If an inner (three), with a black and white disk.

If an outer (two), with a black disk.

With spotters, two disks may be used, fixed in sockets on the top of the parapet so that they may be seen from the firing point. One disk is white on one side and red on the other; the other disk a black cross on a white field on one side and all black on the other. When a hit is made its value is indicated by turning the proper face toward the firer, exposing it a few seconds, and then turning its edge toward the firer. When not indicating the value of hits, disks should be kept edge toward the firing point.

In marking targets the following will govern:

If a ricochet, by displaying the ricochet flag; and if the target is hit, by placing over the shot hole at the same time the appropriate disk. The ricochet flag has a white field with a red center, similar to the flag used in signaling, the size depending on the distance.

If a miss, by waving the danger flag across the front of the target. If the markers know on which side of the target the miss is made, the flag will also be held on that side, but this should not be done unless the marker is absolutely certain on which side the miss is made, as false information regarding misses will so mislead the firer that he is likely to continue to miss the target.

If a hit is in the parapet the flag will be so held as to give the necessary indication.

If two shots strike a target at about the same time both will be signaled.

In slow fire with the pistol two disks are used, one a white disk to indicate a bull's-eye, the other a black disk to indicate all other hits. On one side of the target is printed a column of figures from 2 to 5, inclusive, and on the other side a column of figures from 6 to 9, inclusive. These numbers are large enough to be seen at 75 yards. When a bull's-eye is made the white disk is placed with the center of the disk over the hit. When a hit is made on any other part of the target than the bull's-eye, the black disk is placed on the number indicating the value of the hit, and after a slight pause is placed so that the center of the disk is over the shot hole.

Instead of two disks, a staff with a spearhead, white on one side and black on the other, may be used, the white side being shown the firer when indicating the location of a hit in the bull's-eye and the black side when indicating a hit on any other part of the target.

110. MARKING RAPID FIRE.—In this class of fire the time is regulated in the pit. The targets being ready, they are pulled fully down and a red flag is displayed at the center target. On signal from the firing line, the flag is waved and lowered and five seconds thereafter the targets are run up, being fully exposed for the time required for that range.

At the expiration of the time limit the targets are run down and the hits are marked, beginning with the highest in value, the disk being placed over the shot hole, then swung off the target and back to the next shot hole, care being taken to mark slowly enough to avoid confusing the scorer. The misses will be indicated by slowly waving the red flag once across the face of the target for each miss. The shot holes are then pasted and the target made ready for further firing.

During record practice the officer in charge of each pair of targets will keep a record showing the actual hits made on each of his targets in each score. At the end of the day's firing, or oftener if required by the officer in charge of the firing, this record will be turned over to the company firing at that target and compared with the record kept at the firing point, in order

to determine if the hits recorded at the firing point agree with the hits recorded in the pit. In case the records differ greatly, they may be fired over, at the discretion of the officer in charge of the firing.

The following is suggested as a form for the pit record, rapid fire:

Pit record.

Target ———.

Order.	5's.	4's.	3's.	2's.	Misses.
1.....					
2.....					
3.....					
4.....					
5.....					
6.....					
7.....					
8.....					
9.....					
10.....					
11.....					
12.....					

(Sig. of officer in charge.)

QUALIFICATION COURSE—LONG-DISTANCE PRACTICE—PRACTICE WITH TELESCOPIC SIGHTS.

111. TABULATION.—For convenience of reference a part of the general scheme outlined in paragraph 87 is here tabulated. The tables relate to the following subjects and have the force of written regulations: Qualification course; long-distance firing; practice with telescopic sights. Each table is followed by its regulations.

112. QUALIFICATION COURSE—INSTRUCTION PRACTICE.—The range practice begins with the instruction practice, qualification course. The order of firing is as laid down in Tables 1, 2, and 3.

TABLE 1.—*Slow fire.*

Range.	Time.	Shots.	Targets.	Position.
200	No limit.	15	A	{5 shots prone. 5 shots kneeling. 5 shots standing. 5 shots prone. 5 shots sitting. Prone. Prone, sand-bag rest.
300		10	A	
500		10	B	
600		10	B	

In firing with the sand-bag rest either the back of the hand or the rifle must be on the sand bag.

TABLE 2.—*Target D, slow fire.*

[The battle sight only will be used.]

Range.	Time.	Shots.	Position.
200	No limit.	A minimum of 10 shots at each range.	Kneeling.
300			Prone.
500			Prone.

TABLE 3.—*Target D, rapid fire.*

[The battle sight only will be used.]

Range.	Time.	Shots.	Position.
200	1 minute.	10	Kneeling from standing. Prone from standing. Prone.
300	1 minute 10 seconds.	10	
500	1 minute 20 seconds.	10	

NOTE.—If the model 1898 rifle (Krag-Jørgensen) is used, the time allowance is as follows:

- 200 yards, 1 minute 5 seconds.
- 300 yards, 1 minute 20 seconds.
- 500 yards, 1 minute 35 seconds.

The course in rapid fire (Table 3) will be fired twice, but on different days, for instruction.

PROCEDURE, RAPID FIRE.—At 200 yards there will be but one man firing at each target. The officer in charge of the line will command "Load." The magazine will be filled, the piece loaded with one cartridge therefrom, and the safety lock turned to "Safe." When all is ready in the pit the targets to be fired upon will be drawn fully down (the rear targets being blank or targets of another class than those being fired upon), and a red flag hoisted at the center target. When the red flag is displayed, the officer in charge of the firing line will command "Ready," when the safety lock will be turned to the ready and the position of "Ready" standing assumed, with the sling, if used, on the arm. The officer in charge of the firing line will then call so that all may hear, "Ready on the right; ready on the left." When the officer in charge calls out "Ready on the right," etc., anyone who is not ready must call out, "Not ready on target —." If any soldier fails to so call, it will be assumed that he is ready, and if he fails to fire when the target appears he will be given a total miss for that score.

The firing line being ready, the pit is signaled or telephoned, "Ready on the firing line." When this signal is received in the pit, the red flag is waved and lowered and five seconds thereafter the targets appear, remaining in sight one minute and then disappear. The soldier, without coming to the "Order," takes the kneeling or sitting position as soon as any part of the target appears, begins to fire and attempts to fire 10 shots, reloading with a full clip which is taken from the belt, and continues to fire until 10 shots are fired or until the target disappears.

Each unfired cartridge counts a miss.

In case of a defective cartridge or a disabled piece, or when more than 10 hits are made on a target, the practice is repeated.

At 300 yards the procedure is the same, except that the soldier assumes the prone position as soon as any part of the target appears, the time limit being 1 minute and 10 seconds.

At 500 yards the procedure is the same, except that the soldier is in the prone position, with the piece at the shoulder, before the target appears, the time limit being 1 minute and 20 seconds.

At all ranges, in rapid fire, firing is from a full clip, and the second clip must be loaded from the belt. In case a clip jams or breaks, cartridges may be loaded singly.

At the expiration of the time limit, the target is pulled down and marked, all hits being given their proper value. In case of more than 10 hits on a target, the target will not be marked but the firing line will be notified and the firing on that target repeated. In case a soldier fires on the wrong target, only such shots as he may have fired on his own target will be counted on his score. He will be given misses for the remainder of his score.

In firing rapid fire, if more than one target is used, the first order of men at the firing point will fire together, one man at each target, all targets being fired upon at one time.

(C. S. A. F. M., Nos. 1 and 9.)

113. QUALIFICATION COURSE—RECORD PRACTICE.—This is conducted as prescribed for instruction practice, the greatest care being taken to insure proper marking and scoring. The battle sight will be used at all ranges in rapid fire.

TABLE 4.—*Slow fire.*

Range.	Time.	Shots.	Targets.	Position.
300	No limit.	10	A	5 sitting, 5 kneeling.
500		10	B	Prone.
600		10 (2 S. S.)	B	Prone, sand-bag rest.

TABLE 5.—*Target D, rapid fire.*

Range.	Time.	Shots.	Position.
200	1 minute.	10	Kneeling, or sitting, from standing.
300	1 minute, 10 seconds.	10	Prone from standing.
500	1 minute, 20 seconds.	10	Prone.

(C. S. A. F. M., No. 9.)

114. Rifle practice for Engineer troops will be limited to known distance firing only. There will be neither combat practice nor proficiency test for Engineer troops.

115. LONG-DISTANCE PRACTICE.—For sharpshooters and experts only.

TABLE 6.—*Target C, slow fire.*

[To be fired twice, but on different days.]

Range.	Shots.	Position.
800	10	Prone.
1,000	10	Prone.

After an organization has completed record firing, qualification course, those men in the grades of expert and sharpshooter will take the long-distance practice.

Although the long-distance practice will be shot twice but on different days, after an officer or enlisted man has once fired the complete long-distance course, practice at 800 yards may be omitted at the discretion of the company commander. The practice will be conducted as laid down for slow fire, qualification course. Every effort will be made to teach men the effect of wind, light, and temperature, and the value of small changes in elevation and windage at long ranges.

No report of this firing will be required, although a record of it will be kept in each company.

For the Engineers and Cavalry this practice will be held at the discretion of the battalion and regimental commanders, respectively.

Long-distance practice will not be held by Philippine Scouts.

116. PRACTICE WITH TELESCOPIC SIGHTS (Targets B and C, slow fire).—Distances: Up to and including 1,000 yards. No time limit.

117. WHO WILL FIRE.—After long-distance practice has been completed, the four best enlisted shots of the company will fire, using telescopic sights. The ammunition used will not exceed 40 rounds per man firing.

This practice is intended for long ranges only, but it may be found necessary, until the rifles are accurately sighted and the elevations known, to start at shorter ranges and work back, no range being left until the target can be hit at that range. This part of the practice will be at the discretion of the officer conducting the firing. Target B may be used if found necessary to fire at ranges shorter than 1,000 yards.

At 1,000 yards each man will fire 20 shots for record. No report of the firing will be required, although a record of it will be kept in the company. This record will show the number of the rifle with which the score was made, the elevation and the windage used at the various ranges, and the force and direction of the wind at the time of firing. The data will then be available when further practice is held with this particular rifle and sight. Practice may be held at 1,200 yards where a suitable range is available.

This practice will not be held by Philippine Scouts.

118. SUMMARY OF PRACTICE REQUIRED FOR DIFFERENT GRADES OF SHOTS IN KNOWN-DISTANCE FIRING.—(a) Recruits and those who in the last season of practice failed to qualify as marksmen or better will fire Tables 1 and 2 once through each, as prescribed, and Table 3 through twice, as prescribed, before firing record. Additional instruction practice will be given all the men in this category, or to as many as may need it, in the discretion of the company commander, to the extent of the amount of ammunition that may be made available for this purpose.

(b) Men in the grade of marksman or better will fire through Tables 1 and 2 once each and Table 3 twice, and no more, before firing record practice.

(c) Soldiers of the grade of marksman or better who have been discharged and reenlisted will fire as provided in (b).

(d) All qualified experts and sharpshooters will fire twice through the course laid down in Table 6. But after an officer or enlisted man has once fired the complete long-distance course, practice at 800 yards may be omitted at the discretion of the company commander.

(e) The four (4) best enlisted shots of a company, selected by the company commander, will be given practice with telescopic sights, as prescribed in paragraph 117.

(C. S. A. F. M. No. 19.)

CHAPTER VII.

SPECIAL COURSES.

119. PRELIMINARY DRILLS.—Special courses will be preceded by the required preliminary instruction and sighting drills.

SPECIAL COURSE A.

120. WHEN USED.—When a complete range is not provided and a range of 200 and 300 yards is available, practice may be conducted, if authorized by the department commander, as prescribed in the following special course A. This practice is also prescribed for the Coast Artillery Corps and for bands in the Philippine Islands when required to fire. The instruction practice, special course A, will be followed for the supplementary firing for recruits and others who join too late to fire in the regular season.

121. Special course A shall consist of instruction and record practice as follows:

Instruction practice.—Slow fire, target A; slow fire, target D; rapid fire, target D.

Record practice.—Slow fire, target A; rapid fire, target D.

The details of this practice are as prescribed in the tables given below, which have the force of written regulations.

INSTRUCTION PRACTICE.

TABLE 1.—*Slow fire, target A.*

Range.	Time.	Shots.	Position.
200	No limit.	15	{ prone. 5 kneeling. 5 standing.
300			{ 5 prone. 5 sitting.

TABLE 2.—*Slow fire, target D.*

(Battle sight only will be used.)

Range.	Time.	Shots.	Position.
200	No limit.	10	{ 5 kneeling. 5 standing.
300			{ 5 prone. 5 sitting.

TABLE 3.—*Rapid fire, target D.*

(Battle sight only will be used.)

Range.	Time.	Shots.	Position.
200	1 minute..	10	Kneeling, or sitting, from standing.
300	1 minute, 10 seconds.	10	Prone from standing.

RECORD PRACTICE.

TABLE 4.—*Slow fire, target A.*

Range.	Time.	Shots.	Position.
200	No limit.	10	{5 kneeling. {5 standing.
300		10	{5 prone. {5 sitting.

Rapid fire as given in Table 3.

All practice in special course A will be conducted according to the rules prescribed for the firing at the same ranges in the instruction and record firing in the qualification course.

For qualification see paragraph 242. (C. S. A. F. M. No. 11.)

122. The courses for Organized Militia are prescribed in Part V.

123. Except as indicated in paragraphs 115 and 117 the Philippine Scouts will fire the course prescribed for the Regular Army, and will be subject to the same rules in regard to qualification and classification.

CHAPTER VIII.

ADVICE TO RIFLEMEN.

124. For purposes of instruction, all firing may be divided into three classes, viz:

1. Slow fire at 600 yards and under.
2. Slow fire at ranges over 600 yards.
3. Rapid fire.

125. SHORT RANGE PRACTICE.—In the first class of fire, slight changes of wind, light, and temperature may be almost disregarded. The principal things to be learned are: Setting the sight properly at the beginning of a score; aiming properly; squeezing the trigger properly; holding the rifle. These constitute probably 90 per cent of the work at ranges under 600 yards,

and if the soldier performs these actions correctly with each shot, he will make a good score regardless of small changes in the atmospheric conditions. It is very important that the piece be held firmly and sighted uniformly.

126. LONG RANGE PRACTICE.—In the second class of firing (at distances greater than 600 yards) a large part of the work is in the holding, but changes of wind, temperature, and light must be studied in order to make good scores.

127. WIND.—Wind is the most important factor to be considered in long range known distance practice. It is unnecessary to teach recruits and others who never shoot beyond 600 yards more than the adjustment of the wind gauge for a right or left wind and how to change the wind gauge when a hit is made.

The direction of the wind is shown by considering the range as a clock face, the firer being in the center and the target at 12 o'clock. The direction is then indicated as a 10 o'clock wind, 2 o'clock wind, etc.

The force of the wind is indicated in miles per hour and is shown accurately by the anemometer, and is estimated by observation of flags, by throwing up leaves, grass, or bits of paper, and by the "feel" of the wind on the hands or face.

At long-distance ranges, after firing a shot and before firing again, the firer should look carefully for any change in direction and force of the wind. A change of 4 miles in force or of one hour in direction will make a decided difference in the location of a hit.

Any wind deflects the bullet from its course in the direction the wind is blowing. The amount of deflection varies with the direction and force of the wind.

The wind gauge is graduated in points, and 1 point will move the bullet approximately 4 inches for each 100 yards of distance the firer is from the target and in the direction the movable base of the wind gauge is moved:

At 200 yards 1 point equals 8 inches.

At 600 yards 1 point equals 24 inches.

At 800 yards 1 point equals 32 inches.

At 1,000 yards 1 point equals 40 inches.

The amount of windage to be taken is determined by estimating the force and direction of the wind.

A simple rule for determining the approximate windage at any range is as follows:

$\frac{\text{Range} \times \text{Velocity}}{10}$ equals quarter points required for 3 or 9

o'clock winds. Winds one hour away from 3 and 9 o'clock require only slightly less windage. Winds one hour away from 12 or 6 o'clock require half as much windage as 3 or 9 o'clock winds.

Example: Range 800 yards: 5-mile wind blowing from 9 o'clock.

$\frac{8 \times 5}{10}$ equals 4 quarter points, or 1 point of windage.

128. TEMPERATURE.—After the proper adjustment of the sight has been determined, it will rarely happen while firing a single, or even several consecutive scores, that such changes can occur in the temperature as to make further corrections necessary. If the first shot has been fired from a clean, cool gun, the subsequent fouling and heating of the barrel and the different vibrations of the latter, which are caused by the heating, will generally make necessary a slight increase in elevation for the second shot, and often an additional increase for the third shot. This should be followed, in some cases, where a number of shots are fired without cleaning or without any considerable interval, by a slight lowering of the elevation after additional shots.

A decided increase in the temperature will cause the bullet to strike high; a decided drop in temperature will cause the bullet to strike low.

129. LIGHT.—Changes of light do not affect the flight of the bullet; they do affect the manner in which the aim is taken. As all men are not affected alike by changes of light, each man must determine for himself how changes of light affect him.

Using the peep sight, the bull's-eye of a bright target is more clearly defined than the bull's-eye of a dark one, and the firer will usually hold closer to the bright bull's-eye than to a dark one. If the target changes from bright to dark, the next shot will usually go low.

With the open sight, as the light changes from bright to dark and the rear notch fills with shadow, more front sight is seen, and the shot goes high.

If occasional shadows drift across the face of the target, do not fire until the target is bright.

In a permanent change of light, let the eye accustom itself to the change before firing. Then the aim will be the same as before and there will be no change in the position of the hit.

In rapid firing with open sights, on very dark days shots seem to go high, due entirely to the firer taking more front sight than on bright days.

130. MIRAGE.—This is the term applied in target practice to heated air in motion, as seen through telescopes or field glasses on clear days with winds of from 2 to 14 miles per hour. Through the telescope waves appear to be moving across the face of the target in the direction the wind is blowing.

These waves indicate the general direction and speed of the wind. As to direction, they indicate a right or left wind only, and not one from 11, 1, 5, or 7 o'clock.

In a light 6 o'clock wind or with no wind at all, the waves will go straight up or "boil."

With a light wind the mirage moves slowly across the face with a decided vertical motion, giving a saw-tooth appearance. As the wind increases, the vertical motion of the mirage decreases until, with a 12 to 14 mile wind, the waves seem nearly flat and run across the target with very little vertical motion.

On hot days, with no wind, or a very light wind from 6 o'clock, the mirage will rise straight from the bottom to the top of the target. This condition seldom lasts long, and in a very short time the mirage will run from one side to the other.

Never fire while the mirage is "boiling," for there is usually a slight drift toward one side or the other, invisible to the firer, and if a shot is fired with no windage in a "boil," it will usually be out of the bull's-eye. Wait for the mirage to move from one side.

131. RAPID FIRING.—Success in rapid firing depends upon catching a quick and accurate aim, holding the piece firmly and evenly, and in squeezing the trigger without a jerk.

In order to give as much time as possible for aiming accurately, the soldier must practice taking position, loading with the clip, and working the bolt so that no time will be lost in

these operations. With constant practice all these movements may be made quickly and without false motions.

When the bolt handle is raised it must be done with enough force to start the shell from the chamber; and when the bolt is pulled back it must be with sufficient force to throw the empty shell well away from the chamber, and far enough to engage the next cartridge.

In loading, use force enough to load each cartridge with one motion.

The aim must be caught quickly, and once caught must be held, and the trigger squeezed steadily. Rapid firing, as far as holding the aim and squeezing the trigger are concerned, should be done with all the precision of slow fire. The gain in time should be in getting ready to fire, loading, and working the bolt.

Constant practice will increase the accuracy of aim, and any exercise that will strengthen arms and hands will enable one to hold better through a long string of shots.

192. FIRING AT MOVING TARGETS.—In firing at moving targets, the rifle must move with the target. If the target moves across the front, the aim must be a certain distance in front of it, depending on the distance of the target and its speed. If it moves toward the firer he must hold below it; if away from him, he must hold over it.

The following table shows the approximate distance necessary to aim ahead of the body of a man or horse moving across the range at various distances and various rates of speed:

Distance (yards).	Man walking.		Man double timing.		Horse walking.		Horse trotting.		Horse running.	
	<i>Ft.</i> Front edge.	<i>In.</i>	<i>Ft.</i>	<i>In.</i>	<i>Ft.</i> Front edge of body.	<i>In.</i>	<i>Ft.</i> Front of body..	<i>In.</i>	<i>Ft.</i> Front edge of body.	<i>In.</i>
100				6						
200		8	1	8					1	4
300	1	5	3			1	6	3	10
400	2	2	4	5			3	4	6	6
500	3	1	5	11	1	5	4	9	6
600	4	7	7	2	7	7	12	10

133. FIRING WITH RESTS.—In the ordinary positions for firing with piece supported by hands, arms, and shoulder, the explosion of the powder charge sets up in the barrel of the rifle certain vibrations which become disturbed and altered somewhat when the rifle is fired with the additional support of a solid rest applied at some point of the barrel.

Using the same elevations and aiming point the effect of a rest is exhibited in a changed point of strike of the bullet.

The vertical vibrations of the barrel are the more pronounced, and as these are interfered with by a point of rest under the barrel this species of support will usually change the point of strike more than in the case of a side rest against a vertical surface. In the latter case the piece is steadied rather than rested.

With a rest beneath the balance, or near that point, the tendency is to shoot above and to the right of the point of strike that would be attained without a rest, using the same elevation and point of aim.

The tendency is the same and more pronounced when the rest is under a point near the muzzle. The change in the point of strike in any case is slight and insufficient to carry the shot off the target from the center of target D at 600 yards.

In order that the shooting may be uniform, the piece should always be rested at the same point.

A side rest will cause no appreciable change in the point of strike.

In firing with the bayonet fixed, usually a lower point on the target will be struck corresponding to a reduction in the range of about 50 yards.

134. CLEANING THE RIFLE.—*a.* The proper care of the bore requires conscientious, careful work, but it pays well in the attainment of reduced labor of cleaning, prolonged accuracy-life of the barrel, and better results in target practice. Briefly stated, the care of the bore consists in removing the fouling, resulting from firing, to obtain a chemically clean surface, and in coating this surface with a film of oil to prevent rusting. The fouling which results from firing is of two kinds—one, the products of combustion of the powder; the other, cupro-nickel scraped off (under the abrading action of irregularities or grit

in the bore). Powder fouling, because of its acid reaction, is highly corrosive; that is, it will induce rust and must be removed. Metal fouling of itself is inactive, but may cover powder fouling and prevent the action of cleaning agents until removed, and when accumulated in noticeable quantities it reduces the accuracy of the rifle.

b. Powder fouling may be readily removed by scrubbing with hot soda solution, but this solution has no effect on the metal fouling of cupro-nickel. It is necessary, therefore, to remove all metal fouling before assurance can be had that all powder fouling has been removed and that the bore may be safely oiled. Normally, after firing a barrel in good condition the metal fouling is so slight as to be hardly perceptible. It is merely a smear of infinitesimal thickness, easily removed by solvents of cupro-nickel. However, due to pitting, the presence of dust, other abrasives, or to accumulation, metal fouling may occur in clearly visible flakes or patches of much greater thickness, much more difficult to remove.

c. In cleaning the bore after firing it is well to proceed as follows: Swab out the bore with soda solution (subparagraph *j*) to remove powder fouling. A convenient method is to insert the muzzle of the rifle into the can containing the soda solution and, with the cleaning rod inserted from the breech, pump the barrel full a few times. Remove and dry with a couple of patches. Examine the bore to see that there are in evidence no patches of metal fouling which, if present, can be readily detected by the naked eye, then swab out with the swabbing solution—a dilute metal-fouling solution (subparagraph *j*). The amount of swabbing required with the swabbing solution can be determined only by experience assisted by the color of the patches. Swabbing should be continued, however, as long as the wiping patch is discolored by a bluish-green stain. Normally a couple of minutes' work is sufficient. Dry thoroughly and oil.

d. The proper method of oiling a barrel is as follows: Wipe the cleaning rod dry; select a clean patch and thoroughly saturate it with sperm oil or warmed cosmic, being sure that the cosmic has penetrated the patch; scrub the bore with the patch, finally drawing the patch smoothly from the muzzle to

the breech, allowing the cleaning rod to turn with the rifling. The bore will be found now to be smooth and bright so that any subsequent rust and sweating can be easily detected by inspection.

e. If patches of metal fouling are seen upon visual inspection of the bore the standard metal-fouling solution prepared as hereinafter prescribed must be used. After scrubbing out with the soda solution, plug the bore from the breech with a cork at the front end of the chamber or where the rifling begins. Slip a 2-inch section of rubber hose over the muzzle down to the sight and fill with the standard solution to at least one-half inch above the muzzle of the barrel. Let it stand for 30 minutes, pour out the standard solution, remove hose and breech plug, and swab out thoroughly with soda solution to neutralize and remove all trace of ammonia and powder fouling. Wipe the barrel clean, dry, and oil. With few exceptions, one application is sufficient, but if all fouling is not removed, as determined by careful visual inspection of the bore and of the wiping patches, repeat as described above.

f. After properly cleaning with either the swabbing solution or the standard solution, as has just been described, the bore should be clean and safe to oil and put away, but as a measure of safety a patch should always be run through the bore on the next day and the bore and wiping patch examined to insure that cleaning has been properly accomplished. The bore should then be oiled, as described above.

g. If the swabbing solution or the standard metal fouling solution is not available, the barrel should be scrubbed, as already described, with the soda solution, dried, and oiled with a light oil. At the end of 24 hours it should again be cleaned, when it will usually be found to have "sweated"; that is, rust having formed under the smear of metal fouling where powder fouling was present, the surface is puffed up. Usually a second cleaning is sufficient, but to insure safety it should be again examined at the end of a few days, before final oiling. The swabbing solution should always be used, if available, for it must be remembered that each puff when the bore "sweats" is an incipient rust pit.

h. A clean dry surface having been obtained, to prevent rust, it is necessary to coat every portion of this surface with a film of neutral oil. If the protection required is but temporary and the arm is to be cleaned or fired in a few days, sperm oil may be used. This is easily applied and easily removed, but has not sufficient body to hold its surface for more than a few days. If rifles are to be prepared for storage or shipment, a heavier oil, such as cosmic, must be used.

i. In preparing arms for storage or shipment they should be cleaned with particular care, using the metal-fouling solution as described above. Care should be taken, insured by careful inspection on succeeding day or days, that the cleaning is properly done and all traces of ammonia solution removed. The bore is then ready to be coated with cosmic. At ordinary temperatures cosmic is not fluid. In order, therefore, to insure that every part of the surface is coated with a film of oil the cosmic should be warmed. Apply the cosmic first with a brush; then, with the breech plugged, fill the barrel to the muzzle, pour out the surplus, remove the breech-block, and allow to drain. It is believed that more rifles are ruined by improper preparation for storage than from any other cause. If the bore is not clean when oiled—that is, if powder fouling is present or rust has started—a half inch of cosmic on the outside will not stop its action, and the barrel will be ruined. Remember that the surface must be perfectly cleaned before the heavy oil is applied. If the instructions as given above are carefully followed, arms may be stored for years without harm.

j. Preparation of solutions:

Soda solution.—This should be a saturated solution of sal soda (bicarbonate of soda). A strength of at least 20 per cent is necessary. The spoon referred to in the following directions is the model 1910 spoon issued in the mess outfit.

Sal soda, one-fourth pound, or four (4) heaping spoonfuls.

Water, 1 pint or cup, model of 1910, to upper rivets.

The sal soda will dissolve more readily in hot water.

Swabbing solution.—Ammonium persulphate, 60 grains, one-half spoonful smoothed off.

Ammonia, 28 per cent, 6 ounces, or three-eighths of a pint, or 12 spoonfuls.

Water, 4 ounces, or one-fourth pint, or 8 spoonfuls.

Dissolve the ammonium persulphate in the water and add the ammonia. Keep in tightly corked bottle; pour out only what is necessary at the time, and keep the bottle corked.

Standard metal fouling solution.—Ammonium persulphate, 1 ounce, or 2 medium heaping spoonfuls.

Ammonium carbonate, 200 grains, or 1 heaping spoonful.

Ammonia, 28 per cent, 6 ounces, or three-eighths pint, or 12 spoonfuls.

Water, 4 ounces, or one-fourth pint, or 8 spoonfuls.

Powder the persulphate and carbonate together, dissolve in the water and add the ammonia; mix thoroughly and allow to stand for one hour before using. It should be kept in a strong bottle, tightly corked. The solution should not be used more than twice, and used solution should not be mixed with unused solution, but should be bottled separately. The solution, when mixed, should be used within 30 days. Care should be exercised in mixing and using this solution to prevent injury to the rifle. An experienced noncommissioned officer should mix the solution and superintend its use.

Neither of these ammonia solutions have any appreciable action on steel when not exposed to the air, but if allowed to evaporate on steel they attack it rapidly. Care should, therefore, be taken that none spills on the mechanism and that the barrel is washed out promptly with soda solution. The first application of soda solution removes the greater portion of the powder fouling and permits a more effective and economical use of the ammonia solution. These ammonia solutions are expensive and should be used economically.

k. It is a fact recognized by all that a highly polished steel surface rusts much less easily than one which is roughened; also, that a barrel which is pitted fouls much more rapidly than one which is smooth. Every effort, therefore, should be made to prevent the formation of pits, which are merely enlarged rust spots, and which not only affect the accuracy of the arm but increase the labor of cleaning.

l. The chambers of rifles are frequently neglected because they are not readily inspected. Care should be taken to see

that they are cleaned as thoroughly as the bore. A roughened chamber delays greatly the rapidity of fire, and not infrequently causes shells to stick.

m. A cleaning rack should be provided for every barrack. Rifles should always be cleaned from the breech, thus avoiding possible injury to the rifling at the muzzle, which would affect the shooting adversely. If the bore for a length of 6 inches at the muzzle is perfect, a minor injury near the chamber will have little effect on the accuracy of the rifle. The rifle should be cleaned as soon as the firing for the day is completed. The fouling is easier to remove then, and if left longer it will corrode the barrel.

n. The principles as outlined above apply equally well for the care of the barrel of the automatic pistol. Special attention should be paid to cleaning the chamber of the pistol, using the soda solution. It has been found that the chamber pits readily if it is not carefully cleaned, with the result that the operation of the pistol is made less certain.

(*U. S. A. F. M. No. 15.*)

CHAPTER IX.

PISTOL AND REVOLVER PRACTICE; PRELIMINARY DRILLS; POSITION AND AIMING DRILLS.¹

135. NOMENCLATURE AND CARE OF THE WEAPON; HANDLING AND PRECAUTIONS AGAINST ACCIDENTS.—The soldier will first be taught the nomenclature of those parts of the weapon necessary to an understanding of its action and use and the proper measures for its care and preservation. Ordnance pamphlets Nos. 1806 (description of the Colt's Automatic Pistol), 1919, and 1927 (descriptions of the Colt's revolver, calibers .38 and .45, respectively), contain full information on this subject and are furnished to organizations armed with these weapons.

¹ Whenever in these regulations the word "pistol" appears, the regulation applies with equal force to the revolver, if applicable to that weapon.

Careless handling of the pistol or revolver is the cause of many accidents and results in broken parts of the mechanism. The following rules will, if followed, prevent much trouble of this character :

(a) On taking the *pistol* from the armrack or holster, take out the magazine and see that it is empty before replacing it; then draw back the slide and make sure that the piece is unloaded. Observe the same precaution after practice on the target range, and again before replacing the pistol in the holster or in the armrack. When taking the *revolver* from the armrack or holster and before returning it to the same, open the cylinder and eject empty shells and cartridges. Before beginning a drill and upon arriving on the range observe the same precaution.

(b) Neither load nor cock the weapon until the moment of firing, nor until a run in the mounted course is started.

(c) Always keep the pistol or revolver in the position of "Raise pistol" (par. 156, Cavalry Drill Regulations), except when it is pointed at the target. (The position of "Lower pistol" is authorized for mounted firing only.)

(d) Do not place the weapon on the ground where sand or earth can enter the bore or mechanism.

(e) Before loading the *pistol*, draw back the slide and look through the bore to see that it is free from obstruction. Before loading the *revolver*, open the cylinder and look through the bore to see that it is free from obstruction. When loading¹ the *pistol* for target practice place 5 cartridges in the magazine and insert the magazine in the handle; draw back the slide and

¹ *TO LOAD PISTOL: Being at Raise Pistol* (Right hand grasping stock at the height of and 6 inches in front of the point of the right shoulder, forefinger alongside barrel, barrel to the rear and inclined forward about 30°).

Without deranging position of the hand, rotate the pistol so the sights move to the left, the barrel pointing to the right front and up.

With the thumb and forefinger of the *Left* hand (thumb to the right), grasp the slide and pull it toward the body until it stops and then release it. The pistol is thus loaded, and the hammer at full cock.

If the pistol is to be kept in the hand and not to be fired at once, engage the safety lock with the thumb of the *Right* hand.

If the pistol is to be carried in the holster, remove safety lock, if on, and lower the hammer *fully* down.

insert the first cartridge in the chamber and carefully lower the hammer fully down.

In loading the *revolver* place 5 cartridges in the cylinder and let the hammer down on the *empty chamber*.

(f) Whenever the pistol is being *loaded* or *unloaded*, the *muzzle must be kept up*.

(g) Do not point the weapon in any direction where an accidental discharge might do harm.

(h) After loading do not cock the pistol or the revolver until ready to fire.

(i) Keep the working parts properly lubricated.

136. POSITION, DISMOUNTED.—Stand firmly on both feet, body perfectly balanced and erect and turned at such an angle as is most comfortable when the arm is extended toward the target; the feet far enough apart to insure firmness and steadiness of position (about 8 to 10 inches); weight of body borne equally upon both feet; right arm fully extended, left arm hanging naturally.

REMARKS.—The right arm may be slightly bent, although the difficulty of holding the pistol uniformly and of keeping it as well as the forearm in the same vertical plane makes this objectionable.

137. THE GRIP.—Grasp the stock as high as possible with the thumb and last three fingers, the forefinger alongside the trigger guard, the thumb extended along the stock. The barrel, hand, and forearm should be as nearly in one line as possible when the weapon is pointed toward the target. The grasp should not be so tight as to cause tremors of the hand or arm to be com-

1 TO LOWER THE HAMMER: *Being at the loading position at full cock.*

I. Firmly seat thumb of *Right* hand on the hammer; insert forefinger beside trigger guard.

II. With thumb of *Left* hand exert a momentary pressure on the grip-safety to release hammer from sear.

III. At the same instant exert pressure on the trigger and carefully and slowly lower the hammer fully down.

IV. Remove finger from trigger.

V. Insert pistol in holster.

(Caution) The pistol must *never* be placed in the holster until hammer is fully down.

municated to the weapon, but should be firm enough to avoid losing the grip when the recoil takes place.

REMARKS.—The force of recoil of the pistol or revolver is exerted in a line above the hand which grasps the stock. The lower the stock is grasped the greater will be the movement or "jump" of the muzzle caused by the recoil. This not only results in a severe strain upon the wrist, but in loss of accuracy.

If the hand be placed so that the grasp is on one side of the stock, the recoil will cause a rotary movement of the weapon toward the opposite side.

The releasing of the sear causes a slight movement of the muzzle, generally to the left. The position of the thumb along the stock overcomes much of this movement. The soldier should be encouraged to practice this method of holding until it becomes natural.

To do uniform shooting the weapon must be held with exactly the same grip for each shot. Not only must the hand grasp the stock at the same point for each shot, but the tension of the grip must be uniform.

138. (a) THE TRIGGER SQUEEZE.—The trigger must be squeezed in the same manner as in rifle firing. (See pars. 44 and 46.) The pressure of the forefinger on the trigger should be steadily increased and should be straight back, not sideways. The pressure should continue to that point beyond which the slightest movement will release the sear. Then, when the aim is true, the additional pressure is applied and the pistol fired.

Only by much practice can the soldier become familiar with the trigger squeeze. This is essential to accurate shooting. It is the most important detail to master in pistol or revolver shooting.

(b) SELF-COCKING ACTION.—The force required to squeeze the trigger of the revolver when the self-cocking device is used is considerably greater than with the single action. To accustom a soldier to the use of the self-cocking mechanism, and also to strengthen and develop the muscles of the hand, a few minutes' practice daily in holding the unloaded revolver on a mark and snapping it, using the self-cocking mechanism, is recommended. The use of the self-cocking device in firing is not recommended except in emergency. By practice in cocking the revolver the

soldier can become sufficiently expert to fire very rapidly, using single action, while his accuracy will be greater than when using double action.

139. AIMING.—Except when delivering rapid or quick fire, the rear and front sights of the pistol are used in the same manner as the rifle sights. The normal sight is habitually used (see Pl. VI), and the line of sight is directed upon a point just under the bull's-eye at "6 o'clock." The front sight must be seen through the middle of the rear-sight notch, the top being on a line with the top of the notch. Care must be taken not to cant the pistol to either side.¹

If the principles of aiming have not been taught, the soldier's instruction will begin with sighting drills as prescribed for the rifle so far as they may be applicable. The sighting bar with open sight will be used to teach the normal sight and to demonstrate errors likely to be committed.

To construct a sighting rest for the pistol (see Pl. VI) take a piece of wood about 10 inches long, $1\frac{1}{2}$ inches wide, and $\frac{1}{2}$ inch thick. Shape one end so that it will fit snugly in the handle of the pistol when the magazine has been removed. Screw or nail this stick to the top of a post or other object at such an angle that the pistol when placed on the stick will be approximately horizontal. A suitable sighting rest for the revolver may be easily improvised.

140. (a) HOW TO COCK THE PISTOL.—The pistol should be cocked by the thumb of the right hand and with the least possible derangement of the grip. The forefinger should be clear of the trigger when cocking the pistol. Some men have difficulty at first in cocking the pistol with the right thumb. This can be overcome by a little practice. Jerking the pistol forward while holding the thumb on the hammer will not be permitted.

(b) HOW TO COCK THE REVOLVER.—The revolver should be cocked by putting the thumb on the hammer at as nearly a right angle to the hammer as possible, and by the action of the thumb muscles alone bringing the hammer back to the position

¹The instructor should take cognizance of the fact that the proper aiming point is often affected by the personal and fixed peculiarities of the firer, and if unable to correct such abnormalities, permit firer to direct sight at such point as promises effective results.

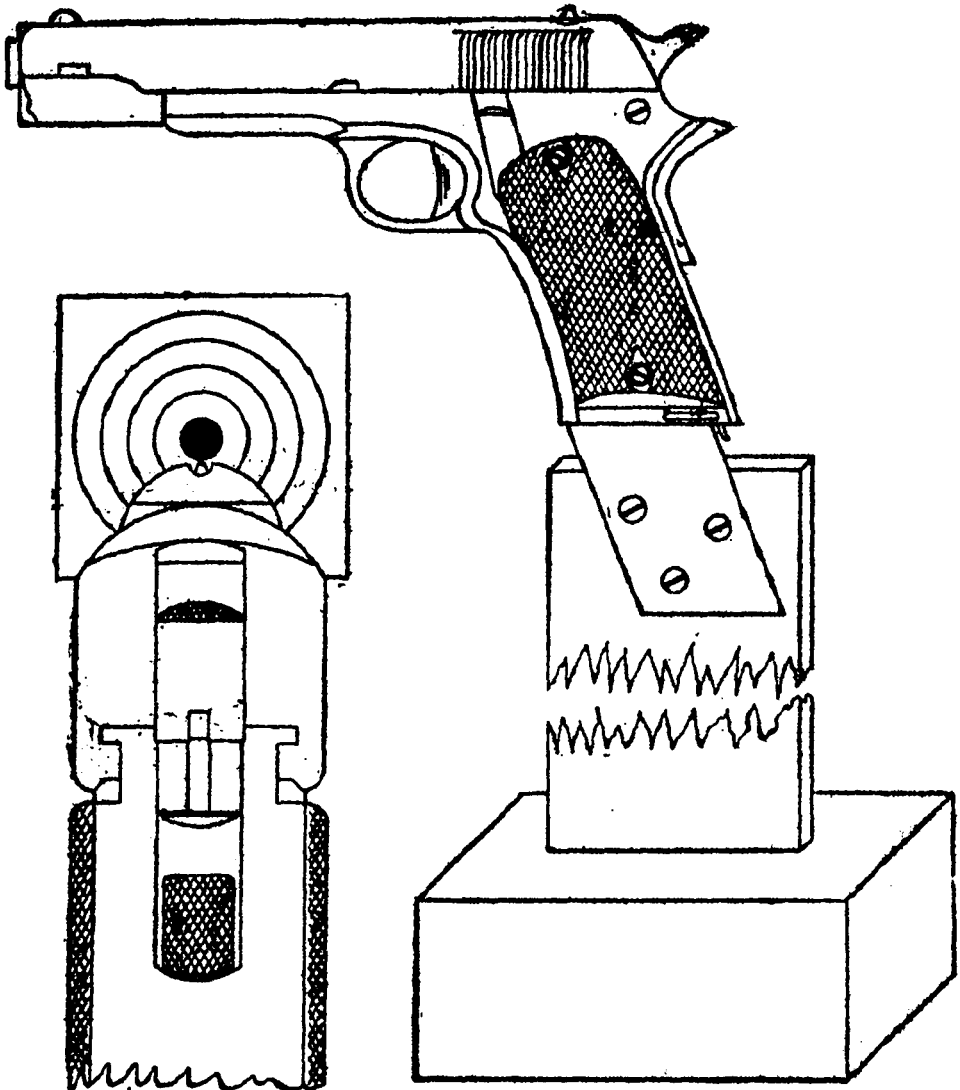

PLATE VI.

of full cock. Some men with large hands are able to cock the revolver with the thumb while holding it in the position of aim or raise pistol. Where the soldier's hand is small this can not be done, and in this case it assists the operation to give the revolver a slight tilt to the right and upward (to the right). Particular care should be taken that the forefinger is clear of the trigger or the cylinder will not revolve. Jerking the revolver forward while holding the thumb on the hammer will not be permitted.

141. POSITION AND AIMING DRILLS, DISMOUNTED.—For this instruction the squad will be formed with an interval of 1 pace between files. Black pasters to simulate bull's-eyes will be pasted opposite each man on the barrack or other wall, from which the squad is 10 paces distant.

The squad being formed as described above, the instructor gives the command. 1. *Raise*. 2. *Pistol* (par. 156, Cavalry Drill Regulations) and cautions, "*Position and Aiming Drill, Dismounted.*" The men take the positions described in paragraph 136, except that the pistol is held at "Raise pistol."

The instructor cautions, "Trigger squeeze exercise." At the command **READY**, cock the weapon as described in paragraph 140. At the command, 1. *Squad*; 2. **FIRE**, slowly extend the arm till it is nearly horizontal, the pistol directed at a point about 6 inches below the bull's-eye. At the same time put the forefinger inside the trigger guard and gradually "feel" the trigger. Inhale enough air to comfortably fill the lungs and gradually raise the piece until the line of sight is directed at the point of aim, i. e., just below the bull's-eye at 6 o'clock. While the sights are directed upon the mark, gradually increase the pressure on the trigger until it reaches that point where the slightest additional pressure will release the sear. Then, when the aim is true, the additional pressure necessary to fire the piece is given so smoothly as not to derange the alignment of the sights. The weapon will be held on the mark for an instant after the hammer falls and the soldier will observe what effect, if any, the squeezing of the trigger has had on his aim.

It is impossible to hold the arm perfectly still, but each time the line of sight is directed on the point of aim a slight additional pressure is applied to the trigger until the piece is finally

discharged at one of the moments when the sights are correctly aligned upon the mark.

When the soldier has become proficient in taking the proper position, the trigger squeeze should be executed at will. The instructor prefaces the preparatory command by "At will" and gives the command HALT at the conclusion of the exercise, when the soldier will return to the position of "Raise pistol."

At first this exercise should be executed with deliberation, but gradually the soldier will be taught to catch the aim quickly and to lose no time in beginning the trigger squeeze and bringing it to the point where the slightest additional pressure will release the sear.

REMARKS.—In service few opportunities will be offered for slow-aimed fire with the pistol or revolver, although use will be made of the weapon under circumstances when accurate pointing and rapid manipulation are of vital importance.

In delivering a rapid fire, the soldier must keep his eyes fixed upon the mark and, after each shot, begin a steadily increasing pressure on the trigger, trying at the same time to get the sights as nearly on the mark as possible before the hammer again falls. The great difficulty in quick firing with the pistol lies in the fact that when the front sight is brought upon the mark, the rear sight is often found to be outside the line joining the eye with the mark. This tendency to hold the pistol obliquely can be overcome only by a uniform manner of holding and pointing. This uniformity is to be attained only by acquiring a grip which can be taken with certainty each time the weapon is fired. It is this circumstance which makes the position and aiming drills so important. The soldier should constantly practice pointing the pistol until he acquires the ability to direct it on the mark in the briefest interval of time and practically without the aid of sights.

The soldier then repeats the exercises with the pistol in the left hand, the left side being turned toward the target.

142. TO DRAW AND FIRE QUICKLY—SNAP SHOOTING.—With the squad formed as described in paragraph 141 except that

the pistol is in the holster and the flap, if any, buttoned, the instructor cautions "Quick fire exercise." And gives the command, 1. SQUAD; 2. Fire. At this command, each soldier, keeping his eye on the target, quickly draws his pistol, cocks it as in paragraph 140, thrusts it toward the target, squeezes the trigger and at the instant the weapon is brought in line with the eye and the objective, increases the pressure, releasing the sear. To enable the soldier to note errors in pointing, the weapon will be momentarily held in position after the fall of the hammer. Efforts at deliberate aiming in this exercise must be discouraged.

Remarks under paragraph 141 are specially applicable also to this type of fire. When the soldier has become proficient in the details of this exercise, it should be repeated at will; the instructor cautions "At will; quick fire exercise." The exercise should be practiced until the mind, the eye, and trigger finger act in unison.

To simulate this type of fire mounted, the instructor places the squad so that the simulated bull's-eyes are in turn, to the RIGHT, to the LEFT, to the RIGHT FRONT, to the LEFT FRONT, to the RIGHT REAR. With the squad in one of these positions, the instructor cautions "Position and aiming drill, mounted." At this caution the right foot is carried 20 inches to the right and the left hand to the position of the bridle hand (par. 246, Cavalry Drill Regulations). The exercise is carried out as described for the exercise dismounted, using the commands and means laid down in paragraphs 161 to 168, inclusive, Cavalry Drill Regulations, for firing in the several directions. The exercise is to be executed at will when the squad has been sufficiently well instructed in detail.

When firing to the left the pistol hand will be about opposite the left shoulder and the shoulders turned about 45° to the left; when firing to the right rear the shoulders are turned about 45° to the right.

When the soldier is proficient in these exercises with the pistol in the right hand, they are repeated with the pistol in the left hand.

POSITION AND AIMING DRILL—MOUNTED.

143. PRELIMINARY TRAINING OF HORSES.—This course must be preceded necessarily by much work during the year, having for its object the training of the horses to the sight of the targets and to the noise of discharge of pistols. In addition to work on the riding track, much can be accomplished in this line by having blank cartridges fired while the horses are being groomed, and by placing targets just outside the corral or in such position that the horses will pass near them when being led to water or to the stables. During the dismounted practice the horses may be picketed near the firing point.

144. QUICK AIM DRILL.—The soldier must be instructed and practiced in taking rapid aim while the horse is in motion. To this end, frequent practice should be had with the pistol throughout the year when drilling on the riding track, going through the motions of aiming and firing (at will) at silhouette targets and other objects placed along the track and 5 yards from it. This practice should be conducted at a walk, trot, and gallop. In quick-aimed fire at a gallop the soldier must endeavor to discharge his pistol at the moment when the horse is in the act of rising in the leap. This can best be done by holding the pistol pointed toward the targets and moving the arm up and down in unison with the motion of the horse. With the eyes fixed on the target, point the pistol just as it starts on the upward motion and squeeze the trigger. The soldier will be taught to exchange magazines and to load his weapon with facility at all gaits.

145. PRELIMINARY RANGE PRACTICE DRILLS.—The pointing and snapping exercises outlined above for the riding school will, in the target season, be extended to and amplified on the range, where a track will be laid out as illustrated in Plate VIII, with a barrier in front of each target, to preserve a uniform distance from the horse to the targets. Parallel to and 10 yards distant from and facing this track will be placed 5 standing silhouette figures 10 yards apart. The squad in column of troopers, with a distance between troopers of about 10 yards, will move around the track at a walk, trot, and gallop, each trooper pointing and snapping his pistol at each target as he arrives opposite it.

146. (a) PRACTICE AS WITH BALL CARTRIDGES, MOUNTED.—As soon as the horses have become sufficiently accustomed to the targets and to the noise of firing the trooper mounted will be practiced in the details of procedure laid down for the several types of fire prescribed for Range Practice with ball cartridges. In firing to the left and left front, the weapon may be held in the left hand.

(b) QUICK FIRE.—Target: Silhouette of standing figure arranged to revolve as a bobbing target and to be operated by means of ropes laid under the track. This type of target is used for firing at the halt and at the walk. For any given individual, the target is turned before firing commences, edge of target toward the firing point. The targets are operated by revolving the target through an arc of 90° so that face and edge are alternately turned toward the firing point. Exposures are for a specified length of time, with an interval of 3 to 5 seconds between exposures. The individual who is to fire takes position at the firing point with his weapon in the holster and loaded as prescribed in paragraph 135 (e); flap of holster, if any, buttoned. At the first appearance of the target the trooper draws and fires, or attempts to fire, one shot at his target before it disappears. Prior to firing of this type the soldier should have been thoroughly instructed in quick pointing to eliminate, so far as practicable, personal errors. For purpose of instruction, the instructor may cause each shot to be marked and the procedure of firing the first shot to be repeated for each shot of the score. (Plate XI.)

CHAPTER X.

REVOLVER OR PISTOL RANGE PRACTICE.

147. GENERAL DESCRIPTION.—This practice includes the instruction of the soldier in firing with the service revolver or pistol and is divided into two distinct courses, the dismounted course and the mounted course. The general scheme is as follows:

		Number of shots.	
Revolver or pistol range practice.	Dismounted course.	Instruction { Slow fire, at 15 and 25 yards, minimum of 2 scores (1 at each range).....	10
		practice . { Rapid fire, at 15 and 25 yards, minimum of 4 scores (2 at each range).....	20
			Quick fire, at 15 and 25 yards, minimum of 4 scores (2 at each range).....
		R e c o r d { Rapid fire, at 25 yards, 2 scores.....	10
			practice . { Quick fire, at 15 and 25 yards, 2 scores at each range.....
	E x p e r t { Rapid fire, at 50 yards, 1 score.....	5	
		test..... { Quick fire, at 15 and 25 yards, 1 score at each range.....	10
	Total.....		95
	Mounted course.	Instruction { Dismounted.. { Slow fire, 15 yards, minimum of 2 scores... 10	10
			practice . { Mounted..... { Quick fire, 15 yards, minimum of 2 scores.. 10
Halt, minimum of 2 scores.....			
R e c o r d { Walk, minimum of 2 scores..... 10			40
		practice . { Gallop, minimum of 8 scores.....	10
E x p e r t { Halt, 2 scores.....		10	
		test..... { Gallop, 4 scores.....	20
test..... { Halt, 1 score (targets at varying ranges).....		5	
		{ Gallop, 1 score (group targets).....	5
Total.....		130	

A score consists of five consecutive shots.

148. PRACTICE SEASON.—Revolver range practice will take place during the season for rifle firing (par. 88). During the supplementary season such practice as time and amount of ammunition will allow will be given to recruits who have not fired the record course mounted and to others requiring it. Recruits joining within thirty days of the close of the supplementary season will be excused from the mounted firing therein.

149. WHO WILL FIRE.—The following table designates those who are required or authorized to fire at revolver range practice and the courses to be followed:

Arm or corps.	To fire.	Course.
1. Cavalry.....	Squadron staff officers, troop officers, and all enlisted men except as noted below. ¹	Mounted.
2. Field Artillery.....	Battalion staff officers, battery officers, and all enlisted men.	} Dismounted.
3. Infantry, battalions of Engineers, and field and telegraph companies and aero squadrons of the Signal Corps.	Battalion staff officers, company officers, and all enlisted men armed with the revolver or pistol.	
4. Coast Artillery.....	Company officers and all enlisted men armed with revolver or pistol.	
5. Field and regimental staff officers of Cavalry.	Authorized but not required.....	Mounted.
6. Staff departments or corps, except medical and chaplains.	} All officers, except such Engineer officers as are noted above, and enlisted men authorized, but not required.	} Dismounted.
7. Regimental, field, and staff officers of Field Artillery and Infantry and field and staff officers of Coast Artillery.		
8. Veterinarians.....		
9. Post noncommissioned staff....		

¹ Cavalry recruits, having no previous mounted service, who join within 30 days preceding the mounted course, will, in the regular practice season, fire dismounted only.

All officers enumerated in the above table of over fifteen years' commissioned or commissioned and enlisted service, except officers of the Medical Corps and chaplains, are authorized but not required to fire, but, if firing, will follow the course prescribed for their department, corps, or arm of the service.

(C. S. A. F. M., No. 8.)

150. ALLOWANCE OF AMMUNITION.—As published annually.

151. INSTRUCTION PRACTICE.—In order to ensure uniformity of instruction the order of procedure and a minimum number of shots are prescribed, but a certain percentage for proficiency at each stage is a requisite for advancement to the next succeeding

stage. If this percentage is not attained, the judgment of the organization commander dictates the type of instruction which he deems best suited to the individual case. In order that the expenditure of ammunition may be fully under the control of the organization commander he may advance men who have fired during a preceding season without requiring them to fire the full number of shots prescribed as a minimum for any type of fire in instruction practice, provided that they fire at least one-half the minimum, and in so doing make a percentage at least as high as that required for advancement to the next succeeding stage. In the exercise of this privilege, however, the organization commander should guard against depriving the soldier of needed practice.

152. RECORD PRACTICE.—In all record practice, both for dismounted and mounted courses, scores will be kept and the record of firing prepared as prescribed for the rifle. The number of shots to be fired in record practice has been made no greater than barely sufficient to demonstrate the soldier's average shooting ability.

153. (a) SCORING IN RAPID AND QUICK FIRE.—In timed, rapid, or quick fire the scorer does not announce the name of the firer after the result of each shot has been signaled. As soon as the value of each hit on the target is signaled it is announced; the number of misses, if any, is announced; the score is then entered; and finally the name of the firer with his total score is announced and the latter recorded.

(b) FIRING ON WRONG TARGET.—In the case of two men firing in timed, rapid, or quick fire on the same target the resulting score will be rejected, the soldier at fault being credited only with such hits as he may have made on his own target, the other soldier repeating his score.

(c) OTHER MISHAPS.—Unfired shots due to the fault of the soldier count as misses. In case of defective cartridges or disabled weapon the entire score is not repeated, but the soldier fires only the necessary number of shots to complete the then unfinished score, and where the time element enters the ratio between the full time per score and the time to be allowed will equal the ratio existing between a full score and the number of shots to be fired. For each shot fired before the commencement

or after the close of the time limit the maximum possible per shot at the particular type of target being fired at will be deducted from the score. Prior to commencing range practice the instructor should thoroughly drill his command in the manipulation of the revolver or pistol.

In the mounted practice no trooper will leave the track except at the ends. If a cartridge misses fire or the weapon fails to work, he should continue to the end of the track, replace the defective cartridge or correct the trouble with the weapon, and take his place for another run.

If by reason of a defective cartridge one or more targets are not fired upon in any run, the trooper, in repeating the run, will fire only at those targets on which he did not fire. (*C. S. A. F. M. No. 2.*)

154. **EXPERT TEST.**—All who in record practice have made the required percentage of the aggregate score possible in either course will fire the expert test prescribed for that course. If at any stage of the test the soldier's score is such that qualification is no longer possible, the test will be discontinued. Should the soldier make the required number of points before firing the full number of shots, he will not be required to continue firing.

155. **ORDER OF PROCEDURE.**—Revolver and pistol firing commence with instruction practice in each course, and this practice is carried to completion for each soldier before proceeding to the next succeeding stage of record practice in the course being pursued. When instruction practice is completed, the soldier proceeds to record practice in the course he is required to fire, and follows this course to completion in accordance with the tables and regulations hereinafter laid down. The soldier may be thus advanced to record practice immediately after he has completed instruction practice without waiting for others less advanced. While engaged in record practice the soldier will do no other firing. In record practice the trooper will, so far as practicable, use the horse regularly assigned to him. In general, the regulations for known distance practice (pars. 87-110, body of text) will regulate, where applicable, revolver and pistol as well as rifle firing.

156. **GENERAL REMARKS.**—With the idea of inculcating in the soldier from the beginning the habit of firing by pointing, as dis-

tinguished from deliberate aiming, firing at the longer ranges has been removed from both courses and quick firing at bobbing targets has been added. Slow fire has been held at the lowest possible number of shots consistent with insuring safe handling of the weapon and a knowledge of its shooting qualities.

157. PRELIMINARY INSTRUCTION.—The importance of preliminary exercises can not be overestimated, and a reasonable amount of pointing and snapping indulged in prior to range practice will be amply repaid by the results obtained when firing with ball cartridges.

158. THE GAIT.—In all cases where the gait is a gallop the prescribed regulation maneuvering gallop is meant (par. 372, Cavalry Drill Regulations) unless otherwise stated. The canter will not be permitted.

159. BLANK CARTRIDGES (REVOLVER).—Exercises with blank cartridges, circling to the right, left, etc., and firing at the silhouettes on the track, should be carried on previous to firing with ball cartridges.

160. BARRIERS.—Barriers will be placed along the edge of and parallel to the track in front of the targets in order to preserve the prescribed distance from track to targets.

161. SYSTEMATIC INSTRUCTION.—All Cavalry troops and all officers and enlisted men armed with the pistol or revolver will be instructed in its use. This instruction will be systematic and progressive, the controlling idea being accurate, rapid work.

162. FIELD FIRING.—Within the limits of the ammunition allowance remaining available after firing the prescribed courses field practice of such nature as the skill and ingenuity of the organization commander may suggest and the availability of material and terrain render practicable will be held from time to time. Such field firing should be rendered as realistic as proper safeguarding from accident will permit. It should be borne in mind, however, that interest can be maintained only so long as results are evident, and exercises should therefore be devised with this end in view.

Since active service conditions can only be approximated and not actually arrived at in instruction, any type of firing which presents a feature of a fire problem that might exist has its

value. Such targets as pendulum targets, glass balls, approaching or receding figures, while lacking any tactical significance, still test the skill of the firer in manipulation of the weapon and present to him an individual problem of value. In general, any means which may tend to develop the powers of quick drawing and accurate shooting, attributed to the early frontiersman, is of the utmost value in preserving the importance which national tradition attaches to the pistol.

163. COMPETITIONS.—When organizations, armed with the revolver, participate in pistol competitions, the regulation automatic pistol, caliber .45, is prescribed. For purposes of competition and of practice in preparation therefor, the issue is authorized of six automatic pistols in addition to the revolvers on hand in such organization.

164. AMMUNITION.—For each designated competitor, selected from an organization firing the revolver course, the organization commander is authorized to expend annually in addition to the ammunition fired in the regular revolver course, 300 rounds of ball cartridges, caliber .45, automatic pistol, in acquainting the selected competitor with this weapon and in preparation for the competition.

165. MODIFICATION OF COURSE.—Whenever the exigencies of the service do not permit of the firing of the prescribed course in full, the commanding general of a territorial department or a tactical division in the field is authorized to modify the course with a view to securing the maximum of training under such conditions, within the limits of the ammunition allowance; but neither officers nor enlisted personnel, who do not fire the course regularly prescribed in these regulations, shall be classified.

166. TABULATION.—The details of practice in mounted and dismounted courses are given in tables (pars. 168, 173, 174, 179, 193, and 196), which have the force of written regulations.

CHAPTER XI.

DISMOUNTED COURSE.

167. TABULATION.—The tables relate to the three divisions of the Dismounted Course and in the order to be followed in range

practice, viz: Instruction Practice, Record Practice, and Expert Test. Each table is followed by regulations applicable.

168. INSTRUCTION PRACTICE.

Slow fire.		Rapid fire.	
Target L.		Target L.	
15 yards.	25 yards.	15 yards.	25 yards.
Scores, minimum of 1. Time limit, none.	Scores, minimum of 1. Time limit, none.	Scores, minimum of 2. Time, 20 seconds per score.	Scores, minimum of 2. Time, 20 seconds per score.

Quick fire.	
Target E—Bobbing.	
15 yards.	25 yards.
Scores, minimum of 2. Time, 3 seconds per shot.	Scores, minimum of 2. Time, 4 seconds per shot.

TIME.—Intervals of time are measured from the last note of the signal or the last word of the command "Commence firing" to the last note or word of "Cease firing." Commands will not be unduly prolonged.

169. PROCEDURE.—The course will be fired in the order set forth in the table, beginning at the shorter range and completing each type of fire before proceeding to the next, in the following order: Slow fire, rapid fire, and quick fire, with the proviso that 50 per cent of a possible score for any type of fire at any

range is a necessary requisite for advancement to the next succeeding step in the course.

Should the soldier fail to make the 50 per cent necessary for advancement, he will be required to repeat the type of firing at the range at which he failed.

If upon the second trial the soldier fails to make 50 per cent of a possible score, he will not be advanced to the next stage, but he may be required to continue such instruction practice as the judgment of the organization commander dictates and the state of the ammunition allowance permits.

No soldier will be advanced to record practice, dismounted course, who, in instruction practice, has failed to make 60 per cent of the aggregate possible score.

170. SLOW FIRE.—The target is the target "L" bull's-eye and is used so that the kind and magnitude of the errors committed by the firer become at once evident to him. Abundant time is permitted in the firing to enable proper explanation of the causes and the remedies for such errors to be pointed out. It is designed as the elementary phase of instruction in the proper manipulation of the weapon and in determining and correcting the personal errors of the firer.

171. RAPID AND QUICK FIRE.—Targets: Target L for rapid; bobbing target E for quick fire.

172. PROCEDURE. (a) **IN RAPID FIRE.**—Time is taken at the firing stand by sand glass or watch. The target being up, the soldier stands with weapon at "Raise pistol." The revolver or pistol is loaded with five cartridges, as prescribed in paragraph 135 (c). The command "Commence firing" is given and the soldier fires five shots within the prescribed limits of time, at the end of which the command "Cease firing" will have been given.

(b) **IN QUICK FIRE.**—The target is operated as a bobbing target. Three to five seconds after notice is received at the pit that all is ready at the firing point the target is alternately exposed to and turned from view of the firing point, exposures being of three to four seconds duration, depending upon the range, with an interval three to five seconds between exposures. The soldier stands at the firing point, and his revolver or pistol, loaded with five cartridges, is at "raise pistol" at "safe."

Upon the first exposure of the target, the soldier fires one shot at the target before it disappears. The weapon is held between shots at "raise pistol." The soldier fires one shot at each re-appearance of his target until five shots have been fired.

(C. S. A. F. M. No. 13.)

173. RECORD PRACTICE.

Rapid fire.	Quick fire.	
Target L.	Target E—Bobbing.	
25 yards.	15 yards	25 yards.
Scores, 2. Time limit, 20 seconds for each score.	Scores, 2. Time, 3 seconds per shot.	Scores, 2. Time, 4 seconds per shot.

All who make 80 per cent of the aggregate possible score will fire the expert test. (Par. 174.)

174. EXPERT TEST.

Rapid fire.	Quick fire.	
Target L.	Target E—Bobbing.	
50 yards.	15 yards.	25 yards.
Scores, 1. Time limit, 30 seconds per score.	Scores, 1. Time, 3 seconds per shot.	Scores, 1. Time, 4 seconds per shot.

Aggregate possible, 60; necessary to qualify, 50.

175. CLASSIFICATION.—All who are required or authorized to fire and who are borne on the rolls of the organization during

any part of the practice season, or who are attached for practice by proper authority, will be classified, or rated as unclassified, according as they have met or failed to meet the requirements of classification.

Classification will be retained from the date of qualification until the next opportunity to requalify, or for one year if no opportunity for requalification is presented within that year.

REQUIREMENTS.—(a) All who in record practice, dismounted course, make at least 80 per cent of the aggregate possible score will be classified as first-class men; (b) those who fail to qualify as first-class men, but who make not less than 60 per cent of the aggregate possible score, will be classified as second-class men; (c) all who fail as second-class men and those who for any reason did not fire the course and are not otherwise classified, will be rated as unqualified. (d) All first-class men who, in firing the expert course, make over 83 per cent of the aggregate possible score in that course, will be classified as expert pistol shots. (C. S. A. F. M. No. 19.)

CHAPTER XII.

MOUNTED COURSE.

176. INSTRUCTIONS FOR PISTOL OR REVOLVER FIRING, WHEN MOUNTED.—(a) Never fire near a horse's head, otherwise he may become gun-shy. When firing to the right front lean well to the right, and when firing to the left front lean well to the left. Treat the horse kindly and handle him quietly, otherwise he may be made to fear firing and become unmanageable.

(b) Take the regulation gallop, neither a canter nor a run. Do not bring the horse to a trot until 25 yards beyond the last target.

(c) Fire from either "raise pistol" or "lower pistol."

(d) Immediately after firing a shot, cock the revolver for the next shot, unless double action or the automatic pistol is used. The best results in firing are obtained by use of the single action.

(e) Be sure before starting on a run, unless otherwise instructed, that the revolver is loaded with five cartridges and that the hammer is on the empty chamber; and in case of the

pistol, that it is loaded, the hammer at the "safe," and that four cartridges are in the magazine.

177. The mounted course is entirely separate and distinct from the prescribed dismounted course and is complete in itself.

178. TABULATION.—The tables relate to the three divisions of the mounted course in the order to be followed in range practice, viz, instruction practice, record practice, and the expert test. Each table is followed by regulations applicable.

179. INSTRUCTION PRACTICE.

Dismounted.		
Slow fire.	Quick fire.	
Target L. Range, 15 yards. Scores, minimum of 2. Time limit, none.	Target M—Bobbing. Range, 15 yards. Scores, minimum of 2. Time, 3 seconds per shot.	
Mounted.		
At the halt.	At the walk.	At the gallop.
Target M—Bobbing. Range, 10 yards. Scores, minimum of 2. Time, 3 seconds per shot.	Target M—Bobbing. Range, 10 yards. Scores, minimum of 2. Time, 3 seconds per shot.	Target M. Range, 10 yards. Scores, minimum of 8. Time governed by gait of at least 12 miles per hour.

INSTRUCTION PRACTICE—DISMOUNTED.

180. GENERAL REMARKS.—The purpose of dismounted instruction is to insure, within reasonable limits, familiarity with the manipulation and the safe handling of the pistol or revolver and a knowledge of its shooting qualities before requiring its use from the horse's back. Such practice is therefore mandatory only in the case of men who have never fired, or who, in the judgment of the organization commander, have not acquired

sufficient familiarity with the pistol to warrant dispensing entirely with dismounted instruction.

181. SLOW FIRE.—The target is the target L bull's-eye, and is used so that the kind and magnitude of the errors committed by the firer become at once evident to him. Abundant time is permitted in the firing to enable proper explanation of the causes and the remedies for such errors to be pointed out.

It is designed as the elementary phase of instruction in the proper manipulation of the weapon and in determining and correcting the personal errors of the firer.

182. QUICK FIRE.—The target is the silhouette of a standing figure arranged as a bobbing target and operated by ropes running under track. (See Targets.)

183. PROCEDURE—(a) IN THE PIT.—Time is taken at the pit. The target is turned edge toward the firing point. Three to 5 seconds after word is received from the firing point that all is in readiness the target is alternately exposed to and turned from the view of the firing point, remaining exposed for a period of 3 seconds, with a period of 3 seconds to 5 seconds between exposures. This procedure is continued until firing has ceased or notice to discontinue has been given.

(b) AT THE FIRING POINT.—The soldier stands at the firing point, and his revolver or pistol, loaded with five cartridges, is at "raise pistol" at "safe." At the first appearance of his target the soldier fires one shot before the target disappears. The pistol or revolver is held between shots at "raise pistol." The soldier fires one shot at each reappearance of his target until five shots have been fired. This procedure is repeated for each score that the soldier may be required to fire. The number of targets simultaneously in operation, being dependent upon the number of men who can be advantageously instructed at one time and upon other local conditions, will be governed by the judgment of the officer conducting the practice, due regard being had to the element of safety.

(C. S. A. F. M. No. 13.)

INSTRUCTION PRACTICE—MOUNTED.

184. GENERAL REGULATIONS.—This course will be fired in the order set forth in the table, beginning with firing at the **HALT**

and completing each type of fire in the order: At the Halt, At the Walk, and At the Gallop, with the proviso that 40 per cent

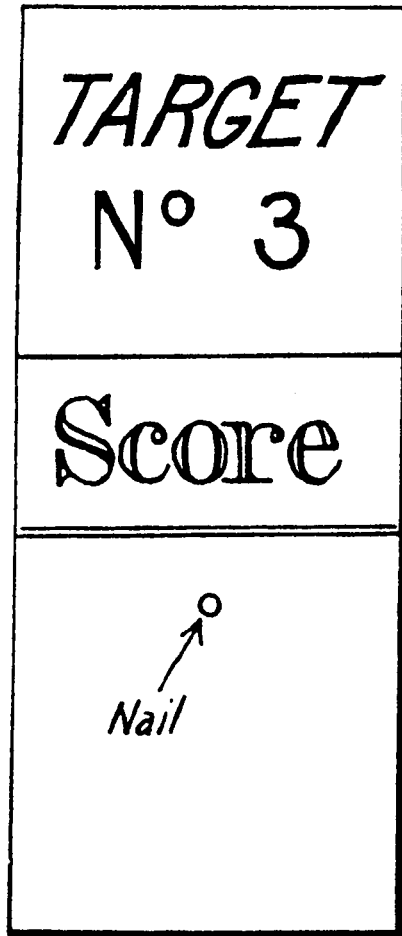

PLATE VII.

of a possible score at any type of fire is a requisite for advancement to the next succeeding step in the course. Should the trooper fail to make the 40 per cent necessary for advancement,

he will be required to repeat the type of firing at which he failed. If, upon the second trial, he fails to make 40 per cent of a possible score, he will not be advanced to the next step, but he will be required to continue such other practice as the judgment of the organization commander dictates and the state of the ammunition allowance permits. No trooper will, however, be advanced to record practice who, in instruction practice, mounted, has failed to make 50 per cent of the aggregate possible score, but will instead be required to continue such instruction practice as may be appropriate and possible.

185. AT THE HALT.—Targets: The silhouette (Target M.) placed on a staff and so arranged that it can be operated as a bobbing target by ropes passing beneath the track. The number of targets in use is dependent upon the number of men who can be advantageously instructed at one time, as well as upon other local conditions, and will be governed by the judgment of the officer conducting the practice, due regard being had to the element of safety. (Plate XXIV.)

186. (a) PROCEDURE.—The targets are arranged as shown in Plate VIII, figure 1, 10 yards from and facing the track. When in operation, the targets are to be alternately exposed to and turned from view, exposure being for a period of 3 seconds with an interval of from 3 to 5 seconds between exposures. Operation of targets begins in 3 to 5 seconds after notification that all is ready at the firing point. The markers operate the targets.

(b) AT THE FIRING POINT.—The soldier mounted, saddle stripped, takes position at the firing point with his target on his right hand. The revolver or pistol, loaded with five cartridges, is at "raise pistol" at "safe." When the target first appears, the soldier fires one shot at the target. The weapon remains in the hand between shots and at either "raise pistol" or "lower pistol," the soldier firing one shot at each reappearance of the target until he has fired five shots. When five shots have been fired to the right, the procedure is repeated, firing to the left. (*C. S. A. F. M. No. 13.*)

187. AT THE WALK.—Targets: Arranged and operated as at the Halt. (See par. 185.)

188. PROCEDURE.—The procedure at the Walk is identical with that at the Halt, with the following exceptions:

The trooper fires one score to the right while moving to the left, and one score to the left while moving to the right, on the circumference of a circle the diameter of which is about 4 yards and which is approximately tangent to the track at the firing point. The interval between exposures is dependent upon the time required by the trooper to completely traverse the circumference of the circle, which, at gait of 4 miles per hour, should require about 7 seconds. (*C. S. A. F. M. No. 1.*)

189. AT THE GALLOP.—Target: The silhouette (Target M) pasted on a B frame resting on the ground and facing the track is used in order that the trooper may see the nature of his errors, and when this purpose has been accomplished the B frame is removed and replaced by Target M alone. Five targets are placed 10 yards from the track with 10 yards between centers when firing with the pistol or 20 yards between centers when firing with the revolver.

190. PROCEDURE (a).—With the silhouettes pasted on B frames arranged as shown in Plate VIII, figure 1, each trooper will enter upon the track 20 yards from the nearest target and will make four circlings of the track, during two of which he fires to the right and two to the left. Further firing at the silhouette on the B frame is optional with the organization commander. The firing on the Target M pasted on the B frame is not to be considered in computing the percentage for advancement of the soldier to record practice.

(b) When this type of fire is completed, the procedure is repeated, substituting for the B frame the standing silhouette alone. (*C. S. A. F. M. No. 2.*)

191. MARKING, SCORING, AND PASTING SHOT HOLES, MOUNTED COURSE.—A soldier is detailed as marker for each target; his position is in front of his target and on the opposite side of the track. When firing is at the bobbing targets, he will operate the targets. The targets will be designated by numerals 1, 2, 3, 4, and 5, from right to left. An improvised score board (Pl. VII) will be provided for each target and placed on the left of the target so as to face the scorer. The marker will be provided with numerals 1 to 5, inclusive. These numerals, except the figure 1, may be cut from the margin of a discarded

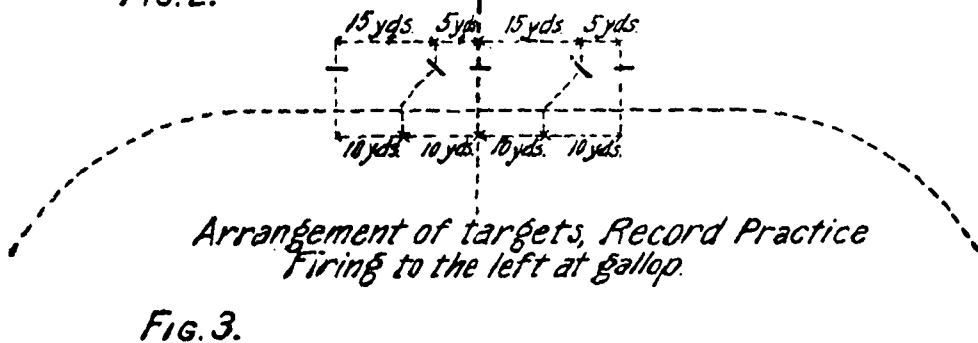
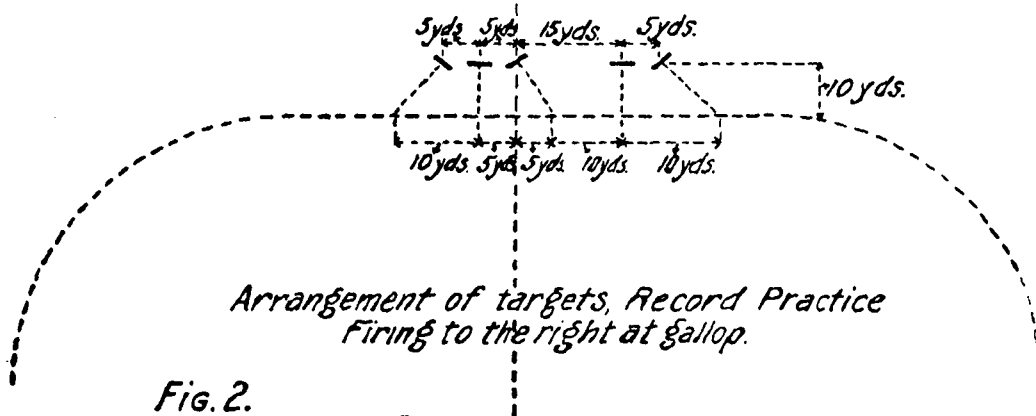
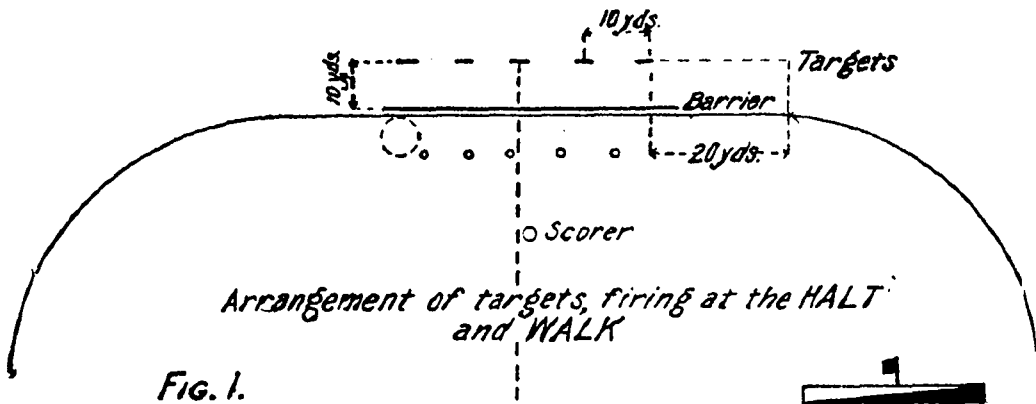

Target L. The figure 1 may be easily improvised by trimming the upright of the figure 4, or by painting. These numerals may be pasted on pieces of tin, board, or of discarded binder-board silhouettes. When a shot or score has been fired at a target, the marker assigned to that target will run toward his target and call "No. 1, score one," or "two," or "miss," as the case may be. He will then hang the proper numeral on the score board and cover the shot hole or holes with a paster. One noncommissioned officer, detailed as scorer, is posted opposite the center target and in rear of the markers. In record practice the scorer and markers should, when practicable, be from a troop other than the one firing. The regulations for scoring and recording scores in rifle practice will govern in revolver or pistol firing as far as they may be applicable. In record firing, new paper covers for the silhouette targets will be used for each day's firing. Upon completion of the firing for the day the troop commander or one of his lieutenants will count the number of hits on each target and compare the totals with the recorded scores. If the examination of the targets gives results very closely agreeing with the recorded scores, the record should be permitted to stand, but the markers cautioned to use greater care in the future.

192. For value of hits, see chapter on targets.

193. RECORD PRACTICE.

Mounted.	
At the halt.	At the gallop.
<p>Target M—Bobbing. Range, 10 yards. Scores, 2 $\left\{ \begin{array}{l} 1 \text{ to right.} \\ 1 \text{ to left.} \end{array} \right.$ Time, 3 seconds per shot.</p>	<p>Target M. Range, 10 yards. Scores, 4 $\left\{ \begin{array}{l} 2 \text{ firing to the right while} \\ \text{circling to the left.} \\ 2 \text{ firing to the left while cir-} \\ \text{cling to the right.} \end{array} \right.$ See Plate VIII, Figs. 2 and 3.</p>

All who make at least 70 per cent of the aggregate possible score will fire the expert test.

194. PROCEDURE (a) AT THE HALT.—The procedure as laid down for this type of fire in Instruction Practice (par. 186) will be followed.

(b) AT THE GALLOP.—The gait will be maintained at not less than 12 miles per hour, or 88 yards in 15 seconds. With the targets arranged as shown in Plate VIII, fig. 2, there will be two circlings of the track, the trooper on each circling firing one shot at a target in each of the following directions and in the order stated, viz: Right front, right, right front, right, and right rear. With the targets arranged as shown in Plate VIII, fig. 3, there will be two circlings of the track, the trooper firing during each circling one shot at a target in each of the following directions and in the order stated, viz: Left, left front, left, left front, and left.

195. When the targets are turned obliquely for firing to the right front, left front, or right rear, they will be set at an angle of 45° to the track.

196. EXPERT TEST—MOUNTED.

At the halt—Quick fire.	At the gallop.	At the gallop extended.
Plate IX.	Plate X, fig. 1.	Plate X, fig. 2.
Target E—Bobbing Range, 8 to 15 yards. Score, 1. Time, 2 seconds per shot.	Target M Range, 10 yards. Score, 1.	Targets, silhouettes of 3 standing, 1 kneeling, and 1 prone figure. Range, 5 to 15 yards. Scores, 2.

Aggregate possible score=20 points. Necessary to qualify, 13 points, or 65 per cent. (*C. S. A. F. M. No. 1.*)

197. PROCEDURE—AT THE HALT.—With the targets arranged as shown in Plate IX, the trooper, mounted, takes the central position shown in the plate. The targets are operated from a position in rear of the firer; exposures are made irregularly

until the soldier has fired five shots. (*C. S. A. F. M. No. 1. See Plate IX.*)

198. AT THE GALLOP.—(a) With the targets arranged as shown in Plate X, fig. 1, the soldier takes the track at the gallop with the targets on the right. He fires one shot at each target, firing in the direction right front, right, and right rear. After passing the last target about 40 yards he turns to the left about, taking the track with the targets on his left, and fires one shot at the target to his left front and one shot at the target to his left.

(b) AT THE EXTENDED GALLOP.—With the targets arranged as shown in Plate X, fig. 2, the soldier takes the track so as to pass at the gallop extended, between the targets and approaching from the side of prone figure, as indicated by arrow. He fires one shot at each target. In this type of fire two runs are made, each run being in the same direction.

Expert Test - Halt

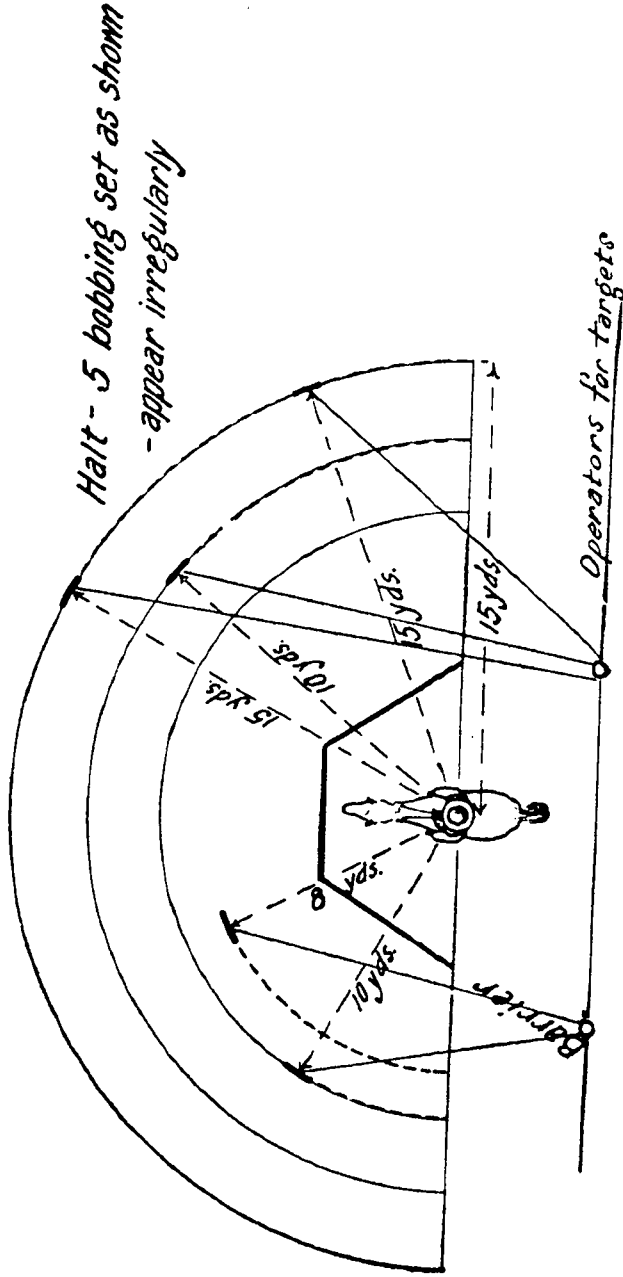

○ Timekeeper

PLATE IX.

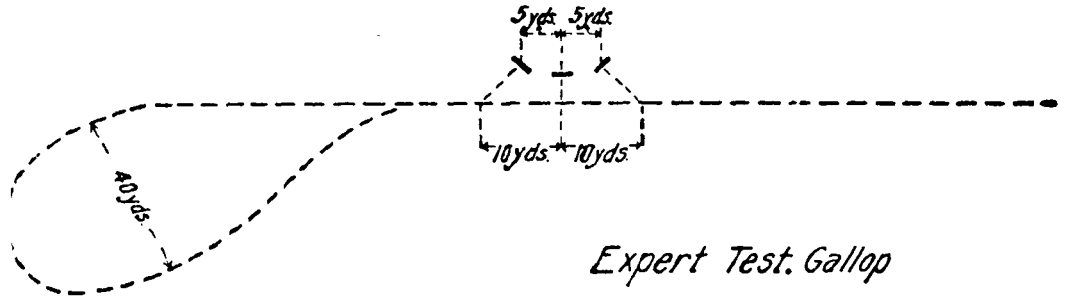

Expert Test Gallop

FIG. 1.

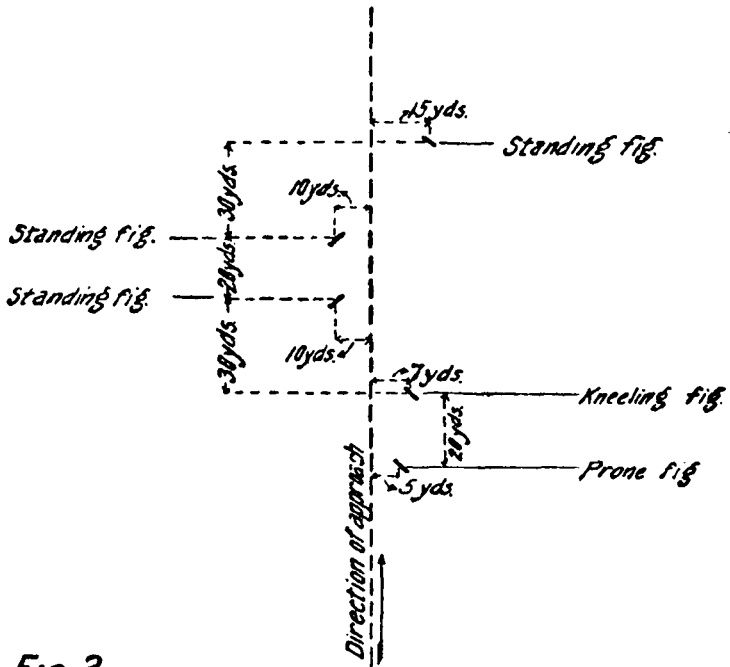

FIG. 2.

Expert Test Extended Gallop

199. CLASSIFICATION.—All who are required or authorized to fire and who are borne on the rolls of the organization during any part of the practice season, or who are attached for practice by proper authority, will be classified, or rated as unclassified, according as they have met or failed to meet the requirements of classification.

Classification will be retained from the date of qualification until the next opportunity to requalify, or for one year if no opportunity for requalification is presented within that year.

Requirements.—(a) All who in record practice make a total of 70 per cent of the aggregate possible score will be classified as first-class men; (b) those who fail to qualify as first-class men, but who make not less than 50 per cent of the aggregate possible score will be classified as second-class men; (c) all who fail as second-class men and those who, for any reason, did not fire the course and are not otherwise classified, will be rated as unqualified; (d) all first-class men who in firing the expert course make at least 65 per cent of the aggregate possible score in that course will be classified as Expert Pistol Shots. (C. S. A. F. M. No. 19.)

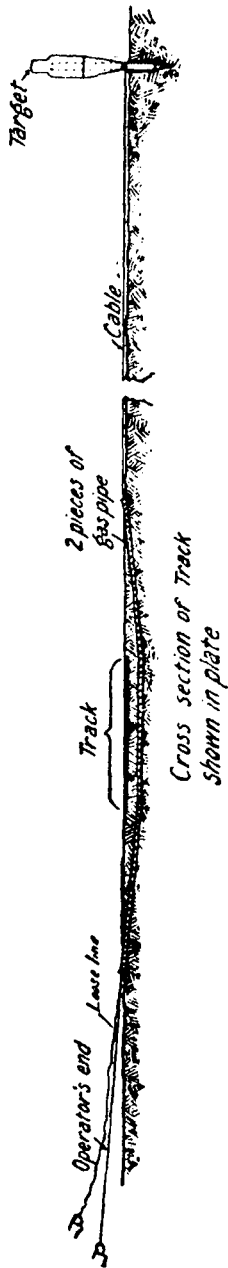

*Cross section of Track
Shown in plate*

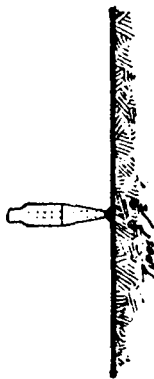

*Longitudinal section of track -
showing pipe in place under track.*

PLATE XI.

PART III.

COMBAT PRACTICE.

GENERAL SCHEME.

200. "The individual instruction is not everything. The maximum effect of a fire is obtained only by instructed and disciplined troops under a commander capable of directing their fire properly. * * * Only instructed and disciplined troops can deliver a fire that can be made use of intelligently * * * its effects become formidable when it is properly directed. When instruction has made of the troops a pliable and manageable instrument capable of understanding orders and executing them, they are in a position to develop all their power in hands that understand how to make a judicious use thereof. It remains to educate those that have to command them."

"In combat the platoon is the *fire unit*. From 20 to 35 rifles are as many as one leader can control effectively." (Par. 250, Infantry Drill Regulations.)

"When the company is large enough to be divided into platoons, it is impracticable for the captain to command it directly in combat. His efficiency in managing the firing line is measured by his ability to enforce his will through the platoon leaders." (Par. 248, Infantry Drill Regulations.)

The fire of the company, the battalion, the regiment, and larger units is nothing more than the combined fire of all the fire units. It is necessary, therefore, that the leaders of the fire units learn how to utilize the power of all the rifles under their command and to control the fire to suit the varied and numerous situations in which the tactical direction of their superiors may place them.

In action the situations vary greatly. They are frequently unforeseen, calling for quick decisions, and the prompt solution

of such questions will arise in the mind only after long practice with numerous exercises in time of peace.

In the training of subordinate officers and leaders, to enable them to play their part intelligently, it is necessary to confront them with definite situations in such a manner as to appeal to their professional knowledge. By such means a judgment may be cultivated which will be equal to any emergency that may arise.

In the combat exercises prescribed in paragraph 357, Infantry Drill Regulations, all the tactical operations associated with the conduct of fire—initiative in opening fire, utilization of the ground, choice of targets, strength of the firing line, and kinds of fire to be employed—may be performed in an instructive manner, using simulated fire. It is important, however, in such exercises that a strict fire discipline be maintained and that the operations involved in the simulated adjustment of the fire be performed with the greatest care and exactness.

It remains to complete the instruction of the unit leaders by exercises with ball cartridges, the results obtained in hits on the targets providing a confirmation or proof of instruction which no other means can afford. Combat exercises, with real fire of the platoon and of the smaller units, the enemy being represented by figure targets and the firing coming as a culmination, provide the best means for this final instruction.

As required by paragraph 356, Infantry Drill Regulations, every combat exercise should be under an assumed tactical situation. In exercises with ball cartridges, however, only portions of an episode or episodes of a combat should be represented. It is difficult to arrange the targets and apparatus so as to reproduce correctly all the phases of an offensive or defensive action. In such a case the results can not well be separated for analysis and proper criticism, so that much of the instructional value of the exercises will be lost.

A combat firing exercise will be conducted for the company. Such exercises may be conducted for the battalion or higher tactical units if the ammunition is available.

201. The Drill Regulations, Infantry, under the headings *Fire* and *Combat* give the rules for the conduct of fire which are applicable to all combat firing exercises. These rules are tactical. The technical phases of the question are included in the sub-

jects, *The Effect of Fire, The Influence of the Ground, The Adjustment of Fire*, given herewith.

Following these subjects, rules are given for the conduct of the class of firing designated as instruction combat practice, held on the class "A" range immediately after the completion of the long range practice. This practice constitutes an intermediate step between range practice at rectangular targets and combat firing on the class "B" range. It marks the transition from individual marksmanship to collective marksmanship. Hence the exercises are purposely made formal and simple.

In addition to the rules for the preparation and conduct of combat firing exercises and rules for the proficiency test, statements are given of several typical firing exercises, including examples of demonstration firings, the subject being concluded by a critique of a hypothetical firing exercise.

CHAPTER I.

THE EFFECT OF FIRE.

202. BALLISTIC QUALITIES OF THE RIFLE.—The ballistic qualities of an arm are indicated by its accuracy, flatness of trajectory, and disabling power.

The accuracy of the United States rifle, caliber .30, model of 1903, is shown in the table of deviations in "Description and Rules for the Management of the United States Rifle, Caliber .30," which exhibits the mean vertical and mean horizontal deviations expressed in inches for the various ranges from 100 yards to 2,000 yards, inclusive. The same publication exhibits in the Table of Ordinates and Table of Fire, the form of the single trajectory. The striking energy or disabling power of the arm is indicated in the table showing the penetration of the bullet at various distances in different materials and substances.

The quality of flatness of trajectory is directly dependent upon the initial velocity and to some extent upon the form of the bullet, a given weight being assumed.

Two rifles of different type may possess the same accuracy, that is to say, the same dispersion, at any given range; but if one of the rifles gives a trajectory more curved than the other, an error in the setting of the sight due to an erroneous estimate

of the range will cause a greater displacement from the aiming point of the center of impact of the diagram of hits than will be the case with the rifle with a flatter trajectory. A flat trajectory can not do away with the influence of errors in aiming, but this quality bestows an advantage in that with one sight a greater extent of ground may be held under fire and the target still be hit when it is not at the exact distance for which the sight is set.

The trajectory cuts the line of sight in two places, the first near the muzzle, the second at the point aimed at (supposing the point to be struck); between these two points all portions of the trajectory are above the line of sight. If aim be taken at the lowest point or element of an object, it follows that if the highest ordinate of the trajectory corresponding to the range is equal to or less than the height of the object aimed at, the danger space for that object will be continuous. For example, the highest point of the trajectory corresponding to a range of 500 yards is 2 feet above the line of sight, so that for an object of that height, or greater, the danger space will be continuous provided aim is taken at the foot of the object. It is this circumstance which permits the adoption of a universal sight—the battle sight—adaptable to all the shorter ranges.

Owing to the fact that curvature of the trajectory increases with the range, the angle of fall for the longer ranges will be greater and the danger space for an object of a given height will be less, the falling branch only of the trajectory being considered. The increase in the distance also makes it more difficult to obtain a close estimate of the range.

203. THE CONE OF DISPERSION AND THE PROBABILITIES OF HITTING.—The causes which make for dispersion of shots as given in the table of deviations of the United States rifle are dependent upon variations in different parts of the rifle and imperfections in the ammunition alone.

In consequence of differences in sights, the variations in different parts of the rifle, and in the ammunition, and, to a much greater extent, individual errors made in aiming and firing, a series of shots fired by a body of soldiers with a common aiming point and the same sight setting, under uniform meteorological conditions, will not all follow the same path but will be more or less separated.

The trajectories considered together make a horn-shaped figure called the cone of fire or cone of dispersion, owing to the resemblance to the geometrical figure of that name. The term "sheaf of bullets" is also used to express the same meaning, and all these are applied to a particular series of collective shots fired in practice, or in service.

If the shots so fired be intercepted by a vertical target in a position normal to the direction of the fire, a diagram of hits will be formed called the shot group. In the diagram of hits the shots appear as most thickly disposed about a point situated approximately in the center of the group, called the center of impact. From this point in all directions the density of the grouping decreases progressively—at first gradually, then more rapidly out to the limits of the group.

The arrangement of shots in the diagram of hits, apparently regardless of any rule, is in fact in conformity to a law which does not exhibit itself until after the delivery of a large number of shots. If measurements be made of a given shot group, the wild shots being disregarded, and the mean vertical and mean horizontal dispersion from the center of impact be found, these measurements will be in effect statements or indexes of the law of distribution of the hits for that particular group. A horizontal strip of the width of the mean vertical dispersion and symmetrically placed as to the center of impact will contain 50 per cent of the hits in the group.

It is well known that the dimensions of the cone of dispersion and of the shot group vary with the skill of those firing; good shots will make a small group and poor shots a large group. If the mean vertical and mean horizontal dispersions for riflemen of a certain grade of skill be determined for various ranges, a large number of shots being considered, means are provided by which, in connection with a table of probability factors, there may be computed the probable number of hits to be expected in collective firing by shots of the same degree of skill at any range, at targets of any size. By this means a suitable standard may be constructed by which the results obtained in combat firing may be judged. A comparison of the efficiency shown in any firing exercise with that to be expected from average instructed shots with properly adjusted sights under favorable

conditions will disclose if the results have fallen somewhat below the probable results; in which case a proper consideration of all the influences which adversely affect shooting under service conditions will enable a judgment to be formed as to why the results have fallen below the requirements. With a known standard of comparison and with a correct appreciation of adverse conditions, effective criticism, which is the basis of good instruction, may be realized.

The intersection of the cone of dispersion with the surface on which the object of the fire stands is called the beaten zone. On a horizontal surface the form of the beaten zone is somewhat that of an ellipse with its major axis in the direction of the line of fire. At short ranges the elliptical figure is very much elongated, and, as the range is increased, the greater axis becomes shorter. When the surface of impact is on ground rising with respect to the line of sight the longer axis is very much shortened, or, in other words, the depth of the beaten zone is very much diminished, as may be seen from the diagram below.

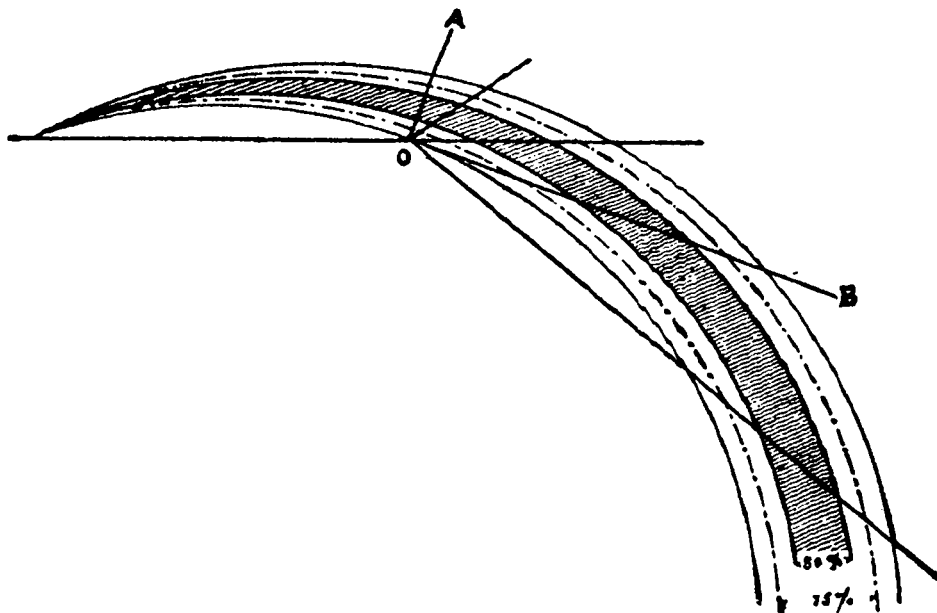

PLATE XII.

The grouping obtained on the surface of the ground by shots fired as a volley, or in a particular series of shots fired collectively, is sometimes referred to as the shot group.

The arrangement of hits in the beaten zone follows a law similar to that in the diagram of hits on a vertical target. The mean longitudinal dispersion on a horizontal surface in the direction of the fire bears a direct relation to the mean vertical dispersion, being the product of the latter by the cotangent of the angle of fall.

In addition to the 50 per cent zone corresponding to the lateral strip containing the best 50 per cent of the hits on the vertical target, the area covered by the best 75 per cent of all the shots in the beaten zone, called herein the zone of effective fire, is considered and the depth of this zone, as determined experimentally for average shots, forms the basis for certain rules laid down under the heading "Adjustment of Fire."

204. The table of dispersion below gives the measures of the mean vertical and mean lateral dispersions in feet and of the longitudinal dispersions in yards for various ranges, as determined by experimental trials at the Musketry School with *average instructed shots*, the surface of reception being assumed as horizontal.

Table of dispersion—Average shots.

Range.	Mean vertical.	Mean lateral.	Mean longitudinal.	Longitudinal 75 per cent zone.
<i>Yards.</i>	<i>Feet.</i>	<i>Feet.</i>	<i>Yards.</i>	<i>Yards.</i>
100	1.07	0.97	¹ 308.04	¹ 423.00
200	2.03	1.77	398.21	¹ 308.00
300	2.87	2.41	348.79	592.00
400	3.59	2.90	282.04	479.00
500	4.21	3.26	219.91	373.00
600	4.88	3.75	185.37	315.00
700	5.62	4.40	156.66	266.00
800	6.44	5.23	135.28	229.00
900	7.33	6.21	118.57	201.00
1,000	8.29	7.37	105.89	180.00
² 1,000	9.33	7.71	96.35	163.80
1,200	10.52	8.69	89.71	152.51
1,300	11.79	9.74	84.50	143.66
1,400	13.12	10.84	80.14	136.23
1,500	14.50	11.98	76.00	129.00
2,000	22.71	18.76	64.00	109.00

¹ Measured from the muzzle in the direction of the line of fire.

² Dispersions beyond 1,000 yards have been calculated from those at the lesser ranges which were determined by experiment.

From the table a conception may be gained of the form and dimensions of the cone of dispersion for average instructed shots.

It is seen from the table that as the range increases a less depth of ground is held under fire with a single sight setting, and if an error in sight setting be made, due to an incorrect estimate of the range, the center of impact will be misplaced and there will be a loss in effect in proportion to the amount of displacement, the loss in effect being greater as the beaten zone is less. Furthermore, the difficulty of exact range determination increases with the distance, the two influences combining to make long-range fire uncertain and usually ineffective.

A somewhat opposite condition prevails at the shorter ranges, where, owing to a very much flattened trajectory, a great depth of beaten zone may be held under fire with a single sight setting.

205. The scope of a single sight setting at the shorter ranges may be illustrated by taking the range of 500 yards and the dispersion for that range, from which may be computed the percentage of hits to be expected on strip targets of different vertical dimensions corresponding to the heights of various service targets, these being set up at ranges from 200 yards to 900 yards. The results of such a computation are shown in the table below.

Percentage of hits to be expected with average shots at various ranges on strip targets of different heights with sight set at 500 yards, aim being taken at the lowest line or element of the target.

	Height 1.33 feet, prone figure.	Height 1.83 feet, prone figure.	Height 3.5 feet, kneeling figure.	Height 5.67 feet, standing figure.	Height 8 feet, horse figure.
200	25.2	38.3	59.0	88.7	89.37
300	20.3	29.3	68.4	78.3	82.57
400	18.9	26.2	48.4	64.7	69.39
500	16.4	21.9	36.8	46.5	49.45
600	10.0	13.0	19.8	23.7	24.77
700	3.2	4.1	5.8	6.7	6.80
800	0.43	0.78	0.78	0.78	0.78
900	0.00	0.00	0.00	0.00	0.00

Low aiming, or the choice of the lowest point or element as an aiming point, which is required, as a rule, in all firing instruction, may be looked upon as the normal practice in service. With the average soldier the best performance to be expected in the heat of action is that he will aim at the foot or lowest element of the objective. While some may in the moments of excitement possess the coolness to estimate the range exactly and choose a higher or lower point according to their judgment, such exceptions can hardly influence to any great degree the general results which are dependent on the performance of the mass or great majority.

206. THE EFFECTIVENESS OF FIRE.—The effectiveness of fire under battle conditions and in combat firing exercises is depend-

ent upon the three factors: *The percentage of hits made, the number of targets hit, and the time of execution.* The ultimate effect may be expressed synthetically by the number of enemies disabled or targets hit in a unit of time.

207. The percentage of hits is dependent upon the dispersion, and this is influenced by the precision of the arm, the distance from the target, the visibility of the target, the prevailing atmospheric conditions, the training and instruction of the troops, and upon their physical and normal state at the time.

The percentage of hits is also dependent upon the visibility of the objective, upon the character of the ground as favoring ricochet hits, upon the correct estimation of the distance, or choice of sight, and designation of the target, these latter pertaining to fire control.

208. With a given accuracy, the number of targets hit or the distribution of fire may be affected by varying degrees of visibility, as men instinctively choose the more conspicuous marks as aiming points. Under any circumstances, an imperfect distribution of the hits made will be due to an absence of proper instructions from the leaders, or, in other words, to poor control, or else to a want of understanding or lack of obedience on the part of the men.

209. The time of execution is important in that the gaining of fire superiority is dependent less upon obtaining high percentages of hits than upon making an absolutely large number of hits in a unit of time. There is necessarily a limit to the rapidity of fire which, if exceeded, will result in some loss of accuracy. With targets of a fair degree of visibility, the following may be taken as standard rates of fire for troops who have been given suitable training in target practice:

200 yards	}	10 shots per minute.
300 yards		
400 yards		
500 yards	}	7.5 shots per minute.
600 yards		
700 yards		
800 yards		
900 yards	}	5 shots per minute.
1,000 yards		
Greater ranges, 3 shots per minute.		

The rates given should not exclude higher rates of fire in the case of large and conspicuous targets. On the other hand, when objectives, or marks used as aiming points, are very indistinct, the requirement of correct aiming imposes rates of fire somewhat lower than the standard rates given even for well-instructed men. With imperfectly trained men who have not fully acquired the habit of using aimed fire only, and who are lacking in the manual dexterity required for executing the standard rates of fire, the maximum rate can not well exceed six shots per minute without incurring the danger of lapsing into unaimed fire. Fatigue and exhaustion, the results of marches or prolonged firing, have a detrimental influence and tend to lower the rates of effective fire.

210. The results obtained in collective firing exercises in time of peace give but a slight basis for estimating the results to be expected in time of war. The somewhat inferior training of units mobilized to war strength, the emotions to which even disciplined men are subject in action, and the physical impairment incident to service conditions are influences which combine to greatly lessen the effects which peace-time experiments give, this lowering in effects being due to increased dispersions, the latter, under the doctrine of chances, giving lesser probabilities of hitting in proportion to the increase in dispersion.

It has been estimated that war-time dispersions will vary according to the training, morale, and physical condition of the troops from twice to four times, or more, the peace dispersions. This is not a condition to be desired or sought, but one to be understood and reckoned with.

CHAPTER II.

THE INFLUENCE OF GROUND.

211. DEFILADE.—An obstacle of sufficient thickness to prevent the penetration of the bullet will protect from fire the space extending from its foot to the point where the bullet, which grazes its crest, meets the ground. The space which is thus protected from fire is called the "defiladed space." Its extent

will depend on the height of the shelter, the curvature of the trajectory, and the slope of the ground behind the shelter.

In the illustration the distance A-T will represent the defiladed space for the trajectory B-T and an obstacle the height of A-B. A soldier beyond T would be struck with bullets passing a slight distance over the crest B; he would be partially sheltered between T and C (the danger space for this trajectory); and would be completely protected throughout the distance A-C.

If the height of the shelter be less than that of a man standing, only a partial protection will be afforded, and to obtain

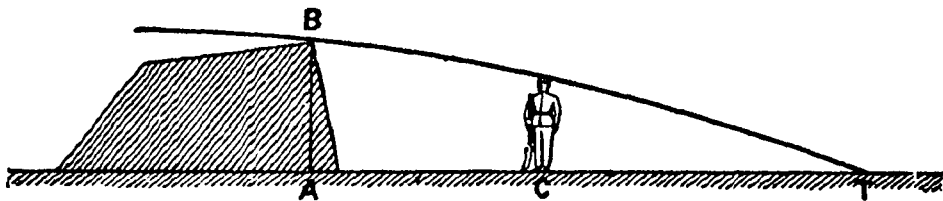

PLATE XIII.

complete shelter it will be necessary for the soldier to assume the kneeling or prone positions. By cover is meant effective defilade from the enemy's fire. Concealment means a screening from view but not necessarily protection from fire.

212. RISING AND FALLING GROUND.—The influence of the ground upon the effect of fire manifests itself in the depth of the beaten zone. This depth is decreased if the surface of reception rises with respect to the line of sight; it increases, on the other hand, if the surface of reception falls with respect to the line of sight.

The effect of different slopes on the depth of beaten zones for various ranges, based upon the dispersion of average shots, is shown in the table below.

Mean (50 per cent) beaten zone on slopes—Average shots.

[Zone given in yards.]

Range.	Rising.							Level.					Falling.			Defladed angle of fall
	25°	20°	15°	10°	5°	4°	3°	2°	1°	0°	-1°	-2°	-3°	-4°	-5°	
600	3	4	6	9	17	20	26	37	61	185						0° 30'
700	4	5	7	10	19	23	29	40	63	156						0° 41'
800	5	6	8	11	21	25	31	41	64	135						0° 54'
900	6	7	9	13	23	27	34	44	64	118	708					1° 10'
1,000	6	7	9	14	24	29	35	45	63	105	315					1° 20'
1,500	9	11	14	20	32	36	41	49	59	76	105	171	456			3° 37'
2,000	13	16	19	26	37	40	44	49	54	64	75	91	116	159	252	6° 46'

NOTE:

a— Angle of fall.

b— Beaten zone on level ground.

s— Angle of slope;
then

$$\frac{ab}{a-s} = \text{beaten zone on falling ground and } \frac{ab}{a+s} = \text{beaten zone on rising ground.}$$

These are von Rohne's formulae, from which the attached tables are computed. These are found in Balck's "Tactics," vol. i (Krueger translation). See footnotes, page 180.

It should be remembered that, assuming a proper adjustment of the fire, depth of beaten zone can affect only targets which have depth. On a lineal target the depth of the beaten zone has

*FIG. 1.**FIG. 2.*

PLATE XIV.

no effect one way or the other. If this target is backed up by supports and reserves, the effect upon them will depend upon their position with respect to the firing line which forms the ob-

jective or aiming point and upon the depth of the beaten zone. The beaten zone, as has been shown, is influenced by the lay of the ground, whether rising or falling, with respect to the line of sight.

An example of the shortening of the beaten zone is seen in the case of fire delivered from a height at a target situated on a horizontal plane beneath. (See fig. 2, Pl. XIV.)

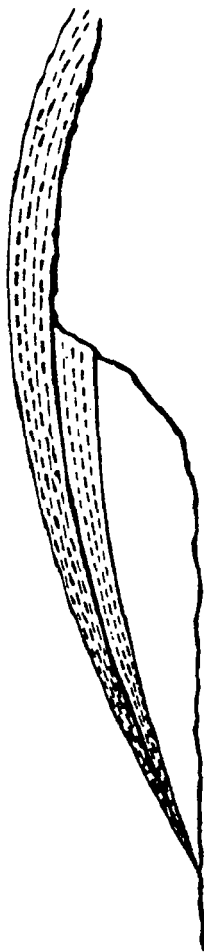
An example of increasing the depth of beaten zone is seen in the case of fire delivered from low ground at a visible target situated at the edge of a plateau or crest of a ridge from which the ground slopes to the rear. (See fig. 1, Pl. XIV.)

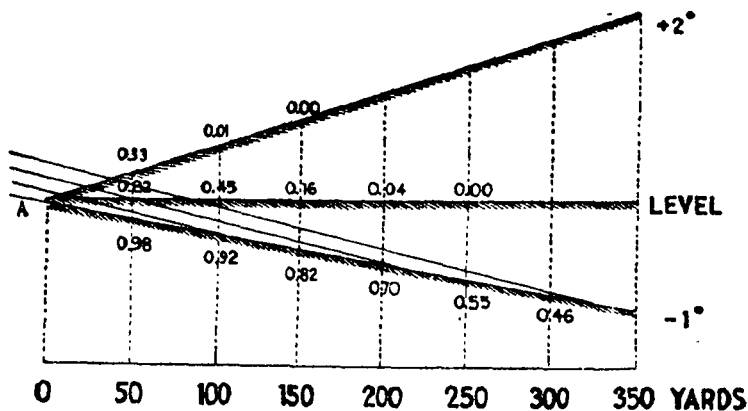

PLATE XV.

Shots which pass over a crest with an angle of fall conforming to the inclination of the surface of the ground beyond the edge of crest, or nearly so, are called grazing shots and fire so delivered is called grazing fire. (See fig. 1, Pl. XIV.)

The diminution or increase in fire effect for average shots due to rising and falling ground is shown in the diagram below, following an idea borrowed from the works of Gen. von Rohne.

A 2° rising slope and a 1° falling slope are assumed. The targets which form the objective are assumed to be at "A." With average shots firing, the figure shows relatively the influence of the ground on the efficacy of the fire on targets similar to those at "A" and placed at different distances in rear thereof.

For better illustration the angles are exaggerated in the drawing. The range is taken as 1,000 yards and the figures expressing effect at different distances in rear of "A" on rising ground, level ground, and falling ground, are ratios, the effect of "A" being unity.

It is seen from Plate XV how rapidly the effect disappears on rising ground and how the effect is better maintained on falling ground.

When the ground slopes upward to the rear from a firing line, the supports may be placed closer without increasing the danger from fire aimed at the firing line. On the same sort of ground it is shown that a column target, or one which has depth, is more vulnerable than a lineal target.

When the ground slopes down and to the rear from the firing line, the supports must be posted at a greater distance in rear, unless the slope is so much greater than the angle of fall of the hostile bullets that a deflated space is created in which no bullets strike. On falling ground, however, opposite conditions prevail as to vulnerability from those stated above. Making the allowable assumption that the fire is equally distributed along the crest, the column target behind the crest and invisible from the firing point will receive hits only in proportion to its width.

It may be said, therefore, that on ground rising with respect to the line of sight, column targets, as those having depth, will suffer the greater losses; on ground falling in respect to the line of sight, the reserve slope of hills or the level grounds of plateaus, line targets will suffer the greater losses.

When the ground falls away to the rear at a greater angle than the angle of fall of the projectile, deflated spaces are created, which enable bringing the supports close to the crest. With the service rifle and ammunition it is well to remember that an angle of fall of 1° corresponds to a range of about 900 yards, an angle of fall of 5° to a range of about 1,800 yards.

Through a judicious choice of ground, the measurement of slopes, the placement of targets, and the selection of firing points, the possibilities of the species of indirect fire known as grazing fire may be demonstrated; but the mere possibility of inflicting damage on invisible enemies must not create a false impression as to the use of this class of fire. (C. S. A. F. M. No. 1.)

213. RICOCHET SHOTS.—Bullets which ricochet usually tumble after striking, and jacketed bullets, on striking a hard, rough surface become altered in form more or less, the jackets sometimes becoming separated from the lead core. Wounds inflicted by ricochet hits are, therefore, as a rule, severe.

The most favorable ground for ricochets is a smooth, hard, horizontal surface. Bullets also ricochet on water and, to a lesser extent on plowed ground, wet clay, wet turf, or swampy ground. The chance of ricochets in sand is very slight. Bullets which ricochet are often deflected laterally and the amount of deflection influences the range of the rebound. The maximum angle of deflection is about 30° and it is usually to the right. The range will be greater as the point of strike is nearer the point from which the piece is fired. A smooth, hard surface so inclined as to give an acute angle of fall to the bullet produces the maximum range of rebound, which is about 2,500 yards or a little more.

While various results may be quoted, it is probably correct to say that the maximum number of ricochet hits to be expected is about 20 per cent of the hits scored.

214. THE OCCUPATION OF GROUND.—The question presents two aspects, as follows:

First. What firing positions may be chosen which will tend to increase the losses of the enemy?

Second. What positions may be chosen and formations adopted to minimize our own losses?

Where other conditions admit, it is obvious that a defensive position well down a slope is preferable to a position higher up, on or near the crest, as by this arrangement the depth of the beaten zone for fire delivered therefrom is increased and the upper portion of the cone of shots will include the supports and reserves advancing to reenforce the firing line of the attacking force. This course also tends to eliminate dead spaces, which might otherwise exist at the foot of the slope.

On the other hand, a defensive position near the crest, besides favoring observation of the enemy, lends itself to a ready withdrawal of the firing line should a falling back be necessary, or else to its prompt reenforcement by the supports advancing from behind the crest. The decision as to choice of ground to be occu-

pled in any particular case must therefore be dependent upon judgment as to the relative value of the ballistic and tactical considerations involved.

Consideration must also be given to the conditions of the action so far as neighboring troops are concerned.

For troops on the defensive there will frequently be no choice of a position. In such cases it will be necessary for them to accept that which circumstances offer. The defense itself will usually be restricted in its choice by the necessities of neighboring troops.

From the point of view of avoiding losses, all gentle reverse slopes are dangerous and are to be avoided when possible. When necessary to traverse or to occupy such ground, precautions must be taken to protect the reserves or other bodies of troops by placing them on the flanks; by disposing them in formations with a narrow front; by causing them to lie down; by the construction of suitable shelter; and by avoiding useless movements. Finally by placing the firing line, which will be the visible target and at which the enemy's fire will be directed, as well down the slope from the crest as tactical considerations will admit, the high ground will interpose as a defilade and intercept the upper portion of the collective cone which might otherwise take effect on objects behind the crest.

It is thus seen that the principal lesson to be learned concerning the influence of the ground consists in finding out the things which are to be avoided.

CHAPTER III.

THE ADJUSTMENT OF FIRE.

215. FIRE AT STATIONARY TARGETS.—The correct adjustment of infantry fire is attained by causing the center of impact of the collective group to fall on the center of the target, this placement of the group under the law of probabilities insuring the greatest number of hits. This is the problem constantly presented in combat firing and in service.

Two distinct and independent elements enter, which may supplement or counteract each other—the influence of the troops

and that of the commander. When a body of troops has aimed correctly at the indicated objective with the elevation ordered and has fired with steadiness, it has done all that can be expected of it; but this is not sufficient. It is the duty of the commander to bring the shot group into proper relationship with the target. If the correct elevation be given, a maximum result will be obtained; if a mistake is made, the result may be nothing.

It is known that good shots make a small group and poor shots a large group, average shots making a group of intermediate size. The maximum effect is obtained if the shots are of the highest grade and if the center of impact is correctly placed. But if the center of impact of the group made by good shots is displaced, the effect falls off very rapidly compared to the other grades of shots, and if the displacement is very great, it may be sufficient to insure that the good shots will make no hits at all, while, with the same displacement of the center of impact, the fire of the poorer grades of shots will continue to have some effect. In other words, the fire of a thoroughly trained body of troops may be less effective than that of much poorer shots if, through a lack of appreciation of the range, the center of impact of its shot group be displaced. These statements are illustrated by the diagram.

Normally, battle-field targets are lineal targets, and hence a lateral displacement is of slight consequence, as shots aimed at one element or section of the hostile line may take effect in some other element or section of the same front. Owing to the slight depth of service targets and to the form of the trajectory, the longitudinal placement of the center of impact is more difficult.

The point of strike of the bullet is determined by the angle of elevation given the axis of the bore when the piece is fired, and the adjustable slide of the rear sight, with the scale of the leaf graduated to yards, is a device for giving the elevation necessary to reach any point within the range of the arm. If the range to a target is known exactly, under average conditions a perfect adjustment of the fire will be obtained by having each man of the firing detachment set his sight for the indicated range, the mean trajectory of the cone of dispersion approximating closely to the normal trajectory for the range indicated.

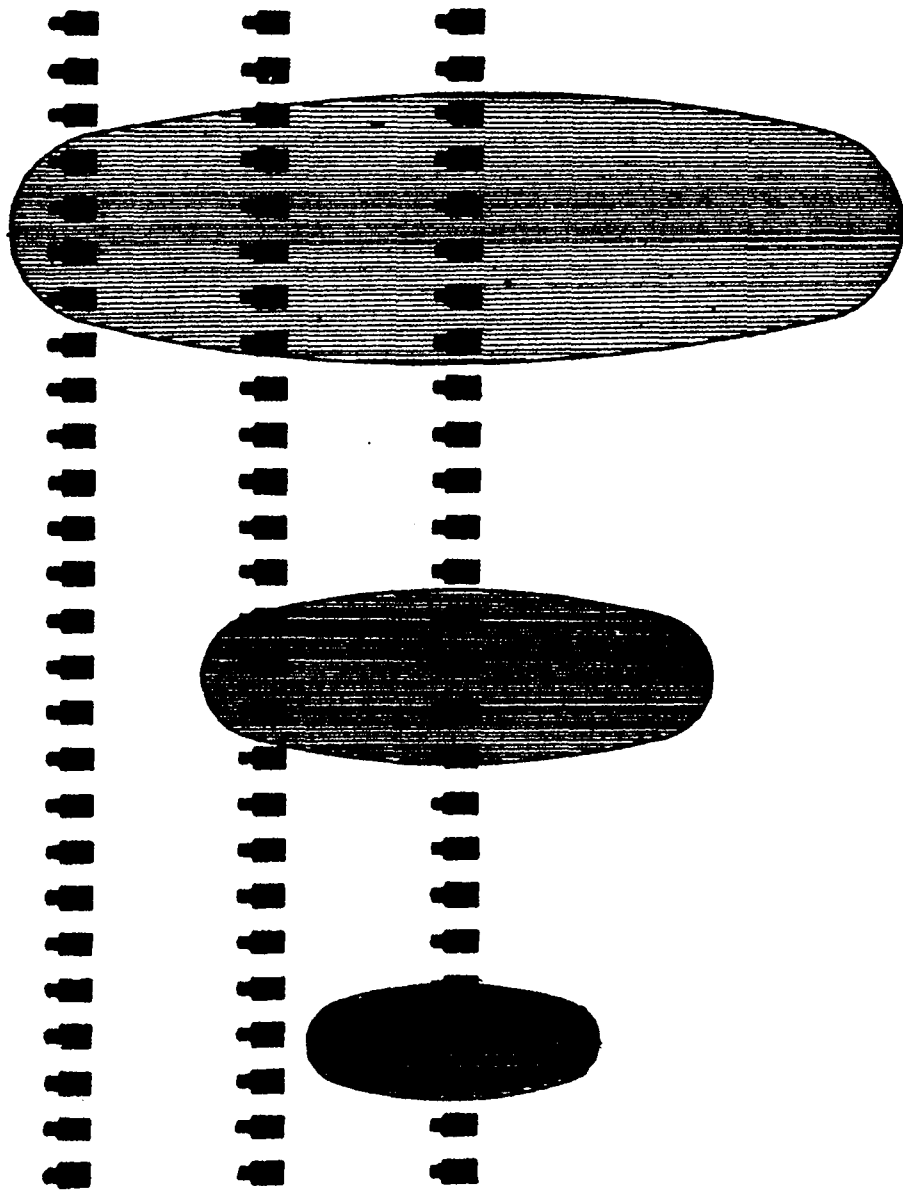

PLATE XVI.

The question resolves itself therefore into the question of finding the range, which, as a rule, in combat firing and in service, will be known only approximately. The result obtained will be in proportion to the accuracy of the means and appliances available for determining the range.

With soldiers who have had some instruction the average error in the estimation of ranges by the eye, for distances between 600 and 1,200 yards, is approximately 15 per cent. The average error of a well-instructed class is about 12½ per cent. The best instrumental range finders will give results with an error not exceeding 5 per cent of the range. The mean estimate of a given range by several trained estimators may be expected under peace conditions to approximate closely the results obtained with a good instrumental range finder. Owing to the fact that, as a rule, the overestimates and underestimates counterbalance each other to some extent, the mean of several estimates will give a better result than the average estimate of the same mean expressed in percentage. By the use of such means it may be expected that the error made will be between 5 per cent and 10 per cent, the latter being more probable in time of war. Some error must always be expected, and the question is one of lessening it or minimizing its effects.

216. REAR-SIGHT CORRECTIONS THROUGH OBSERVATIONS OF SIGNS OF IMPACT.—When the surface on which the objective stands is such as to give visible signs of the impact of bullets, a supplementary means is provided by which rear-sight settings may be corrected. When the ground is favorable, the simultaneous strike of a number of shots fired with the same rear-sight setting gives a better indication of the location of the shot group than the same number of shots would provide if fired at the will of the individuals of the platoon or detachment.

In order to be able to recognize the center of impact on the various surfaces ordinarily met with in service, it is necessary to be acquainted with the form and dimensions of the beaten zone as it will be exhibited thereon. A rising surface of reception produces a shortening effect on the beaten zone. This is shown graphically in Plate XII and more specifically in figures in the table given with paragraph 212. As a rule, surfaces

which afford good signs of impact visible at the firing point will have a rise of 1 degree or more.

When the existence of favorable ground allows the strike of the shots of a trial volley to be plainly seen, the correct placement of the center of impact may be made by a series of approximations. Not more than three trial volleys should be required for a good fire adjustment, and this once attained, a change should be made at once to "Fire at will," at a rate suited to the range and the visibility of the objective. In making rear-sight corrections it is necessary to make positive changes, rarely less than 50 yards at a time. It is an insufficient and faulty procedure to endeavor to correct a wrong adjustment through vague instructions, such as enjoining the men to aim a "little higher" or a "little lower." Where indications of impact are sufficient to form a basis of judgment, it may be stated as a rough rule that the fire will be properly adjusted when about one-third of the shots of a trial volley appear to strike in front and two-thirds in rear, it being remembered that the direct hits will pass through and strike in rear of the target.

As a rule, a perfect condition will not be realized. The ground may be wet or covered with turf, sod, tall grass, or brush, in which cases the indications may be entirely lacking or else so slight as to form no basis of judgment. Indications will be only partial when the objective is along the crest of a ridge, the upper portion of the cone of dispersion going over the crest and giving no indications. The same will be true when the objective occupies the near edge of a body of woods or is along a hedge which completely screens from view the ground in rear of it.

However partial or imperfect the signs of impact, close observation should be resorted to in every case, as slight indications may sometimes furnish a basis for rear-sight corrections. For observing the effect of fire good field glasses are indispensable, and the necessary skill in their use, through which correct conclusions may be drawn, is to be acquired only through practice. An objective is difficult to adjust upon when it occupies one of a succession of parallel ridges alternating with depressions, the ground appearing from the firing point as a continuous surface. In such cases the only indications will come from shots

which strike the ridges, those falling in the depressions being lost. From such indications wrong conclusions may be drawn unless the lay of the ground is discovered through close observation with field glasses.

In noting the strike of shots it should be remembered that the dust will be seen somewhat above the actual point of impact and to the right or left, depending upon the direction of the wind. The best position from which to observe the effects of fire is behind and, if possible, above the party firing, but in this position it must be remembered that bullets which fall short will be most easily seen and consequently will appear to strike farther from the objective than bullets which strike an equal distance beyond. To an observer on or beyond a flank of a party firing, shots which pass over the objective will appear to fall toward the side on which he is posted, and those which fall short toward the opposite side.

When the surface of the ground is such as not to furnish any indication to an observer at the firing point of the effects of fire, the correctness of the rear-sight elevation may sometimes be inferred by careful observation of the actions or movements of the enemy.

Habitual practice on favorable ground may tend to cultivate too great a dependence on signs of impact in making rear-sight corrections, and this is to be guarded against. It should be remembered that even on favorable ground, if a large number of troops be engaged, it will usually be difficult, if not impossible, for commanders and leaders to distinguish indications of their own fire from that of other troops.

217. COMBINED SIGHTS.—When means of exact determination are not available and indications of impact are lacking or insufficient and the range can not be learned from the artillery or neighboring troops, some error in the range must be expected. In such a case, through the expedient of combined sights, a greater depth of beaten zone may be created, giving an assurance of effect which might not otherwise be obtained. Such a fire loses in concentration, and this must be compensated for by the employment of a larger number of rifles. The most common application of combined sights will be in executing fire of

position. The expedient will not usually be employed by bodies of less strength than a battalion.

The approximate ranges for combined sights and the number of sights to be employed in any case are questions which depend upon the depth of the beaten zone and the probable error in the estimation of the range. Both these factors vary between certain limits. The depth of the beaten zone varies inversely with the range. It will also be greater in time of war than in time of peace, but in view of the circumstances under which the fire of position will usually be executed, a very great dispersion need not be looked for. The greatest probable error will be about 15 per cent of the range. When a good instrumental range finder is available the error should not exceed 5 per cent of the range. In the majority of cases the error to be expected will lie between these two extremes.

Taking the 75 per cent zone as being sufficient, if the probable error is such that it does not exceed one-half the zone considered, then it is certain that the objective will lie somewhere within the beaten zone created with a single sight setting. The normal depth of beaten zone for a single sight setting will be sufficient up to the point where the expected error is about equal to 75 per cent zone. Beyond this point it will be necessary to use two sight settings, one above and the other below the estimated range and differing from each other by the depth of the beaten zone at that range. As the normal beaten zone decreases in depth with the range, and as the expected error measured in yards increases with the range, a point will be reached where two sight settings will be insufficient and it will be necessary to resort to three settings of the rear sight, one being set at the estimated range, one over, and the third under, the difference being equal to the normal depth of zone at that range.

The table below exhibits the ranges where it is necessary to resort to combined sights with various assumed errors. The table is given, not as establishing any rigid rule to be followed implicitly, but as a guide in determining in the first place when combined sights should be used and in the next place how they should be used.

Table of combined sights based on peace dispersion of average shots, the 75 per cent beaten zone, and various errors in the estimation of ranges.

Range.		5 per cent error.			10 per cent error.			12½ per cent error.			15 per cent error.		
75 per cent zone.		Zone to be covered (twice the error).	Number of sight readings.	Difference between readings.	Zone to be covered (twice the error).	Number of sight readings.	Difference between readings.	Zone to be covered (twice the error).	Number of sight readings.	Difference between readings.	Zone to be covered (twice the error).	Number of sight readings.	Difference between readings.
Yds.	Yds.	Yds.			Yds.			Yds.			Yds.		
800	229	80	1	160	1	200	1	240	2	150
900	201	90	1	180	1	225	2	150	270	2	150
1,000	180	100	1	200	2	150	250	2	150	300	2	150
1,100	170	110	1	220	2	150	275	2	150	330	2	150
1,200	160	120	1	240	2	150	300	2	150	360	3	150
1,300	150	130	1	260	2	150	325	3	125	390	3	150
1,400	139	140	1	280	2	150	350	3	125	420	4	125
1,500	129	150	2	125	300	3	125	375	3	125	450	4	125
1,600	124	160	2	125	320	3	125	400	4	125	480	4	125
1,700	120	170	2	125	340	3	125	425	4	125	510	4	125
1,800	116	180	2	100	360	4	100	450	4	125	540	5	125
1,900	112	190	2	100	380	4	100	475	5	100	570	5	100
2,000	109	200	2	100	400	4	100	500	5	100	600	6	100

218. AUXILIARY AIMING POINTS AND TARGET DESIGNATION.— Through invisibility and the practice of concealment it will frequently occur in service that individual enemies or deployed bodies of the enemy will be too inconspicuous to provide in themselves a good aiming point. In such case it is necessary to select well-defined marks or objects in the immediate vicinity upon which to direct the fire, these being so chosen and the rear sight so adjusted that the objective will lie at the center of the resulting beaten zone.

When natural and artificial features are numerous enough to make a confusion of forms or when the surface is of a monot-

onous character, unbroken by marks which might serve as aiming points or points of reference, target designation is difficult. It is necessary that indications be given in clear and precise terms, and that the men in ranks have the capacity to understand what is said. A lack of understanding may cause the fire to be delivered in quite another direction from that intended.

It is frequently advantageous to make use of the clock rotation in indicating the direction of a target. For this purpose a well-defined object in front is announced and considered as being at 12 o'clock, the objective being indicated by the usual clock designations according to the difference from the point of reference. Angular differences between the target and reference points may be indicated by finger breadths. The field glass is an important accessory, and the passing of field glasses to the men in ranks will often facilitate target designation, besides tending to allay nervousness or excitement.

219. FIRE AT MOVING TARGETS.—The adjustment of fire on moving objectives is subject to certain special considerations in that, due to changes of position of the target, it is not possible with a certain sight setting to maintain a perfect adjustment of the fire. Changes in sight setting are necessary to conform to the changes in the position of the target, and the two questions naturally arise, what original sight setting should be adopted upon first opening fire and what changes in it should be made as the action progresses.

It is obvious that if a beaten zone be established immediately in front of an enemy, his forward movement into the beaten zone will complete the adjustment of the fire. Due to the chance of overestimating the range, it is necessary to adopt a rear sight setting *well under* the estimated range, in order to insure that the beaten zone will be in advance of the enemy. When the fire becomes effective, as may be judged by the actions and movements of the enemy, the rate of fire should be quickened in order to increase the effect of the fire. When the target continues to advance till it has passed entirely through the zone of effective fire (75 per cent zone), a lower sight setting will be required so as to again bring the center of the beaten zone in front of the target. Frequent changes of sight cause a loss of time, besides multiplying chances of error in sight setting.

In accordance with these ideas, against infantry advancing, a sight setting 200 yards less than the estimated range should first be used. When the enemy has passed through the zone of effective fire, the sight should be lowered 200 yards and the operation repeated till the battle-sight zone is reached, in which no sight manipulation is required other than throwing down the leaf. Against skirmish lines which advance by rushes the sight setting should not be changed during a rush. This should be done at the halts so that the greater vulnerability of the targets presented during the rush may be taken advantage of.

Against attacking cavalry, due to the rapidity of the advance, there will not usually be time for sight manipulation other than throwing down the leaf of the rear sight, so that the battle sight should be resorted to at all ranges.

Against retreating targets fire should be opened with the sight corresponding to the estimated range, and when the target appears to have passed beyond the zone of effective fire 200 yards should be added to the sight.

In firing at a target moving across the line of fire it is desirable, on account of the confusion caused thereby, to hit the head of the column. It is necessary therefore to hold to the front a distance sufficient to allow for the time of flight and the rate of march. This will be accomplished by the observance of the following rough rules:

Against infantry it is sufficient to hold against the head of the marching column.

In the case of mounted troops at a trot, hold to the front 1 yard for every 100 yards of range; and at a gallop, 2 yards to every 100 yards of range.

220. INDIRECT FIRE.—The proper adjustment of fire on an objective which is screened from the view of the observer at the firing point by an intervening obstacle is dependent upon the conjunction of favorable circumstances not usually met with in service. The height of the obstacle and the range must be such that the objective is not defiladed from fire, and besides determining the range, the position of the objective must be known so that the proper lateral direction to the pieces may be given. For this purpose intermediate auxiliary aiming points will be necessary to mark the direction of the fire. In siege operations op-

portunities may arise for the employment of this kind of fire, in which case material may usually be found for constructing rests for rifles so that fire delivered therefrom will reach important stationary objectives.

221. NIGHT FIRING.—The invisibility afforded by darkness neutralizes the power of the rifle to a great extent by making it impossible to employ the ordinary means of fire adjustment.

In night attacks the purpose of the offensive is to gain rapidly and quietly a position where the issue may be decided in a hand-to-hand encounter, or a position from which the superiority of fire may be gained at daylight. For the offensive, therefore, fire action is a subordinate consideration.

On the defensive, when a night attack is apprehended, preparations should be made to sweep with fire the ground immediately in front over which the assailant must advance. Special arrangements may sometimes be made for resting rifles on the parapet, so that the ground in front will be suitably covered. A solid support is necessary for maintaining the proper direction of the pieces during firing. For this purpose notched boards or timbers are convenient. The arrangements should be such that the operations of loading and firing may be performed without removing the rifles from the support. Searchlight illumination may reveal the position and movements of the enemy sufficiently well to permit the use of the sights. In night operations of small parties fire may be well directed when a bright, well-defined light, such as a camp fire, is presented as an aiming point. In such a case a slight illumination of the front sight is required.

CHAPTER IV.

INSTRUCTION COMBAT PRACTICE.

222. This course of firing, which will be held on a class "A" range, follows the long-distance practice prescribed for men in the grades of expert and sharpshooter, and is intended as a preliminary to the combat firing exercises held on the class "B" range.

There will be one firing exercise for each sergeant and the first sergeant of a company and one for each lieutenant not in command of a company. In the firing exercises designated for sergeants the firing will be executed by a platoon consisting of two full squads. In the exercises for lieutenants the platoons will consist of three full squads.

The targets will consist of a row of kneeling figures at intervals of one yard from edge to edge, the number of figures being equal to the number of men firing. The targets will be set up in the open without any special attempt at concealment.

In the exercise for sergeants the firing will take place at a convenient range between 600 and 800 yards; in the exercise for lieutenants the firing will be at a range between 800 and 1,000 yards.

There will be but one firing point for any one series, for which 10 rounds per man will be issued and fired. The firing will be executed by the commands and means prescribed in the Drill Regulations. This firing will be under the immediate supervision of the captain, who will use every effort, through criticism and the correction of faults, to make these exercises instructive for his subordinates.

The best possible use should be made of field glasses in observing the effect of the fire, with the view of getting better results and of giving additional instruction in the use of glasses. Accordingly, in this practice noncommissioned officers, musicians, and others whom it may be desirable to instruct, should be required in turn to act as observers to assist the platoon leader.

A record will be made in each case of the number of hits made, the number of figures hit, and the time of execution, these results being compared with the established standard.

These records form a part of the company record for the season.

COMBAT PRACTICE.

223. RULES.—(a) Combat practice will follow the instruction combat practice and will be held on a class "B" range during the period announced for the field training of the troops.

(b) All who are required to fire in range practice will take part in the combat exercises. Sergeants, musicians, and trump-

eters will not fire, and corporals will fire only when their squads form a part of the firing line of a larger unit.

(c) Each lieutenant not commanding a company (except battalion staff officers) will exercise command in at least one exercise, the number of men firing being equivalent to a platoon at war strength.

Each sergeant of a company will exercise command in at least one firing exercise, the number of men firing being appropriate to the grade of sergeant.

So far as the ammunition allowance will permit, each corporal will be required to exercise command in combat exercises involving one or more squads.

Following the exercises prescribed for lieutenants, sergeants, and corporals, there will be one firing exercise for the company, the company commander exercising command.

(d) Each man will be required to participate in one combat firing exercise wearing the full field equipment. On other occasions the complete equipment except the pack will be carried.

(e) Should it be impracticable to obtain a class "B" range, the exercises prescribed will be carried out on a class "A" range. While distances will be well known on class "A" ranges and an important element will thus be absent, firing exercises containing some unexpected feature may be devised which will be instructive for those taking part. So far as practicable, their preparation and conduct should be governed by the rules given for other combat exercises.

(f) When different exercises are prepared for the several fire units, each exercise will, when practicable, be carried out in the presence of the other units in order that the maximum amount of instruction may be derived therefrom.

224. PREPARATION OF EXERCISES AND THEIR CONDUCT—RULES.—In the preparation and conduct of combat exercises, the following rules should govern:

(a) Every exercise should involve a tactical idea, although only portions of an episode or episodes of a combat should be represented.

(b) The position of the targets and the interval between targets should conform to service conditions. The number of tar-

gets exposed should, as a rule, be equal to the number of men in the firing line.

(c) The position of the targets and the ranges thereto should be unknown to those participating. If practicable, the exercise should be on unknown ground.

(d) Exercises should be simple in their arrangement, but each should involve some feature which is unexpected to those taking part. Gradually those who have shown themselves proficient may be confronted with more difficult exercises.

(e) The number of cartridges issued to each man should admit of a full illustration of the idea involved in the exercise, and no more. In the simpler exercises, with one group of targets exposed and a single firing point, not less than five rounds per man should be issued. Where changes of the objective are called for or where there is more than one firing point, five rounds per man for each objective and each firing point should be issued.

(f) At the beginning of each exercise the commander of the unit taking part will be informed as to the tactical idea involved and as to the general procedure to be followed. Once begun, the exercise should be allowed to take its course free from interruption unless it becomes necessary to interfere to prevent accidents; and as every combat exercise is designed to represent a tactical idea, it will be conducted by means of the prescribed commands and signals and in accordance with the rules laid down in the Drill Regulations under the headings "*Fire*" and "*Combat*," these being supplemented by the principles and rules given herein under the heading "*Adjustment of Fire*."

225. SUPERVISION.—Every combat firing exercise will be supervised by an officer whose duty will be to note the conduct of the exercise, to compare the results obtained with the standard of judgment, and to point out the faults committed. He should have two assistants to record the time, compute the number of hits to be expected under the conditions of the exercise, make notes, etc.

As a rule the captain will supervise the exercises for fractions of his own company. The major will retain the general supervision of the firing exercises of his battalion and will be the

supervisor in all cases involving a company. He may, in his discretion, retain supervision in the case of smaller units.

226. RECORDS.—A record of each exercise will be made which will contain the following data :

- (1) Place, date, designation of organization.
- (2) Nature of exercise, number of men firing, number and kind of targets with arrangement and intervals.
- (3) Number of rounds fired.
- (4) Number of hits expected and number made, number of targets hit.
- (5) Time of execution.
- (6) Atmospheric conditions.
- (7) Remarks as to the preparation, fire discipline, and fire control.

These records will be filed until the close of the next target season, when they may be destroyed.

227. THE CRITIQUE.—Intelligent criticism is the basis of good instruction and insures progress. Hence, to realize the full benefits of the exercises in combat firing a careful analysis will be made by the supervisor as soon as the results of each firing are known, and on the ground on which the exercise was held. A discriminating judgment is required on the part of the officer charged with this duty, and it is important that not only the errors committed but the means of correcting or avoiding them should be carefully explained.

The rules for judgment are those prescribed in the War Department publication "*Regulations Prescribing Standard for Field Firing*," prepared at the Musketry School.

228. RANGE REGULATIONS.—A suitable range party will be detailed by the officer supervising the firing consisting of an officer as range officer and a sufficient number of men to act as target and signal men and range guards.

The duties of the range officer are to prepare the targets, to superintend their placing and manipulation, to see that the range is safe, and where necessary to post range guards to prevent persons from entering the area of fire; to record and report the results of the firing.

Every precaution will be taken to provide for the safety of markers, target men, and others whose duties require them to

be anywhere within or near the area of fire. When it appears to be necessary, a point which will be continually in view of the officer or noncommissioned officer in charge of the firing line throughout the exercise will be selected from which to display the danger signal. This point will be known to all engaged in the firing. No firing of any kind will be done while the danger signal is displayed. Should the danger signal appear while an exercise is in progress, the command will be halted and all firing and movement will cease. When the danger signal is removed the exercise will be resumed.

REPORTS.—Reports of the results of combat exercises will be submitted as prescribed in paragraph 255.

228½. Except during the regular practice season, there will be held monthly, if practicable, such combat practice as the regimental commander may prescribe.

Where local or other conditions prevent the use of ball ammunition, such exercises will be conducted with blank ammunition.

This instruction will include company, battallon, and regimental combat firing exercises. A record of such combat practice will be kept and a report showing the nature of the exercises, with copies of the problems, if any, will be submitted monthly to the department commander.

(C. S. A. F. M. No. 13.)

CHAPTER V.

PROFICIENCY TEST.

229. To determine the proficiency attained in collective marksmanship, courses in firing suitable as tests and adapted to the firing grounds available will be prepared by the regimental commander for the companies or troops of his regiment. These tests will follow the combat practice and will be held near the end of the practice season or later—they must be held during the period announced for the field training of the troops. They are designated as a further and more formal proof or test of instruction than is furnished by the results obtained in the known-distance practice and the combat exercises.

230. RANGE USED.—Whenever practicable, the proficiency test will be held on a class "B" range. Courses in firing may consist of a single firing exercise for the company, or one exercise for the company and one for each of the platoons thereof, or an exercise for each of the platoons only. In any case not more than 40 rounds per man will be expended in the entire test.

231. RULES.—The arrangement of these exercises and their conduct will be governed by the rules prescribed for combat firing so far as they may be applicable, and they will be judged in the same manner. In addition, special rules to suit local conditions may be issued by the commanding officer. The firing will be with the full field equipment as prescribed for the arm of the service.

232. WHO WILL FIRE.—All enlisted men who are required to fire through the known-distance course, except sergeants and musicians and trumpeters, and who are borne on the rolls of an organization at the time of taking the test, will fire throughout the test unless excused by the regimental commander; but no one will be excused until the company commander shall have shown in each case that it will be impracticable for the soldier to be present. A soldier absent through his own fault, or who is not excused by the proper authority, will be considered as present and firing throughout the test.

If the company is not stationed with regimental headquarters and there is not sufficient time to obtain the regimental commander's authority to excuse a soldier, the post commander is authorized to do so, provided so much of the first sentence of the preceding paragraph as refers to the company commander is complied with.

In courses where the test consists of an exercise for the company and an exercise for each of the platoons thereof, a soldier will be allowed to fire in but one platoon in the platoon exercises.

A soldier who has fired in the test for the target season with one organization and becomes, through transfer or reenlistment, a member of an organization which has not yet fired the test, will take part in this firing with his new organization.

233. PROCEDURE.—The test will be fired under the direction and personal supervision of the regimental commander. If the company is not stationed with regimental headquarters the test

will be fired under the supervision of the post commander or an experienced officer of suitable rank specially selected by the post commander. No information in regard to the course which any organization will be required to fire will be given out before the date set for the test.

234. RESULTS.—The results obtained will be recorded as prescribed for combat firing exercises and a judgment rendered as to whether the entire performance was *satisfactory* or *unsatisfactory*, as the results may warrant these characterizations.

It may be said, however, that a collective firing exercise is too complex an operation to have its results expressed by a number, a single word, or even by a phrase. In the best performance some mistakes will probably have been made to which, in the interests of good instruction, attention should be called. With those who have not done so well and whose merit may be doubtful, it is all the more necessary to analyze all the operations involved in the test so that the faults committed may be discovered and the responsibility for any deficiency fixed.

In any case, therefore, this test will be followed by a critique by the officer supervising the test, to be delivered as soon as the results of the firing are known. Mere comparisons between organizations may mean nothing. On the other hand, careful supervision and effective criticism insure progress in any branch of instruction.

235. OFFICERS RESPONSIBLE FOR DEFICIENCY OF ORGANIZATIONS TO BE REPORTED.—Should the results obtained in the annual proficiency test for any organization be such as to warrant a judgment of *unsatisfactory*, a presumption of deficiency for the entire organization will have been established. This, however, is not entirely sufficient. In case the apparent deficiency is manifestly not due to defective leadership, further inquiry should be made into the state of individual marksmanship and fire discipline of the organization as exhibited in the range and combat practice.

Should the presumption of deficient instruction be sustained and the examination establish a proof of the incapacity of the company or troop commander as an instructor, or should the deficiency be owing to defective leadership, or should both these conditions exist, the name of the officer responsible will

be reported to the department commander at the time the reports of target practice are rendered.

236. REPORTING RESULTS.—The rating (*satisfactory* or *unsatisfactory*) obtained by organizations required to fire the annual proficiency test will be entered on the Report of Combat Practice.

CHAPTER VI.

EXAMPLES OF EXERCISES, WITH SUGGESTIONS CONCERNING THE ARRANGEMENT OF TARGETS.

237. TARGETS, BUZZERS, ETC.—With the field targets and apparatus furnished by the Ordnance Department, a stationary target may be represented by lines or groups of silhouette figures on staves, targets “E” and “F.” With target “G”—falling target—enemies which fall when struck may be represented. When there are pits of suitable depth, target “H,” in the hands of pitmen, may be used to represent enemies which appear and quickly disappear, and are called *bobbing targets*. The same effect may be obtained with lines of figures, either kneeling or prone, placed on the beam apparatus, the latter being operated by men in an adjacent pit. Moving effects with field targets are obtained with target “K.”

When a line or group of stationary figures is used as an objective it should be so placed as to be out of sight in the beginning, the targets to come into view as the firing party advances. Targets may be so placed as to be entirely invisible to the naked eye, but visible with field glasses in the hands of the leader, necessitating good judgment in the choice of an aiming point. Pistol shots fired from the position of the targets or from a point in rear of the firing party provide an effectual means of indicating that the simulated enemy has opened fire.

When field buzzers form part of the signal equipment of a post, their use greatly facilitates communication between the firing point and the different target pits. When these have not been supplied, communication must be by means of a code of signals.

238. EXAMPLES OF EXERCISES.—The specific statement of a tactical situation is dependent upon the lay of the ground involved. Hence, owing to the variety in ground to be met with, complete models of firing exercises suitable to different localities can not be stated. No more can be done than to give suggestions which may serve as guides. With those here given and the rules for arrangement that have been stated, it may be expected that firing exercises may be drawn up which will carry out in a good measure the purposes of this class of instruction.

In the case of a company a useful exercise may be framed by having the objective for the company composed of two or three distinct groups of targets, one for each of the platoons of the company, so placed or operated as to call for somewhat different conduct on the part of the platoon leaders. By placing the objectives for the platoons on separate disappearing apparatus, the groups may be made to appear and disappear at different times.

Exercise No. 1.

OBJECT.—To teach men the value of concealment and the use of cover, to pick up obscure targets, and to estimate the range thereto.

SITUATION.—A single man, a member of an outpost, is informed that a small party of the enemy is in observation in the vicinity of a certain point which is pointed out from a concealed position.

ACTION.—The soldier is directed to advance, without exposing himself to the enemy, to a point from which fire may be opened with better effect, and to then fire on the enemy.

TARGETS.—Three figures—one kneeling and two prone, the latter falling targets—so placed among trees or shrubs as to require some search to be found. The range at which the firing takes place should be from about 350 to 600 yards, the initial point of the movement being such that a good line of advance under cover to the best firing point is open to the soldier—but this should not be indicated to him.

REMARKS.—This exercise may also be used for two men acting together.

Exercise No. 2.

OBJECT.—To illustrate the location of obscure objectives, quick estimation of distances, the use of natural features of the terrain for concealment, and the exercise of fire control over a dispersed squad.

SITUATION.—A small patrol under a noncommissioned officer is sent out under the following orders:

“A small party of hostile infantry has been reported in the vicinity of ———. Locate and drive them back.”

ACTION.—The patrol will advance in the indicated direction. The formation will be in conformity with the requirements of the terrain.

When the targets representing the enemy have been located by the patrol, fire will be opened promptly *but only as directed by the patrol commander*. In case any member of the patrol exposes himself so that he would be in plain sight from the targets, blank cartridges will be fired from the pit to indicate that the patrol is under fire. This will be done only on notification by phone from the range officer.

The time for the preparation will be taken from the moment the patrol locates the targets, or the first blank cartridge is fired from the pit—whichever occurs first—to the time the first shot is fired.

Upon completion of the action the patrol commander will send a written report thereof to his company commander.

TARGETS.—An irregular group consisting of one standing, two prone falling targets, and three prone bobbing targets. (This to be modified so that the total number of figures in the target will equal the number of individuals of the patrol.)

Bobbing targets will appear for periods of 10 seconds, with an interval of 10 seconds between appearances, the first appearance to be immediately after the first shot is fired at the falling targets.

EQUIPMENT.—In addition to the authorized equipment, the patrol commander is supplied with a pad of the regulation message blanks. His report will be submitted on this form.

TIME.—As provided under “Action” and “Targets” above.

Exercise No. 3.

OBJECT.—Collective exercise in which fire discipline and fire control are illustrated. No shots will be fired except by direction of the outguard commander.

SITUATION.—An outguard consisting of a noncommissioned officer and six or seven men is given a specific sector of observation. It establishes a double sentry post. The location of the sentries and the remainder of the outguard will be in conformity with the requirements of the terrain.

ACTION.—Upon the first appearance of the enemy, as represented by the targets, the sentries will endeavor to locate them and will notify the outguard commander at once as to the nature of the targets, etc. The outguard commander then makes the proper disposition of the outguard to open and maintain a vigorous fire upon the enemy.

TARGETS.—Six or eight kneeling silhouettes on disappearing apparatus (target "I"). These will be made to appear for periods of 30 seconds each with intervals of 30 seconds between appearances. The first appearance will be indicated by the firing of blank cartridges from the pit. Range 400 to 700 yards.

TIME.—As provided under "*Targets*" above.

Exercise No. 4.

OBJECT.—To illustrate the location of obscure objectives, quick estimation of distances, use of natural features of the terrain for concealment, and the exercise of fire control.

SITUATION.—A strong patrol is sent out under the following orders:

"1. Small parties of the enemy are reported about half a mile from our present position, and in the direction of _____.

"2. You will locate the enemy and, by attacking, determine his dispositions."

ACTION.—The patrol will advance in an indicated direction, the formation being in conformity with requirements of the terrain.

When the targets representing the enemy have been located by the patrol, fire will be promptly opened, but *only as directed by the patrol commander.*

In case any member of the patrol exposes himself so that he would be in plain sight from the targets, blank cartridges will be fired from the pit to indicate that the patrol is under fire. This is done only upon notification by phone from the range officer.

Upon the completion of the action the patrol commander will send a written report of same to the commanding officer Company "A," from whom he is assumed to have received his orders.

TARGET.—Eight kneeling silhouettes on a beam, 1 yard edge to edge, and two prone falling targets. The beam target will appear for 30 seconds and at 30-second intervals.

TIME.—The time for the preparation will be taken from the moment the patrol locates the target or the first blank cartridge is fired from the pit—whichever occurs first—to the time the first shot is fired.

Exercise No. 5.

OBJECT.—To illustrate fire control and the use of the battle sight.

SITUATION.—A platoon of two squads is ordered to attack the enemy in a certain position. The general location of the main objective is indicated to the platoon commander. While advancing, the platoon encounters an outpost of the enemy.

ACTION.—The platoon is assigned certain lateral limits within which the advance is to be confined.

At the first firing point, which will be designated, five rounds per man will be fired and the advance will be resumed under the assumption that fire superiority has been gained. While the platoon is advancing a second target appears. The platoon is halted and fire opened on the nearer group, the battle sight being used.

The main objective is outside of battle sight range; the second target is within battle sight range.

TARGETS.—The distinct target, or main objective, will consist of eight kneeling silhouettes with intervals of 1 yard from edge to edge. The second target will consist of eight prone silhouettes on disappearing apparatus. The second target will appear for periods of 30 seconds each with intervals of 30 seconds between appearances. The first appearance will be controlled by phone.

TIME.—As provided under “*Targets*” above.

REMARKS.—This exercise may be used for a larger platoon.

Exercise No. 6.

OBJECT.—To illustrate the locating and firing upon distant targets and the utility of the battle sight when it is a question of opening promptly a rapid fire on a fleeting objective.

SITUATION.—A platoon of two squads is ordered to attack the enemy. The general location of the targets is indicated to the platoon commander. While advancing, the platoon is assailed by another party of the enemy which moves rapidly as though endeavoring to make a flank attack.

ACTION.—The platoon is advancing in skirmish order when the firing of blank cartridges from the pit will indicate that the enemy has opened fire. The platoon is halted and opens fire, the disappearance of the targets indicating that fire superiority has been gained and that the advance may be resumed. When the second objective is discovered the platoon is again halted and fire opened on the moving target with the greatest possible effect.

TARGETS.—The distant target, or main objective, will consist of eight kneeling silhouettes, 1 yard edge to edge, on beam disappearing apparatus. This target will be raised at the time blank cartridges are fired from the pit and will remain in sight such length of time—not exceeding one minute—as will insure that not more than five rounds per man are expended on it. This time will be regulated from the firing point by phone.

Second objectives, eight kneeling silhouettes on sled (target “K”).

REMARKS.—This exercise may be used for a larger platoon.

Exercise No. 7.

OBJECT.—To illustrate the use of the intrenching tool and range finder, firing from shelter with a rest for the rifle, fire discipline, fire control, and a maximum rapidity of effective fire under the most favorable conditions.

SITUATION.—A platoon of two squads is assigned a portion of a defensive position. They are ordered to intrench and drive back an enemy who is expected to advance and come into view 10 minutes after the position is first occupied.

ACTION.—One end of the trench location is pointed out to the officer, and the direction from which the attack may be expected is indicated. The platoon commander then lays out his trench and proceeds to construction without delay. While the work of construction is going on, the officer will make use of his range finder in determining the range to prominent points in his front.

At the expiration of 10 minutes he will be prepared to immediately fire upon any targets that come into view.

TARGETS.—No. 1. Kneeling silhouettes 1 yard apart on beam disappearing apparatus; range, ----- yards.

No. 2. Kneeling silhouettes 1 yard apart on disappearing apparatus; range, ----- yards.

No. 3. Kneeling silhouettes 1 yard apart on disappearing apparatus; range, ----- yards.

No. 4. Prone silhouettes 1 yard apart on disappearing apparatus; range, ----- yards.

The longest range should not be much in excess of 900 yards, the shortest about 250 yards.

The targets appear in succession, representing an advancing enemy. Each target will be exposed one minute. One minute will elapse between the disappearance of one group and the appearance of the next.

The number of rounds fired at each group will be ascertained between appearances of the target by the officer supervising the exercise.

The construction called for should be with the prescribed field intrenching tools.

TIME.—As provided under "*Action*" and "*Targets*" above.

The shelter here referred to is the *hasty cover* defined in the Infantry Drill Regulations. The same exercise may be carried out with the fire trench, sufficient time for construction being allowed. Three or two groups of figures may be operated instead of four.

Exercise No. 8.

OBJECT.—To illustrate the direction and control of fire, fire discipline, range finding, observation of fire, adjustment of fire, and the use of combined sights on a distant objective.

SITUATION.—A company is ordered to occupy a certain position and fire on a distant objective which is indicated to the company commander.

ACTION.—There will be two or more firing points at each of which two series of firings of ten rounds per man will be made.

In the first series the company commander will attempt to adjust the fire by means of one or two ranging volleys, and will then fire the balance of his ten rounds "At will."

Another officer, who has not been present during the first firing, will be designated to command the company during the second series.

In the second series adjustment of fire will not be attempted, but recourse will be had to combined sights, two or more readings of the rear sight being used, depending on the range.

TARGETS.—The target will consist of four rows of kneeling silhouettes arranged in column, 16 targets in each row placed with intervals of 1 yard from edge to edge. The distance between rows will be 10 yards.

Exercise No. 9.

OBJECT.—Dismounted action for cavalry against superior hostile cavalry.

SITUATION.—A platoon, while reconnoitering, is driven back by two troops, gallops to suitable cover, dismounts, and holds the enemy by fire action.

ACTION.—Scouts report a considerable body of the enemy's cavalry approaching. At revolver fire the platoon retires at the gallop to ground suitable for fire action, and the scouts, clearing the front, take up a position to watch the flanks. The platoon dismounts, the led horses are placed under cover, and three minutes after the revolver shot the target appears in front at a distance of about 800 yards and moves rapidly by the flank for 200 yards. The leader opens fire and continues firing until the target stops or disappears.

TARGET.—Target "K."

Exercise No. 10.

OBJECT.—Dismounted action for troop of cavalry illustrating mutual support of platoons in retirement.

ACTION.—A troop of cavalry is forced back by superior infantry. The platoons in alternation take up successive firing positions to cover the retirement of the other platoons, which fall back at the gallop.

TARGET.—For each firing position there will be a corresponding target, target "K" with 16 kneeling figures, the arrangement being such that each platoon will fire once.

Exercise No. 11 (demonstration).

OBJECT.—To illustrate the effect of incorrect estimates of the range.

ACTION.—Place row of kneeling figures, from 20 to 40, according to number of men firing, at range of 1,000 yards. With a detachment the strength of a platoon, fire a series of shots in succession at 800, 900, 1,000, 1,100, and 1,200 yards, and compare the results made at different ranges. Not less than 5 rounds per man should be fired in each series, and 10 rounds per man will illustrate the point better.

Exercise No. 12 (demonstration).

OBJECT.—To illustrate the relative efficiency of different rates of fire.

ACTION.—Place a row of prone figures, from 20 to 40 in number, according to number of men firing, at a range of 500 yards. Require a detachment the strength of a platoon to fire a series of 10 shots in about 1 minute. When results have been scored, require the same detachment to fire the same number of rounds at the same targets in 2 minutes' time or longer, the additional time being taken up in a more prolonged aim.

Reduce results in the two cases to hits made per minute and compare them.

Exercise No. 13 (demonstration).

OBJECT.—To illustrate the influence of rising ground on the depth of beaten zone and to demonstrate also the scope of a single sight setting at short range when the ground is favorable.

ACTION.—Select as a firing station a point with an elevation of 50 or 100 feet overlooking a level stretch below, on which are placed as targets in a column formation equal rows of kneeling silhouette figures at ranges of 500, 600, and 700 yards from the firing point, giving a surface of reception, which is rising with respect to the line of sight.

With a detachment the strength of a platoon, fire is executed in a series of 10 shots per man, aim being taken only at the first row of figures. The results being scored, with the same arrangement of targets and the same distances, a lower firing point is chosen so that the line of sight is nearly parallel with the surface on which the row of targets stand. The firing is executed as before, aim being taken only at the first row of figures.

The illustration is afforded by the excess in the number of hits made on the second and third rows of figures in the second series over the number made on the same targets in the first instance.

Exercise No. 14 (demonstration).

OBJECT.—To illustrate the influence on the beaten zone of ground which is falling with reference to the line of sight.

ACTION.—In this case a line of figures is placed along a crest or edge of a plateau, from which the ground falls away from the line of sight. The line of figures so placed is the visible target at which the fire is directed. The point to illustrate is the effect on different targets placed in rear of the edge or crest by fire aimed at the visible objective. Two distinct conditions may here arise:

1. If the inclination of the reverse slope is less than the angle of fall, the dispersion in depth will be increased and the number of hits on the rear rows of figures will decrease more slowly than would be the case if the firing took place on a plain.
2. If the reverse slope is steeper than the angle of fall, targets placed on this slope will be partially or fully defiladed from the shots which clear the crest.

It is therefore necessary to determine beforehand the angle of the reverse slope and choose the firing point accordingly. If it is desired to demonstrate that the ground in rear may be effectually swept by bullets, it is necessary to choose a firing

point such that the angle of fall will be greater than the inclination of the slope.

To demonstrate how dead spaces may be created on the reverse slope the firing detachment may be moved forward two or three hundred yards and the firing repeated.

Hits made on line targets and column targets placed on a reverse slope and subjected to indirect fire may be compared to show the greater vulnerability of the former.

239. In addition to the above, the following is given as a typical example of analyzing and criticizing a firing exercise:

SITUATION.—A platoon has been designated as the support of a company acting alone and which is engaged in an attack on a position. The balance of the company is imaginary.

It is assumed that the firing line has reached a certain point and that it has met with such stubborn resistance from the enemy that reenforcement is required in order to gain superiority of fire. The support is in such position and formation as the terrain demands and its commander is cognizant of the general location of the enemy's position. He received from the company commander the following order:

“Advance with your platoon to the firing line, take position on the left of the line, and open a vigorous fire.” (The left flank of the imaginary firing line should be indicated by silhouettes or suitable marker.)

TARGETS.—A line normal to the plane of fire and consisting of 25 prone silhouettes with intervals of 1 yard from edge to edge. Range 700 yards.

AMMUNITION.—Fifteen rounds per man.

ACTION.—When the commander of the platoon receives his orders to advance, he makes a reconnaissance to determine the best route to take in order to arrive on the firing line with the fewest losses consistent with celerity, and then proceeds to advance his platoon by the route selected.

When he arrives on the firing line, the platoon commander estimates the range to be 900 yards. He indicates the objective to his platoon and gives the commands for opening fire at will at 900 yards and seeks a position whence he can best observe the effect of the fire. He soon notices a number of shots striking low and causes the elevation to be raised to 1,000 yards, and the firing is thus completed.

CRITIQUE.—The results of the firing in hits, distribution of hits, and time of execution are announced to be 2 hits on 2 figures in 5 minutes' time. Referring to the standard of judgment as given in "Regulations Prescribing Standard for Field Firing," it is seen that 12 hits should have been made on 8 figures in 2 minutes' time. This comparison warrants a judgment "Unsatisfactory" for this exercise.

In order to make plain the errors committed and to show why the results have fallen below what they should have been, the platoon is assembled at a point overlooking the ground on which the exercise was held and the officer charged with the supervision delivers the following critique:

"Your disposition of the support, before the advance, was very good. The reconnaissance was altogether too deliberate and much valuable time was thus wasted. The route that you finally selected for your advance afforded you plenty of concealment, but would probably have been swept by the fire of the enemy directed on the firing line in your front. This shows you that concealment does not necessarily mean defilade.

"The use of cover by your platoon was good, with the exception of yourself when you were seeking an observation point.

"Your fire was too deliberate. In this exercise average shots should have obtained 12 hits on 8 figures and should have finished their firing within two minutes. You obtained 2 hits on 2 targets in five minutes. Your few hits may be ascribed to the error of 200 and later 300 yards in the estimation of the range, which was, in fact, 700 yards.

"Your designation of the objective and its location was not definite and some of your men fired all their ammunition without knowing just where the target was. It was probably the low shots of these men that caused you to raise the elevation from 900 to 1,000 yards."

PART IV.

MISCELLANEOUS.

CHAPTER I.

CLASSIFICATION, EXTRA COMPENSATION, INSIGNIA, AND TELESCOPIC SIGHTS.

CLASSIFICATION RIFLE FIRING.

240. REQUIREMENTS.—The requirements for the qualification in the several grades of marksmanship are given in the following table:

Table of classification.

Grade.	Rifle firing. Points.
Expert rifleman.....	253
Sharpshooter.....	238
Marksman.....	202
First-class man.....	177
Second-class man.....	152
Unqualified ¹

¹ All who failed to qualify as second-class men or better and those who for any reason did not fire the course and are not otherwise classified.

An officer or a soldier who attains the grade of marksman or better will retain that classification from the date of qualifica-

tion until the next opportunity to requalify, or for one year if no opportunity for requalification is presented within that year.

The soldier who has completed the course of known distance practice and is transferred thereafter, or who is discharged and reenlists, will not be given a second opportunity in the same target year to qualify.

In case the soldier has not, at the time of transfer, completed his known distance practice for that year, his company commander will complete his individual record sheet to date and attach it to the descriptive list which accompanies him, and the soldier will complete his known distance firing with the organization to which transferred, unless in that organization known distance practice for that year has been completed.

For regulations concerning additional pay for enlisted men qualifying as marksmen or better, see paragraph 1345, Army Regulations. (*C. S. A. F. M. Nos. 1, 4, and 19.*)

241. WHO WILL BE CLASSIFIED.—All who fire and who are borne on the rolls of the organization during any part of the practice season, or who are attached for practice by proper authority, will be classified.

Bandsmen who fire in the Philippines will not be classified.

For Coast Artillery, see special course "A."

242. SPECIAL CLASSIFICATION.—A special classification is provided for all those who fire special course "A," as follows:

Table of classification, special course "A."

Grade.	Points.
Marksman	150
First-class man.....	120
Second-class man.....	100
Unqualified ¹

¹ All who failed to qualify as second-class men or better, and those who for any reason did not fire the course and are not otherwise classified.

243. Table of classification, pistol and revolver.

All who are authorized or required to fire the dismounted course.		All who are authorized or required to fire the mounted course.	
Grade.	Percentages at least.	Grade.	Percentages at least.
Expert pistol shot.	{ 80 in record course. 83 in expert course.	Expert pistol shot.	{ 70 in record course. 65 in expert course.
First-class man....	80 in record course.	First-class man....	70 in record course.
Second-class man..	60 in record course.	Second-class man..	50 in record course.
Unqualified. ¹		Unqualified. ²	

¹ See par. 175.

² See par. 199.

244. EXTRA COMPENSATION.—The soldier will receive such extra compensation for qualification in rifle firing as may be authorized by law and regulations; provided, however, that the qualification of marksman in special course "A" will not entitle the soldier to increased pay.

Immediately after the close of the record practice, qualification course, the names of men who qualify in the various grades for which extra compensation is awarded will be published in orders. These orders will be issued by commanders empowered by regulations to issue orders for the appointment and promotion of noncommissioned officers, or in exceptional cases by higher commanders, upon receipt of properly authenticated

evidence as to qualification, and will show the date of actual qualification from which the soldier is entitled to additional pay.

(*C. S. A. F. M. No. 1.*)

INSIGNIA.

245. To each officer and soldier qualifying for the first time as expert rifleman, sharpshooter, marksman, expert pistol shot, and first-class pistol shot certain insignia, indicating their skill in marksmanship, will be issued. In case of loss or damage new issue may be made as provided for in paragraph 250.

Insignia may be worn from date of qualification until the next opportunity to requalify, or for one year if no opportunity for requalification is presented within that year.

Officers who are not required to fire may wear the insignia of last qualification.

(*C. S. A. F. M. No. 19.*)

246. RIFLEMAN'S INSIGNIA—MARKSMAN'S PIN.—(a) To the marksman when first qualifying as such, a marksman's pin will be issued.

(b) **SHARPSHOOTER'S BADGE.**—To the sharpshooter a silver badge will be issued. To those who have qualified as sharpshooters for three years, not necessarily consecutive years, nor, in the case of enlisted men, in the same enlistment, a silver bar will be issued, on which the three years of their qualifications will be indicated, and this will be attached to the badge, below the pin. For each additional three years of qualification an additional bar will be issued, and each in succession attached below the one previously supplied.

(c) **EXPERT RIFLEMAN'S BADGE.**—To the expert rifleman a silver badge will be issued. To those who have qualified as expert rifleman for three years, not necessarily consecutive years, nor, in the case of enlisted men, in the same enlistment, a silver bar will be issued, on which the three years of their qualifications will be indicated, and this will be attached to the badge below the pin. For each additional three years of qualification an additional bar will be issued, and each in succession attached below the one previously supplied.

(*C. S. A. F. M. Nos. 14 and 19.*)

247. MARKSMAN'S PIN, SPECIAL COURSE "A."—To the marksman, when first qualifying in special course "A," a special marksman's pin will be issued.

(*C. S. A. F. M. No. 19.*)

248. EXPERT PISTOL SHOT'S BADGE.—To the expert pistol shot, a silver badge will be issued. To those who have qualified as expert pistol shots for three years, not necessarily consecutive years, nor, in the case of enlisted men, in the same enlistment, a silver bar will be issued, on which the three years of their qualifications will be indicated, and this will be attached to the badge below the pin. For each additional three years of qualification an additional bar will be issued and each in succession attached below the one previously supplied.

(*C. S. A. F. M. Nos. 4 and 19.*)

249. FIRST-CLASS PISTOL SHOT'S PIN.—To the first-class pistol shot a pin will be issued.

(*C. S. A. F. M. No. 19.*)

250. DUPLICATES.—These insignia will become the property of the persons to whom issued. If they are lost by the owner or in transmission to him, or if they become unsightly from long wear, they may be replaced without cost to the owner. But in all cases the official certificate of the company commander to the effect that he has investigated the circumstances of the loss or damage and finds that no negligence can be imputed to the soldier will be required as evidence upon which to make the new issues. In case of loss, claim must be made within 60 days from date of loss. Duplicates, if desired, for use on separate coats, will be sold to those entitled to wear the insignia.

251. HOW OBTAINED.—Immediately after the close of the practice season the company commander will report by letter to the commanding officer the names of men in his organization who have made a new or a renewed qualification. With this letter the company commander will submit a requisition for the required number of badges and bars. This requisition will be disposed of as any other special ordnance requisition.

252. The insignia earned by members of the Organized Militia for qualification under the rules in the grades which in the Regular Army are entitled to insignia are procured by the State

authorities as provided in the last paragraph of paragraph 288, Regulations Organized Militia.

253. TELESCOPIC SIGHTS.—To properly equip a special class of shots who, in action, may be employed as sharpshooters, the telescopic sight is adopted. These sights are supplied by the Ordnance Department at the rate of two to each company. They will be assigned to the enlisted men found best qualified to use them, and may, in the discretion of the company commander, be carried by them at inspection under arms.

Not less than four men of each company will be given a suitable amount of practice with these sights.

CHAPTER II.

RECORDS AND REPORTS.

254. RECORDS.—The company target record consists of three parts:

- (a) The individual record of known-distance rifle firing.
- (b) The individual record of pistol firing.
- (c) The record of the company combat firing and proficiency test.

The sheets forming these records will be bound by the loose-leaf system. By this means the books will be at all times live records. All entries in these records will be made in ink.

During the regular practice season and until paragraph 255 has been compiled with the company target record will be kept in the possession of the company commander.

For companies of Coast Artillery the record will contain the record of firing special course "A," the same individual sheets being used.

The record of an officer attached to a company for practice will be duly attested and transmitted to the officer.

The records of an enlisted man attached to a company for practice will be similarly attested and transmitted to the officer charged with the custody of the soldier's descriptive list and account of pay and clothing.

255. REPORTS.—All reports of rifle and pistol firing will be submitted to the proper headquarters as soon as possible after the completion of the firing. The reports to be rendered are as follows:

1. Report of individual classification in rifle practice (annual, company, excepting companies of Coast Artillery).¹
2. Report of individual classification of firing under special course "A" (annual for companies of Coast Artillery).
3. Battalion commander's report of combat firing (annual).
4. Report of individual classification in pistol practice (annual, company, for all armed with the pistol).
5. Consolidated regimental report of classification, rifle practice.
6. Consolidated regimental report of classification, pistol practice.
7. Regimental commander's report of combat firing and the results of the proficiency tests.

With the exception of the battalion commander's report of combat firing and the regimental commander's report on combat firing and the results of the proficiency test, these reports will be rendered on prescribed forms furnished by The Adjutant General of the Army.

Commissioned officers will be reported on the annual company reports.

Organizations of Engineers, Field Artillery, Coast Artillery Corps, and Infantry will render the report of individual classification, pistol practice, so far as such firing is required.

HOW TRANSMITTED.—As soon as possible after the close of the practice season the battalion commander will forward to the regimental commander the reports of individual classification in rifle and pistol practice of the companies of his battalion. With these he will submit a report of the combat exercises and of the results of the proficiency test when these tests were not supervised by the regimental commander. This report will be in letter form and will set forth briefly when and where the exercises were held, the suitability of the ground for the purpose, the

¹ Casuals attached to a company for practice will be noted in red ink on the company report of individual classification.

number and general character of the exercises, and whether or not proficiency was attained therein according to the established standard of judgment, the number of men in each company participating, and the average number of rounds per man expended in this practice. He will certify that he has personally supervised the known-distance firing of the organizations and that the reports of individual classification agree with the company records. Also that the number of combat exercises prescribed by these regulations were duly held, and that the rules for their conduct were complied with.

If the battalion is serving away from regimental headquarters but in the same territorial department, these reports will be forwarded through the post commander; if serving in a different territorial department, duplicates of all these reports will be forwarded to department headquarters through the post commander.

The regimental commander will transmit to the department commander, with the regimental consolidated reports of classification in rifle and pistol firing, a brief narrative report of the combat firing and results of the proficiency tests of the companies of his regiment. (No data concerning companies serving away from headquarters of the regiment and in a different department therefrom will be included in this report.) This report will be based on the battalion commanders' reports, but should contain any additional information bearing on instruction in rifle and pistol practice necessary or desirable to the department commander.

An annual report of the small-arms firing by the Organized Militia of each State will be rendered as soon as practicable after the close of firing to the Chief of the Division of Militia Affairs.

256. In addition to the reports required by paragraph 255, department commanders will include in their annual reports a statement of the progress made in small-arms practice within their respective commands. This will include a tabulated statement of the number of men of each regiment qualifying in the various grades in rifle and pistol firing, and a report of the combat firing held, with the proficiency attained therein.

CHAPTER III.

TARGETS AND RANGES.

TARGETS.

257. Targets are divided into four classes:

- (a) Known-distance targets (for rifle).
- (b) Field targets (for rifle).
- (c) Pistol targets.
- (d) Miniature targets (for gallery practice).

258. KNOWN-DISTANCE TARGETS.—

Target A.—The short-range target, used for 200 and 300 yards, is a rectangle 6 feet high 4 feet wide. Black circular bull's-eye 8 inches in diameter, value of hit, 5; center ring, 26 inches in diameter, value of hit, 4; inner ring, 46 inches in diameter, value of hit, 3; outer, remainder of target, value of hit, 2.

Target B.—The mid-range target, used for 500 and 600 yards, is a square 6 feet on a side, black circular bull's-eye 20 inches in diameter; center ring, 37 inches in diameter; inner ring, 53 inches in diameter; outer, remainder of target. Value of hits, same as on target "A."

Target C.—The long-range target, used for 800 and 1,000 yards. It is a rectangle 6 feet high and 10 feet wide. Black circular bull's-eye 36 inches in diameter; center ring, 54 inches in diameter; inner space outside of center ring bounded by vertical lines 2 feet from each end of target; outer, remainder of target. Value of hits, same as on target "A."

Target D.—The rapid-fire target. A black silhouette representing a soldier in the prone position placed in the middle of a rectangular target 6 by 6 feet. Value of hits in the figure, 5; in the space (within parallels to figure, 4 inches in width above and at sides of figure, 14 inches below figure) immediately outside the figure, 4; in the space immediately outside the 4 space, 3; remainder of the target, 2.

Field Targets.

259. Target E.—A drab silhouette about the height of a soldier in the kneeling position, made of bookbinder's board or other similar material. Hits on all field targets count 1, and any shot cutting the edge of a silhouette is a hit.

Target F.—A drab silhouette about the height of a soldier in the prone position made of bookbinder's board or other similar material. The life of targets E and F can be materially prolonged by pasting on fresh paper silhouettes when the figure becomes too much damaged by shots. These targets are used as stationary targets as well as on the moving and disappearing appliances. When necessary these targets are fastened to wooden staves with tacks and tin washers.

Target G.—Falling target. The target is made of soft wood about the shape, size, and color of the prone silhouette F. These targets should be placed in small pits (1 by 2 feet), so that about 9 or 10 inches of vertical protection is given the base and mechanism; only the face of the target should show to the front. If the wooden figure becomes unserviceable, it may be repaired at the post.

Target H.—Targets E or F inserted in a slit at the end of a marking disk staff or pole and fastened with wooden pegs. The staffs are held in the hands of markers or in brackets on the inside of the crest of the pit. The targets are held faced to the front. When struck they are turned rapidly so as to show the white side, and then back to the original position.

Target I.—Beam disappearing target. The visible target represents a line of prone or kneeling figures at suitable intervals. In close order 8 figures are mounted on each beam. The figures are targets E and F, mounted on the regulation staves, which are modified by having the points cut off, so that but 6 inches project below the bottom of the figures.

The beam itself is made up of one piece of 2 by 6 inches by 20 feet long, one piece 1 by 6 inches by 20 feet long, and 1 by 6 by 20 inch sections fitted between them, as shown in plate. In the sockets left the staves are fitted.

The beam is laid in a shallow trench, targets horizontal, and a stake is driven in front of the beam at each end. The ropes from

the operating standard lead to the pit (direct and via the rear ring stake) and the beam is turned through 90°, exposing and lowering the targets by pulling on the appropriate ropes. The rope system is in duplicate, so that if one rope is cut by a bullet the target can still be worked. Two or more beams can be coupled together and the whole operated from the center. There should be two end stakes for each beam. The operating standard should be painted a neutral color, have earth rubbed on it or have bundles of vegetation tied to it. The ropes should also be of a neutral color.

This apparatus requires but one man for its operation, even if two beams are coupled together. The pit should be deep enough to give protection, and the earth therefrom should be spread out into a low embankment and concealed by grass or brush.

Target K.—Sled target. The disappearing target beam (target I), is lashed lengthwise to two sleds. A rope from 200 to 300 yards long is used to pull this target and an escort wagon and team has been found to be the best motive power. The rope can be run through a snatch block and the team concealed by inequalities of the ground. If no cover can be found for hiding the sled before it starts, it can be easily masked with brush, grass, etc., which will fall when the targets start.

Pistol Targets.

260. *Target L.*—A rectangle 6 feet high and 4 feet wide, with black circular bulls-eye 5 inches in diameter. Value of hit therein, 10. Seven rings with diameter as follows:

	Value of hit.
(1) 8½ inches-----	9
(2) 12 inches-----	8
(3) 15½ inches-----	7
(4) 19 inches-----	6
(5) 22½ inches-----	5
(6) 26 inches-----	4
(7) 46 inches-----	3
(8) Outer, remainder of target-----	2

Target M.—Silhouette, representing standing figure, of which upper part is target E and lower part a trapezoidal piece whose upper edge is placed closely against lower edge target E. Hits count 1.

Bobbing targets.—Targets E and M, arranged to be fully exposed to firer for limited time. Edge of target toward firer when target is not exposed.

261. MINIATURE TARGETS.—For use in Special Course of Volunteer Recruits, Appendix II, and in gallery practice.

Target X.—A rectangular paper target, 8 by 12 inches. Black circular bull's-eye, $1\frac{1}{2}$ inches diameter; center ring, $4\frac{1}{2}$ inches diameter; inner ring, $7\frac{1}{2}$ inches diameter; outer, remainder of target. Value of hits same as on target A.

Target Y.—A rectangular paper target, 4 by 6 inches. Black circular bull's-eye $\frac{3}{4}$ inch diameter; center ring $2\frac{1}{8}$ inches diameter; inner ring, $3\frac{1}{8}$ inches diameter; outer, remainder of target. Value of hits same as on target A.

Target Z.—A rectangular paper target, $2\frac{3}{4}$ by 4 inches. Black circular bull's-eye, $\frac{1}{2}$ inch diameter; center ring, $1\frac{1}{4}$ inches diameter; inner ring, $2\frac{1}{4}$ inches diameter; outer, remainder of target. Value of hits same as on target A.

The Iron Gallery Target.—As issued by the Ordnance Department.

(C. S. A. F. M., No. 6.)

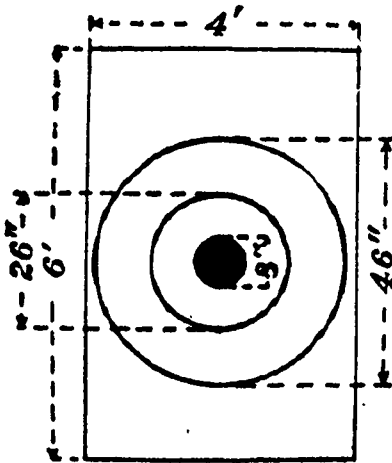

TARGET A.

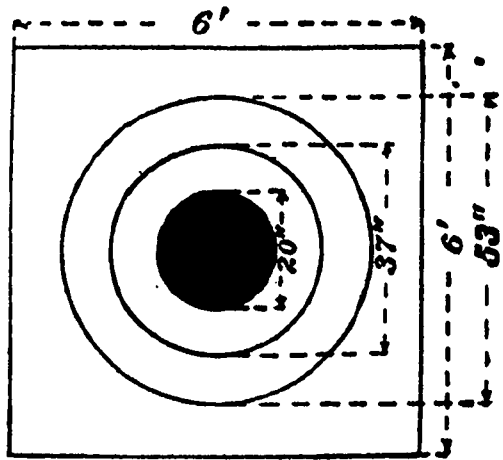

TARGET B.

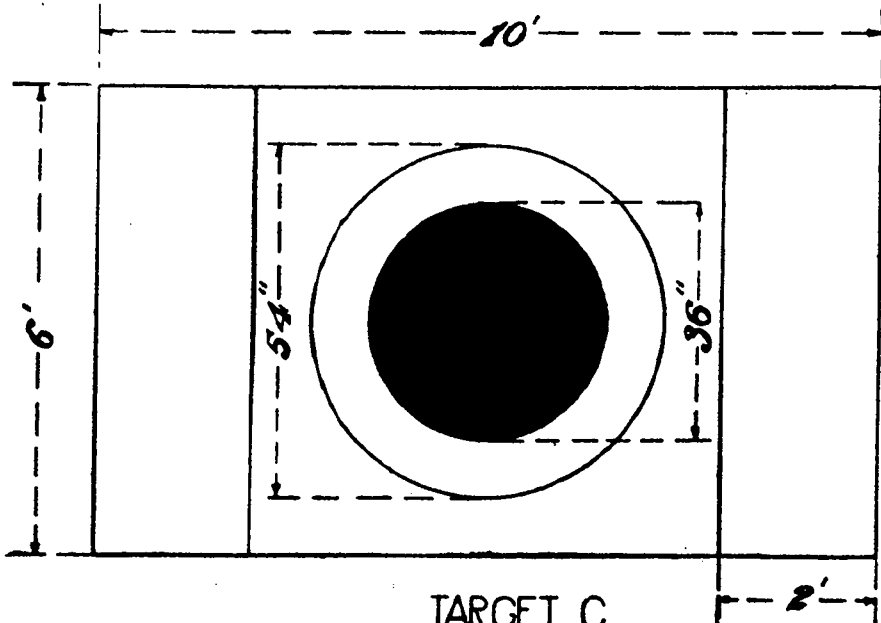

TARGET C

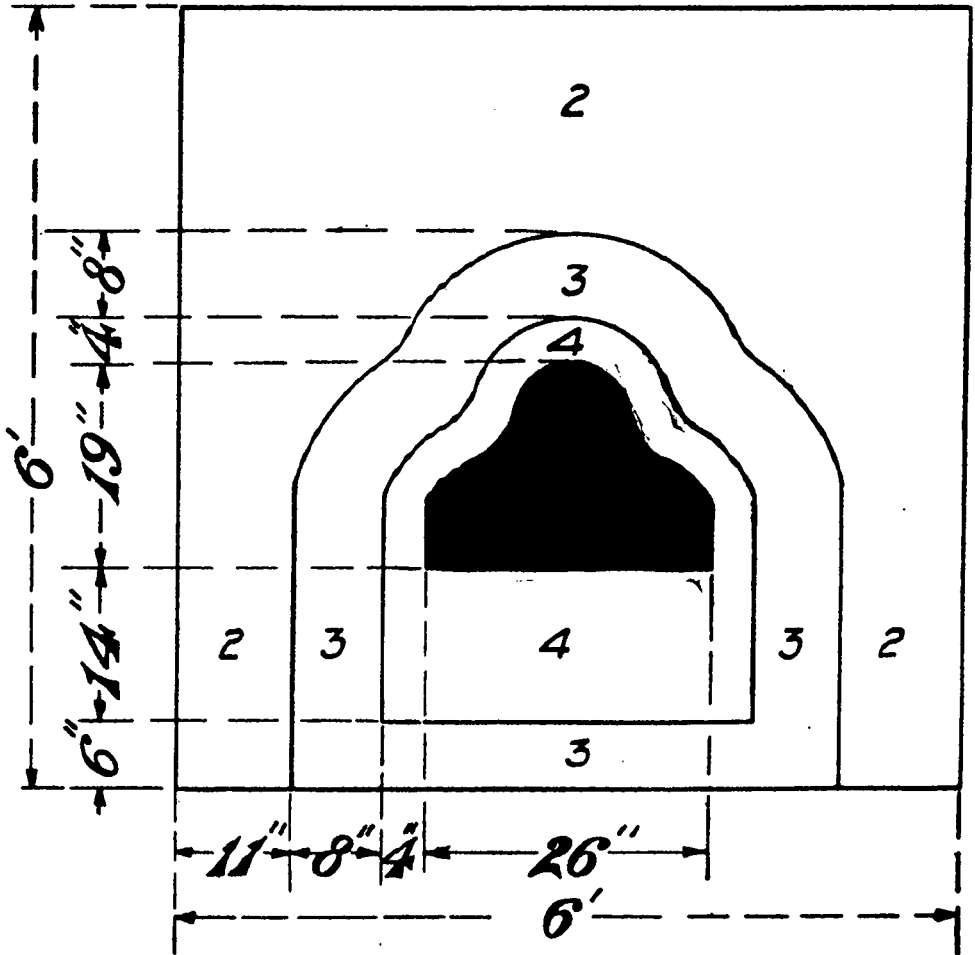

TARGET D.
PLATE XVIII.

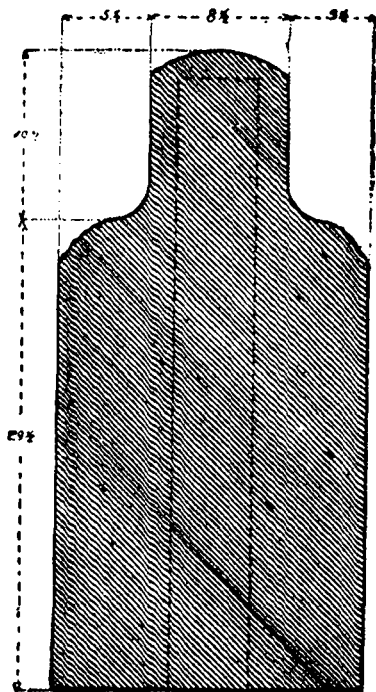

TARGET E

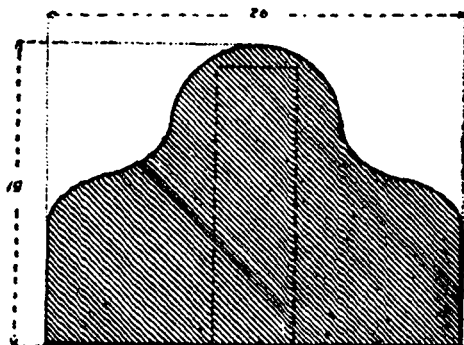

TARGET F

PLATE XIX.

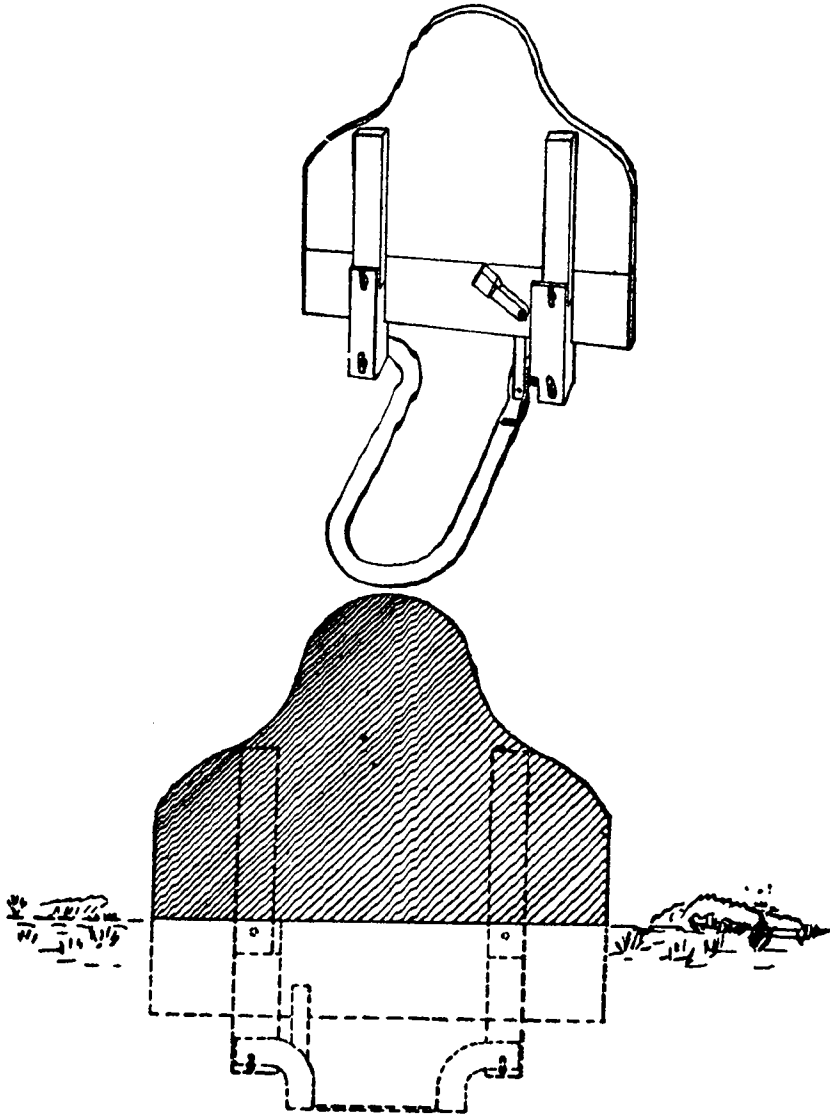

TARGET G
PLATE XX.

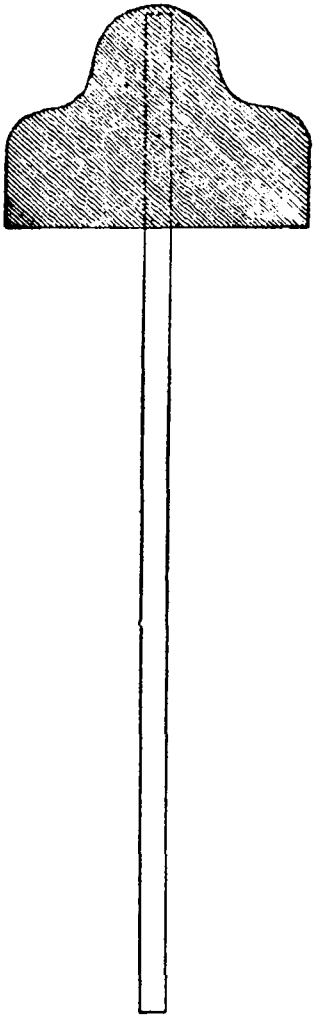

TARGET H

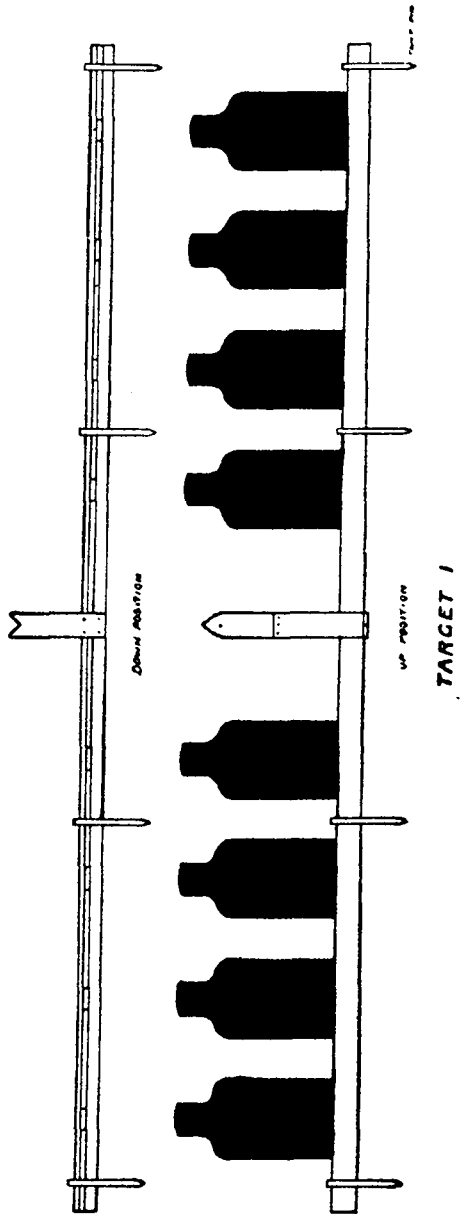

PLATE XXI.

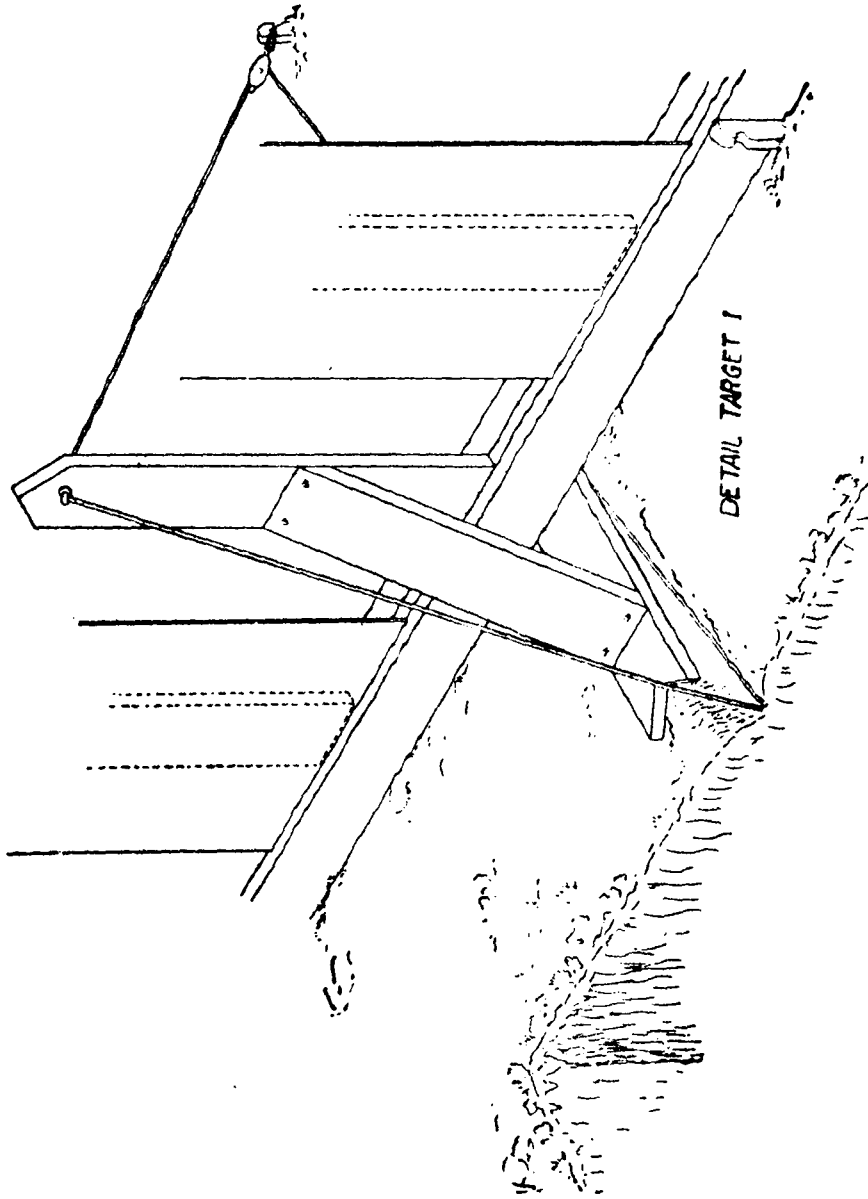
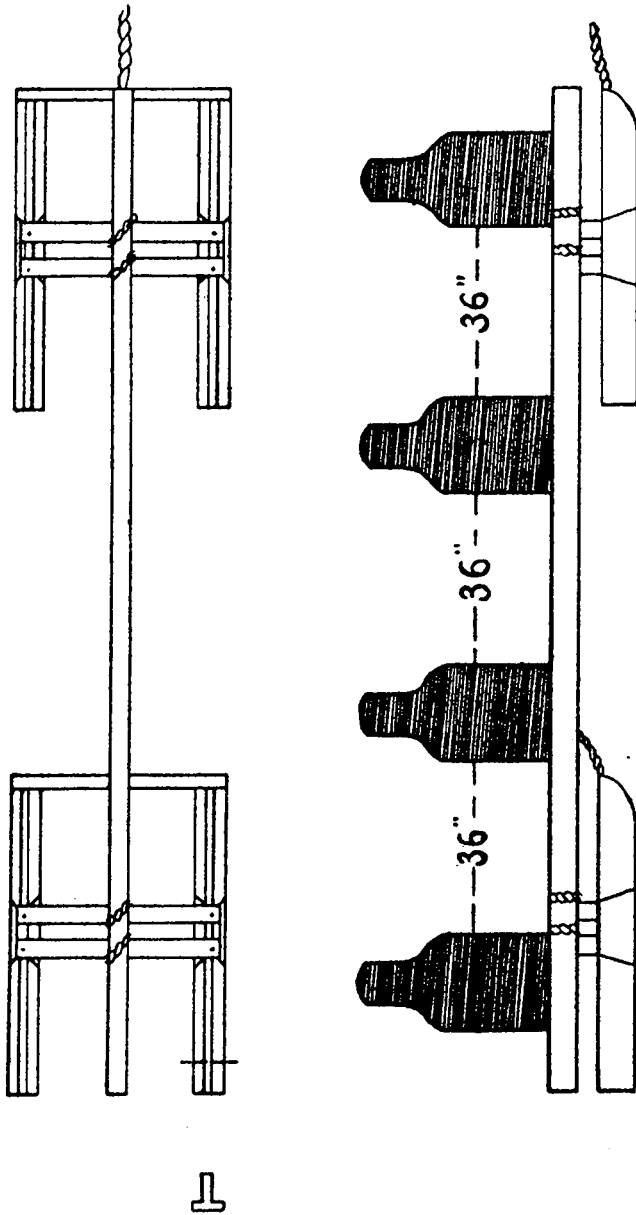
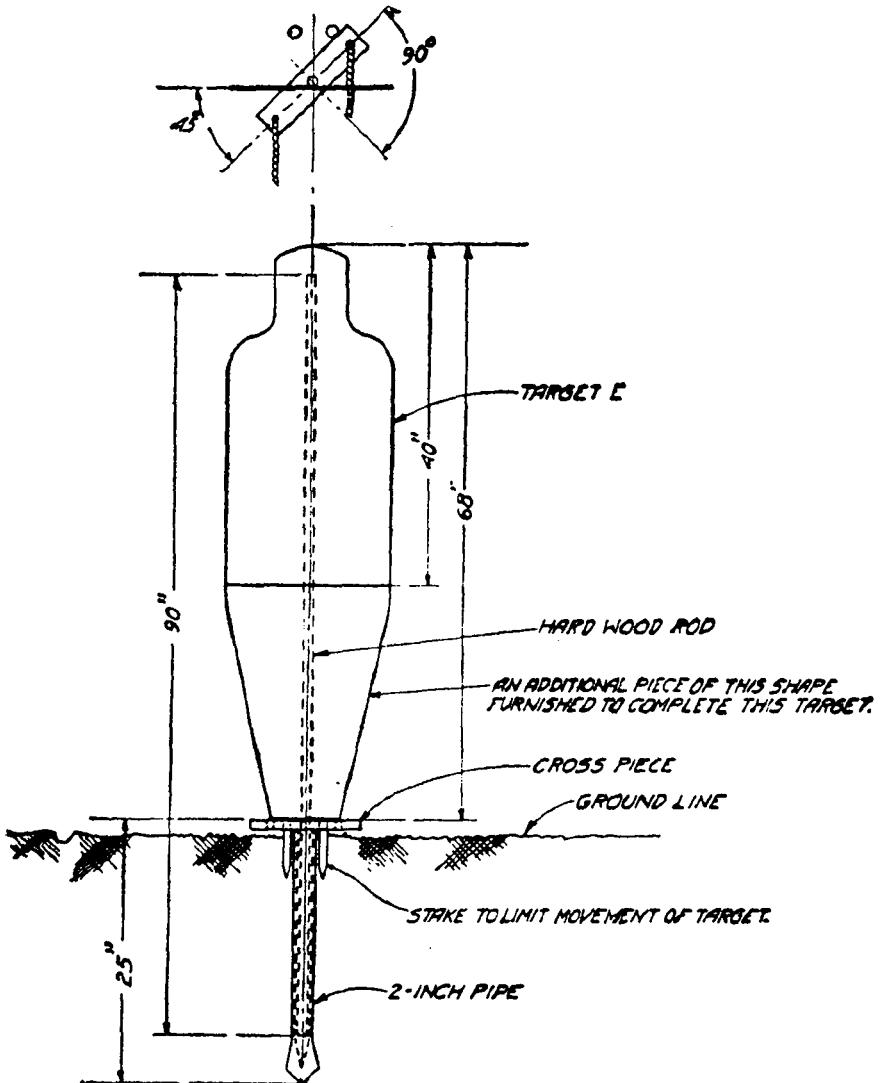

PLATE XXII.



TARGET K.
PLATE XXIII.



BOBBING TARGET
 REVOLVER OR PISTOL RANGE PRACTICE

SMALL-ARMS FIRING MANUAL.

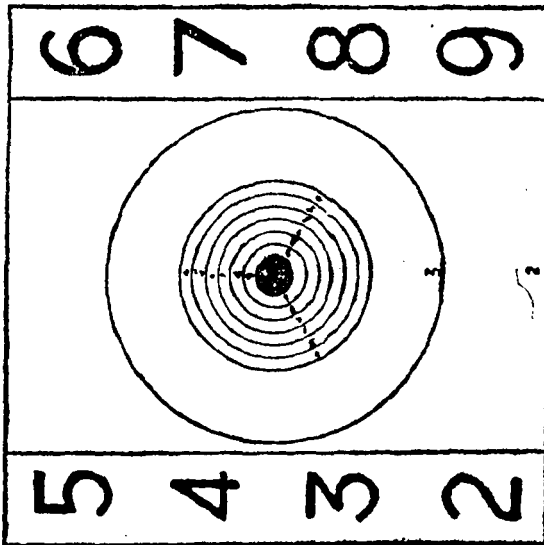

ON OPPOSITE SIDE OF THIS PAGE REFER TO CHAPTER THE SUBJECT.

TARGET L

PLATE XXV.

TARGET M

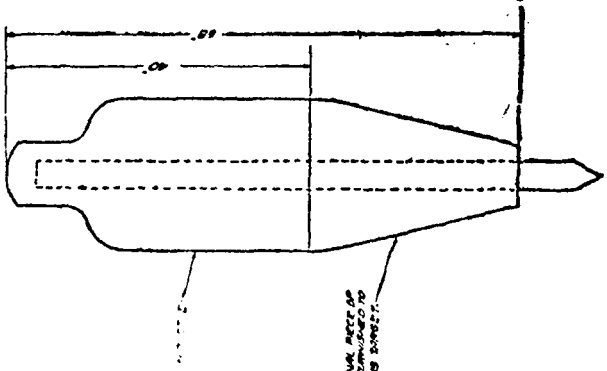

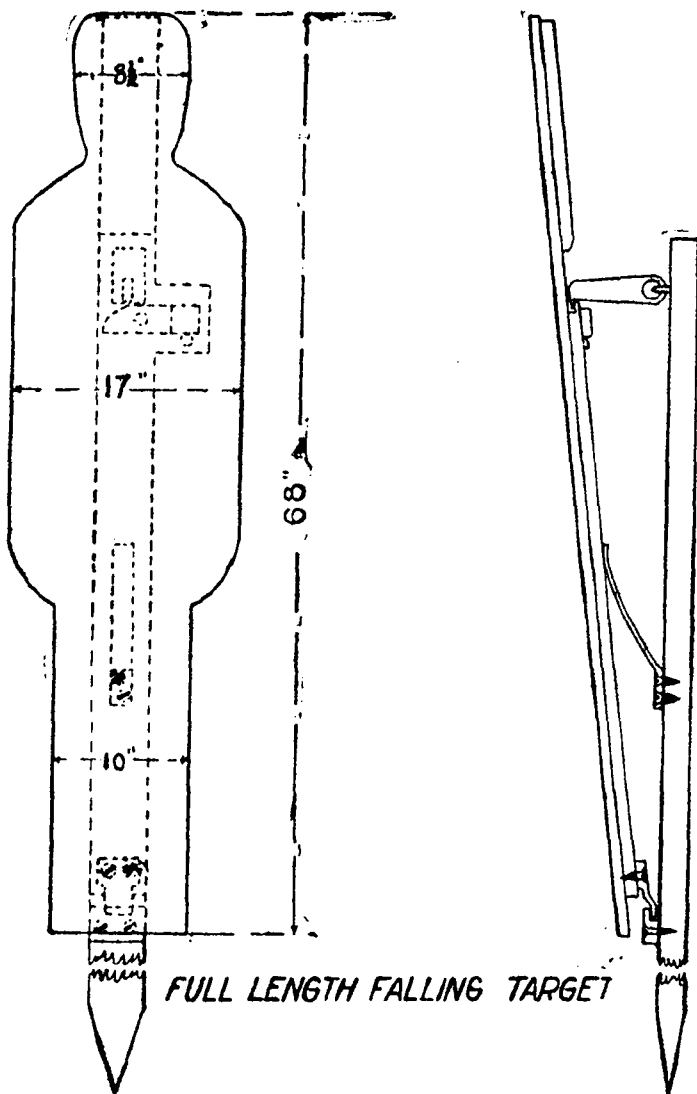

PLATE XXVI.

NOTE.— Plate XXVI illustrates a good form of standing target which falls when hit. This target is not issued, but may be made from scrap material.

RANGES.

262. CLASSES.—There are two classes of ranges: Class "A" ranges, which are more or less limited in extent and which are equipped for known distance practice; class "B" ranges, which are of extended area and diversified terrain, and which are used for combat firing.

Class "A" Ranges.

263. RULES FOR SELECTION.—As the nature and extent of the ground available for target practice and also the general climatic conditions are often widely dissimilar for different military posts, it will not be possible to prescribe any particular rules governing the selection of ranges, but only to express certain general conditions to which ranges should be made to conform as far as may be practicable. In view of the extreme range and penetration of the bullet of the United States rifle, model 1903, it will be found necessary in the case of many posts to have target practice conducted at a distance of several miles from the post, necessitating the establishment of a camp on or near the range. The target practice can then be conducted uninterrupted by the routine of post duties.

SECURITY NECESSARY.—For posts situated in thickly settled localities, where the extent of the military reservation is limited, the first condition to be fulfilled is that of security for those living or laboring near or passing by the range. This requirement can be secured for class "A" range by selecting ground where a natural butt is available or by making an artificial butt sufficiently extensive to stop wild shots. For complete security there should be no road, building, or cultivated ground on either flank of the range nearer than 300 yards nor in the rear of it within the extreme range of the rifle. This condition can rarely be secured unless a natural butt of large extent exists.

264. DIRECTION OF THE RANGE.—If possible, a range should be so located that the firing is toward or slightly to the east of north. This gives a good light on the face of the targets during the greater part of the day. However, security and suitable ground are more important than direction.

265. BEST GROUND FOR CLASS A RANGE.—Smooth, level ground, or ground with only a very moderate slope, is best adapted for a range. If possible, the targets should be on the same level with the firer, or only slightly above him. Firing downhill should, if practicable, be avoided.

266. SIZE OF RANGE.—The size of the range is determined by its plan and by the number of troops that will fire over it at a time. There are two general plans used in range construction—one with a single target pit and firing points for each range, the other with its firing points on one continuous line, the target pits for the various ranges being in echelon. The latter type requires more ground but admits of firing at different ranges at the same time.

267. INTERVALS BETWEEN TARGETS.—To reduce to a minimum the amount of labor required in preparing the range, the targets should be no farther apart than is necessary to obviate the probability of a shot being fired on the wrong target. At all of the targets themselves—that is, at short and mid range, 6 of the targets themselves—that is, at short and mid ranges, 6 feet; at long range, 12 feet.

268. PROTECTION FOR MARKERS.—On all ranges protection must be provided for the pit details. This is done by excavating a pit for the targets or by constructing a parapet in front of them, or by a combination of these methods.

Where there are several targets in a row, the shelter should be continuous. It must be high enough to protect the markers and the target not being fired upon. The parapet may be of earth, with a timber or concrete revetment, of sufficient thickness to stop bullets, and from 7½ to 8 feet high above the ground or platform on which the markers stand.

269. ARTIFICIAL BUTTS.—If an artificial butt is constructed as a bullet stop, it should be of earth not less than 30 feet high and with a slope of not less than 45°. It should be extended about 5 yards beyond the outside targets and should be placed as close behind the targets as possible. The slopes should be sodded.

270. HILLS AS BUTTS.—A natural hill to form an effective butt should have a slope of not less than 45°; if originally more gradual it should be cut into steps, the face of each step having

that slope. As a temporary expedient the face of the hill may be plowed perpendicularly to the range, but as the bullets soon cut down the furrows this measure must be frequently repeated to prevent the danger of ricochets.

271. NUMBERING OF TARGETS.—Each target should be designated by a number. The numbers for ranges up to 600 yards should be at least 6 feet in height and should be painted black on a white background. The Arabic is preferable to the Roman notation, being more readily comprehended by the soldiers; if made of the size suggested, they will always be quickly recognized. They should be placed on the butt behind each target, but not so far above as to prevent the soldier seeing the number when aiming at the target.

272. MEASURING THE RANGE.—The range should be carefully measured and marked with stakes at each 100 yards in front of each target. The stakes should be about 12 inches above the ground, painted white, and lettered in black, with the number of the corresponding target and its distance. These stakes will then designate the firing points for each target at the different distances. Particular care should be taken that each range thus marked out is perpendicular to the face of its own target.

273. RANGES PARALLEL.—The different ranges for the same distance should all be parallel, so that similar conditions with respect to wind and light may exist.

It is not essential, however, that the ranges employed for long-distance shooting should be parallel to those used for the ordinary company practice.

274. FIRING MOUNDS.—If it becomes necessary to raise a firing point on account of low ground, a low mound of earth no higher than absolutely required should be made. The mound should be not less than 8 feet square, level, and sodded. If the entire firing line is raised, the firing mound must be not less than 8 feet wide on top, level, and sodded if possible.

275. PIT SHED.—A small house or shed should be built in or near the target pit, in which the marking disks and signal flags and spare parts of the target frames for making immediate repairs should be stored. It should be sufficiently large to afford a shelter for the markers in case of a sudden storm.

276. DANGER SIGNALS.—A socket for the staff of the danger signals should be placed on the marker's shelter in front of each

target and so inclined that the flag will always fall clear of the staff and be readily seen. This flag will always be displayed when the target is in place and not in use. In addition to the danger signals at the targets one or more danger signals will be displayed near the range to warn passers-by when firing is in progress. These signals will not be placed in such a position as to serve as streamers for judging wind on the range. They should be placed on the roads or on the crest of the hill where they can be plainly seen by those passing.

277. RANGE HOUSE.—On large ranges where competitive firing is held a house containing a storeroom and several office rooms should be erected in some central place, off the range, but in its immediate vicinity. Such facilities as will enable visitors to satisfactorily witness the firing should also be provided.

278. TELEPHONE SERVICE.—When practicable, ranges should be equipped with a telephone system, connecting the target pit with each firing point, the range house, and the post. When a large number of targets are installed, the range should be equipped with the annunciator buzzer system.

279. COVERED WAYS BETWEEN PITS.—Where the pits are in echelon, covered ways or tunnels should be provided between the various pits. This will allow the pit details to be shifted with safety without interrupting the firing.

280. SCORERS' TABLES.—The range should be provided with scorers' tables and benches.

Class "B" Ranges.

281. CLASS B RANGE.—Certain extensive reservations in the United States and the Philippine Islands will furnish ample and suitable ground for combat firing. At times extensive tracts of unoccupied land or land from which the crops have been harvested may be rented near the post. At other points where leased tracts are at the disposal of the garrison for purposes of target practice or maneuvers facilities for combat firing can probably be found. Any ground suitable for maneuvers will also be suitable for combat firing, if the safety of the neighboring inhabitants be taken into consideration and provided for.

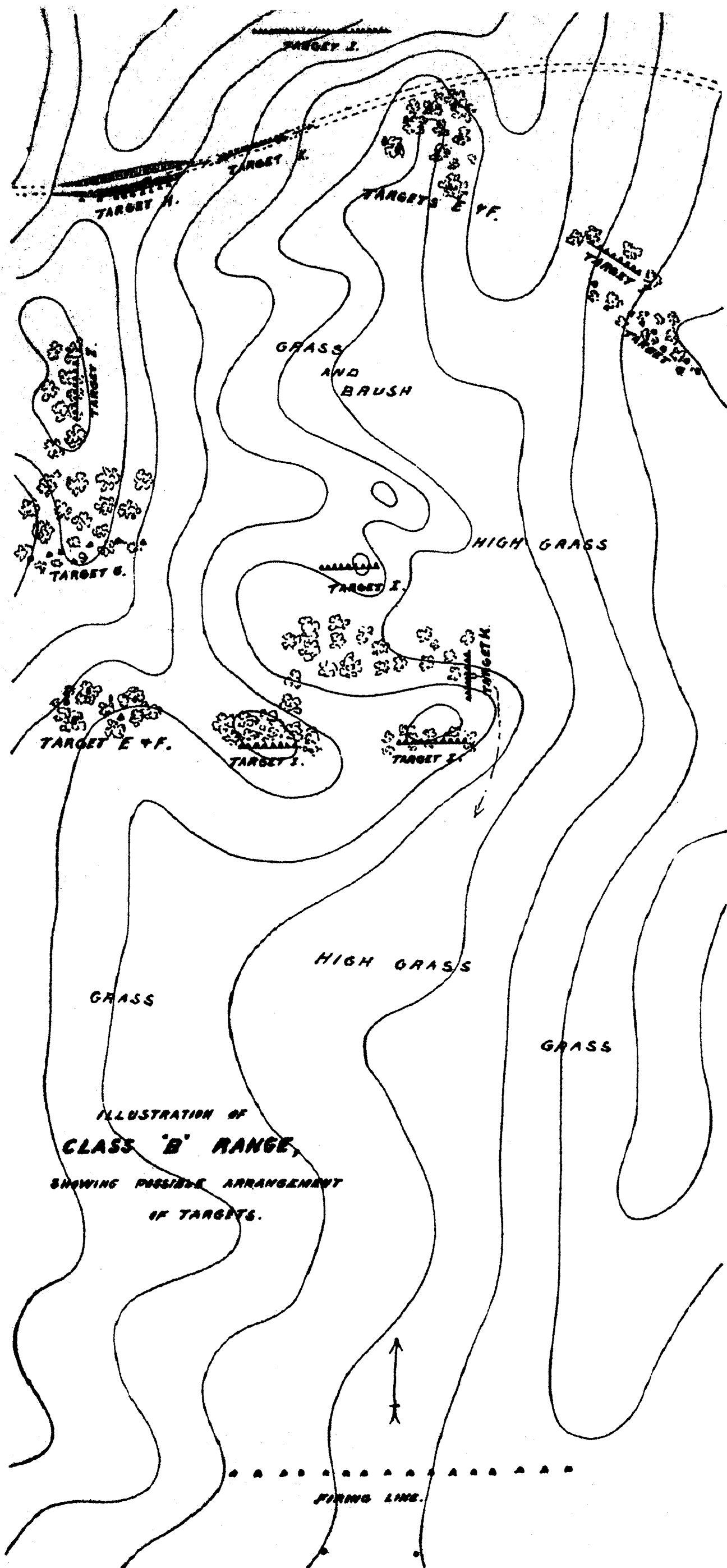

ILLUSTRATION OF
CLASS 'B' RANGE,
 SHOWING POSSIBLE ARRANGEMENT
 OF TARGETS.

Tracts that have been set aside as permanent Class "B" ranges may be improved by the construction of permanent shelters for the markers and pitmen, which should be made inconspicuous. Otherwise, these ranges should be kept in the natural state, but changes made to facilitate the practice or to save labor from year to year should be such as not to provide assistance to those under instruction.

CHAPTER IV.

COMPETITIONS.

282. Competitions exist for the purposes of fostering interest in target practice, of furnishing the means for the exchange of ideas among those who excel in small-arms firing, and of classifying the best shots according to merit shown under similar conditions.

In every alternate year, or when directed by the Secretary of War, the following competitions will be held:

1. Department rifle competitions.
2. Department pistol competitions.

These competitions will be held at such places and times as may be designated by the respective department commanders.

A department rifle competition for Philippine Scouts will be held in every alternate year, commencing with the year 1916.

(*C. S. A. F. M., No. 10.*)

DEPARTMENT RIFLE COMPETITIONS.

283. SELECTION OF COMPETITORS.—(a) OFFICERS.—Each regimental commander will report to the department commander the names of any commissioned officers of his regiment who may desire to enter the competition and whom he can recommend for that purpose, further stating, where more than one officer is recommended, the comparative proficiency as rifle shots of those reported. From these reports, or from such additional reports as he may require, the department commander will

select one officer, as competitor, from each regiment of Cavalry, Infantry, and Engineers, and one from each battalion of mounted Engineers and Philippine Scouts in his command, and in addition such officers of the General Staff and the different staff departments or corps, except the medical department and chaplains, in his department, as he may deem proper.

In case a regiment is divided between two or more departments, the final selection of officers from such a regiment will lie with the Secretary of War.

The Coast Artillery Corps may be represented, at the discretion of the department commander, in the ratio of 1 officer to 12 companies.

(b) ENLISTED MEN.—The commanding officer of each company of Infantry and Engineers and each troop of Cavalry will select from the enlisted men of his organization the most suitable soldier, due regard being paid to excellence of shooting with the rifle, as well as to steadiness and good soldierly habits and conduct, and report the name of the man so chosen to the regimental commander or, in the case of mounted Engineers, to the battalion commander.

The post, regimental, and battalion noncommissioned staff will not be represented.

Enlisted men of the Coast Artillery may be permitted but not required to compete, and will be selected by company commanders as in the case of Infantry organizations.

The names of the men selected will be reported to the department commander, who will order them sent to the competition at the proper time. (*C. S. A. F. M., No. 16.*)

283½. For the department rifle competition for Philippine Scouts, officers and enlisted men will be reported and selected as prescribed for officers and enlisted men of Engineer battalions in sections (a) and (b), paragraph 283.

(*C. S. A. F. M., No. 10.*)

284. ASSEMBLY.—The officers and enlisted men thus selected will be assembled at some convenient place, and, after the completion of the prescribed preliminary practice, the enlisted men will compete for places on the team.

The officers will also compete at the same time with each other, not for places on the team but for medals.

285. PRELIMINARY PRACTICE.—First: Ten shots, slow fire, at 300, 500, and 600 yards each, conducted as in record practice, qualification course, except that at 300 yards the firing will be either from the sitting or kneeling position at the option of the competitor, and no sighting shots will be allowed at 600 yards. At 300 yards target "A" will be used; at 500 and 600 yards target "B" will be used.

Second: Ten shots, slow fire, at 1,000 yards, at target "C," conducted according to paragraph 115, except that no coaching will be allowed. The firing will not be preceded by sighting shots.

Third: Ten shots; rapid fire, at 200, 300, and 500 yards each, at target "D," conducted according to paragraph 112.

In all firing—preliminary practice and the competition proper—either the open or peep sight may be used.

286. COMPETITION PROPER.—The competition proper will consist for each competitor of the practice prescribed for preliminary practice, except that each firing at 600 and 1,000 yards will be preceded by 2 sighting shots, and the course will be fired through twice, making a total of 140 shots for record; the order of sequence in firing being determined by the officer in charge of the competition.

287. DEPARTMENT TEAM.—The strength of the department team will be in direct proportion to the number of enlisted competitors engaged in the competition, the ratio being fixed at 1 member of the team to 5 competitors, fractions not considered. The team will be composed of those enlisted competitors making the highest aggregate scores for the entire competition proper.

288. PRIZES.—To the members of the team thus selected the following gold, silver, and bronze medals will be awarded according to order of merit and in the ratios indicated.

Competitors.	Team.	Gold.	Silver.	Bronze.
30 or more.....	6	1	2	3
35.....	7	1	2	4
40.....	8	1	2	5
45.....	9	1	3	5
50.....	10	2	3	5
55.....	11	2	3	6
60.....	12	2	4	6
65.....	13	2	4	7
70.....	14	2	4	8
75.....	15	2	5	8
80.....	16	2	5	9
85.....	17	2	5	10
90.....	18	2	6	10
95.....	19	3	6	10
100.....	20	3	6	11
105.....	21	3	7	11
110.....	22	3	7	12
115.....	23	3	7	13
120.....	24	3	8	13
125.....	25	3	8	14
130.....	26	3	8	15
135.....	27	3	9	15
140.....	28	4	9	15
145.....	29	4	9	16
150.....	30	4	10	16
155.....	31	4	10	17
160.....	32	4	10	18
165.....	33	4	11	18
170.....	34	4	11	19
175.....	35	4	11	20
180.....	36	4	12	20

and so on according to the principle illustrated in the above table; that is, for each 45 men or fraction, one gold medal; for each 15 men, disregarding fractions, one silver medal; the remainder bronze medals.

Any commissioned competitor (except distinguished marksmen) making a score equal to that of any member of the team will receive a medal like that awarded to such member of the team.

(C. S. A. F. M., No. 12.)

289. PRESENTATION OF PRIZES.—The presentation of competition prizes will be made, when practicable, at the conclusion of

the contest, and will be conducted with the ceremony and formality warranted by the importance of the occasion.

Timely requisition should be made for the prizes required.

Winners of medals in rifle or pistol competitions will not part with them without authority from the Secretary of War, but will hold them subject to inspection at any time.

DEPARTMENT PISTOL COMPETITIONS.

290. WHEN HELD.—These competitions will be held at the same place as the department rifle competitions and will either precede or follow those competitions as the department commander may prescribe. (*C. S. A. F. M., No. 12.*)

291. SELECTION OF COMPETITORS—(a) OFFICERS.—Each regimental commander will report to department headquarters the names of any commissioned officers of his regiment who may desire to enter the competition and whom he can recommend for that purpose, further stating, whenever more than one officer is recommended, the comparative proficiency as pistol shots of those reported. From these reports and such additional reports as he may require, the department commander will select one officer, as competitor, from each regiment of Cavalry, Infantry, Engineers, and Field Artillery in his command, one from each battalion of mounted Engineers and Philippine Scouts, and in addition such officers, except medical officers, from the department staff as he may deem proper. Not to exceed one officer of the Signal Corps may be selected in each department by the department commander.

In case a regiment is divided between two or more departments, the final selection of the officer therefrom will lie with the Secretary of War.

The Coast Artillery Corps may be represented, at the discretion of the department commander, in the ratio of one officer to twelve companies.

(b) ENLISTED MEN.—The commanding officer of each troop of Cavalry and each battery of Field Artillery will select from the enlisted men of his organization the most suitable soldier, due regard being paid to excellence of shooting with the pistol, as well as to steadiness and good soldierly habits and conduct,

and report the name of the man thus chosen to the post commander.

The post noncommissioned staff will not be represented.

Enlisted men of Engineers, Infantry, Coast Artillery Corps, and Signal Corps armed with the pistol may be represented as follows, viz:

ENGINEERS.—Two competitors from each regiment, to be selected by the regimental commander, and one competitor from each battalion of mounted Engineers, to be selected by the battalion commander.

INFANTRY.—Two competitors from each regiment, to be selected by the regimental commander.

COAST ARTILLERY CORPS.—In the ratio of one competitor to six companies, to be selected by the department commander.

SIGNAL CORPS.—One competitor from each company or aero squadron, to be selected by the organization commander.

The names so selected will be reported through military channels to the department commander, who will send the competitors so selected to the place of competition at the proper time.

(C. S. A. F. M., Nos. 5 and 16.)

292. ASSEMBLY.—The officers and enlisted men thus selected will be assembled at times and places designated and, after the completion of the preliminary practice, will compete for places on the team.

293. PRELIMINARY PRACTICE.—The preliminary practice will consist, for each competitor, of the following practice dismounted, in the following order:

Slow fire (30 seconds per shot).

	Yards.
2 scores (7 shots each) -----	50
2 scores (7 shots each) -----	75

Rapid fire (30 seconds per score).

2 scores (7 shots each) -----	25
2 scores (7 shots each) -----	50

Rapid fire (15 seconds per score).

	Yards.
2 scores (7 shots each)-----	15
2 scores (7 shots each)-----	25

Target "L" will be used for all firing.

294. PROCEDURE.—The procedure in all classes of firing will be as prescribed in the dismounted course in this manual and subject to regulations governing competitions.

295. COMPETITION PROPER.—The competition proper will consist, for each competitor, of the firing prescribed for preliminary practice, except that the course will be fired through twice.

296. DEPARTMENT PISTOL TEAM.—The strength of the team will be in direct proportion to the number of enlisted competitors engaged in the competition, the ratio being fixed at one member of the team to five competitors, fractions not considered.

The team will be composed of those enlisted competitors making the highest aggregate scores for the entire competition proper.

297. To the members of the team thus selected, gold, silver, and bronze medals will be awarded, according to merit and in the same ratio as indicated in paragraph 288.

Any commissioned competitor making a score equal to or greater than that of any enlisted member of the team will receive a medal like that awarded to such member.

REGULATIONS FOR COMPETITIONS.

298. (a) OFFICER IN CHARGE.—The officer in charge will be an officer of experience, preferably a field officer.

He will have control of the range for the conduct of the competition and for the police and government of the range during the competition. He will prescribe the hours for preliminary practice, and for the competitions proper. His decision on such matters will be final.

(b) ASSISTANT TO OFFICER IN CHARGE.—An assistant to the officer in charge will report to and receive instructions from the officer in charge and will assist him in the management of the competition. He will also act as chief range officer. He will

have immediate charge of the range and pit and all details pertaining thereto.

(c) The adjutant will discharge the duties of adjutant to the officer in charge, issue by direction of the officer in charge the necessary orders, and perform such other duties as may be assigned to him.

He will be in direct charge of the competitors, whether they are encamped or assigned to companies in barracks.

He will detail daily such range officers, scorers, markers, etc., as may be considered necessary to carry on the competition.

(d) QUARTERMASTER.—The quartermaster will have charge of quartering all competitors and arranging for the transportation of their baggage and property upon their arrival at the competition. If they encamp, he will lay out and put up the camp. He will provide all the property, including stationery and office supplies, other than ordnance and signal property, required for the competition and for the preparation and care of the range, and perform such other duties as may be assigned to him by the officer in charge.

(e) STATISTICAL OFFICER.—The statistical officer will assign the competitors to targets and order of firing by lot or by a scheme worked out prior to the competition. He will verify the additions of the scores as reported by the scorers, grade them in order of excellence, and prepare the result for official announcement. He will issue such bulletins from time to time as may be ordered by the officer in charge.

(f) ORDNANCE OFFICER.—The ordnance officer will make timely requisition for all ammunition and ordnance stores needed in the matches, and during the matches supply these stores as required.

(g) SIGNAL OFFICER.—The signal officer will have charge of the electrical equipment of the range and procure on requisition such telephones, signal stores, and field glasses as may be needed for the proper conduct of the competition.

(h) RANGE OFFICERS.—Under direction of, and as assistants to, the chief range officer are a number of range officers, not fewer than one to two targets in the pit and one to two firing points on the range. Their duties are to supervise the marking and scoring, to see that the firing is conducted according to the regulations, and to perform such other duties as required.

So far as practicable, officers experienced in range work will be selected for duty as range officers.

During the firing at all competitions a range officer will be detailed in charge of the pit at each distance. The officer in charge and chief range officer will formally assemble and instruct the range officers in their duties before the opening of the competition and place them on duty during the preliminary practice for their practical instruction.

299. DETAILS OF ENLISTED MEN.—The officer in charge will apply for such details of enlisted men as he may consider necessary. These details will be permanent for the competition.

300. GENERAL REGULATIONS.—The rules governing every feature connected with range practice as prescribed in this manual will, as far as applicable, regulate the procedure in competitions.

301. UNIFORMS.—Competitors will wear the service uniform and cartridge belt with cartridge belt suspenders. In firing, one suspender may be slipped from the shoulder. The shoulder and elbows of the coat or shirt may be padded. A pad may also be used on the knee upon which the firer kneels in firing kneeling.

302. ARMS.—In authorized competitions officers and men will use the rifle or pistol as issued or sold by the Ordnance Department. Rifles for telescopic sights will be used in competition for telescopic sights only. The fact that a rifle has been star gauged will not debar it from use in competitions.

Should a rifle be issued with a trigger pull under 3 pounds, the bolt may be changed in order to bring the piece up to the required standard.

303. SIGHTS.—No alteration of the service sights will be permitted except that the sight may be blackened and any authorized size of peep slide or slide cap used.

304. TRIGGER PULL.—The trigger pull will always be at least 3 pounds for the rifle and 4 pounds for the pistol, and will be tested (holding the barrel vertically) by a range officer, before firing, each day and at each range. Competitors will submit their arms for further inspection whenever required.

305. AMMUNITION.—The ammunition used will be the service cartridge for the arm as issued by the Ordnance Department, unless the use of other ammunition is authorized.

306. CHANGING ARMS.—No two competitors shall fire in any competition with the same rifle. No competitor shall change his rifle during any competition, unless his first piece has become unserviceable through accident, which must be verified by a range officer. This rule also applies to the pistol. Violation of this rule will be a just cause for exclusion from the competition, according to the discretion of the officer in charge.

307. CLEANING.—Cleaning will be permitted between ranges only.

308. SHELTER FOR FIRER.—Sheds or shelter for the firer will not be permitted at any range.

309. PUNCTUALITY.—Competitors must be present at the firing point at the proper time and in the order stated on their score cards. No application on the part of a competitor for any alteration in his assignment will be entertained.

310. ORDER OF FIRING.—In slow fire the competitors will place themselves at the firing point by twos, and will fire alternately, the odd number of each pair being on the right and firing first.

In rapid fire but one man at a time will be at the firing point of a target.

311. LOADING PIECES.—Pieces will not be loaded except by command or until position for firing has been taken.

312. POSITION IN PISTOL COMPETITION.—At the firing point, when not firing, the pistol will be held at "Raise pistol." While firing, the pistol will be held and supported by one hand only, the arm extended at will but free from the body and unsupported in any way.

313. WITHDRAWING TARGET PREMATURELY.—In slow fire, if the target is withdrawn from the firing position just as the shot is fired, the scorer at that firing point will at once report the fact to the range officer in charge of the scoring on that target, who will investigate and, if satisfied that the case is as represented, will direct that the shot be not considered and that the competitor fire another shot.

314. DELAY IN FIRING.—In slow fire, competitors will not be hurried in firing but such slight delay permitted after each shot as they may desire, provided the time of firing the score does not exceed one minute per shot at 600 yards or less, one and one-half minutes per shot at ranges over 600 yards, and 30 seconds per shot in pistol firing.

If an accident to a target, or any other cause over which a soldier has no control, prevents him from completing his score within the time limit, he will be permitted such additional time as a range officer may decide.

315. COACHING.—No coaching or unnecessary communication of any kind with those actually firing will be permitted.

316. WARMING OR FOULING SHOTS.—No warming nor fouling shots will be allowed at any competition.

317. ORDER OF FIRE.—The order of fire will be as prescribed in paragraph 285 and paragraph 293 and will not be changed.

318. SPECTATORS.—During the progress of a match or competition, no one except the officers on duty on the range, the competitors, and score keepers will be permitted within the ropes without special permission of the officer in charge.

319. STATIONS OF COMPETITORS AWAITING TURN TO FIRE.—Competitors will be stationed 5 yards in rear of the firing point and will remain there until called to the firing point by the score keeper.

320. EXPRESSIONS OF APPROBATION, ETC.—Expressions of approbation or disappointment on the part of the spectators or competitors must not be uttered loud enough to be heard at the firing point.

321. PROTESTS.—Protests and objections must be submitted to the range officer in charge of the target and not directly to the officer in charge. In case a competitor is not satisfied with the decision of the range officer, he may appeal to the officer in charge. Final appeals from decisions of the officer in charge must be made in writing and forwarded through that officer to the authority ordering the competition.

322. SIGNALING AND RECORDING HITS.—Hits in the different divisions of the targets, misses, and ricochets, slow and rapid fire, will be signaled and recorded as prescribed in this manual.

323. MISSES.—In all firing, before any miss is signaled, the target must be withdrawn from the firing position and carefully examined by a range officer. Whenever the target is reversed and a miss is signaled, it will be presumed that this examination has been thoroughly made and no challenge of the value signaled will be entertained or resignaling of the shot allowed.

324. ACCIDENTAL DISCHARGES.—All shots fired by the soldier after he has taken his place at the firing point and it is his turn to fire—the target being ready—will be considered in his score even if his piece was not directed toward the target or is accidentally discharged.

325. FIRING ON WRONG TARGETS.—Shots fired upon the wrong target will be entered upon the score of the man firing as a miss, no matter what the value of the hit upon the wrong target. In rapid fire the soldier at fault is credited with only such hits (if any) as he may have made on his own target. The other soldier repeats his score.

326. TWO SHOTS ON THE SAME TARGET.—In slow fire, if two shots strike a target at the same time or nearly the same time both will be signaled; if a shot was just fired from the firing point assigned to that target, the hit having the highest of the two values signaled will be entered in the soldier's score and no record made of the other hit.

327. NUMBERING COMPETITORS.—At all competitions where a number of men engage in the same match or competition firing, the labor of the statistical officer will be greatly lightened and the prompt announcement of the scores facilitated by giving each competitor a number by which he is known throughout the firing.

328. SCORE CARDS.—Each competitor should be given a score card stating his target and orders of firing at each range and containing space for the record of shots fired and for the signature of the scorer and range officers. As scores are completed an officer detailed for the purpose should, without waiting for all firing to cease, collect the records of the score and transmit them to the statistical officer for entry upon the permanent records and bulletins.

329. STATIONS OF SCORERS.—The scorers will be seated close to and in rear of the firing-point stakes and will record scores and announce results as required in paragraphs 102 and 103.

330. Competitors must pay attention to the score as announced and recorded so that any error may be promptly investigated. The recorded value of any shot will not be changed after the following shot has been fired unless some special message with reference to it is received from one of the range officers in the

target pit. Any alteration of a score must be witnessed by the officer in charge of the firing point and indorsed with his initials.

331. SPECIAL RULES.—Such special rules or directions as the officer in charge may give must be rigidly observed by competitors and all other persons upon the range.

PENALTIES.

332. EVADING RULES.—Any competitor who may be detected in an evasion of the conditions prescribed for any competition will be debarred from further competition.

333. FALSIFYING SCORES.—Any competitor who may be guilty of falsifying his score or being accessory thereto will be debarred from the competition.

334. OFFERING BRIBES.—Any competitor who offers a bribe of any kind to a scorer or marker will be debarred from the competition.

335. DISORDERLY CONDUCT, INTOXICATION, ETC.—Any competitor who refuses to obey the instructions of the officer in charge or his assistants, or who violates any of these regulations, or is guilty of disorderly conduct or intoxication, shall be debarred from the competition.

336. REPORT OF COMPETITORS DEBARRED.—The officer in charge of the competition will, upon the completion of the competition, report to the department commander for the information of the War Department the names of any competitors debarred from the competition, stating the circumstances in each case, in order that the War Department may debar such competitors from all future competitions if such action is deemed advisable.

337. INTERFERENCE.—Any person, whether a competitor or not, interfering with any of the firing squads or annoying them in any way will be warned to desist, and if the offense is repeated he will be ordered off the range at once.

338. ACQUAINTANCE WITH REGULATIONS.—Competitors and all others connected with competitions must make themselves acquainted with the foregoing regulations as well as with the conditions of the competitive firing in which they may be participating, as the plea of ignorance of either of them will not be entertained.

TIES IN RIFLE COMPETITION.

339. TIES.—Ties will be decided as follows:

1. By the highest aggregate score made in rapid fire. If still a tie, by the higher total score in rapid fire at 500 yards. If still a tie, by the highest total score in rapid fire at 300 yards. If still a tie, by the highest total score in rapid fire at 200 yards.

If still a tie:

2. By the fewest misses in rapid fire.
3. By the greatest number of hits in the figure in rapid fire.
4. By the fewest misses in slow fire.
5. By the fewest outers (twos) in slow fire.
6. By the fewest inners (threes) in slow fire.
7. By the shots in slow fire in inverse order.
8. If still a tie, by firing single shots, slow fire, at the longest range.

TIES IN PISTOL COMPETITION.

340. IN AGGREGATE SCORES.—Upon completion of a pistol competition, ties found in aggregate scores will be decided as follows:

1. By the highest aggregate score made in rapid fire.

If still a tie, by the highest total score at 25 yards, rapid fire, 15 seconds per score.

If still a tie, by the highest total score at 15 yards, rapid fire, 15 seconds per score.

If still a tie, by the highest total score at 50 yards, rapid fire, 30 seconds per score.

If still a tie, by the highest total score at 25 yards, rapid fire, 30 seconds per score.

If still a tie, by the value of each shot at 75 yards, slow fire, in the inverse order.

If still a tie, by firing single shots at 75 yards, slow fire.

341. POST COMPETITIONS.—To further the interest in target practice, post contests in small-arms practice are suggested. When practicable, post competitions should form a part of the exercises for field days. The program for these competitions is left to the discretion of the post commander. The firing should, as a rule, be team firing. The rules governing the division com-

petition will, as far as applicable, regulate the procedure in post competitions.

DISTINGUISHED CLASSES OF MARKSMEN.

342. REQUIREMENTS.—Whenever a marksman has won three authorized medals in department rifle competitions, or in department pistol competitions, or as a member actually firing on a prize-winning team in the national team match, he will be announced by the War Department as belonging to a distinguished class, no longer eligible to enter department competitions with the arm in the use of which he is distinguished.

343. DESIGNATIONS.—If the three medals were won in rifle competitions, the marksman will be designated a “distinguished marksman,” and if in pistol competitions, a “distinguished pistol shot.”

344. BADGES.—To distinguished marksmen and distinguished pistol shots appropriate badges will be issued, which after being received by the soldier, if lost, can be replaced by purchase only, for which authority must be obtained from the War Department.

PART V.

COURSES FOR ORGANIZED MILITIA.

The following courses in small-arms firing are prescribed for the Organized Militia :

GENERAL SCHEME.

345. The general scheme of instruction for the Organized Militia embraces: First, a certain amount of instruction in the preliminary drills and exercises, followed by gallery practice, with a prescribed test before the soldier can be advanced to practice on the target range; second, a definite course of instruction practice, under which, by selected scores of five shots each, a soldier must attain a certain proficiency before he can be advanced to fire the record practice, Organized Militia, or the qualification course, Regular Army; third, a definite test, either the qualification course, Organized Militia, or the qualification course, Regular Army, at the discretion of the State authorities, under which the soldier attains a certain grade in marksmanship; fourth, long-range practice.

CHAPTER I.

PRELIMINARY DRILLS AND INSTRUCTION.

346. (a) The period for indoor instruction will be determined by the State authorities and may extend into or include the entire range practice season :

(b) The essentials of indoor instruction will include—

Nomenclature, covering the most important parts and elements.

Manipulation and use of the various working parts.

Care of the arm.

Sighting, aiming, positions, and trigger squeeze.

Gallery practice.

The course to be followed in indoor instruction is laid down in Part II, Chapters I, II, III, IV; but in the discretion of the State authorities, any course embracing the elements given above may be adopted and followed. The recording rifle rod outfit or any other suitable device may be used in such a course.

GALLERY PRACTICE.

347. The principal objects of gallery practice are to continue in a different manner the instruction in aiming, positions, and trigger squeeze, and to determine, in certain cases, whether or not the individual shall be advanced to range practice.

(a) The following course in gallery practice is prescribed:

TABLE I.

Range.	Targets.	Position.	Minimum number of shots.
<i>Feet.</i> 50	The iron gallery target issued by the Ordnance Department or one similar thereto, or paper targets.	Prone.....	10.
50		{Sitting.....	}10 {5 sitting. 5 kneeling.
50		{Kneeling..	
		Standing..	10.

Where it is impracticable to use ranges of 50 feet, gallery practice may be conducted at a greater distance at a target whose dimensions and divisions have been proportionately increased. Firing will be by scores of five consecutive shots. Except in case of accident, a score once begun will be completed.

QUALIFICATION IN GALLERY PRACTICE.

(b) No officer or enlisted man who has failed to qualify as first class or better in a previous season shall be advanced to

range practice until he has attained at least 90 points out of a possible 150 in the gallery practice course, by selecting his two best scores of five shots at each range. If a gallery range be not available, the recording rifle rod outfit or subtarget gun machine may be used to determine eligibility for range practice, under similar conditions, when specially authorized by the State authorities.

CHAPTER II.

KNOWN DISTANCE FIRING.

348. The qualification course is divided into Instruction Practice and Record Practice.

(a) Instruction practice embraces:

1. A prescribed course in which a certain proficiency must be attained in certain cases, before qualification practice is undertaken; this course may be shot through as many times as is necessary to insure proper instruction.

2. Such further preliminary practice at any range as is considered necessary to prepare the individual for the Record Practice.

3. Firing for recruits may be held at 100 yards in any position except standing, but does not count in determining proficiency in the instruction practice.

(b) The instruction practice and the number of shots at each range, upon which eligibility to advance to record practice is determined, are given in the following tables:

INSTRUCTION PRACTICE.

TABLE 2.

Range.	Kind of fire.	Time.	Shots.	Targets.	Position.	Possible.
200	Slow fire.	No limit.	10	A	{5 sitting. 5 kneeling. } Prone. Prone.	50
300	Slow fire.	No limit.	5	A		25
500	Slow fire.	No limit.	10	B		50

TABLE 3.—Target D.

(Battle sight only will be used with this target.)

Range.	Kind of fire.	Time.	Shots.	Targets.	Position.	Possible.
200	Slow.	No limit.	5	D	Kneeling.	25
200	Rapid.	1 minute.	5	D	Kneeling, or sitting, from standing.	25
300	Slow.	No limit.	5	D	Prone.	25
300	Rapid.	1 minute.	5	D	Prone from standing.	25

Total, 225.

1. Each shot is marked in slow fire on target D. Rapid fire is conducted as prescribed in paragraph 110 except as to scores. At each range a total of 60 per cent of the possible must be attained before advancement to the next range.

2. After eligibility to fire-record practice has been determined according to the provisions of paragraphs (d) and (e), the record practice may be preceded by further preliminary practice in the discretion of the State authorities.

3. Firing in instruction practice will be by scores of five consecutive shots. A score once begun will be completed, unless accident or conditions of range weather interfere.

(c) The following grades of classification are obtained in instruction practice by selective scores of five consecutive shots each.

First-classman, 150; possible, 225.

Second-classman, 130; possible, 225.

Unqualified, below 130.

(d) No individual shall be advanced to record practice until he has attained the grade of first-classman, except as provided in paragraph (e).

(e) Instruction practice will be optional with the State authorities for all who have qualified as marksmen or better in the season immediately preceding. (C. S. A. F. M., No. 11.)

RECORD PRACTICE.

349. After completing the instruction practice, those who qualify as first-classmen are eligible to fire record practice, Organized Militia, or the qualification course, Regular Army.

The choice of courses shall be determined by the State authorities. Both courses may be pursued in the same State in the same season, but the course in regiments or in separate smaller tactical units shall be uniform; provided that an individual, who qualifies in record practice, Organized Militia course, as sharpshooter or expert rifleman, may be permitted to fire the Regular Army qualification course and qualify therein at the discretion of the State authorities.

350. QUALIFICATION COURSE.

(a) TABLE 4.—*Slow fire.*

Range.	Time.	Shots.	Targets.	Position.
300	No limit.	10	A.	Prone.
500	No limit.	10	B.	Prone.
600	No limit.	10 (s. s.)	B.	Prone, sandbag rest. ¹

¹ In firing with sandbag rest, either rifle or back of hand must rest on sandbag.

TABLE 5.—*Target D, rapid fire, battle sight.*

Range.	Time.	Shots.	Targets.	Position.
200	1½ minutes.	10	D.	Kneeling, or sitting, from standing.
300	2 minutes.	10	D.	Prone from standing.

This course may be fired three times in any target season, the individual's classification being determined by the best of his three trials, but this provision shall not be construed to permit the formation of a record based on scores selected from two or

more trials—the basis of classification must be the result of one complete course in each case.

(b) Coaching is prohibited in record practice after the individual has taken his position at the firing point.

(c) Instruction and record practice may be fired on the same day, but record practice once begun must be completed without further instruction firing. (C. S. A. F. M., No. 11.)

351. QUALIFICATION COURSE, REGULAR ARMY.—The qualification course of the Regular Army shall be carried out by the Organized Militia with a strict adherence to all conditions and provisions required for the Regular Army, except that instruction and record practice may be fired on the same day, but record practice once begun must be completed without further instruction firing.

352. PRACTICE FOR COAST ARTILLERY RESERVES.—Special course "A," as described in paragraph 121, will be fired by coast artillery reserves of the Organized Militia, unless other courses be prescribed by the State authorities.

353. LONG-DISTANCE PRACTICE.—After the qualification course has been completed, those men who have qualified as experts and sharpshooters may be given long-distance practice, at the discretion of the State authorities.

Practice for record may be preceded by instruction practice. Record practice will consist of any selective score of 10 consecutive shots each. The practice will be conducted as set forth for slow fire known distance.

TABLE 6.—*Target C.*

Range.	Shots.	Position.
800	10	Prone.
1,000	10	Prone.

No one will be advanced to practice at 1,000 yards until he has attained a minimum total of 40 points at 800 yards in any score of 10 consecutive shots.

When an individual has attained a total of 85 points at 800 and 1,000 yards, including a minimum of 40 at 800 yards, by selective scores of 10 consecutive shots, he shall be considered to be qualified in long-distance practice but is not included in the table of classification nor in the computation of the figure of merit. He may be rewarded by suitable medals or other devices at the discretion of the State authorities.

354. PRACTICE WITH TELESCOPIC SIGHTS.—Practice with telescopic sights may be held at the discretion of the State authorities and, when held, will be conducted in accordance with paragraph 117.

355. MISCELLANEOUS.—(a) The conditions and requirements governing the conduct of target practice, except as modified in Part V, shall be the same for the Organized Militia as for the Regular Army.

(b) **DRESS AND EQUIPMENT.**—The dress and equipment of officers and men participating in target practice shall be prescribed by the State authorities. The cartridge belt will be worn at all times.

(c) **MARKING.**—The provisions of these regulations governing marking which are impracticable for the Organized Militia may be modified by the State authorities except for the qualification course, Regular Army.

(d) **SCORING.**—Such provisions of these regulations as are impracticable for the Organized Militia may be modified by the State authorities except for the qualification course, Regular Army.

(e) **ESTIMATING DISTANCE.**—Estimating distance will not be required for the Organized Militia except when firing the Regular Army course, in which case paragraph 85 will be complied with. State authorities may require commissioned officers to qualify in estimating distance in the qualification course, Organized Militia.

(f) **PRACTICE SEASON.**—The practice season will be determined by the State authorities.

(g) **WHO WILL FIRE.**—Known-distance practice.

Required to fire.

All officers and enlisted men of regiments of Infantry, Cavalry, and Engineers, and of Mounted Battalions of Engineers, except those authorized but not required to fire, and except bandsmen, who will not fire.

All officers and enlisted men of companies of Coast Artillery will fire special course A.

Authorized but not required to fire.

Staff departments, except medical and chaplains, all officers and enlisted men.

Staff Corps, all officers and enlisted men.

Field and staff officers of regiments of Infantry, Cavalry, and Engineers, of Mounted Battalions of Engineers, and of the Coast Artillery Corps.

Enlisted men of headquarters, supply, and machine-gun troops and companies of Cavalry and Infantry. Enlisted men of regiments and Mounted Battalions of Engineers who do not belong to companies. Noncommissioned staff officers of the Coast Artillery Corps.

All officers enumerated above of over 10 years' commissioned or commissioned and enlisted service, except officers of the Medical Department and chaplains, are authorized but not required to fire.

Cooks may be excused from firing.

Officers and enlisted men authorized but not required to fire, and who are not on duty with a company or troop which takes target practice, will, if they fire, be attached to organizations for practice and will be classified on the report of the organization to which so attached.

(h) AMOUNT OF FIRE.—The amount of firing in one day for any individual is not restricted for the Organized Militia in any course.

(i) QUALIFICATION.—Qualification will be based on the results obtained in either one of the qualification courses or in the instruction practice, as set forth in the following table:

TABLE 7.—Points required in qualification.

Courses.	Expert.	Sharpshooter.	Marksmen.	1st class.	2d class.	Unqualified. ¹	Possible.	Insignia.
1. Qualification course, instruction practice, Organized Militia.	150	130	Below 130.	225	None.
2. Qualification course, record practice, Organized Militia.	210	190	160	250	Bronze.
3. Qualification course, Regular Army.	253	233	202	177	152	300	Regular Army.
4. Special course "A," coast artillery Reserves.	150	120	100	200	Bronze.

¹ All who fire the qualification course, instruction practice, Organized Militia; the qualification course, Regular Army; the special course "A" and who in any course fail to qualify as second class or better; and all who fail to complete a course or fail to fire.

1. If in case authority is given to fire the qualification course, Regular Army, after a grade of qualification has been attained in the qualification course, Organized Militia, the higher qualification shall be used as the basis of record, and medals will be issued in each case.

2. If an individual fails to qualify as marksman or higher in firing the record practice, Organized Militia, his grading shall be first-class. In the Regular Army course and special course "A" the qualification shall be determined by the result of the firing in that course alone.

(j) **HOLDOVER QUALIFICATIONS.**—Holdover qualifications for the Organized Militia in the qualification courses (Organized Militia and Regular Army) will be limited to expert riflemen. An individual having attained this grade will retain that qualification for three consecutive target years, including the target season in which qualification was made. An individual entitled to a holdover qualification as an expert rifleman may be author-

ized by the State authorities to fire the qualification courses, in which case he forfeits no rights to such holdover qualification. If during such subsequent firing he again qualifies as an expert rifleman, his holdover privileges will begin from his latest qualification.

(k) **INSIGNIA.**—For the qualification course, Organized Militia, bronze badges and pins.

For the qualification course, Regular Army, insignia similar to those issued to the Regular Army.

For special course "A," coast artillery reserves, bronze pins, marksmen only, when firing this course.

An individual qualifying as marksman, sharpshooter, or expert rifleman, will wear his badge or pin so long as he retains such a qualification.

(l) **REQUALIFICATION BARS.**—No requalification bars are issued for marksmen.

SHARPSHOOTERS.—Requalification bars shall be issued at the rate of one bar for each three qualifications (not necessarily consecutive) as sharpshooter. The bar bears the last year of qualification.

EXPERT RIFLEMEN.—Requalification bars are issued at the rate of one bar for each three qualifications as expert rifleman, holdover qualifications included, provided that when an individual qualifies as expert rifleman during a holdover period he is entitled to a bar for each three years of actual requalification. The bar bears the last year of qualification.

(m) **COMBAT PRACTICE.**—Combat practice may be held by the Organized Militia whenever so directed by the State authorities. When held, it will be conducted in accordance with Part III, Small Arms Firing Manual.

(n) **REPORTS.**—A report of target firing shall be forwarded to the chief, Division of Militia Affairs, as soon after the close of the practice season as practicable, but not later than March 31 of the following year.

(o) **FIGURE OF MERIT.**—In each State there will be a company and regimental figure of merit to be calculated by the methods laid down by the Division of Militia Affairs. A proficiency test similar to that prescribed for the Regular Army is authorized at the discretion of the State authorities. (C. S. A. F. M., No. 17.)

CHAPTER III.

PISTOL PRACTICE.

356. PRELIMINARY DRILLS.—(a) All officers and enlisted men belonging to organizations armed with the revolver or pistol shall be instructed in the care, preservation, and use of these arms, following the provisions of paragraphs 135–146, modified only as existing circumstances demand, in any case, in the discretion of the State authorities.

(b) The following course in pistol range practice is prescribed for officers and men armed with the Colt's revolver cal. .38, or the Smith & Wesson, cal. .38, as issued by the Ordnance Department :

TABLE 8.

Range (yards).	Instruction practice.						Record practice. ¹			
	Target L.				Target L, rapid fire.		Target L, rapid fire.		Target L, rapid fire.	
	Slow fire.		Rapid fire.							
	Time limit.	Scores.	Time limit per score in sec- onds.	Scores.	Time limit per score in sec- onds.	Scores.	Time limit per score in sec- onds.	Scores.	Time limit per score in sec- onds.	Scores.
15	No limit.	Minimum of 1 at each range.	30	Minimum of 2 at each range.	15	Minimum of 2 at each range.	15	2
25			30		15		30	2	15	2
50			30			30	2

¹ The record course will be fired but once.

A score consists of five consecutive shots.

(c) Rapid fire shall be conducted as prescribed in paragraph 172.

(d) The dismounted course prescribed in paragraphs 167-175 will be substituted for that prescribed above for any organization or individual of the Organized Militia armed with the Colt automatic pistol, cal. .45. The mounted course prescribed in paragraphs 176-199 is authorized but not required.

(f) WHO WILL FIRE.

Arm or corps.	To fire.	Course.
Cavalry.....	All officers and enlisted men armed with the pistol, except field officers for whom the course is authorized but not required.	Dismounted.
Field artillery.....		
Infantry.....		
Engineers.....		
Coast Artillery.....		
Staff departments, except medical and chaplain.	Authorized but not required.....	Do.

(g) QUALIFICATION AND INSIGNIA.—Qualification and insignia for firing the revolver course shall be as given in the following table:

TABLE 9.

Grade.	Points.	Possible.	Insignia.
Expert pistol shot.....	320	400	Bronze badge.
First classman.....	300	400	Bronze pth.
Second classman.....	250	400	Do.

The qualifications and insignia for firing the courses prescribed in paragraphs 167-175 or paragraphs 176-199 shall be as provided for in paragraphs 248 and 249.

(h) REPORTS.—The number of officers and enlisted men taking pistol practice will be reported on the report of small-arms firing.

APPENDIX I.

(See paragraph 162.)

The following illustrations are in the nature of suggestions for field firing with the pistol. Firing as actually carried out will be left to the discretion of the organization commander, under proper supervision by his superiors, who will report any specially noteworthy developments, with a view to publication to the service in War Department bulletins.

SUGGESTIONS FOR IMPROVISED TARGETS.

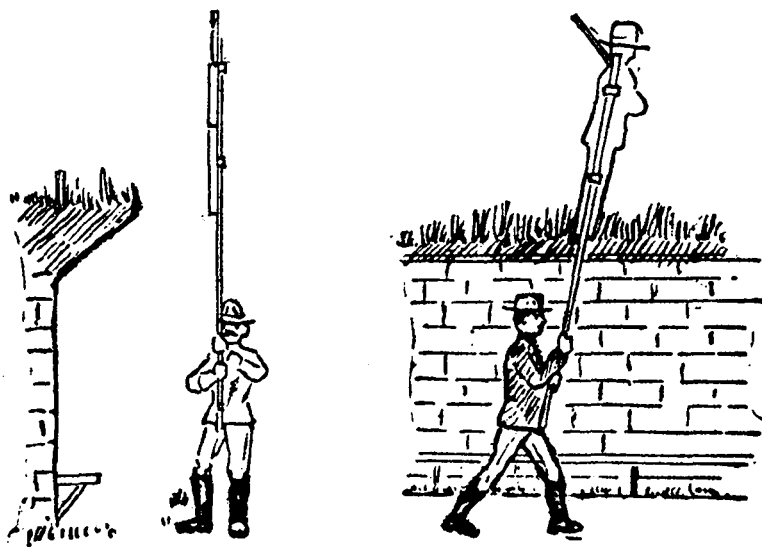

FIG. 1.—Figures on poles, being worked in pit.

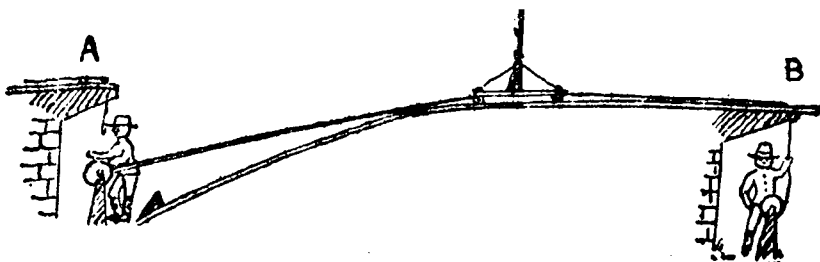

FIG. 5.—Track for moving figures, reversible, advance, or retire.



FIG. 6.—Combined series of tracks and pits. Tracks for movable figures with series of pits where figures can be marked, reversed, removed in part or whole, or others substituted.



FIG. 2.—Figures as seen from firing point.

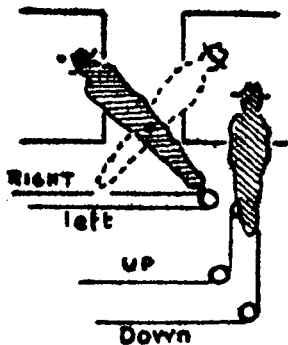

FIG. 3.—Plan of working disappearing figures in pit, around houses, windows, doors, hedges, stumps, trees, etc.

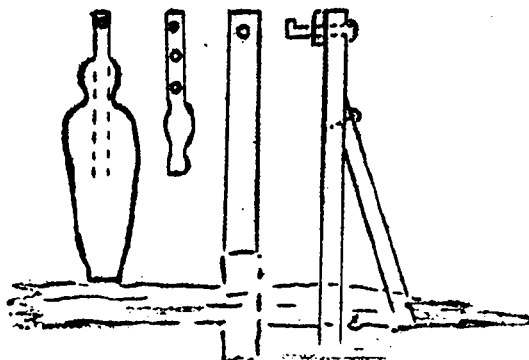

FIG. 4.—Plan of pendulum target.

APPENDIX II.

A. SPECIAL COURSE FOR ORGANIZED MILITIA AND VOLUNTEERS.

1. This course may be prescribed at the discretion of the State authorities for any organization which has not available for its use within 10 miles of its armory a range suitable for the Organized Militia Course.

2. The course will be preceded by the same preliminary practice, including gallery practice, and gallery practice qualification, for all who in a previous season have not qualified as first class or better in the Organized Militia Course.

3. The firing will be conducted with service charges. Each shot is marked in slow fire. Rapid fire is conducted as prescribed in paragraph 110, except as to scores. The order of firing positions will be adhered to.

TABLE 1.—*Target A, slow fire.*

Range.	Time.	Shots.	Targets.	Position.
200	No limit.	10	A.....	Prone with sandbag rest. ¹
200	No limit.	10	A.....	Prone.
200	No limit.	10	A.....	5 kneeling, 5 sitting.
200	No limit.	10	A.....	Standing.

¹In firing with sandbag rest, either rifle or back of hand must rest on sandbag.

TABLE 2.—*Target D, rapid fire, battle sight.*

Range.	Time.	Shots.	Targets.	Position.
200	1 minute.	10	D.....	Prone.
200	1 minute.	10	D.....	Sitting or kneeling.
200	1 minute.	10	D.....	Any position with rest, butt to the shoulder, rest for muzzle in front of forward hand-grasp compulsory.

4. In rapid fire the position may be assumed and cut-off turned to ready prior to the appearance of the target, provided that the butt of the rifle is not placed to the shoulder until the target appears.

5. The course will be fired one or more times for instruction before proceeding to fire it for record. It may be fired for record three times in any target season, the individual classification being determined by the best three trials, but this provision shall not be construed to permit the formation of a record based on scores selected from two or more trials—the basis of classification must be the result of one complete course in each case.

6. In instruction practice, at each kind of fire in each position, a total of at least 30 points (60%) must be attained before advancing to the next kind of fire or position.

7. Instruction practice may be omitted for those who, in the last range practice season, qualified as marksman or better.

8. The following grades of classification are obtained in instruction practice:

First Classman: 210 points, possible 350.

Second Classman: 190 points, possible 350.

Unqualified: Below 190 points.

9. The following grades of qualification are obtained in record practice:

Marksman: 225 points, possible 350.

Sharpshooter: 250 points, possible 350.

Expert Rifleman: 300 points, possible 350.

10. Special insignia, containing the words "Short Range" stamped on bronze badges and pins for the qualification course. Organized Militia, paragraph 355 (*k*), will be issued for qualification in this course.

11. In all matters not prescribed above the regulations for the Organized Militia Course will govern.

B. SPECIAL COURSE FOR VOLUNTEER RECRUITS.

1. In time of war or when war is imminent and the course of target practice laid down in this manual is not practicable for the instruction of recruits, for the reason that ranges with

proper facilities are lacking and time is short, this course may be used.

2. Preparatory to taking up this course, as much preliminary instruction as is practicable should be given in (a) Nomenclature and care of the rifle, (b) Sighting drills, (c) Position and aiming drills, (d) Deflection and elevation correction drills, (e) Gallery practice, and (f) Estimating distance drills. The estimating distance test for these recruits will cover distances from 550 to 800 yards. Proficiency will consist in making in five consecutive estimates an average degree of accuracy of 80 per cent.

3. Firing at miniature targets—service charges.

Instruction practice.

TABLE 1.—*Slow fire.*

Ranges (real) feet.	Ranges (simulated) yards.	Targets.	Time.	Shots.	Position.
50	200	Y.....	No limit.	15	{5 prone. {5 kneeling. {5 standing. {10 prone. {10 sitting.
50	300	Z.....	No limit.	20	

TABLE 2.—*Rapid fire.*

(Battle sight only will be used.)

Ranges (real) feet.	Ranges (simulated) yards.	Targets.	Time.	Shots.	Position.
50	200	Y.....	1 min.....	10	Kneeling from standing. Prone from standing.
50	300	Z.....	1 min. and 10 secs.	10	

*Record practice.*TABLE 3.—*Slow fire.*

Ranges (real) feet.	Ranges (simulated) yards.	Targets.	Time.	Shots.	Position.
50	200	Y.....	No limit.	10	{5 kneeling. {5 standing. {5 prone. {5 sitting.
50	300	Z.....	No limit.	10	

Rapid fire as given in Table 2.

DESCRIPTION OF SYSTEM.

4. *Range.*—The range is 50 feet, which enables the firer to see the hole made by the shot, and saves the time ordinarily taken in indicating the position of the hit.

5. *Targets.*—The division of miniature targets X, Y, and Z (see "Targets," Chap. III, Part IV) are, respectively, one-sixth, one-twelfth, and one-eighteenth of the size of the divisions on the A target, and subtend the same visual angle as do those of the A target when at 100, 200, and 300 yards.

6. *Course.*—The course is similar to Special Course A, using miniature target Y for 200 yards, and target Z for 300 yards firing. It is preceded, when there is no gallery range, by such firing at target X as may be necessary.

7. *Back stop.*—A back stop 10 feet high is, in point of safety, when firing at 50 feet, equivalent to a back stop of 60 feet at a distance of 100 yards and 120 feet at a distance of 200 yards. It is generally possible to find in the vicinity of the station or camp a perpendicular cut bank having a height of 10 feet or more. In case such a bank can not be found a suitable back stop will be constructed. Nine inches of sand or 18 inches of loam will be sufficient to stop the bullet.

8. *Method of firing.*—An instructed man is detailed to coach each recruit. The squad of recruits is drawn up facing the

targets. At the command or signal "Commence firing" the recruits, under the supervision of the expert shots detailed as coaches, fire slowly until 5 cartridges have been fired. The coach, standing by the recruit, corrects his fault of position or trigger squeezing, points out the position of each shot, and in each case explains the cause of each miss. When 10 shots are fired the miniature targets are removed to serve as records, and replaced by new targets, when the firing, if necessary, recommences. The disappearing target is not used in rapid fire in this course. In rapid fire each man takes position standing in front of the target assigned to him. The officer in charge of the line will command "Load." The magazine will be filled, the piece loaded with one cartridge therefrom, and the safety lock turned to "Safe." When all are ready the officer in charge of the firing line will command "Ready," when the safety lock will be turned to the ready and the position of "Ready" standing assumed, with the sling, if used, on the arm. At the command or signal "Commence firing," he takes the prescribed position, opens fire and endeavors to fire 5 shots. The command or signal "Cease firing" is given at the expiration of the time limit, when all firing ceases.

9. *Number of men shooting.*—From 1 to 100 men may fire at the same time, this depending on the number of coaches and the extent of the back stop. With 30 men shooting at the same time, 1,000 men may finish the course of firing in eighty hours.

C. SPECIAL COURSE TO BE FIRED BY EVERY MAN ARMED WITH RIFLE
WHEN FACILITIES ARE AVAILABLE.

PRELIMINARY TRAINING.

The soldier is first given a thorough course of preliminary practice as outlined in paragraphs 1 to 70, inclusive.

Thorough individual training in the preliminary work preparatory to actual firing on the range is the foundation upon which a good shooting organization is built. Without this preliminary training it is a waste of ammunition to allow the soldier to fire on the target range.

TESTS.

After the completion of the preliminary training and before proceeding to known-distance firing the organization commander, assisted by his lieutenants, shall test each man of the organization in the following subjects:

TEST I.—*Nomenclature of the rifle* in so far as is necessary for its efficient care and use.

TEST II.—*Dismounting and assembling of the bolt and magazine mechanism.*

TEST III.—*Care of rifle.*

TEST IV.—*Deflection and elevation or aiming off for wind:* To be sufficiently extended to show that the soldier understands the subject.

TEST V.—*Sight setting:* Normal and peep, with and without deflection. Maximum time limit of 10 seconds in each of not less than 5 consecutive trials.

TEST VI.—*Sighting:* With rifle in sighting rest. (Third sighting exercise, par. 27.)

Normal sight. Peep sight.	}	Proficiency required in 3 consecutive triangles of sighting with each. Distance, 20 feet; no side of triangle to exceed $\frac{1}{2}$ inch.
------------------------------	---	---

TEST VII.—*Loading from belt:* A clip of dummy cartridges in place in a pocket in the belt, the pocket fastened.

Standing. Kneeling. Sitting. Prone.	}	Maximum time limit of 6 seconds each in best 5 out of 7 consecutive trials.
--	---	---

TEST VIII.—*Firing positions:*

- (a) Standing,
- (b) Kneeling,
- (c) Sitting,
- (d) Prone,
- (e) From parapet, wall top, or other rifle rest,
- (f) From vertical edge of wall, door, window, tree, or similar position.

TEST IX.—*Aiming combined with trigger squeeze:*

Test by means of—

- (a) Target machine,
- (b) Aiming rod device,
- (c) Belgian aiming device, or
- (d) Perforated bull's-eye over instructor's eye.

(Methods used to be denoted by abbreviations M, R, B, and P, respectively.)

Standing,
Kneeling,
Sitting,
Prone.

TEST X.—*Rapid loading, aiming, and firing:* Load from belt and simulate fire with two clips of dummy cartridges.

Test by means of—

- (a) Aiming rod device, or
- (b) Belgian aiming device, or
- (c) Perforated bull's-eye over instructor's eye.

(Method used to be denoted by abbreviations R, B, and P, respectively.)

Standing,
Kneeling,
Sitting,
Prone.

} In the open, and from trenches. Time
of each, 1 minute.

No man will be permitted to fire a shot on the range until he has satisfactorily passed the above tests. Commanding officers shall certify on the target record that this provision has been complied with.

There is no limit to the number of times that a soldier may take the tests, and a man who fails the first time shall be given such additional instruction as will enable him to pass the tests. The object is not to prevent the man from firing on the range, but to insure that he is ready for range practice before he takes up that work.

GALLERY PRACTICE.

Gallery practice will be as prescribed in paragraphs 71 to 76, inclusive, when gallery rifles and ammunition are available.

AMMUNITION ALLOWANCE.

An allowance of 300 rounds per man is authorized for the year 1918, of which at least 50 rounds shall be expended in combat practice. The allowance of 250 rounds per man for the year 1917 is considered as cumulative and will be available until expended.

KNOWN-DISTANCE PRACTICE.

Known-distance practice includes short-range practice, mid-range practice, and practice with telescopic sights.

SHORT-RANGE PRACTICE.

Instruction.

The company commander will stop the instruction practice of any man who, in his opinion or that of the next higher commander, is not attaining results commensurate with the ammunition expended. For any man thus stopped the necessary preliminary drills and training shall be resumed until proper improvement is indicated, after which he shall resume instruction practice.

TABLE 1.—*Slow fire.*

All firing from a typical trench, bayonet fixed, rifle resting on the parapet.

Range.	Time.	Shots.	Target.	Position and type of trench.	Sight.
<i>Yards.</i>					
100.....	No limit.....	10	A-4	Prone.....	Leaf.
200.....	do.....	10	A-4	Standing.....	Do.
300.....	do.....	10	A-4	do.....	Do.

TABLE 2.—*Slow fire.*

All firing in the open, bayonet unfixed.

Range.	Time.	Shots.	Target.	Position.	Sight.
<i>Yards.</i>					
100.....	No limit.....	10	A-4	Standing.....	Battle.
200.....	do.....	10	A-4	Kneeling.....	Do.
300.....	do.....	10	A-4	Prone.....	Do.

TABLE 3.—*Rapid fire.*

All firing from a typical trench, bayonet fixed, rifle resting on the parapet.

Range.	Time.	Shots.	Target.	Position and type of trench.	Sight.
<i>Yards.</i>					
100.....	1 minute.....	10	O	Prone.....	Leaf.
200.....	do.....	10	O	Standing.....	Do.
300.....	1 minute 10 seconds...	10	O	do.....	Do.

In order that the soldier may see his shot group, all hits on target O are signaled, but only those hits on the silhouette are recorded.

All rapid fire is conducted as prescribed under procedure, rapid fire, page 71, with the exception that at all ranges the soldier assumes the firing position before the command "Ready" is given, and with the necessary substitutions for ranges and time limit.

TABLE 4.—*Rapid fire.*

All firing in the open, bayonet unfixed.

Range.	Time.	Shots.	Target.	Position.	Sight.
<i>Yards.</i>					
100.....	1 minute.....	10	O	Standing.....	Battle.
200.....	do.....	10	O	Kneeling.....	Do.
300.....	1 minute 10 seconds...	10	O	Prone.....	Do.

Record.

TABLE 5.—*Slow fire.*

The firing from the trenches will be with bayonet fixed, rifle resting on the parapet. The firing in the open will be with bayonet unfixed.

Range.	Time.	Shots.	Target.	Position.	Sight.
<i>Yards.</i>					
100.....	Nolimit...	5	A-4	Prone from prone trench.....	Leaf.
100.....	do.....	5	A-4	Standing in the open.....	Battle.
200.....	do.....	5	A-4	Standing from standing trench.	Leaf.
200.....	do.....	5	A-4	Kneeling in the open.....	Battle.
100.....	do.....	5	A-4	Standing from standing trench.	Leaf.
300.....	do.....	5	A-4	Prone in the open.....	Battle.

TABLE 6.—*Rapid fire.*

All firing in the open, bayonet unfixed.

Range.	Time.	Shots.	Target.	Position.	Sight.
<i>Yards.</i>					
100.....	1 minute.....	10	O	Standing..	} Choice of leaf or battle sight at all ranges.
200.....	do.....	10	O	Kneeling..	
300.....	1 minute 10 seconds...	10	O	Prone....	

Total shots in short-range practice, 180.

MID-RANGE PRACTICE.

For all men who have completed short-range practice.

Instruction.

TABLE 7.—*Slow fire.*

All firing in the open, bayonet unfixed.

Range.	Time.	Shots.	Target.	Position.
<i>Yards.</i>				
500.....	Nolimit.....	10	B	Prone.
600.....	do.....	10	B	Do.

Every effort will be made to teach the men the effect of wind, light, and temperature, and the value of small changes in elevation and windage.

Record.

TABLE 8.—*Slow fire.*

All firing in the open, bayonet unfixed.

Range.	Time.	Shots.	Target.	Position.
<i>Yards.</i>				
500.....	No limit.....	10	B	Prone.
600.....	do.....	10	B	Do.

Total shots in mid-range practice, 40.

PRACTICE WITH TELESCOPIC SIGHTS.

After mid-range practice has been completed, the best eight enlisted shots of the company will fire as prescribed in paragraph 117.

COMBAT PRACTICE.

Combat practice, individual and collective, will be fired by an organization after the completion of the known-distance practice.

TARGETS.

Target A-4 is the A target, as described in paragraph 258, cut down to 4 feet square.

Target O is the target A-4 with paper silhouette F pasted in center. Value of hit on silhouette, 5. (*C. S. A. F. M.*, Nos. 6, 7, 19, and 20.)

INDEX.

	Page.
Accidental discharge counted in score.....	210
Accidents:	
Officers to take precautions against.....	67
Precautions against.....	25
Action, employment of fire in.....	143
Adjustment sights.....	40, 49, 80, 145
Adjutant and statistical officer, duties of.....	206
Adjutant on range, duties.....	206
Aim:	
Deliberation in.....	80
Line of aim, definition of.....	13
Observing the.....	41
Point of.....	28
Aiming:	
And firing, details of.....	80
Device, definition of.....	9
Drill.....	39
Commands.....	39
Exercises.....	39, 40
Formation of squad.....	38
How to be divided.....	38
Purpose of.....	36
Errors in, cause of.....	34
Exercise.....	39, 40
Commands in.....	39
Position of body.....	39-41
Position of rifle.....	39-41
Remarks on.....	39-41
Long range, difficulties in.....	81
Low, to be encouraged.....	133
Moving targets, instructions concerning aiming at.....	84, 150
Preliminary drill, importance of.....	21, 36
Rifle, rest.....	28, 62, 85
Systematic, to be encouraged.....	25, 36
Targets, barracks furnished with.....	37
Alternative method of marking.....	69
Ammunition:	
Allowance of, pistol.....	102, 106
Allowance of, rifle-range practice.....	64
Economy of.....	22
For instruction combat practice.....	155
Minimum amount for gallery practice.....	53
Saving.....	22
To be saved for poor shots.....	22

	Page.
Anemometer definition	9
Use on range.....	63, 81
Use in wind measurement.....	51
Angle of fall	137, 139
Appeal from decision of range officer (<i>see also</i> Protest).....	209
Approbation, expression of, forbidden	209
Arms:	
Accidents to, in competitions.....	200
Changing during competitions.....	208
Kinds used in competitions.....	207
Restrictions as to use in range practice.....	62, 64
Arms and ammunition to be used in competitions	207
Artillery, Coast, classification of (<i>see</i> special course A).....	78
Competitors, department pistol competitions—	
Enlisted men.....	203
Officers.....	203
Department rifle competitions—	
Enlisted men.....	200
Officers.....	199
Troops to have preliminary drill.....	78
Troops to take special course A.....	78
Artillery, Field, competitors:	
Department pistol competition—	
Enlisted men.....	203
Officers.....	203
Assembly of competitors:	
Department pistol competition.....	203
Rifle competition.....	199
Assistants, competitions	205
Atmospheric conditions affecting trajectory, Ordnance Manual No. 1923.	
Attack, use of long-range fire. (<i>See</i> par. 402, Infantry Drill Regulations.)	
Bad shooting, cause of	40
Bad sighting, to correct	33
Badge:	
Duplicates.....	177
Distinguished pistol shot and riflemen.....	176
Expert riflemen's.....	176
Marksman's.....	176
Sharpshooter's.....	176
<i>See also</i> Insignia.	
Band:	
Competitors not authorized from.....	61
Members of, will not be classified if in Philippines.....	174
Not to take prescribed course.....	61
Philippines, to fire only in, as directed by department commander.....	61
Barracks furnished with aiming targets	37
Barrel. (<i>See</i> Ordnance Manual No. 1923.)	
Battalion commanders, duties of	23
Battle:	
Sight, definition of.....	9
Use of, required.....	73, 75, 79, 218, 219
Value of uniform proficiency in training for.....	21

	Page.
Body, position of (<i>see</i> Prone).....	15
Bore, definition of.....	9
Breath, holding, when squeezing trigger.....	41
Breech mechanism, manipulation of, in rapid-fire exercise.....	43
Bribe, penalty for offering.....	211
Bullet:	
Drift, definition.....	11
Time of flight of, rifle. (<i>See</i> Ordnance Manual No. 1923.).....	
Bullet stops, range practice.....	196
Bulletin sheets, entry of scores on.....	210
Bull's-eye:	
Aim to be taken just underneath.....	29
Definition of.....	9
Shot cutting edge.....	69
Butts:	
Artificial.....	196
Definition of.....	9
Hills as.....	196
Ranges not provided with, care to be taken.....	199
Caliber, definition of.....	10
Cant, definition of.....	10
Canting the piece:	
Changing course of bullet.....	34
Deviation caused by.....	34
Effects of.....	34
Exercise to show effect of.....	34
Cards, score (<i>see</i> Score cards).....	210
Definition of.....	16
Cartridge:	
Blank.....	105
Defective.....	74
Unfired.....	74
Casuals, practice of, rifle-range practice.....	62
Cavalry:	
Enlisted men as competitors—	
Department pistol competitions.....	203
Department rifle competitions.....	200
Exercises for collective practice, field training for.....	167
Officers, duties of.....	22
Center, definition of.....	10
Charges, reduced (<i>see</i> Gallery, shooting).....	13
Engineers, battalion of, commander, selection of competitors by.....	200, 204
Chief range officer:	
Duties of.....	205
Position during firing.....	207
Classification:	
Bandsmen will not be classified.....	61
Conditions and requirements.....	173
Definition of.....	10
For pistol or revolver—	
Classification of militia.....	226
Regular service.....	175
Who will be classified.....	173-176

Classification—Continued.	Page.
For rifle—	
General requirements for qualification	173
Special course A	175
Unqualified	173
Who will be classified	174
Cleaning the rifle in competitions	208
Closing the eye at discharge	40, 41
Clouds, effect of, on elevation of sights	82
Coach, definition of	10
Coaching prohibited in record practice and competitions	64, 209, 220
Combat practice, exercises for	161, 170
Combat practice:	
Back position not authorized	47
Company and higher officers exercised in portion of	154
Danger space, discussion of	128
Continuous	128
Definition of	10
Dispersion cone of, definition of	10
Divisions of	132
Effect of fire	133-135
Cone of dispersion	128-131
Danger space	128
Effectiveness	133
Depends upon what	134
Qualities of rifle, ballistic	127
Range and time of flight of bullet. (See Ordnance Manual No. 1923.)	
Rate of fire	134
Table of dispersion	133
Zone beaten	131
Employment of fire in action—	
Auxiliary aiming point	149
Collective fire, results obtained	135
Combined sights	147
Essentials of effective fire	134
Percentage of hits	134
Adjustment of fire	142
Number of targets hit	134
Time of execution	134
Fire of position. (See Infantry Drill Regulations, par. 424.)	
Fire at stationary targets	142
Indirect fire	151
Moving targets	150
Night firing, discussion of	152
Observation of effect of fire	145
Target designation	149
Time for opening fire, discussion of. (See Infantry Drill Regulations, pars. 306-308.)	
Volley firing. (See Infantry Drill Regulations, par. 241.)	
Field kit for	154
General scheme of	125

	Page.
Combat practice—Continued.	
Ground, influence of.....	135
Deflated.....	135
Occupation of.....	141
Rising and falling.....	136-140
Impact, center of, recognition of.....	145
Object of.....	125, 126
Ordnate of trajectory, definition of. (<i>See</i> Ordnance Manual No. 1923.)	
Post commander, duties in regard to.....	23
Instruction, combat practice.....	152
Aiming at moving targets.....	150
Ammunition for.....	155
Classes of fire required in.....	153
Critique, the.....	156
Preparation of exercises.....	154
Range for, how prepared.....	156
Records.....	156
Rules.....	153
Supervision of.....	155
Targets for.....	153
Range, maximum for rifle. (<i>See</i> Ordnance Manual No. 1923.)	
Regimental commander, duties in regard to.....	23
Regular practice—	
Exercises suggested in, collective—	
Analysis and criticism of.....	170, 171
Cavalry.....	166, 167
Company.....	166
Individual.....	161
Influence of the ground.....	163
Platoon.....	163-170
Squad.....	162, 163
General principles of.....	125
Range regulations.....	156
Record of, contains.....	156
System of instruction—	
Collective practice includes what.....	152
Company commanders supervise practicesubdivisions of company.....	153
Practice supervised by battalion commanders.....	155
Individual includes.....	154
Regulations relating to.....	153
Sergeants, musicians, and trumpeters will not fire.....	153
Value of.....	125
Ricochet shots.....	141
Rules for.....	153
Shot group, definition of.....	129
Targets for, description of.....	152
Illustration of.....	187-194
Who will fire in combat practice.....	153
Zone beaten, definition.....	131
Central, definition of.....	128
Form of.....	130
Of effective fire.....	131

	Page.
Commanders:	
Battalion, duties of.....	23
Company—	
Company target record to be kept in possession of.....	178
May modify details of instruction.....	22
Supervises combat practice subdivision of company.....	153
To devote more time to poor shots.....	22
Value of average proficiency.....	21
Department to prescribe regular season.....	60
Philippine Department. (See Department commander.)	
Post, duties of.....	24, 60, 158, 212
Regimental.....	23, 158
Commence firing, rapid-fire exercise, explanation of command.....	42
Company commanders:	
Company target record to be kept in possession of.....	178
Endeavor to make average shots of men.....	21
May modify details of instruction.....	22
Selection of enlisted men as competitors.....	200, 203
Supervise combat practice subdivisions of company.....	153
Company officers:	
Duties of.....	7, 153
Participation of, in pistol and rifle firing.....	22
Company practice, to be always superintended by an officer.....	67
Company:	
Exercises suggested for combat practice of.....	167
Standard of proficiency of a.....	22
Target record.....	178
Entries to be made with ink or indelible pencil.....	178
Will fire proficiency test annually.....	157
Compensation, extra, for expertness with rifle.....	175
Competitions:	
Accidental discharge.....	210
Adjutant and statistical officer.....	206
Ammunition, service cartridge to be used.....	207
Arms to be used.....	207
Assignment to targets.....	206
Assistants.....	205
Changing arms.....	208
Chief range officer.....	205
Cleaning rifle during.....	208
Classes of.....	199
Competitors, numbering of.....	199
Detail of enlisted men to be permanent for.....	207
Department pistol biennial.....	199
Competition proper.....	203
Competitors—	
Assembly of.....	204
Selection of.....	203
Department team.....	205
Preliminary practice.....	204
Prizes.....	205
Procedure and regulations.....	205
Time and place of holding.....	203

	Page.
Competitions—Continued.	
Department rifle.....	199
Biennial.....	199
Competition proper.....	201
Competitors, assembly and selection of.....	199, 200
Department team.....	201
Distinguished marksmen, not selected as competitors.....	213
Officers as competitors.....	199, 200
Preliminary practice.....	201
Prizes.....	201
Presentation of.....	202
Time and place of holding.....	199
Firing on wrong target.....	210
Gallery.....	62
Hits, signaling and recording.....	209
Hours for.....	205
Instructions and suggestions.....	205
Misses, signaling.....	209
Order of fire.....	201, 204
Officer in charge.....	205
Assistants.....	205
Ordnance officer.....	206
Philippine Islands (<i>see</i> Department competitions).....	199
Post.....	212
Object.....	212
Program left to judgment of commanding officers.....	212
Rules governing.....	212
Protests.....	209
Punctuality.....	208
Quartermaster, etc.....	203
Range officers.....	206
Score cards (<i>see</i> Cards, score).....	210
Score, changing in.....	211
Score keepers, station of.....	210
Shelter.....	208
Sights, altering, by competitors.....	207
Signal officer.....	206
Staff officers.....	205
Stationery, etc.....	206
Stations of scorers.....	210
Ties in scores, how decided, in pistol.....	212
Ties in scores, how decided, in rifle.....	212
Trigger pull to be tested.....	207
Two shots on same target.....	210
Uniforms.....	207
Competitors:	
Accidental discharge of piece.....	210
Ammunition to be used.....	207
Arms to be used.....	207
Assembly of.....	203, 204
Assignments to targets, preferably by scheme than by lot.....	206
Statistical officer to have charge of assignment to targets.....	206
When made.....	206

Competitors—Continued.	Page.
Attendance at firing points	208
Coaching prohibited	209
Criticism	209
Delay in firing	208
Disqualification of	211
Firing on wrong target	210
Fouling shots	209
Interference with firing squads	211
Loading the piece	208
Misses	209
Numbering of	210
Order of fire	209
Order of firing	208
Order of merit	200
Position in pistol competition	208
Regulations, compliance with	211
Ignorance of, inexcusable	211
Rifles, cleaning	208
Rifles, exchange of, during competitions	208
Score cards	210
Selection of	200, 206
Signaling and recording hits	209
Special rules	211
Spectators	209
Staff, noncommissioned, post, regimental, and battalion, not eligible as	200, 204
Stations	209
Stations, awaiting turn to fire	209
Time allowed for firing score	208
Uniforms worn at competitions	207
Cone of dispersion, definition of	10
Cover for instruction combat practice. (<i>See</i> Infantry Drill Regulations, pars. 584-595.)	
Use of, to be taught. (<i>See</i> Infantry Drill Regulations, pars. 152-156.)	
Danger signals	197
Danger space, definition of	10
Discussion of	128
Extent of	128
Deflade, definition of	11
Deflection and elevation correction drills:	
Deflection	49
Effect of wind	51
Elevation	49
Exercise	50
Remarks on	52
Sight correction—	
Discussion of	48
For wind	81
Tables	50, 52, 84
Zero of rifle	49
Details of aiming and firing	36-48

	Page.
Department commanders:	
Competitions	199
Officers, selection of, as competitors by	199
To prescribe regular season	60
Descriptive list, classification of transferred soldiers to be noted	179
Deviation, lateral. (<i>See</i> Drift.)	
Deviations from firing instructions by company commander	22
Disappearing target:	
Definition of	11
Time of exposure	71
Use of pistol	107, 108, 111, 118, 119
Discipline, fire (<i>see</i> Fire discipline)	12
Discretion allowed instructors	22
Disk:	
Description of, used in marking	70
Marking, definition of	11
Size of, in sighting drill	27
Used in sighting drill	27
Disorderly conduct, competitors disqualified for	211
Dispersion, cone of	10, 128
Distance, estimating (<i>see</i> Estimating distance)	11
Distinguished marksman:	
Badges	213
Conditions under which, may not attend department competitions	213
Definition of	11
Requirements and designations	213
Distinguished pistol shot:	
Badges	213
Definition of	11
Not authorized to attend department pistol competitions	213
Requirements and designations	213
Division Militia Affairs, report firing to be rendered to, by militia	224
Drift, definition of	11
Drill Regulations:	
Infantry—	
Paragraphs 248, 250	125
Paragraphs 356, 357	126
Paragraph 400	20
Paragraph 405	20
Paragraph 413	20
Cavalry—	
Paragraph 156	91
Paragraphs 161-168	98
Paragraph 246	98
Drills:	
Estimating distance (<i>see</i> Estimating distance drill)	54
For rifle, preliminary	25
Position and aiming (<i>see</i> Position and aiming drill)	36
Preliminary—	
Importance of	47
Neglect of	47, 48
Sighting	25
To whom given	25

	Page.
Duties:	
Of company officers.....	22
Of battalion commanders.....	23
Of post commanders.....	24
Of regimental commanders.....	23
Echelon, definition of.....	11
Education of soldier in rifle firing.....	19
Effectiveness of fire.....	133
Effects of fire:	
Danger space, discussion of.....	128
Deflated space.....	135
Infantry.....	20
Zones of.....	181
Efficiency in rifle firing, how attained.....	19
Elbows in position and aiming drill.....	38, 40
Elevation:	
Changes in.....	50
Drills (<i>see</i> Deflection and elevation correction drills).....	50
Emplacement, definition of.....	11
Employment of fire in action.....	125, 126
Engineer Corps:	
Battalion commander to select competitors, department pistol competitions.....	204
Company commander to select competitors, department rifle competitions.....	200
Enlisted men:	
Classification of marksman or better retained during enlistment.....	173
Details of, on range at competitions.....	207
To be permanent.....	207
Selection of competitors—	
Department pistol competitions.....	203
Department rifle competitions.....	200
Equipment prescribed for range practice.....	63, 207
Errors:	
Correcting, in aiming and firing.....	48
In firing, discovery of.....	48
In scoring.....	210
In sighting, cause of.....	34
Estimating distance:	
Definition of.....	11
Proficiency necessary to qualification in.....	58
Estimating-distance drill:	
Advantage to be taken of, to impart preliminary field training.....	54
Appearance of objects at different distances, levels, lights, etc.....	56
At long ranges.....	56
At short distances.....	56
By sound.....	56
By the eye.....	55
By trial shots, or volleys.....	57
Importance of.....	54
Instruction in.....	55
Methods of estimating.....	55
Percentages necessary for qualification in different classifications.....	58

	Page.
Estimating-distance drill—Continued.	
Range-finding instruments	58
Rules governing test.....	57
Test.....	57
Time when instruction given.....	55
Unit of measure.....	55
Exercise:	
Aiming.	39
Commands in.....	39
Position of body.....	39
Position of rifle.....	39
Remarks on.....	39
Position.	38
Commands in.....	38
Position of body.....	38, 39
Position of rifle.....	38, 39
Remarks on.....	38, 39
Rapid fire—	
Body, position of.....	42
Breech mechanism, manipulation of.....	43
Commands.....	42
Methods.....	42
Purpose.....	42
Repetition.....	43
Rifle, position of.....	42
Trigger squeeze.....	42
Trigger squeeze.	41
Acquaintance with.....	41
Breath, holding in.....	41
Commands in.....	41
Position of body.....	41
Position of rifle.....	41
Remarks on.....	41
Exercises:	
Combat practice record to be kept.....	156
For instruction practice.....	161-170
For individual combat practice.....	151-153
Sighting.....	29, 33, 51
Expert pistol shot.	12, 122, 175
Pin.....	177
Expert revolver shot, militia (see Pistol)	226
Expert rifleman:	
Definition.....	12
Classification as.....	173
Length of time.....	173
Retained by officer.....	174
Course—	
Description of.....	75, 76
Targets.....	75, 76
Extra compensation.	175
Eye:	
Closing at discharge.....	40
Estimating distance by.....	55
Placing in line of sight.....	39

	Page.
Eyepieces, orthoptic, forbidden.....	62
Field glasses.....	65, 153
Figure of merit, for militia.....	224
Fine sight (<i>see</i> Full sight).....	29
Fire:	
Accuracy of. (<i>See</i> Infantry Drill Regulations, par. 401.)	
At night, discussion of.....	152
At will—	
Definition of.....	12
Description of. (<i>See</i> par. 242, Infantry Drill Regulations.)	
Classes of, required in instruction field practice.....	152
Ammunition for.....	154, 155
Collective, volley fire. (<i>See</i> par. 242, Infantry Drill Regulations.)	
Control of.....	12
Direction.....	12
Discipline. (<i>See</i> Infantry Drill Regulations, par. 254.)	
Distribution of. (<i>See</i> Infantry Drill Regulations, par. 245.)	
Effective essentials of.....	133
Employment of, in action.....	142, 143
Indirect, discussion of.....	151
Long range, in action. (<i>See</i> Infantry Drill Regulations, par. 402.)	
Observation of effect of.....	145-147
Of position. (<i>See</i> Infantry Drill Regulations, par. 241.)	
Rapid—	
Marking, pit regulations.....	71
Marksman's course.....	73, 75, 76
Sharpshooter's course.....	73, 75, 76
Value of hits.....	66
Slow—	
Deliberation in aim.....	80
Description of.....	17
Targets to be used.....	59
Marking, pit regulations.....	69
Marksman's course.....	77
Volley. (<i>See</i> Infantry Drill Regulations, par. 241.)	
Fire discipline:	
Definition of.....	12
Description of.....	12
Fire, kinds of. (<i>See</i> Fire; Infantry Drill Regulations, pars. 242-243.)	
Firing:	
Department pistol competition.....	203
Department rifle competition.....	199
Details of aiming and.....	80
Discovering errors in.....	48
Individual, detail for marking.....	68, 69
Method of, special course A.....	78
Mounds.....	197
New methods of, to be encouraged.....	22
On wrong target, scoring of.....	210
Point, accidental discharge.....	210
Position of competitors.....	208
Position of scorekeeper.....	210
Practice, uniformity to be preferred.....	22

	Page.
Firing—Continued.	
Prone, stability of position.....	46
Reports of.....	179
Supervision of, by range officers.....	67
First-class man.....	12
First-class pistol shot.....	12
Flags, danger, to be displayed at times.....	197
Flight, time of, for bullet. (See Ordnance Manual No. 1923.)	
Full sight:	
Description of.....	29
Effect of.....	29
Gallery practice:	
Ammunition, allowance for.....	53
Application of position and aiming drill.....	53
Building range.....	53
Definition of.....	13
Instruction practice.....	53, 54
Interest in.....	54
Matches.....	54
Object of.....	52
Position to be taken.....	53
Range.....	53
Scores.....	53
Target.....	53
Troops firing special course A to take instruction and record practice therein.	80
Value of.....	53
Gallery, shooting, definition of.....	13
General scheme of combat practice.....	125
Glass, field, instruction and use of.....	05, 153
Good shots, how made.....	36
Graduations on rear sight determined for certain conditions.....	50
Grooves, definition of.....	13
Ground falling with respect to enemy's line of sight.....	135
Ground rising with respect to enemy's line of sight.....	136
Gun sling, use of.....	62
Habits, in selection of competitor.....	200
Hands, position of, in position and aiming drill.....	38, 39
Hills as butts.....	196
Hits:	
If in excess of number recorded.....	69
Importance of (see Infantry Drill Regulations, par. 413).....	20
Noncommissioned officer to indicate.....	69
Horse:	
Preliminary training, pistol practice.....	99
Should be broken to fire.....	99
Impact, center of.....	129
Importance of estimating-distance drill.....	54
Importance of rifle fire.....	19
Individual:	
Firing, detail for marking.....	68
Practice, definition of.....	13
Exercises for field combat.....	161-171
Includes what.....	153, 154

	Page.
Infantry fire, importance of.....	19, 20
Inner, definition of.....	13
Insignia:	
Classes.....	176
Definition of.....	13
Distinguished pistol shot and riflemen.....	213
Duplicates.....	177
Expert pistol shot's badge.....	177
Expert rifleman's badge.....	176
For Organized Militia.....	178
How obtained.....	177
Marksman's pin.....	176
Marksman's pin, special course A.....	177
Pistol shot—	
First-class man.....	175
Second-class man.....	175
Replacing lost.....	177
Sharpshooter's badge.....	176
Instruction:	
At longer ranges in estimating distance.....	56
Combat practice, regulations for.....	153, 156
Noncommissioned officers, theoretical.....	22
Object of.....	19
Practice, definition of.....	13
Preliminary period of, and pistol.....	21
Qualification basis.....	21
Scope of, pistol.....	21
Rifle.....	20
Shots.....	65
Instructions:	
Details of.....	20
Deviations from firing.....	22
Instructors:	
Capabilities of.....	21
Discretion allowed.....	22
To exercise judgment in expenditure of ammunition.....	22
Interference with firing squad, penalty for.....	211
Intoxication of competitor, penalty for.....	211
Kneeling:	
Position and aiming drill—	
Choice of position.....	44
Commands.....	43
Formation of squad.....	38
Position, when taken.....	43
Remarks.....	43
Rifle, position of.....	43
Known distance practice. (See index of range practice.)	
Lands, definition of.....	13
Light, changing, effect of.....	82
Line of aim, definition of.....	13

	Page.
Long range:	
Aiming, difficulties in.....	40
Definition of.....	13
Fire in action. (See Infantry Drill Regulations, pars. 430-434.)	
Low aiming to be encouraged.....	133
Lying down:	
Position and aiming drill.....	45
Commands.....	46
Formation of squad.....	87
Position when taken.....	45, 46
Remarks.....	46
Use of sling.....	47
Markers:	
Leaving pit.....	68
Miss, certain of.....	69
Precaution for.....	68
Marking:	
Alternative method of.....	71
Disk, definition of.....	11
Description of.....	69
Fire—	
Rapid.....	71
Record practice a miss.....	70
Slow.....	69
Hits, value of.....	70
Importance of.....	20
Noncommissioned officers of firing company.....	68
Pit regulations.....	68
Rapid fire.....	74
Commands.....	74
Marksmanship:	
Badge issued to.....	176
Classification of.....	173
Classification of, in special course A.....	173
Definition of.....	13
Distinguished, classes of.....	218
Badges.....	213
Conditions under which may enter competitions.....	218
Definitions of.....	11
Designations.....	213
Requirements.....	218
Who may compete.....	218
Requirements.....	173
See also Insignia.....	176
Marksmanship's course:	
Conditions and requirements for qualifications.....	59, 60
Explanation of.....	60
Rifle, department competitions.....	201
Matches in gallery firing.....	54
Medals:	
For department teams.....	202, 205
For officers winning in department teams.....	202, 205
Held subject to inspection.....	203

	Page.
Medals—Continued.	
Militia.....	224
Not to part with, except by authority.....	203
Winning three, to belong to distinguished class.....	213
Medical department, officers of, not to be selected as competitors.....	200
Mid-range, definition of.....	14
Militia, Organized. (See Organized Militia.)	
Mirage, illustrations of its effect.....	85
Misses:	
Markers certain of.....	60
Officers in pit must verify misses before signaling.....	209
Signaling of.....	209
Misfire, no penalty attached.....	74
Mounds, firing.....	197
Moving targets, instructions concerning aiming at.....	84, 150
Table showing point of aim for different moving objects.....	84
Musicians' company to take prescribed course.....	61
Musician's company not to fire, combat practice or proficiency test.....	153, 158
New methods of firing to be encouraged.....	22
Night firing, discussion of.....	152
Noncommissioned officers:	
Duties of, in pit.....	6
Marking by, of firing company.....	67
Responsible for order at their targets.....	63
Staff not eligible as competitors.....	200, 204
Theoretical instruction of.....	22
To indicate value of hit.....	67
To keep permanent records of scores.....	65
To note deficiencies in target material.....	68
Normal sight.....	20
Numbering of competitors.....	210
Numbering of targets.....	197
Obedience, required in fire discipline. (See Infantry Drill Regulations, par. 254.)	
O'clock, definition of.....	14, 51
Officer in charge:	
Disobedience of instructions to disqualify competitors.....	211
Duties and powers.....	67
Protests, consideration of.....	209
Report of disqualification of competitors.....	211
Rules, formulation of, special, by.....	211
Officers:	
Cavalry, selection of, as competitors.....	199, 203
Classification of expert, retained by.....	177
Company, efforts to attain standards of proficiency.....	2
Competitors, selection as.....	200, 20
Duties of—	
Battalion commanders.....	2
Company.....	2
Department commanders.....	2
Post commanders.....	2
Regimental commanders.....	20
Medals for, in department competitions.....	207
Noncommissioned, duties at pit.....	67

Officers—Continued.	Page.
Number of, in pit for record firing.....	68
Ordnance, at competition.....	206
Post competitions to be arranged by commanding.....	212
Responsibility for deficiency of organization.....	159
Staff, selection as competitors.....	200
To attend target practice with men.....	22
To count number of hits, verify misses.....	69
To initial correction of company target record.....	65
To take precautions against accidents.....	67
Use of field glasses.....	65
Order of procedure, rifle-range practice.....	65, 72-78
Order, preservation of.....	67
Organized Militia:	
Classification of.....	223
Combat practice.....	224
Course followed by.....	215
Dress and equipment.....	221
Expert pistol shot.....	228
Figure of merit for.....	224
First-class man, rifle.....	218
First-class man, pistol.....	226
Gallery practice.....	216
General scheme.....	215
Insignia for.....	224
Known distance firing.....	217
Classification.....	218
Instruction practice.....	217
Record practice.....	219
Long-distance practice.....	220
Marking and scoring.....	221
Medals for.....	224
Preliminary drills and instruction.....	215
Proficiency test authorized for.....	223
Qualification course.....	220
Regulations governing small-arms firing by.....	215
Reports to be rendered of firing.....	224
Second-class man.....	218
Second-class man, pistol.....	226
Telescopic sights.....	221
Unqualified.....	218
Who will fire.....	221
Orthoptic eyepieces, use of, prohibited.....	62
Outer, definition of.....	14
Parapet, definition of.....	14
Peepsight (<i>see</i> Full sight).....	29
Penalties:	
Evading rules.....	211
Falsifying scores.....	211
Interference.....	211
Intoxication, etc.....	211
Offering bribe.....	211
Regulations, nonacquaintance with.....	211
Two hits on same target.....	210

	Page.
Penalty, none attached for misfire.....	74
Philippine Islands:	
Commanding general to prescribe firing for bandsmen.....	61
Competitions in.....	199, 200
Piece:	
Canting the.....	10
Cleaning in, competitions.....	208
Disabled in rapid fire.....	74
Pistol:	
Barriers.....	105
Competitions.....	106
Ties in aggregate score.....	212
Description of.....	90
Department team personnel.....	205
Dismounted course—	
Classification.....	109
Expert test.....	109
Instruction practice.....	107, 108
Record practice.....	109
Requirements.....	110
First-class pistol shots, definition.....	12
First-class pistol shots, insignia.....	177
Second-class pistol shots, definition.....	17
Expert, qualification in militia.....	226
Expert, qualification in regular service.....	118
Expert test.....	104
Firing—	
Field.....	105
For militia, course of.....	225
Classification.....	226
Insignia for.....	226
Who will fire.....	226
Participation of company officers in.....	102
Instruction practice.....	102
Marksman, militia.....	217
Mounted course—	
Classification.....	122
Expert test.....	118
Gallop.....	115
Halt at.....	114
Instruction practice, mounted.....	112
Instruction practice, dismounted.....	111
Instruction for pistol or revolver firing, mounted.....	110
Requirements.....	123
Record practice.....	117
Scoring and marking.....	115
Table.....	111
Walk at.....	114
Preliminary instruction for.....	105
Aiming.....	94
Blank-cartridge practice.....	105

Pistol—Continued.

Preliminary instruction for—Continued.

Galt.....	105
How cocked.....	93
Revolver.....	94
Importance of not jerking the trigger.....	36
Nomenclature and care to be first taught.....	90
Position dismounted.....	92
Position and aiming—	
Dismounted.....	96
Remarks.....	67
Mounted.....	99
Quick-aim drill.....	99
Rules for handling, and to prevent accidents.....	91
Self-cocking action.....	93
Preliminary practice, as with ballcartridges.....	100
Preliminary range practice drills.....	99
Preliminary training of horses.....	99
Target.....	100
Qualification of Organized Militia.....	226
Quick fire.....	15
Range practice.....	100, 101
Record practice.....	103
Restrictions as to use of.....	62, 207
Scoring in rapid and quick fire.....	103
Firing on wrong target.....	103
Other mishaps.....	103
Season practice.....	101
Sharpshooter, militia.....	224
Shot, distinguished, definition of.....	213
Snap shooting, firing quickly.....	97
Tabulation.....	106, 111
Targets for.....	183
Triggers squeeze.....	93
Use of, at disappearing target.....	182
Who will fire.....	102

Pit:

Definition of.....	14
Detail of men for.....	67
Duties of enlisted men in.....	68
For field targets.....	183
Marker entering before completion of firing.....	68
Marker leaving.....	68
Noncommissioned officer to be in charge.....	67
Officer in pit for every two or less.....	64
Regulations—	
Marking—	
Rapid-fire.....	71
Slow-fire.....	69
Where post garrison consists of only one company.....	69
Shed.....	197
Target detail.....	68

	Page.
Platoon, exercises suggested for collective fire of.....	164-167
Policing of range (see Range officer).....	67
Poor shots, ammunition to be saved for.....	22
Poorer shots:	
Advisable to encourage.....	22
Ammunition to be expended upon.....	22
Position and aiming drill:	
Application in gallery practice.....	53
For pistol, dismounted.....	96
Aiming.....	96
How cocked.....	94
Position.....	96
Quick aim.....	99
Self-cocking action.....	98
Trigger, importance of not jerking.....	98
For pistol, mounted.....	99
Blank-cartridge practice.....	105
Horses, preliminary training for.....	99
Practice as with ball cartridges.....	100
Quick-aim drill.....	99
Range-practice drills, preliminary.....	99
Snap shooting.....	97
For rifle—	
Back position not authorized.....	47
Breech mechanism, manipulation of.....	43
Formation of squad.....	43
General instructions.....	37
How divided.....	37
Kneeling.....	43, 44
Length of.....	43
Position exercise.....	38
Prone.....	45, 46
Purpose.....	36
Rapid-fire exercise.....	42
Sitting down.....	44, 45
Trigger squeeze exercise.....	37
General remarks.....	47, 48
Position, fire of, definition of. (See Infantry Drill Regulations, par. 424.)	
Position in firing, choice of.....	44
Positions:	
Back not authorized.....	47
Supervision by officer in charge of firing.....	67
Post commanders:	
Duties of.....	24, 60, 62, 159
Hours of practice, to arrange.....	80
May excuse men from proficiency test.....	158
Or field officer to supervise the proficiency test.....	158
Post competitions, encouragement of.....	212
Test proficiency, duties of.....	158

	Page.
Practice:	
Combat. (See <i>Combat practice.</i>)	
Firing, object of.....	19
Hours.....	60
Individual, definition of.....	13
Instruction, definition of.....	13
Known distance. (See <i>Range practice.</i>)	
Record.....	60
Repeated in rapid fire in case of defective cartridge or disabled piece.....	74
Rifle ranges for.....	195
Scoring.....	65, 103, 115
Season--	
Definition of.....	14
Divided into two periods.....	21, 60
Opens with instruction practice.....	65
Supplementary.....	13, 23, 60
Preliminary drills:	
Definition of.....	14
For pistol.....	94-97
Rifle.....	37, 38
Importance of.....	38
Neglect of.....	48
Period of.....	21, 38
Scope of, in combat practice.....	125
Supervision of, by regimental commanders.....	23, 153
Preliminary practice:	
Competitions--	
Definition of.....	14
Department pistol.....	97
Rifle.....	201
Hours for, prescribed by officer in charge of.....	205
Principles, general, for all combat practice.....	125, 126
Prizes:	
Department pistol.....	205
Rifle.....	201
Requisitions for.....	203
Procedure, order of rifle-range practice.....	65
Proficiency:	
Record of, for information of division and department commanders.....	140
Value of uniform average.....	22
Proficiency test in rifle firing.....	157
Ammunition required for.....	158
Annually.....	157
Courses for, confidential.....	157
Courses prepared by regimental commanders.....	157
Definition of.....	15
How prescribed.....	159
Procedure.....	158
Publishing results.....	160
Range.....	158
Regulations for.....	158
Responsibility for deficiency.....	159

	Page.
Proficiency test in rifle firing—Continued.	
Standard of proficiency.....	159
Supervised by, suitable officer.....	158
When fired.....	157
Who will fire the.....	157
Programs, post competitions.....	212
Prono:	
Definition of.....	15
Firing, stability of position.....	46
Protest:	
Definition of.....	15
Must be made to range officer.....	209
Quick fire.....	15
Qualification:	
Conditions and requirements for regular service.....	173, 175
Definition of.....	15
Estimating distance a factor of.....	58
Expert.....	173
Militia.....	223
Of marksman (<i>see</i> Estimating distance).....	57
Of sharpshooter (<i>see</i> Estimating distance).....	58
Of unqualified.....	173, 175
Pistol, expert shot.....	175
Pistol shot—	
First classman in militia.....	223
In militia.....	226
In regular service.....	175
Second classman in militia.....	223
Quartermaster, etc., duties of, at competitions.....	206
Range:	
Definition of.....	15
Determination of.....	15
Effective. (<i>See</i> Ordnance Manual No. 1923.)	
Long range.....	13
Maximum for rifle. (<i>See</i> Ordnance Manual No. 1923.)	
Point blank for rifle. (<i>See</i> Ordnance Manual No. 1923.)	
Regulations for combat practice.....	153
Range finders (<i>see</i> Estimating distance).....	58
Range officer:	
Appeal from decision of.....	209
Appointment of.....	205
Chief, duties of.....	205
Definition of.....	15
Duties and powers.....	67
Number of, at competition.....	206
Officers, duties of, at competitions.....	205
Protests, submission to.....	209
Responsibility.....	67, 205
Spectators, to provide for safety of.....	209
Targets—	
Premature withdrawal of.....	208
Examination after misses.....	69
To provide lookouts on unprotected ranges.....	197

	Page.
Range practice:	
Advantages and uses.....	19
Bandsmen not to take prescribed course.....	61
Participation in, by company officers.....	23
Rifle-range practice, known distance.....	53
Supervision of—	
By battalion commanders.....	23
By company commanders.....	22
By post commanders.....	24
By regimental commanders.....	23
For pistol.....	100
Ammunition, allowance of.....	101
Barriers.....	105
Blank cartridges.....	105
Description.....	90
Dismounted course.....	111
Instruction practice.....	107
Rapid fire.....	107
Procedure.....	107
Target.....	108
Quick fire.....	108
Procedure.....	108
Target.....	108
Slow fire, target.....	108
Equipment.....	63, 207
Gait.....	105
General regulations.....	104
Instruction practice.....	100
Methods of holding the pistol.....	92
Mounted course.....	110
Description of record practice.....	117
Instructions for mounted firing.....	110
Quick fire.....	112
Record practice.....	117
Scoring method of.....	115
Targets.....	117
Order of procedure.....	114
Practice season.....	14, 60
Preliminary drills.....	21
Record practice.....	101, 102
Scheme, general.....	100
Slow fire, necessity for previous instruction.....	104
Systematic instruction.....	107
Tabulations.....	103, 108, 111
Targets for.....	163
Who will fire.....	102
For rifle.....	59-78
Advancing the soldier.....	77
Ammunition, allowance of.....	63, 77
Back position not authorized.....	47
Calling shots.....	66
Casuals, practice of.....	60
Combat. (See Combat practices.)	

Range practice—Continued.

For rifle—Continued.

	Page.
Course, table in.....	59
Deliberation in aim.....	39
Description, general.....	59
Dress and equipment.....	63
Field glasses.....	65
Graduation of rear sight. (See Ordnance Manual 1923.)	
Instruction practice.....	63
Instruction shots.....	65
Instructions and suggestions.....	80-90
Long-range aiming.....	72, 76
Long-range practice.....	72, 76
Low aiming.....	133
Maintenance of order.....	67
Marking.....	69
Rapid fire.....	71
Slow fire.....	69
Officer in charge of firing.....	67
Order of procedure.....	65
Pit regulations.....	67
Target detail.....	68
Practice hours.....	60
Qualification course, instruction and record practice.....	72-75
Range officers.....	67
Record practice.....	64
Regular combat practice.....	152
Reports of.....	179
Restrictions as to arms.....	52
Rests, use of.....	62
Scheme of.....	59
Scoring.....	65
Range officers.....	57
Rapid fire.....	66
Slow fire.....	66
Sighting shots.....	55
Supervision of.....	67
Special courses.....	60
Supplementary course.....	60
Targets for—	
Description of.....	181, 182
Illustration of.....	185-194
Target year and practice season.....	60
Telescopic practice with telescopic sights.....	76, 77
Use of devices for determining force and direction of wind.....	63
Use of gun sling.....	62
Use of rests.....	62
Weather conditions.....	60
Who will fire known distance practice.....	61
Combat practice.....	153

	Page.
Ranges, target:	
Butts, artificial.....	193
Hills as.....	196
Class A.....	195
Class B.....	198
Classes of.....	195
Danger signals.....	197
Direction of.....	195
Distance from post.....	195
Extent of.....	195
Firing mounds.....	197
Ground best for.....	196
In charge of chief range officer.....	205-207
Interval between targets.....	196
Measuring of.....	197
Numbering of targets.....	197
Not provided with butts, care to be taken.....	198
Parallel.....	197
Pit shed.....	197
Prepared for combat practice.....	198
Range houses.....	198
Rules for selection.....	195
Security necessary.....	195
Shelter continuous.....	198
Separate.....	196
Streamers not to be visible to men firing.....	198
Telephone service.....	198
Time, best for practice on.....	195
Rapid fire:	
Competitions.....	201, 205
Definition of.....	16
Kneeling position prescribed for 200 yards.....	72
Marking, pit regulations.....	71, 72
Marksman's course.....	75
Repeated in case of defective cartridge or disabled piece.....	74
Sharpshooter's course.....	72-75
Signaling and recording hits.....	69-71
Ties, method of deciding.....	212
Value of hits.....	69
Rapid-fire exercise:	
For pistol.....	108
Procedure.....	108
Target used.....	108, 183
For rifle.....	42
Body, position of.....	42
Manipulation of breech mechanism.....	43
Methods of.....	42
Purpose of.....	42, 83
Repetition.....	43
Rifle, position of.....	41
Trigger squeeze.....	42
Rear sight, graduation of.....	50

	Page.
Record:	
Company target.....	178
Permanent entry of score.....	178
Record course a test for classification and awarding insignia.....	21
Record practice:	
Definition of.....	59
For pistol, mounted.....	117
Dismounted.....	109
For rifle.....	75
Check on accurate scoring.....	65
Known-distance practice.....	59
Never on same day as instruction practice, same course.....	65
Officer in pit for every two or less targets.....	64
Purpose of.....	21
Rifle-range practice.....	64
Score to be completed at same range, same day.....	65
Sighting shots.....	65
To complete before commencing other firings.....	65
Recruits:	
Preliminary instructions.....	21, 60
Supplementary practice season.....	60
Regimental commanders:	
Duties of.....	23
Supervision of proficiency test.....	158
To submit list of individual men, classification of.....	177
Transmission of target records.....	179
Regular season, definition of.....	16
Regulations:	
General rifle-range practice.....	20
Penalty for nonacquaintance with.....	211
Repairs to target.....	63
Reports of firing to be rendered by Organized Militia.....	180
Reports of firing to be rendered by organizations of regular service.....	179
How transmitted.....	179, 180
Responsibility of range officers.....	67
Rest:	
Combat fire, permitted.....	62
Parapet, for rifle during firing at 600 yards.....	73
Sighting drill.....	27
Use of, rifle-range practice.....	85
Results of proficiency test (entered on report of combat practice).....	160
Ricochet flags, description of.....	70
Ricochet shots:	
Definition of.....	16
Signaling of.....	70
Reports of revolver and pistol firing.....	179
Rifle:	
Accidents to. (See Ordnance Manual No. 1923.)	
Caliber, definition of.....	10
Care of.....	25
Cleaning the.....	25, 85, 86

	Page.
Rifle—Continued.	
Competitions—	
Department rifle.....	199
Fest rifle.....	212
Ties in.....	212
Slow and rapid fire.....	212
Aggregate scopes.....	212
Disabled.....	208
Holding to prevent effect of recoil.....	38
How to clean.....	85
Instruction, score of.....	20
Point-blank range for. (See Ordnance Manual No. 1923.)	
Position of, in position and aiming drill.....	38
Kneeling.....	44
Prone.....	46
Sitting down.....	44
Trigger-squeeze exercise.....	41
Rapid-fire exercise.....	42
Position of, in position exercise.....	39
Preliminary drills for.....	21
Recoil, holding to prevent effect of.....	39
Twist.....	18
Zero, definition of.....	49
Rifle fire:	
Danger space, discussion of.....	128
Importance of.....	20
Progress of, method of instruction.....	21
Rifle firing:	
Education of soldier in.....	21, 22
Participation of company officers in.....	22
Scope of instruction.....	20
Riflemen, advice to.....	80-90
Riflemen, expert:	
Requirements necessary.....	173
See Classification.....	173
See Insignia.....	176
Rifling:	
See Grooves, definition of.....	13
See Twist, definition of.....	18
Rules:	
Evading, penalty for.....	211
Must be observed in record practice.....	61
Sand-bag rest.....	73, 75, 213
Sand glasses, ordnance officer in charge of.....	206
Scheme of rifle-range practice.....	59
Score cards.....	210
Definition of.....	16
Score:	
Definition of.....	16
Rapid fire, how announced.....	66
Sighting shots.....	65
Score keeper, position of.....	210
Scorers, place of.....	210

	Page.
Scores:	
Alterations.....	65
Officers directing practice may make.....	65
Cutting edge of bull's-eye.....	69
Entry on target records to be permanent.....	65
Falsifying, penalty for.....	211
Gallery practice.....	52
Noncommissioned officer to keep record.....	65
To be recorded accurately.....	65
Where target and record do not agree.....	69
Scoring:	
Case of two men firing on same target, how to be kept.....	210
Permanent record to be kept at firing point.....	210
Rapid-fire.....	66
How to be kept.....	66
Rifle-range practice.....	65
Sighting shots, record practice.....	64
Shades, eye, prohibited.....	62
Sharpshooter:	
Badge issued to.....	176
Definition.....	17
Qualifications.....	178
Sharpshooter's course:	
Conditions and requirements for.....	173
Description and explanation.....	59
Sighting shots.....	65, 75
Targets for.....	181
Shelters:	
Continuous.....	196
Separate.....	196
Shooting:	
Bad, causes of.....	39
Competitions—	
Changing arms.....	208
Cleaning pieces.....	208
Coaching.....	209
Expressions of opinions, etc.....	209
General regulations.....	211
Loading pieces.....	208
Order of fire.....	201, 204
Order of firing, slow fire.....	208
Pistol, position of.....	208
Protests.....	209
Punctuality.....	208
Rules, special.....	211
Special rules.....	211
Spectators.....	209
Station of competitors awaiting turn to fire.....	209
Targets, withdrawing prematurely.....	208
Uniform.....	207
Warming shots, not allowed.....	209
Effects of mirage.....	83
Gallery (<i>see</i> Gallery, shooting).....	52

	Page.
Shooting —Continued.	
Peculiarities of guns. (See Ordnance Manual No. 1923.)	
Weather conditions favorable for.....	60
Short range:	
Definition.....	17
See Gallery.....	25
Shot:	
Fired for instruction, permitted only in instruction practice.....	65
Fired on wrong target, value of.....	210
Group, definition of.....	129
More on target than authorized at any range.....	75
Marks, definition of.....	17
Sighting, scoring of, record practice.....	65
Sighting when prescribed.....	75
Test, estimating distance by.....	57
Trial (see Sighting shots).....	65
Value of—	
See Bull's-eye target.....	181
See Inner.....	70
See Outer.....	70
See Spotter.....	70
See Targets.....	181
Sight:	
Black, description of. (See Ordnance Manual No. 1923.)	
Kinds of.....	29
Line of, determined by.....	28
Line of, definition of.....	28
Normal.....	29
Peep.....	29
Telescopic.....	178
Sighting:	
Bar, description of.....	26, 27
Rest for rifle.....	27
Systematic exercises necessary in.....	25
Sighting drill:	
Abnormal shape, causes of, triangle.....	33
Battle sight.....	32
Canting the piece.....	34
Course of instruction.....	32
Disk, description of.....	27
Errors, causes of.....	33
Exercises.....	32, 34
Fine, full, normal, and peep sight.....	29
Instructor, duty of.....	37
Length of.....	38
Line of sight.....	28
Point of aim.....	28
Preliminary drill, importance of.....	47
Purposes of.....	25
Rest for rifle.....	27
Selection of sight.....	32
Triangle of sighting.....	33

	Page.
Sighting shots:	
Definition of.....	17
Must be fired when prescribed.....	76
When prescribed.....	76
Sights:	
Adjustments of.....	39, 49
Authority to blacken.....	62
Battle required.....	73
Changing.....	48
Combined, use of.....	147
Correction.....	48
Deflection.....	49
Elevation.....	49
Graduation of. (See Ordnance Manual No. 1923.)	
Placing eye to.....	29
Telescopic—	
Definition of.....	18
Issue to special class of shots.....	178
Use of, authorized in combat practice.....	178
Signals, danger	197
Silver badge (see Insignia)	176
Silver pin (see Insignia)	176
Sitting down, position and aiming drills	44
Body, position of.....	43
Commands.....	45
Remarks.....	45
Rifle, position of.....	44
Skill, badges for (see Insignia)	176
Slow fire:	
Definition of.....	17
For pistol, when used.....	108, 112
For rifle—	
Marksman's course.....	73, 75
Scoring.....	66
For special courses.....	78
Marking, pit regulations.....	69
Signaling of misses.....	209
Targets, two shots on same, scoring.....	71, 210
Withdrawal, premature.....	208
Ties, method of deciding.....	212
Small-arms firing, militia, report to Chief Division of Militia Affairs	224
Squeezing trigger before taking position	36, 87
Soldier:	
Advancing from gallery to range.....	59
Peculiarities affect methods of instruction.....	22
Sustaining interest in.....	22
Transferred.....	158, 174
Sound:	
Estimating distance by.....	56
See Estimating distance.....	56
Space:	
Dangerous, discussion of.....	128
Defiladed.....	135
Point-blank danger. (See Ordnance Manual No. 1923.)	

	Page.
Special courses:	
A, definition of.....	17
Description of.....	78
Preliminary drills for.....	78
When used.....	78
Qualification in.....	173
Fire—	
Rapid, description of.....	79
Slow, description of.....	79
Instruction practice and record practice.....	78
Prescribed for the supplementary firing under certain conditions.....	60, 78
Regulations governing.....	78
When used.....	78
Rifle-range practice.....	78
Targets for.....	79, 80
Spectators, safety of, rifle-range practice.....	67
Spirit levels, detachable, prohibited.....	62
Spotter, definition of.....	17
Spotting, prohibited in record practice.....	64
Squads:	
Exercises suggested for combat practice.....	161
Length of drills.....	37
Position and aiming drill, formation of.....	37
Staff officers:	
Noncommissioned, can not be selected as competitors.....	200
Number and designation of.....	199
Standard of proficiency of a company.....	159
Stationery, etc., for competitions.....	206
Statistical officer (see Adjutant and statistical officer).....	206
Streamers, use of, prohibited in record practice.....	63
Sun, bright, on target.....	82
Supervision of company practice by an officer.....	23, 67
Supplementary course, object of.....	22
Rifle-range practice.....	60
Special course A prescribed for, under certain conditions.....	60
Supplementary practice season.....	22
Supplementary season, definition of.....	17
Systematic aiming to be encouraged.....	47
Target firing, report of rifle and pistol practice.....	179
When not to be held, weather unfavorable.....	60
Target record:	
Description of.....	178
Entries to be made in ink or indelible pencil.....	178
Officer to initial corrections in.....	65
Target year:	
Definition of.....	60
For pistol, practice season.....	101
For rifle.....	60
Targets:	
Accidents to.....	208
Aiming, barracks to be furnished with.....	37
And ranges.....	181
Apportionment of. (See Infantry Drill Regulations, pars. 244-245.)	

Targets—Continued.	Page.
Assignment to, in competitions.....	206
Stated on score cards.....	210
Choice of. (<i>See</i> Infantry Drill Regulations, pars. 408-410.)	
Definition of.....	18
Description of.....	181-184
Field, rapid, skirmish, and slow fire.....	181-184
Target A, the short-range target.....	181
Target B, the mid-range target.....	181
Target C, the long-range target.....	181
Target D, rapid-fire target.....	181
Target E, field target.....	182
Target F, field target.....	182
Target G, falling.....	182
Target H, bobbing.....	182
Target I, beam disappearing target.....	182
Target K, sled target, type A.....	183
Target L, bull's-eye pistol target (<i>C. S. A. F. M., No. 5</i>).....	183
Target M, moving target.....	184
Target X, miniature target, gallery practice.....	184
Target Y, miniature target.....	184
Target Z, miniature target.....	184
Target iron, gallery.....	184
Detail for.....	68, 207
Disappearing, definition of.....	11
Time of exposure.....	71
Use of pistol.....	107, 109, 111, 117, 118
Division of.....	73
Examination after misses.....	209
Falling.....	182
Field targets, when used.....	184
Illustrations of.....	185-194
Intervals between.....	154, 196
Kind used in marksman's course.....	59, 77
Sharpshooter's course.....	59, 77
Known-distance targets.....	181
Moving, instructions for firing and aiming at.....	84
Numbering of.....	197
Officers to make final examination in record practice before marking miss.	69
Repairs to.....	68
Scoring of shots fired at wrong.....	66
Sharpshooter's course.....	60, 77
Shelters, continuous.....	196
Separate.....	196
Trial of new kinds.....	22
Two men firing on same, score, how kept.....	210
Two shots on same.....	210
Withdrawal by noncommissioned officer.....	69
Premature.....	208
Telephone service on range.....	198
Telescope, use of, to determine effect of mirage.....	83

	Page.
Telescopic sight	76
Assignment to enlisted men.....	178
Definition of.....	18
When worn.....	178
Temperature, effect of.....	82
Test of proficiency in estimating distance.....	57
Test of proficiency in rifle firing (<i>see</i> Proficiency test).....	157
Theoretical instruction of enlisted men.....	21
Training, preliminary, to be given in combat practice.....	152
Trajectory:	
Definition of.....	18
Wind effect of, on. (<i>See</i> Ordnance Manual No. 1923.)	
Trench skirmisher, description of. (<i>See</i> Infantry Drill Regulations, pars. 584-595.)	
Trial shots:	
Estimating distance by.....	57
<i>See</i> Sighting shots.....	65
Triangle:	
Of sighting.....	33
Sighting, abnormal shape, causes.....	33
Use of, in sighting.....	33
Trigger, pull test	207
Snapping.....	42, 48
Squeeze, acquaintance with.....	37
Exercise.....	36
Breath, holding in.....	41
Commands in.....	41
Position of body.....	41
Position of rifle.....	41
Rapid-fire exercise.....	42
Trumpeters and musicians to take prescribed course in rifle practice.....	61
Twist, definition of.....	18
Two shots striking target at the same time.....	71
Uniform to be worn.....	63
Uniformity in practice firing to be preferred.....	22
Unqualified, definition of.....	18
Who will be classed as.....	173, 218
Value:	
Of combat practice depends upon.....	125, 126
Of gallery practice.....	53
Of ricochet shot (<i>see</i> Ricochet shot).....	70
Of shots on wrong target.....	210
Of two shots striking target same time.....	210
Volley fire:	
Advantages of. (<i>See</i> Infantry Drill Regulations, pars. 241, 412.)	
Discussion of. (<i>See</i> Infantry Drill Regulations, par. 241.)	
In action. (<i>See</i> Infantry Drill Regulations; par. 241.)	
Moral effect on enemy. (<i>See</i> Infantry Drill Regulations.)	
Waves, heat.....	51
Weather conditions:	
Effect on shot.....	81
Favorable, to be selected for practice generally.....	60
When most favorable.....	60

	Page.
Who are not required to fire.....	61, 153
Wind:	
Changes in direction of.....	51
Corrections in sight for.....	52
Deflection.....	81
Direction of (<i>see</i> O'clock).....	14, 51
To be noted.....	51
Effect on trajectory. (<i>See</i> Ordnance Manual No. 1923.)	
Windage, definition of.....	18
Table.....	52
Wind gauge, definition of.....	18
Wrong target, shots fired on, value of.....	210
Zero of rifle, definition of.....	49
Zone beaten, definition of.....	9
Form of.....	130
Zone 50 per cent, definition of.....	131
Zone of effective fire, definition of.....	131

