

# INORGANIC SYNTHESSES

## VOLUME II

*The quality of the materials used in the manufacture of this book is governed by continued postwar shortages.*

# Inorganic Syntheses

## *Volume II*

EDITOR-IN-CHIEF

W. CONARD FERNELIUS  
*Syracuse University*

ASSOCIATE EDITORS

LUDWIG F. AUDRIETH  
*University of Illinois*

JOHN C. BAILAR, JR.  
*University of Illinois*

HAROLD S. BOOTH  
*Western Reserve University*

WARREN C. JOHNSON  
*University of Chicago*

RAYMOND E. KIRK  
*The Polytechnic Institute of Brooklyn*

WALTER C. SCHUMB  
*Massachusetts Institute of Technology*

CONSULTANT ON NOMENCLATURE AND INDEXING  
JANET D. SCOTT  
*The Interscience Encyclopedia, Inc., Brooklyn*

*First Edition*  
*Third Impression*

*New York*

*London*

MCGRAW-HILL BOOK COMPANY, INC.

1946

INORGANIC SYNTHESSES, VOLUME II

COPYRIGHT, 1946, BY THE  
MCGRAW-HILL BOOK COMPANY, INC.

---

PRINTED IN THE UNITED STATES OF AMERICA

*All rights reserved. This book, or  
parts thereof, may not be reproduced  
in any form without permission of  
the publishers.*

*To*

the countless unknown but valiant  
soldiers of science upon whose labors  
Inorganic Syntheses are based, this series  
of volumes is dedicated in the hope that  
it will ease the toil of future legions.

## PREFACE

The present volume is the second of a series giving detailed and tested methods for the synthesis of inorganic substances. The reception given the earlier volume and the support extended this one are convincing evidence of the need for this type of compilation.

In the present volume the practices adopted in assembling Volume I have been continued. Each synthesis has been carefully checked in a laboratory other than that in which it was developed. All drawings and procedures have been critically edited by the Board of Editors. Where it was thought helpful, the synthesis has been introduced by a critical survey of known methods and concluded by a summary of the more common properties of the substance to guide the user of the method. The references are intended to be suggestive rather than exhaustive. For convenience the book is arranged in chapters numbered according to the groups in the Mendeleev periodic table.

Experience gained in producing Volume I indicated the need for adopting certain additional policies. Since every chemical compound consists of at least two elements, the inclusion of any synthesis in a given chapter on the basis of the periodic table is somewhat arbitrary. Hence, at the beginning of each chapter is given a list of syntheses which are presented in other chapters but which might have been included in that one. In certain instances of groups of closely related syntheses in the present volume, it was deemed advisable to incorporate general summaries of the fields involved. No one today can work in the inorganic field for long without realizing the great need for an extensive systematization of inorganic nomenclature. This problem has been carefully studied, and the best practices have been adopted. These are explained fully in the Appendix. The index is cumulative for Volumes I and II.

Inasmuch as the syntheses in INORGANIC SYNTHESSES originate from individual contributors, the editors have been perturbed to find specific references to Volume I that do not mention the individual contributor. The editors prefer that INORGANIC SYNTHESSES be considered as a periodical when references are given and that credit be given to the contributor.

Since the publication of Volume I, Dr. W. C. Schumb has been added to the Board of Editors and Miss Janet D. Scott has consented to serve as consultant on nomenclature and indexing. Professor L. F. Audrieth, of the University of Illinois, will serve as editor-in-chief of Volume III of INORGANIC SYNTHESSES. The collection and checking of syntheses for this volume are now under way, and contributions should be sent directly to Professor Audrieth. The Board asks contributors to adhere to the style followed in previous volumes and to submit drawings and manuscripts in triplicate. It is hoped that future volumes can appear at intervals of two to three years.

The editors wish to express their appreciation to those who have contributed and checked the syntheses in Volume II and ask for their continued cooperation. They likewise take this occasion to thank Dr. Austin F. Patterson and Dr. E. J. Crane for their helpful suggestions concerning nomenclature.

The editor-in-chief is grateful to his associates for their vigorous enthusiasm and tireless labor in the preparation of Volume II. Further, he wishes to acknowledge his great indebtedness to his wartime colleagues, Dr. C. L. Rollinson, Dr. L. E. Marchi, and Dr. E. M. Larsen, who have given unstintingly of their time and energy to help in the editing of this volume. Without their support its publication would have been further delayed.

The editors will deem it a favor if readers will call their attention to any errors or omissions.

WEST LAFAYETTE, INDIANA.  
*August, 1946.*

W. CONARD FERNELIUS.

## CONTENTS

	PAGE
Preface.....	vii
CHAPTER I	
1. Copper(I) Chloride.....	1
2. Silver Chlorate.....	4
3. Recovery of Silver and Iodine from Silver Iodide Residues.....	6
CHAPTER II	
4. Metal Derivatives of 1,3-Diketones.....	10
5. Beryllium Acetylacetonate [Bis(2,4-pentanediono)beryllium].....	17
6. Barium Bromate.....	20
CHAPTER III	
7. Porous Boron Oxide.....	22
8. Ammonium Tetrafluoroborate.....	23
A. Reaction in Aqueous Solution.....	23
B. Fusion Reaction.....	24
9. Aluminum Acetylacetonate [Tris(2,4-pentanediono)aluminum].....	25
10. Gallium(III) Perchlorate 6-Hydrate.....	26
11. The Rare Earth Elements and Their Compounds.....	29
12. The Extraction of Rare Earth Minerals. I. Monazite and Xenotime.....	38
A. Cracking the Mineral.....	39
B. Removal of Thorium.....	41
C. Recovery of Rare Earths.....	41
D. Conversion to Oxides.....	42
E. Subsequent Treatment.....	43
13. The Extraction of Rare Earth Minerals. II. Allanite, Cerite, and Gadolinite (Separation of Cerium and Yttrium Earths by the Double Sulfate Method).....	44
A. Extraction.....	45
B. Precipitation of Rare Earths.....	46
C. Separation of Cerium and Yttrium Earths.....	46
14. The Separation of Cerium from Rare Earth Mixtures..	48
A. Separation of Cerium.....	48
B. Recovery of Cerium.....	51
15. Fractional Crystallization; The Magnesium Rare Earth Nitrates.....	52
A. Preparation of a Series.....	52
B. Fractional Crystallization.....	53
C. Modifications.....	57

	PAGE
16. The Average Atomic Weight of Rare Earth Elements in a Mixture; Method Based on the Ratios, Oxalate: Oxide and Oxalate: Permanganate.....	58
17. Rare Earth Bromates.....	62
A. Preparation of the Rare Earth Sulfate Solution.....	63
B. Preparation of Rare Earth Bromates.....	64
18. Europium Amalgam; Separation of Europium from Rare Earth Mixtures.....	65
A. Preparation of Europium Amalgam.....	66
B. Separation of Europium from Other Rare Earths.....	68
19. Europium(II) Salts.....	69
A. Europium(II) Sulfate.....	70
B. Europium(II) Carbonate.....	71
C. Europium(II) Chloride.....	71

## CHAPTER IV

20. Sugar Charcoal.....	74
21. Monosodium Acetylide (Ethylnylsodium).....	75
A. Purification of Reagents.....	76
B. Sodium Acetylide from Sodium and Acetylene.....	76
C. Sodium Acetylide from Sodium Amide and Acetylene.....	79
22. Carbon Monoxide.....	81
23. Ammonium Carbamate.....	85
24. Alkali Metal Cyanates.....	86
A. Potassium Cyanate.....	87
B. Sodium Cyanate.....	88
25. Cyanogen Chloride.....	90
26. Silica Gel.....	95
27. Disilicon Hexabromide (Hexabromodisilane).....	98
28. Germanium(II) Sulfide (Precipitated).....	102
A. Reduction of Germanium(IV) Oxide.....	103
B. Reduction of Germanium(IV) Sulfide.....	104
29. Germanium(II) Iodide.....	106
30. Germanium(IV) Chloride.....	109
31. Germanium(IV) Iodide.....	112
32. Titanium(IV) Bromide.....	114
33. Titanium(III) Bromide.....	116
34. Bis[tris(2,4-pentanediono)titanium(IV)] Hexachlorotitanate(IV).....	119
35. Zirconium Acetylacetonate [Tetrakis(2,4-pentanediono)-zirconium].....	121
36. Thorium Acetylacetonate [Tetrakis(2,4-pentanediono)-thorium].....	123

## CHAPTER V

37. Nitric Oxide [Nitrogen(II) Oxide].....	126
38. Sodium Amide.....	128



	PAGE
39. Ammonium Azide .....	136
40. Potassium Azide (Sodium Azide) .....	139
A. Butyl Nitrite .....	139
B. Potassium Azide .....	140
41. Phosphonium Iodide .....	141
42. Phosphorus(III) Chloride .....	145
43. Phosphorus(III) Bromide .....	147
44. Phosphorus(V) Oxybromide (Phosphoryl Tribromide) ..	151
45. Phosphorus(V) Sulfobromide (Thiophosphoryl Tribro- mide) .....	153
46. Ammonium Monofluophosphate .....	155
47. Ammonium Difluophosphate .....	157

## CHAPTER VI

48. Addition Compound of Sulfur Dioxide and Trimethyl- amine .....	159
49. Sulfites and Pyrosulfites of the Alkali Metals .....	162
A. Sodium Sulfito and Sodium Pyrosulfito .....	162
B. Potassium Sulfito and Potassium Pyrosulfito .....	166
50. Salts of Dithionic Acid .....	167
A. Calcium Dithionate .....	168
B. Barium Dithionate .....	170
C. Sodium Dithionate .....	170
51. Addition Compounds of Sulfur Trioxide .....	173
A. Pyridine—Sulfur Trioxide .....	173
B. Dimethylaniline—Sulfur Trioxide .....	174
C. Dioxane—Sulfur Trioxide .....	174
52. Sulfamic Acid .....	176
A. Sulfamic Acid from Hydroxylammonium Sulfate .....	176
B. Sulfamic Acid from Acetoxime .....	177
C. Purification of Sulfamic Acid for Use as an Acidimetric Standard .....	178
53. Triammonium Imidodisulfate 1-Hydrate .....	179
A. Ammonium Sulfamate .....	180
B. Potassium Hexabromotellurate(IV) .....	180
54. Potassium Nitridotrisulfate .....	182
55. Aluminum Selenide and Hydrogen Selenide .....	183
56. Potassium and Sodium Selenocyanates .....	186
57. Hexahalogenotellurates(IV) (Halotellurites) .....	188
A. Ammonium Hexachlorotellurate(IV) .....	189
B. Potassium Hexabromotellurate(IV) .....	189
58. Chromium(III) Oxide Gel .....	190
59. Anhydrous Chromium(III) Chloride .....	193
60. Tris(ethylenediamine)chromium(III) Salts .....	196
A. Anhydrous Chromium(III) Sulfate .....	197
B. Anhydrous Ethylenediamine .....	197
C. Tris(ethylenediamine)chromium(III) Sulfate .....	198
D. Tris(ethylenediamine)chromium(III) Chloride .....	198
E. Tris(ethylenediamine)chromium(III) Halides .....	199

	PAGE
61. <i>cis</i> -Dichlorobis(ethylenediamine)chromium(III) Chloride and <i>trans</i> -Bis(thiocyanato)bis(ethylenediamine)-chromium(III) Thiocyanate.....	200
62. Potassium Hexacyanochromate(III).....	203
63. Chromyl Chloride (Chromium(VI) Dioxychloride).....	205
64. Potassium Monochlorochromate.....	208
CHAPTER VII	
65. Hydriodic Acid; Regeneration of Oxidized Solutions...	210
66. Trisodium Orthoperiodate (Sodium Paraperiodate): Sodium Iodide-Bromine Method.....	212
67. Potassium Hexacyanomanganate(III).....	213
CHAPTER VIII	
68. Beta-Iron(III) Oxide 1-Hydrate.....	215
69. Hexamminecobalt(III) Salts.....	216
A. Hexamminecobalt(III) Chloride.....	217
B. Hexamminecobalt(III) Nitrate.....	218
C. Hexamminecobalt(III) Bromide.....	219
D. Hexamminecobalt(III) Oxalate.....	220
70. Tris(ethylenediamine)cobalt(III) Chloride.....	221
71. <i>cis</i> - and <i>trans</i> -Dichlorobis(ethylenediamine)cobalt(III) Chloride and the Resolution of the <i>cis</i> -Form.....	222
A. Preparation of the <i>trans</i> -Form.....	223
B. Conversion to the <i>cis</i> -Form.....	223
C. Resolution of the <i>cis</i> -Form.....	224
72. Potassium Hexacyanocobaltate(III).....	225
73. Potassium Tetracyanonickelate(II).....	227
74. The Metal Carbonyls.....	229
75. Nickel Tetracarbonyl.....	234
76. Dicobalt Octacarbonyl, Cobalt Nitrosyl Tricarbonyl, and Cobalt Tetracarbonyl Hydride.....	238
A. Potassium Salt of Cobalt Tetracarbonyl Hydride.....	238
B. Cobalt Nitrosyl Tricarbonyl.....	239
C. Cobalt Tetracarbonyl Hydride.....	240
D. Dicobalt Octacarbonyl.....	242
77. Iron Tetracarbonyl Dihydride.....	243
78. Potassium Tetracyanopalladate(II).....	245
79. Potassium Tetrachloroplatinate(II) (Potassium Chloroplatinite).....	247
80. Tetrammineplatinum(II) Chloride (Tetrammineplatinous Chloride).....	250
81. Platinum(IV) Chloride.....	253
Appendix. The Nomenclature of Inorganic Compounds...	257
Index of Contributors.....	269
Subject Index.....	270
Formula Index.....	287

# INORGANIC SYNTHESSES

## CHAPTER I

See also: Hydrogen selenide, synthesis 55	Sodium selenocyanate, synthesis 56B
Hydriodic acid, synthesis 65	Sodium orthoperiodate, synthesis 66
Cobalt tetracarbonyl hydride, synthesis 76C	Potassium cyanate, synthesis 24A
Iron tetracarbonyl dihydride, synthesis 77	Potassium amide, synthesis 38
Lithium amide, synthesis 38	Potassium azide, synthesis 40
Monosodium acetylide, synthesis 21	Potassium sulfite and pyrosulfite, synthesis 49B
Sodium cyanate, synthesis 24B	Potassium nitridotrisulfate, synthesis 54
Sodium amide, synthesis 38	Potassium selenocyanate, synthesis 56A
Sodium azide, synthesis, 40	Potassium hexabromotellurate(IV), synthesis 57B
Sodium sulfite and pyrosulfite, synthesis 49A	Potassium monochlorochromate, synthesis 64
Sodium dithionate, synthesis 50C	Potassium hexacyanometallates, syntheses 62, 67, 72, 73, 78
	Potassium tetrachloroplatinate(II), synthesis 79

### 1. COPPER(I) CHLORIDE

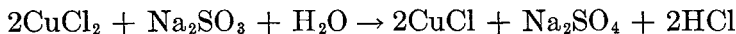

SUBMITTED BY R. N. KELLER\* AND H. D. WYCOFF†  
CHECKED BY LOUIS E. MARCHI‡

No copper(I) salts soluble in water to give copper(I) ions,  $\text{Cu}^+$ , are known. The only known stable copper(I) salts

\* University of Wisconsin, Madison, Wis.; present address: University of Michigan, Ann Arbor, Mich.

† University of Wisconsin, Madison, Wis.

‡ Indiana University, Bloomington, Ind.; present address: Central Research Department, Monsanto Chemical Company, Dayton, Ohio.

are either slightly soluble compounds or complex salts.<sup>1</sup> Copper(I) chloride may be obtained from a solution containing copper(II) and chloride ions by using any of a number of reducing agents, including stannous chloride,<sup>2</sup> metallic copper,<sup>2-5</sup> sulfurous acid, sulfites,<sup>6-9</sup> hydrazine sulfate,<sup>10</sup> hydroxylamine chloride,<sup>11-13</sup> sodium dithionite,<sup>14</sup> sodium hypophosphite,<sup>15</sup> phosphine,<sup>16</sup> and phosphorous acid.<sup>17</sup> In the present method sodium sulfite is used as the reducing agent and a solution of copper(II) chloride as the source of the copper(II) and chloride ions.

### Procedure

To a stirred solution of 10 g. of copper(II) chloride,  $\text{CuCl}_2 \cdot 2\text{H}_2\text{O}$ , in 10 ml. of water is added slowly at room temperature a solution of 7.6 g. of anhydrous sodium sulfite,  $\text{Na}_2\text{SO}_3$ , in 50 ml. of water. The copper(II) chloride solution first becomes very dark brown, and then white copper(I) chloride slowly separates. After all the sodium sulfite solution has been added and the mixture stirred thoroughly, the copper(I) chloride settles readily and the supernatant liquid is faintly green. The precipitate and supernatant liquid are then poured into about a liter of water to which 1 g. of sodium sulfite and 2 ml. of concentrated hydrochloric acid have been added, and the mixture is stirred well and allowed to stand until all the copper(I) chloride has settled. The supernatant liquid is carefully decanted and the precipitate is quickly washed onto a suction filter (sintered glass type preferred) with dilute sulfurous acid solution. Care should be taken that a layer of liquid covers the salt in the funnel at all times.

The copper(I) chloride is then washed four or five times with 20 to 25 ml. of glacial acetic acid. During this washing process the suction should be adjusted so that the wash liquid is sucked through rather slowly. When only a thin film of liquid covers the solid, the next portion of glacial acetic acid is added. The walls of the funnel should be washed each time with the washing liquid. The washing

with glacial acetic acid is followed by three 30-ml. washings with absolute alcohol and six 15-ml. washings with anhydrous ether in exactly the same way. After the last portion of ether has been removed fairly completely by applying suction for about 30 seconds, the white solid (with filter paper removed) is transferred quickly to a previously dried watch glass and placed in an oven (75 to 100°) for 20 to 25 minutes. The sample should be preserved in an airtight bottle. Yield about 5 g. (85 to 90 per cent based on  $\text{CuCl}_2 \cdot 2\text{H}_2\text{O}$ ). Anal. Calcd. for  $\text{CuCl}$ : Cu, 64.2; Cl, 35.8. Found: Cu, 64.1; Cl, 35.8.

The copper(I) chloride prepared by this method is a white crystalline powder that remains practically unchanged for an indefinite period if kept dry. If all the alcohol is not removed during the washing process, the copper(I) chloride may become slightly discolored on heating or standing. Some samples of anhydrous ether tend to impart a gray tint to the product.

As a substitute for the copper(II) chloride in this synthesis, a solution of copper(II) sulfate,  $\text{CuSO}_4 \cdot 5\text{H}_2\text{O}$ , containing slightly more than 1 mol of sodium, potassium, or ammonium chloride per mol of the copper salt may be used. This same method can likewise be employed for the preparation of copper(I) bromide.

The colored impurity in a sample of copper(I) chloride that has become green owing to exposure to the atmosphere can be removed by grinding the material in a mortar with enough 1 *N* sulfuric acid to form a paste, stirring the paste into a large quantity of dilute sulfurous acid, and proceeding with the washing and drying as outlined above.

### Properties

Copper(I) chloride when pure is a perfectly white substance and in the absence of moisture is unaffected by light or air. On exposure to light in the presence of moisture, copper(I) chloride develops a violet or dark-blue tint. Moist air converts it into a dark-green material that is

probably a mixture of copper(II) chloride and basic copper(II) chloride.

Copper(I) chloride dissolves readily in aqueous ammonia to form a colorless ammine in the absence of oxygen and in concentrated hydrochloric acid solution to form a chloro complex. Solutions of copper(I) chloride in either of the above solvents readily absorb carbon monoxide gas. A maximum of one molecule of the gas per atom of copper is absorbed and the crystalline compound  $[\text{CuCl}\cdot\text{CO}]\cdot 2\text{H}_2\text{O}$  can be isolated from these solutions.

#### References

1. MORGAN and BURSTALL: "Inorganic Chemistry, A Survey of Modern Developments," p. 63, W. Heffer & Sons, Ltd., Cambridge, England, 1936.
2. PROUST: *Ann. chim. phys.*, [1] **32**, 26 (1799).
3. GRÖGER: *Z. anorg. Chem.*, **28**, 154 (1901).
4. DENIGÈS: *Compt. rend.*, **108**, 567 (1889).
5. GERNES: U. S. patent 1964569 (June 26, 1934).
6. WÖHLER: *Ann.*, **130**, 373 (1864).
7. ROSENFELD: *Ber.*, **12**, 954 (1879).
8. LORENS: *Chem. Ztg.*, **36**, 898 (1912).
9. WARDLAW and PINKARD: *J. Chem. Soc.*, **121**, 210 (1922).
10. PURGOTTI: *Gazz. chim. ital.*, [2] **26**, 559 (1906).
11. LOSSEN: *Ber.*, **8**, 257 (1875).
12. ANGEL: *J. Chem. Soc.*, **89**, 345 (1906).
13. PECHARD: *Compt. rend.*, **136**, 504 (1903).
14. FIRTH and HIGSON: *J. Chem. Soc.*, **123**, 1515 (1923).
15. CAVAZZI: *Gazz. chim. ital.*, **16**, 167 (1886).
16. KULISCH: *Ann.*, **231**, 327 (1885).
17. STEVERTS and MAJOR: *Z. anorg. Chem.*, **64**, 29 (1909).

## 2. SILVER CHLORATE

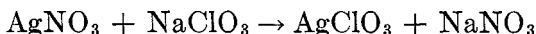

SUBMITTED BY D. G. NICHOLSON\* AND CHARLES E. HOLLEY, JR.†

CHECKED BY GEORGE W. WATT‡ AND JOE C. EVANS‡

Silver chlorate has been found to be an effective oxidizing agent for certain organic compounds. Among these are

\* University of Illinois, Urbana, Ill.; present address: University of Pittsburgh, Pittsburgh, Pa.

† University of Illinois, Urbana, Ill.

‡ University of Texas, Austin, Tex.

crotonic acid and isocrotonic acid, which are oxidized, respectively, to *dl-threo- $\alpha,\beta$ -dihydroxybutyric acid* and to *dl-erythro- $\alpha,\beta$ -dihydroxybutyric acid*.<sup>1,6</sup>

Hitherto, silver chlorate has been prepared by passing chlorine gas into a suspension of silver oxide,<sup>2</sup> silver carbonate,<sup>7</sup> or an aqueous solution of silver fluoride<sup>4</sup> or by the action of chloric acid on silver oxide,<sup>8</sup> finely divided silver,<sup>5</sup> or silver carbonate.<sup>3</sup> These methods are neither dependable nor satisfactory.

The procedure outlined below is based upon a consideration of the solubilities of silver nitrate, silver chlorate, and the corresponding sodium salts. Under appropriate conditions simple metathesis involving interaction of concentrated solutions of silver nitrate and sodium chlorate leads to the desired product.

Salt	Soly., g./100 ml. H <sub>2</sub> O			
	0°	15°	80°	100°
AgClO <sub>3</sub>	...	10	50	
AgNO <sub>3</sub>	122	..	..	952
NaClO <sub>3</sub>	79	..	..	230
NaNO <sub>3</sub>	73	..	..	180

### Procedure

A product of sufficient purity for use in the oxidation reactions mentioned above may be prepared by dissolving 170 g. (1 mol) of silver nitrate and 106 g. (1 mol) of sodium chlorate each in 100 ml. of water. After the two solutions are heated to 85°, they are mixed and allowed to cool slowly to 0°, and at this temperature the mother liquor is carefully decanted. Fifty milliliters of distilled water, previously cooled to 0°, is added to the solid product, and the crystals are separated by suction filtration. Yield 150 g. (78.5 per cent). The product contains 95.2 per cent AgClO<sub>3</sub> as indicated by a silver determination.

For further purification the product obtained after the

initial filtration is dissolved in 125 ml. of distilled water at 90°, the solution cooled to 0°, and the product filtered by suction. This procedure is repeated with 120 ml. of water for the second recrystallization. The product is dried in a desiccator. Yield 118.7 g. (62 per cent); purity 99.7 per cent  $\text{AgClO}_3$ .

Since silver chlorate decomposes slightly (darkens in color) when exposed to light, it should be stored in a dark bottle. While the opinion of the authors, based on their own experience, is that silver chlorate is perfectly safe to handle, attention is directed to the fact that chlorates in general are powerful oxidizing agents. Caution would dictate the advisability of keeping silver chlorate away from organic vapors and other easily oxidizable materials.

### Properties

Silver chlorate forms heavy white crystals, which melt at 230°. The compound decomposes when heated above its melting point.

### References

1. BRAUN: *J. Am. Chem. Soc.*, **51**, 228 (1929).
2. CHENEVIX: *Nicholson's J.*, **3**, 171, 229 (1802).
3. FOOTE: *Am. Chem. J.*, **27**, 346 (1902).
4. GORE: *Chem. News*, **23**, 13 (1871).
5. HENDRIXSON: *J. Am. Chem. Soc.*, **25**, 637 (1903).
6. SMITH: thesis, University of Illinois, 1937.
7. STAS: *Mém. acad. belg.*, **35**, 3 (1865).
8. VAUQUELIN: *Ann. chim.*, [1] **95**, 124 (1815).

## 3. RECOVERY OF SILVER AND IODINE FROM SILVER IODIDE RESIDUES<sup>1</sup>

SUBMITTED BY JOSEPH R. SPIES\*

CHECKED BY HAROLD S. BOOTH† AND ALBERT F. DOLANCE†

Considerable quantities of silver iodide-silver oxide residues sometimes accumulate in the laboratory, for

\* Allergen investigations, Bureau of Agricultural Chemistry and Engineering, Washington, D. C.

† Western Reserve University, Cleveland, Ohio.



example, in methylation studies involving the use of methyl iodide and silver oxide.<sup>2</sup> While silver alone is usually recovered from silver residues, iodine is valuable enough to warrant its recovery when the residue contains a large proportion of silver iodide. In the method described, the presence of silver iodide and of silver salts soluble in concentrated aqueous ammonia is assumed. If significant quantities of contaminating salts, such as silver sulfide, are present, suitable modification is required.

### Procedure

#### A. PRELIMINARY TREATMENT OF RESIDUE



The residue containing silver iodide is freed from organic matter by extraction with a suitable solvent, dried, and ground to pass a 40-mesh sieve. The powdered residue is shaken with sufficient concentrated ammonia (sp. gr. 0.90) to dissolve all soluble silver salts. The suspension is filtered on a Büchner funnel and the filtrate (I) is reserved for subsequent recovery of silver by reduction with sodium dithionite solution.

The insoluble silver iodide is washed with water on the filter, dried, and weighed.\*

#### B. RECOVERY OF SILVER

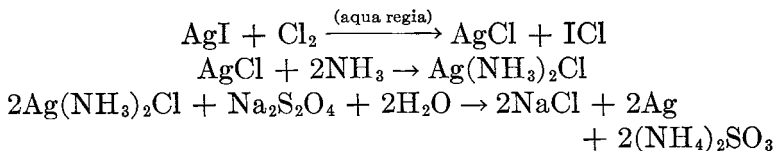

The powdered silver iodide (40-mesh) is treated with excess aqua regia (under hood). A solution consisting of 81 ml. of concentrated nitric acid (sp. gr. 1.42) and 216 ml. of concentrated hydrochloric acid (sp. gr. 1.19) is suitable

\* It is desirable to know the weight of silver iodide because a subsequent reaction involving the reduction of iodic acid with sodium dithionite requires exact quantities.

for each 100 g. of silver iodide.\* The reaction proceeds vigorously but not violently. The mixture should be shaken frequently for 5 minutes until the initial vigorous reaction has subsided. The suspension is then heated gently on the steam bath for 25 minutes, with occasional shaking.† The contents of the reaction vessel are then diluted with 330 ml. of distilled water and cooled in ice. The silver chloride is filtered on a Büchner funnel and washed with distilled water on the filter. The filtrate (II) is reserved for recovery of iodine. Silver chloride obtained in the reaction is dissolved in concentrated aqueous ammonia and combined with the previous ammoniacal filtrate (I).‡ This solution is treated with an excess of a 6 per cent solution of sodium dithionite,§ which quantitatively precipitates pure silver as a grey powder.<sup>4</sup> The silver is washed with distilled water and dried. This method of recovering silver from silver chloride appears preferable to reduction with zinc or by other agents involving heterogeneous reactions.

### C. RECOVERY OF IODINE

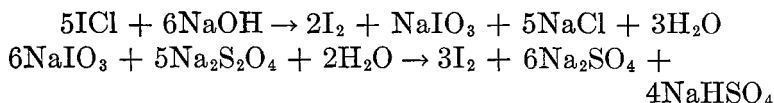

To the filtrate (II) from the aqua regia treatment, cooled in ice, 20 per cent sodium hydroxide solution is slowly

\* The quantities given in the subsequent description apply to 100-g. lots of silver iodide.

† If the silver iodide contains no lumps, this treatment suffices for practically complete conversion to silver chloride. However, a test for completion of the reaction may be made by removing a small quantity of the precipitate, which after washing with water should all dissolve in concentrated ammonia solution.

‡ Any residue remaining undissolved in ammonia should be treated again with aqua regia. Ammoniacal silver chloride solutions should not be allowed to stand too long before precipitating the silver since some insoluble material separates, which, on occasion, has produced violent explosions.

§ Commercially known as hydrosulfite. Ammonium formate has been used as a reducing agent for silver; filtering and decantation would be facilitated by use of this reagent which gives a more granular precipitate.<sup>3</sup>

added, with stirring, until the solution is slightly basic. Then hydrochloric acid is added dropwise until the solution is just acid to litmus. This causes 80 per cent of the iodine to precipitate. To the suspension is added a solution containing exactly 12.3 g. of sodium dithionite (calculated as  $\text{Na}_2\text{S}_2\text{O}_4$ ), which precipitates the remaining 20 per cent of the iodine. The acidity is adjusted as before. Excess sodium hydroxide must be avoided to prevent solution of some iodine. The precipitated iodine is filtered from the ice-cold solution by means of a hardened paper on a Büchner funnel. The filtrate is tested for complete precipitation of iodine by dropwise addition of sodium dithionite. The calculated amount may not have been quite sufficient, probably because of the oxidizing action of some chlorine or hypochlorous acid. Excess sodium dithionite is to be avoided, however, to prevent loss of iodine by reduction to soluble iodide. The iodine is washed with cold water, filtered, and dried in a desiccator over concentrated sulfuric acid. If further purification is desired; sublimation may be employed.

The recovery of silver and iodine from silver iodide by this method is quantitative except for slight manipulative losses.

#### References

1. SPIES: *Ind. Eng. Chem., Anal. Ed.*, **7**, 118 (1935); U. S. patent 2060539 (Nov. 10, 1936).
2. PURDIE and PITKEATHLY: *J. Chem. Soc.*, **75**, 153 (1899).
3. MAXSON: *INORGANIC SYNTHESSES*, **1**, 4 (1939).
4. FIRTH and HIGSON: *J. Soc. Chem. Ind.*, **42**, 427T (1923).

## CHAPTER II

See also: Magnesium-rare earth Barium dithionate, synthesis 50B  
          nitrates, synthesis 15      Europium amalgam, synthesis 18  
          Calcium dithionate, syn-  
          thesis 50A

### 4. METAL DERIVATIVES OF 1,3-DIKETONES

BY LOUIS E. MARCHI\*

Many compounds of metal ions with 1,3-diketones,  $\text{RCOCH}_2\text{COR}$ , are known. Because of their characteristic and somewhat unusual properties,<sup>1,2</sup> the metallic derivatives of the 1,3-diketones have been found useful not only in laboratory operations but also in the development of chemical theory. The properties and behavior of these diketone derivatives are visualized most clearly in terms of the coordination theory of Werner.

**Structure of 1,3-Diketones.** The 1,3-diketones exist in two tautomeric forms, keto and enol:

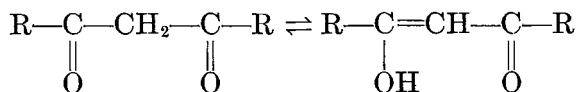

For example, chemical analyses and measurements of the absorption spectra of 2,4-pentanedione,  $\text{CH}_3\text{COCH}_2\text{COCH}_3$  (acetylacetone), by Grossman<sup>3</sup> and by Acly and French,<sup>4</sup> indicate that the enol form is present in water at 25° to the extent of 15 to 20 per cent and in 95 per cent alcohol to the extent of 55.7 per cent. The tautomerism has also been studied by means of the Raman effect,<sup>5</sup> by exchange reactions with deuterium,<sup>6</sup> and by polarographic oxidation-reduction measurements.<sup>7</sup> Insofar as 2,4-pentanedione and other 1,3-diketones exist in the enol form, they probably

\* Central Research Department, Monsanto Chemical Company, Dayton, Ohio; present address; University of Pittsburgh, Pittsburgh, Pa.

have a cyclic structure with hydroxyl hydrogen coordinated to the carbonyl oxygen:

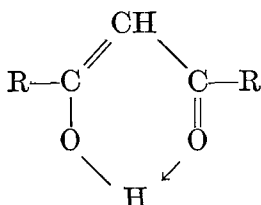

**Formation of Chelate Compounds.** The hydrogen of the hydroxyl group of the enol form of a 1,3-diketone may be replaced by metals. In general, the resulting compounds in the case of the alkali metals behave like ordinary salts. For example, the anhydrous sodium salt of 1-phenyl-1,3-butanedione chars on heating without melting, dissolves readily in water, and is insoluble in toluene and benzene, properties that are considered to be saltlike. However, the 2-hydrate of this compound

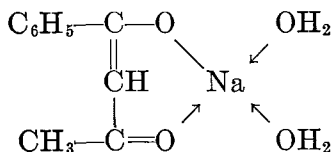

has the characteristics of a truly covalent compound (*e.g.*, solubility in toluene). In most instances, the behavior of the metal derivative definitely indicates that a chelate ring has formed owing to the marked coordinating power of the carbonyl oxygen:<sup>18</sup>

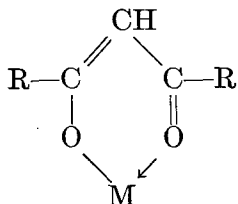

The metallic derivatives of the aromatic *o*-hydroxyaldehydes and the *o*-hydroxyphenones fall into the group of

those of the 1,3-diketones, because the ring that includes the metal is the same:

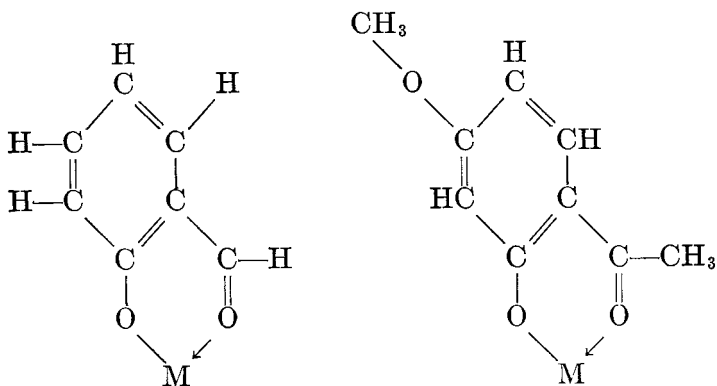

Such metallic derivatives are *inner complex* compounds like those of the  $\alpha$ -amino acids:

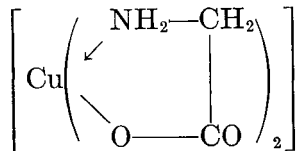

For 1,3-diketones in which both hydrogens of the carbon atom between the carbonyl groups are substituted, *e.g.*,

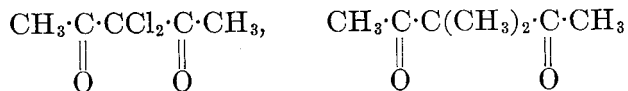

no enolization is possible; consequently, metallic compounds do not form.

**Types of Metallic Derivatives of 1,3-Diketones.** The metal derivatives of the 1,3-diketones may be classified in the following manner:

**1. Simple Salts.** Those containing a 1,3-diketonate ion, such as  $\text{Na}^+$ ,  $-\text{O}-\text{C}(\text{CH}_3)=\text{CH}-\text{CO}-\text{CH}_3$ ,<sup>16</sup> where chela-

tion is not the dominant tendency, have typical saltlike properties.<sup>17</sup>

**2. Nonelectrolytes.** Whenever the coordination number (C.N.) of a metal atom is twice that of its oxidation state (O.S.), the chelate compound formed is a nonelectrolyte or an inner complex compound of the first order. These are illustrated for the 2,4-pentanediono compounds:

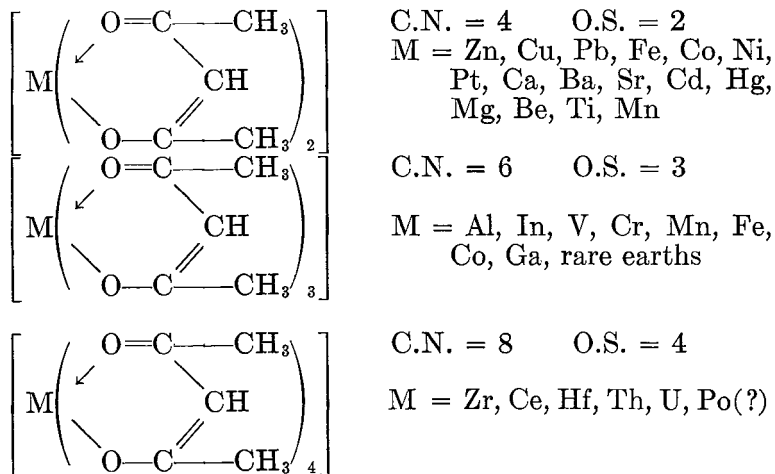

This type is the most outstanding and most important of the derivatives of the 1,3-diketones.

Nonelectrolytes of somewhat different types are illustrated by the following:<sup>11-15</sup>

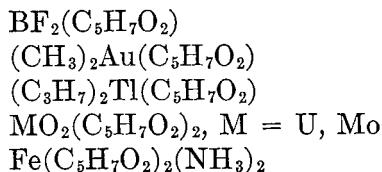

**3. Complex Ions Containing 1,3-Diketones.** *a. Simple Types.* Whenever 1,3-diketones are the only coordinated groups and the coordination number is less than twice the value of the oxidation state, complex cations may result:

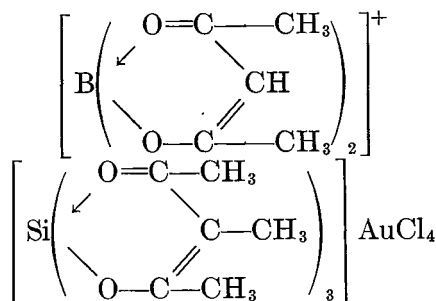

*b. Mixed Types.* One or more 1,3-diketone units are present in a complex ion as well as other uni- or multidentate groups.

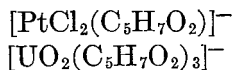

**Preparation.** 1. *Action of a 1,3-Diketone on a Metal.* This method of preparation is useful for obtaining 2,4-pentanediono compounds of sodium,<sup>8</sup> copper,<sup>9</sup> and lead:<sup>10</sup>

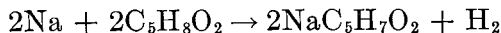

2. *Action of a 1,3-Diketone on a Compound of a Metal.* Reactions of this type are carried out in a variety of ways. The compounds of the metals that are most frequently used are hydroxides, oxides, and salts of weak acids such as carbonates and acetates. Frequently, a buffer such as sodium acetate is added in order to prevent a marked lowering of the pH of the solution as the reaction proceeds. In other cases, the reaction is conducted in an organic solvent such as ether or chloroform, where, presumably, the acid (*e.g.*, hydrogen chloride) escapes from the solution as it is formed.

3. *Action of a Salt of a 1,3-Diketone on a Salt of a Metal.* This method finds wide applicability and usually gives a good yield of product.

**Properties.** In general, the type 2 metallic derivatives of the 1,3-diketones melt at temperatures below 200°; many of them are not decomposed when melted, and some of them, such as  $\text{Al}(\text{C}_5\text{H}_7\text{O}_2)_3$  and  $\text{Cr}(\text{C}_5\text{H}_7\text{O}_2)_3$ , can be dis-



tilled without decomposition at temperatures above 300°. In fact, the molecular weights of many of them have been determined by the vapor-density method. The vapor pressure of tetrakis(2,4-pentanediono)thorium<sup>19</sup> is  $3.2 \times 10^{-4}$  mm. at 100°. The relative stability of these compounds has been found to parallel the percentage of the enol form in the pure compound.<sup>20</sup>

Directions are given for the preparation of the following: beryllium acetylacetonate (synthesis 5), aluminum acetylacetonate (synthesis 9), bis[tris(2,4-pentanediono)titanium(IV)] hexachlorotitanate(IV) (synthesis 34), zirconium acetylacetonate (synthesis 35), and thorium acetylacetonate (synthesis 36).

With but few exceptions these compounds are very soluble in the common organic solvents. On the other hand, they are usually only very slightly soluble in water, in which they give nonconducting and nonhydrolyzed solutions; some few are decomposed by water, while most of them are decomposed by strong acids.

The absence of the simple ions of the metals is demonstrated by the failure of analytical tests for the metal on solutions of 1,3-diketone derivatives. Furthermore, the carbonyl groups of the 1,3-diketones involved in chelation do not react with such reagents as phenylhydrazine.

Proof of the presence of covalent bonds is the existence of stereoisomers for compounds of the 1,3-diketones, *e.g.*:

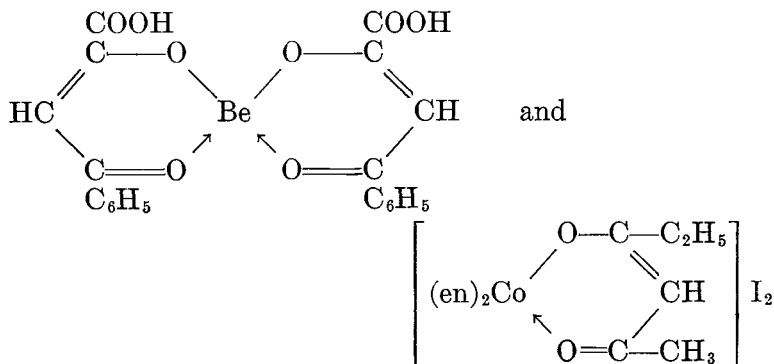

The active components of the bis(ethylenediamine)-2,4-hexanedionocobalt(III) iodide are so stable that they are not racemized even when their aqueous solutions are evaporated.

**Uses.** The metallic derivatives of the 1,3-diketones have been used in chemical separations<sup>1</sup> that depend on their volatility and on differences in their solubilities.<sup>2</sup> There is the further possibility of their use in such difficult separations as for zirconium and hafnium and the individual members of rare earths. Since many of these metallic derivatives decompose on strong heating, it is necessary to find a 1,3-diketone that will yield more stable metallic derivatives. Some progress has been made<sup>21</sup> with fluorine-substituted 2,4-pentandiones. In general, the substitution of hydrogen by fluorine in organic molecules increases the stability and lowers the melting point.

**Nomenclature.** The nomenclature of the metallic derivatives of the 1,3-diketones in the literature has not been definitive. These compounds have usually been called acetylacetonates or derivatives of acetylacetonates, *e.g.*, zirconium acetylacetonate, beryllium benzoylacetate, and lanthanum trifluoroacetylacetonate. A better nomenclature is based on the extensions of the International Union of Chemistry (I.U.C.) rules for inorganic nomenclature to include all types of coordination compounds.<sup>22</sup> Thus, the foregoing names become tetrakis(2,4-pentanediono) zirconium, bis(1-phenyl-1,3-butanediono)-beryllium, and tris(1,1,1-trifluoro-2,4-pentanediono)lanthanum. Further examples are

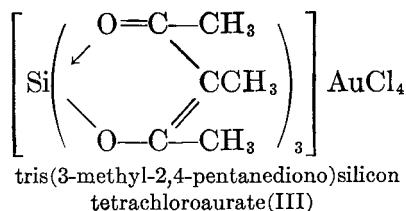
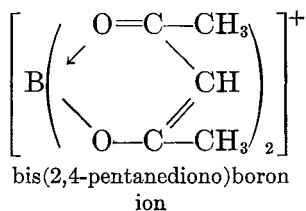

## BERYLLIUM ACETYLACETONATE

17

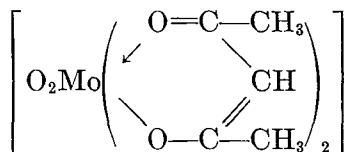

dioxobis(2,4-pentanediono)molybdenum(VI)

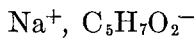

sodium 2,4-pentanedionate

## References

- MORGAN and DREW: *J. Chem. Soc.*, **117**, 1456 (1920).
- URBAIN: *Ann. chim. phys.*, **19**, 184 (1900).
- GROSSMAN: *Z. physik. Chem.*, **109**, 305 (1924).
- ACLY and FRENCH: *J. Am. Chem. Soc.*, **49**, 847 (1927).
- TARCHYASKI: *Sci. Papers Inst. Phys. Chem. Research (Tokyo)*, **23**, 16 (1933).
- KLAR: *Z. physik. Chem.*, **B26**, 335 (1934).
- SAMERANO and CHISINI: *Gazz. chim. ital.*, **66**, 504 (1936).
- COMBES: *Ann. chim. phys.*, [6] **12**, 245 (1887).
- CIOCCA: *Gazz. chim. ital.*, **67**, 346 (1937).
- MENZIES: *J. Chem. Soc.*, **1934**, 1755.
- MORGAN and TURNSTALL: *ibid.*, **125**, 1963 (1924).
- FUNK: *Ber.*, **67B**, 1801 (1934).
- JANTSCH: *J. prakt. Chem.*, **115**, 7 (1927).
- BRAIN and GIBSON: *J. Chem. Soc.*, **1939**, 762.
- HAGER: *Z. anorg. allgem. Chem.*, **162**, 82 (1927).
- MORGAN and MOSS: *J. Chem. Soc.*, **105**, 189 (1914).
- WHITE: *ibid.*, **1928**, 1413.
- DIEHL: *Chem. Rev.*, **21**, 39 (1937).
- YOUNG, GOODMAN, and KOVITZ: *J. Am. Chem. Soc.*, **61**, 876 (1939).
- MOORE and YOUNG: *J. Chem. Soc.*, **1932**, 2694.
- STANFORTH: dissertation, The Ohio State University, 1943.
- FERNELIUS, LARSEN, MARCHI, and ROLLINSON: in press.

## 5. BERYLLIUM ACETYLACETONATE

## [Bis(2,4-pentanediono)beryllium]

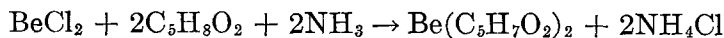

SUBMITTED BY ARNOLD ARCH\* AND RALPH C. YOUNG\*

CHECKED BY EDGAR E. LINEKEN†

Beryllium acetylacetonate can be readily prepared in a pure condition because it is relatively insoluble in

\* Massachusetts Institute of Technology, Cambridge, Mass.

† University of Vermont, Burlington, Vt.

water, it is soluble to varying degrees in different organic solvents, and it is comparatively volatile. It was first prepared from beryllium acetate and acetylacetone by Combes,<sup>1</sup> who described many of its properties. Parsons<sup>2</sup> and Jaeger<sup>3</sup> prepared it by reaction of acetylacetone with basic beryllium carbonate, and Parsons<sup>4</sup> also used beryllium hydroxide. Biltz<sup>5</sup> synthesized the compound from ammonium acetylacetonate and beryllium chloride.

### Procedure

Three grams of basic beryllium carbonate suspended in 45 ml. of water is converted to the chloride by the gradual addition of 6 *N* hydrochloric acid until the solution is slightly acid. During this process the suspension should be heated and stirred to facilitate solution. Approximately 20 ml. of acid is required. Freshly distilled acetylacetone (10 g.) is suspended in 45 ml. of water, and 6 *N* ammonia is added dropwise from a buret, with stirring, until solution is practically complete. Any small amount of undissolved oil or insoluble matter is removed by filtration, and the clear solution is added, with stirring, to that of the beryllium chloride. The final mixture should be nearly neutral to litmus. The precipitated beryllium acetylacetonate is filtered by suction, washed with water, and air-dried. Yield 7 g. (70 per cent). The crude product may be purified by treating with the least amount of benzene necessary for solution, filtering to remove any benzene-insoluble matter, and precipitating the acetylacetonate by the gradual addition of petroleum ether, with stirring. The precipitated solid is washed with petroleum ether. The compound prepared in this way consists of small white crystals. Colorless crystals are obtained by crystallization from petroleum ether or benzene.

If it is desired to purify the crude material by sublimation, the following procedure is convenient. A pyrex tube (diameter 18 mm., length 30 cm.) is joined at one end to a smaller tube, which can be connected to a high-

vacuum pump. Glass wool is inserted into the other end and pushed forward about 10 cm. Against this is placed the crude beryllium acetylacetonate. After all material clinging to the sides is removed, the large tube is sealed at its outer end. The apparatus is placed in an upright position, connected to the high-vacuum pump, and, after the pressure is reduced to 0.1 mm., is heated with steam at 100° to a point above the glass wool. A large glass test tube in which water can be boiled, fitted with cork stopper and reflux condenser, is suitable for the heating. If the sublimate is contaminated with a small amount of oily matter, the latter can be removed by the procedure described in the first method of purification.

### Properties

Beryllium acetylacetonate is characterized by the following physical properties: m.p. 108.5 to 109°; b.p. 270°;  $d_4^{20}$  1.168<sup>2</sup>; crystal form, monoclinic.<sup>3</sup> In a vacuum (0.1 mm. pressure) it sublimes slowly at 80° and rapidly at 100°. It is almost insoluble in cold water but is decomposed by hot water as well as by acids and alkalis. The compound is soluble in some organic solvents<sup>4</sup> such as alcohol, ether, benzene, and carbon disulfide, but the solubility is considerably less in light petroleum fractions such as petroleum ether. Beryllium acetylacetonate forms addition compounds with ammonia<sup>5</sup> and sulfur dioxide.<sup>6</sup> Its structure has been discussed by Sidgwick,<sup>7</sup> Morgan and Moss.<sup>8</sup> Smith and Angus,<sup>9</sup> Booth and Smiley,<sup>6</sup> and Sugden.<sup>10</sup>

*Note:* The beryllium derivatives of benzoylacetone, dibenzoylmethane, and ethyl acetoacetate are similar to beryllium acetylacetonate and can be prepared in a similar manner.<sup>11</sup>

### References

1. COMBES: *Compt. rend.*, **119**, 1222 (1894).
2. PARSONS: *J. Am. Chem. Soc.*, **26**, 732 (1904).
3. JAEGER: *Rec. trav. chim.*, **33**, 394 (1914).
4. PARSONS: *Z. anorg. allgem. Chem.*, **40**, 412 (1904).
5. BILTZ: *ibid.*, **82**, 439 (1913).
6. BOOTH and SMILEY: *J. Phys. Chem.*, **37**, 171 (1933).

7. SIDGWICK: "The Electronic Theory of Valency," p. 120, Oxford University Press, New York, 1929.
8. MORGAN and MOSS: *J. Chem. Soc.*, **105**, 189 (1914).
9. SMITH and ANGUS: *Proc. Roy. Soc.*, A **137**, 372 (1932).
10. SUGDEN: *J. Chem. Soc.*, **1929**, 318; "The Parachor and Valency," pp 143-145, Alfred A. Knopf, New York, 1930.
11. BOOTH and PIERCE: *J. Phys. Chem.* **37**, 59 (1933).

## 6. BARIUM BROMATE

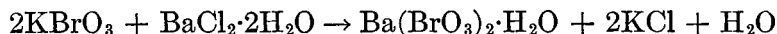

SUBMITTED BY D. W. PEARCE\* AND R. G. RUSSELL\*†

CHECKED BY LAURENCE L. QUILL‡

Barium bromate is useful in the preparation of the bromates of other elements, particularly those of the yttrium group of the rare earths (Synthesis 17). Workers in this field have found that the freshly prepared material is usually more satisfactory than that which is commercially available; the differential in cost also definitely favors the former. The synthesis is carried out by pouring together hot saturated solutions of barium chloride and potassium bromate. Barium bromate in the form of a fine crystalline powder is obtained.

### Procedure

Three hundred forty-five and seven-tenths grams§ of potassium bromate is dissolved in about 700 ml. of water at almost the boiling temperature. To this is added a hot solution of 253 g. of barium chloride 2-hydrate in 400 ml. of water. The resulting mixture is allowed to cool, the solution is decanted from the crystals, and the latter washed several times with 100-ml. portions of cold water. Yield about 410 g. As prepared in this way, the material

\* Purdue University, West Lafayette, Ind.

† Present address: Aluminum Company of America, New Kensington, Pa.

‡ Michigan State College, East Lansing, Mich.

§ It is not advisable to carry out this reaction with larger amounts than those specified because of the large volumes of solution that would be necessitated by the relatively low solubility of potassium bromate.

is sufficiently pure for the described use; however, for other purposes, it may be desirable to recrystallize the product from hot water a number of times.

### Properties

Barium bromate,  $\text{Ba}(\text{BrO}_3)_2 \cdot \text{H}_2\text{O}$ , is a stable, colorless crystalline material that may be dehydrated without decomposition. It is soluble in cold water to the extent of less than 1 g./100 ml. but is approximately seven times as soluble at 100°. It is insoluble in most organic solvents. Barium bromate upon long standing may develop a slight odor of bromine.

## CHAPTER III

See also: Aluminum selenide, synthesis 55

### 7. POROUS BORON OXIDE

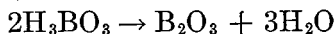

SUBMITTED BY WILLY LANGE\*

CHECKED BY H. S. BOOTH† AND FRED E. KENDALL‡

When prepared by fusion of boric acid, boron oxide forms a very hard and tough mass that can be ground only with great difficulty. However, the anhydrous oxide can be obtained in a porous form by carefully heating crystallized boric acid in a vacuum.<sup>1</sup> The resulting product can be powdered readily.

#### Procedure

Crystallized boric acid is placed in a small vessel in a drying pistol over phosphorus(V) oxide and dehydrated completely by heating in a vacuum at 200°. The vacuum of the water-jet pump is sufficient, but a better vacuum is preferable. It is important that the temperature be raised slowly to 200°; otherwise, the mass sinters, and the further escape of moisture is prevented. The larger the quantities used, the longer heating at 200° must be continued, up to 4 hours, before dehydration is complete. For 3 g. of boric acid, 1 hour of heating is sufficient.‡

\* University of Cincinnati, Cincinnati, Ohio.

† Western Reserve University, Cleveland, Ohio.

‡ Those who checked this synthesis found that it is possible to dehydrate boric acid in a current of dry air provided that the temperature is not permitted to rise above 200°. Air, dried by passing it through sulfuric acid, a trap, and then through either phosphorus(V) oxide or porous barium oxide, is passed over the boric acid in a boat or other container in a combustion tube. The latter is heated in a tubular electric furnace so that a thermom-



## Properties

Boron oxide obtained from pure crystallized boric acid by this procedure is a snow-white, porous, slightly sintered substance. It can be powdered easily, but atmospheric moisture must be excluded during this operation. The sintered material is highly reactive and, when wet with water, evolves heat and hisses, like phosphorus(V) oxide.

### Reference

1. TIEDE and RAGOSS: *Ber.*, **56**, 656 (1923).

## 8. AMMONIUM TETRAFLUOBORATE



SUBMITTED BY HAROLD S. BOOTH\* AND SOL REHMAR\*

CHECKED BY NOEL F. ALBERTSON†‡ AND M. R. FREDERICK†§

Ammonium tetrafluoborate is frequently used for the preparation of boron trifluoride.<sup>1</sup> The pure fluoborate is most readily obtained in the manner described below. Procedure A is satisfactory for small amounts. Procedure B is more suitable where larger quantities are desired.

## Procedure

### A. REACTION IN AQUEOUS SOLUTION

To 100 ml. of water in a platinum, hard rubber, or suitable plastic dish (Beetle Ware) are added 33 g. of

---

eter placed alongside, but outside the tube, never indicates a temperature higher than 200°. The exit end of the combustion tube is connected through a phosphorus(V) oxide or barium oxide drying tube and a trap to a water suction pump. The air should be passed so slowly that a bubble rises through the sulfuric acid about every 5 to 10 seconds. This rate of flow can be attained by a stopcock placed just before the entrance end of the combustion tube.

\* Western Reserve University, Cleveland, Ohio.

† The Ohio State University, Columbus, Ohio.

‡ Present address: Winthrop Chemical Company, Inc., Rensselaer, N.Y.

§ Present address: Purdue University, West Lafayette, Ind.

ammonium hydrogen fluoride\* and 13 g. of boric acid. On stirring with a platinum, hard rubber, or plastic rod the boric acid slowly goes into solution. Any slight turbidity remaining will disappear when the material is concentrated on a water or steam bath. Long, needlelike, water-white crystals form on cooling. Several crops of crystals may be obtained, although the last ones may be slightly contaminated. The crystals are filtered and dried. The yield is entirely dependent upon the completeness of evaporation of the solution.

### B. FUSION REACTION

Ninety-three grams of ammonium hydrogen fluoride and 40 g. of boric acid are mixed in an iron dish† and heated. The two substances react readily with the liberation of steam and ammonia and the formation of a homogeneous melt. After cooling, the crystalline mass is broken, dissolved in about 100 ml. of hot water, and allowed to crystallize. The crystals are filtered and dried. Additional crystals of somewhat lower purity may be obtained by evaporation of the filtrate. The yield depends only upon the number of crops of crystals obtained and may be nearly quantitative.

### Properties

Ammonium tetrafluoroborate is a clear crystalline solid that sublimes when heated strongly. It is soluble in 100 ml. of water to the extent of 25 g. at 16° and 97 g. at 100°

### Reference

1. BOOTH and WILLSON: INORGANIC SYNTHESSES, 1, 21 (1939).

\* Commercial ammonium hydrogen fluoride generally contains lead, fluosilicate, and sulfate ions, but these impurities are readily eliminated in this synthesis.

† A deep steel skillet obtainable from any hardware store is very convenient for this purpose.

## 9. ALUMINUM ACETYLACETONATE

## [Tris(2,4-pentanediono)aluminum]

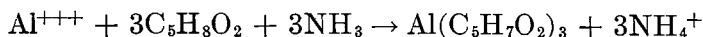

SUBMITTED BY RALPH C. YOUNG\*

CHECKED BY JAMES P. McREYNOLDS†

Aluminum acetylacetonate was first prepared by Combes<sup>1</sup> by treatment of a mixture of hydrous aluminum oxide and acetylacetone with hydrochloric acid. Gach<sup>2</sup> made the compound by the action of aluminum amalgam on acetylacetone, while Urbain and Debierne<sup>3</sup> used anhydrous aluminum chloride and acetylacetone. The recommended procedure was first described by Biltz.<sup>4</sup>

### Procedure

A solution of freshly distilled acetylacetone is prepared by adding 6 *N* ammonia dropwise, with stirring, to a suspension of 6 g. of the oil in 40 ml. of water until complete solution has been effected. This solution is added to a solution of 6 g. of aluminum sulfate,  $\text{Al}_2(\text{SO}_4)_3 \cdot 17\text{H}_2\text{O}$ , in 60 ml. of water. The mixture of the two solutions should be neutral to litmus. Aluminum acetylacetonate precipitates immediately in practically theoretical yield. The precipitate is filtered, washed with water, and air-dried. For purification the product is first sublimed at a pressure of 1 mm. or lower (see synthesis 5) at about 156° (vapor of boiling bromobenzene). The sublimate is dissolved in the least possible quantity of benzene, and the pure acetylacetonate is then precipitated by the addition of petroleum ether. After the precipitate is filtered by suction, it is washed with petroleum ether and air-dried. For many purposes the sublimation may be omitted. Yield 4.2 g. (81 per cent).

\* Massachusetts Institute of Technology, Cambridge, Mass.

† The Ohio State University, Columbus, Ohio. Deceased.

### Properties

Aluminum acetylacetonate (m.p. 194.6°; b.p. 314 to 315.6°) is insoluble in water but soluble in organic solvents. It is monomolecular both in carbon disulfide and in the vapor state.<sup>7</sup> The compound reacts with alkalis, with acids, and with water at elevated temperatures. The crystal structure has been studied by Sarkar<sup>8</sup> and the electrical polarization by Sutton and coworkers.<sup>9,10</sup> In a vacuum of 1 mm., sublimation occurs very slowly at 100° but rapidly at 156°.

### References

1. COMBES: *Compt. rend.*, **105**, 870 (1887).
2. GACH: *Monatsh.*, **21**, 99 (1900).
3. URBAIN and DEBIERNE: *Compt. rend.*, **129**, 302 (1899).
4. BILTZ: *Ann.*, **331**, 348 (1904).
5. COMBES: *Compt. rend.*, **108**, 406 (1889).
6. COMBES: *Bull. soc. chim.*, [3] **1**, 345 (1889).
7. FRIEND: "A Text-book of Inorganic Chemistry," Vol. 4, p. 92, J. B. Lippincott Company, Philadelphia, 1921.
8. SARKAR: *Phil. Mag.*, [7] **2**, 1153 (1926).
9. FINN, HAMPSON, and SUTTON: *J. Chem. Soc.*, **1938**, 1254.
10. COOP and SUTTON: *ibid.*, **1938**, 1269.

## 10. GALLIUM(III) PERCHLORATE 6-HYDRATE

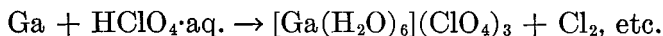

SUBMITTED BY LAURENCE S. FOSTER\*

CHECKED BY WARREN C. JOHNSON† AND FRED HILDEBRAND‡

Gallium is remarkably passive and dissolves very slowly in concentrated acids, such as hydrochloric, hydrofluoric, nitric, sulfuric, and aqua regia.<sup>1,2</sup> In constant boiling perchloric acid (72 per cent), on the other hand, it dissolves very rapidly,‡ and when the solution is cooled

\* Brown University, Providence, R.I.; present address: Watertown Arsenal, Watertown, Mass.

† University of Chicago, Chicago, Ill.

‡ Gallium dissolves still more rapidly in a mixture of two-thirds (by volume) sulfuric acid (98 per cent) and one-third perchloric acid (72 per cent),<sup>7</sup> but the product is not soluble in the hot acid mixture.<sup>3</sup> The perchlo-

gallium perchlorate 6-hydrate precipitates nearly quantitatively.<sup>3</sup> Because of the ease with which this salt can be prepared, it is a very satisfactory starting material for the synthesis of other gallium compounds. Furthermore, it has been shown by Willard and Fogg<sup>4,5</sup> that metallic gallium can be obtained by electrolysis of aqueous gallium perchlorate solutions, prepared from hydrous gallium oxide.

### Procedure

Ten grams of pure gallium\* is placed in a 250-ml. Erlenmeyer flask, equipped with a Smith refluxing head<sup>6</sup> (Fig. 1) and allowed to react with excess constant-boiling perchloric acid (72 per cent). If the volume of acid used is larger than 150 ml., the product is entirely soluble at the boiling point of the mixture and the disappearance of the last small globules of the metal may be observed. If much less acid is used, the gallium perchlorate separates as a precipitate during the course of the reaction but does not interfere with its progress. Heating is continued until the metal has reacted entirely and the characteristic fumes of constant-boiling perchloric acid escape from the flask. The entire operation requires no more than an hour. As soon as the flask has been cooled only slightly below the boiling point of the mixture (200°), crystals of gallium perchlorate 6-hydrate separate. After the mixture has cooled to room temperature, the product may be collected by suction

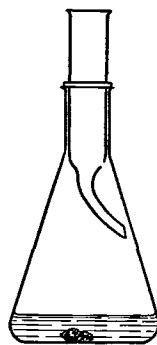

FIG. 1.—Apparatus for dissolving gallium in perchloric acid.

---

ric acid may be removed completely by heating until sulfur trioxide fumes appear, but at that point bumping becomes severe. The gallium sulfate thus produced dissolves in water to form a solution containing excess sulfuric acid.

\* To remove gallium from glass it is moistened with dilute hydrochloric acid, whereupon it may be gathered to a large globule by means of a glass stirring rod.<sup>1</sup>

filtration on a sintered-glass funnel and pressed dry with a glass tamping rod or porcelain spatula.

**Caution.** *The moist crystals must not be allowed to come in contact with any organic material such as filter paper or a horn spatula. Because of the removal of water, resulting from the formation of the hydrate, the perchloric acid adhering to the product is more highly concentrated than 72 per cent.*

The adhering excess acid may be removed by heating the crystals *in vacuo* at 125°. If special equipment is not available, a glass test tube sufficiently large to hold the porcelain boat containing the product may be used. It can be exhausted through a glass connection tube in a rubber stopper.\* The closed end of the tube may be heated conveniently in a thermostatically controlled electric drying oven. The tube should be long enough (2 ft.) to permit the volatilized perchloric acid to condense before it reaches the rubber stopper. In fact, it is desirable to provide a bulb into which the condensate may run. After the gallium perchlorate 6-hydrate has been heated under the prescribed conditions, it is a dry, free-flowing powder.

The 140 ml. of filtrate contains about 0.2 g. of gallium, and the yield of gallium perchlorate 6-hydrate is 60 g. (88 per cent).

### Properties

Gallium perchlorate 6-hydrate is a dry, crystalline meal that is very deliquescent, extremely soluble in water, and very soluble in alcohol and glacial acetic acid. Large octahedral crystals may be prepared by evaporating a solution of the perchlorate, containing a considerable excess of perchloric acid, over concentrated sulfuric acid in a vacuum desiccator. If the solution contains no free acid, large, deliquescent, monoclinic crystals of the  $9\frac{1}{2}$ -hydrate are

\* The perchloric acid that distills from the product does not attack the rubber stopper since it is kept at room temperature. To protect the pump from corrosion due to perchloric acid, it is advisable to exhaust the gases through a drying tower filled with solid sodium hydroxide or barium oxide.

produced. At atmospheric pressure the 6-hydrate decomposes at 175° and in vacuo at 155° yielding gaseous products and basic gallium perchlorates of indefinite composition. At still higher temperatures, it is converted into the insoluble form of gallium oxide. When the 9½-hydrate is heated, it is converted into the 6-hydrate at temperatures above 80°.

#### References

1. SEBBA and PUGH: *J. Chem. Soc.*, **1937**, 1373.
2. GMELIN: "Handbuch der anorganischen Chemie," 8th ed., No. 36, pp. 42-45, Verlag Chemie. G. m. b. H., Berlin, 1936.
3. FOSTER: *J. Am. Chem. Soc.* **61**, 3122 (1939).
4. FOGG: *Trans. Electrochem. Soc.*, **66**, 107 (1934).
5. WILLARD and FOGG: *J. Am. Chem. Soc.*, **59**, 1197 (1937).
6. SMITH and GETZ: *Ind. Eng. Chem., Anal. Ed.*, **9**, 378 (1937).
7. SMITH: "Mixed Perchloric, Sulfuric and Phosphoric Acids and Their Application in Analysis," G. F. Smith Chemical Co., Columbus, Ohio, 1935.

## 11. THE RARE EARTH ELEMENTS AND THEIR COMPOUNDS<sup>1-4</sup>

BY D. W. PEARCE\*

The term "rare earth" has long been applied to the oxides of the group of closely related elements with atomic numbers 57 to 71 (lanthanum through lutecium). Yttrium ( $Z = 39$ ) is almost always included among the rare earth elements because its chemical behavior is typical of this group. Scandium is usually and actinium is often considered to belong to the group of rare earth elements because the chemical behavior of each very closely resembles that of the metals of the rare earths. When it is desired to distinguish the group of elements of atomic numbers 58 to 71 from the other rare earth elements, the term "lanthanides" is customarily used. The tendency at an earlier date to include among the rare earths oxides of elements that occur frequently in rare earth minerals

\* Purdue University, West Lafayette, Ind.

but that are not in Group IIIA, such as those of thorium, zirconium, columbium, and uranium, is inaccurate and confusing.

In a literal sense, the term "earth" signifies an oxide and "rare earth" an oxide of a particular group of elements. Hence, one should speak of the salts of this group of elements as the rare earth *metal* salts. However, usage permits one to speak of the *rare earth salts*, *rare earth ions*, etc. This practice will be followed here.

**Electronic Structures.** Almost all the physical properties and chemical behavior of the rare earth elements find a logical explanation in terms of their electronic structures. Scandium, yttrium, lanthanum, and actinium are the first members, respectively, of the first, second, third, and fourth *transition sequences* of elements. In other words, each such element marks the beginning of an *inner building* where a stable group of 8 electrons is expanding to a completed (or more nearly complete) group of 18. This situation is illustrated for the first transition sequence.

Element	Z	Quantum groups					
		1	2	3s	3p	3d	4s
Ca	20	2	8	2	6		2
Sc	21	2	8	2	6	1	2
Ti	22	2	8	2	6	2	2
.	.	.	.	.	.	.	.
.	.	.	.	.	.	.	.
Co	27	2	8	2	6	7	2
Ni	28	2	8	2	6	8	2
Cu	29	2	8	2	6	10	1
Zn	30	2	8	2	6	10	2

Lanthanum differs from the other members of Group IIIA in that it is followed not only by the usual transition sequence but immediately by an *inner transition sequence*



where a previously stable group of 18 electrons is expanding to a completed group of 32:

Element	Z	Quantum groups										
		1	2	3	4s	4p	4d	4f	5s	5p	5d	6s
Ba	56	2	8	18	2	6	10		2	6		2
La	57	2	8	18	2	6	10		2	6	1	2
Ce	58	2	8	18	2	6	10	2	2	6		2
Pr	59	2	8	18	2	6	10	3	2	6		2
Gd	64	2	8	18	2	6	10	7	2	6	1	2
Tm	69	2	8	18	2	6	10	13	2	6		2
Yb	70	2	8	18	2	6	10	14	2	6		2
Lu	71	2	8	18	2	6	10	14	2	6	1	2
Hf	72	2	8	18	2	6	10	14	2	6	2	2
Ta	73	2	8	18	2	6	10	14	2	6	3	2
.	.	.	.	.	.	.	.	.	.	.	.	.
.	.	.	.	.	.	.	.	.	.	.	.	.
Pt	78	2	8	18	2	6	10	14	2	6	9	1
Au	79	2	8	18	2	6	10	14	2	6	10	1
Hg	80	2	8	18	2	6	10	14	2	6	10	2

Thus it is evident that, whereas lanthanum and lutecium are ordinary transition elements, the elements from cerium to ytterbium ( $Z = 58$  to  $70$ ) are inner transition elements.

**Physical Properties.** The inner transition elements, like the ordinary transition elements, are paramagnetic (some very highly) and form colored ions. However, the absorption spectra of the colored rare earth ions show narrow bands or lines instead of broad bands. Since the electronic transitions responsible for the color of the rare earth ions are deep within the atom, the absorption lines are not broadened by the electric fields of neighboring ions. Further, the stepwise completion of an electronic shell far

within the atoms causes the electrons to be subjected to a regularly increasing nuclear charge as the atomic number increases. This situation results in a gradual decrease (lanthanide contraction) in the atomic volume (or ionic radius) of the elements.

**Chemical Characteristics.** The rare earth elements are active metals that exhibit a characteristic oxidation state of three. The rare earth(III) ions are all remarkably

PROPERTIES OF THE RARE EARTH ELEMENTS

Element	At. No.	Radius of R.E. <sup>+++</sup> in crystals	Effective Bohr magneton numbers of R.E. <sup>+++</sup>	Colors of R.E. <sup>+++</sup>	Grams per ton, earth's crust <sup>s</sup>
Sc	21	0.83	0.00	Colorless	5
Y	39	1.06	0.00	Colorless	28.1
La	57	1.22	0.00	Colorless	18.3
Ce	58	1.18	2.56	Colorless	46.1
Pr	59	1.16	3.62	Yellow-green	5.53
Nd	60	1.15	3.68	Red-violet	23.9
Il	61	....			
Sm	62	1.13	1.55-1.65	Pale yellow	6.47
Eu	63	1.13	3.40-3.51	Pale pink	1.06
Gd	64	1.11	7.94	Colorless	6.36
Tb	65	1.09	9.7	Very pale pink	0.91
Dy	66	1.07	10.6	Pale yellow	4.47
Ho	67	1.05	10.6	Yellow	1.15
Er	68	1.04	9.6	Rose	2.47
Tm	69	1.04	7.6	Pale green	0.20
Yb	70	1.00	4.5	Colorless	2.66
Lu	71	0.99	0.00	Colorless	0.75

similar in their behavior because the differences between the ions of the several rare earth elements are not, in general, differences that affect the outer (or valence) electrons. However, because of the lanthanide contraction, there are small and regular variations from lanthanum to lutecium. These variations are reflected by the variations in the basicities of the hydroxides, solubilities of compounds, etc.

Some of the rare earths exhibit an oxidation state other

than three. Cerium(IV) resembles to a great degree thorium(IV) in all its many compounds. The other rare earths that have this tendency (Pr, Tb, and possibly Nd) show it only in the oxides. Certain other of these elements (Eu, Yb, and, with difficulty, Sm) may be reduced to an oxidation state of two (synthesis 19). In this condition, the ions are similar to those of barium and strontium.

One of the characteristic chemical properties of the group, and certainly the most useful in connection with analysis and isolation, is the ease and completeness of precipitation of the hydrated oxalates from acidic solutions. When the oxalates are ignited at  $900^{\circ}$ , the oxides  $(R.E.)_2O_3$ , are obtained, except in the case of cerium(III) oxalate, which gives the dioxide.

The oxides,  $(R.E.)_2O_3$ , are readily soluble in acids unless they have been ignited at high temperatures, in which case they dissolve more slowly. However, cerium(IV) oxide dissolves in acids exceedingly slowly. It may be converted to the anhydrous sulfate by heating with concentrated sulfuric acid or may be reduced to cerium(III), and thus rendered soluble, by means of hydrogen peroxide or alkali metal iodide in acidic solution.

The fluorides are very slightly soluble in water and are precipitated quantitatively from slightly acidic solution when hydrofluoric acid is added. They may be decomposed by fuming with sulfuric acid.

The halogenides and nitrates of the rare earth elements and yttrium are very soluble in water. Various hydrates may be obtained by evaporation of the solutions until they crystallize when cooled. The nitrates are decomposed to the oxides by ignition, but the hydrated chlorides melt and hydrolyze when ignited and basic chlorides such as  $LaOCl$  are formed. The very useful anhydrous chlorides are prepared by the careful heating of hydrated chlorides with excess ammonium chloride.<sup>5</sup>

Solutions of the rare earth sulfates are prepared by dissolving the oxides or hydroxides in sulfuric acid. Various

hydrates, depending upon the temperature of crystallization, may be obtained from the solution. The 8- or 9-hydrates crystallize over the temperature range 20 to 40°. The sulfates are soluble to the extent of about 50 to 100 g./l. of water but have a negative temperature coefficient of solubility. The anhydrous sulfates may be prepared by heating the hydrated salts carefully with concentrated sulfuric acid at the fuming temperature and finally driving off all the excess acid. The sulfates may be ignited to oxides, but a high temperature is required to complete the reaction.

The bromates are quite soluble, but the solubilities vary greatly from one element to another. Because the bromates have a very great temperature coefficient of solubility, they are exceedingly valuable in fractional crystallization processes. They may be prepared by dissolving the hydroxides in bromic acid or by double decomposition of the sulfates with barium bromate (synthesis 17).

Certain double salts are of great importance in the chemistry of the rare earths. By the addition of solid sodium or potassium sulfate to a solution of the rare earth ions, double sulfates of the general formula  $\text{Na}_2\text{SO}_4 \cdot (\text{R.E.})_2 \cdot (\text{SO}_4)_3 \cdot x\text{H}_2\text{O}$  are precipitated. The rare earths may be separated conveniently into the cerium and yttrium subgroups on the basis of the lower solubilities of the double sulfates of the former. The double nitrates of the rare earths with divalent elements,  $2(\text{R.E.})(\text{NO}_3)_3 \cdot 3\text{Mg}(\text{NO}_3)_2 \cdot 24\text{H}_2\text{O}$ , are generally used in the preliminary fractional crystallization of the cerium group. The double ammonium nitrates,  $(\text{R.E.})(\text{NO}_3)_3 \cdot 2\text{NH}_4\text{NO}_3 \cdot 4\text{H}_2\text{O}$ , have been useful in the separation of praseodymium and lanthanum.

**Occurrence.** The geochemistry of the rare earths indicates that they are usually present in the final crystallization processes of the magma. They are therefore found in pegmatite dykes in association with other elements of low abundance that also were too diluted in the principal stages of the magmatic crystallization to form their own

minerals. Hence, the rare earth minerals are found in those areas where granitic or syenitic rocks or their metamorphic equivalents have been sufficiently eroded to reveal the pegmatites that crystallized at great depths. Among the more important types of such rocks valued for their rare earth minerals are the highly siliceous (granite) pegmatites of southern Norway, Sweden, Brazil, Madagascar, northern Karelia and the Kola Peninsula, Texas, and Colorado; the gneissic granites and the sands derived from them in Ceylon, India, Brazil, and the Carolinas; and the alkali (nepheline-syenite) pegmatites of Norway, the Kola Peninsula (Khibin Mountains), Lovozero Tundra, and Ural regions in Russia, and the island of Greenland.

The most important rare earth minerals are listed in the following table where Ce and Y represent concentrations particularly of the cerium and yttrium groups, respectively:

Monazite.....	$\text{CePO}_4$	Samarskite...	$(\text{Fe, Ca, UO}_2)_3\text{Y}_2\text{-}$ $(\text{Cb, Ta})_6\text{O}_{21}$
Xenotime.....	$\text{YPO}_4$	Fergusonite...	$\text{Y}(\text{Cb, Ta})\text{O}_4$
Gadolinite.....	$\text{FeBe}_2\text{Y}_2\text{Si}_2\text{O}_{10}$	Thalenite....	$\text{Y}_2\text{Si}_2\text{O}_7$
Cerite.....	$\text{H}_3(\text{Ca, Fe})\text{Ce}_3\text{Si}_3\text{O}_{13}$	Columbite	$(\text{Fe, Mn})[(\text{Cb, Ta})\text{O}_3]_2$
Allanite.....	$4(\text{Ca, Fe})\text{O} \cdot 3(\text{Al, Fe, (Ce)}_2\text{O}_3 \cdot 6\text{SiO}_2 \cdot \text{H}_2\text{O})$	Thortveitite..	$(\text{Sc, Yb})_2\text{Si}_2\text{O}_7$
Yttriofluorite...	$x\text{CaF}_2 \cdot y\text{YF}_3$		
Yttrotitanite...	$\text{CaTiSiO}_5 \cdot (\text{Y, Al, Fe})_2\text{-SiO}_5$	Euxenite.....	$\text{Y}(\text{CbO}_3)_3 \cdot \text{Y}_2(\text{TiO}_3)_3$
Apatite.....	$x\text{Ca}_3(\text{PO}_4)_2 \cdot y\text{CaF}_2$	Lovchorrite...	$(\text{Ce, Y})_4(\text{TiO}_3)_6 \cdot 20\text{CaSiO}_3 \cdot 10\text{-}$ $11\text{NaF}$
Fluocerite.....	$(\text{Ca, Ce})_3\text{OF}_4 \cdot \text{OH}$		

**Extraction.** The process of extraction of the rare earths from minerals and their isolation as a group from the other elements with which they are generally associated is not a complicated one; but, in most cases, it does demand the use of large-scale apparatus. In general, the silicates such as allanite, cerite, and gadolinite are "opened up," or "cracked," by treatment of the finely powdered mineral with hot concentrated nitric or hydrochloric acid

(synthesis 13). Monazite, xenotime, and yttrifluorite yield readily to the action of concentrated sulfuric acid (synthesis 12); the first two require strong heating, while the third reacts quite vigorously with the warm acid. The columbate-tantalates, the titanocolumbates, and the titanosilicates are fused in clay crucibles with sodium or potassium hydrogen sulfate and the melt, after cooling, is extracted with cold water. All the rare earth content will be found in the acidic solutions resulting from the extraction of the minerals mentioned above if the acid extraction or the fusion has been efficient. Essentially all of the columbium, tantalum, and tungsten and a small fraction of the titanium will be found in the insoluble residue from the water extraction of the hydrogen sulfate fusion. In general, the first three of the above elements are present only to a very small extent in the phosphate, fluophosphate, and silicate minerals and are removed as the insoluble acid anhydrides in the acid extraction procedures mentioned for those minerals.

Extraction of columbate-tantalates, titanocolumbates, and titanosilicates may also be initiated by treatment of the mineral with hydrofluoric acid. The procedure has the advantage that columbium, tantalum, uranium(VI), scandium, titanium, zirconium, and hafnium are dissolved, while silica is volatilized as silicon tetrafluoride and the rare earth elements, together with thorium and uranium(IV), remain as slightly soluble fluorides. The residue is then heated with concentrated sulfuric acid to remove hydrogen fluoride and to oxidize uranium(IV), the thorium is separated by precipitation of the phosphate (synthesis 12), and the rare earths are precipitated as oxalates.

Thorium and scandium oxalates are also very slightly soluble under the conditions used for the precipitation of the rare earth elements with oxalic acid. These may be retained in solution, however, if excess ammonium oxalate is used as precipitant. It is probable that, with this reagent, some of the least basic (Yb, Lu) of the desired elements also remain unprecipitated. Thorium and cerium

(IV) may be removed together from acidic solution by precipitation with potassium iodate, but the reagent is too expensive for large-scale work.

**Separation.** The separation methods used for the individual earths are largely fractional in character. As a preliminary step before fractionation, it is usually desirable to separate the rare earths into the cerium and yttrium subgroups. This separation is most often accomplished by precipitating the cerium earths as double sulfates (synthesis 13). The fractional methods for the individual earths are: (1) fractional crystallization [double nitrates of magnesium, (synthesis 15), manganese, or ammonium for the cerium subgroup, and bromates for the yttrium subgroup]; (2) fractional precipitation; (3) fractional decomposition; (4) preferential adsorption (or ion exchange).<sup>6</sup>

For those elements which exhibit oxidation states other than three, the greatly differing behavior in the higher or lower state may be advantageously used for separations. The cerium(IV) state has long been utilized for this purpose (synthesis 14). Praseodymium and terbium may be separated in a few operations by forming higher oxides in a nitrate fusion followed by extraction of the cold melt with dilute, nonreducing acids. On the other hand, europium and ytterbium may be reduced and separated as the slightly soluble sulfates. Since samarium(II) ion liberates hydrogen from water, no such separation is possible in this case. Europium and ytterbium also may be separated by forming amalgams in aqueous solution (synthesis 18).

When a mixture of rare earths is being fractionated, it is desirable to follow the course of separation in some manner. For this purpose the following methods have been used: (1) arc and spark spectra; (2) absorption spectra<sup>7</sup>; (3) average atomic weight (synthesis 16); (4) paramagnetism; (5) X-ray spectra; (6) mass spectra.

**Uses.** The rare earths have several important industrial uses. Cerium is used for impregnating gas mantles and as an opacifier in ceramic ware. Praseodymium and neo-

dymium are used to a minor degree as colorants in glassware. Rare earth fluorides are used in cored carbons for arc lighting. The acetates are used as a sizing in textiles for the proofing of fabrics against corrosion, fire, mildew, and moths as well as for aiding in dyeing and printing operations. Rare earth compounds have been used to some extent as pharmaceuticals and as catalysts. The metals are often used in pyrophoric and other alloys and as scavengers in metallurgy.

Because of the peculiar relationships among the rare earths, there are many theoretical problems that can most readily be solved by a detailed study of these elements. The difficulty of separation, together with the lack of specific directions, has retarded progress in this field.

#### References

1. BOHM: "Die Darstellung der seltenen Erden," Veit, Leipzig, 1905.
2. LEVY: "The Rare Earths, Their Occurrence, Chemistry, and Technology," 2d ed., Longmans, Green and Company, New York, 1924.
3. PETAR: The Rare Earths, *U.S. Bur. Mines, Info. Circ.* 6847, 1935.
4. SPENCER: "The Metals of the Rare Earths," Longmans, Green and Company, New York, 1919.
5. REED, HOPKINS, and AUDRIETH: *INORGANIC SYNTHESSES*, 1, 28 (1939).
6. RUSSELL and PEARCE: *J. Am. Chem. Soc.*, 65, 595 (1943).
7. PRANDTL and SCHEINER: *Z. anorg. allgem. Chem.*, 220, 107 (1934).
8. GOLDSCHMIDT: *J. Chem. Soc.*, 1937, 655.

## 12. THE EXTRACTION OF RARE EARTH MINERALS

### I. MONAZITE AND XENOTIME

SUBMITTED BY D. W. PEARCE,\* R. A. HANSON,\* AND J. C. BUTLER\*†

CHECKED BY WARREN C. JOHNSON‡ AND WALTER O. HAAS‡

Monazite, the orthophosphate of the cerium group rare earths, is, without doubt, the most important rare earth mineral. It contains<sup>1</sup> cerium-group oxides (49 to 74 per cent), yttrium-group oxides (1 to 4 per cent), thoria (1 to 20 per cent), and variable quantities of silica, iron(III) oxide, alumina, etc. Typical commercial samples of

\* Purdue University, West Lafayette, Ind.

† Present address: General Tire and Rubber Company, Akron, Ohio.

‡ University of Chicago, Chicago, Ill.



monazite will contain  $\text{Ce}_2\text{O}_3$ , about 24 per cent; other cerium earth oxides, about 25 per cent; yttrium earth oxides, trace;  $\text{ThO}_2$ , about 6 per cent. Monazite occurs in the form of crystalline masses in a few localities, but it is very much more widespread in the form of sand.

Xenotime, the orthophosphate of the yttrium-group rare earths, contains<sup>2,3</sup> yttrium-group oxides (54 to 67 per cent) and cerium-group oxides (1 to 11 per cent), together with silica, thoria, zirconia, etc. It is neither as abundant nor as widespread in its occurrence as monazite, but has been reported from Norway, Sweden, Brazil, Colorado, North Carolina, and a few other localities.

The rare earth oxides obtained as a by-product from the commercial extraction of monazite have long served as starting materials for the preparation and purification of compounds of the rare earths. While such residues are still readily available, they are becoming of greater value industrially and, furthermore, it is often difficult to obtain the desired complete details of the large scale extraction processes. For these reasons the laboratory extraction of monazite is more often carried out at the present time than formerly.

The extraction procedure that follows is based upon the usual preliminary "cracking" by means of hot concentrated sulfuric acid. This process has been found quite satisfactory in the extraction of monazites from many geographical localities and has also been applied to xenotime with equal success.

### Procedure

#### A. CRACKING THE MINERAL

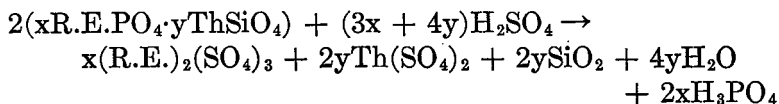

The sands or crystals are first pulverized in a ball mill to about 100-mesh.\* Three and one-quarter kilograms of

\* The sand as obtained on the market is often of suitable particle size

commercial concentrated sulfuric acid is placed in a 16-in. porcelain dish\* and heated to about 200°. Then 3.5 kg.† of the powdered monazite is added slowly in small portions while the mixture is stirred with a heavy glass rod or large porcelain spatula. Heating and stirring are continued (for about ½ hour) until the batch has a consistency like that of stiff mud (*i.e.*, it can just be stirred) and retains a deep-gray color—not the light-gray, almost white color that results when the material is heated nearly to dryness.‡

Following the cracking process, the material is poured slowly, with stirring, into 24.5 l. of cold water. The stirring is continued for at least 1 hour. If by this time the solution has not become cool, the stirring is continued and cracked ice is added until the temperature is 25° or lower. The temperature is important at this point because the rare earth sulfates are more soluble in *cold* than in hot water. Finally, the residue is allowed to settle, is removed by filtration with suction, and is washed five times with sufficient cold water to cover the solid residue to a depth of ¼ in. Time will be saved if the supernatant liquid be first decanted onto the filter and the solids added only at the very end. The residue consists of silica, rutile, zircon, etc., and any unreacted monazite. It is tested by re-treatment with concentrated sulfuric acid to determine whether the cracking process has been complete. If any considerable amount of mona-

---

and requires no grinding. Material not retained by a 200-mesh screen does not react as completely as the usual unground sand. On the other hand, material failing to pass through a 100-mesh screen will require a second or third treatment with concentrated sulfuric acid to effect complete cracking. The present outline is descriptive of the treatment of Madagascar monazite.

\* This size conveniently holds 6 l.

† Owing to the difficulty of stirring the mixture toward the end of the reaction no more than 3.5 kg. of sand should be treated in one batch.

‡ The advantages of heating to dryness are these: (1) the initial filtration is rendered somewhat easier because of the more complete dehydration of the silica and (2) a lesser dilution is required for the removal of thorium. However, these advantages are overbalanced by the greater time necessitated for dissolving the soluble material.

zite remains, the residues from repeated runs are saved, dried, and re-treated in the manner just outlined.

### B. REMOVAL OF THORIUM

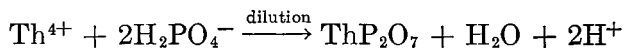

The filtrate from (A) (which contains  $\text{H}^+$ ,  $\text{SO}_4^{=}$ ,  $\text{H}_2\text{PO}_4^-$ ,  $\text{Th}^{+4}$ ,  $\text{La}^{+3}$ ,  $\text{Ce}^{+3}$ ,  $\text{Nd}^{+3}$ , etc.) is diluted to a total volume of 168 l.\* in a stoneware jar or wooden barrel and stirred for at least 1 hour. Then the pale, blue-gray, heavy, gelatinous precipitate is allowed to settle for 8 to 12 hours. This precipitate consists of thorium phosphate together with some cerium and other rare earth phosphates. To be certain that all the thorium has been removed, a sample is filtered and tested by further dilution. This simple test is sufficient to determine whether the removal of thorium has been complete, since a tremendously greater dilution would be necessary to cause precipitation of rare earth phosphates. The main precipitate is removed by filtration and washed free of rare earth ions. If it is desired to obtain the thorium from this phosphate precipitate, the material should be washed free of sulfuric acid and air-dried. If the phosphate is allowed to dry with sulfuric acid present, it will become hard and glassy in character. It is then almost entirely unreactive toward concentrated acids and bases and yields only to a basic fusion.

### C. RECOVERY OF RARE EARTHS

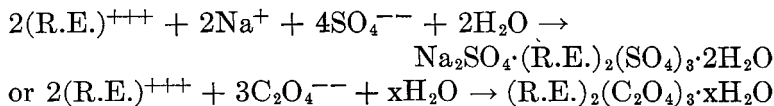

After the thorium has been removed, the rare earths are recovered from the solution. Finely ground solid sodium

\* This dilution provides the proper pH for the complete precipitation of thorium pyrophosphate.

sulfate is slowly sprinkled into the stirred solution until the absorption bands of neodymium are no longer visible through a 5-cm. layer of the clear supernatant liquid. The solids are removed by filtration, washed, and dried.

If the original material contained any considerable quantity of xenotime, the yttrium earths (which will be present) will not be precipitated completely by sodium sulfate. In such a case, solid oxalic acid may be substituted for the sodium sulfate or added to the filtrate from the sulfate precipitation. Otherwise, the filtrate may be discarded. Solid oxalic acid is preferable to the saturated solution in that it does not further dilute the solution and does not form any troublesome gummy precipitates, which must be heated or allowed to stand for some time before effective filtration may be obtained. Ordinarily, the use of oxalic acid is not justified because of the greater expense involved.

#### D. CONVERSION TO OXIDES

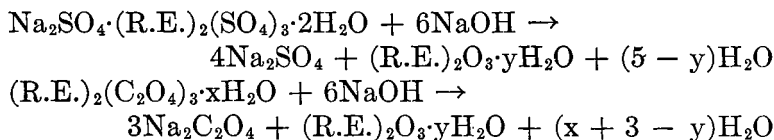

Although the rare earths are conveniently stored as oxalates or double sulfates, they are frequently converted to oxides for storage and, particularly, for use in reactions. However, if the sample of rare earth material contains an unusually large amount of cerium, it is not advisable to convert it to oxides because of the difficulty of dissolving cerium(IV) oxide in common reagents.

The oxalates or double sulfates are made into a thick paste with water, and then sodium hydroxide\* flakes or

\* The amount of sodium hydroxide required for this conversion is calculated from the formulas  $\text{Na}_2\text{SO}_4 \cdot (\text{R.E.})_2(\text{SO}_4)_3 \cdot 2\text{H}_2\text{O}$  and  $(\text{R.E.})_2(\text{C}_2\text{O}_4)_3 \cdot$

pellets are added in small portions, with constant stirring, while the mixture is strongly heated. As the conversion proceeds, during the addition of the alkali, there is a decided change in the texture of the mass so that the slurry becomes more fluid and can be stirred more easily. The solution should not be strongly basic. Heating and stirring are continued for an hour.

The hydrous rare earth oxides are now washed into a 12-gal. crock, 8 gal. of water is added with stirring, the precipitate is allowed to settle, and then it is washed repeatedly by siphoning off wash waters until they are only slightly basic. The hydrous oxides are then dissolved in concentrated nitric acid (with the aid of 3 per cent hydrogen peroxide if the quantity of cerium is significant).

#### E. SUBSEQUENT TREATMENT

The cerium may now be removed from this solution by the bromate method (synthesis 14). Then the resulting solution is treated as before with excess oxalic acid or sodium sulfate, the precipitates are again converted to hydrous oxides, and the latter are again dissolved in nitric acid. The rare earths from monazite are generally converted to double magnesium nitrates,  $3\text{Mg}(\text{NO}_3)_2 \cdot 2(\text{R.E.})-(\text{NO}_3)_3 \cdot 24\text{H}_2\text{O}$  (synthesis 15), for preliminary fractionation. The rare earths from xenotime, after complete removal of cerium, may be converted to bromates (synthesis 17), and fractional crystallization of these salts may be commenced.

#### References

1. LEVY: "The Rare Earths," pp. 18, 71, 79, Edward Arnold & Co., London, 1924.
2. *Ibid.*, pp. 24, 74.
3. SPENCER: "The Metals of the Rare Earths," p. 18, Longmans, Green and Company, New York, 1919.

---

$5\text{H}_2\text{O}$  (dried at  $110^\circ$ ) on the assumption of an atomic weight of 139 for the rare earth. Such a calculation will provide for sufficient excess of reagent.

## 13. THE EXTRACTION OF RARE EARTH MINERALS

## II. ALLANITE, CERITE, AND GADOLINITE

## (Separation of Cerium and Yttrium Earths by the Double Sulfate Method)

SUBMITTED BY D. W. PEARCE,\* R. G. RUSSELL,\*† AND J. C. BUTLER\*‡

CHECKED BY WARREN C. JOHNSON§ AND WALTER O. HAAS§

Allanite (orthite), cerite, and gadolinite are of particular importance in rare earth research since they are the most readily obtainable rare earth silicates. Gadolinite is especially important as probably the most abundant mineral containing a high percentage of the yttrium group; it has been widely used as a source of these elements. These minerals have the following approximate compositions:

Mineral	Formula	Cerium group earths, %	Yttrium group earths, %	Other oxides, %
Allanite <sup>1</sup> (orthite).	(Al, Fe <sup>III</sup> , R.E.) <sub>3</sub> (Ca, Fe <sup>II</sup> , Be) <sub>2</sub> (OH)Si <sub>3</sub> O <sub>12</sub>	3.6-51	0-8	0-3.5 thoria
Cerite <sup>2</sup> . . . . .	H <sub>3</sub> (Ca, Fe <sup>II</sup> )(R.E.) <sub>3</sub> -Si <sub>3</sub> O <sub>13</sub>	50.7-71.8	7.6	11.7 zirconia
Gadolinite <sup>3</sup> . . .	FeBe <sub>2</sub> (R.E.) <sub>2</sub> Si <sub>2</sub> O <sub>10</sub>	3.4-51.5	5-60	Small amounts of scandia and thoria

Allanite is a common mineral but in many cases has a low rare earth content. Cerite is a rarer mineral occurring at Ryddarhyttan, Sweden, and in very few other localities. Gadolinite occurs in notable amounts in the Scandinavian countries, in Llano County, Texas, and in many other localities.

\* Purdue University, West Lafayette, Ind.

† Present address: Aluminum Company of America, New Kensington, Pa.

‡ Present address: General Tire and Rubber Company, Akron, Ohio.

§ University of Chicago, Chicago, Ill.

All three of these minerals can be treated for their rare earth content by extraction with acids. The somewhat troublesome use of concentrated sulfuric acid is not necessary, since it has been found that excellent results<sup>4</sup> can be obtained with either hydrochloric or nitric acid.\*

The following procedure has been used in the extraction of Norwegian gadolinite, Virginia allanite, and Swedish cerite. The extraction of gadolinite is described here for illustration.

The most significant step in the process being described is the Berzelius "double-sulfate"<sup>4</sup> method for the separation of the cerium group from the yttrium group of rare earth elements. Since the cerium group content of some gadolinites is high and since this mineral is usually extracted mainly for its yttrium group content, the use of this procedure is particularly advisable in this case.

## Procedure

### A. EXTRACTION

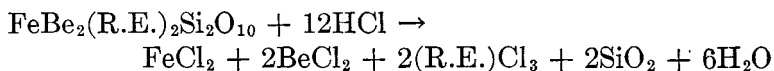

The massive gadolinite is crushed in a jaw crusher and pulverized in a ball mill to about 100 mesh. About 2.27 kg. of the powder is then added slowly, with stirring, to 5 l. of hot concentrated (12 *N*) hydrochloric acid (technical) in a 16-in. porcelain dish. After most of the excess acid has been removed by evaporation, the solution is diluted to 6 l. and filtered. The residue is washed with hot water and then dried; the washings are added to the original solution. The residue is composed mainly of silica and large grains of unattacked gadolinite. The latter are removed by screening them from the fine silica and are again sent through the crusher and ball mill; a second extraction

\* Concentrated nitric acid in the same proportions has been found somewhat more efficient in the extraction of allanite; there seems to be little choice between the two acids for the extraction of cerite.

results in their decomposition. If the residues from the extraction are light gray or almost white, the practically complete decomposition of the mineral is indicated.

### B. PRECIPITATION OF RARE EARTHS\*

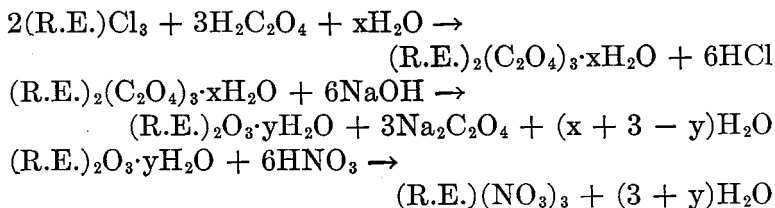

From the diluted acid solution† the rare earth oxalates are precipitated by the addition of a small excess‡ of hot concentrated oxalic acid solution. Usually about 2 kg. of oxalic acid is required. The precipitated oxalates are thoroughly washed with hot water, converted to hydrous oxides by boiling with concentrated sodium hydroxide solution (see synthesis 12D) and the washed hydrous oxides dissolved in the least amount of concentrated (16 N) nitric acid (about 2 l.). This solution is then diluted to 12 l.

### C. SEPARATION OF CERIUM AND YTTRIUM EARTHS

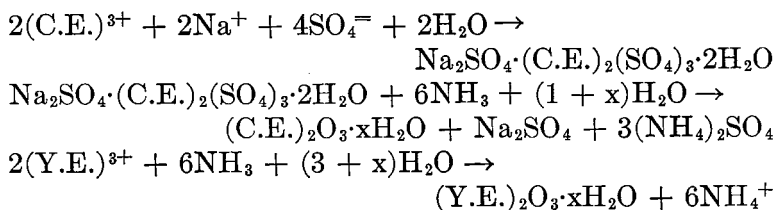

Solid sodium sulfate is *slowly* sifted, with thorough stirring, into the dilute nitrate solution at room tempera-

\* It is not advisable to carry out a double sulfate separation in the presence of the other materials that are present in this solution.

† The concentration of hydrochloric acid should be 0.5 to 1 N for the precipitation of the oxalates.

‡ To ensure complete precipitation, the excess of oxalic acid must be sufficient to form a complex with all of the iron present.



ture. The solution becomes quite cold, and the crystalline double sulfates\* of the cerium group precipitate. The addition is continued until only a faint trace of the  $\lambda$  5200-Å. absorption band of neodymium is to be seen when a 5-cm. layer of the clear solution is examined with a hand spectroscope. If the addition of sodium sulfate is stopped at this point, a reasonably good separation of the two groups is obtained and no repetition of the process is necessary. The precipitate is now removed from the solution by filtration with a large Büchner funnel and is washed with a small volume (500 ml.) of saturated sodium sulfate solution.

To the double sulfate precipitate, 2 l. of water and 2 l. of 15 *N* ammonia solution† are added and the mixture is well stirred until the texture of the precipitate indicates conversion to hydrous oxides (see synthesis 12D). The hydrous oxide precipitate is washed (by decantation) with large volumes of water in a 5-gal. crock until the washings, removed by siphoning, are only very slightly basic. The precipitate is then dissolved in the least amount of concentrated nitric acid. Cerium is next removed from this solution by the bromate method (see synthesis 14), and the remaining rare earths are converted to double magnesium nitrates (synthesis 15).

The yttrium group solution is treated with a slight excess of ammonia solution. The resulting hydrous oxides are washed and then converted to bromates (synthesis 17) for fractional crystallization.

#### References

1. LEVY: "The Rare Earths," p. 8, Edward Arnold & Co., London, 1924.
2. *Ibid.*, pp. 12, 26.
3. *Ibid.*, pp. 14, 29.
4. JAMES: *J. Am. Chem. Soc.*, **34**, 757 (1912).

\* The potassium double sulfates are less soluble than those of sodium and are often used in this separation.

† Ammonia is to be preferred to sodium hydroxide since the former permits of a quicker and more thorough washing.

## 14. THE SEPARATION OF CERIUM FROM RARE EARTH MIXTURES

SUBMITTED BY D. W. PEARCE\* AND J. C. BUTLER\*†

CHECKED BY WARREN C. JOHNSON‡ AND WALTER O. HAAS‡

The better known methods for the removal of cerium from rare earth mixtures depend upon the ease of oxidation of cerium and the subsequent precipitation of cerium(IV) compounds by hydrolysis. Among these are the permanganate-phosphate,<sup>1,2</sup> the permanganate-cerium dioxide,<sup>3</sup> the electrolytic,<sup>2</sup> and the potassium bromate<sup>4</sup> methods. The method of G. F. Smith,<sup>5</sup> in which ammonium-cerium(IV) nitrate is crystallized from a nitric acid solution of the rare earths in the presence of an excess of ammonium nitrate, is particularly valuable as a commercial method for the production of large amounts of very pure cerium compounds.

The bromate method, however, has been found to be admirably suited for laboratory-scale operations but not for large quantities because of the expense. It presents three very definite advantages over the other methods: first, no extraneous materials are introduced into the precipitate; second, the solution is rendered practically free from cerium in a minimum of operations; and, third, the basic cerium(IV) nitrate so obtained is practically free from other rare earths. Little or no reworking of the precipitate is necessary in order to obtain a cerium compound of high purity, and only very small amounts of the other rare earths are carried out of the solution.

### Procedure

#### A. SEPARATION OF CERIUM

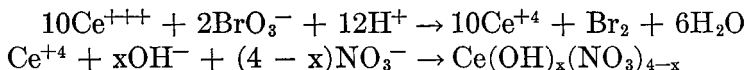

A solution of rare earth oxides in nitric acid or a similar solution, obtained directly from a mineral extraction, is

\* Purdue University, West Lafayette, Ind.

† Present address: General Tire & Rubber Company, Akron, Ohio.

‡ University of Chicago, Chicago, Ill.

used.\* Twelve liters of a solution containing approximately 4100 g. of rare earth oxides is a convenient quantity to use. The present directions are adapted for an oxide mixture containing somewhat less than half cerium dioxide.<sup>5</sup>

The solution is conveniently treated in three batches of approximately equal size. To each batch, contained in a porcelain dish fitted with a stirrer, is added an excess of marble in the form of walnut-sized lumps.† The solution is then heated over Méker burners and thoroughly stirred until it is only slightly acidic. A 100-g. quantity of potassium bromate is then added, and the solution is evaporated to a volume of about 1 l.‡ The yellow precipitate of basic cerium(IV) nitrate appears during this operation.

The solution is now diluted to a volume of 4 l. and then evaporated to 1 l. Several repetitions of the dilution and reconcentration of the solution are required for the complete oxidation of the cerium and its consequent hydrolysis and precipitation.§ The concentrated solution is diluted to 5 l., heated almost to boiling and allowed to stand, preferably overnight, until the precipitate settles.|| Filtration is exceedingly difficult in those cases in which a large

\* If the solution is to be prepared from a rare earth oxide mixture, it is generally necessary to add hydrogen peroxide in order to reduce and dissolve the higher oxide of cerium that is present.

† Not all marble is suitable for this purpose. Some types of marble dissolve so slowly in acids as to be ineffective. Hence, the solubility of the marble in acids should be tested before use. Marble is used to maintain the acidity at a low value; otherwise, the bromate decomposes, and precipitation will not occur. Pure calcium carbonate in the form of a powder may be used if it is desired not to contaminate the solution with magnesium or iron salts from the marble.

‡ Thorough stirring to bring all parts of the solution into contact with the marble is essential throughout all operations. If bromine fumes are noticeable during the evaporation, more marble, preferably in powder form to obtain quick reaction, should be added.

§ The oxidation seems to occur during the evaporation and in the hot concentrated solution, while the *hydrolysis* takes place in the hot dilute solution.

|| If the precipitate fails to settle within this time, the addition of  $\frac{1}{2}$  to 1 l. of cold water will usually produce the desired result.

amount of cerium is present, since rapid precipitation results in a fine-grained precipitate. Under these conditions, siphoning or decanting the major part of the mother liquor is to be preferred.

Each of the batches of original liquor is treated as described above. The three filtrates are then combined in a larger dish, evaporated with an additional 60 g. of potassium bromate to 2 to 3 l., diluted to about 8 l., heated to boiling, and again decanted. Six liters of water is added to the combined precipitates, the mixture is heated almost to boiling, and the supernatant liquor is decanted. The precipitate is sucked as dry as possible in a Büchner funnel, and the wash liquor is added to the main solution containing the other rare earths. The residual pieces of marble may then be either picked from the precipitate or removed from it by a thorough washing with dilute nitric acid.

To test for the complete removal of cerium the following sensitive test for cerium may be made: A drop of the solution is made acidic with nitric acid. A few drops of 3 per cent hydrogen peroxide are added, and the solution is made ammoniacal; a yellow to orange color in the precipitate indicates<sup>6</sup> the presence of cerium, and a re-treatment of the solution is then necessary if the complete removal of this element is desired.\* In such a case the presence of excess bromate should be verified before proceeding with the further removal of cerium from the solution. The appearance of bromine fumes upon warming 1 ml. of the solution with a few crystals of oxalic acid will indicate the presence of an excess of bromate. More potassium bromate should be added to the main solution if necessary.†

\* If the material is to be separated into the cerium and yttrium groups of rare earths by precipitation of the double sulfates of the former, removal of the last trace of cerium is unnecessary since it does not seriously interfere in the fractionation of the cerium group double magnesium nitrates. It is important, however, that there be no cerium in a bromate series.

† From the cerium-free solution the rare earths may be precipitated for storage as oxalates as previously described (Synthesis 13B).

## B. RECOVERY OF CERIUM

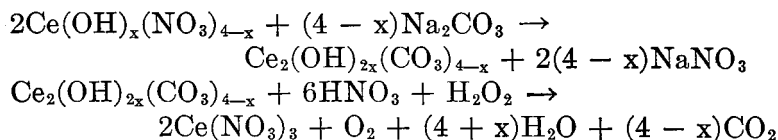

Fifty grams of the moist basic nitrate is boiled with 200 ml. of 3 *N* sodium carbonate solution, the liquor is decanted, and the precipitate is washed with 50 ml. of water. The precipitate is now readily dissolved in concentrated (16 *N*) nitric acid with the aid of sufficient 3 per cent hydrogen peroxide to reduce cerium(IV) to cerium(III). The solution, when evaporated to a volume of 75 ml. and examined with a hand spectroscope through a thickness of 5 cm., should show no rare earth absorption bands. If bands are evident and a purer cerium preparation is desired, the entire quantity of basic nitrate should be boiled with sodium carbonate, dissolved in nitric acid with the aid of hydrogen peroxide, and the precipitation of the basic nitrate repeated by the described procedure.

## References

1. VON KNORRE: *Z. angew. Chem.*, **10**, 717 (1897).
2. NECKERS and KREMERS: *J. Am. Chem. Soc.*, **50**, 955 (1928).
3. ROBERTS: *Am. J. Sci.*, [5] **31**, 350 (1911).
4. JAMES: *J. Am. Chem. Soc.*, **33**, 1326 (1911); **34**, 757 (1912).
5. SMITH: "Ceric Sulfate," p. 14, G. F. Smith Chemical Co., Columbus, Ohio, 1933; "Cerate Oxidimetry," pp. 3-5, G. F. Smith Chemical Company, Columbus, Ohio, 1942.
6. PISSARJEWSKY: *Z. anorg. allgem. Chem.*, **31**, 359 (1900).

## 15. FRACTIONAL CRYSTALLIZATION

### THE MAGNESIUM RARE EARTH NITRATES<sup>1</sup>

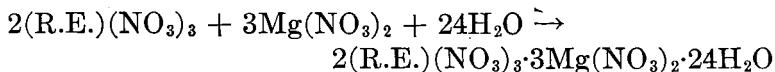

SUBMITTED BY D. W. PEARCE\*

CHECKED BY LAURENCE L. QUILL†

The most widely used method of separating most of the individual rare earths is that of fractional crystallization. In this process advantage is taken of the slight differences in solubility among a series of rare earth simple or double salts of the same type. To be suitable for fractionation, salts must be neither too soluble nor too little soluble; they must have a marked temperature coefficient of solubility and must remain stable over long periods during which they are repeatedly heated and cooled. The magnesium rare earth nitrates are most generally useful for fractionating the cerium earths, while the bromates are most often used for the yttrium earths.

### Procedure

#### A. PREPARATION OF A SERIES

To 3500 g. of a cerium-free rare earth oxide mixture in a 16-in. porcelain dish is added sufficient water to wet all portions of the mass. The thick paste so obtained is treated with 4.2 l. of concentrated nitric acid in small portions‡ and heated until solution is complete. The magnesium nitrate may now be added in the form of  $\text{Mg}(\text{NO}_3)_2 \cdot 6\text{H}_2\text{O}$  crystals (810 g.) dissolved in 1.5 l. of water. If, however, many large series are to be set up, it is more

\* Purdue University, West Lafayette, Ind.

† Ohio State University, Columbus, Ohio; present address, Michigan State College, East Lansing, Mich.

‡ Care must be observed during these additions and the mixture well stirred during the reaction since considerable heat is generated and much local boiling and frothing occur.

economical to use light-burnt U.S.P. magnesium oxide (420 g.) mixed into a paste with water and then dissolved in concentrated nitric acid<sup>2</sup> (1.4 l.) and to add this solution to that containing the rare earths. The resulting solution is then well stirred and concentrated by evaporation on a hot plate or on a tripod (asbestos-centered gauze) over Méker burners, preliminary to dividing the material into the starting fractions.

The solution is evaporated to about 4.5 l. either by gentle boiling or by blowing a stream of air over the surface of the heated solution. The solution is allowed to cool; about one-sixth of the mass should crystallize. The liquor is poured from the crystals into another dish and is again evaporated. To the crystals is added about 200 ml. of water and the dish heated until these crystals are dissolved. The resulting solution is poured into a 2-l. pyrex Florence flask and the dish rinsed into the same container; this flask is labeled\* fraction 1. From the remaining rare earth solution are then removed further fractions in the same way, and each is transferred to a 2-l. flask and labeled in sequence 2, 3, etc. The final liquor, which will have a volume of about 200 ml., forms the fraction with the highest number. The series will now consist of fractions 1 to 7; all should be nearly the same size except the last.

## B. FRACTIONAL CRYSTALLIZATION

While the series was set up by the process of removing relatively small crops of crystals from the liquor, the further fractionation of the material can best be carried on by removing small amounts of liquor from larger amounts of crystals. For the greatest efficiency all intermediate fractions (those other than the least soluble and the most soluble) should be nearly the same size, and the

\* If several series are to be set up and fractionated, it is necessary that a distinction be made between them. This is usually done by giving to each a distinctive letter or combination of letters. Thus the first fraction removed as above described might be labeled A1, A being the chosen series letter and 1 the fraction number.

cold liquors should have about one-fourth to one-fifth the volume of the crystals.\* If the volumes of the various fractions do not meet these conditions, the proportion of liquor should be adjusted by adding more water and redissolving the fraction or by dissolving the fraction and boiling down the solution. Following these adjustments and the subsequent crystallization of the fractions concerned, the series is ready for routine fractional crystallization.

Commencing with the fraction next to the most soluble one (fraction 6 in this case) the liquor is poured into the most soluble fraction and the crystals allowed to drain as thoroughly as time allows. The liquor from fraction 5 is then poured onto the crystals in 6, that from fraction 4 onto the crystals in 5, etc., until the liquor from fraction 1 is poured onto the crystals in 2. Thus there has been accomplished a one-series fractionation.† Since fraction 1 is now dry, more solvent‡ must be added to it. The volume of solvent must be somewhat smaller than the amount of solution that it is desired to pour from this fraction in the next fractionation.

All fractions are now placed on gauze-covered tripods over individual Méker burners (or better on a large 20- by 20-in. steel hot plate covered with thin sheet asbestos and heated with eight Méker burners) and the crystals completely dissolved. Care must be taken during the dissolution of the crystals because of the fact that a hotter, more concentrated layer of solution is often formed at the bottom of the flask and this, if suddenly mixed into the upper layer, may cause much of the contents to be violently erupted

\* The mass of crystals in each fraction must always occupy less than one-half the volume of the flask; otherwise, the strain of repeated heating and cooling will soon break the flask.

† The record is most conveniently kept by counting these series operations and not the total of all operations with the individual fractions.

‡ The solvent in the case of an average cerium-group mixture should continue to be distilled water until the majority of the lanthanum-praseodymium has been removed; after this, 6 *N* HNO<sub>3</sub>, which decreases the solubility of the remaining more soluble crystals, becomes preferable.



from the flask. For this reason, and to break up the crystals and speed their dissolution, the fractions should be shaken often and carefully\* during the time they are on the burners. When the crystals have dissolved, the fractions are removed from the burners and set aside to crystallize again overnight. In general, only one series fractionation may be made per day if the fractions are large.

As fractionation proceeds, the least soluble fraction (1) will decrease in volume, the intermediate fractions should remain constant, and the most soluble fraction will increase owing to the constant addition of liquors to it. The last fraction should be boiled down periodically or kept evaporated until it is of such volume that, when allowed to crystallize, it will have the desired volume of crystals and ratio of liquor to crystals. When this situation is realized, another flask is added to the series, the next higher number assigned to it, and the pouring of liquors into it commenced.

If, as happens occasionally during the course of fractional crystallization of a series, the most soluble fraction is markedly different in appearance from the pouring that would ordinarily be added to it from the preceding fraction, then it is advisable to preserve this separation by not adding the pouring in the usual manner. Instead, the number of the most soluble fraction may be increased by 1 and an empty flask introduced into the series at the vacated place. Into the new flask the end pouring is admitted, and no pourings are added to the most soluble fraction until they are more nearly the composition of that material. In this way the fortuitous separation that had been obtained is not lost by contaminating the most soluble fraction with liquors of markedly different composition.

At the less soluble end, somewhat similar considerations apply. It is at this point of the series that the purest

\* It is advisable to protect the hand and arm with a folded towel or heavy glove during these operations since exceedingly bad burns may be obtained from the hot liquors. It is also advisable to have near by clean 8- or 10-in. porcelain dishes into which the fraction, flask and all, may be placed should a crack develop.

material is crystallizing. If, then, a least soluble fraction is obtained the liquor from which is markedly different in color from the crystals of the next fraction, the usual pouring should not be made. In such a case the pouring of fraction 1 should be retained for a few fractionations and fraction 2 treated as if it were the least soluble fraction. When fraction 2 is of such a composition that the liquors from 1 are similar to it, then the fractionation process is allowed to proceed normally. When fraction 1 becomes quite small, it may conveniently be added in its entirety to fraction 2 (if the compositions are similar) and the series continued with the latter as the least soluble fraction.

With the earths from monazite as starting material, the following separations will become apparent as fractionation continues.

1. Yellow liquors containing principally yttrium-group earths with samarium will be obtained from the most soluble fractions and will fail to crystallize. These may be removed from the series to be combined later with other materials of similar composition obtained in the same manner. When these fractions are of sufficient volume they should be used for the preparation of bromates (synthesis 17).

2. White fractions with little or no absorption and greenish-white crystals with green liquors will soon appear at the less soluble end. These consist mainly of lanthanum with praseodymium and should be removed from the series and used later as the least soluble fractions in a series for the preparation of highly pure lanthanum and lanthanum-praseodymium mixtures.

3. When some of the intermediate fractions\* have become the brilliant violet color characteristic of neodymium, the solvent may be changed from water to 6 *N* HNO<sub>3</sub>.

\* As the fractions become smaller, owing to continued removal of material from both ends of the series, they must be removed to smaller flasks since it will be found that small masses of crystals in larger flasks do not adhere to the glass during the pouring and cause loss of material by slipping into the liquid during this operation.

by adding the latter to the least soluble end and allowing it to work through the series as the fractionations are made.

4. When the yellow color of the more soluble end fractions indicates that a good separation of neodymium and samarium is taking place, the series may be split so as to yield a high neodymium–low samarium series and a low neodymium–high samarium series. Each series may be continued in the same way; but, owing to the lesser abundance of samarium, combination of the more soluble material with similar fractions from other series is necessary to provide the bulk necessary to ensure a reasonably pure product. Indeed, proper cutting, combining, and recutting of the various series are a prerequisite for obtaining even the comparatively abundant neodymium in a pure condition.

### C. MODIFICATIONS

1. The quite difficult separation of praseodymium from lanthanum by fractional-crystallization methods may be aided considerably if fractions containing the corresponding cerium(III) double salt are admitted to the series at an intermediate point. If the cerium is kept in the reduced form by the use of hydrogen peroxide in acidic solution, it acts as an *élément séparateur*<sup>2</sup> owing to its intermediate solubility and consequent “splitting” between lanthanum and praseodymium. In the same way, a large fraction of  $2\text{Bi}(\text{NO}_3)_3 \cdot 3\text{Mg}(\text{NO}_3)_2 \cdot 24\text{H}_2\text{O}$  may be prepared and admitted to the samarium series. The isomorphous bismuth salt concentrates with europium and, since it is present in great excess over the latter, acts to separate europium from its neighbors (samarium and gadolinium) on either side with fractions containing bismuth only; the latter may easily be removed later by the use of hydrogen sulfide. In this case, however, it is advantageous to introduce the bismuth fraction in concentrated nitric acid into the series as the least soluble fraction and to use its pourings as liquors for the first fraction of the samarium

series; in this way, the bismuth finds its correct position in the series and effectively separates the elements at the desired points.

2. It should be mentioned that some workers prefer to contain the fractions in casseroles rather than in flasks, to make larger pourings (1:1 or greater volume ratios of liquor to crystal), to stir the fractions during cooling so that a crystal meal rather than a compact mass is obtained, and to separate the crystals by filtering on large Büchner funnels. While such methods undoubtedly yield a better approach to equilibrium it is felt that the greatly increased time factor mitigates against their use when many series must be fractionated day after day.

#### References

1. JAMES: *J. Am. Chem. Soc.*, **34**, 757 (1912); **38**, 41 (1916).
2. URBAIN: *Compt. rend.*, **138**, 84 (1904).

## 16. THE AVERAGE ATOMIC WEIGHT OF RARE EARTH ELEMENTS IN A MIXTURE<sup>1</sup>

METHOD BASED ON THE RATIOS, OXALATE: OXIDE  
AND OXALATE: PERMANGANATE

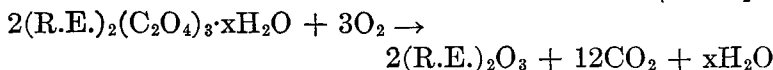
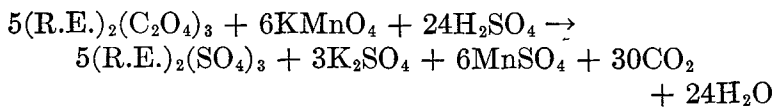

SUBMITTED BY D. W. PEARCE,\* G. L. BARTHAUER,\*† AND R. G. RUSSELL\*‡

CHECKED BY LAURENCE L. QUILL§|| AND STUART A. MAYPER§

A rapid but accurate method for the determination of the average atomic weight of a mixture of rare earths is helpful

\* Purdue University, West Lafayette, Ind.

† Present address: Magnolia Petroleum Company, Dallas, Tex.

‡ Present address: Aluminum Company of America, New Kensington, Pa.

§ The Ohio State University, Columbus, Ohio.

|| Present address: Michigan State College, East Lansing, Mich.

in many instances where work with these elements is undertaken. The need for such a method arises, for example, in the preparation of the rare earth bromates (synthesis 17), where it is desirable to avoid the use of large excesses of expensive reagents that are difficult to recover from the resulting mixtures. Furthermore, such a method is helpful in following the progress of fractional separations. The atomic weight method here recommended was proposed by Gibbs<sup>2</sup> and was used by Brauner and Batek<sup>3</sup> in the revision of the atomic weight of cerium. It has been found to give excellent results in a minimum of time and employs common c.p. reagents and ordinary analytical skill.

### Procedure

**Preparation of the Mixed Oxalates.** About 1 g. of the rare earth oxides is dissolved in 50 ml. of water containing 7 ml. of concentrated nitric acid, and the solution is filtered to remove any traces of insoluble material. The solution is then diluted to 100 ml., heated to boiling, and the rare earth oxalates are precipitated by the slow addition of a hot solution of 10 g. of oxalic acid in 50 ml. of water. The mixture is digested on the steam plate for 15 to 20 minutes, then filtered, and the precipitate washed thoroughly to remove any excess oxalic acid. This operation should consist of two washings by decantation with 100-ml. portions of hot water, followed by a washing on a filter, removal to a beaker, and another series of decantations. After a final washing on a filter, the wet oxalates are removed to a beaker, the supernatant liquid is decanted, and the precipitate is dried at 110° for a period of 8 to 12 hours.

**Ignition of Oxalates to Oxides.\*** Duplicate samples of

\* A large error in this procedure may occur in the ignition of oxalates to oxides. Aside from mechanical losses on ignition, there is some evidence that furnace atmosphere conditions are of importance. If crucible linings are etched during the ignition, erratic results will be obtained. Since this may be due to partial reduction of samarium, europium, or ytterbium, an

about 0.5 g.\* of the dried oxalates are weighed out into tared crucibles. These samples are ignited to constant weight in an electric muffle furnace set to reach a temperature of 900°. It is advisable to put the oxalates into a cold furnace and to allow the temperature to rise slowly since the dry powder is very easily blown from the crucible by the escaping gases if the crucible comes suddenly into contact with a hot surface. For this reason, an open-flame ignition would require extreme care.

**Determination of the Oxalate Content.** Two other duplicate samples of the oxalates of about 0.15 g. each are weighed out, transferred to 125-ml. beakers, dissolved in 20 ml. of warm 10 *N* sulfuric acid, diluted with 100 ml. of water, and titrated hot with 0.025 *N* potassium permanganate† recently standardized against Bureau of Standards sodium oxalate or, better, against a rare earth oxalate of known purity.

**Data and Calculations.** The table on page 61 gives data acquired in the analysis of a sample of pure neodymium oxalate and illustrates the degree of precision obtainable with a reasonable amount of practice. (The permanganate solution was standardized against sodium oxalate.)

Equally precise and considerably more accurate atomic weight values may be obtained if the potassium permanganate solution is standardized against the oxalate of that rare earth element which is the principal constituent of the mixture. The explanation of the phenomenon may be that the precipitated rare earth oxalates are, in part,

---

oxidizing atmosphere within the furnace is a necessity. On the other hand, the method will naturally yield results of lesser significance for mixtures containing large amounts of cerium, praseodymium, terbium, and possibly neodymium. These elements may be oxidized partly or completely to oxidation states higher than three.

\* Samples as small as 0.15 g. are satisfactory if the material is scarce.

† The normality of the potassium permanganate solution may be either 0.04 or 0.025 *N* (1.25 or 0.78 g.  $\text{KMnO}_4$  per l., respectively), which allows a convenient volume of titrant for a 0.3- or 0.15-g. sample, respectively.

nitrate- or hydroxoöxalates. For standardization with a pure rare earth, the identical procedure outlined above is followed. For the calculation, the same formula is used except that the atomic weight of the rare earth is known and the normality of the permanganate solution is the unknown. Thus, the permanganate solution used in the

Wt., g., oxalate titrated	Vol., ml., KMnO <sub>4</sub> used	N KMnO <sub>4</sub> vs. Na <sub>2</sub> C <sub>2</sub> O <sub>4</sub>	Wt., g., oxalate ignited	Wt., g., oxide obtained	Calcd. at. wt.
0.1421	55.35	0.02494	0.1410	0.0775	145.8 <sub>5</sub>
0.1275	49.60	0.02494	0.1912	0.1049	145.7

$$\frac{2\text{Nd} + 3\text{O}}{3\text{C}_2\text{O}_3} = \frac{\text{g. oxide obtained}}{\text{g. oxalate ignited}} \times \text{g. oxalate titrated}$$

$$\frac{2\text{Nd} + 48}{216.06} = \frac{\frac{0.0775}{0.1410} \times 0.1421}{0.02494 \times \frac{72.02}{2 \times 1000} \times 55.35}$$

$$\text{Nd} = 145.8_5$$

foregoing determination was 0.02515 N by standardization in duplicate against the oxalate of pure neodymium. When this value is used with the same analytical data as employed before, values of 144.4 and 144.3 for the atomic weight of pure neodymium were obtained. The accepted (1941) value is 144.27.

References

1. BARTHAUER, RUSSELL, and PEARCE: *Ind. Eng. Chem., Anal. Ed.*, **15**, 548 (1943).
2. GIBBS: *Am. Chem. J.*, **15**, 546 (1893).
3. BRAUNER and BATEK: *Z. anorg. allgem. Chem.*, **34**, 103, 307 (1903).

**17. RARE EARTH BROMATES**

SUBMITTED BY D. W. PEARCE\* AND R. G. RUSSELL\*†

CHECKED BY LAURENCE L. QUILL‡§ AND SAM RICCARDI‡

The fractional crystallization of the bromates is one of the most rapid and efficient methods for the preliminary separation of the yttrium-group rare earths. The method as devised by James<sup>1</sup> for the preparation of the bromates involves a number of steps. A paste of rare earth oxalates or oxides with concentrated sulfuric acid is heated until sulfur trioxide is no longer evolved, in order to prepare the anhydrous sulfates. These are dissolved in ice water, treated with barium bromate solution, and the mixture is filtered to remove barium sulfate. The solution is then concentrated until proper crystallization takes place. Many difficulties are encountered in this procedure when large batches of material are to be prepared. All sulfuric acid must be driven from the sulfate mass to avoid later decomposition of the bromate by the acidic solution, although some decomposition to insoluble basic sulfate is almost inevitable in accomplishing this. Barium bromate is not very soluble even in warm water, and the combination of the two solutions necessitates the handling of a large volume even when a small batch of the desired salt is prepared. Warming of the rare earth solution in the presence of sulfate ion may result in the precipitation of the slightly soluble hydrated rare earth sulfates, which are difficult to filter and rework. Finally, the barium sulfate is difficult to coagulate and filter when precipitated under these conditions.

The James method has been modified to avoid both the preparation of the solid anhydrous sulfate and the use of large volumes of solution. It is desirable, although not

\* Purdue University, West Lafayette, Ind.

† Present address: Aluminum Company of America, New Kensington, Pa.

‡ The Ohio State University, Columbus, Ohio.

§ Present address: Michigan State College, East Lansing, Mich.



necessary, that the average atomic weight of the rare earth mixture be known in order that any large excess of expensive reagents be avoided.

### Procedure

#### A. PREPARATION OF THE RARE EARTH SULFATE SOLUTION

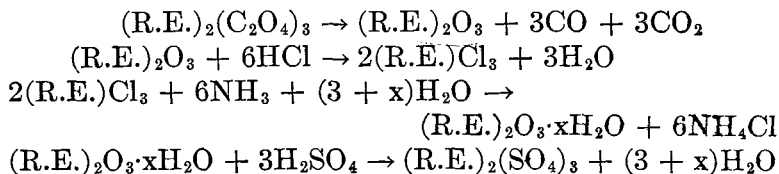

In the directions to follow it will be assumed that 1 kg. of oxides of rare earths with average atomic weight equal to 128.25 (see synthesis 16) is to be transformed to bromates. For a smaller amount of material or for a different average atomic weight, proportionate amounts of reagents must be used. The rare earths must be cerium-free because cerium catalyzes a troublesome decomposition of bromate ion.

The batch of rare earth oxalates is ignited to oxides, and the latter are weighed. The oxides are made into a thin paste with water and dissolved in 3.3 l., which is a slight excess, of warm 6 *N* c.p. hydrochloric acid. The solution is then diluted to 8 l. and the rare earth hydrous oxides are precipitated with 3.5 l., which is a slight excess, of 6 *N* ammonia solution. The precipitated hydrous oxides are washed by decantation in a large crock with 12- to 20-l. volumes of water by siphoning off the supernatant liquors until the washings are only very slightly basic to litmus. About five washings are required. Sulfuric acid (6 *N*) is slowly added to dissolve almost all the hydrous oxides; about 3.2 l. will be required. A small excess of the precipitate is allowed to remain and the solution filtered from it. The small portion is then treated separately with dilute sulfuric acid, drop by drop, until

solution is complete, and this small volume of solution is added to the main volume. The resulting solution is only slightly acidic, and hydrated sulfates do not separate from it even on long standing.

#### B. PREPARATION OF RARE EARTH BROMATES

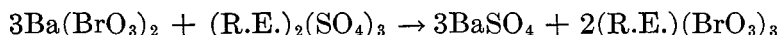

The solution of rare earth sulfates (about 3.5 l.) is now added with prolonged stirring to 4.1 kg. of freshly prepared solid barium bromate (synthesis 6) in an evaporating dish. The mixture is heated and stirred, and further small amounts of barium bromate are added, if necessary, until a sample gives no further precipitation with a solution of the latter reagent. The barium sulfate and any excess barium bromate are then removed by filtration, and the solution is carefully evaporated\* on a steam bath until a small sample crystallizes almost completely when it is allowed to cool. Any small amount of barium bromate that crystallizes during the evaporation may be allowed to remain, as it is easily removed later at the less soluble end of the fractional crystallization series.

#### Properties

The mixed rare earth bromates are obtained in the form of colorless or faint-pink needlelike or feathery crystals. They are moderately soluble in cold water and very soluble in hot. The minimum in solubility among the various earths occurs at europium although the position of this minimum depends upon the crystallization temperature.

Since the bromates tend to form highly supersaturated solutions, no fractions should be completely dissolved during the dissolution operation in fractionation; otherwise, when crystallization occurs, either by agitation or by sudden

\* If air is blown over the surface of rare earth bromate solutions during evaporation, care should be taken to ensure that it is entirely free from oil, which is sometimes present in the compressed air lines. The oil causes reduction of bromate ion.

## EUROPIUM AMALGAM

65

cooling, a hard solid mass will be obtained. Such a fraction should be reheated, until solution is almost complete, and set aside to cool, whereupon the stable crystal form and the correct volume of mother liquor will be obtained.

The rare earth bromates are relatively stable in the absence of cerium or other reducing materials. Very little thermal decomposition occurs if overheating of the crystals and of the solution is avoided. To avoid such decomposition, the fractions should be heated carefully always on the steam bath and should be regularly mixed by gentle swirling during this operation.

## Reference

1. JAMES: *J. Am. Chem. Soc.*, **30**, 182 (1908).

## 18. EUROPIUM AMALGAM

## SEPARATION OF EUROPIUM FROM RARE EARTH MIXTURES

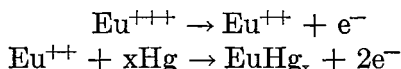

SUBMITTED BY HERBERT N. MCCOY\*

CHECKED BY H. MORRIS† AND P. W. SELWOOD†

The preparation of amalgams of lanthanum, neodymium, and cerium by electrolysis of the anhydrous chlorides in alcoholic solution has already been described.<sup>1</sup> The electrolysis of a rare earth chloride in water solution proves unsatisfactory<sup>2</sup> because of the production of a precipitate of hydrous oxide at the cathode and the liberation of chlorine at the anode.

These difficulties are overcome when solutions of certain rare earth acetates in aqueous potassium citrate are used as electrolytes. Such solutions may be made alkaline without causing precipitation of rare earth hydrous oxide.

\* Private laboratory, 1226 Westchester Place, Los Angeles, Calif.; deceased.

† Northwestern University, Evanston, Ill.

A low voltage suffices for the electrolysis, and little heat is generated since the solution conducts exceptionally well.

Europium amalgam is very easily prepared by this method. Simultaneously, some potassium amalgam is formed. After the electrolysis, the latter may be removed nearly completely by action of water, which scarcely attacks europium amalgam as long as any potassium amalgam\* remains. Ytterbium and samarium are the only other rare earth metals that yield amalgams by the electrolysis of their acetate-citrate solutions. The electrical efficiency is high for europium, considerably less for ytterbium, and small for samarium.

A practical method for the separation of europium (as amalgam) from accompanying rare earths is given below after the description of the method in which the starting material is a pure europium compound.

#### A. PREPARATION OF EUROPIUM AMALGAM

##### Procedure

To prepare europium(III) acetate from a solution of a soluble europium salt, the oxalate is first precipitated from an acidified dilute solution of a soluble europium(III) salt at 50 to 70° by the slow addition of a 5 per cent solution of oxalic acid while the reaction mixture is stirred. The amorphous precipitate first formed soon becomes crystalline. It is filtered and washed with water and methanol. The product is converted to the oxide by ignition in a muffle furnace at 900°.

Five grams of europium oxide is dissolved in a small excess (20 ml.) of boiling 25 per cent acetic acid. The concentrated acetate solution (which will deposit well-formed crystals if cooled) is neutralized with potassium carbonate.

Tertiary potassium citrate is prepared by neutralizing

\* When potassium amalgam is stirred with europium acetate-citrate solution for 30 to 60 minutes, europium amalgam is formed.

20 g. of citric acid in 64 ml. of water with 21.6 g. of anhydrous potassium carbonate. The solutions of acetate and citrate are mixed, and the resulting solution is made distinctly alkaline to litmus by adding 2.5 g. more of potassium carbonate.

The mixed solution is introduced into an electrolytic cell (Fig. 2) consisting of a 150-ml. pyrex beaker to which a piece of small-bore tubing has been sealed. By means of the latter, contact is made with the 200 g. of mercury that forms the cathode. The anode is a spiral of platinum wire or a platinum plate. Provision is made for gentle stirring by a motor-driven stirrer and for cooling with water to keep the temperature of the solution below 25°. A source of current at a potential of 6 to 8 volts is connected through a rheostat and an ammeter. A current density of 0.04 to 0.06 amp./sq. cm. of cathode surface (1 to 2 amp.) is maintained throughout the electrolysis.

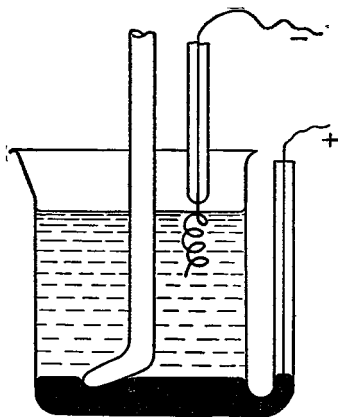

FIG. 2.—Electrolytic cell for producing europium amalgam.

Electrolysis is continued until the solution no longer bleaches litmus paper because of the presence of europium(II) salts (1 to 2 hours). The electrolyte should then be decanted and the amalgam washed with water. Contact of the amalgam with water for 1 or 2 hours will convert practically all the potassium in the amalgam to the hydroxide. During this period, hydrogen is given off slowly. If any europium reacts with water, it will appear as hydrous oxide and may readily be recovered by filtering the aqueous layer.

If the potassium-free amalgam contains more than 1.38 per cent of europium, a solid crystalline alloy,  $\text{Hg}_{10}\text{Eu}$ ,

will form. This may be separated by filtering the amalgam through a sintered glass filter.\*

### Properties

Treatment of the liquid or solid amalgam with hydrochloric or acetic acid causes liberation of hydrogen, with formation of a light greenish-yellow solution of europium(II) chloride or acetate. Such solutions are strong reducing agents,<sup>4</sup> as indicated by their ability to bleach litmus paper instantly. The europium(II) ion is converted by oxidizing agents such as hydrogen peroxide to the nearly colorless europium(III) ion.

The purity of a europium preparation may be tested by observing its absorption spectrum. In a 5- to 10-cm. layer a dilute solution of a europium(III) salt shows two sharp bands at about 4650 and 5350 Å. In a chloride solution these bands are of about equal intensity. In an acetate solution the latter band is approximately as strong as in the chloride solution, but the band at 4650 Å. is greatly enhanced. A number of weaker bands<sup>5</sup> are also visible in concentrated europium(III) solutions.

Europium(II) solutions show no characteristic absorption bands<sup>4</sup> in the visible; instead, light of lower wave length than 4600 Å. is largely absorbed.

The purity of a europium preparation may also be checked iodometrically<sup>4</sup> by titrating a europium(II) chloride solution prepared from a weighed portion of the oxide.

## B. SEPARATION OF EUROPIUM FROM OTHER RARE EARTHS

### Procedure

From a partly refined rare earth mixture, europium, practically free from other rare earths, may be recovered

\* Distillation of solid or liquid europium amalgam in a high vacuum produces a second solid alloy,  $\text{Hg}_2\text{Eu}_3$ , which is fairly stable at red heat. Further heating of this alloy does not readily yield metallic europium since the latter is volatile in a high vacuum at the temperature at which the alloy is decomposed.

readily as an amalgam if the mixture contains 5 per cent or more of europium.<sup>7</sup>

In practice, ytterbium, which also forms an amalgam, need not be considered, since it will have been eliminated at an earlier stage in the separation of the rare earths.<sup>6</sup> Samarium does not interfere if the electrolysis is stopped at the point at which the solution ceases to bleach litmus.

The required rare earth acetate-citrate solution is prepared from the crude material as described in part A for a pure europium compound. The electrolytic cells may be increased in size to handle any required quantity of solution. Electrolysis is carried out under conditions paralleling those described in part A.

#### References

1. JUKKOLA, AUDRIETH, and HOPKINS: *INORGANIC SYNTHESSES*, **1**, 15 (1939).
2. HOPKINS and AUDRIETH: *Trans. Am. Electrochem. Soc.*, **66**, 135 (1934).
3. MCCOY: *J. Am. Chem. Soc.*, **63**, 1622 (1941).
4. MCCOY: *ibid.*, **58**, 1577 (1936); **59**, 1131 (1937); **61**, 2455 (1939).
5. FRIEND: "Inorganic Chemistry," LITTLE, Vol. 4, p. 289, Charles Griffin & Company, Ltd., London, 1921.
6. MARSH: *J. Chem. Soc.*, **1937**, 1367.
7. MCCOY: *J. Am. Chem. Soc.*, **63**, 3432 (1941).

## 19. EUROPIUM(II) SALTS

SUBMITTED BY ROBERT A. COOLEY\* AND DON M. YOST\*

CHECKED BY HOSMER W. STONE†

The reduction of europium(III) to europium(II) may be accomplished simply with a Jones reductor<sup>1</sup> or, more elaborately, by the action of hydrogen on the chloride at 700°.<sup>2</sup> In the three procedures below the preparation of (1) europium(II) sulfate, (2) europium(II) carbonate, and (3) europium(II) chloride are described. Fortunately, these europium salts when dry are not appreciably oxidized by dry air and hence may be handled and stored conveniently. The first procedure is based on the preparation of insoluble europium(II) sulfate after reduction of europium(III) in

\* California Institute of Technology, Pasadena, Calif.

† University of California, Los Angeles, Calif.

a Jones reductor. The second procedure depends upon the conversion of the washed europium(II) sulfate to carbonate according to the reversible metathetic reaction,

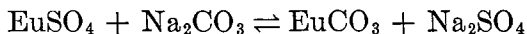

The third procedure involves treating dry europium(III) chloride in a quartz boat at about  $700^\circ$ , with an approximately equimolal mixture of dry hydrogen and hydrogen chloride to prepare europium(II) chloride.

### Procedure

#### A. EUROPIUM(II) SULFATE

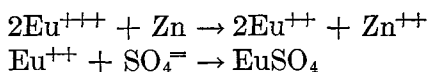

About 3.5 g. of europium oxide,  $\text{Eu}_2\text{O}_3$ , is dissolved in 5.4 ml. of 6 *M* hydrochloric acid to give, on dilution, about 200 ml. of solution 0.10 *M* with respect to europium(III) and hydrochloric acid. A Jones reductor containing 20- to 30-mesh amalgamated zinc\* in a column 40 cm. high and 2 cm. in diameter is flushed out with 200 ml. of 0.10 *M* hydrochloric acid. Sufficient acid is left in the column just to cover the zinc. The outlet of the reductor is then dipped into 50 ml. of 8 *M* sulfuric acid in a 600-ml. beaker covered with a paper disc. A stream of carbon dioxide is passed into the beaker to ensure the exclusion of air. The europium(III) chloride solution is passed slowly (at a rate of approximately 2 ml./min.) through the reductor and is followed by a wash solution of 150 ml. of 0.10 *M* hydrochloric acid. A feathery or tuftlike white precipitate, the  $\alpha$ -modification of europium(II) sulfate, is formed at first. The mixture is heated under carbon dioxide to  $80^\circ$ , whereupon the  $\alpha$ -form changes to the more stable  $\beta$ -form, which is dense and crystalline and settles to a compact mass.

\* The amalgamated zinc should contain 1 per cent of mercury: 60 ml. of saturated mercuric chloride (about 0.25 *M*) to 300 g. of zinc. See Stone and Hume, *Ind. Eng. Chem., Anal. Ed.*, **11**, 598 (1939).



The  $\beta$ -form, unlike the  $\alpha$ -form, is only slightly soluble in sulfuric acid solution. The mixture containing the dense white europium(II) sulfate is cooled and filtered. The precipitate is washed with dilute hydrochloric acid and then with a few milliliters of methyl alcohol containing hydrogen chloride. An atmosphere of carbon dioxide is not required during the filtration. The final product is dried in air at 75°. Yield 4.4 g. (90 per cent). *Anal.* 99.7 per cent purity (acid iron(III) sulfate-permanganate titration).

### B. EUROPIUM(II) CARBONATE

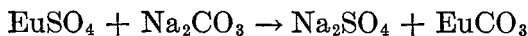

To 300 ml. of a vigorously boiling\* solution that is normal with respect to sodium carbonate and 0.4 *N* in sodium hydroxide (12.6 g.  $\text{NaHCO}_3$  + 10.8 g.  $\text{NaOH}$ ), about 5 g. of dry europium(II) sulfate as prepared above is added gradually. Shortly after the addition, the mixture becomes dark in color; but on continued boiling the dark color disappears, and a lemon-yellow, dense, crystalline precipitate of europium(II) carbonate† forms. The europium(II) carbonate is filtered and dried in air at 75°. Yield 90 per cent. *Anal.* Nearly 100 per cent (iodine-thiosulfate titration).

### C. EUROPIUM(II) CHLORIDE

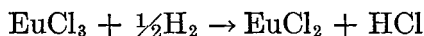

About 3 g. of dry europium(III) chloride<sup>3</sup> in a quartz boat‡ is introduced into a vitrified quartz tube,§ and the

\* Boiling rids the solution of dissolved oxygen, which rapidly oxidizes europium(II) ion.

† Treatment of larger quantities requires removal of the first amount of sulfate ion formed and renewal of the carbonate ion used up.

‡ Platinum is not suitable because it is attacked to a greater extent by the molten salt than is quartz.

§ Pyrex combustion tubing has been found to be satisfactory.

tube is placed in an electric furnace. A stream of a 1:1 mixture of hydrogen gas and hydrogen chloride gas is passed through the tube,\* and the temperature is raised first to 120° for 20 minutes and then slowly (1 hour) to 700°. The heating is continued for 2 hours at 700°. The furnace is then turned off, and when it is cool the hydrogen-hydrogen chloride atmosphere is replaced by one of nitrogen dried over phosphorus(V) oxide or barium oxide.

Figure 3 depicts a convenient apparatus for carrying out the above procedure. The introduction of tank hydrogen

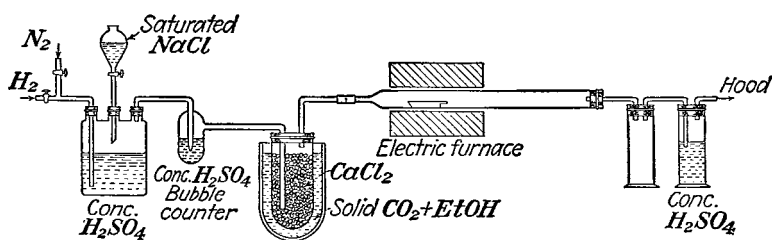

FIG. 3.—Apparatus for the preparation of europium(II) chloride.

or nitrogen may be controlled by stopcocks as indicated at the left of the diagram. Hydrogen chloride gas is formed by dropping a saturated solution of sodium chloride into sulfuric acid.<sup>4</sup> The bubble counter filled with concentrated sulfuric acid is used as follows: Hydrogen gas is introduced through the counter at the rate of one bubble per second, and then the rate of formation of hydrogen chloride gas is regulated so that the rate of flow of the gas mixture through the counter is two bubbles per second. Water in the gas is removed when it reaches the trap, containing freshly fused calcium chloride mixture immersed in a solid carbon dioxide-alcohol bath. A thermocouple wrapped in asbestos paper and placed between the furnace and quartz tube

\* To avoid any possibility of a hydrogen-oxygen explosion, the introduction of the hydrogen gas mixture should precede turning on the furnace, and the hydrogen gas mixture should be replaced by nitrogen before removing the quartz boat.

indicates the temperature. Yield 100 per cent. The purity of europium(II) chloride prepared in this manner is such that the salt has been used for the determination of the atomic weight of europium.

### Properties

Europium(II) sulfate is a white microcrystalline salt of density 4.98 at 25°. It is isomorphous with strontium and barium sulfates and is only slightly soluble in water.

Europium(II) carbonate is a lemon-yellow, dense granular salt that is insoluble in water but soluble in hydrochloric acid. This compound is important because practically any europium(II) compound may be obtained from it by reaction with the appropriate acid.

Europium(II) chloride is a white solid having a bluish cast. Its density is 4.87 at 25°.

### References

1. McCoy: *J. Am. Chem. Soc.*, **57**, 1756 (1935); **58**, 1577, 2279 (1936).
2. BAXTER and TRUEMMLER: *ibid.*, **59**, 1131 (1937); **60**, 602 (1938).
3. REED, HOPKINS, and AUDRIETH: *INORGANIC SYNTHESSES*, **1**, 28 (1939).
4. MAXSON [*INORGANIC SYNTHESSES*, **1**, 147 (1938)] gives an alternate method for preparing hydrogen chloride.

## CHAPTER IV

See also: Metallic carbonyls, syntheses 74 to 77      Alkali metal selenocyanates, synthesis 56  
Cyanometallates, syntheses 62, 67, 72, 73, 78      Europium(II) carbonate, synthesis 19B

### 20. SUGAR CHARCOAL

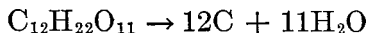

SUBMITTED BY GEORGE G. MARVIN\*

CHECKED BY HAROLD S. BOOTH† AND ALBERT DOLANCE†

Charcoal prepared from sugar has long been used when a pure form of carbon is desired. The preparation of this material by treatment of sugar with concentrated sulfuric acid involves long, tedious washing operations and yields a product of questionable purity. The following method has been found to give a product of high purity in a minimum of time.

#### Procedure

Approximately 100 to 150 g. of pure cane sugar is weighed into a 1200-ml. casserole. The casserole is placed in an electric muffle furnace heated to a temperature of about 800°. The sugar melts, then chars, and volatile products start to burn. The casserole is removed from the furnace and the burning mass is stirred with a long quartz rod to minimize frothing. When the contents cease burning, the casserole is put back into the muffle furnace and heated until the mass begins to solidify into a bulky, porous product. After no more volatile matter is evolved from the solid mass, the casserole is removed from the furnace

\* Massachusetts Institute of Technology, Cambridge, Mass.

† Western Reserve University, Cleveland, Ohio.

and allowed to cool. Heating after the mass has solidified will result only in burning off some of the charcoal to give lower yields.

After the charcoal has cooled, it may easily be removed from the casserole and ground in an agate mortar. It is then sifted to size and stored for use. The grinding of this charcoal to pass a 100-mesh screen is slow but necessary for certain types of work. A yield of about 12 g., corresponding to about 30 per cent of the theoretical, is readily obtainable.

## 21. MONOSODIUM ACETYLIDE

### (Ethylnsodium)

SUBMITTED BY K. W. GREENLEE\* AND A. L. HENNE\*

CHECKED BY W. CONARD FERNELIUS†

Monosodium acetylide (or more simply sodium acetylide) is an important reagent in the synthesis of many organic compounds.<sup>1a</sup> Only a few of the many possible reactions of this reagent with inorganic compounds have been studied.<sup>1b</sup> Sodium acetylide may be prepared by heating sodium in a stream of acetylene gas<sup>2</sup> or by the reaction of acetylene with sodium<sup>3,4</sup> or sodium amide<sup>5</sup> in liquid ammonia. In the direct reaction of acetylene with sodium in liquid ammonia, various methods have been used to increase the absorption rate. The reaction mixture may be chilled, or the ratio sodium: acetylene may be kept low by the slow addition of the sodium as an ammonia solution<sup>6</sup> or by the gradual immersion of a block of sodium into the reaction mixture at a measured rate.<sup>7</sup> These techniques are superfluous if a reflux condenser cooled with dry ice is used,<sup>8</sup> as described in synthesis 38. Gaseous acetylene that does not react in the first pass through the reaction vessel is dissolved and returned to the vessel by the condensing ammonia. Loss of acetylene, by reduction to

\* The Ohio State University, Columbus, Ohio.

† Purdue University, West Lafayette, Ind.

ethylene,<sup>3</sup> can be minimized by reaction with sodium amide instead of sodium. This procedure is especially desirable in preparing the sodium derivatives of alkylacetylenes, which cannot be purchased and are expensive to synthesize.<sup>9,10</sup>

## Procedure

### A. PURIFICATION OF REAGENTS

Analysis of crude acetylene and its purification for laboratory purposes have been reviewed elsewhere.<sup>1</sup> For most purposes, tank acetylene may be used after merely scrubbing out the acetone used as a solvent.\*

The gas is passed through concentrated sulfuric acid in two 1-liter widemouthed bottles (half full), an empty trap, and a tower containing soda lime (for absorbing sulfur dioxide) and calcium chloride. The glass tubing and the connecting rubber tubing should have an internal diameter of 6 to 8 mm., in order to pass large volumes of gas even at low tank pressure, and a mercury-filled safety trap should be attached somewhere along the line to release pressure in case of plugging.

Commercial ammonia in small tanks is usually quite pure, but certain grades contain appreciable amounts of water and oil. These are completely eliminated by boiling the ammonia into the reactor from another container to which a little sodium has been added.

Commercial sodium is pure enough for most purposes. It is prepared for use as described in synthesis 38.

### B. SODIUM ACETYLIDE FROM SODIUM AND ACETYLENE

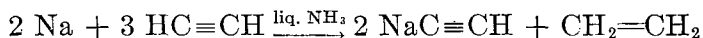

An apparatus identical with that used for the preparation of sodium amide (synthesis 38) is set up, with a three-

\* For example, acetylene supplied by the National Cylinder Gas Company is usually 99.6 to 99.7 per cent pure and gives no test for such substances as phosphine and arsine.

necked flask of a size appropriate to the amount of product desired. If a flask large in proportion to the batch size is used, the ceiling is far enough from the surface of the reaction mixture to minimize deposition of solids by splashing.

If a 12-l. flask is used, 5 l. of ammonia is liquefied in it, as indicated by a ring previously marked on the outside of the flask. Then 20 g.-atoms of sodium in lumps of any convenient size is carefully added. If the sodium is in many pieces, it is best to pour them in rapidly through the center neck; otherwise, after some have dissolved, the remainder may cause the sodium solution to splash. Alternatively, the sodium may be placed in the flask and the ammonia liquefied over it if the ammonia is not introduced in a violent stream, which, again, would splash sodium solution. The stirrer, which must have a narrow sweep to avoid interference with the acetylene inlet tube, should be run slowly until the sodium is dissolved; there is danger of jamming and breaking the stirrer as long as solid lumps are present.

A stream of acetylene is then introduced through a tube supported by a rubber stopper.\* This tube is curved to fit the inner contour of the flask and is of the same internal diameter as the tubing in the purification train. With the acetylene thus discharged directly beneath the stirrer turning at a moderate rate, absorption is much more rapid than if the gas were simply introduced into the space above the sodium solution.

A rapid stream of acetylene should be passing through the tube as it is inserted and continuously thereafter until it is removed, or it may become plugged by solids deposited by the ammonia solution. Flow rates of 15 to 30 l. of acetylene per minute are easily attained unless the tank pressure is low, but it may seem desirable to run more slowly to minimize splashing.

\* Apparatus with ground-glass joints is not recommended because the joints may be attacked by alkali and frozen in.

For every 3 volumes of acetylene introduced, approximately 1 volume of ethylene, with a little ammonia and acetylene, escapes through the condenser and may be observed in a bubbler. When all the sodium has reacted, the evolution of gas ceases, but this does not indicate the end of the reaction, for 5 to 20 per cent of the sodium is in the form of insoluble disodium acetylide, which makes the reaction mixture milky. The addition of acetylene is continued until a clear solution of sodium acetylide\* remains. During this period the stirrer is run at high speed to wash as much sodium from the walls as possible, though this is at the expense of depositing more sodium acetylide. Observation of the contents of the flask is usually difficult because of these deposits; sometimes the only unobscured surfaces of the flask are the sides of the center neck.

If acetylene is added past the end point, some dissolves (about  $\frac{1}{2}$  mol per liter of solution) and then begins to escape through the condenser; this may serve to indicate that the reaction is complete. Presence of the dissolved excess of acetylene is a drawback only when the purpose is to prepare a low-boiling acetylenic hydrocarbon, such as propyne or butyne.

The sodium acetylide solution thus prepared may be used for a variety of organic syntheses by the addition of alkyl halides, sulfates, sulfonates, ketones, aldehydes, and esters. Where a fine suspension of the dry acetylide is desired in an inert solvent such as ether or a hydrocarbon, the solvent is added to the ammonia solution and the mixture is stirred while the ammonia is evaporated. Extra solvent must be used to replace that entrained by the ammonia, the last traces of which are removed by a period of refluxing. Such a suspension gives better yields of, for example, propiolic acid (by the reaction with carbon dioxide) than sodium acetylide prepared in any other way.

When it is desired to isolate the dry sodium acetylide in a pure state, the reactor is dismantled. Only one neck at a

\* The saturated solution at  $-34^{\circ}$  is about 4.1 *M*.



time is opened. The necks are closed with rubber stoppers one of which bears a 4- to 6-mm. delivery tube for attachment to a vacuum line. The flask is removed from its insulation and placed in a warm place, preferably in a current of warm air; the ammonia is allowed to evaporate overnight\* through the delivery tube whose small diameter minimizes the chance of back diffusion of moist air. Then a vacuum is drawn on the flask for 10 minutes to remove the remaining ammonia. The vacuum is broken with dry air or nitrogen. The brittle, powdery cake of acetylide is broken up with a roughly pointed wooden stick (a broom-stick sawed off at an oblique angle serves well) inserted through the center neck. Meanwhile, it is desirable to pass in dry air or nitrogen through a side neck to blanket the solid product. The stoppers are then replaced, and a vacuum is drawn again for one to several hours. Removing the last traces of ammonia is difficult; careful heating to 50 to 60° during evacuation speeds the process. The product, a mass of lumps and powder, is poured from the flask, which may then be used to repeat the process without being cleaned. In exactly the same manner, disodium acetylide or sodium alkylacetylides may be utilized in solution or isolated free of solvent.

### C. SODIUM ACETYLIDE FROM SODIUM AMIDE AND ACETYLENE

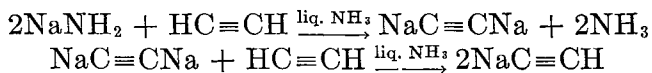

Sodium acetylide prepared by this method is identical with that made as in part B except that it contains slight impurities introduced in the sodium amide, chiefly decomposition products of the iron salt catalyst. However, since preparation of sodium amide is not attended by much splashing, this method leaves less unreacted sodium on the

\* A longer time may profitably be allowed if a drying tube with barium oxide is attached to the delivery tube.

walls of the flask, and there is less danger of partly reducing some product, such as an alkylacetylene, derived from the sodium acetylide. More manipulation and a somewhat longer time may be required, but in practice this method is more adaptable and somewhat less troublesome. By metering in just sufficient acetylene for the first reaction, disodium acetylide is obtained;<sup>11,12</sup> liquid alkylacetylenes are added by a dropping funnel for conversion to sodium alkylacetylides.

The sodium amide (20 mols) is prepared in 5 l. of liquid ammonia in a 12-l. flask by the procedure described in synthesis 38, then acetylene is introduced exactly as in part B. No gas is evolved through the condenser, and the reaction mixture becomes milky with insoluble disodium acetylide, which masks the dark color imparted by colloidal iron. The milky appearance persists until the theoretical amount of acetylene has been added, when the original deep-brownish or black iron color appears. Acetylene is absorbed for a few minutes longer, to saturate the ammonia solution, and is then discharged through the condenser as a final indication that the reaction is complete.

The ammonia solution may be used directly in various syntheses, or the sodium acetylide may be isolated as described in part A.

### Properties

Sodium acetylide prepared by these methods is a white to yellowish friable solid. It is gray if made from sodium amide containing iron. It deliquesces slowly in moist air but seems inert to dry air at room temperature. Disodium acetylide is similar in appearance. These substances may be stored in tightly capped bottles under dry air or nitrogen for long periods without noticeable change. After long storage, sodium acetylide can be redissolved in liquid ammonia and used for the same purposes as freshly prepared material, though the solution may show a slight turbidity due to absorption of moisture.

Sodium acetylide is said to disproportionate to disodium acetylide and acetylene when heated to 160 to 210° under reduced pressure; disodium acetylide is stable to a much higher temperature, finally decomposing into sodium and carbon. It has been repeatedly observed that when sodium acetylide is heated to about 150° at atmospheric pressure an extensive decomposition occurs. This proceeds spontaneously and gases are evolved that catch fire in the air (owing to pyrophoric carbon). A black residue remains that is still very reactive.

#### References

1. a. VOGT AND NIEUWLAND: "The Chemistry of Acetylene," Reinhold Publishing Corporation, New York, 1945.  
b. *ibid.*, p. 49.
2. MOISSAN: *Compt. rend.*, **126**, 302 (1898).
3. *Ibid.*, **127**, 911 (1898).
4. LEBEAU AND PICON: *Compt. rend.*, **156**, 1077 (1913).
5. PICON: *Bull. soc. chim.*, [4] **29**, 709 (1921).
6. VAUGHN, HENNION, VOGT, and NIEUWLAND: *J. Org. Chem.*, **2**, 1 (1937).
7. HENNION: *Proc. Ind. Acad. Sci.*, **47**, 116 (1937).
8. GREENLEE: dissertation, The Ohio State University, 1942.
9. LEBEAU and PICON: *Compt. rend.*, **157**, 137 (1913).
10. HENNE and GREENLEE: *J. Am. Chem. Soc.*, **65**, 2020 (1943).
11. BRIED and HENNION: *ibid.*, **59**, 1310 (1937).
12. HENNE and GREENLEE: *ibid.*, **67**, 484 (1945).

## 22. CARBON MONOXIDE

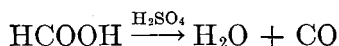

SUBMITTED BY W. L. GILLILAND\* AND A. A. BLANCHARD†

CHECKED BY C. M. MASON‡§ AND ROBERT L. BARNARD† AND BY CORNELIUS GROOT|| AND WARREN C. JOHNSON||

Carbon monoxide is prepared in tremendous quantities for industrial use by the water-gas reaction, by the partial oxidation of carbon or hydrocarbons, and by the reduction of carbon dioxide. These methods are not suitable for

\* University of Maine, Orono, Maine; present address: Purdue University, West Lafayette, Ind.

† Massachusetts Institute of Technology, Cambridge, Mass.

‡ University of New Hampshire, Durham, N. H.

§ Present address: U. S. Bureau of Mines, Tuscaloosa, Ala.

|| University of Chicago, Chicago, Ill.

small-scale operation; therefore, the gas is usually prepared for laboratory work by the dehydration of oxalic or formic acid.

On the industrial scale, carbon monoxide is used as a reducing agent in metallurgical operations, in the refining of metallic nickel, in the synthesis of phosgene, and in the synthesis of a wide variety of organic compounds. In the laboratory, it is used in the preparation of carbonyls and aromatic aldehydes.

### Procedure

*(Caution. In handling carbon monoxide it should always be borne in mind that this gas is extremely poisonous. Since it is odorless, it gives no warning of its presence. All work with carbon monoxide should therefore be carried out under a well-ventilated hood. A convenient way to dispose of carbon monoxide is to insert the exit tube into the air inlet at the base of a lighted Meker burner.)*

The apparatus shown in Fig. 4 is very convenient for generating carbon monoxide. The reservoir and generator are conveniently fashioned from 750- or 1000-ml. flasks.

The cocks are opened and sufficient 6 *N* NaOH nearly to fill the carbon monoxide reservoir is poured through the leveling bulb. Water is drawn into the measuring buret and when the surface of the water is at the zero level, the screw clamp is closed. About 30 ml. of concentrated sulfuric acid is placed in the filling cup. The leveling bulb is lowered so that sulfuric acid will run into the generating flask. Likewise, about 1 ml. of 85 per cent formic acid is admitted from the other filling cup. This will generate nearly 500 ml. of carbon monoxide. The process is repeated with several small additions of formic acid to flush the air out of the apparatus. When the generation of gas becomes sluggish, the heater is turned on. Fuming sulfuric acid should be used for further additions of dehydrating agent. Occasionally spent liquor is drawn off, but always as much as 30 ml. is left in the generator bulb.

Five grams of pyrogallic acid is dissolved in enough water to fill the tube of glass beads about one-half full, and the solution is drawn up into that tube. Then sufficient 6 *N* NaOH is drawn into the tube to fill it to the indicated level, and the screw clamp is closed. This sodium pyrogallate solution removes any traces of oxygen, as well as carbon dioxide or other volatile acids.

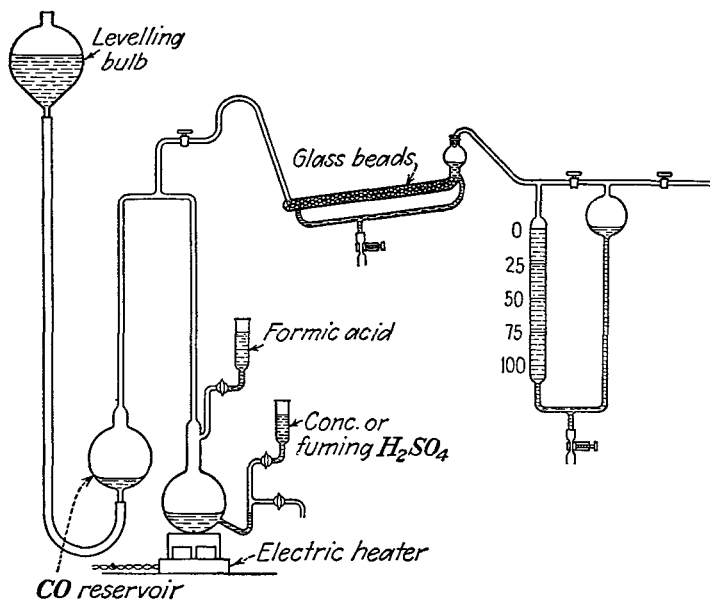

FIG. 4.—Apparatus for the preparation of carbon monoxide.

The heater should be turned off when the generator is not in use but should always be turned on again to anticipate any sudden demand for the gas.

This generator may be used for both steady and intermittent withdrawals of carbon monoxide gas. It is particularly useful when attached to a closed absorption apparatus whose contents are slowly absorbing carbon monoxide. When dry carbon monoxide is desired, a tube containing a suitable desiccant may be attached to the apparatus.

The metering device attached to the generator in Fig. 4 is manipulated in the following manner. The middle stopcock and the screw clamp at the bottom are opened. Water is sucked into the buret and the bulb until the level is at the zero mark on the buret. Then the screw clamp is closed. The middle stopcock is now closed, the right-hand one opened, and the gas allowed to bubble through the meter until the air is swept out. Next, the right-hand stopcock is closed, the center one opened, and the water permitted to take its proper level at the zero mark on the buret. Finally, the center stopcock is closed, the right-hand one opened, and the flow of gas to the absorption vessel is started. When the water level has descended to the limit of graduation, the right-hand stopcock is closed quickly, the middle one opened, and the buret permitted to refill with water to the zero mark. Upon closing the middle stopcock and opening the right-hand one, metering is resumed.

### Properties

The physical properties of carbon monoxide and nitrogen are strikingly similar:

	CO	N <sub>2</sub>
Melting point.....	-200°	-210°
Boiling point.....	-190°	-196°
Density (liquid).....	0.793	0.796
Critical temperature.....	-140°	-146°
Critical pressure, atm.....	36	35
Critical volume, cc.....	5.05	5.17

This resemblance has been attributed to the fact that the two gases have closely related electronic structures.

Chemically, carbon monoxide is reactive. It forms coordination compounds with some of the metals and with many salts. It also combines readily with the more reactive nonmetals, such as oxygen and chlorine. When

inhaled, it combines with the hemoglobin of the blood, rendering it incapable of acting as an oxygen carrier.

### 23. AMMONIUM CARBAMATE

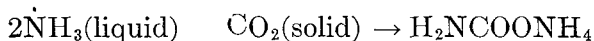

SUBMITTER J. A. BROOKS\* AND L. F. AUDRIETH\*

CHECKED BY H. BLUESTONE† AND WARREN C. JOHNSON‡

Ammonium carbamate has been prepared by the direct combination of ammonia and carbon dioxide in the gas phase and also in cooled inert solvents such as absolute alcohol and petroleum ether.<sup>1</sup> The direct laboratory preparation from readily available Dry Ice and liquid ammonia offers a convenient source of ammonium carbamate. It is interesting to note that under other conditions these same reactants produce urea.

Ammonium carbamate may be used as an ammoniating agent where a reagent less vigorous than ammonia is desired.

#### Procedure

About 400 ml. of anhydrous liquid ammonia is placed in a 1-liter pyrex Dewar flask,‡ preferably unsilvered for visual observation. Dry Ice is powdered and added slowly, yet as rapidly as feasible, to the liquid ammonia.§ Addition of solid carbon dioxide is continued until the mixture attains a slushy consistency. The excess of ammonia is then allowed to evaporate, leaving the car-

\* University of Illinois, Urbana, Ill.

† University of Chicago, Chicago, Ill.

‡ These vacuum flasks are obtainable from the American Thermos Bottle Co., Norwich, Conn. Unsilvered flasks of ordinary glass may also be used, but these do not withstand the repeated temperature changes as well as those made of pyrex.

§ Care should be taken both in the powdering of the dry ice and in its addition to ammonia to prevent absorption of moisture. This is best accomplished by keeping the Dry Ice in a suitable container and powdering it in small portions as it is needed. Condensation of moisture at the surface of the liquid ammonia can be prevented by closing the flask with a stopper fitted with a bent capillary tube, which serves as an ammonia vapor trap.

bamate as a lumpy residue. This material is transferred to a desiccator and kept under slightly reduced pressure for 24 hours. It is transformed, through loss of excess ammonia and dissociation of some ammonium carbamate, into a powdery product. When the quantities of ammonia specified above are used, 200 to 300 g. of ammonium carbamate can be prepared. *Anal.* Calcd. for  $\text{H}_2\text{NCO}_2\text{NH}_4$ : N, 35.9. Found: N, 35.3, 35.2.

### Properties

Ammonium carbamate is obtained as a fine crystalline powder, slightly volatile at room temperature and completely dissociated at  $59^\circ$ . It is very soluble in water but, in solution or on standing in moist air, it undergoes hydration to ammonium carbonate:



A solution of ammonium carbamate may be distinguished from one of ammonium carbonate by adding a drop or two of a soluble calcium salt. No immediate precipitate is observed; but, after standing or heating, hydration occurs, resulting in the precipitation of calcium carbonate.

### Reference

1. For a complete review, with bibliography, of the properties and reactions of ammonium carbamate see Gmelin, "Handbuch der anorganischen Chemie," 8th ed., No. 23, pp. 348-362, Verlag Chemie G.m.b.H., Berlin, 1936.

## 24. ALKALI METAL CYANATES



SUBMITTED BY ALLEN SCATTERGOOD\*

CHECKED BY DON R. McADAMS† AND JAMES P. McREYNOLDS‡

Potassium cyanate has been prepared by the oxidation of potassium cyanide by many reagents,<sup>1</sup> by fusion of

\* Union Junior College, Roselle, N.J.

† The Ohio State University, Columbus, Ohio.

‡ Deceased.



potassium hexacyanoferrate(II) with various oxidizing agents,<sup>2</sup> and by other less important methods. The hydrolysis that cyanates undergo in hot aqueous solution makes isolation of pure potassium cyanate difficult when prepared by any of these methods. According to the patent literature, alkali metal cyanates may be prepared by heating alkali metal carbonates with urea.<sup>3</sup> Since these starting compounds are inexpensive, this method was developed in order to obtain a pure product.

### Procedure

#### A. POTASSIUM CYANATE

Seventy grams (0.5 mol) of finely powdered anhydrous potassium carbonate (U.S.P.) and 80 g. (1.3 mol) of urea are thoroughly mixed. The mixture, in a porcelain evaporating dish, is heated (under the hood) with a burner whose flame is gradually increased until the full flame is utilized. The mixture is pressed down from time to time but should not be stirred since this increases the mechanical loss. Partial melting occurs, with the evolution of much ammonia. The mixture then becomes nearly solid and finally remelts, forming a clear liquid, which may be brownish if dust is present. As soon as the melt is quiescent and the surface is nearly free of bubbles, the flame should be turned down and the test for carbonate made (see section on tests, page 89). If the melt is not carbonate-free, 1 g. of urea should be stirred in and the mixture heated until gas evolution has ceased. Prolonged heating of the fused cyanate should be avoided as it gradually changes to potassium carbonate under these conditions. As soon as the melt has been found to be carbonate-free, the molten substance is poured into a dry mortar, which is swirled until the crystals begin to adhere to the sides. The product is easier to grind while it is still hot. The yield of crude potassium cyanate is 74 g. (94 per cent). The losses are mainly mechanical.

The crude potassium cyanate is satisfactory for many purposes. However, an aqueous solution of this product should be filtered before use. The crude product may be purified by a careful recrystallization. **Caution.** *It must be remembered that potassium cyanate in aqueous solution hydrolyzes slowly, even at room temperature, forming ammonium and carbonate ions. If the temperature limit is exceeded or the work is not carried out promptly, the recrystallized product may be less pure than the starting material.*

Fifty grams of finely powdered crude potassium cyanate is stirred mechanically with 50 ml. of water at 50° until most of the solid has dissolved. Glacial acetic acid (10 to 20 drops) is added until the solution is neutral to phenolphthalein. The warm solution is then quickly filtered into a 500-ml. flask. Five milliliters of water at 50° is used to rinse out the apparatus. The filtrate is treated with 250 ml. of alcohol. After thorough mixing, the flask containing the crystalline slush is placed in a refrigerator overnight. The crystals are then removed on a Büchner funnel and washed with alcohol. The crystals must be dried thoroughly over barium oxide or a similar desiccant to prevent partial hydrolysis and the formation of ammonia on storage. Yield 40 g. (80 per cent).

#### B. SODIUM CYANATE

A mixture of 26.5 g. (0.25 mol) of finely powdered anhydrous sodium carbonate\* and 35 g. (0.58 mol) of urea is heated in a tall-form crucible as rapidly as possible with two Méker or similar burners. Sodium cyanate melts at a higher temperature than potassium cyanate; therefore, smaller quantities are used, and stronger heating is necessary. Otherwise, the fusion operation is the same as that for potassium cyanate. It is difficult to obtain a carbonate-free melt of sodium cyanate, but the carbonate may be

\* A photographic grade should be used since washing soda gives a brown product.

eliminated by a single recrystallization. Yield 28 to 32 g. (86 to 98 per cent).

Since sodium cyanate is less soluble in water than potassium cyanate, the soluble impurities are more easily removed by crystallization. Further, because an alcohol precipitation would require more alcohol per gram for sodium cyanate than for potassium cyanate, the recrystallization is made from water alone. The yield is lower but the product is pure.

A solution of sodium cyanate is made by mechanically stirring the finely powdered material with water at 50° (100 ml. of water for each 15 g. of material). Glacial acetic acid is added until the solution is neutral to phenolphthalein. After filtration, the solution is allowed to stand in a refrigerator for a few hours. Then the crystals are collected and washed with alcohol. Yield 5 g. (33 per cent). The substance is thoroughly dried in a vacuum desiccator to avoid partial hydrolysis on storage.

### Qualitative Tests

**Carbonate.** The tip of a glass rod is touched to the surface of the cyanate melt, and the cap of solid that forms is dissolved in 2 ml. of distilled water. Ten drops of 0.1 *M* barium nitrate is added. The presence of carbonate ion is indicated by the formation, within a minute, of a precipitate of barium carbonate.

**Ammonium Ion and Urea.** To a solution of 0.1 g. of the cyanate in 2 ml. of distilled water is added a few drops of 0.1 *M* mercury(II) chloride solution. The mixture is then made alkaline with sodium hydroxide solution. If a white precipitate is obtained, ammonium ion or urea is present, or both. A yellow precipitate of mercury(II) oxide indicates the substantial absence of these impurities.

**Cyanate.** An aqueous solution of a cyanate gives a deep-blue color, with a solution containing cobalt ions.

**Cyanide.** A solution of the cyanate containing an iron(II) salt is made alkaline with sodium hydroxide solu-

tion, gently warmed, and acidified, and then a few drops of iron(III) chloride solution are added. The formation of Prussian blue indicates the presence of cyanide.

Both the crude and the recrystallized potassium cyanate give satisfactory results with these tests. A sample of potassium cyanate prepared by the oxidative fusion method of Gattermann<sup>2</sup> showed a test for carbonate, and one commercial sample tested was largely potassium carbonate. The application of these tests during physical measurements on potassium cyanate solutions<sup>4,5</sup> would have prevented some misinterpretations.

### Properties

The alkali metal cyanates are stable crystalline solids if kept dry but undergo rapid hydrolysis to carbonates and ammonia in a moist atmosphere or in aqueous solution. Cyanates are widely used in organic syntheses for the preparation of substituted urethanes and ureas and also for production of semicarbazide and its derivatives.

### References

1. GATTERMANN and WIELAND: "Laboratory Methods of Organic Chemistry," p. 123, The Macmillan Company, New York, 1932.
2. *Ibid.*, p. 120.
3. KLOEFFER: U. S. patent 1915425 (June 27, 1933); *Chem. Abstracts*, **27**, 4354 (1933).
4. PAL and SENGUPTA: *Indian J. Phys.*, **5**, 13 (1930).
5. WILLIAMS: *J. Am. Chem. Soc.*, **62**, 2442 (1940).

## 25. CYANOGEN CHLORIDE

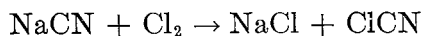

SUBMITTED BY GEORGE H. COLEMAN,\* ROBERT W. LEEPER,\* AND CHRIS C. SCHULZE\*

CHECKED BY LOUIS D. SCOTT† AND W. CONARD FERNELIUS‡

Cyanogen chloride has been prepared by the action of chlorine on hydrocyanic acid,<sup>1</sup> on potassium cyanozincate,<sup>2</sup>

\* The State University of Iowa, Iowa City, Iowa.

† The Ohio State University, Columbus, Ohio.

‡ Present address, Purdue University, West Lafayette, Ind.

and on sodium cyanide.<sup>3,4</sup> The procedure described here is a modification of the last method.

### Procedure

**Caution.** *Because of the poisonous character of cyanogen chloride, it should be prepared in a well-ventilated hood, and the operator should be provided with a suitable gas mask.*

A 500-ml. three-necked flask is fitted with a mercury-sealed stirrer\* and inlet and outlet tubes for gas as shown

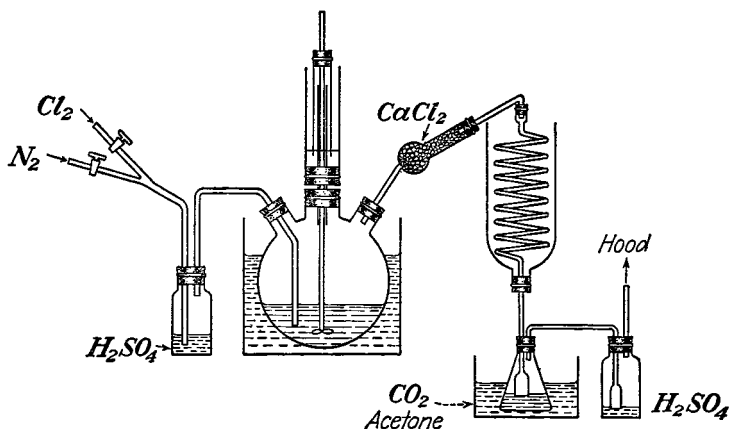

FIG. 5.—Apparatus for the preparation of cyanogen chloride.

in Fig. 5. The incoming gases are dried by passing them through a sulfuric acid wash bottle before entering the flask. The gas outlet leads to a spiral condenser surrounded with an ice and salt mixture. At the bottom of the spiral condenser is a wide-mouthed adapter inserted into a 125-ml. Erlenmeyer flask. An outlet tube from the receiving flask leads to a sulfuric acid wash bottle, which is equipped with a trap large enough to prevent acid from being drawn back into the apparatus.

\*The mercury seal is so constructed that there is very little mercury surface exposed to chlorine. Consequently, only a limited reaction takes place between chlorine and mercury, and this does not interfere with the operation of the stirrer during the preparation.

Forty grams of dry powdered sodium cyanide and 140 ml. of carbon tetrachloride are placed in the reaction flask. The flask and its contents are immersed in an ice-salt mixture until the temperature is lowered to  $-5$  or  $-10^{\circ}$ . The apparatus is flushed out with dry nitrogen, 3 to 4 ml. of glacial acetic acid is added to the reaction mixture, and the stirrer and flow of chlorine are started. The reaction flask must be maintained at  $-5^{\circ}$  or below at all times.\* The chlorine is bubbled through at such a rate that there is no excess chlorine passing through the exit wash-bottle.

After 4 to  $4\frac{1}{2}$  hours, the reaction is complete. The receiving flask is surrounded by acetone cooled to  $-40$  to  $-50^{\circ}$  with Dry Ice and the stream of chlorine replaced by nitrogen. The bath around the reaction flask is now gradually warmed, the temperature rising during the course of 1 to  $1\frac{1}{2}$  hours to  $60$  to  $65^{\circ}$ . During this time, a slow stream of nitrogen is passed through the apparatus.

When distillation is complete, the receiving flask is removed and attached to a fractionating column about 16 in. in length and  $\frac{3}{4}$  in. in diameter. The column is surrounded with acetone cooled to  $-25^{\circ}$  with Dry Ice. Gentle heat is applied to the flask to reflux the crude cyanogen chloride and to remove excess chlorine. When purification is complete, the cyanogen chloride is a pale yellow color. The column is detached, and the flask is connected to a receiver<sup>5</sup> consisting of a bulb of about 35 to 40 ml. capacity sealed to a glass tube about 8 mm. in diameter, which is convenient for sealing after the product is collected. The delivery tube and the receiver are connected through a T tube by means of short lengths of

\* A dark color appears when chlorine is passed into a suspension of sodium cyanide at a temperature above  $0^{\circ}$ . This color is due to the reaction of cyanogen chloride and sodium cyanide to form paracyanogen:

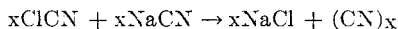

There is a definite decrease in the yield of cyanogen chloride if the reaction mixture turns brown.

rubber tubing. The outlet is attached to a phosphorus(V) oxide tube to prevent moist air from entering the receiver. The receiver is surrounded with acetone, cooled with Dry Ice to  $-15$  to  $-20^{\circ}$ , and the purified cyanogen chloride is distilled into it. The tube is then removed, sealed, and weighed. Yield 36 to 39 g. (72 to 78 per cent). Cyanogen chloride stored in sealed tubes and kept in a refrigerator in the absence of light gives good analyses after 4 months.

The cyanogen chloride may also be collected in anhydrous ether cooled in ice water.

Chemically pure cyanogen chloride may be made by saturating the crude material with chlorine, shaking with mercury to remove the excess chlorine, with dry sodium bicarbonate to remove hydrogen chloride, drying over calcium chloride, and distilling. Prolonged shaking with zinc oxide will give an almost quantitative removal of hydrogen cyanide.

#### Analysis of an Ethereal Solution

A 2-ml. sample of the cyanogen chloride-ether solution is run into a known excess of 0.1 *N* sodium hydroxide and shaken for 5 minutes. It is best to have some phenolphthalein present to be sure of an excess of alkali.



The excess alkali is back-titrated with 0.1 *N* sulfuric acid.

As an additional check, a known excess of standard sulfuric acid is added and the solution gently refluxed on the steam bath for 15 minutes. The cyanate ion is decomposed into carbon dioxide and ammonia, which in the presence of the sulfuric acid forms the sulfate.



The excess sulfuric acid is back-titrated with standard sodium hydroxide, methyl red being used as an indicator.

The above neutralized solution contains a chloride ion for each molecule of cyanogen chloride used. This solution

is diluted to 250 ml. in a volumetric flask. The chloride in a 50-ml. portion is determined by using standard silver nitrate with potassium chromate as an indicator. The chloride analysis should agree closely with the preceding analysis.

### Properties

Cyanogen chloride boils at  $13^{\circ}$  and melts at  $-5$  to  $-6^{\circ}$ . Its density is 1.2 at  $0^{\circ}$ . It is very soluble in water and many organic solvents. It readily polymerizes into its trimer, cyanuric chloride.

Dry chlorine has no polymerizing effect on cyanogen chloride.<sup>6</sup> Moist chlorine produces a slow reaction, but no polymer is formed, since the action is solely due to the water present. Traces of water present with the cyanogen chloride result in the formation of a small amount of ammonium chloride. Any hydrogen chloride present has the following effects:

1. In the presence of water, the cyanogen chloride is hydrolyzed to cyanic acid and carbon dioxide. This is a much more rapid reaction than (2).
2. In the absence of water, the cyanogen chloride is polymerized to cyanuric chloride.

### References

1. BERTHOLLET: *Ann. chim. phys.*, [1] **1**, 35 (1789).
2. HELD: *Bull. soc. chim.*, [3] **17**, 287 (1897).
3. JENNINGS and SCOTT: *J. Am. Chem. Soc.*, **41**, 1241 (1919).
4. DIETERLE: U.S. patent 1938461.
5. COLEMAN *et al.*: *INORGANIC SYNTHESSES*, **1**, 56 (1939).
6. PRICE and GREEN: *J. Soc. Chem. Ind.*, **39**, 98-100T (1920).



## 26. SILICA GEL

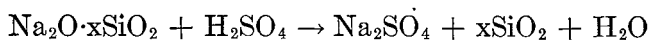

SUBMITTED BY ROBERT F. RUTHRUFF\*

CHECKED BY H. S. BOOTH† AND ALBERT DOLANCE†

Silica gel is frequently recommended as a catalyst or catalyst support; yet it is difficult to find detailed and entirely satisfactory directions for the preparation of this material. It is usually made by the interaction of water glass and an acid.<sup>1-3</sup> Water glass-acid mixtures form sols, which set to gels with more or less rapidity, the time of set depending upon concentration, temperature, kind of acid, amount of acid, and other factors.<sup>3,4</sup> The influence of the amount of acid on time of set is very marked. Water glass itself has an infinite time of set. As water glass-acid mixtures of decreasing alkalinity are made, the time of set decreases with great rapidity and becomes a minimum just short of neutrality; the time of set then is in the neighborhood of 3 to 5 seconds. With more acid, the time of set increases with the greatest rapidity, reaching a maximum value of perhaps 200,000 to 300,000 seconds just beyond the neutral point on the acid side. With further increasing amounts of acid, the time of set decreases rapidly.

If the stream of acid is added to water glass, a homogeneous acid sol is not obtained. Even with vigorous agitation, the final reaction mixture is contaminated with more or less precipitated hydrated silica, which forms just short of the neutral point when the time of set is minimum. Yet this method of preparation is frequently suggested.<sup>5,6</sup> If, on the other hand, water glass is added to acid, it is possible to obtain a homogeneous sol if the acid is stirred with extreme rapidity. But again the sol is usually contaminated with precipitated hydrated silica due to the

\* Present address, 1711 West 100th Street, Chicago, Ill. The author wishes to express appreciation to the M. W. Kellogg Company, 255 Broadway, New York, N.Y., for permission to publish this synthesis.

† Western Reserve University, Cleveland, Ohio.

rather short time of set in highly acid medium. A homogeneous sol is most conveniently made by adding the water glass and the acid simultaneously to the reaction vessel. This method is employed in the procedure to be described.

### Procedure

One volume of sodium silicate solution (N brand, Philadelphia Quartz Company)\* containing about 8.85 per cent  $\text{Na}_2\text{O}$  and 28.5 per cent  $\text{SiO}_2$  and having a specific gravity of approximately 1.3956 is diluted with 1 volume of water. This diluted solution is run at a rapid rate into a vessel provided with efficient stirring means. Simultaneously, 0.66 volume of 6 *N* sulfuric acid is added to the same vessel. The two solutions are charged to the single vessel at rates proportional to the respective total volumes employed. As soon as addition of the two solutions is complete, agitation is discontinued and the stirrer is removed from the resulting reaction mixture.

By the above series of operations there results a homogeneous clear sol, which sets to a firm gel in 2 to 4 hours, depending largely upon the temperature of the room. Calculation will show that the sol contains some 150 g. of silica per liter and that twice the theoretical amount of acid is employed in the preparation. This excess acid, as well as the sodium sulfate formed, must be removed by washing. To wash the gel one may proceed in either of two ways:

**A. Partial Drying Method.**<sup>7</sup> Immediately after formation, the sol is poured into glass or lead trays to a depth of 2.5 cm. After the gel has formed, it is partly dried at about 65° in a rapid current of air. During this drying operation, the gel first splits horizontally into two layers, each about 1.25 cm. thick; following this, these sheets fracture vertically, and finally, when the water content reaches about 50 per cent, salts begin to effloresce from the

\* The concentration and brand of sodium silicate are critical and should be adhered to closely.

fragments of gel. When this occurs, drying is discontinued and the physically strong fragments are placed in a convenient vessel and covered with distilled water. After standing 30 minutes, the water is removed and replaced with fresh. A total of eight washings are completed in this manner, and the washed particles are then dried at the temperature and under the conditions previously specified. Finally the material is dried at 110° in an ordinary drying oven.

**B. Direct Washing Method.** The sol is allowed to gel in the reaction vessel, and the product is forced through a 4-mesh screen. The resulting gel particles are covered with distilled water, which is allowed to stand for 30 minutes and is then removed (conveniently by drainage through a large Büchner funnel without paper). The gel particles are then covered with fresh water, and the operation is repeated until the gel has been washed eight times. The washed and drained gel is worked mechanically until the whole becomes a semifluid, somewhat thixotropic mass. (This may be accomplished by kneading the gel by hand.) The resulting material is cast in trays and dried at about 110° to form the final gel.

The yield of dried gel by either of the two procedures averages 98 per cent of theory. But since the product obtained contains 5 to 10 per cent moisture, the true recovery on silica taken is about 90 per cent, most of the loss occurring during washing.

### Properties

By either of the above procedures a highly active acid silica gel is obtained, the particles of which are of appreciable size (larger than 4-mesh). Large gel particles are obtained either by partly drying the gel to form large, strong fragments, which can be washed without disintegration, or by washing undried gel particles, knitting them into a single whole by mechanical working, and then drying the resulting reconstructed gel.

While silica gel itself is employed in many reactions as a catalyst, more often it is used as a catalyst support. For this last purpose the gel is usually impregnated with a solution of the catalytically active element, dried, and calcined to give an oxide of the desired catalytic element, which may be reduced if desired before use. Silica gel particles shatter to a considerable extent when immersed in water. Those prepared as described, after being impregnated with the solution of the catalytically active element, have shattered to a convenient size for use in laboratory reactors. However, if it is desired to maintain the original size of the gel particles, it is necessary to add the catalytically active element to the undried gel. In procedure A, the partly dried and thoroughly washed gel fragments are impregnated with the catalytic element. In procedure B, the catalytic element is added to the washed gel particles prior to mechanical working.

#### References

1. GRAHAM: *Phil. Trans.*, **151**, 205 (1861).
2. GRAHAM: *J. Chem. Soc.*, **16**, 216 (1862).
3. *Ibid.*, **17**, 318 (1864).
4. FLEMING: *Z. physik. Chem.*, **41**, 427 (1902).
5. PATRICK: U. S. patent 1297724 (March 18, 1919).
6. WEISER: "Inorganic Colloid Chemistry," Vol. 2, p. 193, John Wiley & Sons, Inc., New York, 1935.
7. HOLMES and ANDERSON: *Ind. Eng. Chem.*, **17**, 280 (1925).

## 27. DISILICON HEXABROMIDE

### (Hexabromodisilane)

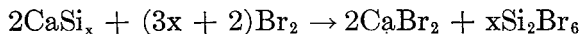

SUBMITTED BY WALTER C. SCHUMB\*

CHECKED BY ROY E. HEATH†

Disilicon hexabromide (hexabromodisilane),  $\text{Si}_2\text{Br}_6$ , may be prepared by the action of bromine on a calcium-silicon

\* Massachusetts Institute of Technology, Cambridge, Mass.

† University of Wisconsin, Madison, Wis.; present address: Wyandotte Chemicals Corporation, Wyandotte, Mich.

alloy\* at a temperature of 180 to 200°. The use of the alloy instead of elementary refined silicon permits a lower reaction temperature and materially increases the yield of the desired product. At the higher temperatures required for the reaction with silicon, progressively larger proportions of silicon tetrabromide are formed the higher the temperature employed.†

### Procedure

Two hundred and fifty or 300 g. of the calcium-silicon alloy, broken into lumps not larger than 1 cm. in diameter,

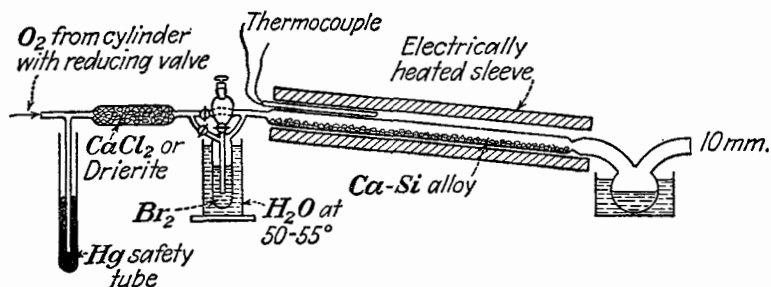

Fig. 6.—Apparatus for the preparation of disilicon hexabromide.

is packed into a 34-mm. pyrex glass tube approximately 160 cm. long, which is surrounded by an electric heating sleeve or hinged-type electric-tube furnace, the temperature of which may be adjusted by an external variable resistance or rheostat. Sealed to the inlet end of the reaction tube is a bubble tube (about 15 by 2.5 cm.) provided with a small dropping funnel for the introduction of liquid bromine, and sealed to and preceding this is a calcium chloride drying tube (about 45 by 2.5 cm.) for the drying of the gas used to entrain the bromine vapors (Fig. 6). The bubble tube,

\* Obtained from the Electro Metallurgical Co., Niagara Works, Niagara Falls, N.Y. The alloy used in the preparation here described contained 30 to 35 per cent calcium, 60 to 65 per cent silicon, and a maximum of 3.5 per cent iron.

† Compare the synthesis of the higher chlorides of silicon, Schumb and Gamble, *INORGANIC SYNTHESIS*, **1**, 42 (1939).

when in use, may advantageously be kept at about 50° by immersion in a beaker of warm water to increase the rate of vaporization of the bromine.

Sealed to the exit end of the reaction tube, which is placed so as to slope slightly downward toward the exit, is a receiving flask of about 250 ml. capacity, with as little constriction as possible between it and the reaction tube. Several small dents in the reaction tube placed at the end of the heated layer of alloy and the use of a few larger lumps of the latter at this point suffice to prevent the solid from slipping down into the receiver. The tube should be filled not more than half full since considerable expansion in volume occurs during the reaction and the tube is apt to become clogged tightly. The receiving flask is cooled by immersion in ice. An outlet tube leads from the receiver to a second calcium chloride tube and thence to the hood.

Oxygen\* from a cylinder provided with a needle valve and a safety tube is passed through the bromine bubble tube at a rate of four to six bubbles per second; the mixed gases then pass through the reaction tube, the external temperature of which may be read by means of a thermocouple or, more simply, by means of an ordinary thermometer placed between the tube and the heating surface. As stated above, this temperature is best kept under 200°. The temperature of the tube contents in the zone undergoing reaction is naturally higher than this.

When the desired quantity of crude product has collected in the receiver, the latter is cut off or sealed off from the train and the product fractionated at reduced pressure with the use of a suitable column. A satisfactory arrangement consists of a flask sealed to a 22-in. Podbielniak type of column, made of 8-mm. pyrex tubing containing a glass spiral. The column is heated either by means of a vapor jacket, the temperature of which is controlled by refluxing

\* Other gases, such as carbon dioxide, could be used in place of oxygen to entrain the bromine; but the use of oxygen gives entirely satisfactory results, only minute amounts of oxybromides being formed.

a mixture of organic chlorides,\* or by means of an electrically heated jacket, the temperature of which is controlled by external variable resistance.

The fractions may be received conveniently and sealed off in a series of ampoules attached to a manifold, which leads from the top of the distilling column at a slight declination from the horizontal.

The first fractions will contain some bromine and a small quantity of silicon tetrabromide. The disilicon hexabromide distills at a fairly constant temperature, depending upon the pressure employed. Thus a considerable proportion comes over at 130 to 140°, if the pressure is varied from 15 to 20 mm. This material may have a pale-yellow color, but on redistillation or sublimation a pure-white well-crystallized substance may be obtained (m.p. 95°). Yield 80 per cent based on the bromine used or 60 per cent based on the calcium-silicon alloy.

### Properties

Disilicon hexabromide, hexabromodisilane, forms well-crystallized white plates or prisms (m.p. 95°, b.p. 265°).<sup>2</sup> It is soluble in a variety of organic solvents, such as carbon tetrachloride, chloroform, carbon disulfide, and benzene, as well as in silicon tetrachloride or tetrabromide. It is rapidly hydrolyzed by the moisture of the air, forming insoluble "silicooxalic acid,"  $(\text{H}_2\text{Si}_2\text{O}_4)_x$ ; and with solutions of ammonia or of strong bases it forms silicic acid or silicates, with liberation of hydrogen.

### References

1. FRIEDEL: *Bull. soc. chim.*, [2] **16**, 244 (1871).
2. FRIEDEL and LADENBURG: *Ann. chim. phys.*, [5] **19**, 404 (1880); *Ann.*, **203**, 253 (1880).

\* Such a mixture may contain, for example, 10 ml. of chloroform, 10 ml. of chlorobenzene, 40 ml. of amylene dichloride, 20 ml. of high-boiling kerosene, 20 ml. of  $\alpha$ -chloronaphthalene. The temperature of the jacket may be progressively raised by distilling off some of the lower boiling material through a side tube and condenser attached to the top of the jacket.

3. BESSON and FOURNIER: *Compt. rend.*, **151**, 1055 (1910).
4. MOISSON and HOLT: *ibid.*, **135**, 78 (1902).
5. SCHEUMB and KLEIN: *J. Am. Chem. Soc.*, **59**, 261 (1937).

## 28. GERMANIUM(II) SULFIDE (PRECIPITATED)

SUBMITTED BY LAURENCE S. FOSTER\*

CHECKED BY J. A. ROBERTSON† AND A. W. LAUBENGAYER†

Although Winkler prepared germanium(II) derivatives soon after his discovery of the element in 1886, much less attention has been paid to them than to the more stable germanium(IV) compounds.<sup>1,2</sup> Germanium(II) chloride is not stable *in vacuo* above 75° and is very difficult to prepare. Germanium(II) bromide is only slightly more stable, but germanium(II) iodide is readily prepared and preserved. Germanium(II) sulfide and oxide are very stable even at high temperatures. The sulfide, in the form of a hard, lustrous, black, leafy sublimate is the product of the treatment of germanite proposed by Johnson, Foster, and Kraus<sup>3</sup> and serves as a very satisfactory starting material for the preparation of germanium(II) iodide.<sup>4</sup>

The advantage of using germanium(II) sulfide as the starting material in the preparation of germanium(II) derivatives is that it can be prepared and used in acid solution. Under this condition, it is not oxidized by the air. If germanium(II) hydroxide is used, an inert atmosphere must be maintained to prevent its oxidation in the alkaline solutions required for its preparation. Except in large-scale operations, it is not feasible to produce germanium(II) sulfide by sublimation from germanite, but it is readily prepared from commercially available germanium(IV) oxide. It may also be made from germanium(IV) sulfide, which is obtained by the usual methods of recovering germanium from its solution.

\* Brown University, Providence, R.I.; present address: Watertown Arsenal, Watertown, Mass.

† Cornell University, Ithaca, N.Y.

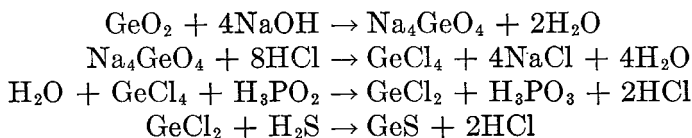

## A. REDUCTION OF GERMANIUM(IV) OXIDE

**Procedure**

Since germanium(IV) oxide is much more readily dissolved in concentrated caustic solutions than in acid, it is convenient to prepare the germanium(IV) solution in the following way. Five grams of the oxide, in a 250-ml. beaker, is moistened with water and heated gently with 25 ml. of 10 *N* sodium hydroxide solution. In  $\frac{1}{2}$  hour most of the oxide has disappeared, and the solution is cooled and neutralized with 6 *N* hydrochloric acid, care being taken to avoid boiling since germanium(IV) chloride may be volatilized. Addition of acid is continued until the precipitated germanium hydroxide redissolves. The clear solution, which has a volume of about 150 ml., is transferred to a 500-ml. Erlenmeyer flask, and 50 ml. of concentrated hydrochloric acid is added to make the solution 3 *N* in acid concentration. Twenty-five grams (excess) of 50 per cent hypophosphorous acid solution is introduced and the mixture heated on a steam bath for a period of 2 to 4 hours.<sup>6,7</sup> Reduction is complete when a 5-ml. sample of the solution, mixed with 150 ml. of 6 *N* sulfuric acid and saturated with hydrogen sulfide, shows no immediate precipitate but only a small amount of turbidity due to white germanium(IV) sulfide.\*

The reduced solution is cooled in ice and neutralized with concentrated aqueous ammonia (50 to 60 ml.), until a

\* When this test is performed, it is essential that the acid strength be not less than that stated or germanium(II) sulfide may precipitate. The formation of an orange-colored precipitate *on standing* is indicative not of incomplete reduction but rather of partial atmospheric oxidation of the material in solution.

permanent, cream-colored precipitate of germanium(II) hydroxide appears. The solution is then agitated with hydrogen sulfide under pressure until it is saturated (1 hour). The reddish-brown precipitate is collected in a Büchner funnel and washed with distilled water that has been slightly acidified with hydrochloric acid. If it is not to be used at once, the product is dried *in vacuo* over phosphorus(V) oxide. The conversion is practically quantitative.

#### B. REDUCTION OF GERMANIUM(IV) SULFIDE

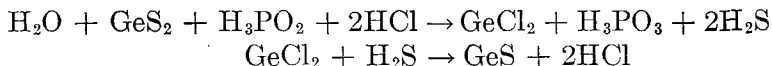

Germanium is frequently recovered from solution by precipitating germanium(IV) sulfide. Other metals present in the solution may often be separated from the germanium by fractional precipitation. With the acid concentration at 0.2 *N*, many of the heavy metals are thrown down by hydrogen sulfide. The acidity of the filtrate is then increased to 6 *N* by the addition of sufficient 18 *N* sulfuric acid, and pure white germanium(IV) sulfide immediately separates. After more hydrogen sulfide is passed into the solution to ensure complete precipitation, the (IV)sulfide is collected in a Büchner funnel.<sup>8</sup> To produce the (II)sulfide, the (IV)sulfide may be reduced directly, without being converted to the oxide.

#### Procedure

Five grams of germanium(IV) sulfide is suspended in 200 ml. of 6 *N* hydrochloric acid in a 500-ml. Erlenmeyer flask and treated with 50 ml. (excess) of a 50 per cent solution of hypophosphorous acid. The mixture is heated on a steam bath and stirred occasionally with a glass rod to disintegrate the lumps of unattacked sulfide. Hydrogen sulfide escapes slowly, and the sulfide disappears, leaving

a clear colorless solution. The reaction is complete within 2 hours. The solution is cooled in ice and neutralized with concentrated ammonia until a permanent cream-colored precipitate of germanium(II) hydroxide appears. After the solution has been saturated with hydrogen sulfide, the reddish-brown precipitate of the (II)sulfide is collected in a Büchner funnel. Yield practically quantitative.

With lower acidity, the reduction requires a much longer time, and the germanium(IV) sulfide becomes coated with an orange layer of the (II)sulfide, which does not dissolve in the dilute acid solution.

### Properties

Unlike germanium(IV) sulfide, which may be precipitated by means of hydrogen sulfide only from solutions that are more acid than 6 *N*, germanium(II) sulfide may be obtained only from weakly acid or alkaline solutions and redissolves if the acidity is increased. When dry, germanium(II) sulfide is stable in air.

### References

1. GMBLIN: "Handbuch der anorganischen Chemie," No. 45, p. 51, Verlag Chemie G.m.b.H., Berlin, 1931.
2. MELLOR: "Comprehensive Treatise on Inorganic and Theoretical Chemistry," Vol. 7, p. 273, Longmans, Green and Company, New York, 1927.
3. JOHNSON, FOSTER, and KRAUS: *J. Am. Chem. Soc.*, **57**, 1828 (1935).
4. JOHNSON, MOREY, and KOTT: *ibid.*, **54**, 4278 (1932).
5. FLOOD: *ibid.*, **55**, 4935 (1933).
6. DENNIS and HULSE: *ibid.*, **52**, 3553 (1930).
7. TCHAKIRIAN: *Ann. chim.*, [11] **12**, 422-424 (1939).
8. FOSTER and TOMPSON: *J. Am. Chem. Soc.*, **61**, 236 (1939).

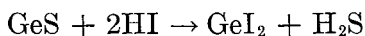
**29. GERMANIUM(II) IODIDE**

SUBMITTED BY E. A. FLOOD,\* L. S. FOSTER,† AND E. W. PIETRUSZA‡

CHECKED BY J. A. ROBERTSON§ AND A. W. LAUBENGAYER§

The reaction of sublimed germanium(II) sulfide with concentrated hydriodic acid is initially rapid but soon becomes very slow after only a relatively small percentage of the sulfide has dissolved. Evidently the germanium(II) iodide produced reacts with the remaining hydrogen iodide to form complexes, which effectively reduce the concentration of the acid and lower the reaction rate.<sup>1</sup> However, the reaction is rapidly brought to completion by the use of a considerable excess of hydriodic acid and periodic removal of the dissolved iodide. When precipitated germanium(II) sulfide (synthesis 28) is used, the reaction proceeds a little more rapidly, the finer state of subdivision compensating somewhat for the reduced activity of the acid. The procedure then becomes, in effect, one of recrystallization, and the (II)iodide is extracted from the remaining (II)sulfide by the hot concentrated acid and is thrown out of solution again by judicious cooling.

To ensure a maximum yield, the reaction may be carried out in an inert atmosphere ( $\text{H}_2\text{S}$ ,  $\text{CO}_2$ ,  $\text{N}_2$ , etc.) to prevent formation of germanium(IV) by atmospheric oxygen, but this involves additional apparatus, skill, and expense. Owing to the escape of hydrogen sulfide from the reaction mixture, the entrance of air is diminished, and, except near the end of the preparation, its effect is negligible. Furthermore, the germanium(IV) iodide that usually contaminates the product is completely removed by sublimation during the drying of the material or may be extracted with ben-

\* National Research Council of Canada, Ottawa, Ontario, Canada.

† Brown University, Providence, R.I.; present address: Watertown Arsenal, Watertown, Mass.

‡ Gilbert and Barker Company, Springfield, Mass.

§ Cornell University, Ithaca, N.Y.

zene, in which germanium(II) iodide is only slightly soluble.

Not all the (II)iodide will separate from the concentrated hydriodic acid solution. The germanium in the filtrate is recovered by diluting it and precipitating germanium(II) sulfide.

The sublimed germanium(II) sulfide, recovered from germanite, is usually not pure but contains lead and arsenic sulfides. These are eliminated during the process of preparing the (II)iodide and need not be removed previously. After oxidation of the residues left in the reaction flask, however, it is convenient to precipitate these elements by hydrogen sulfide from a dilute acid solution (0.2 *N*) before recovery of the germanium as the (IV)sulfide that is precipitated from a 6 *N* acid solution.<sup>2</sup>

The procedure given here is adaptable for large-scale production. Actually, with batches of 300 ml. of hydriodic acid and excess sublimed germanium(II) sulfide, 500 g. of the (II)iodide has been prepared in the course of 4 to 5 hours. Under these circumstances, however, the percentage yield is not so high.

### Procedure

Ten grams of germanium(II) sulfide is ground to a coarse powder and placed in a 250-ml. Erlenmeyer flask, together with a 200 per cent excess (80 ml. or 125 g.) of freshly prepared constant-boiling hydriodic acid<sup>3</sup> (57 per cent HI, sp. gr. 1.7). The flask, whose neck is closed with a plug of glass wool, is heated in a water bath at 100° and swirled occasionally to mix the contents. Hydrogen sulfide is evolved rapidly at first, and a considerable amount of the sulfide disappears, but the rate of gas evolution soon diminishes. When the reaction seems to have stopped (15 to 20 minutes) and the residue has settled, the supernatant liquid is filtered while still hot through a mat of glass wool in a Gooch crucible. The filter flask (250 ml.) holding the filtrate is cooled in water not colder than +10°. If the

cooling process is too rapid or if the mixture is cooled below  $+10^{\circ}$ , a thick curdy mass of triiodogermane,  $\text{GeHI}_3$ , forms throughout the solution. If this occurs, the filtrate must be warmed and then cooled more carefully. The gleaming burnt-orange, hexagonal, crystalline plates of germanium(II) iodide settle rapidly. When crystallization is complete (30 minutes), the crop of crystals is removed by filtration through a fairly coarse sintered-glass filtering crucible and the filtrate is returned to the flask containing the residual germanium(II) sulfide. After three or four repetitions of the process, most of the sulfide is converted to the iodide. The combined product is transferred to a porcelain boat and dried *in vacuo* in a steam-jacketed tube for 2 hours. If the material is not heated, it is very difficult to remove the adhering hydriodic acid. During the process, the germanium(IV) iodide, present as a contaminant, volatilizes completely and appears on the cooler portion of the apparatus. To preserve the germanium(II) iodide, it should be sealed to prevent entrance of moisture. Yield 19 g. (60 per cent based on the impure sublimed sulfide).

### Properties

Germanium(II) iodide is golden russet to burnt orange and crystallizes in hexagonal plates. It is stable, if kept dry, but in the presence of moisture hydrolyzes slowly. The compound undergoes ammonolysis in liquid ammonia to form germanium(II) imide. It is not oxidized by dry air. It is somewhat soluble in cold hydriodic acid but much more so in hot<sup>4,5</sup> and may be recrystallized from this solvent. It is only slightly soluble in benzene. Germanium(II) iodide may be advantageously used for the preparation of certain organometallic germanium compounds that otherwise may be obtained only with great difficulty.<sup>6</sup>

### References

1. JOHNSON, MOREY, and KOTT: *J. Am. Chem. Soc.*, **54**, 4278 (1932).
2. FOSTER and TOMPSON: *ibid.*, **61**, 236 (1939).

3. HEISIG and FRYKHOLM: *INORGANIC SYNTHESSES*, **1**, 157 (1939).
4. BREWER and DENNIS: *J. Phys. chem.*, **31**, 1536 (1927).
5. TCHAKIRIAN: *Ann. chim.*, [11] **12**, 424 (1939).
6. FLOOD: *J. Am. Chem. Soc.*, **55**, 4935 (1933).

### 30. GERMANIUM(IV) CHLORIDE

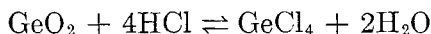

SUBMITTED BY L. S. FOSTER,\* J. W. DRENAN,† AND A. F. WILLISTON‡  
CHECKED BY EDITH BOLDEBUCK§ AND WARREN C. JOHNSON§

Winkler prepared germanium(IV) chloride by reaction of germanium(IV) oxide and hydrochloric acid.<sup>1</sup> This reaction is very convenient because germanium(IV) oxide is easy to obtain and no special apparatus or elaborate technique is required.

The reaction is reversible. If the concentration of hydrochloric acid in the solution falls to too low a value, hydrolysis occurs. If the concentration of hydrogen chloride is above that of the maximum-boiling mixture, gaseous hydrogen chloride escapes and carries uncondensed germanium(IV) chloride through the condenser.<sup>2c,d</sup> Various modifications of the procedure have been advocated to obviate these difficulties. In any event, some 6 *N* hydrochloric acid distills over with the germanium(IV) chloride, which necessitates drying and redistilling the product.<sup>2a</sup>

In the procedure described in this synthesis, advantage is taken of the more rapid reaction that occurs in hydrochloric acid of higher concentration and the high volatility of germanium(IV) chloride at room temperature. The volatile chloride is swept through the water condenser by means of gaseous hydrogen chloride into a collector cooled in Dry Ice, where it freezes out with little contamination. The procedure was worked out by using 5-g. lots

\* Brown University, Providence, R.I.; present address: Watertown Arsenal, Watertown, Mass.

† Harvard Medical School, Boston, Mass.

‡ B.M.C. Durfee High School, Fall River, Mass.

§ University of Chicago, Chicago, Ill.

of the oxide but can be adapted to larger lots with only very slight modification.

### Procedure

The apparatus is set up as illustrated in Fig. 7. Hydrogen chloride gas<sup>3</sup> is lead through a safety trap and a flow-

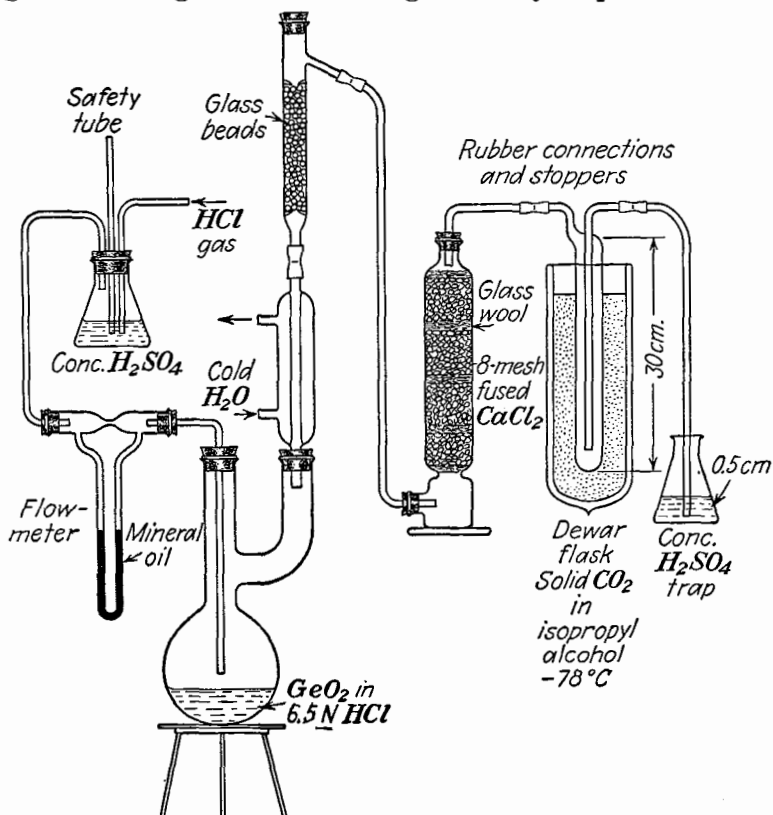

FIG. 7.—Apparatus for the preparation of germanium(IV) chloride.

meter (not essential) into a 1-l. Claisen flask containing 125 ml. of 6.5 N hydrochloric acid solution and 5 g. of germanium(IV) oxide.\* The mixture is kept at the boiling point by means of a small flame. Germanium(IV)

\* The procedure described is satisfactory only if pure germanium oxide is used or, at least, an oxide that contains no tin, antimony, or arsenic, which also form volatile chlorides.



chloride and constant-boiling hydrochloric acid reflux in a water-cooled condenser, which is surmounted by a still head filled with glass beads to remove spray droplets. The mixture of hydrogen chloride gas and germanium(IV) chloride vapor is conveyed through a drying tower filled with alternate layers of 8-mesh anhydrous calcium chloride and glass wool into a collecting tube cooled to  $-78^{\circ}$  in a mush of powdered Dry Ice and isopropyl alcohol. Germanium(IV) chloride is frozen (f.p.  $-49.5^{\circ}$ ) on the walls of the tube, and the hydrogen chloride (b.p.  $-85^{\circ}$ ) escapes through the central tube into the atmosphere (**Caution.** *Hood*) after passing through a trap containing sulfuric acid, which enables one to observe the rate of escape.

The rate of flow of hydrogen chloride must be sufficiently rapid to carry the germanium(IV) chloride produced along into the collector. During the conversion of the oxide to chloride, the flow of hydrogen chloride should be around 600 to 1000 ml./minute. Later, when absorption slows up, the flow is reduced to 300 ml./minute and is continued at this rate until it is apparent that no germanium oxide or chloride remains in the flask. The reaction is practically complete at the end of 45 minutes; but, to ensure complete removal of the germanium, heating is continued for 15 to 30 minutes longer. By raising the level of the cooling mixture around the collector, one can readily ascertain whether the incoming gas still contains germanium(IV) chloride. Yield 5.15 ml. (94 per cent).

The product is dry but contains a small amount of dissolved hydrogen chloride. This can be removed by allowing the product to stand over anhydrous sodium carbonate, filtering, and distilling<sup>2a</sup> in a dry apparatus. After being melted, the nearly colorless liquid germanium(IV) chloride can be kept in a glass-stoppered bottle, sealed with paraffin.

### Properties

Germanium(IV) chloride is a mobile liquid with a density of  $1.879_{20}^{20}$ , which boils at  $83.1^{\circ}$  and freezes at  $-49.5^{\circ}$ .

It fumes in the air and is hydrolyzed in water, with a crackling noise, but is stable, although not very soluble, in 6 *N* hydrochloric acid. As the concentration of hydrogen chloride increases, germanium(IV) chloride becomes less soluble.<sup>2b</sup> It is soluble in many organic solvents, such as benzene and ether. It may be used in Grignard reactions for the preparation of organometallic derivatives..

#### References

1. WINKLER: *J. prakt. Chem.*, **142**, 187 (1886).
2. a. TABERN, ORNDORFF, and DENNIS: *J. Am. Chem. Soc.*, **47**, 2039 (1925).  
b. ALLISON and MÜLLER: *ibid.*, **54**, 2833 (1932).  
c. LUNDIN: *Trans. Am. Electrochem. Soc.*, **63**, 149 (1933).  
d. ATKENHEAD and MIDDLETON: *Ind. Eng. Chem., Anal. Ed.*, **10**, 633 (1938).
3. MAXON: *INORGANIC SYNTHESSES*, **1**, 147 (1939).
4. BOOTH and MORRIS: *J. Am. Chem. Soc.*, **58**, 92 (1936).

### 31. GERMANIUM(IV) IODIDE

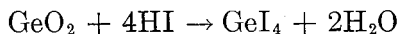

SUBMITTED BY LAURENCE S. FOSTER\* AND AMASA F. WILLISTON†

CHECKED BY WARREN C. JOHNSON‡

Germanium(IV) iodide may be prepared directly from the elements,<sup>1</sup> but it is more convenient to prepare it from the oxide by reaction with concentrated hydriodic acid.<sup>2</sup> The product is hydrolyzed if the acid concentration becomes too low; but if excess constant-boiling acid is used, the yield is excellent. The preparation may be carried out in a beaker,<sup>3</sup> but a higher yield is obtained if an inert atmosphere is maintained, which prevents oxidation of the hydriodic acid to free iodine.

#### Procedure

Five grams of germanium(IV) oxide is placed in a 125-ml. short-necked round-bottomed flask, which is provided with

\* Brown University, Providence, R.I.; present address: Watertown Arsenal, Watertown, Mass.

† B.M.C. Durfee High School, Fall River, Mass.

‡ University of Chicago, Chicago, Ill.

a still head, attached by means of a ground joint, and an inlet tube for carbon dioxide.\* The air is swept out by means of a gentle stream of carbon dioxide. When this has been accomplished, a 10 per cent excess (28 ml.) of clear, colorless, constant-boiling hydriodic acid<sup>4,5</sup> is introduced, and the mixture is refluxed gently. After boiling has continued for 10 minutes, the white germanium(IV) oxide disappears completely and is replaced by a mass of bright-red crystals. The rate of heating is increased to distill off the water produced until the product is *almost* dry. If the mixture is overheated, some local decomposition may occur.

The contents of the flask are removed by means of a bent glass rod and filtered through a sintered-glass crucible under reduced pressure. The reddish-orange product is tamped to remove the remaining acid as completely as possible. Very little germanium(IV) iodide remains in solution, and the filtrate may be discarded or saved for iodine recovery. The crystalline mass is air-dried at room temperature or on a steam bath. A vacuum desiccator is not advised because of the volatility of the product.

After the remaining acid has been removed, the germanium(IV) iodide may be purified by sublimation *in vacuo*, but more conveniently by recrystallization from chloroform. Usually it contains a small percentage of unchanged oxide. Yield about 20 g. of pure product (75 per cent, disregarding the oxide recovered).

### Properties

Germanium(IV) iodide is reddish orange in color, crystallizes in the cubic system, and melts at 146°. It decomposes above 440° but is readily sublimed *in vacuo* at 100°. It is soluble in carbon disulfide, benzene, methyl alcohol, chloroform, and many other organic solvents. It is hydrolyzed by water but dissolves to form a clear, colorless

\* The neck of the flask should be as wide as possible to facilitate removal of the product.

acidic solution. It is not soluble in concentrated hydriodic acid. It is ammonolyzed to germanium(IV) imide by liquid ammonia.

#### References

1. DENNIS and HANCE: *J. Am. Chem. Soc.*, **44**, 2854 (1922).
2. LAUBENGAYER and BRANDT: *ibid.*, **54**, 621 (1932).
3. TCHAKIRIAN: *Ann. chim.*, [11] **12**, 428 (1939).
4. HEISIG and FRYKHOLM: INORGANIC SYNTHESSES, **1**, 157 (1939).
5. CALBY and BURFORD: *ibid.*, 159.

### 32. TITANIUM(IV) BROMIDE

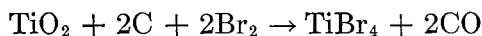

SUBMITTED BY RALPH C. YOUNG\*

CHECKED BY W. CONARD FERNELIUS†

Titanium(IV) bromide may be prepared by passing bromine vapor over a heated mixture of titanium(IV) oxide and carbon<sup>1</sup> or by the action of hydrogen bromide on titanium(IV) chloride heated just below its boiling point.<sup>2</sup> The following directions are for the former method.

#### Procedure

An apparatus as shown in Fig. 8 is constructed. *A* and *B* are two gas-washing bottles containing concentrated sulfuric acid and 180 g. of dry bromine, respectively. The pyrex combustion tube *C* surrounded by an electric furnace leads to a 500-ml. distilling flask *E*, which is provided with a mercury well for taking temperature readings during subsequent purification of the product.

An intimate mixture of 40 g. of titanium(IV) oxide and 24 g. of sugar charcoal (synthesis 20) is distributed in a layer in the combustion tube at the center point of the furnace. With the furnace at a temperature of 300°, dry carbon dioxide (or nitrogen) is passed through the apparatus until the reaction mixture is thoroughly dry. Any

\* Massachusetts Institute of Technology, Cambridge, Mass.

† The Ohio State University, Columbus, Ohio; present address: Purdue University, West Lafayette, Ind.

moisture that may collect in *D* is expelled by flaming the exposed portions of the apparatus. A drying tube is now attached at *F*; the carbon dioxide is passed through the bromine, and the temperature of the furnace is raised to about 600°. As the solid titanium(IV) bromide condenses in *D*, it is occasionally melted by a free flame so that it will run down into *E*.

At the end of the reaction, the excess bromine is removed by a current of carbon dioxide. Then the drying tube attached to *E* is removed and replaced by an air condenser, which in turn is attached to a suitable container. After the apparatus has been flushed out with carbon dioxide, the

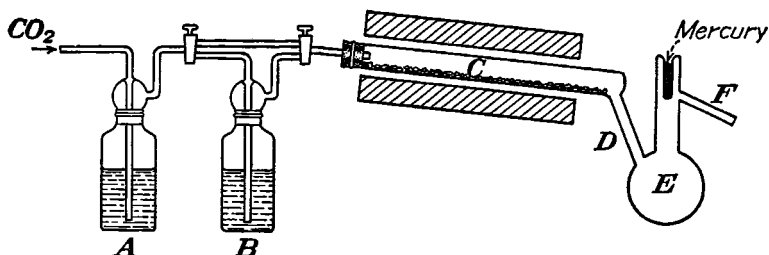

FIG. 8.—Apparatus for the preparation of titanium(IV) bromide.

distilling flask is sealed off at *D*, and the product is distilled. The fraction boiling near 230° is collected. Yield 160 g. (80 per cent). *Anal.* Calcd. for  $TiBr_4$ : Ti, 13.0; Br, 87.0. Found: Ti, 13.3; Br, 86.6.

### Properties

Titanium(IV) bromide is a hygroscopic, crystalline, amber-yellow substance:  $d_4^{20}$  3.25; m.p. 39°; b.p. 230°. It is soluble in chloroform, carbon tetrachloride, absolute ether, absolute alcohol, and hydrobromic and hydrochloric acids. It is hydrolyzed by water, decomposed completely by aqueous solutions of bases, and ammonolyzed by ammonia.

### References

1. BAXTER and BUTLER: *J. Am. Chem. Soc.*, **50**, 408 (1928).
2. OLSEN and RYAN: *ibid.*, **54**, 2215 (1932).

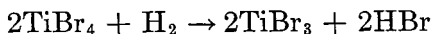
**33. TITANIUM(III) BROMIDE**

SUBMITTED BY RALPH C. YOUNG\* AND WILLIAM M. LEADERS\*

CHECKED BY NORMAN O. CAPPEL† AND DONALD W. LYON‡

Titanium(III) bromide<sup>1</sup> has been obtained in small yields by heating titanium(IV) bromide with titanium or mercury in a sealed tube at 300°. This reduction can be accomplished at room temperature with mercury and a benzene solution of the (IV)bromide. The (III)bromide may be satisfactorily produced by the interaction of the (IV)bromide with hydrogen at 750°, provided that the products are chilled to prevent decomposition of the (III)-bromide,

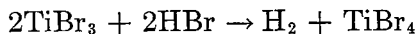

and reversal of the reaction of synthesis,

**Procedure**

The apparatus (Fig. 9) consists of a 50-ml. flask *A* sealed to a 30-mm. pyrex tube *B* 66 cm. long through the center of which passes tube *C*, 8 mm. in diameter. Cold water is conducted through this by means of a 4-mm. tube *D*. The apparatus is so placed in a 33-cm. hinged-type electric furnace, slightly tilted, that the end of the cooling tube is at the center of the furnace.

About 50 g. of titanium(IV) bromide is poured or distilled into flask *A*, in an atmosphere of carbon dioxide.‡ Hydrogen, freed from oxygen by passage over platinized asbestos at 300° (or copper at 425 to 450°) and dried by sulfuric acid, is passed from tube *I* through the apparatus

\* Massachusetts Institute of Technology, Cambridge, Mass.

† The Ohio State University, Columbus, Ohio.

‡ Nitrogen is satisfactory if it has been freed of oxygen by passage over copper turnings heated to about 600°.

until all the carbon dioxide is displaced. The reaction tube is heated so that the temperature of the forward part is  $750^{\circ}$ , and the hydrogen is then directed from *J* into the liquefied titanium(IV) bromide at the rate of about 150 ml. of gas per minute. The titanium bromide is kept at such a temperature (about  $180^{\circ}$ )\* that 15 g. is vaporized per hour.

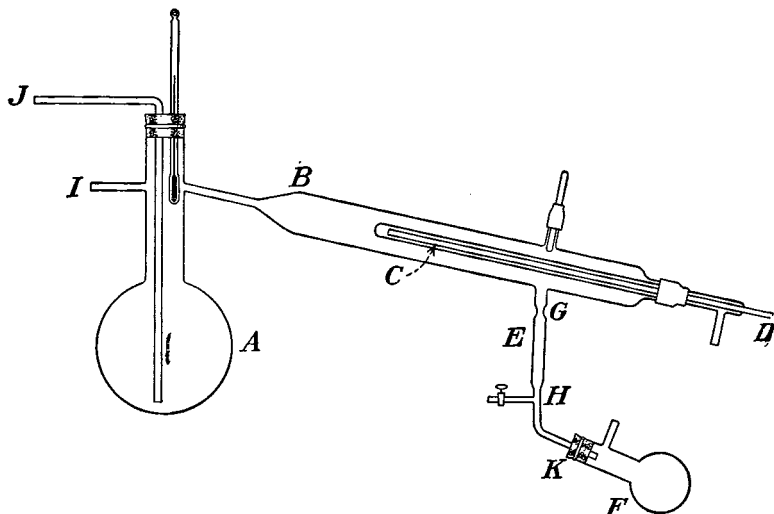

FIG. 9.—Apparatus for the preparation of titanium(III) bromide.

A brilliant-black, closely adhering deposit forms on the end of the cold tube, and from this there builds up an interlacing network of black needles and hexagonal plates of titanium(III) bromide. It is not unusual to obtain two types of crystals of the same substance when a synthesis occurs at such a great temperature gradient as exists here. After a sufficient quantity of product is obtained, the hydrogen is redirected through tube *I* and the heating of the flask discontinued. The furnace is cooled to  $250^{\circ}$

\* The temperature cannot be stated exactly because the amount of titanium(IV) bromide that condenses varies with the length of the flask neck and of tubing between the flask neck and the heated zone of the reaction tube. In general, the temperature will lie between  $150$  and  $180^{\circ}$ .

and the flow of water stopped. The excess titanium(IV) bromide that deposited in the part of the apparatus cooled by tube *D* will now be volatilized, and all, including that outside the furnace and forward of tube *E*, is driven with a free flame into flask *F*. After the reaction tube has cooled to room temperature, dry carbon dioxide is substituted for hydrogen and the system flushed out. With carbon dioxide now directed through the outer end of *B* by the loosening of the rubber connector, the small tube is sealed at *H*. Tube *C* is withdrawn partly, and any adhering (III)bromide is transferred by aid of the rod to tube *E*. Any of the compound that fell on the bottom wall of the reaction tube may also be transferred by removing the apparatus from the furnace, tipping it, and tapping the walls. To provide for this the rubber tubing through which the hydrogen passes from the sulfuric acid should be  $1\frac{1}{2}$  ft. long. Tube *E* is sealed at *G*, so that the product is obtained in an atmosphere of carbon dioxide.

Although the percentage yield is high since a large part of the unchanged (IV)bromide can be recovered, the quantity of (III)bromide produced per hour under the conditions outlined is about 1 g. *Anal.* Calcd. for  $\text{TiBr}_3$ : Ti, 16.7; Br, 83.3. Found: Ti, 16.6, 16.6; Br, 82.9, 83.0.

### Properties

Titanium(III) bromide is a black compound crystallizing in both hexagonal plates and needles under the conditions of preparation described. It becomes violet to red on exposure to moist air and dissolves in water to give a violet solution. In vacuum at about  $400^\circ$  the compound dissociates into the (II)bromide and (IV)bromide.

### Reference

1. YOUNG and SCHUMB: *J. Am. Chem. Soc.*, **72**, 4233 (1930).



**34. BIS[TRIS(2,4-PENTANEDIONO)TITANIUM(IV)]  
HEXACHLOROTITANATE(IV)**

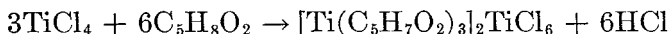

SUBMITTED BY RALPH C. YOUNG\* AND ALLEN J. VANDER WEYDEN\*  
CHECKED BY WILLIAM E. WHEELER†

The composition of the product obtained in attempts to synthesize titanium acetylacetonate from titanium(IV) chloride and acetylacetone is represented by the formula  $\text{TiCl}_2(\text{C}_5\text{H}_7\text{O}_2)_2$ . This formula is analogous to that of the dichloroacetylacetonate of tin.<sup>3</sup> However, the titanium compound resembles in some respects the silicon compound  $(\text{C}_5\text{H}_7\text{O}_2)_2\text{SiCl}_2$ , which because of its saltlike properties is considered to be  $[(\text{C}_5\text{H}_7\text{O}_2)_3\text{Si}]_2\text{SiCl}_6$ . It is ionized in alcohol and acetic acid, and the  $[\text{SiCl}_6]$  radical may be replaced by other groups. While these properties are not as marked in the case of the titanium compound as in the silicon complex, the formation of  $[\text{Ti}(\text{C}_5\text{H}_7\text{O}_2)_3]\text{FeCl}_4$ <sup>3</sup> from the supposed dichloroacetylacetonate of titanium indicates that the formula  $[\text{Ti}(\text{C}_5\text{H}_7\text{O}_2)_3]_2\text{TiCl}_6$  may well be assigned to it.

### Procedure

**A. Dehydration of the Acetic Acid.** Ten milliliters of titanium(IV) chloride is added to 200 ml. of glacial acetic acid to react with any water present in the latter. This mixture is then carefully warmed in a distilling flask fitted with a condenser and receiver. A vigorous reaction occurs in which titanium acetate and hydrogen chloride are formed. Some liquid may be carried over into the receiver. After the hydrogen chloride has been expelled, the acetic acid is distilled and collected in a clean receiver.

\* Massachusetts Institute of Technology, Cambridge, Mass.

† The Ohio State University, Columbus, Ohio.

**B. Preparation of the Acetylacetonone Derivative.** Ten milliliters of the glacial acetic acid from A is placed in an Erlenmeyer flask provided with a drying tube. To this is added, in an atmosphere of carbon dioxide, 3.2 ml. of freshly distilled titanium(IV) chloride. Six milliliters of acetylacetonone is introduced to the cooled mixture. After boiling and cooling, a red-yellow crystalline precipitate forms. Yield 6.4 g. (70 per cent). The mother liquor is removed by decantation, and the crystals are washed several times with petroleum ether and dried in an atmosphere of carbon dioxide. The product is recrystallized from 12 ml. of boiling glacial acetic acid in which it is readily soluble though relatively insoluble at 20°. Yield 5 g. (54 per cent). *Anal.* Calcd. for  $[\text{Ti}(\text{C}_5\text{H}_7\text{O}_2)_3]_2\text{TiCl}_6$ : Ti, 15.1; Cl, 22.3. Found: Ti, 15.1; Cl, 21.1.

### Properties

Bis[tris(2,4-pentanediono)titanium(IV)] hexachlorotitanate(IV) is soluble in nonaqueous solvents, such as benzene and chloroform, but only slightly soluble in cold glacial acetic acid. It is completely decomposed by water into acetylacetonone, hydrous titanium oxide, and hydrochloric acid. When a glacial acetic acid solution of the titanium compound is added to one of iron(III) chloride, a red crystalline compound having the composition  $[\text{Ti}(\text{C}_5\text{H}_7\text{O}_2)_3]\text{-FeCl}_4^3$  is precipitated.

### References

1. ROSENHEIM, LOEWENSTAMM, and SINGER: *Ber.*, **36**, 1833 (1903).
2. DILTNEY: *Ann.*, **344**, 300 (1906).
3. DILTNEY: *Ber.*, **37**, 589 (1904).

### 35. ZIRCONIUM ACETYLACETONATE

[Tetrakis(2,4-pentanediono)zirconium]

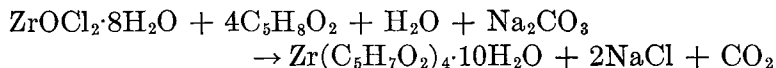

SUBMITTED BY RALPH C. YOUNG\* AND ARNOLD ARCH\*

CHECKED BY MARVIN R. FREDERICK† AND W. CONARD FERNELIUS†

Zirconium acetylacetonate was first prepared by Biltz and Clinch<sup>1</sup> by the reaction of zirconyl nitrate and sodium acetylacetonate in water solution. The compound was crystallized as the 10-hydrate from a slightly acid solution and dehydrated by several crystallizations from alcohol. Von Hevesy and Lögstrup<sup>2</sup> later developed a method for the preparation of hafnium acetylacetonate that has been found applicable to the synthesis of the zirconium compound and this forms the basis of the present procedure.

#### Procedure

**A. Purification of Zirconium Oxychloride.** Commercial zirconium oxychloride 8-hydrate is recrystallized according to the following method:<sup>3</sup> Twenty-five grams is dissolved in a solution of 6 ml. of concentrated hydrochloric acid in 100 ml. of water. The solution is warmed to 70° and filtered. The filtrate is concentrated to 75 ml. and cooled but not stirred. The salt that crystallizes is filtered by suction and washed with a cold solution consisting of a 1:1 mixture of alcohol and concentrated hydrochloric acid. Ten grams of the purified product is obtained. An additional quantity (7 g.) may be recovered from the mother liquor by further concentration and crystallization.

**B. Preparation of Zirconium Acetylacetonate.** Five and eight-tenths grams of the crystallized zirconium oxychloride

\* Massachusetts Institute of Technology, Cambridge, Mass.

† The Ohio State University, Columbus, Ohio; present address: Purdue University, West Lafayette, Ind.

is dissolved in 50 ml. of water, and the solution is cooled to 15°. Ten grams of acetylacetone is added to 50 ml. of a 10 per cent solution of sodium carbonate, and the mixture is stirred until the oil is dissolved. After this solution has been cooled in ice water and filtered, it is added gradually, with stirring, to that of the chloride. The mixture is surrounded by ice during this process, and after 1 hour's cooling the crystallized zirconium acetylacetonate 10-hydrate is filtered by suction and washed with cold water. Yield 4.6 g. The undiluted mother liquor is cooled in ice for 24 hours to recover an additional amount of the acetylacetonate. A total of 5 g. of crude product containing a small amount of hydrous zirconium oxide is obtained.

The crude material is dissolved in the minimum quantity of benzene (about 25 ml.), and the undissolved oxide removed by filtration. The anhydrous acetylacetonate is precipitated by adding petroleum ether to the filtrate.

### Properties

Zirconium acetylacetonate 10-hydrate effloresces in air and may be completely dehydrated in a vacuum of 0.1 mm. The anhydrous salt sublimes slowly with some decomposition *in vacuo* at about 140° and melts at 194.5 to 195° with decomposition. The acetylacetonate reacts with alcohol.<sup>2</sup> Its solubility at 25° per liter in other organic solvents is as follows: carbon disulfide, 30 g.; carbon tetrachloride, 47 g.; acetylacetone, 56 g.; ethylene dibromide, 44 g.; benzene, approximately 200 g. Both the hydrate and the anhydrous compound give a red color with carbon disulfide on standing. This is also true of hafnium acetylacetonate but not of the thorium compound.

### Reference

1. BILTZ and CLINCH: *Z. anorg. Chem.*, **40**, 218 (1904).
2. VON HEVESY and LÖGSTRUP: *Ber.*, **59**, 1890 (1926).
3. SCHUMB and PITTMAN: private communication.

### 36. THORIUM ACETYLACETONATE

#### (Tetrakis(2,4-pentanediono)thorium)

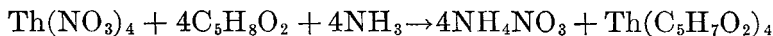

SUBMITTED BY RALPH C. YOUNG\* AND JULIAN KOVITZ\*

CHECKED BY L. E. MARCHI†

Thorium acetylacetonate was first described by Urbain,<sup>1,2</sup> who synthesized it by the action of an alcoholic solution of acetylacetone on freshly precipitated hydrous thorium oxide and by a metathetical reaction between sodium acetylacetonate and a thorium salt such as thorium nitrate. The crude product was purified by sublimation and by crystallization from chloroform. Biltz,<sup>3,4</sup> who subsequently determined the atomic weight of thorium by means of the acetylacetonate, added a solution of acetylacetone in aqueous ammonia to a solution of thorium nitrate and crystallized the precipitate from alcohol.

#### Procedure

To 25 g. of freshly distilled acetylacetone suspended in 50 ml. of water 6 *N* ammonia is added (drop by drop from a buret), with stirring, until solution is complete. This solution is mixed with one containing 25 g. of thorium nitrate in 200 ml. of water, and 6 *N* ammonia is added drop by drop until the mixture becomes alkaline to litmus. The precipitated thorium acetylacetonate is removed by filtration, washed, and air-dried. Yield 26 g.

The compound is purified by sublimation in a high vacuum. A pyrex tube 20 cm. in length and 20 mm. in diameter is sealed to a tube 30 cm. in length and 12 mm. in diameter, to the outer end of which is joined a short length of 8-mm. tubing. At the junction of the two larger tubes is placed a wad of glass wool. Five grams of the

\* Massachusetts Institute of Technology, Cambridge, Mass.

† The Ohio State University, Columbus, Ohio; present address: University of Pittsburgh, Pittsburgh, Pa.

crude acetylacetonate is placed in the largest tube, which is then sealed 15 cm. from the junction. After the compound is spread out uniformly, the apparatus is connected to a high-vacuum pump and is so placed in a sleeve-type electric furnace that the sealed end, as well as the part containing the glass wool, is at least 7.5 cm. within the heated zone. The furnace is very gradually heated to 160°, and the sublimation, requiring several hours, is carried out at this temperature, which is well below the melting point of the compound. Colorless crystals are obtained; m.p. 170.8 to 171°, cor. Yield 4.8 g.

If too high a temperature is used for the sublimation, an oily material resulting from decomposition will collect beyond the main body of the product and may contaminate it. Crystallization from alcohol is effective provided that the crystals are removed from the mother liquor as soon as it cools.<sup>3</sup> The compound can be crystallized from benzene, toluene, or chloroform in which it is very soluble, or it may be precipitated from such solutions by means of petroleum ether.

To recrystallize from toluene\* 25 g. of thorium acetylacetonate is dissolved in 100 g. of toluene. The small amount of undissolved suspended material is removed by stirring the solution with a few grams of animal charcoal and filtering. The clear, pale-yellow filtrate is cooled to -78° in a dry ice-acetone bath for several hours. The acetylacetonate separates as a mass of small white crystals, which are filtered in a Büchner funnel previously cooled in powdered dry ice, and washed with a little toluene at -78°; m.p. 171.5°. Yield 15 g. (60 per cent).

### Properties

Thorium acetylacetonate is insoluble in water and soluble in many organic solvents. It is converted by acids into acetylacetone and the thorium salt of the acid used. Its vapor pressure<sup>5</sup> at 100° is  $3.2 \pm 0.3 \times 10^{-4}$  mm.

\* This procedure was suggested by the checker.

The molecular weight of thorium acetylacetonate has been determined in carbon tetrachloride and other organic solvents. According to Biltz it forms an ammoniate  $[\text{Th}(\text{C}_5\text{H}_7\text{O}_2)_4]_2 \cdot \text{NH}_3$  and a similar derivative with aniline, which can be crystallized from ether.

#### References

1. URBAIN: *Bull. soc. chim.*, [3] **15**, 338, 347 (1896).
2. URBAIN: *Ann. chim. phys.*, [7] **19**, 223 (1900).
3. BILTZ: *Ann.*, **331**, 340 (1904).
4. BILTZ and CLINCH: *Z. anorg. Chem.*, **40**, 218 (1904).
5. YOUNG, GOODMAN, and KOVITZ: *J. Am. Chem. Soc.*, **61**, 876 (1939).

## CHAPTER V

- See also: Ammonium tetrafluoroborate, synthesis 8  
Magnesium-rare earth nitrates, synthesis 15  
Ammonium carbamate, synthesis 23  
Alkali metal cyanates, synthesis 24  
Cyanogen chloride, synthesis 25  
Sulfamic acid, synthesis 52  
Triammonium imidodisulfate, synthesis 53  
Potassium nitridotrifluoroborate, synthesis 54  
Alkali metal selenocyanates, synthesis 56  
Ammonium hexachlorotellurate(IV), synthesis 57A  
Cyanometallates, syntheses 62, 67, 72, 73, 78  
Hexamminecobalt(III) salts, synthesis 69  
Cobalt nitrosyl tricarbonyl, synthesis 76  
Tetrammineplatinum(II) chloride, synthesis 80

### 37. NITRIC OXIDE

#### [Nitrogen(II) Oxide]

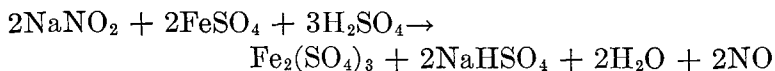

SUBMITTED BY ARTHUR A. BLANCHARD\*

CHECKED BY C. M. MASON†‡ AND ROBERT L. BARNARD†

Nitric oxide is produced in greater or less purity by the action of a wide variety of reducing agents on either nitric or nitrous acid. In the following procedure the reaction of acidified iron(II) sulfate with sodium nitrite produces directly almost pure nitric oxide. The small amounts of higher oxides of nitrogen and carbon dioxide (from sodium carbonate in the nitrite) are removed by the alkali in the leveling bulb and the purifying tube. The almost negli-

\* Massachusetts Institute of Technology, Cambridge, Mass.

† University of New Hampshire, Durham, N.H.

‡ Present address: U.S. Bureau of Mines, Tuscaloosa, Ala.



ble traces of nitrous oxide and nitrogen will interfere with few if any of the uses to which the nitric oxide will be put.

### Procedure

The apparatus shown in Fig. 10 is convenient for generating nitric oxide. The reservoir and generator are made from 500- or 750-ml. flasks.

The cocks are opened and sufficient 6 *N* sodium hydroxide to nearly fill the nitric oxide reservoir is poured through the leveling bulb. Water is drawn up into the measuring

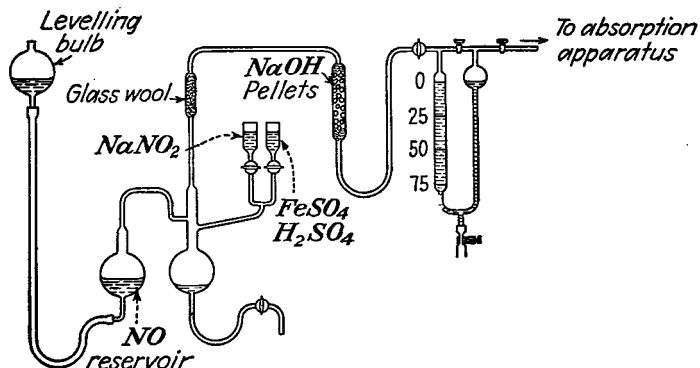

FIG. 10.—Apparatus for the preparation of nitric oxide.

buret and the screw cock closed when the water stands at the zero level.

The following stock solutions are prepared:

(1) 278 g.  $\text{FeSO}_4 \cdot 7\text{H}_2\text{O}$  and 55 ml. 36 *N*  $\text{H}_2\text{SO}_4$  in 1 l. of solution.

(2) 69 g.  $\text{NaNO}_2$  in 1 liter.

About 20 ml. of water is admitted to the generator flask. Then 10 ml. each of (1) and (2) is placed in the respective filling cups. The leveling bulb is lowered, and the reagents are run into the generating flask. Then the leveling bulb is raised. More than 200 ml. of nitric oxide will be quickly generated. The first two portions of gas are allowed to escape through the filling cups (to save the sodium hydroxide pellets). Successive amounts of reagents are added.

Since the response becomes slower as the spent liquor accumulates, all but 20 ml. of the latter is drawn off whenever the flask becomes one-third full.

This generator may be used for both steady and intermittent withdrawals of nitric oxide. It is particularly useful when attached to a closed absorption apparatus whose contents are slowly absorbing nitric oxide. When the dry gas is desired, it may be dried by passing through a tube filled with phosphorus(V) oxide.

Directions for operating the metering device are given in Synthesis 22.

### Properties

Nitric oxide is a colorless gas with the following physical properties:

Melting point.....	-163.6°
Boiling point.....	-151.7°
Density (liquid).....	1.269 (at b.p.)
Critical temperature.....	-94°
Critical pressure.....	65 atm.
Heat of dissociation (N <sub>2</sub> + O <sub>2</sub> ).....	-21 kg.-cal.

The molecule contains an odd number of electrons and is paramagnetic. The oxide is somewhat soluble in water: 4.7 volumes per 100 volumes of water at 20° and 1 atm.

Nitric oxide reacts readily with oxygen to form brown nitrogen dioxide at ordinary temperatures. Several metal ions form complex ions with nitric oxide. It can also replace carbon monoxide in certain metal carbonyls.

### 38. SODIUM AMIDE



SUBMITTED BY K. W. GREENLEE\* AND A. L. HENNE\*

CHECKED BY W. CONARD FERNELIUS†

In the last few years sodium amide has become increasingly important as a reagent in organic syntheses. Its

\* The Ohio State University, Columbus, Ohio.

† Purdue University, West Lafayette, Ind.

preparation, properties, and uses have been reviewed at length.<sup>1</sup> It is therefore surprising that none of the chemical supply houses lists this important chemical in its catalogue. The reason for this situation is that, although sodium amide is prepared in large quantities for the manufacture of sodium cyanide, sodium azide, and indigo, it is not isolated as an article of commerce but is consumed as it is generated. In addition, the opinion is widely held that sodium amide is a dangerous chemical. While several accidents have occurred in using sodium amide, practically all of them have been traced to (1) the highly reactive character of sodium amide, (2) improper manufacture, or (3) deterioration due to improper storage. There is every reason to feel that sodium amide is in no sense an unstable compound. However, until the present situation changes, chemists must prepare sodium amide as needed for their investigations.

The direct action of pure gaseous ammonia upon pure sodium produces sodium amide of high purity.<sup>2</sup> However, for most uses the material prepared by catalytic reaction of sodium with liquid ammonia at its normal boiling point is preferable because (1) it is finely divided, (2) it is always free of sodium hydride and unconverted sodium, and (3) it can be freed of ammonia, if needed, or left *in situ* when used further in liquid ammonia. It is well known that the reaction of alkali metals with liquid ammonia is catalyzed by many metals and metal oxides.<sup>3</sup> When the catalytic metal is produced in finely divided form directly in the solution by the reducing action of sodium, the catalytic activity of the metal is greatly enhanced.<sup>4</sup> This method of preparation has attained widespread use.<sup>5-9</sup> The procedure outlined below is very convenient and requires little special equipment.

### Procedure

**Apparatus.** The apparatus consists of a three-necked flask fitted with a mercury-sealed stirrer and a reflux con-

denser (Fig. 11). The size of the reactor is not critical but depends upon the amount of product desired and the capacity of the stirrer available. In general, the reactor is not filled to more than three-fifths capacity with liquid ammonia, 1 liter of which is provided for each 4 to 10 mols of sodium. Since the mixture becomes increasingly difficult to stir as the insoluble amide forms, the upper limit of sodium concentration should be avoided unless a powerful stirrer is being used. The blade of the stirrer may be a glass loop or a Hershberg wire stirrer<sup>10</sup> of stiff, corrosion-

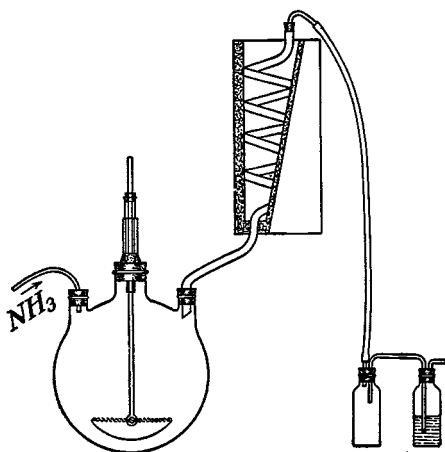

FIG. 11.—Apparatus for the preparation of sodium amide.

resistant metal such as Chromel. The condenser is built to be cooled by dry ice in a solvent such as acetone or methanol. It consists of a vertical coil of tubing ( $\frac{1}{2}$  in. i.d. or larger), with a gradient of not less than 1:7, fitting snugly inside a cylindrical open-top double-wall container. Alternative types of condensers are shown in Fig. 12 (double coil) and Fig. 13 (annular type). The tubing should be of some material resistant to the combined action of moist ammonia and oxygen. Of the metals usually available, block tin is the most suitable; copper is chemically unsuitable; lead is too soft; glass may be used if care is taken to

avoid breakage and if the lesser heat conductivity of glass does not matter. The delivery tube leading to the reactor is an extension of the coil.

The double-wall container may be made of two concentric metal cans (tin cans are suitable if free from corroded spots), separated by some good insulating material such as glass or rock wool. Soldering the coil where it passes through the jacket must be done cautiously as the melting point of tin is near that of solder. To prevent the slow collapse of a tin coil in use, it is braced to the top of the jacket. The space between the cans is closed at the top by metal and solder or plaster of paris. The following precautions should be taken: The liquid is removed

promptly from the jacket after each run, and the condenser is kept dry when not in use. Such a condenser was in fair condition after a year and a half during which some 100 liquid ammonia reactions were carried out.\*

During the reaction at least the lower part of the flask should be surrounded by some good insulating material such as magnesia, asbestos, or sawdust. The reduced visibility may be compensated for by washing off the frost with alcohol and by using a bright light.

Unless ventilation is very good, some provision should be made for disposal of the large volumes of hydrogen evolved. Its evolution is observed in a bubbler filled with mineral oil or concentrated aqueous ammonia; water is not a suitable liquid because it would be sucked back into other parts of the apparatus.

\* The condenser may be dispensed with altogether, but at the expense of convenience in handling of ammonia and with a great reduction in the amount of amide that can be made in a given quantity of the solvent.

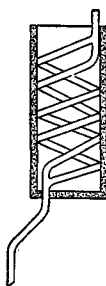

FIG. 12.—  
Double-coil type  
of condenser.

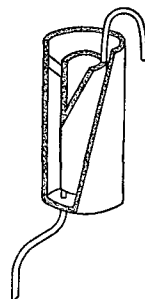

FIG. 13.—An-  
nular type of  
condenser.

If desired a special sodium addition flask (Fig. 14) may be provided to contain all the sodium required for one run and yet permit addition of one piece at a time. This addition flask is attached to the reactor by a thin rubber sleeve. Of the side necks pictured, one allows the insertion of a glass rod to break up possible jams at the neck, and the other facilitates washing and drying of sodium while in the flask itself.

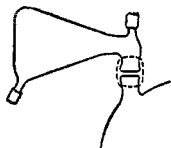

FIG. 14.—Sodium-addition flask.

**Preparation of Sodium Pellets.** Sodium is cut under mineral oil into cubes (of convenient size to pass through one of the small necks of the reactor). These are transferred to a cylinder containing petroleum ether. The latter solvent is poured off, and the cubes are dried by a stream of dry nitrogen or of ammonia gas led to the bottom of the container. A pound of sodium can easily be pelleted and dried in a half hour.

**Charging of Reactor with Solvent.** The condenser jacket is filled with roughly crushed Dry Ice, and acetone (about one-fifth the capacity of the jacket) is poured in slowly. More Dry Ice\* is added from time to time as needed and punched down with a stick, since it may deceptively leave an empty crust. Liquid ammonia† is run into the flask at such a rate that all the vaporized ammonia condenses without loss or flooding. When the desired amount of ammonia has been withdrawn, the stopper bearing the inlet tube is replaced by a solid stopper.

If gaseous ammonia is drawn from the tank and liquefied in the reactor, freedom from suspended matter and dissolved salts is ensured but the cost in time and refrigeration is increased. To ensure perfectly anhydrous conditions, ammonia that has been stored over sodium<sup>11</sup> should be used,

\* In converting 1 lb. of sodium in 3 l. of ammonia in a 5-l. flask, about 30 lb. of Dry Ice is consumed.

† Liquid ammonia may be withdrawn from a commercial cylinder by supporting it in an inverted position or inclining it so that the inner end of the siphon outlet dips into the liquid. The delivery tube may be metal (for example, clean copper), glass, or even rubber tubing.

and dry ammonia gas should be passed through the condenser for several minutes before it is liquefied by addition of Dry Ice and acetone to the condenser. In this case, the exit tube from the condenser should be attached to a drying tube containing barium oxide to absorb water from the air that will be drawn back when liquefaction of ammonia is begun.

**Preparation of Catalyst.** For each mol of sodium to be converted, 0.2 to 0.3 g. of coarsely powdered iron(III) nitrate 9-hydrate is added to the liquid ammonia after momentarily removing the stopper. The reaction mixture is stirred vigorously for 5 to 10 minutes to disperse the ammonolysis products of the iron(III) nitrate as finely as possible. A quantity of clean sodium, two or three times the weight of the iron(III) salt, is added, and stirring is continued at a slower rate. The reaction that takes place is probably the following:

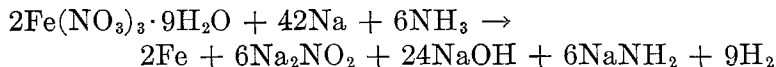

The reaction is completed when the blue color of dissolved sodium spreads through the solution. The color must be detected where the liquid splashes against the walls, because the body of the solution is quite dark from the catalytic iron.

The rate of formation of sodium amide is doubled or tripled if the catalytic mixture contains sodium peroxide, which acts as a promoter and may be formed as follows: A glass tube connected to an air line is inserted deep into the reaction mixture, and a brisk stream of air (dry if anhydrous conditions are being maintained) is led in for 15 to 25 seconds. A slow stream of air is apt to produce a mixture of sodium amide and sodium hydroxide (ammonolysis products of sodium oxide).\*

\* Other metals such as cobalt, nickel, and platinum have been found effective but to a lesser degree than iron.<sup>4</sup> Wide variations in the activity

**Preparation of Sodium Amide.** With the catalyst made, the bulk of the sodium is now added in batches of 1 to 3 mols, or according to the capacity of the reflux condenser to absorb the heat of reaction without entraining liquid ammonia in the exit gases. Each time the sodium is used up, the evolution of hydrogen (observed in the external bubbler) stops abruptly. Throughout the reaction the stirrer is run slowly; but when the final batch of sodium has thus been used up, the stirrer should be raised to near the surface and run at high speed for a few minutes if necessary to wash down and destroy sodium splattered on the sides and roof of the flask. This sodium is frequently pyrophoric and, besides, could contaminate the product. There should be no difficulty in bringing the reaction to completion. The sodium amide is almost insoluble in liquid ammonia and appears in the form of a grainy sludge.

If dry, ammonia-free amide is desired, the stirrer and condenser are removed from the reactor and replaced by well-fitting rubber stoppers, one of which carries a delivery tube. At this point some of the iron catalyst and the more soluble impurities could be removed simply by decanting the supernatant liquid, which would then require caution in disposal. In any case, the reactor is allowed to stand in a well-ventilated hood overnight for evaporation of ammonia.\* Outward flow of ammonia prevents access of air to the amide, but a drying tube filled with barium oxide may be used as an added precaution. Next day, a vacuum is drawn on the residue for 10 to 30 minutes, and the vacuum is broken with dry nitrogen gas, which is then led through

---

of iron catalyst with small variations in procedure have been observed. One of the most important factors seems to be the state of division of the iron compounds prior to reduction by sodium. It is sometimes hard to remove the colloidal iron catalyst from a liquid product of a reaction (such as a substituted acetylene) carried out in liquid ammonia solution. However, drying the amide flocculates the iron, which can then easily be removed from a liquid product by washing with dilute acid.

\* To hasten evaporation, the flask may be removed from the insulation or even warmed by a stream of air.



one small neck while the cake of sodium amide is broken up with a stick inserted through the large center neck. When freshly prepared, sodium amide is easily pulverized into a mass of crystals like fine sand and is surprisingly light in color, in contrast with its black appearance before removal of the ammonia.

For storage, sodium amide must be protected from air and moisture. Hence it is transferred to bottles filled with dry nitrogen and sealed with paraffin. Sodium amide thus prepared can be kept safely and in an active condition for long periods of time. Unless a batch of amide is to be used immediately or all at one time, it should be divided among several bottles so that, if one deteriorates during use or storage, all of the remainder will not have to be discarded. The bottles should be of clear glass, and any amide in which a yellow color appears (due to oxidation) should be discarded. The amide is best disposed of by tossing it into a large quantity of water out of doors. **Caution.** *Samples that become oxidized are apt to explode when heated.* However, with suitable protection, sodium amide is quite stable.

Lithium amide<sup>12</sup> and potassium amide<sup>13</sup> may be prepared by this same method.

### Properties

See INORGANIC SYNTHESSES, 1, 76 (1939).

### References

1. BERGSTROM and FERNELIUS: *Chem. Rev.*, **12**, 43-179 (1933), **20**, 413-481 (1937).
2. DENNIS and BROWNE: INORGANIC SYNTHESSES, **1**, 74 (1939).
3. FRANKLIN: *J. Am. Chem. Soc.*, **27**, 831 (1905).
4. VAUGHN, VOGT, and NIEUWLAND: *ibid.*, **56**, 2120 (1934).
5. BRIED and HENNION: *ibid.*, **59**, 1310 (1937).
6. CAMPBELL, CAMPBELL, and EBY: *ibid.*, **60**, 2882 (1938).
7. ZOSS and HENNION: *ibid.*, **63**, 1151 (1941).
8. U.S. patents 2106180, 2106181, 2106182, 2125384, 2194363.
9. SHREVE and ROTHENBERGER: *Ind. Eng. Chem.*, **29**, 1361 (1937).
10. HERSHBERG: *Ind. Eng. Chem., Anal. Ed.*, **8**, 313 (1936).
11. JOHNSON and FERNELIUS: *J. Chem. Education*, **6**, 441 (1929).
12. CAMPBELL and CAMPBELL: *Proc. Indiana Acad. Sci.*, **50**, 123 (1940).
13. MCCUSKER and VOGT: *J. Am. Chem. Soc.*, **59**, 1307 (1937).

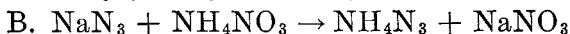
**39. AMMONIUM AZIDE**

SUBMITTED BY W. J. FRIERSON\*

CHECKED BY W. F. FILBERT†

Ammonium azide was first prepared by Curtius,<sup>1</sup> who saturated an alcoholic solution of diazohippuramide with gaseous ammonia and precipitated the pure ammonium azide by addition of ether. Curtius<sup>2</sup> also prepared ammonium azide by the action of hot alcoholic ammonia upon certain acyl azides,  $\text{RCON}_3$ .

Two later methods, which involve no organic compounds, have been developed by A. W. Browne and his coworkers. These methods depend upon (A) the neutralization of hydrazoic acid in ethereal solution by gaseous ammonia<sup>3</sup> and (B) the metathetical reaction between dry sodium azide and an ammonium salt, at relatively high temperatures.<sup>4</sup>

**Procedure A**

A solution of hydrogen azide in ether is prepared as described previously.<sup>5</sup> Fifty milliliters of this solution is diluted to 500 ml. with anhydrous ethyl ether and cooled in an ice-salt mixture. Pure, dry ammonia gas is slowly bubbled through this solution until precipitation is complete. This operation should be carried out in a well-ventilated hood. The precipitated ammonium azide is filtered and stored in a vacuum desiccator, which from time to time is alternately evacuated and filled with dry air, until the ether has completely evaporated. Yield 4.1 g. (74 per cent). The product is of a high degree of purity.

\* Hampden-Sydney College, Hampden-Sydney, Va.; present address: Birmingham Southern College, Birmingham, Ala.

† Eastern Laboratory, E. I. duPont de Nemours & Company, Inc., Gibbstown, N.J.

### Procedure B

**Caution.** *This method should be used for the preparation of ammonium azide in quantities no larger than those specified in the directions.*

A dry mixture containing 6 g. of ammonium nitrate\* and 5 g. of sodium azide is placed in a 200-ml. flask. Any other mixture containing equimolecular quantities of these two salts may be used, but amounts larger than 10 to 15 g. should be avoided unless extreme care be taken to protect the workers from injury. Although no explosion has as yet occurred during the repeated use of this method with the quantities specified here, it is advisable that the operator be protected at all times by a heavy metal or wooden screen with a small observation window of shatterproof glass.†

The flask containing the dry mixture is supported in a horizontal position in a gas-heated oven. A suitable oven can be made from an old pneumatic trough by cutting a hole in one side and placing a piece of asbestos board over the top. The flask for receiving the sublimed ammonium azide is placed in a similar position on the outside of the oven with its neck inserted through a hole in the side of the oven, mouth to mouth with the flask containing the charge. The tighter connection obtainable by means of ground-glass joints is preferable. Any similar assembly would be satisfactory, if so arranged that the necks of both flasks are in the oven to prevent obstruction by condensation of the sublimate.

The temperature is slowly raised to 200° over a period of 15 minutes and is maintained approximately at this point until the reaction is complete. The 11-g. mixture will take several hours, but for a 2-g. mixture the reaction is ordi-

\* As a matter of safety, the ammonium nitrate should be free from heavy metal impurities, particularly copper salts.

† In checking this synthesis, it was found that larger batches often explode at lower temperatures than those which are recommended for the preparation of small batches. For example, a 50-g. batch exploded when heated to 158°.

narily completed within 30 minutes. According to Muller, the addition of a small amount of water considerably lowers the temperature necessary for the metathetical reaction.<sup>6</sup>

Yields of 85 to 95 per cent are obtained, and the ammonium azide is of a high degree of purity.

Ammonium sulfate may be used instead of ammonium nitrate, but the temperature then must be kept at about 300°.

### Properties

Ammonium azide is a white crystalline salt, with the following solubilities per 100 ml. of solvent, at 20°: water 20 g.; methanol 3.3 g.; ethanol 1.06 g.; ether 0.006 g.; benzene 0.003 g. It crystallizes from aqueous solutions in anhydrous form, has a relatively high vapor tension, and sublimes at 133° without melting. It is one of the more stable azides but, when properly initiated, detonates with high velocity. It usually detonates with extreme violence when heated in a sealed tube but not in the open air.

### References

1. CURTIUS: *Ber.*, **23**, 3023 (1890).
2. *Ibid.*, **29**, 759 (1896).
3. BROWNE and HOULEHAN: *J. Am. Chem. Soc.*, **33**, 1742 (1911).
4. FRIERSON and BROWNE: *ibid.*, **56**, 2384 (1934).
5. AUDRIETH and GIBBS: INORGANIC SYNTHESSES, **1**, 77 (1939).
6. MULLER: German patents 637781 and 640004 (1936).
7. FROST, COTHRAN, and BROWNE: *J. Am. Chem. Soc.*, **55**, 3516 (1933).
8. BROWNE and HOULEHAN: *ibid.*, **35**, 649 (1913).
9. BROWNE and HOLMES: *ibid.*, **35**, 672 (1913).
10. BROWNE, HOLMES, and KING: *ibid.*, **41**, 1769 (1919).
11. HOWARD, FRIEDRICHS, and BROWNE: *ibid.*, **56**, 2332 (1934).
12. AUDRIETH: *Chem. Revs.*, **15**, 169 (1934).

## 40. POTASSIUM AZIDE

### (Sodium Azide)

SUBMITTED BY M. W. MILLER\* AND L. F. AUDRIETH\*

CHECKED BY W. F. FILBERT†

The preparation of potassium azide from aqueous potassium hydroxide and hydrazoic acid has been described earlier.<sup>1</sup> The preparation of hydrazoic acid is always hazardous because of its explosive nature and its unpleasant physiological effects. Consequently, an alternative procedure based on the initial reaction of hydrazine with nitrous acid is described here.

Similar reactions have been carried out by various investigators using ethyl nitrite,<sup>2</sup> amyl nitrite,<sup>3,4</sup> and other alkyl nitrites<sup>5</sup> in aqueous or alcoholic solution in the presence of potassium hydroxide or potassium ethylate. In the procedure given below butyl nitrite is used. It is more easily prepared and handled than ethyl nitrite. It may also be used for the preparation of sodium azide.

### Procedure

#### A. BUTYL NITRITE<sup>5</sup>

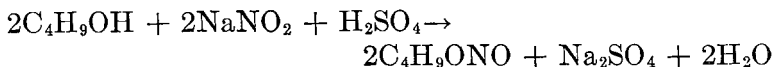

Eighty-seven milliliters of concentrated sulfuric acid (1.5 mol  $\text{H}_2\text{SO}_4$ ) is poured into 60 ml. of water. The mixture is cooled to  $0^\circ$  in an ice-salt bath and maintained at this temperature while 222 g. (3 mols) of *n*-butyl alcohol is added slowly, with constant agitation. During the course of an hour this mixture is then introduced beneath the surface of a cold ( $0^\circ$ ) solution of 228 g. (3.3 mols) of sodium nitrite dissolved in 900 ml. of water, which is contained in a

\* University of Illinois, Urbana, Ill.

† Eastern Laboratory, E. I. duPont de Nemours &amp; Company, Inc., Gibbstown, N.J.

1.5-l. beaker. The nitrite solution should be well cooled in an ice-salt bath and the solution agitated during the addition of the butyl alcohol-sulfuric acid mixture.\* The butyl nitrite forms as a yellow oily layer that floats on the surface of the aqueous solution. This layer† is separated, and the crude product is washed three times with 60-ml. portions of a solution of 45 g. of salt and 5 g. of sodium bicarbonate in 180 ml. of water. The product is dried over anhydrous sodium sulfate. Yield 270–289 g. (87 to 93.5 per cent).

### B. POTASSIUM AZIDE

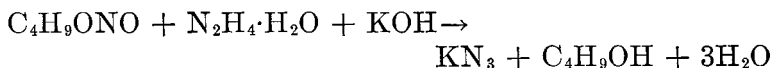

A solution of 65 to 70 g. of potassium hydroxide in 500 ml. of absolute ethyl alcohol is first prepared. The process of solution is extremely slow at room temperature and may be hastened by heating. The alcohol-insoluble contaminants are preferably allowed to settle in a tall cylinder, and the clear solution is decanted into a 1-l. round-bottomed flask fitted to a condenser by means of a ground glass joint.‡ Sixty grams (1 mol) of technical 85 per cent hydrazine hydrate§ is added to the solution. The mixture is warmed slightly on a steam bath, and 15 g. of butyl nitrite is added to start the reaction. The flask with the attached condenser is then removed from the steam bath, and an additional quantity of 110 g. of butyl nitrite (total amount 125 g. or 1.2 mols) is added at such a rate that the solution

\* To prevent the formation of a viscous emulsion, the mixture should be well agitated.

† If an emulsion forms it is advisable to separate the upper layer of butyl nitrite and then add more water to the lower layer which will effect separation of additional nitrite.

‡ If an all-glass apparatus is not available, cork or rubber connections should be covered with tin foil to protect them from the corrosive action of hydrazine vapors.

§ If the 45 per cent grade is used, the yields are poorer and more of the product remains in solution.

refluxes gently. This will ordinarily take about 1 hour. The flask is then reheated on the steam bath for 15 minutes to ensure completion of the reaction. As the reaction proceeds, potassium azide precipitates from the solution. The flask is cooled in an ice bath. The solid product is removed by filtration, washed with four 50-ml. portions of cold absolute ethyl alcohol, followed by two portions of anhydrous ether of 125 and 100 ml., respectively. The product is dried in air at 55 to 60°. Yield 63–69 g. (78 to 84 per cent).

This product is sufficiently pure for most purposes (98.9 per cent KN<sub>3</sub>) but, if desired, may be purified by dissolving in water and reprecipitating by the addition of ethyl alcohol.<sup>1</sup> An additional 6 to 8 g. of impure potassium azide may be obtained by evaporating the mother liquor to about 100 ml. and then cooling and filtering.

### Properties

The properties of the alkali and alkaline earth azides are discussed in Vol. 1 of this series.<sup>1</sup>

### References

1. BROWNE: *INORGANIC SYNTHESSES*, **1**, 79–81 (1939).
2. THIELE: *Ber.*, **41**, 2681 (1908).
3. STOLLE: *ibid.*, **41**, 2811 (1908).
4. NAEGELI and VOGT-MARKUS: *Helv. Chim. Acta*, **15**, 60 (1932).
5. WILCOXON and GROTTA: U.S. patent 1628380; *cf. Chem. Abstracts*, **21**, 2137 (1943).
6. NOYES: *J. Am. Chem. Soc.*, **55**, 3888 (1933).

## 41. PHOSPHONIUM IODIDE

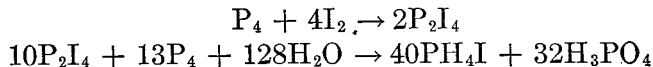

SUBMITTED BY J. B. WORK\*

CHECKED BY J. A. MATTERN† AND R. ANTONUCCI†

Phosphonium iodide was first prepared by Billardiere<sup>1</sup> in 1817, by mixing dry phosphine and hydrogen iodide. This

\* University of Illinois, Urbana, Ill.

† The Ohio State University, Columbus, Ohio.

compound is now of interest since its decomposition affords means of obtaining pure dry phosphine. The preparation of phosphonium iodide, inefficient at best, is usually effected by the hydrolysis of an intimate mixture of diphosphorus tetraiodide and white phosphorus.<sup>2,3</sup>

### Procedure

**Apparatus.** The apparatus is set up as shown in Fig. 15. *A* is a dropping funnel; *B* is a T tube; *C* is a 1000-ml. reaction flask; *D* is a thin-walled glass tube 2 cm. in diam-

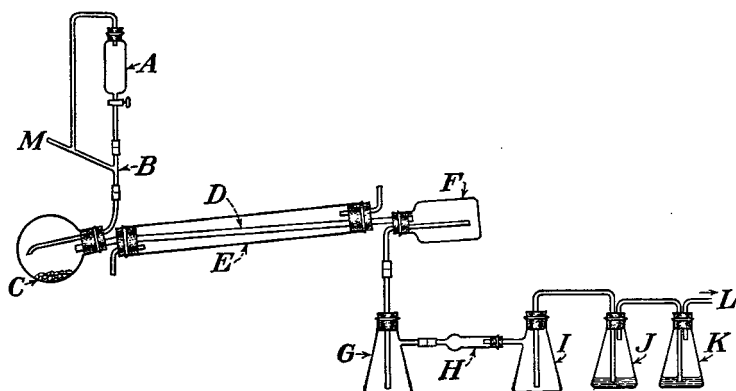

FIG. 15.—Apparatus for the preparation of phosphonium iodide.

eter and about 60 cm. in length, surrounded by the jacket *E* 4 cm. in diameter and about 50 cm. in length; *F* is a tared receiver for the phosphonium iodide, which, because of its wide mouth, can be detached quickly from the apparatus and closed with a ground-glass stopper; *G* and *I* are safety flasks, the former to collect any phosphonium iodide that is not collected in *F* and the latter for water that may be drawn back from *J*; *H* is a calcium chloride drying tube; *J* and *K* contain water to remove excess hydrogen iodide and to indicate the rate of flow of gases through the system. *M* is a pressure equalizer to allow liquid in *A* to flow smoothly into *C*. Rubber stoppers are used throughout. The outlet *L* leads to an efficient hood for disposal of excess



phosphine. The condenser is inclined slightly upward to prevent mechanical transfer of particles from *C* to *F*.

**Preparation of Phosphorus-Diphosphorus Tetraiodide.** Twenty-five grams of white phosphorus is cut into small pieces (**Caution.** *Cut under water!*) each of which is dried individually with absorbent paper and quickly placed in a 300-ml. flask (not the 1000-ml. flask in Fig. 15) from which the air has been displaced by carbon dioxide. During this operation, and subsequently until the phosphorus is entirely dry, carbon dioxide is passed through the flask. Then 25 to 30 ml. of carbon disulfide is added through a funnel and the mixture shaken until the phosphorus has dissolved.

The funnel is removed and 44 g. of iodine is added in small portions, with constant shaking and cooling. A condenser is attached to the flask, and carbon disulfide is removed by immersing the flask in warm water. Volatilization of the last traces of carbon disulfide may be accomplished by passing a slow stream of carbon dioxide through the apparatus.

The flask is detached and the red cake of phosphorus and diphosphorus tetraiodide is broken up by means of a glass rod into a coarse powder, preferably in an atmosphere of carbon dioxide. Although this mixture is quite inflammable, especially if some carbon disulfide remains, it may be ground quickly in a clean, dry mortar that is blanketed by a stream of carbon dioxide.

**Preparation of Phosphonium Iodide.** The mixture is placed in the vessel *C* (Fig. 15) from which all air has been swept with carbon dioxide (through *M*). With cold water circulating in *E*, 15 ml. of water is allowed to drip from *A* into *C*. The rate of addition of the water should be such that bubbles flow continuously through *J* and *K*. If this rate is too slow, *C* will cool off and phosphonium iodide will condense in the bottom of the flask; the next drops of water will then decompose this product instead of producing more of it by action with diphosphorus tetraiodide and phos-

phorus. If the water is added too rapidly, phosphonium iodide may be swept through *D* and *F* before it can condense. Furthermore, the reaction approaches explosive violence if water is added too rapidly.

When all the water has been added, *C* is immersed in boiling water until all the phosphonium iodide has sublimed into *D*. This condition is indicated when cooling *C* does not produce a white crystalline deposit on the inner wall. Several hours may be required for this operation unless carbon dioxide is swept through the system occasionally. The vessel *C* is cooled and removed, and a one-hole rubber stopper is quickly inserted into the open end of *D* and connected to the carbon dioxide supply.

The condenser is inclined at a 30° angle with *F* at the lower end and surrounded by ice. Water, heated to 80°, is run through *E*. With the aid of a very slow stream of carbon dioxide the phosphonium iodide sublimes into *F* as well-formed crystals. This requires 2 or 3 hours. Yield 28 to 34 g. (50 to 60 per cent).

### Properties

Phosphonium iodide is a crystalline white solid, isomorphous with ammonium iodide. It has a vapor pressure of 50 mm. at 20° and 760 mm. at 62.5°. It melts under its own vapor pressure at 18.5° where the heat of fusion is 12,680 cal./mol. The salt dissociates into phosphine and hydrogen iodide when heated or moistened. It will detonate if heated rapidly in air. For these reasons, and because decomposition yields the highly poisonous phosphine, phosphonium iodide is preferably kept in sealed glass vessels. Very beautiful cube-like crystals form if one end of the tube containing the salt is maintained at a temperature about 20° below that of the other end.

### References

1. BILLARDIERE: *Ann. chim. phys.*, **6**, 304 (1817).
2. BAEYER: *Ann.*, **155**, 269 (1870).
3. HOFMANN: *Ber.*, **6**, 286 (1873).

## 42. PHOSPHORUS(III) CHLORIDE

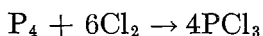

SUBMITTED BY M. C. FORBES,\* C. A. ROSWELL,\* AND R. N. MAXSON\*†  
CHECKED BY HAROLD S. BOOTH‡ AND ALBERT DOLANCE‡

The synthesis of phosphorus(III) chloride sometimes offers experimental difficulty. The following synthesis proceeds smoothly, gives good yields, and is entirely satisfactory for the preparation of this compound.<sup>1</sup> The apparatus is simple and easy to assemble.

### Procedure

The apparatus is assembled as shown in Fig. 16: (a) chlorine tank; (b) platform scales; (c) sulfuric acid safety trap; (d) Drechsel bottle, tall form, containing concentrated sulfuric acid used to indicate the rate of flow of the chlorine gas; (e) 2-l. Claisen flask; (f) inlet tube of 2.5 cm. i.d.; (g) special condenser, 130 cm. in length, the condensing tube having an internal diameter of 2.5 cm. It is important that the inlet tube and condenser be of large diameter to avoid plugging and flooding. All joints are butted glass to glass. The condenser and the inlet tube are luted to the flask with litharge-glycerin cement, which resists the attack of chlorine and phosphorus(III) chloride better than does rubber. If greater purity is desired it would be advantageous to have all ground-glass joints. The side arm of the flask is closed with a glass rod plug held in position by rubber tubing or with an ordinary cork, which will withstand the attack of cold phosphorus(III) chloride. The inlet tube extends to within  $\frac{1}{2}$  cm. of the bottom of the reaction flask.

The chlorine tank is placed on a platform scales and connected to the apparatus. The tank is balanced by the

\* University of Kentucky, Lexington, Ky.

† Deceased.

‡ Western Reserve University, Cleveland, Ohio.

sliding weight on the balance or lever arm. This position is marked as the zero on an auxiliary scale, which is graduated in half centimeters and placed at the end of the pointer.\*

Two hundred grams of dry red phosphorus is placed in the flask.† Excess phosphorus must be present to inhibit

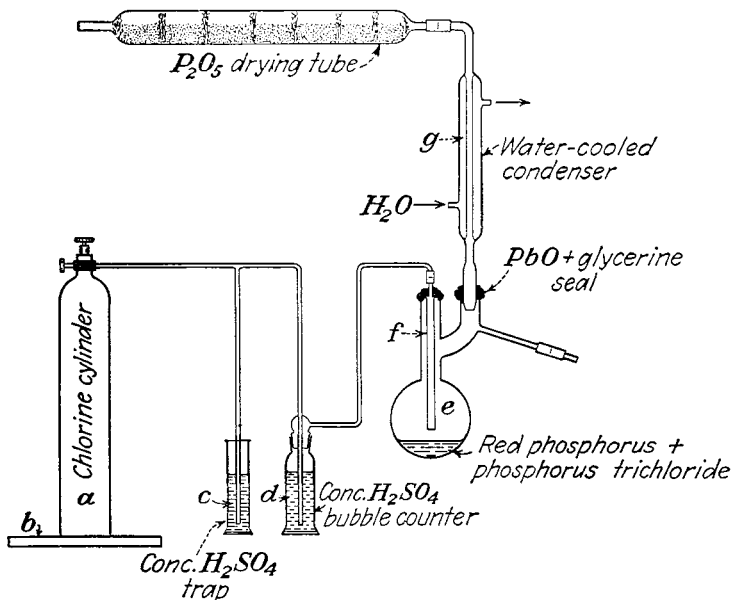

FIG. 16.—Apparatus for the preparation of phosphorus(III) chloride.

the formation of phosphorus(V) chloride. The phosphorus must be dried for several days in a thin layer in a vacuum desiccator over concentrated sulfuric acid. The phosphorus is covered with 250 ml. of phosphorus(III) chloride—enough to make a mobile suspension. This mixture is heated, and when it is boiling vigorously the addition of the chlorine is started.

\* The sensitivity of the scales may be increased by adding an extension to the lever arm. A short piece of heavy wire will be suitable for this purpose.

† This synthesis also is suitable for much smaller quantities of materials.

**(Caution.** *It is very important to keep the phosphorus(III) chloride boiling vigorously at all times to prevent the formation of phosphorus(V) chloride, which will plug the inlet tube.*)

A 1-lb. weight is now placed on the platform of the scales. The chlorine is added as rapidly as possible until the lever arm returns to its zero point; at this point 453 g. (1 lb.) of chlorine will have been added.\* After the addition of the chlorine, the flask is disconnected and the necks are closed with rubber stoppers. The phosphorus(III) chloride is then distilled by using a water bath and an ordinary condenser. It fumes in moist air and should be stored in a glass-stoppered or sealed bottle. The excess phosphorus may be recovered for future use. The yield, based on the amount of chlorine added, is about 94 per cent of the theoretical.

### Properties

Phosphorus(III) chloride is a clear colorless liquid having a boiling point of 75.9° and a specific gravity of 1.574 (21°).

### Reference

1. GRAEBE: *Ber.*, **34**, 645 (1901).

## 43. PHOSPHORUS(III) BROMIDE

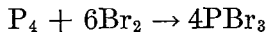

SUBMITTED BY J. F. GAY† AND R. N. MAXSON†‡

CHECKED BY J. KLEINBERG§|| AND R. E. HAAN§

The various published methods for the preparation of phosphorus(III) bromide are all variations of the simple but

\* On large runs that may take considerable time, it would be quite possible to wire up the scales with an electric bell that would ring when the required amount of chlorine has been added. Thus unnecessary watching of the apparatus could be avoided.

† University of Kentucky, Lexington, Ky.

‡ Deceased.

§ James Millikin University, Decatur, Ill.

|| Present address: College of Pharmacy, University of Illinois, Chicago, Ill.

vigorous reaction of bromine with phosphorus. In order to reduce the violence and consequent danger of the reaction, it is best to use red phosphorus and to conduct the reaction in the presence of an inert solvent: carbon tetrachloride,<sup>1</sup> thiophene-free benzene,<sup>2</sup> or phosphorus(III) bromide itself.<sup>3</sup> By use of the last, the troublesome fractionation of two liquids at the end of the reaction is avoided.

### Procedure

The apparatus shown in Fig. 17 is satisfactory for the rapid production of phosphorus(III) bromide. It consists of a Claisen flask of 1-l. capacity with a reflux condenser fitted into the neck to which the side arm is attached. The upper end of the condenser is fitted with a phosphorus(V) oxide drying tube. The side arm is closed with a short length of rubber tubing containing a rounded-end glass rod of slightly larger diameter than the side arm so that a good butt joint is formed. The tube for the introduction of bromine is inserted into the other neck. This tube is of pyrex glass and has an outside diameter slightly less than the inside diameter of the neck. This tube must be large to avoid plugging by the phosphorus(V) bromide that is sometimes formed. It extends from just above the bottom of the flask to just above the neck, where another smaller tube (large enough in diameter just to accommodate the end of the separatory funnel) is sealed onto it. Rubber tubing (about 2 in. long) is placed over the end of the small tubing and the separatory funnel placed in this rubber joint and pushed down far enough for the end of the separatory funnel to be seen through the smaller glass tubing. If ground-glass joints are not available, fittings for the reflux condenser and bromine introduction tube may be made of Neoprene or even cloth composition tape, *but not rubber tape*. Cloth tape is not greatly affected by phosphorus(III) bromide.

One hundred twenty-five grams of dry red phosphorus (dried in an oven for 3 hours at 105° and preserved for

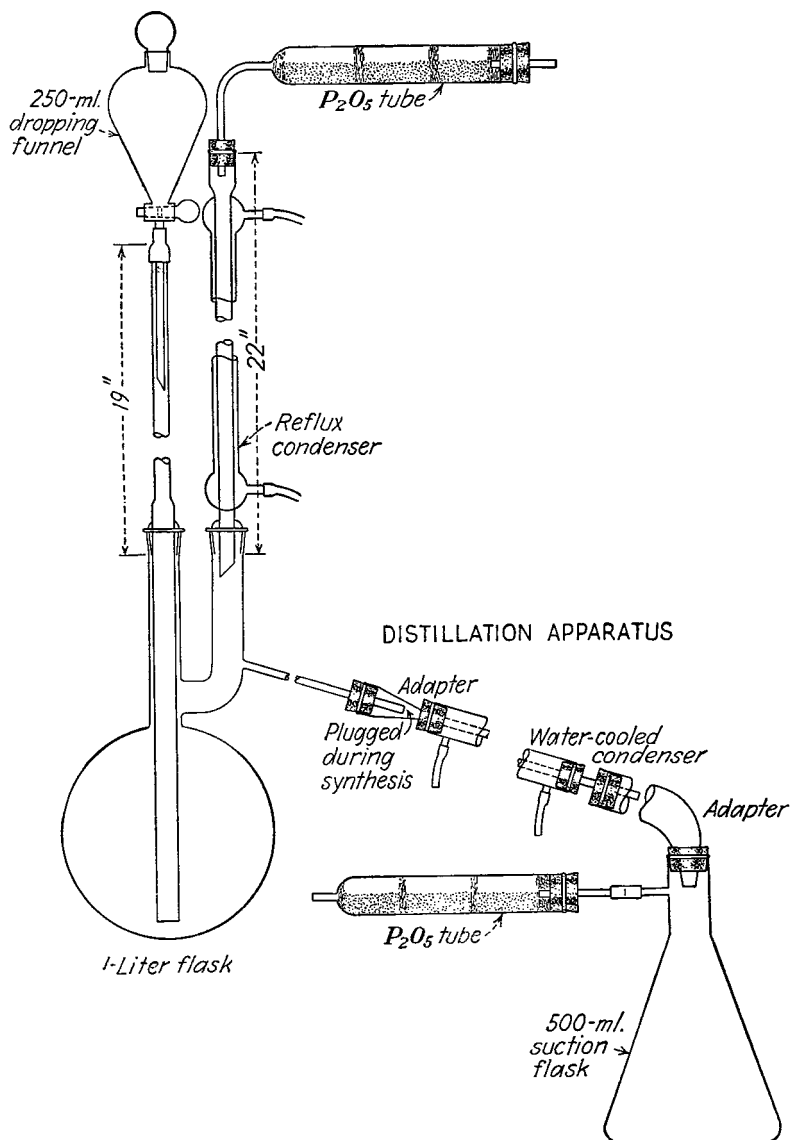

FIG. 17.—Apparatus for the preparation of phosphorus(III) bromide.

subsequent use in a desiccator containing sulfuric acid) is placed in the flask and covered with 500 g. of phosphorus(III) bromide. If no phosphorus(III) bromide is available, phosphorus(III) chloride will serve but only 295 g. need be added. [If phosphorus(III) chloride is used, it is necessary to fractionate the reaction mixture at the end of the run.]

**Caution.** *No less than the amount of phosphorus(III) bromide or phosphorus(III) chloride indicated for 125 g. of phosphorus should be used. If there is not enough liquid to make a mobile suspension of phosphorus, the phosphorus may hold back the vapors of the suspending medium long enough for them to build up sufficient vapor pressure to cause an explosion.*

An amount of bromine equivalent to 100 g. of phosphorus, 773.5 g., is weighed out and about half of it placed in the separatory funnel. An air bath is placed around the flask and the reaction mixture brought to boiling. The bromine is allowed to drop in slowly for a period of about 5 minutes until the inlet tube is filled with bromine vapor. The flame is now removed and the bromine added rapidly enough (about 20 ml./minute) to cause the reaction mixture to boil from the heat of reaction. After all the bromine has been added, the flame is replaced and boiling continued for 10 minutes.

**Caution.** *Excess phosphorus, 25 to 35 per cent, should be present at the end of the run to avoid the formation of phosphorus pentabromide.*

The side arm of the Claisen flask is connected to a short condenser that leads to a 500-ml. suction flask. The whole system is protected from the moisture of the air by means of a phosphorus(V) oxide drying tube connected to the side arm of the receiver. The first 15 to 20 ml. of distillate is colored with excess bromine and must be discarded or retained for additional runs.

The remainder of the distillate boils at 172.9° (corrected to 760 mm. pressure.) Yield 819 g. (94 per cent based on the bromine used.)



### Properties

Phosphorus(III) bromide is a clear, colorless, fuming liquid with a specific gravity of 2.852 and a normal boiling point of 172.9°. It is stable when dry but is readily hydrolyzed even at low temperatures to orthophosphorous acid and hydrobromic acid.

#### References

1. NOLLER and DINSMORE: "Organic Syntheses," Vol. 13, p. 21, John Wiley & Sons, Inc., New York, 1933.
2. CHRISTOMANOS: *Z. anorg. Chem.*, **41**, 276 (1904).
3. Editor's note: Independently of those submitting this synthesis, TSENG and Ho, *Sci. Quart. Natl. Univ. Peking*, **5**, 324 (1935), have made a careful study of the phosphorus-bromine reaction and recommend the use of phosphorus(III) bromide as a diluent.

## 44. PHOSPHORUS(V) OXYBROMIDE

### (Phosphoryl Tribromide)

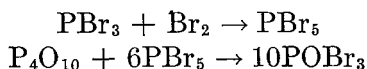

SUBMITTED BY HAROLD S. BOOTH\* AND C. G. SEEGMILLER\*

CHECKED BY PHILIP S. BAKER,† SOL WEXLER,† AND ROY D. JOHNSON†

Of the various possible methods<sup>1-3</sup> for the preparation of phosphorus(V) oxybromide that of digestion of phosphorus(V) oxide and bromide<sup>1</sup> presents the simplest procedure and yields the purest product.

### Procedure

Phosphorus(V) bromide is first prepared by slowly adding 370 g. of liquid bromine to 630 g. of phosphorus(III) bromide (or by reaction between red phosphorus and bromine as described in synthesis 45) in a 1-liter pyrex distilling flask. The bromine is added through a separatory funnel inserted through one hole of a two-hole rubber stopper in the neck of the flask. To allow for expansion of gases and to prevent hydrolysis, a horizontal drying tube containing phosphorus(V) oxide is connected to a tubular

\* Western Reserve University, Cleveland, Ohio.

† University of Illinois, Urbana, Ill.

glass elbow inserted in the other hole of the stopper. During the addition, the flask must be cooled by running tap water over it. The mass so produced is then well broken up with a glass stirring rod, and 120 g. (slightly more than the theoretical amount) of fresh phosphorus(V) oxide\* is added.

The two solids are thoroughly mixed, the stopper is then replaced, and the flask is *gently* heated on a water bath for several hours until the mass has completely liquefied. Strong heating *must be avoided* up to this point to prevent decomposition of the phosphorus(V) bromide. The distilling flask is then connected to an air condenser, and the liquid is heated more and more strongly for about an hour and finally distilled over at atmospheric pressure, the first and last portions being discarded. Yield about 80 per cent [based on the phosphorus(III) bromide].

In bottling phosphorus(V) oxybromide, it is advisable to dry the bottle carefully to prevent hydrolysis from moisture on the walls of the container. The drying can be accomplished by heating the bottle in an oven, with a current of dry air running inside the bottle, and cooling it while in the stream of dry air.

### Properties

Phosphorus(V) oxybromide is a solid crystallizing in thin, colorless plates; in large masses, it is orange. The compound melts at  $56^{\circ}$ <sup>4</sup> and boils at  $193^{\circ}$  at 758 mm. pressure. It readily hydrolyzes in water and must be carefully kept in sealed glass containers away from moisture.

### References

1. BERGER: *Compt. rend.*, **146**, 400 (1908); *Bull. soc. chim.*, [4] **3**, 721 (1908).
2. HÖNIGSCHMIDT and HIRSCHBOLD-WITTNER: *Z. anorg. allgem. Chem.*, **243**, 355 (1940).
3. JOHNSON and NUNN: *J. Am. Chem. Soc.*, **63**, 141 (1941).
4. BESSON: *Compt. rend.*, **111**, 972 (1890).

\* For this purpose, a fresh bottle of phosphorus(V) oxide should be used to avoid low yields due to metaphosphoric acid commonly present in opened bottles.

## 45. PHOSPHORUS(V) SULFOBROMIDE

### (Thiophosphoryl Tribromide)



SUBMITTED BY HAROLD S. BOOTH\* AND C. A. SEABRIGHT\*

CHECKED BY W. C. COOPER,† AND BY JOHN M. STEWART‡ AND LOUIS  
FERNSTANDIG‡

Of the various methods of preparing phosphorus(V) sulfobromide, experience has shown that the simplest is that of Michaelis.<sup>1</sup> It consists of digesting phosphorus(V) sulfide and phosphorus(V) bromide until the reaction is complete, followed by suitable purification.

### Procedure

A 1-l. pyrex three-necked flask is fitted with a separatory funnel and a horizontal drying tube attached with rubber stoppers. The drying tube containing phosphorus(V) oxide is connected in a horizontal position to a glass tube elbow inserted in a rubber stopper to allow for pressure changes.

Thirty-one grams of dry red phosphorus is placed in the flask, and 400 g. of liquid bromine is *slowly* added through the separatory funnel while the flask is cooled by running tap water over it. Next, 100 g. of phosphorus(V) sulfide is added to the phosphorus(V) bromide, just prepared, and the mass is heated on a water bath (or steam cone) for 2 hours. The flask is then heated more vigorously with a direct flame until its contents are completely liquid.

Using an all-glass condenser and connections (standard-taper conical-joint connections preferred) the phosphorus(V) sulfobromide is distilled at about 25 mm. pressure, and the crude product boiling between 120 to 130° is collected. The yield of crude product based on red phosphorus used is 80 to 85 per cent.

\* Western Reserve University, Cleveland, Ohio.

† The University of British Columbia, Vancouver, Canada.

‡ University of Illinois, Urbana, Ill.

### Purification

If the crude product is a red liquid instead of an orange-yellow solid at room temperature, it is impure, probably owing to excess bromine, and may be purified by the following procedure:

To the crude distillate is added about double its volume of distilled water and a few drops of a 10 per cent solution of potassium bromide. The mixture is then warmed on a water bath until it is entirely liquid. A gentle stream of compressed air is allowed to bubble through the liquid material for several minutes. After this, most of the water is decanted and any sulfur appearing as a coagulated mass is removed.

The yellow layer of phosphorus(V) sulfobromide is then allowed to crystallize, the remainder of the water is removed and the product is dried thoroughly in thin layers on watch glasses in a desiccator over phosphorus(V) oxide. A second water treatment may be necessary if the product is highly colored. Final yield of pure  $\text{PSBr}_3$  approximately 60 per cent.

### Properties

Pure phosphorus(V) sulfobromide is a yellow solid melting at  $37.8^\circ$ . It has a pungent odor and distills at about  $212^\circ$ , with some decomposition, or without decomposition at  $125$  to  $130^\circ$  at 25 mm. pressure. It dissolves sulfur and is dissolved by phosphorus(III) chloride and such organic solvents as carbon disulfide, chloroform, and ether. Although it reacts readily with alcohol, it is quite stable toward water. It is only very slightly attacked by cold water and can even be distilled with steam although much is lost in the process. It reacts with sublimed antimony(III) fluoride to give the gas phosphorus(V) sulfofluoride,  $\text{PSF}_3$ , and two volatile liquids, phosphorus(V) sulfobromodifluoride,  $\text{PSF}_2\text{Br}$ , and phosphorus(V) sulfodibromodifluoride,  $\text{PSFBr}_2$ .<sup>2</sup>

**References**

1. MICHAELIS: *Ann.*, **164**, 36 (1872).
2. BOOTH and SEABRIGHT: *J. Am. Chem. Soc.*, **65**, 1834 (1943).

**46. AMMONIUM MONOFLUOPHOSPHATE**



SUBMITTED BY WILLY LANGE\*

CHECKED BY HAROLD S. BOOTH† AND FRED KENDALL‡

Ammonium monofluophosphate,  $(\text{NH}_4)_2\text{PO}_3\text{F}$ , is formed in about equal amount with the difluophosphate by the reaction of phosphorus(V) oxide with ammonium fluoride.<sup>1</sup> Monofluophosphates can also be prepared by carefully hydrolyzing difluophosphates,<sup>1</sup> which may be obtained by hydrolysis of phosphorus(V) oxyfluoride.<sup>2</sup> The following sequence of reactions takes place:

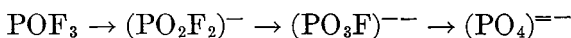

Under certain conditions, the last reaction is reversible, as considerable amounts of monofluophosphoric acid are formed from hydrofluoric acid and concentrated orthophosphoric acid<sup>3</sup> according to the equation

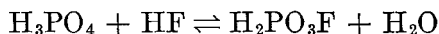

**Procedure**

In the preparation of ammonium difluophosphate (synthesis 47) 4.15 g. of impure ammonium monofluophosphate is obtained. If this is dissolved in 5.8 ml. of hot water and filtered into a platinum crucible cooled in ice, 0.58 g. of pure, well-crystallized salt separates. The crystals are dried on filter paper in the open air. However, it is preferable to dissolve the finely powdered crude product in water at room temperature in a platinum dish and to evaporate the solution in a vacuum over sulfuric acid. Then the

\* University of Cincinnati, Cincinnati, Ohio.

† Western Reserve University, Cleveland, Ohio.

greater part of the salt is obtained in large crystals. It is necessary to remove individual crystals from time to time and to determine by tests when impurities (fluorides, phosphates) start to crystallize. Small crystals should dissolve in calcium chloride solution without forming a precipitate after some minutes. The air-dried crystals are stable indefinitely in closed platinum containers. Glass bottles are attacked in the course of a year.

### Properties

Ammonium monofluophosphate 1-hydrate crystallizes from water in compact rectangular prisms, which effloresce in the air. At 105°, the crystals become anhydrous. At higher temperatures, ammonia is slowly lost, and, at 220°, the acid ammonium salt,  $\text{NH}_4\text{HPO}_3\text{F}$ , is formed. This melts at 225° without decomposition.

The salt is very soluble in water and gives a neutral solution. After some time, however, salts of orthophosphoric acid are formed by hydrolysis. If possible, solutions should be stored in platinum containers.

The monofluophosphates closely resemble the sulfates in their solubilities. Therefore, monofluophosphates can be obtained by allowing ammonium monofluophosphates in water solution to react with easily soluble salts of those cations which form more difficultly soluble sulfates. The silver compound crystallizes especially well in colorless rhombs. It is used for preparing the alkali salts from solutions of the corresponding alkali chlorides. The solutions so obtained are evaporated *in vacuo* at room temperature.

### References

1. LANGE; *Ber.*, **62**, 793 (1929).
2. *Ibid.*, **62**, 789 (1929).
3. *Ibid.*, **62**, 1084 (1929).

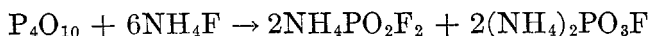
**47. AMMONIUM DIFLUOPHOSPHATE**

SUBMITTED BY WILLY LANGE\*

CHECKED BY HAROLD S. BOOTH† AND FRED KENDALL†

Ammonium difluophosphate has been prepared in large quantities by the reaction of phosphorus(V) oxide with ammonium fluoride.<sup>1</sup> In this reaction di- and monofluophosphates are formed in equimolecular amounts. After the molten mixture has cooled, ammonium difluophosphate,  $\text{NH}_4\text{PO}_2\text{F}_2$ , is extracted with boiling alcohol.

**Procedure**

A mixture of 11.84 g. of phosphorus(V) oxide and 9.24 g. of dry, powdered ammonium fluoride is placed in a 150-ml. nickel crucible, and the open crucible is heated at one spot with a Bunsen burner under a hood. When the temperature of the heated spot rises to about 135°, a vigorous reaction starts. This spreads through the whole mass, which becomes molten. After cooling, the solidified product is powdered and refluxed with 300 ml. of absolute alcohol for a short time. During the heating and boiling, the solid material must be continually stirred. The hot solution is filtered quickly through a folded filter, then it is cooled immediately and neutralized with ammoniacal alcohol. The 4.15 g. of ammonium monofluophosphate that separates is removed by vacuum filtration. The filtrate is evaporated to dryness in a platinum dish on the water bath while dry air is blown against the surface of the liquid. The residue of 5.8 g. of ammonium difluophosphate amounts to 70 per cent of the substance present in the fusion. This product contains some ammonium fluoride as an impurity, but it is satisfactory for work in which fluoride ions are not undesirable.

\* University of Cincinnati, Cincinnati, Ohio.

† Western Reserve University, Cleveland, Ohio.

To prepare the pure salt, the crude material is dissolved in 3 ml. of hot water, and the solution is quickly filtered into a platinum crucible. The filtrate is cooled in ice and the crystals are filtered and dried on filter paper; 1.6 g. of analytically pure substance is obtained (20 per cent of the product present in the fusion). The product is dried in a desiccator over sulfuric acid and solid potassium hydroxide and stored in the absence of moisture. In a platinum container it is stable indefinitely, but glass is attacked in the course of time.

When larger amounts of the pure salt are required, several reactions are carried out with the indicated quantities. The collected raw products should be dissolved in hot water in one portion and recrystallized very quickly.

### Properties

Ammonium difluophosphate crystallizes in colorless rhombic prisms and melts at  $213^{\circ}$  without decomposition. It is very soluble in water. The solution at first has a neutral reaction but hydrolyzes after a time to acid ammonium monofluophosphate, this process being greatly accelerated by raising the temperature. Therefore, solutions of the salt should be stored only for a short time and at the lowest possible temperature, especially if handled in glass equipment.

The salts of difluophosphoric acid have solubilities resembling those of the perchlorates. However, the slightly soluble perchlorates are somewhat less soluble than the corresponding difluophosphates. These solubility relationships allow the conversion of ammonium difluophosphate to less soluble salts by metathesis.

### Reference

1. LANGE: *Ber.*, **62**, 786 (1929).



## CHAPTER VI

See also: Europium(II) sulfate, Phosphorus(V) sulfobromide, synthesis 19A synthesis 45  
Germanium(II) sulfide, synthesis 28

### 48. ADDITION COMPOUND OF SULFUR DIOXIDE AND TRIMETHYLAMINE



SUBMITTED BY J. RUSSELL BRIGHT\*† AND W. CONARD FERNELIUS\*‡  
CHECKED BY RALPH FIRMINHAC§ AND ROY E. HEATH§||

Sulfur dioxide resembles sulfur trioxide in forming addition compounds with a number of organic molecules containing nitrogen or oxygen. The addition compounds of sulfur dioxide are not as stable as those of sulfur trioxide, and few of them are solid at ordinary temperatures. The compound of sulfur dioxide and trimethylamine is a solid and may be readily precipitated in pure anhydrous form by passing sulfur dioxide into a cold petroleum-ether solution of trimethylamine. The addition compound has possible value as an agent for bringing either sulfur dioxide or the amine into reaction with other substances under special circumstances.

#### Purification of Reagents

**Trimethylamine.** Aqueous trimethylamine (usually supplied as the 25 per cent solution) is treated (Fig. 18) with solid sodium hydroxide in a flask *A* connected to a reflux

\* The Ohio State University, Columbus, Ohio.

† Present address, Wayne University, Detroit, Mich.

‡ Present address, Purdue University, West Lafayette, Ind.

§ University of Wisconsin, Madison, Wis.

|| Present address, Wyandotte Chemicals Corporation, Wyandotte, Mich.

condenser *B* and an all-glass purification train, consisting of three units: a section *C* containing potassium hydroxide pellets as a desiccant, a section *D* containing yellow mercury(II) oxide for removal of ammonia,<sup>1</sup> and finally a unit *E* containing barium oxide as a second desiccant. The gaseous amine is condensed in glass ampoules cooled by a Dry Ice-acetone mixture. Before sealing these ampoules a few pieces of metallic sodium are added to remove the last

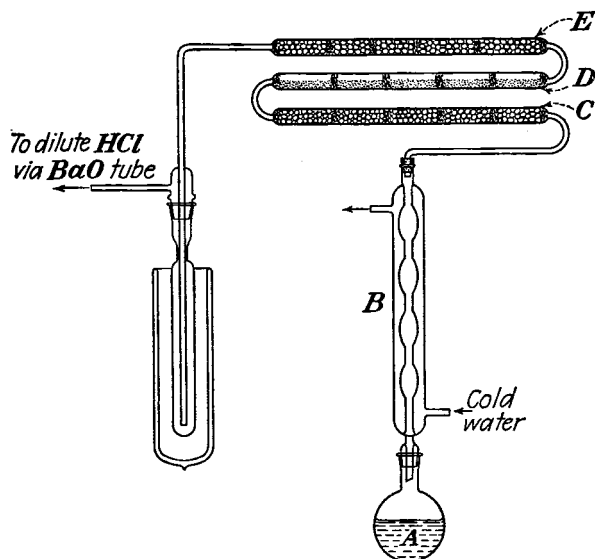

FIG. 18.—Apparatus for preparing anhydrous trimethylamine.

traces of water. Alternatively, a small quantity of freshly sublimed phosphorus(V) oxide may be added. This desiccant has the advantage of also removing small amounts of primary and secondary amines.<sup>2</sup>

**Sulfur Dioxide.** The gas, which may be conveniently obtained from a small commercial tank, is passed through concentrated sulfuric acid, then is passed over phosphorus(V) oxide, and finally is condensed in glass ampoules (ice-salt or Dry Ice-acetone bath), where it is stored until used.

### Procedure

Four hundred milliliters of petroleum ether (dried-over sodium) is poured into a dry three-necked flask fitted with an inlet tube, a mechanical stirrer, and a barium oxide drying tube. The flask is cooled by an ice-salt mixture. Then 46 g. of gaseous amine is slowly added.\* Next 50 g. of dry sulfur dioxide is added, with continuous stirring and at such a rate that the temperature of the reaction mixture remains at about 0°. The solid sulfur dioxide addition compound is filtered quickly in a Büchner funnel. The product is then left *in vacuo* over phosphorus(V) oxide for several hours. Yield 90 to 96 g. (94 to 100 per cent). *Anal.* Calcd. for  $(\text{CH}_3)_3\text{N}\cdot\text{SO}_2$ : N, 11.4. Found: N, 11.4; 11.5.

An alternative procedure is to combine the amine and sulfur dioxide in dry benzene solution from which the product is precipitated by the addition of petroleum ether.

### Properties

Trimethylamine-sulfur dioxide is a white crystalline solid; m.p. 76° (sealed tube). It decomposes if heated much above its melting point but is readily sublimed *in vacuo* below its melting point (slow sublimation produces large transparent crystals). It is practically insoluble in dioxane, carbon tetrachloride, petroleum ether, and cyclohexane; slightly soluble in chloroform; moderately soluble in bromoform, benzene, and ethylene dichloride; and very soluble in alcohol and water.

The pure compound reacts with the moisture of the air, forming a product insoluble in benzene.

### References

1. FRANÇOIS: *Compt. rend.*, **144**, 567, 857 (1907).
2. BURG: private communication.

\* This manipulation may be conveniently accomplished by first condensing the required weight of the gas in a weighed glass ampoule fitted with a stopcock.

## 49. SULFITES AND PYROSULFITES OF THE ALKALI METALS

### A. SODIUM SULFITE AND SODIUM PYROSULFITE

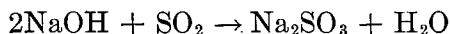

SUBMITTED BY H. F. JOHNSTONE\*

CHECKED BY J. A. MATTERN† AND W. CONARD FERNELIUS‡

Anhydrous sodium sulfite and pyrosulfite, free from sulfate, may be prepared by the method of Foerster.<sup>1</sup> Solutions of the salts are readily oxidized by air. Therefore, the product must not be exposed to air until it is thoroughly dried if a high degree of purity is to be attained. Moist crystals of the pyrosulfite decompose slowly even in the absence of air to form the sulfate and sulfur. An odor of sulfur dioxide over this product will indicate that drying was not complete. Both salts may be kept in a desiccator in a hydrogen atmosphere for several months without showing a test for more than a trace of sulfate.

### Procedure

**a. Anhydrous Sodium Sulfite.** The preparation is best carried out in a widemouthed Erlenmeyer flask arranged as shown in Fig. 19. The sulfur dioxide inlet tube is a glass T through one arm of which a small rod is inserted to push off the crystals, which soon obstruct the flow of gas.

One hundred seventy-five grams of sodium hydroxide is dissolved in 500 ml. of freshly boiled distilled water contained in the flask. A slow flow of hydrogen is first started, and sulfur dioxide is then added rapidly. The reaction is exothermic, and the temperature soon reaches the boiling point, where it remains until the hydroxide is converted to the sulfite. At this point the solution turns slightly

\* University of Illinois, Urbana, Ill.

† The Ohio State University, Columbus, Ohio.

‡ Present address: Purdue University, West Lafayette, Ind.

yellow, and the temperature begins to fall. The flow of sulfur dioxide is now stopped. The sodium sulfite crystals are filtered from the hot solution through a sintered-glass funnel placed in a vacuum desiccator as shown in Fig. 20. If a funnel with sintered-glass disk is not available, a Büchner funnel may be equipped with a porous Filtros plate\* sealed in with Insalute cement.† Filter paper cannot be used because of the swelling action of the hot solution on the fibers. Gentle suction may be applied to withdraw the liquid, but care must be taken to allow no air to pass through the crystals. When all the mixture is in the funnel, the top of the desiccator is replaced, the stopcock on the vacuum line to the funnel is closed, and the desiccator is flushed out with

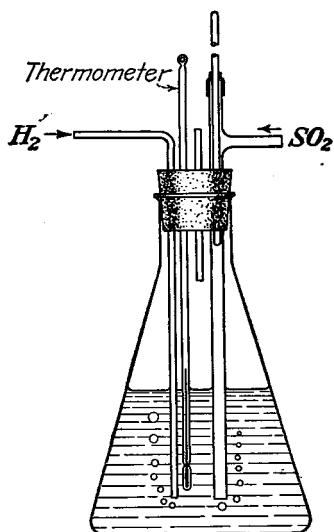

FIG. 19.—Apparatus for the preparation of alkali metal sulfites and pyrosulfites.

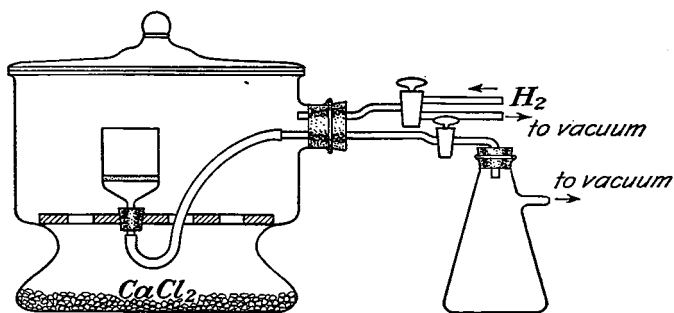

FIG. 20.—Apparatus for filtration in a hydrogen atmosphere.

hydrogen several times. The filtration is then completed by applying vacuum to the funnel. A slow stream of

\* Filtros, Inc., East Rochester, N.Y.

† Sauereisen Cements Company, Pittsburgh, Pa.

dry hydrogen is allowed to pass into the desiccator and through the funnel until the crystals are thoroughly dry. The desiccator should not be opened until this condition is reached. This operation requires 24 hours, or more, depending upon the thickness of the layer of crystals in the funnel and the rate of flow of the hydrogen. The product should be kept in a tightly stoppered hydrogen-filled bottle. Yield approximately 225 g. *Anal.* Calcd. for  $\text{Na}_2\text{SO}_3$ :  $\text{Na}_2\text{O}$ , 49.2;  $\text{SO}_2$ , 50.8. Found  $\text{Na}_2\text{O}$ , 49.0;  $\text{SO}_2$ , 50.2; sulfates, none.

If the solution is cooled to a temperature below  $33.4^\circ$  before filtering, the hydrate  $\text{Na}_2\text{SO}_3 \cdot 7\text{H}_2\text{O}$  is obtained in pure form.

**b. Sodium Pyrosulfite.** The pyrosulfite is prepared in the same apparatus. Two hundred twenty-five grams of sodium hydroxide is dissolved in 500 ml. of boiled distilled water. Hydrogen is passed through the solution to exclude air, and sulfur dioxide is added until the sulfite, which is first formed, is completely dissolved. Crystallization of the pyrosulfite is quite slow, and the flask must be shaken continuously to avoid caking. The crystals are filtered from the cooled solution in the apparatus described above. Yield about 200 g. *Anal.* Calcd. for  $\text{Na}_2\text{S}_2\text{O}_5$ :  $\text{Na}_2\text{O}$ , 32.6;  $\text{SO}_2$ , 67.4. Found:  $\text{Na}_2\text{O}$ , 32.9;  $\text{SO}_2$ , 66.6; sulfates, none.

### Properties<sup>1</sup>

The solubilities of sodium and potassium sulfites and pyrosulfites and their hydrates are shown in Fig. 21.<sup>2</sup>

Sodium hydrogen sulfite,  $\text{NaHSO}_3$ , does not exist as a solid. Foerster found evidence based on freezing-point lowering that in solution no pyrosulfite ions are present, only hydrogen sulfite ions:

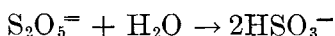

The solubility diagram shows that the anhydrous sulfite decreases in solubility as the temperature is raised. It is

less soluble than the pyrosulfite; consequently, it separates from solutions in which the ratio of  $\text{SO}_2$  to  $\text{Na}_2\text{O}$  varies considerably from that of the pure salt. Crystals of the 7-hydrate are less suitable for laboratory work than the anhydrous sulfite because of their high vapor pressure of water. This causes efflorescence and rapid oxidation in air.

Solutions in equilibrium with the pyrosulfite have high vapor pressures of  $\text{SO}_2$  at temperatures above  $70^\circ$ .<sup>3</sup> Evap-

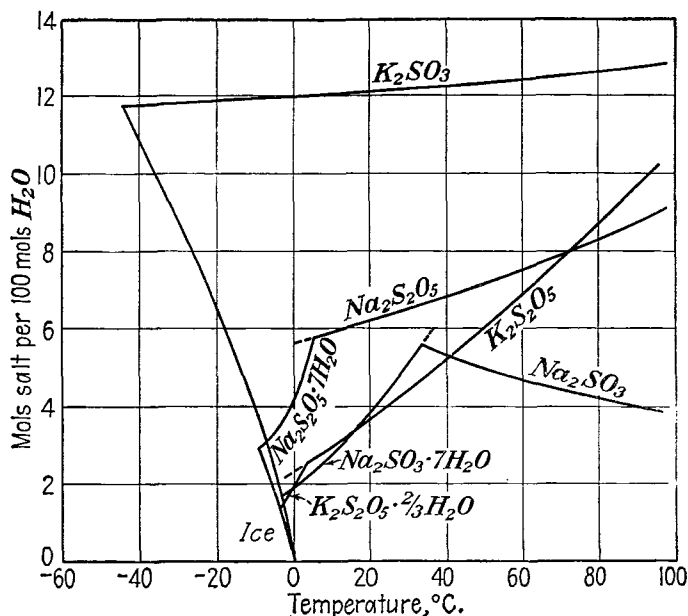
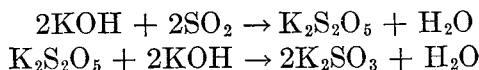

FIG. 21.—Solubilities of sodium and potassium sulfites and pyrosulfites.

oration of these solutions to increase the yield of crystals results in the loss of  $\text{SO}_2$  unless a stream of this gas is passed through the solution. If the ratio of  $\text{SO}_2$  to  $\text{Na}_2\text{O}$  falls much below 1.8, coprecipitation of the normal sulfite is apt to occur. The equilibrium vapor-pressure measurements show that the temperature coefficient of the vapor pressure of water over these solutions is about the same as that of sulfur dioxide. Little is to be gained, therefore, by evaporation under a vacuum.

**B. POTASSIUM SULFITE AND POTASSIUM PYROSULFITE**

SUBMITTED BY H. F. JOHNSTONE\*

CHECKED BY T. MISKIMEN† AND W. CONARD FERNELIUS‡‡

Because of its high solubility and the small effect of temperature, as shown in Fig. 21, potassium sulfite is more difficult to prepare than sodium sulfite. Foerster<sup>1</sup> and earlier workers found it necessary to proceed from a solution of the acid sulfite. The pyrosulfite may be crystallized readily from water. Both salts oxidize rapidly in air when moist but are stable when dry.

**Procedure**

**a. Anhydrous Potassium Sulfite.** One hundred grams of pure potassium hydroxide is dissolved in 200 ml. of freshly boiled distilled water (same apparatus as used for sodium sulfite). Sulfur dioxide is added in the presence of a stream of hydrogen until a sample of the solution is just acid to bromocresol green indicator. An equal quantity of potassium hydroxide dissolved in about 100 ml. of water is then added to the solution. Evaporation is carried out at the boiling point at atmospheric pressure in the presence of a slow stream of hydrogen. The crystals are filtered and handled in the manner described for sodium sulfite. Washing is undesirable because of the high solubility and, furthermore, is unnecessary when the crystals have the same composition as the dissolved salt. Yield about 200 g.

**b. Potassium Pyrosulfite.** The pyrosulfite is precipitated when a solution of 30 per cent potassium hydroxide is saturated with sulfur dioxide and cooled to room tem-

\* University of Illinois, Urbana, Ill.

† The Ohio State University, Columbus, Ohio.

‡ Present address: Purdue University, West Lafayette, Ind.



perature. Filtration and drying in the absence of air are necessary to prevent oxidation.

### Properties

Potassium sulfite forms no hydrates, but the pyrosulfite forms the compound  $K_2S_2O_5 \cdot \frac{2}{3}H_2O$ , which is probably the double salt  $K_2S_2O_5 \cdot 4KHSO_3$ . In solution, the pyrosulfite is converted to the hydrogen sulfite.

Because of the small solubility of the pyrosulfite, this compound crystallizes from solutions containing as little as 1.2 mols  $SO_2$  per mol  $K_2O$ . Excess  $SO_2$ , therefore, is to be avoided when the pure sulfite is being prepared. Like the sodium compounds, the hydrogen sulfite solutions have high vapor pressures of  $SO_2$  at the boiling point,<sup>3</sup> but the loss of  $SO_2$  during evaporation can never reduce the ratio of  $SO_2$  to  $K_2O$  to a point where the pyrosulfite will not crystallize in pure form. This indicates that the mother liquor from the pyrosulfite precipitation can be evaporated to increase the yield.

### References

1. FOERSTER, BROSCHE, and NORBERG-SCHULTZ: *Z. physik. Chem.*, **110**, 435 (1924).
2. "International Critical Tables," Vol. 4, p. 236, McGraw-Hill Book Company, Inc., New York, 1928.
3. JOHNSTONE, READ, and BLANKMEYER: *Ind. Eng. Chem.*, **30**, 101 (1938).

## 50. SALTS OF DITHIONIC ACID

SUBMITTED BY ROBERT PFANSTIEL\*

CHECKED BY O. F. HILL,† R. E. BARNHART,† AND L. F. AUDRIETH†

Dithionates may be prepared by the electrolytic<sup>1</sup> or chemical oxidation of sulfurous acid and sulfites. Chemical oxidation is accomplished by the action of chlorine, iodine, hydrogen peroxide, or oxygen in an acid medium;<sup>2</sup> by the action of chromates or permanganates in neutral solution;<sup>2,3</sup>

\* Experimental Laboratory, Grasselli Chemicals Department, E. I. du Pont de Nemours & Company, Inc., Cleveland, Ohio.

† University of Illinois, Urbana, Ill.

or by the action of metallic ions<sup>2,4</sup> or metallic oxides,<sup>5</sup> which are readily reduced. All these procedures give low yields except the method that involves the use of metallic oxides. Various oxides have been employed, but pyrolusite has been found to be most satisfactory, giving yields that vary from 65 per cent to 85 per cent\* of the theoretical value. Specific directions are given for the preparation of the calcium, barium, and sodium salts, but the general method may be modified suitably for the production of other dithionates.

### Procedure

#### A. CALCIUM DITHIONATE

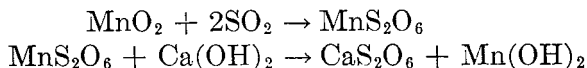

A 1-l., three-necked, round-bottomed flask is fitted with a thermometer, a mechanical agitator, and a sulfur dioxide delivery tube, which reaches to the bottom of the flask. The flask is placed in an ice bath. Five hundred milliliters of water is placed in the flask and saturated with sulfur dioxide at a temperature below 10°. Pyrolusite is then added in 1- to 2-g. portions until 80 g. has been introduced. The solution is kept saturated with sulfur dioxide during the process, and rapid agitation is maintained continuously. The temperature is not allowed to rise above 10°. Each small portion of added ore is allowed to react completely before more is added. This is evidenced by the change in color of the suspension from black to brown.

\* Wide variations in yield may be attributed to such factors as the fineness of subdivision of the pyrolusite, the temperature maintained during reaction, and the concentration of the sulfurous acid. It should also be borne in mind that most commercial samples of pyrolusite are quite impure. Since only the manganese in the form of a manganese(IV) effects the conversion into dithionate, it is necessary to analyze the ore for its available oxygen content. The ore used both originally and in checking was a high-grade Java pyrolusite containing 16.5 per cent available oxygen, as compared with 18.4 per cent required for pure manganese(IV) oxide.

After all the ore has been added ( $2\frac{1}{2}$  to 3 hours), the agitation is continued until there is no further change in color of the slurry (light brown). To draw off excess sulfur dioxide, the slurry is placed under vacuum and warmed gently until a temperature of  $40^\circ$  is reached. The gelatinous residue is removed by filtration and washed with warm water.

The filtrate (at  $25$  to  $40^\circ$ ) is stirred continuously while 80 g. of calcium hydroxide (slaked lime) is added over a period of about  $\frac{1}{2}$  hour. Stirring is continued for  $\frac{1}{2}$  hour longer. The slurry is then heated to  $65$  to  $75^\circ$  and stirred vigorously while additional hydroxide is added until the slurry is *strongly alkaline*\* toward litmus paper, and stirring is continued for  $\frac{1}{2}$  hour longer. An excess of lime does no harm other than to add to the bulk of the solids to be filtered out and washed.

The hot slurry is filtered by suction. The filter cake is washed with 300 ml. of water saturated with calcium hydroxide at  $65^\circ$ . The filter cake is slurried in 400 ml. of water saturated with calcium hydroxide at  $65^\circ$  and refiltered. The residue is washed with 200 ml. of hot water saturated with calcium hydroxide. The filtrates and washings are combined. If the solution now does not show strong alkalinity to litmus paper, a little more lime should be added and the solution refiltered.

Carbon dioxide is passed into the solution to remove the excess of calcium hydroxide as calcium carbonate, which is then removed by filtration.

The calcium dithionate is recovered by concentrating the solution on a steam bath and cooling. Successive crops of crystals are obtained by further concentration and cooling. When the volume of mother liquor has been reduced to 50 ml., the remaining calcium salt is thrown down by the addition of 75 ml. of ethyl alcohol. The crystal crops are

\* An excess over the calculated quantity of calcium hydroxide is required because of the presence in the crude manganese dithionate solution of such impurities as iron, aluminum, and free sulfurous acid.

not washed but sucked as dry as possible on a Büchner funnel. The crops of crystals are combined and spread out to dry at room temperature.

In a preparation starting with 80 g. of Java pyrolusite,\* 194 g. of calcium dithionate,  $\text{CaS}_2\text{O}_6 \cdot 4\text{H}_2\text{O}$ , was obtained. Yield 86 per cent.

### B. BARIUM DITHIONATE

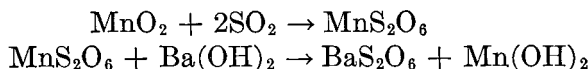

The procedure used in the preparation of calcium dithionate is followed except that barium hydroxide is employed instead of calcium hydroxide. For the amounts specified for calcium dithionate, the initial quantity of barium hydroxide,  $\text{Ba}(\text{OH})_2 \cdot 8\text{H}_2\text{O}$ , should be about 160 g. Because of the greater solubility of barium hydroxide, greater care must be exercised in arriving at the end point (strong alkalinity to litmus paper).

Using 80 g. of 90 per cent pyrolusite, a yield of 203 g. (73 per cent) of barium dithionate,  $\text{BaS}_2\text{O}_6 \cdot 2\text{H}_2\text{O}$ , was obtained.

### C. SODIUM DITHIONATE

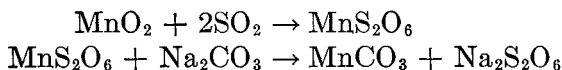

The crude dithionate solution is prepared in accordance with the instructions given for calcium dithionate. This solution is brought to a temperature of 35 to 40°. With continuous agitation, barium carbonate powder is added a little at a time until further addition does not cause immediate increase in carbon dioxide evolution. Agita-

\* The Java pyrolusite contained 16.5 per cent available oxygen (90 per cent  $\text{MnO}_2$ ). This material had been ground so that 99.1 per cent passed through 100-mesh, 94.3 per cent through 200-mesh, and 90.7 per cent through 300-mesh.

tion is continued for 10 minutes, whereupon powdered barium hydroxide is added a little at a time until the slurry is neutral to litmus paper. At this point, a small portion is filtered into a test tube, diluted with an equal amount of water, acidified slightly with hydrochloric acid, and 10 per cent barium chloride solution added. If a precipitate forms, more barium hydroxide (in the form of a saturated solution at 50°) is added to the batch. Addition of barium hydroxide solution and testing for sulfates are repeated, if necessary, until the filtrate is free of sulfate ion. Since any excess of barium hydroxide will be removed in the next step, it is better to add an excess than to use an insufficient quantity, which would leave some sulfates or sulfites in solution.

The slurry is filtered by suction and the filter cake washed with 50 ml. of water at room temperature. To the filtrate warmed to 35° and strongly agitated, about 65 g. of sodium carbonate is added in 1- to 2-g. portions. The temperature is brought up to 45°. The slurry is tested a few minutes after each addition with blue litmus paper. When a distinct, permanent but mildly alkaline condition is reached (red litmus changing to a pale, not a *deep*, blue), the addition of sodium carbonate is stopped. The warm slurry is filtered and the cake washed with 150 ml. of water at 50° made alkaline to litmus with sodium carbonate. The precipitate is sucked as dry as possible. The filter cake is slurried in 200 ml. of water, made slightly alkaline to litmus with sodium carbonate, and the slurry, heated to 45°, is filtered and washed with 50 ml. of slightly alkalized water at 50°. If the combined filtrates do not react slightly alkaline to litmus, a little more sodium carbonate is added and the solution refiltered.

Sodium dithionate is recovered by concentrating the solution on a steam bath. Successive crops of crystals are obtained by cooling to about 10°. These crystals are filtered off, sucked as dry as possible, but not washed. A precipitate, which may come down in the first concentra-

tion, is removed by filtration from the hot solution before cooling for crystallization. When the volume of mother liquor has been reduced to about 10 ml., it is discarded since most of the dissolved material in it is sodium carbonate. The combined crops of crystals are spread out on absorbent paper to dry at room temperature.

In a preparation starting with 80 g. of Java pyrolusite (90 per cent  $\text{MnO}_2$ ), 177 g. (88.5 per cent) of sodium dithionate,  $\text{Na}_2\text{S}_2\text{O}_6 \cdot 2\text{H}_2\text{O}$ , was obtained.

### Properties

The solid dithionates are stable at ordinary temperatures but undergo dehydration and decomposition at high temperatures. Above  $150^\circ$  they lose sulfur dioxide, forming sulfates.

In general, the dithionates are very soluble in water. Alkali and alkaline earth dithionates are remarkably stable. Such oxidizing agents as bromine, permanganate, and nitric acid have no effect at ordinary temperatures. In boiling solutions, oxidation to the sulfate takes place slowly. Continued heating with concentrated hydrochloric acid brings about conversion into sulfate with evolution of sulfur dioxide. Such agents as sodium amalgam and zinc in acid solution reduce dithionates to sulfites.

### References

1. ESSIN: *Z. Elektrochem.*, **34**, 78 (1928).  
GLASSTONE and HICKLING, *J. Chem. Soc.*, **1933**, 829.
2. BASSET and HENRY: *ibid.*, **1935**, 914.
3. DYMOND and HUGHES: *ibid.*, **71**, 314 (1897).  
ASHLEY: *Chem. News*, **94**, 223 (1906).
4. ALBU and VON SCHWEINITZ: *Ber.*, **65B**, 729 (1932).
5. VON HAUER: *J. prakt. Chem.*, **80**, 229 (1860).  
MEYER: *Ber.*, **34**, 3606 (1901).  
SPRING and BOURGEOIS: *Bull. soc. chim.*, [2] **46**, 151 (1885).  
VOGEL, *Metallbörse*, **21**, 19 (1929).

## 51. ADDITION COMPOUNDS OF SULFUR TRIOXIDE

SUBMITTED BY H. H. SISLER\*† AND L. F. AUDRIETH\*  
CHECKED BY JOHN A. LOWER‡

The use of sulfur trioxide as a sulfonating agent is often inconvenient, and reactions carried out with it are usually vigorous and difficult to control. The addition compounds that sulfur trioxide forms with tertiary amines and other strong electron donors, however, have been found to be very convenient sulfonating agents. Procedures for the preparation of three typical compounds, pyridine-sulfur trioxide,  $C_5H_5N \cdot SO_3$ ; dimethylaniline-sulfur trioxide,  $C_6H_5-N(CH_3)_2 \cdot SO_3$ ; and dioxane-sulfur trioxide,  $O(CH_2 \cdot CH_2)_2 O \cdot SO_3$ , are presented here.

### A. PYRIDINE-SULFUR TRIOXIDE<sup>1,2</sup>

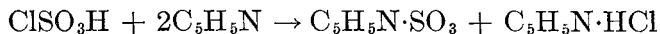

A solution of 62 g. of dry pyridine§ in 350 ml. of dry chloroform is placed in a three-necked flask fitted with a thermometer, mechanical stirrer, and a dropping funnel. The flask is cooled by an ice-salt mixture while 38.5 g. of chlorosulfonic acid is slowly added to the solution, with continuous stirring. The rate of addition is regulated so that the temperature of the reaction mixture is kept in the neighborhood of 0°. At the end of the reaction, the solid pyridine-sulfur trioxide (pyridinium chloride remains in solution) is filtered on a Büchner funnel and quickly washed four times with 30- to 40-ml. portions of ice-cold chloroform. The product is then placed between porous

\* University of Illinois, Urbana, Ill.

† Present address: University of Kansas, Lawrence, Kans.

‡ The Ohio State University, Columbus, Ohio.

§ Pyridine dried over solid sodium hydroxide and then redistilled is sufficiently pure for this preparation. More effective drying can be achieved by use of barium oxide or activated alumina.

plates *in vacuo* over concentrated sulfuric acid for 2 hours to remove adhering solvent. Yield 33 g. (62 per cent). The product contains a small amount of pyridinium sulfate.

### B. DIMETHYLANILINE-SULFUR TRIOXIDE<sup>3</sup>

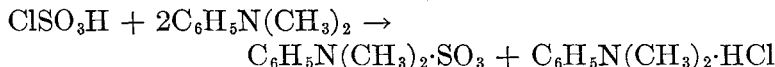

This compound is prepared in the same way as the pyridine compound. Suitable proportions are 45 g. of purified dimethylaniline\* in 80 ml. of chloroform and 19.5 g. of chlorosulfonic acid. Yield 16 g. (48 per cent).

### C. DIOXANE-SULFUR TRIOXIDE<sup>4†</sup>

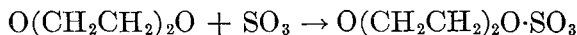

**Caution.** *Since pure dioxane-sulfur trioxide sometimes decomposes violently on standing for some time at room temperature, it should be prepared immediately prior to use.*<sup>5</sup>

Less than an equivalent quantity of sulfur trioxide is distilled from 60 per cent oleum into a solution of 88 g. of redistilled dioxane in 300 ml. of ethylene chloride, which is chilled and stirred mechanically. The white crystalline addition compound precipitates where the sulfur trioxide strikes the surface of the solution. The compound is filtered and dried as in the previous cases. It usually contains considerable sulfate, ‡ since dioxane-sulfur trioxide is very sensitive to moisture.

\* See footnote on the purification of pyridine.

† If more than an equivalent quantity of sulfur trioxide is added, some of the compound of the formula,  $\text{O}_3\text{S}\cdot\text{O}(\text{CH}_2\text{CH}_2)_2\text{O}\cdot\text{SO}_3$ , will form. The chemical properties of this compound are reported to be similar to those of the mono addition product.

‡ A sulfate-free product may be obtained by careful purification of the dioxane.<sup>6</sup> This is accomplished by first refluxing over solid sodium hydroxide. The clear liquid is then separated from the excess sodium hydroxide and some brown residue, which also forms, after which it is refluxed over sodium and distilled.



### Properties

*Pyridine-sulfur trioxide* is a white crystalline compound that is only slightly soluble in cold water, ether, chloroform, or carbon tetrachloride. It is hydrolyzed quantitatively to pyridine and sulfuric acid by hot water. Pyridine-sulfur trioxide reacts with aniline to form the pyridinium salt of *N*-phenylsulfamic acid.<sup>1</sup> Both aqueous<sup>7</sup> and liquid<sup>8</sup> ammonia ammonolyze pyridine-sulfur trioxide, yielding ammonium sulfamate.

*Dimethylaniline-sulfur trioxide* is very similar to pyridine-sulfur trioxide in appearance. However, it is much more easily hydrolyzed even by atmospheric moisture. This is in accordance with the general rule that compounds of the type formula  $R_3N \cdot SO_3$ , become less stable when one of the alkyl groups is replaced by an aryl radical.<sup>7</sup> Dimethylaniline-sulfur trioxide reacts with absolute ethyl alcohol, phenol, aniline,<sup>3</sup> and aqueous<sup>7</sup> or liquid ammonia.<sup>8</sup>

*Dioxane-sulfur trioxide* is stable at room temperature under anhydrous conditions but is decomposed on heating to 75° in carbon tetrachloride. It is much more reactive than is pyridine-sulfur trioxide and is hydrolyzed instantly by water to form sulfuric acid and dioxane. Its use as a sulfonating agent for a wide variety of organic compounds has been the subject of an extensive investigation by Suter, Evans, and Kiefer.<sup>4</sup>

### References

1. BAUMGARTEN: *Ber.*, **59**, 1166 (1926).
2. *Ibid.*, **60**, 1174 (1927).
3. WILLCOX: *Am. Chem. J.*, **32**, 446 (1904).
4. SUTER, EVANS, and KIEFER: *J. Am. Chem. Soc.*, **60**, 538 (1938).
5. ILER: private communication, Grasselli Experimental Laboratory, Cleveland, Ohio.
6. EIGENBERGER: *J. prakt. Chem.*, [2] **130**, 75 (1931).
7. BAUMGARTEN: *Ber.*, **59**, 1976 (1926).
8. SISLER and AUDRIETH: *J. Am. Chem. Soc.*, **61**, 3392 (1939).

## 52. SULFAMIC ACID

SUBMITTED BY H. H. SISLER,\*† M. JOSETTA BUTLER,\*‡ AND L. F. AUDRIETH\*  
CHECKED BY JOHN A. LOWER§ AND W. CONARD FERNELIUS¶||

Sulfamic acid,  $\text{NH}_2\text{SO}_3\text{H}$ , is an ammonoquosulfuric acid in which one of the hydroxyl groups of sulfuric acid has been replaced by the isosteric amido group. It is prepared commercially by the interaction of fuming sulfuric acid and urea.<sup>1</sup> This method is not readily adaptable to laboratory preparation on a small scale. Consequently, the sulfur dioxide-hydroxylamine reaction<sup>2</sup> is recommended.¶ Sulfamic acid may also be obtained by the action of sulfur dioxide upon certain compounds which yield hydroxylamine such as acetoxime.<sup>4</sup> The recommended procedures are modifications of older processes and involve the use of sulfur dioxide under pressure<sup>5</sup> upon aqueous solutions of hydroxylammonium salts and compounds yielding hydroxylamine.

Since sulfamic acid has been found to be an excellent acidimetric standard of reference,<sup>6</sup> detailed directions for the purification of the commercial grade of acid are also given.

### Procedure

#### A. SULFAMIC ACID FROM HYDROXYLAMMONIUM SULFATE

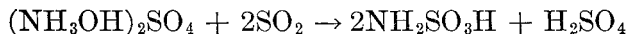

A solution of 82.5 g. (0.5 mol) of hydroxylammonium sulfate in 250 ml. of water is cooled to  $-30^\circ$  or lower by

\* University of Illinois, Urbana, Ill.

† Present address, The Ohio State University, Columbus, Ohio.

‡ Present address: St. Xavier College, Chicago, Ill.

§ The Ohio State University, Columbus, Ohio.

¶ Present address, Purdue University, West Lafayette, Ind.

¶|| Hydroxylammonium sulfate has recently become readily available as a by-product from the hydrolysis of nitroparaffins<sup>2</sup> and is obtainable in quantity at a very moderate price.

means of an alcohol-solid carbon dioxide bath. An excess (approximately 100 g.) of sulfur dioxide\* is condensed into the container. The container is then placed in an autoclave† and allowed to stand at room temperature under pressure (about 55 to 60 lb./sq. in.) for 24 hours. The excess of sulfur dioxide is then permitted to escape slowly through a release valve, and the quantity still remaining in solution may be removed by bubbling air through the solution. The solid sulfamic acid that has crystallized is filtered, drained thoroughly in a Büchner funnel, and dried in air. A further quantity of sulfamic acid may be recovered by adding 150 ml. of concentrated sulfuric acid to the mother liquor and cooling to 0°. In a typical experiment, 47.5 g. of sulfamic acid was obtained directly and an additional 22.5 g. recovered from the mother liquor. Total yield 72 per cent.

#### B. SULFAMIC ACID FROM ACETOXIME

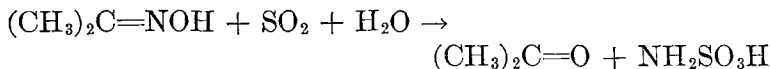

A solution of 50 g. of acetoxime in 50 ml. of water and an excess of liquid sulfur dioxide (about 50 g.) are placed in an autoclave and kept at room temperature under pressure for 5 hours. The excess sulfur dioxide is then allowed to escape slowly, and the product is removed by filtration. It is washed on the filter with alcohol and then with ether. Yield 60 g. (90 per cent).

\*Liquid sulfur dioxide is practically insoluble in the solution. The quantity specified represents an appreciable excess over that required for reaction.

† If an autoclave is not available, pressure bottles of the type used in ordinary hydrogenation processes, capable of withstanding pressures of 60 to 100 lb./sq. in. may be employed. If neither a pressure bottle nor an autoclave is available, the preparation may be carried out by bubbling sulfur dioxide through the cold solution. This procedure is naturally slower, and the yields are much smaller.

### C. PURIFICATION OF SULFAMIC ACID FOR USE AS AN ACIDIMETRIC STANDARD

One hundred twenty-five grams of commercial sulfamic acid is added to 300 ml. of hot water to form a saturated solution at 70 to 75°. The hot solution is filtered three times through a Büchner funnel. During these filtrations, which must be carried out as rapidly as possible, the temperature of the solution drops about 20 to 25°. The material that crystallizes is discarded.\* The final filtrate (45 to 50°) is cooled rapidly in an ice-salt mixture, with continuous stirring. After the solution has stood in the cooling bath for ½ hour, the crystals are separated on a Büchner funnel or preferably a sintered-glass filter, washed with 50 ml. of cold distilled water, twice with cold absolute alcohol, and finally with ether. The crystals are air-dried for an hour in a dish loosely covered so as to prevent contamination with dust particles. The product is then ground in an agate mortar and placed in a desiccator over a suitable drying agent and subsequently stored in a tightly stoppered bottle.† Yield 41 g. (33 per cent). The purity of this sulfamic acid by analysis and by standardization was found to be 99.945 per cent.<sup>6</sup>

#### Properties

Sulfamic acid is a crystalline, nonhygroscopic solid, melting with decomposition at 205°. Its solubility in 100 g. of water varies from 14.689 g. at 0° to 47.08 g. at 80°.<sup>7</sup> It is not appreciably soluble in organic oxygen-containing solvents, but it does dissolve easily in such nitrogenous solvents as liquid ammonia<sup>8</sup> and formamide.<sup>7</sup> The solubility of sulfamic acid in water is decreased markedly by the addition of sulfuric acid.

\* The second and third crops of crystals are satisfactory for most purposes but are not sufficiently pure for use as an analytical standard.

† The additional drying is not absolutely necessary since air drying of the sulfamic acid after grinding has been found to be completely satisfactory.

**TRIAMMONIUM IMIDODISULFATE 1-HYDRATE 179**

Sulfamic acid is a strong acid and may be titrated with bases by means of indicators whose transition ranges lie within the pH range 4.5 to 9. Because of its unusual physical properties and the ease with which it may be prepared in a state of high purity, it has found application as an acidimetric standard of reference.<sup>6</sup> It has also been suggested for the estimation and detection of nitrates and nitrites in the presence of each other.<sup>9</sup> A comprehensive review of the physical and chemical properties of sulfamic acid and of its inorganic derivatives has recently appeared in *Chemical Reviews*.<sup>10</sup>

**References**

1. BAUMGARTEN: German patent 636329 (1938); *cf. Chem. Abstracts*, **32**, 2959 (1938).
2. RASCHIG: *Ann.*, **241**, 161 (1887).
3. HASS, HODGE, and VANDERBILT: *Ind. Eng. Chem.*, **28**, 339 (1936).
4. SCHMIDT: *J. prakt. Chem.*, **44**, 513 (1891).
5. SISLER and AUDRIETH: *J. Am. Chem. Soc.*, **61**, 3389 (1939).
6. BUTLER, SMITH, and AUDRIETH: *Ind. Eng. Chem., Anal. Ed.*, **10**, 690 (1938).
7. CUPERY: *Ind. Eng. Chem.*, **30**, 627 (1938).
8. BUTLER and AUDRIETH: *J. Am. Chem. Soc.*, **61**, 914 (1939).
9. BAUMGARTEN and MARGGRAFF: *Ber.*, **63**, 1019 (1930).
10. AUDRIETH, SVEDA, SISLER, and BUTLER: *Chem. Revs.*, **26**, 49 (1940).

**53. TRIAMMONIUM IMIDODISULFATE 1-HYDRATE**

SUBMITTED BY H. H. SISLER\*† AND L. F. AUDRIETH\*

CHECKED BY JOHN A. LOWER‡ AND W. CONARD FERNELIUS§

Triammonium imidodisulfate 1-hydrate is obtained when a solution of the diammonium salt is treated with ammonia and cooled. The crude diammonium salt may be prepared readily by the fusion of ammonium sulfamate.<sup>1</sup> The diammonium salt may also be prepared by the fusion of an equimolar mixture of ammonium sulfamate and sul-

\* University of Illinois, Urbana, Ill.

† Present address: University of Kansas, Lawrence, Kans.

‡ The Ohio State University, Columbus, Ohio.

§ Present address: Purdue University, West Lafayette, Ind.

famic acid.<sup>2</sup> While this latter procedure is more rapid and takes place at a lower temperature, yields are much smaller.

Since ammonium sulfamate is required as the starting material for the recommended procedure, directions for its preparation are also given.

### Procedure

#### A. AMMONIUM SULFAMATE<sup>3</sup>

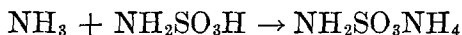

Purified sulfamic acid (synthesis 52) is readily soluble in liquid ammonia. Spontaneous evaporation of the solvent leaves a residue of ammonium sulfamate in practically quantitative yield.

If liquid ammonia is not available, the ammonium sulfamate may be obtained by neutralization of sulfamic acid with aqueous ammonia. During the process of evaporation, the solution should be kept distinctly ammoniacal to prevent hydrolysis.

Ammonium sulfamate, (m.p. 131°) is extremely soluble in water and in liquid ammonia. It is somewhat soluble in hot ethanol.

#### B. TRIAMMONIUM IMIDODISULFATE 1-HYDRATE

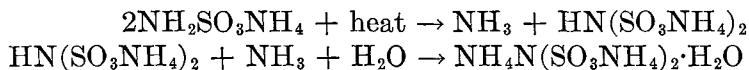

Two hundred grams of ammonium sulfamate is heated gradually to a temperature of 290 to 305°. Vigorous evolution of ammonia begins at about 200°. The reaction mixture is kept at the maximum temperature for about ½ hour and stirred continuously. The molten product begins to solidify at about 260°.

The cold diammonium imidodisulfate, which contains some sulfate and unchanged sulfamate, is dissolved in 500 ml. of water containing just enough ammonia to keep the solution alkaline and thus prevent hydrolysis. Solution

of the fused mass may be hastened by warming the water to not over 50°.

This solution is cooled in an ice-salt mixture and then saturated with ammonia gas\* and allowed to stand for 1 hour. The crystalline triammonium salt is separated from the solution and washed first with alcohol, then with ether. Yield 165 g. (76 per cent). The triammonium salt is sulfate-free.

### Properties<sup>4</sup>

The triammonium salt is the most readily obtainable derivative of imidodisulfuric acid,  $\text{HN}(\text{SO}_3\text{H})_2$ . Since the hydrolysis of imidodisulfuric acid is strongly catalyzed in acid solution,<sup>5</sup> the dissolving and recrystallization of imidodisulfates must be effected from neutral or alkaline solutions. The so-called "neutral" salts,  $\text{HN}(\text{SO}_3\text{M})_2$ , are obtained in the first case, whereas the "basic," or trisubstituted, salts,  $\text{MN}(\text{SO}_3\text{M})_2$ , are obtained from alkaline solutions.

The triammonium salt is unstable and loses both water and ammonia on standing in air. The residue gradually approaches the composition of the diammonium salt. Solutions of triammonium imidodisulfate, like all trisubstituted salts of the parent acid, give insoluble precipitates when treated with barium chloride. These precipitates are of variable composition but may be distinguished from barium sulfate by the fact that they are acid-soluble.

### References

1. BERGLUND: *Bull. soc. chim.*, [2] **29**, 422 (1878).
2. BAUMGARTEN: *Ber.*, **69**, 1929 (1936).
3. BUTLER and AUDRIETH: *J. Am. Chem. Soc.*, **61**, 914 (1939).
4. For a comprehensive review of the properties and reactions of imidodisulfuric acid and its derivatives, see AUDRIETH, SVEDA, SISLER, and BUTLER: *Chem. Revs.*, **26**, 49 (1940).
5. SISLER and AUDRIETH: *J. Am. Chem. Soc.*, **60**, 1947 (1938).

\* The commercial 27 per cent aqua ammonia may be used, although yields are appreciably lowered because of dilution of the solution.

#### 54. TRIPOTASSIUM NITRIDOTRISULFATE

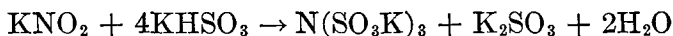

SUBMITTED BY H. SISLER\*† AND L. F. AUDRIETH\*

CHECKED BY U. S. BRANSON, JR.,‡ AND WARREN C. JOHNSON†

One of the by-products always obtained in the reactions of sulfites with nitrites, regardless of the ratio of the reactants, is the corresponding nitridotrisulfate. It becomes the main product when an excess of hydrogen sulfite ion is allowed to react with nitrite ion at higher temperatures.

The nitridotrisulfates are intermediate products in the preparation of sulfamic acid by the nitrite-hydrogen-sulfite reaction. The preparation of the potassium salt only is feasible, since it is but slightly soluble in water and therefore is not hydrolyzed as readily as the more soluble sodium salt. The method outlined below is a modification<sup>1</sup> of the procedure first proposed by Claus and Koch.<sup>2</sup>

#### Procedure

A solution of 25 g. of potassium nitrite (0.294 mol) in 100 ml. of water is heated to boiling and then added slowly, with stirring, to a warm solution of potassium hydrogen sulfite, prepared by saturating a solution of 100 g. (1.78 mol) of potassium hydroxide in 200 ml. of water with sulfur dioxide. The solution clouds immediately, with formation of a mass of crystals. After standing for an hour in the mother liquor, enough water (about 1500 ml.) is added to the solution to redissolve the crystals on heating.§ The solution is then allowed to cool, resulting in the separation of needlelike crystals, which are filtered and washed

\* University of Illinois, Urbana, Ill.

† Present address: The Ohio State University, Columbus, Ohio.

‡ University of Chicago, Chicago, Ill.

§ During the recrystallization, care must be taken that the solution remains alkaline. If necessary, a few pellets of potassium hydroxide or a few milliliters of aqueous ammonia should be added. If the solution becomes even slightly acid, the hydrolytic product, potassium imidodisulfate, will be obtained.



thoroughly with ice water,\* then alcohol, and finally ether. The product is stored in a desiccator. Yield 65 to 77 g. (54 to 64 per cent). *Anal.* Calcd. for  $N(SO_3K)_3 \cdot 2H_2O$ : K, 28.8; S, 23.6. Found: K, 28.8, 28.7; S, 23.4, 23.8.

### Properties<sup>3</sup>

Potassium nitridotrisulfate crystallizes as the 2-hydrate in long brilliant needles. It is very slightly soluble in water and not appreciably soluble in liquid ammonia. In aqueous solutions it gives no precipitate with manganese(II), mercury(II), silver, cadmium, cobalt(II), copper(II), or iron(II) ion but yields a white precipitate with lead acetate. Potassium nitridotrisulfate yields a precipitate with barium ion only in basic solution.

Potassium nitridotrisulfate hydrolyzes slowly in neutral solution, and very rapidly in the presence of acid; however, the solution may be stabilized by the addition of a base. If the compound is carefully purified, it may be kept in a desiccator for about a month before decomposition becomes appreciable.

### References

1. SISLER and AUDRIETH: *J. Am. Chem. Soc.*, **60**, 1947 (1938).
2. CLAUS and KOCH: *Ann.*, **152**, 336 (1869).
3. For a comprehensive review of the properties and reactions of the nitridotrisulfates, see AUDRIETH, SVEDA, SISLER, and BUTLER: *Chem. Revs.*, **26**, 49 (1940).

## 55. ALUMINUM SELENIDE AND HYDROGEN SELENIDE

SUBMITTED BY G. R. WAITKINS† AND R. SHUTT‡

CHECKED BY IRVIN W. KINNEY‡ AND JAMES P. McREYNOLDS‡§

Hydrogen selenide can be prepared by direct union of hydrogen and selenium at 250 to 570°. <sup>1,2</sup> The amount of

\* The washing with ice water should be thorough in order that complete removal of sulfite is ensured. The presence of this impurity brings about rapid decomposition of the nitridotrisulfate.

† Battelle Memorial Institute, Columbus, Ohio.

‡ The Ohio State University, Columbus, Ohio.

§ Deceased.

hydrogen selenide in the equilibrium mixture is a maximum (over 50 per cent) at 570°; above this temperature, the percentage decreases. When paraffin and other high-boiling hydrocarbons are heated with selenium above 200°, hydrogen selenide contaminated with other gases<sup>3,4</sup> is produced. A steady stream of hydrogen selenide is generated when phosphorus(V) selenide is warmed with water.<sup>5</sup> Iron selenides may also be used to generate the gas.<sup>6</sup> Many authors agree, however, that the purest hydrogen selenide with the best yields<sup>7,8</sup> is obtained from aluminum selenide and magnesium selenide.

### Procedure

#### A. ALUMINUM SELENIDE



Thirty grams of aluminum powder is freed from oil by washing with acetone and ether and mixed with 50 g. of finely divided precipitated selenium.<sup>9</sup> Five grams of this mixture is placed in a 200-ml. heavy-walled clay crucible fitted with a cover. The crucible cover is held with tongs, a small piece of ignited magnesium ribbon is dropped into the crucible, and the cover is replaced immediately. (Work under a good hood.) After a few seconds, the cover is removed, 3 g. of the mixture is added to the glowing mass, and the crucible is again covered. Usually, the temperature of the mass is high enough to maintain the reaction without additional magnesium. This procedure is continued until all the mixture has been added. After the crucible has cooled, the aluminum selenide is removed and the material is kept away from moisture in a tightly stoppered container.

#### B. HYDROGEN SELENIDE

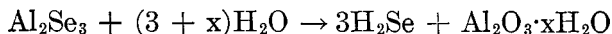

**Caution.** *Hydrogen selenide is a colorless gas with a characteristic and penetrating odor. It is a potent lachrymator and paralyzes the olfactory nerves rapidly. For this*

reason, it should never be breathed even in small quantities, and the preparation should be carried out under a hood and in a gastight apparatus with provisions made for its complete absorption by alkalis.

The aluminum selenide is placed in a dry 500-ml. Erlenmeyer flask fitted with a gas inlet, a dropping funnel containing freshly boiled water, and an outlet that leads the gases through drying trains containing calcium chloride and phosphorus(V) oxide. The apparatus is swept free of oxygen by allowing nitrogen from a cylinder to flow through at a rapid rate for at least 10 minutes. A slow stream of nitrogen is maintained, and the cold water is added drop by drop. (The reaction is violent when more than a few drops of water are added at a time.) Dilute hydrochloric acid is added instead of water when the evolution of gas diminishes, so as to complete the reaction.

If the selenium used in the preparation of aluminum selenide is pure, the hydrogen selenide obtained by this method is contaminated only with nitrogen and hydrogen. If the gas is required in a high degree of purity, the dried gas can be liquefied by means of acetone and solid carbon dioxide and obtained pure by vaporization.<sup>8</sup>

### Properties

Hydrogen selenide solidifies at  $-64^{\circ}$  and boils at  $-42^{\circ}$  under atmospheric pressure. Pure hydrogen selenide is colorless; however, in the presence of moisture, it is decomposed rapidly by oxygen, with deposition of red selenium. Hydrogen selenide burns with a blue flame.

One volume of water at  $22.5^{\circ}$  dissolves 2.7 volumes of hydrogen selenide. Precipitates of pure metallic selenides can be obtained by allowing salt solutions to drop slowly into saturated aqueous solutions of the gas, an excess of hydrogen selenide being maintained.<sup>10</sup>

### References

1. PELEBON: *Z. physik. Chem.*, **26**, 659 (1898).
2. BODENSTEIN: *ibid.*, **29**, 429 (1899).

3. GRAEFE: *Z. angew. Chem.*, **34**, 509 (1921).
4. GREEN and BRADT: *Proc. Indiana Acad. Sci.*, **43**, 116 (1933).
5. BECKER and MEYER: *Ber.*, **37**, 2550 (1904).
6. HEMPEL and WEBER: *Z. anorg. Chem.*, **77**, 48 (1912).
7. FONZES-DIACON and MOISSAN: *Compt. rend.*, **132**, 1314 (1900).
8. MOSER and DOCTOR: *Z. anorg. Chem.*, **118**, 284 (1921).
9. BAKER and MAXSON: *INORGANIC SYNTHESSES*, **1**, 119 (1939).
10. MOSER and ATYNSKI: *Monatsh.*, **45**, 235 (1924).

## 56. POTASSIUM AND SODIUM SELENOCYANATES

SUBMITTED BY G. R. WAITKINS\* AND R. SHUTT\*

CHECKED BY JAMES P. McREYNOLDS†† AND ROBERT L. McFADDEN†

Potassium selenocyanate serves as a very useful starting material in the synthesis of a variety of organoselenium compounds. Selenocyanates find some use in photographic emulsions, in which they act as sensitizers.

The potassium salt can be prepared in low yield by fusing a mixture of potassium hexacyanoferrate(II) and selenium.<sup>1</sup> This salt can also be made by dissolving selenium in cold or warm aqueous potassium cyanide.<sup>2,3</sup> However, this method is troublesome because it is difficult to crystallize selenocyanates from water without decomposition. The procedure described here yields a very pure product and is easy to carry out even with large amounts of materials.<sup>4,5</sup>

### Procedure

#### A. POTASSIUM SELENOCYANATE

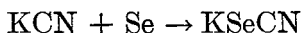

**Caution.** *This preparation and the subsequent purification should be carried out under a hood. Canvas or rubber gloves should be worn because the selenocyanate is readily decomposed, with the deposition of red selenium, on coming in contact with the skin. The selenium may be removed by swabbing the skin with dilute aqueous ammonium sulfide.*

A mixture of 210 g. (95 per cent) potassium cyanide and 240 g. commercial gray selenium is melted in a large

\* Battelle Memorial Institute, Columbus, Ohio.

† The Ohio State University, Columbus, Ohio.

‡ Deceased.

porcelain evaporating dish at 150 to 160° by using either a sand bath or an electric hot plate. The melt is stirred with a porcelain spatula until all the selenium dissolves. It is then permitted to cool slowly, with continuous stirring, in order to prevent caking during solidification.

The cold melt is crushed to a fine powder and is immediately dissolved in 1½ l. of hot acetone.\* The salt is very deliquescent and must not be allowed to stand in the open air. A slow stream of carbon dioxide, dried over phosphorus(V) oxide, is bubbled into the acetone solution for 2 hours; this treatment removes alkali hydroxides as insoluble carbonates. The slime, consisting of carbonates and tellurium, is collected in a Büchner funnel and is washed with warm acetone. The filtrate is transferred to a distilling flask, and two-thirds of the acetone is distilled off. The residual solution is poured into a beaker, where a large part of the salt separates on cooling. The colorless needles are filtered and washed several times with anhydrous ether; then they are rapidly transferred to a vacuum desiccator, where the remaining ether is removed. The mother liquor is evaporated to one-half its volume in order to obtain another crop of crystals. Yield 325 g. (75 per cent). If the remaining brown solution is boiled with decolorizing carbon, more of the pure salt (about 65 g.) can be recovered from the filtered solution, and a total yield of 90 per cent or greater can be obtained. *Anal.* Calcd. for KSeCN: Se, 54.8. Found: Se, 54.6.

#### B. SODIUM SELENOCYANATE

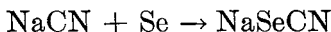

Sodium selenocyanate can be prepared and purified by following the exact procedure outlined above except that a mixture of 200 g. of sodium cyanide and 320 g. of selenium

\* The use of methyl or ethyl alcohol is usually suggested; however, these solvents react with the selenocyanate to form volatile, malodorous alkyl selenides, which do not allow the preparation of an odorless product, as acetone does.

is used. A temperature of 240 to 260° is necessary to complete the reaction, and more charring of the cyanide occurs.

### Properties

Potassium and sodium selenocyanates are obtained in the above manner as colorless needles, which decompose on standing in air or on being heated above 100°. The salts are extremely deliquescent, and solution in water is accompanied by a marked lowering in temperature. The aqueous solutions are strongly basic. If the pH of these solutions is reduced to 5 or below, all the selenium is deposited in the finely divided red form. Precipitates of the corresponding metal selenocyanates are obtained from aqueous solutions containing  $\text{Ag}^+$ ,  $\text{Cu}^+$ ,  $\text{Tl}^+$ ,  $\text{Hg}_2^{++}$ ,  $\text{Hg}^{++}$ , and  $\text{Pb}^{++}$ . Copper(II) ion produces brown copper(II) selenocyanate, but this decomposes rapidly and forms black copper(I) and (II) selenides. Silver selenocyanate is characteristic when formed in the presence of ammonia; the gleaming, satinlike crystals darken rapidly in sunlight.<sup>6,7</sup>

### References

1. BERZELIUS: *Jahresber.*, **1**, 49 (1822).
2. WIGGERS: *Ann.*, **29**, 319 (1839).
3. KYPKE and NEGER: *ibid.*, **115**, 207 (1860).
4. MUTHMANN and SCHRÖDER: *Ber.*, **33**, 1766 (1900).
5. BIRCKENBACH and KELLERMANN: *ibid.*, **58**, 790 (1925).
6. CROOKES: *Ann.*, **78**, 177 (1851).
7. CAMERON and DAVY: *Chem. News*, **44**, 63 (1881).

## 57. HEXAHALOGENOTELLURATES(IV)

### (Halotellurites)

SUBMITTED BY H. MARSHALL\*

CHECKED BY G. WAITKINS† AND R. SHUTT‡ AND BY ROY E. HEATH‡

Tellurium(IV) halides form compounds of the type  $\text{Me}_2\text{TeX}_6$  (where X = Cl, Br, or I) resembling the cor-

\* Canadian Copper Refiners, Ltd., Montreal East, Quebec, Canada.

† Battelle Memorial Institute, Columbus, Ohio.

‡ University of Wisconsin, Madison, Wis.; present address: Wyandotte Chemicals Corporation, Wyandotte, Mich.

responding platinum compounds. The preparation of two of these compounds is described here.

### Procedure

#### A. AMMONIUM HEXACHLOROTELLURATE(IV)<sup>1</sup>

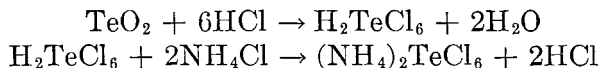

Five grams of tellurium dioxide is dissolved in 15 ml. of concentrated hydrochloric acid, and the solution is evaporated to 7.5 ml. A saturated solution of two molal equivalents of ammonium chloride (3.5 g. in about 12 ml. of water) is added and the evaporation continued on a steam bath until a mass of glistening yellow crystals is formed. The crystals are carefully drained on a filter and then dried in a vacuum desiccator over soda lime. Yield 8.2 to 9.6 g. (70 to 82 per cent). The product hydrolyzes in moist air to give tellurium dioxide.

#### B. POTASSIUM HEXABROMOTELLURATE(IV)<sup>2,3</sup>

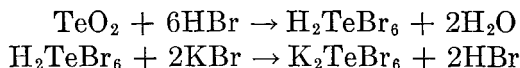

Tellurium dioxide (0.5 g.) is dissolved in 5 ml. of 40 per cent hydrobromic acid. A saturated solution of two molal equivalents of potassium bromide (0.75 g. in about 1.4 ml. of water) is then added. The solution is evaporated on a steam bath and stirred until the orange crystals settle well. The salt is recrystallized from boiling water containing 5 to 10 per cent hydrobromic acid and is dried in a vacuum desiccator over soda lime and finally over sulfuric acid. Yield 1.60 g. (75 per cent).

### Properties

The halogenotellurates(IV) are decomposed by pure water to form hydrated tellurium dioxide. They are soluble in dilute acids without decomposition. Ammonium

hexachlorotellurate(IV) can be recrystallized from anhydrous methyl or ethyl alcohols, but potassium hexabromotellurate(IV) is decomposed by the same alcohols.

Aliphatic and aromatic amines, as well as many alkaloids, form well-defined crystalline halogenotellurates(IV) analogous to the ammonium salts.<sup>4,5,6</sup> Rubidium and cesium salts also have been described.<sup>7</sup> All the bromides are red and the chlorides yellow.

#### References

1. WHEELER: *Am. J. Sci.*, **45**, 267 (1893).
2. LENHER: *J. Am. Chem. Soc.*, **31**, 22 (1909).
3. DENNIS and ANDERSON: *ibid.*, **36**, 902 (1914).
4. LENHER: *ibid.*, **22**, 136 (1900); **25**, 730 (1903).
5. MORRIS and MOMMERS: *Am. Chem. J.*, **23**, 486 (1900).
6. GUTBIER and FLURY: *J. prakt. Chem.*, **86**, 150 (1912); *Z. anorg. Chem.*, **86**, 169 (1914).
7. WHEELER: *ibid.*, **3**, 428 (1893).

### 58. CHROMIUM(III) OXIDE GEL

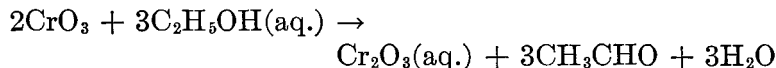

SUBMITTED BY ROBERT F. RUTHERUFF\*

CHECKED BY J. KLEINBERG†‡ AND J. DEANE SENSENBAUGH†

Catalytically active chromium(III) oxide gel has previously been prepared by the slow precipitation of dilute solutions of chromium(III) compounds with dilute ammonia.<sup>1</sup> The resulting highly flocculent precipitate is thoroughly washed, usually by decantation, separated by filtration, and dried. Complete directions are given by Kohlschütter.<sup>2</sup> The procedure is very tedious (the washing frequently requires a week); and because of the dilute solutions used (0.03 to 0.08 *M*), the production of catalyst,

\* Present address: 1711 West 100th Street, Chicago, Ill. The author wishes to express appreciation to the M. W. Kellogg Company, 225 Broadway, New York, N.Y., for permission to publish this procedure.

† James Millikin University, Decatur, Ill.

‡ Present address: College of Pharmacy, University of Illinois, Chicago, Ill.



even with the largest laboratory equipment, is extremely small. The procedure described here, which is based on earlier observations by Traube,<sup>3</sup> is convenient and rapid. Since concentrated solutions are employed, large quantities can easily be prepared with ordinary laboratory equipment.

#### Procedure<sup>4</sup>

One hundred and sixty grams of chromium(VI) oxide is dissolved in 2000 ml. of water. Eight 10-ml. portions of ethanol are added to the well stirred solution, with shaking, at successive 5-minute intervals. (**Caution.** *Hood.*) The solution is allowed to stand approximately 4 hours, after which an additional 80 ml. of ethanol is added as previously described. The reaction mixture is then boiled vigorously under reflux for a period of 16 hours. Stirring during this time is necessary to prevent the severe bumping that otherwise occurs. At the end of the heating period the finely divided dark-brown precipitate is separated from the mother liquor (on a 24-cm. Büchner funnel) and is dried, without washing, at 110°. Variations in the extent of hydration of the filter cake make dry yield figures mean little, but usually 145 to 150 g. of gel is obtained. If desired, a small amount of additional material, usually 30 to 35 g., may be obtained by concentrating the filtrate, or the filtrate may be reserved and used in place of an equal amount of water in making the next batch of gel.

#### Properties.

The final, dried product is obtained in the form of shining, vitreous, jet-black particles of the proper size for direct use in experimental catalytic reactors. The gel exhibits catalytic activity in several diverse reactions, for example, dehydration of alcohols, hydrogenation of olefins, dehydrogenation of paraffins, especially gaseous paraffins, and aromatization of paraffins containing six or more carbon atoms in a straight chain. The material prepared as described is appreciably more active than that made by

precipitation. If the activity of the precipitated gel in the reaction involving conversion of normal heptane to toluene is set arbitrarily as 100, the activity of the reduced gel is about 160.

To produce material of maximum catalytic activity, it is necessary to subject the reaction mixture to heat-treatment sufficiently severe to effect substantially complete reduction of the chromium(VI) oxide. If, instead of boiling, the reaction mixture is heated under reflux on a steam bath for 16 hours, without stirring, the whole sets to a black gel, which may be broken, filtered, and dried as usual. The resulting material has an activity of 140 in the aromatization of normal heptane. When subjected to thermal analysis, this gel exhibits a slight but unmistakable exothermic reaction at 215 to 220°. Chromium(III) chromate, prepared either by treating chromium(III) nitrate solution with ammoniacal ammonium chromate solution or by adding an excess of ammonia to a solution containing chromium(III) nitrate and chromium(VI) oxide, exhibits a strong exothermic reaction when heated to 215 to 220°. In the preparation of chromium oxide gel as described, it is believed that chromium(III) ions formed during reduction unite with unchanged chromic acid to form chromium(III) chromate. Rather strenuous conditions are required to reduce this compound. (By thermal analysis, the gel prepared as described under Procedure, exhibits no exothermic reaction at 215 to 220°.)

The normal color of chromium(III) oxide is green. The observed color of the present preparation probably is due to the presence of a small amount of higher oxide. When employed as a catalyst, this higher oxide can be reduced, prior to adding the charge, by treating the catalyst at reaction temperature with hydrogen for a short time.

When employed in organic systems at elevated temperatures, all catalysts sooner or later become inactive owing to the deposition of a carbonaceous residue on the surfaces. The present catalyst is no exception. After exhaustion, it

## ANHYDROUS CHROMIUM(III) CHLORIDE

193

may be restored to its original activity by slowly burning the carbonaceous residues from the catalytic surfaces by means of air diluted with nitrogen.

## References

1. LAZIER and VAUGHEN: *J. Am. Chem. Soc.*, **54**, 3080 (1932).  
FREY and HUPPKE: *Ind. Eng. Chem.*, **25**, 54 (1933).
2. KOHLSCHÜTTER: *Z. physik. Chem.*, **A170**, 307 (1934); *Z. anorg. allgem. Chem.*, **220**, 370 (1934).
3. TRAUBE: *Ann.*, **66**, 87 (1848).
4. TURKEVITCH and RUTHRUFF: U.S. patent 2211302 (August 13, 1940); *Chem. Abstracts*, **35**, 588 (1941).

## 59. ANHYDROUS CHROMIUM(III) CHLORIDE

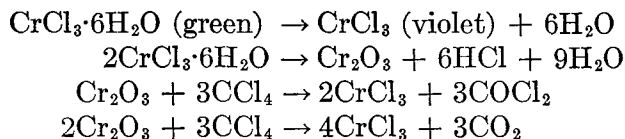

SUBMITTED BY G. B. HEISIG,\* B. FAWKES,\* AND R. HEDIN\*

CHECKED BY ARTHUR A. BLANCHARD† AND CLARENCE K. MOREHOUSE†

Anhydrous chromium(III) chloride is usually prepared<sup>1-6</sup> by passing a chlorinating agent such as chlorine, sulfur chloride, carbon tetrachloride, phosgene, or hydrogen chloride and carbon disulfide over hot chromium(III) oxide (about 600°) or an oxide-carbon mixture. In the latter case, the chloride is separated from excess carbon by sublimation.

In the procedure outlined here, hydrated chromium(III) chloride is the starting material. This is readily converted by heating to a spongy mass of basic chloride or oxide or both. Because of its large surface, this is readily converted to the anhydrous compound. The net result of the process is given by the first equation. Other equations are given to show the formation of chromium(III) oxide and its subsequent reaction<sup>6</sup> with carbon tetrachloride to form phosgene and carbon dioxide. Hexachlorobenzene,<sup>6</sup>

\* University of Minnesota, Minneapolis, Minn.

† Massachusetts Institute of Technology, Cambridge, Mass.

formed by the pyrolysis of carbon tetrachloride, is also present in the effluent gas.

### Procedure

The apparatus shown in Fig. 22 is constructed. The furnace *E* may be any suitable commercially available crucible furnace closed with several layers of sheet asbestos perforated for the neck of the flask and covered with a 1-in. layer of insulating material. A homemade furnace of 600 watts that will serve equally well may be constructed

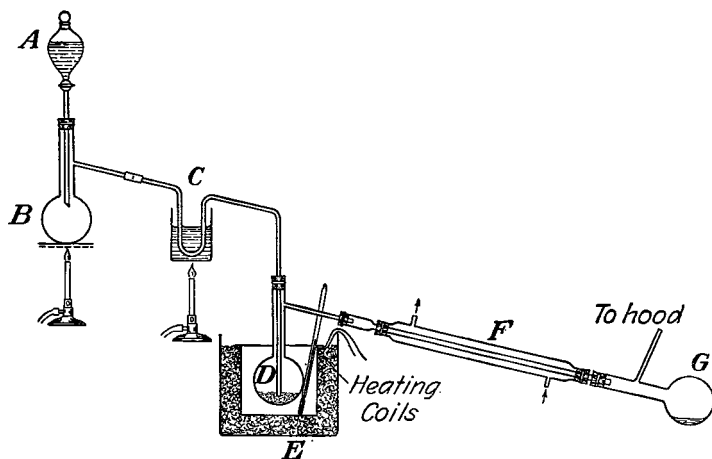

FIG. 22.—Apparatus for the preparation of anhydrous chromium(III) chloride.

from a round crimped can (8 by 8 in.) such as is used to dispense 10 lb. of commercial sodium hydroxide. The side of the can is wrapped with asbestos paper. On the asbestos paper is wound about 32 ft. of No. 20 B. & S. gauge nichrome wire previously made into a coil  $\frac{1}{8}$  in. in diameter and stretched to a length of approximately 6 ft. The heating element is tied with asbestos cord to prevent short circuiting, and then the wire is covered with the asbestos cement used for lagging pipes. After the cement dries, the furnace is placed in a larger can filled with dry asbestos cement to insulate the furnace.

**Caution.** *Since phosgene is formed in this preparation, the effluent gas is led to a hood or outdoors. A water suction pump will not dispose of phosgene because this gas is not hydrolyzed rapidly.*

Thirty seven grams of hydrated chromium(III) chloride,  $\text{CrCl}_3 \cdot 6\text{H}_2\text{O}$ , is placed in the 500-ml. distilling flask *D* and 100 ml. of carbon tetrachloride in the separatory funnel *A*. The furnace is connected to a 110-volt line. When the furnace is hot, and the water in the beaker *C* used to superheat the carbon tetrachloride is boiling, the flash distillation is started. One drop from the separatory funnel every 2 seconds is a suitable rate. The green hydrate melts at approximately  $150^\circ$  and soon forms a spongy mass, which fills the flask. At approximately  $300^\circ$ , a condensate of water and carbon tetrachloride begins to collect in the receiver. At higher temperatures, phosgene is present in the effluent gas, and anhydrous chromium(III) chloride is formed. The reaction is complete when the temperature of the furnace is approximately  $650^\circ$ .\* Except for traces of green and purple dust carried over into the receiver, the entire product is left in the flask as a loose mass of glistening violet crystals, which can be easily shaken out of the flask. Of a calculated yield of 22 g., 20 g. (91 per cent) was obtained, and an estimated 2 g. was left clinging to the sides of the flask.

### Properties

Anhydrous chromium(III) chloride forms violet-colored "greasy" scales, which sublime at  $950^\circ$  and begin to dissociate above  $\pm 300^\circ$ . The vapor density at temperatures where there is no dissociation is in agreement with the formula  $\text{CrCl}_3$ . Anhydrous chromium(III) chloride remains in contact with cold water for some time without dissolving or reacting. This is possibly due to the fact that the

\* The temperatures are determined with a thermocouple such as Chromel-Constantan calibrated at three temperatures: the boiling point of water and the melting points of lead and antimony.

solid is not wetted by water. Hydration is catalyzed by substances that either react with the anhydrous compound or alter the surface tension at the salt-water interface. The solid slowly dissolves on the addition of chromium(II) chloride. The anhydrous chloride reacts with anhydrous ammonia, forming chloropentamminechromium(III) chloride together with some hexamminechromium(III) chloride.

## References

1. MELLOR: "A Comprehensive Treatise on Inorganic and Theoretical Chemistry," Vol. 11, p. 371, Longmans, Green and Company, New York, 1931.
2. HENDERSON and FERNELIUS: "A Course in Inorganic Preparations," p. 68, McGraw-Hill Book Company, Inc., New York, 1935.
3. UFER: *Ann.*, **228**, 112 (1885).
4. HALL: *J. Am. Chem. Soc.*, **26**, 1244 (1904).
5. DEMARCAV: *Compt. rend.*, **104**, 112 (1887).
6. COMBAULIVES: *ibid.*, **150**, 175 (1910).

### 60. TRIS(ETHYLENEDIAMINE)CHROMIUM(III) SALTS



SUBMITTED BY CARL L. ROLLINSON\*† AND JOHN C. BALLAR, JR.\*

CHECKED BY LAURENCE S. FOSTER‡§ AND GABRIEL GEVER‡

The chromium(III) amines closely resemble the corresponding cobalt(III) complexes in many respects. For example, analogous compounds in the two series are usually isomorphous and of similar color. While the preparative methods used for cobalt(III) amines can sometimes be employed for the preparation of the corresponding chromium(III) amines, other methods are usually preferred. Thus a mixture of a chromium(II) salt and ethylenediamine absorbs atmospheric oxygen even more readily than does a mixture of a cobalt(II) salt and the base. The procedure for preparing tris(ethylenediamine)chromium(III)

\* University of Illinois, Urbana, Ill.

† Present address: Central Research Department, Monsanto Chemical Company, Dayton, Ohio.

‡ Brown University, Providence, R.I.

§ Present address: Watertown Arsenal, Watertown, Mass.

salts<sup>1</sup> based on this reaction is rather tedious. Consequently, methods beginning with readily available chromium(III) salts are commonly employed.

Molecules that coordinate strongly can often displace others from the coordination sphere. Ethylenediamine does not readily replace water from the hydrated chromium(III) ion, but it does readily displace pyridine. Pfeiffer has described the preparation of tris(ethylenediamine)chromium(III) chloride from trichlorotripyridinechromium<sup>2</sup> and the corresponding sulfate from dehydrated chrome alum.<sup>3</sup>

The method outlined here<sup>4</sup> is similar to the latter but obviates the separation of potassium sulfate from the product. The new methods described below for obtaining various tris(ethylenediamine)chromium(III) salts with anhydrous chromium(III) sulfate as the starting material can be used also for preparing the corresponding propylenediamine derivatives.<sup>4</sup>

## Procedure

### A. ANHYDROUS CHROMIUM(III) SULFATE

Hydrated chromium(III) sulfate is dehydrated by heating for several days in an oven at 100 to 110°. The material, originally lumpy, can be ground to a powder after the first 2 or 3 days and then returned to the oven for further drying. Dehydration is complete when the powder fails to dissolve in water.

### B. ANHYDROUS ETHYLENEDIAMINE

Aqueous ethylenediamine is dehydrated by a modification of the method of Putnam and Kobe.<sup>5</sup> Five hundred grams of solid sodium hydroxide and 875 ml. of commercial (70 per cent) ethylenediamine are digested on the steam bath overnight.\* The hot liquid separates into two layers,

\* It is necessary to cover all corks with tin foil or aluminum foil in this procedure, as ethylenediamine vapor attacks cork readily. Ethylenediamine also attacks rubber.

the upper of which is decanted, digested with a new portion of sodium hydroxide (150 g.) for several hours, decanted again, and distilled. The boiling point is 116 to 117° at 760 mm. Yield almost quantitative.\* This method may also be used to dehydrate propylenediamine.

**C. TRIS(ETHYLENEDIAMINE)CHROMIUM(III) SULFATE,**

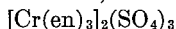

Forty-nine grams (0.125 mol) of anhydrous chromium(III) sulfate and 50 ml. (0.75 mol) of dehydrated ethylenediamine are heated on the steam bath in a 300-ml. Erlenmeyer flask fitted with an air condenser; the stopper is covered with tin foil. Within an hour (often much less), the sulfate begins to lose its bright-green color and powdery character. If this does not happen within a few hours, a drop of water may be added to accelerate the reaction. From this point on, the flask must be shaken at intervals to keep the unchanged sulfate exposed to the amine. Finally, a brown mass is formed, and no excess liquid is present. The flask is left on the steam bath overnight. The orange-yellow mass is broken up with a spatula and ground to a powder, which is washed with alcohol and allowed to dry in air. Yield 89 g. [95 per cent based on  $\text{Cr}_2(\text{SO}_4)_3$ ].

**D. TRIS(ETHYLENEDIAMINE)CHROMIUM(III) CHLORIDE,  
HYDRATE,  $[\text{Cr}(\text{en})_3]\text{Cl}_3 \cdot 3\frac{1}{2}\text{H}_2\text{O}$**

Thirty-two grams (0.043 mol) of the tris(ethylenediamine) sulfate is dissolved in a mixture of 30 ml. of water and 5 ml. of concentrated hydrochloric acid at 60 to 65°. The hydrochloric acid is necessary to prevent the formation of a red product, evidently formed by reaction of the

\* If the ethylenediamine is too dry, it reacts very slowly with the anhydrous chromium(III) salt. The full procedure described by Putnam and Kobe should not, therefore, be used in this synthesis. Their procedure involves refluxing the material decanted from the sodium hydroxide with 40 g. of metallic sodium before distilling. The yield is cut to about 75 per cent by this process.



sulfate with warm water, which not only decreases the yield but makes filtration very slow. The solution is filtered rapidly in a Büchner funnel. Twenty-seven milliliters of concentrated hydrochloric acid mixed with 42 ml. of alcohol is added to the filtrate, which is cooled in ice and stirred. The chloride separates in yellow crystals. Yield 20 g. of crude material (60 per cent based on the sulfate).

The product prepared in this way is contaminated with sulfate and may be purified by recrystallization from water. A solution of 20 g. of the crude product dissolved in 20 ml. of water at 65° yields on cooling, 12 g. of pure product (60 per cent based on crude chloride or 36 per cent based on the sulfate).

**E. TRIS(ETHYLENEDIAMINE)CHROMIUM(III) HALIDES,**  
 $[\text{Cr}(\text{en})_3]\text{X}_3$  (X = Br, I, or SCN)

The bromide, iodide, and thiocyanate can be prepared from the chloride by adding a 100 per cent excess of the solid sodium or ammonium salt of the desired anion to 30 g. of the tris(ethylenediamine) chloride in 100 ml. of warm water. The solution is stirred rapidly and cooled in ice. In each case, crystallization starts as soon as the salt is added. The salt is filtered by suction. The crude salt is recrystallized from water at 65°. After the solution has cooled, the crystals are filtered by suction, washed with alcohol and ether, and air-dried. Typical experimental yields are given in the following table:

Desired salt $[\text{Cr}(\text{en})_3]\text{X}_3 \cdot y\text{H}_2\text{O}$ where X and y are	$\text{NH}_4\text{X}$ or $\text{NaX}$ required for 0.075 mol chloride, 100 per cent excess, g.	Grams of crude product and percentage yield based on $[\text{Cr}(\text{en})_3]\text{Cl}_3 \cdot 3\frac{1}{2}\text{H}_2\text{O}$	$\text{H}_2\text{O}$ for recrystal- lization, ml.	Grams of pure product and percentage yield based on crude salt
$\text{Br}^- \cdot 4\text{H}_2\text{O}$	44-46	40 g., 98 %	75	31 g., 78 %
$\text{I}^- \cdot \text{H}_2\text{O}$	65-68	45 g., 96 %	250	32 g., 71 %
$\text{SCN}^- \cdot \text{H}_2\text{O}$	34-36	30 g., 94 %	100	23 g., 77 %

### Properties

The tris(ethylenediamine)chromium(III) salts (luteo chromic salts) are all markedly crystalline, orange-yellow substances. While the sulfate is extremely soluble and the chloride highly soluble in water, the bromide, iodide, and thiocyanate are relatively insoluble. All of these salts are slowly decomposed in cold water and rapidly in hot water, forming deep-red gummy materials, which are evidently hydroxoamminechromium compounds. The dry salts are slowly decomposed by exposure to light. The dry chloride and thiocyanate are decomposed readily by heat to bis(ethylenediamine) salts (synthesis 61).

### References

1. BALTHIS and BAILAR: *J. Am. Chem. Soc.*, **58**, 1474 (1936).
2. PFEIFFER: *Z. anorg. Chem.*, **24**, 286 (1900).
3. PFEIFFER: *Ber.*, **37**, 4277 (1904).
4. ROLLINSON and BAILAR: *J. Am. Chem. Soc.*, **65**, 250 (1943).
5. PUTNAM and KOBE: *Trans. Am. Electrochem. Soc.*, **74**, 609 (1934).

### 61. CIS-DICHLOROBIS(ETHYLENEDIAMINE)- CHROMIUM(III) CHLORIDE AND TRANS-BIS- (THIOCYANATO)BIS(ETHYLENEDIAMINE)- CHROMIUM(III) THIOCYANATE

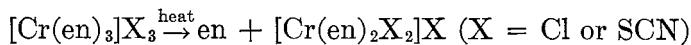

SUBMITTED BY CARL L. ROLLINSON\*† AND JOHN C. BAILAR, JR.\*

CHECKED BY JAMES P. McREYNOLDS‡

The tris(ethylenediamine)chromium(III) salts are much less stable than their cobalt analogs, and lose one molecule of ethylenediamine readily. The temperature of decomposition depends upon the nature of the anion, part of which enters the complex cation during the thermal decomposition. The reaction has been studied in detail for the

\* University of Illinois, Urbana, Ill.

† Present address: Central Research Department, Monsanto Chemical Company, Dayton, Ohio.

‡ The Ohio State University, Columbus, Ohio; deceased.

chloride and thiocyanate<sup>1</sup> and constitutes the best method of preparing the corresponding diacido salts. The reaction is catalyzed, in each case, by the presence of the ammonium salt of the anion in question. As Pfeiffer and coworkers<sup>2</sup> have shown, decomposition of the tris(ethylenediamine) chloride gives the *cis*-dichloro salt, while decomposition of the thiocyanate gives the *trans*-bis(thiocyanato) salt.

### Procedure

#### A. CIS-DICHLOROBIS(ETHYLENEDIAMINE)CHROMIUM(III) CHLORIDE

The salt  $[\text{Cr}(\text{en})_3]\text{Cl}_3 \cdot 3\frac{1}{2}\text{H}_2\text{O}$  (synthesis 60) is recrystallized from a 1 per cent aqueous solution of ammonium chloride.\* After the salt has been dried, it is spread in a thin layer on a large watch glass and is heated to 210°. Careful control of the temperature is essential; above 215°, more extensive decomposition occurs, while, below 200°, the reaction is very slow. In a few minutes the evolution of ethylenediamine starts, and the salt begins to darken. After an hour or two, it is red-violet. The course of the decomposition is followed by the loss in weight. Complete change to the dichloro salt corresponds to a 30.6 per cent loss. Decomposition beyond 85 per cent of this value is very slow, however, and is hardly practicable.

The product is not entirely pure, but for many purposes (including resolution into the optical antipodes) it may be sufficiently purified simply by washing with ice-cold concentrated hydrochloric acid. If desired, it may be recrystallized as follows:<sup>3</sup> The salt is quickly dissolved in water (4 ml. for each gram of salt) that has been warmed to 70°, and the filtered solution is cooled in an ice-salt mixture.

\* If the tris(ethylenediamine) salt is prepared for this purpose, ammonium chloride can simply be added to the liquid used in its recrystallization (see p. 199). Instead of this crystallization, the salt may be intimately ground with about 2 per cent of its own weight of ammonium chloride, but the results are not as good, as the decomposition is much slower.

One milliliter of ice-cold concentrated hydrochloric acid is added for each gram of salt used. The red-violet needles are filtered with suction and washed with alcohol and ether. Yield 0.45 g. (60 per cent) for each gram of starting material. *Anal.* Calcd. for  $[\text{Cr}(\text{en})_2\text{Cl}_2]\text{Cl}\cdot\text{H}_2\text{O}$ : Cr, 17.5. Found: Cr, 17.6.

**B. TRANS-BIS(THIOCYANATO)BIS(ETHYLENEDIAMINE)  
CHROMIUM(III) THIOCYANATE**

In the above manner, *trans*- $[\text{Cr}(\text{en})_2(\text{SCN})_2](\text{SCN})$  is obtained from  $[\text{Cr}(\text{en})_3](\text{SCN})_3\cdot\text{H}_2\text{O}$ . The tris(ethylenediamine) salt is prepared from the chloride and ammonium thiocyanate and is used without recrystallization. It is heated to 130° (not above 134°). The theoretical loss in weight is 18.40 per cent. The product is quickly recrystallized from warm water. Yield 0.45 to 0.55 g. (60–65 per cent) for each gram of starting material. *Anal.* Calcd. for  $[\text{Cr}(\text{en})_2(\text{SCN})_2](\text{SCN})\cdot\text{H}_2\text{O}$ : Cr, 14.3. Found: Cr, 14.4.

**Properties**

The dichloro salt is reddish violet and the bis(thiocyanato), orange. These salts are useful as starting materials in the preparation of other compounds of the two series. Both are quite soluble in water and are readily aquated to oily products.

**References**

1. ROLLINSON and BAILAR: *J. Am. Chem. Soc.*, **66**, 641 (1944).
2. PFEIFFER: *Z. anorg. Chem.* **24**, 294 (1900); **29**, 113 (1901).  
PFEIFFER, KOCH, LANDO, and TRIESCHMANN: *Ber.*, **37**, 4269, 4277 (1904).
3. FERGUSON: thesis, University of Illinois, 1934.

## 62. POTASSIUM HEXACYANOCHROMATE(III)

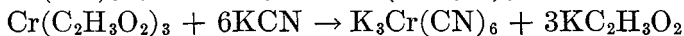
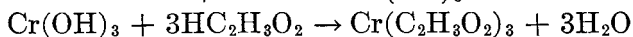
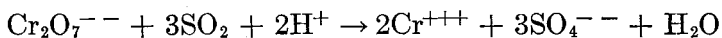

SUBMITTED BY JOHN H. BIGELÓW\*

CHECKED BY JOHN C. BAILLAR, JR. †

Cruser and Miller<sup>1</sup> have described a method for the preparation of potassium hexacyanochromate(III) whereby chromium(VI) oxide is dissolved in hydrochloric acid, reduced with alcohol, evaporated to dryness, taken up with water, and poured into a hot solution of potassium cyanide. The resulting solution is digested several hours, filtered, and allowed to evaporate in air. The following method is a modification of that given by Christensen.<sup>2</sup> It differs from that of Cruser and Miller in that a dichromate is reduced with sulfur dioxide and that chromium(III) acetate instead of chromium(III) chloride is poured into potassium cyanide solution. In following the directions outlined here, special care should be exercised to obtain pure chromium(III) acetate and to avoid decomposition of the relatively unstable potassium hexacyanochromate(III).

### Procedure

Twenty-five grams of potassium dichromate is dissolved in approximately 500 ml. of water and reduced by passing sulfur dioxide into the solution, which is then boiled to remove the excess sulfur dioxide. The boiling solution is stirred vigorously while chromium(III) hydroxide is precipitated by slow addition of aqueous ammonia. ‡ A piece

\* The Ohio State University, Columbus, Ohio; present address: Patterson Screen Department, E. I. duPont de Nemours and Company, Towanda, Pa.

† University of Illinois, Urbana, Ill.

‡ Care should be taken to have only a slight excess of ammonia present because of the tendency of chromium to form soluble complex ammine compounds. Vigorous boiling of the solution until only a faint odor of ammonia is perceptible will prevent this.

of carborundum may be added to prevent bumping. The gray-green chromium(III) hydroxide is filtered with suction and washed with hot water. It is transferred to a casserole while still damp to prevent loss of water and conversion to insoluble chromium(III) oxide and is dissolved in about 100 ml. of glacial acetic acid. The solution is evaporated almost to dryness (**Caution:** *Do not permit the evaporation to go too far*) and taken up with 180 ml. of water. It is then poured into a flask containing a boiling solution of 75 g. of potassium cyanide in 300 ml. of water. The solution is filtered, evaporated to about 300 ml., filtered again while still hot, and cooled. Potassium hexacyanochromate(III) is deposited as pale-yellow needles. The process of evaporation, filtration, and cooling may be repeated two or three times with the mother liquor.

For purification, the crude crystals may be recrystallized from water. Two or three recrystallizations are necessary to obtain a pure product. Alternatively, the salt may be purified by dissolving in warm water and adding 3 or 4 volumes of alcohol. The material obtained in this way is not quite as pure or as definitely crystalline as that obtained from water alone.

Heat and prolonged exposure to light bring about decomposition of the compound, whence chromium(III) hydroxide precipitates from the solution. Yield 36 g. (65 per cent).

### Analysis

Cyanide is determined by a modified Kjeldahl method. A suitable sample is distilled with 125 ml. of 3 *N* sulfuric acid; 100 ml. of the distillate is caught in a solution of 0.1 *N* sodium hydroxide, which is then titrated with standard silver nitrate solution. Potassium and chromium are determined on the same sample. The sample is decomposed with aqua regia, evaporated to dryness, and taken up with water, and chromium(III) hydroxide is precipitated by addition of ammonia. The filtrate is evaporated with sul-

furic acid and potassium determined as the sulfate. Chromium(III) hydroxide is oxidized with sodium peroxide, and the solution is boiled to remove excess oxygen, made acid, and titrated with a standard iron(II) salt solution using potassium hexacyanoferrate(III) as an outside indicator. *Anal.* Calcd. for  $K_3[Cr(CN)_6]$ : K, 36.0; Cr, 16.0; CN, 48.0. Found: K, 37.4; Cr, 15.5; CN, 46.8.

### Properties

Potassium hexacyanochromate(III) forms light-yellow monoclinic crystals. The crystals are soluble in water, fairly soluble in liquid ammonia, and insoluble in alcohol. Although the compound is stable in the solid form if kept away from the light, it hydrolyzes slowly in aqueous solution to precipitate chromium(III) hydroxide. This decomposition is aided by heat and light. Mineral acids decompose the salt readily. The dry salt begins to decompose at 159° and, on ignition at red heat, becomes black and melts, yielding a green residue of chromium(III) oxide. The crystals decrepitate when strongly heated.

### References

1. CRUSER and MILLER: *J. Am. Chem. Soc.*, **28**, 1132 (1906).
2. CHRISTENSEN: *J. prakt. Chem.*, [2] **31**, 163 (1885).

## 63. CHROMYL CHLORIDE

### [Chromium(VI) Dioxychloride]

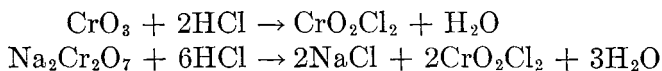

SUBMITTED BY HARRY H. SISLER\*

CHECKED BY LOUIS E. MARCHI†

Among the more common methods used for the preparation of chromyl chloride are the distillation of a mixture of concentrated sulfuric acid with the solid formed by melting

\* University of Kansas, Lawrence, Kans.

† Indiana University, Bloomington, Indiana; present address, University of Pittsburgh, Pittsburgh, Pa.

together sodium chloride and an alkali metal chromate or dichromate;<sup>1</sup> the reaction of chromium(VI) oxide with an acid chloride such as phosphorus pentachloride or chlorosulfonic acid;<sup>2,3</sup> and the reaction of chromium(VI) oxide with concentrated hydrochloric acid in the presence of a strong dehydrating agent such as concentrated sulfuric acid.<sup>4</sup> An equivalent quantity of a soluble chromate or dichromate may be substituted in the last procedure. In either case, the third method is convenient and leads to good yields of chromyl chloride.

### Procedure

A solution of 150 g. of chromium(VI) oxide (c.p.) in 100 ml. of water is placed in a 1500-ml. three-necked flask fitted with a dropping funnel, a mechanical stirrer, a thermometer, and a tube to carry away the vapors of chromyl chloride and hydrochloric acid.\* Three hundred thirty milliliters of concentrated hydrochloric acid is added, and the solution is cooled to 0° by an ice-salt mixture. While the solution is stirred, 450 ml. of concentrated sulfuric acid is added drop by drop from the dropping funnel. Ice is added to the cooling bath as needed, and the rate of addition of the sulfuric acid is regulated so that the temperature of the reaction mixture does not rise above 15 to 20°. When all the sulfuric acid has been added, the reaction mixture is transferred to a separatory funnel. After the two liquid layers have separated, the lower layer of chromyl chloride is drawn off into a glass-stoppered container.† Yield 189 g. (81 per cent).‡

\* A mechanical stirrer of the type described on p. 33 of "Organic Syntheses," Collective Vol. 1, 2d ed., John Wiley & Sons, Inc., New York, 1941, is especially suitable. The reaction should be carried out in a hood since the fumes are offensive and poisonous.

† The upper layer may be disposed of safely by pouring it slowly into 1500 ml. of water, in a 2-l. beaker, which is stirred continuously during the operation.

‡ When the synthesis was checked, a yield of 90 per cent was obtained. The higher yield is believed to be due to the fact that the temperature was kept below 10°.



The product is distilled through an 18-in. Vigreux column. The fraction boiling between 115 and 116° at 735 mm. amounts to 65 per cent of the crude product. Since chromyl chloride reacts with stopcock grease and has a tendency to cause glass joints to stick, ground-glass apparatus is not recommended for this distillation.

If chromium(VI) oxide is not available, a saturated solution of an equivalent quantity of sodium dichromate is used. In this case, crystallization of white solids (presumably sodium sulfate and chloride) takes place during the reaction. These solids are removed before separation of the chromyl chloride by filtering the reaction mixture through sintered glass or glass wool.

If chromyl chloride is to be kept for any length of time, traces of hydrochloric acid should be removed by bubbling dry air through the liquid. The liquid should be carefully distilled, sealed in glass tubes, and stored in the dark. Even then it sometimes slowly decomposes, with the formation of solids. The boiling range of the remaining liquid, however, indicates that it is still fairly pure chromyl chloride.

### Properties

Chromyl chloride is a dark-red liquid of density 1.92, boiling point 117° (760 mm.), and freezing point -96.5°. In odor and appearance in the liquid and vapor states it resembles bromine. It hydrolyzes vigorously and fumes in moist air. Chromyl chloride reacts vigorously with ammonia in the vapor or liquid state. It has extremely strong oxidizing properties, inflaming many organic compounds. Its solution in carbon tetrachloride is fairly stable.

### References

1. ETARD: *Ann. chim. phys.*, [5] **22**, 218 (1881).
2. FRY: *J. Am. Chem. Soc.*, **33**, 697 (1911).
3. LIEBKNECHT: German patent 524559 (1926); *Chem. Abstracts*, **25**, 4367 (1931).
4. LOW and PERKINS: *J. Chem. Soc.*, **91**, 191 (1907).

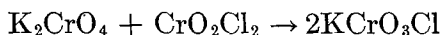
**64. POTASSIUM MONOCHLOROCHROMATE**

SUBMITTED BY HARRY H. SISLER\*

CHECKED BY LOUIS E. MARCHI†

The methods for the preparation of potassium monochlorochromate include the action of hydrochloric acid on potassium dichromate in aqueous solution,<sup>1</sup> the reaction of potassium chloride with chromium(VI) oxide in aqueous solution<sup>1</sup> and the action of chromyl chloride on potassium chromate dissolved in water or glacial acetic acid.<sup>2,3</sup> The last method is to be preferred, since it gives a good yield of the monochlorochromate of a fair degree of purity. With the first or second method, the product often contains some greenish impurities. These impurities are probably produced by reduction of some of the chromate by hydrochloric acid.

**Procedure**

A solution of 75 g. of potassium chromate in 125 ml. of hot water is placed in a three-necked flask fitted with a mechanical stirrer, thermometer, dropping funnel, and a tube to carry away irritating vapors. While the solution is kept warm with a Bunsen flame, 86 g. of chromyl chloride‡ is added drop by drop while the reaction mixture is stirred. The rate of addition and the height of the Bunsen flame are regulated so as to keep the temperature between 90 and 100°. Stirring is continued at this temperature for one hour. The solution is then placed in a covered beaker to crystallize. After 18 hours, the red-orange crystals formed are filtered with suction; they should be pressed

\* University of Kansas, Lawrence, Kans.

† Indiana University, Bloomington, Ind.; present address, University of Pittsburgh, Pittsburgh, Pa.

‡ For complete conversion of the chromate, a moderate excess of chromyl chloride is required. Some of the acid chloride is lost owing to vaporization, and some hydrolyzes.

down firmly, and as much of the mother liquor as possible should be drawn off. The product is then placed on a porous plate, covered with a watch glass, and left 10 hours. Yield 109 g. (81 per cent based on potassium chromate). *Anal.* Calcd. for  $\text{KCrO}_3\text{Cl}:\text{Cl}$ , 20.3. Found: Cl, 20.2, 20.2.

The mother liquor is cooled to  $0^\circ$  in an ice-salt mixture and allowed to stand 90 minutes. The crystals that form are removed and dried as above. This second fraction weighs about 16 g.\* but is less pure than the first. *Anal.* Found: Cl, 19.2, 19.4.

Impure fractions may be purified by precipitation from acetone. Potassium monochlorochromate (30 g.) is dissolved in 100 ml. of acetone.† The solution is filtered, and to the filtrate is slowly added 700 to 800 ml. of carbon tetrachloride while the reaction mixture is stirred. Yield 16.6 per cent (55.3 per cent based on crude product).

### Properties

Potassium monochlorochromate forms reddish-orange monoclinic crystals without water of hydration. It decomposes when heated mildly and is quickly hydrolyzed when dissolved in water. It reacts vigorously with liquid ammonia. If treated with concentrated hydrochloric acid, it forms some chromyl chloride and also undergoes some reduction.

### References

1. PELIGOT: *Ann. chim. phys.*, [2] **52**, 267 (1833).
2. GEUTHER: *Ann.*, **106**, 239 (1858).
3. PRAETORIUS: *ibid.*, **201**, 1 (1880).

\* The yield varies considerably with the temperature. When the synthesis was checked, the yield of crude product was 70 per cent at  $32^\circ$ . However, the second crop amounted to 30 g. instead of 16 g.

† The acetone solution of the chlorochromate should not be allowed to stand very long before reprecipitation, since the chlorochromate reacts slowly with acetone.

## CHAPTER VII

See also: Copper(I) chloride, synthesis 1	Phosphonium iodide, synthesis 41
Silver chlorate, synthesis 2	Phosphorus(III) halogenides, syntheses 42, 43
Recovery of iodine from silver iodide residues, synthesis 3	Phosphorus(V) oxybromide, synthesis 44
Barium and rare earth bromates, syntheses 6 and 7	Phosphorus(V) sulfobromide, synthesis 45
Ammonium tetrafluoroborate, synthesis 8	Ammonium mono- and difluorophosphates, syntheses 46 and 47
Gallium(III) perchlorate, synthesis 10	Hexahalogenotellurates(IV), synthesis 57
Europium(II) chloride, synthesis 19C	Chromium(III) chloride, synthesis 59
Cyanogen chloride, synthesis 25	Chromyl chloride, synthesis 63
Disilicon hexabromide, synthesis 27	Potassium monochlorochromate, synthesis 64
Germanium halogenides, syntheses 29, 30, 31	Potassium tetrachloroplatinate(II), synthesis 79
Titanium bromides, syntheses 32, 33	Tetrammineplatinum(II) chloride, synthesis 80
	Platinum(IV) chloride, synthesis 81

### 65. HYDRIODIC ACID\*

#### REGENERATION OF OXIDIZED SOLUTIONS

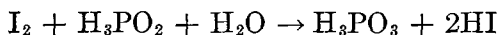

SUBMITTED BY L. S. FOSTER† AND H. G. NAHAS, JR.‡

CHECKED BY EDGAR E. LINEKEN§

Concentrated hydriodic acid that has been stored for some time is usually opaque, owing to oxidation.

\* For syntheses of hydriodic acid see *INORGANIC SYNTHESIS*, 1, 156 (1939).

† Brown University, Providence, R.I.; present address: Watertown Arsenal, Watertown, Mass.

‡ Pawtucket, R.I.

§ University of Vermont, Burlington, Vt.

Because of the stability of the complex acid,  $\text{HI}_3$ , iodine is very soluble in the hydriodic acid solution and cannot be extracted by the usual solvents, such as carbon disulfide. Treatment with hydrogen sulfide at room temperature reduces the iodine to hydriodic acid; but the reaction is slow, and after several hours a yellow coloration persists. Furthermore, the liberated sulfur must be coagulated and removed by filtration prior to distillation of the product.

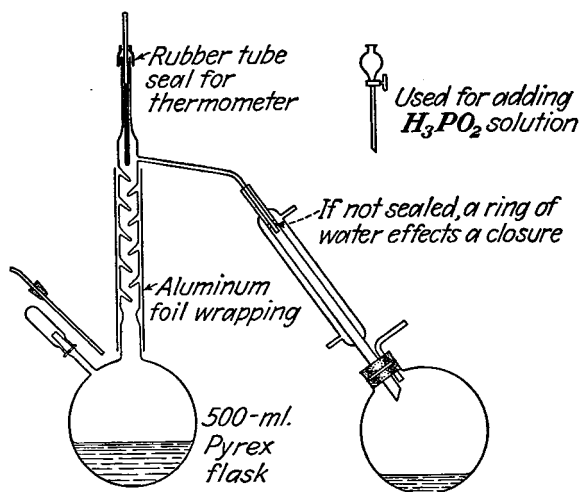

FIG. 23.—Apparatus for the distillation of hydriodic acid. The auxiliary tube shown at the left is for introducing an inert atmosphere.

Distilling the acid in the presence of red phosphorus is rapid and satisfactory except for the foaming induced by the presence of the insoluble powdered reactant. Treatment with hypophosphorous acid<sup>1</sup> is preferable.

### Procedure

The hydriodic acid sample is placed in an all-glass distillation apparatus (Fig. 23) equipped with a fractionating column. The apparatus is filled with an inert atmosphere (nitrogen, hydrogen, or carbon dioxide). Then the solution is heated nearly to boiling and treated dropwise with 50 per cent hypophosphorous acid until the red

color has disappeared. Only a few milliliters is required, depending upon the condition of the sample. The reduction is practically instantaneous. The rate of heating is increased, and colorless, constant-boiling hydriodic acid (sp. gr. 1.7, 57 per cent HI) is collected. For 500 g. of hydriodic acid solution, the entire purification may be performed in less than  $\frac{1}{2}$  hour.

#### Reference

1. HEISIG and FRYKHOLM: INORGANIC SYNTHESSES, 1, 159 (1939).

### 66. TRISODIUM ORTHOPERIODATE (SODIUM PARAPERIODATE)

#### SODIUM IODIDE-BROMINE METHOD



SUBMITTED BY PETER M. BERNAYS\*

CHECKED BY JOHN C. BALLAR, JR.,† AND EARL L. HUMPHREY†

Although most references<sup>1</sup> give iodate as the starting material for the production of periodates, it is possible to make the compound in one step from an iodide. Either bromine or chlorine can be used for the oxidation. This procedure is based on the method of Lange and Paris.<sup>2</sup>

#### Procedure

Fifty grams of sodium iodide and 264 g. of sodium hydroxide are dissolved in 2 l. of water in a 4-l. beaker equipped with a mechanical stirrer. The solution is heated to 80°, stirring is begun, and 80 ml. of pure bromine is slowly added (2 ml./minute) from a dropping funnel, the stem of which dips beneath the surface of the liquid. The temperature should be kept as near 80° as possible.

After  $\frac{1}{2}$  to  $\frac{3}{4}$  hour, a large amount of precipitate suddenly forms. The reaction is not complete, and the remaining bromine is added as described. If bumping occurs, the liquid is decanted from the solids and reheated

\* Massachusetts Institute of Technology, Cambridge, Mass.

† University of Illinois, Urbana, Ill.

**POTASSIUM HEXACYANOMANGANATE(III) 213**

and the remaining bromine added. Finally, the material is filtered through a fritted-glass filter, with suction. The solid is washed four times with 25-ml. portions of distilled water. Each portion of wash water is allowed to remain in contact with the solid for 15 minutes before applying suction. The last wash should show no more than traces of bromide or iodate. The crystalline mass is dried in the air. Yield 85 to 90 g. (93 to 98 per cent).

**References**

1. WILLARD: *INORGANIC SYNTHESSES*, **1**, 168 (1939).
2. LANGE and PARIS: *J. pharm. chim.*, **21**, 403 (1935).

**67. POTASSIUM HEXACYANOMANGANATE(III)**

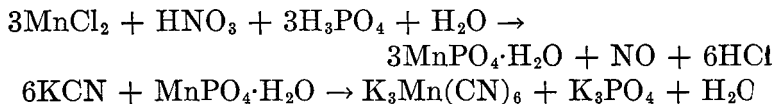

SUBMITTED BY JOHN A. LOWER\* AND W. CONARD FERNELIUS\*†  
CHECKED BY THERALD MOELLER‡ AND VIRGIL O. BRECHT‡

Potassium hexacyanomanganate(III) may be prepared by the oxidation of potassium hexacyanomanganate(II).<sup>1,5</sup> However, the latter is an unstable compound and one difficult to prepare in quantity. Potassium hexacyanomanganate(III) may be prepared more readily in pure form by the direct reaction of potassium cyanide with manganese(III) orthophosphate.

**Procedure**

**Manganese(III) Orthophosphate.**<sup>2,3</sup> To a warm solution of 34.2 g. of manganese(II) chloride,  $\text{MnCl}_2 \cdot 4\text{H}_2\text{O}$ , or an equivalent amount of the nitrate or acetate, in 50 ml. of water, is added 30 g. of sirupy phosphoric acid and 10 g. of concentrated nitric acid. On concentrating to near dryness, this mixture first turns an amethyst color and gradually deposits a green-gray precipitate, which, if the mixture

\* The Ohio State University, Columbus, Ohio.

† Present address: Purdue University, West Lafayette, Ind.

‡ University of Illinois, Urbana, Ill.

is not well stirred or if it is evaporated too far, is apt to stick fast to the bottom of the beaker. After cooling, water (about 50 ml.) is added, and the precipitate is collected on a Büchner funnel, washed well with water and dried. Yield 15 to 23 g. (53 to 80 per cent).

**Potassium Hexacyanomanganate(III).**<sup>4</sup> Thirty grams of potassium cyanide is dissolved in 80 ml. of water and the solution heated to 80°. After removing the source of heat, 8 g. of manganese(III) orthophosphate is added slowly with continuous stirring. **Caution.** *If the solution is overheated at this point, manganese(III) oxide is precipitated, which must be removed by filtration before continuing the operations.* After a short time, the mixture becomes deep red, and all the phosphate dissolves. The solution is allowed to cool and is air-evaporated. If a crust forms and no more evaporation can take place, enough water (5 to 10 ml.) is added to dissolve the crust, leaving the red crystalline needles of potassium hexacyanomanganate(III). These are collected on a Büchner funnel and sucked dry. The filtrate can be air-evaporated again or treated with alcohol and a small additional crop of crystals collected. Yield 7.3 g. (94 per cent). For purification, the salt is recrystallized from water. *Anal.* Calcd. for  $K_3Mn(CN)_6$ : Mn, 16.7; N, 25.6. Found: Mn, 16.2; N, 24.7, 25.6.

### Properties

Potassium hexacyanomanganate(III) forms dark-red prisms. When boiled with water, this salt is decomposed and all the manganese is precipitated as hydrated manganese(III) oxide. When a solution of the hexacyanomanganate(III) is treated with potassium amalgam, it is reduced to the dark-blue hexacyanomanganate(II).

### References

1. EATON and FITTIG: *J. prakt. Chem.*, [2] **28**, 14 (1883).
2. CHRISTENSEN: *Danske Via. Selsk. Föch.*, **94**, (1896).
3. CHRISTENSEN: *J. prakt. Chem.*, [2] **28**, 7, 20 (1883).
4. *Ibid.*, [2] **31**, 167 (1885).
5. MEYER: *Z. anorg. Chem.*, **81**, 390 (1913).



## CHAPTER VIII

### 68. BETA IRON(III) OXIDE 1-HYDRATE

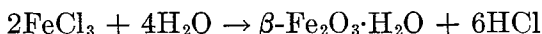

SUBMITTED BY HARRY B. WEISER,\* W. O. MILLIGAN,\* AND E. L. COOK\*  
CHECKED BY HAROLD S. BOOTH† AND ALBERT DOLANCE‡

The slow hydrolysis of iron(III) chloride solutions yields a yellow hydrous precipitate containing an amount of chloride that varies with the conditions of formation. The X-ray diffraction pattern of this yellow precipitate is distinct from the patterns of  $\alpha\text{-Fe}_2\text{O}_3\cdot\text{H}_2\text{O}$ ,  $\gamma\text{-Fe}_2\text{O}_3\cdot\text{H}_2\text{O}$ , and  $\text{FeOCl}$ .<sup>2,3</sup> The dehydration isobar for the yellow compound is characteristic of a hydrous 1-hydrate.<sup>2</sup> This form of iron(III) oxide has been designated as  $\beta\text{-Fe}_2\text{O}_3\cdot\text{H}_2\text{O}$  (or  $\beta\text{-FeOOH}$ )<sup>2</sup> in order to distinguish it from the alpha and gamma<sup>1</sup> 1-hydrates.

#### Procedure

Four liters of freshly prepared 0.1 *M* iron(III) chloride solution in an Erlenmeyer flask is heated slowly at such a rate that the temperature reaches 80° after 8 hours. This temperature is maintained for 2 hours, after which the resulting yellow precipitate is digested at room temperature for 24 hours. The supernatant liquid is removed and the precipitate washed with 3-l. portions of water by careful decantation. The precipitate is transferred to a glass jar of 12-l. capacity and washed eleven times with 12-l. portions of water, to which has been added the smallest amount of ammonia solution necessary to prevent peptization.‡

\* The Rice Institute, Houston, Tex.

† Western Reserve University, Cleveland, Ohio.

‡ If ammonia is added before the excess iron(III) chloride is removed, the ordinary reddish-brown hydrous iron(III) oxide will be precipitated. Peptization will cause such serious losses as to cut the yield to as little as one-tenth the usual amount.

The precipitate is finally washed with 12-l. portions of water, centrifuged, and dried at 110° in an electric oven. A yield of 35 g. of the hydrous  $\beta$ -1-hydrate is obtained from 100 g. of  $\text{FeCl}_3 \cdot 6\text{H}_2\text{O}$ . The process of settling in the later stages is very slow and much time may be saved by the use of a centrifuge.

### Analysis

The amount of chloride in the sample is determined by dissolving a weighed portion in warm, concentrated nitric acid. After evaporation to remove excess acid and dilution with water, the chloride is precipitated as silver chloride, dissolved in ammonia, reprecipitated with dilute nitric acid, and weighed in the usual manner. The iron(III) in the combined filtrates is determined by precipitating with ammonia and is weighed as  $\text{Fe}_2\text{O}_3$  according to the standard procedure. Typical analytical results give an Fe:Cl ratio of 40:1.

### References

1. BAUDISCH and HARTUNG: *INORGANIC SYNTHESSES*, **1**, 185 (1939).
2. WEISER and MILLIGAN: *J. Am. Chem. Soc.*, **57**, 238 (1935).
3. WEISER and MILLIGAN: *Chem. Revs.*, **25**, 1 (1939).

## 69. HEXAMMINECOBALT(III) SALTS\*

SUBMITTED BY JANNIK BJERRUM† AND JAMES P. McREYNOLDS‡  
CHECKED BY ALFRED L. OPPEGARD§ AND R. W. PARRY§

Hexamminecobalt(III) salts may be prepared by any of three methods that depend on oxidation of cobalt(II) ion

\* Procedures for preparing most of these salts were originally submitted by Dr. McReynolds, who was impressed by the simplicity of Dr. Bjerrum's method. Shortly after the manuscript for Vol. II had been sent to the publisher, similar procedures for three of these salts were submitted by Dr. Bjerrum. Inasmuch as the method was developed by Dr. Bjerrum and war conditions prevented his submitting the procedures at an earlier date, the editors have taken the liberty of combining the two sets of directions and presenting them as a joint effort of the two men.

† University of Copenhagen, Copenhagen, Denmark.

‡ The Ohio State University, Columbus, Ohio; deceased.

§ University of Illinois, Urbana, Ill.

in ammoniacal solution: (1) air oxidation, with formation of the pentammine ion, which is converted to the hexammine by heating with aqueous ammonia under pressure;<sup>1-3, 11</sup> (2) oxidation with an agent such as hydrogen peroxide,<sup>4</sup> iodine,<sup>5</sup> potassium permanganate,<sup>6</sup> lead dioxide,<sup>7</sup> or hypochlorite solutions;<sup>8</sup> (3) oxidation in the presence of a catalyst that allows equilibrium between the pentammine and hexammine ions to be established at room temperature and atmospheric pressure. These compounds may also be prepared indirectly from other hexamminecobalt(III) salts.<sup>9, 10</sup>

In the best of the catalytic methods diamminesilver ion<sup>12, 13</sup> or decolorizing charcoal<sup>14</sup> is used as a catalyst. The method devised by J. Bjerrum<sup>14</sup> in which decolorizing charcoal is the catalyst is simple, gives high yields of pure product, and is not time-consuming. A high concentration of ammonium salt is sufficient to stabilize the hexamminecobalt(III) ion, and the carbon serves only to establish the equilibrium. Air is used as oxidant except when the cobalt(II) compound is slightly soluble in the ammoniacal solution, as in the preparation of  $[\text{Co}(\text{NH}_3)_6]\text{Br}_3$ , for which hydrogen peroxide is preferable.

## Procedure

### A. HEXAMMINECOBALT(III) CHLORIDE

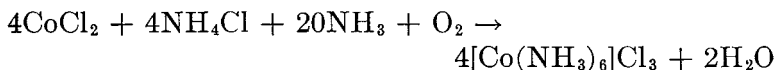

Two hundred and forty grams (1 mol) of cobalt(II) chloride 6-hydrate and 160 g. (3 mols) of ammonium chloride are added to 200 ml. of water. The mixture is shaken until most of the salts are dissolved. Then 4 g. of activated decolorizing charcoal\* and 500 ml. of concentrated ammonia are added. Air is bubbled vigorously

\* In order to obtain a rapid reaction, care must be exercised in the choice of this catalyst. Charcoal from the center of a package has been found to be much more effective than that from the top.

through the mixture until the red solution becomes yellowish brown (usually about 4 hr.).\* The air inlet tube is of fairly large bore (10 mm.) to prevent clogging with the precipitated hexamminecobalt(III) salt.

The crystals and carbon are filtered on a Büchner funnel and then added to a solution of 15 to 30 ml. of concentrated hydrochloric acid in 1500 ml. of water; sufficient acid should be used to give the entire mixture an acid reaction. The mixture is heated on a hot plate to effect complete solution and is filtered hot. The hexamminecobalt(III) chloride is precipitated by adding 400 ml. of concentrated hydrochloric acid and slowly cooling to 0°. The precipitate is filtered, washed first with 60 per cent and then with 95 per cent alcohol, and dried at 80 to 100°.† Yield 230 g. (85 per cent). *Anal.* Calcd. for  $[\text{Co}(\text{NH}_3)_6]\text{Cl}_3$ : Co, 22.0; Cl, 39.8;  $\text{NH}_3$ , 38.2. Found: Co, 22.0; Cl, 39.8;  $\text{NH}_3$ , 38.1.

#### B. HEXAMMINECOBALT(III) NITRATE

1.  $4\text{Co}(\text{NO}_3)_2 + 4\text{NH}_4\text{NO}_3 + 20\text{NH}_3 + \text{O}_2 \rightarrow 4[\text{Co}(\text{NH}_3)_6](\text{NO}_3)_3 + 2\text{H}_2\text{O}$
2.  $[\text{Co}(\text{NH}_3)_6]\text{Cl}_3 + 3\text{HNO}_3 \rightarrow [\text{Co}(\text{NH}_3)_6](\text{NO}_3)_3 + 3\text{HCl}$

**Method 1.** Seventy-three grams of cobalt nitrate 6-hydrate (0.25 mol) is dissolved in 100 ml. of water, and, in the order mentioned, 80 g. (1 mol) of ammonium nitrate, 2 g. of activated charcoal, and 180 ml. of concentrated ammonia (about 2.5 mols of  $\text{NH}_3$ ) are added. The solution is oxidized by air as specified in Procedure A. The salt is washed with a little ice-cold water and is dissolved on a steam bath in 1300 to 1500 ml. of water containing enough nitric acid to give the mixture an acid reaction. After

\* Care should be taken that the bubbling is not too vigorous, as this removes part of the ammonia from the solution. If this happens, the solution stays red instead of becoming yellow. Although more ammonia may be added, the yield will be decreased somewhat.

† When the salt is dried at a higher temperature, it sometimes turns green. The original color is restored by redissolving and reprecipitating with hydrochloric acid.

removal of the carbon by filtration, the solution is treated with 200 ml. of concentrated nitric acid and left to cool. The precipitated salt is washed with water and alcohol and dried at 100°. Yield 77 to 79 g. (88 to 90 per cent). *Anal.* Calcd. for  $[\text{Co}(\text{NH}_3)_6](\text{NO}_3)_3$ : Co, 17.0;  $\text{NH}_3$ , 29.4. Found: Co, 16.9;  $\text{NH}_3$ , 29.4.

**Method 2.** The precipitate from the oxidation of cobalt(II) chloride (Procedure A) is dissolved in 1500 ml. of water containing 15 to 30 ml. of concentrated nitric acid. The carbon is removed and the salt precipitated with 450 ml. of concentrated nitric acid. The crystals are washed with two 200-ml. portions of alcohol to remove excess acid and dried at 100°. Yield 103 g. (88 per cent). A solution of these crystals gives only a slight turbidity with silver nitrate.

### C. HEXAMMINECOBALT(III) BROMIDE

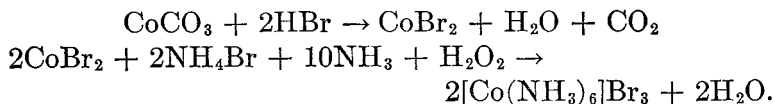

Twenty-four grams (0.20 mol) of cobalt carbonate\* is added slowly to 100 ml. of 45 per cent hydrobromic acid (0.80 mol). To the solution, 2 g. of activated charcoal and 120 ml. of concentrated ammonia (1.6 mols of  $\text{NH}_3$ ) are added. The precipitate of cobalt(II) salt that appears is disregarded, and 40 ml. of 30 per cent hydrogen peroxide (0.40 mol) is added slowly while the solution is stirred. When the vigorous effervescence has ceased, the main part of the cobalt(II) precipitate has been converted into the desired product. To complete the equilibrium adjustment, the mixture is heated for 5 min. on a steam bath and then left standing for  $\frac{1}{2}$  hr. The salt-carbon mixture is filtered, washed with a little cold water, and treated with 900 to 1000 ml. of water containing sufficient

\* A cobalt determination must be made on the cobalt carbonate used if an accurate check on the yield of the complex salt is desired.

hydrobromic acid to give a slight acid reaction. The mixture is heated on the steam bath until all the salt is dissolved. To the hot solution is added 50 ml. of 45 per cent hydrobromic acid, and the reaction mixture is slowly cooled to 0°. The product is filtered, washed with ice-cold water, washed with alcohol, and dried at 100°. Yield about 64 g. (80 per cent). *Anal.* Calcd. for  $[\text{Co}(\text{NH}_3)_6]\text{Br}_3$ : Co, 14.7; Br, 59.8;  $\text{NH}_3$ , 25.5. Found: Co, 14.7; Br, 59.9;  $\text{NH}_3$ , 25.3.

#### D. HEXAMMINECOBALT(III) OXALATE

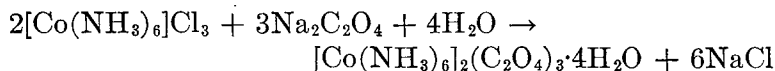

Hexamminecobalt(III) oxalate is prepared by adding a soluble oxalate to a solution of the chloride.<sup>15</sup> The salt dried at 96° contains four mols of water. This precipitation is a quantitative method for determining the amount of hexamminecobalt(III) ion in a mixture.

#### Properties

The hexamminecobalt(III) salts are obtained as reddish-brown crystals, orange-yellow when finely divided. The solubilities in water in mols per liter at 20° are: chloride, 0.26; nitrate, 0.052; sulfate, 0.020; oxalate (18°), 0.00069; bromide (18°), 0.04. In liquid ammonia at -80° the chloride forms a 6-ammoniate of the formula

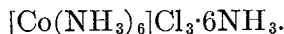

The oxalate is soluble in oxalic acid solution. A great many double salts are formed. A detailed discussion of the properties and formation of other salts appears in Gmelin.<sup>16</sup>

#### References

1. FREMY: *Ann. chim. phys.*, [3] **35**, 257 (1852).
2. JÖRGENSEN: *Z. anorg. Chem.*, **17**, 455 (1898).
3. LAMB and LARSON: *J. Am. Chem. Soc.*, **42**, 2025 (1920).
4. MORGAN and MAIN SMITH: *ibid.*, **121**, 1970 (1922).

## TRIS(ETHYLENEDIAMINE)COBALT(III) CHLORIDE 221

5. JÖRGENSEN: *J. prakt. Chem.*, [2] **23**, 229 (1881).
6. MILLS: *Phil. Mag.*; [4] **35**, 245 (1868).
7. BRAUN: *Ann.*, **142**, 52 (1867).
8. JACOBSEN: *Overs. Danske Scelsk. Forh.*, **1899**, 564.
9. Ref. 2, p. 457.
10. BILTZ: *Z. anorg. Chem.*, **83**, 178, (1914).
11. BILTZ and BILTZ: (trans. by Hall and Blanchard): "Laboratory Methods of Inorganic Chemistry," p. 175, John Wiley & Sons, Inc., New York, 1909.
12. Ref. 8, p. 575.
13. Ref. 10, p. 177.
14. BJERRUM: "Metal Ammine Formation in Aqueous Solution," p. 241, P. Haase and Son, Copenhagen, 1941.
15. SÖRENSEN: dissertation, p. 64, Copenhagen.
16. GMELIN: "Handbuch der anorganischen Chemie," No. 58 B (Kobaltammine), pp. 46-72, Verlag Chemie G.m.b.H., Berlin, 1930.

**70. TRIS(ETHYLENEDIAMINE)COBALT(III)  
CHLORIDE**

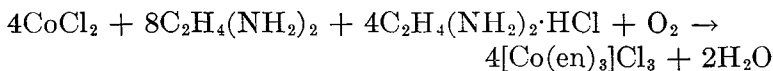

SUBMITTED BY J. B. WORK\*

CHECKED BY JAMES P. McREYNOLDS†

Ethylenediamine coordinates with metallic ions through both nitrogen atoms. The five-membered chelate rings that are thus formed are very stable. Many cobalt(III) amines are converted by aqueous ethylenediamine to tris(ethylenediamine)cobalt(III) chloride. Thus, Jørgensen<sup>1</sup> prepared the salt by heating  $[\text{Co}(\text{NH}_3)_5\text{Cl}]\text{Cl}_2$  with aqueous ethylenediamine. Grossman and Schück<sup>2</sup> obtained the salt by oxidizing a mixture of cobalt(II) chloride, ethylenediamine, and water. The method described below has been developed from the latter suggestion.

**Procedure**

Sixty-one grams of 30 per cent ethylenediamine is partly neutralized with 17 ml. of 6 N hydrochloric acid and the

\* University of Illinois, Urbana, Ill.

† The Ohio State University, Columbus, Ohio; deceased.

resulting mixture poured into a solution of 24 g. of cobalt chloride 6-hydrate in 75 ml. of water. The cobalt is oxidized by bubbling a vigorous stream of air through the solution for 3 hours. The solution is allowed to evaporate on a steam bath until a crust begins to form over the surface (the volume will be about 15 to 20 ml.); then 15 ml. of concentrated hydrochloric acid and 30 ml. of ethyl alcohol are added. After cooling, the crystals of tris(ethylenediamine)cobalt(III) chloride are filtered and washed with alcohol until the washings are colorless. They are then washed with ether or dried in an oven. Yield 31 g. (89 per cent).

### Properties

Tris(ethylenediamine)cobalt(III) chloride crystallizes in orange-yellow needles, which are readily soluble in water but insoluble in the usual organic solvents. Its solubility in 6 *N* hydrochloric acid is about 3 per cent. It is stable at temperatures as high as 200° and is decomposed only slowly by hydrogen sulfide and sodium hydroxide.

### References

1. JÖRGENSEN: *J. prakt. Chem.*, [2] **39**, 8 (1889).
2. GROSSMAN and SCHÜCK: *Ber.*, **39**, 1899 (1906).

## 71. CIS- AND TRANS-DICHLOROBIS-(ETHYLENEDIAMINE)COBALT(III) CHLORIDE AND THE RESOLUTION OF THE CIS FORM

SUBMITTED BY JOHN C. BAILAR, JR.\*

CHECKED BY CARL L. ROLLINSON†

Among the inorganic complex compounds that can be resolved into optically active forms, *cis*-dichlorobis(ethylenediamine)cobalt(III) chloride is one of the best known and easiest to prepare. It is often used in stereochemical

\* University of Illinois, Urbana, Ill.

† Grasselli Chemicals Department, E. I. duPont de Nemours & Company, Inc., Cleveland, Ohio; present address: Central Research Department, Monsanto Chemical Company, Dayton, Ohio.



studies and as an intermediate in the preparation of other cobalt complex salts. The best directions for the preparation of the *trans* salt are those given in the thesis of Vera Tupizina.<sup>1</sup> Jörgensen<sup>2</sup> has described the conversion of the *trans* modification to the *cis*; the latter may easily be resolved in the manner described by Bailar and Auten.<sup>3</sup>

### Procedure

#### A. PREPARATION OF THE *trans* FORM

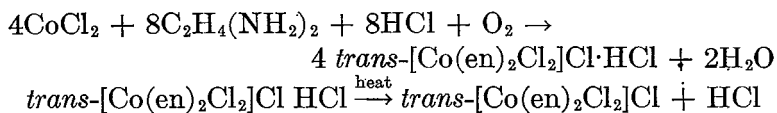

Six hundred grams of a 10 per cent solution of ethylenediamine is added, with stirring, to a solution of 160 g of cobalt chloride 6-hydrate in 500 ml. of water in a 2-l beaker or bottle. A vigorous stream of air is drawn or passed through the solution for 10 or 12 hours. (Longer aeration causes undesirable secondary reactions to take place.) Three hundred and fifty milliliters of concentrated hydrochloric acid is added, and the solution is evaporated on the steam bath until a crust forms over the surface (750 ml.) The solution is allowed to cool and stand overnight before the bright-green square plates of the hydrochloride of the *trans* form are filtered. These are washed with alcohol and ether and dried at 110°. At this temperature, the hydrogen chloride is lost, and the crystals crumble to a dull-green powder. Yield 83 g. (52 per cent based on the ethylenediamine).

#### B. CONVERSION TO THE *cis* FORM

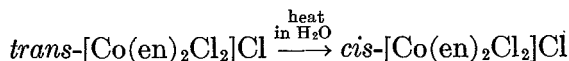

Conversion to the *cis* form is brought about by evaporating a neutral solution of the *trans* form to dryness on the steam bath. The unchanged *trans* form may be washed

out with a little cold water, or the transformation may be completed by repeating the evaporation. It should be repeated not more than two or three times, however, as some decomposition takes place. Yield 65 to 70 g.

### C. RESOLUTION OF THE *cis* FORM

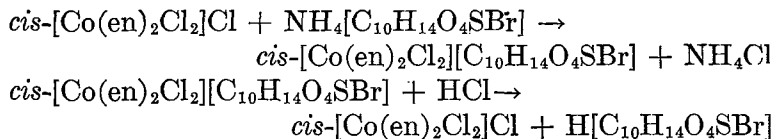

Forty grams of the finely powdered racemic *cis* form is dissolved *as quickly as possible* in 1120 ml. of water, previously cooled to 15 to 17°. The solution is quickly filtered, and 88 g. of solid ammonium *d*- $\alpha$ -bromocamphor- $\pi$ -sulfonate is added. The mixture is stirred for 30 minutes, while the temperature is maintained at 15 to 17°. The *l*-*cis*-dichlorobis(ethylenediamine)cobalt(III) *d*- $\alpha$ -bromocamphor- $\pi$ -sulfonate is filtered and washed with alcohol and then with ether. Yield 20 to 25 g.

This salt is ground, in an ice-cold mortar, with an ice-cold mixture of concentrated hydrochloric acid, alcohol, and ether (1:1:1); 75 ml. of the mixture is used for each 10 g. of salt. After several minutes, the *l*-*cis*-[Co(en)<sub>2</sub>Cl<sub>2</sub>]Cl is filtered and washed with alcohol and then with ether. The yield is 5 g.—nearly the theoretical value. The specific rotation (Na<sub>d</sub>) of a 0.4 per cent solution is -200° and of a 0.1 per cent solution is +215.°

The other optical isomer of the complex salt cannot be precipitated from the solution, and evaporation causes decomposition. It is therefore lost.

The  $\alpha$ -bromocamphor- $\pi$ -sulfonate in the filtrate from the precipitation of the *l*-*cis*-dichloro salt can be recovered by adding an excess of ammonium carbonate and evaporating to small volume. On cooling, the ammonium salt of the resolving agent crystallizes, leaving the extremely soluble carbonatobis(ethylenediamine)cobalt(III) chloride in solution. The hydrochloric acid-alcohol-ether mixture

**POTASSIUM HEXACYANOCOBALTATE(III)      225**

is evaporated to dryness and taken up in water, and the resolving agent is recovered as before. Total recovery about 75 per cent.

### Properties

Both the *trans* and the *cis* salts are readily soluble in water but insoluble in the common organic solvents. They aquate in water, producing the chloroaquo salts and a little of the diaquo salts. The optically active *cis* salt is completely racemized in solution in one day at room temperature. During the change, the color of the solution becomes bright red. Evaporation to dryness of the aquated solution gives the *cis*-dichloro salt. The colors of the *cis*- and *trans*-dichloro salts are typical of the dichlorotetramine compounds of cobalt and chromium.

### References

1. TUPIZINA: dissertation, Zurich, 1912.
2. JÖRGENSEN: *J. prakt. Chem.*, **39**, 16 (1889); **41**, 448 (1890).
3. BAILLAR and AUTEN: *J. Am. Chem. Soc.*, **56**, 774 (1934).

### 72. POTASSIUM HEXACYANOCOBALTATE(III)

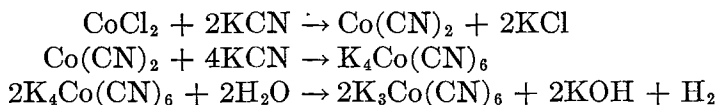

SUBMITTED BY JOHN H. BIGELOW\*  
CHECKED BY JOHN C. BAILLAR, JR. †

Grube<sup>2</sup> gives a method whereby potassium hexacyanocobaltate(III) can be prepared from potassium cyanide and cobalt carbonate, with subsequent oxidation of cyanocobaltate(II) to cyanocobaltate(III), and purified by repeated crystallization from water. The following method was first described by Zwenger<sup>3</sup> and later by Benedetti-Pichler.<sup>1</sup> It has the advantage over Grube's method that cobalt(II) cyanide is first precipitated and washed free

\* The Ohio State University, Columbus, Ohio; present address: Patterson Screen Department, E. I. duPont de Nemours & Company, Towanda, Pa.

† University of Illinois, Urbana, Ill.

from potassium chloride. This impurity would otherwise have to be separated from potassium hexacyanocobaltate(III) by crystallization from water.

### Procedure

Cobalt cyanide is precipitated from a vigorously-stirred boiling solution of 48 g. of cobalt chloride 6-hydrate in 500 ml. of water by dropwise addition of a solution of 30 g. of potassium cyanide in about 200 ml. of water. The reddish-brown precipitate of cobalt cyanide is removed by filtration, with suction, washed with cold water, and, while still moist, transferred to a beaker containing 60 g. of potassium cyanide dissolved in 150 to 200 ml. of water; the mixture is stirred until the precipitate is completely dissolved.\* The deep-red solution of potassium hexacyanocobaltate(II),  $K_4Co(CN)_6$ , is heated to boiling and kept at the boiling point for 10 or 15 minutes. The solution acquires the yellow color of potassium hexacyanocobaltate(III). It is filtered while still hot; while the solution cools, yellow crystals of the salt are formed. These are filtered and washed with a little cold water. The mother liquor can be concentrated on a steam bath, filtered and cooled, and the resulting crystals filtered and washed. The process may be repeated two or three times.

For purification, the crude crystals may be recrystallized from water; two recrystallizations are sufficient to give a pure product. A quick test for purity is to boil some of the salt solution for a short time after acidifying with acetic acid. The pure salt will give little or no turbidity. Yields of better than 90 per cent of the theoretical are possible.

### Analysis

Nitrogen is determined by the Dumas method. Cobalt and potassium are determined in the same sample. The

\* The slight excess of cyanide that is recommended is favorable, because, if too little cyanide is used, green potassium cobalt(II) hexacyanocobaltate(II),  $K_2Co[Co(CN)_6]$ , is precipitated on standing.

POTASSIUM TETRACYANONICKELATE(II) 227

sample is decomposed with concentrated sulfuric acid, cobalt is separated from potassium by precipitation of cobalt sulfide, then determined as the sulfate, and potassium also is determined as the sulfate. *Anal.* Calcd. for  $K_3Co(CN)_6$ : K, 35.9; Co, 17.8; N, 25.5. Found: K, 35.3; Co, 17.7; N, 25.3.

### Properties

Potassium hexacyanocobaltate(III) crystals have a faint yellow color and belong to the monoclinic system. Their specific gravity is 1.906. The compound is not appreciably hydrolyzed in solution, but concentrated mineral acids decompose it. On heating to moderately high temperatures it melts, with decomposition, to an olive-green mass. The crystals are very soluble in water at room temperature, only very slightly soluble in liquid ammonia at  $-33^\circ$ , and insoluble in alcohol. The preparation of potassium hexacyanocobaltate(III) is sometimes used in qualitative analysis in the separation of cobalt and nickel.

### References

1. BENEDETTI-PICHLER: *Z. anal. Chem.*, **70**, 258-259 (1927).
2. GRUBE: *Z. Elektrochem.*, **32**, 561-566 (1926).
3. ZWENGER: *Ann.*, **62**, 163 (1847).

### 73. POTASSIUM TETRACYANONICKELATE(II)

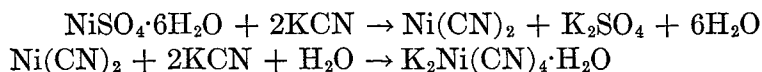

SUBMITTED BY W. C. FERNELIUS\*† AND JOSEPH J. BURBAGE\*

CHECKED BY NATHAN E. BALLOU‡

Potassium tetracyanonickelate(II) may be prepared by adding an excess of potassium cyanide to a solution of a soluble nickel salt and bringing the solution to crystallization.<sup>1-3</sup> However, the preliminary precipitation of nickel

\* The Ohio State University, Columbus, Ohio.

† Present address: Purdue University, West Lafayette, Ind.

‡ University of Illinois, Urbana, Ill.

cyanide followed by solution in potassium cyanide permits of the removal of other soluble potassium salts prior to crystallization.

### Procedure

**Nickel Cyanide.** Sixty grams of nickel sulfate,  $\text{NiSO}_4 \cdot 6\text{H}_2\text{O}$ , is dissolved in 200 ml. of water. To this solution is added slowly, with stirring, 29.7 g. of potassium cyanide dissolved in 70 ml. of water. A grayish-green precipitate of nickel cyanide is immediately produced, which is washed free of sulfates and collected in a Büchner funnel. Yield 24.8 g. (98 per cent).

**Potassium Tetracyanonickelate(II).** Twenty-nine and two-tenths grams of potassium cyanide is dissolved in approximately 30 ml. of water. To this solution is added the solid nickel cyanide, which dissolves to form a brilliant-red solution. This solution is heated on the hot plate until small crystals begin to form. They are redissolved, and the solution is permitted to cool. Large, well-formed crystals are obtained in this manner, and successive crops are taken. Yield 57.4 g. (97 per cent).

### Properties<sup>4</sup>

Potassium tetracyanonickelate(II) crystallizes in orange-red monoclinic<sup>1</sup> crystals that have one molecule of water of hydration.<sup>2</sup> This water is lost when the compound is dried at 100°. The salt is extremely soluble, even in cold water.<sup>3</sup> It is decomposed by the action of the mineral acids with precipitation of nickel cyanide. Potassium tetracyanonickelate(II) is readily decomposed by the addition of sodium hypobromite, whence hydrated nickel peroxide is thrown down as a black precipitate.

### References

1. RAMMELSBERG: *Pogg. Ann.*, **90**, 35 (1853).
2. BALARD: *Compt. rend.*, **19**, 909 (1844).
3. WÖHLER: *Pogg. Ann.*, **3**, 177 (1825).
4. GMELIN-FRIEDHEIM: "Handbuch der anorganischen Chemie," Vol. 5, Part I, 135, Verlag Chemie G.m.b.h., Berlin.

## 74. THE METAL CARBONYLS\*

BY W. CONARD FERNELIUS†

The metal carbonyls are of peculiar interest in the chemistry of the metals. Not only does this group of compounds exhibit certain striking physical properties, but also their constitution has presented an unusual challenge to all theories of chemical combination. The elements that form true carbonyls are located in Groups VIA, VIIA, and VIII of the periodic system. The individual compounds that have been prepared are the following:

	Group VIA	Group VIIA	Group VIII		
			Subgroup A	Subgroup B	Subgroup C
First long period . . .	Cr(CO) <sub>6</sub>		Fe(CO) <sub>5</sub> Fe <sub>2</sub> (CO) <sub>9</sub> Fe <sub>3</sub> (CO) <sub>12</sub>	Co <sub>2</sub> (CO) <sub>8</sub>  Co <sub>4</sub> (CO) <sub>12</sub>	Ni(CO) <sub>4</sub>
Second long period . . .	Mo(CO) <sub>6</sub>		Ru(CO) <sub>5</sub> Ru <sub>2</sub> (CO) <sub>9</sub> [Ru(CO) <sub>4</sub> ] <sub>n</sub>	Rh <sub>2</sub> (CO) <sub>8</sub> <sup>6</sup>  [Rh(CO) <sub>3</sub> ] <sub>n</sub> <sup>6</sup> Rh <sub>4</sub> (CO) <sub>11</sub> <sup>6</sup>	
Third long period . . .	W(CO) <sub>6</sub>	[Re(CO) <sub>5</sub> ] <sub>2</sub> <sup>7</sup>	Os(CO) <sub>5</sub>	Ir <sub>2</sub> (CO) <sub>8</sub> [Ir(CO) <sub>3</sub> ] <sub>n</sub>	

In addition, the following closely related nitrosyl carbonyls and carbonyl hydrides are known:

Fe(CO) <sub>4</sub> H <sub>2</sub> Fe(NO) <sub>2</sub> (CO) <sub>2</sub>	Co(CO) <sub>4</sub> H CoNO(CO) <sub>3</sub>
Ru(CO) <sub>4</sub> H <sub>2</sub>	Rh(CO) <sub>4</sub> H <sup>6</sup>
	Ir(CO) <sub>4</sub> H

\* There are several excellent review articles<sup>1-5</sup> covering the metal carbonyls that should be consulted for further details.

† Purdue University, West Lafayette, Ind.

### Preparation

Most of the carbonyls can be prepared by the direct combination of the metal with carbon monoxide. It is necessary that the metal be in a very active state as when freshly reduced from the oxide or a salt of the metal. While finely divided, freshly reduced nickel combines readily with carbon monoxide at room temperature and atmospheric pressure (synthesis 75); other metals require more elevated temperatures (up to 400°) and very high pressures (up to 700 atm.). Cobalt nitrosyl tricarbonyl is produced when specially prepared cobalt is treated with a mixture of carbon monoxide and nitric oxide.

Carbonyls also are prepared from metal salts and carbon monoxide in the presence of a variety of combinations of reagents. Always, however, one essential function of the reagents is to effect the reduction of the metal. This reduction may be accomplished in the dry way by treating a mixture of the metal salt and finely divided silver or copper with carbon monoxide:<sup>8</sup>

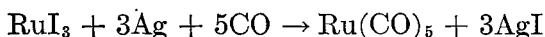

In organic solvents, the Grignard reagent undergoes a number of reactions with metal halides, among which is a partial reduction of the salt. Apparently, carbon monoxide combines with one of these reduction products, which, upon acid decomposition, yields among other products the metal carbonyl. In aqueous solutions, the reduction may be brought about by sulfides, cyanides (synthesis 76), or even carbon monoxide itself in strongly alkaline solutions:

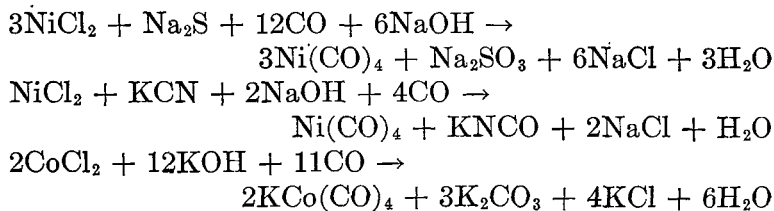



In the last reaction, the presence of some carrier such as cysteine or cyanide is essential. Apparently, the carrier forms an intermediate complex containing carbon monoxide and cobalt, which reacts further to yield the salt of the carbonyl hydride and to regenerate the carrier.

### Properties

The monometallic carbonyls are sufficiently volatile to permit molecular-weight determinations by the vapor-density method at temperatures generally below 100°. In addition, the following carbonyls can be sublimed:  $\text{Fe}_2(\text{CO})_9$ ;  $\text{Co}_2(\text{CO})_8$ ;  $\text{Ru}_2(\text{CO})_9$ . Further, all the carbonyls are insoluble in polar solvents and very soluble in most organic solvents. On heating, the carbonyls are decomposed into carbon monoxide and the metal, although, in the case of the monometallic carbonyls, polymetallic carbonyls may be intermediate products.

While the physical properties of the metal carbonyls are distinctly different from those of both carbon monoxide and the particular metal, much of the chemical behavior of the carbonyls is typical of that of the metal and of carbon monoxide. Thus, nickel carbonyl reacts vigorously with bromine to form nickel bromide and liberate carbon monoxide:

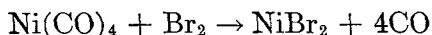

In contrast, Grignard reagents act solely upon the carbon monoxide of nickel tetracarbonyl and leave the nickel as a jet-black residue. However, other reagents leave unchanged the essential structural pattern of the carbonyl molecule. For example, carbon monoxide may be displaced only partly by the halogens to form carbonyl halides, by electron-donor molecules like ammonia to form carbonyl amines such as  $\text{Fe}(\text{CO})_3(\text{NH}_3)_2$ , and by hydrogen (usually in strongly basic solution) to form carbonyl hydrides. All the carbonyls are reactive toward the oxygen



or halogen atom contributes only one electron to the electronic system of the metal. Thus, the effective atomic number of iron and cobalt in  $\text{H}_2\text{Fe}(\text{CO})_4$  and  $\text{HCo}(\text{CO})_4$  is 36, the atomic number of krypton, and that of rhenium in  $\text{Re}(\text{CO})_5\text{X}$  is 86 ( $75 + 10 + 1$ ), the atomic number of radon. Because cobalt requires an odd number of electrons to attain a closed configuration, a monometallic carbonyl hydride is possible even though a monometallic carbonyl is not. The formulas of many of the carbonyl amines indicate that the lone pair of electrons on the nitrogen atom,  $:\text{NR}_3$ , may be shared with the metal in the same manner as the lone pair of the carbon monoxide molecule. Finally, the nitrosyl carbonyls may be included in this same picture if the nitric oxide molecule,  $:\text{N}::\text{O}:$ , is regarded as contributing not two but three electrons to the electronic system of the metal. Here again a monometallic cobalt compound becomes possible.

### Uses

The principal use of the carbonyls is that of obtaining pure metals. The Mond process for refining nickel and the preparation of pure iron for special purposes, such as magnet cores, involve the formation of a volatile carbonyl, transport of the vapors away from impurities in the original metal, and subsequent decomposition to obtain the pure metal. The carbonyls of chromium, molybdenum, and tungsten have been used in mass spectroscopy to determine the stable isotopes of the respective metals.<sup>9</sup> Nickel carbonyl has been used to obtain metallic mirrors and to coat objects with a thin film of metal. Iron carbonyl has been used as an antiknock agent in gasoline.

### References

1. BLANCHARD: *Chem. Rev.*, **21**, 3 (1937); **26**, 409 (1940).
2. TROUT: *J. Chem. Education*, **14**, 453, 575 (1937); **15**, 133 (1938).
3. EMELÉUS and ANDERSON: "Modern Aspects of Inorganic Chemistry," pp. 390-431, D. Van Nostrand Company, Inc., New York, 1938.
4. WARDLAW: *Ann. Repts.*, **31**, 99 (1934).

5. WELCH: *ibid.*, **38**, 71 (1941).
6. HIEBER and LAGALLY: *Z. anorg. allgem. Chem.*, **251**, 96 (1943).
7. HIEBER and FUCHS: *ibid.*, **248**, 256 (1941).
8. HIEBER, BEHRENS, and TELLER: *ibid.*, **249**, 26 (1942).
9. ASTON: *Proc. Roy. Soc. (London)*, **A130**, 306, 308 (1931); **A132**, 491 (1931).

## 75. NICKEL TETRACARBONYL<sup>1</sup>

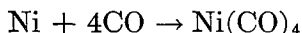

SUBMITTED BY W. L. GILLILAND\* AND A. A. BLANCHARD†

CHECKED BY C. M. MASON‡§ AND ROBERT L. BARNARD† AND BY CORNELIUS GROOT|| AND WARREN C. JOHNSON||

Nickel tetracarbonyl is best prepared in the laboratory by direct synthesis from metallic nickel and carbon monoxide at atmospheric pressure and room temperature. The nickel, however, must be in an extremely active condition, and its activity is much increased by the presence of a little mercury. A trace of oxygen greatly depresses the activity, but strangely enough a little hydrogen sulfide destroys the inhibiting effect of oxygen. However, hydrogen sulfide is not necessary in the preparation of nickel tetracarbonyl by the following procedure.

### Procedure

**Caution.** *The greatest care should be exercised to avoid leaky connections that would allow nickel carbonyl vapor to escape into the open laboratory. The odor of nickel carbonyl is not arresting enough to give sufficient warning. When the vapor is inhaled, it passes through the lung membranes, hemoglobin combines with the carbon monoxide, colloidal nickel is carried to the various organs of the body by the blood, and the destructive action is irreparable.*

The active nickel is prepared from nickel formate in an

\* University of Maine, Orono, Maine; present address: Purdue University, West Lafayette, Ind.

† Massachusetts Institute of Technology, Cambridge, Mass.

‡ University of New Hampshire, Durham, N.H.

§ Present address: U.S. Bureau of Mines, Tuscaloosa, Ala.

|| University of Chicago, Chicago, Ill.

apparatus as shown in Fig. 24. Since nickel carbonyl should not come in contact with rubber, the receiver is sealed directly to the reaction tube. A glass-wool plug is inserted at *A* to serve as a filter. Nickel formate is mixed with 1 per cent of its weight of mercuric oxide, and the mixture is placed in the tube at *B*. The open end of the tube *C* is closed with a rubber stopper with stopcocks for admitting hydrogen or carbon monoxide at will, and the tube is placed in a hinged-top furnace. The hydrogen should be passed over heated copper or platinum to remove oxygen

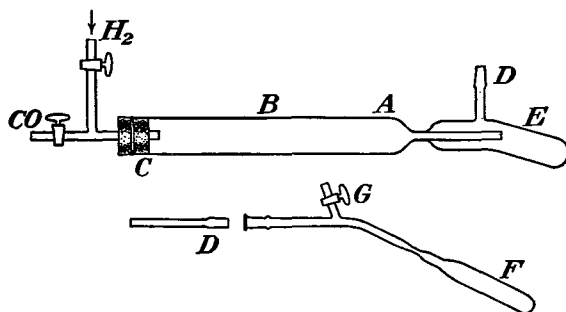

FIG. 24.—Apparatus for the preparation and storage of nickel tetracarbonyl.

and through a tube containing phosphorus(V) oxide to remove water. Sources of hydrogen and carbon monoxide (synthesis 22) are attached to the reaction tube by thick-walled rubber tubes of sufficient length to allow manipulation of the apparatus. To the ground-glass end at *D* is attached a rubber tube leading through a mercury check valve to the hood, where it terminates in a glass capillary inserted in the bottom of a laboratory burner. The flame will destroy any poisonous nickel tetracarbonyl and at the same time give a brilliant grayish color, which is an extremely delicate indication of the presence of this substance.

After the tubes from both gas sources are swept out by the respective gases, a slow current of hydrogen is passed steadily and the temperature of the furnace is raised to between 190 and 200°. The more slowly the nickel is

reduced, the more active it will be. The hydrogen is not necessary to reduce the nickel formate, but it does serve to sweep out water vapor. At no time should the temperature rise above 200°.

When the tube has cooled to room temperature, it is placed under a hood in a vertical position, with the gas entering at the top. The receiver *E* is immersed in a cooling mixture of solid carbon dioxide and alcohol in a Dewar tube, and the carbon monoxide is allowed to flow freely. The check valve is very necessary to prevent air from sucking back through the exit tube. After the hydrogen has been swept out, the exit tube should be nearly or even completely closed, and the carbon monoxide should be allowed to enter as fast as it will react. Liquid nickel tetracarbonyl, as well as the vapor, will pass into the receiver and freeze to a white solid.

After the nickel tetracarbonyl is collected, the exit may be closed, the solid material in the receiver may be allowed to melt, and the liquid may be allowed to remain in the atmosphere of carbon monoxide until it is convenient to transfer it to permanent containers.

**Caution.** *Nickel tetracarbonyl should never be poured in the open air. Since its vapor pressure at room temperature is approximately one-third atmosphere, its deadly fumes spread readily. It is somewhat liable to spontaneous combustion and oxidizes so rapidly that even a moment's exposure to the air causes a visible formation of a flocculent precipitate in the liquid.*

For preservation, nickel carbonyl should be kept in sealed glass ampoules. The following procedure for transferring is convenient: The nickel carbonyl in the receiver *E* is frozen. The rubber tube from the ground-glass end *D* is removed, and, with carbon monoxide flowing slowly, the ground-glass socket of *F* is slipped in place. The ampoule is twisted to point upward, and carbon monoxide is allowed to escape slowly through *G* until the air in the ampoule has been displaced. Nickel tetracarbonyl is so mobile that it

may be poured from *D* to *F* through the capillary. The ampoule should be filled to no more than two-thirds its capacity. The contents of the ampoule and receiver are frozen, and, after the stopcock *G* is opened to relieve any pressure, the capillary is sealed. Another ampoule with capillary may be sealed to *G* and another sample taken in the same way.

The method of transferring to ampoules may be made much simpler if complete freedom from suspended oxidation product is not required. A series of ampoules may be prepared, each filled with dry carbon dioxide, and the liquid nickel tetracarbonyl simply poured into them (hood with good draft). Then the nickel tetracarbonyl is frozen, and the ampoules are sealed.

### Properties

Nickel tetracarbonyl is a colorless, very mobile liquid with a vapor pressure of 261 mm. at 15°. It melts at -25°. It begins to decompose, with liberation of carbon monoxide, at 50°, depositing a mirror of metallic nickel on a surface at that temperature.

Nickel tetracarbonyl does not immediately ignite in the air, but it often will do so after some time. Either pure or in solution, it oxidizes rather rapidly to nickel oxide (or hydroxide if moisture is present), with liberation of carbon monoxide. If the concentrated vapor at room temperature comes in contact with a hot surface, a flash or mild detonation occurs, with formation of a cloud of heavy black soot:

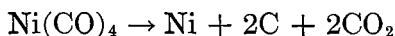

Nickel tetracarbonyl is not soluble in water, nor does it react with water or aqueous acids or alkalis. It is soluble in most organic solvents.

### Reference

1. MOND: *J. Soc. Chem. Ind.*, **14**, 945 (1895).

## 76. DICOBALT OCTACARBONYL, COBALT NITROSYL TRICARBONYL, AND COBALT TETRACARBONYL HYDRIDE

SUBMITTED BY PAUL GILMONT\* AND ARTHUR A. BLANCHARD\*

CHECKED BY C. M. MASON†† AND ROBERT L. BARNARD†

The alkali salt of cobalt tetracarbonyl hydride can best be prepared by the absorption of carbon monoxide in an alkaline cobalt(II) cyanide suspension.<sup>1,2,3</sup> Treatment of this solution with nitric oxide yields the volatile cobalt nitrosyl tricarbonyl,<sup>1,2</sup> while treatment with acid yields the volatile cobalt tetracarbonyl hydride.<sup>1,4,5</sup> At room temperature, the latter compound decomposes into hydrogen and the nonvolatile dicobalt octacarbonyl,  $[\text{Co}(\text{CO})_4]_2$ .

### A. POTASSIUM SALT OF COBALT TETRACARBONYL HYDRIDE

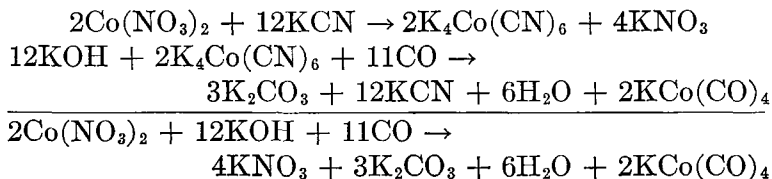

### Procedure

A shaking apparatus capable of keeping the liquid in the condition of a fine spray and yet allowing the passage of gases during the shaking is necessary. Figure 25 shows the design of a very effective apparatus for this purpose.

Water is added to 7.3 g. of cobalt nitrate 6-hydrate to make 15 ml.; to 11.2 g. of potassium hydroxide to make 15 ml.; to 1.6 g. of potassium cyanide to make 5 ml. All air is swept from the shaking vessel, and it is left filled with carbon monoxide. Each of these solutions in turn is introduced through the side arm and the arm washed each time with 5 ml. of water. There results 50 ml. of a solution approximately 0.5 *M* in cobalt nitrate, 0.5 *M* in potassium

\* Massachusetts Institute of Technology, Cambridge, Mass.

† University of New Hampshire, Durham, N.H.

‡ Present address: U.S. Bureau of Mines, Tuscaloosa, Ala.



cyanide, and 4.0 *M* in potassium hydroxide. *No bubble of air is allowed to enter with these solutions.*

With the exit stopcock closed and the stopcock from the carbon monoxide generator (synthesis 22) open, the apparatus is shaken vigorously for about 7 hours. At the outset, carbon monoxide is absorbed at the rate of 8 to 10 ml./minute. The rate slowly rises to 15–20 ml./minute and finally decreases. A total of 2200 to 2600 ml. will be absorbed, 80 to 90 per cent of which occurs in the first 2 hours. The contents of the shaker change in appearance from a gelati-

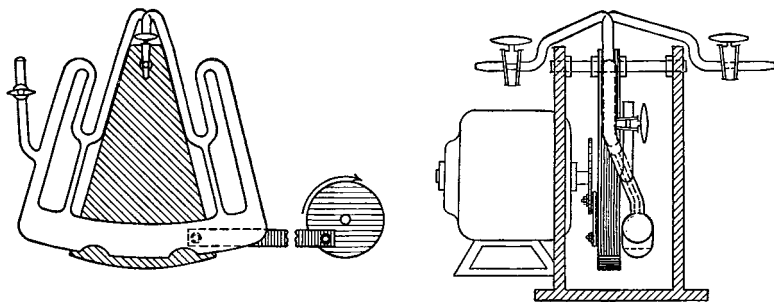
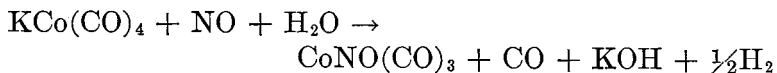

FIG. 25.—Shaking apparatus for use in the preparation of metal carbonyls and certain of their derivatives.

nous blue suspension to a pink solution containing a good deal of suspended white solid and finally to a yellow solution with only a trace of suspended white material.

#### B. COBALT NITROSYL TRICARBONYL



#### . Procedure

The shaker containing the yellow solution of the potassium salt of cobalt tetracarbonyl hydride is connected with the nitric oxide reservoir (synthesis 37), swept with nitric oxide, and the shaking action started. Soon the solution turns red, and after a time a yellow vapor appears above the solution. From this point on, the solution is swept slowly with nitric oxide at the rate of 2 l./hour for 5 hours, with the

shaker in operation throughout. The gas leaving the shaker is passed through calcium chloride and phosphorus(V) oxide drying tubes and then through a trap cooled to about  $-79^\circ$  (solid carbon dioxide and alcohol). Beyond this trap, a mercury valve is placed to prevent air from entering the system.

The product thus obtained in the trap is reasonably pure. Any trace of cobalt tetracarbonyl hydride is eliminated by allowing the trap to stand at room temperature for 24 hours. The trap is then cooled again to about  $-79^\circ$  and the system connected to a prepared sample tube. After the system has been evacuated, the trap is allowed to warm up. Cooling the sample tube causes the cobalt nitrosyl tricarbonyl to distill into the latter. Finally, the capillary of the sample tube is sealed in the flame. Yield 2.5 g. (58 per cent).

### Properties

Cobalt nitrosyl tricarbonyl is a deep-red mobile liquid. It is not soluble in water, nor does it react with water, but it is completely miscible with most organic solvents.

Molecular weight.....	173
Melting point.....	$-11^\circ$
Boiling point.....	$78.6^\circ$
Vapor pressure at $20^\circ$ .....	91 mm.
Specific gravity.....	1.47

Treatment of the product with bromine yields the calculated quantities of cobalt(II) bromide, nitric oxide, and carbon monoxide:

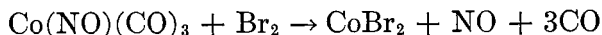

### C. COBALT TETRACARBONYL HYDRIDE

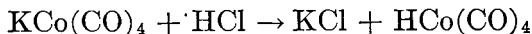

### Procedure

**Caution.** *The odor of cobalt tetracarbonyl hydride is so intolerable that the danger from inhaling it is much less than*

*from nickel tetracarbonyl. However, it is probably equally poisonous, and the same precautions should be taken as with nickel tetracarbonyl.*

The procedure for the preparation of the potassium salt of cobalt tetracarbonyl hydride is carried out as already described. Because acidification of this solution liberates not only the hydride but also 700 ml. of carbon dioxide, the operation cannot be carried out in the shaker owing to excessive foaming.

A 500-ml. distilling flask is fitted with an inlet tube reaching to the bottom and another short inlet tube. The side arm of the flask is attached to a drying train followed by a trap kept at about  $-79^{\circ}$  and a mercury valve. The long inlet tube is attached to the shaker, and the entire apparatus is filled with carbon monoxide. The shaker is tilted and the solution allowed to flow into the distilling flask. The flask is cooled with ice water and, while it is shaken gently by hand, 30 ml. of 12 *N* hydrochloric acid is run in slowly through the short tube. The quantity of hydrochloric acid specified not only reacts with the surplus of potassium hydroxide, the potassium salts of carbonic acid, hydrocyanic acid, and cobalt tetracarbonyl hydride but provides a concentration of approximately 2.3 *N* hydrochloric acid. With a slow stream of carbon monoxide passing, the flask is allowed to come to room temperature; but care must be taken that the evolution of gas (carbon dioxide and cobalt tetracarbonyl hydride) does not carry the foam into the drying train. A slow stream of carbon monoxide is continued for 10 hours, to sweep the hydride from the solution. A better yield of a purer product may be obtained by sweeping at a lower temperature (10 to  $15^{\circ}$ ), but this requires a longer time. Yield 2.2 g. of redistilled cobalt tetracarbonyl hydride (45 per cent).

### Properties

The cobalt tetracarbonyl hydride that is frozen out in the trap is white to light yellow. It melts at  $-33^{\circ}$  to a light-

yellow liquid, which darkens rapidly with increasing temperature. This darkening is due to the decomposition into dicobalt octacarbonyl,  $[\text{Co}(\text{CO})_4]_2$ , and hydrogen, and in the end it results in a brown nonvolatile solid. In a current of carbon monoxide, the hydride may be distilled with practically no decomposition.\*

Cobalt tetracarbonyl hydride cannot be preserved at room temperature except at pressures that would burst the usual glass sample tube. However, small quantities of the material as a yellow vapor will remain in equilibrium with hydrogen and the solid dicobalt octacarbonyl.

#### D. DICOBALT OCTACARBONYL

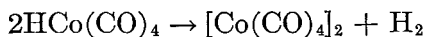

#### Procedure

The trap in which the hydride is collected is connected through a tube of about 100 ml. capacity with a sample tube, and the system is evacuated. Upon cooling the sample tube to  $-79^\circ$  and removing the trap from the cold bath, the hydride distills into the sample tube. The latter is allowed to come to room temperature, which causes the hydride to decompose. The trap is again cooled to  $-79^\circ$ , the hydrogen is pumped out, and the remaining yellow cobalt tetracarbonyl hydride vapor is condensed in the trap. The hydride is again distilled back into the sample tube, and the process is repeated until no more yellow vapors appear after several days' standing. Then the sample tube is sealed off.

#### Properties

Dicobalt octacarbonyl is a dark-brown microcrystalline solid. If it stands in a vacuum, it slowly sublimes, forming a few clear orange crystals on the walls. It has a vapor

\* It is noteworthy that cobalt tetracarbonyl hydride vapor mixed with large amounts of carbon monoxide at room temperature can be carried through long connections and a drying train without obvious sign of decomposition.

## IRON TETRACARBONYL DIHYDRIDE

243

pressure of 0.07 mm. at 15°. It melts at 51°, and slightly above this temperature it begins to decompose. Cryoscopic molecular-weight determinations indicate the dimeric formula.

Above 51° dicobalt octacarbonyl decomposes into tetracobalt dodecacarbonyl  $[\text{Co}(\text{CO})_3]_4$ , and carbon monoxide. This carbonyl is sparingly soluble in benzene and pentane and can be purified from these solvents to give pitch-black glistening crystals. Its molecular weight by the freezing-point method indicates the tetrameric formula.<sup>6</sup>

## References

1. BLANCHARD and GILMONT: *J. Am. Chem. Soc.*, **62**, 1192 (1940).
2. BLANCHARD, RAFTER, and ADAMS: *ibid.*, **56**, 16 (1934).
3. SCHUBERT: *ibid.*, **55**, 4563 (1933).
4. COLEMAN and BLANCHARD: *ibid.*, **58**, 2160 (1936).
5. EWENS and LISTER: *Trans. Faraday Soc.*, **35**, 681 (1939).
6. BLANCHARD: *Chem. Rev.*, **21**, 3 (1937).

## 77. IRON TETRACARBONYL DIHYDRIDE

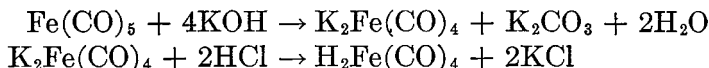

SUBMITTED BY ARTHUR A. BLANCHARD\* AND GEORGE W. COLEMAN\*

CHECKED BY C. M. MASON†† AND ROBERT L. BARNARD†

Iron pentacarbonyl is the starting material for this preparation. Although iron pentacarbonyl can be prepared very readily on a commercial scale by a high-pressure technique,<sup>1</sup> there is no convenient laboratory method available. However, iron pentacarbonyl is available commercially§ admixed with 3 per cent of kerosene in lots as small as 1 lb.

## Procedure

The shaking apparatus (Fig. 25) is filled with carbon monoxide, and 5 ml. of iron pentacarbonyl-kerosene mix-

\* Massachusetts Institute of Technology, Cambridge, Mass.

† University of New Hampshire, Durham, N.H.

‡ Present address: U.S. Bureau of Mines, Tuscaloosa, Ala.

§ Kentucky Chemical Industries, Inc., Este Avenue, Cincinnati, Ohio.

ture is added. Twenty-five milliliters of 6 *N* potassium hydroxide is added, and the mixture is shaken for 6 hours. Thirty milliliters of 6 *N* hydrochloric acid is slowly added. While the apparatus is shaken, a steady current of carbon monoxide is allowed to sweep the vapor of iron tetracarbonyl dihydride through drying tubes of calcium chloride and phosphorus(V) oxide and into a trap cooled with solid carbon dioxide and alcohol.

The product caught in this trap may be contaminated with iron pentacarbonyl and kerosene. After all the carbon dioxide is swept out, a second trap, cooled with liquid air, is attached to the train. With a slow stream of carbon monoxide passing, the first trap is allowed to warm up to  $-10^{\circ}$ , and all the iron tetracarbonyl dihydride is swept into the trap cooled with liquid air.\* The iron tetracarbonyl dihydride collects as a white crystalline solid.

### Properties

Iron tetracarbonyl dihydride melts at  $-70^{\circ}$ , and it has a vapor pressure of 11 mm. at  $-10^{\circ}$  (extrapolated). However, it is very unstable when pure and decomposes below  $-10^{\circ}$ . In a current of carbon monoxide, the dilute vapors do not decompose even at room temperature. In alkaline solution, the potassium salt,  $K_2Fe(CO)_4$ , is stable but is very sensitive to oxidation by air.

### Reference

1. MITTASCH: *Angew. Chem.*, **41**, 827 (1928).

\* Vacuum technique may be used instead of sweeping, but in the absence of carbon monoxide the iron tetracarbonyl dihydride is much more likely to decompose in the warmer part of the apparatus.

## 78. POTASSIUM TETRACYANOPALLADATE(II)

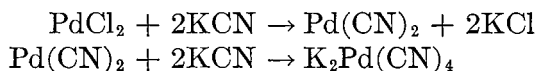

SUBMITTED BY JOHN H. BIGELOW\*

CHECKED BY B S. HOPKINS† AND J. L. CRAVEN†

Rammelsberg<sup>1</sup> and Rossler<sup>2</sup> state that potassium tetracyanopalladate(II) can be prepared by first precipitating palladium(II) cyanide and then dissolving it in additional potassium cyanide. The method given here differs from theirs only in that care is taken to wash the precipitated palladium(II) cyanide free from potassium chloride, which otherwise would have to be separated by fractional crystallization.

### Procedure

Five grams of palladium(II) chloride [or 8 g. of ammonium tetrachloropalladate(II)] is dissolved in about 350 ml. of warm water to which a few drops of hydrochloric acid has been added. To the well-stirred solution is added dropwise a solution of 3.7 g. of potassium cyanide in about 50 ml. of water. As yellow palladium(II) cyanide precipitates, the supernatant liquid becomes colorless. The gelatinous precipitate is filtered on a Büchner funnel, washed well with water, transferred to a beaker, and dissolved in a solution of 4 g. of potassium cyanide in about 75 ml. of water. Heat and agitation aid the solution process. The liquid is filtered and evaporated on a hot plate until crystals begin to form. When the solution has cooled, the crystals are filtered on a small Büchner funnel and washed with a few drops of cold water. The process of evaporation, cooling, and filtering off the crystals formed may be repeated once or twice with the mother liquor. The salt may be purified by recrystallization from water;

\* The Ohio State University, Columbus, Ohio; present address: Patterson Screen Department, E. I. duPont deNemours & Company, Towanda, Pa.

† University of Illinois, Urbana, Ill.

one recrystallization is sufficient to give the pure 3-hydrate. Yields of better than 70 per cent of the theoretical are possible.

### Analytical

The compound is dried at 100°, when the 1-hydrate is formed. Nitrogen is determined by the Dumas method. Potassium and palladium are determined in the same sample as follows: The compound is decomposed with concentrated sulfuric acid, evaporated to a small volume (5 to 10 ml.), and taken up with cold water, and palladium is precipitated with a 1 per cent dimethylglyoxime solution in 95 per cent ethyl alcohol. The palladium dimethylglyoximate thus formed is filtered on a porous-bottomed crucible, washed well with hot water, and dried at 110°. Potassium is determined in the filtrate as the sulfate. *Anal.* Calcd. for  $K_2Pd(CN)_4 \cdot H_2O$ : K, 25.5; Pd, 34.8; N, 18.2. Found: K, 25.2; Pd, 35.0; N, 18.2.

### Properties

Potassium tetracyanopalladate(II) when crystallized from water forms the 3-hydrate, which is a white crystalline salt, isomorphous with the corresponding rhombic tetracyanoplatinate(II). The 3-hydrate is efflorescent in air; it loses two molecules of water of crystallization at 100° and the third at 200°. When the compound is heated to moderately high temperatures, it decomposes with the formation of palladium, cyanogen, and potassium cyanide. The 1-hydrate is readily soluble in water and in liquid ammonia and is somewhat soluble in alcohol giving colorless solutions in each case. The addition of dilute acids to potassium tetracyanopalladate(II) precipitates palladium(II) cyanide, while boiling with concentrated sulfuric acid completely decomposes the compound.

### References

1. RAMMELSBERG: *Ann.*, **28**, 217 (1838).
2. ROSSLER: *Z. anal. Chem.*, **5**, 403 (1866).



## 79. POTASSIUM TETRACHLOROPLATINATE(II)

### (Potassium Chloroplatinite)

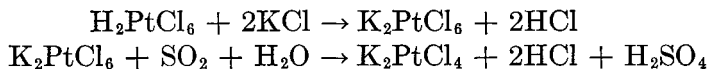

SUBMITTED BY R. N. KELLER\*

CHECKED BY THERALD MOELLER† AND J. V. QUAGLIANO‡

The preparation of compounds of platinum(II) usually involves a preliminary preparation of platinum(IV) compounds. For example, the synthesis of metal salts by treating a solution of tetrachloroplatinic(II) acid with carbonates or chlorides<sup>1</sup> requires the preliminary preparation of the acid by reducing hexachloroplatinic(IV) acid with a suitable reagent such as sulfur dioxide.<sup>2</sup> Otherwise, a metallic hexachloroplatinate(IV) may be reduced to the corresponding tetrachloroplatinate(II) by sulfur dioxide,<sup>3,4</sup> potassium oxalate,<sup>3,4</sup> potassium hydrogen sulfite,<sup>5</sup> hydrogen sulfide,<sup>6</sup> potassium hypophosphite,<sup>7</sup> or copper(I) chloride.<sup>8</sup>

The present method starts with the readily obtainable potassium hexachloroplatinate(IV) and uses sulfur dioxide as a convenient reducing agent.

### Procedure

Five grams of crystalline hexachloroplatinic(IV) acid,  $\text{H}_2\text{PtCl}_6 \cdot 6\text{H}_2\text{O}$ , is dissolved in 50 ml. of distilled water, and potassium hexachloroplatinate(IV),  $\text{K}_2\text{PtCl}_6$ , is precipitated from this solution by the addition, with stirring, of 1.6 g. of potassium chloride dissolved in 15 ml. of water. The resulting mixture is diluted with an equal volume of alcohol and allowed to stand about 15 minutes in an ice bath. After the supernatant liquid has been decanted

\* University of Wisconsin, Madison, Wis.; present address: University of Michigan, Ann Arbor, Mich.

† University of Illinois, Urbana, Ill.

through a suction filter, the potassium salt is washed thoroughly by decantation with two 25-ml. portions of 50 per cent alcohol and is then transferred to the filter with the aid of 95 per cent alcohol. Here the yellow solid is finally washed with three 20-ml. portions of ether and dried in the air until no odor of ether remains.

The dry potassium hexachloroplatinate(IV) is placed in a 50-ml. beaker along with 35 ml. of water and reduced with freshly prepared sulfur dioxide solution. The flask is placed on a steam bath (85 to 90°) during the reduction process and stirred constantly with a mechanical stirrer. Not more than 1.0 ml. of the reducing solution is added at a time, and sufficient time is allowed between additions for all the sulfur dioxide odor to disappear. A volume of about 35 ml. is maintained by adding distilled water as needed. The solution becomes red as the reduction proceeds, and near the end of the reaction smaller quantities of sulfur dioxide solution are added and larger intervals allowed between additions. In practice, the following procedure is employed: About fifteen 0.6-ml. portions of the saturated sulfur dioxide solution are added in 2- to 3-minute intervals to the mixture in the beaker, which is maintained at 85 to 90°. This is followed by the addition of about ten to fifteen 0.4-ml. portions at 3- to 4-minute intervals. Near the end of the reaction, when very little of the hexachloroplatinate(IV) remains, longer intervals are allowed between additions. In all cases, care is taken that sufficient time is allowed between additions for all the sulfur dioxide odor to disappear. The reduction process is continued until only a trace of the solid hexachloroplatinate(IV) remains. It is best to stop slightly short of the end point, for with an excess of the reducing solution sulfite complexes are formed.

After reduction is complete, the red solution is concentrated on the steam bath to the point of crystallization. After the beaker and contents have cooled to room temperature, the red potassium tetrachloroplatinate(II) crystals are

dissolved in about 40 ml. of cold water and the resulting solution is filtered to remove any unreduced hexachloroplatinate(IV). Five milliliters of water is used to flush out the funnel after the filtration. Then, in transferring the solution to a beaker for the next step, the receiver flask is rinsed with two 5-ml. portions of water for complete removal of potassium tetrachloroplatinate(II). The total volume at this point is about 55 to 60 ml. To this filtrate is added rapidly and with stirring 660 ml. of a solution consisting of equal parts of ordinary ether and ordinary acetone to precipitate the tetrachloroplatinate(II). After the precipitate has settled, the supernatant liquid (which is light yellow in color) is decanted and the precipitate washed by decantation with three 120-ml. portions of the acetone-ether solution until the washings are colorless, then three times with 80-ml. portions of ether alone, transferred to a filter paper by means of ether, and finally dried in the air and powdered.

The product so obtained is a pink powder, which is satisfactory for most purposes. If, however, crystals are desired or traces of sulfate need to be removed, the powder can be recrystallized from hot water containing several drops of concentrated hydrochloric acid. When it is so recrystallized, beautiful, red, needlelike crystals are obtained. If a solution of the salt containing a few drops of concentrated hydrochloric acid is concentrated slowly in a desiccator over sulfuric acid, large well-formed crystals result. Yield 3.0 g. (75 per cent).

### Properties

Potassium tetrachloroplatinate(II) is somewhat soluble in water (0.93 g./100 ml. water at 16° and 5.3 g./100 ml. at 100°). It is almost insoluble in alcohol but when in contact with alcohol undergoes reduction. The dry salt and aqueous solutions are completely stable in light. The crystals are dark red or brownish red and furnish a convenient starting point for many platinum(II) derivatives.

## References

1. NILSON: *J. prakt. Chem.*, [2] **15**, 260 (1877).
2. CLAUS: *Ann.*, **107**, 137 (1858).
3. KLASON: *Ber.*, **37**, 1360 (1904).
4. VÈZES: *Bull. soc. chim.*, [3] **19**, 879 (1898).
5. LEA: *Am. J. Sci.*, [3] **48**, 398, 400 (1894).
6. BÖTTGER: *J. prakt. Chem.*, [1] **91**, 251 (1863).
7. LEA: *Am. J. Sci.*, [3] **48**, 397 (1894).
8. THOMSEN: *J. prakt. Chem.*, [2] **15**, 295 (1877).

## 80. TETRAMMINEPLATINUM(II) CHLORIDE

## (Tetrammineplatinous Chloride)

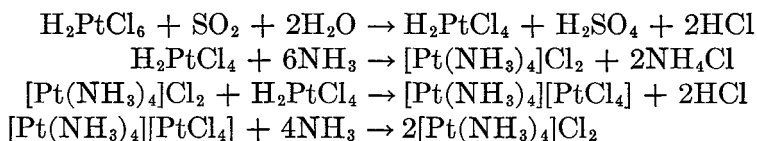

SUBMITTED BY R. N. KELLER\*

CHECKED BY THERALD MOELLER† AND J. V. QUAGLIANO†

Tetrammineplatinum(II) chloride may be prepared by heating any one of the following with excess aqueous ammonia until a colorless solution results:<sup>1-5</sup> platinum(II) chloride; tetrammineplatinum(II) tetrachloroplatinate(II) (Magnus's green salt),  $[\text{Pt}(\text{NH}_3)_4][\text{PtCl}_4]$ ; diamminedichloroplatinum,  $[\text{Pt}(\text{NH}_3)_2\text{Cl}_2]$ ; or a solution of tetrachloroplatinic(II) acid. The present method involves the preparation of pure tetrammineplatinum(II) tetrachloroplatinate(II) and its subsequent reaction with aqueous ammonia.

## Procedure

A solution of 5.0 g. of solid hexachloroplatinic(IV) acid,  $\text{H}_2\text{PtCl}_6 \cdot 6\text{H}_2\text{O}$ , in 30 ml. of water and 1 ml. of concentrated hydrochloric acid in a 50-ml. Erlenmeyer flask is reduced

\* University of Wisconsin, Madison, Wis.; present address: University of Michigan, Ann Arbor, Mich.

† University of Illinois, Urbana, Ill.

with a freshly prepared solution of sulfur dioxide.\* The end point of the reaction is taken when a drop of the red solution added to three drops of a saturated solution of ammonium chloride on a watch glass gives only a trace of a precipitate after about 1 minute. Care should be taken that no excess of the reducing solution is added, since sulfite complexes may be formed under such conditions.

After reduction is complete, the solution of tetrachloroplatinic(II) acid is diluted to a volume of 50 ml. and then divided into two exactly equal portions. One portion is diluted to 100 ml. with water and heated to boiling. To this boiling solution is added 125 ml. of a boiling solution of equal parts of water and concentrated ammonia. The ammonia solution should be added steadily while the resulting solution is stirred vigorously (with a mechanical stirrer) and kept at the boiling point. After all the ammonia solution has been added, the yellow solution should be heated and stirred until it is completely colorless. The above procedure converts the tetrachloroplatinic(II) acid directly into tetrammineplatinum(II) chloride without involving the insoluble intermediate,  $[\text{Pt}(\text{NH}_3)_4][\text{PtCl}_4]$ . If any of this insoluble green salt should form, it can be converted into soluble tetrammine chloride by heating with excess ammonia.

The above solution of tetrammineplatinum(II) chloride is heated on the steam bath until only a faint odor of ammonia is present and is then diluted with water to about 175 ml. To this solution is added slowly and with stirring the second portion of the tetrachloroplatinic(II) acid solution, which has been diluted to 50 ml. The green salt,  $[\text{Pt}(\text{NH}_3)_4][\text{PtCl}_4]$ , precipitates. After the precipitate has settled, the supernatant liquid is decanted through a suction filter and the precipitate washed by decantation with small quantities of hot water until the washings give a negative sulfate test. The precipitate is then trans-

\* The details of the reduction process are the same as those for the reduction of potassium hexachloroplatinate(IV) (synthesis 79).

ferred to the filter and sucked free of the bulk of the wash water. The moist salt is placed in a beaker, and 25 ml. of water, 2 ml. of concentrated hydrochloric acid, and 100 ml. of concentrated ammonia are added. This mixture is heated to boiling and stirred with a mechanical stirrer until the green precipitate has entirely dissolved. The reaction is rather slow, and constant stirring facilitates solution. The flame should be adjusted so that the solution is kept just at the boiling point, and a volume of about 100 ml. is maintained by adding concentrated ammonia frequently.

When the green precipitate has completely dissolved, the resulting solution of tetrammineplatinum(II) chloride is concentrated on the steam bath until only a faint odor of ammonia is present. The volume is adjusted to about 50 ml. and the solution filtered. The filtrate is made just acid to litmus with dilute hydrochloric acid, 1 ml. of concentrated hydrochloric acid added in excess, and the tetrammineplatinum(II) chloride precipitated immediately with 10 volumes of a solution of equal parts of alcohol and acetone. After about 1 hour, the supernatant liquid is decanted through a suction filter and the white precipitate washed by decantation with three 50-ml. portions of the alcohol-acetone solution, transferred to the filter with the same solution, washed with acetone alone, and finally washed thoroughly with ether and dried in the air.

The product prepared by this method is a white powder. To obtain the crystalline 1-hydrate, the above powder is recrystallized from hot water or a concentrated solution allowed to crystallize slowly in a desiccator over sulfuric acid. Yield about 2.8 g. (80 to 85 per cent). *Anal.* Calcd. for  $[\text{Pt}(\text{NH}_3)_4]\text{Cl}_2 \cdot \text{H}_2\text{O}$ : Pt, 55.4; Cl, 20.1. Found: Pt, 55.7; Cl, 19.9.

### Properties

Tetrammineplatinum(II) chloride dissolves in four to five parts of water at room temperature, and the solubility

increases with rise of temperature. This ready solubility in water makes this compound very useful in reactions involving the tetrammineplatinum(II) ion,  $[\text{Pt}(\text{NH}_3)_4]^{++}$ . The salt is practically insoluble in alcohol, acetone, and ether. It loses water at  $110^\circ$  and two molecules of ammonia at  $250^\circ$  to form sparingly soluble, yellow dichlorodiammineplatinum,  $[\text{Pt}(\text{NH}_3)_2\text{Cl}_2]$ .

## References

1. CLEVE: *Acta Upsal.*, **6**, No. 5, 24 (1866).
2. JÖRGENSEN: *Z. anorg. Chem.*, **24**, 181 (1900).
3. PEYRONE: *Ann.*, **51**, 1 (1844).
4. RAMBERG: *Z. anorg. Chem.*, **83**, 35 (1913).
5. REISET: *Ann. chim. phys.*, [3] **11**, 417 (1844); *Compt. rend.*, **11**, 711 (1840); **18**, 1100 (1844).

## 81. PLATINUM(IV) CHLORIDE



SUBMITTED BY R. N. KELLER\*

CHECKED BY THERALD MOELLER† AND J. V. QUAGLIANO‡

Pure platinum(IV) chloride cannot be prepared by the decomposition of hexachloroplatinic(IV) acid in air because the platinum(IV) chloride begins to decompose before all the water and hydrogen chloride have been expelled. On the other hand, this substance may be readily prepared by slow thermal decomposition of hexachloroplatinic(IV) acid in an atmosphere of either dry hydrogen chloride<sup>1</sup> or chlorine.<sup>2,3</sup> An adaptation of Kharasch and Ashford's procedure for the latter method is given here.

## Procedure

Six grams of crystalline hexachloroplatinic(IV) acid,  $\text{H}_2\text{PtCl}_6 \cdot 6\text{H}_2\text{O}$ , is placed in a combustion boat, which in turn is placed in a glass combustion tube contained in an elec-

\* University of Wisconsin, Madison, Wis.; present address: University of Michigan, Ann Arbor, Mich.

† University of Illinois, Urbana, Ill.

trically heated tubular furnace. If the starting material is a solution of hexachloroplatinic(IV) acid, this solution may be heated in an oven at 75° until no further evaporation seems to occur. The concentrated solution upon cooling solidifies, and the solid so obtained may be used instead of the crystalline hexachloroplatinic(IV) acid above. A steady stream of dry chlorine is passed through the combustion tube while the temperature is raised gradually to about 115°. At about 60°, the crystals melt in their water of hydration; as the temperature is increased, water is driven off and the mixture thickens. A too rapid increase in temperature should be avoided while the water is being driven off; otherwise, considerable foaming and spattering may occur. Heating is continued at 115° until most of the water is expelled from the solid. With chlorine passing through the tube all the while, the temperature is then raised gradually to 275° over a period of approximately 2 hours, held there for ½ hour, and allowed to fall gradually to about 150°. The boat is removed and the contents quickly ground in an agate mortar while hot. The material is very hygroscopic, and undue exposure to the air should be avoided. The pulverized material is again placed in the combustion tube and heated to 275° in the presence of chlorine. After about ½ hour at this temperature, the platinum(IV) chloride is allowed to cool to about 150° in the atmosphere of chlorine, removed from the furnace, transferred to a glass-stoppered bottle, and placed in a desiccator over a drying agent. Yield 3.7 g. (95 per cent). *Anal.* Calcd. for PtCl<sub>4</sub>: Pt, 57.9; Cl, 42.1. Found: Pt, 58.0; Cl, 41.8.

### Properties

Platinum(IV) chloride prepared by this method is a reddish-brown hygroscopic powder, soluble in water and acetone, but only slightly soluble in alcohol. When it is exposed to the air, water is absorbed and the salt becomes bright yellow. Its aqueous solution has an acid reaction



and probably contains the acid  $\text{H}_2[\text{PtCl}_4(\text{OH})_2]$ . Platinum(IV) chloride dissolves in hydrochloric acid to form hexachloroplatinic(IV) acid.

#### References

1. PULLINGER: *J. Chem. Soc.*, **61**, 422 (1892).
2. ROSENHEIM and LÖWENSTAMM: *Z. anorg. Chem.*, **37**, 403 (1903).
3. KHARASCH and ASHFORD: *J. Am. Chem. Soc.*, **58**, 1736 (1936).

## APPENDIX

### NOTES ON THE NOMENCLATURE OF INORGANIC COMPOUNDS

BY JANET D. SCOTT\*

A brief discussion of nomenclature and of the names adopted in Vol. II of *INORGANIC SYNTHESSES* has seemed advisable because of the lack of uniformity of practice in this regard in the inorganic field.<sup>1</sup> Since the index in each volume beginning with Vol. II will be cumulative, there is need for consistency in nomenclature. The nomenclature adopted here has made it necessary to change some of the names used in the index in Vol. I; it is hoped that the present policies will be capable of extension to future volumes.

Attempts by various national and international committees in the last two decades to bring some order out of the confusion in inorganic nomenclature culminated in 1940 in the Rules for Naming Inorganic Compounds (Report of the Committee for the Reform of Inorganic Chemical Nomenclature of the International Union of Chemistry, 1940).<sup>2</sup> The preferred names adopted in this volume of *INORGANIC SYNTHESSES* and in the Cumulative Index conform in general with these I.U.C. rules and with the *Chemical Abstracts* index names.<sup>3</sup> Common alternative names are often given in the titles of syntheses.

#### **Binary Compounds (and Those Named Like Binary Compounds)**

Binary compounds are named in the customary manner, with the more electropositive part of the name first, in the case of both salts and nonsalts. Since no order of decreasing electropositivity for nonmetallic elements is provided

\* The Polytechnic Institute of Brooklyn, Brooklyn, N.Y.

in the I.U.C. rules, the order given in a report of the German Commission for Nomenclature<sup>4</sup> has been followed: Sb, As, B, Si, C, P, Te, Se, S, I, Br, Cl, N, O, F, except for nitrogen halides.

Compounds of hydrogen are designated in the following manner: by hydride names, especially in the case of compounds containing  $H^-$  (e.g., *sodium hydride*); by "hydrogen . . . ide" and acid names (e.g.,  $H_2Se$ , *hydrogen selenide*;  $HI$ , *hydrogen iodide* and *hydriodic acid*); or by special names, used commonly instead of systematic names for the parent compounds and their derivatives, both inorganic and organic (see also Compounds of Germanium and Silicon):

$NH_3$	Ammonia (amine in derivatives and ammine when coordinated)
$N_2H_4$	Hydrazine
$PH_3$	Phosphine
$AsH_3$	Arsine
$SbH_3$	Stibine

Among compounds named like binary compounds are  $NaNH_2$ , *sodium amide*;  $KN_3$ , *potassium azide*;  $CaNCN$ , *calcium cyanamide*. These electronegative groups and others (not including radicals of oxygen acids and thio acids except the cyanates) are named in the best accepted manner:

$O^-$	Oxide	$CN^-$	Cyanide†
$OH^-$	Hydroxide	$NC^-$	Isocyanide
$O_2^-$	Peroxide	$CN_2^-$	Cyanamide
$O_2H^-$	Hydroperoxide	$OCN^-$	Cyanate
$O_2^{2-}$	Superoxide	$NCO^-$	Isocyanate
$S^-$	Sulfide	$SCN^-$	Thiocyanate‡
$SH^-$	Hydrosulfide	$NCS^-$	Isothiocyanate
$C^4-$	Carbide	$SeCN^-$	Selenocyanate
$C_2^-$	Carbide or acetylide*	$TeCN^-$	Tellurocyanate
$N^{3-}$	Nitride		
$N_3^-$	Azide		
$NH_2^-$	Amide†		
$NH^-$	Imide		

\*  $NaHC_2$ , monosodium acetylide.

†  $NaNH_2$ , sodium amide;  $NO_2NH_2$ , nitramide;  $NH_2Cl$ , chloramide, instead of monochloroamine, used in Vol. I; but  $NH_2OH$ , hydroxylamine. See also Nitrogen Compounds of Phosphorus and of Sulfur.

‡ But  $ClCN$ , cyanogen chloride.

§ Not sulfocyanate or sulfoyanide.

(More extensive lists of anions have been given elsewhere.)<sup>3,5</sup>

Where there is need of indicating the proportions of constituents, the Stock system<sup>6</sup> adopted in the I.U.C. rules has been used to designate oxidation state by means of Roman numerals in parentheses immediately following the names of the elements or radicals to which they refer. Thus, for  $\text{FeCl}_3$ , *iron(III) chloride* is preferred to ferric chloride; for  $\text{GeCl}_4$ , *germanium(IV) chloride* to germanium tetrachloride. In some cases, especially with nonpolar compounds and compounds in which the oxidation state or structure is uncertain, Greek numerical prefixes have been used to indicate stoichiometric composition (*mono-* usually being omitted unless it seems to be needed, as to distinguish  $\text{NaHC}_2$ , monosodium acetylide, from  $\text{Na}_2\text{C}_2$ ): *e.g.*,  $\text{Ni}(\text{CO})_4$ , *nickel tetracarbonyl*;  $\text{Si}_2\text{Br}_6$ , *disilicon hexabromide*.

#### Mixed Salts and Similar Compounds

With compounds having two or more cations the more electropositive constituent is named first, as with simple compounds. However, in the case of two or more electronegative constituents, decision in regard to the "order of increasing electronegative character" (I.U.C. rules) is too difficult, and hence the alphabetical order adopted in *Chemical Abstracts* indexes is more feasible: thus  $\text{KCl} \cdot \text{K}_2\text{SO}_4$  is called *potassium chloride sulfate*. With compounds having two or more simple electronegative constituents, the I.U.C. rules permit the use of prefixes to denote the presence of one or more of these constituents; here again alphabetical order (*e.g.*,  $\text{PClF}_2$ , phosphorus chlorodifluoride) seems the simplest, except that *oxy-*, *hydroxy-*, and *sulfo-* have customarily been placed first:  $\text{POBr}_3$ , *phosphorus(V) oxybromide*;  $\text{PSBr}_3$ , *phosphorus(V) sulfobromide*. Though the I.U.C. rules sanction the use of special designations for radicals in oxy salts and *Chemical Abstracts* has used many of these names, only *chromyl* seems justified by experimental results; preference is given to "oxy" names over

*thoryl*, *zirconyl* (used in Vol. I), and *vanadyl* (which has been used for three different radicals). *Carbonyl*, *thiocarbonyl*, *nitrosyl*, *nitryl*, *thionyl*, and *sulfuryl* have been retained because of well-established usage and logical derivation (except for *thionyl*) from the names of the corresponding acids; phosphoryl and thiophosphoryl, although used in recent *Chemical Abstracts* indexes, are not so well established as the others and have been used only in synonyms for names such as *phosphorus(V) oxybromide* ( $\text{POBr}_3$ ) and *phosphorus(V) sulfobromide* ( $\text{PSBr}_3$ ) in Vol. II.

### Oxygen Acids and Salts

The I.U.C. rules have been followed in retaining well-established names for most of the important simple oxygen acids, with as much consistency as possible in the use of the prefixes *ortho-*, *pyro-*, and *meta-* and of *hypo-* and *per-*.

The prefix *ortho-* generally applies to the highest hydroxylated acid known either in the free state or in salts or esters, and *pyro-* and *meta-* denote successive stages of dehydration.  $\text{H}_5\text{IO}_6$  then becomes *orthoperiodic acid* instead of *paraperiodic acid* (*paraperiodate* was used in Vol. I). No provision is made in the I.U.C. rules for naming the highest possible hydroxylated acids (hypothetical in many cases), but they can be designated by the prefix *holo-*, proposed by the German Commission:<sup>4</sup> e.g.,  $\text{H}_7\text{IO}_7$ , *holoperiodic acid*;  $\text{H}_5\text{PO}_5$ , *holophosphoric acid*.

As stated in the I.U.C. rules, the name *hypo . . . ous* has customarily been applied to that acid in which each atom of the acid-forming element exhibits an oxidation stage of two less than that in the corresponding *-ous* acid; e.g.,  $\text{HClO}$ , *hypochlorous acid*;  $\text{HClO}_2$ , *chlorous acid*. Accordingly, the rules strongly recommend abandoning the name "hyposulfurous acid" (as well as the original misnomer "hydrosulfurous acid") for  $\text{H}_2\text{S}_2\text{O}_4$  in favor of *dithionous acid* because of its relation to *dithionic acid*,  $\text{H}_2\text{S}_2\text{O}_6$ .

The use of *per-* is preferably restricted to acids derived from the highest oxidation stages of some elements (*e.g.*,  $\text{HClO}_4$ , *perchloric acid*) to distinguish them from acids derived from hydrogen peroxide and better called *peroxy acids* (*e.g.*,  $\text{H}_2\text{SO}_5$ , *peroxy(mono)sulfuric acid*).

In cases of confusion in the names of acids or anions such as the manganites and manganates and the ferrites and ferrates, the use of the Stock system with an invariable *-ic* or *-ate* ending, followed by the Roman numeral, offers a satisfactory solution:

Formulas	Stock names	Usual names
$\text{M}_2\text{MnO}_2^*$	Manganate(II)	Hypomanganite Manganite
$\text{M}_2\text{MnO}_3$ , $\text{M}_2\text{Mn}_2\text{O}_5$ , etc.	Manganate(IV)	Manganite Permanganite
$\text{M}_2\text{MnO}_4$	Manganate(VI)	Manganate
$\text{MMnO}_4$	Manganate(VII)	Permanganate (retained)

\* M represents a univalent cation.

Replacement of oxygen by sulfur is denoted by *thio-*, with a Greek numeral prefix except that, with mono-substituted acids, mono is usually not expressed (*e.g.*,  $\text{H}_2\text{S}_2\text{O}_3$ , *thiosulfuric acid*;  $\text{H}_2\text{CS}_3$ , *trithiocarbonic acid*).

### “Acid Salts”

In naming “acid salts” the I.U.C. rules recommend the use of “hydrogen” for the hydrogen atoms contained and naming of the hydrogen last of the electropositive constituents. The terms “*primary*,” “*secondary*,” and “*tertiary*” are also admissible, but not terms containing bi-, such as bicarbonate and bisulfate. Thus  $\text{NaHCO}_3$  becomes *sodium hydrogen carbonate* (instead of sodium bicarbonate),  $\text{KHSO}_4$  potassium hydrogen sulfate (not potassium bisulfate), and  $\text{NaH}_2\text{PO}_4$  *sodium dihydrogen phosphate*. The rules do not provide for class names for these compounds or for names for coordinated groups of this type. Since

there is a need for such names at times, *hydrocarbonates*, *hydroperoxides*, and *hydrosulfides* will be used here as class names and *hydrocarbonato*, *hydroperoxo*, and *hydrosulfido* as names for coordinated groups (see Coordination Compounds).

### Coordination Compounds

Complex compounds have been named according to the I.U.C. rules (extended where necessary<sup>5</sup>), on the basis of Werner's nomenclature modified by the Stock system to indicate the oxidation state of the central atom by means of Roman numerals. The order of attached groups is: negative, neutral, positive. The characteristic endings for them are: *-o*, (none), *-ium*, respectively (but *ammine* stands for  $\text{NH}_3$ , and *aquo* for  $\text{H}_2\text{O}$  in deference to usage). The Greek prefixes *mono-*, *di-*, *tri-*, etc., are used with simple substituting groups, and the prefixes *bis-*, *tris-*, *tetrakis-*, etc., with complex names in parentheses. At least with complex anions containing halogeno, cyano, and analogous radicals, it has seemed better always to use numerical prefixes (including *mono-*), since the omission of a prefix in such cases has usually denoted the presence, not of just one group, but of as many of the designated groups as possible (*e.g.*,  $\text{PtCl}_6^-$ , chloroplatinate, better *hexachloroplatinate*). Geometrical isomers are distinguished by the prefixes *cis-* and *trans-* or by numbers, as 1,2- and 1,3-, and 1,2- and 1,6- for planar and octahedral structures, respectively. Optical isomers are distinguished as *d-*, *l-*, *dl-*, and *meso-*. Examples of names involving complex cations, complex anions, and neutral entities are, respectively:

$[\text{CrCl}_2(\text{en})_2]\text{Cl}$	<i>cis</i> -Dichlorobis(ethylenediamine)- chromium(III) chloride
$\text{K}_3[\text{Co}(\text{CN})_6]$	Potassium hexacyanocobaltate(III)*
$[\text{Cu}(\text{H}_2\text{NCH}_2\text{COO})_2]$	Bis(aminoacetato)copper or diglycino- copper

\* The "i" of the Werner system indicating an oxidation state of 3 has been dropped before the *-ate* ending because the Roman numeral III makes it unnecessary. Potassium trioxalatocobaltate,  $\text{K}_3[\text{Co}(\text{C}_2\text{O}_4)_3]$ , of Vol. I then becomes *potassium trioxalatocobaltate(III)*.

### Isopoly and Heteropoly Acids and Salts

Of the two methods of naming isopoly acids and their salts given in the I.U.C. rules, the more satisfactory (partly because it is simpler and more familiar) seems to be the method based on the simplest empirical formulas and employing Greek numerical prefixes through 10 (instead of 12) and Arabic figures for higher numbers. The other method is based on formulas resolved into the base anhydride: acid anhydride ratios, shown by Arabic figures. Thus for  $\text{Na}_2\text{B}_4\text{O}_7$  preference would be given to *disodium tetraborate* rather than sodium (1:2) borate (on the basis of the resolved formula  $\text{Na}_2\text{O}\cdot 2\text{B}_2\text{O}_3$ ) or sodium pyroborate (the usual name, which is incorrect, as the I.U.C. rules point out, because the salt contains less base than the metaborate,  $\text{NaBO}_2$  or  $\text{Na}_2\text{O}\cdot\text{B}_2\text{O}_3$ ). In order to distinguish polymers it is preferable to say "*dimeric*" or "*dimer of,*" etc., rather than to use the same Greek prefixes that denote compounds formed by loss of water. For example, it is better to call the supposed  $(\text{NaPO}_3)_6$  *hexameric* or *hexamer of sodium metaphosphate* than sodium hexametaphosphate.<sup>7</sup>

Heteropoly acids and salts are preferably named in conformity with other complex compounds, the structure-determining element (*e.g.*, phosphorus, silicon, boron) being named last, though these names are often not the common ones. According to the I.U.C. rules, the numbers of atoms of the two acid-forming elements derived from the simplest formula are shown in the name by Arabic figures or Greek numerical prefixes. The formula is obtained by resolution of the acid into: nonmetallic acid, oxide of the acid-forming metal, water; or of the salt into: salt of the nonmetallic acid, oxide of the acid-forming metal, water (see changes made below in formulas and names of three acids in Vol. I). This method of resolution and naming agrees with the results of X-ray crystallographic studies.



Formulas and names used in Vol. I		Resolved formulas and names based thereon	
$H_4SiMo_{12}O_{40} \cdot xH_2O$	Silicomolybdic acid	$H_4SiO_4 \cdot 12MoO_3 \cdot xH_2O$	12-Molybdosilicic acid
$H_4SiW_{12}O_{40} \cdot xH_2O$	Silicotungstic acid	$H_4SiO_4 \cdot 12WO_3 \cdot xH_2O$	12-Tungstosilicic acid
$H_7P(W_2O_7)_6 \cdot xH_2O$	Phosphotungstic acid	$H_3PO_4 \cdot 12WO_3 \cdot xH_2O$	12-Tungstophosphoric acid

### “Onium” Compounds

Salts like ammonium chloride,  $NH_4Cl$ , are named as *-onium* compounds:  $PH_4I$ , *phosphonium iodide*;  $[H_3NOH]Cl$ , *hydroxylammonium chloride* (not hydroxylamine hydrochloride);  $[N_2H_5]HSO_4$ , *hydrazonium hydrogen sulfate* (not hydrazine sulfate). For want of any name for the alleged  $[N_2H_6]^{++}$ , the old name of *hydrazine dihydrochloride* has been retained for  $N_2H_4 \cdot 2HCl$  or  $[N_2H_6]Cl_2$ .

### Hydrates, Ammoniates, and Similar Compounds

So-called “solvates” containing molecules of  $H_2O$ ,  $H_2O_2$ , and  $NH_3$  are called *hydrates*, *peroxyhydrates*, and *ammoniates*, respectively, in accordance with the I.U.C. rules. The number of such molecules present is indicated by Arabic figures rather than Greek numerical prefixes (both methods are given in the I.U.C. rules); *e.g.*, *gallium(III) perchlorate 6-hydrate* (rather than hexahydrate).

### Carbonyls and Related Compounds

Since the I.U.C. rules and the *Chemical Abstracts* indexes do not provide any assistance in naming carbonyls and nitrosyls, the names used in the literature, in which Greek numerical prefixes are used, have been retained; *e.g.*,

$Ni(CO)_4$	Nickel tetracarbonyl
$[Co(CO)_4]_2$	Dicobalt octacarbonyl
$CoNO(CO)_3$	Cobalt nitrosyl tricarbonyl
$H_2Fe(CO)_4$	Iron tetracarbonyl dihydride

## Nitrogen Compounds of Phosphorus and of Sulfur

Compounds of these types are not covered in the I.U.C. rules. In substantial agreement with *Chemical Abstracts* usage many of these compounds can be named as *amido* ( $-\text{NH}_2$ ), *imido* ( $\text{>NH}$ ), and *nitrido* (instead of the more usual nitrilo for  $\text{>N}$ ) substitution derivatives of the oxygen acids (ammono- and ammonoquosphoric, -phosphorous, and -sulfuric acids):<sup>7</sup>

### *Ammonoquosphoric Acids*

$\text{H}_2\text{NPO}(\text{OH})_2$	Amidophosphoric acid
$\text{HN}[\text{PO}(\text{OH})_2]_2$	Imidodiphosphoric acid
$(\text{H}_2\text{N})_2\text{PO}(\text{OH})$	Diamidophosphoric acid
$\text{PO}(\text{NH}_2)_3$	Phosphoramidate [phosphoryl amide or phosphorus(V) oxytriamide]
PON	Phosphorus oxynitride (phosphoryl nitride)

### *Ammonophosphoric Acids*

$\text{P}(\text{NH}_2)_5$	Phosphorus pentamide
$\text{P}_3\text{N}_5$	Triphosphorus pentanitride [phosphorus(V) nitride]

### *Ammonoquo- and Ammonophosphorous Acids*

$\text{H}_2\text{NP}(\text{OH})_2$	Amidophosphorous acid
$(\text{H}_2\text{N})_2\text{POH}$	Diamidophosphorous acid
$\text{P}(\text{NH}_2)_3$	Phosphorus triamide
PN	Phosphorus nitride
$\text{P}_4\text{N}_6$	Tetraphosphorus hexanitride

### *Ammonoquosulfuric Acids*

$\text{H}_2\text{NSO}_2\text{OH}$	Sulfamic acid (amidosulfuric or aminosulfonic acid)
$\text{HN}(\text{SO}_2\text{OH})_2$	Imidodisulfuric acid (imidodisulfonic acid)
$\text{N}(\text{SO}_2\text{OH})_3$	Nitridotrisulfuric acid (nitridotrisulfonic acid)
$\text{SO}_2(\text{NH}_2)_2$	Sulfamide (sulfuramide, sulfuryl amide or diamide)
$\text{HN}(\text{SO}_2\text{NH}_2)_2$	Imidodisulfamide (disulfamyl imide)
$\text{HNSO}_2$	Sulfimide (sulfuryl imide)

## Compounds of Germanium and of Silicon

Certain inorganic compounds of germanium and of silicon have been named at times as though they were derivatives of organic compounds when actually they are not and

may not even be chemically similar. These compounds are not included in the I.U.C. rules. The names given first below are suggested as suitable for representative

## GERMANIUM COMPOUNDS\*

Parent compounds		Derivatives	
GeH <sub>4</sub>	<i>Germane</i> (monogermane, "germanomethane")	GeHI <sub>3</sub>	Triiodogermane ("germanoiodoform")
Ge <sub>2</sub> H <sub>6</sub>	<i>Digermane</i> ("germanoethane")	(C <sub>2</sub> H <sub>5</sub> ) <sub>3</sub> GeGe(C <sub>2</sub> H <sub>5</sub> ) <sub>3</sub>	Hexaethyldigermane
Ge <sub>3</sub> H <sub>8</sub>	<i>Trigermane</i> ("germanoethane")	(C <sub>6</sub> H <sub>5</sub> ) <sub>3</sub> GeGe(C <sub>6</sub> H <sub>5</sub> ) <sub>2</sub> Ge(C <sub>6</sub> H <sub>5</sub> ) <sub>3</sub>	Octaphenyltrigermane
HGeOOH	Germanoic acid [germanium(II) hydroxide, " <i>germanoformic acid</i> "]		

\* *Chemical Abstracts* index names for parent compounds are italicized, and organic-type names are in quotes.

SILICON COMPOUNDS<sup>\*,8,9</sup>

Parent compounds		Derivatives	
SiH <sub>4</sub>	Silane (monosilane, <i>silicane</i> , "silicomethane")	SiH <sub>3</sub> Br	Bromosilane
		SiH <sub>2</sub> Br <sub>2</sub>	Dibromosilane
		SiHBr <sub>3</sub>	Tribromosilane ("silicobromoform")
		SiBr <sub>4</sub>	Silicon tetrabromide (tetrabromosilane)
		SiClF <sub>3</sub>	Silicon chlorotrifluoride (chlorotrifluorosilane)
Si <sub>2</sub> H <sub>6</sub>	Disilane (disilicane, " <i>disilicoethane</i> ," "silicoethane")	Si <sub>2</sub> Br <sub>6</sub>	Disilicon hexabromide (hexabromodisilane)
Si <sub>3</sub> H <sub>8</sub>	Trisilane (trisilicane, " <i>trisilicopropane</i> ," "silicopropane")		
SiH <sub>3</sub> OH	Silanol (silicanol, <i>silicol</i> )	(C <sub>6</sub> H <sub>5</sub> ) <sub>3</sub> SiOH	Triphenylsilanol
Si(OH) <sub>4</sub>	(Ortho)silicic acid (silanetetro)	Si(OC <sub>2</sub> H <sub>5</sub> ) <sub>4</sub>	Tetraethyl (ortho)silicate (tetraethoxysilane)

\* *Chemical Abstracts* index names [through Vol. 39 (1945)] for parent compounds are italicized, and organic-type names are in quotes.

compounds and for both inorganic and organic derivatives; these names are analogous to arsine, stibine, phosphine, and bismuthine and names based thereon.

### Organic Compounds and Coordination Groups

The rules of the I.U.C. (Definitive Report of the Commission on the Reform of the Nomenclature of Organic Chemistry<sup>10</sup>) and the *Chemical Abstracts* indexing system<sup>3</sup> are followed for the most part, with adaptation to meet the needs of situations encountered in certain coordination compounds.<sup>5</sup> For example,  $\text{OCH}_2\text{CH}_2\text{OCH}_2\text{CH}_2$  is called *p-dioxane* and  $\text{NH}_2\text{CH}_2\text{CH}_2\text{NH}_2$  is called *ethylenediamine* (instead of the I.U.C. name, 1,2-ethanediamine); e.g.,  $[\text{Cr}(\text{en})_3]_2(\text{SO}_4)_3$ , *tris(ethylenediamine)chromium(III) sulfate*. For the naming of metallic derivatives of 1,3-diketones, see page 16.

### References

1. SCOTT: *Chem. Revs.*, **32**, 73-97 (1943).
2. JORISSEN, BASSETT, DAMIENS, FICHTER, and REMY: *J. Am. Chem. Soc.*, **63**, 889-897 (1941). Reprints can be obtained for 10 cents apiece from E. J. Crane, *Chemical Abstracts*, The Ohio State University, Columbus 10, Ohio.
3. *Chemical Abstracts* Subject Index, Vol. 39, Introduction, p. 5869 (1945). Reprints are obtainable for fifty cents apiece.
4. MEYER, *Helv. Chim. Acta*, **20**, 159-175 (1937).
5. FERNELIUS, LARSEN, MARCHI, and ROLLINSON: in press.
6. STOCK: *Z. angew. Chem.*, **32**, I, 373-374 (1919); *Chem. Abstracts*, **14**, 19417; *Z. angew. Chem.*, **33**, Aufsatzteil, 79-80 (1920); *Chem. Abstracts*, **15**, 2799<sup>e</sup>.
7. AUDRIETH, STEINMAN, and TOY: *Chem. Revs.*, **32**, 99-108 (1943).
8. SAUER: *J. Chem. Education*, **21**, 303-305 (1944).
9. Dow-Corning Nomenclature Committee: *Progress Repts.* (mimeographed), No. 1 (July 1, 1944); No. 2 (Sept. 20, 1944). Nomenclature, Spelling, and Pronunciation Committee, The American Chemical Society: *The Nomenclature of Silicon Compounds* (unpublished) (March, 1946).
10. PATTERSON: *J. Am. Chem. Soc.*, **55**, 3905-3925 (1933). Reprints can be obtained for 10 cents apiece from E. J. Crane, *Chemical Abstracts*, The Ohio State University, Columbus 10, Ohio.

## SUBJECT INDEX

In this cumulative subject index for the first two volumes, it has been necessary to change some of the names used in the text and index in Vol. I to conform with the names adopted in Vol. II (see Appendix, page 257). The chief changes involve (1) the substitution of the Stock system (as, *Iron(II) oxide*; *Potassium hexachlororhenate(IV)*) for "ous" and "ic" and "ite" and "ate" names (as, ferric oxide; potassium chlororhenite); (2) the introduction of general headings such as *Chromium(III) complex compounds* and *Ammine*s for grouping ammine and similar coordination compounds, in addition to entries under specific names for individual compounds (halogeno and cyano complexes, however, have been entered only under their specific names, which are less cumbersome than the names for the other complexes); (3) the use for heteropoly acids of names in which the structure-determining element (as phosphorus) is named last (as, *12-Tungstophosphoric acid* instead of phosphotungstic acid); (4) the use of general headings obtained by dropping (at the beginnings of names) numerical prefixes and prefixes such as "ortho-" and "meta-," but not "hypo-" and "per-" (as, *Silicon chlorides*; *Phosphoric acid*).

Formulas for specific compounds are used under general headings, such as *Chromium(III) complex compounds* and *Silicon chlorides*, and with a few unsatisfactory names that have been retained (in quotation marks) for want of better ones. The formula index should also prove particularly helpful in troublesome cases.

In view of these changes in practice, it has seemed advisable to make entries or cross references under all names used in the Vol. I index and under specific names for compounds entered under group headings. Thus, two or more entries may be made for one compound in these and a few other cases. As in *Chemical Abstracts* indexes, for example, two entries are made for compounds having two cations.

Inverted names are used only for derivatives of silanes (as *Silane, dibromo-*; *Disilane, hexachloro-*), but not for the few organic compounds (this last is contrary to *Chemical Abstracts* practice).

Headings are alphabetized straight through, letter by letter, as in *Chemical Abstracts* indexes, not word by word. Roman numerals in Stock names are ignored unless two or more names are otherwise the same.

A	Acetic acid-acetic anhydride solution, <b>1:85</b>
Acetic acid, glacial, dehydration for use in preparation of titanium derivative of acetylacetone, <b>2:119</b>	Acetylacetone, metal derivatives of, <b>2:14, 17, 25, 119, 121, 123</b> metal derivatives of, nomenclature of, <b>2:16</b>

- Acetylacetone, structure of, **2:10**  
 Acetylene, purification of, **2:76**  
 Acids, nomenclature of isopoly and heteropoly, **2:263**  
   nomenclature of oxygen, **2:260**  
 Alkali metal amides, **1:74; 2:80, 128, 135**  
 Alkali metal azides, **1:79, 2:139**  
 Alkali metal cyanates, **2:86**  
 Alkali metal pyrosulfites, **2:162**  
 Alkali metal sulfites, **2:162**  
 Alkaline earth azides, **1:79**  
 Allanite, extraction of, **2:44**  
 Alumino-oxalates (*see* Aluminum complex compounds)  
 Aluminum acetylacetonate, **2:25**  
 Aluminum complex compounds, anions, oxalato,  $K_3[Al(C_2O_4)_3] \cdot 3H_2O$ , **1:36**  
   nonelectrolytes, with acetylacetone,  $Al(C_5H_7O_2)_3$ , **2:25**  
 Aluminum selenide, **2:183, 184**  
 Amalgams, **1:5**  
   europium, **2:65, 66, 68n.**  
   rare earth, **1:15**  
     concentration of, **1:17**  
 Amides, alkali metal, **1:74; 2:80, 128, 135**  
 Ammines, of chromium(III), **2:196**  
   of cobalt(III), **1:186, 187, 188; 2:216**  
   of copper(I), **2:4**  
   (*See also* Ammoniates)  
 Ammonia, purification of, **1:75; 2:76**  
   reaction of liquid, with sodium, **2:128, 134**  
 Ammoniates, of hexamminecobalt(III) chloride, **2:220**  
   nomenclature of, **2:264**  
   of thorium acetylacetonate, **2:123**  
   of thorium bromide, **1:54**  
   (*See also* Ammines)  
 Ammonium azide, **2:136**  
   by neutralization of hydrazoic acid with ammonia, **2:136**  
   by reaction of sodium azide with an ammonium salt, **2:137**  
 Ammonium carbamate, **2:85**  
 Ammonium difluophosphate, **2:157**  
 Ammonium hexachlorotellurate(IV), **2:189**  
 Ammonium imidodisulfates,  $HN(SO_3NH_4)_2$ , **2:180**  
    $NH_4N(SO_3NH_4)_2 \cdot H_2O$ , **2:179, 180**  
 Ammonium ion, qualitative tests for, in cyanates, **2:89**  
 Ammonium monofluophosphate, **2:155**  
 Ammonium perrhenate, mixture of, with ammonium nitrate, **1:177, 178**  
 Ammonium salt of nitrourethan, **1:69**  
 Ammonium sulfamate, **2:180**  
   formation of, from pyridine-sulfur trioxide, **2:175**  
 Ammonium tetrafluoborate, **2:23**  
   by fusion reaction, **2:24**  
   by reaction in aqueous solution, **2:23**  
 Ammonoaquophosphoric acids, nomenclature of, **2:265**  
 Ammonoaquophosphorous acids, nomenclature of, **2:265**  
 Ammonoaquosulfuric acids, nomenclature of, **2:265**  
 Ammonophosphoric acids, nomenclature of, **2:265**  
 Ammonophosphorous acids, nomenclature of, **2:265**  
 Aniline, compound with thorium acetylacetonate, **2:215**  
 Anions, nomenclature of, **2:258**  
 Antimony(III) iodide, **1:104**  
 Antimony(III) oxyiodide, formation of, by antimony(III) iodide, **1:105**  
 Aquopentamminecobalt(III) bromide, **1:187, 188**  
 Arsenic(III) iodide, **1:103**  
 Asbestos, platinized, **1:160**  
 Atomic weight, determination of average, of rare earth elements in a mixture, **2:58**  
 Azides, alkali and alkaline earth, **1:79; 2:136, 139, 140**

- “Azido-carbon disulfide,”  
 $(\text{SCSN}_3)_2$ , 1:81, 82
- Azidodithiocarbonic acid,  $\text{HSCSN}_3$ ,  
 1:81, 82
- Azoimides (see Azides)
- B
- Barium amalgam, 1:11  
 by displacement method, 1:14  
 by electrolytic method, 1:12
- Barium bromate, 2:20
- Barium dithionate, 2:170
- Barium orthoperiodate (paraperiodate), 1:171
- Benzalazine, 1:92
- Benzoylacetone, beryllium derivative of, 2:19
- Beryllium acetylacetonate, 2:17
- Beryllium complex compounds, nonelectrolytes, with acetylacetone,  $\text{Be}(\text{C}_5\text{H}_7\text{O}_2)_2$ , 2:17  
 nonelectrolytes, with benzoylacetone,  $\text{Be}(\text{C}_{10}\text{H}_9\text{O}_2)_2$ , 2:19  
 with dibenzoylmethane,  $\text{Be}(\text{C}_{15}\text{H}_{11}\text{O}_2)_2$ , 2:19  
 with ethyl acetoacetate,  $\text{Be}(\text{C}_6\text{H}_9\text{O}_3)_2$ , 2:19
- Binary compounds, nomenclature of, 2:257
- Bismuth magnesium nitrate,  $2\text{Bi}(\text{NO}_3)_3 \cdot 3\text{Mg}(\text{NO}_3)_2 \cdot 24\text{H}_2\text{O}$ , separation of europium from samarium and gadolinium by, 2:57
- Bis(2,4-pentanediono)beryllium, 2:17
- trans*-Bis(thiocyanato)bis(ethylenediamine)chromium(III) thiocyanate, 2:200, 202
- Bis[tris(2,4-pentanediono)titanium(IV)] hexachlorotitanate(IV), 2:119
- Boron fluoride, for catalysis, 1:23  
 high-purity, 1:21
- Boron oxide, porous, 2:22
- Bromamide, di- $(\text{NHBr}_2)$ , 1:62  
 analysis of, 1:64
- Bromine solution, in carbon tetrachloride, 1:86
- Bromopentamminecobalt(III) bromide, 1:186
- Bromoplumbic(IV) acid  $(\text{H}_2\text{PbBr}_6)$ , 1:48
- Butyl nitrite, 2:139
- C
- Calcium dithionate, 2:168
- Carbonates, qualitative test for, in cyanates, 2:89
- Carbon monoxide, 2:81
- Carbon tetrafluoride, 1:34
- Carbonyls, metal, 2:229  
 metal, nomenclature of, 2:264  
 structure of, 2:232
- Catalysts, boron fluoride, 1:23  
 chromium(III) oxide gel, 2:190  
 iron, for preparation of sodium amide, 2:133  
 silica gel for, or for supports, 2:95, 98
- Cement, laboratory, 1:189
- Cerite, extraction of, 2:44
- Cerium, separation of, from rare earth mixtures, 2:43, 47, 48  
 test for, 2:50
- Cerium amalgam, 1:15
- Cerium-group earths, separation of, from yttrium earths by double-sulfate method, 2:44, 46
- Cerium(III) magnesium nitrate,  $2\text{Ce}(\text{NO}_3)_3 \cdot 3\text{Mg}(\text{NO}_3)_2 \cdot 24\text{H}_2\text{O}$ , separation of praseodymium from lanthanum by, 2:57
- Cerium(III) nitrate, 2:51
- Cerium(IV) nitrate, basic, 2:49
- Cesium, cesium azide for preparation of, 1:79
- Cesium azide, 1:79
- Charcoal, sugar, 2:74
- Chelate compounds, of 1, 3-diketones, 2:11  
 of *o*-hydroxyaldehydes and *o*-hydroxyphenones, 2:11

- Chloramide ( $\text{NH}_2\text{Cl}$ ), 1:59  
 analysis of, 1:62
- Chloropentamminechromium(III) chloride, formation of, from chromium(III) chloride, 2:196
- Chloroplatinic(II) acid ( $\text{H}_2\text{PtCl}_4$ , chloroplatinous acid), solution of, 2:251
- Chloroplumbic(IV) acid ( $\text{H}_2\text{PbCl}_6$ ), 1:48
- Chromioxalates (see Chromium complex compounds)
- Chromium(II) acetate, 1:122
- Chromium(II) chloride, 1:125  
 3-hydrate, 1:126  
 4-hydrate, 1:126  
 solution, 1:124
- Chromium(III) chloride, anhydrous, 2:193
- Chromium(III) chromate, formation of, in reduction of chromium(VI) oxide to chromium(III) oxide, 2:192
- Chromium(III) complex compounds, anions, oxalato,  $\text{K}_3[\text{Cr}(\text{C}_2\text{O}_4)_3] \cdot 3\text{H}_2\text{O}$ , 1:37  
 cations, ammines,  $[\text{Cr}(\text{NH}_3)_6\text{Cl}]\text{Cl}_3$ , 2:196  
 $[\text{Cr}(\text{NH}_3)_6]\text{Cl}_3$ , 2:196  
 with ethylenediamine, 2:196, 200  
*cis*- $[\text{Cr}(\text{en})_2\text{Cl}_2]\text{Cl} \cdot \text{H}_2\text{O}$ , 2:200, 201  
*trans*- $[\text{Cr}(\text{en})_2(\text{SCN})_2](\text{SCN}) \cdot \text{H}_2\text{O}$ , 2:200, 202  
 $[\text{Cr}(\text{en})_3]\text{Br}_3 \cdot 4\text{H}_2\text{O}$ , 2:199  
 $[\text{Cr}(\text{en})_3]\text{Cl}_3 \cdot 3\frac{1}{2}\text{H}_2\text{O}$ , 2:198  
 $[\text{Cr}(\text{en})_3]\text{I}_3 \cdot \text{H}_2\text{O}$ , 2:199  
 $[\text{Cr}(\text{en})_3](\text{SCN})_3 \cdot \text{H}_2\text{O}$ , 2:199  
 $[\text{Cr}(\text{en})_3]_2(\text{SO}_4)_3$ , 2:198
- Chromium(VI) dioxchloride, 2:205
- Chromium(III) oxide gel, 2:190  
 catalytic activity of, 2:191
- Chromium oxychloride, formation of, by  $\text{CrCl}_2$ , 1:126
- Chromium(III) sulfate, anhydrous, 2:197
- Chromyl chloride, 2:205
- Cinnabar, 1:20
- Cobalt carbonyls,  $[\text{Co}(\text{CO})_8]_4$ , formation from  $[\text{Co}(\text{CO})_4]_2$ , 2:243  
 $[\text{Co}(\text{CO})_4]_2$ , 2:238, 242
- Cobalt(III) complex compounds, anions, oxalato,  $\text{K}_3[\text{Co}(\text{C}_2\text{O}_4)_3]$ , 1:37  
 cations, ammine, 1:186, 2:216  
 determination of hexamminecobalt(III) ion, 2:220  
 $[\text{Co}(\text{NH}_3)_5\text{Br}]\text{Br}_2$ , 1:186  
 $[\text{Co}(\text{NH}_3)_5\text{H}_2\text{O}]\text{Br}_3$ , 1:187, 188  
 $[\text{Co}(\text{NH}_3)_6]\text{Br}_3$ , 2:219  
 $[\text{Co}(\text{NH}_3)_6]\text{Cl}_3$  (and  $+6\text{NH}_3$ ), 2:217, 220  
 $[\text{Co}(\text{NH}_3)_6](\text{NO}_3)_3$ , 2:218  
 $[\text{Co}(\text{NH}_3)_6]_2(\text{C}_2\text{O}_4)_3 \cdot 4\text{H}_2\text{O}$ , 2:220  
 with ethylenediamine,  $[\text{Co}(\text{en})_3]\text{Cl}_3$ , 2:221  
*cis*- and *trans*- $[\text{Co}(\text{en})_2\text{Cl}_2]\text{Cl}$ , 2:222, 223, 224
- Cobaltioxalates (see Cobalt complex compounds)
- Cobalt nitrosyl tricarbonyl, 2:238, 239
- Cobalt tetracarbonyl hydride, 2:238, 240  
 potassium salt of, 2:238
- Coordination compounds, nomenclature of, 2:262, 267
- Copper(I) bromide, 2:3
- Copper carbonyl chloride,  $[\text{CuCl} \cdot \text{CO}] \cdot 2\text{H}_2\text{O}$ , 2:4
- Copper(I) chloride, 2:1
- Copper(I) complex compounds, ammine, from copper(I) chloride, 2:4  
 chloro, from copper(I) chloride, 2:4
- Crystallization, fractional, of magnesium rare earth nitrates, 2:52, 53  
 fractional, of rare earth bromates, 2:62
- Cyanates, alkali metal, 2:86  
 qualitative test for, 2:89



- Cyanides, qualitative test for, in cyanates, **2:89**  
 Cyanogen chloride, **2:90**  
   analysis of an ethereal solution of, **2:93**  
 Cyanuric chloride, formation of, from cyanogen chloride, **2:94**

## D

- Diammonium imidodisulfate, **2:180**  
 Dibenzoylmethane, beryllium derivative of, **2:19**  
 Dibromamide (dibromoamine), **1:62**  
   analysis of, **1:64**  
*cis*-Dichlorobis(ethylenediamine)-chromium(III) chloride, **2:200, 201**  
 Dichlorobis(ethylenediamine)cobalt(III) chloride, *cis*- and *trans*-, **2:222, 223**  
   resolution of *cis*-, **2:222, 224**  
 Dichlorodiammineplatinum, formation from  $[\text{Pt}(\text{NH}_3)_4]\text{Cl}_2$ , **2:253**  
 Dicobalt octacarbonyl, **2:238, 242**  
 1,3-Diketones, metal derivatives of, **2:10, 12, 14**  
   metal derivatives, nomenclature of, **2:16**  
   structure of, **2:10**  
   (See also 2,4-Pentanedione)  
 Dimethylaniline, purification of, **2:174n.**  
 Dimethylaniline-sulfur trioxide, **2:174**  
 Dioxane-bis(sulfur trioxide), **2:174**  
 Dioxane-sulfur trioxide, **2:174**  
 Diphosphorus tetraiodide, **2:143**  
 Disilane, hexabromo-, **2:98**  
 Disilane, hexachloro-, **1:42**  
 Disilicon hexabromide, **2:98**  
 Disilicon hexachloride, **1:42**  
 Disodium acetylide,  $\text{NaC}\equiv\text{CNa}$ , **2:79, 80**  
 Dithionic acid, salts of, **2:167**  
 Dithiotriazofornic acid ( $\text{HSCSN}_3$ ), **1:81**

## E

- Ethyl acetoacetate, beryllium derivative of, **2:19**  
 Ethylenediamine, anhydrous, **2:197**  
   complex cations with chromium(III), **2:196, 200**  
   complex cations with cobalt(III), **2:221, 222**  
 Ethynylsodium,  $\text{NaC}\equiv\text{CH}$ , **2:75, 76, 79**  
 Europium, purity of preparations of, tests for, **2:68**  
   separation of, from rare earth mixtures, as amalgam, **2:65, 68**  
   from samarium and gadolinium, as magnesium nitrate double salt, **2:57**  
 Europium(II) acetate, formation of, from europium amalgam, **2:68**  
 Europium(III) acetate, **2:66**  
   citrate solution of, **2:67**  
 Europium amalgams, **2:65, 66, 68n.**  
 Europium(II) carbonate, **2:69, 71**  
 Europium(II) chloride, **2:69, 71**  
   formation of, from europium amalgam, **2:68**  
 Europium(III) oxalate, **2:66**  
 Europium(III) oxide, **2:66**  
 Europium(II) salts, **2:69**  
 Europium(II) sulfate, **2:69, 70**

## F

- Ferric compounds [see *specific compounds under Iron(III)*]  
 Ferrioxalates [see *Iron(III) complex compounds*]  
 Ferrous compounds [see *specific compounds under Iron(II)*]  
 Fluoboric acid,  $\text{HBF}_4$ , **1:25**  
 Fluorides, of sulfur(VI), selenium(VI), and tellurium(VI), **1:121**  
 Fluorine, **1:136**  
   by high-temperature method, **1:138**  
   electrolyte for, **1:140**

- Fluorine, by medium-temperature method, 1:142  
electrolyte for, 1:143
- G
- Gadolinite, extraction of, 2:44  
separation of europium from samarium and, as magnesium nitrate double salt, 2:57
- Gallium, 1:26  
removal of, from glass, 2:27
- Gallium(III) chloride, 1:26
- Gallium(III) oxide, insoluble, formation of, from gallium(III) perchlorate 6-hydrate, 2:29
- Gallium(III) perchlorate, basic, formation of, from gallium(III) perchlorate 6-hydrate, 2:29  
6-hydrate, 2:26  
9½-hydrate, 2:28
- Germanium(IV) chloride, 2:109
- Germanium compounds, nomenclature of, 2:265
- Germanium imides, formation of, from germanium iodides, 2:103, 114
- Germanium(II) iodide, 2:106
- Germanium(IV) iodide, 2:112
- Germanium(II) sulfide, precipitated, 2:102  
from germanium(IV) oxide, 2:103  
from germanium(IV) sulfide, 2:104
- Guanidonium nitrate, 1:94,  
from calcium cyanamide, 1:97  
from dicyandiamide, 1:96
- H
- Halogenoplumbic(IV) acids,  $H_2PbX_6$ , 1:48
- Halogenotellurates(IV), 2:188
- Halotellurites, 2:188
- Heteropoly acids, nomenclature of, 2:263
- Hexabromoplumbic(IV) acid, 1:48
- Hexachloroplumbic(IV) acid, 1:48
- Hexahalogenoplumbic acids, 1:48
- Hexahalogenotellurates(IV), 2:188
- Hexamminechromium(III) chloride, formation of, from chromium(III) chloride, 2:196
- Hexamminecobalt(III) bromide, 2:219
- Hexamminecobalt(III) chloride, 2:217  
6-ammoniate, 2:220
- Hexamminecobalt(III) nitrate, 2:218
- Hexamminecobalt(III) oxalate, 2:220
- Hydrates, nomenclature of, 2:264
- Hydrazine, 1:90  
residues, recovery of, 1:92
- Hydrazine dihydrochloride, 1:92
- Hydrazoic acid, 1:77, 78
- Hydrazonium hydrogen sulfate, 1:90, 92, 94
- Hydriodic acid, 1:157, 159  
by action of iodine on hydrogen sulfide, 1:157  
constant-boiling, 1:158  
fuming, 1:162  
regeneration of oxidized solutions of, 2:210  
stabilization of, 1:159
- Hydrobromic acid, constant-boiling, 1:155  
(See also Hydrogen bromide)
- Hydrogen azide, 1:77  
ethereal solution, 1:77, 78
- Hydrogen bromide, 1:39, 114, 149, 150  
by bromination of tetrahydronaphthalene, 1:151  
by direct combination over platinumized silica gel, 1:152  
(See also Hydrobromic acid)
- Hydrogen chloride, 1:147; 2:72
- Hydrogen compounds, binary, nomenclature of, 2:258
- Hydrogen fluoride, anhydrous, 1:134
- Hydrogen iodide, by catalytic union, 1:159  
(See also Hydriodic acid)
- Hydrogen selenide, 2:183, 184
- Hydrogen sulfide, liquid, 1:111

*o*-Hydroxyaldehydes, metal derivatives of, **2:11**  
 Hydroxylamine, **1:87**  
 Hydroxylammonium chloride, recovery of, **1:89**  
*o*-Hydroxyphenones, metal derivatives of, **2:11**  
 Hypochlorite solution, **1:90**  
 Hypovanadous oxide (*see* Vanadium(II) oxide)

## I

Iodine, recovery of, from silver iodide residues, **2:6, 8**  
 Iodine(I) chloride, **1:165**  
 Iodine(III) chloride, **1:167**  
 Iron, catalysts for preparation of sodium amide, **2:133**  
 Iron(II) complex compounds, cations, with pyridine,  $[\text{Fe}(\text{C}_5\text{H}_5\text{N})_4]\text{Cl}_2$ , **1:184**  
 Iron(III) complex compounds, anions, oxalato,  $\text{K}_3[\text{Fe}(\text{C}_2\text{O}_4)_3] \cdot 3\text{H}_2\text{O}$ , **1:36**  
 Iron(III) oxide, beta-, 1-hydrate, **2:215**  
   gamma-, **1:185**  
   1-hydrate, **1:185**  
 Iron tetracarbonyl dihydride, **2:243**  
   potassium salt of, in solution, **2:244**  
 Isopoly acids, nomenclature of, **2:263**

## L

Lanthanide contraction, **2:32**  
 Lanthanides, term, **2:29**  
 Lanthanum, separation of mixtures with praseodymium from monazite, as magnesium nitrate double salt, **2:56, 57**  
 Lanthanum amalgam, **1:15**  
 Lanthanum chloride, anhydrous, **1:32**  
 Lead(IV) acetate, **1:47**  
 Lead(IV) oxide, **1:45**  
 Lead(II) thiocyanate, **1:85**

Lithium amide, **2:135**  
 Lithium carbonate, purification of, **1:1**

## M

Magnesium bismuth nitrate,  $3\text{Mg}(\text{NO}_3)_2 \cdot 2\text{Bi}(\text{NO}_3)_3 \cdot 24\text{H}_2\text{O}$ , separation of europium from samarium and gadolinium by, **2:57**  
 Magnesium cerium(III) nitrate,  $\text{Mg}(\text{NO}_3)_2 \cdot 2\text{Ce}(\text{NO}_3)_3 \cdot 24\text{H}_2\text{O}$ , separation of praseodymium from lanthanum by, **2:57**  
 Magnesium chloride, anhydrous, **1:29**  
 Magnesium rare earth nitrates, **2:43, 47, 52**  
   fractional crystallization of, **2:53**  
 Manganates, nomenclature of, **2:261**  
 Manganese(II) chloride, anhydrous, **1:29**  
 Manganese(III) orthophosphate, **2:213**  
 Manganites, nomenclature of, **2:261**  
 Marble, for use in separation of cerium from rare earth mixtures by bromate method, **2:49**  
 Mercury, solubility of metals in, **1:6**  
 Mercury(II) sulfide, red, **1:19**  
 Metals, solubility of mercury in, **1:6**  
 "Metaplumbates," **1:45**  
 "Metaplumbic acid," **1:45**  
 12-Molybdosilicic acid, **1:127**  
   analysis of, **1:128**  
 Monazite, extraction of, **2:38**  
   separation of rare earths from, **2:56**  
 Monochloramide (monochloroamine), **1:59**  
   analysis of, **1:62**  
 Monosodium acetylide, **2:75, 76, 79**

## N

Neodymium, determination of atomic weight of, in neodymium oxalate, **2:61**

- Neodymium, separation of, from samarium from monazite, as magnesium nitrate double salt, **2:56, 57**
- Neodymium amalgam, **1:15**
- Neodymium chloride, anhydrous, **1:32**
- Neodymium oxalate, determination of atomic weight of neodymium in, **2:60**
- Nickel cyanide, **2:228**
- Nickel tetracarbonyl, **2:234**
- Nitramide, **1:68, 72**
- Nitric oxide, **2:126**
- Nitrocarbarnates, **1:68, 69, 70**
- Nitrogen, pure, azides for preparation of, **1:79**
- Nitrogen(III) chloride, **1:65**  
analysis of, **1:67**
- Nitrogen compounds, of phosphorus, nomenclature of, **2:265**  
of sulfur, nomenclature of, **2:265**
- Nitrogen(II) oxide, **2:126**
- Nitrosyl chloride, **1:55**  
analysis of, **1:57**
- Nitrosyls, nomenclature of, **2:264**
- Nitrosylsulfuric acid, **1:55**
- Nitrourethan, and ammonium salt, **1:69**
- Nomenclature, of inorganic compounds, **2:257**  
of metal derivatives of I,3-diketones, **2:16**  
of organic compounds and coordination groups, **2:267**  
of rare earth elements and their compounds, **2:29**
- O
- "Onium" compounds, nomenclature of, **2:264**
- Organic compounds, nomenclature of, **2:267**
- Organic coordination groups, nomenclature of, **2:267**
- Orthite, extraction of, **2:44**
- Orthoperiodic acid ( $H_5IO_6$ ), **1:172**  
solubility in nitric acid, **1:173**
- Orthophosphoric acid, **1:101**
- Oxalates, determination of, in rare earth oxalates, **2:60**
- Oxalato salts, **1:35**
- Oxygen acids, nomenclature of, **2:260**
- Oxygen fluoride, **1:109**
- P
- Paracyanogen, formation of, from sodium cyanide and chlorine, **2:92n.**
- Paraperiodic acid (*see* Periodic acid)
- 2,4-Pentanedione, metal derivatives of, **2:14, 17, 25, 119, 121, 123**  
metal derivatives of, nomenclature of, **2:16**  
structure of, **2:10**
- Perchloric acid, removal of, from gallium perchlorate 6-hydrate, **2:28**
- Periodates, **1:168**  
analysis of, **1:170**
- Periodic acid ( $H_5IO_6$ ), **1:172**  
solubility in nitric acid, **1:173**
- Peroxyhydrates, nomenclature of, **2:264**
- Phosphonium iodide, **2:141, 143**
- Phosphoric acid,  $H_3PO_4$ , crystalline, **1:101**
- Phosphorus, mixture of, with diphosphorus tetraiodide, **2:143**
- Phosphorus(III) bromide, **2:147**
- Phosphorus(III) chloride, **2:145**
- Phosphorus(V) chloride, **1:99**
- Phosphorus compounds, of nitrogen, nomenclature of, **2:265**
- Phosphorus iodides,  $P_2I_4$ , mixture of, with phosphorus, **2:143**
- Phosphorus(V) oxybromide, **2:151**
- Phosphorus(V) sulfobromide, **2:153**
- Phosphorus(V) sulfobromodifluoride, formation of, from phosphorus(V) sulfobromide, **2:154**

- Phosphorus(V) sulfodibromofluoride, formation of, from phosphorus(V) sulfobromide, **2:154**
- Phosphorus(V) sulfofluoride, formation of, from phosphorus(V) sulfobromide, **2:154**
- Phosphoryl tribromide, **2:151**
- Phosphotungstic acid (*see* 12-Tungstophosphoric acid)
- Platinic compounds [*see specific compounds under* Platinum(IV)]
- Platinized asbestos, **1:160**
- Platinized silica gel, use of, in preparation of hydrogen bromide, **1:152**
- Platinum(IV) chloride, **2:253**
- Platinum(II) complex compounds, cations, ammines,  $[\text{Pt}(\text{NH}_3)_4]\text{Cl}_2$  and 1-hydrate, **2:250**  
 $[\text{Pt}(\text{NH}_3)_4][\text{PtCl}_4]$ , **2:251**  
nonelectrolytes, ammines,  $[\text{Pt}(\text{NH}_3)_2\text{Cl}_2]$ , **2:253**
- Plumbates,  $\text{M}_2\text{PbO}_3$ , **1:45**
- "Plumbic acid,"  $\text{H}_2\text{PbO}_3$ , **1:46**
- Plumbic compounds [*see specific compounds under* Lead(IV)]
- Plumbous compounds [*see specific compounds under* Lead(II)]
- Potassium, potassium azide for preparation of, **1:79**
- Potassium amide, **2:135**
- Potassium azide, **1:79**; **2:139**, **140**
- Potassium chloroplatinite, **2:247**
- Potassium cyanate, **2:87**
- Potassium hexabromotellurate(IV), **2:189**
- Potassium hexachlororhenate(IV), **1:178**
- Potassium hexacyanochromate(III), **2:203**
- Potassium hexacyanocobaltate(III), **2:225**  
analysis of, **2:226**
- Potassium hexacyanomanganate(II), formation of, from potassium hexacyanomanganate(III), **2:214**
- Potassium hexacyanomanganate(III), **2:213**, **214**
- Potassium hydrogen fluoride, **1:140**
- Potassium hydrogen sulfite, in solution, **2:167**
- Potassium iodide, for use as a primary standard, **1:163**
- Potassium metáperiodate, **1:171**
- Potassium monochlorochromate, **2:208**
- Potassium nitridotrisulfate, **2:182**
- Potassium nitrocarbamate, potassium salt, **1:68**, **70**
- Potassium permanganate, solution of, standardization of, for determination of average atomic weight of rare earth elements in oxalates, **2:60**, **61**
- Potassium pyrosulfite, **2:166**  
and its  $\frac{2}{3}$ -hydrate, **2:165**
- Potassium rare earth sulfates, **2:47**
- Potassium selenocyanate, **2:186**
- Potassium sulfite, anhydrous, **2:166**  
solubility of, **2:165**
- Potassium tetrachloroplatinate(II), **2:247**
- Potassium tetracyanonickelate(II), **2:227**, **228**
- Potassium tetracyanopalladate(II), **2:245**  
analysis of, **2:246**  
1- and 3-hydrates, **2:246**
- Potassium tetrafluoroborate, **1:24**
- Potassium trioxalatoaluminate, **1:36**
- Potassium trioxalatochromate(III), **1:37**
- Potassium trioxalatocobaltate(III), **1:37**
- Potassium trioxalatoferrate(III), **1:36**
- Praseodymium, separation of mixtures with lanthanum from monazite, as magnesium nitrate double salt, **2:56**, **57**
- Pyridine, complex cation with iron(II), **1:184**  
purification of, **2:173n**.
- Pyridine-sulfur trioxide, **2:173**

- Pyridinium *N*-phenylsulfamate, 2:175
- Pyrolusite, in oxidation of sulfurous acid to dithionate ion, 2:168
- Pyrosulfites, alkali metal, 2:162
- R
- Radicals, nomenclature of, in oxy salts and similar compounds, 2:259
- Rare earth acetates, citrate solution of, 2:69
- Rare earth amalgams, 1:15  
concentration of, 1:17
- Rare earth bromates, 2:43, 47, 56, 59, 64  
fractional crystallization of, 2:62
- Rare earth chlorides, anhydrous, 1:28
- Rare earth elements, pure, concentrated amalgams for preparation of, 1:18  
determination of average atomic weight of a mixture of, 2:58  
electronic structures of, 2:30  
and their compounds, 2:29
- Rare earth magnesium nitrates, 2:43, 47, 52  
fractional crystallization of, 2:53
- Rare earth minerals, extraction of, 2:35, 38, 39, 44, 45  
occurrence of, 2:34
- Rare earth oxalates, 2:42, 46  
for determination of average atomic weight of rare earth elements in mixtures, 2:59
- Rare earth potassium sulfates, 2:47
- Rare earths, cerium separation from mixtures of, 2:43, 48  
for determination of average atomic weight of rare earth elements in mixtures, 2:59  
europium separation from mixtures of, as amalgam, 2:66, 68  
hydrous, 2:42, 46, 47, 63  
separation of, 2:37
- Rare earths, term, 2:29
- Rare earth sodium sulfates, 2:42, 46
- Rare earth sulfates, 2:63
- Rhenium, 1:175  
by reduction of ammonium per-rhenate, 1:177  
by reduction of potassium per-rhenate, 1:176
- Rhenium(III) chloride, 1:182
- Rhenium(V) chloride, 1:180
- Rhenium(VII) sulfide, 1:177
- Rubidium, rubidium azide for preparation of, 1:79
- Rubidium azide, 1:79
- S
- Salts, "acid," nomenclature of, 2:261  
of isopoly and heteropoly acids, nomenclature of, 2:263  
mixed (oxy, etc.), nomenclature of, 2:259  
of oxygen acids, nomenclature of, 2:260
- Samarium, separation from neodymium from monazite by magnesium nitrate, 2:57  
separation of europium from gadolinium and, as magnesium nitrate double salt, 2:57  
separation with yttrium-group earths from monazite by magnesium nitrate, 2:56
- Selenides, pure metallic, precipitation of, from solutions of  
hydrogen selenide, 2:185
- Selenium, red and gray, 1:119
- Selenium(VI) fluoride, 1:121
- Selenium(IV) oxide, 1:117  
by combustion of selenium, 1:117  
by oxidation of selenium by nitric acid, 1:119
- Selenocyanates, metal, 2:186, 188
- Silane, dibromo-, 1:38
- Silane, tribromo-, 1:38  
analysis of, 1:41

- Silica gel, **2:95**  
  platinized, use in preparation of  
    hydrogen bromide, **1:152**
- Silicobromoform (*see* Silane, tri-  
  bromo-)
- "Silicoformic anhydride,"  $H_2Si_2O_3$ ,  
  **1:42**
- Silicomolybdic acid (*see* 12-Molyb-  
  dosilicic acid)
- Silicon bromide,  $Si_2Br_6$ , **2:98**
- Silicon chlorides, higher, **1:42**  
   $Si_2Cl_6$ , **1:42**  
   $Si_3Cl_8$ , **1:44**
- Silicon compounds, nomenclature of,  
  **2:265**
- Silicon tetrabromide, **1:38, 40**
- Silicon tetrachloride, **1:44**
- "Silicooxalic acid,"  $(H_2Si_2O_2)_x$ , for-  
  mation of, by disilicon hexabro-  
  mide, **2:101**
- Silicotungstic acid (*see* 12-Tungsto-  
  silicic acid)
- Silver, **1:4**  
  recovery from silver iodide resi-  
  dues, **2:6, 7**  
  residues, purification of, **1:2**
- Silver chlorate, **2:4**
- Silver chloride, reduction of, **1:3**
- Silver cyanamide, **1:98**
- Silver iodide, residues of, recovery of  
  silver and iodine from, **2:6**
- Sodium, preparation of pellets of,  
  for reaction with liquid am-  
  monia, **2:132**
- Sodium acetylides,  $NaC \equiv CNa$ ,  
  **2:79, 80**  
   $NaC \equiv CH$ , **2:75**  
  from sodium amide and acety-  
  lene, **2:79**  
  from sodium and acetylene,  
  **2:76**
- Sodium alkylacetylides, **2:79, 80**
- Sodium amalgam, **1:10**
- Sodium amide, **1:74; 2:80, 128, 134**
- Sodium azide, **2:139**  
  purification of, **1:79**
- Sodium azidodithiocarbonate, solu-  
  tion of, **1:82**
- Sodium butoxide, **1:88**
- Sodium cyanate, **2:88**
- Sodium dithionate, **2:170**
- Sodium hydrogen sulfite, in solution,  
  **2:164**
- Sodium hypochlorite, solution of,  
  **1:90**
- Sodium iodate, **1:168**
- Sodium metaperiodate, **1:170**
- Sodium orthoperiodate (paraper-  
  iodate), by chlorine method,  
  **1:169**  
  by persulfate method, **1:170**  
  by sodium iodide-bromine method,  
  **2:212**
- Sodium paraperiodate (*see* Sodium  
  orthoperiodate)
- Sodium pyrosulfite, **2:162, 164**  
  and its 7-hydrate, **2:165**
- Sodium rare earth sulfates, **2:42, 46**
- Sodium selenocyanate, **2:186, 187**
- Sodium sulfite, anhydrous, **2:162**  
  and its 7-hydrate, **2:164, 165**
- "Solvates," nomenclature of, **2:264**
- Stock system, of nomenclature,  
  **2:259, 261**
- Strontium amalgam, **1:11**
- Structure, of 1,3-diketones, **2:10**  
  electronic, of rare earth elements,  
  **2:30**  
  of metal carbonyls, **2:232**
- Sulfamic acid, **2:176**  
  from acetoxime, **2:177**  
  from hydroxylammonium sulfate,  
  **2:176**  
  purification of, for use as acidi-  
  metric standard, **2:178**
- Sulfites, alkali metal, **2:162**
- Sulfur compounds, of nitrogen,  
  nomenclature of, **2:265**
- Sulfur dioxide, addition compound  
  with trimethylamine, **2:159**  
  purification of, **2:160**
- Sulfur(VI) fluoride, **1:121**
- Sulfur trioxide, addition compounds  
  with pyridine, dimethylaniline,  
  and dioxane, **2:173, 174**
- Sulfuryl chloride, **1:114**

## T

- Tellurium(VI) fluoride, **1:121**  
 Tetrammineplatinous chloride, **2:250**  
 Tetrammineplatinous chloroplatinite, **2:251**  
 Tetrammineplatinum(II) chloride, **2:250**  
 Tetrammineplatinum(II) tetrachloroplatinate(II), **2:251**  
 Tetrachloroplatinic(II) acid, solution of, **2:251**  
 Tetracobalt dodecacarbonyl, **2:243**  
 Tetrakis(2,4-pentanediono)thorium, **2:123**  
   1-ammoniate, **2:125**  
   compound with aniline, **2:125**  
 Tetrakis(2,4-pentanediono)zirconium, **2:121**  
   10-hydrate, **2:121**  
 Tetrapyridineiron(II) chloride, **1:184**  
 Thiocyanogen solution, **1:84, 86**  
   standardization of, **1:86**  
 Thionyl bromide, **1:113**  
 Thiophosphoryl tribromide, **2:153**  
 Thorium, removal of, in extraction of monazite and xenotime, **2:41**  
 Thorium acetylacetonate, **2:123**  
   1-ammoniate, **2:125**  
   compound with aniline, **2:125**  
 Thorium bromide, ammoniates, **1:54**  
   anhydrous, **1:51**  
   hydrates, **1:53**  
 Thorium complex compounds, nonelectrolytes, with acetylacetone, **2:123**  
   nonelectrolytes, with acetylacetone, 1-ammoniate, **2:125**  
   compound with aniline, **2:125**  
 Thorium oxybromide, **1:54**  
 Titanium(III) bromide, **2:116**  
 Titanium(IV) bromide, **2:114**  
 Titanium complex compounds, cations, with acetylacetone,  $[\text{Ti}(\text{C}_5\text{H}_7\text{O}_2)_3]_2\text{TiCl}_6$  and  $[\text{Ti}(\text{C}_5\text{H}_7\text{O}_2)_3]\text{FeCl}_4$ , **2:119, 120**  
 Triammonium imidodisulfate, 1-hydrate, **2:179, 180**  
 Triazoates (*see* Azides)  
 Tribarium orthoperiodate (paraperiodate), **1:171**  
 Trimethylamine, purification of, **2:159**  
 Trimethylamine-sulfur dioxide, **2:159**  
 Trinitrides (*see* Azides)  
 Tripotassium nitridotrисульфate, **2:182**  
 Tris(ethylenediamine)chromium(III) bromide, 4-hydrate, **2:199**  
 Tris(ethylenediamine)chromium(III) chloride,  $3\frac{1}{2}$ -hydrate, **2:198**  
 Tris(ethylenediamine)chromium(III) iodide, 1-hydrate, **2:199**  
 Tris(ethylenediamine)chromium(III) sulfate, **2:198**  
 Tris(ethylenediamine)chromium(III) thiocyanate, 1-hydrate, **2:199**  
 Tris(ethylenediamine)cobalt(III) chloride, **2:221**  
 Trisilane, octachloro-, **1:44**  
 Trisilicon octachloride, **1:44**  
 Trisodium orthoperiodate (paraperiodate), **1:169, 170; 2:212**  
 Tris(2,4-pentanediono)aluminum, **2:25**  
 Tris(2,4-pentanediono)titanium(IV) chloroferrate(III), **2:120**  
 12-Tungstophosphoric acid, **1:132**  
   ether complex, **1:133**  
 12-Tungstosilicic acid, **1:129**  
   analysis of, **1:131**  
   ether complex, **1:131**

## U

- Urea, qualitative test for, in cyanates, **2:89**

## V

- Vanadium(IV) chloride, removal of, from vanadium(V) oxychloride, **1:107**



Vanadium(II) oxide, black, 1:106  
Vanadium(V) oxychloride, 1:106  
Vermilion, 1:20

## X

Xenotime, extraction of, 2:38

## Y

Yttrium-group earths, containing samarium, separation from monazite by magnesium nitrate, 2:56  
separation by fractional crystallization of bromates, 2:56, 62  
separation from cerium earths by double-sulfate method, 2:44, 46

## Z

Zirconium acetylacetonate, 2:121  
10-hydrate, 2:121  
Zirconium bromide, anhydrous, 1:49  
Zirconium complex compounds, non-electrolytes, with acetylacetonate,  $Zr(C_5H_7O_2)_4 \cdot 10H_2O$ , 2:121  
Zirconium oxybromide, formation of, from zirconium bromide, 1:51  
Zirconium oxychloride, 8-hydrate, purification of, 2:121  
Zirconyl bromide (*see* Zirconium oxybromide)

## FORMULA INDEX

The chief aim of this formula index, like that of other formula indexes, is to help in locating specific compounds—or even groups of compounds—that might not be easily found in the Subject Index. To this end and to save an extra step in rearranging formulas to, say, an alphabetical form, the formulas have been used in approximately their usual form (*i.e.*, that used in the text) for easy recognition:  $\text{PbO}_2$ ,  $\text{EuSO}_4$ ,  $\text{Si}_2\text{Cl}_6$ ,  $\text{ThOBr}_2$ . For compounds containing the more uncommon elements and groupings and also for complexes, the significant or central atom has been placed first in the formula in order to throw as many related compounds together as possible. This procedure usually involves placing the cation last (often of relatively minor interest, especially in the case of alkali and alkaline earth metals):  $\text{PtCl}_4\text{K}_2$ ;  $[\text{Al}(\text{C}_2\text{O}_4)_3]\text{K}_3 \cdot 3\text{H}_2\text{O}$ ;  $(\text{IO}_6)_2\text{Ba}_3\text{H}_4$ . The guiding principle in these cases has been the chapter in the text in which the compounds occur. Where there is likely to be almost equal interest in two or more parts of a formula, two or more entries have been made:  $\text{AgClO}_3$  and  $\text{ClO}_3\text{Ag}$ ;  $\text{Al}_2\text{Se}_3$  and  $\text{Se}_2\text{Al}_2$ ;  $\text{SF}_6$  and  $\text{F}_6\text{S}$  (simple halides other than fluorides are entered only under the other element in most cases);  $\text{NaNH}_2$  and  $\text{NH}_2\text{Na}$ ;  $\text{NH}_2\text{SO}_3\text{H}$  and  $\text{SO}_3\text{HNH}_2$ .

Formulas for organic compounds are structural or semistructural:  $\text{CH}_3\text{COCH}_2\text{COCH}_3$ . Consideration has been given to probable interest to inorganic chemists; *i.e.*, any element other than carbon, hydrogen, or oxygen in an organic molecule is given priority in the formula if only one entry is made, or equal rating if more than one entry:  $\text{Zr}(\text{C}_5\text{H}_7\text{O}_2)_4 \cdot 10\text{H}_2\text{O}$ ;  $\text{NaCH} \equiv \text{CH}$  and  $\text{CH} \equiv \text{CNa}$ .

The names used with the formulas are the preferred specific names.

The formulas are listed alphabetically by atoms or by groups (considered as units) and then according to the number of each in turn in the formula rather than by total number of atoms of each element (see Appendix, page 258, for a list of some groups occurring in compounds named like binary compounds). This system results in arrangements such as the following:

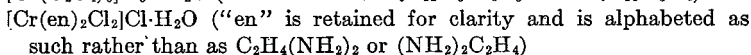
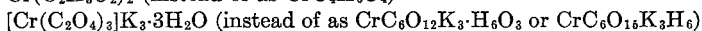
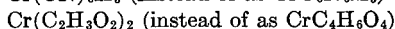
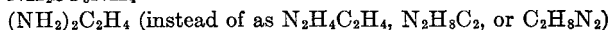

A

$\text{AgCl}$  Silver chloride, 1:3  
 $\text{AgClO}_3$  Silver chlorate, 2:4

$\text{AgI}$  Silver iodide, 2:6

$\text{Ag}_2\text{CN}_2$  Silver cyanamide, 1:98

$[\text{Al}(\text{C}_2\text{O}_4)_3]\text{K}_3 \cdot 3\text{H}_2\text{O}$  Potassium tri-oxalatoaluminate, 1:36

- Al(C<sub>5</sub>H<sub>7</sub>O<sub>2</sub>)<sub>3</sub> Aluminum acetylacetonate, **2:25**  
 Al<sub>2</sub>Se<sub>3</sub> Aluminum selenide, **2:183, 184**  
 AsI<sub>3</sub> Arsenic(III) iodide, **1:103**
- B**
- BF<sub>3</sub> Boron fluoride, **1:21, 23**  
 BF<sub>4</sub>H Fluoboric acid, **1:25**  
 BF<sub>4</sub>K Potassium tetrafluoroborate, **1:24**  
 BF<sub>4</sub>NH<sub>4</sub> Ammonium tetrafluoroborate, **2:23**  
 B<sub>2</sub>O<sub>3</sub> Boron oxide, **2:22**  
 Ba(BrO<sub>3</sub>)<sub>2</sub>·H<sub>2</sub>O Barium bromate, **2:20**  
 Be(C<sub>5</sub>H<sub>7</sub>O<sub>2</sub>)<sub>2</sub> Beryllium acetylacetonate, **2:17**  
 Be(C<sub>6</sub>H<sub>9</sub>O<sub>3</sub>)<sub>2</sub> Beryllium derivative of ethyl acetoacetate, **2:19**  
 Be(C<sub>10</sub>H<sub>9</sub>O<sub>2</sub>)<sub>2</sub> Beryllium derivative of benzoylacetone, **2:19**  
 Be(C<sub>15</sub>H<sub>11</sub>O<sub>2</sub>)<sub>2</sub> Beryllium derivative of dibenzoylmethane, **2:19**  
 2Bi(NO<sub>3</sub>)<sub>3</sub>·3Mg(NO<sub>3</sub>)<sub>2</sub>·24H<sub>2</sub>O Bismuth magnesium nitrate, **2:57**  
 BrH Hydrobromic acid, **1:151, 152, 155**  
     Hydrogen bromide, **1:39, 114, 149, 150, 151, 152**  
 (BrO<sub>3</sub>)<sub>2</sub>Ba·H<sub>2</sub>O Barium bromate, **2:20**  
 Br<sub>2</sub>NH Dibromamide, **1:62, 64**
- C**
- CF<sub>4</sub> Carbon tetrafluoride, **1:34**  
 CH≡CH Acetylene, **2:76**  
 CH≡CNa Monosodium acetylide, **2:75, 76, 79**  
 CH<sub>3</sub>COCH<sub>2</sub>COCH<sub>3</sub> 2,4-Pentanedione (acetylacetone), **2:10**  
 CH<sub>3</sub>COOH Acetic acid, **2:119**  
 (CN)<sub>x</sub> Paracyanogen, **2:92n**  
 CNCl Cyanogen chloride, **2:90, 93**  
 (CN)<sub>2</sub>Ni Nickel cyanide, **2:228**  
 CN<sub>2</sub>Ag<sub>2</sub> Silver cyanamide, **1:98**  
 CNa≡CNa Disodium acetylide, **2:79, 80**  
 CO Carbon monoxide, **2:81**  
 C<sub>3</sub>N<sub>3</sub>Cl<sub>3</sub> Cyanuric chloride, **2:94**  
 CaCO<sub>3</sub> Marble, **2:49**  
 Ce(NO<sub>3</sub>)<sub>3</sub> Cerium(III) nitrate, **2:51**  
 2Ce(NO<sub>3</sub>)<sub>3</sub>·3Mg(NO<sub>3</sub>)<sub>2</sub>·24H<sub>2</sub>O Cerium(III) magnesium nitrate, **2:57**  
 ClH Hydrogen chloride, **1:147; 2:72**  
 ClNH<sub>2</sub> Chloramide, **1:59, 62**  
 ClNO Nitrosyl chloride, **1:55, 57**  
 ClONa Sodium hypochlorite, **1:90**  
 ClO<sub>3</sub>Ag Silver chlorate, **2:4**  
 ClO<sub>4</sub>H Perchloric acid, **2:28**  
 (ClO<sub>4</sub>)<sub>3</sub>Ga·6 (and 9½) H<sub>2</sub>O Gallium(III) perchlorate, **2:26, 28**  
 Cl<sub>3</sub>N Nitrogen(III) chloride, **1:65, 67**  
 Co(CN)<sub>6</sub>K<sub>3</sub> Potassium hexacyanocobaltate(III), **2:225**  
 [Co(CO)<sub>3</sub>]<sub>4</sub> Tetracobalt dodecacarbonyl, **2:243**  
 [Co(CO)<sub>4</sub>]<sub>2</sub> Dicobalt octacarbonyl, **2:238, 242**  
 Co(CO)<sub>4</sub>H Cobalt tetracarbonyl hydride, **2:238, 240**  
 Co(CO)<sub>4</sub>K Cobalt tetracarbonyl hydride, potassium salt, **2:238**  
 [Co(C<sub>2</sub>O<sub>4</sub>)<sub>3</sub>]K<sub>3</sub> Potassium trioxalatocobaltate(III), **1:37**  
 [Co(en)<sub>2</sub>Cl<sub>2</sub>]Cl *cis*- and *trans*-Dichlorobis(ethylenediamine)cobalt(III) chloride, **2:222-224**  
 [Co(en)<sub>3</sub>]Cl<sub>3</sub> Tris(ethylenediamine)cobalt(III) chloride, **2:221**  
 [Co(NH<sub>3</sub>)<sub>5</sub>Br]Br<sub>2</sub> Bromopentamminecobalt(III) bromide, **1:186**  
 [Co(NH<sub>3</sub>)<sub>5</sub>H<sub>2</sub>O]Br<sub>2</sub> Aquopentamminecobalt(III) bromide, **1:187, 188**  
 [Co(NH<sub>3</sub>)<sub>6</sub>]Br<sub>3</sub> Hexamminecobalt(III) bromide, **2:219**  
 [Co(NH<sub>3</sub>)<sub>6</sub>]Cl<sub>3</sub> (and +6NH<sub>3</sub>) Hexamminecobalt(III) chloride, **2:217, 220**

- [Co(NH<sub>3</sub>)<sub>6</sub>](NO<sub>3</sub>)<sub>3</sub> Hexamminecobalt(III) nitrate, **2:218**
- [Co(NH<sub>3</sub>)<sub>6</sub>]<sub>2</sub>(C<sub>2</sub>O<sub>4</sub>)<sub>3</sub>·4H<sub>2</sub>O Hexamminecobalt(III) oxalate, **2:220**
- CoNO(CO)<sub>3</sub> Cobalt nitrosyl tricarbonyl, **2:238, 239**
- Cr(CN)<sub>6</sub>K<sub>3</sub> Potassium hexacyanochromate(III), **2:203**
- Cr(C<sub>2</sub>H<sub>3</sub>O<sub>2</sub>)<sub>2</sub> Chromium(II) acetate, **1:122**
- [Cr(C<sub>2</sub>O<sub>4</sub>)<sub>3</sub>]K<sub>3</sub>·3H<sub>2</sub>O Potassium trioxalatochromate(III), **1:37**
- CrCl<sub>2</sub>·3 (and 4)H<sub>2</sub>O Chromium(II) chloride, **1:124, 125, 126**
- CrCl<sub>3</sub> Chromium(III) chloride, **2:193**
- [Cr(en)<sub>2</sub>Cl<sub>2</sub>]Cl·H<sub>2</sub>O *cis*-Dichlorobis(ethylenediamine)chromium(III) chloride, **2:200, 201**
- [Cr(en)<sub>2</sub>(SCN)<sub>2</sub>](SCN)·H<sub>2</sub>O *trans*-Bis(thiocyanato)bis(ethylenediamine)chromium(III) thiocyanate, **2:200, 202**
- [Cr(en)<sub>3</sub>]Br<sub>3</sub>·4H<sub>2</sub>O Tris(ethylenediamine)chromium(III) bromide, **2:199**
- [Cr(en)<sub>3</sub>]Cl<sub>3</sub>·3½H<sub>2</sub>O, Tris(ethylenediamine)chromium(III) chloride, **2:198**
- [Cr(en)<sub>3</sub>]I<sub>3</sub>·H<sub>2</sub>O Tris(ethylenediamine)chromium(III) iodide, **2:199**
- [Cr(en)<sub>3</sub>](SCN)<sub>3</sub>·H<sub>2</sub>O Tris(ethylenediamine)chromium(III) thiocyanate, **2:199**
- [Cr(en)<sub>3</sub>]<sub>2</sub>(SO<sub>4</sub>)<sub>3</sub> Tris(ethylenediamine)chromium(III) sulfate, **2:198**
- [Cr(NH<sub>3</sub>)<sub>5</sub>Cl]Cl<sub>2</sub> Chloropentamminechromium(III) chloride, **2:216**
- [Cr(NH<sub>3</sub>)<sub>6</sub>]Cl<sub>3</sub> Hexamminechromium(III) chloride, **2:196**
- CrO<sub>2</sub>Cl<sub>2</sub> Chromyl chloride, **2:205**
- CrO<sub>3</sub>ClK Potassium monochlorochromate, **2:208**
- (CrO<sub>4</sub>)<sub>3</sub>Cr<sub>2</sub> Chromium(III) chromate, **2:192**
- Cr<sub>2</sub>O<sub>3</sub> + *x*H<sub>2</sub>O Chromium(III) oxide gel, **2:190, 191**
- Cr<sub>2</sub>(SO<sub>4</sub>)<sub>3</sub> Chromium(III) sulfate, **2:197**
- CsN<sub>3</sub> Cesium azide, **1:79**
- CuBr Copper(I) bromide, **2:3**
- CuCl Copper(I) chloride, **2:1**
- [CuCl·CO]·2H<sub>2</sub>O Copper carbonyl chloride, **2:4**

## E

- EuCO<sub>3</sub> Europium(II) carbonate, **2:69, 71**
- Eu(C<sub>2</sub>H<sub>3</sub>O<sub>2</sub>)<sub>2</sub> Europium(II) acetate, **2:68**
- Eu(C<sub>2</sub>H<sub>3</sub>O<sub>2</sub>)<sub>3</sub> Europium(III) acetate, **2:66**
- EuCl<sub>2</sub> Europium(II) chloride, **2:68, 69, 71**
- EuSO<sub>4</sub> Europium(II) sulfate, **2:69, 70**
- Eu<sub>2</sub>(C<sub>2</sub>O<sub>4</sub>)<sub>3</sub>·10H<sub>2</sub>O Europium(III) oxalate, **2:66**
- Eu<sub>2</sub>O<sub>3</sub> Europium(III) oxide, **2:66**
- Eu<sub>3</sub>Hg<sub>2</sub> Europium amalgam, **2:68n.**

## F

- FH Hydrogen fluoride, **1:134**
- F<sub>2</sub>KH Potassium hydrogen fluoride, **1:140**
- F<sub>2</sub>O Oxygen fluoride, **1:109**
- F<sub>4</sub>C Carbon tetrafluoride, **1:34**
- F<sub>6</sub>S Sulfur(VI) fluoride, **1:121**
- F<sub>6</sub>Se Selenium(VI) fluoride, **1:121**
- F<sub>6</sub>Te Tellurium(VI) fluoride, **1:121**
- Fe(CO)<sub>4</sub>H<sub>2</sub> Iron tetracarbonyl dihydride, **2:243**
- Fe(CO)<sub>4</sub>K<sub>2</sub> Iron tetracarbonyl dihydride, potassium salt, **2:244**
- [Fe(C<sub>2</sub>O<sub>4</sub>)<sub>3</sub>]K<sub>3</sub>·3H<sub>2</sub>O Potassium trioxalatoferrate(III), **1:36**
- [Fe(C<sub>5</sub>H<sub>5</sub>N)<sub>4</sub>]Cl<sub>2</sub> Tetrapyrroline(II) chloride, **1:184**

- FeOOH  $\beta$ -Iron(III) oxide, **2:215**  
 Fe<sub>2</sub>O<sub>3</sub>  $\gamma$ -Iron(III) oxide, **1:185**  
 Fe<sub>2</sub>O<sub>3</sub>·H<sub>2</sub>O  $\beta$ -Iron(III) oxide, hydrate, **2:215**  
 $\gamma$ -Iron oxide, hydrate, **1:185**
- G**
- GaCl<sub>3</sub> Gallium(III) chloride, **1:26**  
 Ga(ClO<sub>4</sub>)<sub>3</sub>·6 (and 9½) H<sub>2</sub>O Gallium(III) perchlorate, **2:26, 28**  
 Ga<sub>2</sub>O<sub>3</sub> Gallium(III) oxide, **2:29**  
 GeCl<sub>4</sub> Germanium(IV) chloride, **2:109**  
 GeI<sub>2</sub> Germanium(II) iodide, **2:106**  
 GeI<sub>4</sub> Germanium(IV) iodide, **2:112**  
 GeNH Germanium(II) imide, **2:108**  
 Ge(NH)<sub>2</sub> Germanium(IV) imide, **2:114**  
 GeS Germanium(II) sulfide, **2:104**
- H**
- HgS Mercury(II) sulfide, **1:19**  
 Hg<sub>2</sub>Eu<sub>3</sub> Europium amalgam, **2:68n.**
- I**
- ICl Iodine(I) chloride, **1:165**  
 ICl<sub>3</sub> Iodine(III) chloride, **1:167**  
 IH Hydriodic acid, **1:157, 158, 159, 162; 2:210**  
 Hydrogen iodide, **1:159**  
 IO<sub>3</sub>Na Sodium iodate, **1:168**  
 IO<sub>4</sub>K Potassium metaperiodate, **1:171**  
 IO<sub>4</sub>Na Sodium metaperiodate, **1:170**  
 IO<sub>6</sub>H<sub>5</sub> Orthoperiodic acid, **1:172, 173**  
 IO<sub>6</sub>Na<sub>3</sub>H<sub>2</sub> Trisodium orthoperiodate, **1:169, 170; 2:212**  
 (IO<sub>6</sub>)<sub>2</sub>Ba<sub>3</sub>H<sub>4</sub> Tribarium orthoperiodate, **1:171**
- K**
- KI Potassium iodide, **1:163**  
 KNH<sub>2</sub> Potassium amide, **2:135**
- KN<sub>3</sub> Potassium azide, **1:79; 2:139, 140**
- L**
- LaCl<sub>3</sub> Lanthanum chloride, **1:32**  
 LiNH<sub>2</sub> Lithium amide, **2:135**  
 Li<sub>2</sub>CO<sub>3</sub> Lithium carbonate, **1:1**
- M**
- MgCl<sub>2</sub> Magnesium chloride, **1:29**  
 3Mg(NO<sub>3</sub>)<sub>2</sub>·2Bi(NO<sub>3</sub>)<sub>3</sub>·24H<sub>2</sub>O Magnesium bismuth nitrate, **2:57**  
 3Mg(NO<sub>3</sub>)<sub>2</sub>·2Ce(NO<sub>3</sub>)<sub>3</sub>·24H<sub>2</sub>O Magnesium cerium(III) nitrate, **2:57**  
 Mn(CN)<sub>6</sub>K<sub>3</sub> Potassium hexacyanomanganate(III), **2:213, 214**  
 Mn(CN)<sub>6</sub>K<sub>4</sub> Potassium hexacyanomanganate(II), **2:214**  
 MnCl<sub>2</sub> Manganese(II) chloride, **1:29**  
 MnO<sub>2</sub> + xH<sub>2</sub>O Pyrolusite, **2:168**  
 MnO<sub>4</sub>K Potassium permanganate, **2:60, 61**  
 MnPO<sub>4</sub> Manganese(III) orthophosphate, **2:213**
- N**
- (—N=CHC<sub>6</sub>H<sub>5</sub>)<sub>2</sub> Benzalazine, **1:92, 93, 94**  
 N(CH<sub>3</sub>)<sub>2</sub>C<sub>6</sub>H<sub>5</sub> Dimethylaniline, **2:174n.**  
 N(CH<sub>3</sub>)<sub>3</sub> Trimethylamine, **2:159**  
 NC<sub>5</sub>H<sub>5</sub> Pyridine, **2:173n.**  
 NCl<sub>3</sub> Nitrogen(III) chloride, **1:65, 67**  
 NHBr<sub>2</sub> Dibromamide, **1:62, 64**  
 [NH=C(NH<sub>2</sub>)<sub>2</sub>H]NO<sub>3</sub> Guanidonium nitrate, **1:94, 96, 97**  
 NH(C<sub>6</sub>H<sub>5</sub>)SO<sub>2</sub>[NC<sub>6</sub>H<sub>5</sub>] Pyridinium *N*-phenylsulfamate, **2:175**  
 NHGe Germanium imide, **2:108, 114**  
 NH(SO<sub>3</sub>NH<sub>4</sub>)<sub>2</sub> Diammonium imidodisulfate, **2:180**

- $\text{NH}_2\text{CONH}_2$  Urea, 2:89  
 $\text{NH}_2\text{COONH}_4$  Ammonium carbamate, 2:85  
 $\text{NH}_2\text{Cl}$  Chloramide, 1:59, 62  
 $\text{NH}_2\text{K}$  Potassium amide, 2:135  
 $\text{NH}_2\text{Li}$  Lithium amide, 2:135  
 $\text{NH}_2\text{NO}_2$  Nitramide, 1:68, 72  
 $\text{NH}_2\text{Na}$  Sodium amide, 1:74; 2:80, 128  
 $\text{NH}_2\text{OH}$  Hydroxylamine, 1:87  
 $\text{NH}_2\text{SO}_3\text{H}$  Sulfamic acid, 2:176, 177, 178  
 $\text{NH}_2\text{SO}_3\text{NH}_4$  Ammonium sulfamate, 2:175, 180  
 $(\text{NH}_2)_2\text{C}_2\text{H}_4$  Ethylenediamine, 2:197  
 $\text{NH}_3$  Ammonia, 1:75; 2:76, 128  
 $[\text{NH}_3\text{OH}]\text{Cl}$  Hydroxylammonium chloride, 1:89  
 $\text{NH}_4\text{N}_3$  Ammonium azide, 2:136, 137  
 $\text{NNH}_4(\text{SO}_3\text{NH}_4)_2 \cdot \text{H}_2\text{O}$  Triammonium imidodisulfate, 2:179, 180  
 $\text{NO}$  Nitric oxide, 2:126  
 $\text{NOCl}$  Nitrosyl chloride, 1:55, 57  
 $\text{NOHSO}_4$  Nitrosylsulfuric acid, 1:55  
 $\text{NO}_2\text{C}_4\text{H}_9$  Butyl nitrite, 2:139  
 $\text{NO}_2\text{NHCO}_2\text{C}_2\text{H}_5$  Nitrourethan, 1:69  
 $\text{NO}_2\text{NH}_2$  Nitramide, 1:68, 72  
 $\text{NO}_2\text{NKCO}_2\text{K}$  Potassium nitrocarbamate, potassium salt, 1:68, 70  
 $\text{NO}_2\text{N}(\text{NH}_4)\text{CO}_2\text{C}_2\text{H}_5$  Ammonium salt of nitrourethan, 1:69  
 $\text{N}(\text{SO}_3\text{K})_3$  Potassium nitridotrisulfate, 2:182  
 $\text{N}_2\text{H}_4$  Hydrazine, 1:90, 92  
 $\text{N}_2\text{H}_4 \cdot 2\text{HCl}$  Hydrazine dihydrochloride, 1:92  
 $[\text{N}_2\text{H}_5]\text{HSO}_4$  Hydrazonium hydrogen sulfate, 1:90, 92  
 $\text{N}_3\text{CSSH}$  Azidodithiocarbonic acid, 1:81, 82  
 $\text{N}_3\text{CSSNa}$  Sodium azidodithiocarbonate, 1:82  
 $\text{N}_3\text{Cs}$  Cesium azide, 1:79  
 $\text{N}_3\text{H}$  Hydrazoic acid, 1:77, 78  
 Hydrogen azide, 1:77, 78  
 $\text{N}_3\text{K}$  Potassium azide, 1:79; 2:139, 140  
 $\text{N}_3\text{NH}_4$  Ammonium azide, 2:136, 137  
 $\text{N}_3\text{Na}$  Sodium azide, 1:79; 2:139  
 $\text{N}_3\text{Rb}$  Rubidium azide, 1:79  
 $(\text{N}_3\text{SCS})_2$  "Azido-carbon disulfide," 1:81, 82  
 $\text{NaC}\equiv\text{CH}$  Monosodium acetylide, 2:75, 76, 79  
 $\text{NaC}\equiv\text{CNa}$  Disodium acetylide, 2:79, 80  
 $\text{NaNH}_2$  Sodium amide, 1:74; 2:80, 128  
 $\text{NaN}_3$  Sodium azide, 1:79; 2:139  
 $\text{NaOC}_4\text{H}_9$  Sodium butoxide, 1:88  
 $\text{NdCl}_3$  Neodymium chloride, 1:32  
 $\text{Nd}_2(\text{C}_2\text{O}_4)_3 \cdot 10\text{H}_2\text{O}$  Neodymium oxalate, 2:60  
 $\text{Ni}(\text{CN})_2$  Nickel cyanide, 2:228  
 $\text{Ni}(\text{CN})_4\text{K}_2 \cdot \text{H}_2\text{O}$  Potassium tetracyanonickelate(II), 2:227, 228  
 $\text{Ni}(\text{CO})_4$  Nickel tetracarbonyl, 2:234
- O
- $(\text{OCN})\text{K}$  Potassium cyanate, 2:87  
 $(\text{OCN})\text{Na}$  Sodium cyanate, 2:88  
 $\text{OF}_2$  Oxygen fluoride, 1:109
- P
- $\text{PBr}_3$  Phosphorus(III) bromide, 2:147  
 $\text{PCl}_3$  Phosphorus(III) chloride, 2:145  
 $\text{PCl}_5$  Phosphorus(V) chloride, 1:99  
 $\text{PH}_4\text{I}$  Phosphonium iodide, 2:141, 143  
 $\text{POBr}_3$  Phosphorus(V) oxybromide, 2:151  
 $\text{PO}_2\text{F}_2\text{NH}_4$  Ammonium difluophosphate, 2:157  
 $\text{PO}_3\text{F}(\text{NH}_4)_2$  Ammonium monofluophosphate, 2:155

- $\text{PO}_4\text{H}_3$  Orthophosphoric acid, 1:101  
 $\text{PSeBr}_3$  Phosphorus(V) sulfobromide, 2:153  
 $\text{PSFBr}_2$  Phosphorus(V) sulfodibromofluoride, 2:154  
 $\text{PSF}_2\text{Br}$  Phosphorus(V) sulfobromodifluoride, 2:154  
 $\text{PSF}_3$  Phosphorus(V) sulfotrifluoride, 1:154  
 $(\text{PW}_{12}\text{O}_{40})\text{H}_3 \cdot x\text{H}_2\text{O}$  12-Tungstophosphoric acid, 1:132  
 $\text{P}_2\text{I}_4$  Diphosphorus tetraiodide, 2:143  
 $\text{PbBr}_6\text{H}_2$  Hexabromoplumbic(IV) acid, 1:48  
 $\text{Pb}(\text{C}_2\text{H}_3\text{O}_2)_2$  Lead(IV) acetate, 1:47  
 $\text{PbCl}_6\text{H}_2$  Hexachloroplumbic acid, 1:48  
 $\text{PbO}_2$  Lead(IV) oxide, 1:45  
 $\text{PbO}_3\text{H}_2$  "Metaplumbic acid," 1:46  
 $\text{Pb}(\text{SCN})_2$  Lead(II) thiocyanate, 1:85  
 $\text{Pd}(\text{CN})_4\text{K}_2 \cdot 1$  (and 3)  $\text{H}_2\text{O}$  Potassium tetracyanopalladate(II), 2:245, 246  
 $\text{PtCl}_4$  Platinum(IV) chloride, 2:253  
 $\text{PtCl}_4\text{H}_2$  Tetrachloroplatinic(II) acid, 2:251  
 $\text{PtCl}_4\text{K}_2$  Potassium tetrachloroplatinate(II), 2:247  
 $[\text{Pt}(\text{NH}_3)_2\text{Cl}_2]$  Dichlorodiammineplatinum, 2:253  
 $[\text{Pt}(\text{NH}_3)_4\text{Cl}_2]$  (and  $+1\text{H}_2\text{O}$ ) Tetrammineplatinum(II) chloride, 2:250, 252  
 $[\text{Pt}(\text{NH}_3)_4][\text{PtCl}_4]$  Tetrammineplatinum(II) tetrachloroplatinate(II), 2:251
- R
- $\text{RbN}_3$  Rubidium azide, 1:79  
 $\text{ReCl}_3$  Rhenium(III) chloride, 1:182  
 $\text{ReCl}_5$  Rhenium(V) chloride, 1:180  
 $\text{ReCl}_6\text{K}_2$  Potassium hexachlororhenate(IV), 1:178  
 $\text{ReO}_4\text{NH}_4$  Ammonium perrhenate, 1:177, 178  
 $\text{Re}_2\text{S}_7$  Rhenium(VII) sulfide, 1:177
- S
- $(\text{SCN})_2$  Thiocyanogen, 1:84, 86  
 $(\text{SCN})_2\text{Pb}$  Lead(II) thiocyanate, 1:85  
 $\text{SF}_6$  Sulfur(VI) fluoride, 1:121  
 $\text{SH}_2$  Hydrogen sulfide, 1:111  
 $\text{SOBr}_2$  Thionyl bromide, 1:113  
 $\text{SO}_2$  Sulfur dioxide, 2:160  
 $\text{SO}_2\text{Cl}_2$  Sulfuryl chloride, 1:114  
 $\text{SO}_2 \cdot \text{N}(\text{CH}_3)_3$  Trimethylamine-sulfur dioxide, 2:159  
 $\text{SO}_3 \cdot \text{C}_5\text{H}_5\text{N}$  Pyridine-sulfur trioxide, 2:173  
 $\text{SO}_3 \cdot \text{C}_6\text{H}_5\text{N}(\text{CH}_3)_2$  Dimethylaniline-sulfur trioxide, 2:174  
 $\text{SO}_3\text{H}\text{NH}_2$  Sulfamic acid, 2:176, 177, 178  
 $\text{SO}_3\text{KH}$  Potassium hydrogen sulfite, 2:167  
 $4\text{SO}_3\text{KH} \cdot \text{S}_2\text{O}_8\text{K}_2$ , 2:167  
 $(\text{SO}_3\text{K})_3\text{N}$  Tripotassium nitridotrisulfate, 2:182  
 $\text{SO}_3\text{K}_2$  Potassium sulfite, 2:165, 166  
 $(\text{SO}_3[\text{NC}_5\text{H}_6])\text{NHC}_6\text{H}_5$  Pyridinium *N*-phenylsulfamate, 2:175  
 $(\text{SO}_3\text{NH}_4)\text{NH}_2$  Ammonium sulfamate, 2:175, 180  
 $(\text{SO}_3\text{NH}_4)_2\text{NH}$  Diammonium imidodisulfate, 2:180  
 $(\text{SO}_3\text{NH}_4)_2\text{NNH}_4 \cdot \text{H}_2\text{O}$  Triammonium imidodisulfate, 2:179, 180  
 $\text{SO}_3\text{NaH}$  Sodium hydrogen sulfite, 2:164  
 $\text{SO}_3\text{Na}_2$  (and  $+7\text{H}_2\text{O}$ ) Sodium sulfite, 2:162, 164, 165  
 $\text{SO}_3 \cdot \text{O}(\text{CH}_2\text{CH}_2)_2\text{O}$  Dioxane-sulfur trioxide, 2:174  
 $2\text{SO}_3 \cdot \text{O}(\text{CH}_2\text{CH}_2)_2\text{O}$  Dioxane-bis(sulfur trioxide), 2:174

$\text{SO}_4\text{HNO}$  Nitrosylsulfuric acid, 1:55  
 $\text{S}_2\text{O}_5\text{K}_2$  (and  $+ \frac{2}{3}\text{H}_2\text{O}$ ) Potassium pyrosulfite, 2:165, 166  
 $\text{S}_2\text{O}_5\text{K}_2 \cdot 4\text{SO}_3\text{KH}$ , 2:167  
 $\text{S}_2\text{O}_5\text{Na}_2$  (and  $+ 7\text{H}_2\text{O}$ ) Sodium pyrosulfite, 2:162, 164, 165  
 $\text{S}_2\text{O}_6\text{Ba} \cdot 2\text{H}_2\text{O}$  Barium dithionate, 2:170  
 $\text{S}_2\text{O}_6\text{Ca} \cdot 4\text{H}_2\text{O}$  Calcium dithionate, 2:168  
 $\text{S}_2\text{O}_6\text{Na} \cdot 2\text{H}_2\text{O}$  Sodium dithionate, 2:170  
 $\text{SbI}_3$  Antimony(III) iodide, 1:104  
 $\text{SeCNK}$  Potassium selenocyanate, 2:186  
 $\text{SeCNNa}$  Sodium selenocyanate, 2:186, 187  
 $\text{SeF}_6$  Selenium(VI) fluoride, 1:121  
 $\text{SeH}_2$  Hydrogen selenide, 2:183, 184  
 $\text{SeO}_2$  Selenium(IV) oxide, 1:117, 119  
 $\text{Se}_3\text{Al}_2$  Aluminum selenide, 2:183, 184  
 $\text{SiBr}_4$  Silicon tetrabromide, 1:38, 40  
 $\text{SiCl}_4$  Silicon tetrachloride, 1:44  
 $\text{SiHBr}_3$  Silane, tribromo-, 1:38, 41  
 $\text{SiH}_2\text{Br}_2$  Silane, dibromo-, 1:38  
 $(\text{SiMo}_{12}\text{O}_{40})\text{H}_4 \cdot x\text{H}_2\text{O}$  12-Molybdo-silicic acid, 1:127, 128  
 $\text{SiO}_2$  Silica gel, 2:95  
 $(\text{SiW}_{12}\text{O}_{40})\text{H}_4 \cdot x\text{H}_2\text{O}$  12-Tungsto-silicic acid, 1:129, 131  
 $\text{Si}_2\text{Br}_6$  Disilicon hexabromide, 2:98  
 $\text{Si}_2\text{Cl}_6$  Disilicon hexachloride, 1:42  
 $(\text{Si}_2\text{O}_2\text{H}_2)_x$  "Silicooxalic acid," 2:101  
 $\text{Si}_2\text{O}_3\text{H}_2$  "Silicoformic anhydride," 1:42  
 $\text{Si}_3\text{Cl}_8$  Trisilicon octachloride, 1:44

T

$\text{TeBr}_6\text{K}_2$  Potassium hexabromotellurate(IV), 2:189  
 $\text{TeCl}_6(\text{NH}_4)_2$  Ammonium hexachlorotellurate(IV), 2:189  
 $\text{TeF}_6$  Tellurium(VI) fluoride, 1:121  
 $\text{ThBr}_4$  Thorium bromide, 1:51; ammoniates, 1:54; hydrates, 1:53  
 $\text{Th}(\text{C}_5\text{H}_7\text{O}_2)_4$  (and  $+ \text{NH}_3$  and  $+ \text{C}_6\text{H}_5\text{NH}_2$ ) Thorium acetyl-acetate, 2:123, 125  
 $\text{ThOBr}_2$  Thorium oxybromide, 1:54  
 $\text{TiBr}_3$  Titanium(III) bromide, 2:116  
 $\text{TiBr}_4$  Titanium(IV) bromide, 2:114  
 $[\text{Ti}(\text{C}_5\text{H}_7\text{O}_2)_3]\text{FeCl}_4$  Tris(2,4-pentanediono)titanium(IV) chloroferrate(III), 2:120  
 $[\text{Ti}(\text{C}_5\text{H}_7\text{O}_2)_3]_2\text{TiCl}_6$  Bis[tris(2,4-pentanediono)titanium(IV)] hexachlorotitanate(IV), 2:119

V

$\text{VCl}_4$  Vanadium(IV) chloride, 1:107  
 $\text{VOCl}_3$  Vanadium(V) oxychloride, 1:106  
 $\text{V}_2\text{O}_2$  Vanadium(II) oxide, 1:106

Z

$\text{ZrBr}_4$  Zirconium bromide, 1:49  
 $\text{Zr}(\text{C}_5\text{H}_7\text{O}_2)_4$  Zirconium acetylacetonate, 2:121; 10-hydrate, 2:121  
 $\text{ZrOBr}_2$  Zirconium oxybromide, 1:51  
 $\text{ZrOCl}_2 \cdot 8\text{H}_2\text{O}$  Zirconium oxychloride, 2:121