







Autographed

by

Alfred W. Lawson

Editor of

Pittsburgh





# AIRCRAFT

Vol. 3, No. 1

MARCH, 1912

15 Cents a Copy

9 TL  
501  
A 298  
NASM  
V-3 (No 1-10)  
March-Dec  
1912  
V-3 - No 11-12  
Jan Feb-1913



SALUTING THE AIRMEN

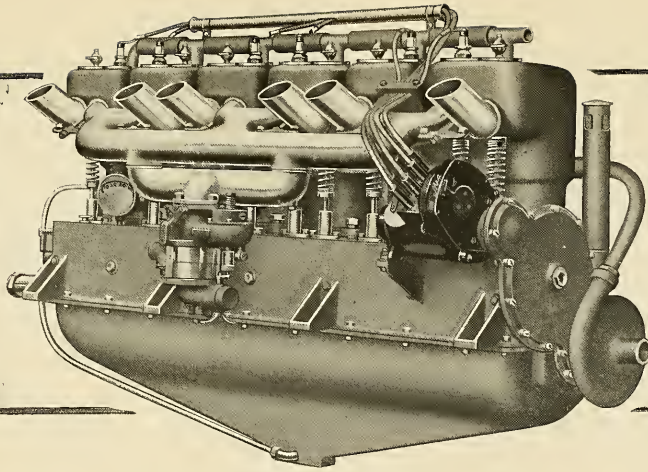

ANNOUNCING THE  
**Sturtevant**  
Aeronautical Motors  
and  
Propellers

**4 Cylinders--40 Horse Power**

**6 Cylinders--60 Horse Power**

**IMMEDIATE DELIVERY**

All manufacturing concerns, designing and consulting engineers know the B. F. Sturtevant Company as leaders in design and building of Air Moving Apparatus, special engines and power units for air propulsion and pressure.

The Sturtevant Aeronautical Motors are placed on the market and backed by the Sturtevant reputation and guarantee.

SEND FOR CATALOG 200-A STURTEVANT ENGINEERING SERIES

**B. F. STURTEVANT COMPANY**

Main Office and Works, HYDE PARK, BOSTON, MASSACHUSETTS

OFFICES IN LARGE CITIES

Plant of the B. F. Sturtevant Company. For fifty years the largest Builders of Air Moving Apparatus in the World



# Curtiss Superiority

Again Demonstrated at Home and Abroad—On Land and Sea

While Lincoln Beachey and other famous **Curtiss Aviators** were making a clean sweep in competition at the Los Angeles International Meet with the **new 1912**, Hugh Robinson was giving Europe its first view of flights from the Sea at Nice, France, in the new 1912.

## Curtiss Aeroplane



BEACHEY AT LOS ANGELES

In keeping with these evidences of CURTISS superiority, the Aero Club of America, the highest Authority on aviation in the United States, has officially recognized.

### CURTISS PROGRESS

By awarding to M<sup>r</sup>. GLENN H. CURTISS, the COLLIER AVIATION TROPHY, for the greatest advance during the year 1911.

These things are facts and they go to prove absolute CURTISS dependability.

## Curtiss Hydroaeroplane

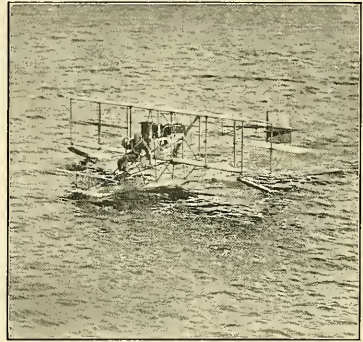

ROBINSON AT NICE, FRANCE

## Achievements are the best Arguments: Records are the only Proofs

If Beachey and Robinson had not been using Machines of the highest degree of perfection, equipped with the famous CURTISS MOTOR, they would not have been able to convince two Continents of the superior speed, safety, practicability and progress of the CURTISS AEROPLANE and HYDROAEROPLANE. These facts cannot be ignored. They furnish conclusive evidence of the rapid advances of the practical sort. Most of all, they prove beyond dispute that the name

## CURTISS LEADS THE WORLD IN AVIATION

Our new 1912 Catalogue is now ready for distribution. It contains facts and illustrations that will interest you about CURTISS AEROPLANES, HYDROAEROPLANES, MOTORS, THE CURTISS AVIATION SCHOOLS and EXHIBITIONS by the famous CURTISS AVIATORS.

FOR PARTICULARS REGARDING ANY OF THESE SUBJECTS, ADDRESS :

# THE CURTISS EXHIBITION CO.

1737 BROADWAY

JEROME FANCIULLI, General Manager

NEW YORK CITY

Sales Agents and Foreign Representatives for The Curtiss Aeroplane Co., Hammondsport, N. Y.

# "KIRKHAM" AVIATION POWER PLANTS

FOR SEASON  
OF 1912



Model B-6 installed in "KIRKHAM" Tractor Biplane

THE "KIRKHAM" AVIATION MOTOR IS OFFERED IN FOUR DIFFERENT MODELS:

Model B-4,	35 H-P.,	4-cyl.,	weight, 185 lbs.
Model B-6,	50 H-P.,	6-cyl.,	weight, 235 lbs.
Model B-G-6,	70 H-P.,	6-cyl.,	weight, 255 lbs.
Model B-12,	120 H-P.,	12-cyl., V.,	weight, 400 lbs.

All of these models are sold as complete power plants or motor only, as desired.

THE universal success of every 6-cylinder, 50-H. P., "KIRKHAM" motor for season of 1911 has demonstrated their unquestionable reliability and efficiency; therefore the new models listed above contain not only all the features which have made the "KIRKHAM" Aviation motor noted for its reliability but in addition, all models for 1912 are to be equipped with the new Bosch 2-spark magneto, larger valves and special cooling tubes through oil tank, whereby the oil is always at a safe temperature no matter how hard or how long the motor is run.

Now is the time to get in your order if you want reasonably quick delivery as a large number of orders have been booked for spring delivery and there is sure to be a rush when the spring opens. Anyway, you better get acquainted with the only American motor that actually delivers what is claimed for it.

CATALOG FOR THE ASKING

CHARLES B. KIRKHAM, *Manufacturer*  
SAVONA, NEW YORK



# GOODYEAR BALLOONS

## Balloon and Aeroplane

### FABRICS---ACCESSORIES

No longer do you need send to Europe for Balloons. We not only manufacture a full line of balloon fabrics—cotton or silk—but we also build spherical or dirigible balloons complete.

Goodyear Balloon cloth and construction is the result of exhaustive study in England, France and Germany and we guarantee our balloons equal to anything purchasable in any foreign country. Our cotton fabric, which we recommend, is made out of high grade cotton and is **rubberized**. Hence it is most enduring.

Our big manufacturing facilities enable us to make quick shipments. You don't have to wait on foreign makers nor do you have any duties to pay. Let us send samples and tell you more about Goodyear Balloon Service.

### Goodyear Rubberized Aeroplane Fabric

Damp and moisture-proof, our Rubberized Aeroplane Fabric is the most durable made.

In the rubberizing process, the fabric is subjected to heat many times more intense than it will ever undergo in aerial service. So ordinary heat has no effect upon it.

It can't dry out, stretch, flap, and cut down speed because no moisture can get into it. Nor, for the same reason, can it shrink up and twist the planes out of alignment. It is **non-shrinkable—unstretchable, heat-proof, cold-proof, damp-proof, rot proof**, and it is always the same. So dependable that every veteran aviator and manufacturer in this country uses it exclusively. Used by Rodgers, Ovington, Atwood, Fowler and Brookins in all their big events. Used by the Wright Co., Burgess Co. and Curtis, The Curtiss Aeroplane Co., Glenn L. Martin, Moisant National Aviators, and many other leading manufacturers.

### Goodyear Detachable Aeroplane Tires

Veteran Aviators know the importance of landing on tires that can not tear loose. Such tires are Goodyear Detachables. These tires are made like No-Rim-Cut Auto Tires—are most durable and bind the rim in a vise-like grip. Extra-thick treads make them practically non-puncturable.

**Single Tube Tires**, Strong, light, durable, built in all standard sizes—the only single tube aeroplane tire with valve protected by metal. This keeps valve from tearing loose.

**20 x 4 Clincher Tires**—the most popular tire for rigid machines. Used in all Curtiss Aeroplanes. Extensible rubber beads. We make tires in sizes to fit any and all machines. Made with or without leather treads.

### Bleriot Type Shock Absorbers

Steel Springs snap in cold weather, catch in the tubes, are not satisfactory. The Bleriot Type Rubber Shock Absorbers are the only successful springs for monoplanes. You can now get this type of spring at home. We are the sole manufacturers. Can fill your order promptly and **savingly**. Ask us about our springs. We make all kinds.

Whether you contemplate manufacturing aeroplanes or merely intend to purchase a machine, you should find out all we have to offer you before making any final decision. We have with us all the veterans—both aviators and manufacturers. That speaks for itself. Tell us your wants.

## THE GOODYEAR TIRE & RUBBER CO.

Main Office and Factory: AKRON, O.

Branches and Agencies in 103 Principal Cities

# PAUL LACROIX AUTOMOBILE CO.

AGENTS FOR

## Anzani, Gnome, Renault AVIATION MOTORS BOREL-MORANE MONOPLANES

Early Deliveries on all Types.

Write for Catalogue and Prices

1770 BROADWAY, 57th STREET, NEW YORK

The Business End of your Aeroplane is the Propeller



Patented March 14, 1911; July 25, 1911; October 17, 1911; Others Pending

We confine our business to the **Business End**. That is one reason why we succeed and make such propellers as we do make. There are also a lot of other reasons.

**Anyhow**, you have got to have propellers if you fly; **good** ones if you fly, well and the **best** one if you want to do your **best flying**. You want the best and your problem is how to get it. We can solve this for you at once and for all. You will never change when once you have tried a Paragon Propeller furnished for your machine in accordance with our system of calculation.

Paragon Propellers are patented in every detail. There are none others like them and none others that you would want after your first Paragon experience. We admit our opinion of our work is not impartial, but we refer to the hundreds of Paragon flyers all over the country for their opinions. Our illustrated booklet will interest you.

It won't hurt to write to us, anyhow, and we will give you our expert engineering advice as to power, pitch, thrust, etc., gratis, whether you become a purchaser or not. We have earned a reputation for special knowledge in our line and we will make good that reputation with **you**, if you will let us.

**AMERICAN PROPELLER CO.**  
WASHINGTON, D. C.



Winter has no terrors for the airmen. The above picture shows Clifford O. Hadley flying along the Hudson River which, as can be seen, is covered over with a thick layer of ice and snow. On Sunday, February 11th, and several days following, Mr. Hadley gave flying exhibitions before large crowds, making flights between Tarrytown and Ossining, in which he raced against automobiles and the Twentieth Century Limited New York Central Railroad train, easily defeating in the races both the automobiles and the railroad train.

**CONTENTS---MARCH, 1912**

The Words We Use . . . . .	Denys P. Myers	7
Sailing the Air With Wind Power . . . . .	D. W. Starrett	8
Fatal Aeroplane Accidents (Statistical Table) . . . . .		9
Editorial . . . . .		10
Scale Drawing Heinrich School-type Monoplane . . . . .		12
The Heinrich 1912 Mono-Biplane . . . . .		13
Foreign News . . . . .	W. H. Phipps	14
German News . . . . .	Stella Bloch	15
Club News . . . . .		16
The New Kirkham Tractor Biplane . . . . .		17
General News . . . . .	D. E. Ball	18
Advance Toward Aerial Law . . . . .	Communicated by Denys P. Myers	20
The Trade . . . . .		22

**AIRCRAFT**

ALFRED W. LAWSON  
*President and Treasurer*  
ERNEST C. LANDGRAF  
*Secretary*

Published Monthly by The Lawson Publishing Company  
37-39 EAST 28th STREET, NEW YORK, U. S. A.  
Telephone, 5017 Madison Square

ALFRED W. LAWSON  
*Editor*  
WALTER H. PHIPPS  
*Ass. Editor*

**TERMS TO SUBSCRIBERS**

In the United States, Mexico, Puerto Rico, Guam, Philippine Islands, Hawaiian Islands, Cuba (including Postage), \$1.50 per year.  
Fifteen Cents the Copy, of All News Dealers.  
Foreign Subscriptions, Two Dollars per year.  
In changing order give old as well as new address.  
Advertising copy must be in hand by the 1st of month previous to date of publication.  
Only high-grade advertisements of thoroughly reliable firms are solicited.

**WHEN YOUR SUBSCRIPTION EXPIRES**

One month before a subscription expires we enclose a renewal blank on which you will write your order for the renewal.  
WHEN FIRST NOTICED that your subscription will expire, you should send your renewal at once, in order not to miss a number. New subscriptions which are received by us on or before the 15th of any month will begin with the issue of that month. If received after that date they will begin with the following month's issue. We cannot enter subscriptions to begin with back numbers. One month's notice is necessary before a change of address can be made.

Entered as "second-class matter" February 18, 1910, at the Post Office, at New York, N. Y., under Act of March 3, 1879.  
Copyright, 1912, by the Lawson Publishing Co.  
"Aircraft" is registered as a trade-mark by the U. S. Patent Office, under date of August 9th, 1910.

# Aeroplane Motors and Equipment Company

NEW YORK

1780 BROADWAY

Tel. Col. 1335



The Latest Development in Aviation  
 "BLERIOU FAMILY AEROCAR"  
 DRIVEN BY 100 H. P. GNOME MOTOR

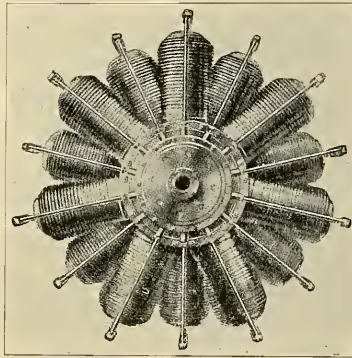

## GNOME MOTORS

50 H. P.

70 H. P.

100 H. P.

IN STOCK FOR IMMEDIATE DELIVERY

AGENTS FOR

ALL STANDARD FOREIGN AVIATION MOTORS.

IMMEDIATE DELIVERY GUARANTEED.

### Imported Aeroplane Cloth

Used in France by: Bleriot, Farman, Nieuport, Deperdussin, Etc., and all other manufacturers.

Used in America by: Moissant Company, Queen Company, McCurdy, Willard, Etc., and all leading aviators

EVERYTHING ELSE IN IMPORTED SUPPLIES FOR AVIATION



# A I R C R A F T

Vol. 3. No. 1

NEW YORK, MARCH, 1912

15 CENTS A COPY  
\$1.50 A YEAR

## THE WORDS WE USE

By DENYS P. MYERS.

**I**N many ways Europe is more thorough than America. The Yankee has a habit of going ahead—sometimes blundering ahead—and getting results, not caring whether he has observed the etiquette of the game. In Europe they take themselves seriously, perhaps caring more how a thing is done than what is accomplished,—at least that is the way it often looks to the American. It thus happens that, although the basic principles of mechanical flight are credited to America, many of the niceties of it were originated across the Atlantic. Abroad, for instance, they have fixed the nomenclature of flight to a far greater extent than we have here, where "airship" applied to all sorts of air-going vehicles is now palling on aviators and technical writers. It is probably time for a concerted movement to be made with the object of defining the terms we use.

The leaders in aviation have a full appreciation of the new words the infant sport is introducing into common parlance, but many lesser lights lisp in these numbers, haltingly and incorrectly. The public does as it pleases, not because it desires to be wrong—or right—but chiefly because its little knowledge of aviation is a dangerous thing on the tip of the tongue.

The definite point of this article is the desirability of determining by means of a committee or otherwise the meaning of the new words used in aviation, particularly in the case of the kinds of aerial vehicles. Here are suggestions and a summary of what has been done in this regard abroad, designed to assist such a procedure.

One linguistic crime on the part of the public which has been prosecuted by this magazine is the popular failure to distinguish between the great types of aerial vehicles. Airships is the indiscriminate term, used by newspapers, magazines, the Consular Reports, everybody apparently, except those directly interested in aviation. Even the Connecticut licensing law, which went into effect January 1, employs the word in a general sense, and a protest against its use in that statute proved unavailing. No other piece of legislation, prospective or complete, makes that mistake.

The Aerial Navigation Act of the United Kingdom and that of India says "aircraft;" the New York project speaks only of aviation; the Massachusetts one differentiates "flying machine, dirigible halloon, glider or other apparatus;" the Pennsylvania bill mentions "aeroplane;" the California bill clumsily defined "a motor vehicle which is designed to navigate above ground in the air," the excuse for this phrasing being that the act was intended to be administered by the Motor Vehicles Department. Even the ordinance of Kissimmee City, Fla., mentions flying machines, specifying aeroplanes, helicopters, ornithopters, and other types. Abroad the French use *aéronef*, which is best translated by aircraft, and the Germans employ *flugmaschine*.

About the only word not adopted from maritime navigation to flight is the generic one of vessel, which, always connoting something hollow, would manifestly be ridiculous as applied to an aeroplane. The need of specific terms naturally does not bother the trade much, for it appreciates and deals in fine distinctions,

though it is constantly aggravated by seeing and hearing incorrect terms by the laity. About a year ago the English Technical Words Committee announced its first list of terms, in which that authority decided *aircraft* was the best general word to cover all classes of aeronautic machines. One other list known to the writer has appeared in English, though according to the New York Sun an Admiral of the Navy also suggests *super-terrene* as a general term, with the *floquilla* the *floquita* and the *flesk* representing the marine flotilla, squadron and fleet. These efforts at standardizing the vocabulary of aeronautics in English have as yet borne little fruit, and it would seem well that some concerted action be taken by the American governing body toward this end.

France had its nomenclature all congealed into usage before aviation, or even much ballooning, was a fact. Over a score of years ago the Société française d'Aérostation suggested the word *avion* as a general term. At the Paris Exposition of 1889 the Congrès international aéronautique discussed the definition of technical terms. At its session of August 3 *aérostat* was accepted as defining a free balloon, and *aéronat* adopted for dirigibles. Neither is necessary in English, though single words as precise would be convenient. For heavier-than-air machines—then non-existent—the generic term *aéronef* was accepted, it having been coined as early as 1864 by G. de La Landelle. It was decided to class under it aeroplanes, sustained by surfaces, helicopters and ornithopters, sustained respectively by screws and flapping devices. At the same time the French savants determined that the word *sustentation*, which we frequently employ in English to denote the sustaining principle of a machine, was incorrect, since it comes from the Latin *sustentare*, to maintain one's strength by food. The word *sustention*, from *sustinere*, whence our word sustain, was adopted as proper. *Sustentation* persists in English.

The words then adopted in French have since become common and are officially recognized in France. This did not come about without effort, for when the new science was actually born, as well as before, a great many odd combinations of the Greek root *aroe-*, the Latin *ala*, *avare* and others were resurrected, suggestively and otherwise. Thus such words as *alérion*, *icarien* (from Icarus), *aéromobile*, *autoplane*, *avia*, *avait*, *aviomobile*, *oumeç*, *motoplan*, *aviostat*, *avicine*, *aérophine*, *scaphair* and *autofuge* were brought forward, each accompanied by the allegation that it filled the bill. From aeroplane down to pylon and hangar we have borrowed terms from the French, and probably it is to this cause that we may assign our escape from such a series of brain storms as the above list indicates occurred in France.

But what we need in English is an authoritative standard of our own, not an imported one. As *aéronef* is now generally used in France to cover both aeroplanes and balloons, so we have aircraft, a word all English. Aviator, thanks to the London Times, has fallen almost into complete disuse in England, and airman, with no hint of a Romance tongue in it, has succeeded

to it. Airship is being confined, by the aeronautic world at least, to the lighter-than-air vehicle, which alone it defines. Otherwise we all do pretty much as we please, and invent for ourselves if the need arises. Lately the "staggered" plane has been discussed. What is to prevent any firm or writer insisting on calling the type, say, "angled," and adding confusion to a new idea?

The centrifugal tendency is already in evidence, General Roques, French Inspector of Military Aeronautics, having de-

creed that military machines be called "avions," in commemoration of the Ader machine of 1893. Also the current army appropriation bill in Congress devotes money for the purchase of "airplanes."

Why should not the Aeronautical Manufacturers' Association take the initiative in establishing a standard for technical words as it must for supplies; and why should it not be aided in that work, if not led by the aero clubs?

## SAILING THE AIR WITH WIND POWER

By D. W. Starrett

**I**N an article entitled "The Use of Wind Power In Aviation" the present writer proved that a wedge, if placed in a wind current with its thick end facing the direction whence the wind is blowing, will remain in a state of equilibrium if no other forces, with the exception of the one to be disclosed are acting to overcome this condition.

The article showed that the wind pressure upon the thick end would be exactly balanced by the same pressure upon the two sides of the wedge.

It stated further that, this principle accounted, in part, for the ease with which a bird can cease movement of its wings and sail directly against the wind.

This discovery is important but it is not comparable with the one which discloses the force which overcomes inertia, gravity and friction and enables the bird, without an apparent effort, to sail on and on as long as the wind blows.

Quoting in part from "Aerial Navigation of Today," by Charles C. Turner, who says: "Lanchester writes in the 'Engineer' that the frigate bird will not touch a rigid support for months; that it secures its food by theft from other birds while on the wing, then soaring aloft, it floats in great circles without the movement of a wing."

Again he says: "The great swooping crane will ascend from Winnipeg and from a mile elevation sail straight for the Gulf of Mexico, never once during the flight fluttering a wing."

The crane went high enough to reach a current of air which was blowing north, from the Gulf; otherwise it would have had to circle to reach its destination.

No bird if moving in a general way with the wind can keep a certain elevation for any great distance without flapping its wings.

It must, in a general way, face the wind if it sails approximately in a straight line.

The reason why birds circle when sailing without movement of the wings is that they sail against the wind to get elevation, which they lose when sailing with it.

The writer has made experiments which prove conclusively that it is the wind force alone which enables the bird to perform this feat.

The experiments are so simple that anyone can prove to his satisfaction the truth of them.

When one considers what the results of this discovery will mean in aviation, he will certainly give this article more than passing attention.

See, in the imagination, an aeroplane with power, ascend at Winnipeg to the height that will give it a head wind, then idly float—as it will seem with the current—directly against it to the Gulf of Mexico without a turn of the propeller.

It is well known that great currents of wind blow continually around the earth in positive directions. These currents can be used with as much precision as are the trade winds of the Pacific ocean.

The fact that a bird is balanced in a wind when facing it can be seen from ships that sail salt water particularly, because here will be found the sea gulls which are so tame that they frequently light upon the ship's decks.

The writer has seen these birds settle down on the flag staff of a ship moving twelve knots per hour. The birds always

align with their heads facing the wind. When they desire to leave their resting place they give a slight jump forward into the wind, spread their wings and the wind does the rest as far as propulsion goes.

This shows that what has been said regarding a bird being in equilibrium in any wind is true; but the great secret yet to disclose is that force which overcomes inertia, gravity, and friction.

To prove that the force which enables the bird to sail against the wind does not come from the bird's especial construction, or the life within the mass, or that it is continually falling against an ascending column of air, the writer constructed a paper wedge from two sheets of typewriting paper, five-eighths inches thick at one end with an elliptical front, and tapered to the thickness of the two sheets of paper at the other end.

This made a wedge nine inches wide and eleven inches long. The wedge had an eye one-half inch in diameter made of very fine wire, projecting its diameter beyond the side at each corner.

Two very fine wires were stretched a distance apart to receive the eyes exactly in the center, so that the wedge could slide freely along the wires. These wires were strung parallel with the wind's course and where there could be no swirling currents.

Although there was considerable friction to overcome, it was found that when the thick end of the wedge was pointed against the current of the wind, invariably it traveled into the wind; and when reversed so that the thin edge pointed into the wind, it traveled with the wind.

One test made for speed was quite surprising; the wedge traveled thirty feet in eight minutes after having overcome inertia, against a fifteen mile current. It would always start from rest and make headway. Many tests were made to be sure of the conclusions. There were no failures.

These experiments brought the mystery into the field of mechanics, because there was nothing peculiar about the construction of the wedge; not even a convex surface. *The writer knew positively that the wedge moved against the wind from the wind power itself.*

This was the sure foundation from which to make a start toward the solution of this seemingly difficult problem.

Mechanics presents an analogous phenomenon which aided the writer in reaching the solution.

The appliance known as a boiler injector or inspirator is referred to. With this wonderful machine the boiler pressure forces the water into the boiler against its own pressure, without the use of mechanical levers. The impetus of the stream is imparted to a fine stream of water, which enters the boiler with a greater pressure than that of the boiler.

In the experiments recorded the mysterious force sought started the wedge from rest into action; but the writer has never observed a bird start sailing from rest without first moving its wings or giving itself a start with its feet. However, that is no proof that a mechanical bird will not be able to imitate the wedge.

To solve the problem the writer imagined the wedge in a current of air, at rest, with the thick end squarely facing the wind without supports.

If the speed of the wind is forty miles per hour, the pressure

will be eight pounds per square foot. This pressure is acting upon all sides of the wedge.

If the wedge is maintained in its relative position to the wind current, and allowed to drift it never could advance because the speed of the wind could not act. Here is a basic principle namely; for a wedge form to move against a current of wind without power applied, it must be approximately in the relative position stated above, and in a state of rest.

The speed of the wind must have an opportunity to act; it strikes the front elliptical end of the wedge and is formed into two air wedges between the passing air currents above and below the wedge, which just miss it. These two wedges have a greater pressure than the surrounding air, because of the sudden checking of the speed of this air against the wedge.

These air wedges are forced between the currents above and below the wedge, and the higher pressure of these wedges does not fail until they have passed the greater thickness of the wedge when it reacts against the tapers, forcing the wedge against its own pressure.

The side currents are compressed to some extent and in expanding assist in squeezing the wedge ahead.

To illustrate this point take a wedge and drive it into the end of a piece of green wood; then take two more wedges and drive them along side of the first one and it will be forced from its position.

No doubt the concavity of the bird's wings utilizes this force to a greater degree, because as soon as the air wedges pass by

the thick part of the wings, they expand with greater impetus into this space of slightly lower pressure.

This explains the reason for the greater efficiency found in the tests of planes which are constructed as curved wedges, with the greatest concavity near the thick part.

In the tests of the paper wedges moving against the wind, the effect of an increased speed of the wind was plainly noticeable. When a gust of wind came the wedge would jump ahead several inches, whereas if the wind came evenly, it would move ahead with light even jumps. This was caused, no doubt, by the friction of the eyes upon the wire supports.

But, one is inclined to ask, if this principle is true why is it that flying machines with curved wedge planes do not sail without power? The man and machinery, and the tail trussing will have to be encased within a birdlike body to give more wedging surface and prevent retarding friction; the exposed propeller will have to remain an unknown quantity for the present.

The dirigible balloon will have to have planes resembling those of the monoplane, with the machinery and the car inside of the main body.

At present the aviator has to come to earth for fuel; with this principle developed he will be inside of a wedge shaped cabin with fuel and food and all the comforts of home. He will sail in great circles if he wishes to go with the wind, and will float straight ahead if he desires to go against it.

Then it will be only a matter of carrying sufficient food to sail around the world without mechanical power, as did our first ocean navigators.

## FATAL AEROPLANE ACCIDENTS.

Statistical table compiled by Automobil-Welt up to December 13th, 1911, which makes a very interesting study for the thorough student of aircraft.

The 93 fatal accidents occurred with . . .	Per Cent. of Victims Killed in Flying		12 Passenger Flights ended Fatally for			In 12 Passenger Flights were Killed		No. of Flights Terminating Fatally	No. of Aviators Killed who had Not Pilot Certificates										
	Alone	With Passenger	Pilot and Passenger	Pilot only	Passenger only	Pilots	Passengers												
(In two cases type was unknown)	81	19	7	3	2	10	9	93	16*										
Monoplanes . . . . .	Total 38	15	3	2	2	2	1 each Dorner, Deperdussin, Lilienthal, † Leforestier, Moisant, Oertz, Pietschker, Pilcher, † Pischoff; Poulain, Queen, Russijan, Sommer, Wieserbach.												
Name . . . . .	Bleriot	Antoinette	Nieuport	R.E.P.	Valkyrie														
Biplanes . . . . .	Total 52	10	8	5	4	4	3	2	1 each Albatros, Astra, Baldwin, Bristol, British Army, Breguet, Caudron, M. Farman, Fernandez, Hartle, I.A. M.C., Lière, L.V.G., Marra, Short (Grace).										
Name . . . . .	H. Farman	Wright	Sommer	Aviatik	Curtiss	Savary	Voisin	Curtiss copies											
Countries. . . . .	France	America	Germany	England	Italy	Russia	Austria	Spain	Belgium	Holland	Luxemburg	Bulgaria	Siberia	Switzerland	Algeria	China	Brazil	Peru	Unknown
Per cent. of victims belonged to . . . . .	34	15	15	12	8	5	3	2	1	1	1	1	1	1	1	1	1	1	1
Country of origin of machine . . . . .	53	12	14	7	1	1	3	1	1	1	1	1	1	1	1	1	1	1	1
No. and country where accidents occurred	32	16	14	8	6	5	1	1	2	1	1	1	1	1	1	1	2	1	3
	America	Italy	England	Germany	Russia	France													
Ratio of No. killed to No. of holders of pilot certificates ‡ = 17.1 per cent.	12 (74†)	7 (45†)	9 (110†)	11 (135†)	3 (55†)	27 (500†)													
	15.5	15.5	8.2	8.14	5.45	5.4													

\* Including 3 killed on gliders. † Gliders. ‡ The figures in brackets give the number of certificated pilots up to the end of October, 1911. § Those who were killed while flying without pilot's certificate, or as a passenger, or in glider experiments, have been omitted. Their numbers are: France, 7; Germany, 4; America, 3; England, 3; Russia, 2; Italy, 1.

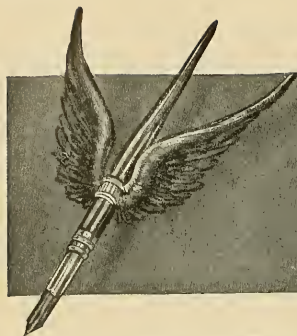

# EDITORIAL

## NO AXE TO GRIND.

**W**ITH this number *Aircraft* begins its third year of usefulness. For over two years it has been circulating among aeronautical people of the world conveying periodically a message of good cheer and a promise of continued progress. This Magazine was established at a time when an aeronautical publication was a very precarious thing and it required some courage of conviction to give time, energy and money toward such an undertaking. But we believed then as we believe now and as we have always believed since in a great future for the air vehicle, and so we went ahead and kept going ahead irrespective of all obstacles thrown, either intentionally or unintentionally, in our pathway.

While other aeronautical magazines were coming and going, some for a month, some for six or eight or ten months and then petering out—dying as it were by the wayside for want of support and appreciation—this magazine has gone on without a break, and now begins its third year triumphantly and with the supreme confidence of the entire aeronautical movement, not only in this country, but in every country in the world where aviation has thrived. Our efforts and our policy have been appreciated by everyone who has the welfare of the movement at heart.

It would be hard to say just what has given *Aircraft* its great prestige. Some of the others were "just as good as *Aircraft*" and some were "even better than *Aircraft*," but there was a difference somewhere, for *Aircraft* LIVED and grew STRONG and self supporting, whereas the others DIED and were buried and forgotten.

It is just possible that this magazine achieved success because its readers discovered that our sole aim in life is to develop the movement along substantial lines. We are optimistic and we cannot hide our optimism when discussing the future of aerial transportation. We are sincere and our readers believe in us, in fact a bond of sympathy between the magazine and its readers has been permanently established. They believe in our oneness of purpose and unite with us in it. And we give them the facts—pure, unadulterated facts.

Further than that we have kept aloof from the little

schisms of the movement. We have repeatedly refused to allow *Aircraft* to be exploited as the official organ of any club or corporation or organization of whatsoever nature. The petty quarrels and ambitions of a few scheming club politicians never interested us in the least. We know that these little schemers must come and go, like the June bugs of early summer, but that the aeronautical movement as well as this publication must and will continue to go on indefinitely.

*Aircraft* stands first, last and all of the time for the entire aeronautical movement—nothing more, nothing less. It has, up to the present time, given much assistance to men, concerns and clubs. We feel proud of every big man, every big concern and every big club we have helped to develop in the past, but we cannot for a moment consider lending the columns of this publication to furthering the ambitions of any man, concern or club when it goes contrary to the best interests of the movement itself. So we stand aloof as we have always done in the past—owned nor controlled by no one.

We have no axe to grind, and therefore we can give to our readers absolutely unbiased information. This movement is going to develop wonderfully and along various lines in the next few years, and it is well for the men who are now in the movement and for those who will come into the movement later on that there is such a magazine as *Aircraft* to watch over their interests.

## THE FRENCH DECREE.

**O**NCE more the French lead the aeronautic world and the Decree regulating aerial traffic which we publish on page 20 is another witness to the oft-repeated statement.

This Decree is meritorious, establishing a proper but not restrictive control over flying, and best of all giving the aviator a legal status within which he can easily keep and within which he can be protected from many petty annoyances on the part of any hostile public wanting to deny the aviator fair treatment in the exercise of his art. It tells the airman many simple things which he must do to have the State on his side, and, on the other hand, it indicates to the public the extent of its rights. Above all, the Decree cannot con-

ceivably hamper the progress of aviation. It was written by men with the true interests of aeronautics at heart, a body of experts which came into being as early as 1908, when certain deputies of the French Chamber organized a Committee on Aviation. Two years later this self-constituted body was made official and, as a Government Commission, sought help from flying men, aircraft constructors and legal authorities so that their work might be satisfactory to all. At least a dozen projects were studied before the final text was drawn up.

What enlightened activity at all comparable to this Decree has America to record? None.

The general principles of the French Decree might be adopted for the United States—when we are ready; its details, however, do not fit our system of government. Therefore, we must make our own laws and, as we pointed out last December, we should be prepared to do so. The omnivorous legislator will not long leave aviation alone, and the aviation world should be ready and waiting to show him the way.

---

#### AVIATORS SHOULD ORGANIZE.

**A**N aviators' protective association for the purpose of watching the law makers should be organized. There is no one who should know more about the conditions under which machines should be allowed to go into the air and the conduct of such machines when in the air than the man who must take the machine into and manipulate it while in the air. Therefore, he should have something to say regarding the laws that are going to be made relating to air travel.

At the present time there are in the neighborhood of five hundred aviators in this country, and no doubt before the end of this year there will be at least one thousand to fifteen hundred of them. These men should have their own organization for the purpose of considering and deciding aerial questions. They should at least have a voice in the matter when the rules and regulations governing flight are prepared.

The aviator should remember that as an individual he is incapable of competing with a combined force, and that his strength will only become apparent when combined with and acting in unison with that of others. He must organize if for no other reason than to protect his own interests against the schemes of the politician who is now becoming a factor in shaping the affairs of the movement.

The aviators' association should be national in scope and entirely separate and distinct from clubdom.

---

#### BUSINESS AT SUMMER RESORTS.

**T**HE professional aviator could probably do well this season at the various summer resorts. We think that it would pay an aviator moderately well to locate at a watering place with an hydro-aeroplane, or at an inland resort

with a regular aeroplane, and carry passengers on little tours at a stated fare per head. If the amount was made small enough no doubt a very profitable business could be worked up along this line, and what is good for one resort would be good for almost all resorts, so that if the idea has value for one it should have value for many, as there are many hundreds of good watering places or inland summer resorts scattered throughout the United States.

Aviators should open up correspondence with the managers of these resorts immediately and see what can be done. No doubt these managers would be willing to offer some inducement, but the aviator must depend principally upon the amount made through carrying passengers on short trips. If possible, make the price ten dollars per head for a short distance, or more if longer trips are desired. Almost any summer vacationist could afford a ten-dollar ride, and ten of them a day for sixty days will not only pay for the machine and operating expenses, but should include the aviator's stipend as well.

---

#### AERIAL OPPORTUNITIES.

**W**ITHIN a year or two many rich young men, scattered about the country, are going to purchase aeroplanes as part of their transportation equipment. Some of them will know little or nothing about the mechanical makeup of the machines and will care even less, so that they will need men who not only understand construction work, but men who will be able to act as aeroplane drivers.

So we suggest that young, ambitious mechanics become competent airmen as quickly as possible, and furthermore learn how to build the machine from nose to tail, and the science of aviation generally. This cannot be done in a day, and if future success is anticipated, careful preparation must be made in advance. There will be more aerial opportunities for good men in the near future than there will be good men to take advantage of them.

---

#### SPECIAL AEROPLANE SERVICE.

**M**R. GROVER CLEVELAND LOENING has suggested to the Editor of *Aircraft* that the time has now arrived for the railroads of this country to inaugurate special aeroplane service to take the place of special trains, which he contends will not only land the passenger at his destination in a shorter space of time which is usually the object for engaging special trains, but that the cost can be very materially reduced also. We can see no good reason why this suggestion could not be worked out to good advantage by the large railroads and especially those winding, mountainous roads over which trains sometimes take hours to go between two points that could be reached by aeroplane in a few minutes.

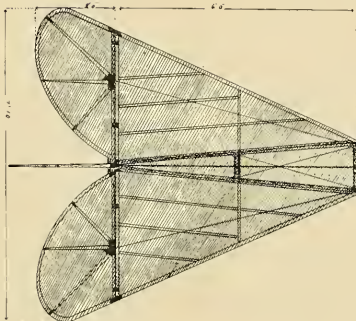
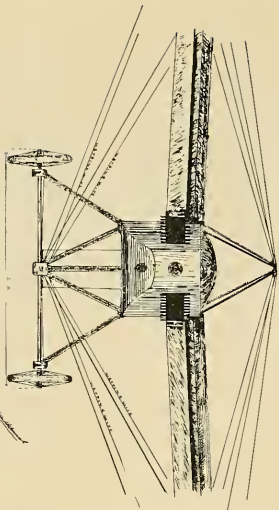

ANGLE OF INCIDENCE 14°
DISCORD ANGLE 1°
ANGLE OF TILT 4.5°
AREA WING SURFACE 130 SQ. FT.
AREA OF STABILIZER 23 SQ. FT.
AREA OF ELEVATOR 11 SQ. FT.
AREA OF RUDDER 5 SQ. FT.
SPAN 21.5'
CHORD 14.75'
CAMBER 3'
LENGTH 21.5'
WEIGHT WITH MOTOR 800 LBS.

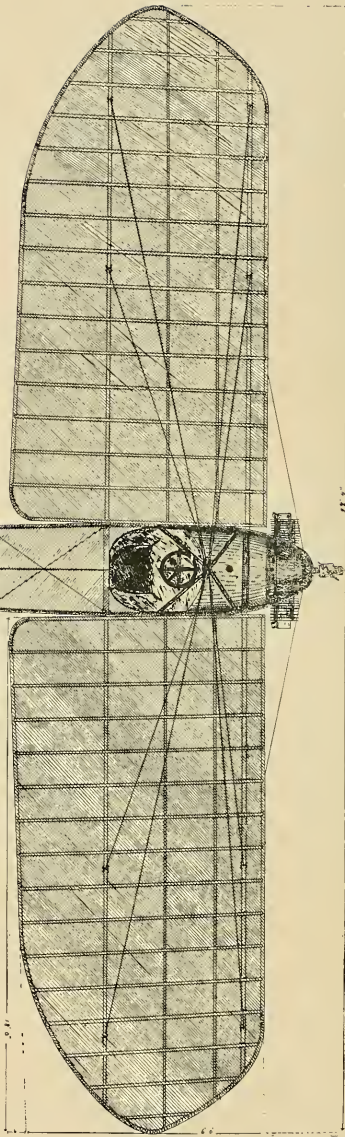

HEINRICH MONOPLANE MODEL D.

HEINRICH MONOPLANE, TYPE (D)

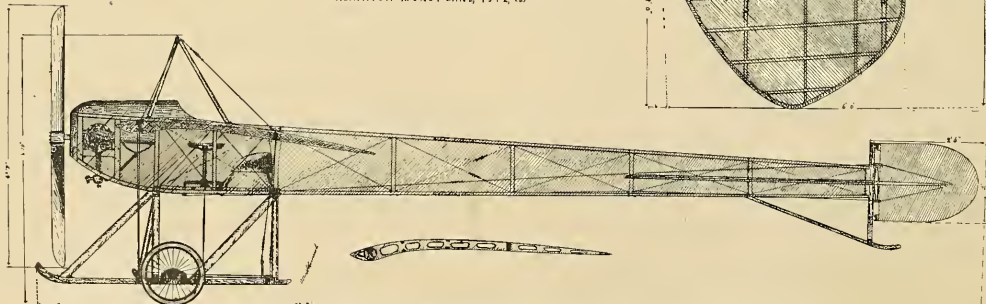

SCALE DRAWINGS OF THE HEINRICH SCHOOL TYPE MONOPLANE.

# THE HEINRICH 1912 MONO-BIPLANE

An interesting all-American machine of sound design and pleasing appearance is the 1912 Heinrich mono-biplane, so called because it is fitted with interchangeable wings and can be flown as either a biplane or a monoplane.

The Heinrich Brothers, of Baldwin, L. I., and is of conventional monoplane design, but has many original construction fea-

separated from the motor by an aluminum partition. The gas tank compartment is also fitted with drains so that any leakage from the tank will immediately drain out.

### THE TAIL.

The greatest care has been used in the design of the tail, which is of the flat and non-lifting type. In the tail lies the whole success of the

spars, two main spars of ash are  $2\frac{1}{2}$  ins. by  $1\frac{1}{2}$  ins., channeled out for lightness. The other two spars are, one at the leading edge, 1 in. by  $1\frac{1}{2}$  ins. of spruce, and one, 1 ft. from the trailing edge 1 in. sq. of ash. Ribs are spaced 10 ins. apart and are of I beam section, the middle section of ash, and the struts or upper and lower sections of white wood. The wings are held up by two steel wires in front, two to each wing, capable of withstanding 1,500 lbs. apiece, and two flexible steel wires in the back capable of withstanding 2,000 lbs. apiece run through two tubes on the truss to allow warping, the truss which holds the wires is made of four pieces of oval steel tubing terminating into one piece which holds the tubes for the warping wires at the top.

All wires are made tight by the best type turnbuckles. The under fastenings of the wings are five in number, two to the front main spar of the wing, which practically have to sustain the entire weight of the machine, and are capable of sustaining 2,300 lbs. each. The warping wires are two in number, of flexible steel the same as the front wires; one runs over a pulley which takes the strain of the other, which runs to the warping arm. The fifth wire is fastened to the small spar 1 ft. from the trailing edge, and runs over a separate pulley.

### THE LANDING CHASSIS.

Too much care cannot be given to the design and construction of the landing chassis. This is of the wheel and skid type. One long central skid of laminated spruce and ash, turned well up at the end serves three purposes: to protect the propeller in case of a bad landing, even though part of the chassis is damaged; to keep the machine from taking a header in case of a bad landing; and to form a substantial anchor for the wing wires and warping arm. Two small skids, one on either side of the large skid, are braced out with oval tubing. To these are fastened the rubber chock absorbing springs through which the axel runs, with a wheel at either end. The small wheels and skids take all the shock of landing.

### THE CONTROL.

This is of an original ONE WHEEL type, viz: longitudinal movement works the elevator, lateral movement works the warp, and turning the wheel steers.

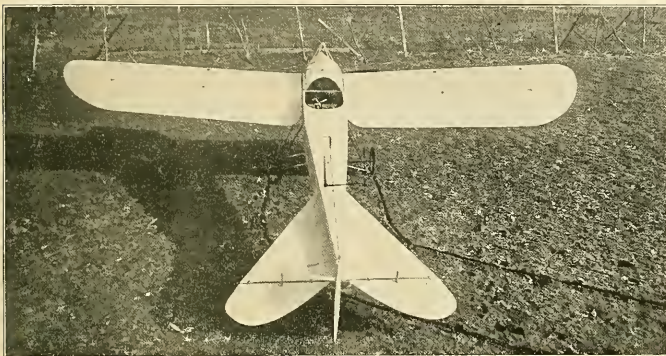

TOP VIEW OF HEINRICH MONO-BIPLANE.

tures not found in other machines, so that altogether it is a great improvement over the machine of last year, which was illustrated and described in Volume II AIRCRAFT, page 245, and should—if properly powered—give a good account of itself. The Heinrich mono-biplanes are made in two types, each with two sets of interchangeable monoplane and biplane wings, a description of which is given below. In addition to the mono-biplane the Heinrich Brothers also turn out the small school type monoplane, which is illustrated in the accompanying drawings.

Turning now to a description of the machine, which is built in two types, one a high speed design and the other a passenger type, the principal dimensions are as follows:

### GENERAL DIMENSIONS.

High speed type—Length, 24 ft. 6 ins.; spread, 29 ft. 4 ins.; chord, 6 ft. 6 ins.; Camber of wings, 2 ins.; angle of incidence, 6 deg.; dihedral angle,  $3\frac{1}{2}$  ins. Passenger type—Length, 25 ft.; spread of wings, 33 ft.; chord, 7 ft.; camber,  $3\frac{1}{2}$  ins.; angle of incidence,  $7\frac{1}{2}$  deg.; dihedral angle,  $3\frac{1}{4}$  deg.

### FUSELAGE.

Great care has been used in the design of the fuselage to reduce head resistance to a minimum. It is of the box girder type, 22 ft. long running from a blunt point at the front to a point at the stern. Four ash members run the full length of the fuselage. They are joined in the middle by a sliding fit into square steel tubes 1 ft. long so that the fuselage can be taken in half for shipment. The four main frames are  $1\frac{1}{4}$  ins. square at the front tapering down to  $\frac{3}{4}$  in. at the stern, where they join a stern post of ash 2 ft. by 2 in. by  $\frac{3}{4}$  in., to which the rudder is fastened. The fuselage is 20 ins. deep at the front and 28 ins. wide, and tapers down to one ft. deep at the sternpost and 1 in. wide. It is strengthened by stanchions every  $2\frac{1}{2}$  ft., except at the motor, where the stanchions are only 2 ft. apart. All the stanchions aft of the aviator's seat are 1 in. by 2 ins. The fuselage is further strengthened by No. 33 steel wire galvanized, which is fastened to U bolts of 3/16 in. cold rolled steel. The seat is slightly forward of the trailing edge of the wings. Forward of the seat it is entirely covered with aluminum, with the exception of three windows of celluloid, one in the bottom, 2 ft. wide, runs entire across the machine and one on either side 1 ft. by 16 ins. This gives the aviator a good view of the ground at all times, and also allows him to inspect his landing gear while in flight. A steel tube 2 ins. in dia. runs across the fuselage in front into which the main spars of the wings fit. The ends of the main spar have a shoulder which fits snugly against the tube. A box of laminated spruce and ash runs across in front of the seat into which the second main or warping spar is fitted. This also serves as a dash-board on to which the tachometer, watch, and engine controls are fitted. The fuselage is also covered the entire length with cloth.

### THE MOTOR.

Great care has been exercised in placing the motor and gas tank so as to eliminate any possibility of danger from fire. The gas tank is

separated from the motor by an aluminum partition. The gas tank compartment is also fitted with drains so that any leakage from the tank will immediately drain out.

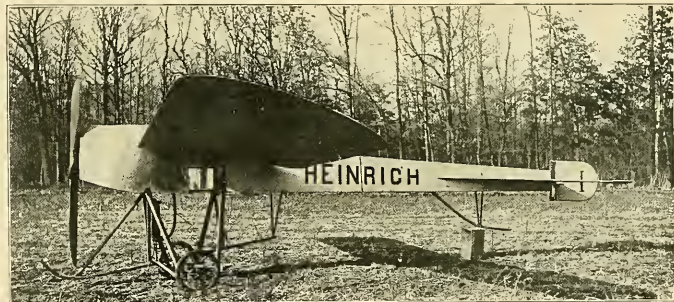

SIDE VIEW OF HEINRICH MONO-BIPLANE.

which are hinged onto the main part of the tail and form the elevators. The tail and rudder and elevators are so constructed that it is only a matter of ten minutes' work to take off the entire tail. The tail is supported when on the ground by a light laminated skid.

### THE WINGS.

In the construction of the wings lies the whole safety of the machine. They are built up on four

The machine is called a mono-biplane because it is so constructed that it can be changed from a biplane into a monoplane with about one hours work. It is built with two sets of wings. The monoplane wings have 180 sq. ft. for the high speed type, and 210 sq. ft. in the passenger type. The biplane wings for the high speed type have 300 sq. ft. and the biplane wings for the passenger type have 420 sq. ft.



FRONT VIEW OF HEINRICH MONO-BIPLANE SHOWING WARP.

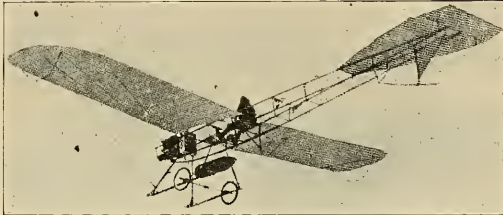

The Harlan monoplaner in flight. It was on a machine of this make that Herr G. L. Ulrich, at Johannisthal, recently broke the world's records for duration flights with two and three passengers aboard.

# FOREIGN NEWS

BY  
WALTER H. PHIPPS

## Brazil

As predicted in AIRCRAFT as far back as July of last year, large sums of money have been made by flying in South America. Letters received from South America tell us of the great success of exhibition flights recently made there by Roland Garros, Edmond Audemars and Rene Barrier, in Blériot, Nieuport and Deperdussin monoplanes, under the management of Willis McCormick, of New York. Mons. Garros at Rio Janeiro won the President's prize of \$17,000, and also won a \$20,000 cross-country prize for flying one hundred miles. As a result of the impression made, the Brazilian government has decided to buy several of the French machines exhibited.

## England

### CODY MAKES NEW ENGLISH PASSENGER CARRYING RECORD AT ALDERSHOT.

At Aldershot on February 3rd, Colonel S. F. Cody made a new English flying record by carrying four passengers seven miles at a height of 100 feet in a strong wind. The weight of pilot and passengers was 750 pounds.

A new silent biplane, built to the designs of Mr. Geoffrey de Havilland, one of England's most persistent and clever designers, has been turned out by the British Army Aircraft factory, and in numerous trial flights under the pilorage of de Havilland, has shown itself a capable flyer. The machine is a tractor screw biplane, having a stream line fuselage with silenced motor in front and a Nieuport type tail at the rear. The wings are warplable and the landing gear consists of a wheel and skid arrangement.

## Belgium

On January 16th Crombez arrived at Brussels on his Deperdussin, having continued his tour from Tournai, France. He covered the 100 kilometers in just one hour.

## France

### VEDRINES BREAKS SPEED RECORD—FLIES AT NINEEY-TWO MILES AN HOUR.

At last the speed records of the late Edouard Nieuport have been broken. Vedrines on a new Deperdussin monoplaner of 21 metres span and 13 square metres surface, fitted with a 100 H. P. Gnome and 2.5 metres diameter "Rapid" propeller, set out on January 19th at Pau to break the speed records and succeeded in breaking every record from 1 to 150 kilometres. His speed works out at 92 miles per hour. The accompanying table shows both the new and old records:

#### SPEED RECORDS BY DISTANCE.

	Vedrines.		Nieuport.	
	H. M. S.	H. M. S.	H. M. S.	H. M. S.
5 kiloms.....	0 2 6.25	0	2 18.25	0
10 kiloms.....	0 4 13.25	0	4 30.15	0
20 kiloms.....	0 8 26.35	0	9 14.45	0
30 kiloms.....	12 40.45	0	13 33.45	0
40 kiloms.....	0 16 53	0	18 31.35	0
100 kiloms.....	0 41 56.45	0	46 27.25	0
			Weyman.	
150 kiloms.....	1 2 43.45	1 11 36.15		

#### SPEED RECORD BY TIME.

	Nieuport.	
	(21.7m.)	32 kils. (19.8m.)
½ hour... 70	kils. (43.4m.)	64 kils. (39.8m.)
1 hour... 142.43	kils. (88.8m.)	129 kils. (79.9m.)

New r'd, Vedrines...145.177 k.p.h. (92 m.p.h.)  
Old rec'd, Nieuport...133.136 k.p.h. (82½ m.p.h.)  
**BATHIAT BEATS VEDRINES' RECORD AND MAKES WORLD'S RECORD FOR 100 KILOMETRES.**

On January 26th at Douzy, Leon Bathiat, flying a Sommer monoplaner, broke Vedrines' record for a distance of 100 kilometres by covering this dis-

tance in 41 minutes 29 seconds, as against Vedrines' time of 41 minutes 56.45 seconds. His best speed works out at 93 miles an hour.

### WORLD'S FIVE PASSENGER RECORD.

On the same day (January 26th) at Douzy, Henri Molla, on a Sommer biplane, broke the passenger carrying record by remaining aloft for 1 hour 6 minutes, with five passengers, of a total weight of 948 pounds, exclusive of gasoline and oil.



VEDRINES, THE GREAT FRENCH AEROPLANE DRIVER.

### TWO-PASSENGER HEIGHT RECORD.

Using his Borel monoplaner, Verrept, at La Vidance, on January 20th, carried two passengers, MM. Voigt and Liva, to a height of 1,075 metres. The useful load carried was 215 kilograms, while the total weight, including petrol, etc, was offi-



THE DORNIER MONOPLANE, A NOVEL AND INTERESTING ALL-GERMAN MACHINE.

cially checked at 300 kilograms. Verrept intended to try and beat Lieut. Bier's record of 1,220 metres, but after 18 minutes he found the cold too trying, and had to come down. He had, however, beaten Moineau's French record of 876 metres.

### FISCHER GOES HIGHER.

On January 23rd, at Bouy, Fischer, on his Henry Farman biplane, attacked the double-pas-

senger height record, and took his two friends, MM. Loygrin and Ram, up to an altitude of 1,000 metres. He has set the world's record, but only held it for a few hours, as at Rheims, a few kilometres away, Prevost was making preparations for a similar flight, with the success seen below. Fischer will, however, have another try for the record shortly.

### PREVOST ESTABLISHES WORLD'S RECORD.

Also on January 23rd, but at the Courcy-Betheny ground, near Rheims, Prevost attempted to beat Lieut. Bier's record, and by taking up Lieut. Brat and M. Besnard to 2,200 metres he secured the right to the title of world's record holder.

His machine was a Deperdussin monoplaner, fitted with Gnome engine and a Rapid propeller. The start was made at a quarter past three, when although there was little wind, a thick mist made the conditions uncomfortable for the flyers. At 300 metres height the machine disappearing from view, but another couple of hundred metres higher the record breakers found themselves under a bright blue sky. In 23 minutes a height of 1,750 metres had been attained, and four minutes later the barograph registered 2,000 metres. Prevost kept the machine climbing until 2,200 metres had been reached, and then started to come down in a spiral *vol plané*. He suddenly found himself above the towers of Rheims Cathedral, and taking his bearings by this landmark, found his way to his hangar, before which he landed, after being in the air 38 minutes.

### TABUTEAU ESTABLISHES NEW FIGURES.

At Pau on January 24th, Maurice Tabuteau, flying a monoplaner, made world's records for the distances of 200, 250 and 300 kilometres (124.28, 155.35 and 186.41 miles, respectively). He covered the 200 kilometres in 1 hour 54 mins, and 21 secs., the 250 kilometres in 2 hours 22 mins, and 57 secs., and the 300 kilometres in 2 hours and 51 mins.

Mons. Tabuteau also established new records for flights of two and of three hours. In two hours he covered 205 kilometres, 287 metres (127 miles, 5 furlongs), and in three hours, 316 kilometres 287 metres (196 miles 973 yards).

### PAULHAN-ROBINSON TOUR.

Hugh Robinson and Louis Paulhan have arranged to give demonstrations with Curtiss hydro-aeroplanes at Cannes, Nice, Monte Carlo and other places on the Riviera during the next month.

It is probable that they will also enter the hydro-aeroplane meet which is to be held at Monaco during the last week in March. The International Sporting Club has offered a prize of \$3,000, and it is probable that more will be contributed. The contest will comprise six tests—(a) starting from calm water and going round a course of 4½ kilometres in the Bay; (b) resting on calm water; (c) starting from broken water; (d) resting on broken water; (e) landing on the seashore so that the pilot may descend from machine; (f) starting from the shore. In addition to Paulhan and Robinson it is stated that Colliex will compete on a Voisin and Renaux on a new Farman hydro-aeroplane.

### SCOTT'S BOMB THROWING.

Lieutenant Riley E. Scott, the American whose picture was reproduced on the front cover of the November AIRCRAFT, is making some interesting trials at Villacoublay, in which he is employing "bombs" from a Wright's machine with wonderful accuracy. He is making these trials in view of competing for the Michelin prize for bomb throwing. Among the spectators at Villacoublay recently were Colonel Bontoux and a delegation from the Turkish Embassy. Lieutenant Scott, at a height of 200 metres, easily throws two elongated projectiles within the circle, as prescribed



in the Prix Michelin rules, and frequently he is so accurate as to place the projectiles within a metre or two of the bull's-eye centre.

**LONG DISTANCE BALLOON RECORD.**

Official figures on the world's long distance balloon record made by Emile Dubonnet and Pierre L'herit on their flight of January 7th and 8th from La Motte-Breuil, France, to Sopolowska, in Russia, show that the distance covered was 1,214 miles, or thirty miles more than the record of Count de la Vaulx in his flight from Vincennes, near Paris, to Kovostychev, Russia, made October 9, 10 and 11th, 1900.

**FRENCH WAR MINISTER WANTS \$4,200,000.**

The War Minister of France, M. Millerand, is asking for an appropriation of \$4,200,000 for military aviation purposes in 1912. The War Minister is being backed up by the Minister of Marine, M. Delcasse, and 185 members of the Cabinet, and it is hoped that this appropriation will be granted. As we go to press it is reported that this appropriation has been granted.

**NAVAL APPROPRIATION.**

The French Naval authorities are asking for an appropriation of \$200,000 for experiments with hydro-aeroplanes. It is proposed to establish a flying ground on the coast and also to fit up the warship "Foudre" as an experimental vessel for aeroplanes.

**Germany**

**WORLD'S RECORDS BROKEN.**

The world's record for duration carrying the aviator and two passengers was beaten on January 22nd at Berlin at the aerodrome at the Johannisthal field by Herr G. L. Ulich, an engineer, who, in his Harlan monoplane, stayed in the air two hours, two minutes and forty-five seconds.

The previous record for duration was held by Lieut. T. De Witt Milling, an American, who, on September 26, 1911, at Nassau Boulevard, L. I., using a Burgess-Wright biplane, with two passengers, remained in the air one hour fifty-five minutes and forty-two and three-fifths seconds.

**AVIATOR AND THREE PASSENGERS RECORD.**

On January 25th, at Berlin, a new endurance record for a flight carrying the aviator and three passengers was created at the aerodrome at Johannisthal by Dr. G. L. Ulich, who, with three companions stayed one hour and thirty-five minutes in the air in his Harlan monoplane. The Austrian aviator, Herr Warchanowski, held the duration record for pilot and three passengers since October last, when at Weiner Neustadt, with three companions, he remained in the air in his biplane 45 minutes 46 seconds.

**INTERNATIONAL AVIATION EXHIBITION IN GERMANY.**

An International Aviation and Aero Exhibition will be held in Berlin, Germany, from April 3 to April 14, 1912, open to aeroplanes and dirigible balloons of all kinds; motors and propellers for flying machines; materials (crude and worked) used in the making of aero apparatus; bodies; accessories; repairs and parts for aeroplanes and dirigibles; models; plans; drawings of air craft; hangars, tents, balloon sheds, and models of the same and of aviation grounds; contrivances and means of transporting aeronautic apparatus; motors and gas generators; equipments and kits; meteorological, physiological, photographic, and cinematographic provisions; signaling devices; lighting apparatus; maps; aero travelers' equipment (special clothing, prepared food, etc.); scientific and art works; and other exhibits appertaining to airships and aero travel.

**German News**

By Stella Hoch.

The Royal Danish Aeronautical Society is planning a flight from Copenhagen to Berlin for the summer and has secured the assistance of the Imperial German Aero Club for the project. German and Danish aviators only will be eligible for competition.

The Zeppelin Company proposes, so far as we are informed, to send two moderately equipped passenger vessels to the World's Fair in San Francisco in 1915 to undertake circular and cross-country trips in that vicinity.

A regular aerial post is about to be instituted from Bork to Brueck, near Potsdam, on Grade aeroplanes. This service will not be of an intermittent character, but will constitute a regular postal delivery.

Following on the report of a special commission appointed by the Army, the construction of the German military "M" airships on the Gross semi-rigid system will be discontinued henceforth. It has been found that the semi-rigid framework which characterized this type could not of late be built strongly enough to prevent accidents to the gas envelope without detracting from that most important factor, speed.

A Japanese military aviation commission, consisting of Colonels Jamada, Krakomo and Kita-



THE CLEMENT-BAYARD MACHINE IN FLIGHT. THIS MACHINE IS FITTED WITH INTER-CHANGEABLE WINGS AND CAN BE FLOWN AS EITHER A MONOPLANE OR A BIPLANE. BELOW WE SHOW IT AS A BIPLANE.

yama, two majors and several captains and lieutenants, is due in Berlin, and will then go on to Austria to study aviation there. The new Japanese Ambassador at Berlin has received personal permission from the Kaiser to show his countrymen the military aviation and aeronautical workshops and to allow them to take part in the tests. The time from June 14 to 25 has been set aside for the competition from Berlin to Vienna, ar-

the team will be selected as the outcome of trials to be held at Leipzig and Dresden on April 28th and finally at Wlukun in Breslau; quite a number of military men have entered for the tests.

**Tripoli**

On February 1st, Captain Monte, of the Italian Military aviation corps, was shot at and wounded

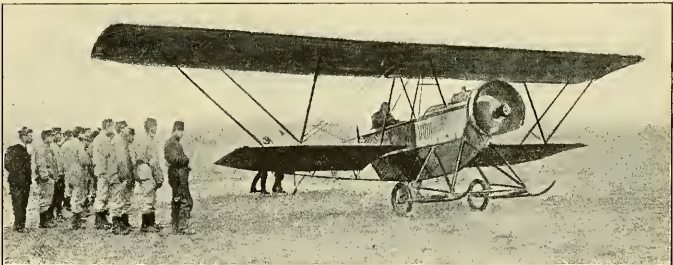

THE CLEMENT-BAYARD MACHINE FITTED WITH BIPLANE WINGS. NOTE THE METHOD OF BRACING THE BIPLANE CELLULE WITH SLOPING UPRIGHTS.

ranged by the Society of German Aero Technicians and the Austrian Aero Club. One of the conditions of the event is the carrying of passengers.

The German Gordon Bennett Balloon Race is to be held at Stuttgart on October 27th. Germany has nominated last year's winner, Herr Gericke, as its representative, and the other two members of

while dropping bombs from his aeroplane into an Arab encampment near Tobruk. The aeroplane was struck four times by Arab bullets, one of which hit Captain Monte, wounding him severely. He was, however, able to return to camp with the assistance of his companions, and both landed safely, bringing valuable information.

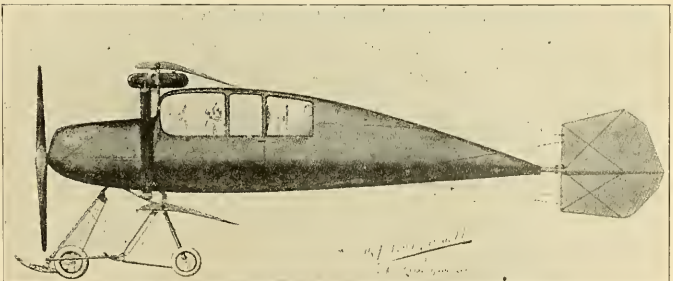

SIDE VIEW OF THE DESIGN FOR A NEW BREGUET ENCLOSED AEROCAR.

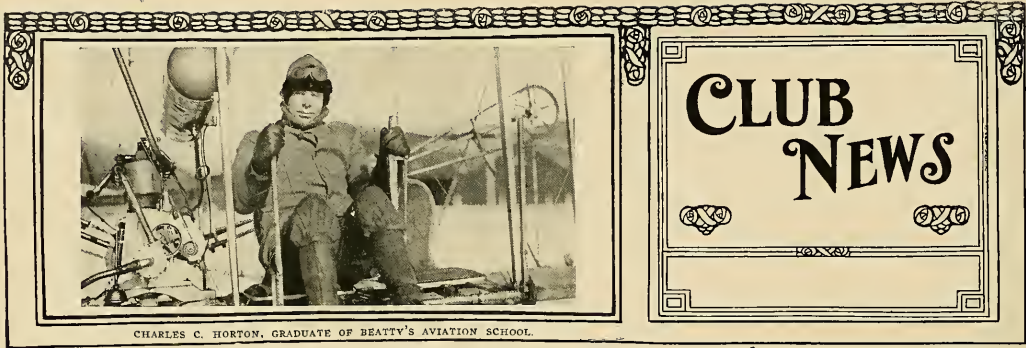

CHARLES C. HORTON, GRADUATE OF BEATTY'S AVIATION SCHOOL.

### Aero Club of Illinois

The Aero Club of Illinois is probably doing more for the development of aviation than any other club in this country at the present time. Arrangements are now being made to hold the Coupe Internationale d'Aviation at Chicago this summer.

It is intended that Mr. Cortland Field Bishop, the vice-president of the Internationale Federation Aeronautique, and the man who was instrumental in inducing Weymann to fly the American flag at the Internationale race at Eastchurch, England, last year, will visit Chicago shortly for the purpose of looking over the ground and ascertaining as to whether or not it will be suitable for the race. It is intended that the contest will be held in Chicago about the last week in September.

The laying out of the courses for events under the new rules of the federation will be more difficult than in former years. In the interests of safety, there are several new requirements to prevent obstruction. At last year's races on the Isle of Sheppey there were ditches, water courses and cattle grazing. At Belmont Park in 1910 there were houses, trees, poles and all sorts of obstructions.

A complete copy of the new sections adopted at the Rome congress of the federation has been forwarded by Mr. Bishop to the Aero Club of Illinois. A translation from the French text into English shows that no meeting on an aerodrome can be authorized if the course does not comply with the following conditions:

1. The track must have a width not less than 100 metres (328 feet) on its entire extent and a perimeter of not less than 1,500 metres (4,920 feet).
2. The interior surface bound by the course as expressed in square metres (1.19 square yards) must equal at the least the product obtained by multiplying by 25 the perimeters of the track as expressed in metres.
3. There must be between the outer edge of the track and the space reserved for spectators a strip of neutral territory 30 metres (98 feet) wide. On this strip aeroplanes are not allowed to be moved unless when pushed by hand.
4. The surface of the track must be everywhere of such a nature that an automobile can be run over it.

For the Coupe Internationale d'Aviation race for 1912, the track must conform with the above regulations and its minimum perimeter must be 5 kilometres (3.1 miles). The track if possible, it is stated, should be 200 metres (656 feet) wide and the neutral ground between it and the railing also 200 metres in width, and the infield not narrower than 200 metres (984 feet). The distance for the five races is 300 kilometres (224 miles). It is also specified that no angle in the course can be an acute angle, that is to say, less than a right angle.

Concerning the blue ribbon event of the year Mr. Bishop said that the cash prizes offered by the donor of the Coupe Internationale d'Aviation for the time of its institution had all been awarded, but that it was believed that the city obtaining the event this year would offer a prize in money as an inducement to aviators to undertake the heavy expense of entering the race.

Horace B. White returned recently from Europe after purchasing for Harold F. McCormick a four passenger Parseval dirigible balloon, to be delivered in May. This dirigible, which is 185 feet long and can fly thirty miles an hour, remaining long and in the air without alighting, will be used by the members of the Aero Club.

The second Anniversary Banquet was held at the Auditorium Hotel, Saturday evening, February 10th. There was a musical entertainment, motion pictures, including the Grant Park meet, and addresses galore.

At a meeting of the Aero Club of Illinois in the Auditorium Hotel January 30 a proposed "Marathon flight" between the larger cities of the Central West, and similar to the "Mammoth Combination Meet" proposed by the December Aircraft, was considered, including a circuit of Chi-

cago, Omaha, St. Louis, Kansas City, Indianapolis, Dayton and South Bend, special prizes are proposed for each flight between cities and a grand prize for the best performance on the entire circuit. These plans are as yet tentative.

The championship races will be held here in September and an early date in that month probably will be selected. The race as proposed would cover approximately fifteen hundred miles.

Preliminary arrangements for holding the races for the Coupe Internationale d'Aviation, if obtained for Chicago, were made at the meeting. The Board of Directors of the Illinois Aero Club was increased to eighteen members.

### The Aeronautical Society

On January 25th the Aeronautical Society held a smoker and social meeting that was an unqualified success. A "Mock Trial," covering an actual aeronautical situation, was enacted that met with enthusiastic applause. Messrs. A. Leo Stevens entertained the Society with a number of original cartoons projected by the stereopticon, and Mr. H. Percy Sherman, of Williams College Aero Club, talked upon the amusing side of "Balloon as a Sport."

On February 8th at a regular meeting Mr. Frederick Charavay delivered an interesting address on the "Balance of Aeroplanes," in which he dwelt upon the determination of the center of pressure and the correct disposition of weight. Mr. Robert G. Eob, an active aeronautical experimenter and aviator, gave an illustrated address upon the "Soaring Flight of Birds." His pictures were of exceptional interest. The recent "Paris Salon" and Mr. Matthew B. Sellers' paper upon "Propeller Thrusts" were also reviewed by Mr. Stanley Y. Beach, of the "Scientific American," and the well-known technical authority, Mr. Wilbur K. Kimball, respectively.

Aeronautical missionaries, who will wage an educational campaign in the interest of aerial locomotion, will be sent in all directions of the compass around New York City, as a result of formal action taken by the Directors of the Aeronautical Society.

The missionary board, unique in the annals of aeronautics, was instituted to carry out the fundamental purpose of the organization, which is to advance aeronautics to the fullest extent within its means by spreading proper knowledge.

### Aero Club of St. Louis

To aid in popularizing the aeroplane and demonstrating to the public that the machines now being manufactured for general use are reliable and practical, an aerial reliability tour along the same lines proposed editorially by Aircraft last December will take place next June if arrangements can be completed. It is expected that at least a dozen aeroplanes will cover a six hundred mile triangular course in the States of Illinois, Missouri and Indiana, and will be checked in and out of controls, inspected for damages, and their scores kept as automobiles are scored on reliability tours.

It is stated that five prominent aviators and manufacturers have consented to enter the contest and are preparing machines for the tour. E. Percy Noel, secretary of the Aero Club of St. Louis, is working it up.

The route will be from St. Louis to Indianapolis, from there to Chicago and then back to St. Louis. The tour will occupy six days, there being no attempt to make speed records, but merely to establish the reliability of various types of aeroplanes by actual cross country flights. The tentative course to be followed is from St. Louis to Champaign, Ill., the first day; from Champaign to Indianapolis on the second day; from Indianapolis to Logansport on the third day, and to Chicago on the fourth day. The trip from Chicago to St. Louis will occupy two days, the night being spent at Bloomington. Each leg of the triangle will be divided into four controls, where gasoline, oil and other supplies will be provided, and the scores of the machines recorded. Each aeroplane

will start with a perfect score of 1,000, and for broken parts penalties will be imposed according to the importance of the damage. Delay in reaching the various controls will also result in penalties.

The sole idea is to demonstrate the reliability of the aeroplane as developed to-day, and there will be no premium on speed, altitude or exhibition flying.

### Aero Club of Kansas City

The Aero Club of Kansas City has been awarded the 1912 national elimination balloon race. Before the departure of George M. Myers for a trip around the world the Kansas City Aero Club held a meeting and applied for the race. Louis W. Shouse was notified that the offer had been accepted by the national organization.

The terms are the same as those of last year. Kansas City must furnish the field and gas and \$100 to each balloon that enters. It also must provide a suitable cap to the winner.

The National Balloon race is an elimination contest. Its purpose this year is to choose three American balloons to go to Berlin to try to wrest the Coupe Internationale des Aeronautes from Lieutenant Hans Gericke, of Germany, who won it in the international race that started from Kansas City last October.

### Louisville Aero Club

With a membership of thirty-five the Louisville Aero Club, at a meeting January 12 effected a temporary organization, appointed a committee to draft a constitution and by-laws and elected temporary officers.

The committee is composed of G. H. Mounning, Jr., chairman, N. W. Funk, Roscoe Conking and R. O. Rubel, Jr.

Officers will be elected and a permanent organization effected at the next meeting, when plans to open club rooms, obtain aviation ground and purchase flying machines will be discussed.

Otto and Louis Seelbach were made honorary members of the club, and a resolution was adopted, providing that one representative of every daily newspaper in Louisville be made an honorary member, these members to constitute the Press Committee.

Temporary officers elected are: Chairman, C. A. Wicklife; secretary, Roscoe Conking; treasurer, Frank C. Carpenter. All members applying for membership within one month will be counted as charter members, and will be charged no initiation fee.

### Hydro-Aeroplane Club

Louis E. Stoddard, a former Yale football hero and one of the polo team that captured the international trophy in England, is the head of an organization of wealthy young men of New Haven, Conn., who have organized the first hydro-aeroplane club in the world. It will be known as the Hydro-aeroplane Club of New Haven.

Stoddard has purchased a hydro-aeroplane which he has presented to the club. The craft will be delivered in April, and Stoddard and T. W. Farnum, the vice-president of the club, will immediately be trained in handling it. The club plans to have at least six craft of the kind before summer.

Long cross-water flights for sport have been planned. A regular touring itinerary along the Atlantic coast will be laid out. It is hoped that other organizations of the kind will come into being during the summer so that competitive touring flights may be held.

### Philadelphia Aero Club

The Philadelphia Aero Club was organized in December, and having adopted a constitution and by-laws, is already planning to hold a Model Contest, which will be open to all members in good standing. The club is as yet small, being composed of a few young men interested in non-professional aeronautics, and they invite all others living in the locality of Philadelphia who have similar interests to join with them. Detailed information may be obtained from the secretary, D. Earl Dunlap, 2208 Brown St., Philadelphia.

**The Aeronautical Society of Women**

The Aeronautical Society of Women continue to hold instructive and interesting meetings at 250 West 54th street, and are getting quite a substantial membership. At a recent meeting Mr. Wilbur R. Kimball gave an illustrated lecture entitled "The Story of Aviation." Some two hundred pictures were thrown upon the screen and described by the speaker, showing the early crude construction and ideas for aeroplanes right up to the latest development.

It has been decided that henceforth meetings are to take place afternoons instead of at night, the first afternoon meeting to be held on Thursday, February 29th.

**Intercollegiate Aeronautical Association of America**

By GEORGE ATWELL RICHARDSON, *President.*

The annual meeting of the Intercollegiate Aeronautical Association will be held in New York City, at a place which will be designated later, on Friday and Saturday, April 12th and 13th. Of-

ficers will be elected for the ensuing year and other business relating to the college aeronautical movement will be taken up.

This meeting will be open to every college club in existence at the time it is held and it is hoped that every club will put forth its best efforts to send at least one delegate. An important consideration is that all of the officers to be elected should be good active workers.

**SECOND INTERCOLLEGIATE GLIDING MEET.**

The Intercollegiate Gliding Meet will be held this year at Ithaca, N. Y., under the auspices of the Aero Club of Cornell University. Invitations to participate have been sent out to all the college clubs. Correspondence re the gliding meet should be addressed to Mr. Kerr Atkinson, Ithaca, N. Y.

**SECOND ANNUAL INTERCOLLEGIATE BALLOON RACE**

The second annual intercollegiate balloon race will be held under the auspices of the Intercollegiate Aeronautical Association through the courtesy of the University of Pennsylvania Aero Club, which has relinquished its rights to the

same. This race, which was held last year under the auspices of the Williams Aeronautical Society, was won by Penn.

Last year colleges competed in the race; Williams, Dartmouth, and the University of Pennsylvania. This year definite entries have been received from Princeton, University of Virginia, University of Pennsylvania, Dartmouth, and Percy Sheerman, who piloted the Williams balloon last year, has signified his willingness to go to Kansas City though a formal decision has not yet been received from the Williams Club. There is no reason why there should not be at least ten balloons ready to start when the race is called.

The date of the race has not yet been decided definitely, but it will fall the latter part of June or the first few days in July.

**Ovington's Lectures**

Earle L. Ovington, one of America's greatest aviators, delivered an illustrated lecture on the modern aeroplane with some personal reminiscences at Huntington Hall, Massachusetts Institute of Technology, on January 22nd.

**THE NEW KIRKHAM TRACTOR BIPLANE**

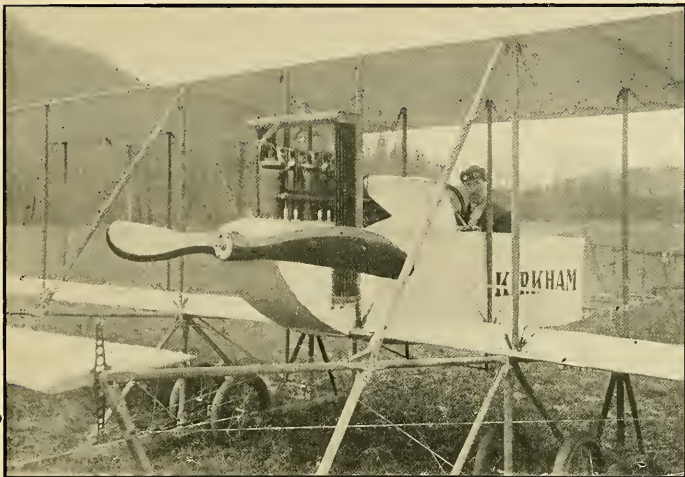

The accompanying illustration shows a new biplane recently brought out by Charles B. Kirkham, the manufacturer of the well known "KIRKHAM" Aviation Motors. As will be seen, this machine is of the motor in front, tractor propeller type. While brought out originally for experimental work in connection with the manufacture of the "KIRKHAM" Aviation Motors, it has demonstrated in recent trial flights such remarkable speed and climbing qualities that it has been decided to offer them for sale generally in the near future.

In general, this machine consists of a conventional biplane cellule, into which is fitted a monoplane fuselage carrying the complete power plant, fuel tanks, operator and controls.

**MAIN PLANES.**

The main planes are 34 feet spread with a 5 feet 6 inch rib and are placed 58 inches apart. The rib curve is a modification of the curve used on the Nieuport monoplane, the ribs being of the built-up type spaced 13 inches center to center. The planes are double covered with Naiaid cloth put on diagonally. Each plane is made up in three sections, so arranged as to be very easily taken down or assembled. This is also facilitated by a new design of strut socket, which is so made that all of the struts can be removed without loosening any of the wiring therefore to completely take down the main planes it is only necessary to disconnect the wires in the two panels where the sections come together. All other wiring can be left alone, which means a considerable saving in the lining up operation.

**FUSELAGE.**

The fuselage is built up somewhat on the Blériot design with elm longitudinal members and spruce struts. The wiring and U bolts are the regular Blériot type, which are used on account of their extreme simplicity. The fuselage is covered with sheet aluminum for nearly one-half its length.

**ENGINE LOCATION.**

The engine is located in the front end and is completely housed except the cylinders. The front end of the fuselage is curved to reduce head resistance. It fits directly onto the lower wing bars, where it is fastened by four nickel steel bolts, and there is a separate pan bolted underneath the wing bars, continuing the curve of the front end until it joins the line of the bottom of fuselage, thus reducing the resistance of this part to the minimum.

**GENERAL ARRANGEMENT.**

The gasoline tank is immediately back of engine under the sloping hood shown in cuts. This tank holds 22 gallons of gasoline, and as it is mostly below the carburetor on engine, air pressure is used to force the fuel up to the float chamber on the carburetor, this pressure being maintained by a special pump on the end of engine cam shaft, which is supplemented by a hand operated pump on the left side of fuselage. There is also a pressure gauge directly in front of operator, so that he can see at all times. The sloping hood completely protects the aviator from all air blast.

**RUNNING GEAR.**

The running gear is of the wheel and skid type, similar to the Wright, but is fastened to the main cellule in such a way that by the removal of six bolts and four nuts the complete landing gear can be removed.

The center panel of the main cellule is supported by a heavy flat steel truss underneath front and rear, which carries the main portion of the weight of fuselage and power plant, the skids being connected to the above truss and also to the next outer post socket bolts—front by a flat steel ribbon and in the rear by heavy Koebling cables. All of

the other wire bracing is of heavy cable, thus there is no tubing used in the construction of the landing gear, except wheel axles and their steering rods. The weight of the complete landing gear is 100 lbs.

**CONTROL.**

The tail, which is of the flat, non-flying type, has a semi-circular stationary surface, 8 ins. wide with two semi-circular movable flaps, 43 ins. wide, each of which are separately connected to the control, thus adding a certain element of safety. The rudder is pivoted to the rear of the fuselage, and this is also double connected to the foot steering bar. The ailerons are of the double acting Farman type, 7 ft. 7 ins. by 18 ins. hinged to both upper and lower surfaces, thus providing ample control for any emergency. These are separately connected to the control wheel and are both positive in both directions, even if one set should become disconnected. With the machine standing the tail is supported on a swiveling, shock absorbing rear skid.

This feature of double connection to the controls is carried out most completely in this machine, it being considered essential that the safety of the aviator be given every possible consideration.

The control system is similar to the Deperdussin—that is, steering is by pivoted foot bar. For the control of the elevating flaps and ailerons a wheel mounted on a bow, pivoted to the sides of the fuselage is used, the wires for rear flaps being connected—one set to the bow on each side of the fuselage, and are controlled by a fore and aft movement of the bot by means of the wheel, while the ailerons are operated by turning the wheel in its bearings.

**POWER PLANT.**

The power plant shown is a regular model B-6-50 H. P. "KIRKHAM" Aviation Motor, which drives a 7 ft. 2 in. by 5 ft. pitch propeller 1,325 turns, which flies the machine at from 56 to 62 miles, depending on the load carried. This machine can also be furnished with a model B-6-6-70 H. P. "KIRKHAM" power plant instead of the 50 shown.

It might be mentioned that the B-6-50 power plant actually delivers to the propeller 56 h. p. at 1,360 r. p. m. and consumes 36 lbs. of gasoline and 1 oz. of lubricating oil per H. P. hour, which is a remarkable showing in economy—a feature so necessary for long distance flying. Another point of interest is the fact that in dismantling this machine for shipment it is not necessary to disconnect a single power plant connection, either gas, oil, water, or control, as the whole power plant, including radiator, can be taken out by the removal of four bolts holding it to the main cellule.

The weight complete, with 28 gallons of gas, 3 gallons of lubricating oil, 2 1/2 gallons water, ready for flight, less operator, is 980 pounds. This, owing to liberal supporting surface, makes only a trifle over 3 lbs. per sq. ft., which the machine has demonstrated it could handle at less than 35 miles per hour, while the regular flying speed is nearly 60, giving a large margin of safety for windy weather.

Recent test flights, which were made by Aviator W. F. Cline at the Kirkham factory testing grounds, have shown that while this machine rises easily at less than 35 miles, it behaves very much the same as the Nieuport monoplane in flight, that as the speed goes up the tail rises until the machine flies at a very small angle of incidence, this angle being approximately 4 degrees when flying with 13 gallons of gasoline on board, and of course owing to the small angle in flight the machine is a good glider with power off.

## NEWS IN GENERAL

By D. E. BALL

## POSTAL TELEGRAPH - COMMERCIAL CABLES

RECEIVED AT  
48 W. 30TH ST. N. Y.  
TEL. 1548 MADISON 60.  
ALWAYS OPEN

CLARENCE H. WAGGAY, PRESIDENT

TELEGRAM

DELIVERY NO.

The Postal Telegraph Cable Company, Incorporated, transmits and delivers this message subject to the terms and conditions printed on the back of this blank.

10-021-1522

DESIGN PATENT No. 6625

B196 NY .MS 50 Collect DPR

Ameruous Ga Feb 20th 1912

FEB 20 1912

Aircraft, Lawson Pub. Co., 37 E 28th St.

Fowler finished flight at Pablo Beach, Florida, February Fifteenth, flying from Jacksonville in nineteen minutes, distance eighteen miles. He was followed by photographers, moving picture and newspaper men. He also took moving picture from his Wright machine. Aeroplane landed in the water of Atlantic at 2:37 afternoon sensational.

Charles L Young - 340 PM

The above telegram from Charles L. Young shows that Robert G. Fowler completed in good style his trans-continental aeroplane trip in which he flew from the Pacific Ocean to the Atlantic Ocean along the Southern route, starting from the Pacific Ocean, at Los Angeles, on October 19th, and ending on the Atlantic Ocean at Pablo Beach, on February 15th.



This picture shows Robert G. Fowler in his Wright biplane en route from the Pacific to the Atlantic Ocean. Seated by his side is Edward R. Shaw, who took some remarkable pictures with his moving picture machine throughout the journey.

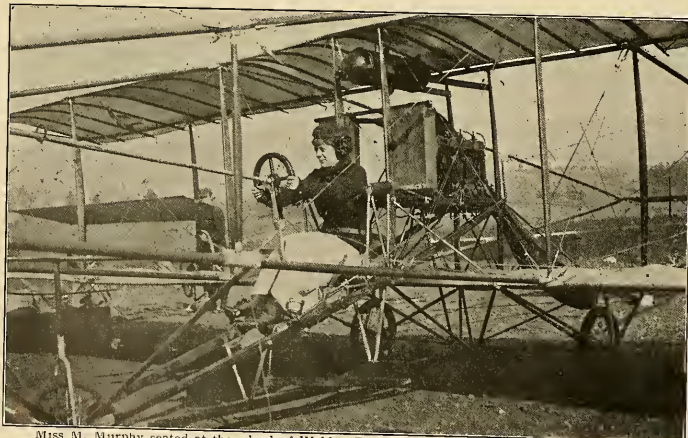

Miss M. Murphy seated at the wheel of Weldon B. Cooke's biplane. Miss Murphy is an aviation enthusiast and is having a machine built with which she intends to fly.

## California News

By Ernest Ohrt.

Messrs. Ivan R. Gates and P. C. Cribbet, owners of a Maximotored Greene biplane, have dissolved partnership. Mr. Cribbet intends to enter the Curtiss Aviation School at San Diego. Mr. Ivan R. Gates has joined the Diddier-Masson camp in capacity of manager. They are building a new 45 foot Masson Gnome biplane from parts furnished by the California Aviation Co. The plane will be headless, double covered, top plane to extend 5 feet over the lower plane on each end. The covering will be Goodyear No. 10. All bolts are to be made of bicycle axles. It will also combine several other original features. The machine will be made to carry three passengers and capable of staying in the air for ten hours. The machine will be finished before the San Francisco meet, which starts on February 22. When completed Masson will start on a trip from San Francisco to Los Angeles, Cal., advertising the World's Fair of 1915.

On December 13th, Weldon B. Cooke received his pilot license at Adams Point, near Lake Merritt, Oakland, Cal. He made two good flights. On his first flight he stopped 38 feet from his starting point, and on the second he stopped right over the mark. He made figure eights, spiral glides, Dutch rolls, and dips, and he certainly earned the license. This is the first pilot's license given in the vicinity of San Francisco, and it aroused the aviation interests to quite an extent in Northern California.

Weldon B. Cooke made an hour and a half flight over Santa Rosa recently for a purse given by the Chamber of Commerce. Fully 2,000 people were at the race track and 8,000 were on the streets. When Cooke reached an altitude of 2,000 feet the wind had increased to over thirty miles an hour, and for fully ten minutes Cooke was hovering over one place.

Frank Bryant in an 8-cylinder Standard Curtiss biplane and Roy Francis in an 8-cylinder Hall-Scott motored Gage biplane flew at Redding on January 14th and 15th and had a fairly good attendance. About a thousand persons paid admission and about 5,000 viewed from outside. They complained about landing on account of the crowd swarming all over the field. Both made two twenty minute flights each day.

John Legrieve, with an Elbridge engine Delfort type monoplane, smashed his machine beyond repair at the Spokane Fair. He has ordered a new machine from the California Aviation Co. E. H. Thompson, of said company, will shortly try out the Curtiss type biplane of A. Fry.

## GRIFFITH'S AVIATION PARK.

Another aviation park is to be established near Los Angeles, California, which makes this section of the country one of the most important aeronautical centres in the United States. The new flying station will be known as Griffith's Aviation Grounds, and embraces 150 acres in the San Fernando Valley, within nine miles of Los Angeles.

The C. J. Griffith Company, corporation, has leased the field to Van M. Griffith for five years, and it will be under the direct management of the latter for that period. It will be operated under the sanction of the Aero Club of California, but all the business will be conducted by Van M. Griffith.

The following business concerns will establish enterprises at the park: Glenn L. Martin, aeroplane factory and school; Gage Aviation School, aeroplane factory and school; Harry S. Dosh, monoplane factory; Earl T. Hanna, propeller factory and aeronautical supplies; Sky Pilot Motor Company, aeronautical motors.

## THE LOS ANGELES MEET.

January 20th to 28th. The Los Angeles Meet, held at Dominguez Field, Los Angeles, January 20th to 28th, was a great success, both financially and from an exhibition standpoint. On the first Sunday of the meet it is estimated that fully 30,000 people paid admission to the field, while on week-days the attendance, although not nearly as large, was quite good and was very encouraging to the aviators, as they received a percentage of the gate receipts in addition to prize money.

The sensational flying of the meet was done by Lincoln Beachey, Phil Parmelee, Weldon B. Cooke, Farnum Fish, W. H. Hoff and Glen Martin, who carried off the honors for the entire week. Blanche Scott also flew for over twelve minutes on every day of the meet but one.

The speed, altitude and figure-eight contests were closely contested for by Lincoln Beachey (Curtiss 1912 biplane) and Phil Parmelee (Wright Model X.)

Weldon B. Cooke, in a biplane equipped with a 50 H. P. 4-cylinder Roberts motor, went in for daily and total duration as well as altitude. He won the total duration by flying 18 hours 5 minutes and finished well in several of the altitude events.

William Hoff, formerly chief mechanic of the late Pagenet Ely, and a recent graduate of the Curtiss aviation school, made his first public flights and succeeded in winning many second and third prizes in the speed and other events.

Glenn Martin, while not achieving any sensational feats, flew consistently throughout the entire meet and showed that he was a capable pilot as well as a builder. He flew a Martin biplane equipped with a Hall-Scott motor.

Fatum T. Fish, the eighteen-year-old Wright graduate, went in for total duration and won second place in this event besides winning several other daily duration events. He used a standard Wright biplane and carried passengers most of the time.

Horace Kearney flew a Hall-Scott Benoist and made a good showing by entering many events and winning several prizes.

Turpin and Gill carried passengers and also entered some of the events. Gill, however, was injured during a night flight and was compelled to retire from the meet. Hillery Beachey, on a Heinman-Beachey biplane, flew consistently and entered many of the events, including those for speed. He succeeded in winning several prizes and showed himself to be a capable flyer.

Charles F. Willard flew a 1912 Curtiss but contented himself for the most part in carrying the mails.

**Army News**

It was announced on January 22nd that eight new aeroplanes are to be added to the War Department's Aerial fleet between March 1st and June 30th. Brigadier General James Allen, Chief of the Signal Corps, has \$65,000 left of the \$125,000 appropriated last year, and is going to make use of it by bringing the number of aeroplanes in the army up to fifteen or sixteen.

Following Wilbur Wright's recent visit to the Army aviation school at Augusta, Ga., during which he had a conference with Captain Charles de Forest Chaffee and the aviators stationed there, it was announced that Wilbur Wright had worked out designs for a new biplane specially designed for military purposes and fitted with a larger motor and a larger carrying surface, as it was found that the present machines are hardly powerful enough to carry much extra weight in the way of military paraphernalia.

The wireless equipment which was designed in the Signal Office, Washington, especially for use on aeroplanes has been received at the Aviation School at Augusta, Ga., and is now being installed on the Wright aeroplane.

The first aeroplane for the Aviation School was received at College Park, Md., June 16th, 1911. From that date until December 31, 1911, seven hundred and nineteen flights were made by the four aeroplanes, the total duration being 138 hours and 54 minutes.

The average duration of each flight was 11.5 minutes. This short time of average is due to the many flights made by beginners in practicing take starting and landing.

The most flights were made with the standard type B Wright biplane, this machine having four hundred and nine flights to its credit, the total duration being 76 hours and 13 minutes. It was received at College Park June 16, 1911.

The Burgess-Wright aeroplane was received at the School July 8, 1911, and it made 183 flights, the total time in the air being 36 hours and 30 minutes.

The Curtiss 8-cylinder machine was received from San Antonio July 25, 1911, and since its arrival at the School has made 81 flights, the total time in the air being 14 hours 47 minutes.

The Curtis 4-cylinder aeroplane which was purchased especially for training student officers, arrived at College Park July 27, 1911, and has made 36 flights, the total time in the air being 3 hours and 34 minutes. On November 15th the 8-cylinder Curtiss engine was taken from the old machine and installed in the new training aeroplane, where it has remained and with very good results.

Captain Charles Lieuts. Kirland, Arnold and Milling fly the Wright type biplanes; Captain Beck, Lieuts. Kennedy and Milling fly the Curtiss type.

The House Military Committee recently referred two bills looking to an increase of pay for army aviators to the Secretary of War, with the request that the War Department examine them and recommend such changes or additions as might be desirable. The committee then will consider the bills again, and it is probable a favorable report will be made.

**Curtiss Doings**

The first successful demonstration of a hydro-aeroplane in Europe was made February 6th on the Mediterranean near Nice, France, by Hugh Robinson, the American aviator, using the latest type of Curtiss hydro-aeroplane. The machine which Mr. Robinson used was the one recently sold by the Curtiss Company to Louis Paulhan, the famous French aviator and aeroplane builder.

The public aviation school conducted by Glenn H. Curtiss on the island of San Diego Bay, and the United States Navy's experimental station, located at the same place, have developed into one of the most remarkable aviation camps ever estab-

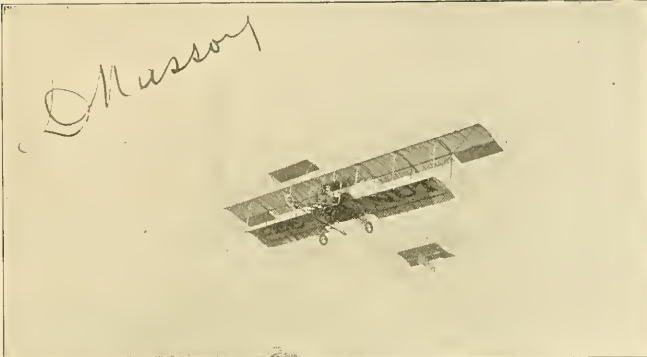

DIIDIER MASSON IN FLIGHT AT SAN FRANCISCO IN HIS CNOINE DRIVEN BIPLANE, WITH WHICH HE HAS BEEN DOING GOOD WORK ON THE COAST.

lished. The scene sometimes resembles an international aviation meet more than a school or experimental station. In addition to the fifteen pupils under the instruction of Lieut. J. W. McCluskey, U. S. M. C., retired, who has charge of the Curtiss school, some half a dozen mechanics and helpers, the camp has recently been augmented by the arrival of the four Navy aviators—Lieut. Elyson and Towers, who operate the Navy's Curtiss hydro-aeroplane, and Lieut. John Rodgers and Ensign Victor Herbstler, who fly the Wright aeroplane with a Burgess hydroplane attachment.

The south end of the island resembles a military camp, with tents and hangars dotting the shore for a quarter of a mile. In addition to the Navy's aviation force now at San Diego, it is announced that three more officers are to be detailed for instruction at this place. Constructor Richardson, of the Navy, who has been at work on the new style of hull, or boat, for the hydro-aeroplane, has been ordered to San Diego, and will carry on his experiments at the North Island camp.

Lieut. Towers' experiments in wireless telegraph at San Diego are watched with great interest. He has exchanged signals with the Government station at Point Loma on several occasions when in flight, and will continue his work with the idea of increasing the range and efficiency of the wireless aeroplane engine.

**Standardizing Propellers**

The following letter, by Spencer Heath, President of the American Propeller Company, was addressed to Mr. E. V. Lallier, Chairman, The Aeronautical Society, and which no doubt contains some interesting points for consideration of propeller manufacturers:

Washington, D. C., January 30, 1912.

"Dear Sir: We have your communication of the 25th asking our suggestions in regard to the standardization of aeroplane propellers.

We think it would be a most excellent plan to standardize such features of the propeller as do not depend for their excellence upon the special skill in design or mode of construction upon which the efficiency and general excellence of the propeller depends. To standardize these would be to put all propellers on a level as regards their excellence, and further development and improvement could not be made by departing from such standards as might be established.

Regarding the features which we think might be standardized to advantage, we would suggest that standard templets for hub borings be adopted by propeller makers in conjunction with engine builders, so that propellers of different manufacturers would be interchangeable on the same engine. A



Frank T. Coffyn has been demonstrating lately that winter flying can be made just as popular as summer flying, on condition, of course, that the aviator is dressed warm enough. The above photograph shows him at the bow of his Wright machine, fitted with special rocker pontoons. As can be readily understood the effect of these pontoons is to skim along over the water easily and also over broken ice during the winter in case it is necessary to do so. Mr. Coffyn spent most of the month of February flying about the North and East rivers in juxtaposition to New York City. His flights were of the highly sensational order and were witnessed by hundreds of thousands of people.

series of, perhaps, three templates could be established based upon the A. L. A. M. rating of the engine. Speaking off-hand, we would say that for less than 25 H. P., a bolt-circle of 3-1/2 ins. might be adopted, using six 3-8 in. or 5-16 in. bolts; for 25 to 75 H.P. the circle might be 4 ins. or 4-1/4 in., with six 3-8 in. bolts. For greater than 75 H.P. a circle of about 4-1/2 ins. or 5 ins. might be adopted, using six 5-8 in. bolts, or possibly six 7-16 in. bolts. The center hole might also be standardized if the engine manufacturers can be gotten together on this. We do not think the center hole should ever be more than 2-1/2 ins., if it can be avoided.

The length of hub might also be standardized, and we would suggest 4-1/2 ins. to 4-3/4 ins. as a suitable hub length for 25 to 75 H.P.; for less than a length of 3-1/2 ins. to 4 ins. would probably be good.

The diameter of the propeller in relation to the size and weight of the entire machine, might also be a proper subject of standardization.

Many builders do not provide for a sufficient

propeller diameter, not realizing that the efficiency drops very much from the amount of traction obtained, and that this varies approximately as the square of the propeller diameter, hence the diameter should always be as large as possible (within reasonable limits) regardless of the power of the engine (the difference in pitch taking account of the available power and consequent flying speed.)

With the advances that are being made in an experimental way to determine the head-resistance at different speeds, it should be possible in the near future to lay down definite rules as to the number of square feet of area of propeller sweep per unit of head-resistance of the machine.

A most inviting field of calculation is opened up in this direction which should be productive of the most valuable engineering results leading, as it does, to the tabulating of the necessary propeller diameters required for different percentages of efficiency as worked out from the flying thrust, or head-resistance, at different

speeds. As soon as this information becomes generally available, standards of propeller diameters will doubtless be definitely established.

It is to be hoped that the Technical Committee of your Society would be able to make valuable advances towards the standardization of diameters.

Regarding competitive tests of propellers this, of course, to be of any value, would have to be carried on under actual flying conditions, and would require the same rules in regard to course, timing, entries, etc., that are necessary in competitive tests involving the entire flying equipment, including airplanes, the machines, including power, weight, equipment, etc., should, of course, be as nearly identical as possible, and provision should be made for alternating the aviators, so that the propellers between the different machines for different events, so that each propeller could be tested on a different machine (of the same size and type) and with a different aviator, tests will ultimately become possible at some of the large flying fields."

## THE ADVANCE TOWARD AERIAL LAW

By DENYS P. MYERS

The President of the French Republic on Nov. 21, issued a decree regulating aerial navigation in respect to permits, management, control of circuit, landing, departure and en route, public aircraft, etc., together with a set of regulations on carrying lights and signals, signals phonic, rules of the "road," landing and distress signals and the use of ballast. The project was prepared by a permanent commission organized by aerial navigation and is the first thorough-going attempt at state control of aerial navigation in the world. The decree reads:

On the reports of the ministers of public works, posts and telegraphs, the interior, finances, war and marine.

Having considered the opinion of the Permanent Commission on Aerial Navigation, organized by order of the minister of public works, posts and telegraphs under date of June 28, 1910,

Decrees:

### TITLE I.

#### Permits of Navigation.

Art. 1. No aircraft may be put into service in France without a permit of navigation, unless it shall have satisfied the conditions laid down by international conventions.

Art. 2. The request for a permit is addressed by the owner of the aircraft to the prefect of his department.

To the request there should be attached:

1. A declaration of the name, domicile and nationality of the owner. If the request comes from a foreigner, the identity of the applicant is established by document issued by the consular authorities of his country;

2. The photograph of the aircraft, if the request applies to a dirigible balloon or a flying machine; or the proof that the aircraft is of French origin or has paid the customs duties;

3. A certificate of navigability.

Art. 3. The certificate of navigability is established by the *service des mines*\* according to tests deemed sufficient by it.

\* This department controls mines, local railroads and the distribution of electric energy.

The certificate of navigability must contain the following information: Name or firm and domicile of the builder; place and year of manufacture; numbers and other marks of identification given by the builder; the characteristics of the aircraft conformably to the provisions determined by an instruction of the minister of public works. The applicant is required to (*renu de*) send to the prefect the necessary documents for the establishment of these tests.

Aircraft recognized after trials by associations qualified for this purpose as capable of navigation, those of French origin conforming to a type already accepted, as well as free balloons may be considered by the *service des mines* as presenting sufficient guarantees of navigability.

In view of the application of the present article, every builder of a type already accepted must give to each machine a serial number and, in the series to which it belongs, a number. He sends to the purchaser a declaration giving the characteristics of the aircraft and certifying that they agree in all respects with that of the type accepted. This document is attached to the request for certificate addressed to the *service des mines*.

There are also sent to the *service des mines* the certificates of navigability issued by the societies which have determined the navigability of an aircraft.

Art. 4. On receipt of the request for permit and of the papers attached, the prefect proceeds with the matriculation of the aircraft.

The inscription on the register of enrollment includes: 1, the date of the entry; 2, the number of the register of enrollment; 3, declaration of the home port (*port d'attache*) if the aircraft is a

dirigible balloon; 4, the description of the aircraft; 5, declaration of the marks of identification given by the builder; the letters and distinctive number assigned by the prefect under the conditions which will be determined by the minister of public works; the name, domicile and nationality of the owner of the aircraft.

After having proceeded with the matriculation, the prefect delivers the permit of navigation, which reproduces the details of the certificate of navigability and those of the matriculatory register. On the permit is placed the photograph of the aircraft, if it is a dirigible balloon or flying machine.

Art. 5. No aircraft shall circulate without carrying in visible characters, under the conditions to be determined by the minister of public works; the letter F, if the aircraft belongs to a Frenchman or to a foreigner domiciled in France, or to a company having its headquarters in France;

2. The letters and distinctive numbers entered on the matriculatory register.

Art. 6. The permit of navigation ceases to be valid and must be renewed in case of change involving modifications in the declarations concerning the permit, which has ceased to be valid or by the expiration of the term of the permit to the prefect from whom it issued for the purpose of effecting its erasure from the matriculatory register.

The owner of an aircraft is likewise to return his permit of navigation to the prefect who delivered it, for purposes of erasure, if the aircraft has been destroyed or if it is out of use.

The *service des mines* may at any time inspect aircraft admitted to circulation. The duly qualified associations may likewise inspect the aircraft whose navigability they have given their result of their inspection.

If it is ascertained that an aircraft does not correspond to the specifications of the permit of navigation, this permit is rescinded by decree of the prefect upon advice of the *service des mines*, and immediate notification of this order is made to the owner of the machine.

If it is learned that an aircraft is not in a good state of repair (*entretien*), the permit may also be rescinded, after a demand to that effect is unheeded.

### TITLE II.

#### The Management of Aircraft.

Art. 8. Aircraft are admitted to circulation only if they have on board a pilot provided with a license of fitness (*licence de pilotage*).

The license of fitness is delivered by the prefect, after examination by the *service des mines* of persons qualified for this purpose by the administration.

Art. 9. Separate licenses are given for the management of a free balloon, a dirigible balloon or a flying machine, and the license of fitness for managing a machine of another kind.

Art. 10. The license of fitness contains the name surname, Christian names and description of the holder, the place and date of his birth, as well as his photograph and signature.

It may not be granted to persons less than 18 years of age, except with special authorization of the minister of public works; it may be given only to persons of good moral character.

The license of fitness may be rescinded by the prefect, without recourse to the minister of public works, if it is evident that the conditions under which it was granted have not been fulfilled.

### TITLE III.

#### Circulation of Aircraft.

Art. 11. It is forbidden to aircraft to land in inhabited places (*agglomérations*), except on plots especially designated by the municipal authority.

Art. 12. Without special authorization it is prohibited (*défendu*) to aircraft to pass over forbidden zones. These zones are listed in a decree which defines their bounds, and which is inserted in the *Journal officiel*.

Art. 13. Every aircraft which enters without authorization above forbidden zone is to land as soon as it is asked to do so and, if it is impossible to do so immediately, as soon as it can.

Art. 14. The government will decree the method of notice to be used in warning an aircraft that it is above forbidden zone and to ask it to land.

Art. 15. Without special authorization by the minister of the interior, the carriage by aircraft of explosives, arms and munitions of war and carrier pigeons is forbidden.

This authorization will be valid for carriage of carrier pigeons only with the assent of the minister of war or of marine when the aircraft shall be authorized to pass above forbidden zones.

Art. 16. The carriage and use of photographic apparatus are forbidden, unless with special authorization of the prefect.

This authorization will be valid only with the assent of the minister of war or of marine when the aircraft shall be authorized to pass above forbidden zones.

Art. 17. Aircraft may have on board wireless telegraphic or wireless telephonic apparatus only on condition of this having been authorized by the minister of public works, posts and telegraphs, after advising the interministerial commission on wireless telegraphy.

### TITLE IV.

#### Rules to Observe in Landing, Departure and in Course of Flight.

Art. 18. Without prejudice to the fulfillment of the fiscal formalities, aircraft must have on board, in order to circulate, their permits of navigation, as well as the licenses of the personnel necessary to man them.

It is also to have a logbook (*livre de bord*). These documents must be presented at every demand of the public authority.

Art. 19. The journal must contain the following information: The course to which the aircraft belongs, the place and number of matriculation, the name, nationality, profession and domicile of the owner.

Art. 20. There are also entered on the journal for each ascension:

1. The name, nationality, domicile of the pilot and members of the crew, as well as the names of the passengers;

2. The declaration of the course followed in plane and in altitude at all times that circumstances will permit this; for dirigible balloons the horizontal course is indicated on a map and the course in respect to altitude is indicated with the aid of a barograph which they ought to carry on board;

3. Information of all interesting events, especially stops (*escalas*) and accidents occurring to the aircraft, the crew and other passengers.

The details enumerated above are entered in the journal as far as possible in the course of the ascension or, in case of this being prevented, after the ascension and with a maximum delay of 12 hours.

Art. 21. For flying machines the information relative to the personnel, points of departure and arrival, stops and accidents of the passengers.

Art. 22. The journal must be preserved for two years after the last entry and is to be presented at every demand of the public authority.

Art. 23. Representatives of the public authority may inspect every aircraft in order to fulfill police duties and fiscal inspection (*surveillance*).

Art. 24. When an aircraft arrives from abroad the pilot must immediately notify the mayor of

# The New Elbridge "Six" . . .

Possesses features that will interest you if you are buying or building a Hydro-Aeroplane or heavy Biplane requiring more power than our 4-cylinder engines.

**THE ELBRIDGE "60-90" WEIGHS LESS THAN 200 LBS.**

When equipped with imported alloy cylinders; and only 260 lbs. with standard iron cylinders.

Greatly increased production of "Sixes" for 1912 enables us to make prices that are right. Drop us a line today asking for special news.

**ELBRIDGE ENGINE COMPANY, Rochester, New York.**

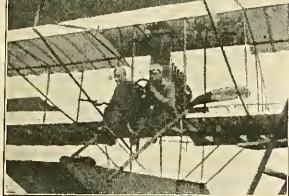

After Wild Ducks in the HAMILTON HYDRO-AEROPLANE With Elbridge 60-90 H. P.

the locality of the place of landing and the mayor should see to it that the cargo, if there is any, shall not be broken, nor the machine itself removed before the fiscal agent shall have been able to proceed with the examinations and the necessary operations.

Art. 25. Aerial circulation must be performed in conformity with the special regulation annexed to the present decree and especially concerning:

- Lights;
- Phonic signals;
- Rules of the course and manoeuvres;
- Landing and distress signals;
- Use of ballast.

Art. 26. In case of danger encountered by an aircraft, the local authorities must take measures possible to them to lend it assistance.

Art. 27. Every person who finds a wreck of an aircraft must make declaration thereof to the municipal authority; if the wreck is found at sea, the declaration must be made to the authorities of the first port where the ship lands.

**TITLE V.**

**Public Aircraft.**

Art. 28. Aircraft assigned to the service of the State and those under the orders of an official duly commissioned for this purpose are considered as public aircraft.

Art. 29. The provisions of the present regulation are applicable to public aircraft, with the exception of Art. 2 to 10 and 17 to 23.

The technical conditions applicable to wireless telegraphic and wireless telephonic apparatus placed on board of public aircraft are determined by the ministry interested, after advising with the inter-ministerial commission on wireless telegraphy.

Art. 30. Public aircraft placed under the orders of a commanding officer wearing the uniform and which have on board a certificate establishing their military character are considered as military aircraft. The provisions mentioned in Arts. 12 to 16 are not applicable to them.

Art. 31. Public aircraft should carry as their signal mark a distinctive mark which is different for military aircraft and for those belonging to other public departments.

Art. 32. The circulation of foreign military aircraft is prohibited in France.

**TITLE VI.**

**Various Provisions.**

Art. 33. Aircraft performing evolutions above aerodromes, so far as these evolutions do not take place as a public spectacle, are not submitted to the provisions of Titles I. and II. and of Art. 18 to 22, 24, 26 and 27 of Title IV.

Titles I. and II. and Arts. 18 to 22 of Title IV. are not applicable to aircraft performing evolutions outside of aerodromes in the regions approved by the department of public works as training fields.

Art. 34. The evolutions of aircraft, when they constitute public spectacles, may take place only by virtue of an authorization of the prefect, after advising with the minister of the interior.

For contests comprising a flight across open country and organized on a fixed date, the authorization will be given after advising with the ministers of the interior, where the departures, stops, and arrivals must take place, by the prefect of the department if only one department is interested, by the minister of the interior in the contrary case.

For these contests, as for public spectacles, the request must be made at least one month in advance, in order to permit the competent authority to take all necessary measures.

No authorization will be granted except under reserve of the engagement taken by the applicant to bear the expense of inspection and all other expenses occasioned to the government by the contest.

The applicant must, to this end, make an advance deposit.

Art. 35. The ministers of public works, posts and telegraphs, of the interior, of finances, of war and of marine are charged, each in what concerns him, with assuring the execution of the present decree, which will be published in the *Journal officiel* and inserted in the *Bulletin des lois*.

Done at Paris, Nov. 21, 1911. A. FALLIERES.  
For the President of the Republic;

- The Minister of Public Works, Posts and Telegraphs, VICTOR AUGAGNEUX.
- The President of the Council, Minister of the Interior, J. CAILLAUX.
- The Minister of Finances, L. L. KLOTZ.
- The Minister of Marine, DELCASSE.
- The Minister of War, MESSIMY.

**ANNEXE.**

**Regulations of Aerial Circulation.**

**I. Regulations Concerning Lights.**

Art. 1. The rules concerning lights must be observed in all weather, from the setting to the rising of the sun, and, during this period, no light which could be taken for one of the prescribed lights shall be shown.

**Lights of Which Dirigible Balloons Must Carry.**

Art. 2. A dirigible balloon making its course, that is to say, having a speed of its own, must carry:

(a) In front, a brilliant white light placed so as to show an uninterrupted beam over the whole range of a horizontal arc of 220 degrees, or 110 degrees on each side of the aircraft reckoning from the head.

(b) At the right, a green light fixed in a manner to project an uninterrupted beam over the whole range of a horizontal arc of 110 degrees, that is to say, from the front to 20 degrees to the rear of the side, from the right quarter;

(c) At the left, a red light fixed in a manner to project an uninterrupted beam over the whole range of a horizontal arc of 110 degrees, that is to say, from the front to 20 degrees to the rear of the side, from the left quarter;

(d) The three lights, white, green and red, must be visible in every vertical plane corresponding to their respective zones in every direction comprised between the vertical, downward, and a line drawn as nearly as possible from the vertical line and making an angle of at least 30 degrees with the horizontal, upward;

(e) The side lights, green and red, must be furnished with screens placed in such a manner that their beams cannot be seen from the opposite side;

(f) The white light must be visible to a distance of at least 4 kilometres, the green and red lights to a distance of at least 2 kilometres, on a dark night when the air is clear;

(g) A dirigible balloon should also have means to show occasionally a rear white light, if it is being overtaken by another aircraft.

**Lights for Flying Machines.**

Art. 3. The regulations relative to lights are applicable, in principle, to flying machines. However, as a temporary measure of indulgence, they may, to a certain extent, carry a single signal light, arranged in such a manner as to show a green light at the right and a red light at the left.

The angles of visibility, in the horizontal plane, must be the same provided for dirigible balloons. Concerning the angles of visibility in the vertical plane and the minimum of visibility of the lights, it is simply recommended that they approach as nearly as possible to the regulations which have been prescribed for dirigible balloons.

**Light for Free Balloons.**

Art. 4. Free balloons must have, ready for use, a lantern with white light and show it on the approach of another aircraft.

**II. Phonic Signals.**

Art. 5. (a) Dirigible balloons must, by day as well as by night, make use of phonic signals, capable of being stopped, during foggy or misty weather, or during rain, snow or during heavy showers of rain.

(b) Under the same conditions, free balloons will have to make the same signals when they shall be in the vicinity of motored aircraft.

(c) The above regulations are applicable to flying machines only so far as possible.

**III. Rules of the Course and Manoeuvres.**

Art. 6. Every aircraft with motor must always keep a distance of at least 100 kilometres from every other aircraft, in every horizontal, vertical or oblique direction.

Art. 7. Aircraft with motors must always get out of the way of free balloons.

Art. 8. When two aircrafts with motors are on courses which cross in a manner to make a collision feared, the aircraft which has the other on its right in the direction in which it is going must deviate from the course of this other aircraft.

When, according to the rule above, one of the air ships must change its course, the other must keep its course and maintain its speed.

Art. 9. Every aircraft with motor which is, according to these rules, bound to get out of the course of another aircraft must, if the circumstances permit it, avoid intersecting the course of the other, in front of it.

Art. 10. When two aircraft with motors are head-on or nearly head-on in respect to each other, following opposite or nearly opposite directions, at slightly different altitudes, so as to make a collision feared, each of them must turn to the right in its own direction, so as to leave the other upon its left.

Art. 11. Regardless of the rules of the preceding articles, every aircraft with motor which is overtaking another must get out of the course of the latter.

Every aircraft which is approaching another coming from a direction more than 20 degrees aft of the latter, that is to say, which finds itself in a position in relation to the overtaken aircraft that it cannot see any of the side lights of the latter must be considered as an aircraft which overtakes another. No later change in the bearing of the two aircraft can make the one which overtakes the other considered as crossing the route of the latter in the sense of Art. 8 and cannot discharge it from the obligation of getting out of the course of the overtaken aircraft until it has completely passed it.

Art. 12. At all times when the preceding rules do not define the manoeuvre which must be effected, the aircraft or aircrafts which are obliged to manoeuvre may move in the vertical as well as in the horizontal direction.

Art. 13. In case of imminent collision, the two aircraft must effect the most possible manoeuvre. Particularly, the highest must ascend and the other must descend.

When they are on the same level, in case of crossing, that one of the two which has the other on its right in its own direction must ascend and the other must descend.

Art. 14. When a dirigible balloon stops voluntarily, it must show a black ball in a conspicuous position; in this case, it remains subject to the same rules as aircraft in flight.

If it is not master of its own operations on account of a wreck, it must show two black balls in a conspicuous position and placed vertically one above the other. In this case, it is considered as (*assimilable aux*) in the class of free balloons. At night, it must show, in addition to the white light and is considered as in the class of free balloons.

**IV. Landing and Distress Signals.**

Art. 15. When a dirigible balloon desires to land, it must:

By day, display beneath its car a red flag of triangular form;

By night, cause to twinkle or wave a white light, keeping its side lights lit.

Art. 16 (a) In case of distress, above ground as above the sea, a dirigible balloon must, as far as possible:

By day, display under its car a red flag of triangular form and show the two superposed black balls provided by Art. 14.

At night, cause to twinkle a white light, extinguishing its side lights.

By day as by night, it may also make use of a phonic signal.

(b) A free balloon in distress must:

By day, display beneath its car a red triangular flag and, by night, wave a white light.

It may, in addition, by day as by night, make use of phonic signals.

Art. 17. It is forbidden to use any other ballast than very fine sand or water.

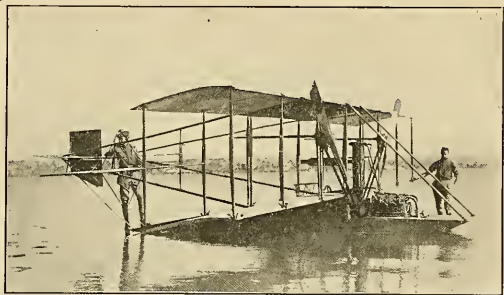

ANOTHER VIEW OF THE FLYING BOAT WHICH GLENN H. CURTISS IS EXPERIMENTING WITH AT SAN DIEGO, CAL.

## THE TRADE

The Frontier Iron Works of Buffalo, New York, report a brisk trade in aero motors during the past two months and feel sanguine over the prospects of selling a great many of their motors during the summer season. This company expects to exhibit its motors at the Motor Boat Show, New York, the Automobile Show at Boston, and the Aeronautical Show in New York. The company also extends to any interested party a cordial invitation to call and inspect their motors at their splendidly equipped plant and watch them as they pass through the various stages of construction.

Messrs. A. Heinrich & Brothers of Baldwin, L. I., are making extensive preparations for a large sale in aeroplanes this season. Their 1912 models show four different types of machines which they will place on the market as follows: single seat, high speed, cross-country type; a two and three seater machine and a small school or practise machine which will weigh about 500 pounds or less without pilot and will have a two-cylinder 25 H.P. motor. This machine will sell for \$1,000.

E. W. Roberts, Vice-President of the Roberts Motor Company, who has just returned from an extended trip West, reports that the Roberts motors are meeting with considerable favor in the Western States. The Roberts Motor Company expects to make during the year of 1912 over 500 aeroplane motors. They are now getting out a motor of 125 H.P., for which they already have some orders.

The excellent work done by Weldon B. Cooke, both at San Francisco and at Los Angeles Meet, was achieved with a Roberts motor. Cooke won the daily duration prize at the Los Angeles Meet, and also flew over Mount Tamalpais, which is about 11,000 feet high.

The Roberts Motor Company state that they are now exporting quite a number of motors to Europe and other countries and received recently a very nice order from Germany as the outcome of the results their motor gave in the aeronautical laboratory of the German Army Division.

Paul Lacroix, one of the best known automobile dealers in New York, has entered the aeroplane field, which he will operate in conjunction with the automobile enterprise. He announces that he has obtained the sales agency in this country for the Anzani motor. This motor is constructed in three, five and six-cylinder types, giving from 25 to 100 H.P. Mr. Lacroix intends to sell the Gnome and Renault motors as well in this country. He has also established an agency for the Borel-Morane monoplane and has one machine here and expects to import several more by spring.

The Goodyear Tire and Rubber Company of Akron, Ohio, who were the first American tire manufacturers to reckon with the aeroplane as a coming factor in transportation and make preparations for its arrival, are now increasing their force working on aeroplane tires and aeroplane fabrics with the expectation of a larger business this year than in any of the preceding years.

The American Aeroplane Supply House of Hempstead, L. I., will, about the first of March move from their present location into a two-story brick building located at 137-143 Jackson street, Hempstead, L. I., arriving out-grown their present limited building. The new quarters are specially adaptable for the manufacture of Blériot type

monoplanes and they intend to install a full equipment of machinery necessary for turning out their machines. They also state that they will have sufficient capacity for setting up and the facilities for completely furnishing six machines at one time. Their new quarters are in an ideal location, being located but one block from the Hempstead railroad station and directly in the centre of most of the permanent aerodromes of Long Island.

The American Propeller Company, of Washington, D. C., reports a continuously improving condition of trade during the past month. This Company is now putting out a booklet containing illustrations of nearly all the various types of aeroplanes on which their "Paragon" propellers are being used. In connection with the various illustrations they are publishing numerous very flattering letters of indorsement which they have taken from their regular files as received in the ordinary course of business without request or solicitation on their part. The booklet will be ready for distribution shortly and is expected to be an example of the typographic art in proper keeping with the Paragon Propellers it recommends.

The E. J. Willis Company of New York, have recently installed in their store at considerable expense one of the finest collection of aeroplane models obtainable. They are built to scale and no minor detail, which would be necessary to a full size machine equipped ready to fly, has been neglected in these small models. They include the Wright Cross-Country type, Blériot type machine equipped with two fifty H.P. Gnome motors coupled together, Santos Dumont Demoiseille type Machine with seating accommodation for seven passengers, Antoinette machine, Motor Driven Kite and one of unique design equipped with pontoons; also a twelve foot model of the Zeppelin 23 Dirigible Balloon equipped with electric lighting outfit and two small motors, wireless equipment, in fact, correct and full equipment in miniature such as is used on the full size machine.

The Wolverine Aeronautic Company of Detroit, Mich., reports that on November 24th, last a contract was entered into with the Chinese Revolutionary Party for the sale of three aeroplanes and a skilled instructor to go to China with them for the purpose of teaching the Chinese how to operate them and that on November 24th, Mr. Wilcox, one of the members of the firm, left for China for that purpose.

The Aeroplane Motors and Equipment Company of New York has begun business as importers of foreign aeroplane motors and supplies. They announce that they will always keep a supply of Gnome motors in stock to meet the demand of aviators in a hurry. They have now in their show room six 50 H.P., two 70 H.P., and two 100 H.P. Gnome motors ready to be shipped to customers. The Aeroplane Motors and Equipment Company have also made arrangements to furnish other standard makes of French Aviation Motors. This company is also the American agent for the imported aeroplane cloths made by the Society des Telephones of Paris. A. L. S. McCurdy is connected with this company.

The International Aeronautic Construction Company of Jamaica, New York, report that the season of 1912 has opened up most favorably for them and that they have already made delivery of two machines since January 1st, both of which

were exported; one a Blériot type monoplane equipped with a 4-cylinder Roberts motor was sent to Australia and the other, a military type biplane, was shipped to China.

According to Walter E. Watts, the enterprising President of the New York Aeronautical Supply Company, these are the heydays of success for that ever growing concern. Double shifts, says Mr. Watts, are now necessary to keep pace with the orders, notwithstanding an increase having been made in the office and factory space of nearly three times the original size. This company is now manufacturing "Knock Down" planes and has at present several 30x5 ft. K. D. Curtiss type machines in stock ready for delivery. Three machines with Roberts motors have been recently shipped to South American ports. The New York Aeronautical Supply Company is also working to fit out a complete line of Blériot monoplane woodwork and metal fittings.

The M. L. Oberdorfer Brass Company of Syracuse, New York, apparently have a monopoly on the sale of circulating pumps for aeroplanes in this country, having experimented for a good many years on a pump that would just suit aeroplane service.

The Hall Scott Motor Car Company is now entering upon its third year in the construction of aviation power plants and apparently they are meeting with continued and increasing popularity. Their motors are now being used all over the United States and a great many of them are being shipped to foreign countries. These motors have been advertised in AIRCRAFT for a period of nearly two years and it is a source of great satisfaction for us to note the remarkable success with which the Hall Scott Motor is meeting.

The El Arco Radiator Company of New York, owing to the quality of their goods, holds practically a monopoly on the sale of aeroplane radiators in the United States.

During the winter season R. O. Rubel, Jr., & Company has been busily engaged enlarging their factory and their present plant now covers two acres of ground. This concern has just sold to Mr. J. W. Richardson, of Dayton, Ohio, a passenger carrying monoplane and has under construction at their factory four other planes. They have also established an aviation school and upon their aviation field have equipped an eight-room house for the use of students which includes a pool table and piano.

Another big manufacturing concern have entered the aeronautical industry. The B. F. Sturtevant Company, of Hyde Park, Mass., have now completed an aeronautical motor, after several years' experimenting, and are ready to market it. This concern has been making automobile motors, etc., for many years and announce that they have a most important catalogue, number 200a, which they will be glad to send to anyone interested, free of charge.

The Standard Aviation Company of Chicago, have engaged as its superintendent, Mr. Francis Raiche, formerly of Mineola, L. I. Mr. Raiche's activities in the aeronautical movement dates back several years, he being the first member of the Aeronautical Society to make a machine that would fly. Moreover, Mr. Raiche's wife, Mrs. Bessica Raiche, was the first woman in America to pilot an aeroplane in flight, in recognition of which the Aeronautical Society presented her with a gold medal.



# CLASSIFIED ADVERTISING

15 CENTS A LINE SEVEN WORDS TO LINE CASH WITH ORDER

## FOR SALE

If you want passenger balloons, dirigibles, captives or aeroplanes; large stock; immediate shipment; any size built to order. Teach purchaser to operate. Exhibitions furnished throughout United States and Canada. G. L. Bumbaugh, builder and operator, Indianapolis, Ind., U.S.A.

**FOR SALE**—One Regna-Gibson propeller, 7 ft. diameter, 6 ft. pitch..... \$35.00  
 One French propeller type 8.097 ft. diameter, 3.987 ft. pitch..... 50.00  
 One French propeller type 8.097 ft. diameter, 3.45 pitch..... 50.00  
 One Dean Mig. Co. propeller type 6½ ft. diameter, 4¾ ft. pitch..... 50.00  
 The above French propellers were made in France, are made of the very best of material and workmanship. The price F. O. B. Paris is \$100.00 each.

1 30 H. P. Harriman engine, 4 cylinder, 4 cycle. This engine sells for \$1,650.00, our price 1 6-cylinder, 2 cycle, 48 H. P. engine, \$775.00. \$700.00. This includes a complete power plant. This includes radiator propeller and high tension magneto. This engine sells for \$1,500.00.  
 We are closing out our business and must sell. LeBron-Adams Aeroplane Co., Omaha, Neb.

**FOR SALE**—New 1912 Model Detroit Aero Engine, 20 to 30 H. P. Address Stewart's Aeroplane Co., Allentown, Pa.

**MODEL Aeroplane Supply Dealers:** I can furnish the trade with propellers, propeller blanks, and wood in assorted kinds and sizes, selected Poplar, Spruce, Maple, Birch, Holly, etc., at most reasonable prices. G. C. Stevens, 305 7th Street, Brooklyn, N. Y.

**CURTIS'S** latest improved type (Pigeon tail) 1912 Model. Made over 300 very successful flights 1,000 ft. high, 30 miles cross-country. My construction is strongest in the world. New, complete, ready to fly, tested and guaranteed, including free lessons to buyer, \$2,500. Buy direct from Builder and Aviator of 10 years' experience. H. C. Cooke, Aviator and Builder, 128 West 65th St., New York City.

**DO YOU WANT an aeroplane?** If so, by all means let us get together. We have the machines and can fill your wants. Complete line of parts. American Aviation Co., Inc., 2957 N. Lawndale, Chicago, Ill.

**FOR SALE**—One 50 H. P. DeChenne Power Plant complete. Cheap if taken soon. Reason, have closed for season and can make more by spring. DeChenne Motor & Aeroplane Co., Monett, Mo.

**BIPLANES**—Curtiss Military types, built to order, double covered \$400, single covered \$375. Farmans \$475; modified Niuport Monoplanes \$400. Also other types. Send for particulars. Frank Lavista, Dobbs Ferry, New York.

**THIRTY** perfect photographs of prominent aviators, mechanics, flights, etc.; interesting authentic descriptions; \$1.00 Sample, six photographs, 25 cents. Aero Specialty Co., Revere, Mass.

**FOR SALE**—50 H. P. Curtiss Military Type Biplane with duplicate surfaces and parts. First class outfit. Price \$2,500. Address Box 98, Mineola, L. I.

**FOR SALE**—Complete sets of castings for building the Blériot monoplane. Lynch Brothers, Aeronautic Engineers, 61 Wick Place, Youngstown, Ohio.

**FOR SALE**—Monoplane, Blériot Type 11 complete, covered with No. 10 Goodyear fabric, equipped with 60 H. P. engine, magneto, radiator, and seven foot propeller with five foot pitch. Never had a fall. Owner is now flying biplane for large exhibition company. Will sell outfit complete for \$850, or engine \$650 and plane \$250. Send for photo at once. Box 755, care AIRCRAFT.

**FOR SALE**—Genuine Glenn H. Curtiss Aeroplane without motor, newly covered with Capt. Baldwin's rubberized linen, having latest controls, packing cases, etc. Good as new. Bargain for quick buyer. Address: Box 758 Aircraft.

## MISCELLANEOUS

**WANTED**—Small factory or shop with facilities for light woodworking in good manufacturing location. Middle West or near New York. Full particulars. Box 2476, Station G, Washington, D. C.

**WANTED**—A second-hand engine for an aeroplane, 25 H. P. and upwards. Must be in good repair and guaranteed. State price and give particulars. J. A. Colton & Co., 1012 Walnut Street, Philadelphia, Pa.

**WANTED**—Very neat, refined young colored man wishes position any kind that gives chances as aviator or mechanic. Eight years a chauffeur. References unexcelled. For particulars address Griffith Gunther, 349 West 59th St., New York City.

**\$500** will buy a 40-50 H. P. Elbridge Featherweight Aero Motor, two propellers, radiators and tank. All in excellent condition. This equipment has made flights. Address M. A. Schmitt, 584 Eagle Street, Buffalo, N. Y.

**WANTED**—Aerial motor, 25 or 30 H. P. In answering give description and lowest cash price. Address R. J. Straight, Long Lake, Wis.

## POSITIONS WANTED

**YOUNG MAN**, 20, school graduate, good drafts man and familiar with shop work, desires position as aviator's assistant with prospects of learning to construct and fly. Address R. L. G., 416 Third St., Baton Rouge, La.

**A YOUNG MAN**, age 18, desires position as an aviator's assistant, with prospects of learning to fly. Address Louis Fenouillet, 132 West 47th St., New York City.

**YOUNG MAN**, intelligent, reliable, lately a pupil of Blériot, ready to do anything to succeed, or at hangar. One year experience building large working models. Understand controlling systems of monoplanes and biplanes, with a good knowledge of construction work. Four years' experience as pilot of locomotion. If you want the services of a good intelligent worker, let us communicate. Unquestionable references. Address Cable Box 757, AIRCRAFT.

**CAPABLE**, reliable young man (age 26), desires a position in aeronautical work, factory or at hangar. One year experience building large working models. Understand controlling systems of monoplanes and biplanes, with a good knowledge of construction work. Four years' experience as pilot of locomotion. If you want the services of a good intelligent worker, let us communicate. Unquestionable references. Address Cable Box 757, AIRCRAFT.

## CO-OPERATION WANTED

**LADIS LEWKOWICZ**, the experienced international aviator, who is the only man to fly over the City of New York, late manager and chief instructor to the Queen Aeroplane Company, has a chance to become affiliated with one of the best aeroplane manufacturing concerns in France and wishes to establish an agency in New York with some responsible man with a few thousand dollars to invest in the enterprise. Address Ladis Lewkowicz, 102 West 64th St., New York City.

**A PRACTICAL DOUBLE MONOPLANE, CENTRAL BALANCE, GREAT STABILITY. RUDDERLESS. PATENT RECEIVED RECENTLY. WANTED PARTY WITH CAPITAL TO BUILD OR INCORPORATE. ADDRESS W. A., BOX 756, AIRCRAFT.**

**CAPITAL** wanted to patent and build aeroplane that will fly three hundred miles per hour. Will give 49 per cent. of patents. I will guarantee to fly across Atlantic in twelve hours. Address A. Harbottle, 18 Eldert St., Brooklyn, N. Y.

**YOUNG MAN** requires financial assistance to build aeroplane. I have made two flights as a passenger. A great enthusiast. Will make good terms on receipts from flights. References furnished. H. Hertzman, 1123 13th Ave., Moline, Ill.

## AVIATORS' DIRECTORY

### LADIS LEWKOWICZ

The well known aviator, lately Manager and Chief Instructor of the Queen Aeroplane Company, is open to any proposition from responsible firms or individuals, to organize and manage Aeroplane Factory and Aviation School. Write, stating full particulars, to

### LADIS LEWKOWICZ

102 West 64th St., New York City

**REYBURN, Amedee V. Jr., with Blériot one hundred horse power monoplane. Is now booking engagements for exhibition flights. For particulars apply to 5305 Delmar Boul., St. Louis, Missouri.**

## Aeroduster

**AERODUSTER SPECIAL**  
 20-foot Biplane (Glider) (Glider Type)  
**TWENTY-FIVE DOLLARS**  
 Guaranteed to sustain 185 pounds. Best spruce construction throughout. Laminated ribs. Glider guerd with tested Aviator wire and turnbuckles. Shipped anywhere for \$25.00, f. o. b. Chicago. Others are flying them! Why not you?  
**AERODUSTER CONSTRUCTION COMPANY**  
 3751 Indiana Ave., Chicago, Ill.

## Gibson Propeller Co.

We have served you since **1909**  
 We are ready to serve you **NOW**  
**FORT GEORGE PARK SEND FOR NEW YORK CITY "RED BOOK"**

## BIRD-MODEL

The most natural, perfect and scientific Flying-Machine model in the world (patented) which shows the secrets of birds flight.

Will fly from 20 to 200 feet without power.  
 Most interesting for the enthusiast in aviation.  
 Everybody experimenting in flying machines cannot be without it.  
 Send 25 Cents in coin for complete model.  
 Agents wanted. Idea is worth the money.

**Ernest Ebbinghaus 316 East 93rd Street New York, N. Y.**

## CHICAGO AERO WORKS

**H. S. RENTON** 164 North Wabash Avenue  
 Proprietor  
**AEROPLANES** ACCESSORIES MOTORS PARTS  
 HARDWARE PROPELLERS  
**WHEELS** ALSO MODELS AND MODEL STOCK  
**FSTA315HFD 1909.** First in Chicago and the Middle West  
 Aviators Taught Flights Furnished Send stamp for Catalog

## Aeroplane Wire Wheels

STOCK SIZES PROMPT DELIVERIES

- 16" x 1½" Monoplane Tail Wheel—weight 3 lbs.
- 20" x 2" Curtiss Type—weight 7 lbs. sustain Dead Load of 600 lbs.—Rims either wood or steel.
- 20" x 2" Wheels for Single Tube Tires.
- 20" x 3" Wheels for Single Tube Tires.
- 20" x 4" Wheels for Clincher Tires.
- 24" x 3" Wheels for Clincher Tires.

Hubs furnished 4", 5", 5½" or 6" wide fitted with Plain or Knock Out Axle—also Bronze Bearing to fit 1½ Axle.  
 14" Steering Wheels.

**FARMAN TYPE RUNNING GEARS.**  
 Write for Prices to  
**J. A. WEAVER, Jr., 132 West 50th St., NEW YORK**

# A VALUABLE SOUVENIR,

The souvenir will be expensive. It is to be handed only to those who are actively affiliated with any branch or phase of the aeronautical industry. In order that we may be able to estimate the number of souvenirs we need, please write us immediately your name and address and in what way you are connected with the aeronautical industry; also send us the names of any of your friends and associates whom you think should receive one of the souvenirs.

Which you will be proud to wear, will be distributed absolutely free of cost by the Sloane Aeroplane Company.

## SLOANE AEROPLANE COMPANY

Charavay Propellers. Sloane 'Planes. Parts.

1731 BROADWAY, NEW YORK CITY



PROPELLERS for model aeroplanes; light, smooth aluminum blades; variable pitch; steel shaft accurately and securely attached: 3 1/2 in. 10c., 6 in. 25c., 8 in. 35c., 10 in. 50c., 12 in. 75c. Post-paid. Low quantity prices. Jersey Skeeter Aeroplanes 25c.

LINCOLN SQUARE NOVELTY WORKS  
Department B. 1931 Broadway, New York

## BAMBOO Special Grades of Bamboo for AERONAUTIC WORK

Reed, Rattan and Split Bamboo for Models. All sizes in stock. Large size Rattan for skids.

J. Deltour, Inc. 49-6th Ave., N. Y.

## IN PATENT MATTERS

An experienced Mechanical Engineer can Advise You Better, Protect You Better, Develop Your Idea, Improve Your Invention.

G. M. SACERDOTE, M. E.

Patent Attorney, Registered in United States Patent Office  
1919 BROADWAY, N. Y. CITY Tel. 8690 Columbus  
FRENCH and ITALIAN SPOKEN

## PATENTS THAT PROTECT AND PAY

Advice and Books Free. Rates Reasonable. Highest References. Best Services.

WATSON E. COLEMAN, Patent Lawyer  
622 F St., N. W., Washington, D. C.

## PATENTS SECURED or Fee Returned

Send sketch for free search of Patent Office Records. How to Obtain a Patent, and What to Invent, with List of Inventions Wanted and Prizes offered for Inventions sent free. Patents advertised free.

We are experts on AIRSHIPS and all patents and technical matters relating to AERIAL NAVIGATION.  
VICTOR J. EVANS & CO., Washington, D. C.

DETROIT AERO POWER PLANT  
COMPLETE \$300 READY TO RUN  
INCL. PROPELLER-CARBURETOR-BOSH MAGNETO. OIL PUMP-CABLE-SWITCH-MOUNTING BOLTS.  
IS GUARANTEED TO 240 LBS MIN. STATIONARY THRUST 150 LBS MAX WEIGHT (COMPLETE)  
36 HOURS DELIVERY

LIFT AND FLY  
CURTIS BYPLANES  
BLERHOT II MONOPLANES  
DEMOISELLE MONOPLANES  
OR CRAFTS OF SIMILAR MAKE

DETROIT AEROPLANE CO.  
DETROIT MICHIGAN



## THE PERFECTED RACERS NEW FRENCH Record flyer, 950 MODELS . . . ft. Very durable.

Excellent for experiments. Wonderful prize winners. 30"x14" finished model, \$1.15 postpaid. Three-foot racer, very speedy and durable, 1000 ft flights \$2.25. Which one? Send now. Prompt shipment insured. Also our Catalogue of supplies Free. Liberal Discount to Dealers.

(Box 255)  
ROBIE MANUFACTURING CO., Williamson, N. Y.

## GOLDIE

Who has been connected with all of the large meets and shows held in the country to date, is at liberty for the coming season.

Address Box 753 care Aircraft

## Anglo Model Aeroplane Mfg.

561 West 147th Street New York City

Ready Models

2' BLERHOT \$5.00 2 1/2' ANGLONETTE \$7.00

Knockdown \$1.50 This machine we positively guarantee to fly 800 to 1000 feet or money refunded. WE CARRY SUPPLIES.

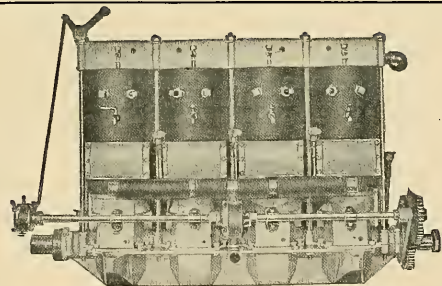

AEROPLANE MOTORS 40 to 50 H. P.

H. J. LEIGHTON, 1017 West Fayette Street SYRACUSE, N. Y.

## WIRE

Aviator Wire supplied in 12 sizes with a plate finish making soldering easy. This wire is specially drawn from extra quality high grade steel. Also Aviator Cord of twisted wire.

John A. Roeblings Sons Co.

TRENTON, N. J.

## AEROPLANE RADIATORS

IN STOCK OR TO ORDER

SEND FOR PRICE LIST. EL ARCO RADIATOR CO. 6 EAST 31st ST., NEW YORK

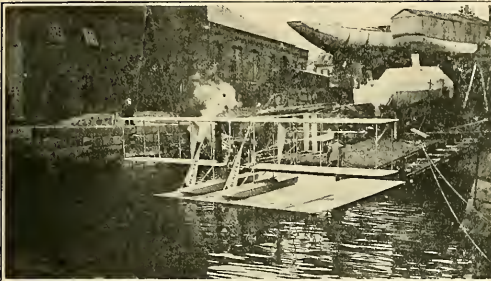

"THE PASSING OF THE YACHT"

The Burgess Hydro-aeroplane is epoch making. It has brought flight into the field of yachting.

Wherever there is a small body of water, at the summer place, by the sea, on inland lakes and rivers, the Burgess Hydro-aeroplane meets the demand of the sportsman for safe flying.

In the 1912 models we offer no untried experimental devices, simply refinements in construction, additional strength and durability. Both the hydro-aeroplane and aeroplane may be started by the operator while in the machine.

The following aviators, when free to choose their own aeroplanes, selected a Burgess type:

- |                      |                     |                         |
|----------------------|---------------------|-------------------------|
| C. Grahame-White     | H. N. Atwood        | C. K. Hamilton          |
| Lieut. T. D. Millang | Clifford L. Webster | H. W. Gu                |
| T. O. M. Sopwith     | W. R. Brookins      | U. S. Navy (hydroplane) |
| Phillips W. Page     | U. S. Army.         |                         |

Training on Burgess Hydro-aeroplane equipped with duplicate control, under the instruction of licensed aviators only, may be secured during February and March at Daytona (aeroplane), Ormond (hydro-aeroplane), Fla., Los Angeles, Calif., or Marblehead, Mass. weather permitting.

**BURGESS COMPANY & CURTIS**

Dept. C MARBLEHEAD, MASS.

**FLYING ALL WINTER**

Become a PILOT on the latest . . .  
**WRIGHT AEROPLANE**

The Greatest Money Maker in the World  
WE make you a FLYER in 10 lessons  
WE stand all breakage  
NO extra charge to you  
ENROLL NOW and be an OPERATOR when the good weather sets in  
FINEST and BEST equipped AVIATION GROUNDS in AMERICA

Passengers carried daily, \$25.

STEVENS & BEATTY, Box 181 Mad. Sq., N. Y.

**Course \$ 2 5 0 Course**

**NAIAD**  
**Aeronautical Cloth**

Manufactured Especially for Aeroplanes and Used by Aviators of Prominence

**LIGHT, STRONG, AIR-TIGHT**  
AND  
**MOISTURE-PROOF ON BOTH SIDES**

Sample Books, including Data and Prices, sent on request

**THE C. E. CONOVER CO.**  
101 Franklin Street - - New York

**AEROPLANE SUPPLIES**

Build NOW Be ready for Early Spring Flying. We are manufacturers and can save you money on ALL AIR GOODS.

ALLOW US TO ESTIMATE ON! YOUR WANTS

- |                |                |
|----------------|----------------|
| Turnbuckles    | Bed Rail       |
| Post Sockets   | Clamps         |
| Terminals      | Outrigger      |
| Wheels, Seats  | Ends           |
| Eyelet Outfits | Rib Fasteners  |
| Running Gears  | Steering Posts |
| U-Bolts        | Ferrules       |
| Wire Cable     | Sheaves        |
| Pulleys        | Snap Hooks     |



"K. D." Tails, Rudders, Ailerons, Skids, Struts, single and double Surface Ribs—Bleriot Ribs, Bed Rail, etc., etc.

Tubeing—Cloth—Radiators  
Tanks—Propellers "Roberts" Motors

Send 4 cents in stamps for catalogue and revised prices

**NEW YORK AERONAUTICAL SUPPLY CO.**

Suite 62-3-4-5-6  
50 BROADWAY, NEW YORK



Heinrich 1912 Mono-Biplane, Model (A) showing seat, also windows in side and bottom

1 9 1 2  
**Heinrich Mono-Biplanes**

The only Aeroplane built to take two sets of wings, Mono-plane or Biplane, practically two machines in one, at the cost of one, and takes up the space of one. Built in the following sizes; Biplane wings extra.

- Model (A) single seat, high speed, cross country type, \$900 without motor.
- Model (B) two seat, cross country type, with 100 H. P. Motor \$2,550.
- Model (C) three seat military type, with 100 H. P. Motor \$2,500.
- Model (D) special type, single seat, with 25 H. P. 2 cyl. Motor \$1,000.

**HEINRICH BROS. Baldwin, L. I., N. Y.**

Particulars and illustrated booklet sent free on request

\$1200 to \$4800

**THE**  
**REX** **MONOPLANE**  
**CO.**

South  
Beach, S. I.  
N. Y.

DUPLICATE PARTS  
at  
SAVE 50% **COST** SAVE 75%

## Buy a REX Monoplane and Save

**\$500 to \$1000 on Purchase**  
**\$250 Tuition Fee to Learn to Fly**  
**50% to 75% on Maintenance**

The REX, with its interchangeable wings, makes it possible to enter Speed, slow and passenger contests during the same day. **WHAT OTHER AEROPLANE CAN DO THIS?** Remember, we **Guarantee Before** delivery to fly the REX at **Least 1000 Feet High and 10 Miles** across country.

We Supply an Extra Pair of Racing Wings with each REX.  
We Duplicate Parts at Absolute Cost, a Saving of 50% to 75% in Maintenance

**THE REX MONOPLANE CO.,** South Beach, S. I., N. Y.

**MONOPLANES**  
"Bleriot" type  
"Nieuport" type

Single and passenger, cross country, racing, and special machines to your own design and specifications. We guarantee our machines to be superior in workmanship, materials, etc., to those of any constructed here or abroad regardless of price paid.

An inspection of our products will convince you that we can supply you with an "Up to the minute" machine at the same price others are asking for models manufactured 1, 2, and 3 years ago. Do you realize what this means to you?

**"KNOCKDOWN"**  
Ready to assemble  
All parts fitted, drilled, ribs, stabilizer, rudder, and elevator assembled.

# AEROPLANES.

**Best Equipped Plant in this Country.**

You must order now if you want to take advantage of the coming season. Special prices on reservations made now. Let us know what types, and in what form you are interested. Be on the safe side and order from a responsible concern. You take no chances. Look us up.

**INTERNATIONAL AERONAUTIC CONSTRUCTION CO., Inc.**

Office  
JAMACA, N. Y. CITY  
Main Line Long Island Railroad.

**BIPLANES**  
"Farman" type  
"Curtiss" type

**"COMPLETE"**  
With "Gnome" "Anzani" "Roberts"  
Any type motors installed.

Reference, Bank of Long Island  
Aviation Grounds  
NASSAU BOULEVARD



**Farman Running Gears Complete as above \$47.50**

## Aeronautical Supplies

**Everything to build any type flying machine**

New catalogue with working drawings of Curtiss, Farman and Bleriot type machines in course of construction and will be mailed free upon request to all interested parties as soon as received from the printer. Write for quotations.

**A FEW IMMEDIATE DELIVERY PRICES**

Curtiss Seats - \$5.50	Oval Post Sockets - \$0.17
5 Gallon Tanks \$6.15	Curtiss Steering Wheels - \$9.00
Aluminum Pulleys with Brass Bushings 2'-2 1/2''-3'-25c., 30c., 40c.	Out Rigger Fittings \$0.29
Aviator Caps - \$1.25	
20 x 2 1/4'' - \$6.75	Wheels and Tires complete Eclipse Hub 20 x 3'' - \$9.50

Free with every \$50.00 order for Aeronautical Supplies

**FLEECE LINED AVIATOR CAP**  
**E. J. WILLIS CO.,** 85 CHAMBERS STREET  
67 RADE STREET  
Tel. 3624 Worth NEW YORK CITY

## For Aeroplanes Only

Extreme in  
Lightness  
Strength  
Simplicity  
Efficiency

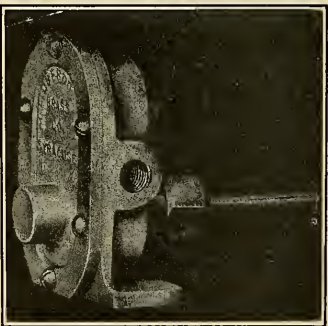

Positive  
Suction  
Positive  
Pressure

### Oberdorfer Aluminum Circulating Pump

This is the most necessary part of any aeroplane—it's a pump extreme in lightness and strength. The minimum pressure of 80 pounds per square inch insures a plentiful supply of oil passing through the engine. 4) The pump isn't new—it contains every important feature of the famous Oberdorfer Bronze Pumps with a reduction in the size of the Drive Shaft, by replacing the bronze with steel. All gears have been lightened by removing metal at certain points not interfering with the strength. It's important that you know more about these pumps.

Do you own one of our free catalogs?

Send for it right now before you forget.

**M. L. OBERDORFER BRASS CO., E. Water St., Syracuse, N. Y.**

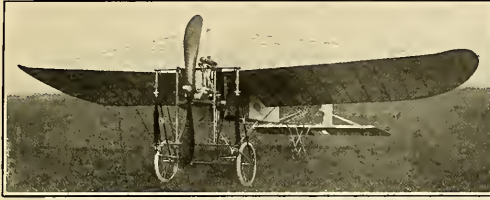

OUR 1912 MODEL "CROSS-COUNTRY" TYPE."

## Bleriot Monoplanes PLACE YOUR ORDER NOW

Our Monoplanes now flying in the North, South, East and West by

- E. J. MARLEY, Sumner, Miss., Racing Monoplane
  - A. C. MENGES, Memphis, Tenn., Racing Monoplane
  - WILLIE HAUPT, Philadelphia, Pa., Single Seater Machine
  - CHAS. W. SPENCER, Philadelphia, Pa., Single Seater Machine
  - J. A. BRACKETT, Boston, Mass., Passenger Type Monoplane
  - A. V. REYBURN, JR., St. Louis, Mo., Passenger Type Monoplane
  - GEO. B. McNAMARA, Norton, Mass., Passenger Type Monoplane
- SINGLE SEATERS, PASSENGER MONOPLANES,  
RACING MONOPLANES, ETC.**

Write to-day for 1912 Catalogue

**American Aeroplane Supply House**  
266 FRANKLIN ST. Tel. 427 HEMPSTEAD, N. Y.  
Hempstead

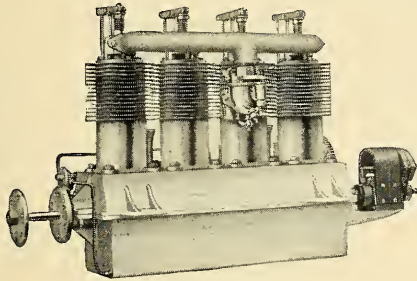

There's a Reason Why . . .

## GRAY EAGLE MOTORS

Made Good Last Year

25 amateurs flew their home-made planes with them.  
Do you want their names and addresses?

**The 1912 Models are still better and fully guaranteed.**

We will install either model 30-40 or 6 cylinder 50 H.P. in your aeroplane and allow you free use of our private Aviation Park to try them out.  
Don't buy a motor until you have tried a new Model Gray Eagle at our expense  
**ISN'T THAT FAIR.**

All we want is a chance to show you. We'll get your order then.  
A visit to our factory would give us an opportunity to demonstrate why we can sell them at such a low price. They are built in quantities of the best material and sold on a small profit direct from factory to you.

4 Cylinder 30-40 H. P.  
Complete \$485 net.

6 Cylinder 50 H. P.  
Complete \$675 net.

No Discounts

Write for circular describing the new six cylinder and the improved four cylinder. Yours for the asking.  
**R. O. RUBEL, Jr., & CO., Inc. 1600 Floyd St., Louisville, Ky.**

## Winter Training Grounds Curtiss Aviation School SAN DIEGO, CALIFORNIA.

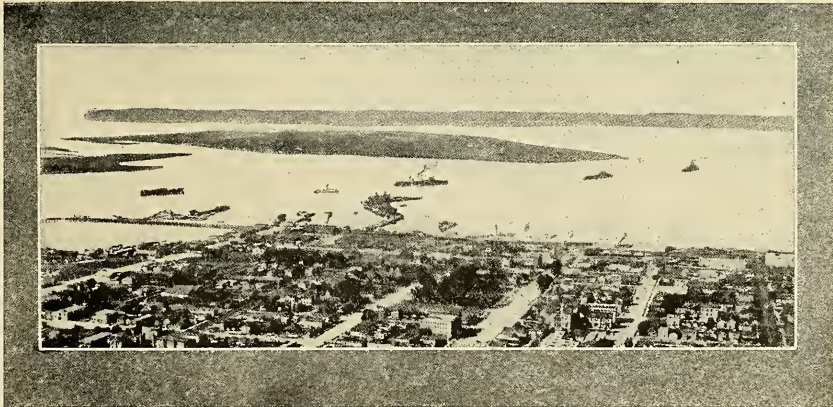

NORTH ISLAND IN SAN DIEGO HARBOR

1,000 acres of level sand without a tree or building to interfere with flying. Undoubtedly the best grounds for aeroplane flying in America, if not in the world. Delightful and perfect climatic conditions. Leased exclusively for

### The Curtiss Aviation School and Experimental Grounds

Opened October 20th, 1911, Season 1911-12, under the direct supervision of GLENN H. CURTISS, assisted by Lieut. J. W. McCLASKEY and staff of aviators. Among the prominent aviators trained at these grounds are: Lieut. T. G. Ellyson, U. S. N., Capt. Paul W. Beck, U. S. A., C. C. Witmer, Hugh Robinson, R. C. St. Henry.

TUITION applies on purchase price of aeroplane. All classes filling rapidly. Get our proposition and booklet "TRAINING" to-day.

**THE CURTISS AEROPLANE CO., HAMMONDSPORT, NEW YORK.**

Sales Agents and Foreign Representatives  
The Curtiss Exhibition Company, 1737 Broadway, New York City

# Model A-1 Frontier Aerial Motor

SIXTY TO SEVENTY HORSE POWER, EIGHT CYLINDER

- ☞ The Motor Pre-eminent of Merit
- ☞ Built like a Watch and delivers the Power.
- ☞ Ballbearing throughout.
- ☞ Hollow Shafts.
- ☞ Forced Lubrication
- ☞ Centrifugal Water Pump Circulation.
- ☞ Copper *or* Iron Jacketed.

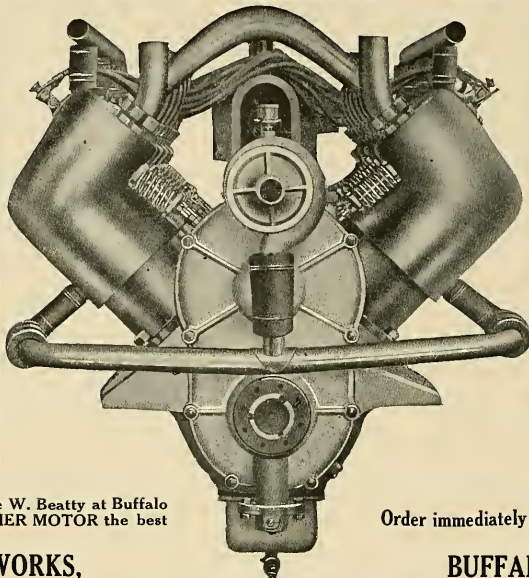

- ☞ Krupp's Nickel Steel Parts, treated and hardened.
- ☞ No Experiment.
- ☞ Parts are interchangeable and can be duplicated.
- ☞ Built and backed by a responsible concern.
- ☞ Write *today* for descriptive folder and prices.

Tests made by George W. Beatty at Buffalo recently proved the FRONTIER MOTOR the best engine in the world.

**FRONTIER IRON WORKS,**

Order immediately and avoid disappointment.

**BUFFALO, N. Y. (Dept. C)**

# BLERIOT MONOPLANES

(GENUINE)

**Winners of ALL the European Contests in 1911**

In 1909—The First Aerial Crossing of the Channel.

1910—The "Circuit de l'Est."

1911—The Paris-Rome Race (1st and 2d.)

The European Circuit (1st and 2d.)

The English Circuit (Daily Mail Race.)

The Belgian Circuit.

The St. Petersburg, Moscow Race.

The Valencia Alicante Race.

The London to Paris non-stop Raid, etc. etc.

**WORKS AND OFFICES: - 39, Route de la Révolte à Levallois - PARIS**  
and Belfast Chambers, 156 Regent Street, LONDON

FRANCE

ENGLAND

**AVIATION SCHOOLS; Etampes, near Paris during Summer**

**Hendon, near London**

**Pau during Winter**

# WAIT

Examine this 4 cylinder crankshaft (absolutely unique among American aeromotors); but merely one example of the sound, construction in the new

## MAXIMOTOR

The New Catalog will soon be off the press.

FOR THE 1912

# MAXIMOTOR

Far! LIGHTER; more EFFICIENT than ever.  
Built for exhibition and cross-country work requiring RELIABILITY and ENDURANCE.

MAXIMOTOR MAKERS  
DETROIT  
52 CRANE AVENUE

DEPT. 15

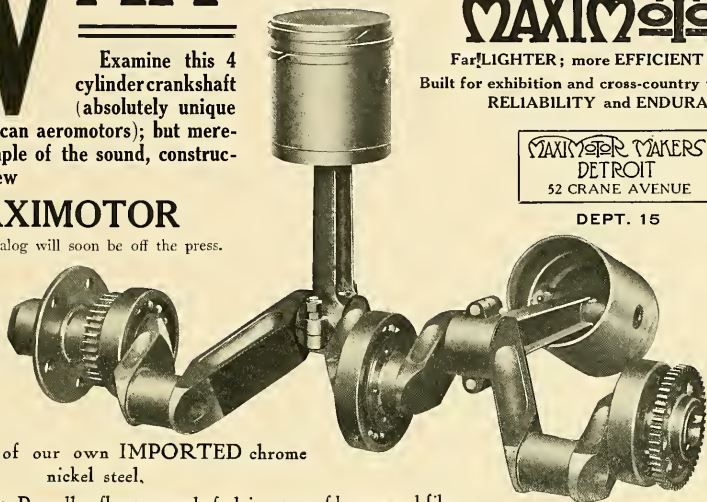

Shaft made of our own IMPORTED chrome nickel steel,

Left to right: Propeller flange; camshaft drive gear of bronze and fiber; imported ball bearing; manganese bronze connecting rod with piston and three eccentric piston rings (pinned); imported ball bearing with quick detachable collar; piston assembly; imported ball bearing; magneto drive gear of steel  
Guaranteed strength of Shaft, in natural condition, untreated, 150,000 to 170,000 lbs. per inch.

# ... The Wittemann Biplane ...

HAS A REPUTATION, NOT ONLY FOR PACE, BUT FOR QUALITY AND SERVICE

Write for information of 1912 Biplane with our new stabilizer.

If you want to build a machine of your own design or parts thereof, we can help you to make it successful. Some parts of your plane can be made of steel. We rid you of the annoyance of constant repairs and insure absolute safety.

Send us your specifications and requirements and secure our quotations.

Large stock of steel fittings, laminated ribs and struts of all sizes carried in stock.

Own a Wittemann Biplane Glider; the best, the safest, easiest to operate, and enjoy flying in a moderate form.

## YOUR OPPORTUNITY

Two single cover biplanes for immediate delivery; slightly used, perfect condition with 8 Cyl. 60 H. P. Hall Scott power plant.

Write for Particulars.

Write for Catalogue.

### C. & A. WITTEMAN Aeronautical Engineers

The Oldest aeronautic manufacturing concern in the United States.

Established 1906.

Works: Ocean Terrace and Little Clove Road

Staten Island

New York

**YOU'VE SEEN IT FRIEND ?** before, As you turned these pages o'er, and again—The same thing may be found, In some other papers 'round, Thru the town. How the Gyro (safe and sane) Is the only form of plane, w rth a darn.

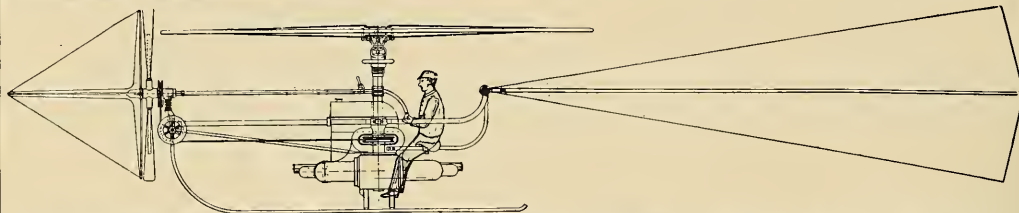

That the "movement's" here to stay, Altho the "stiff wing" must give way Before long So—HERE'S THE BOYS COME 'ROUND, TO ADMIT THE HELO—sound, as a gong. Then watch up in the skies!—Watch the old World rub its eyes!—"Acht—So long" JOS. E. BISSELL Box 795 PITTSBURG, PA.

## THE CALL AVIATION ENGINE

Four Cycle, Water Cooled, Opposed Cylinders  
THE GREATEST KNOWN THRUST PER RATED HORSEPOWER

WRITE FOR CATALOG.

The Aerial Navigation Company of America, Girard, Kansas.

## A FEW HANGARS OF VARIOUS SIZES AT PROPORTIONATE PRICES ARE NOW FOR RENT AT

The Aerodrome of the Aero Club of New York

NASSAU BOULEVARD,

LONG ISLAND, N. Y.

FOR TERMS APPLY TO THE SUPERINTENDENT ON THE AVIATION FIELD

Those engaging and occupying hangars now will have preference over all others when the rush begins for accommodations for the season of 1912, when the daily gate receipts will be shared with the aviators.

EDWIN HOPKINS

PAUL DeKILDUCHEVSKY

"Built on  
Broadway"

## THE H.-DeK. MOTOR

The Aristocrat of  
Aviation Engines.

THE standard all-steel motor, unrivalled in design, construction and workmanship. Chrome and nickel steels used exclusively where other metals are not required by good engineering, more than two-thirds of the principal parts being of steel, the remainder of manganese and phosphor bronze, copper and fine grey cast iron, with but a single member, the crank case of aluminum. Absolute reliability is thus attained by the use of known materials of known qualities, all uncertain and experimental metals being avoided.

In simplicity and strength of design, the H.-DeK. is unsurpassed. It is a standard four cycle, four cylinder, vertical water cooled motor, with integral steel cylinders 5 3-16 inch bore by 6 inch stroke, 60-80 H. P. and with equipment including "Mea" magneto, weighs but 248 pounds.

Feature for feature the H.-DeK. is the peer of the best European motors and compared with motors of similar standard type is from ten to eighty pounds lighter for the same piston displacement, or develops five to twenty horsepower more for equal weight, advantages arising from special features, increased simplicity of design and the use of the best materials. It is impossible to put more value into a motor than goes into the H.-DeK. or to get a motor of finer design, materials and workmanship.

If you want the best that can be built, get the H.-DeK. Catalogue sent free. Order now to insure delivery.

**HOPKINS & DeKILDUCHEVSKY**

1533 BROADWAY

NEW YORK, N. Y.



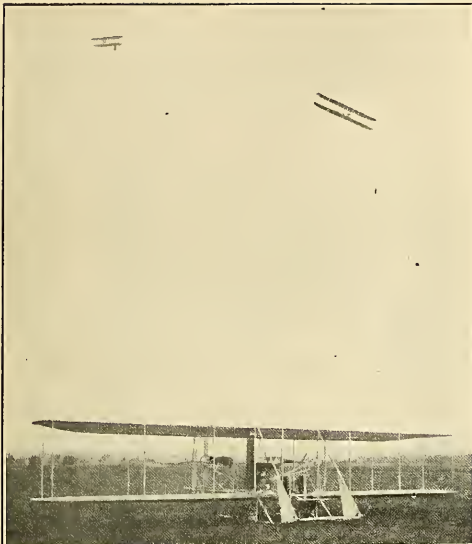

# The Wright Flyer

## 1912 MODELS

In addition to these features which in the past have made Wright Flyers famous for efficiency and reliability, the new models can be furnished with **Automatic Control, Silent Motors, and Hydroplanes.** These special features make the 1912 machine unusually attractive to sportsmen.

## EXHIBITION MACHINES

For exhibition work we have other models especially adapted to high winds and small fields. It was a stock "EX" Model that Rodgers made his wonderful flight from coast to coast. Reliability means dollars to the exhibitor.

## WRIGHT SCHOOL OF AVIATION

Training consists of actual flying, in which the pupil is accompanied by a competent teacher. No risks and no expense whatever from breakage. The most famous flyers in America are graduates of our school and include such names as

- |                |                |                  |
|----------------|----------------|------------------|
| Lieut. Arnold  | Drew           | Lieut. Rodgers   |
| Atwood         | Elton          | Fairleece        |
| Brookins       | Lieut. Foulois | Page             |
| Brundley       | Fowler         | Reynolds         |
| Bonney         | Gill           | Simmons          |
| Betty          | Lieut. Lahm    | Turpin           |
| Burgess        | Lieut. Milling | Welsh            |
| Coffyn         | Mitchell       | Webster          |
| Capt. Chandler | C. P. Rodgers  | and many others. |

Our School at Dayton is now open and pupils may begin training at once if they wish. By enrolling now you can reserve date most convenient to you for training. Write for particulars.

# THE WRIGHT CO.

Dept. "B"

DAYTON, OHIO

We Manufacture . . .

## BIPLANES

Single and Double Surface, Latest Design, easy to assemble and take down with the use of our aluminum connecting castings.

Wood and metal parts, ribs made of several pieces, accurately shaped, all parts fitted ready to assemble.

We are Inventors of the Best Wire Tighteners Made.

Hollow steel steering post, with wire guides inside.

WRITE FOR CIRCULARS AND PRICES.

**WOLVERINE AERONAUTIC COMPANY**  
DETROIT, MICH.

## BALDWIN

### VULCANIZED PROOF MATERIAL

For Aeroplanes, Airships, Balloons. First Rubberized Fabric on the market. Lightest and strongest material known. Dampness, Heat and Cold have no effect. Any Strength or Color.

### "RED DEVIL" AEROPLANES

That anyone can fly. Free Demonstrations.

### HALL-SCOTT MOTORS

Eastern distributor, 40 h. p., 4-cyl.; 60 and 80 h. p., 8-cyl., on exhibition at Frank Schumacher's, 164 W. 46th Street, New York. All motors guaranteed. Immediate delivery.

### EXPERTING

Will install a Hall-Scott free of charge in anyone's Aeroplane and demonstrate by expert flyer. Expert advice. Planes balanced.

**CAPT. THOMAS S. BALDWIN**

Box 78 Madison Sq. P. O., New York

## AEROPLANES

## SUCCESS

Rests with you when you purchase a Fox De Luxe Aero Motor. The best Aviation Motor on the market today for endurance, power and efficiency.

Illustration shows 50 H. P. Fox De Luxe Aero Motor 4 cylinders 4 $\frac{3}{4}$ x4 $\frac{1}{4}$ , with Bosch Magneto and Propeller.

We build other sizes Write today for catalogue

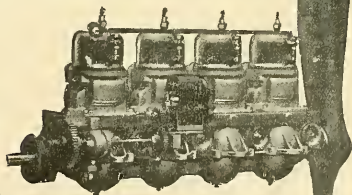

50 H. P. Fox De Luxe Aero Motor

### Expert Report on Fox Aero Motor Endurance Test

Lieutenant John Rodgers, U. S. N., detailed for Aviation, writes on April 9, 1911:

"After witnessing a six-hour run during which time the engine maintained a speed of between 1,000 and 3,000 R. P. M., I shut down the Fox De Luxe Motor (shown in cut). At the end of the run the motor was cool and in good condition, ready to start again."

FOR DETAILS, SIZES AND PRICES WRITE

## THE DEAN MFG. CO.

225 Front Street, Newport, Ky.



# Hall-Scott Aviation Power Plants

OVER TWO YEARS OF PROVEN SUCCESS



Lincoln Beachey and H. F. Kearney in speed race at Los Angeles International Meet

**D**URING the past year of 1911, there were more professional and amateur airmen flying with HALL-SCOTT equipment than with any other make of aviation power plant.

HALL-SCOTT AVIATION POWER PLANTS are now entering upon their third year of success. They were successful from the start, being built upon the right principles of design and of the best materials obtainable. A HALL-SCOTT motor never grows old. If the HALL-SCOTT COMPANY make any improvements during the year, they supply the new parts free of charge to all of their customers.

The HALL-SCOTT COMPANY were the first to arrange for the cooling of the oil in the crank case, by pumping same through the intake manifold dome, thereby not only cooling the oil but also heating the manifold, an assurance against freezing of the carburetor at any altitude.

Over 50 per cent. of the aviators actually taking part in the Los Angeles International Meet used Hall-Scott Equipment, a positive proof of the popularity of that equipment, among all classes of aviators both amateur and professional.

Write today for pamphlet describing in detail results obtained with HALL-SCOTT EQUIPMENT at the Los Angeles International Meet.

**HALL-SCOTT MOTOR CAR COMPANY,**

**San Francisco, California**

# \$100 Reward

*Will be paid to the person who first brings  
to our notice the town and site on  
which we finally locate*

## **FACTORY SITE WANTED**

The AERIAL CONSTRUCTION COMPANY of New York having outgrown its present quarters at 42, 48 and 58 West 43d Street, and anticipating the increased volume of business it will have to look after in the future, has decided to erect an up-to-date factory, with aviation school and flying field at some spot in the United States, suitable for the purpose.

### **WHAT WE WANT**

*First*—A good live town that is looking for a reliable manufacturing concern to locate in the vicinity and where the business men are willing to aid in the establishment of a permanent industry in their territory.

*Second*—A good level stretch of land over which the students of our school may learn to fly. Preferably with water frontage for Hydroaeroplaning.

Write submitting plans and full details of what you have to offer.

**LATEST STYLE MONOPLANES AND PROPELLERS IN STOCK  
READY FOR IMMEDIATE DELIVERY**

**Aerial Construction Company**

OF NEW YORK

**42, 48 and 58 West 43d Street**

**New York, N. Y.**

# The Supreme Test

## DURATION

Won by Cooke at the Los Angeles Meet

## With a Roberts 4-X Motor

18 Hours, 5 Minutes, out of a possible 22½ Hours

Six Days out of Nine, in the air total official time 2½ Hours each day



WELDON B. COOKE, "The Marathon Winner of the Air."

Cooke prefers the Roberts Motor to any other because of its simplicity and absolute reliability. His Roberts Motor carried him twice over Mt. Tamalpais in Marin County, California, at an altitude of 4,500 feet. It has stood every test required of it and is better today than ever before. It is the lightest 50 H. P. made in America.

**The Roberts Motor Co.,** 1463 COLUMBUS AVENUE  
SANDUSKY, OHIO, U. S. A.

# AIRCRAFT

Vol. 3 No. 2

APRIL, 1912

15 Cents a Copy



New Curtiss School Biplane fitted with twin steering wheels, which enable the pilot to instruct the pupil and still retain control of the machine at all times

# GIBSON

We have consistently refrained from any attempt to persuade the public by mere argument and advertisement that **our propellers are the best.** That method never lives.

We have consistently **refused to build** propellers for the purpose of producing a **high thrust when anchored** to the ground. We know that such a propeller will tend to keep the would-be flyer on the ground. It fools him by an appearance of value.

We know that a propeller must be built to give maximum thrust when **in flight.** We proved it. We are the only concern in America to make an exhaustive series of tests at the only propeller testing plant in America--that of the Worcester Polytechnic Institute. Those tests were made under flying conditions.

We found that **our propellers, designed for flying,** gave under flying conditions **30 per cent. more thrust per horsepower** than those whose only merit is the great thrust they will show on a scale anchored to the ground.

That is why Beatty conquered every other Wright machine--he had our propellers.

We want to do as well for you--to help you fly--to discuss the subject with you and submit to you Prof. Gallup's curves of actual results obtained at flying speeds. It costs you nothing to confirm this. We feel sure that you really want to have this valuable data in your possession.

Let us have your inquiry. We will send you "Proof by Test" by return mail.

**GIBSON PROPELLER COMPANY,** 197th St. and Amsterdam Ave., New York City

'Phone 6762 Audubon

## PROPELLERS

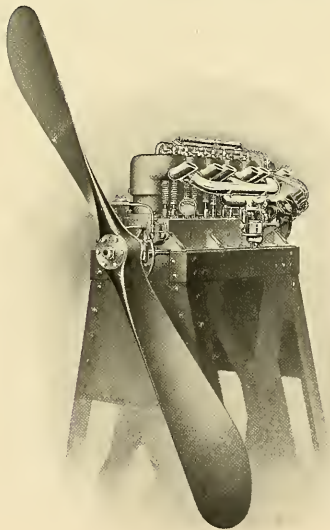

### Sturtevant

#### AERONAUTICAL MOTORS

AND

#### PROPELLERS

4 Cylinders 40 H. P. 6 Cylinders 60 H. P.

Four Cycle — Water cooled — Weight complete 200 and 285 pounds

Positive lubrication for any length of time.

No hand oiling — No grease cups.

Valves instantly removable.

No push rods — No rocker arms.

All gears enclosed.

Mea Magneto.

Exhaust valve lifters allowing motor to coast in the air.

Muffler furnished if desired.

Can be throttled to 300 R. P. M.

**Rigid Construction for Long Life and Continuous Service**

*Send for Catalog 200-A Sturtevant Engineering Series*

## B. F. STURTEVANT COMPANY

:: :: MAIN OFFICE AND WORKS :: ::  
HYDE PARK, BOSTON, MASS.

OFFICES IN ALL LARGE CITIES

# THE CURTISS HYDROAEROPLANE

Was the **FIRST** and is now, the only successful machine of the sort in the world

It has been officially recognized as representing the greatest advance in aviation in the year 1911 — and that year furnished many marvelous things in aviation.

It has been aptly described by a well-known magazine as

**“The Acme of Ease, Safety, Comfort and Exhilaration”**

*It is  
Motor Boat  
plus the  
ability to  
fly*

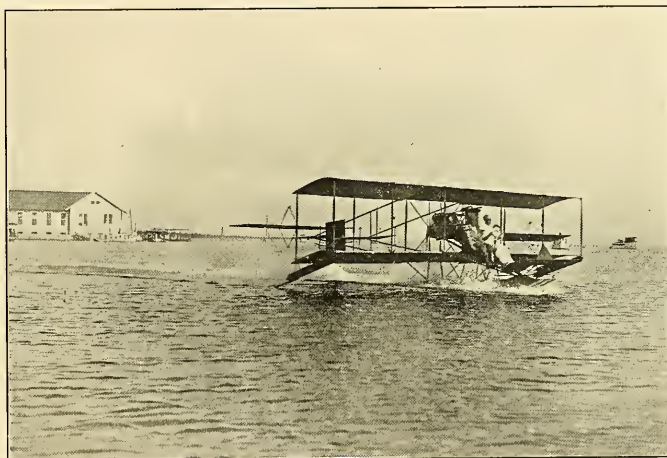

*It has  
been widely  
imitated  
but never  
equaled*

“Hydroaeroplaning” is the coming sport! It appeals to **everybody** interested in Flying **and** Sailing.

The Curtiss “Triad” is as Safe as a Power Launch and as Swift as a Sea Gull.

The season of water sports is near at hand! Get your “Hydro” now and be ready to carry passengers, to race Motor Boats, to give Exhibitions and to demonstrate in other ways that **the age of practical aviation has arrived.**

**THE CURTISS HYDRO MAKES IT SAFE FOR EVERYBODY TO FLY**

:: :: *For our 1912 Catalogue, with prices and particulars on* :: ::  
*CURTISS Aeroplanes and Hydroaeroplanes, Motors, Schools and Exhibitions, write to*

## THE CURTISS EXHIBITION CO.

1737 BROADWAY

JEROME FANCIULLI, General Manager

NEW YORK CITY

Sales Agents and Foreign Representatives for The Curtiss Aeroplane Co., Hammondsport, N. Y.

# **“KIRKHAM” Aviation Power Plants**

FOR SEASON OF 1912



MODEL B-6 INSTALLED IN BURGESS HYDROAEROPLANE

## *The “KIRKHAM” Aviation Motor is Offered in Four Different Models*

Model B-4, 35 H. P., 4-cyl., weight, 185 lbs.

Model B-6, 50 H. P., 6-cyl., weight, 235 lbs.

Model B-G-6, 70 H. P., 6-cyl., weight, 255 lbs.

Model B-12, 120 H. P., 12-cyl., weight, 400 lbs., V. type.

All of these models are sold as complete power plants or motor only, as desired. Also all models can be furnished with manifolds and mufflers, and push button self-starters, at small extra cost.

**T**HE universal success of every 6-cylinder, 50 H. P. **KIRKHAM** Motor for the season of 1911 demonstrated their unquestionable reliability and efficiency, therefore, the new models listed above contain not only all the features which have made the **KIRKHAM** Aviation Motor noted for its reliability, but in addition, all models for 1912 are to be equipped with the new Bosch 2-spark magneto, larger valves and special cooling tubes through oil tank, whereby the oil is always at a safe temperature, no matter how hard or how long the motor is run.

**KIRKHAM** Aviation Motors are endorsed by every owner, and not one of the sixteen motors delivered in 1911 has changed hands, but on the other hand, they have replaced one or more of nearly every other American motor. The latest converts are Nels J. Nelson, of New Britain, Conn., and the Burgess Company & Curtis, of Marblehead, Mass., who have adopted the **KIRKHAM** Motor as standard power for 1912. The test installation is shown by above cut.

There is a reason why all these people pay the price to get **KIRKHAM** Motors, and you should get posted on the *ONE AMERICAN MOTOR*. Catalog for the asking.

# **CHARLES B. KIRKHAM, Manufacturer**

SAVONA, N. Y.





## BALLOONS NOW BUILT AT HOME

**Efficient Goodyear Balloon Making Facilities Banish Need of Buying Abroad  
Big Saving of Time and Money. Quality Unequaled**

If in the market for a BALLOON, don't buy elsewhere until first consulting with us. We are the largest plant in America manufacturing Balloon fabric and Balloons complete, dirigible or spherical. We make them complete for all purposes, advertising, exhibition, or for co-operation between cities. Our Balloon cloth is made of silk or cotton **rubberized**. We recommend more strongly the latter because of its unequalled endurance. Coated with fine Para gum, Goodyear Fabric will not crack when rolled or folded. Prompt deliveries—**GUARANTEED QUALITY—DUTIES SAVED.** Write us for samples of cloth.

**GOOD YEAR**  
Rubberized Aeroplane Fabric

### Only Weather-Proof Fabric Used by all Veteran Aviators

This fabric—**RUBBERIZED**—is heat, cold, and damp **PROOF**. It can't shrink, can't stretch, can't mildew, rot, or weaken. It is the strongest, most reliable fabric made. And it is **FAST** and **safe**. All due to the special rubberizing process which **IMPREGNATES** every thread with **RUBBER** and renders it positively unaffected by all degrees of humidity and change of temperature.

Used by Rodgers, Ovington, Atwood, Fowler and Brookings;—by the Wright Co., Burgess Co. & Curtis, The Curtiss Aeroplane Co., Glenn S. Martin, Moisant, Int. Aviators and practically every other aviator and manufacturer of note.

### Tires That Won't Wrench Off Safest--Strongest--Most Economical

**GOOD YEAR**  
Detachable Aeroplane Tires

Dangers of landing are minimized by Goodyear Detachable Aeroplane Tires. This Aeroplane tire is built like the No-Rim-Cut Tire. Clings to rim in a grip that will resist the severest wrench upon landing.

Our **SINGLE TUBE TIRES** built with valve protected with **METAL**. Valve **CAN'T TEAR LOOSE**.

Our **20x4 CLINCHERS** most popular for rigid machines. Used on Curtiss Aeroplanes. Extensible Rubber Beads.

**ALL AMERICAN AND FOREIGN MADE MACHINES FITTED.**

**GOOD YEAR**  
Aeroplane Springs

### Bleriot Type Rubber Shock Absorbers for Monoplanes

We are the sole American manufacturers of the Bleriot Type Rubber Shock Absorber—the only successful spring for monoplanes. These springs are strong and resilient. Unlike steel springs they can neither catch in the tubes nor snap in cold weather. We make all kinds of springs. Ask us about them.

**WRITE TO-DAY FOR DETAILED INFORMATION**

**THE GOODYEAR TIRE & RUBBER COMPANY**  
**AKRON, OHIO**

*Branches and Agencies in 103 Principal Cities*  
*We make all kinds of Rubber Tires and Accessories*

# AMERICAN AEROPLANE SUPPLY HOUSE

Manufacturers of

# BLERIOT MONOPLANES

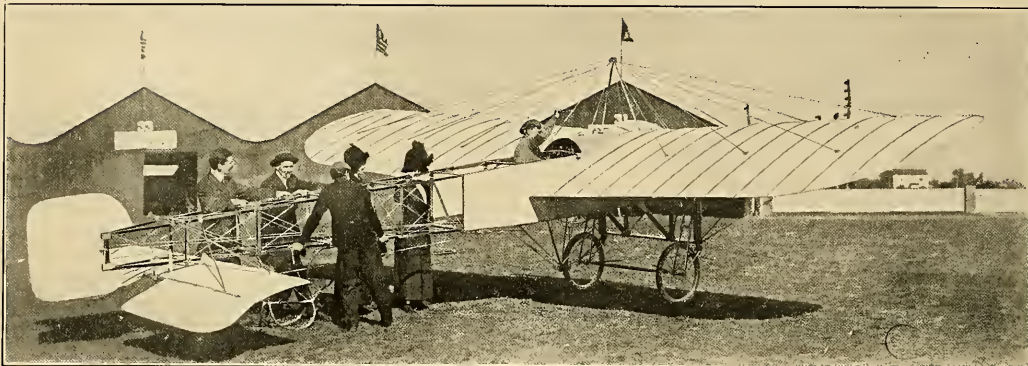

One of our BLERIOT TYPE MONOPLANES equipped with 70 H.P. Gnome Engine about to make flight at Nassau Boulevard  
 IMMEDIATE DELIVERIES 3 MODELS Send for 1912 Catalog  
 SINGLE SEATERS PASSENGER CARRYING MONOPLANES RACING MONOPLANES

Visit our factory and examine in detail the excellent construction of our Monoplanes

**AMERICAN AEROPLANE SUPPLY HOUSE**  
 137-143 JACKSON STREET Telephone 427 Hempstead HEMPSTEAD, L. I., N. Y.

## Paragon Propellers Excel



Patented March 14, 1911; July 25, 1911; October 17, 1911; Others Pending.

PARAGON blades are harmoniously designed without excess materials and without weak spots.

Our usual construction of quartered white oak with edge grain silver spruce interior is the very climax of propeller construction. There is a story of superiority in every detail from hub to tip.

The blades exactly correspond in pitch at every point. We select the wood so that the grain runs the same and the pitch stays the same. We guarantee it within one per cent. This is only possible by our patented construction. No other propeller will do it. In others the grain of the wood is opposite; one blade warps up or the other warps down. Sometimes there is a foot of difference in the pitch. Ours are **made** right and they **stay** right.

Paragon propellers are exclusive in their design, construction and processes of manufacture. They are made under the protection of numerous United States patents which recognize and protect their superior features.

There is in every blade a grace and beauty which bespeaks its solid worth. There are none others like them. Paragon **strength**, Paragon **beauty**, Paragon **efficiency** cannot be obtained under any other name.

We have designs in endless variety; we can make anything that **has been** or **can be** made.

Remember our Consultation Department is always available, without charge, for competent advice as to speed, power, pitch, thrust and power-plant problems in general. It is a pleasure for us to correspond on technical matters with all who are earnestly striving for the advancement of the flying art.

Our illustrated booklet will interest you. Shall we send it?

**American Propeller Company :: :: Washington, D. C.**



HUGH ROBINSON DEMONSTRATING PAULHAN'S CURTISS HYDROAEROPLANE BEFORE THE FRENCH AND RUSSIAN MILITARY OFFICIALS AT NICE, FRANCE. AS A RESULT OF THESE EXHIBITIONS THE RUSSIAN GOVERNMENT HAS ORDERED THREE HYDROAEROPLANES FROM THE CURTISS COMPANY.

**CONTENTS---APRIL, 1912**

Don't Go to France to Learn to Fly . . . . .	Earle L. Ovington	39
The Patent Situation . . . . .	Denys P. Myers	40
United States Army Aviation Service . . . . .		41
Editorial . . . . .	Alfred W. Lawson	42
Foreign News . . . . .		45
Correspondence . . . . .		47
Letter from the Wright Brothers . . . . .		47
Sturtevant Aeronautical Motor . . . . .		48
The Dornier Monoplane . . . . .	Walter H. Phipps	48
Drawings Dornier Monoplane . . . . .		49
General News . . . . .	D. E. Ball	50
California News . . . . .	Ernest Ohrt	50
The Trade . . . . .		53

**AIRCRAFT**

ALFRED W. LAWSON  
*President and Treasurer*  
 ERNEST C. LANDGRAF  
*Secretary*

**Published Monthly by The Lawson Publishing Company**  
 37-39 EAST 28th STREET, NEW YORK, U. S. A.  
 Telephone, 5017 Madison Square

ALFRED W. LAWSON  
*Editor*  
 WALTER H. PHIPPS  
*Asst. Editor*

**TERMS TO SUBSCRIBERS**

In the United States, Mexico, Puerto Rico, Guam, Philippine Islands, Hawaiian Islands, Cuba (including Postage), \$1.50 per year.  
 Fifteen Cents the Copy, of All News Dealers.  
 Foreign Subscriptions, Two Dollars per year.  
 In changing order give old as well as new address.  
 Advertising copy must be in hand by the 1st of month previous to date of publication.  
 Only high-grade advertisements of thoroughly reliable firms are solicited.

**WHEN YOUR SUBSCRIPTION EXPIRES**

One month before a subscription expires we enclose a renewal blank on which you will write your order for the renewal.  
 WHEN FIRST NOTIFIED that your subscription will expire, you should send your renewal AT ONCE, in order not to miss a number. New subscriptions which are received by us on or before the 15th of any month will begin with the issue of that month. If received after that date they will begin with the following month's issue. We cannot enter subscriptions to begin with back numbers. One month's notice is necessary before a change of address can be made.

Entered as "second-class matter" February 18, 1910, at the Post Office, at New York, N. Y., under Act of March 3, 1879.  
 Copyright, 1912, by the Lawson Publishing Co.  
 "Aircraft" is registered as a trade-mark by the U. S. Patent Office, under date of August 9th, 1910.

# OUR CUSTOMERS ARE OUR REFERENCES

W  
H  
A  
T  
  
T  
H  
E  
Y  
  
S  
A  
Y:

HOWARD LINN PRES

ARTHUR ORR VICE-PRES

W SCOTT LINN SECY &amp; TREAS

## NATIONAL AEROPLANE COMPANY

OPERATING THE

### NATIONAL SCHOOL OF AVIATION

2023 MICHIGAN AVENUE

Phone Columbus 2004

Galveston, Tex. March 2nd, '12.  
CHICAGO, ILL.,

MANUFACTURERS OF  
AEROPLANES PROPELLERS  
PIES BEAMS STRUTS  
TURNBUCKLES TERMINALS  
SPIKE THIMBLES CONTROLS  
OUTRIGGERS CONNECTIONS  
CHASSIS

AGENTS FOR  
MOTORS WHEELS TIRES  
CLOTH CABLE ETC

BLUE PRINTS  
MODELS

EXHIBITIONS ARRANGED FOR

Aeropl. Motors & Equipment Co.,  
1780 Broadway, New York City, N.Y.

Gentlemen:--

We are in receipt of your telegram of Feb. 23rd, stating that you were expressing our order of the day before for Gnome parts. We wish to appreciate and congratulate you upon this service which is the most efficient we have received from any source since we have been in the aeroplane business. Furthermore, we do not know of any other concern in this country that could have filled the order at all. We wired you another order last night and trust that it will receive the same attention.

As requested we gave you the address of our Paris representative, the extent of his purchases will be controlled by his own judgment, and we would appreciate the cooperation of your Paris office.

Very Truly Yours,

National Aeroplans Co.,

By 

Not Confidential.

A  
T  
Y  
O  
U  
R  
  
S  
E  
R  
V  
I  
C  
E

# GNOME

50 H. P.

70 H. P.

100 H. P.

140 H. P.

## IN STOCK AT NEW YORK

We carry also IN STOCK a Complete Line of Spare Parts at the Service of our Customers

## AEROPLANE MOTORS EQUIPMENT COMPANY

1780 BROADWAY

NEW YORK

Telephone 1335 Columbus

# AIRCRAFT

Vol. 3. No. 2

NEW YORK, APRIL, 1912

15 CENTS A COPY  
\$1.50 A YEAR

## DON'T GO TO FRANCE TO LEARN TO FLY

By Earle L. Ovington

**F**T seems to be generally accepted as an axiom that if one is to become the most expert aviator in the shortest possible time he should go to France for his instruction. I was of that opinion at the Belmont Park two years ago and in fact at that time I perhaps took the best course by going abroad.

During the last season, however, the instruction courses in the best aviation schools have been so much improved that now one can learn the art of man-flight in this country more easily and at a less expense than by going to Europe. I graduated from the Blériot School at Pau, in the southern part of France, and yet to many who have inquired regarding instruction in aviation I have given the advice heading this article.

I have assumed that the would-be aviator wishes to fly a biplane, which is distinctly an American product. Of course, if a monoplane, which is particularly a French product and original design, is chosen that alters the case somewhat, although during the past year several American companies have been building very creditable monoplanes, in fact there are now several companies having factories within a few miles of New York who construct just as good monoplanes as are made in France, but unquestionably France holds the lead in monoplane construction to-day and naturally has a good many very big schools for monoplane instruction.

The largest number of pupils is turned out by Blériot either from his summer school, just outside of Paris, or from his winter school at Pau, in the southern part of France, where I took my first hop on a single deck machine.

The Farman School at Etampes is the next largest foreign aviation school, but the biplane has not met with the favor accorded the monoplane in France and probably for that reason the Farman school is not as well patronized as that of Blériot. All of the leading constructors, of course, have their own flying school. The aviation schools in connection with the Nieuport, Deperdussin, Morane, Hanriot and Antoinette are most complete in their equipment.

The schools in England pattern very much after the French ones and the English machines are largely copies of the French models. The English schools, however, offer nothing but what can be obtained in America.

Personally I am of the opinion that the immediate future of the aeroplane rests very largely in the development of the hydro-aeroplane, which, as a loyal American, I am proud to say is distinctly an American invention. To be sure, a Frenchman was the first to experiment with hydroplanes, but it was not until Curtiss evolved his wonderfully efficient machine, that arising from and alighting upon the water was a proved success.

Great advances in instruction methods were made during the flying season of 1911 and reliable aviation schools were estab-

lished at all the large aerodromes in America. During the winter these schools have perfected their organization and are planning an active campaign for the season of 1912. He who desires to soar amongst the clouds, therefore, will be afforded ample opportunity for obtaining the required instruction right here in this country without the necessity of spending time and money incident to a trip across the ocean.

I think that all schools, whether American or foreign, could be greatly improved by including in their course of instruction not only practical work on the ground and in the air, but by giving the student in addition a thorough course in the theoretical principles underlying aero-dynamic flight.

In the early days of the aeroplane when the principal desire was to turn out flyers who could engage in exhibition work, and when the fundamental principles were not as well understood, there was possibly some excuse for neglecting the theoretical part of the subject, but now that flying has become more or less of a practical proposition, and the underlying theory well recognized, there is no longer the excuse for this neglect.

We would have far better aviators, and I am sure that the death list would be much reduced, if the embryo bird-men were given a thorough theoretical course of instruction in the fundamental principles of aeronautics before he was allowed to even get into a machine. There are many aviators today, and successful exhibition flyers, I mean, who really do not understand the elementary principles upon which the design and construction of their machine rests. However expert they may be in the manipulation of their control levers, I claim that they would be far better flyers if they knew more about the theory of the subject.

Comparing the foreign and the American schools I know as a matter of fact that the course of instruction in the schools abroad is not even as complete as it is in this country with regard to the theoretical instruction. At Blériot's School at Pau, for instance, they put a student directly into the machine without giving him any instruction whatever except in the actual manipulation of the levers, and keep him "grass cutting" until he becomes efficient enough to steer a straight course across the field. He is then given a machine with sufficient power to raise him from the ground, but not a word of instruction is imparted regarding the laws which make flight possible.

In America the preparation of the student for flight is a little better. He is not only told that by pulling a certain lever his machine is righted, but he is shown why this effect is produced.

In the French and English schools the aviator is placed in a machine alone when he receives his practical experience. In this country, on the other hand, he first takes several flights with an instructor in order to become used to the sensations of being in a machine during flight. He has an opportunity at this time

to observe carefully the manipulations of the control by an expert. After this information has been assimilated he is given an extra set of levers by means of which he can operate the aeroplane himself, but the instructor stands ready at all times to check a false move. This may be distinctly designated as the American method and is much better than the foreign method of putting the aviator in the machine by himself. Not only is the possibility of breakage much less with the American method but the danger to the student is almost entirely eliminated, since in the most modern machine the levers are so fixed that if the student makes a wrong move the instructor can take charge of affairs immediately and if in a panic the student tends to counteract the effect of the instructor's move, the instructor can take the control entirely from the student by a violent pull

at the control lever, which breaks the connection between the student's lever and his controlling wire.

As I have said at the beginning of this article—don't go to France to learn to fly. A year or two ago that might have been necessary, but now it is not only unnecessary but not even advisable. Much better instruction can be obtained in this country. Incidentally you are dealing with people who understand you and whom you can understand. Until you have tried it you cannot appreciate how inefficient is the instruction, where, owing to your lack of knowledge of the French language, you only get about three words out of ten, and have to ask all of your questions in such poor French that the instructors become disgusted with you and leave you to your own devices to get what instruction you may in the hard school of experience.

## THE PATENT SITUATION

By Denys P. Myers



AT the present time the decisions of the courts favorable to the Wright pioneer patents have been rendered against Paulhan, Curtiss, and, it is stated, Grahame-White in America, Robitsch in Germany, Société Antoinette, Blériot, Henry Farman, Farman frères, Clément-Bayard, Fernandez, Dufour et Bauer, Kœchlin, les Ateliers Vogsiens de la Société aéronautique de l'Est, R. Esnault-Pelterie, Compagnie Aérienne, Office d'aviation and la Banque Automobile in France. The Compagnie générale de Navigation aérienne, the French lessee of the Wright patents, failed in its suit against Santos-Dumont, who was made a defendant with the long list of other French manufacturers.

On the other hand, the suits against Paulhan and Curtiss (Herring-Curtiss Co.), in which the court granted preliminary injunctions, were reversed on appeal, so far as the order for injunction was concerned. The entire set of French cases was referred to experts for determination whether, as a matter of scientific fact, the alleged infringements were so mechanically. The Robitsch decision has not become available in this country. The Grahame-White decision, according to newspaper reports, is now dependent upon the determination of the extent to which the aviator's personal skill, as distinct from the mechanism of his machine, was responsible for his winnings. Also according to a newspaper report, the German Patents Court at Berlin has held that the Wright patent is invalid. This opinion is known not to be the outcome of the Robitsch case. The Wrights explain this decision by a technicality in the German law whereby a thing is not patented if it has been previously described (see the Wright Brothers' letter to AIRCRAFT, page 47—Editor); and add that their contrivance had been referred to in detail by a German lecturer in an academic address, their own connection with such an actual contrivance being, however, unsuspected by the speaker. The United States is primarily interested in the American and French patents, the latter affecting popular French machines.

At first sight, it appears from this review of the patent status that the courts everywhere have originally admitted the validity of the Wright pioneer invention, only to nullify the opinion by "ifs" and "buts;" yet that is not the case, if all the decisions in hand are interpreted correctly by the writer. The proper conclusion would seem to be that the decisions indicate that the pioneer patents, No. 821,393 in the United States and Nos. 342,188, 384,124 and 384,125 in France, are perfectly valid and enforceable patents but that the courts have balked at expressing a judgment on the extra-judicial question as to what extent—purely as a matter of mechanical and aeronautical fact—other contrivances of like or similar character obtaining, by and large, the same result, infringe, if they do infringe, upon the mechanism invented and patented by the Wrights.

Put into plain words, this statement, if correct, means: That

six years after the granting of letters patent to the Wright brothers in the United States and eight years after similar grant in France, neither the Wrights nor the rest of the aviation world know definitely where they are at, to use the colloquial phrase.

This is, of course, an unfortunate situation, and should be faced by the aeronautic world boldly. It is not the purpose of this article to make out a brief for or against the patents, nor to argue the pending cases out of court; but if the situation is as the writer sees it, there is need to consider it on the basis of reality and for aviation to progress on the conditions which the patent situation imposes.

Judge Hazel in the suit in equity by the Wright Company against the Herring-Curtiss Company et al., decided January 3, 1910, granted the motion for preliminary injunction in these words (177 Fed. Rep., 257 at 261):

"The requirements in patent causes for the issuance of an injunction *pendente lite*—the validity of the patent, general acquiescence by the public, and infringement by the defendants—are so reasonably clear that I believe it not improbable that complainant may succeed at final hearing, and therefore, the *status quo* should be preserved and a preliminary injunction granted."

In the same case on appeal to the Circuit Court of Appeals, Second Circuit, June 14, 1910, the court reversed this order (180 Fed. Rep., 111):

"The record before us contains numerous affidavits which were not presented until after original decision and which, as both sides state, were admitted upon motion for rehearing without discussion of their contents by the court, but for the purpose of bringing the case more fully before the Court of Appeals.

"In this record, upon the question of fact above stated, there is a sharp conflict of evidence, numerous affidavits testifying. All their statements are *ex parte* affidavits made without any opportunity to test their probative force by cross-examination. Under such circumstances, it seems to us, irrespective of any of the other questions in the case, that infringement was not so clearly established as to justify a preliminary injunction."

Studying the series of French cases before the Civil Tribunal of the Seine it is found that the Wright lessees sued the exhibitors at a show for infringement and were met by a cross-suit alleging nullity on account of divulgence. This they won, and secured decisions against all the defendants, except Santos-Dumont, whose machine was exhibited for historical reasons and not for present or future profit.

The decision of the Third Chamber of the Civil Tribunal of the Seine in the suit against Blériot, which is typical of all, says that three experts shall be appointed to study patents anterior to the Wrights and in case there were none to determine

(Continued on Page 48)

# UNITED STATES ARMY AVIATION SERVICE

Official Document Approved by the Secretary of War

The following "Qualifications for Military Aviators" and rules covering the "Physical Examination of Candidates for Aviation Duty" have been approved by the Secretary of War:

## QUALIFICATIONS FOR MILITARY AVIATORS.

Military aviators must be commissioned officers of the regular army or organized militia.

All officers who qualify as military aviators according to the conditions enumerated below will receive certificates from the Secretary of War covering such qualification and will be carried on the Army Register as "Military Aviators," with the date of qualification in each case.

To obtain such certificate the candidate must fulfill the following requirements:

1. Attain an altitude of at least 2,500 feet, recorded by a suitable barograph.

2. Make a cross-country flight of at least 20 miles (ten miles going and ten miles returning), at a minimum height of 1,000 feet.

3. Make a flight of at least five minutes' duration with the wind blowing at the rate of at least fifteen miles per hour (indicated by an anemometer).

4. Carry a passenger to a height of at least 500 feet and on landing come to rest within 150 feet of a previously designated point, the engine being completely cut off prior to touching the ground. The combined weight of passenger and pilot must be at least 250 pounds.

5. Execute a volplane from an altitude of at least 500 feet with the engine completely cut off, and cause the aeroplane to come to rest within 300 feet of a previously designated point on the ground.

6. Make a military reconnaissance flight of at least twenty miles for the purpose of observing and bringing back information concerning features of the ground or other matter which the candidate is instructed to report upon. This flight must be made at an average altitude of 1,500 feet.

The tests for "Military Aviators" will be conducted under the direction of the Chief Signal Officer of the Army, at such times and places, and before such Boards of Officers, as may be convenient. The names of officers who qualify and the date of such qualification will be reported to the Adjutant General of the Army.

## PHYSICAL EXAMINATION OF CANDIDATES FOR AVIATION DUTY.

All candidates for aviation duty shall be subjected to a rigorous physical examination to determine their fitness for such duty.

Examination as to physical qualifications will conform to the

standard required for recruits, except as stated below. The rules for the examination of recruits as published in G. O. 66, W. D., 1910, will be adhered to.

(Additional physical requirements and examination.)

The visual acuity without glasses should be normal. Any error of refraction requiring correction by glasses or any other cause diminishing acuity of vision below normal will be a cause for rejection. The candidate's ability to estimate distances should be tested. Color-blindness for red, green or violet is a cause for rejection.

The acuity of hearing should be carefully tested and the ears carefully examined with the aid of the speculum and mirror. Any diminution of the acuity of hearing below normal will be a cause for rejection. Any disease whatever of the middle ear, either acute or chronic, or any sclerosed condition of the ear drum resulting from a former acute condition will be cause for rejection. Any disease of the internal ear or of the auditory nerve will be a cause for rejection.

The following tests for equilibrium to detect otherwise obscure diseased conditions of the internal ear should be made:

1. Have the candidate stand with knees, heels and toes touching.

2. Have the candidate walk forward, backward, and in a circle.

3. Have the candidate hop around the room.

All these tests should be made with the eyes open, and then closed; on both feet, and then on one foot; hopping forward and backward, the candidate trying to hop or walk in a straight line. Any deviation to the right or left from the straight line or from the arc of the circle should be noted. Any persistent deviation, either to the right or left is evidence of a diseased condition of the internal ear, and nystagmus is also frequently associated with such condition. These symptoms, therefore, should be regarded as cause for rejection.

The organs of respiration and the circulatory system should be carefully examined. Any diseased condition of the circulatory system, either of the heart or arterial system, is a cause for rejection. Any disease of the nervous system is a cause for rejection.

The precision of the movements of the limbs should be especially carefully tested, following the order outlined in paragraph 17, G. O. 66, W. D., 1909.

Any candidate whose history may show that he is afflicted with chronic digestive disturbances, chronic constipation, or indigestion, or intestinal disorders tending to produce dizziness, headache, or to impair his vision, should be rejected.

### APPLICATION FOR DETAIL TO MILITARY AVIATION SERVICE.

Station .....

Date .....

THE ADJUTANT GENERAL,  
UNITED STATES ARMY,  
WASHINGTON, D. C.  
(Through Military Channels.)

Sir: The undersigned hereby applies for assignment to duty at the Signal Corps Aviation School for instruction as an aviator.

Name .....

Rank .....

Organization .....

Age.....

Weight (without clothes).....Lbs.

Married or Single.....

Graduate from Technical Schools or Colleges.....

Any particular knowledge or ability possessed by applicant which would especially fit him for aviation duty.....

If any experience in the following, so state:  
Gas engines; Practical Telegraphy (words per minute, receiving); Knowledge of Wireless Telegraphy; Practical Photography; Practical Topographical Work (map reading or map making).  
Surgeon's certificate of physical examination is inclosed, together with list of qualifications for military aviators.

Very respectfully,

.....

.....

.....

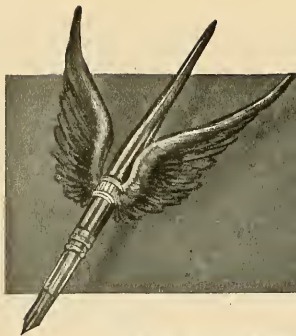

# EDITORIAL

## RAIN, NOT AIM BOMBS.



NE little drop of water falling from the clouds has a very small chance of hitting or wetting a fleet of battleships, or an inland fort, but—and but must always be taken into consideration in profound reasoning—if there are enough little drops of water falling from above, every inch of every battleship exposed, as well as every inch of the fort exposed, will not only be hit but literally drenched with water. Is not that a fact? Well, that is your answer to the near-sighted snail in the army or navy who says that the chances of hitting a ship or fort is very small, because an aeroplane will have to go up a distance of more than 3,000 feet, out of gun reach, in order to drop explosives, and at that distance the aim of the aviator would be useless.

Right here let us remind you that the rain drop is not aimed, it just falls and hits anything that happens to be under it, and as stated before when there are enough rain drops they hit about everything there is exposed to be hit. So it would be with aeroplanes—if there are enough of them—by circling over any given area for ten hours steadily and just dropping explosives without aim, their rain of them would come very near drenching whatever happens to be upon the area covered, whether it be battleships, forts, or houses of Parliament.

Five thousand aeroplanes—which can be built and operated at less cost than five battleships—drilled in manoeuvring with the same care and precision that is given to land brigades, could devastate any section a mile square within ten to twenty hours by concentrating their entire operations upon that particular section.

Each machine would simply have to fly about four thousand feet above the section bombarded, or even less in height, if painted the color of the sky, and thus made invisible as pointed out editorially in AIRCRAFT (volume 2, number 11), drop its 500 or more pounds of explosives and return to its base for another load, repeating the same operation over and over again.

Assuming that its base is thirty miles distant, and allowing two hours for each machine to return to its base and re-load, there would be forty-one (and a fraction) machines dropping their entire loads of explosives over that particular section every minute, and allowing

500 pounds for each load would make a shower of 20,500 pounds falling each minute, or 1,230,000 pounds per hour, or 12,300,000 pounds every ten hours, (including the fraction would make it 12,500,000).

There being 3,097,600 square yards to a mile, means that an average of about four pounds of explosives would be dropped to every square yard of surface every ten hours. We are of the opinion that under such operations, human habitation in that particular section whether upon land or sea would become untenable.

## A COMMERCIAL PRODUCT.

REPORTS available to our editorial staff show that Italy, Brazil, Turkey, Russia and Japan, as well as France, are buying aeroplanes for war purposes from French manufacturers, and it will not be long before every government in the world will be ready to buy aeroplanes for army and navy purposes.

We, therefore, think it is about time that the American capitalist awakened to the commercial possibilities of the aeronautical industry. We often hear people say that when the flying machine becomes a commercial product, that then they will invest both money and services in the industry. We would like to know, however, what the industry is to-day, if not a commercial proposition.

In France there are in the neighborhood of forty well equipped factories turning out flying machines which are being sold for either exhibition, recreation or war purposes. Is this not commercial? The fact of the matter is, France realizes that the aircraft industry is a commercial proposition NOW, and are deliberately running away from the rest of the world by recognizing this fact, and by foreseeing the great possibilities of the future in it. That is just why orders are pouring in to the French concerns from all the different governments now in the market for aeroplanes.

The world's market for aeroplanes is now open, and it is time the American went into this market to secure his full share of the business. Before he can do this, however, he must be able to compete with the Frenchman in turning out machines, both from their point of excellence in construction work, and in the number to be turned out, and this can only be done by having



well equipped factories and schools equal in standard to those in France.

The French are beginning to reap the reward of many years of toil and investment, and the American must understand that it is necessary for him to go through those same years of toil and investment before he can expect to compete with his French rival. However, the new market has just opened and a few years later business will be very brisk and competition very keen, so we advise the American builder to lay his plans very carefully and go into the movement with the idea of successfully competing with the foreign manufacturer in the future, when real rewards will be forthcoming. To be successful then, means preparation now. This country should have at least fifty aeroplane factories working over time to fill orders this year.

#### A FAMOUS PIONEER.

**T**HE Aero Club of America was extremely fortunate in securing such an able man as Cortlandt

Field Bishop to act as Secretary, even though it was but temporarily. When the time comes for a general summing up of the actual value of services contributed to the development of the aeronautical movement, the name of Bishop must naturally shine forth as an example of unselfish devotion to the cause in its earliest and neediest stages.

It is, of course, unnecessary to say that Mr. Bishop received no salary for performing the duties of secretary. He gave his most valuable time, and better still his vast knowledge of aeronautical affairs to the club gratis, and besides all this, also spent a great deal of his own personal funds in the performance of his duties.

It would take many pages to recount the many good deeds Cortlandt Field Bishop has to his credit for the promotion of aeronautics in America, as well as in Europe, and executed at times when there were no others willing to open their purses, nor to contribute their time and energies for the purpose. As the movement progresses and broadens in all its various branches and we become more and more elated over the success with which we are meeting, we must not, in the exuberance of our spirits forget those splendid pioneers who by their unselfish efforts, unshakable confidence and money expenditures made possible the ultimate success of aerial transportation toward which we all look forward. Mr. Bishop is one of these pioneers.

#### SAVING TIME.

**A**CCORDING to cable accounts, on March 8th, Henri Salmé flew from London to Paris, a distance of 222 miles, in 177 minutes without a stop. Mr. Salmé had some important business to transact in Paris and was of the opinion that the quickest way to get there was to fly, which he did in less than half the time he could have gone by the fastest railroad and steamboat service.

To go from London to Paris by the common route, one first has to wait for his train to start at London, and when he gets to Dover, move himself and baggage to a steamer, and then another delay is caused by another change when the steamer arrives at Calais and another transfer made to the railroad train.

There was a time when it took from two to three days to go from London to Paris. In those days they rode on stage coaches on land and sailing boats by water. Every few miles a stop had to be made to feed or change horses. The railroad and steamboat system which now takes six hours, therefore was a big time saver for the traveler, and consequently this saving of time is what naturally caused the railroad and steamboat to supersede the state coach and sailing vessel. So because the flying machine cuts in half the time now required by the railroad and steamboat, or with increased flying facilities making the distance in one-third or less time, the air vehicle will supersede the railroad and steamboat as a means of transportation between London and Paris just as the railroad and steamboat superceded the stage coach and sailing vessel.

But this will not happen in a day, nor a year. It will come so gradually that it will hardly be noticed.

#### PATRONIZE HOME INDUSTRIES.

**E**ARLE L. OVINGTON, one of America's leading airmen, in one of a series of articles which he is writing for AIRCRAFT, says that Americans should stay at home and learn to fly in American schools instead of going abroad.

We heartily endorse Mr. Ovington's suggestion for two good reasons: First, we believe that there are no better aeroplane schools in the world than those conducted by such concerns as The Wright Company, The Curtiss Company, The Burgess Company, and Curtis, The Milwaukee School of Aviation, and Stevens and Beatty, right here in America; and second, because we believe that it is good policy for the American to patronize home industries and thus help to build up in this country the source from which he expects to sooner or later derive, to a large extent, his profits.

The above mentioned schools by the way, are all biplane concerns. What is needed now in America are some first class monoplane schools to be in keeping with the finely constructed monoplanes now being turned out by some of our American manufacturers.

#### A PROGRESSIVE ORGANIZATION.

**I**N a large modern fire-proof building located at 250 West 54th Street, New York, may be found within a good-sized room on the eighth floor every second and fourth Thursday evenings of the month, between the hours of eight and eleven, a body of serious-minded men, congregated for the purpose of aeronautical discussion. This body is organized under the name of The Aeronautical Society and as such has been working quietly, but most energetically,

to advance the science of aeronautics in this country during the past three years.

This is not a social club, nor a commercial club, nor a political club, but just simply an aeronautical society with but one aim, and that to develop the aeronautical movement.

Here, will be found the aviator, both professional and amateur, who knows by practical experience what it is to guide a machine from the earth up into cloud-land and back again. It is not theory with him, it is practise, and he tells you first hand his actual experiences while navigating the air under all sorts of conditions.

Here, you will find the manufacturer, both big and little, the back-bone practically of the movement itself. This is the man who builds the machines without which the aviator could not go into the air. This is, the man who not only, as a constructor of machines, makes flying possible, but the man who invests his money in the industry as well.

Here, you will find the scientist, the man who goes into the laboratory and sifts out the causes and effects of things and through whose work the builder and aviator are enabled to both construct and fly their machines with the aid of the knowledge acquired and are therefore enabled to eliminate the obstacles which make failures and adopt methods which make successes.

Here, you will even find the sporting man who, while not particularly interested in the technical developments of aeronautics, is anxious to know at least the elementary principles of flight, and goes there to associate periodically with the practitioners who know.

A more democratic organization could not be found in the world. Here, the rich man hobnobs with the poor man and feels that he owes to the mechanic with whom he may have had an half hour's delightful chat a debt for the information received and the most gratifying intellectual treat derived therefrom.

In fact, men in all stages of life may be found at these meetings who have but one common object and that is aircraft. The absence of the club politician—so detrimental to the progress of many clubs—is most delightfully conspicuous. Here, there are no politicians. Every member is as good as every other member and is entitled to have a say in the general directing of the club's movements. There are no secrets of any kind to be withheld from anybody and therefore absolute harmony prevails.

We believe that every aeronautical man in the United States would be benefitted by attending these meetings and suggest that every one go there as often as possible. Form the habit if you live in New York, and if you do not then arrange your trips so that you will be in New York on meeting nights. These meetings are worth going hundreds of miles to attend and when you do attend them do not go there with the idea that you are helping The Aeronautical Society, but that The Aeronautical Society is helping you.

This organization is doing a great work. Become a member if you can.

---

#### EXHIBITION OPPORTUNITIES.

**P**ROFESSIONAL aviators should not overlook the chances of flying at the different motor boat races this year. We are of the opinion that wherever there are motor boat races a hydro-aeroplane should be exhibited, and we feel sure that the managers of such meets would be glad to make it worth the while of the hydro-aeroplane driver to fly his machine as an added attraction. It would be well to ascertain where the motor boat races—or yacht races for that matter—will take place this year and get into correspondence with the managers at as early a date as possible. It seems to us also, that wherever automobile races are held in closed circuits that races between the automobiles and aeroplanes would prove attractive features.

(Since the above was written we have learned that the Aero Club of Illinois are considering a proposition to combine their big aviation meet this year with the Chicago Yacht Carnival.)

---

#### FAST TRANSPORTATION.

Another region where an aeroplane taxi-service could be operated at a profit today, as suggested by Grover Cleveland Loening, is between Key West, Florida, and Havana, Cuba. The distance between these two points is about 100 miles and it requires about seven hours travel by boat. An aeroplane could make the trip easily within two hours, and if speeded in about one hour and thirty minutes. Since Flagler's new railroad has been completed, running as it does over a series of keys and concrete viaduct right into Key West, the time of travel between New York and Havana has been shortened considerably and now if Flagler, or anybody else for that matter, will add the aeroplane service from Key West to Havana then New York and Havana will be neighbors sure enough.

---

#### TOO VISIONARY.

**S**AID the Orang Outang to his brother-in-law about fifty thousand years B. C. (before Confucius): "The day will come when jackasses will be made to draw bob sleighs." "You are entirely too visionary," grunted the brother-in-law.

Said the jackass to his grandmother about one hundred years B. C.: "The day will come when railroad engines will be made to do the work we are now doing." "You are entirely too visionary," snorted the grandmother.

Said the boy to his father in the year of 1912 A. D.: "The day will come when aircraft will do the work the railroads are now doing." "You are entirely too visionary," quoth the father. And as it was, so it is and always will be.

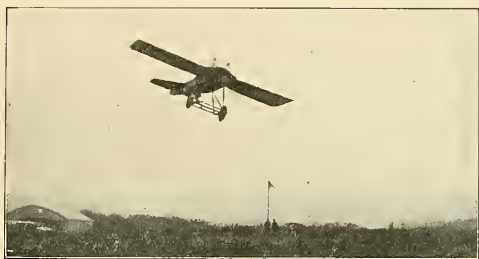

VEDRINES ON THE NEW 140 H. P. DEPERDUSSIN RACER BREAKING THE WORLD'S SPEED RECORDS.

# FOREIGN NEWS

## Belgium

King Albert of Belgium has conferred on Count de la Vaux the honor of a Chevalier of the Order of Leopold. Count de la Vaux is a well known authority on aeronautics and aerostatics in particular and was one of the founders of the Belgian Aero Club.

On February 17th, Lanser tested a military biplane at Kiewit, which has been entirely constructed in Belgium and fitted with a 40 horse power valveless engine. He subsequently made a flight with a passenger to Genck and back. The same day Paul Hancicot, on a Belgian-built Deperdussin, flew from Genck to Kiewit and back, via Hasselt, at a height of 4,500 feet.

## England

On February 27th it was announced that the estimates for the British Army for the year of 1912-1913, including both effective and non-effective services, aggregated \$1,550,000.

The money will be used to establish a large military aviation school with a full complement of aeroplanes and motors and all the workshops necessary to keep the machines in first class condition. The sum of \$800,000 will be spent on purchasing aircraft alone.

Messrs. Short Brothers, the well known English balloon and aeroplane makers, have just produced a new monoplane, which when given its first trials in the hands of Lieutenant Sanson proved itself a good flyer, and so added another monoplane to the rapidly growing list of English machines.

## LONDON-PARIS IN THREE HOURS.

On March 14th, M. Henri Salmet, the Bleriot instructor at Hendon, flew from London to Paris, about 222 miles, in 2 hr. 57 min. By this magnificent performance Salmet broke the non-stop record of M. Pierre Prier, his predecessor at Hendon, who took 3 hr. 59 min., for a longer route of 250 miles. Salmet beat the fastest passenger route from London to Paris by 3 hr. 44 min. He had an average speed of over 73 miles an hour.

## France

M. Millerand, the French Minister of War, has given out the following information concerning French military aviation in 1912. He states that five dirigibles are to be built and that the aviation section of the army will be divided up into "squadillas," of which there will probably be thirteen to start. A "squadrilla" will comprise eight aeroplanes, eleven or twelve automobiles, one traction engine, one exciting automobile and a repair car and van. By the end of the year there will probably be twenty-seven field and five Garrison "squadillas," with a total of 344 machines. Thirty aviation centres will also be established and fitted up. The flying regiment will be divided into seven companies, and will consist of 23 officer-pilots, 210 scouts, 42 mechanics, 110 officers, 1,600 sappers and 550 privates. M. Millerand states that the money already voted for aviation, \$2,400,000, would be insufficient, and he proposes to bring in a special bill setting aside a further \$2,200,000 for material and \$200,000 for personnel, making a total of \$4,800,000. Next year's expenditure will probably amount to \$5,000,000. It is also proposed to add \$500,000 to the \$1,000,000 already provided for aerostations (balloons and dirigibles). M. Delcasse, Minister of Marine, stated that a special machine was being tested for the Navy.

The French Navy recently took delivery of a Voisin hydro-aeroplane, and experiments are being carried out with it by Lieutenant Cayla and Commandant Daviley at Lannes d'Hyeres.

Cordon Bell, the English R. E. P. pilot, has been conducting experiments at Buc recently with one of the new R. E. P. monoplanes fitted with a seven cylinder 70 horse power radial R. E. P. motor. In all its tests the new motor performed excellently and enabled the machine to climb very rapidly.

Henry Farman has constructed a hydro-aeroplane which is now undergoing tests at Buc in the hands of Cayla, preparatory to being sent to Nice to compete with the Curtiss. Up to the time of

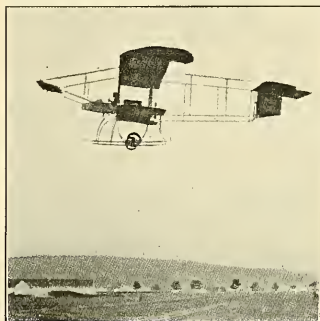

ADOLPH WARCHALOWSKI, FORMER HOLDER OF THE WORLD'S THREE PASSENGER RECORD, IN FLIGHT ON HIS AUSTRIAN BUILT VINDOBONA BIPLANE. NOTE THE FLEXIBLE WING TIPS AND ARCH-SKID SUPPORTS.

writing no details concerning this machine have come to hand, and it is not known how successful it is. Further trials will be awaited with interest.

A prize of 10,000 francs (\$2,000) has been offered by the Peugeot firm for a ten metre flight by a man without using mechanical power.

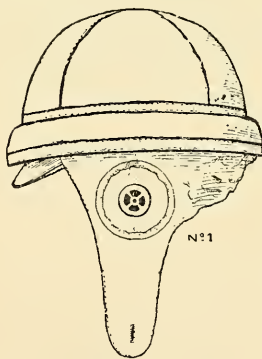

THE ROOLD SAFETY HELMET, INVENTED BY M. GOUTTES, WHICH RECEIVED THE HIGHEST AWARD FOR SAFETY APPLIANCES AT THE CONCOURS DE SECURITE DE LA LIGUE NATIONALE AERIENNE AT PARIS.

Lieuts. Battini, Chentini, Varcini, Leclercq, Groville and Marzac established something of a record for passenger carrying at St. Cyr. On February 15th, forty-five officers and fifteen cadets from the superior Military School visited the aerodrome and each was taken for a trip by one

or the other of the above aviators, and on the following day an equal number of officers and cadets visited the field and were taken for trips, which makes one hundred and twenty passenger carrying flights in two days without the slightest accident, an accomplishment which clearly shows the safety of flying when no spectacular stunts are indulged in.

## SPEED RECORDS.

On February 22nd, at Pau, Vedrines set out on his 140 horse power Deperdussin to break the world's speed record, and succeeded in establishing new records up to 200 kilometres. Vedrines' speed for his fastest lap works out at 169 k. p. h., or 105 miles and a half per hour, or 20 kilometres better than Bathiat's best speed. We append herewith a table showing the new and the old figures:

Kiloms.	New Records.		Old Records.			
	H. M.	S.	H. M.	S.		
50	0	19	3	4	5 (Bathiat)	
100	0	37	58	2	5 (Bathiat)	
150	0	56	41	2	3	5 (Vedrines)
200	1	15	20	4	5 (Vedrines)	
Hour.	Kiloms.		Kiloms.			
1/4	39/303		35		(Vedrines)	
1/2	79/303		70		(Vedrines)	
1	159/303		142/43		(Vedrines)	

On February 15th, at Compiegne, Guinard was flying for an hour and ten minutes on his Clement-Bayard machine, two pictures of which we published in No. 1, volume 3, page 13, during which time he flew over the surrounding country and also circled the cathedral. In the evening he made several fine passenger flights.

Those of our readers who take a deep interest in aviation will be glad to hear of the reappearance of the Tellier monoplane, which it will be remembered gave such a good account of itself about a year ago in the hands of Emile Dubonnet, but which for some unexplained reason was little heard of after Dubonnet gave up aeroplaning.

On February 15, at St. Omer, Marc Poupet made a flight of over an hour in a new machine fitted with a Ciennu motor, during the course of which he flew over the town and altogether proved the worth of this splendid monoplane.

On February 17th, with Paulhan at the wheel, the Curtiss hydro-aeroplane flew from Juan les Pins to Cannes and back, and during the 40 minutes flight it manoeuvred above the torpedo flotilla. A second trip to Cannes was made by Paulhan with his mechanic as passenger, this time only 20 minutes being taken. In a third trip the passenger was a lady. On the previous day Dubonnet had piloted the machine over to Cannes, and landed in the harbor, afterwards returning to Nice.

Testing the Paulhan-Tatin torpedo monoplane at Rheims on February 17th, Chambenois, who had only made one previous flight upon it, covered 10 kilometres, in a closed circuit at a height of 150 metres at a speed of 140 kiloms. an hour. This was not officially timed, however. On the following day he flew 12 kiloms. at a speed which was said to be 150 kiloms. an hour.

## RECORD FLIGHT.

On February 24th, at Pau, Maurice Tabuteau broke the world's record for two hours' flight by covering a distance of 227 kilometres 454 metres (141 1/2 miles).

## The Roold Safety Helmet

The highest award in the class for aviators' safety appliances at the Concours de Sécurité de la Ligue Nationale Aérienne at Paris was a medal which was won by M. Gouttes, 50 Avenue de la Grande Armée, inventor of the Roold safety-helmet.

As can be noticed in the accompanying drawing, the Roold helmet has the appearance of a modified colonial hat and is made of cork, rubber, padding and leather in such a manner as to protect an aviator's head. There is a space between the outer and inner sections of the helmet which is



THE PARSEVAL DIRIGIBLE MAKING A NIGHT FLIGHT OVER BERLIN FOR THE PURPOSE OF DISPLAYING AN ADVERTISEMENT AS WELL AS CARRYING PASSENGERS.

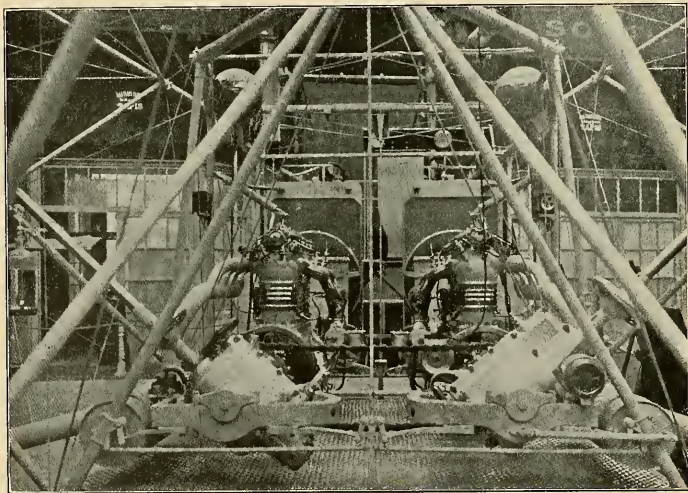

THE ENGINE SECTION OF THE CAR OF THE CLEMENT-BAYARD DIRIGIBLE SHOWING THE TWO INTERCONNECTED MOTORS AND THE GEAR AND SHAFT TRANSMISSION TO THE PROPELLERS. NOTE THE MOUNTING OF THE MOTORS ON LEAF SPRINGS TO RELIEVE THE FRAME OF VIBRATION.

thickly padded with what is termed "fibre metalique," an elastic padding which absorbs the shocks and prevents injury to the skull.

Many fatal accidents have been avoided by the use of these helmets and many testimonials have been written in their praise. Aviators Deletang, chief pilot of the Clement-Bayard firm; Lieut. Ludman, officer aviator; Frey, Tabuteau, d'Hessel and others testifying to having had falls from heights of 60 metres or less and landing on their heads without receiving serious injury, owing to the protection afforded by the Rood helmets.

#### CROSS-COUNTRY FLYING AT RATE OF 101 MILES AN HOUR.

On March 11th Maurice Tabuteau on a Morane-Saulnier monoplane flew from Pau to the Villacoublay aerodrome, Paris, with one stop at Poitiers for luncheon. He covered the total distance of 720 kilometres (447 miles) in five hours. The first stage of the journey from Pau to Poitiers, 261 miles, was covered in 2 hours 35 minutes, or at a rate of approximately 101 miles an hour.

#### Germany

On February 19th, Fokker, using his monoplane fitted with automatic lateral stability, rose to a height of 7,000 feet at the Johannisthal aviation field and flew for some time. As the Fokker

machine is one of the most interesting developments in aviation and as it is attracting considerable attention abroad, we feel sure the following data will be of interest.

The Fokker monoplane has a length of 8 metres and a spread of 11 metres; the wings are rigidly attached to the fuselage and have no provision for warping or ailerons. They are covered only on one side and have a chord of 2 metres, the total carrying surface being 22 square metres. The two wings attach to the fuselage at a very pronounced obtuse angle.

The tail and rudder structure is flexible and resembles that of the Etrich-Rumpler monoplanes and Albatross biplanes. The motor used at the start was a 50 horse power Argus, but this has now been changed to a 70 horse power Argus. It is placed very high with the pilot and his passenger in back and below it. Steel tubing is used throughout, and the machine rests on a large and strong chassis, which is fitted with two wheels.

The control is very simple. A lever works the elevator, while the steering is done by pedals. The transversal stability is automatic and is produced by the peculiar form of the wings and the very pronounced V at which they set and the relatively high position of the centre of gravity.

On February 9th Lieutenant Barend, accompanied by Lieutenant Schmetz on his Rumpler monoplane, made a fine flight from Doberzeit at Hamburg, a distance of 130 miles, in 2 hours and

one-half. The return journey was made two days later with one stop at Ludwigshist.

#### WORLD'S RECORD FOR FLIGHT WITH AVIATOR AND FOUR PASSENGERS.

On March 8th, at Johannisthal, Hoffmann on a monoplane flew for 32 minutes 33 seconds with four passengers, establishing a new world's record for a flight with four passengers.

On February 23rd the German Patent Office invalidated the basic feature of the German Wright patents in regard to the simultaneous action of the rudder and warping.

The suit, which was in progress for a long time, was brought by five German firms. The court upheld two specific forms of patent combining the steering and warping, but disallowed the general claim. The judgment is, however, open to appeal before the Imperial Supreme Court at Leipzig.

L. Z. II, the new Zeppelin airship, will be sent up to Frankfort-on-Maine as soon as it is ready. It is proposed to carry out regular trips in the summer-time, going as far as the German North Sea watering places.

The German aerial cruiser Suchard, destined to cross the Atlantic, is being mounted in the Parseval hangar at Berlin-Johannisthal. The huge gondola, which contains motor and screw, has been hung up, but it was not possible to begin with inflation up to the time of writing, owing to the excessive cold reigning in North Germany.

On the occasion of his birthday on January 27th, the German Emperor made a grant of 50,000 marks for a competition for the best aerial motor, the award to be made personally on his next birthday. His Majesty, who gives a renewed proof of his great interest in all aeronautical matters thereby, has ordered the committee to be composed of members of the Imperial Automobile and Aero Clubs, the Society of German Manufacturers and of a representative of the Home Office, War Office, Admiralty, Board of Education and the Technical High School.

#### Holland

It is announced that Henri Wynnmalen has been chosen to represent Holland in the 1912 international aviation race. Wynnmalen is known as a former world's altitude record holder, and also as the winner of the Paris-Brussels and return flight of October 17th, 1910.

#### Russia

Reports from Paris state that Jerome S. Fancull, vice president of the Curtiss Aeroplane Company, has signed a contract with the Russian Naval Commission for three of the Curtiss hydro-aeroplanes. The machines ordered, however, will be fitted with 75 horse power motors instead of the 50 horse power engines that drive the two Curtiss hydro-aeroplanes owned by the United States Navy. Two of the Russian machines are to have the same spread of wing as the navy's—thirty-five and a half feet—while the other machine, built more for speed and agility than wing, will have a spread of thirty-three feet one inch. All three hydro-aeroplanes are of the dual control, passenger carrying, single pontoon biplane type. They are being set up at the Curtiss factory, at Hammondsport, New York, and the first will be ready to ship about April 1st. It will go to France, where it is possible that the acceptance trials will be held. Besides the aeroplanes the order includes a spare motor.

The Aeronautic Society of Moscow will hold an international exposition April 7-21, 1912, for exhibiting all kinds of balloons, dirigibles, aeroplanes, motors, and their accessories, such as Magneto, rotors, radiators, hydrogen producers, wireless apparatus, scientific instruments designed for aerial work, aeronautic costumes, and in fact all those articles which enter into the aeronautic field will be displayed.

#### Switzerland

Tadeoli, the Swiss aviator, has been working on the design of a new hydro-aeroplane during the winter. The machine is now completed and will be experimented with during the springtime on the beautiful Lake Geneva.

#### Tripoli

On March 6th a dirigible was used for the first time in actual warfare. The airship was operated by the Italian army and was used for reconnoitering purposes and bomb dropping. A number of bombs were dropped into the Turkish and Arab camp at Zanzur and considerable damage done.

#### Tunisia

On February 8th, Obre and Duval, having got clear of the Italian military authorities, commenced their exhibition at Tunis. In spite of a strong wind both Obre on a monoplane of his own design and Duval on a Gaudron tractor biplane, made circular flights of 60 kilometres, passing over Carthage, Ariana, Tannanoubia and Tunis.

**CORRESPONDENCE**

March 14, 1912.

Lawson Publishing Co., New York, N. Y.

Gentlemen—We are in receipt of information from Germany, regarding the recent action of the German Patent Office, nullifying the main claim of the Wright German Patent. A letter from our attorney says—

"After the discussion of all of these points, the Division took one hour and a half to deliberate, and then pronounced as their judgment that claim 1 should be annulled on the disclosure contained in 'L'Aeronaut', page 103, passage 5, in connection with 'Automotor', of February 15, 1902, page 197, column 1, lines 2 to 4. The full grounds were not verbally pronounced. It was said that they would be given in writing."

The citation from 'L'Aeronaut' is from a report of an address by Mr. Chanute before the Aero Club of France, in April, 1903, describing the experiments of the Wright Brothers at Kitty Hawk, N. C., in 1902. The citation from the "Automotor" is a synopsis of the address of Mr. Wilbur Wright before the Western Society of Engineers in 1901, describing the experiments at Kitty Hawk, N. C., in 1901. The statement of Mr. Chanute which is cited as a disclosure of the Wright invention was as follows:—

"To assure transverse equilibrium, the operator works two cords, which warp the right and left wings and at the same time adjust the vertical rear rudder."

Under the laws of Germany and France, a disclosure of an invention by the inventors, or by any one else, who has no knowledge of the invention, before the application for a patent is filed, is sufficient to render the patent void. The disclosure must be sufficient to enable any one to understand how to build and use the invention.

The German Patent Office has taken the extreme position that these few words were sufficient to teach any one how to build and operate a flying machine in 1903, and that they canceled the right of the inventors to any property in their invention in Germany. The Wright Brothers do not believe that this action of the Patent Office is based on a proper interpretation of the law, and will take an appeal to a higher tribunal.

The address of Mr. Chanute, on which the German decision turned, was delivered about two years after the date of the French application, and, therefore, could not be used against the Wrights in the French trial, which they won. The German application was not filed until after the date of this address by Mr. Chanute.

Very truly yours,  
**WRIGHT BROTHERS.**

Editor AIRCRAFT:

The following ideas on the efficiency of systems for the lateral control of flying machines will perhaps interest your readers and, I hope, will lead to some discussion of the subject. These ideas were more fully treated by me in a lecture which I gave before the American Society of Mechanical Engineers at Boston on Feb. 16, 1912.

There are three systems of lateral control now in common use and they are known as the Wright, Farman and Curtiss systems. The Wright system consists of the simultaneous movement of three elements, two wings and the rudder. The angle of incidence of the wing is increased, that of the high wing is decreased, and the rudder is turned towards the wing having the lesser angle of incidence. This is done mechanically and involves the use of a complex mechanism. In Farman's system only two elements are used, the aileron on the low side and the rudder. The positive angle of incidence of the aileron on the low side is increased and the rudder is turned towards the other side. In the Curtiss system the aileron on the low side is given a positive angle of incidence, and then, instead of using a rudder as an offset, another aileron on the high side is raised to a negative angle.

The similarity of the three systems lies in the fact that they all increase the positive angle of the wing or aileron on the low side and thereby introduce a pressure which has to be offset and is offset either by the rudder or by another aileron. If we draw two lines representing the lift and drift of a surface at all angles from zero to ninety degrees, we will find that from zero to about twenty degrees the lift increases rapidly from there to about thirty-five degrees, slowly, and then it drops to nothing at ninety degrees. The drift, on the other hand, increases constantly from zero to ninety degrees. It is evident, therefore, that to get the greatest pressure from a surface it should be placed where its drift component can be utilized. If a surface is placed where its drift component is dangerous, it can be used efficiently only at very small angles. This is why increasing the positive angle on the low side of a flying machine as a means of regaining lateral stability means a loss of pressure, and a cause of disaster, because not only is the drift component not used, but it is absolutely harmful and if not offset will cause disaster.

On the other hand, if we leave the low side alone and devote our attention to the high side,



THE NEW ETRICH MONOPLANE "SWALLOW" IN FLIGHT, WHICH AS CAN BE SEEN, RESEMBLES THE BIRD AFTER WHICH IT IS NAMED.

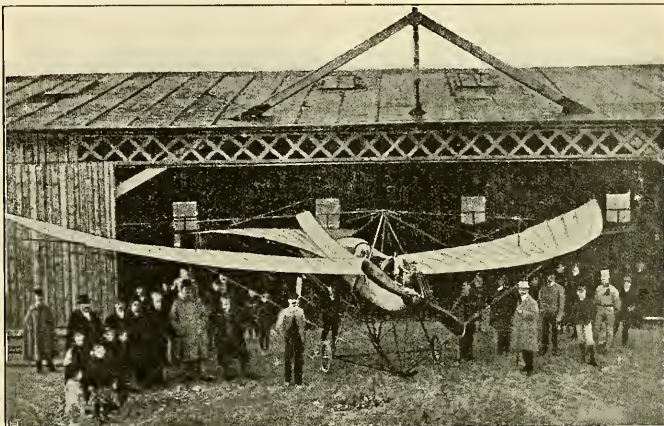

FRONT VIEW OF THE ETRICH "SWALLOW," SHOWING THE TURNED UP WING TIPS, POSITION OF THE ENGINE AND THE SIMPLIFIED WHEELS AND SKID LANDING CHASSIS.

it will be seen that we can use all the forces we introduce. By simply reversing the system used by Farman we keep his simplicity of construction and at the same time we transfer the drift component from the low to the high side where it belongs, and hence we need no offset. By having ailerons movable only to a negative angle and only one at a time, and by moving only the one on the high side, we introduce a downward and backward pressure on the high side, both of which pressures help to produce the desired result. By using all the pressures we introduce, we gain in efficiency. Moreover, in such a system, there is no danger from over control because no matter how large the drift is (because of too large a movement of the aileron) that drift retards the high side and so lowers it. Thus this system is less dangerous than the others.

It is my opinion that designers will discard, in time, all systems that effect the low side and will devote their attention to the best and simplest system of introducing downward and backward pressures on the high side. Claims have already been allowed me for such a system and I understand that in Germany there is a biplane using such a system, which is a successful flyer.

No flying machine is as safe as it ought to be if it introduces a dangerous force which has to be offset, and the presence of this force and its offset is evidence of the inefficiency of the control. Moreover to require the co-operation of two surfaces to produce a result, (as is required in the Wright, Farman and Curtiss systems) when the same result can be produced as well with one surface, is, in my opinion, evidence of poor design.

It will interest me to learn the views of others concerning the points brought out in this letter.

Yours respectfully,  
 A. A. MERRILL.

February 21, 1912.

**Van M. Griffith's Great Work**

Los Angeles, Cal., February 23rd, 1912.

Mr. A. W. Lawson, Editor.

My Dear Mr. Lawson—About a year ago I formed a plan whereby all of the aeronautical concerns, private owners, etc., would assemble together on a community field. To those interested at that time, it appeared feasible but premature. I stored the plans away, realizing that some day the aeronautical concerns would see it in a different light. This they did the early part of November, 1911. At a mass meeting held at that time it was unanimously decided by those present that they would give their moral support to the establishing of a community field. I leased a tract of land, comprising nearly 200 acres, of which 180 acres is as level as a floor. Along one side I ran a bunch of 50 foot lots to be rented to tenants or private owners. In order to get the proposition started I have given everyone free use of the field until July 1st. After that time they will be charged a more than reasonable rental. I say, "more than reasonable." However, I will let you decide that for yourself.

Here are the figures: Two hundred acres of land within the city limits of Los Angeles. City taxation value, \$1,000 per acre, making total value of 200 acres, \$200,000. My rental is 4 per cent. of the city taxation value, or \$8,000 per year. At the present time there are four lots leased to concerns and about ten that will be used by private owners, making a total income of \$50 per month. Figuring that the maximum income will be twice this amount during this year, or \$100 per month, and multiplying this amount by the number of months in the year, you will find that the maximum income will be about \$1,200. (Deducting the latter amount from the

(Continued on page 52.)

## THE PATENT SITUATION.

(Continued from Page 40)

whether the structure of the organs of the (Blériot) machine is bound up in the discovery of the Wright brothers and must be considered as a necessary perfecting of their invention, and whether, on the other hand, by their use or for any other reason, they constitute essential differences modifying the characteristic elements of the machine patented by the Wright brothers.

According to the newspaper reports, the Wright suit against Grahame-White resulted in an order restraining him from flying in this country and was referred to a referee before a final accounting. A foreign report is to the opposite effect. The case report is not yet available.

It is understood that the Wright suits against Curtiss and Paulhan are not yet ended.

In addition to all this litigation there remains to be recorded the fact that competitive meets in this country during the past year have been licensed by the Wrights, the contracts calling for a division of the profits and insuring the tournament authorities from further liability to the Wrights, whatever the outcome of any pending suits.

## STURTEVANT AERONAUTICAL MOTORS

The B. F. Sturtevant Company of Hyde Park, Boston, Mass., are bringing out aeronautical motors as another addition to their already extensive line of special engines and motors for driving air handling machinery, and it is interesting to note that they believe that the aeronautical motor of the future will be built after the general lines of the automobile engine, whose reliability has commended its use to them for aeronautical power plants. In general knowledge of the science of flying and the successful working out of new theories in airplane construction, they claim, have enabled the use of heavier motors, which has allowed designers to come back to standard practice and to lighten motors only by using stronger materials, thus producing a more reliable engine. The weight of this motor has therefore been reduced only by careful design and the selection of proper materials, and in no case has strength or reliability of service been sacrificed to this end.

These motors are built in two sizes, four and six cylinder rated at 40 and 60 horsepower and weighing complete, 200 and 285 pounds respectively. The cylinders are cast separately and have a bore and stroke in both models of 4½ inches.

It was the object of the designers to build a motor that would operate continuously for long periods without attention, that would operate at extreme angles for a considerable length of time, that would require no hand oiling or adjustment of running and that would be so simple in construction and operation that a person familiar with the automobile

engine of to-day would be a competent operator. It has therefore, they say, been made as fool-proof as possible, and parts needing accurate adjustment or constant care have been eliminated. The evident impossibility of oiling a motor by

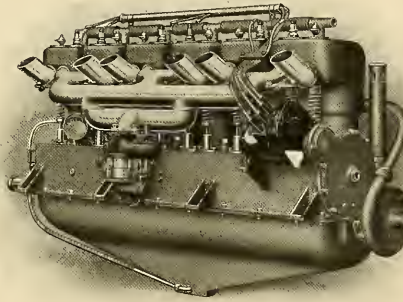

hand when in flight has resulted in the design of a system of forced lubrication in this motor which leaves no bearing to be lubricated by hand and which requires no grease cups. Moreover, to ensure against the possibility of anything happening

to the lubricating system and thus rendering ineffective the most vital part of the engine, two pumps are used, one forcing oil through passages in the crankcase to the main bearings and thence through the crankshaft to the other bearings, the other drawing the oil from the base, where none is allowed to accumulate, and returning it to a storage tank, after forcing it through a filter. In event of the filter becoming clogged in this system, the pump furnishes sufficient pressure to burst it, so that oil will be pumped in any case, it being considered more important under such conditions that even dirty oil be supplied to the bearings than none at all. As in this system no oil is allowed to accumulate in the base, this motor can be operated at extreme angles without flooding any cylinder.

To ensure perfectly balanced operation, all connecting rods and pistons are brought to within two grams of a standard weight. The ratings are conservatively placed, for the 40 horse power motor has shown actually 52 horse power on the test plate, and a standing thrust of 375 pounds at 1200 revolutions per minute.

All parts are thoroughly standardized and jigged and can be supplied from stock and bearing bushings are made interchangeable.

All outside parts are thoroughly water-proofed by a heavy casting of nickel plate and there are no exposed gears or bearings to be damaged by dampness. These motors will be exhibited in the coming Aero show in New York, May 9th to 18th.

## THE DORNER MONOPLANE

By Walter H. Phipps

ONE of the few really original and distinctive types of successful monoplanes is the Dorner machine, a product of H. Dorner, of Berlin, one of Germany's most consistent aeronautical designers and pilots. Although the Dorner monoplane differs radically from most accepted designs, it nevertheless has proved itself a capable flier and record breaker.

It is of the low centre of gravity under-slung type, having the weight of both the engine and the pilot situated below the main plane. The motor, which is situated in front, is hand cranked and drives the large two-bladed propeller through a clutch, shaft and chain transmission as shown in Fig. 1. This system of transmission has the advantage of allowing the operator to start his motor when on the ground without the propeller turning and also permits him to accomplish glides with his motor running and the propeller stationary.

The principal dimensions of the machine are as follows: Span, 31 feet; length, 37 feet; chord of wing, 9 feet 8 inches; engine, 36 H. P., 4-cylinder Korting, which drives a large "Eta" propeller at reduced speed through sprocket and chain transmission.

### THE FUSELAGE.

The fuselage, which is built of wood and steel tubing, is of the open triangular type tapering front and rear with the single main spar running along the bottom and acting as a skid. The two

upper spars are spread out in the vicinity of the propeller to allow plenty of clearance, but taper to a point both front and rear. The fuselage uprights are put in slanting fashion thereby acting as cross braces and eliminating the necessity



THE MAIN PLANE.

The construction and warping arrangement of

the main plane is the chief peculiarity of the Dorner machine. It is built contrary to general practise, with three main spars, one in the centre and the other two near the edges of the planes. The centre main spar is rigid and has three vertical posts mounted on it, one in the centre and one near each end of the wing. A system of wiring runs through pulleys mounted on these posts and is so connected to the two outer main spars of the wings that these can be moved equally, one up the other down in such a manner as to warp the plane the same amount at each end, thereby overcoming the usual drag on the low side. A careful study of the accompanying drawing will show clearly how the Dorner warping system works.

### THE TAIL.

The tail of the machine is of the flat non-lifting type and is longer than it is wide and is intended to act as a stabilizer. Two elevator flaps attach to its rear while the rudder is placed directly between them.

### THE CHASSIS.

The landing chassis is of the single skid and two wheel variety and in principal is somewhat similar to the Nieuport, although its construction is somewhat different. The two wheels are mounted on a springy arched wooden axle which is strengthened without losing its flexibility, by a system of springs stretched across between the wheel centres under the arch of the wooden axle.

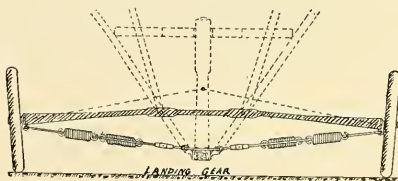
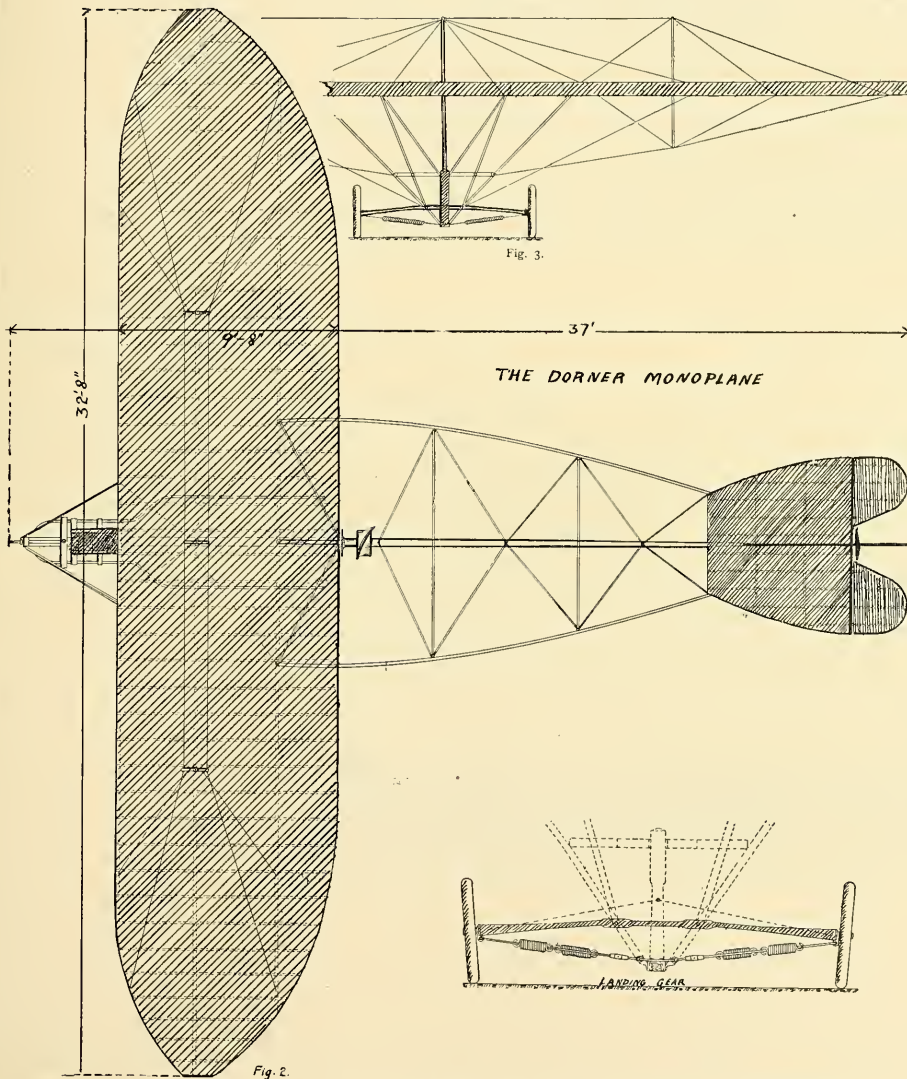
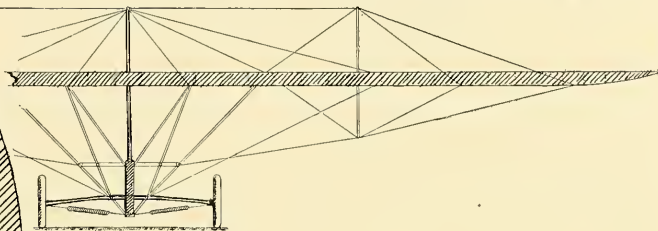
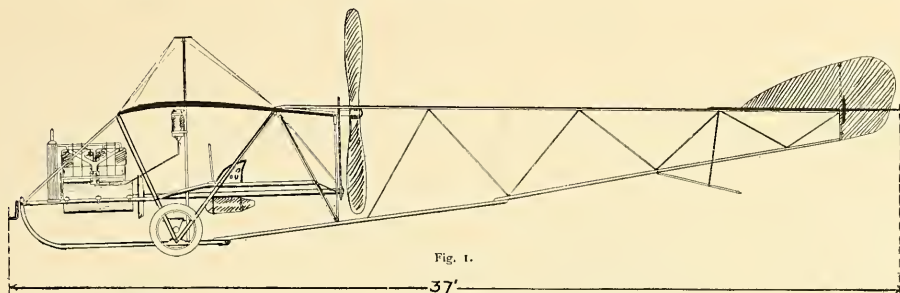

THE DORNER MONOPLANE

# GENERAL NEWS

By D. E. Ball

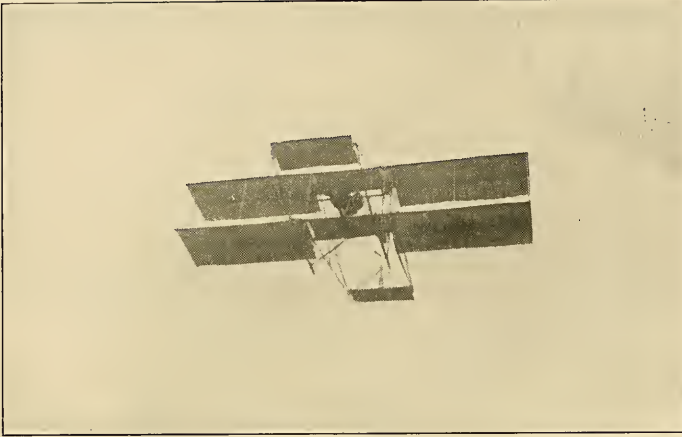

The new experimental biplane of Frank E. Boland, designed with a view to testing the efficiency of the control of the regular conventional type machine as compared with his own rudderless machine (a picture of which we show in flight below). As a result of a series of tests carried out during the winter, Mr. Boland is convinced more than ever of the worth of his tailless and aileronless machine, and is now building a new racer of that type.

## New England Notes

By Denys P. Myers

ACCORDING to William A. P. Willard, the Harvard Aviation Field at Squantum will be the scene of a third meet this year from June 29 to July 7. The Harvard Aeronautical Society will not be connected with the venture. It is understood about fifteen aviators have been signed for the event.

J. Emery Harriman, Jr., of Boston, has built

2. The control must be capable of use by either operator from either seat.
3. The machine must be able to ascend at a minimum rate of 2,000 feet in ten minutes while carrying a weight of 450 pounds, and the amount of fuel stated in paragraph 4.
4. The fuel supply must be sufficient for at least four hours of continuous flight.
5. It must be easily transportable by road, rail, etc., and easily and rapidly assembled and adjusted.

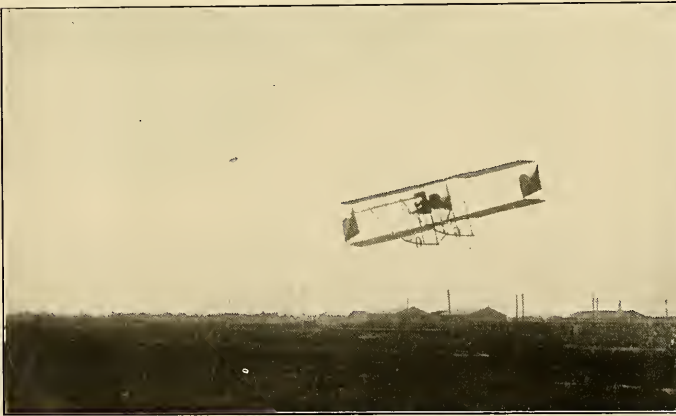

FRANK E. BOLAND MAKING A TURN IN HIS TAILLESS, RUDDERLESS AND AILERONLESS BIPLANE AT THE MINEOLA AVIATION FIELD.

a steel hydro-aeroplane after seven years of experimentation, a feature of which is the method of stabilizing. This is effected by constructing the wings in such a manner that they pivot upon the central longitudinal line, whereby they may be raised, lowered, or held at any desired angle. The workmanship on the machine is very fine.

Burgess Company & Curtis, of Marblehead, are completing for delivery to the government on May 1 an army aeroplane for weight carrying, which must fulfill strict conditions. Another machine, for scouting, is desired, and will have to make 65 miles per hour. The biplane under construction must meet these official requirements:

1. It must carry two persons with the seats so arranged as to permit of the largest possible field of observation for both,

6. The starting and landing devices must be part of the machine itself, and it must be able to start without outside assistance.

7. The engine must be capable of throttling to run at reduced speed.

8. The engine will be subject to an endurance test in the air of two (2) hours continuous flight.

9. The aeroplane must develop a speed in the air of at least forty-five miles an hour.

10. The machine must be capable of landing on and arising from plowed fields.

11. The supporting surfaces must be of sufficient area to insure a safe gliding angle in case the engine stops. This will be determined by a test during calm atmospheric conditions. At an altitude of 1,000 feet the engine will be entirely cut off and a glide made to the ground. The

horizontal distance between position of cut-off and landing must be at least 6,000 feet or at other altitudes of the same ratio.

The Aero Club of New England held its first ladies' night at a Boston hotel March 5, when Mrs. Mahel Loomis Todd, of Amherst, wife of Professor David Todd, of Amherst College, and Mrs. H. Helen Clayton, were the chief after-dinner speakers. Lieutenant Governor Robert Luce was one of the guests of honor. The president of the club, Jay B. Benton, presided, and introduced as the first speaker Lieutenant Governor Luce, who discussed the progress of the propeller as a means of propulsion, and presented Earle L. Ovington an engrossed life membership certificate, done on parchment. Ovington and Harry N. Atwood were elected to honorary life membership on February 19. Mr. Atwood, who arrived late, as he had been flying all day, was presented with his certificate by President Benton. Mrs. Todd told of two balloon ascensions, one by daylight and another by night, accompanied by her husband and Charles J. Glidden, who acted as pilot. Mrs. Clayton told of one ascension.

## California News

By Ernest Ohrt.

THE following is a report of the Oakland, California, Aviation Meet, which was held at the Emeryville Race Track near the shores of San Francisco Bay. The meet lasted six days, beginning February 17th and ending February 25th, omitting the 19th, 20th and 21st. The contestants and their machines were as follows:

- Lincoln Beachey—Curtiss biplane.
- Hillery Beachey—Beachey-Heineman biplane.
- Weldon B. Cooke—Diamond biplane.
- H. F. Kearney—Denoist biplane.
- Tom Gunn (Chinese)—Farman type biplane.
- Glenn Martin—Martin biplane.
- Miss Blanche Scott—Martin biplane.
- Phil O. Parmelee—Two Wright biplanes.
- Farmum T. Fish—Wright biplane.
- William H. Hoff—Curtiss biplane.

The First Day, Saturday, February 17, 1912.

The meet was opened at 2 P. M. by the firing of bombs, which was followed by a five mile handicap race in which Lincoln Beachey started from scratch and crashed the winner. Gustly winds caused Miss Blanche Scott and Tom Gunn, the Chinese aviator, to withdraw from their special exhibition flights. The next was the Race of all Nations, in which Hoff carried the German flag. Hoff was the first starter in this race. Upon leaving the ground Hoff rose at too steep an angle, and at a height of 30 feet his machine lost all headway and crashed to the ground, totally wrecking the biplane and pinning him underneath it, resulting in may painful bruises. Beachey thrilled the crowd and ended the first day by making a glide of 3,000 feet with his power shut off. Horace Kearney started from the aviation field, and after flying across San Francisco Bay (a distance of 7 miles) he landed on Van Ness avenue, the widest street in San Francisco. After talking with Mayor Rolph for several minutes, Kearney arose from the street among telegraph wires and flew back to his starting point. This is the first time that such a feat has been accomplished in San Francisco.

The Second Day, Sunday, February 18, 1912.

The second day was the best day of the meet, as Miss Scott and all the aviators made sensational flights. Lincoln Beachey won the five mile handicap, being six circles the field for more than a minute with both hands completely off his steering gear. Later on Beachey took up half a dozen oranges and two baseballs, which he threw from a height of about 100 feet to two Oakland ball players. The very last ball was the only one caught. Miss Scott flew for about six minutes, while Tom Gunn made a fine flight in his Farman type biplane. Kearney made a flight over San Francisco Bay. Farmum Fish took up a bag of mail and dropped it outside the grounds.

The Third Day, Thursday, February 22, 1912.

This day was attended with a very large crowd, but it was marred by one serious accident to Tom Gunn, who left the ground with difficulty, and after flying north to a height of about 150 feet his engine started to miss fire, which caused the machine to swerve. Gunn was headed for the Bay, but he managed to steer to the right, and after doing so he darted almost perpendicularly and crashed into a small building, which completely wrecked the machine and pinned him underneath. Gunn escaped with a slight injury. This (his second flight) ended Gunn's flying in the meet. Miss Scott made a five minute flight. Glenn Martin rose to a height of about 8,000 feet. Parmelee and Fish made sensational flights.

The Fourth Day, Friday, February 23, 1912. Benefit Day for the Widows of the late Eugene Ely.

This day was very windy. Mrs. Ely was scheduled to make a flight as passenger with Miss



Blanche Scott, but it was postponed on account of the wind. As Weldon B. Cooke, the Oakland aviator, was hurrying on landing at a height of 100 feet his crank shaft snapped, but he managed to get to the ground safely. This accident stopped Cooke's flying with that machine.

The attendance was very large this day, Mrs. Ely received a fairly large sum, as the aviators volunteered their services. Glenn H. Curtiss appeared at the meet. Fish won the wireless handicap by a close margin. He also created a sensation by towing an automobile horn attached to his machine as he flew. Parmalee flew in the Baby Wright, which was equipped with a Hall-Scott motor. Mrs. Ely was given the gold medal which was intended for her husband just before he met death. The medal was awarded by the California Association, of which she was a member.

**The Fifth Day, Saturday, February 24, 1912.**

The attendance was smallest on this day. Hillary Beancey, W. B. Cooke, Tom Gutce and Wm. Hoif did not fly. Miss Scott did not fly on account of high and gusty winds. Kearney made a wireless experiment and also flew over the Bay. Westrum made an abrupt landing after a spiral glide from 2,000 feet. Glenn Martin made several fine flights in his beautiful biplane. Beancey performed his usual feat of going up 3,000 feet and shutting off his power.

**The Sixth and Last Day, Sunday, February 25, 1912.**

The last day was very windy with a large attendance. Parmalee, L. Beancey and Martin were the stars. Parmalee and Martin went up about 7,000 feet. Beancey did his usual daring feats. Fish went up with the mail sack, but after half a mile engine trouble forced him to land. Kearney again flew over the Bay. At 4:30 P. M. Beancey did his finishing stunt by gliding from 3,000 feet.

Just as the majority of the crowd had left (at 4:50 P. M.) Weldon B. Cooke appeared in his beautiful new Diamond Biplane after flying from Eimhurst (ten miles distant), where he had just completed it after a long day and night. This was Cooke's very first night in the new machine, which is of the Curtiss headless type and fitted with a Roberts 6-cylinder motor. Before landing Cooke circled the field several times at a height of about 1,500 feet. With the exception of Beancey, who will take a three months rest, all the aviators went to Sacramento, where a meet will be held.

**California Notes**

James M. Sears, aged 79, a tourist from Salem, Ohio, is the oldest man in the United States to make a flight in a hydro-aeroplane. In company with W. B. Atwater, in the new model Curtiss machine, he ascended to a height of 500 feet and circled San Diego Bay.

Aviator Jeff Devilla had a bad fall in his Blériot type monoplane from a height of 100 feet when he attempted to volplane to earth. Devilla has his machine at the Ingerside Coursing Park, San Francisco.

The California Aviation Company of San Francisco are building a Farman type biplane for a local Japanese. They are also overhauling the biplane that Weldon B. Cooke used in the recent Los Angeles Meet. Business has increased to such an extent that night work is necessary.

**Army News**

**RECORD EVENTS AT AUGUSTA, GA.**

LIEUT. F. H. KENNEDY, who was injured in an aeroplane accident about two weeks ago, has now recovered sufficiently to be removed from the City Hospital to his home.

The fast Curtiss aeroplane was rebuilt after the accident of February 19th; parts were received and assembly completed March 1st. The next day Captain Beck was flying it, and while at an altitude of about 300 feet the engine stopped. In descending to make a landing, the machine grazed the top of a tree which changed its course somewhat, and it struck the ground at an angle, breaking the chassis and lower part of the aeroplane. Fortunately Captain Beck was not injured.

Lieut. L. W. Hazelhurst, Jr., reported for duty on March 1st, and the next day began his lessons in learning to fly the Wright aeroplane. Lieut. Milling has been assigned as his instructor.

Rain prevented flying for two days of the week of March 1st. Twenty-one flights were made, having a total duration of three hours and twenty-eight minutes.

Aviator Adolph Richter of the Rex Smith Company, arrived recently and has permission to use a tent for the use of the government flying field and fly here while instructing several students. His aeroplane and equipment have been delivered and students are also here.

Rain and wind prevented flying only three days during the week of March 7th; twenty-one flights were made, having a total duration of four hours and forty minutes. Only the Burgess-Wright aeroplane is present in use in the Army school. Both Curtiss planes having been wrecked recently—and the standard Wright machine is having the engine overhauled.

Officers of the aviation school at College Park,

Md., are planning, if the session of Congress extends into the Summer, to invite members of the two houses to take rides in the flying machines. In this way they expect to make enthusiasts of the Senators and Representatives and aid their plans for appropriations sought.

**Three Aerial Battalions for American Army**

On March 11th it was announced that General James Allen, chief of the United States Signal Corps, has arranged the organization of a complete aeroplane division. This body is to have

twenty-four acroplanes, a colonel, three majors, fifty-four captains and lieutenants and three surgeons. The division will be divided into three battalions of six companies each, each company to consist of nine officers, twelve enlisted men and a property sergeant, clerk, cook and assistant cook. The division is expected to be completely organized before summer.

Miss Harriet Quimby, America's first woman aviator, left New York for Paris on March 7th. Miss Quimby has been engaged for several exhibitions abroad and will enter several contests. She will use a new 70 horse power Blériot monoplane.

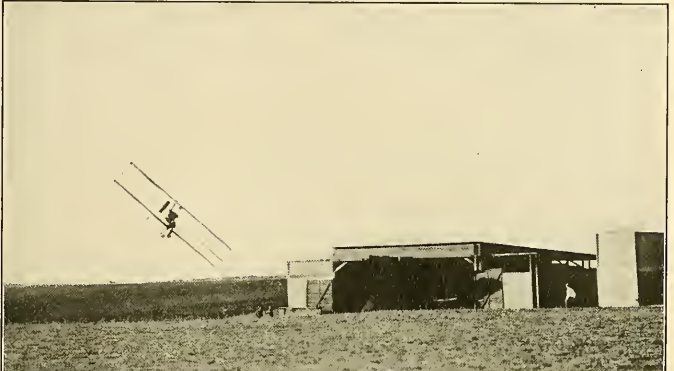

LINCOLN BEACHEY AT LOS ANGELES MAKING A PARTICULARLY DANGEROUS TURN AROUND ONE OF THE HANGARS ON HIS CURTISS HEADLESS TYPE BIPLANE.

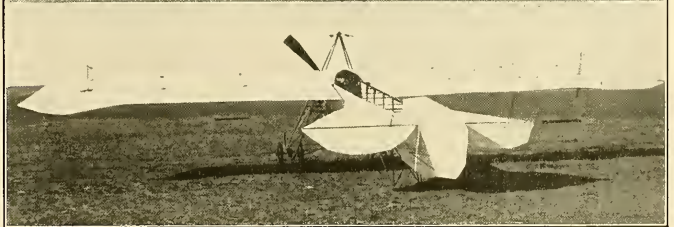
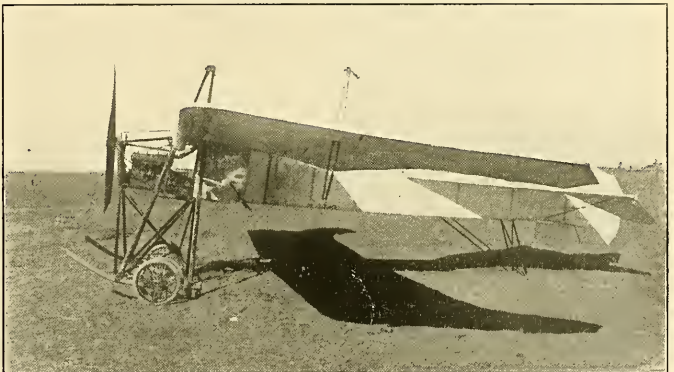

TWINING MONOPLANE.

The above photographs are of the Twining Monoplane, designed by Sidney J. Twining, son of H. La V. Twining, treasurer of the Aero Club of California.

The spread of the wings from tip to tip is 38 feet. Width of chord, 6 feet. Fore and aft dimensions, 22 feet. Surface in main planes, 220 square feet. The weight of this machine is 750 pounds, including aviator (150 pounds) and engine (150 pounds).

The plane is equipped with a 4-cyl. 22 H. P. motor. The cooling is of the thermosiphon system. The compression of the engine has been increased, an oiling system has been added, and large auxiliary ports provided, thus increasing its horsepower.

The propeller is geared down three to one, and it is proposed to run the engine at 1,800 r. p. m., thus obtaining 600 r. p. m. from the propeller.

This experiment is an attempt to develop a machine that can be flown on low power. The tendency so far is toward high-powered machines, and it is worth while to endeavor to accomplish something in the other direction. If a person desires merely to fly he should build or purchase one of the successful types already developed; but if he finds his pleasure in invention, he is justified in trying to develop a new type.

REPRESENTATIVE WILLIAM G. SHARP, of Ohio, who introduced a resolution in the House of Representatives calling upon the Secretary of War for information about what this and other countries are doing with aeroplanes, explained the purpose of his resolution as follows:

"Our showing in this country is miserable. We are hopelessly outclassed. We are so far behind that it will be years until we catch up unless Congress takes some action."

"The possibilities of aviation only can be seen by men and women who study aeronomics. Its future is brighter than what the future of the automobile was when it reached its present state of perfection."

"I believe the aeroplane will be recognized as a greater power than battle ships. An aeroplane does not cost as much as the paint for a battle ship, yet the fierer sooner or later become a more effective instrument of war than all the guns of a battle ship combined."

"We have only a few aeroplanes and hydro-aeroplanes in the government service, while France, England, Germany, Austria, Spain and other foreign nations have a wonderful fleet of fliers."

"The aeroplane is here to stay. I believe future battles will be fought in mid-air. The money we spend for one battle ship would give this nation the most wonderful aeroplane fleet in the world. Such a fleet of flying machines, used by intelligent army and navy men, could completely destroy a squadron of the finest battle ships and cruisers."

"I hope Congress will show the greatest liberality in making appropriations for aviation in the future, so that our country can take the place—the front rank—it rightfully deserves."

### The 1912 International Aviation Cup Race

BELGIUM, England, France, Germany, Holland and Switzerland have sent in their challenges to America for the International Aviation Cup race which will probably be held at Chicago.

Audemars will probably represent Switzerland, while France may be represented by the three speediest fliers selected from the following: Jules Vedrines, Leon Bathiat, Henri Molla, Maurice Tabuteau and Chambenois. Belgium has not as yet announced her flier, but Holland will be represented by Henri Wynmalen.

It is announced that as soon as the signal corps attached to the National Guard of this country have been re-organized, aeronatic work will be taken up by the men. Lieutenant Benjamin D. Foulis, detailed to the Department on Militia affairs at Washington, will be in charge of the project.

On March 1st, for the first time in the history of aviation, a man leaped from an aeroplane. The feat was accomplished by Bert Berry, at Jefferson Barracks, St. Louis.

Berry and Anthony Jannus left the Kinloch aviation field in the afternoon in a two-seater, headless biplane fitted with a Roberts motor. Attached to the skid rail of the machine was a conical case which contained the parachute. When the machine had maneuvered to a height of 1,500 feet, and was directly over the Barrack grounds. Berry left his seat in the machine, and climbing onto the skid grasped the bar of the parachute and then cut loose. The aeroplane relieved of this extra weight tilted upward at quite an angle, but it did not take Jannus long to get it under control. Berry shot downward three hundred feet with the parachute trailing after him. Suddenly it opened, the rapidity of the fall was checked, and he floated down gradually and landed safely. On March 10th Berry again repeated this feat successfully.

Frank T. Coffyn has been continuing his hydro-aeroplane flights during the past few weeks in the vicinity of Battery Park, New York and is creating much entertainment and a great deal of excitement by his flights in and around the boats in the harbour.

On March 7th, Coffyn gave a demonstration of his machine before the Wrights, who had never seen one of his machines fitted with the Coffyn floats.

It is announced that the Aero Club of the University of Virginia, at Charlottesville, has made arrangements with the Curtiss Exhibition Company to have an experienced aviator make a series of flights from Lambeth Field, probably during Easter week. Three flights of thirty minutes each will be made. A representative of the Curtiss company has pronounced Lambeth Field admirably suited for exhibition purposes.

S. S. Jerwan, a monoplane pilot of considerable experience, has been giving a series of interesting lectures at the different Y. M. C. A. Clubs in New York on "Practical Flying." Mr. Jerwan illustrates his talks with a large working model. All those who have attended the lectures pronounce them very instructive as well as entertaining.

Theodore Ahlborn, of Waterloo, Iowa, has perfected the design for a new monoplane which he stated will be built and sold for \$3,000. It has very graceful lines, special wing tip balancers, and will weigh complete about 700 pounds with 30 H. P. motor.

To George W. Beatty goes the honor of being the first airman to alight on Manhattan Island. On February 13th he flew in his Wright biplane from Nassau Boulevard to New York City, where he landed in an open space in Central Park. The following day he flew back to Nassau Boulevard.

### Le Triomphe De La Navigation Aerienne. (The Triumph of Aerial Navigation)

By Count Henry De La Vaulx.

This is a large publication of 400 pages and contains many excellent illustrations and valuable documents and tables.

The book is divided into three parts, as follows: Part 1, Balloons; Part 2, Dirigibles; Part 3, Aeroplanes.

The new Websterian 1912 Dictionary, just published, contains a glossary of aviation terms as well as a glossary of automobile terms. The book contains 1,197 pages altogether and is a most remarkable work of reference. It is edited by Harry Thurston Peck, Ph.D., Litt. D., LL.D., and published by the Syndicate Publishing Company, New York.

TELEPHONE MADISON SQUARE 5017.

VAN M. GRIFFITH'S GREAT WORK.

(Continued from page 47.)

rental I have to pay for the field (\$8,000), you will see I have \$6,800 to make up. You are probably wondering what kind of an insane person would take over a proposition of that kind. Mr. Lawson, I am taking on a pretty heavy load, just about as heavy as any man of my years ever carried. I am doing it for the game and to show the public that there is a real practical side. I am looking forward for your hearty support in this undertaking, and trust that you will realize that we have started the biggest step in practical advancement ever undertaken. Within the next few months I expect to establish at least twelve municipal landing grounds in the various towns of Southern California.

At the present time an aeroplane is absolutely worthless for pleasure purposes, and as for touring the country, it is impossible. My plans may be premature, but let's try it, even if they are. It will certainly have a tendency to help toward the end for which we are all working.

Two factories are now in operation and the erecting of a third was started this morning. The prospects look good, but a thousand and one things must be done in order to make it a success.

Hoping to have the pleasure of hearing from you in the near future, I beg to remain, yours most sincerely,

VAN M. GRIFFITH.

CIRCULATION DEPARTMENT

# AIRCRAFT

Published Monthly by

THE LAWSON PUBLISHING COMPANY

37-39 EAST 28th STREET

NEW YORK. March 5, 1912.

Mr. Alfred W. Lawson, President,

The Lawson Publishing Company,

New York City.

My dear Sir:

At the second annual meeting of the stock-holders of The Lawson Publishing Company, held at 37-39 East 28th Street, New York, Tuesday, March 5th, 1912, beginning at 11 o'clock A.M., the following motion was made by Mr. Edward C. Gough:

"In view of the personal sacrifices made by the President of this company during the past in pledging his personal credit to meet the obligations of the company, and, in view of the gratifying progress made by the Aircraft magazine as evidenced by its increased paid circulation and advertising receipts

I move that:

The stock-holders present at this their second annual meeting, authorize the Secretary to place on the minutes of the company a record of their appreciation of the faithful service and business ability of Mr. Alfred W. Lawson, the President of the company and their confidence in his management of its affairs, and further direct that this motion be published in the April issue of the Aircraft magazine".

This motion met with the hearty approval of the stock-holders present at the meeting, and was unanimously carried.

*Ernest C. Landgraf*

Secretary.

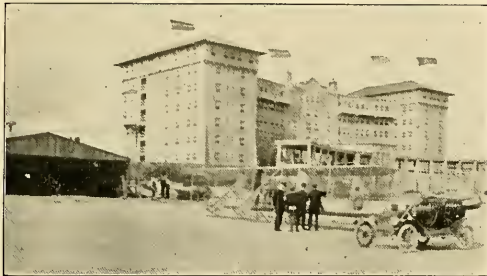

PHILIP PAGE READY TO FLY THE BURGESS BIPLANE AT DAYTONA, FLORIDA.  
NOTE THE WIND FORCE BY THE FLAGS ON THE HOTEL.

Mr. John Carrington Yates, organizing manager for the Committee on exhibitions of the **International Exposition Company**, which will hold an aeronautical show at the new Grand Central Palace, New York, May 9 to 18, reports that the following firms have already contracted for space: The Curtiss Exhibition Company; the Gallaudet Engineering Company; The Max Ams Machine Company; The American Aeroplane Company of Wilmington; The Boland Aeroplane and Motor Company; H. W. Jacobs; The Aerial Construction Company; The White Aeroplane Company; The Frontier Iron Works; The Baby Engine Company; The Twombly Motor Company; The B. F. Startsev Company; The Roberts Motor Company; The Goodyear Tire and Rubber Company; The B. F. Goodrich Company; The Diamond Rubber Company; The Electric Speedometer Company; Messrs. Marburg Brothers, Incorporated; A. F. Mangels; F. A. O. Schwarz; W. A. Crawford-Frost.

It is intended to make a big feature of the historical section, and several concerns have agreed to loan full sized machines of an historical nature and scale models. Among the foreign exhibits will be the Newport, Farnam, Deperdussin, Antoinette and Blériot machines.

The **Chicago Aero Works**, by the removal of a tin lattice and tool concern, have enlarged their borders and with increased space have added an immense show window on Wabash Avenue between Randolph and Lake streets for the display of aeronautical goods, models, accessories, etc. Mr. H. S. Renton, the proprietor, reports a good outlook and says that his new catalog now on the press will be most complete in every particular.

The **Rex Monoplan Company**, of South Beach, Staten Island is making extensive preparations for the summer trade. They have engaged Mr. Denduyver, a Belgian aviator, to demonstrate their machines. Their first monoplane is now completed and will be flown and exhibited at Nassau Boulevard about April first.

The machine this Company builds is of the Blériot type, but contains many of their own improvements. It is a two-seater standard machine equipped with a 50 H. P. Kirkham motor. In addition to this machine the Rex Monoplan Company have also under construction an entirely new type which they originated and which they claim will be very speedy with low horse power. As well as demonstrating the machines Mr. Denduyver will also act as instructor to purchasers. Edwin H. Skinner is manager of this company.

The **American Propeller Company**, of Washington, D. C., report a most gratifying state of affairs in respect to the patent protection which they enjoy for their numerous improvements and in respect to a number of important developments of comparatively recent date which they are now incorporating in their work. Their Paragon propellers are now being made under three separate United States Patents covering both the technical design of their propellers as well as the peculiar structural features which they employ. In addition to this the company has process patents covering the modes and processes of production which have found very valuable and which enable them to put up special designs as well as their stock patterns with great facility and uniformity. A number of still more recent improvements have been worked out and proved during the present winter, patent applications on which are about ready for allowance.

This company anticipates a very active season for 1912 and is making arrangements for putting out propellers in larger quantities than they have ever made in this country before.

The **Aeroduster Construction Company**, of Chicago, who have during the past been confining their business to aeronautical supplies and models, have lately put upon the market a 20 foot biplane glider which they sell to clubs or individuals especially interested in the sport of gliding.

The **American Aeroplane Supply House**, have completed the construction of their first machine—one of their passenger carrying Blériot type monoplanes—since moving into their new and commodious factory at Hempstead, New York. Another machine, a single seater monoplane cross country type is also under construction. Mr. E. C. Hild, the president of this company, extends a very cordial invitation to aeronautical enthusiasts to call and inspect both his new factory and machines.

The **Burgess Company and Curtis** report that flying was resumed at Marblehead on March 8 by a 23 minute flight with Mr. Burgess at the levers, followed by a 12 minute flight with a passenger. These flights were to test the new 1912 Burgess hydro-aeroplane which proved entirely satisfactory. Regular training will begin at Marblehead on March 20.

The new weight carrying machine ordered by the United States Government is now in course of construction as well as several others. The Burgess Company and Curtis' Florida school at Ormond Beach, in charge of Clifford L. Webster, is proving a most successful undertaking.

At Daytona, also, there has been regular flying for about two months, although restricted to some extent by bad weather. Out of the first 71 flights made, 52 carried passengers. The Burgess hydro-aeroplane operated by Walter R. Brooks, has been kept very busy during the winter season in the passenger carrying service.

The **Gressier Aviators**, of New York will open their new school about April first with a full line of Parman, Blériot and Morane machines. This company is under the management of Frederick Branniger, who anticipates a lively season's work.

The **Sloane Aeroplane Company**, of New York reports that their force at the factory has been working overtime during the past month constructing Charavay propellers and Sloane aeroplanes. Mr. Harry B. Vise, who has made a trip to San Francisco and back in the interests of the company, reports that business on the Pacific Coast was especially good. He also found business brisk in the different cities at which he stopped en route.

The **Roberts Motor Company**, of Sandusky, Ohio, report that they have just shipped two six cylinder 75 horse power motors to Germany, which are to be used by the German military authorities. They also say that judging from the number of their present sales and their prospective orders for future delivery of their motors in the United States, indications point to a very large increase in the number of machines to be manufactured in this country this year.

Mr. Ernst Ebbinghaus, of New York, has brought out a very interesting and instructive bird-like gliding model which, when thrown from the hand, will travel a considerable distance, and is therefore suitable for gliding contests. These models are so constructed that they can also be fitted with a small rubber band motor.

Mr. H. Percy Shearman, ex-President of Williams College Aeronautic Society, is the winner of the

## THE TRADE

**Stevens Trophy**, which was offered for the greatest distance made by a balloon in the East, outside of Stevens himself.

The trip of Mr. Shearman's was from Pittsfield, Mass., to Auburn, Maine, which is 189 miles, while the second longest distance was made by Mr. Denton, who sailed from Pittsfield, Mass., to Lakewood, N. J., a distance of 170 miles.

Mr. Hago C. Gibson, the President of the **Gibson Propeller Company** of New York, reports that he has been making a lot of propellers for special machines lately. Mr. Gibson says that these call for development of efficient propellers of exceptionally small diameter. One example was the adaptation of a propeller of six foot diameter to a new type hydro-aeroplane equipped with a 50 horse power engine, and another was a speed plane of the Paulhan-Latin type having 100 horse power engine with a positive limitation of propeller diameter to six foot, the propeller in this case being placed at the extreme tail of the machine.

Mr. Walter E. Watts, President of the **New York Aeronautical Supply Company**, reports that the summer season business with his company is now here and that his concern is actually swamped with orders and working seven days a week to keep pace with them. He reports also in the sale of two Roberts motors during the past month.

The **Milwaukee School and College of Aviation** is now running in full swing. This concern has its school, shops, hangars and flying field at West Allis, Wisconsin, while its business offices are located in the business district of Milwaukee.

The **Aeroplane Motors and Equipment Company** of New York are well pleased with the business they have done during the past month. Being direct agents for many of the foreign standard aviation motors, and carrying these motors in stock, they have the advantage of offering to patrons immediate delivery of their motors. This company is making preparations for a very large sale of Gnome motors in this country this year. Mr. Yves de Willers, who is connected with the Aeroplane Motors and Equipment Company, left for Paris recently in order to make more efficient than ever the service of importation of these foreign motors to this country.

Increased business during the past month is reported from the **Stevens and Beatty Aviation School** at Nassau Boulevard, many new students—men of prominence, having been enrolled, therefore everything has been going along nicely and to the entire satisfaction of the managers. Mr. A. Leo Stevens, one of the firm, has invented what he calls a "Life Pack," which consists of linen canvas with an umbrella-like arrangement attached thereto and fastened to the pilot or passenger's waist. "Should an accident occur to the aeroplane or the machine get on fire," says Mr. Stevens, "all the wearer has to do is to fall forward, when the 'pack' automatically discharges the umbrella-like arrangement and brings its human freight safely to the earth."

The **R. O. Rubel Jr. and Company**, the big Western supply house, reports that they have recently received orders for aeroplanes from the following people: W. O. Huff and J. C. Maris of Columbus, Ohio; S. C.ombs, New Martinsville, W. Va.; Charles Wickliffe, Louisville, Ky.; Walter Ralston, Holton, Kansas; R. W. Ross and C. B. Prodder, of Mandan, N. Dakota, while two other machines have been ordered for the use of the Rubel School of Aviation.

# CLASSIFIED ADVERTISING

15 CENTS A LINE

SEVEN WORDS TO LINE

CASH WITH ORDER

## FOR SALE

**I**F you want passenger balloons, dirigibles, captives or aeroplanes; large stock; immediate shipment; any size built to order. Teach purchaser to operate. Exhibitions furnished throughout United States and Canada. C. L. Bumbaugh, builder and operator, Indianapolis, Ind., U.S.A.

**F**OR SALE—Complete sets of castings for building the Blériot monoplane. Lynch Brothers, Aeronautic Engineers, 61 Wick Place, Youngstown, Ohio.

**N**URU the new rubber strands for models 30% more power, 25% more turns than square rubber. As used on English racing models, 3/16 wide, 50 feet, 75c.; 150 feet, \$2.00. Sole (U. S. A.) agents for "Mann" Monoplane (Rown 4,200 feet) and other English models. A. Melcombe, 2102 Seventh Avenue, Seattle, Wash.

**B**LUE PRINTS, 40 sq. ft., giving every working detail of machine together with instructions in building and flying. By mail \$5.00. Aviators' Exchange, 58 W. Washington St., Chicago, Ill.

**B**IPLANES—Built to order, single seaters, B double surfaced, \$400; single surfaced, \$375. Passenger types, double surfaced, \$475; single surfaced, \$450. Monoplanes, \$425. Write for particulars and save \$200 to \$400. Frank Lavista, Dobbs Ferry, New York.

**G**ENUINE Glenn Curtiss aeroplane, good condition, 4-cylinder water-cooled Curtiss motor, together or separate at a bargain. You pay express, will ship for inspection. Box 758, AIRCRAFT.

**M**OTOR for sale—Hall Scott 8-cylinder 60 H. P. motor, with propeller practically new, perfect condition guaranteed, price \$1,200.00. R. Tremper, 167 Penn St., Brooklyn, N. Y.

## MISCELLANEOUS

**W**ANTED—Small factory or shop with facilities for light woodworking in good manufacturing location. Middle West or near New York. Full particulars. Box 2476, Station G., Washington, D. C.

**A**ERO BUILDER will sell his complete shop outfit, reasonable. Address P. B., 263 West 69th St., New York, N. Y.

**W**HILE PAY more to learn flying; \$35 per week or \$125 per month. No other charge. Complete equipment. Students now flying at our field which is one-half mile square. Construction course FREE. Aerovraft Company, 117 N. Dearborn St., Chicago, Ill.

**P**ROPELLERS, made to order, increase your thrust, when we know the make of motor, bore, stroke and R. P. M., we can make you a propeller which will give you more thrust and guarantee it. Hoover-Conrow Aeroplane Company, Atlanta, Georgia.

**A**EROPLANES bought and sold. American A Aviation Company, Incorporated, 2957 N. Lawndale Avenue, Chicago, Ill.

## POSITIONS WANTED

**I** WANT to become new wizard of the air. Age 25; energetic, courageous, weight 170 pounds. Ten years practical mechanic with theoretical knowledge of aircraft. Would like position as mechanic for aviator or in factory with opportunity learn to fly. Will give best of references if fair proposition offered. J. Moore, 3004 So. 40th Ave., Chicago, Ill.

**A** YOUNG MAN, age 18, desires position as an aviator's assistant, with prospects of learning to fly. Address Louis Fenouillet, 132 West 47th St., New York City.

**Y**OUNG MAN 18, desires position in aeronautical work, factory or an aviator's assistant. Have considerable experience on various type models. Best references as to habits, ability, etc. Address Earl Schoppe, 3042 E Street, Philadelphia, Pa.

**W**ELL KNOWN aviator, licensed by the Aero Club of France, experienced instructor and mechanic, seeks engagement; can handle Blériot monoplane, Farman and Curtiss biplanes. Made numerous flights in America. Address I. Semeniouk, 121 West 97th St., New York, N. Y.

## CO-OPERATION WANTED

**Y**OUNG Jewish American, 21, having improvement for biplane without infringing Wright or Curtiss machines, desires financial assistance to build and patent. Rare opportunity. Michael M. Meizel, 728 N. 24th St., Camden, N. J.

**C**APITAL wanted to patent and build aeroplane that will fly three hundred miles per hour. Will give 49 per cent. of patents. I will guarantee to fly across Atlantic in twelve hours. Address A. Harbottle, 18 Eldert St., Brooklyn, N. Y.

**D**ESIRE communication with someone who will invest in most bird-like, practical self-balancing flying machine; will require less power than any other type. Ernest Ebbinghaus, 316 East 93rd St., New York.

**A**EROPLANE FOR SALE. GENUINE CURTISS AEROPLANE, LATEST MODEL, EQUIPPED WITH GNOME MOTOR; SHIPPING CRATES AND SPARE PARTS FOR BOTH ENGINE AND MOTOR. PERFECT EQUIPMENT FOR EXHIBITIONS. EVERYTHING GUARANTEED; LIKE NEW; PRICE \$3,500 CASH. ATTORNEY, BOX 760, AIRCRAFT.

## CHICAGO AERO WORKS

**H. S. RENTON**  
Proprietor  
164 North Wabash Avenue  
**AEROPLANES** ACCESSORIES MOTORS PARTS  
HARDWARE PROPELLERS  
WHEELS ALSO MODELS AND MODEL STOCK  
ESTABLISHED 1909. First in Chicago and the Middle West  
Aviators Taught. Flights Furnished. Send Stamp for Catalog.

## BIRD—MODEL

The most natural, perfect and scientific Flying-Machine model in the world (patented), which shows the secrets of birds' flight.  
Will fly from 20 to 200 feet without power.  
Most interesting for the enthusiast in aviation.  
Everybody experimenting in Flying Machines cannot be without it.

Send 25 cents in coin for complete model.

Agents wanted. Idea is worth the money.

Ernest Ebbinghaus 316 East 93rd Street New York, N. Y.

# The Call Aviation Engine

## Four Cycle, Water Cooled, Opposed Cylinders

THE GREATEST KNOWN THRUST PER  
RATED HORSEPOWER

WRITE FOR CATALOGUE

## THE AERIAL NAVIGATION CO.

OF AMERICA

GIRARD, KANSAS

## FLYING ALL WINTER

Become a PILOT on the latest . . .

### WRIGHT AEROPLANE

The Greatest Money Maker in the World  
WE make you a FLYER in 10 lessons  
WE stand all breakage  
NO extra charge to you  
ENROLL NOW and be an OPERATOR when the good weather sets in  
FINEST and BEST equipped AVIATION GROUNDS in AMERICA

Passengers Carried Daily, \$25

STEVENS & BEATTY Box 181 Mad. Sq., N. Y.

Course \$250 Course

## AERONAUTICAL ENCYCLOPEDIA

# AIRCRAFT

BOUND IN CLOTH

VOL. 1  
VOL. 2 Price \$3.50 each

## THE LAWSON PUBLISHING CO.

37-39 East 28th Street

NEW YORK



After Wild Ducks in the HAMILTON HYDRO-AEROPLANE With Elbridge 60-90 H. F.

## The New Elbridge "Six"

Possesses features that will interest you if you are buying or building a Hydro-Aeroplane or heavy Biplane requiring more power than our 4-cylinder engines.

**THE ELBRIDGE "60-90" WEIGHS LESS THAN 200 LBS.**

when equipped with imported alloy cylinders; and only 260 lbs. with standard iron cylinders.

Greatly increased production of "Sixes" for 1912 enables us to make prices that are right. Drop us a line today asking for special news.

**ELBRIDGE ENGINE COMPANY, Rochester, New York**

EVERYBODY isn't doing it because  
EVERYBODY have the TWENTY-FIVE DOLLARS—  
IF EVERYBODY did have the TWENTY-FIVE DOLLARS,  
EVERYBODY would buy an

*Aeroadster*

### THE AEROADSTER SPECIAL 20-FOOT BIPLANE GLIDER

Guaranteed to sustain 185 pounds. Best spruce construction throughout. Laminated ribs. Glider guyed with tested Aviator wire and tarabuckles.

Shipped anywhere for \$25.00 l.o.b. Chicago. We are prepared to furnish any special work for AEROPLANE construction as well as GLIDER WORK of any description. Write for information regarding AERONAUTICAL work of any kind and then compare our prices with others.

*Aeroadster* CONSTRUCTION COMPANY  
3751 INDIANA AVENUE, CHICAGO, ILLINOIS  
This ad guarantees all our claims

## AngloModel Aeroplane Mfg.

Ready Models

2' BLERIOT \$5.00 2½' ANGLONETTE \$7.00

561 West 147th Street New York City

Knockdown \$1.50 This machine we positively guarantee to fly 800 to 1000 feet or money refunded. WE CARRY SUPPLIES.

## Apply for Catalogue "P" of the Moteurs Rotatifs

(Rotary Motors)

# F I E U X

## For Aeroplanes

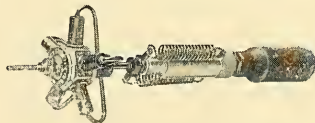

Works and Offices:

**57 Rue Cambronne, Paris, France**

**AGENTS WANTED**

Agents Wanted in all the Principal Towns of the United States, Canada, Mexico and South America

## COOKE BIPLANES

*Curtiss Improved 1912 Type (Pigeon Tail)*

Perfect fliers. No freak construction. Ten years' experience. Strongest in the world. Ample powered (Roberts Motors.)

Anybody can fly these machines. One ready for immediate delivery **\$2,500**

Free Instruction to Buyer

H. C. COOKE, 127 West 64th St. NEW YORK CITY

NOW is the time to buy Aeronautical

# SUPPLIES

at prices that will astound you, and the Best Quality included. Have you received a copy of our latest book on this subject

"EVERYTHING AVIATIC"

Containing a completely revised AERO DICTIONARY and valuable information regarding Hydroaeroplanes, Pontoons, Monoplanes, Biplanes, Motors, Propellers, Gliders, Raising Gears, Models and all kinds of supplies. Profusely illustrated. Send names and addresses of three persons actually contemplating or building aeroplanes, a red stamp for postage and we will send you a copy. Do it now.

HAMILTON AERO MFG. CO., 208-30th Avenue, Seattle, Wash.

## A VALUABLE SOUVENIR,

Which you will be proud to wear, will be distributed absolutely free of cost by the Sloane Aeroplane Company. The souvenir will be expensive. It is to be handed to those who are actively affiliated with any branch or phase of the aeronautical industry. In order that we may be able to estimate the number of souvenirs we need, please write us immediately your name and address and in what way you are connected with the aeronautical industry; also send us the names any of your friends and associates whom you think should receive one of the souvenirs.

**SLOANE AEROPLANE COMPANY**

Charavay Propellers. Sloane Planes. Parts.

1731 BROADWAY, NEW YORK CITY



PROPELLERS for model aeroplanes; light, smooth aluminum blades; variable pitch; steel shaft accurately and secretly attached; 3 1/2 in. 10c., 6 in. 25c., 8 in. 35c., 10 in. 50c., 12 in. 75c. Post-paid. Low quantity prices. Jersey Skeeter Aeroplanes 25c.

LINCOLN SQUARE NOVELTY WORKS  
Department B 1931 Broadway, New York

### DETROIT AERO POWER PLANT

COMPLETE \$300 READY TO RUN

INCL. PROPELLER-CARBURETOR-BOSH MAGNETO.  
OIL PUMP-CABLE-SWITCH-MOUNTING BOLTS.

IS GUARANTEED TO  
210 LBS. MIN. STATIONARY THRUST  
158 LBS. MAX. WEIGHT (COMPLETE)  
36 HOURS DELIVERY

LIFT AND FLY  
CURTIS BYPLANES  
BLERIOT XI MONOPLANES  
DEMOISELLE MONOPLANES  
OR CRAFTS OF SIMILAR MAKE

DETROIT AEROPLANE CO.  
DETROIT MICHIGAN

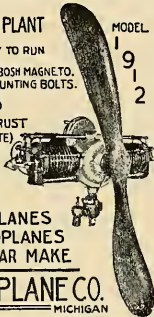

## IN PATENT MATTERS

An experienced Mechanical Engineer can Advise You Better, Protect You Better, Develop Your Idea, Improve Your Invention.

G. M. SACERDOTE, M. E.

Patent Attorney, Registered in United States Patent Office  
1919 BROADWAY, N. Y. CITY Tel. 8690 Columbus  
FRENCH and ITALIAN SPOKEN

## PATENTS THAT PROTECT AND PAY

Advice and Books Free. Rates Reasonable.  
Highest References. Best Services.

WATSON E. COLEMAN, Patent Lawyer  
622 F St., N. W., Washington, D. C.

## PATENTS SECURED or Fee Returned

Send sketch for free search of Patent Office Records. How to Obtain a Patent, and What to Invent, with list of Inventions Wanted and Prizes offered for Inventions sent free. Patents advertised free.

We are experts on AIRSHIPS and all patents and technical matters relating to AERIAL NAVIGATION.

VICTOR J. EVANS & CO. Washington, D. C.

**PUPILS** desiring tuition on genuine Farman and Bleriot machines should get my special rates before entering any other school. F. Brauning, 1717 Broadway, New York, N. Y.

## BAMBOO Special Grades of Bamboo for AERONAUTIC WORK

Reed, Rattan and Split Bamboo for Models. All sizes in stock. Tonka Rattan for Skids, 1 1/4 inch and under, any length.

J. DELTOUR, Inc.  
804 Jefferson St. Hoboken, N. J.

## HOW TO SPEAK IN PUBLIC



Give Grenville Kleiser (former Yale Instructor), fifteen minutes of your time daily at home and he will teach you by mail how

to make after-dinner speeches, propose toasts, tell stories, make political speeches address board meetings; his Mail Course will help salesmen sell more goods, develop power and personality, improve memory increase vocabulary, give poise and self-confidence; it will help a man earn more, achieve more. "Your Course has been of great service to me in my business and I commend it to others in the highest terms," says Joseph P. Day, New York's foremost auctioneer

If you'll write to-day, we'll tell you all about it by mail.

## FUNK & WAGNALLS CO.

Dept. 435  
NEW YORK

## Principles and Design of Aeroplanes

By Herbert Chatley

A text book on Aeroplanes, containing many details and drawings.  
Price, 50 Cents.

Lawson Publishing Co.  
37-39 East 28th Street New York City



## 1800-FOOT RECORD

1912 Type "ROBIE" RACING MONOPLANES

3-ft. Racer, Twin Propellers, Complete Materials.

Drawings and Instruction \$2.00. Finished \$7.00.

IT PAYS TO BUY of a House FULLY ESTABLISHED. "Known the World Over."

Write for Complete Catalogue (of all sizes), Models and Supplies

ROBIE AEROPLANE CO. :: :: Williamson, N. Y.

## J. C. (BUD) MARS, NOW BOOKING

ADDRESS

17 N. La Salle Street, Chicago, Ill.

## STOCK SIZES—PROMPT DELIVERIES

16"x1 1/2" or 2" 20"x2"-2 1/4"-2 1/2"-3" or 4"

24"x2" or 3" 28"x2"-2 1/4"-2 1/2" or 3"

20"x2 1/4" Wheel less Tire, \$4.00

Each. Stock Size Hub—6" wide.

Ball bearing—3/8" or 1/2" Axle

or bronze bushed to

fit 1"-1 1/4" or 1 1/2"

Tubular axle—

Any width

Hubs to

Order

20"x2 1/4"

Complete

with Tire,

\$5.75. 20"x3"

Complete with

Tire, \$8.25. Com-

plete Farman Type

Running Gears, \$42.50.

Deposit required on orders—

balance C. O. D. Examination allowed.

J. A. WEAVER, Jr., Mfr., 132 W. 50th St., N. Y.

## WIRE

Aviator Wire supplied in 12 sizes with a plate finish, making soldering easy. This wire is specially drawn from extra quality high grade steel. Also Aviator Cord of twisted wire.

John A. Roblings Sons Co.

TRENTON, N. J.

## AEROPLANE RADIATORS

IN STOCK OR TO ORDER

SEND FOR PRICE LIST

EL ARCO RADIATOR CO. 6 EAST 31st St., NEW YORK

Swiftly skim over the western wave,  
 Helicop—tear!  
 High up from the misty mariner's grave,  
 Where all alone in the pale moon's light  
 Thou weavest dreams of joy and fear  
 Which make thee terrible and dear—  
 Swift be thy flight!

Mark thy course by the Polar Ray,  
 Star o'er-fraught—  
 While far in arrears the eye of day  
 Comes blazing—hot!  
 Beat him until he wearies out—  
 Then away to the hangar and lightly land.  
 Touching the earth like a feathered wand—  
 Come—long sought?

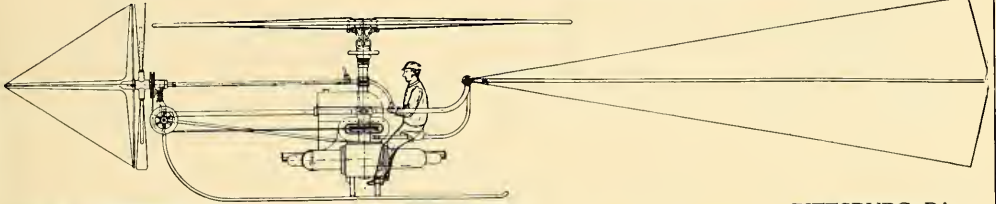

JOS. E. BISSELL

Box 795

PITTSBURG, PA.

# “ROOLD”

FOR SAFETY HELMETS  
 AVIATION SUITS  
 UNBREAKABLE GLASS GOGGLES

“EVERYTHING FOR THE AVIATOR”

50 Avenue de la Grande Armee, PARIS

Official Contractors to the French and Russian Armies

# NAIAD Aeronautical Cloth

Manufactured Especially for Aeroplanes and Used by  
 Aviators of Prominence

LIGHT, STRONG, AIR-TIGHT

AND  
 MOISTURE-PROOF ON BOTH SIDES

Sample Books, including Data and Prices, sent on request

THE C. E. CONOVER CO.

101 Franklin Street - - New York

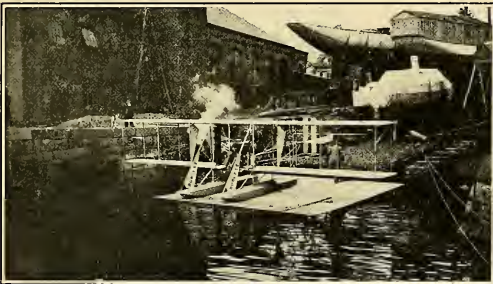

“THE PASSING OF THE YACHT”

The Burgess Hydro-aeroplane is epoch making. It has brought flight into the field of yachting.

Wherever there is a small body of water, at the summer place, by the sea, on inland lakes and rivers, the Burgess Hydro-aeroplane meets the demand of the sportsman for safe flying.

In the 1912 models we offer no untried experimental devices, simply refinements in construction, additional strength and durability. Both the hydro-aeroplane and aeroplane may be started by the operator while in the machine.

The following aviators, when free to choose their own aeroplanes, selected a Burgess type:

- |                      |                     |                         |
|----------------------|---------------------|-------------------------|
| C. Grahame-White     | H. N. Atwood        | C. K. Hamilton          |
| Lieut. T. D. Milling | Clifford L. Webster | H. W. Gill              |
| T. O. M. Sopwith     | W. R. Brookins      | U. S. Navy (hydroplane) |
| Phillips W. Page     | U. S. Army          |                         |

Training on Burgess Hydro-aeroplane equipped with duplicate control, under the instruction of licensed aviators only, may be secured during February and March at Daytona (aeroplane), Ormond (hydro-aeroplane), Fla., Los Angeles, Calif., or Marblehead, Mass., weather permitting.

## BURGESS COMPANY & CURTIS

Dept. C

MARBLEHEAD, MASS.

# To Builders and Those Contemplating Building



SEND 4 cents in STAMPS for our illustrated catalogue of monoplane and biplane parts and fittings. We manufacture all the woodwork and metal fittings used in the construction of HEAVIER-THAN-AIR machines. OUR facilities are UNLIMITED—OUR Quality and PRICES—unbeatable. Allow us the privilege of estimating on your list of wants. WE CAN SAVE YOU MONEY AND TIME.



### SPECIALS

1 in. round post sockets	- 8 .10	20x2½ in. wheels and tires	- 8 6.60
Oval post sockets	- - .16	20x3 in. wheels and tires	- - 9.15
Lock turnbuckles	- - .49	5 gallon tank	- - - 6.00
Plain turnbuckles	- - .06½	Blenior rubber shock absorbers (set of 4)	- - 50.00
Steering post and wheel	- - 8.75	2, 3, 4 way terminals	- - - .04
Flexible seats	- - - 5.40		

## New York Aeronautical Supply Company

Suite 62-3-4-5

50 Broadway

NEW YORK

\$1200 to \$4800

**THE**

**REX**

**MONO-PLANE**

**CO.**

South Beach, S. I. N. Y.

**DUPLICATE PARTS**

at

**SAVE 50% COST SAVE 75%**

**Buy a REX Monoplane and Save**

\$500 to \$1000 on Purchase.

\$250 Tuition Fee to Learn to Fly.

50% to 75% on Maintenance.

The REX, with its interchangeable wings, makes it possible to enter Speed, slow and passenger contests during the same day. **WHAT OTHER AEROPLANE CAN DO THIS?**

Remember, we **Guarantee Before delivery** to fly the REX at **Least 1000 Feet High and 10 Miles** across country.

We Supply an Extra Pair of Racing Wings with each REX.

We Duplicate Parts at Absolute Cost, a Saving of 50% to 75% in Maintenance.

**THE REX MONOPLANE CO. South Beach, S. I., N. Y.**



SIDE VIEW OF 1912 HEINRICH MONO-BIPLANE MODEL (A).

1912

## Heinrich Mono-Biplanes

The only Aeroplane built to take two sets of wings, Monoplane or Biplane, practically two machines in one, at the cost of one, and takes up the space of one. Built in the following sizes: Biplane wings extra.

- Model (A) single seat, high speed, cross country type, \$900 without motor
- Model (B) two seat, cross country type with 100 H. P. Motor \$2,550
- Model (C) three seat military type, with 100 H. P. Motor \$2,800
- Model (D) special type, single seat, with 25 H. P. 2 cyl. Motor \$1,000

**Heinrich Bros. Baldwin, L. I., N. Y.**

Particulars and illustrated booklet sent free on request

**Farman Running Gears** **\$47.50**  
Complete as Above

### Aeronautical Supplies

Everything to build any type flying machine

New catalogue with working drawings of Curtiss, Farman and Bleriot type machines, in course of construction and will be mailed free upon request to all interested parties as soon as received from the printer. Write for quotations.

**A FEW IMMEDIATE DELIVERY PRICES**

- Curtiss Seats - \$5.50
  - Oval Post Sockets - \$0.17
  - Curtiss Steering Wheels - \$9.00
  - 5 Gallon Tanks - \$6.15
  - Out Rigger Fittings - \$0.29
  - Aluminum Pulleys with Brass Bushings 2"-2 1/2"-3" - 25c., 30c., 40c.
  - Aviator Caps - \$1.25
  - Wheels and Tires complete Eclipse Hub 20 x 2 1/4" - \$6.75
  - 20 x 3" - \$9.50
- Free with every \$50.00 order for Aeronautical Supplies

**FLEECED LINED AVIATOR CAP**

**E. J. WILLIS CO.,** 85 CHAMBERS STREET  
67 READE STREET  
Tel. 3624 Worth NEW YORK CITY

## FRONTIER MODEL A

**8 Cylinders**  
**60-70 H. P.**

**V. Type**  
**Water Cooled**

Four and three quarter lbs. per actual Horse Power

Flying time will soon be here.  
Place your order early and  
avoid delay : : : : : :

WRITE FOR CATALOGUE AND PRICES TO-DAY

**Frontier Iron Works Buffalo, N. Y.**





TO COMPETENT GRADUATES we FURNISH a STANDARD-TYPE AEROPLANE PRACTICALLY WITHOUT COST.



# AVIATORS WANTED

We Are the Real Western Pioneers  
We **TEACH FLYING** on (CURTISS FARMAN BLERIOT) **Machines.** NO BREAKAGE CHARGED

We MANUFACTURE ANY TYPE AEROPLANE and make a specialty of HYDRO-AEROPLANES.

ALL our machines are GUARANTEED TO FLY and GUARANTEED as to MATERIAL and WORKMANSHIP.

HOME STUDY COURSE (Theory and Aerodynamics.)  
CONSTRUCTION COURSE (Aerial Engineering.)  
AERO-MOTOR COURSE.  
FLYING COURSE.

OUR BASIC PATENTS GIVE US PROTECTION.

*Our Prices are the Lowest.*

*Full and Honest Value.*

FLYING EXHIBITIONS BOOKED FOR COMING SEASON.

Send for our **SPECIAL OFFER No. 2 TODAY.**

# LEARN TO FLY

## Milwaukee School & College of Aviation

S. E. COR. GRAND AVE. AND FIFTH STREET,  
MILWAUKEE, WIS.

School-Shops, Hangars, Flying Field, foot of 64th  
Ave., West Allis, Wisconsin.

# BLERIOT MONOPLANES

(GENUINE)

## Winners of ALL the European Contests in 1911

In 1909---The First Aerial Crossing of the Channel.

In 1910---The "Circuit de l'Est."

In 1911---The Paris-Rome Race (1st and 2d.)

The European Circuit (1st and 2d.)

The English Circuit (Daily Mail Race.)

The Belgian Circuit.

The Saint Petersburg, Moscow Race.

The Valencia Alicante Race.

The London to Paris non-stop Raid, etc., etc.

WORKS AND OFFICES: - - 39, Route de la Révolte à Levallois - - PARIS  
and Belfast Chambers, 156 Regent St., LONDON

AVIATION SCHOOLS: Etampes, near Paris during Summer  
Pau, during Winter

FRANCE

ENGLAND

Hendon, near London

# Points of Actual MAXIMOTOR Superiority

Every one of them vitally important to the aviator's security.

Get the list. Check them over.

You'll find every advantageous feature to be found on any American aeromotor---and many more on the MAXIMOTOR alone.

This is broad.

Won't you investigate it?

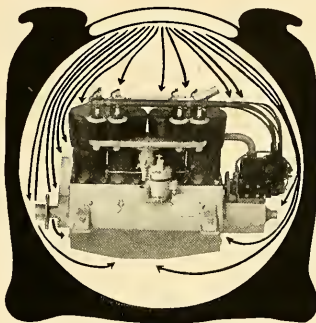

"SAFETY FIRST" has been the governing aim in building the 1912 MAXIMOTOR.

No fatal accident ever occurred with the MAXIMOTOR in over a year's flying of scores of planes under all sorts of conditions the world over.

We intend to keep the record clear.

1912

## MAXIMOTOR

*If you'll give details of your plane we'll be glad to advise you on the power plant question*

MAXIMOTOR MAKERS  
DETROIT  
52 CRANE AVENUE

Dept 16

In Making

No engine is better than its bearings. At aeromotor's continuous high speeds, long bearings cannot stand up. The flights stopped in mid-air by "burnt" bearings prove it. **ALL** bearing trouble is eliminated by the MAXIMOTOR'S crankshaft ball bearings which last as long as the engine.

In Flying

"Your MAXIMOTOR stands up; is dependable; continues to run until stopped by the aviator. In short it is an ideal aviation motor." Prominent Lawrence, Mass., Civil and Electrical Engineer who flies the 40-50 MAXIMOTOR.

# ... The Wittemann Biplane ...

HAS A REPUTATION, NOT ONLY FOR PACE, BUT FOR QUALITY AND SERVICE

Write for information of 1912 Biplane with our new auxiliary stabilizer.

If you want to build a machine of your own design or parts thereof, we can help you to make it successful. Some parts of your plane can be made of steel. We rid you of the annoyance of constant repairs and insure absolute safety.

Send us your specifications and requirements and secure our quotations.

Large stock of steel fittings, laminated ribs and struts of all sizes carried in stock.

Own a Wittemann Biplane Glider; the best, the safest, easiest to operate, and enjoy flying in a moderate form.

## YOUR OPPORTUNITY

Two single cover biplanes for immediate delivery; slightly used, perfect condition with 8 Cyl. 60 H. P. Hall Scott power plant.

Write for Particulars.

Write for Catalogue.

### C. & A. WITTEMANN

Aeronautical Engineers

The Oldest aeronautic manufacturing concern in the United States.

Established 1906.

Works: Ocean Terrace and Little Clove Road.

Staten Island

New York

# THE AERO CLUB OF AMERICA

*Announces the*

# First Annual International Aeronautical Exhibition

*Will be held on MAY 9th to 18th at the*

**New Grand Central Palace**  
NEW YORK CITY

*For information regarding space for exhibits  
of completed Aeronautic Machines, Motors,  
Accessories, Models, etc., make application to*

**THE SHOW COMMITTEE**

**AERO CLUB OF AMERICA**

297 MADISON AVENUE

NEW YORK CITY

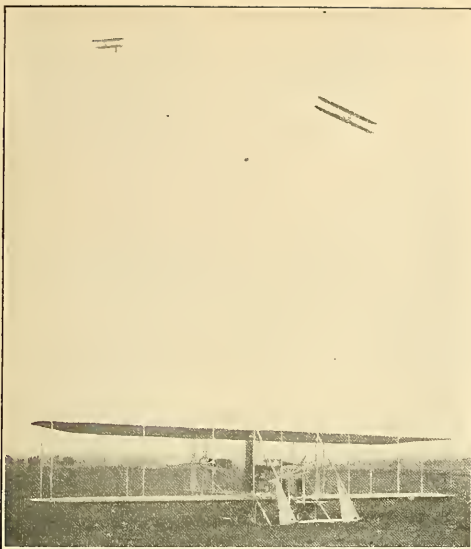

# The Wright Flyer

## 1912 MODELS

In addition to these features which in the past have made Wright Flyers famous for efficiency and reliability, the new models can be furnished with **Automatic Control, Silent Motors, and Hydro-planes.** These special features make the 1912 machine unusually attractive to sportsmen.

## EXHIBITION MACHINES

For exhibition work we have other models especially adapted to high winds and small fields. It was a stock "EX" Model that Rodgers made his wonderful flight from coast to coast. Reliability means dollars to the exhibitor.

## WRIGHT SCHOOL OF AVIATION

Training consists of actual flying, in which the pupil is accompanied by a competent teacher. No risks and no expense whatever from breakage. The most famous flyers in America are graduates of our school and include such names as

Lieut. Arnold	Drew	Lieut. Rodgers
Atwood	Elton	Parmalee
Brookins	Lieut. Foulois	Page
Brinlley	Fowler	Reynolds
Bonney	Gill	Simmons
Beatty	Lieut. Lahan	Turpin
Burgess	Lieut. Milling	Welsh
Coffyn	Mitchell	Webster
Capt. Chandler	C. P. Rodgers	and many others.

Our School at Dayton is now open and pupils may begin training at once if they wish. By enrolling now you can reserve date most convenient to you for training. Write for particulars.

## THE WRIGHT CO.

Dept. "B"

DAYTON, OHIO

## BUILD YOUR OWN MACHINE

We furnish the material. Wood and metal parts for Biplanes or Monoplanes, single and double surface. Latest in design, easy to assemble and take down for transportation. We have them either in solid or laminated wood. Our Propellers are as good as the best. If you have a broken one or one you would like a duplicate of send it to us, and by means of a machine we have we will make you a duplicate within 1-100 part of an inch, and allow you \$5.00 off any of our regular prices.

WRITE FOR A 1912 CATALOG

**WOLVERINE AERONAUTIC COMPANY**  
DETROIT, MICH.

## BALDWIN

### VULCANIZED PROOF MATERIAL

For Aeroplanes, Airships, Balloons. First Rubberized Fabric on the market. Lightest and strongest material known. Dampness, Heat and Cold have no effect. Any Strength or Color.

### "RED DEVIL" AEROPLANES

That anyone can fly. Free Demonstrations

### HALL-SCOTT MOTORS

Eastern distributor. 40 h. p. 4-cyl.; 60 and 80 h. p. 8-cyl., on exhibition at Frank Schumacher's, 164 W. 46th Street, New York. All motors guaranteed. Immediate delivery.

### EXPERTING

Will install a Hall-Scott free of charge in anyone's Aeroplane and demonstrate by expert flyer. Expert advice. \*Planes balanced.

**CAPT. THOMAS S. BALDWIN**  
Box 78 Madison Sq. P. O., New York  
**AEROPLANES**

## SUCCESS

Rests with you when you purchase a Fox De Luxe Aero Motor. The best Aviation Motor on the market today for endurance, power and efficiency.

Illustration shows 50 H. P. Fox De Luxe Aero Motor 4 cylinders 4 $\frac{3}{4}$  x 4 $\frac{1}{4}$ , with Bosch Magneto and Propeller.

We build other sizes. Write today for catalogue

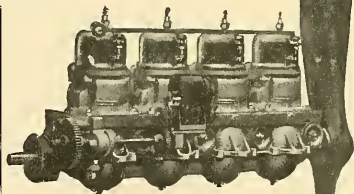

50 H. P. Fox De Luxe Aero Motor

### Expert Report on Fox Aero Motor Endurance Test

Lieutenant John Rodgers, U. S. N., detailed for Aviation, writes on April 9, 1911:

"After witnessing a six-hour run during which time the engine maintained a speed of between 1000 and 3000 R. P. M., I shut down the Fox De Luxe Motor shown in cut. At the end of the run the motor was cool and in good condition ready to start again."

For Details, Sizes and Prices Write

**THE DEAN MFG. CO.**

225 Front Street, Newport, Ky.

# Hall-Scott Aviation Power Plants

USED AND ENDORSED BY PROFESSIONAL AVIATORS

LOS ANGELES INTERNATIONAL MEET:—14 Entries used HALL-SCOTT EQUIPMENT, Over 50 Per Cent.  
OAKLAND INTERNATIONAL MEET:—7 Entries used HALL-SCOTT EQUIPMENT, 70 Per Cent.

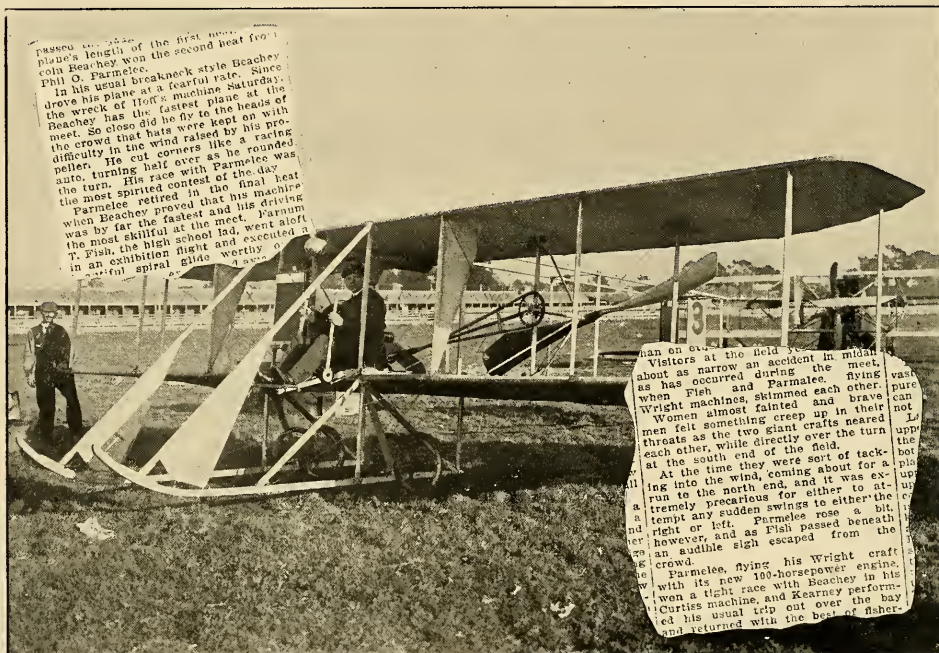

Phil. O. Parmalee in his double propeller bi-plane, equipped with HALL-SCOTT SILENT 60 H. P., Power Plant

What an installation of HALL-SCOTT EQUIPMENT, in two propeller machine, means:

Ideal cross-country flying, no irritating noise, plenty of power to fly fast on half throttle, with 50 per cent. reserve power for high speed work, and passenger carrying, no vibration, wonderful flexibility of control and the possibility of climbing without the necessity of leveling off every few minutes.

The installation in Mr. Parmalee's machine was made in a very substantial manner, and the HALL-SCOTT COMPANY are in a position to furnish any of these three types of power plants, ready for immediate installation and service.

Mr. Howard W. Gill has recently purchased a HALL-SCOTT 60 H. P., plant for installation in his Burgess Curtis double propeller machine. Mr. J. Gage has obtained wonderful results with his twin tractor bi-plane, with HALL-SCOTT 40 H. P., installation, and in a test flight carried three passengers in addition to the operator.

INSTALLATION BLUE PRINTS FURNISHED UPON REQUEST

HALL-SCOTT MOTOR CAR COMPANY, San Francisco, California

# CURTISS MOTORS

ARE USED BY

The majority of professional men in exhibition work. Three governments. Old experienced aviators, year after year. The people who are doing "real flying."

**WHY NOT BY YOU?**

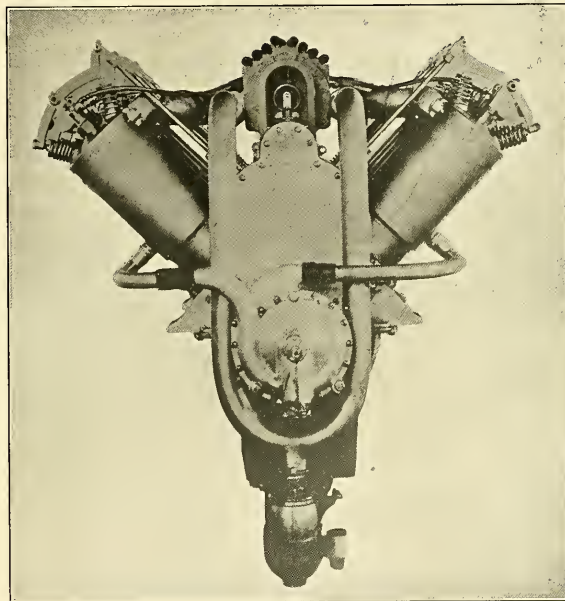

---

*Four  
cyl.  
40  
H.  
P.*

---

---

*Eight  
cyl.  
75  
H.  
P.*

---

*MODEL "O" 8 CYL. 75 H. P.  
(Developed 86 H. P. in French Government Test)*

**MAXIMUM  
POWER**

**WONDERFUL  
RELIABILITY**

**UNUSUALLY  
ECONOMICAL**

**IMMEDIATE DELIVERIES ON COMPLETE POWER PLANTS**

Our illustrated catalog X gives detailed information and is free for the asking. A copy will solve your motor problem. Write for it to-day.

**The CURTISS MOTOR CO., Hammondsport, N. Y.**

# The Roberts Scores Again

The Benoist Biplane from which Captain Berry made the first *Parachute Drop* in the history of aviation was powered with a 6-X ROBERTS MOTOR



ANTHONY JANNUS (Pilot). CAPT. BERT BERRY (Parachutist).

ON March 1, 1912, at 2:50 p. m., Capt. Berry dropped from this plane at an altitude of 1,500 feet, landing safely on the Parade Ground at Jefferson Barracks, St. Louis, Mo.

***NO MORE DARING FEAT HAS EVER BEEN ACCOMPLISHED.***

Only their absolute confidence in the machine and the motor made the feat seem anything but foolhardy.

They knew the machine and the motor were to be relied upon and this confidence gave them courage.

You should know more about the wonderful **ROBERTS MOTOR.**

SEND FOR CATALOG TODAY

**The Roberts Motor Company,**

1463 Columbus Ave.,  
Sandusky, O., U. S. A.



# AIRCRAFT

Vol. 3 No. 3

MAY, 1912

15 Cents a Copy



THE LATEST WATER SPORT

René Caudron in the Caudron airboat starting from the platform in one of the events at the Monaco Hydro-Aeroplane meet

# THESE MEN MADE *Aircraft*

## The Greatest Aeronautical Magazine on Earth

They furnished the bone and sinew of the first three volumes of *Aircraft*, making them a work of reference of which none other extant is comparable.

This list not only includes the greatest Aeronautical writers in the world, but also the very greatest Aeronautical Scientists, Aeronauts, Aviators and Aeroplane and Balloon Builders as well.

### *These are the Contributors to AIRCRAFT*

Hudson Maxim	Clement Ader	Hon. George von L. Meyer (Sec'y of U. S. Navy)
A. Lawrence Rotch	R. E. Honeywell	D. E. Connor
Denys P. Myers	Henry L. Call	Van M. Griffith
Sir Hiram Maxim	Horace Geigh Hopkins	Baron Ladislav d'Orcy
Louis Paulhan	Wm. F. Turnbull	A. Heinrich
Hiram Percy Maxim	E. L. Buchanan	Theo. H. Gibon
Israel Ludlow	H. A. Toulman	A. P. Herff
G. F. Campbell Wood	H. La V. Twining	Emil Buergin
Walter H. Phipps	John M. Crowley	W. Nicholson Jennings
Edward H. Young	Claude Grahame White	James E. Plew
James S. Stephens	D. E. Ball	Ernest Ohrt
Hugo C. Gibson	John Jay Ide	Professor David Todd
C. G. Grey	Henry A. Wise Wood	H. O. Ejane
John G. Hanna	Philip P. Baldwin	D. W. Starrett
Louis Bleriot	Major S. Reber	Earle L. Ovington
Arthur Wiener	Alfred W. Lawson	A. F. B. Silvanetto
Robert Esnault Pelterie	Cortlandt Field Bishop	Lee S. Burridge
Glenn H. Curtiss	T. R. MacMechen	Wright Brothers
Augustus Post	Thomas Preston Brooke	Melvin Vaniman
Brig.-Gen. James A. Allen	Louis Breguet	Capt. W. Irving Chambers (U. S. Navy)
William R. Rumlmer	S. H. Paterson	Albert Adams Merrill
Gustave R. Thompson	Henry Woodhouse	
Charles K. Hamilton	James V. Martin	

☞ Bound in book-form and ready for the library table or shelves of individual or association, two volumes of AIRCRAFT are now offered as a solid entity of incomparable value to the student of, and to the enthusiast in, matters aeronautic.

☞ As an ornament for any booklover's delectation, as well as a monument to the birth and to the lightning-like development of human flight, and as a faithful reflection of its intricate and amazingly-rapid history, these volumes of America's great magazine of aerial navigation, valuable as they are now, will in years to come, when travel by air has reached as advanced a stage as that by water has to-day, constitute an hereditary asset—literary, historical, scientific—of unique worth.

☞ It is "VOL. 1 and 2" of an Aeronautical Encyclopedia.

☞ A Reference which any library or club cannot afford to be without; one which every thinking individual requires for the accuracy and completeness of his information on the latest triumph of the genius of Man.

☞ The number of copies available for sale is very limited, owing to the scarcity of one or two of the numbers.

Price per copy, delivery to any part of the United States, prepaid:

Cloth Bound, \$3.50 Each Volume.

## THE LAWSON PUBLISHING COMPANY

37-39 EAST 28th STREET, NEW YORK, U. S. A.

# THE CURTISS HYDROAEROPLANE

Was the **FIRST** and is now, the most perfect machine of the sort in the world

It has been officially recognized by the Aero Club of America as representing the greatest advance in aviation in the year 1911 — and that year furnished many marvelous achievements in aviation.

It can be described in this one striking sentence:

**“The Acme of Ease, Safety, Comfort and Exhilaration”**

*It is  
Motor Boat  
plus the  
ability to  
fly*

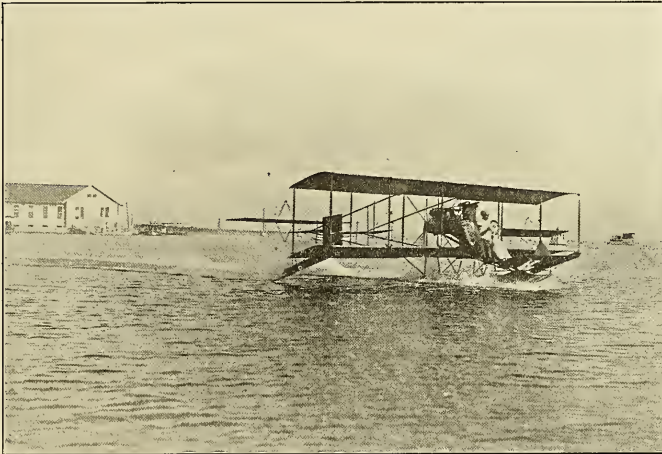

*It has  
been widely  
imitated  
but never  
equaled*

“Hydroaeroplaning” is the coming sport. It appeals to **everyone** interested in Flying **and** Boating.

The Curtiss “**Triad**” is as Safe as a Power Launch and as Swift as a Sea Gull.

## CURTISS AEROPLANES AND HYDROAEROPLANES

Will comprise the largest separate exhibit at the great Aeronautical Exhibition to be held in New York May 9-18. Come and see them and compare them with others. Immediate delivery can be made. Place your order now.

**THE CURTISS HYDRO MAKES IT SAFE FOR EVERYBODY TO FLY**

*:: :: For our 1912 Catalogue, with prices and particulars on :: ::  
CURTISS Aeroplanes and Hydroaeroplanes, Motors, Schools and Exhibitions, write to*

## THE CURTISS EXHIBITION CO.

1737 BROADWAY

NEW YORK CITY

SALES AGENTS AND FOREIGN REPRESENTATIVES FOR

**The Curtiss Aeroplane Co., Hammondsport, N. Y.**

# GIBSON

We have consistently refrained from any attempt to persuade the public by mere argument and advertisement that **our propellers are the best.** That method never lives.

We have consistently **refused to build** propellers for the purpose of producing a **high thrust when anchored** to the ground. We know that such a propeller will tend to keep the would-be flyer on the ground. It fools him by an appearance of value.

We know that a propeller must be built to give maximum thrust when **in flight.** We proved it. We are the only concern in America to make an exhaustive series of tests at the only propeller testing plant in America---that of the Worcester Polytechnic Institute. Those tests were made under flying conditions.

We found that **our propellers, designed for flying,** gave under flying conditions **30 per cent. more thrust per horsepower** than those whose only merit is the great thrust they will show on a scale anchored to the ground.

That is why Beatty conquered every other Wright machine---he had our propellers.

We want to do as well for you---to help you fly---to discuss the subject with you and submit to you Prof. Gallup's curves of actual results obtained at flying speeds. It costs you nothing to confirm this. We feel sure that you really want to have this valuable data in your possession.

Let us have your inquiry. We will send you "Proof by Test" by return mail.

**GIBSON PROPELLER COMPANY, 197th St. and Amsterdam Ave., New York City**  
'Phone 6762 Audubon

# PROPELLERS

Our exceptional manufacturing facilities enable us to make

**Prompt and Quick Deliveries on Monoplanes or Biplanes**  
of the following types:

**"Bleriot" "Nieuport" "Farman" "Curtiss"**

*Exact duplicates of the originals to the smallest detail.*

**SINGLE, PASSENGER, RACING AND MILITARY MODELS**

Special machines to your own design and specifications. We guarantee our machines to be superior in workmanship and materials to those manufactured by any other concern here or abroad, regardless of price paid.

*Complete with any motor you select or prefer, demonstrated in flight.*

*Completely assembled ready for power plants.*

*Knockdown, all parts fitted and finished, ready for assembly, holes drilled, etc.*

All latest improvements and modifications at not more, and even less, than others charge for old-time and obsolete models. Consider this carefully.

We invite your personal inspection of our well equipped factory, where at all times you will find opportunity to inspect our careful method of constructing, under skilled experts.

**SPECIAL NOTICE** OUR SCHOOL, under the direction of Mr. I. Semenouk, French Licensed Pilot No. 326, Bleriot Graduate, operating Bleriot and Farman type machines, specially equipped with dual controls, at your service. Tuition fee applied to purchase of machine.

It will be worth while to deal with a responsible concern. Look us up. Write at once.

**INTERNATIONAL AERONAUTIC CONSTRUCTION CO.**

MEMBERS AERO CLUB OF N. Y.

OFFICE, P. O. BUILDING, JAMAICA, NEW YORK CITY

Factory, Hollis, L. I.

Flying Grounds, Nassau Boulevard

# BLERIOT MONOPLANES

IMMEDIATE DELIVERIES

3 MODELS

FROM \$1,500 TO \$10,000

Our BLERIOT MONOPLANES are in every way suited to contest and exhibition work, including speed, altitude, distance and duration, cross country and cross city flying, where thorough, reliable strength and high efficiency are so vitally important.

SINGLE SEATERS

PASSENGER-CARRYING MONOPLANES

RACING MONOPLANES

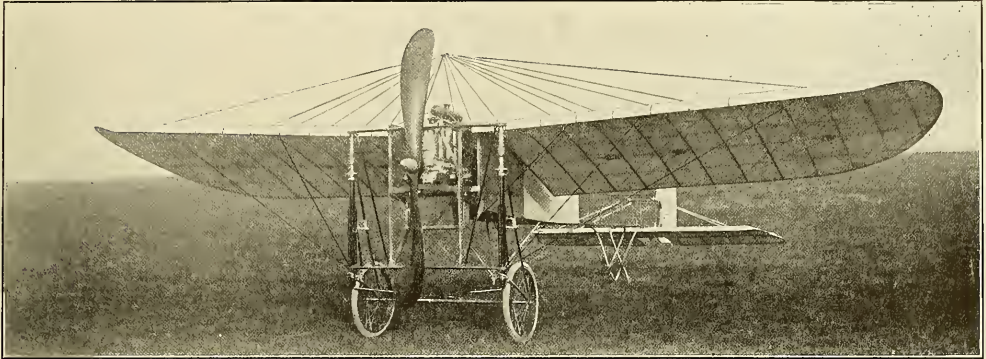

One of our Single Seater Monoplanes (Cross Country type) fitted with 50 H. P. Roberts Engine. Price complete as illustrated, \$2,700  
 All Passenger-Carrying Monoplanes are fitted with twin steering wheels, which enables the pilot to instruct the passenger and still retain control of the machine at all times.

A. C. MENCKES, Memphis, Tenn.  
 E. J. MARLEY, Sumner, Miss.

J. ALBERT BRACKETT, Boston, Mass.  
 A. V. REYBURN, Jr., St. Louis, Mo.

WILLIE HAUPT, Philadelphia, Pa.  
 CHAS. W. SPENCER, Phila., Pa.

Visit our factory and examine in detail the EXCELLENT CONSTRUCTION of our Monoplanes  
 Write for 1912 Catalogue, giving specifications and prices.

AMERICAN AEROPLANE SUPPLY HOUSE

137-143 Jackson St., Hempstead, L. I., N. Y.  
 Telephone 427 Hempstead

**T**HE SEASON OF 1912 is now in full swing. **OUR NEW ILLUSTRATED CATALOGUE** just from the press, fully covering **BIPLANES, MONOPLANES** and **AVIATION** requirements to date, with many **NEW FEATURES** and unassembled **CURTISS** and **BLERIOT TYPE PLANES**.

Send 6 cents postage and secure a copy.  
 Wherever you find **AVIATION**, you find us.

Telephone BROAD 1521, with long distance connection

**New York Aeronautical Supply Co.**  
 (Suite 62) 50 Broadway New York

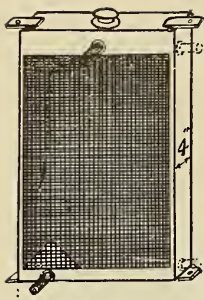

\$36.00 up

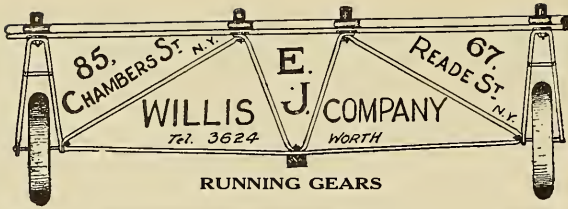

RUNNING GEARS

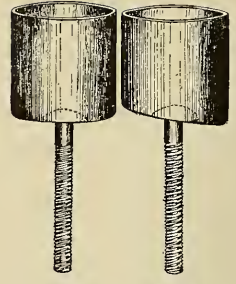

15 cts. to 25 cts.

**Aeronautical Supplies**  
**READY FOR IMMEDIATE SHIPMENT**

10 cts. to 24 cts.

7 cts. to 18 cts.

**NEW 1912 CATALOGUE NOW READY** *With Working Drawings of*  
**Curtiss, Farman and Bleriot Type Machines Mailed FREE**  
**EVERYTHING NECESSARY to build ANY TYPE FLYING MACHINE**

The following low prices apply on orders for immediate shipment only

- Curtiss Seats ..... \$5.50
- Curtiss Steering Wheels ..... 9.00
- 5-gallon Tanks, 2 conical ends ..... 6.15
- Outrigger Fittings ..... 29 cents

- Oval Post Sockets ..... 17 cents
- Farman Running Gears ..... \$47.50
- Wheels and Tires complete, 6 1/4 in. hubs. 20x2 1/2, \$6.75. 20x3 ..... \$9.50



From \$5.50 up



## PROPELLER PERFECTION



Patented March 14, 1911; July 25, 1911; October 17, 1911; Others Pending.

Paragon Propellers are **exclusive** in their design and construction—made under the protection of numerous United States Patents which recognize and protect their superior features. There are none others like them. Paragon **Strength**, Paragon **Beauty**, Paragon **Efficiency**, cannot be obtained under any other name.

With every Paragon Propeller we give our **engineering skill and experience**—and the perfect **security of our guarantee** of superior results. Wood and workmanship alone are not sufficient.

The **proof** of what we say is in the **results**. We might publish an endless array of calculations and diagrams. These might have a value to the designer, but **practical results** alone appeal to the purchaser and user. Our booklet will tell you something about practical results. May we send it?

Our success has brought us a reputation for special skill and knowledge in our line and we are prepared to make good that reputation with every customer.

We furnish propellers for all standard machines, but if your requirements are special we can make up quickly whatever you require and **guarantee** the results. Let us hear from you.

**American Propeller Company :: :: Washington, D. C.**

Makers of the Celebrated Paragon Propellers



The above picture shows a number of Breguet tractor biplanes assembled upon their testing grounds in France preparatory to their delivery to the French Government. This picture is proof to some extent of the forward movement of the aeronautical industry, especially in France, where there are about forty other prominent manufacturers of aeroplanes as well as Breguet.

**CONTENTS--MAY, 1912**

Importance of Aeronautical Armaments . . . . .	Hudson Maxim	71
The Aeronautical Manufacturers' Association . . . . .		73
Editorial . . . . .	Alfred W. Lawson	74
Revolutionizing Air Travel . . . . .	Melvin Vaniman	76
A Straight Talk to the Manufacturer . . . . .	Denys P. Myers	79
Hydroairmanship or Airboatmanship . . . . .	Captain W. Irving Chambers, U. S. Navy	80
An Analysis of the Farman Control . . . . .	Albert Adams Merrill	81
Foreign News . . . . .		82
German News . . . . .	Stella Bloch	83
Monaco Hydro-aeroplane Contests . . . . .	(Illustration)	84
Tractor Screw Biplanes . . . . .	Walter H. Phipps	85
Scale Drawing of the Breguet Military Biplane . . . . .		86
Scale Drawing of the Avro Biplane . . . . .		87
General News . . . . .	D. E. Ball	88
California News . . . . .	Ernest Ohrt	88
The Trade . . . . .		90
Advertisers' Index . . . . .		104

**AIRCRAFT**

ALFRED W. LAWSON  
*President and Treasurer*  
ERNEST C. LANDGRAF  
*Secretary*

**Published Monthly by The Lawson Publishing Company**  
37-39 EAST 28th STREET, NEW YORK, U. S. A.  
Telephone, 5017 Madison Square

ALFRED W. LAWSON  
*Editor*  
WALTER H. PHIPPS  
*Ass. Editor*

**TERMS TO SUBSCRIBERS**

In the United States, Mexico, Puerto Rico, Guam, Philippine Islands, Hawaiian Islands, Cuba (including Postage), \$1.50 per year.  
Fifteen Cents the Copy, of All News Dealers.  
Foreign Subscriptions, Two Dollars per year.  
In changing order give old as well as new address.  
Advertising copy must be in hand by the 1st of month previous to date of publication.  
Only high-grade advertisements of thoroughly reliable firms are solicited.

**WHEN YOUR SUBSCRIPTION EXPIRES**

One month before a subscription expires we enclose a renewal blank on which you will write your order for the renewal.  
WHEN FIRST NOTICED that your subscription will expire, you should send your renewal AT ONCE, in order not to miss a number. New subscriptions which are received by us on or before the 15th of any month will begin with the issue of that month. If received after that date they will begin with the following month's issue. We cannot enter subscriptions to begin with back numbers. One month's notice is necessary before a change of address can be made.

Entered as "second-class matter" February 18, 1910, at the Post Office, at New York, N. Y., under Act of March 3, 1879.  
Copyright, 1912, by the Lawson Publishing Co.  
"Aircraft" is registered as a trade-mark by the U. S. Patent Office, under date of August 9th, 1910.

# Aeroplane Motors and Equipment Co.

NEW YORK



1780 Broadway

Tel. Col. 1335

The Latest Development in Aviation  
*"Bleriot Family Aerocar"*  
 Driven by 100 h. p. Gnome Motor

Prepare  
 for  
 International  
 Meet  
 at  
 Chicago

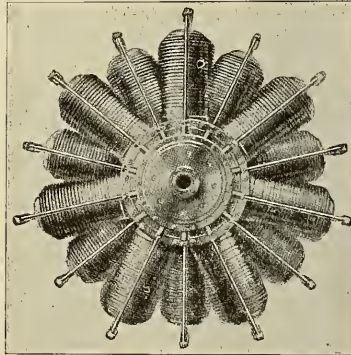

It will take  
 one of  
 Our Motors  
 to win the  
 Gordon-  
 Bennett  
 Cup Race

## MOTORS

Gnome — Renault — Clement Bayard

50 h. p., 70 h. p.,  
 100 h. p., 140 h. p.

50 h. p., 70 h. p.

25 h. p., 30 h. p.

In Stock for Immediate Delivery

Spare Parts on Hand for All Motors

Customers' Motors Overhauled and Repaired

IMPORTED AEROPLANE CLOTHS



# A R C R A F T

Vol. 3, No. 3

NEW YORK, MAY, 1912

15 CENTS A COPY  
\$1.50 A YEAR

## IMPORTANCE OF AERONAUTICAL ARMAMENTS

By HUDSON MAXIM

**HUDSON MAXIM**, although a great patron of the arts, has given most of his attention to chemistry, engineering and the natural sciences during his remarkably active career. In 1896 he built a dynamite factory and smokeless powder mill at Maxim, N. J., where he developed the first smokeless powder to be adopted by the United States Government. In 1897 he sold the smokeless powder invention to E. J. du Pont de Nemours and Company, Wilmington, Del. In 1901 he sold to the United States Government the secret of his invention known as Maximite, the first high explosive to be fired through heavy armor plate. He is also the inventor of a detonating fuse for high explosive projectiles, and has perfected a new smokeless powder of his invention known as Stibellite. He is the inventor of a new system of driving automobile torpedoes of the Whitehead type by means of a self-combustive material known as Nitrotrone. He invented the process now in general use in the United States for making calcium carbide continuously by the electrical resistance of a molten tarlike conductor, removing the carbide as fast as formed, and simultaneously supplying fresh material to the heating field.

were warmed. They strove for knowledge, for wealth, position, power, fame, just as we are striving.

The only lamp that illuminated the darkness of their foreview was experience, and we, like them, can look ahead only by the light of experience; and when we do not heed that light, when we neglect to heed the lessons of history, we are destined to pay the same penalties that all the nations and peoples of the earth have in their turn paid for the same negligence.

The history of nations is an Iliad of wars and human woes. Superstition and science, ignorance and enlightenment, weakness and strength, have always been arrayed against each other, and under that strife and because of that strife, the brute was lifted into manhood, and savage man developed, civilized and enlightened.

In ancient times, war was the principal business of mankind, while the chief warfare of our day is business, though the strife is as strenuous. Avarice urges on ambition with the same spur, and ambition over-rides all opposition, trampling upon prostrate mankind as mercilessly as they were trampled upon under the war-horse and war chariot of olden time.

The character of the strife is altered, but the strife is still as strong as ever it was, for human nature is always the same. The human nature of to-day is the same as it was yesterday, and the human nature of to-day will be that of to-morrow, and to-morrow it will be the human nature of ancient Rome, Persia, Greece, and old Egypt. It will be the same that intrigued and warred and shook the thrones of even sea-sunk Atlantis, whose glory set before the sun of our history rose.

When we read the story of the nations, we are impressed most by the blood-curdling brutalities of old-time wars. It is well-nigh inconceivable to us how human nature could be so cruel, and we do not realize that cruelly was warring with equal cruelty.

It is an old trite saying that history repeats itself. Human nature is always the same under like circumstances.

"We drink the same stream, and we see the same sun,

And we run the same course that our fathers have run."

We feel the chill of winter just as they felt it. We are warmed by the airs of June just as they

The greatest wonder of the lesson that history teaches is not that men were so cruel, but that they were so short-sighted and improvident.

When wars were constant and universal and the dove of peace found no perch except on the sword, it is strange that, with success and opulence, the sword was allowed to rust and lose its edge. We think it strange that success was so quickly and so surely followed with intemperance and all the degenerating debaucheries and luxuries of peace and idleness, and we smile at the irony of fate as we see vanity and arrogance swell and grow from growing weakness.

It seems to have been a decree of nature that Mars should be the commingler of nations and peoples, to unite their blood for mutual improvement, and that when the military spirit of a people should be weakened, vanity and arrogance should grow like mushrooms upon that weakness to invite invasions of some new warlike race, whose martial spirit had been kept alive and keen by constant keen necessity.

Belshazzar and his minions drank and caroused while Cyrus thundered at the gates of Babylon, and the Medo-Persian empire of Cyrus, becoming rich, non-militant and effeminate, went down like a house of cards before the irresistible march of the Macedonian phalanx.

Imperial Rome became a fatted glutton, having no interest in armies or generals, but having cooks salaried as though they were conquerors. The Roman triumph became a triumph of edibles even while the vengeful, fiery Gauls were hovering in clouds upon the northern frontier, gathering for the march to Rome.

The success of the great Napoleon, and the ease with which he swept everything before him, was due not only to his transcendent genius, but also equally to the lack of preparedness and the inefficiency of his opponents.

Now, my dear American reader, we have cause for sincere congratulations, do we not, that the United States is so rich and powerful, and so amply prepared for the undesirable eventuality of war, that, if war should come with any of the great powers, or any combination of them, we should be able to sweep all before us? It is gratifying to feel that the other nations are aware of this fact, and will never dare to tempt us to war.

It is pleasing to feel that we can well afford to devote ourselves entirely to peaceful pursuits and the internal development of the country. It is delightful to be so care-free as we are. It is most gratifying to feel that we should be able, without danger—and that it would be a noble thing to do—to take the advice of our over-zealous, sentimental peace advocates, and disarm entirely, in order to set the other nations of the world a great

How little do we realize that this attitude of ours is but a moral example.

repetition of the attitude that has, through all history, been a fore-runner of disaster!

At the battle of Santiago, we made about two per cent. of hits with our big guns. To-day, at the same range, we would not miss more than two per cent. Efficiency of our gunnery to-day is twelve hundred per cent. better than it was at the battle of Santiago.

Had we disarmed then, as we were advised to do by the over-zealous peace advocates, or remained where we were after the Spanish war, without making further expenditures upon our Army and Navy, we would to-day be absolutely at the mercy of any second rate foreign power, for it would be necessary to send against us but one ship with one gun in order to wipe our Navy off the seas, because that one gun would be more efficient than would be our entire Navy even with a thousand guns.

Warfare to-day is one of science against science, of education and training against education and training. It is largely an engineering proposition, and is altogether an economic and business proposition. When one nation contemplates the wealth of another nation, it is deterred from attempting to acquire that wealth by the difficulty and cost of overcoming the armed opposition to its acquirement. Every coast fortification, every regiment of soldiers, must be taken into account, and the cost of overcoming them calculated; and if there is a good prospect of the plunder being much in excess of the cost of the war, then war is likely to be declared, and, if, on the other hand, the cost is likely to exceed the plunder, then war is not likely to be declared.

Secretary Meyer said, at the recent Convention of the Navy League in Washington, that had Spain been amply prepared for war, we should not have dared to declare war on Spain, and that, had we been so well prepared for war that Spain could have foreseen she had no chance, we should not have had any war either, for Spain would not have dared to fight.

The advent of aviation introduces an absolutely new condition that must be taken into careful consideration by all the nations of the world in their military preparations.

Last spring, at the first annual banquet of the Aeronautical Society, at which I had the honor of presiding, I predicted that the aeroplane is destined to become a very potential war engine and that, in future wars, we should see it doing very valuable service as a scouting craft and for other purposes.

Two prominent speakers on that occasion took exception to my views and said in substance that though admitting the practicability of the flying machine for military purposes, there was likely now to be a lack of available wars, for international disputes would soon be settled by arbitration, and that law would be substituted for war.

Since that time, we have had two revolutions in Mexico, the war between Italy and Turkey, the great revolution in China, the life has been trampled out of Persia, and we have seen the aeroplane performing very important and useful service in Tripoli. We have heard of it in China, and it has proved its value on the frontiers of Mexico. There has been no apparent shortage of wars.

In modern warfare, the chief desideratum is to keep informed as to the movements and intentions of the enemy, the character of its fortifications, and the disposition of its troops. As one famous general has said, the chief thing nowadays is to find out what the enemy is doing behind that hill. The flying machine is able to do this.

As I have said in previous articles,—the flying machine takes war into the third dimension. Heretofore warfare has been conducted chiefly as a series of siege operations on the two-dimensional plane of the earth's surface. It has heretofore been necessary to send spies through the enemy's lines, and to send out reconnoitering troops in force to be frequently ambushed and slaughtered.

All this will now be changed, for the flying machine can easily spy upon all the dispositions and operations of an enemy and make plans and take photographs.

Hannibal ambushed and destroyed the whole Roman army at

Lake Thrasymenus, because the Romans knew nothing of the whereabouts of Hannibal.

Alexander and Darius passed each other a few miles apart without either knowing anything of the proximity of the other.

Lack of knowledge of the whereabouts of Lee's army before the Battle of Gettysburg spread terror through the North, and both terror and conurbation in the city of Washington; while, on the other hand, Lee's lack of knowledge of the whereabouts of the Army of the Potomac made the presence of that army, drawn up in line of battle on Cemetery Hill, a surprise to him.

At the Battle of Antietam, my brother Henry was a dispatch bearer and rode the line of battle from one end to the other, frequently dodging cannon balls. The cannon ball of that time traveled only about two hundred feet a second, and was quite as easy to dodge as is a baseball. He saw nearly four Federal regiments shot down at one fire by a force of Confederates under cover of a wood, because the Northern troops did not know that the Confederates were there.

At the Battle of Mukden, with its firing line two hundred miles long, how impossible it would have been for horse and rider to bear dispatches from end to end of that line. As the Japanese army advanced in a line having a length more than ten times the distance that the eye can compass from horizon to horizon, telegraph and telephone wires were stretched from headquarters to every strategic point, and communication with extreme right and extreme left of the whole van line was instantaneous. The stoical, pleasant-mannered little Japanese general sat at a table in his tent, studying a map, which was stuck with pins having different colored heads. The pins were changed from time to time as the Japanese line of attack advanced. How important then was the telephonic and telegraphic means of communication! How superior to the old-time mounted messenger!

Similarly will the aeroplane prove itself superior in the acquisition of premonitory war news. Battles must now be fought under the eye of the world. Surprises in force are things of the past, and manoeuvre and counter-manoeuve, counter-mine, and counterplot, will take the place of many a bloody engagement.

So important will be the flying machine in future campaigns that the nation which shall, from lack of its appreciation, make no proper aeronautical preparations, will find itself well nigh at the mercy of an opposing force equal in strength, but possessing the necessary aeronautical equipment.

Not only must the future army be provided with aeroplanes for reconnaissance, but also it must be provided with veritable aerial fleets; for no military force will allow an opposing force to spy upon it from aeroplanes without opposing them with other aeroplanes. It will be found a very great essential for contending armies not only to spy upon each other, but, also, to prevent being spied upon in return.

By consequence, then, it will be necessary first to clear the sky of an enemy, and place him at the disadvantage of being spied upon, without the ability to obtain corresponding information in return.

Aerial military operations, therefore, will be quite as important as those which will be conducted upon the land, and it will be found impractical to proceed with military operations upon the ground except under the guidance of aerial operations, and it will become an adage of future warfare—He who would conquer upon the earth must first conquer the sky.

This country is unfortunately far behind the other great powers in its aerial military equipment. Most Americans believe that we are so rich and numerous that we need few if any armaments, oblivious to the fact that he who has much money in his pockets is not so safe against the attack of the highwayman as he who has no money. Our wealth is no protection. Our numbers cannot avail.

The wealth of this country is more than one hundred and thirty billions of dollars, and yet we allow little Japan, with a wealth of little more than seven billions of dollars, less than a twentieth of our wealth, to outstrip us in many indispensabilities to national defence. (Continued on page 78)

# THE AERONAUTICAL MANUFACTURERS' ASSOCIATION



HILE capital and Congress may be somewhat tardy in showing signs of aeronautical life in America, the manufacturers of aircraft and accessories in this country at least have shown that they are right up to the times and a little beyond.

Having recognized the fundamental principle of development, which is organization, they have taken time by the forelock and created the Aeronautical Manufacturers' Association of America and now lead the rest of the world in this branch of aeronautics, even France being behind the United States in this respect.

The Aeronautical Manufacturers' Association was organized in New York City on April 29th, 1911, under the laws of the State of Connecticut. Its officers are: Ernest La Rue Jones, President; Alfred W. Lawson, Vice-President; Frank A. Seiberling, Second Vice-President; F. D. Wood, Secretary; and John B. Maus, Treasurer.

Already it contains almost all of the leading manufacturers of aeroplanes and accessories in this country.

The objects of the association are:

"To foster the interest of those engaged in the trade or business of manufacturing aircraft or accessories through establishing, conducting and managing exhibitions, displays, tests, trials and demonstrations;

To reform abuses relative thereto;  
To secure freedom of its members from unjust or unlawful exactions;

To gather and diffuse accurate and reliable information as to the standing of merchants and others dealing with members as to all transactions, patents, processes or devices designed or intended for use in, upon or in connection with aircraft and accessories and the manufacture thereof, as to the state of the art relative thereto, and as to the condition and development of the trade in which the members are engaged, in the United States and foreign countries;

To procure conformity and certainty in the customs and usages of such trade;

To foster and promote the art of aeronautics;  
To establish, conduct and operate means and places of disseminating information as to the adaptability, construction and use of such means and systems of aeronautics and accessories, parts and equipment;

To promote and encourage in all lawful ways the adoption and enforcement of laws and regulations providing for and securing safety, convenience and comfort in the use, keeping and operation of aircraft;

To encourage and assist in the establishment and maintenance of improved courses, signals, signs of direction and all other means of rendering the use of aircraft more secure and attractive;

To afford opportunity to the members of associating and interchanging views with one another, and establishing customs, plans and systems, to the end that the manufacture, disposition and use of aircraft may be improved, the services to and the re-

quirement of the trade better appreciated and fulfilled to the mutual advantage of the manufacturer, dealer and the purchaser of such vehicles and property;

To gather, obtain and procure information and intelligence for the use and benefit of its members and to the credits and standing of firms, corporations and individuals;

To arrange and care for the machines of members of this corporation at shows, race meets and other places;

To establish a laboratory for the compilation of aerodynamic data;

To standardize material and adopt uniform formulas;

To secure the enactment of laws for the licensing of machines, and traffic rules;

To secure proper transportation rates, etc.;

To find means for the restriction of dangerous practices and the investigation and exposition of frauds:

To conduct or encourage endurance, speed and other tests, the arranging of tours;

To acquire by grant, gift, purchase, devise or bequest, to hold and to dispose of such property as the purposes of the corporation shall require, subject to such limitations as may be prescribed by law, including inventions, letters patents and processes, or rights thereunder, for the benefit of its members and not for pecuniary profit."

Section 1 of the by-laws relating to membership is as follows:

"Any individual, firm or corporation engaged in manufacturing, jobbing, dealing in aeronautical supplies or solely devoting themselves to the interests of the trade,

in the United States, whose application is approved by the Membership Committee, may become a member of this Association upon complying with all the rules, regulations and requirements in relation thereto, and subject to the provisions of the articles of incorporation of this Association and the by-laws, and all amendments thereto and rules and regulations hereafter adopted. Applications for membership must be made according to prescribed forms and be endorsed by at least one member of the Association."

There can be no doubt that this body of manufacturers is in a position to do a great deal of good toward the progress of the aeronautical movement; in fact, the very foundation of the movement itself rests upon the shoulders of the men who not only build the machines, but who invest their capital in the production of them.

Unity of effort on their part, therefore, is absolutely necessary and if properly applied will result in not only greater strength and influence of each individual manufacturer, but the combined labors of the whole will result in the upbuilding of the industry in less time than if their labors remained separate and distinct.

Every industry has its great trade organization and this Aeronautical Manufacturers' Association is the trade organization of the American aeronautical industry. Those manufacturers, therefore, who are not already members should join at once and help to build up a body that will be able to protect in the most efficient manner the interests of one and all.

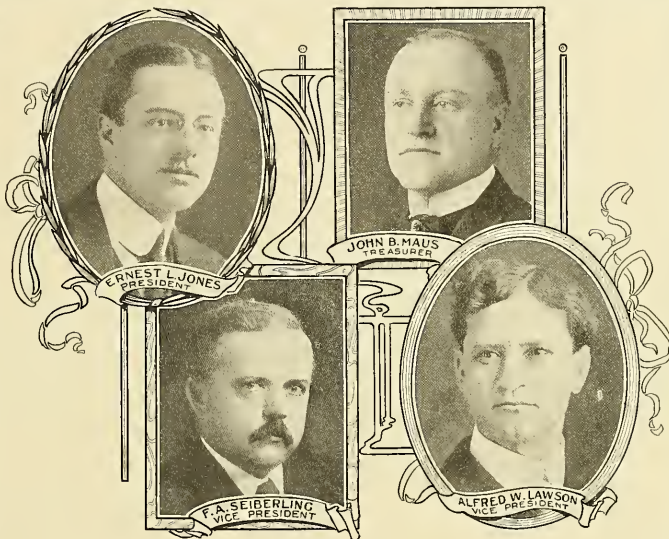

ERNEST L. JONES  
PRESIDENT

JOHN B. MAUS  
TREASURER

F. A. SEIBERLING  
VICE-PRESIDENT

ALFRED W. LAWSON  
VICE-PRESIDENT

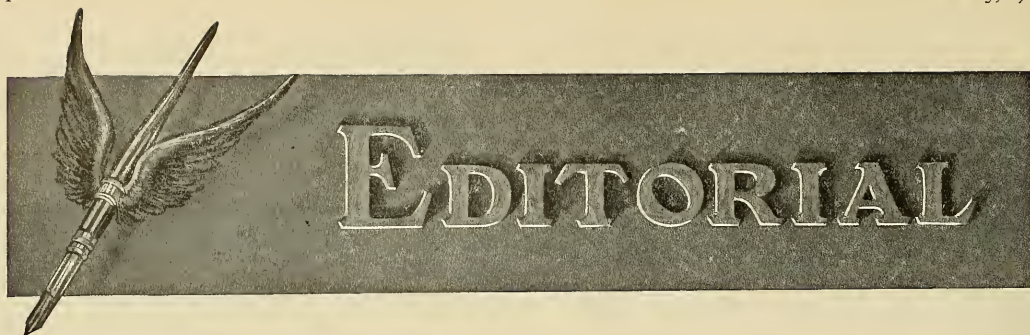

### ATTENTION, CONGRESS.

**S**AY, look here, Mr. United States Congressman, you have an idea that you are just as intelligent—a little more so perhaps—than the man who makes the laws in England, have you not?

You think that you are just as wide awake—or a little more so—than the man who makes the laws in Germany, do you not?

You believe that you are just as capable of looking into the future and preparing for what must come as the man who makes the laws in France, do you not?

Then if you think so, why don't you prove it? Don't you know (and if not, why not) that not only have France and Germany and England run away from this country in the development of aircraft by reason of large governmental appropriations for army aerial work, but that there are several other countries of the world who have outdistanced us for the same reason?

What position in the aerial procession must the United States Army take. Must it follow along after the Turk and Chinaman? Or are you willing to live up to your usual boast that America leads the world in Progress. If so you will have to move lively from now on. Europe has been setting a fast pace lately.

Let us tell you something you ought to know, something you ought to think seriously over; something you should take immediate action upon: For every flying machine the United States Government has contracted for today, France has contracted for, approximately, fifty. For every man the United States Army has in its aerial service today, France has more than fifty. For every dollar appropriated by the United States Government for aerial service in its Army today, France has appropriated approximately fifty.

So you will readily see, Mr. Congressman, that it is fifty to one in favor of France against the United States in this important field of human accomplishment. Now, under these conditions, do you really think that America leads the world in Progress?

What we want you to consider at the present time is that the United States Army needs immediately both money and men to develop its aerial service properly, and be it understood thoroughly that while money can be given at any time, officers, to become efficient pilots and observers, require years of special training for that purpose. In fact, it takes at least two years to turn out

a competent aeroplane pilot who would be of real use under war conditions, so that while money and even machines might be procurable at short notice, neither would have any value if there were no trained officers and men to utilize them.

Moreover, it will even be impossible for our American manufacturers to keep pace with the foreign manufacturers of aeroplanes unless the United States Government gives them the same encouragement by purchasing their machines that France, Germany and England give to their manufacturers of air vehicles, so that in taking prompt action in this matter you will be doing double service; first, by increasing the efficiency of the United States Army, and second, by encouraging the aeronautical industry in America.

You have already appropriated \$75,000 for army aerial work but, strange to say, have not made arrangements to man the machines which even this niggardly amount will purchase. An immediate increase of the number of officers and men in the Signal Corps therefore, is absolutely essential in order to make any progress whatsoever.

While the duties of the Signal Corps have multiplied during the past few years there has been no increase in men for this body since 1903. The War Department has repeatedly called attention to this shortage since 1904, but they have not been given the relief desired. So, Mr. Congressman, we put the matter up to you for attention. It needs it, and needs it badly.

### BIG BUSINESS AHEAD.

**A** report from Germany states that the German War Office has ordered forty aeroplanes from Etrich, the builder of the swallow type of monoplane, photographs of which appeared in the April, 1912, number of AIRCRAFT.

Just stop and consider, Mr. American manufacturer, what this means: an order for forty aeroplanes at one time. It means that the German Government have given a contract to Etrich to build \$200,000 worth of flying machinery, allowing \$5,000 for each machine.

Assuming that only twenty per cent. of this is actual profit for the manufacturer that means \$40,000 profit on one order alone, but that is not all. It will not be long before Germany will not only order aeroplanes in lots of forty but in lots of one hundred or even one thousand. This, no doubt, seems to be a big statement

but that is what Germany or any other first class power will have to do before many years have passed in order to keep in the front ranks of the war game.

After all, one thousand aeroplanes can be built and operated for less than it costs to build and operate one battleship and who can deny that one thousand of these machines hovering over the enemy and out of reach of its guns would be of more service to its country in case of war than the one battleship?

The day will come when every war department will keep whole battalions of well trained and well drilled officers with machines to do not only the scouting work as the primitive aerial prognosticator proclaims, but the actual fighting as well. In the French and German armies ten thousand aeroplanes is not too large a number to expect to see in operation within the next ten years and if in these countries why not in America?

So, Mr. American Manufacturer, this is what you have to look forward to if nothing else, and we think it is well for you to be able to fill these orders properly when the time arrives that large orders are to be gotten.

#### OPTIMISM vs. PESSIMISM.

**T**HE law of opposite rules the universe and thereby causes friction and action.

Thus we have light and dark, heat and cold, strength and weakness, optimism and pessimism, etc. These opposites are in a constant state of warfare. Light fights dark, heat fights cold, strength fights weakness, optimism fights pessimism, etc.

The quantity and quality of the opposites, however, must be equal or otherwise one would eventually devour the other and thus end the struggle. Such a thing as an end being impossible, the battle is merely shifted from place to place, condition to condition, etc.

Just now optimism and pessimism are beginning to war with each other in the field of aeronautics. Up to a short time ago pessimism reigned supreme in this particular territory but now optimism having gotten a foothold therein is fighting its way forward inch by inch, foot by foot and yard by yard until it appears that it must eventually crowd its enemy out of the field.

Optimism is the sword-bearer of success; pessimism is the mud-thrower of failure.

Optimism opens up the avenues of light; pessimism guards the gates of darkness.

Optimism creates warmth and life; pessimism harbors cold and death.

Optimism is the foundation of faith and intelligence; pessimism is the upholder of doubt and ignorance.

Optimism pursues; pessimism is pursued and routed.

Optimism always wins; pessimism always loses.

Optimism defeated pessimism in the fields of railroads, steamboats, telegraphs, telephones and automobiles in the face of overwhelming numbers and optimism will defeat pessimism in the field of aeronautics or any other field which lies in the path of human progress. So if you want to win you must be optimistic or

else you will surely be carried out of the arena upon a short, narrow stretcher by those who will permit no resuscitation.

#### ORGANIZATION MEANS STRENGTH.

**E**VERYTHING is divisible and sub-divisible without limitation and still every particle is necessary to make a complete whole.

Everything in the universe is dependent upon everything else for existence. Therefore, nature is merely a combination of all things. It is a gigantic and complete organization.

Thousands of years ago man discovered that organization meant strength. He discovered that several little men combined could whip one big man standing alone, so he organized for offensive as well as defensive purposes.

This organization work has been going on in every branch of human effort since and is especially noticeable now in the industries of the world. The units of each industry discover that to try and stand alone and fight counteracting external influences successfully and economically is impossible and so a combination is formed for mutual self-protection and development.

So we find that the aeronautical manufacturers of America have been able to size up the situation correctly as indicated by the organization of the Aeronautical Manufacturers' Association, an article concerning which appears on page 73.

We advise all manufacturers to read that article carefully and those who have not yet become members to send in their applications for membership immediately. Remember that this association will be the big stick that will be used to protect your interests and you should add as much weight to it as it is possible for you to do.

You must do your share in shaping and keeping in prime condition the stick that will defend you in case of emergency and inspire confidence in your strength and ability to do things properly.

If, for instance, you can prove to the hired men of your Uncle Sam that you are strong enough to swing a bludgeon the size of a telegraph pole instead of staggering under the weight of a tooth pick, they will feel more like taking some notice of you and giving to the aeronautical industry in this country the encouragement and support necessary to put it upon a healthy and permanent foundation.

#### UTILIZATION.

**I**N future aerial warfare, an important feature of strategy will be to fight the enemy's flock over his own land forces, so that not only will the disabled machines together with their cargoes of explosives fall into the ranks of the enemy, but the carcasses of the dead aviators will be utilized as a destructive force as well, especially if falling upon the heads of the land men below, and thus the aviator will be made to do effective work whether alive or dead.

# REVOLUTIONIZING AIR TRAVEL

By Melvin Vaniman

**MELVIN VANIMAN**, one of the world's greatest exponents of the dirigible, has had, perhaps, more real adventure in experimenting with it than any other man on earth. He is an engineer of marvellous resourcefulness and clear understanding of the problems of mechanical flight. It was Vaniman who built and operated the Wellman dirigible which made two attempts to reach the North Pole from Spitzbergen in 1907 and 1908. It was Vaniman who re-constructed and operated the same airship "America," which attempted to cross the Atlantic Ocean, October 15th, 1910, and after traveling over one thousand miles in seventy-two hours the ship was abandoned near Bermuda, October 18th. In 1911 Vaniman began building the transatlantic airship "Akron," which is now ready for trial. Vaniman built and flew a triplane in Paris in 1908. He invented the movable steel military dirigible sheds used by France, Russia and Spain. His inventions include an aerial sextant, speed and direction indicator for dirigibles, hydrogen carburetor, orientable propellers; but his most important invention is the steel fabrics for dirigibles as described herewith.

FOR a number of years, aeroplane enthusiasts have had the air field to themselves, have held the stage of public performance and have represented in the public mind, the much advertised "age of the air" and that popular mania known as the "aviation craze." They have amused themselves with various "developments," dropping

bombs down the stacks of helpless battleships, on water and with every performance the predictions have enlarged until they include the complete revolutionizing of warfare, the annihilation of armies, the carrying of mail, the replacing of automobiles and even of railroads. Developing the machine to cross the ocean, with landing stages mid-sea for fuel, is one of the aeroplane's latest coups to say nothing of flying as the birds, without engines, the prophets apparently forgetting that the birds never leave their perch without having plenty of fuel and a most excellent and economical motor.

If the adherents of heavier-than-air machines would confine themselves to developing the aeroplane for its sphere of work, their progress would be more definitely satisfying, and not so many people would bemoan the financial and commercial futility of the results.

I admit, in the earlier stages of the game, having myself attempted to build an aeroplane to do the work of a dirigible and of realizing a signal failure. The two machines have different spheres; as different as that of the steam yacht and battleship, the motorcycle and touring car. The dirigible will not take or monopolize the sphere of the aeroplane, nor will the aeroplane take the place of existing modes of travel.

The destiny of the dirigible, so far as one may at present predict, is to add to present means of travel. It will provide the largest pleasure civilization has yet enjoyed, and that it will be practically one of the safest pleasures will call into play the resource of civilization's skill and put to use the tools that have been preparing for man's hands to accomplish journeys through the air. Travel by land and by sea, beneath land and beneath sea are accomplished facts. Travel in the air is, from a pictorial standpoint, the next logical step and, as I shall show, one which will be realized in the immediate future, practically, economically and with undreamed-of possibilities of an ideal delight.

The difficulties of the dirigible have been the same that put a limit to the scope of the spherical gas bag. The modern type of dirigible can steer in the air, can rise and descend by planes and engines, but otherwise is "sister under the skin" to the helpless bubble which is controlled solely by releasing gas or throwing over ballast.

The present type of dirigibles have not one feature that is more than an expedient, a compromise with the power of the air, not a solution or in any sense an effective conquering of the old problems. These problems have not lightened or lessened; the sun continues to shine and expand the gas and draw the aerostat to unsafe altitudes when gas or ballast must be released, and the great vessels have continued to be at the mercy of winds and fluctuating temperatures. All the planes, engines, rigid and non-rigid structures and various forms of ballast have been additional refinements that in no way touched the quick of the air problem, and there has never been, in any practical sense, an air vessel at home in its own element.

In the "Akron" I designed every feature to solve these timeless difficulties; my purpose was not to circumvent the air problem, but to attack it; yet at the time I did not dream that my work would lead to a practical, definite outcome which will assuredly revolutionize the science of air navigation and allow the world in its present generation a practical realization of air travel. Probably if there were more than a scant few capable and creative engineers working upon the dirigible balloon this solution would have been arrived at long ago.

To overcome the loss of gas by expansion under heat, the gas bag of the "Akron" was made of heavier material than any ever used before in dirigible construction, this thick material, allowing the least possible escape of hydrogen, permitted a further control of the gas by its air chambers, the inner ballonets, which inflated, compress the hydrogen in the envelope, decrease its lifting power and add to the balloon the weight of air, which is fourteen times heavier than that of hydrogen gas, and in a lighter-than-air machine must make a considerable difference. In this way, by compressing the hydrogen and adding the weight of air, the "Akron" may be controlled in sunshine with the added feature of the changeable water ballast, which is scooped from the sea by the hydroleveter, a device of self-filling tanks, which are wound by engine up into the car on a cable and the water stored in rubber buckets and emptied out at will as it is desired to lighten the vessel of weight.

One might say that invention, like man, must crawl before it can stand alone and run. The "Akron" represents that delicate stage of between. In the fall, it will be remembered, the "Akron" made a trial flight. It was a short journey of a few hours, but the experience was of incomparable value. At a height of 2,000 feet we had engine troubles and to effect a safe landing I used the control of the gas bag, pumped air into the ballonets added weight, decreased lifting power and brought the ship gently down. That adventure supplied the thought germ which later on developed the idea of a steel fabric envelope.

When the strenuous time was over, I began to work on the suggestion of that control. The proposition which presented itself was simply this: if I could evolve a gas fabric in which hydrogen could not expand and could not escape, that is, a balloon of fixed volume, I would have a well-nigh perfect solution, since it would not only be possible, but necessary, to use an air control, making the old-fashioned ballast obsolete. It was a proposition well worth the conquering.

Experimenting on these lines, I evolved a cloth of web-like



MELVIN VANIMAN.

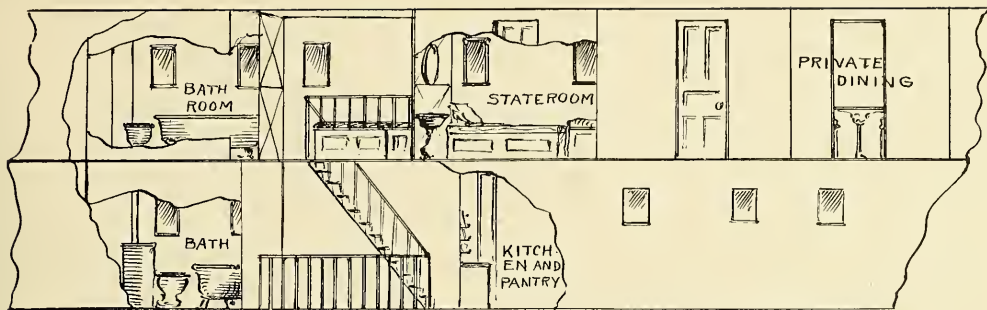

SECTIONAL DRAWING SHOWING THE ARRANGEMENT OF THE DIFFERENT COMPARTMENTS OF THE TWO DECKS OF VANIMAN'S LATEST AIRSHIP.

steel piano wire as the woof and cotton as the warp. The weight of such a material is amazingly light, yet when it has been adequately rubberized, and is in a finished state, a steel shell would not have a greater strength. To realize fully the power of such an envelope, one must first understand how it is made. The gas shell, to begin with, will be 52½ feet long by 52 feet in diameter. It must be made upon a large form in this way: Strips of the material are put on lengthwise, with the steel wires running in unbroken lengths an inch apart, the overlapping seams cemented and vulcanized as applied. The balloon is then rolled and wound around with strips of the fabric, having the wire woven in an inch apart and thus giving the value of a cross weave of wire. The strips, cemented as laid on, are cemented and vulcanized to the inner covering. On the outside the shell is once more coated with rubber, painted and varnished. This process over, keeping the balloon expanded with air pressure, the inside is coated with a lining of jelly-like substance of secret process, which in a test of four years has allowed no escape of gas. The envelope is now practically like an egg shell in its hardness, yet a soft egg shell in a certain pliability to touch; it may be dented by outside pressure, yet will not expand under inner expansion of hydrogen. The hydrogen gas is put into the shell at the coldest hour of the twenty-four, when it has its minimum volume, and is sealed in, not to be again released.

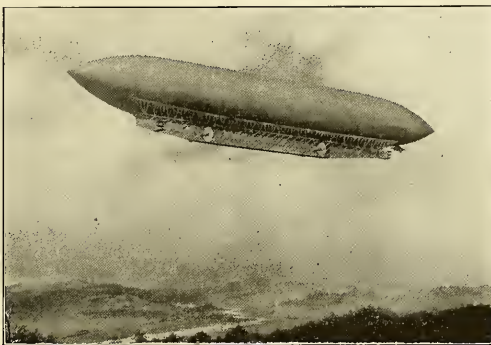

DESIGN FOR VANIMAN'S LATEST DIRIGIBLE.

Here, then, is a balloon which will never have less than its pristine power, through whatever chilly change of temperature it passes, nor will it have more than its determined volume, for the wire fabric will resist 1 6-10 pounds pressure to the square inch,

due to a rise of 50 degrees Fahrenheit. In other words, the first inflation under ordinary circumstances will be its first and only one, the gas cannot expand under the heat of the sun, nor shrink beyond its primal value, and released into the air the shell would seek its plane of safety and float upon an imaginary surface line of air density, the horizon line, one might say, of barometric pressure, as a steamship might be set adrift upon the wandering bosom of the sea. But a derelict ocean liner

that could not be propelled and guided back to port would be scarcely less useless than the dirigible balloon of fixed volume if it could not be brought down, inch by inch from a great height or halted at any desired altitude and held at that altitude under all normal conditions. To effect this control, as has been pointed out, the air itself becomes the possible and necessary control. Within the envelope there will be an inner ballast tank into which air may be pumped by engine. This effect is to compress the hydrogen within the shell, at once depleting its lifting power

and at the same time add the weight of the air used.

If any aircraft of known existing type begins to fall, the pilot must do something every inch of that fall to stop or lessen the catastrophe. In the case of aeroplanes, he must glide to earth. In the case of the dirigible he must release gas, or throw over ballast, use planes and work his engines. But in the airship of steel wire fabric, the pilot must do something every inch of the way to get his ship down to earth. He need use no planes nor engines; as long as he continues pumping air into a ballast tank the ship descends, and when the valve is closed it

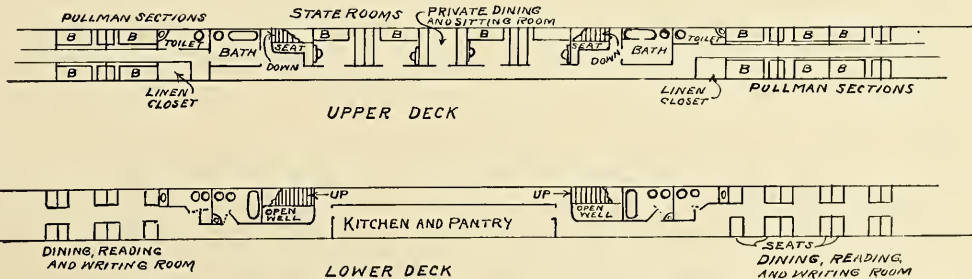

PLAN VIEWS OF THE UPPER AND LOWER DECKS OF VANIMAN'S NEW DIRIGIBLE.

remains at that level and may be kept at that height for days, for weeks, or months. It is instinctive to the pessimistic mind, of which there are a few in the world, to exclaim: "Well, it sounds all right, but it's really too good to be true; it can't be done—something's wrong! How about storms, winds," etc., etc. It is true there are contingencies—a meteor might make a hole in the shell, but otherwise floating on its line of barometric pressure, only one thing will cause the balloon to fall, a barometric depression; but these conditions take place gradually over large areas, and the greatest barometric change that could be experienced would only be a drop of ten or fifteen feet.

The cloth, the machinery and looms for weaving the fabric of the steel-wired dirigible have been patented, and plans and specifications of the new ship are being drawn up. It will be a vessel that requires two decks. The upper deck will be 200 feet long and in this will be the cabins, designed like a Pullman, from which the idea is taken. In the lower cabin will be dining saloons, smoking room, kitchens, etc. and promenade. The engines will be placed forward and in the rear.

Piloting the airship of the future will open a new profession that will demand men whose intelligence is the modern threefold requirement—knowledge good judgment and skill. A knowledge of meteorology must be part of his mental equipment and, in fact, a weather man will keep the lookout as keenly as the watch aboard the ocean liner. The course of a cruising airship will be influenced and charted by weather conditions and land topography; storms moving in different directions, heavy rains or other unpleasant contingencies may be avoided. As to unavoidable storms and head winds, even these present no great impediments to the air traveller. Every-day winds which rattle the shutters and shake the house may be passed over by the airship; anti-cyclonic storms do not rise to a great height, and the pilot's simplest course will be merely to raise his ship and travel above such antagonistic currents. The cyclonic storms of our hemisphere, which move counter-clockwise, will neither seriously hinder an air voyager; the pilot will turn his ship at an abrupt right angle to the circular storm center, be carried beyond it, and find the air stream going in the direction of his goal. It will be a sea of curious changes that he must master. Not alone are the air currents and storm winds to be considered; the pilot

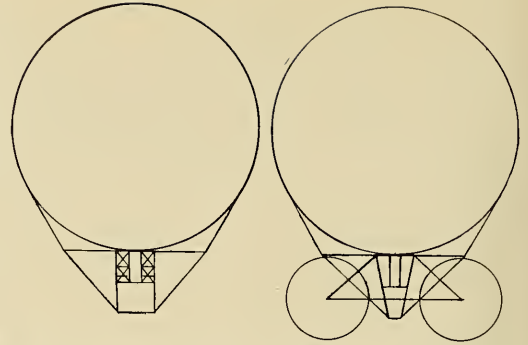

CROSS SECTIONAL VIEWS OF THE VANIMAN DIRIGIBLE. ON THE LEFT THE PULLMAN BERTH SECTION; ON THE RIGHT THE ENGINE SECTION.

will have his charts which show every elevation of land or building that, rising toward the sky, are dangerous according to his determined elevation. High level of land will be marked upon his chart as shoals, extraordinarily tall factory chimneys and skyscrapers will be the rocks and islands of his ocean. Therefore, as one may see at once, the dirigible airship of the future will not take the place of steamships and railroads, since only an approximate schedule could be followed. The commercial usages will be found in handling large tourist ships, which will offer the fascinations of travel in an ideal state. Further than this mission, such ships will be used for scientific exploration, opening valuable mines now inaccessible, and transporting men, provisions and ore or precious stones.

It is the strangeness of the experience that halts the mind at the thought of air travel, but once launched it is destined, so to speak, to catch up the whole world, air travel will be the most comfortable, most safe and economical way to visit distant countries, when the voyager will sit in an easy chair in a cosy saloon and watch the world moving beneath, as if solely for his pleasure.

#### IMPORTANCE OF AERONAUTICAL ARMAMENTS—Continued from Page 72

It has been estimated that the industries in the United States alone, which have come as a development based upon the inventions of Thomas A. Edison, equal seven billions of dollars. Thus one man has been a creator or founder of American wealth practically equal to the entire wealth of the Japanese empire.

It is a favorite argument that, because of our vastly superior wealth, we need not concern ourselves about the war preparations of poor little Japan, but it can do no harm to make a few inquiries and comparisons. War with Japan may be most unlikely. Still the unlikely sometimes happens, and unpreparedness for an unlikely event may render it likely.

General Homer Lea, the author of "The Valor of Ignorance," and the friend and associate and war adviser of Sun Yet Sen, the first President of the great Chinese Republic, told me last summer while visiting me at my country place on Lake Hopatcong, New Jersey, that it costs us twenty-five times as much to feed and pay our soldiers in the field as it does the Japanese to feed and pay its soldiers.

Now, then, though we are twenty times as wealthy as Japan, if the Japanese can feed and pay their soldiers for less than a twentieth of the cost to us, then the cost is less for them in proportion to their wealth than it is for us in proportion to ours.

But this is not all. Our soldiers are twice as big on the average as are the Japanese soldiers, and, consequently, in battle intercept twice as many bullets. The Japanese men can shoot as well as we, and they have proven themselves as brave as any soldiers in the world. There are no better fighters than the Japanese.

If, therefore, a given number of Japanese soldiers could kill

and wound twice as many of our soldiers with an equal number of bullets as we could kill and wound of them, then they would need only half as many men as we to do an equal amount of killing and wounding.

This gives the Japanese an advantage, at the start, of a hundred per cent.

By consequence, then, the Japanese would be able to put and maintain an army in the field at an expenditure of only one-fiftieth of what it would cost us to oppose to it an army of equal fighting force.

Of all the people in the world, the Japanese are the best informed about the military equipment and war preparations of all other nations. They know exactly what we are doing, and why we are doing it. They keep a finger constantly upon the American pulse. They appreciate better than any other people the value of early information.

By consequence, they naturally look to aviation as a very important arm of the Japanese service, for they fully appreciate the value and importance of any advantage over an enemy in matters of reconnoissance.

All who have an open mind for the admonitions of aviation should exert every influence in their power, from patriotic motives, to induce the American Congress to provide much needed aerial equipment, for, should we be called upon to meet a powerful enemy in the field, though we should be able to array against him in every other respect an equal force, with equal preparation, with equal science and equal skill, equal generalship, and equal bravery, unless we should have an equal aerial equipment, we must inevitably be defeated.



# A STRAIGHT TALK TO THE MANUFACTURER

By Denys P. Myers

**T**HE aeronautical manufacturer who lasts through the present season is in the game to stay, unless he hangs himself with his own rope. Business is business, except in the beginning, and so far aeronautical manufacturing has scarcely been business. It has rather been speculation in a new field and its conditions

have been in some degree comparable to those of '49 in California. Yet with all the excitement and hue and cry of those days, the production of gold to-day vastly exceeds its quantity when placer mining was young. Aeronautics up to now has existed chiefly on the fact of its novelty. It is rapidly sloughing off that character, and its future is to depend on its stability as an industry, and on that industry producing a generally marketable and indispensable commodity. In all industry such an advance is registered when the industry leaves its swaddling clothes. And it is well to remember that infant mortality is as large a factor in business as in life.

If you want to succeed, look facts in the face, introduce yourself and establish an undying acquaintance. What follows may not be all the facts, but they are some of the facts, which the manufacturer should appreciate, now that the time is approaching when aeronautical progress is to be governed on a basis of supply and demand. So consider for a moment the row the manufacturer must hoe.

First, aeronautics has become an industry, which means that the fool must keep away. Two years ago almost anybody could raise money enough to build a machine on lines as hare-brained as you please. To-day you have to have the goods to get in at all. Then you could start ten-horsepower companies with one-horsepower ideas. Now it takes more than five minutes of spare time to think up a method of doing something aviatonal and making a fortune out of it. The result is that the legitimate manufacturer with a commodity of merit need not fear the sudden and inflated competition which used to consist in the organization of mushroom companies to build things that belonged in the aeronautical kindergarten.

But as that kind of competition is disappearing, other factors enter. Aerial progress this year will not notably be of the aerodrome. It will rather be a phase of sport, and to an increasing degree the man of means will take a course of aeronautics—as he once did in automobiling—so that he may add to his summer repertory of sport. The older fliers are teaching, because exhibition work is declining; and this means for the manufacturer that his market is moving—perhaps toward Fifth Avenue, or at least toward its outskirts.

The great incentive toward the purchase of a machine in the past has been the idea that the operator would be able to master it and then exhibit at round prices, getting his investment and a handsome profit back. The principal coming market is to be of two kinds: supplying the amateur or semi-professional and catering to the needs of the military departments of the Government. The latter head is worth separate treatment; but it should not be forgotten that as the market shifts from the professional to the amateur the question that is going to be asked is not, "Can I run the thing?" but "Can I run the thing safely and for sport?" The answer is, of course, in the affirmative, and it is

not putting it too strongly to say that the manufacturer who most insists and most clearly proves the factor of safety will do more than any single individual for aviation in the immediate future. Last season the public seemed to take a delight in pointing to every aviation mishap; this year they ought to be made to eat their words, even if they are a year old.

The record of safety—not to speak of the added insurance element of the hydroaeroplane—has increased 1,000 per cent. in twelve months. It would be front page newspaper news if that occurred in railroading. M. Besançon, secretary of the Aero Club de France, in his last annual report showed that in France there had been one death for every 100,000 kilometres flown, while the figure for the previous period was one death for every 10,000 kilometres. In 1911 the kilometres flown amounted to 2,600,000, against 500,000 in 1910. Thirteen thousand 'cross country flights against 3,000; 12,000 passengers carried against 4,800 and 30,000 hours in the air against 8,300. Those figures can yield safety statistics absolutely bewildering to the man who has read three lines in a cablegram of an aviator's death and then pules about the danger of aviation. As the market shifts to a general rather than a specialized public it will be necessary to prove that confidence is warranted, and if I had my way no layman would begin a conversation with an aeronautical manufacturer without being administered doubly potent doses of confidence. Quote the above figures and watch doubting Thomas shrivel up and be blown away—or into the fold.

American aeronautical manufacturers are of three types: those doing business only in this country; those doing business in more than this country, usually by national companies; and those manufacturers who have taken up aeronautics as a side line. The latter class is economically safe, and probably counts on aviation only to swell, not primarily to furnish, profit. The other two classes confront normal business conditions, and will stand or fall on their own merits. Among themselves competition can scarcely be very keen this year, for the market is not yet broad or discriminating enough as yet to distinguish minutely between makes, and it is still large enough for the pest who takes a joy ride in every ten thousand dollar machine demonstrated on Motor Row only to buy a two thousand dollar runabout not to be a factor.

Chiefly the American manufacturer has to make up a tremendous handicap this year as compared with his kind the world over. The manufacturer who has no foreign connections must bear the brunt of this handicap which is found in the appropriations for military aviation. The figures are:

Nation.	Estimate.	Aeroplanes.	
		Owued.	Building.
France .....	\$6,400,000	208	344
Russia .....	5,000,000	50	300
Great Britain.....	1,610,000	16	131
Germany .....	1,500,000	50	150 (?)
United States.....	75,000	7	13

That is, four countries in Europe are spending in this fiscal year \$14,500,000 for aviation and intends to build 925 machines—with Germany uncertain—while the United States is spending \$75,000 and will have thirteen machines to show for it. Of course, not all the money can be devoted to purchasing flying apparatus and accessories, but probably close to \$10,000,000 will be used for that purpose. Manufacturers who have in prospect anywhere near that amount of Government contracts may reasonably expect to live through the year, and might even do enough business with private customers to make a profit.

It makes no difference whether your neighbor is rich if he does not use the power of his money against you. Consular reports state that in 1910 France exported to the United States and its dependencies aeroplanes, balloons and parts to the value of \$138,152, and in 1911 to the value of \$107,846. Aeroplane and

**DENYS P. MYERS**, who has been writing for *Aircraft* since its first issue, is an Aviator by birth, but has lived in Cambridge, Mass., during the last ten years. He is a member of the Harvard class of 1906, and has engaged in newspaper and international legal work since 1905. He was successively reporter, foreign news editor, copy reader and editorial writer on the Boston Herald, served as copy reader for a time on the *Christian Science Monitor*, and has been a copy reader, special writer and editorial writer on the Boston Globe. Mr. Myers has done some special work for New York and other newspapers and some magazine articles. Since 1910 he has been the international law advisor of the World Peace Foundation, founded by a \$1,000,000 gift of Edwin Ginn. He is one of the American members of the International Juridic Committee on Aviation, which has headquarters at Paris and is elaborating a code of laws on aviation. His articles for *Aircraft* have been quoted by Journals in all parts of the world.

airship exports from Great Britain to October, 1911, were \$33,870 in value. The United States, so far as known, has exported two machines from Boston at appraised value of \$3,000 each, and one from New Orleans to Cuba, worth \$2,550. It can be seen that France is already a fair competitor in the American market, and the practical question is whether her manufacturers, along with other Europeans, will be able to build aircraft for their governments at abnormal profits and scalp their prices for the American trade. That is not probable, but it does show the value of a handicap.

As a matter of fact, only France and Great Britain are manufacturing to any considerable extent, and Russia in particular will have to buy many machines abroad, and even now has come to America. It is, moreover, probably a good guess to say that for this year at least the European manufacturers will have all the business they can attend to at home, unless those already established abroad be excepted.

The practical points for the manufacturer to be drawn from these things are that while the foreigner will probably not enter the American field as a competitor to any extent this year, his underlying economic position will be relatively stronger owing to his large business with governmental contracts. Moreover, the growth of flying under government auspices abroad will in no small degree foster the popularity of flight as a sport, and assist in bridging the gap between professionalism and general use of

aircraft. Which is a condition to be envied. If it should so happen that a foreign builder with a capacity of 500 or 1,000 machines a year should decide to send fifty or one hundred to the United States as a surplus output, such rivalry in the American market might spell the difference between success and failure to some native manufacturers.

Now there is no evidence of putting the European handicap on any such use, but that future possibility ought to be kept clearly in mind by the manufacturer who expects to continue in business and die in its harness. On the other hand, we here have the hydroaeroplane developed to an extent it has not attained in Europe, chiefly because it has appealed more to our constructors. We have no monopoly of it, but with it can be made the present necessary appeal of safety and ease in handling which are indispensable in reaching the amateur who desires a new sport and who is henceforth to be more and more the type of man upon whom the manufacturer must depend.

To conclude with a paraphrase of the beginning, the aeronautic manufacturer who successfully solves the problems of this year, marking as it will the beginning of the transition of aircraft from the exhibition stage to that of use by the general public, can reasonably expect to last. May all weather any air holes they encounter! If this article assists the pilot of any business in the aeronautic world, it will have served its purpose.

## HYDROAIRMANSHIP OR AIRBOATMANSHIP

By Captain W. Irving Chambers, U. S. Navy

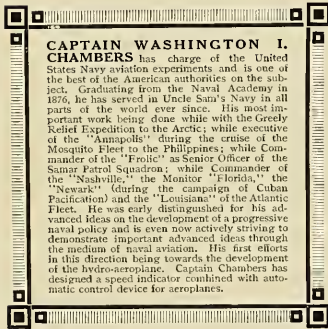

**CAPTAIN WASHINGTON I. CHAMBERS** has charge of the United States Navy aviation experiments and is one of the best of the American authorities on the subject. Graduating from the Naval Academy in 1876, he has served in Uncle Sam's Navy in all parts of the world ever since. His most important work being done while with the Greely Relief Expedition to the Arctic; while executive of the "Annapolis" during the cruise of the Mosquito Fleet to the Philippines; while Commander of the "Frolic" as Senior Officer of the Sanjar Patrol Squadron; while Commander of the "Nashville," the Monitor "Florida," the "Newark" during the campaign of Cuban Pacification) and the "Louisiana" of the Atlantic Fleet. He was early distinguished for his advanced ideas on the development of a progressive naval policy and is even now actively striving to demonstrate superior advanced ideas through the medium of naval aviation. His first efforts in this direction being towards the development of the hydro-aeroplane. Captain Chambers has designed a speed indicator combined with automatic control device for aeroplanes.

**T**HE hydroplane has brought the airman,

the boatman and the seaman together, but airmen, in order to fully appreciate and enjoy the use of that attractive machine, will have to combine airmanship with some of the instincts and experiences of boatmen and seamen.\*

I have been much amused as well as surprised to discover

that certain aviators have curious ideas about the sea. For example, one of our best land flyers wants the Navy to furnish a torpedo boat, capable of steaming at the modest speed of forty-seven miles per hour, to be placed at his disposal (loaded down with press representatives and invited guests, of course) to follow him in a flight across the Atlantic, lying to at night near the positions where he may alight on the water. Another, an amateur, conceived the idea of being the first in such a flight without knowing that he could not depend upon the ordinary mariner's compass to guide him.†

The following suggestions on hydroaeroplane flights have occurred to me in watching such flights both as spectator and as passenger. I do not know whether they meet the views of the

aviators or not, but they show the trend of experimental activities that are desired in the endeavor to reach the goal of safety in flight.

The hydroaeroplane may be placed in the category of a "heavily loaded machine." Its range of speed, i. e., the sector between the "critical limits," is considerably less than in the same machine when used without the hydroplane attachment, but a wide range of speed is desirable.

The use of a standard speed, well within the critical limits, is also desirable during hydroaeroplane flights in fickle winds and it should always be possible to increase the speed of the motor in turning. The turns should not be made too sharp in high winds nor at a low altitude.

With the considerable head resistance and load of the hydroplane the acceleration of speed required for sustentation, on turning to run before a strong wind, requires an appreciable time during which, if too sharp an angle of descent is given for acceleration, the center of horizontal head resistance on the upper surface of the hydroplane, which is applied considerably below and usually forward of the center of pressure of the sustaining surfaces, may suddenly force the machine to dive quickly.

On landing it is always desirable to take the water at a small rearing angle, to avoid sticking the bows of the hydroplane in the water first.

I am disposed to think that it will be possible to land in rough water that has curling wavecrests by coming down before the wind and that it may be possible also to rise from such water by starting with the wind, provided the hydroplane is of the single boat type with balancing hydroplanes on the wings.

Since writing the above the following incident occurred at the Naval Aviation Camp, San Diego, Cal., in which a forced landing was made before the wind:

During a trial of the new navy model hydroplanes for the Wright machine Lieutenant John Rodgers went up in a good stiff breeze with Assistant Naval Constructor H. C. Richardson as an observer. After circling about the bay at about 200 feet altitude, he proceeded up the Spanish Bight towards the Curtiss Camp when two cylinders started missing and a descent was obligatory. To go straight into the wind was dangerous, as the telephone wires to the camp were just ahead, so Rodgers made a left spiral. There was no room to make a complete turn and there

\* Note: The qualities required are worthy of a new term. Shall it be Hydroairmanship, Seairmanship, Airseamanship, Boat-airmanship or Airboatmanship? I incline to the latter term, *airboatmanship*. And now that the French are adopting the term "avion," I would like to see our rural friends pleased by changing aeroplane to *airplane*, fuselage to *body*, chassis to *landing gear*, hydroplane (when applied to airplanes) to *boat* and hydroaeroplane to *airboat*.

† Note: For the benefit of the ocean-crossing aspirants, I will announce that I expect to have, ere long, a practical compass designed to permit of navigating an airship accurately either in fog or at sea. This instrument is another of the class which deserves special attention in advancing the interests of safe flying. Cecil Grace would have appreciated such an aid in his unfortunate Channel flight, and the Italian aviator who started for Sicily and fetched up at Gorgona, as far away from his destination as that point was from the point of departure, would have accomplished his object with such an instrument to guide him.

was nothing left to do but land *before* the wind, which was blowing about twenty-five miles per hour. He landed at a speed between fifty and sixty miles and, although the boats hit rather hard, they took the water as cleanly as could be desired, without any tendency to bury the bows, and they slipped ahead at a high rate of speed without shipping any water. A good landing on the beach resulted.

The landing should always be made either before the wind or directly into the wind and with double hydroplanes special care should be used to prevent side-swiping and to have both boats touch the water at the same time. Lieutenant Rodgers on a previous occasion at Annapolis had his first hydroplanes swiped

off during a forced landing, on a turn, when the machine struck the water sideways.

The speed should not be cut off until after touching the water, as the water resistance will deaden the headway quickly. The sensation of coming down on smooth water is that of softly landing on a cushion.

In running on a beach the speed should not be cut off entirely until the bow almost touches the sand, unless, of course, there be stones or obstructions that may injure the boat. Lieutenant Ellyson frequently runs the robust Curtiss hydroplane well up on the beach before cutting off the speed.

## AN ANALYSIS OF THE FARMAN CONTROL

By Albert Adams Merrill

**ALBERT ADAMS MERRILL** has been a close student of aviation since the year 1890. As far back as 1892 he delivered an important series of lectures upon the subject. In 1895 he formed the Boston Aeronautical Society, which was composed of a few business men and scientists who devoted most of their attention to kite flying and aerial investigation. In 1898 Mr. Merrill made many flights in a biplane glider of his own design, it having 158 square feet of surface and a camber of one in twelve. Several experiments with a whirling table which proved the existence of the soaring vortex, first mentioned by Hargraves, and also a surface having a compound curve somewhat similar to that now used in the Nieuport design, were made by Mr. Merrill and published in the British Aeronautical Journal for July, 1899. At the Harvard-Boston Aero Meets Mr. Merrill was first a member of the Contest and then of the Executive Committee and formulated the rules for these two successful meets. He is a pupil of the Wright School of Dayton, O., and his interest in aviation that of a student anxious to increase the efficiency of and decrease the danger from flying machines.

**T**HE following analysis is made with the idea of finding out the magnitude and effect of the forces brought into play by means of the Farman control.

We start with a hypothetical monoplane, with a Bleriot No. 11 surface of 200 sq. ft., having two flat Farman ailerons of 10 sq. ft. each. The machine is to fly at an

larger angle the actual lift of the right wing will be less than it was in the first place, showing the fallacy and danger of the Farman system.

Suppose now we reverse the Farman system and move the aileron on the left wing to a negative angle of 7 degrees. This will reduce the speed of the left wing to 48.712 m. p. h., the lift of the left wing will drop to 435.66 pounds and the lift of the aileron, which in this case is downward, amounting to 29.528 pounds, will have to be subtracted from 435.66, leaving 406.142 pounds lift on the left wing. As the original lift was 459 with this system there is a righting couple of over 52 pounds, and the machine banks and turns in the same direction, that is to the left, while with the regular Farman system the righting couple is only 6 pounds and the machine banks to the left, but turns to the right. So far as safety and efficiency is concerned the reversed Farman is far superior to the regular Farman.

To mathematicians who may read this I would say that I realize these figures are only approximate ones. To solve the problem accurately one would have to know the moment of inertia of every portion of the machine and the turning moment of every increment of drift. Moreover, I have assumed that the wing not effected would maintain a speed of 50 m. p. h., when, as a matter of fact, it would under certain conditions move at a higher rate of speed. The introduction of resistance would produce a negative acceleration of the whole machine, but if this resistance is put in at the left tip there would be a positive acceleration of the right tip that in many cases would be greater than the negative acceleration of the whole machine, so that the right tip would travel faster than it did before. In other words, starting at 50 m. p. h., by putting resistance into the left tip it is possible to make the right tip go more than 50 m. p. h. without increasing the thrust of the screw. This, of course, comes from the acceleration due to the turning moment.

Lift varies as the square of the speed, but it varies only as less than the first power of the angle of incidence; therefore, a change of speed has more effect on lift than a change of angle. The lesson to be learned is, do nothing to the low side, but introduce a downward and a backward pressure on the high side, that is, reverse the Farman system.

The use of a vertical rudder in connection with lateral stability is unnecessary. The albatross is as fine a soaring bird as there is. How much of a vertical rudder does he carry?

angle of 6 degrees at 50 m. p. h.

The hypothesis is that the thrust of the screw and the angle of incidence of the main plane is constant during the whole operation.

The point to be proved is, what happens to the machine when the right aileron is pulled down 7 degrees?

The figures which follow are based upon Eiffel's co-efficients.

At 50 m. p. h. and 6 degrees the lift of each wing will be 459 and the drift will be 51 pounds. As the thrust is constant, the energy expended is constant, therefore, for each wing DVsquare is constant, when D equals drift in pounds and V equals speed in m. p. h.

When the aileron is pulled down to a positive angle of 7 degrees the increased drift reduces the speed to 48.712 m. p. h. and at this speed the lift of the main plane is 435.66 pounds. To this must be added the lift of the aileron, which is 29.528 pounds, making a total of 465.188 pounds. The lift of the right wing has been increased only 6 pounds, in spite of the fact that the aileron itself lifts 29 pounds. This is because the speed has been reduced.

The most important thing to note here is that this operation banks the machine to the left, but turns it to the right. This is about the most dangerous thing that could be done to a flying machine, and the only way to prevent an accident is to turn the rudder so as to retard the left wing until its speed equals the speed of the right wing. If the aileron is pulled down to a

# GNOME ENGINE

50 H. P. 7-CYLINDER

FOR SALE AT A BARGAIN

FOR FULL PARTICULARS WRITE TO

E. T. TOOGOOD, 88 Reade Street, New York, N. Y.

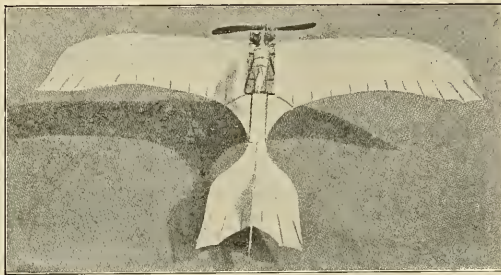

TOP VIEW OF THE LATEST GRADE MONOPLANE.

# FOREIGN NEWS

## Algeria

### MILITARY FLYING IN ALGERIA.

Recently Saper Servies made a flight from Oudja and Naima to El-Aionn-Sidi-Mellonk, and then on to Taourit, his machine creating no small amount of wonder among the natives.

## Australia

The Australian Government has postponed ordering aeroplanes until after the British Aviation Military trials, when they will probably purchase some machines from the winning concerns.

werp, four for Leige, and four for Namur, as well as two dirigibles for the centre of the country. Eight officers have been nominated to receive instruction, and any other officers wishing to qualify for a brevet will be allowed two months leave on full pay and be given an indemnity of \$200 on their admission to the military school.

## Bavaria

The Bavarian Minister of War has ordered a number of aeroplanes and is now organizing a company of aviators to comprise 70 officers and non-commissioned officers. The headquarters of the company will be at Ober-Schleissheim, close to Munich, and operations will commence at the end of the month.

## England

On April 2nd a woman crossed the Channel from England to France as a passenger in an aeroplane for the first time in history. She was Miss Mary Davis, and accompanied Gustav Mamel, the noted Blériot pilot.

They left Hendon at 9:38 A. M., passed over Dover at 10:50 and quickly crossed over the Channel and landed at Saint Inglevert. After a short stay there they flew to Paris with one stop at Handelet for luncheon.

## France

A splendid flight was put up at the Blériot Military School at Etampes on March 16th by Lieut. Sylvestre, who flew, accompanied by his mechanic, for 4 hours 12 minutes, covering 500 kilometres without a descent.

On March 12th Lieut. Bon was flying on a Caudron biplane for an hour and fifty minutes over the country round Le Crottoy. The same day Sapper Jacquemont, also on a Caudron, flew over the circuit Le Crottoy-Rue-Arry. Rene Caudron, making some tests with his hydro-aeroplane, also went to Arry and back on his machine.

On March 12th, Marcel Hanriot was flying over Rheims for an hour at a height of 1,500 metres. Two days later he paid a visit to Chalons, using his new machine, which attains a speed of 140 K. P. H. It is fitted with brakes by the aid of which it can be pulled up in 15 metres.

On March 15th, a detachment of military officers visited Buzoy to witness the experiments with a new military biplane specially designed by Henry Farman with a view to easy dismantling for transport. The tests were made by Chevillard, who dismantled the machine in two minutes and had it ready again for flight in three minutes.

## MONACO HYDRO-AEROPLANE MEET.

The first hydro-aeroplane meet held during the last week in March at Monaco, was a great success and proved a surprise to many, both the new Farman machines proving a revelation and winning first and second prizes. The two Curtiss machines which finished third and fourth, made an excellent showing, but were handicapped in the weight carrying events on account of their small size. It is probable that had the weather been more severe and the water rougher, that the Curtiss machines would have swept all before them. It is interesting to note that the winning French machines were influenced in design by American machines for, like those of the Wrights, Burgess-Curtis and Frank T. Coffyn, they were fitted with two hydroplane floats. Following are the results tabulated by points:

1st—Mons. Fischer (Henry Farman).....	112 points
2nd—Mons. Renaux (Maurice Farman).....	100 points
3rd—Mons. Paulhan (Curtiss).....	96 points
4th—Hugh Robinson (Curtiss).....	71 points
5th—Caudron (Caudron).....	63 points
6th—Benoit (Sanchez-Desa).....	50.3 points
7th—Rugère (Voisin).....	41.7 points

The conditions of this race were published in the March number of AIRCRAFT, page 14. At the last moment, apparently for no other reason than to give the large French machines an advantage over the small but fast Curtiss craft, it was decided to add a new rule which credited the pilots an extra 30 per cent. for every additional passenger carried.

On April 16th, Miss Harriet Quimby, the American aviatrice, on a Blériot monoplane, flew across the English Channel from Dover to Handelet, near Boulogne.

Miss Quimby is the first woman to fly across the Channel alone, although an English woman, Miss Davis accompanied Gustav Mamel on his trip of April 2nd from Paris to London. She learned to fly in America and was seen here in several exhibition flights and aviation meets.



HOW THE FRENCH ARMY TRANSPORTS ITS MILITARY AEROPLANES.

## Austria

Two Army officers have recently been sent by the Austrian military authorities to Germany in order to study the latest examples of dirigible construction. On March 19th they visited Frankfurt and were taken for a cruise in the Zeppelin cruiser, "Victoria Louise."

## Belgium

The Belgian Military Authorities are asking for \$468,000 for military aviation and the reorganization proposals allow for twenty-four machines for the general army, six for the reserve, six for Ant-

## Chili

It is announced that Marcel Paillette, a French aviator, will shortly attempt to cross the Andes mountains in his aeroplane.

## China

Mr. and Mrs. W. B. Atwater are planning to make a flight shortly in their Curtiss machine over the city of Peking.

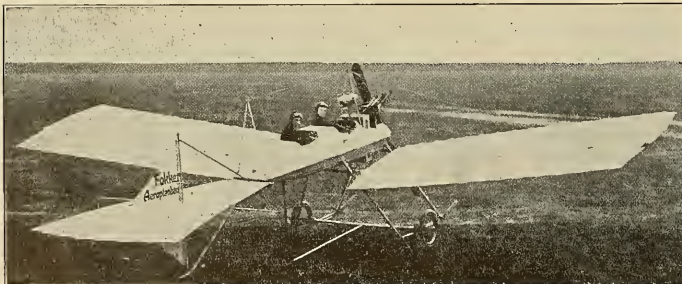

The Fokker machine, an automatically balanced monoplane, which has been making wonderful flights at Johannisthal, Germany. This machine, which was described in the April issue of AIRCRAFT, page 46, has repeatedly stayed up for over an hour in strong winds and has on numerous occasions risen to a height of 7,000 feet. Note the peculiar attachment of the wings and the high position of the fuselage, which gives it a high center of gravity.

**Germany**

According to reports we learn that the German War Office has ordered 40 Etrich machines of the latest swallow type as illustrated in the April AIRCRAFT, page 47.

**GERMAN NEWS.**

By Stella Block.

Forty German officers were appointed recently to various aeroplane factories throughout the Empire to undergo a thorough course of instruction, qualifying them to later on go up to Doberitz with their pilot's certificate. The War Office pays the firms in question a sum of 5,000 marks per pupil, this including a certain amount of breakage. Further damage is carried by the firms themselves. Another batch of officers will be added to the above shortly. This procedure is intended to relieve the strain at Doberitz, where it has been found impossible to cope with all the work.

Following on the Imperial gift of 50,000 marks for the best aerial engine comes the news that the members of the Henkell champagne firm at Wirsbaden have placed the handsome sum of 100,000 marks at the Emperor's disposal for the purchase of military aeroplanes. His Majesty has graciously accepted the gift.

P. L. 6, the well-known Parseval passenger airship, goes to Lucerne for the months of July, August and September for a series of circular tours in the vicinity of the Lake of Four Cantons.

Besides the new very fast Zeppelin cruiser, "Victoria Louise," which has achieved the record speed of 20.2 metres per second, two other vessels are nearly finished at Friedrichshafen. The one, L. Z. 12, is to become the property of the German Aerial Transport Company, who own the V. L. as well, whilst number 13 is being built to the order of the War Office. The nomination of the vessel will be altered to fit in with the current number of the military dirigibles, and therefore number 13, that ill-omened appellation, is but a transitory phrase. It may be remembered though that the military Zeppelins have been singularly unlucky.

A new passenger world's record with four passengers was set up by A. Kartzel on an Otto double-decker at Munich on February 17, as he remained aloft for 21 minutes, 45 seconds, thereby beating Dusson's record of 17 minutes, 28 seconds, by a considerable margin. The five inmates, all grownups, included a lady and weighed 344 kilogrammes in all. This brings the number of world's records held by Germans up to five.

The Gordon Bennett Balloon Race commences at Stuttgart on October 27th. Twenty-four balloons have been entered, this being the largest number since the event was instituted. Three balloons each have been entered by Germany (holder), the United States, Belgium, France, Austria, Switzerland and Italy, and one each by England, Russia and Denmark.

Two thousand ascents were made by 78 different men, lasting for 220½ hours in all at Johannisthal last month. Besides this, 79 other persons took part as passengers in the ascents. The largest number of flight was made by Stuessel on an Albatros, with 17 ascents.

Since penning the above, Kartzel's world's record has been beaten by Hoffman on a Harlan military type monoplane with a 100 H. P. Argus motor and a Garaua propeller. Hoffman took up four passengers and remained aloft for 32 minutes and 39 seconds.

Six aeroplanes divided into two groups took part in the manoeuvres at Doberitz on March 15th, and rendered very considerable assistance. One of the pilots on a biplane ran short of petrol and had to land on the road, but replenishments were obtained by a cavalryman and the aviator was able to get away after a stop of 35 minutes.

**Portugal**

The Portuguese Government has ordered that aeroplanes be included in the customs tariff, subject to the import duty of 40 milreirs (milreir = \$1.00) each, when imported complete.

**Russia**

While piloting a biplane at the Sebastopol Military Flying School on March 23rd, Lieutenant Albockinoff and his assistant were killed as the result of the machine being overturned by a sudden gust of wind and thrown to the ground.

**Tripoli**

In the orders for the day issued at Derna, on March 14th, the Lieut-General Commanding, referring to the fact that the volunteer aviators Cagno, Verona, Cobianchi, Dal Mistro, and Battagli are returning to Italy, their places having now been taken by military aviators, thanks them for the splendid work they have done during the past three months. He says that the magnificent and noble spirit of self-sacrifice which was exhibited by them at all times, and the audacity with which they flew in spite of the tricky winds of the desert, won the admiration of all.

**India**

Lieut. H. H. Harford has recently been giving exhibitions with a Bristol biplane at Peshawm. His was the first machine to be seen in the Punjab district, and occasioned no little sensation amongst the natives.

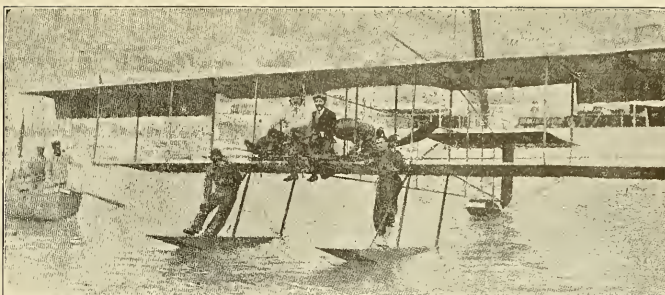

The Henry Farman hydro-aeroplane, which at its first public appearance in the hands of Fischer succeeded in winning first prize at the Monaco Meet. As will be noticed, this machine, except for the tapering rear tail outriggers and floats, is identical with the regular headless military Farmans. On account of its large size, light weight and consequent great weight lifting capacity, this machine had a great advantage over the others, owing to the fact that 30 per cent. of points was given for each passenger carried. Our picture shows the manner in which the extra passengers were carried on the Farman.

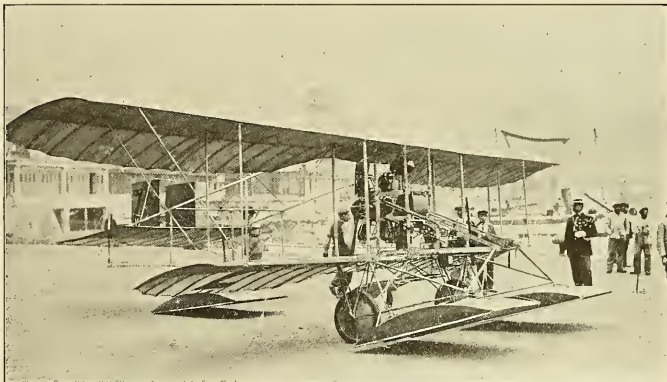

Three-quarter view of the Caudron hydro-aeroplane, which in spite of its small size made a very creditable showing at Monaco in the hands of its designer, René Caudron. Special attention is called to the arrangement of the wheels and floats, the flexible wings and elevator, also the position of the engine and pilot.

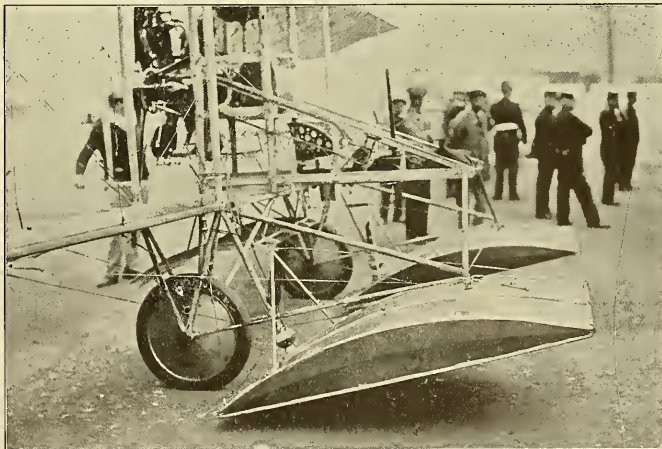

Close view of the Caudron showing the flexible attachment of the floats to the frame of the biplane. Note the pivoting joints in front and the pneumatic and rubber band shock absorbers at the rear of the floats and also the spray shield in front of the propeller. It is interesting to note that the Caudron machine is usually flown as a tractor biplane but for over water flying it was found advisable to re-design it as shown, so that now the engine and seating arrangement is similar to the Curtiss.

## THE HYDROAEROPLANE CONTEST AT MONACO, MARCH 24-31, 1912

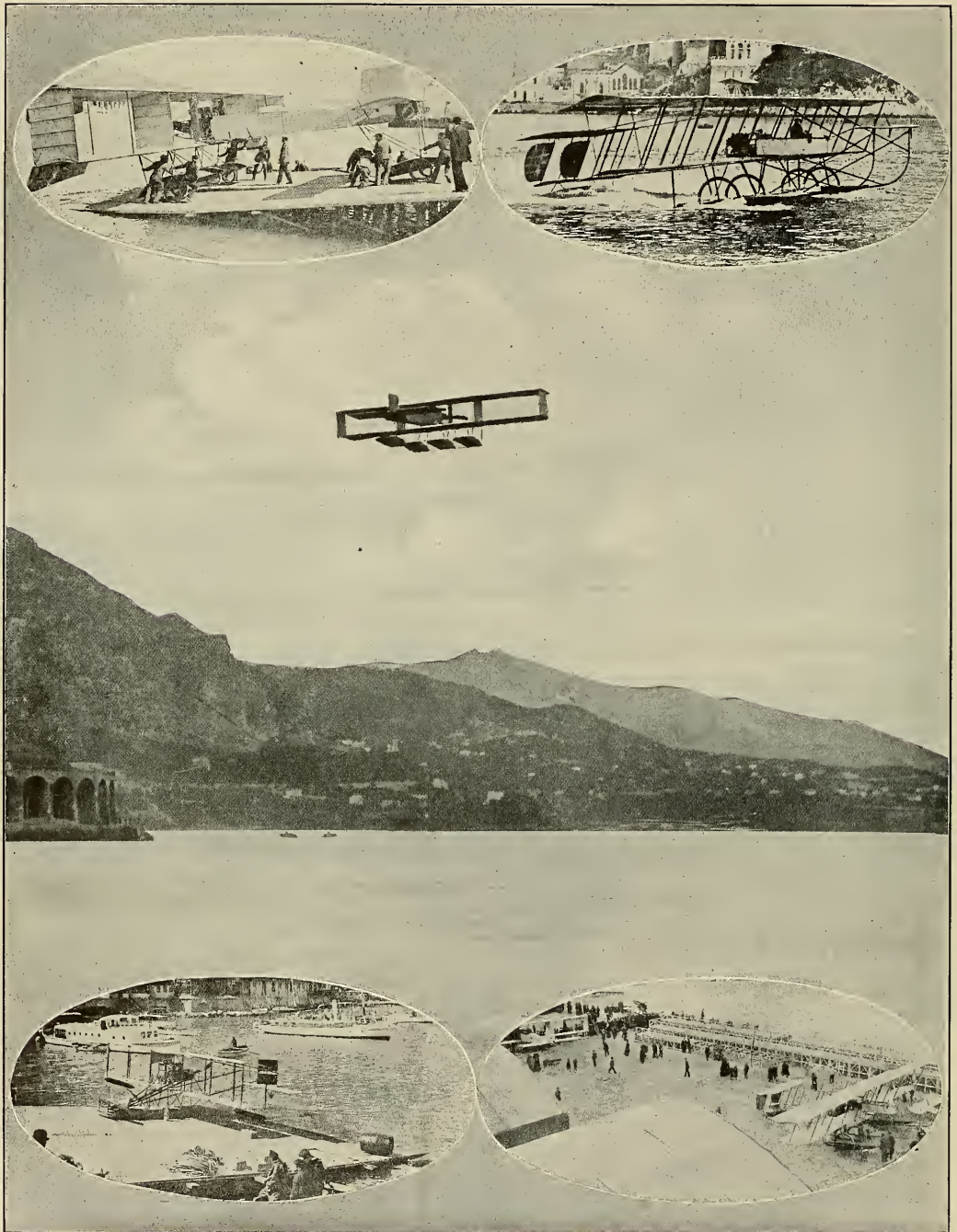

The centre picture shows Collieux descending by *vol plane* on a Voisin-Canard after making a test flight. The same machine can be seen in the upper left hand corner being drawn up on the starting platform after a successful flight. It is noticeable that this machine is now fitted with a stationary plane in front, to which are attached hinged elevator flaps.

The right hand top picture shows Renaux starting a flight in the Maurice Farman "Triad." Attention is called to the large diameter wheels with which this machine is fitted to facilitate running on land. The same machine can be seen at the lower right hand corner on the esplanade. The bottom left hand picture shows one of the Curtiss machines on the starting platform.

# TRACTOR SCREW BIPLANES

(Comparison of Avro and Breguet Machines)—By Walter H. Phipps

In our report on the Third Paris Aero Salon in the February, 1912, issue of AIRCRAFT, it was shown that ten out of the fourteen biplanes exhibited were of the tractor screw type, and as, doubtless, many of our readers have wondered at the growing popularity of the "propeller in front" machines, it will be the object of the writer to explain in this article the merits of this type and to give a descriptive comparison of two original tractor screw biplanes, viz: the Avro and the Breguet.

The chief merit of the tractor screw type of biplane lies in the use of a fuselage body which permits (1) of an increase in speed by cutting down the head resistance of the pilot, engine and tanks; (2) it affords the pilot a larger degree of comfort, protection and security, and also permits him to watch his motor and planes, thereby having these important organs under his inspection at all times,—a very great advantage in the event of anything loosening up; (3) it adds to the strength of the machine as it permits not only of the regular biplane trussing, but allows of additional guy wire anchorages to the fuselage and (4) it adds to the safety of the machine by having the engine placed in front where it is not likely to crush the pilot in the event of a hard landing and also, as there is no vital structure (as outriggers, control wires or braces) in the vicinity of the propeller, there is comparatively less danger in the event of a propeller breaking.

When it is likewise taken into account that the fuselage type of tractor biplane is the more beautiful and graceful and adapts itself easily to the fitting of the tail, elevator and rudders, as well as almost any type of landing gear and, generally speaking, is faster for a given amount of horsepower than the propeller behind the planes type, it is no wonder that the tractor biplane has found favor among the modern aeroplane builders.

Having pointed out the merits of this type, the writer will now pass on to a description and comparison of the Avro and Breguet biplanes, two machines of similar design but totally different construction.

As can be noticed from the accompanying drawings, the Avro biplane is less original and much simpler in design and construction than the Breguet, and being built mostly of wood, cloth and wire, can be built by almost anybody possessing a slight woodworking and mechanical knowledge, whereas the Breguet being constructed of many less parts and having only four uprights throughout the whole flexible biplane cellule (cell or structure) requires a great deal of special fittings to stand the consequent increased strains upon the uprights and the guy wires and other parts. It will thus be seen that the Breguet machines require a well-equipped factory in which to build them and consequently they cannot very well be copied by individual builders or small concerns, and this can more readily be understood from the following detailed descriptions of the two machines.

## THE AVRO BIPLANE (SCHOOL TYPE).

The Avro tractor screw biplane is the result of over five years experiment on the part of Mr. A. V. Roe, of Manchester, England, both with triplanes and biplanes. It is characterized by its graceful lines, extreme simplicity of construction, and splendid efficiency (easily carries a passenger with a 35 H. P. engine). As will be seen from the accompanying drawings and sketches the machine possesses a number of interesting features in simple but strong construction work. The principal dimensions are as follows:

### PRINCIPAL DIMENSIONS.

Span, 31 feet; length over all, 30 feet; chord of wing, 4 feet 6 inches; gap between planes, 5 feet; width of tail, 8 feet; chord of tail, 2 feet 9 inches; motor, 4 cylinder, 35 horsepower water-cooled Green; propeller, 8 feet 6 inches diameter.

### MAIN PLANES.

The main planes which are detachable in sections, are set at a dihedral angle and are double surface, being built up with light double strip ribs (Wright fashion) and covered top and bottom. The total span is 31 feet, with two feet of each end of the planes extending beyond the end uprights. They are spaced five feet apart, the uprights fitting into rigid sockets in the center section and hinged sockets at the outer sections to accommodate warping. The rear spar is hinged by the simple joint shown in the accompanying drawings, to allow warping.

### THE FUSELAGE.

The fuselage or body, which is covered throughout its length is triangular in section and has a maximum width of two feet and a maximum depth of two feet. (Note: In the new military type the body has been altered to a quadrilateral type, two feet wide at the top, three feet deep, maximum, and a single skid and two wheel chassis fitted.) The passenger sits between the two planes with the aviator behind him and just in back of the rear edges.

The control arrangement is identically the same in operation as the Deperdussin and Short types, although differing in construction. The arrangement consists of a lever at the upper extremity of which is mounted a rotatable wheel which by turning (as on the Deperdussin) to the right or left works the warping, while a fore and aft movement of the wheel and column operates the elevators. Steering to the right or left is accomplished by a foot lever or yoke.

### CONTROL.

As far back as 1907, Louis Breguet began his aeronautical work, and it is interesting to note that his "Gyroplane" experimented with at Donau in 1907, is one of the only three direct lift machines that has ever shown itself capable of getting off the ground with any degree of success. The gyroplane was a combination aeroplane and helicopter, and even at that early date bore the earmarks of his present machine—steel tube construction, folding back planes, special steel fittings, single steel uprights, and the engine in front.



THE NEW MILITARY TYPE AVRO BIPLANE.

### RUNNING GEAR.

The running gear is of the wheel and skid type *à la Fagnan*. In view of the tendency of tractor machines to capsize on landing, the skids have been strengthened and extended quite some distance forward and braced both to the fuselage and the biplane framework.

### TAIL.

The tail is of the rectangular section and contrary to usual practise, much wider than it is long. It is of the non-lifting stabilizing type, 8 ft. by 2 ft. 9 in., and is supported when on the ground by a swiveling shock absorbing tail skid.

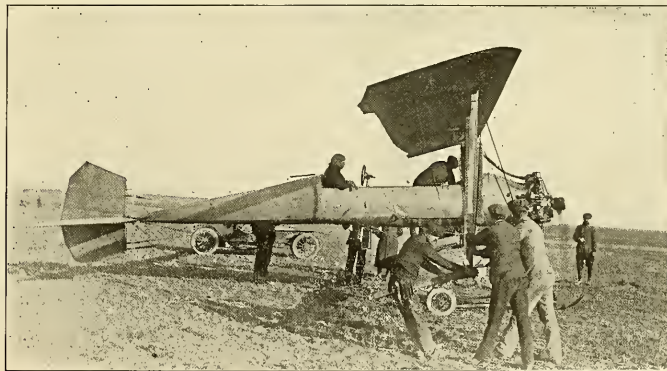

SIDE VIEW OF THE BREGUET.—NOTE THE SINGLE UPRIGHTS AND FLEXIBLE PLANES.

### ELEVATORS.

The elevators consist of two small flaps having a total area of 13 square feet. These attach to the tail by hinges which have only one long pin to facilitate dismantling.

### RUDDER.

The rudder is of fairly large size, measuring 4 ft. 6 ins. by 3 ft. 6 ins., giving a rudder surface of 14 square feet.

### PROPULSION.

Propulsion is furnished by a 4 cylinder, 4 cycle, water-cooled Green motor which drives direct an 8 ft. 6 in. Avro propeller. The engine is mounted high up in the bow of the fuselage.

### BREGUET BIPLANE.

The Breguet biplane is one of the most original and distinctive machines ever turned out. In design and construction it differs from every other machine and bears the stamp of a great engineer's work.

The simplicity, strength and efficiency of the Breguet machines have peculiarly adapted them for military purposes and we now find them amongst the most favored by the French Government for military purposes.

The military three-seater, illustrated in the accompanying drawings, represents one of the latest types, and as will be noticed is fitted with three seats, the front one for the officer observer, who has map, note book and glasses in front of him. Immediately at the back of him is the assistant pilot, with his back to the direction of flight in a position where he can take temporary charge of

the control, in the event of an emergency. He also has a clean view backward and downwards and also forms a connecting link between the officer and pilot who is behind him.

The dimensions of the Breguet machine are as follows: Span, upper plane, 47.6 ft., lower plane, 31 ft.; chord, 4.9 ft.; gap, 6.5 ft.; camber (under surface), 2 1/2 ins., (upper surface), 3 ins.; length o. a. 29.8 ft.; plane area, 355 sq. ft.; elevator area, 54 sq. ft.; rudder area, 17 sq. ft.

Net weight, 1,375 lbs.; net loading, 3.9 lbs.; live load, 970 lbs.; loading in flight, 6.6 lbs.; lift (net) 10 lbs per H. P., (in flight) 17 lbs. per H. P.; speed (about) 70 m. p. h.

As a complete technical description of the Breguet machine was published in AIRCRAFT Volume II No. 4 it is not necessary to repeat it here.

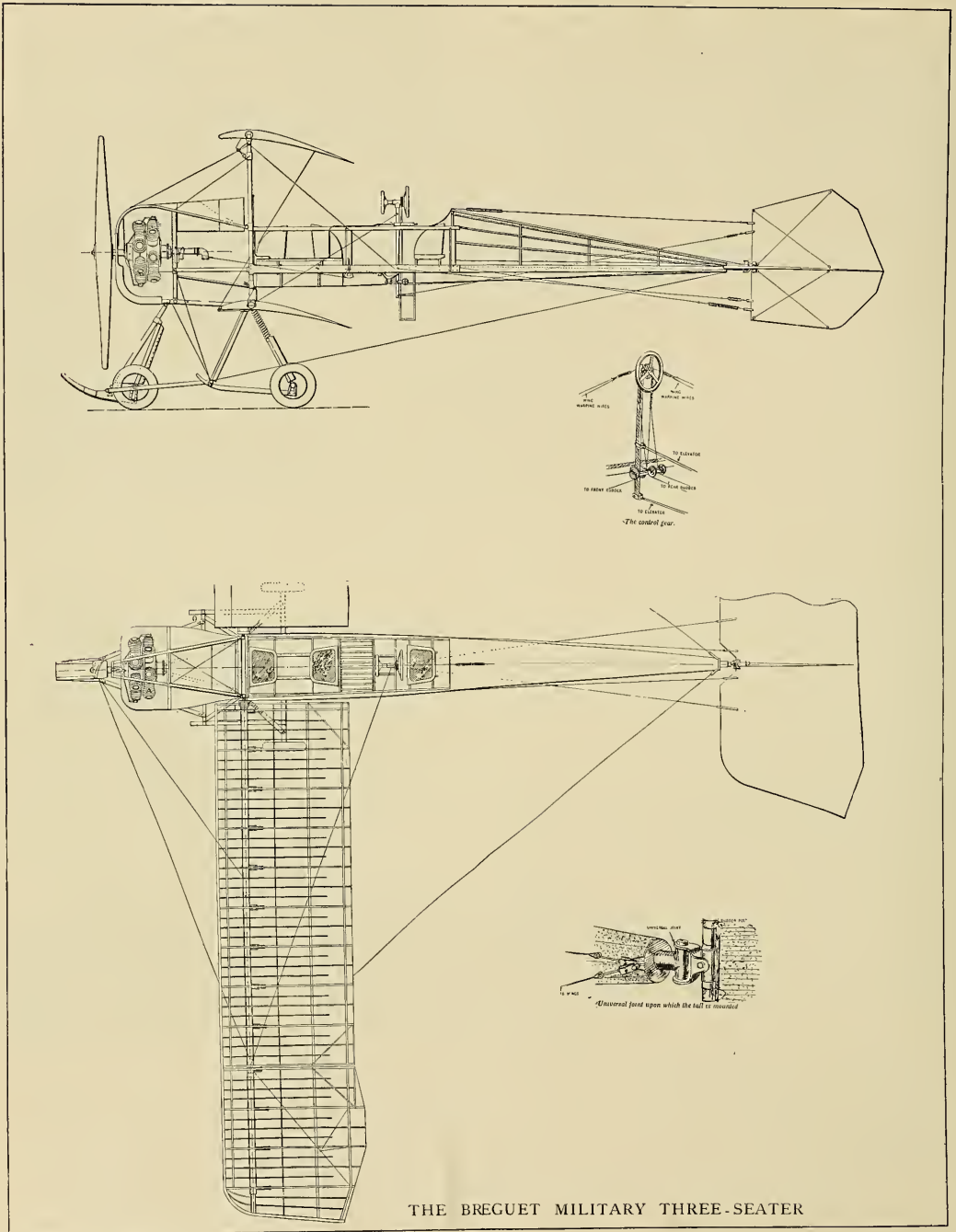

THE BREGUET MILITARY THREE-SEATER

DETAILED PLAN DRAWING OF THE BREGUET MILITARY BIPLANE



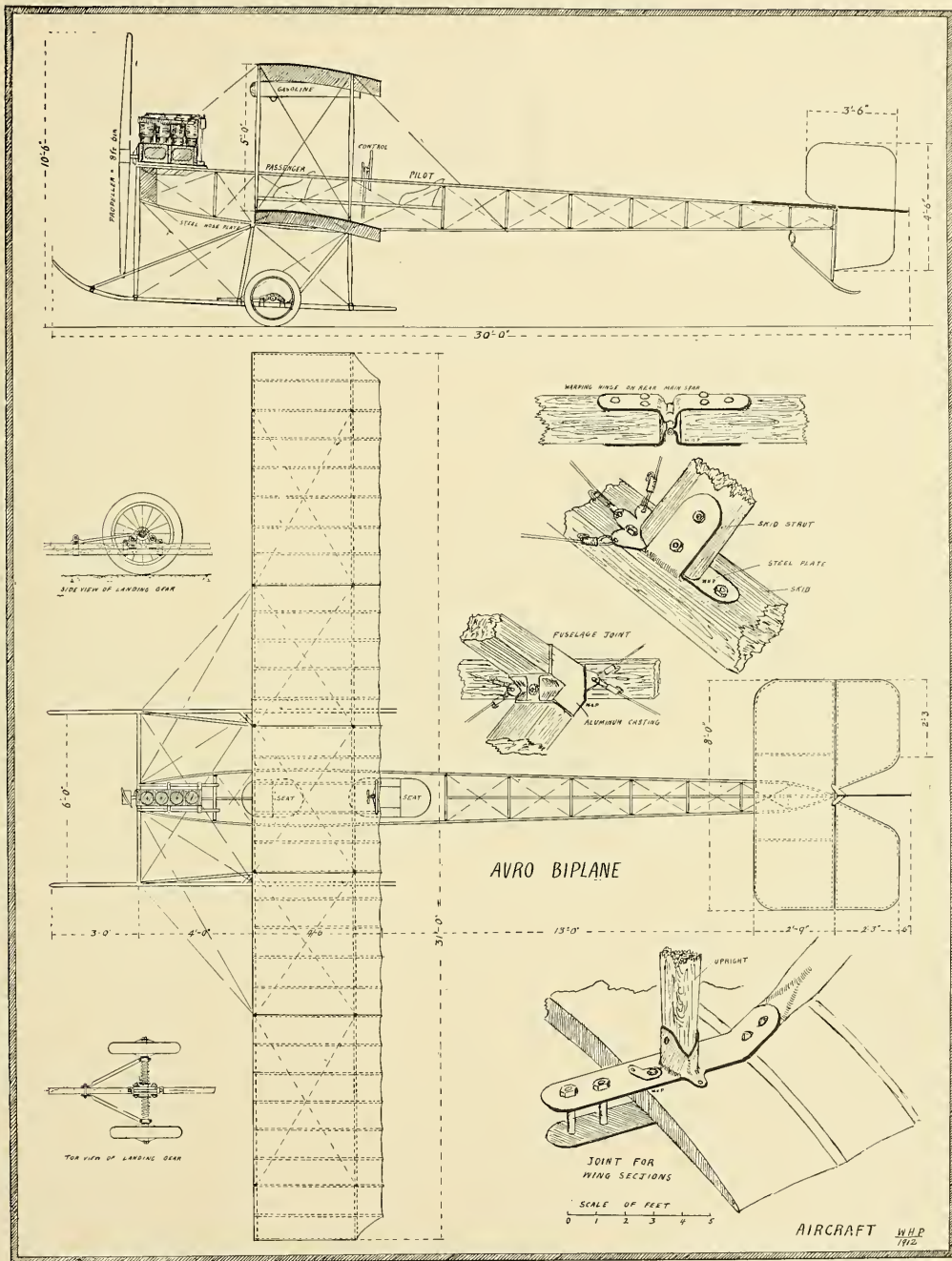

SCALE DRAWING AND CONSTRUCTION DETAILS OF THE AVRO BIPLANE

# GENERAL NEWS

By D. E. Ball

## Marine Air Races

The Aero Club of America have made plans for the first hydro-aeroplane meet ever held in America. The meet, scheduled for Saturday, May 4, will be the forerunner of the Aeronautic Show, which opens May 8 at the Grand Central Palace, New York.

The races will start from the pier of the Columbia Yacht Club, at the foot of West Eighty-third street in the North River, New York, and the course of the distance speed contest, without passenger will extend to a point opposite the house of the Atlantic Yacht Club, at Sea Gate, Coney Island, and return.

The passenger-carrying speed contest will be around the Statue of Liberty and return, and the winner of the contest will receive the Aviation Show Trophy, which has been donated by the International Exposition Company.

The "blue ribbon" prize—that for the distance speed contest—will carry with it a substantial cash prize as well.

In addition to the events noted the programme embraces bomb dropping upon the decks of real battle ships, quick get-away contests, accurate alighting competition, capturing of free balloons, carrying orders for aerial scouts from battle ships, as in real warfare; returning information to battle ships by means of special weighted message carriers.

Among the entrants are Harry N. Atwood, Frank C. Coffey, Walter Brookings, George W. Beatty, Hugh Robinson and Grover C. Loening.

## The Great American Circuit

The plans outlined by the Aero Club of Illinois last January for a "Marathon flight" between the big cities of the Central West as published in the March number of AIRCRAFT, and suggested previously in a December AIRCRAFT editorial, have been enlarged upon lately and the proposed route now includes Chicago, Milwaukee, Cedar Rapids, Des Moines, Omaha, St. Joseph, Kansas City, Jefferson City, St. Louis, Charleston, Indianapolis, Cincinnati, Columbus, Cleveland, Toledo, Detroit, Chicago, making a circuit of 1,810 miles altogether. The plans, which are still in an embryonic state, are being arranged by the Aero Club of America, under whose auspices and management the meet will be conducted, but from all indications the probabilities are that the meet will take place. During the past month the secretary of the Aero Club of America has been making a trip around the circuit and reports much enthusiasm over the meet in every city visited.

It is hoped the prizes will amount to \$100,000, and will include a Grand Prize of \$25,000, second prize of \$5,000, third prize of \$2,500. Among other prizes to be given are: Prizes for first and second machines to reach each control; a special prize for American built and flown machine first to arrive.

- Special prizes for:
- Least horsepower to complete course.
  - Passenger-carrying.
  - First to flash a wireless message to a control.
  - Greatest number of wireless messages delivered.
  - Best maps made en route and description of conditions, etc.
  - First aeroplane fitted with stabilizer to arrive.

Newly most completely equipped machine. If these plans materialize, the Great American Circuit, as it will be called, should thus be greater than any of the circuits held last year in Europe and will include features never before included in aerial contests. All the circuits last year were essentially races for speed between two points and the prize went to the fastest. No effort was made to bring out the qualities of aeroplanes other than speed. Thus while the splendid performances of Beaumont, Vedrine, Garros and other clever airmen created a great deal of enthusiasm and interest, there was really little of practical value brought out that the world did not know or that would bring the aeroplane nearer to the average man for general use.

In the Great American Circuit every inducement is given to bring out and demonstrate the practical side of aviation.

Using less horsepower, carrying passengers over a long distance, using wireless telegraphy for communicating from aeroplanes, using automatic stabilizers and less human element, and having aeroplanes fitted with scientific instruments for travel and devices to promote comfort—these are all practical features which, when applied, will make the aeroplane cheaper, safer, and a vehicle of service as well as pleasure.

At Philadelphia on April 25, V. de Jonckheere, of the Belgian army, and a representative of Belgium in the forthcoming Gordon-Bennett aviation cup contest at Chicago, made his first flight in America in his monoplane.

## The Aeronautical Society

The Aeronautical Society has been doing as usual, yeoman service for the aeronautical movement during the past month, and is now growing at such a rapid rate in membership and prestige that it becomes necessary for them to go into larger quarters, so that after May 1st, their headquarters will be changed to Reisenweber's, Eighth Avenue and Fifty-eighth Street, New York. The new quarters consist of an entire parlor floor which is especially adapted for club purposes and which contain reading, writing, lounging and billiard rooms. Meals and refreshments will also be served in the rooms at nominal prices for members who desire these services. The general meetings of the society will be held in a large assembly room in the Reisenweber building.

New members are constantly being enrolled by the society and their meetings, which take place every second and fourth Thursday of the month, are usually crowded to the doors.



Aviator J. Hector Worden, of the National Aero-Plane Co., landing on Galveston beach after 18 minute flight over Fort Crockett at altitude of 1,500 feet.

The Aeronautical Society now issues periodically a very interesting Club Bulletin which is sent to the members of the club free of charge.

On Thursday night, April 11, Thomas A. Hill, First Vice President of the club, was unanimously elected as President to supersede Willis S. McCormick, during the term of office for which he was elected. The society is extremely fortunate to secure Mr. Hill for that important office as he has ability, energy, enthusiasm and knowledge of the movement combined. In fact Mr. Hill's indefatigable work for the Aeronautical Society up to the present time has helped in a very large degree to place that wideawake organization in its present leading position.

## The Aero Club of St. Louis

The Aero Club of St. Louis will be represented by three of its aeronautic pilots in the national balloon race from Kansas City in July, as a result of action taken by the Board of Governors at a meeting held recently. William F. Assmann was appointed to represent the club in its own balloon St. Louis No. 4. Paul McCulloch, who has just qualified for his license, will pilot the Million Population Club balloon and John Berry will pilot the Viking balloon, purchased for the Million Club by Albert von Hoffmann.

Other matters were taken up at the meeting including the matter of the \$10 initiation fee formerly required of new members. It was decided to waive this fee indefinitely, reducing the cost of new membership in the club to \$10 annually.

## California News

(By Ernest Obrt)

At San Diego, on March 25, Aviator Horace F. Kearney in his 1912 Curtiss biplane, accompanied the Steamer Yale three miles out to sea to bid farewell to Miss Elsie Berlin and her brother, C. H. Berlin. At times Kearney flew high above the steamer, only to descend and skim along the sea alongside the vessel. The aviator dropped several packages to the steamer's deck.

At San Diego, on March 2nd, while Ensign V. D. Herberst and Walter Waterman were about 100 feet above the bay in a Wright biplane, a turbulence hydroplane accident, the control became jammed. The machine fell, striking the water sideways, settled and turned turtle, only the pontoon parts visible. Herberst and Waterman climbed up on it, while W. B. Atwater, who had seen the accident from shore, arrived in his Curtiss hydro-aeroplane with his mechanic. The Wright biplane was somewhat damaged, but the aviator and passenger escaped unhurt.

While flying at Dominguez Field, near Los Angeles (Cal.), Beryl Williams, the 19-year-old Pasadena aviator fell fifty feet and received severe bruises. His biplane was wrecked. A weakened plane support snapped and caused the accident.

Charles K. Hamilton has recently flown several times from Sacramento to Marysville (Cal.), a distance of 55 miles.

Didier Masson has been making many successful flights in and around San Rafael (Cal.) in his new 50 H. P. Gnome Farman type biplane, which he built here. Recently he flew over San Quentin prison, a short distance.

Thaddeus S. Kerns, of Chico, tried out his new Curtiss type machine three miles above Sacramento. In his first trial flight he stayed in the air over 15 minutes. Kerns is getting to be an old hand at the game.

His new machine has many original features. It has not a single turnbuckle throughout the whole construction, but uses Kern's patented inert system. This makes Kern's fourth machine. He is flying every day, with weekly permits, and will start out on the road giving exhibitions as soon as the Sacramento Valley Carnival season begins.

Mr. E. H. Thompson, of the California Aviation Company, has made several successful tests with Albert S. Fry's new Curtiss type, fitted with a two-cylinder, opposed offset, 4 cycle, McDermott motor.

R. S. Timothy has tested out his new Curtiss type biplane on the California Aviation Company's flying field at Easton. The machine is one of the finest built on the Coast.

Mr. John R. Lagreve is having a Curtiss type biplane built at the California Aviation Company's shops. It embodies a good many original features and should make a very speedy machine. He will use a Roberts 4 X motor.

## Curtiss Doings

Charles C. Witmer, in charge of the Curtiss Aviation School at Miami, Florida, made a record for carrying passengers in a Curtiss hydro-aeroplane at that point recently. Mr. Witmer made seven flights of ten minutes each, carrying a passenger on each trip. Among the passengers were H. B. Moore of New York, Harry N. Leonard of New York, Alexander K. Nimick, nephew of Andrew Carnegie, and Vernon Price Williams of Miami. The hydro-aeroplane has become very popular with the Northern visitors at the big winter hotels in Florida during the past winter, and it is likely that a number of them will purchase this type of machine for sporting purposes during the coming summer.

At San Diego, Cal., March 23rd, four more aeroplane pilots were added to the growing list of American airmen at the Curtiss aviation camp on North Island. Those who qualified are F. J. Terrill, Springfield, Mass.; R. E. McMillan, Perry, Iowa; M. M. Sten, Vallejo, Cal.; and C. A. Berlin, of Centralia, Washington. This makes a total of ten aviators to qualify at the Curtiss camp during the past two months, and there are more than a score still under instruction.

## Wright Patents in Court

The action brought by the Wright brothers against Glenn H. Curtiss for alleged infringement of patent rights in the Wright biplane, scheduled for hearing on April 11th at Buffalo, was again postponed upon the plea of counsel for the defendant. Judge Hazel fixed June 25th as the date of the final hearing.

Emerson R. Newell, attorney for Mr. Curtiss, maintained that the balancing plane, the principle involved in the litigation, was the invention of the late Hugo Matulath, and that it was now public property. The Wright's attorney, H. A. Toumin, said Matulath never constructed a man-carrying machine, and that the Wrights knew nothing of his idea when they obtained their patents.

**Nassau Boulevard**

Probably before the next issue of AIRCRAFT appears the Nassau Boulevard Aviation Field will be abandoned as an aerodrome, owing to the ownership of the grounds changing hands.

With the advent of the spring weather activity was on the increase at the field and several new machines arrived and flying was to be seen almost every day when the weather permitted.

Amongst those with machines at the grounds were: The Rex Monoplane Company, who had one of their latest Blériot type Rex machines there, assembled ready for flying in the hands of a pilot in charge of Mr. J. Boyd, is of excellent construction and finish and is fitted with a Kirkham motor. It was being undergoing trials in the hands of Aviator Senekay and has already made several very creditable flights.

Beckwith Havens, of the Curtiss Company, had one of the latest type 75 H. P. Curtiss machines at the grounds, with which he indulged in flying and spectacular flights. George W. Beatty had a number of pupils enrolled and was kept busy instructing them on his Wright machine.

A. N. Ridgely had a Church biplane fitted with a Kirkham motor, which was flown by Oliver B. Sherwood.

Amongst the others who had machines on the grounds were: Charles Morok (2 monoplanes and one biplane); Fred C. Wright; F. S. Schneider (Shneider biplane, Roberts motor); Howard Dietz (paraplane); G. Boyd (Curtiss type); Dr. Northwood (Biplane); Alexander Williams (Williams biplane); William A. G. Arthur; Arthur Maynard (Curtiss type, Harriman motor); C. S. Peets (Farman type, British-American motor); Charavay propeller); W. Irving Twombly (Twombly biplane, Twombly rotax motor); Guyton Aeroplane Co. (collapsible monoplane, Efridge engine, Gibson propeller); National Aeroplane Co. (National monoplane); S. M. Moore (Curtiss type, Harriman motor).

**BEATTY FLIES WITH FOUR PASSENGERS.**

On March 28th George W. Beatty, in a Wright aeroplane, succeeded in establishing a new American record for flying in a machine, remaining up at the Nassau Boulevard field for twelve minutes with four passengers beside himself. The total live weight carried was about 550 pounds.

**Mincola**

Now that it appears that Nassau Boulevard is to be abandoned as an aerodrome, it seems certain that most of the machines will take up their quarters at Mincola, at least for the time being.

Although there have not been as many machines

at the Mincola field as at Nassau, good flying has, however, been done there by Frank Boland and his pupils, using his tailless biplane and his other machine of more conventional design, (pictures of which were published in the April number of AIRCRAFT, page 50). Other machines there, are those of Carl Strom and Oscar Oleser, J. S. Spinkhour, William Chambers, George Smith, S. H. Beckwith, Godley, Stanley Y. Beach, Harry Eno, and Joe Stevenson.

On the other side of the field there are four sheds. In one of these Harry Harkness has four Antoinettes, and Jack Kiley, a biplane with a Macomber motor, built by Eaton brothers, of Los Angeles. In another shed Walter Fairchild has his latest monoplane. Harold Kantner, who has a Gyro-Blériot type, shares Fairchild's hangar. The sheds last year occupied by the Moisant Aviation Club are now vacant. The big Baldwin-Made hangar, which was razed to the ground in a big wind storm a few weeks ago, is being rebuilt. On their return from South America McLaughlin and his flyers, including Coland Middleton, will take up their quarters on this field.

On April 10th, George W. Beatty and Marshall Reid, who had been arrested for speeding in an automobile, flew to the court at Mincola, each carrying a passenger as witnesses. Court was in session as the aeroplanes appeared, and spectators, witnesses and others left the room to see their descent.

The day came down in a series of spirals and landed almost at the front door of the court house. Reid also landed safely within a few yards of the doorway.

Beatty pleaded guilty to the charge of exceeding the speed limit and paid ten dollars fine.

**Hydro for Yale**

Edward B. Hine, 1912, president of the Yale Aero Club, announced recently that the club will have a hydro-aeroplane at their grounds shortly, and that a school, principally for Yale men, will be conducted here under the auspices of the Yale Club, of which there are 250 members. Mr. Hine returned to New Haven from New York after Easter vacation and said that he had made arrangements with the Curtiss Company to have a marine craft sent there. A hangar will be built on the harbor front, and Mr. Hine is of the opinion that a large number of Yale men will learn the art of flying before the college year ends. One of the Curtiss aviators will have charge of the hydro-aeroplane.

The Yale Aero Club will not enter the intercollegiate aero meet in Kansas City in June, as the contest is for balloons only.

**Rodgers' Fatal Accident**

On April 3rd, Calbraith P. Rodgers, the noted American aviator, and coast to coast flyer, fell to his death while giving an exhibition flight at Long Beach, Cal. The cause of this unfortunate accident is not known, but it is supposed that Rodgers, who often flew the 3rd all of the probably heart trouble) while in the air, and indeed attributed his well high fall last November to this cause, was probably overcome in the same manner while giving the exhibition flight, with the result that he was unable to bring the nose of the machine up and plunged into the surf where the water was only two feet deep. Another theory advanced is that the elevator may have jammed in the downward position.

**Parachute Jump from High Building**

Frederick R. Law, steeplejack and parachute jumper, leaped with his parachute from the roof of the forty-one story Bankers' Trust Building, at Wall and Nassau Sts., N. Y., on April 8th. Thousands of persons in the financial district watched the drop.

**Army News**

The last day of flying at Augusta for the Aviation School was March 28th, after which the aeroplanes were packed for shipment and the loading of the planes proceeded for the next three days. The afternoon of April 1st the school departed in a special train of ten cars on the Atlantic Coast Line, arriving at College Park the afternoon of the 2nd. It was reported that all of the cars were unloaded, and since then the entire detachment has been engaged in preparing the hangars and equipment for a busy season.

March 28 (Stenham) was a day which is reported at Augusta as a student officer and will be instructed in flying the Wright aeroplane.

While at Augusta the Aviation School made a total of 436 flights during a total duration of 81 hours and 20 minutes. Out of 124 days at Augusta, not including Sundays nor the time engaged in packing or unpacking aeroplanes, the officers were flying 58 days, but some of these, rain or high wind permitted only a few flights only early in the mornings or late in the evenings.

Commander Cleland Davis, U. S. N., of Washington, has invented a new gun with which to arm military aeroplanes, which is designed to destroy foes of the air or to attack an enemy on earth from a height where gun, gunner and aeroplane will be an almost invisible target.

**LOUIS BLÉRIOT EXPLAINS CAUSE OF MONOPLANE ACCIDENTS**

The following is a translation of the text of one of the most important documents dealing with the technical side of aviation that has yet been prepared. It is the letter of M. Blériot to the French Government, which resulted in the issue by the French Air Ministry of an order to suspend temporarily the use of monoplanes in the French Army.

**M. BLÉRIOT'S REPORT.**

The death of Lieut. Seville was not, as have been so many preceding calamities, useless to the cause of aviation. It has brought to light a new conception of the forces, with which aeroplanes are subjected in flight. It has come to enlighten a series of mysterious accidents that have overtaken Chavez, Blanchard, Lanthesuame and Dincourneau.

Up to the present no one has admitted that the wings of monoplanes can carry top loadings. After Chavez's death, witnesses affirmed to having seen the wings fold down beneath the machine. No one heard their words regarding them, but the coming of an optical illusion, meanwhile the wings (of monoplanes) were strengthened once more. Then came Blanchard's death, followed by a second reinforcement of the wings. Following upon that came the death of Lanthesuame, which caused a military commission to decide that the wing spars should be strengthened yet a third time, and it was not until reinforced wings that Lieut. Seville met his death.

Alas, it was not the weakness of the wings that caused these accidents. These four deaths occurred under similar circumstances; the machines had remained for a long time in the air amidst most violent gusts (*remous*). Chavez had crossed the Alps. Blanchard had journeyed from Orleans to Paris. Lanthesuame had just finished a flight of 50 kilometres, and Seville a flight of 2 hours 10 minutes duration. Their machines had resisted perfectly the buffeting of the wind, when suddenly, as they (the pilots) proceeded to descend by *voils planés*, the wings, which carry very little positive loading at this time, broke and doubled up.

I do not speak of Lieut. Dincourneau's accident, for that constitutes the first case in which the upper guys (*haubans supérieures*) were broken, and is probably due to an analogous cause.

In Lieut. Seville's machine the four upper guys were completely broken, and the machine was completely led to the idea that the wings must be forced from above, and had to resist pressure acting vertically in the direction.

Then it was that I realized how the momentum

of an aeroplane flying in a straight line, and made suddenly to descend by a *vol piqué*, would reverse the loading on the wing, and now this phenomenon cannot be doubted by any who care to analyse the problem. If, by a strong movement of the machine moving horizontally will, when the motive power is diminished, descend by a parabolic path, which will be longer in proportion to the speed. If, by a strong movement of the elevator, the pilot transforms the trajectory into a straight line slanting at a steeper angle towards the earth than the parabola, the machine is immediately subjected to a force from above (*Grise par dessus*). In order that it (the machine) should make this descent to earth, which takes place more rapidly than that resulting from the gravitational influence of its own weight, a downward force must act upon the wings.

The diagram herewith shows that, if the pilot is moving horizontally in the direction AB, and at the point B throttles his engine without touching his elevator, he will follow a natural parabolic trajectory, BC.

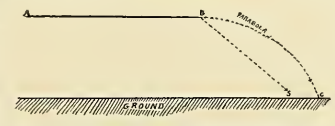

If, on the contrary, at the point B he suddenly uses his elevator in order to descend in the direction BS, of which the slope is greater than that of the parabola, it is evident that, in order to overcome the momentum of his machine, he must apply a force on the top of the wings, and at the same time of course this will stress the upper guys.

It is then the change from the direction AB to the direction BS that causes the danger to the pilot and not the *vol piqué* itself, which if performed slowly and progressively presents no objections.

There is no longer room for doubt that the deaths of Chavez, Blanchard, and Lanthesuame were caused, not, as has been believed up to the present, by the breaking of the wings, that have withstood their trials and tests of positive loading successfully, but by the failure of the upper-guys, which have no strength to resist these forces coming from above.

It is therefore necessary to test monoplanes with a top loading on the wings, so as to obtain a system of upper bracing that will be of corresponding strength to the lower bracing now in use. It is to be regretted that four deaths should have been required to pave the way to this solution, which must completely modify the design of aeroplanes.

At all times, however, the new factor of safety for these new forces? We estimate that, theoretically, the resistance of the upper guys may be less than the upper guys.

In practice, allowing for the rare occasions on which the upper guys are stressed, we can allow for a factor of safety of five with the lower guys, a factor of safety of three for the upper system. This relationship of momentum and live-load on the machine also causes the factors of safety to change according to the speed of flight.

In effect, the momentum is proportional to the square of the speed; consequently, if we allow a factor of safety of 5 for a machine incapable of exceeding a speed of 100 k. p.h., it is necessary to give a f.s. four times as great, viz., 20, for the speed of a machine flying at 200 k. p.h. The explanation how it is that accidents have not happened to machines that have much smaller factors of safety, but do not exceed 60 k. p. h.

In the matter of momentum, it would seem that a machine capable of 60 kilometers per hour and having a factor of safety of 3.6 will be as strong as a machine flying at 100 k. p.h. with a f.s. of 10.

Again, it is necessary to enquire if the pilot's own body can resist the sudden shocks that are immediately experienced in the air, and being certain that a man seated cannot resist a shock directed from beneath upwards of a magnitude greater than twice his own weight without being seriously injured, it is evident that he cannot resist a vertical upward force exceeding that which will stress the wings of his machine to a factor of 5 or 6, without serious inconvenience to the internal organs.

It is, then, necessary not to fall into the error of exaggeration in respect to these factors. Their proportion must be subordinate to the physical resistance of the pilots, who withstand, by shock on their bodies, the aerodynamic pressure proportional to the altitude. (This is only meant to apply to rigid machines like those in actual use.)

These new conceptions must sensibly modify the conditions of the acceptance of flyers, machines and will tend considerably towards safety.

(Signed) L. BLÉRIOT.

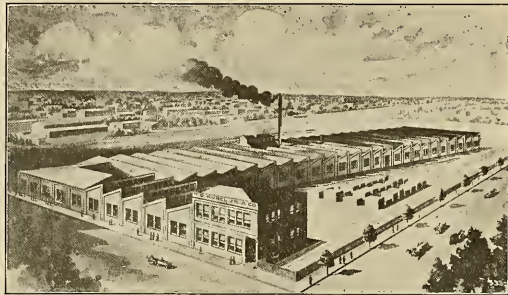

THE R. O. RUEBEL, JR., AEROPLANE FACTORY, LOUISVILLE, KY.

The International Exposition Company are making herculean efforts to make the Aero Show, to be held at the Grand Central Palace, New York, May 8-19, a big success. Among the new concerns secured since AIRCRAFT published the list of exhibitors a month ago, is the Wright Brothers and the E. J. Willis Company. A. Leo Stevens has also decided to send a small full-sized hydrogen balloon as an exhibit and also a Zodiac dirigible. Horace B. Wild intends to exhibit a Parseval airship which he recently purchased in Germany for the Aero Club of Illinois. There will also be an exhibition from the United States Weather Bureau. It is understood that there will be a hydro-aeroplane race held over New York waters during the week of the show, for which a trophy will be offered to the contestant by Charles E. Spratt, the head of the International Exposition Company.

Dr. William W. Christmas, president of the Christmas Aeroplane Company, of Washington, D. C., states that his company is a corporation capitalized at \$1,000,000, which has entered the aeronautical field with the sole object of commercializing the aeroplane. In other words, he believes that by a system of demonstration of well-made aeroplanes, both to the government and general public, the industry can be made to pay a handsome profit, just as the automobile, steamboat and railroad industries were made to pay handsome profits after a demonstration of their utility for transportation purposes. He says the aeroplane has got beyond the exhibition stage and is now a commercial proposition entirely. This company will exhibit a three-seater headless biplane at the Aeronautic Show to be held in New York in May.

I. Semeniouk has been trying out the new Rex Monoplane at Nassau Boulevard and has made several very satisfactory flights in it. The machine is of the Blériot type, but is noticeable for its fine construction and finish.

The Aeroplane Motors and Equipment Company, of New York, by attending strictly to business lines, has been building up lately a most excellent trade. This concern announces that it is their intention to always keep in stock a full supply of Gnome, Renault and Clement-Bayard motors, for which engines they are agents. Besides this they keep on hand a supply of spare parts as well as imported aeroplane cloths.

The Ideal Aeroplane and Supply Company, of New York have apparently withstood the strain of competition in the model line, and they have practically become almost the monopolists of the model business in this country. They manufacture and deal in almost every known model of a flying machine made and it is most remarkable the great quantity of these models which are marketed each year by this company.

The Standard Aviation Company of Chicago are making great efforts to put the business of manufacturing aeroplanes as well as a school of aviation upon a paying basis. They have been, during the past year, gradually preparing a foundation and now report that business with them is in a profitable state. This company has for its superintendent Mr. F. Raiche, formerly of Minnola.

The C. E. Conover Company, of New York who have been advertising their aeronautic cloth in AIRCRAFT for over two years, inform us that the last month's sales have shown a large increase over the previous months, and that they are securing a great many new customers, among which they mention Dionne & Son, New Britain, Conn.; C. Wade Brasseur, Los Angeles, Cal.; A.

M. Williams, Douglas, Ariz.; Morok Aeroplane Co., New York; Northwestern Motor & Supply Co., St. Paul, Minn.; Leland Knowland, Green Bay, Wis., and C. & A. Wittemann, Stapleton, S. I., N. Y.

The Milwaukee School and College of Aviation report that their business is in splendid condition, having at present a large number of students enrolled and on the ground studying the art of aviation. Among their flying outfit they have a genuine Curtiss machine and a Curtiss type pigeon tail military machine, a genuine Blériot and a Farman type machine; also a machine of their own construction, and have contracted for the parts of a great many Curtiss type machines and will shortly have in operation a hydro-aeroplane.

Carl E. Myers, one of the pioneer balloon constructors of America, is still in the business, manufacturing balloons at his "Balloon Farm" at Frankfort, New York. He reports a thriving business in the sale of captive balloons for exhibition purposes.

The R. O. Rubel, Jr., and Company report that seven students are already enrolled in their aviation school and that flights are being made on the school field every day when the weather permits. Mr. R. O. Rubel, Jr., the president of the company, says there is no question but that this will be the biggest year for manufacturers who can deliver the goods that has yet been experienced.

Messrs. Thomas Brothers, of Bath, N. Y., who have been building and experimenting with aeroplanes since 1910, have now entered the ranks of the aeronautical concerns who intend to market their machines along broad commercial lines. Their specialty is the biplane.

Earle L. Ovington, who has been using the Rood Safety Helmet in all his flights for the last season, says that they are much lighter and more comfortable than the heavy football helmets often worn by aviators.

It has come to our attention that the Norwich Business Men's Association, Inc., of Norwich, Conn., are desirous of getting into touch with a reliable aviation school, one desiring a factory site, flying course, etc., preferred. We believe that they are willing to make important concessions to a responsible company or individual and we suggest that those interested take up the matter direct with the Norwich Business Men's Association by correspondence.

Mr. Louis Blériot, of France, desires to make it known through AIRCRAFT that up to the present time no one has been allowed by him to use his name or build machines under his patents in the United States of America. He says that he reserves all rights for himself.

The Dean Manufacturing Company, of Newport, Ky., have just gotten out their new type cross-country Fox de Luxe motor, which is now ready for the market.

The American Aeroplane Supply House, of Hempstead, N. Y., reports that they have just received an order for a monoplane of special design from Howard Huntington, of Princeton, N. J. They also mention the fact that A. C. Menges, of Memphis, Tenn., who purchased one of their machines last September, has received, on February 22nd, his French pilot's license at Pau, France, and will return to this country in April to fill a number of contracts for exhibition flying.

Tom Benoist, president of the Benoist Aircraft Company, of St. Louis, Mo., is apparently one of the live aeronautical builders of the West. The Benoist Aircraft Company builds a headless biplane of more or less original design, which embodies many features not found on other machines. Many of these machines are now being used successfully by professional flyers, in fact, it was from the Benoist machine that the first aeroplane parachute jump was made by Bert Berry with Anthony Jannus as pilot on March 1st at St. Louis.

The Roberts Motor Company, of Sandusky, Ohio, report that there is a big demand this year for more power, and that they are selling a large number of 6-cylinder 75 H. P. motors. Among the well known aeronautical concerns ordering these motors during the past month are the National Aeroplane Company, Mr. J. E. Harriman, of Boston, and the Benoist Aircraft Company, of St. Louis.

Frederick Brunninger, the head of the Gressier Aviators, states that they will open their new school at Belmont Park, May 1st, and that they are now booking students to begin instruction from that date.

The Mills Aviators, Inc., have their own training school and aeroplane factory in Chicago, where they are offering attractive inducements to the prospective aviator wanting to obtain instruction in the art of flying the heavier-than-air machine. They report that Aviator Art Smith has just purchased a new Mills biplane equipped with pontoons, with which he is to fly this season, continuing under the management of the Mills Aviators, and that E. G. Vedder and L. K. Moffitt, of Adrian, Mich., have also purchased the latest improved Mills biplane. Mr. Vedder is to pilot this craft.

The Louis L. Crane Airship Transportation Company, Inc., of Brooklyn, N. Y., is considering building a non-rigid dirigible balloon with box kite steering apparatus, the gas bag to be 160 feet long and 30 feet in diameter.

The Curtiss Aeroplane Company, of Hammondsport, N. Y., have been winning their factory on a full time lately, owing to the constantly increasing number of orders received from both foreign and domestic purchasers. The success of their latest creation—the war aeroplane—which recently underwent its official tests at the Army Aviation School, Augusta, Ga., prior to its purchase by the United States Government, has helped to increase orders for both the Curtiss aeroplanes and the Curtiss motors. Besides this there is a constantly growing demand for the Curtiss hydro-aeroplane.

The International Aeronautic Construction Company, of Jamaica, N. Y., have now secured the services of M. Semeniouk, a graduate of the Blériot school, and a well known French pilot, to take charge of their aviation school, which is to use the latest types of Blériot and Farman machines with dual controls, which makes it possible for students to acquire experience under the direct supervision of the instructor while in the air. This company reports that during the past month they received orders for one of the latest Farman type military machines from Marshall Reid, of Philadelphia, and also two specially constructed monoplanes, one of which is being built for M. E. Koster, of Yonkers, and the other is for a patron whose name they refuse to divulge.

The Frontier Iron Works, of Buffalo, N. Y., report that a great number of manufacturers of aeroplanes as well as aviators are becoming interested in their Frontier motor, and that they are now preparing to build these motors in lots of twenty-five.

# THE TRADE

Herbert C. Doyle, who started some time ago in the aeronautical supply business in Rochester, N. Y., reports that his business is increasing every day and that he is called upon to deliver supplies of every description for standard and special machines to all parts of the United States.

The Hoover-Crowow Aeroplane Company, of Atlanta, Ga., state that they are having an increasing demand for their propellers, whose efficiency is beginning to attract the attention of those of broad experience. This concern also manufactures aeroplanes, and is probably the "farthest South" aeronautical manufacturing establishment in America.

The French American Balloon Company, of St. Louis, Mo., is one of the oldest balloon manufacturing concerns in the United States. Mr. H. E. Horeywell, its director, reports that there is just as much ballooning done in America to-day as ever before, and that his concern is kept busy the year around making balloons for the sportsmen who indulge in this most fascinating gentleman's pastime.

The National Aeroplane Company, of Chicago, is, from all reports, an enterprising concern. It has established an aviation field at Galveston, Texas, as well as in Chicago. Quite a large number of students have already been enrolled for tuition in their school, and the company is kept busy building machines for their own use, as well as making them for sale.

The American Aviation Company, Inc., of Chicago, announces the opening of an aviation school in addition to their manufacturing business, and expect to enroll a number of students for the coming season.

What promises to be a very successful engine for model aeroplane use, has lately been placed on the market by the **Nomie Engine Co., Ltd.**, of Cicero, Ill. This motor is built on the principle

of the Gnome rotary motor, and has every characteristic of the latter. Three distinctive power plants are offered, viz., 3-cylinder  $\frac{1}{2}$  H. P., 3-cylinder  $\frac{1}{4}$ , and 6-cylinder  $\frac{1}{2}$  H. P. The smallest type weighs 3½ ounces, while the larger one weighs 16 ounces. The manufacturers claim that their engines are the lightest and most powerful miniature engines in the world. Foreign and domestic patents have been taken out.

Of the visitors to Nassau Boulevard, perhaps the highest crowd is usually to be found around hangar No. 27, that of the **Morok Aeroplane Co.** Mr. Chas. Morok, who has been nominated by Belgium to represent that country in the Gordon Bennett cup race, is busily constructing a racing monoplane, and has ordered a fourteen cylinder 100 H. P. Gnome motor to use in the event. He also has two monoplanes and two biplanes equipped with Gnome and Anzani motors, all of which will be used in exhibition work this season. Mr. Morok says the demand for machines this spring has been good and sales have been active.

To satisfy the demand of a high powered low priced aeronautical motor, a syndicate in Detroit, comprised of several business men, has recently formed under the name of the **Albatross Company.** A location has been secured on West Jefferson and Polawski avenues, with 125 foot frontage on the main street, running down to the river. An ideal location for experiments with hydro-aeroplanes, which is included in the program of the company. The engine manufactured by the company is a six cylinder air-cooler of the star type and weighs but 235 pounds. The engine is put on the market completely equipped with magnets, carburetor and propeller, and a self starter. It is claimed to deliver fully 50 brake H. P., and an original novelty is the attachment of a starting handle and clutch, which makes the old and dangerous method of starting by means of the propeller unnecessary even if the self starter should fail at times to start the engine.

The **American Propeller Company**, of Washington, D. C., reports great activity in bringing out some additional designs and new modes of construction particularly adapted to certain classes of machines which require high pitch with low rotational speed. It is their very confident expectation that these newer constructions, while more economical in manufacture, will find as high favor and popularity as their present well known styles and designs. They are receiving many inquiries for their new illustrated booklets, which they are sending out in large numbers together with their 1912 price list, which has been somewhat modified from the list prevailing in 1911.

The **Diana Aero Company**, of Detroit, Mich., is now installed in a fire location beside the second business street in the city. It has a large frontage on the Detroit River within a mile of Lake St. Clair. The bridge to Belle Isle is only a few hundred feet away and in full view of the company's aeroplane testing grounds.

The Diana Company is devoting its attention to propeller, aero-hydroplane and aeroplane manufacturing.

Among the experts on its staff is a designing mechanical and civil engineer, a propeller maker of years' experience, also an aviator to test out its planes.

The **Aeroduster Construction Company**, of Chicago, are extending their business latitude and have appointed Mr. Frederick Brauninger as their New York representative to look after their trade in the metropolis.

Mr. John E. Sloane, the enterprising president of the **Sloane Aeroplane Company**, of New York, has engaged George M. Dyott, the famous monoplane pilot, to demonstrate the capabilities of both the Sloane aeroplane and the Charavay propeller. Mr. Sloane reports exceptionally good business during the past month.

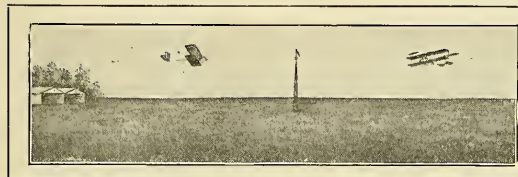

## Rubel School of Aviation

OFFERS MORE INDUCEMENTS to students than any other aviation school in America.

Instructions in flying Monoplanes and Biplanes. Room and board can be had at our dormitory on the Aviation grounds.

Our private Aviation Park is at the disposal of amateur and professional aviators. Motors and hangars for rent. Write for school booklet and terms. We can guarantee engagements to competent graduates. Visit us before you enroll.

R. O. RUBEL, Jr. & CO., Inc. 1600 Floyd St., Louisville, Ky.



**MONOPLANES  
PROPELLERS  
BIPLANES**

Paul Beck in his 138-mile flight at the Army Aviation Field, Augusta, Ga., March 27, 1912

Duration of flight, 2 hours, 18 minutes, climbing 400 ft. per minute.

**Gyro Power Plants furnished in all machines from 22 to 100 h. p.**

**WASHINGTON  
AEROPLANE CO.**

809 Water Street, S. W.  
WASHINGTON, D. C.

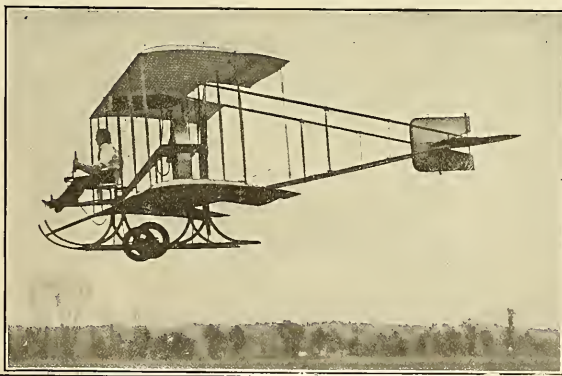

St. Louis, Mo., April 6, 1912.  
Mr. J. Lee Simmons, Gen'l Mgr.,  
Washington Aeroplane Co.,  
Washington, D. C.

Dear Sir:—  
Several weeks ago we acknowledged receipt of the 7.75' diameter 6.25' pitch oak propeller, same being for our Roberts six, and for use in our school machine.

I am pleased to report that this is the finest propeller that I have ever had occasion to use. It has the most delightful property of increasing its thrust in the air, and is perfectly balanced.

We are also in receipt of the 9 ft. tractor propeller which I will test out as soon as we get our new motor.

Very truly yours,  
THE BENOIST AIRCRAFT CO.  
(Signed) ANTONY JANNUS

(This is one of the many similar letters we have on file in our office.)  
Booklet Free.

# CLASSIFIED ADVERTISING

15 CENTS A LINE

SEVEN WORDS TO LINE

CASH WITH ORDER

## FOR SALE

IF you want passenger balloons, dirigibles, captives or aeroplanes; large stock; immediate shipment; any size built to order. Teach purchaser to operate. Exhibitions furnished throughout United States and Canada. G. L. Bumbaugh, builder and operator, Indianapolis, Ind., U.S.A.

**FOR SALE**—Complete sets of castings for building the Bleriot monoplane. Lynch Brothers, Aeronautic Engineers, 61 Wick Place, Youngstown, Ohio.

**A PRIZE winner, boys.** "Hercules" Model Propellers, light, strong and efficient. Accurately carved from selected wood. Try one on your model and see the difference in speed and distance. Sizes 6" to 12" at 5c an inch. Other sizes and prices sent on application. Designed and manufactured by Madrian Brothers, 66 Sumner Ave., Brooklyn, N. Y.

**ST Carl Myers' Latest, best system Captive Balloons;** 300,000 passengers carried; millions attracted. Airships, gas-works, motors, accessories. Balloon Farm, Frankfort, N. Y.

**FOR SALE, \$750.00**—1 36-48 H. P. Fox aeroplane motor, with propeller, Bosch magneto, etc., ready to run, first class condition, been used only 2 or 3 times. Original price \$1,400.00. H. A. Meldrum, Buffalo, N. Y.

**VICINI Guaranteed Propellers**—Backed by two years' experience in propeller making, five laminations of spruce with walnut or ash. Price \$16.50, six to eight feet in diameter. Western Aeroplane Supply House, Sedalia, Mo.

**FOR SALE**—Biplane Glider, 360 sq. ft. surface, everything complete, drawings, castings, patterns, except fabric. Price \$15.00. S. C. Allen, 700 Bristol St., Saginaw, Mich.

**DISSOLVING partnership:** passenger Biplane (new) with or without motor. Best offer takes either or both. E. L. Buchanan, 36 West 4th St., New York City.

**FOR SALE**—Paris Curtiss Military Type, \$125.00. Address A. B. C., 93 West St., Malden, Mass.

## FOR SALE

**CURTISS** latest improved type (Pigeon tail) 1912 Model. Made over 300 very successful flights 1,000 ft. high, 30 miles cross-country. My construction is strongest in the world. New, complete, ready to fly, tested and guaranteed, including free lessons to buyer, \$2,500. Buy direct from Builder and Aviator of 10 years' experience. H. C. Cooke, Aviator and Builder, 128 West 65th St., New York City.

## MISCELLANEOUS

**WANTED**—Experienced Aviators, mechanics and helpers. State salary. Manufacturer, c/o Aircraft.

**AVIATOR**—Will train four reliable men for exhibition flying and furnish aeroplanes to be paid for with percentage of earnings. Not a school proposition. H. B. Crowsdon, 446 Bowen Ave., Chicago, Ill.

**"REAL FLYING TAUGHT"**—\$75 complete. "Curtiss-Farman" machine used. Students limited. No correspondence or hard labor course. Excellent flying facilities. American Aviation Co., Incorporated, 2957 North Lawndale, Chicago, Ill.

**WANTED**—To receive catalogs and agency propositions for aeroplanes, motors, accessories, models and model supplies. Crescent Aero Co., 7736 Jeannette Street, New Orleans, La.

## POSITIONS WANTED

**TO Whom it May Concern**—I desire a position as aviator's assistant. I have knowledge of gasoline engines. My weight is 100 lbs. and my ambition aviation. I am willing to go any place in the world and will work for my expenses, with prospects of learning to fly. Give me a chance and I will prove myself worthy. Edward Cooley, c/o Aircraft.

## POSITIONS WANTED

**ENERGETIC** and intelligent young man, age 21, with mechanical ability and accustomed to shop work, desires position in aeroplane factory or at hangar. One that offers good opportunity in construction. Address J. V. O., 5817 13th Ave., Brooklyn, N. Y.

**CAPABLE,** reliable young man with four years practical experience in locomotion, wants a position on aeroplane work, have built large working models, possesses a good knowledge of monoplane and biplane construction (age 26) intelligent, with ambition, and good health. References given. Address "Locomotion," Box 757, Aircraft.

**A YOUNG MAN,** age 18, desires position as an aviator's assistant, with prospects of learning to fly. Address Louis Fenouillet, 132 West 47th St., New York City.

**YOUNG man,** 21, thorough student of aviation, desires position as aviator's assistant. Will give services for expenses. Michael M. Meizell, 728 N. 24th St., Camden, N. J.

## CO-OPERATION WANTED

**CAPITAL** wanted to patent and build aeroplane that will fly three hundred miles per hour. Will give 49 per cent. of patents. I will guarantee to fly across Atlantic in twelve hours. Address A. Harbottle, 18 Eldert St., Brooklyn, N. Y.

**DESIRE** communication with someone who will invest in most bird-like, practical self-balancing flying machine; will require less power than any other type. Ernst Ebhinghaus, 316 East 93rd St., New York.

## LEGAL NOTICE

**AS** I am manufacturing Aeroplanes, I desire to give notice to all persons that are using my "Patent Rudders" with inverse and simultaneous action, and also my "Patent Semi-automatic engine control," that it is my intention in the future to ask a small "Royalty" from them. Hugh L. Wiloughby, Sewall's Point, Florida.



## Learn to Fly

**N**OW'S THE TIME.  
Flying graduation  
**GUARANTEED.**  
French method instruction; mechanic course. We positively have the only REAL Aviation School, two aviation fields, three factory buildings, aeroplanes, motors, etc., and the LARGEST aviation field in America. Motor, propeller, construction and flying thoroughly taught. Send for a home study course; FREE lesson.

### STANDARD AVIATION COMPANY

1309 Manhattan Bldg. Chicago, Ill.

## "GRESSIER AVIATORS"

Now conducting finest equipped School in America  
**FARMAN MORANE BLERIoT VOISIN-HYDRO**  
 Using only Gnome and Anzani Motors  
 LET ME SHOW YOU. GET MY RATES  
 Address F. H. BRAUNINGER, No. 263 W. 69th St., N. Y.

## COOKE BIPLANES

**Curtiss Improved 1912 Type (Pigeon Tail)**  
 Perfect fliers. No freak construction. Ten years' experience. Strongest in the world. Amply powered (Roberts Motors.)  
**Anybody can fly these machines.** One ready for immediate delivery  
*Free Instruction to Buyer*  
**H. C. COOKE, 127 West 64th St. NEW YORK CITY**

## CHICAGO AERO WORKS

**H. S. RENTON** Proprietor  
**164 North Wabash Avenue**  
**AEROPLANES** ACCESSORIES MOTORS PARTS  
 HARDWARE PROPELLERS  
 WHEELS ALSO MODELS AND MODEL STOCK  
 ESTABLISHED 1909. First in Chicago and the Middle West  
 Aviators Taught. Flights Furnished. Send Stamp for Catalog.

EVERYBODY isn't doing it because  
 EVERYBODY hasn't the TWENTY-FIVE DOLLARS—  
 II EVERYBODY did have the TWENTY-FIVE DOLLARS,  
 EVERYBODY would buy an

*Aeroadster*

### The Aeroadster Special 20-Foot Biplane Glider

Guaranteed to sustain 185 pounds. Best spruce construction throughout. Laminated ribs. Glider guyed with tested Aviator wire and turnbuckles.

Shipped anywhere for \$25.00 f.o.b. Chicago  
 We are prepared to furnish any special work for AEROPLANE construction as well as GLIDER WORK of any description. Write for information regarding AERONAUTICAL work of any kind and then compare our prices with others.

See the AEROADSTER at the Aeronautical Show, Gressier Aviators' Booth.

**CONSTRUCTION COMPANY**

*Aeroadster* 3751 INDIANA AVENUE, CHICAGO, ILLINOIS

This Ad guarantees all our claims

New York Representative, F. BRAUNINGER, 263 West 69th St., N. Y.

# The Call

# Aviation Engine

**Four Cycle, Water Cooled, Opposed Cylinders**  
 THE GREATEST KNOWN THRUST PER  
 RATED HORSEPOWER

WRITE FOR CATALOGUE

**THE AERIAL NAVIGATION CO.**  
 OF AMERICA

GIRARD, KANSAS



PROPELLERS for model aeroplanes; light, smooth aluminum blades; variable pitch; steel shaft accurately and securely attached; 3 1/2 in. 10c, 6 in. 25c, 8 in. 35c, 10 in. 50c, 12 in. 75c. Post paid. Low quality prices. Jersey Scooter Aeroplanes 25c.

**LINCOLN SQUARE NOVELTY WORKS**  
Department B 1931 Broadway, New York

**TOY AIRSHIP PATENT FOR SALE**

**CRANE'S YANKEE FLYER**

A good investment for a man or boy to make a fortune in his own home. The best money making Toy in the market. Can prove it. Investigate.

**LOUIS L. CRANE**

259 9th St., between 4th and 5th Ave., Brooklyn, N. Y.

**MODEL SUPPLIES**

That are right. Drawings for 3 ft. Blériot and 3 ft. Antoinette with full building instructions, Price 15 cents each. Drawings for 40 in. Curtiss, as used by Lincoln Beachy, Price 25 cents. Ball-bearing Shafts 30 and 50 cents each. We carry everything used in Model Building. Send stamp for catalogue.  
**BROOKLYN AEROPLANE SUPPLY CO.**  
Woodhaven, Long Island, N. Y.

**C**ONCERNS that need expert aeronautical engineers and mechanics or aviators, and managers or organizations who wish the services of competent aviators, are invited to communicate with the **AERONAUTICAL SOCIETY**.

We have just established a **SERVICE BUREAU** for the purpose of bringing the reputable employer or manager in contact with people who can give competent services.

We do this work without any charge whatever in behalf of our members. We thoroughly investigate the capability of every person or organization we recommend.

Members who wish employment in aeroplane industries or who wish engagements as aviators or who wish to fill flight exhibition dates are requested to communicate with us at once. All communications will be treated as confidential. If there is anything any member wishes to sell or trade or if there is anything you wish to secure that you cannot locate, register your requirements with the Service Bureau. All letters should be addressed to the

**GENERAL SECRETARY, The Aeronautical Society, 250 West 54th Street, New York City.**

**FOR SALE—BLERIOT TYPE MONOPLANE**  
**Immediate Delivery**

Finest construction throughout. Best of materials combined with expert workmanship makes this an excellent bargain. Crated ready for shipment. Price complete, exclusive of power plant, \$700.00. FOB., N. Y. Write "Aeroplane," 44 West 43rd Street, New York, N. Y.

**J. C. (BUD) MARS, NOW BOOKING**

—ADDRESS—

**17 N. La Salle Street, Chicago, Ill.**

**DETROIT AERO POWER PLANT**

COMPLETE \$300 READY TO RUN

INCL. PROPELLER-CARBURETOR-BOSH MAGNETO, OIL PUMP-CABLE-SWITCH-MOUNTING BOLTS.

IS GUARANTEED TO

210 LBS. MIN. STATIONARY THRUST

150 LBS. MAX. WEIGHT (COMPLETE)

36 HOURS DELIVERY.

LIFT AND FLY

CURTIS BYPLANES

BLERIOT II MONOPLANES

DEMOISELLE MONOPLANES

OR CRAFTS OF SIMILAR MAKE

**DETROIT AEROPLANE CO.**

DETROIT MICHIGAN

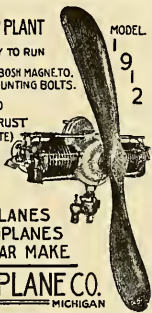

**BAMBOO Special Grades of**

Bamboo for AERONAUTIC WORK

Reed, Rattan and Split Bamboo for Models.

All sizes in stock. Tonka Rattan for Skids,

1 1/4 inch and under, any length.

**J. DELTOUR, Inc.**

804 Jefferson St. Hoboken, N. J.

**PATENTS**

**IN PATENT MATTERS**

An experienced Mechanical Engineer can Advise You Better, Protect You Better, Develop Your Idea, Improve Your Invention.

**G. M. SACERDOTE, M. E.**

Patent Attorney, Registered in United States Patent Office

1919 BROADWAY, N. Y. CITY Tel. 8690 Columbus

FRENCH and ITALIAN SPOKEN

**PATENTS THAT PROTECT AND PAY**

Advice and Books Free. Rates Reasonable. Highest References. Best Services.

**WATSON E. COLEMAN, Patent Lawyer**

622 F St., N. W., Washington, D. C.

**PATENTS SECURED or Fee Returned**

Send sketch for free search of Patent Office Records. How to Obtain a Patent, and What to Invent, with list of Inventions Wanted and Prizes offered for Inventions sent free. Patents advertised free.

We are experts on AIRSHIPS and all patents and technical matters relating to AERIAL NAVIGATION.

**VICTOR J. EVANS & CO.** Washington, D. C.

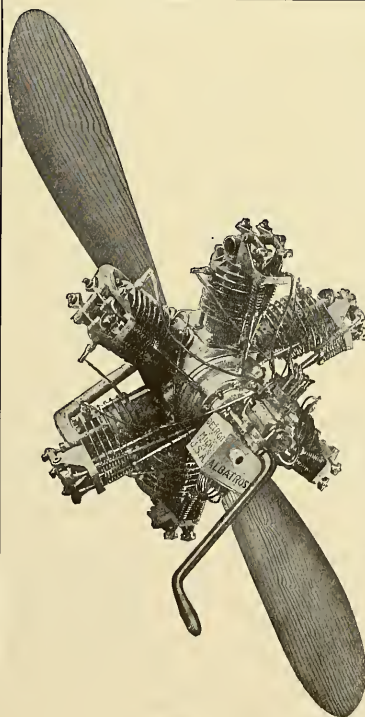

**It is an Insult to Your Intelligence**

To be asked more money for a high powered aeronautical motor than you are compelled to pay for a complete motor car of Vanadium steel construction. We therefore offer you

**The Self-Starting 50 H. P. Six Cylinder Albatross**

Including Magneto, Carburetor, Propeller and Self-Starter complete for \$650.00, F. O. B., Detroit.

If you want to get into the International Races this year, get an ALBATROSS, and have a sure chance. Our large illustrated catalogue tells you why Detroit people can do what George can't. It is free for the asking.

AGENTS WANTED EVERYWHERE

**Albatross Company**

Detroit, Mich., U. S. A.

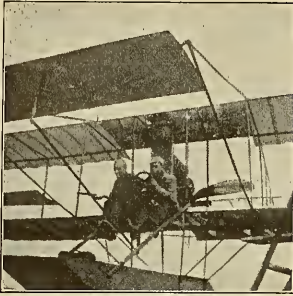

After Wild Ducks in the  
HAMILTON HYDRO-AEROPLANE  
With Elbridge 60-90 H. P.

## The New Elbridge "Six"

Possesses features that will interest you if you are buying or building a Hydro-Aeroplane or heavy Biplane requiring more power than our 4-cylinder engines.

**THE ELBRIDGE "60-90" WEIGHS LESS THAN 200 LBS.**

when equipped with imported alloy cylinders; and only 260 lbs. with standard iron cylinders.

Greatly increased production of "Sixes" for 1912 enables us to make prices that are right. Drop us a line today asking for special news.

**ELBRIDGE ENGINE COMPANY, Rochester, New York**

## BIRD-MODEL

The most natural, perfect and scientific Flying-Machine in the world (patented), which shows the secrets in birds' flight.

Most interesting for enthusiasts and experimenters in Flying Machines, who cannot be without it.

Send 25 cents for power model, or 15 cents for gliding model, in coin.

Agents wanted. Idea is worth the money.

**Ernst Ebbinghaus 316 East 93rd Street New York, N.Y.**

## MOROK AEROPLANE CO.

Manufacturers and Exhibitors of

*Monoplanes and Biplanes*

INSTRUCTION FREE TO PURCHASERS

**303 FIFTH AVENUE NEW YORK**  
Telephone, Madison Square 8610

## MILLS AEROPLANES

**POSITIVELY GUARANTEED TO FLY**

Equipped with any reliable motor as may be selected by purchaser. Our planes have flown in all central states. Competent Aviators Booked for Exhibition Work through our Exhibition Department.

**MILLS AVIATORS, Inc.**

**1612 Masonic Temple Chicago, Illinois**

## BALLOONS—DIRIGIBLES

Write for RECORDS and PRICES before buying anywhere  
We arrange CONTESTS, QUALIFY PILOTS, etc.

**FRENCH AMERICAN BALLOON COMPANY**  
Oldest, Largest in America

**H. E. Honeywell, Pres. and Mgr. St. Louis, Mo.**

Type A **PROPELLERS** have no equal  
MOTORS **STREAMLINE** SUPPLIES  
Monoplanes **STREAMLINE** Biplanes

**Hoover-Conrow Aeroplane Co., Atlanta, Ga.**

## SUPPLIES

Material and Workmanship the Best

- 5' Laminated Curtiss Ribs, set of 70—\$18.00
- 5' Double Surface Ribs, - set of 70—\$30.00
- 5' Curtiss Struts, - set of 20—\$ 8.00
- 6' Bed Rail Clamps, - set of 20—\$ 4.00

ALL WOODWORK SHELLACED

Everything else in proportion. Price list for stamp

**Herbert C. Doyle, 321 Lake Ave., Rochester, N. Y.**

## NAIAD Aeronautical Cloth

Manufactured Especially for Aeroplanes and Used by  
Aviators of Prominence

**LIGHT, STRONG, AIR-TIGHT**

AND

**MOISTURE-PROOF ON BOTH SIDES**

Sample Books, including Data and Prices, sent on request

**THE C. E. CONOVER CO.**

**101 Franklin Street - - New York**

## THOMAS AEROPLANES

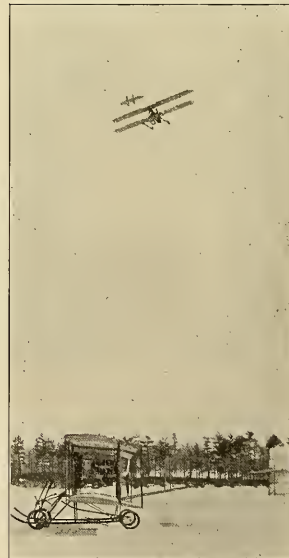

*Designed  
To Suit the  
Requirements of*

The Conservative Flier  
The Sportsman  
The Yachtsman  
The Exhibition Flier  
The Speed Fiend

*Equipped with  
the following  
Power Plants:*

- 35 H. P.
- 50 H. P.
- 70 H. P.
- 120 H. P.

Write for 1912  
Catalog and

*Learn WHY  
Thomas' Planes  
Are Reliable, Safe  
And Comfortable*

School and Training Grounds, Bath, N. Y.  
**THOMAS BROTHERS,**

**Bath, N. Y.**



# GOOD YEAR

## Goodyear Tire & Rubber Co.

### PIONEER BALLOON MAKERS OF AMERICA

An opportunity for you to now enter the big profitable field of ballooning for racing, exhibition, or advertising purposes with the American-made balloon--a **GOODYEAR**. We build them complete for all purposes--start with raw material, end with finished product--even to fitting up with engines and parts. We guarantee our construction and quality equal to anything in the world. Prompt deliveries--reliable quality and money saved--is the value of Goodyear Balloon service.

### Rubberized Aeroplane Fabric

The only weather-proof fabric. Hence most durable--*safest*. It neither rots, mildews nor weakens. It won't shrink nor stretch, pull the planes out of line, nor flap and cut down speed. The process which *impregnates* the cloth with rubber makes the fabric impervious to varying degrees of heat, cold, or moisture. Used by all leading air-men and manufacturers.

### Aeroplane Tires--Springs

Our Detachable Aeroplane Tire is most popular. This tire is built like the Goodyear No-Rim-Cut Auto Tire. It binds the rim in a grip that holds in spite of landing wrenches--prevents loss and injury. Made of special fabric of unequalled resiliency and strength.

We make tires of all kinds for all American and Foreign machines. With or without leather treads. We also make a full line of springs, including the Elieriot Type Rubber Shock Absorber, of which we are the sole manufacturers in America.

Write us before doing anything definite.

## The Goodyear Tire & Rubber Co.

### AKRON, OHIO

Branches and Agencies in 103 Principal Cities

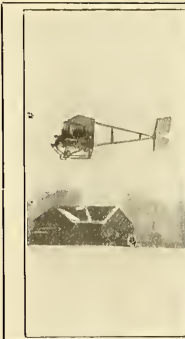

# BENOIST

## BIPLANES

### TYPE XII.

### Three Models

- School Machine
- Cross Country Machine
- Military Machine

Also operate the  
**Benoist School of Aviation**  
 For further particulars address  
**BENOIST AIRCRAFT CO.**  
 6630 Delmar Blvd., St. Louis, Mo.

# WIRE

Aviator Wire supplied in 12 sizes with a plate finish, making soldering easy. This wire is specially drawn from extra quality high grade steel. Also Aviator Cord of twisted wire.

## John A. Roebblings Sons Co.

### TRENTON, N. J.

## FLYING ALL WINTER

Become a PILOT on the latest . . .  
**WRIGHT AEROPLANE**

The Greatest Money Maker in the World  
 WE make you a FLYER in 10 lessons  
 WE stand all breakage  
 NO extra charge to you  
 ENROLL NOW and be an OPERATOR when the good weather sets in  
 FINEST and BEST equipped AVIATION GROUNDS in AMERICA

Passengers Carried Daily, \$25

STEVENS & BEATTY Box 181 Mad. Sq., N. Y.

Course \$ 2 5 0 Course

### STOCK SIZES--PROMPT DELIVERIES

- 16"x1 1/2" or 2" 20"x2"-2 1/4"-2 1/2"-3" or 4"
- 24"x2" or 3" 28"x2"-2 1/4"-2 1/2" or 3"
- 20"x2 1/4" Wheel less Tire, \$4.00

Each. Stock Size Hub--6" wide.

- Ball bearing--3/8" or 1/2" Axle or bronze bushed to fit 1"-1 1/4" or 1 1/2"
- Tubular axle--
- Any width
- Hubs to
- Order

Buy AEROPLANE WIRE WHEELS from Manufacturer and Save Money

- 20"x2 1/4" Complete with Tire, \$5.75.
- 20"x3" Complete with Tire, \$8.25.
- Complete Farman Type Running Gears, \$42.50.

Deposit required on orders--balance C. O. D. Examination allowed.

J. A. WEAVER, Jr., Mfr., 132 W. 50th St., N. Y.

## "Expanding Pitch" Propellers



Are used by all discriminating Aviators who want *efficiency*. They are sold on their merits and backed with a binding guarantee.

*The Propeller that propels.* It's the propeller you'll eventually use.

Write for illustrated catalogue, printed in five colors, telling how they are made. It's free for the asking.

**R. O. RUBEL, Jr. & CO., Incorporated**  
 1600 Floyd Street LOUISVILLE, Ky.

## AEROPLANE RADIATORS

IN STOCK OR TO ORDER

SEND FOR PRICE LIST EL ARCO RADIATOR CO. 6 EAST 31st St., NEW YORK

# Continuous Operation at Extreme Angles with every bearing Positively Lubricated

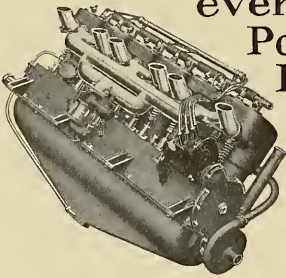

No  
Hand  
Oiling

## Sturtevant Aeronautical Motor

FOUR AND SIX CYLINDER  
Four Cycle—Water Cooled Automobile Type

An Aeronautical Motor built for service under all conditions and at extreme angles.

Heavy enough to be durable—light enough for flying. Lightness secured by refinement in design and in those parts best suited to give lightness. No vital parts weakened to secure light weight.

Entire design tends to eliminate trouble-producing parts. There are no push rods—no rocker arms.

The valves located in the side are instantly removable for re-grinding. No danger from broken valves. The exhaust valves are equipped with lifters to permit coasting in air.

All the gears are enclosed and run in oil. The high-tension Mea Magneto permits easy starting with retarded spark.

A muffler may be furnished if desired which makes the motor practically noiseless.

The normal speed of 1200 R. P. M. may be reduced by throttle to 300 R. P. M.

*A Dependable, Durable Motor backed by the STURTEVANT Guarantee.*

Ask for Booklet 200 E

**B. F. STURTEVANT COMPANY**  
HYDE PARK, BOSTON,  
MASSACHUSETTS.

Offices in all Principal Cities.



**Tandem Gear Pump**  
The Heart of the Oiling System

**WAKE UP BIRDMEN!** It's time?—  
In **HELICOPTRES** climb to heights unknown,  
And all the Earth explore. Then will obtain  
The glory of your prime for Peace or War.

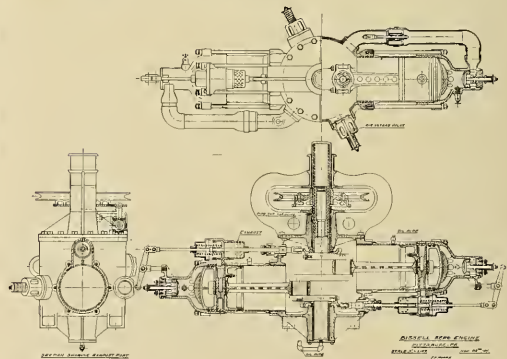
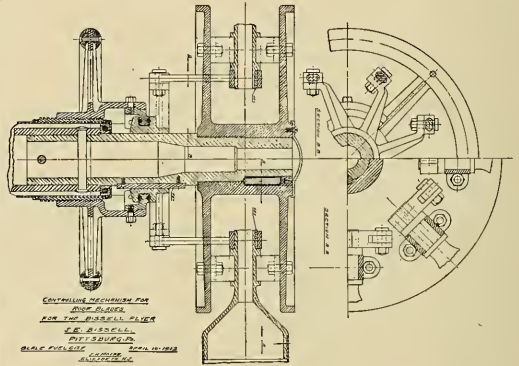
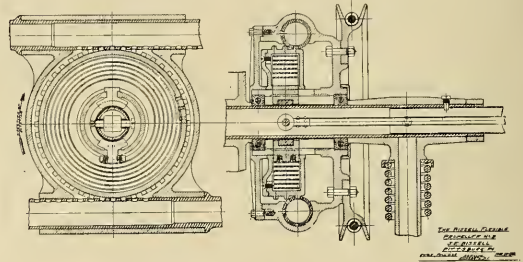
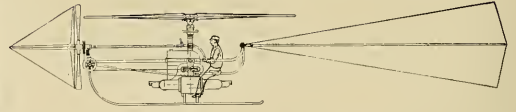

In either day or night the **HELO**  
Spins upright through zephyrs mild,  
Or midst the tempest's roar—whizzes  
Swifter than an arrow in its flight,  
And will remain aright—**CONQUEROR.**

**JOS. E. BISSELL, Box 795, Pittsburg, Pa.**

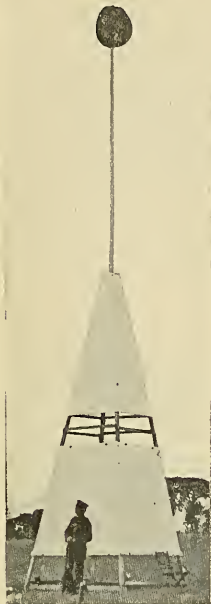

**T**HIRTEEN American aeroplane records are held by American aviators. Nine records were made in biplanes and monoplanes equipped with **CHARAVAY Propellers**. No record was made by any other concern which specializes on propellers.

With a **CHARAVAY Propeller** on his monoplane St. Croix Johnstone captured the record for distance; three records for the greatest speed over given distances; and three records for distance flight within a fixed period of time.

With a **CHARAVAY Propeller** on his monoplane Rene Simon captured the climbing speed record by reaching the altitude of 1,600 feet in 3 minutes 35 seconds.

With a **CHARAVAY Propeller** on his biplane Charles K. Hamilton broke the world's record for biplane speed over a circular course by flying at the rate of 79.8 miles an hour.

Over one-fifth of all the aviators in America secured their pilot's license with a **CHARAVAY Propeller**.

There is no more convincing array of hard, cold, practical, unassailable facts that demonstrates the unparalleled flying efficiency, reliability and durability of the **CHARAVAY Propeller**.

The **CHARAVAY Propeller** must have all these qualities because it is built according to a scientific formula that has been adopted as a part of the curriculum of the Stevens Institute of Technology.

Most important of all, you can buy it for less money than any other propeller in the world.

Can you afford to use any other propeller?

*Manufactured and Sold by*

## SLOANE AEROPLANE COMPANY

Aeroplanes

Charavay Propellers

Parts and Repairs

1731 BROADWAY, NEW YORK CITY

AGENTS

*Eames Tricycle Co., San Francisco and Los Angeles*

*National Aeroplane Co., Chicago*

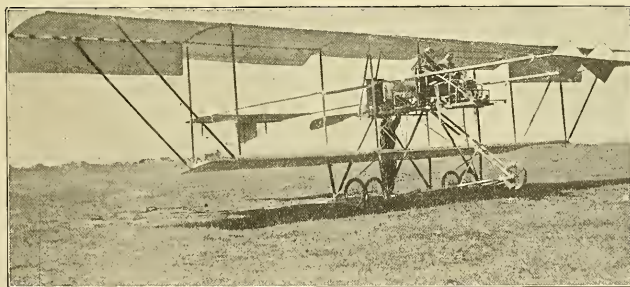

Showing double control school machine built in our Chicago factory. Width 52 feet.

# A NATIONAL AEROPLANE COMPANY

2023 Michigan Avenue

Summer School  
Opens May 1st  
Chicago, Illinois

Manufacturers, Exhibitors, School of Aviation

REFERENCES:

Dun or Bradstreet  
Corn Exchange National Bank, Chicago



*(The new name for screw or spiral propeller chosen at a prize competition among the aviation public, September, 1911.)*

Biplane propellers are "push-Spiroons"  
Monoplane tractors are "pull-Spiroons"

There is a 2-bladed or du-Spiroon  
and a 3-bladed or tri-Spiroon

Thorough tests on identical engines with a number of the leading makes in the country have shown the du-Spiroon to give greater thrust in every case.

3-99 BALDWIN AVE.

WRITE

## Aerial Screws cannot be fully efficient without even turning.

The disconnectedness of cylinder explosions at even 1200 r. p. m. sets up a fine tremble in the screw. This makes it impossible for the entering edge to cut the air with a clean, efficient stroke.

Even turning can be obtained in only three ways:

1. By adding a flywheel of 40 to 80 lbs.
2. By using a rotary engine (which loses 20 per cent. of its power in rotating besides its greatly increased head assistance.)
3. By use of the 3-bladed or tri-Spiroon, which is a natural flywheel.

The 3-bladed type has made a remarkable showing in European aviation. It is adopted on the latest Breguet, Rumpler Taube, and other planes.

DETROIT, U. S. A.



\$1200 to \$4800

THE  
**REX** MONO-  
 PLANE CO.

South  
 Beach, S. I.  
 N. Y.

DUPLICATE PARTS

at

SAVE  
50%**COST**SAVE  
75%

## Buy a **REX** Monoplane and Save

\$500 to \$1000 on Purchase.

\$250 Tuition Fee to Learn to Fly.

50% to 75% on Maintenance.

The REX, with its interchangeable wings, makes it possible to enter Speed, slow and passenger contests during the same day. **WHAT OTHER AEROPLANE CAN DO THIS?** Remember, we **Guarantee Before** delivery to fly the REX at Least 1000 Feet High and 10 Miles across country.

We Supply an Extra Pair of Racing Wings with each REX.

We Duplicate Parts at Absolute Cost, a Saving of 50% to 75% in Maintenance.

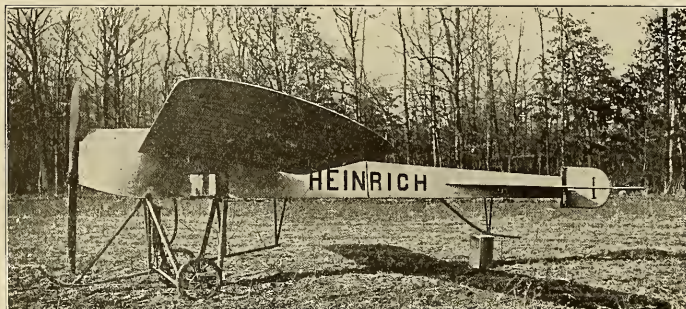
**THE REX MONOPLANE CO.****South Beach, S. I., N. Y.**

SIDE VIEW OF 1912 HEINRICH MONO-BIPLANE MODEL (A).

1912

## Heinrich Mono-Biplanes

The only Aeroplane built to take two sets of wings, Monoplane or Biplane, practically two machines in one, at the cost of one, and takes up the space of one. Built in the following sizes; Biplane wings extra.

Model (A) single seat, high speed, cross country type, \$900 without motor

Model (B) two seat, cross country type with 100 H. P. Motor \$2,550

Model (C) three seat military type, with 100 H. P. Motor \$2,800

Model (D) special type, single seat, with 25 H. P. 2 cyl. Motor \$1,000

**Heinrich Bros. Baldwin, L. I., N. Y.**

Particulars and illustrated booklet sent free on request

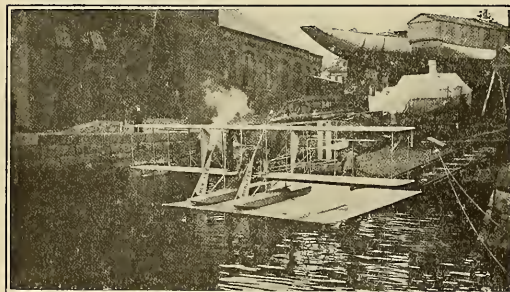

"THE PASSING OF THE YACHT"

## Marblehead Flying School Re-Opens

Hydroaeroplanes used exclusively. You can learn without delay. The Burgess factory adjoins the flying station. Aeroplanes for exhibition, military and sporting use under construction. All leading motors used. Pupils secure not only training, but latest information concerning construction and design.

## INSTRUCTORS:

HOWARD W. GILL      PHILIPS W. PAGE  
 CLIFFORD L. WEBSTER

All Licensed Aviators

New Booklet just printed will give you full particulars

**THE BURGESS COMPANY & CURTIS**

Box A

MARBLEHEAD, MASS.

## FRONTIER MODEL A

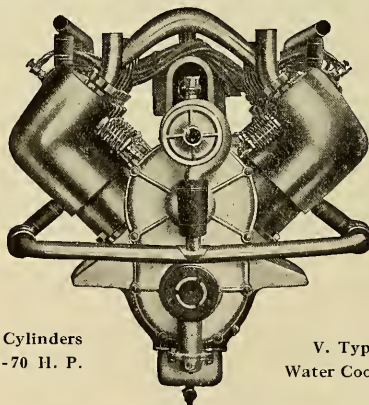

8 Cylinders  
 60-70 H. P.

V. Type  
 Water Cooled

Four and three quarter lbs. per actual Horse Power

Flying time will soon be here.  
 Place your order early and  
 avoid delay : : : : : :

WRITE FOR CATALOGUE AND PRICES TO-DAY

**Frontier Iron Works Buffalo, N. Y.**

# NOMIE ROTARY MOTORS

## MINIATURE TYPE

Operate on Compressed Air, Steam or Carbonic Acid Gas.

Invaluable for working models of Aeroplanes, Boats, Dynamos, Gyroscopes, etc.  
**LIGHTEST AND MOST POWERFUL MINIATURE ENGINES IN THE WORLD.**

Type "A" 3 cylinder 1/2 H. P. complete unit weighs 16 ounces.

Type "B" 6 cylinder 1/2 H. P. complete unit weighs 26 ounces.

**POWER, RELIABILITY, DURABILITY and EFFICIENCY GUARANTEED.**

Every motor fully guaranteed to deliver the rated horsepower, and to be as represented or money refunded without question. A NOMIE MOTOR recently propelled a 5 ft. monoplane a distance of 1/4 mile. The NOMIE ENGINE is without question the only model aviation motor in the U. S. that is a tried and proven success. All distinctive features of our engine are fully protected by letters of patent. Infringers will be promptly prosecuted. We are the originators of the Carbonic Gas motors in the U. S.

Price of type "A"—Motor complete with charged tank, \$15.00 F. O. B.

Price of type "B"—Motor complete with charged tank, \$30.00 F. O. B.

Illustrated catalogue and testimonials on request. Leading model dealers handle the NOMIE MOTOR, or write the manufacturers direct.

**NOMIE ENGINE COMPANY (Ltd.), Aviation Field, Cicero, Ill.**

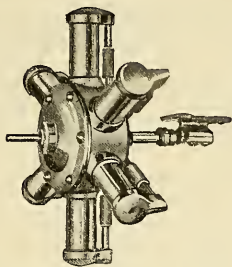

Type "B" 6 cylinder 1-2 H. P.

## Ship Your Aeroplane to Louisville

We will install either model GRAY EAGLE MOTOR and show you what they will do. It's hard to convince some people that they can save money when buying a motor, and that's a reason we offer free use of our Private Aviation Park and use of a Gray Eagle Motor, just to prove every statement we make.

4 Cylinder 30-40 H. P.

**\$485.00**

6 Cylinder 50 H. P.

**\$675.00**

Prices include Bosch Magneto Ignition, Schebler Carburetor, Oiler, Plugs and Wires. No discounts or agents' propositions. One price to everybody.

GRAY EAGLE MOTORS are flying amateur-built monoplanes and biplanes in twenty states. The Chinese Revolutionary Government uses a GRAY EAGLE MOTOR on their American Biplane.

We guarantee your plane to fly when equipped with a GRAY EAGLE. Visit our factories and Aviation Park and see for yourself what they are doing. Write for special motor circular and Aero supply catalogue. Prompt deliveries on orders received this month.

1600 FLOYD STREET

**R. O. RUBEL, JR. & CO., Inc., LOUISVILLE, KY.**

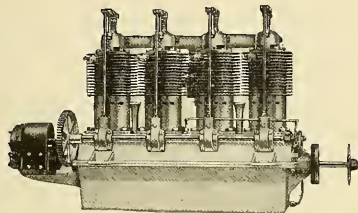

# HOTEL CUMBERLAND

NEW YORK

Broadway at 54th Street



Headquarters for Aviators and Automobilitists.

**New and Fireproof**

Strictly first class.  
Rates reasonable.

**\$2.50**  
With Bath  
and up

Send for booklet.

Ten Minutes' Walk to Thirty Theatres

**H. P. STIMSON**

Formerly with Hotel Imperial

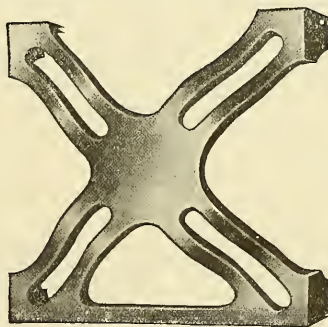

MANUFACTURERS OF

**AEROPLANE PARTS in Brass, Steel and Aluminum**

Engine Mountings for any Motor

Also Copper and Brass Tanks of any Description

Steel Tube Frames to Order

**RELIANCE AUTO PARTS MANUFACTURING CO.**

244-250 W. 49th Street New York City

Telephone 5135 Bryant

To COMPETENT GRADUATES we FURNISH a STANDARD-TYPE AEROPLANE PRACTICALLY WITHOUT COST.



# AVIATORS WANTED

We Are the Real Western Pioneers  
We TEACH FLYING on (CURTISS FARMAN BLERIOT) Machines. NO BREAKAGE CHARGED  
We MANUFACTURE ANY TYPE AEROPLANE and make a specialty of HYDRO-AEROPLANES.

ALL our machines are GUARANTEED TO FLY and GUARANTEED as to MATERIAL and WORKMANSHIP.

HOME STUDY COURSE (Theory and Aerodynamics.)  
CONSTRUCTION COURSE (Aerial Engineering.)  
AERO-MOTOR COURSE.  
FLYING COURSE.

OUR BASIC PATENTS GIVE US PROTECTION.

Our Prices are the Lowest.

Full and Honest Value.

FLYING EXHIBITIONS BOOKED FOR COMING SEASON.

Send for our SPECIAL OFFER No. 2 TODAY.

# LEARN TO FLY

## Milwaukee School & College of Aviation

S. E. COR. GRAND AVE. AND FIFTH STREET,  
MILWAUKEE, WIS.

School-Shops, Hangars, Flying Field, foot of 64th  
Ave., West Allis, Wisconsin.

# LOOK FOR US

in the  
NEW YORK SHOW, MAY 9-18

## The Christmas Aeroplane

The only automatically balanced heavy weight carrying and strictly commercial aeroplane in the world

**S**AFE as an automobile for pleasure.  
The Greatest Machine for War Purposes.  
Its Gliding Factor Greater Than Others.  
Built Only on Most Scientific Principles.  
The Nearest Approach to the Natural Flyer.  
Result of 14 Years' Study and Work.  
Not Affected by Recent Patent Decisions.

Orders will be taken for our machines for PROMPT DELIVERY.  
Don't place your order until you have seen and compared it with others.

## Christmas Aeroplane Co.

Manufacturers of Monoplanes and Biplanes  
Offices and Factory, Washington, D. C.

## "IDEAL"

### Model Aeroplane Supplies

**A**RE the standard supplies of the U. S., because of their excellency of workmanship; they are backed by a concern ABSOLUTELY RELIABLE whose standing you can look up in Dun's and Bradstreet's commercial agencies.

"IDEAL" Plans and Drawings are absolutely accurate in every detail, and are accompanied by clear instructions and cost no more than inaccurate plans and drawings, with which the market is flooded.

"CECIL PEOLI" CHAMPION RACER  
(Official Record, 1691 feet, 6 inches.)

Plans and directions for building and flying this Model.....25c  
WRIGHT BIPLANE, 3-ft. Flying Model, plan for building.....25c  
BLERIOT MONOPLANE, 3-ft. Flying Model, plan for building, 15c

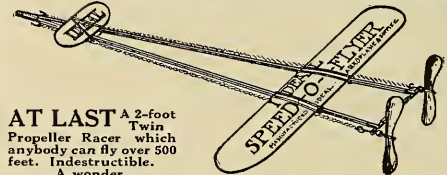

AT LAST <sup>A 2-foot</sup> Twin  
Propeller Racer which  
anybody can fly over 500  
feet. Indestructible.

A wonder.

The "IDEAL" SPEED-O-FLYER is packed in a box, adjusted for instant flight. Price \$2.00. By PREPAID express, \$2.25.

"IDEAL" Patent Friction Winder

(Ratio 5 to 1) 40c. postpaid

**O**UR new, up-to-the-minute catalog of Model Aeroplane Supplies contains everything. 40 pp. Also has official rules for contests. 5c. brings it. WORTH \$1.00. None free.

**Ideal Aeroplane & Supply Co.**  
82B West Broadway New York



# MAXIMOTOR INSURANCE

The last twelve months were full of costly aviation accidents. These may be left to blacken aviation's reputation, or used to help aviation's progress. But they must be frankly faced.

Of the seven prominent American aviation engines, only one has never had a fatal accident—the MAXIMOTOR—in spite of the hundreds of flights made with it the world over.

To take advantage of the tremendous developments of last year new 1912 models are absolutely essential. The 1912 MAXIMOTOR is additionally protected against the weaknesses shown in other engines last year.

Two aviators suffered fatal injuries because of defective crank bearings on American engines. Official investigation proved it; though the facts did not get into the magazines. Other engines have been "stalled" from the same difficulty with babbitt and bronze bearings.

Crank bearing trouble has never been known on the ball-bearing MAXIMOTOR, which is the only American aeromotor so equipped, except one \$3,000 engine. The shafts of the world's champion aeromotor and automobile motor each run on ball bearings.

Another fatal accident resulted from cylinder blowing off a crankcase. The MAXIMOTOR Compression is figured to a safe limit. The cylinder bolts, as also the connecting rod bolts, are of chrome nickel steel, imported specially from Sheffield for the MAXIMOTOR.

The records show that numerous engines have stopped in mid-air and caused deaths and serious injuries as a consequence of every one of the following: **Open gears becoming entangled with loose wires—All MAXIMOTOR gears are housed. Lubrication failing on account of oil becoming heated and thin. Oil circulation stopping unnoticed by the aviator. Carburetor freezing.**

All these are prevented by the MAXIMOTOR oil jacketed glass intake. The cold gas and heated oil bring each other to the best working temperature. By a single glance the aviator can inspect the carburetor and the oil sight just above it.

Valves dropping on pistons which then burst cylinder heads. Impossible on the MAXIMOTOR. The valves are at the sides of the cylinders. Rotary intake valve breaking—from weakness of design. No rotary on the MAXIMOTOR.

Crankshaft breaking as a result of straining for extreme lightness. The MAXIMOTOR shaft is of a safe size in the highest grade imported chrome nickel steel, strength 150,000 to 170,000 lbs. per inch.



Of the 25 famous machines in the French military contest (severest test to date) just two makes of engines won. One was the MAXIMOTOR type, 4 cycle, 4 cylinder vertical water-cooled. So were the champions of the "Around Germany" race and the great international endurance contest in England.

**MAXIMOTOR MAKERS**  
DETROIT  
52 CRANE AVENUE  
Dept. 17

## A WORD TO YOU

**Mr. Aviator:**  
Early last August we began planning for the 1912 MAXIMOTOR. We took the attitude a sensible aviator would take—the attitude you would take if you were to have a motor built to your order for your own flying.

(As a matter of fact we are personally "going up" with the engine this spring.)  
So we went to extreme lengths to get the very best of everything in material and men.

From the scores of aviators out flying MAXIMOTORS during 1911 we got detailed reports on their engines—the lubrication, carburetion, cooling, bearings, thrust, ignition, etc., etc. Some of them carried on special tests for us.

Out of all this we got suggestions of great value from the view-point of the man who flies with the engine.

Our factory experiments covered, for instance, several types of cylinders in five different materials. The best chrome nickel crankshaft steel we could find in the world was produced in Prussia. So we send to Prussia for it.

We could buy aluminum at 25% less than our crankcase material costs us. We pay the difference for the privilege of rejecting everything not up to the strict MAXIMOTOR standard. As high as 75% of materials (good enough for ordinary engines) have been rejected as unfit for the exacting requirements of aviation.

We are satisfied with nothing less than *thorough dependability*. Your safety and our reputation demand it.

1912 MAXIMOTOR—4 cyl., 50 h. p., weight about 200 lbs., thrust over 420 lbs. Also a 6 cyl., 75 h. p. model. Ask

# ... The Wittemann Biplane ...

HAS A REPUTATION, NOT ONLY FOR PACE, BUT FOR QUALITY AND SERVICE

Write for information of 1912 Biplane with our new auxiliary stabilizer.

If you want to build a machine of your own design or parts thereof, we can help you to make it successful. Some parts of your plane can be made of steel. We rid you of the annoyance of constant repairs and insure absolute safety.

Send us your specifications and requirements and secure our quotations.

Large stock of steel fittings, laminated ribs and struts of all sizes carried in stock.

Own a Wittemann Biplane Glider; the best, the safest, easiest to operate, and enjoy flying in a moderate form.

## YOUR OPPORTUNITY

Two single cover biplanes for immediate delivery; slightly used, perfect condition with 8 Cyl. 60 H. P. Hall Scott power plant.

Write for Particulars.

Write for Catalogue.

## C. & A. WITTEMANN

Aeronautical Engineers

The Oldest aeronautic manufacturing concern in the United States.

Established 1906.

Works: Ocean Terrace and Little Clove Road.

Staten Island

New York

# THE AERO CLUB OF AMERICA

*Announces the*

# First Annual International Aeronautical Exhibition

*Will be held on MAY 9th to 18th at the*

**New Grand Central Palace**  
NEW YORK CITY

*For information regarding space for exhibits  
of completed Aeronautic Machines, Motors,  
Accessories, Models, etc., make application to*

**THE SHOW COMMITTEE**

**AERO CLUB OF AMERICA**

297 MADISON AVENUE

NEW YORK CITY



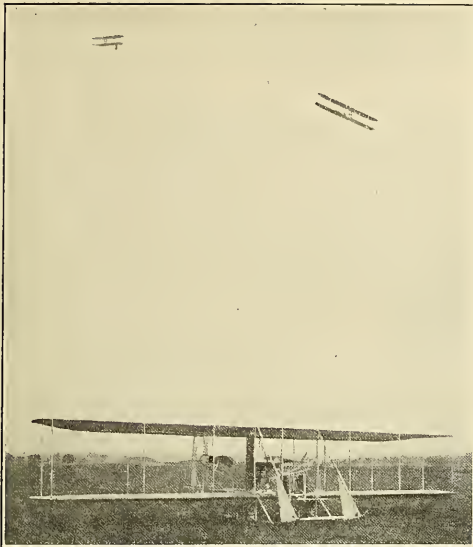

# The Wright Flyer

## 1912 MODELS

In addition to these features which in the past have made Wright Flyers famous for efficiency and reliability, the new models can be furnished with **Automatic Control, Silent Motors, and Hydroplanes.** These special features make the 1912 machine unusually attractive to sportsmen.

## EXHIBITION MACHINES

For exhibition work we have other models especially adapted to high winds and small fields. It was with a stock "EX" Model that Rodgers made his wonderful flight from coast to coast. Reliability means dollars to the exhibitor.

## WRIGHT SCHOOL OF AVIATION

Training consists of actual flying, in which the pupil is accompanied by a competent teacher. No risks and no expense whatever from breakage. The most famous flyers in America are graduates of our school and include such names as

Lieut. Arnold	Drew	Lieut. Rodgers
Atwood	Elton	Patrmalee
Brookins	Lieut. Foulois	Page
Brindley	Fowler	Reynolds
Bonney	Gill	Simmons
Beatty	Lieut. Lahm	Turpin
Burgess	Lieut. Milling	Welsh
Coffyn	Mitchell	Webster
Capt. Chandler	C. P. Rodgers	and many others.

Our School at Dayton is now open and pupils may begin training at once if they wish. By enrolling now you can reserve date most convenient to you for training. Write for particulars.

## THE WRIGHT CO.

Dept. "B"

DAYTON, OHIO

## BUILD YOUR OWN MACHINE

We furnish the material. Wood and metal parts for Biplanes or Monoplanes, single and double surface. Latest in design, easy to assemble and take down for transportation. We have them either in solid or laminated wood. Our Propellers are as good as the best. If you have a broken one or one you would like a duplicate of send it to us, and by means of a machine we have we will make you a duplicate within 1-100 part of an inch, and allow you \$5.00 off any of our regular prices.

WRITE FOR A 1912 CATALOG

**WOLVERINE AERONAUTIC COMPANY**  
DETROIT, MICH.

## BALDWIN

### VULCANIZED PROOF MATERIAL

For Aeroplanes, Airships, Balloons. First Rubberized Fabric on the market. Lightest and strongest material known. Dampness, Heat and Cold have no effect. Any Strength or Color.

### "RED DEVIL" AEROPLANES

That anyone can fly. Free Demonstrations

### HALL-SCOTT MOTORS

Eastern distributor. 40 h. p. 4 cyl.; 60 and 80 h. p., 8-cyl., on exhibition at Frank Schumacher's, 164 W. 46th Street, New York. All motors guaranteed. Immediate delivery.

### EXPERTING

Will install a Hall-Scott free of charge in anyone's Aeroplane and demonstrate by expert flyer. Expert advice. Planes balanced.

CAPT. THOMAS S. BALDWIN  
Box 78 Madison Sq. P. O., New York

## AEROPLANES

## Fox De Luxe Aero Motors

For 1912

Are sold on 30 days' free trial under a money back guarantee.

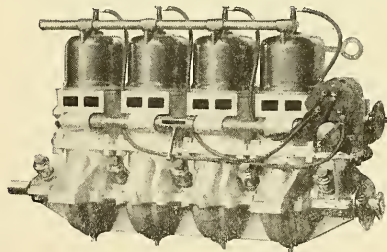

60 H. P. 4-cylinder Fox De Luxe Motor

We build 45 H. P., 60 H. P., 90 H. P. Fox De Luxe Motors

**Special Features** (1) The Fox Fourth Port Accelerator.  
(2) Rotary Valve, free from back pressure.  
(3) Average weight less than 3 3-5 lbs. per horse power.

Ten years' experience in the gas engine business has developed our 1912 Model, the **Best Aero Motor ever produced.** Let us prove it. Write to-day for catalog.

**The DEAN M'F'G CO.** 225 Front St.  
Newport, Ky., U. S. A.

# ADVERTISERS' INDEX

<b>AERONAUTICAL SHOW</b>	
International Exposition Company, The.....	102
<b>AEROPLANE MANUFACTURERS</b>	
American Aeroplane Supply House.....	67
Baldwin, Captain Thomas S.....	103
Benoist Aircraft Company, The.....	95
Burgess Company & Curtiss.....	98
Christmas Aeroplane Company, The.....	100
Cooke, H. C.....	92
Curtiss Aeroplane Company, The.....	65
Heinrich Brothers.....	98
International Aeronautic Construction Company, The.....	66
Morok Aeroplane Company, The.....	94
National Aeroplane Company, The.....	97
Rex Monoplane Company, The.....	98
Sloane Aeroplane Company, The.....	97
Standard Aviation Company, The.....	92
Thomas Brothers, Messrs.....	94
Wittemann, Messrs. C. & A.....	101
Wright Company, The.....	103
Washington Aeroplane Co.....	91
<b>ASSOCIATIONS</b>	
Aeronautical Society, The.....	93
<b>AVIATORS</b>	
Mars, J. C. (Bud).....	93
Mills Aviators, The.....	94
Gressier Aviators, The.....	92
<b>BALLOONS</b>	
Bumbaugh, G. L.....	92
French-American Balloon Company, The.....	94
Myers, Carl E.....	92
Goodyear Tire and Rubber Company, The.....	95
<b>BAMBOO</b>	
Deltour, J., Incorporated.....	93
<b>BOOKS</b>	
The Lawson Publishing Co.....	64
<b>CLASSIFIED</b>	
Classified Advertisements.....	92
<b>DESIGNER</b>	
Bissell, Joseph E.....	96
<b>EXHIBITION</b>	
Curtiss Exhibition Company, The.....	65
Milwaukee School and College of Aviation, The.....	100
Wright Company, The.....	103
Mills Aviators.....	94
<b>FABRICS</b>	
Baldwin, Captain Thomas S.....	103
Conover Company, The C. E.....	94
Goodyear Tire and Rubber Company, The.....	95
<b>GLIDERS</b>	
Aerodster Construction Company, The.....	92
<b>HOTELS</b>	
Hotel Cumberland.....	99
<b>MODELS</b>	
Ebbinghaus, Ernst.....	94
Ideal Aeroplane and Supply Company, The.....	100
Lincoln Square Novelty Works, The.....	93
<b>MODEL MOTORS</b>	
Nomie Engine Company, The.....	99
<b>MOTORS, 2nd Hand</b>	
E. T. Toogood.....	81
<b>MOTORS</b>	
Aerial Navigation Company of America.....	92
Aeroplane Motors and Equipment Company.....	70
Albatross Company.....	93
Curtiss Motor Company, The.....	105
Dean Manufacturing Company, The.....	103
Detroit Aeroplane Co.....	93
Elbridge Engine Company, The.....	94
Frontier Iron Works, The.....	98
Maximotor Makers.....	101
Roberts Motor Company, The.....	Back Cover
Rubel, R. O., Jr., & Co.....	99
Sturtevant Company, The B. F.....	96
Washington Aeroplane Co.....	91
Wright Company, The.....	103
<b>PATENTS</b>	
Coleman, Watson E.....	93
Evans, Victor J., & Co.....	93
Sacerdote, G. M.....	93
<b>PROPELLERS</b>	
American Propeller Company, The.....	68
Diana Aeroplane Company (Spiron).....	97
Gibson Propeller Company, The.....	66
Hoover-Conrow Aeroplane Company, The.....	94
Rubel, R. O., Jr., & Co.....	95
Sloane Aeroplane Company (Charavay).....	97
Wolverine Aeronautic Company, The.....	103
<b>RADIATORS</b>	
El Arco Radiator Company.....	95
<b>SCHOOLS</b>	
American Aviation Company, Incorporated.....	92
Benoist Aircraft Co.....	95
Brauninger, F. H.....	92
Curtiss Exhibition Company, The.....	65
International Aeronautic Construction Co.....	66
Milwaukee School and College of Aviation, The.....	100
National School of Aviation, The.....	97
Rubel, R. O., Jr., & Co.....	91
Standard Aviation Co.....	92
Stevens & Beatty.....	95
Wright Company, The.....	103
<b>STEEL TUBING</b>	
Reliance Auto Parts Manufacturing Company.....	99
<b>SUPPLIES AND ACCESSORIES</b>	
Brooklyn Aeroplane and Supply Co.....	93
Chicago Aero Works.....	92
Doyle, Herbert C.....	94
New York Aeronautical Supply Company.....	67
Reliance Auto Parts Manufacturing Company.....	99
Willis Company, The E. J.....	68
Wolverine Aeronautic Company, The.....	103
<b>TANKS</b>	
Reliance Auto Parts Manufacturing Company.....	99
<b>TIRES</b>	
New York Aeronautical Supply Company, The.....	67
Goodyear Tire and Rubber Company.....	95
Willis Company, The E. J.....	68
<b>TOYS</b>	
Crane, Louis L.....	93
<b>WHEELS</b>	
Weaver, Jr., J. A.....	95
<b>WIRE</b>	
Roebing's Sons Company, The John A.....	95

# The Only Safe Way to Judge an Aeronautical Motor is by Its Accomplishments

Their existence denotes sterling worth and superiority. Their absence, weakness.

## CURTISS MOTORS

**W**ON the Scientific American Trophy, 3 years in succession.

**W**ON the Gordon-Bennett Cup.

**W**ON the Albany to New York \$10,000 prize---  
150 miles, 150 minutes.

**W**ON the New York to Philadelphia race, 1911.

**B**ROKE the World's Altitude Record at Chicago,  
1911, 11,642 feet.

**F**LEW the greatest number of miles at International meet at Chicago, 1911.

**W**ON all speed events at International meet at Chicago, 1911.

**W**ON all speed events at Los Angeles meet, 1912.

**H**AVE proven that they can stand the grind of exhibition work without fatigue.



SCIENTIFIC-AMERICAN TROPHY

Can You Say as Much for the Other Kind?

***Immediate Delivery Complete Power Plants***

*Two Models*

*8 cyl. 75 H. P.*

*4 cyl. 40 H. P.*

Catalogue X is illustrated and gives full details. It's free upon request.

**THE CURTISS MOTOR CO.,** *Hammondsport, N. Y.*

# ROBERTS

# MOTOR

## ANNIVERSARY

*Cooke at Los Angeles*

*Janrus  
at Kirklock*

*Wetzig at  
Rosewell, N.M.*

*Fichter  
College  
Park, Md.*

*Adams at  
Riverport, Wyo.*

*McGowan  
Dallas, Texas*

*Model-6X-75HP*

*Hadley  
at Mineola*

*McNamara  
at Mineola*

JUST a year ago this month the first **Roberts Motor** flew at Mineola. Since that time **Roberts Motors** have flown in nearly every state in the Union. They now occupy the leading place in American Aviation and have been adopted as the **standard power plant** by the majority of aeroplane manufacturers in the United States.

WRITE FOR CATALOGUE TODAY

# THE ROBERTS MOTOR CO.

1463 COLUMBUS AVENUE, SANDUSKY, OHIO, U. S. A.

THE ESSEX PRESS, PRINTERS  
NEWARK AND NEW YORK

# AIRCRAFT

Vol. 3 No. 4

JUNE, 1912

15 Cents a Copy

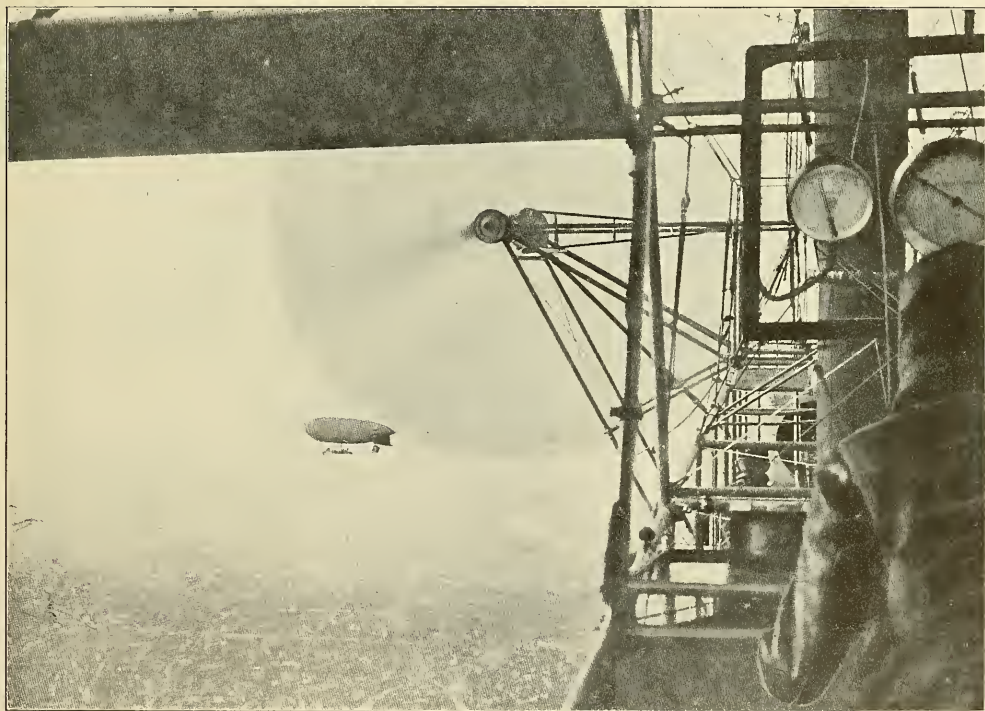

TRAVELING VIA AIRSHIP IN FRANCE

This remarkable photograph was taken from the rear of the nacelle of the dirigible "Adjutant Reau" and shows part of its deck and also the dirigible "Capitaine Ferber" in the distance, passing over the outskirts of Paris. Both of these ships of the air, with others, were on their way to take part in the Spring military manoeuvres.

# PAUL LACROIX AUTOMOBILE CO.

Agents for

## Anzani, Gnome, Renault

### AVIATION MOTORS BOREL-MORANE MONOPLANES

Early Deliveries on All Types

Write for Catalogue and Prices

1770 BROADWAY 57th STREET NEW YORK

To COMPETENT GRADUATES we FURNISH a STANDARD-TYPE AEROPLANE PRACTICALLY WITHOUT COST.



# AVIATORS WANTED

We Are the Real Western Pioneers

We TEACH FLYING on (CURTISS FARMAN BLERIOT) Machines. NO BREAKAGE CHARGED

We MANUFACTURE ANY TYPE AEROPLANE and make a specialty of HYDRO-AEROPLANES.

ALL our machines are GUARANTEED TO FLY and GUARANTEED as to MATERIAL and WORKMANSHIP.

HOME STUDY COURSE (Theory and Aerodynamics.)  
CONSTRUCTION COURSE (Aerial Engineering.)  
AERO-MOTOR COURSE.  
FLYING COURSE.

OUR BASIC PATENTS GIVE US PROTECTION.  
Our Prices are the Lowest. Full and Honest Value.

FLYING EXHIBITIONS BOOKED FOR COMING SEASON.

Send for our SPECIAL OFFER No. 2 TODAY.

# LEARN TO FLY

## Milwaukee School & College of Aviation

S. E. COR. GRAND AVE. AND FIFTH STREET,  
MILWAUKEE, WIS.

School-Shops, Hangars, Flying Field, foot of 64th  
Ave., West Allis, Wisconsin.



PRESIDENT MADERO OF MEXICO IN FLIGHT WITH GEORGE M. DYOTT

# SLOANE

## School of Aviation

---

### For \$300

WE GUARANTEE to make the first ten pupils who enroll competent to pass the rigid military aeroplane test. Pupils completing course without breakage receive a rebate of ten per cent.

Our school is on Long Island, New York, the heart of America's aviation center. **GEORGE M. DYOTT**, the first man to fly a Deperdussin Monoplane in America, is our instructor. **DYOTT** holds several European pilot's licenses. In Mexico City he carried President Ma lero as a passenger. He is an expert aeroplane builder and knows motors.

The **DEPERDUSSIN** Monoplane holds the world's distance, altitude and passenger-carrying records, and is considered the safest, most economical aircraft built in France. We sell the Deperdussin equipped with high-grade motors and **CHARAVAY** propellers.

The School is now in operation.

## SLOANE AEROPLANE CO.

AEROPLANES

CHARAVAY PROPELLERS

PARTS, REPAIRS

1731 BROADWAY

Phone 5421 Columbus

NEW YORK CITY

AGENTS--Eames Tricycle Co., San Francisco and Los Angeles; W. E. Boughton, Washington, D. C.

## HOLDING THE LEAD

For more than a year the Elbridge "Featherweight" Engine was the only practical Aero Engine on the American market.

Now we propose to lead other manufacturers by another year in being the only firm in America to supply our customers with Standard Aeroplanes at somewhere near their actual value.

### WHY DO WE DO IT?

It's just this way. We are in business to manufacture and sell engines. We can't sell Aero Engines to men who don't own aeroplanes. So we propose to make it as easy as possible for our customers to buy the Planes.

Volume is what counts in manufacturing. And it is only because the volume of our Aero Engine business is greater than that of any other manufacturer in America that we are able to offer these Aeroplane quotations.

**HEADLESS BIPLANE**, every part properly made, \$750.00, power plant, 3-cyl. Elbridge "Featherweight."

**HEADLESS BIPLANE**, 4-cyl. 40-60 "Featherweight" \$875.00.

(Above machines are not assembled, but all parts are accurately made and properly finished. The equipment includes Naid Cloth, 3-in. Continental Tires, full instructions for setting up, etc.)

**WITTEMAN BIPLANE**, 1912 Model, complete, \$1,450.00. Their latest model, with steel outriggers, etc., including Elbridge 40-60 h. p. engine.

**WITTEMAN BIPLANE**, 60-90 h. p. engine, etc., \$1,900.00.

**BOENOIST BIPLANE**, 40-60 h. p. Elbridge engine, including full instruction course at St. Louis, \$1,950.00.

Burgess Co. & Curtis, Fred L. Schneider and other well known makes at correspondingly low prices.

EVERYTHING FULLY  
GUARANTEED.

NO EXTRAS--NO CHANCES

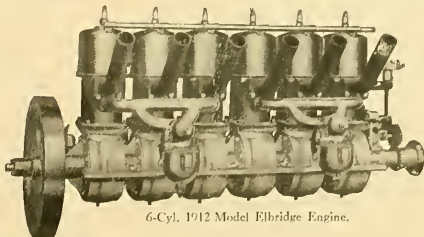

6-Cyl. 1912 Model Elbridge Engine.

Tell Us What You Want  
and When You  
Want It

We'll Tell You What It  
Will Cost and When  
You Can Have It

**ELBRIDGE ENGINE COMPANY,**

8 Culver Road, Rochester, N. Y.

## FRONTIER MODEL A

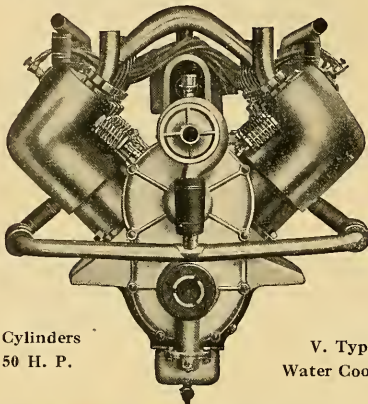

8 Cylinders  
50 H. P.

V. Type  
Water Cooled

Four and three quarter lbs. per actual Horse Power

## Simple Reliable Durable

Reliability and durability coupled with minimum weight, consistent with absolute safety, are the important points of superiority combined in the FRONTIER Aero Motor of quality.

Our claim for distinction lies in the unique and well balanced design and the mode of fuel supply, giving equal and never-failing power for all altitudes and temperatures.

Embodied in its construction are these essentials:

- Highest grade of workmanship.
- Best materials.
- Experienced and capable engineers.
- Perfect shop equipment for manufacture.

Catalog and Price List on Application

**Frontier Iron Works**  
BUFFALO

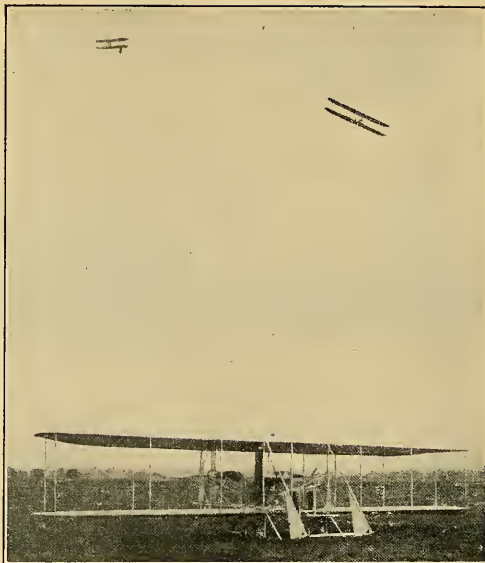

# The Wright Flyer

## 1912 MODELS

In addition to these features which in the past have made Wright Flyers famous for efficiency and reliability, the new models can be furnished with **Automatic Control, Silent Motors, and Hydroplanes**. These special features make the 1912 machine unusually attractive to sportsmen.

## EXHIBITION MACHINES

For exhibition work we have other models especially adapted to high winds and small fields. It was with a stock "EX" Model that Rodgers made his wonderful flight from coast to coast. Reliability means dollars to the exhibitor.

## WRIGHT SCHOOL OF AVIATION

Training consists of actual flying, in which the pupil is accompanied by a competent teacher. No risks and no expense whatever from breakage. The most famous flyers in America are graduates of our school and include such names as

Lieut. Arnold	Drew	Lieut. Rodgers
Atwood	Elton	Parnalee
Brookins	Lieut. Foulis	Page
Brindley	Fowler	Reynolds
Bunnay	Gill	Simmons
Beatty	Lieut. Lahm	Turpin
Burgess	Lieut. Milling	Welsh
Coffyn	Mitchell	Webster
Capt. Chandler	C. P. Rodgers	and many others.

Our School at Dayton is now open and pupils may begin training at once if they wish. By enrolling now you can reserve date most convenient to you for training. Write for particulars.

## THE WRIGHT CO.

Dept. "B"

DAYTON, OHIO



# YOU CAN WIN THE MOST OF THE \$100,000

Offered in the GREAT AMERICAN CIRCUIT RACE by using one of our

# BLERIOT MONOPLANES

**We sold more successful Bleriot Type Monoplanes in 1911 than all other manufacturers combined**  
 Our BLERIOT TYPE MONOPLANES are in every way suited to contest and exhibition work, including speed, altitude, distance and duration, cross country and cross city flying, where thorough, reliable strength and high efficiency are so vitally important.

**SINGLE SEATERS      PASSENGER-CARRYING MONOPLANES      RACING MONOPLANES**



A. C. MENGES (Licensed French Pilot) ABOUT TO MAKE A FLIGHT AT NASSAU BOULEVARD WITH ONE OF OUR RACING MONOPLANES  
**ALL PASSENGER CARRYING MONOPLANES ARE EQUIPPED WITH A DUAL CONTROL SYSTEM**

A few of the most prominent owners of our BLERIOT TYPE MONOPLANES are:

A. C. MENGES, Memphis, Tenn.  
 E. J. MARLEY, Sumner, Miss.

J. ALBERT BRACKETT, Boston, Mass.  
 G. B. McNAMARA, Norton, Mass.

WILLIE HAUPT, Philadelphia, Pa.  
 CHAS. W. SPENCER, Phila. Pa.

**Visit our factory and examine in detail the EXCELLENT DESIGN and CONSTRUCTION of our Monoplanes**  
 ILLUSTRATED CATALOGUE W. GIVING FULL DETAILS. FREE FOR THE ASKING

**AMERICAN AEROPLANE SUPPLY HOUSE**

137-143 Jackson St., Hempstead, L. I., N. Y.  
 Telephone 427 Hempstead

# 48 HOURS' RUNNING BEFORE YOU ACCEPT IT

**OUR GUARANTEE ON EVERY 1912**

*You'll find it in the New Catalogue*

We can do it because our material is higher grade than in any other American aeromotor today.

**For instance:**

1. Imported ball bearings that cut friction to 1/4 and eliminate "burning out."
2. Imported chrome nickel steel crankshaft; 150,000-170,000 lbs. strength per inch; capable of treatment up to 240,000 lbs.

(Not another equals it in the U. S. A.)

**These are 2 out of 15 points of superiority.**

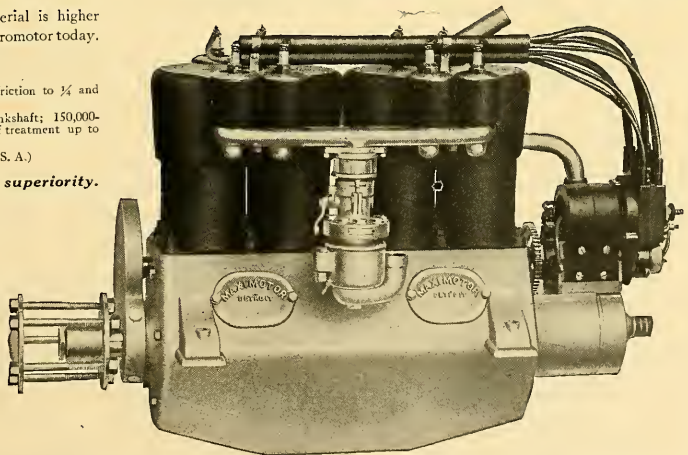

**WANTED**

**Live Representatives**

in a few remaining districts to fly and demonstrate their own 1912 MAXIMOTORS. Give personal and aeroplane particulars.

**MAXIMOTOR MAKERS**  
 DETROIT  
 52 CRANE AVENUE

Dept. 18

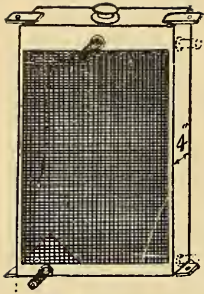

\$36.00 up

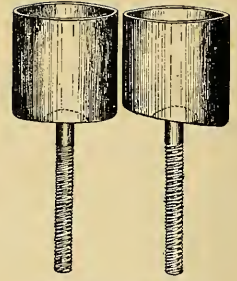
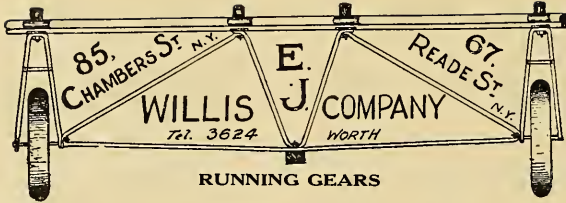

15 cts. to 25 cts.

# Aeronautical Supplies

READY FOR IMMEDIATE SHIPMENT

10 cts. to 24 cts.

7 cts. to 18 cts.

**NEW 1912 CATALOGUE NOW READY** *With Working Drawings of*  
Curtiss, Farman and Bleriot Type Machines Mailed FREE  
**EVERYTHING NECESSARY** to build ANY TYPE FLYING MACHINE

The following low prices apply on orders for immediate shipment only

- Curtiss Seats ..... \$5.50
- Curtiss Steering Wheels ..... 9.00
- 5-gallon Tanks, 2 conical ends ..... 6.15
- Outrigger Fittings ..... 29 cents

- Oval Past Sockets ..... 17 cents
- Farman Running Gears ..... \$47.50
- Wheels and Tires complete, 6 1/4 in. hubs. 20x2 1/2, \$6.75. 20x3 ..... \$9.50



From \$5.50 up

# WARRANTED SUPERIOR



Patented March 14, 1911; July 25, 1911; October 17, 1911; Others Pending

## Insured Against Accident

### ANNOUNCEMENT

From the beginning we have always guaranteed the superiority of Paragon Propellers. So great has been their excellence it has cost us almost nothing to make good and keep good our guarantee with every customer.

We have always said and have always proved that our propellers would outwear and outlast any other construction—but we have not heretofore guaranteed them against accident and breakage. However, we have found our propellers so superior in this respect also that we now propose to insure them against accident and guarantee them against breakage, and this without additional charges or expense of any kind. It is the phenomenal strength and toughness and the general durability of Paragon Propellers that enables us to do this. Under no other condition would it be possible.

When you purchase a Paragon Propeller as recommended by us, you have three protections:

**First.**—Protection against faulty design, workmanship or construction, and against guesswork in lieu of intelligent calculation. Our guarantee of absolute satisfaction and superior results covers all this.

**Second.**—Full protection, for a limited time, against total loss or destruction of the propeller; pro rata protection for a longer period.

**Third.**—Protection against minor accidents and damages that can be repaired.

A propeller damaged in an accident is either a total loss or it can be repaired. In either case we protect you.

The quality of our work protects us. That is how we can do it. Ask for particulars.

We won't stop now to tell about PARAGON EFFICIENCY; it's getting so everybody knows about that everywhere.

Write for booklet of RESULTS, price list and full information. Results tell the story.

# American Propeller Company

245-251 HAMBURG STREET

BALTIMORE, MD.

Please note our change of address. We have now removed to the manufacturing city of Baltimore, where we have a fine, large building and equipment wholly devoted to the manufacture of our famous PARAGON PROPELLERS on a scale far larger than ever before. We have to thank our many patrons for the great growth of our business which has made this removal and enlargement necessary.



Bedel, the winner of the Coupe Pommery, starting from Villacoublay in this event on his Morane-Saulnier monoplane. The conditions of this race called for the longest flight in a straight line between sunrise and sunset. Bedel took first place with a flight of 800 kilometres. It was while trying in this event that Vedrines sustained his recent bad fall.

**CONTENTS---JUNE, 1912**

The Government and Aviation . . . . .	Denys P. Myers	111
Burgess Military Machine (Illustration) . . . . .		112
The Aeronautical Manufacturers' Association . . . . .		113
The Aeronautical Show . . . . .	Walter H. Phipps	114
The Aeronautical Show (Illustrations) . . . . .		115
A Method of Computing the Efficiency of Lateral Control Systems . . . . .	Albert Adams Merrill	120
General News . . . . .	D. E. Ball	121
Description of an American-made Monoplane . . . . .		123
Foreign News . . . . .	R. H. Blanquie	124
The Trade . . . . .		126
Advertisers' Index . . . . .		136

**AIRCRAFT**

ALFRED W. LAWSON  
President and Treasurer  
ERNEST C. LANDGRAF  
Secretary

Published Monthly by The Lawson Publishing Company  
37-39 EAST 28th STREET, NEW YORK, U. S. A.  
Telephone, 5017 Madison Square

ALFRED W. LAWSON  
Editor  
WALTER H. PHIPPS  
Asst. Editor

**TERMS TO SUBSCRIBERS**

In the United States, Mexico, Puerto Rico, Guam, Philippine Islands, Hawaiian Islands, Cuba (including Postage), \$1.50 per year.  
Fifteen Cents the Copy, of All News Dealers.  
Foreign Subscriptions, Two Dollars per year.  
In changing order give old as well as new address.  
Advertising copy must be in hand by the 1st of month previous to date of publication.  
Only high-grade advertisements of thoroughly reliable firms are solicited.

**WHEN YOUR SUBSCRIPTION EXPIRES**

One month before a subscription expires we enclose a renewal blank on which you will write your order for the renewal.  
WHEN FIRST NOTIFIED that your subscription will expire, you should send your renewal AT ONCE, in order not to miss a number. New subscriptions which are received by us on or before the 15th of any month will begin with the issue of that month. If received after that date they will begin with the following month's issue. We cannot enter subscriptions to begin with back numbers. One month's notice is necessary before a change of address can be made.

Entered as "second-class matter" February 18, 1910, at the Post Office, at New York, N. Y., under Act of March 3, 1879.  
Copyright, 1912, by the Lawson Publishing Co.  
"Aircraft" is registered as a trade-mark by the U. S. Patent Office, under date of August 9th, 1910.

# AEROPLANE MOTORS AND EQUIPMENT CO.

1780 BROADWAY, NEW YORK

Telephone 1335 Columbus

63 AVENUE CHAMPS ELYSÉES, PARIS

Telephone 645-93

## IMPORTERS

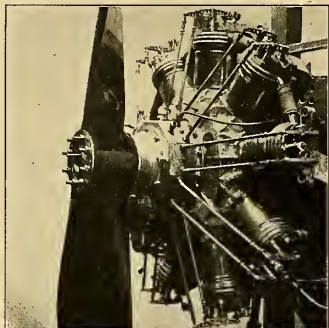

MOTOR E. SALMSON  
Canton Unné Type, 120 H. P.  
60 H. P., 80 H. P.

SOLE  
AMERICAN  
AGENTS

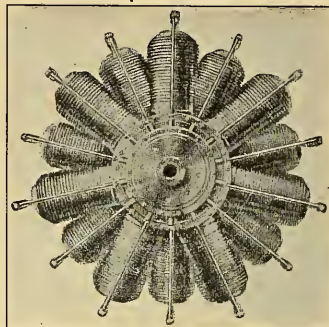

Gnome Motors, 140 H. P.  
50 H. P., 70 H. P., 100 H. P.



Morane Monoplane

SOLE  
AMERICAN  
AGENTS



Train Monoplane

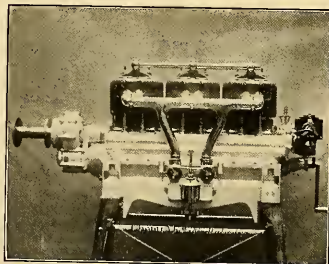

Chenu Aviation Motor, 100 H. P.  
50 H. P., 200 H. P.

SOLE  
AMERICAN  
AGENTS

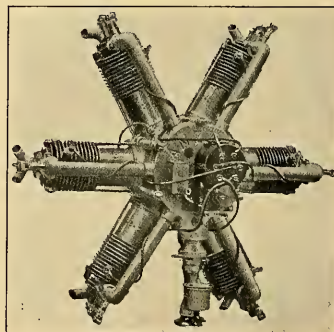

Anzani Motor, 80 H. P.  
30 H. P., 40 H. P., 60 H. P.

NO MORE RUBBER CLOTH

## ASTROL VARNISH

USED EXCLUSIVELY BY ALL MANUFACTURERS ABROAD

SOLE AMERICAN AGENTS

# A I R C R A F T

Vol. 3. No. 4

NEW YORK, JUNE, 1912

15 CENTS A COPY  
\$1.50 A YEAR

## THE GOVERNMENT AND AVIATION

By Denys P. Myers

**R**T is notorious among airmen that the United States has been the laggard among nations of the first class in adding an aeronautical branch to its defensive services. In point of actual adoption of aircraft for naval and military uses we were pioneers, but in point of development we have hitherto been behind Europe, years behind. It is pleasant now to record that, though the Government has moved slowly, it is moving with a momentum comparable, in outline, to that which has been attained by sheer enthusiasm in Europe, and especially in France.

In the course of the winter session of Congress Congressman Thomas W. Hardwick, of Georgia, and William G. Sharp, of Ohio, introduced bills providing for increase of pay for army aviators and the House Committee on Military Affairs on January 22 gave a hearing on the subject. At that time the problems involved were thoroughly canvassed and it appeared that what was needed was men, which seemed impossible to obtain for this branch of the Signal Corps work. House Resolution 448 of March 26, introduced by Mr. Sharp, called for information and on April 20 Secretary of War Stimson transmitted a budget of material showing what foreign governments are doing, the extent of the present equipment and the plans for the future.

The report shows the Army's balloon property is valued at \$94,614.40, of which \$79,924.49 has been put into hydrogen generating plants and a balloon house. Six aeroplanes in use are valued at \$31,025 and six ordered at \$36,980, a total of \$68,005. Maintenance and operation cost \$15,916.76 and \$8,286.30 respectively, and the total aeroplane equipment is valued at \$92,208.06. There is \$32,000 left of the \$125,000 appropriation for the current year, which is expected to be expended by July 1.

From the third part of the report, dealing with the plans of the War Department, we quote:

The plans of the War Department for increasing the present equipment of aeroplanes, hydro-aeroplanes, and other air craft for war purposes and the national defense; the employing and training of commissioned and enlisted personnel; distribution of aeroplanes, hydro-aeroplanes, organization of units, contemplate the following:

1. Five conveniently located training schools, known as "centers of aviation," to be located, one on the Atlantic coast, one on the Pacific coast, one on the Great Lakes, one on the Gulf coast, and one at some central interior point; and as many auxiliary centers as it may be possible to organize, with a view to having a school of instruction in each state. Each center will comprise sheds, workshops, storerooms, and barracks, and will be both a place of instruction and a place of concentration for the squadrons.

2. The organization of three aviation squadrons as the complement for one field army of Regular troops, this being an al-

lowance of one squadron for each division (2) and one for the headquarters of the field army. It is expected to specialize for each field army a company or squadron of extra powerful machines for long-distance reconnaissance, and to specialize also a number of machines for use in connection with the Field Artillery.

3-5. The organization of two squadrons for the Philippine Islands, one squadron for Hawaii and one squadron for Panama.

6. The organization of aero units for use at fourteen groups of coast defense stations in the United States, the equipment for these fourteen stations not to be less than the equivalent of eight squadrons.

7. All mobile troops of the National Guard in addition to one field army to be provided with aviation service from the Organized Militia, with the assistance of the staff of the five training schools ("aviation centers"); the allowance of aeroplanes to be in the same proportion as for the Regular Establishment; i. e., one squadron for each division of troops.

\* \* \* \* \*

For the purpose of providing officers for the pursuit of military aviation the Secretary of War on March 14 recommended as a first increment to the Military Committee of the House of Representatives the following bill:

Be it enacted, etc., That there are hereby added to the Signal Corps of the Army, one colonel, twelve captains, twelve first lieutenants, and thirty second lieutenants.

Sec. 2. That the original vacancies thus created shall be filled first by promotion of officers holding permanent appointments in the Signal Corps according to seniority after the examination now required by law, and second, by details to the Signal Corps from the line of the Army from the grade in which the vacancy exists and in accordance with the provisions of Sec. 27 of the Act approved Feb. 2, 1901.

Sec. 3. That an increase of twenty per centum in the pay of their grade shall be granted to all officers of the Regular Army of the United States who are now or may hereafter be designated as military aviators and charged with the actual operation of aeroplanes or other flying devices: Provided, That the increased pay shall be drawn only while serving on such duty.

Sec. 4. That an increase of twenty per centum in the pay of his grade shall be granted to each enlisted man of the Regular Army of the United States who is now or may hereafter be detailed on aviation duty by the Secretary of War and who shall have attained the rating of aeroplane mechanician: Provided, That not to exceed one enlisted man for each aeroplane actually operated by the Government shall receive a rating as aeroplane mechanician.

Sec. 5. That the Secretary of War be, and he is hereby, authorized to formulate all necessary regulations and requirements to govern the rating of military aviators and aeroplane mechan-

icians; and such rating shall be certified by the Secretary of War in the form of diplomas for the rating of military aviators and warrants for the rating of aeroplane mechanics.

Sec. 6. That there shall be paid to the widow of any officer or enlisted man who dies as the result of an aviation accident in line of duty, or to any other person previously designated by him, an amount equal to six months' pay at the rate received by him at the time of his death, in addition to the amount provided to be paid by the Act approved May 11, 1908.

This bill provides for the personnel of the Signal Corps two colonels, two lieutenant colonels, six majors, thirty captains, thirty first lieutenants and thirty second lieutenants. In order to further carry out in a measure the plans proposed in the report of the Secretary of War on military aviation, briefed on page 1105, the Secretary recommends, as a second increment, that there be added to the number provided for in this bill one colonel, one lieutenant colonel, three majors, fifteen captains, fifteen first lieutenants and fifteen second lieutenants, and an increase of 600 in the enlisted strength, to be in grades according to the present proportion of non-commissioned grades.

In foreign armies it is regarded as one of the essentials that the officers instructed shall be from all branches of the service. The War Department is thoroughly in accord with this view in training officers from the various branches of the service that they may keep in mind the special requirements of machines for use in the branch of the service to which they belong. The recommendations made above provide for this, as the officers detailed for duty to the Signal Corps are selected from the Army at large. In order to develop aviation it requires two essential things, namely, money and officers and men; either one of these without the other brings all adequate development to a standstill.

The chief need is men, it may be added, though the official report does not dwell much on it. But in official circles in Washington it is well known that Gen. Allen has been calling vainly for more men for years. At the hearing on January 22 this conversation took place:

GEN. ALLEN—We have not got enough men now if they stayed (in the Signal Corps) permanently.

THE CHAIRMAN (MR. HAY)—General, it seems to me what you want is an increase in the officers of the Signal Corps.

GEN. ALLEN—Yes, sir; above all things.

That is the real reason why the United States has been lagging behind in military aviation.

The other day one of the AIRCRAFT staff was at the military Aviation School at College Park, Md. He found theoretically ten officers detailed to the post and 22 enlisted men there, 16 of whom were assigned as mechanics to the four aeroplanes in commission there. What he actually found was that the ranking officer was doing desk duty in the Department at Washington, another was also working at the capital, others had duties elsewhere or were on leave, and the only second Lieutenant who was there was so busy checking up property that in four hours he had exactly ten minutes in which to discuss his real business of aviation. All other conversation took place amid a medley of tool chests, tent supplies, axes, pans and the vouchers for all and sundry. The enlisted men helped him most of the time, during which only one had anything at all to do with an aeroplane. Nobody complained, and it is proper to state that these facts are set down entirely at the writer's initiative. But we submit that the Government should make better provision for aviation than this experience indicates. We are glad to note that this seems likely to come about. If Congress does its duty by Gen. Allen and his nucleus of Army fliers, the aerial service of the Army will be separately organized on a company basis consisting of eight commissioned officer aviators, one other commissioned officer, 20 enlisted men, one enlisted property sergeant, a clerk, a cook and his assistant. These 33 will fly and care for four aeroplanes, assigned to two platoons. Above all, the scheme, which was devised by Gen. Allen and approved by Secretary of War Stimson, will enable the aviators to fly and to develop their airmanship. Let Congress pass the legislation recommended by the Secretary!

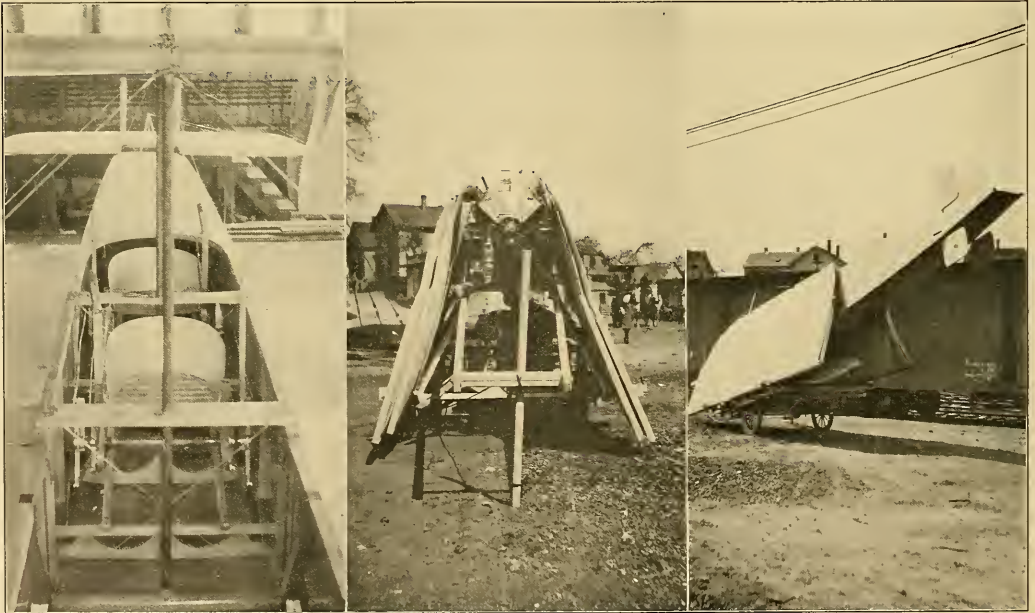

Three views of the latest Burgess military tractor biplane. On the left a view looking down into the fuselage, showing the upright steel masts supporting the biplane surfaces, the two seats and double control levers and also the tail and rudders. The picture in the centre and the one on the right show the machine dismantled for transportation by rail.



The first annual banquet of the Aeronautical Manufacturers' Association was held on the evening of May 16th at the Café Des Beaux Arts, New York City. Those present were: E. L. Jones, Spencer Heath, W. T. Thomas, Grover Cleveland Loening, John E. Slocane, Max Dingfelder, Marcus Mead, Michael F. Donoghue, Greely Curtis, John B. Maus, E. W. Roberts, J. A. D. McCurdy, E. F. Gaskell, C. G. Goddard, Hugo C. Gibson, H. N. Bliss, Stanley Y. Beach, N. Foss, James W. Wallace, Alfred H. Bartsch, LeRoy McCafferty, C. Azro Stiles, Charles D. Spence, Jr., Morris R. Machol, T. L. Coleman, Raife Emerson, Charles Edward Spratt and Alfred W. Lawson.

## AERONAUTICAL MANUFACTURERS' ASSOCIATION



AKING advantage of the large number of aeronautical manufacturers in New York during the aeronautical show, the Aeronautical Manufacturers' Association decided to hold their first annual banquet on the evening of May 16th at the Café Des Beaux Arts.

The attendance included the heads or the representatives of concerns manufacturing aeroplanes, balloons, motors, propellers, fabrics, models and accessories of all kinds as well as publishers of aeronautical literature, in fact those present represented that branch of the aeronautical movement which furnishes the capital and the constructive power upon which the very foundation of the movement in this country rests.

Extemporaneous addresses were made by E. L. Jones, Charles E. Spratt, J. A. D. McCurdy, Greely Curtis, E. W. Roberts, Hugo C. Gibson, John B. Maus, Morris R. Machol, C. G. Goddard and Alfred W. Lawson.

Mr. Jones set forth the aims of the organization in a few well chosen words. J. A. D. McCurdy called attention to the fact that the manufacturers would have to devote more time in the future to demonstrating their aeroplanes to the public, and thought that there was a big field for the sale of machines to the various Yacht Clubs and Country Clubs throughout the United States if flying machines were sent to these clubs and their capabilities explained by expert salesmen and proper demonstration given by competent aviators.

Mr. Spratt stated that notwithstanding the fact that he had been identified during the past with several budding industries, none had shown the exceptional growing qualities in their infancy as had the aeronautical industry up to the present time, and he urged all manufacturers to join the Aeronautical Manufacturers' Association as a means of not only strengthening their own position, but of strengthening the entire aeronautical industry in this country as a whole. He said that the only way that the industry would ever be

able to develop upon a large scale was through the course of organization.

Mr. Roberts told some interesting facts concerning the short flight made by the flying machine constructed by Sir Hiram Maxim eighteen years ago in England, he at that time acting as the chief engineer for Mr. Maxim.

Greely Curtis told of the great development being made by the hydro-aeroplane and of the numerous daily flights taking place on the Burgess machine at Marblehead.

Alfred W. Lawson called attention to the necessity of united effort among the manufacturers of this country, and also of the necessity of the Aeronautical Manufacturers' Association working in harmony with all the other forces which make up the aeronautical movement. He contended that by a combination of effort between the Aeronautical Manufacturers' Association and all the Aero Clubs and Aeronautical Societies in the United States, a gigantic work could be accomplished and a representation of the aeronautical movement effected in Washington that would cause the United States Government to not only take notice of but to give immediate action toward the advancement of the movement in this country.

Hugo C. Gibson complimented the promoters of the aeronautical show, and John B. Maus presented Mr. Charles E. Spratt, chairman of the executive committee of the International Exposition Company, with a large bouquet of American Beauties as a slight token from the Aeronautical Manufacturers' Association for the good work he had accomplished.

Absolute harmony and general good fellowship prevailed to the highest degree during the feast, and the consensus of opinion was that the dinner was not only most opportune but that it had the effect of solidifying all the various factors of and strengthening the general position occupied by the industrial side of aeronautics in America.

# THE AERONAUTICAL SHOW

By Walter H. Phipps

**W**HEN the first plans of the New York aeronautical show were made public some few months ago, we were somewhat skeptical as to the success of the venture, and the editor of this magazine pointed out to some of the promoters good reasons why it would not be a howling success, so to speak.

In the first place it was pointed out that the aeronautical movement as a whole and the aeronautical industry as the foundation, had not yet reached a state of development which would warrant the assumption that an aeronautical show could be made either a financial or an artistic success.

To operate an indoor show at the present time in America is like picking the fruit before it is ripe or plucking the flower while yet in the bud, for not only is there no real essence or strength to be absorbed therefrom, but the very vitality of its foundation is sapped prematurely. There is no chance for gain for anyone, but a decided loss is incurred by everyone who takes part therein. So firstly we contended the show should not have been held at all this year.

Secondly: A worse time to hold an aeronautical show could not have been picked. It was pointed out that the month of May was usually the first month of the year when the people could depend upon good weather and plenty of sunshine. During the whole winter they are cooped up indoors and are longing for the first days when they can go out in the open and enjoy the good fresh air and sunlight, and that these days in May picked for the aeronautic show were just likely to fall upon such weather. Strange to say just as outlined the weather happened, for on the 10th day of May, the second day of the show, the sun came out in all his glory, and the weather remained exceedingly pleasant during the balance of the time set aside for the exhibition excepting two rainy days.

Thirdly: The promoters of the show actually made their arrangements without taking the manufacturers into consideration, which was like trying to give a performance of the play "Hamlet" without a Hamlet in the cast. Had the manufacturers of aeroplanes and accessories in this country been given a chance to express their opinions regarding the plans of the show at the time they were first considered, there is no question that the show would have been at least 50 to 75 per cent. more successful than it was.

However, notwithstanding these drawbacks, the Aeronautical Show held at the Grand Central Palace, New York, from May 9 to 18, was very well staged, and contained many exceedingly interesting exhibits, and the experience gained by the promoters therefrom will no doubt prove of great value in the organization and operation of the show contemplated for next year.

We have nothing but praise to offer the International Exposition Company, under whose management the show was conducted, and special mention should be made of the very courteous, efficient and liberal manner in which the exhibitors were treated at all times by Charles E. Spratt, the general manager of the company, and his extremely able assistant, John Carrington Yates. Likewise the good results accomplished by Irving W. Twombly, the chairman of the plan and scope committee, was most creditable.

In contrast to the Third Paris Show, there were more biplanes than monoplanes exhibited, there being 12 biplanes and 9 monoplanes, as well as one quadruplane.

The revelation of the show was the new 100 H. P. Galaudet monoplane, an American machine, designed expressly to defend the Gordon Bennett Cup. The Curtiss and Rex companies also exhibited machines which are intended for use in this race.

The following is a detailed description of the more important exhibits.

## Wright.

The Wright brothers exhibited a new two-seater biplane, which on account of its fine finish and new fittings attracted considerable attention. As a type it differed little from the regular headless models, the only change being that it was fitted with two long narrow vertical planes in front and a larger vertical rudder in the rear, these changes apparently being the outcome of the experiments conducted by Orville Wright at Kitty Hawk last year with his soaring glider. An additional and very important change was the fitting of a bell crank, instead of the two usual pulleys, to transmit the necessary warping movement to the warping wires, which are now double. The gasoline tank has now been placed behind the passenger seat, while the radiator is put in the rear of the engine. On the Wright stand was also to be seen for the first time one of their new 6-cylinder 60 H. P. aeroplane motors, as well as a new three step hydroplane designed expressly for use on their machines.

## Curtiss.

The Curtiss Aeroplane Company occupied a space in the centre front of the hall, where they showed three of their latest biplanes and two motors, while in the balcony was the original Curtiss biplane, which won the first Gordon Bennett Race at Rheims in 1909.

The centre of attraction of the Curtiss exhibit was the new small spread headless machine which has been built expressly to defend the Gordon Bennett Cup this year. This machine has a spread of only 21 feet 3 inches and a chord of 4½ feet and an overall length of 32 feet. It is equipped with a 75 H. P. 8-cylinder V water-cooled Curtiss motor, and it is figured out that its speed should be at least 85 miles an hour. The Curtiss hydro-aeroplane shown was almost an exact duplicate of the one which was being flown daily on the Hudson River by C. C. Witmer, and for this reason attracted more than ordinary interest. It is likewise one of the three Curtiss hydro-aeroplanes ordered by the Russian Government. The chief dimensions are as follows: Spread, 28 feet 8 inches; chord, 5 feet; overall length, 34 feet 4 inches; motor, 8-cylinder 75 H. P. water-cooled Curtiss.

In addition to the hydro and racer the Curtiss Company showed a two-passenger military type machine fitted with a shift control. As a type this machine differs but little from the regular two-passenger Curtiss, with the exception that an improvement has been made for military and cross-country flying. The skid that runs forward under the machine has now been turned sharply up in front and has a two wheel shock absorbing landing gear fitted at the tip instead of the regular forward rigid wheel. An accompanying photograph shows clearly the construction and operation of this alighting device.

## Burgess.

The Burgess Company and Curtis showed three biplanes, one a large two-seater military tractor, a regular Burgess-Wright hydro-aeroplane and the "Flying Fish," the original Burgess, which first made its appearance at the Boston Aero Show in 1910.

The military type is a large tractor biplane, having the engine and propeller mounted in front of the fuselage. The seats for the aviator and passenger are arranged tandem fashion behind the gasoline tanks and immediately between the two planes. Near the rear of the fuselage is attached a stationary horizontal stabilizing tail, while at the extreme rear may be found the horizontal rudder, which is a flat surface plane similar to the stationary tail, but in no way attached to it. Immediately between the two is the vertical



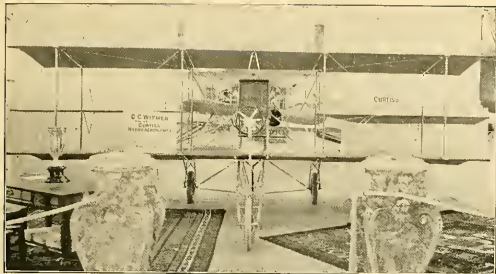

Front view of the new 75 H. P. Gordon Bennett Curtiss racer. Note the small spread, only 21 ft. 3 ins., and the position of the ailerons, which pivot on the central uprights.

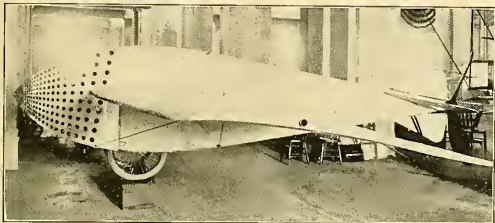

Side view of the new rear propeller 100 H. P. Gnome driven Gallaudet monoplane, which is built mostly of steel tubing. It has been expressly designed by Mr. Gallaudet, a graduate of both the Wright and Macaport schools, to defend America in the forthcoming Gordon Bennett race. As will be noticed, all head resistance has been cut down to a minimum, the unusually broad and deep fuselage serving as structure for the landing wheels, as well as an anchorage for both the top and bottom wing wires in addition to housing the fuel tanks, controls and secret mechanism for changing the angle of incidence of the main planes and warping. It is interesting to note that no wires run to the rear spar of the wings as on other machines. The 100 H. P. 14-cylinder Gnome is mounted in front and drives through a long shaft the 3-bladed Paragon propeller at the extreme rear behind the elevator and rudder.



Three-quarter view of the large Farman type hydro-aeroplane designed and built by Paul Schill, of the Max Ams Company, and equipped with an 8-cylinder water-cooled V type 100 H. P. Max Ams motor, which is hand cranked from the seat. A peculiarity of this machine is the way in which the outer sections of the wings slope backward in the form of a large open V.

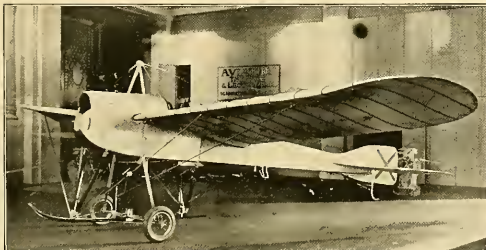

Three-quarter view of the new Rex Gordon Bennett racer, showing the neat covered in fuselage; new type landing gear and reverse curve wings. The rear spars of the wings pivot to a central upright in the fuselage, thus permitting a very powerful warp. As this is one of the few all American built and designed tractor monoplanes, its trials will be awaited with considerable interest.

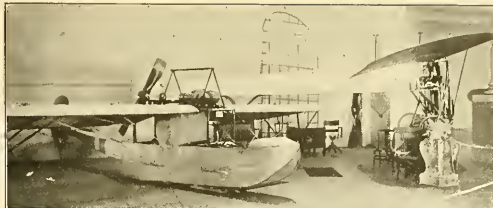

View of the Queen Aeroplane Company's stand showing in the foreground the Loening 50 H. P. Gnome aeroboot and in the rear the 35 H. P. Anzani Queen Bleriot.

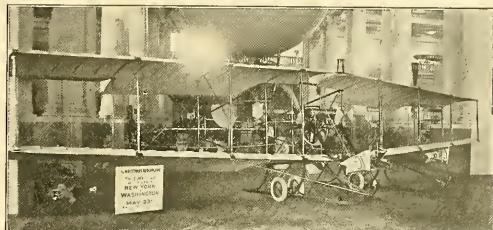

The new 50 H. P. Christmas headless biplane, which is equipped with a 50 H. P. air cooled revolving Gyro motor. Note the double dihedral angle wings with opening in centre, and also the long flexible trailing edge of the wings.

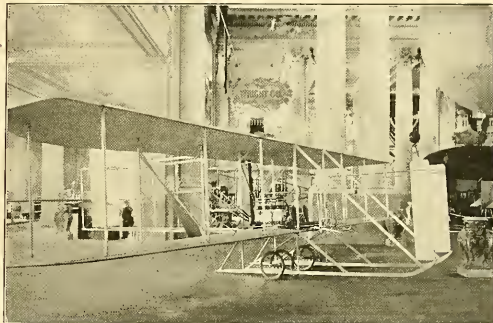

The latest two passenger 35 H. P. Wright biplane. Note the long straight skids extending forward, the vertical fins in front, the large rear vertical rudder and the radiator behind the motor. The gasoline tank has now been placed behind the passenger's seat, and the necessary operating mechanism grouped nearer together so as to cut down head resistance. The controls are arranged in exact duplicate with the warping levers on the right and the elevator lever on the left. In place of the usual complication of pulleys, chains and wires used heretofore in transmitting the warping motion from the warping lever to the rear warping wires, a simple push rod and bell crank arrangement has been substituted. Another change has been the placing of the skids nearer together, they now being only 4 ft. 4 ins. apart.

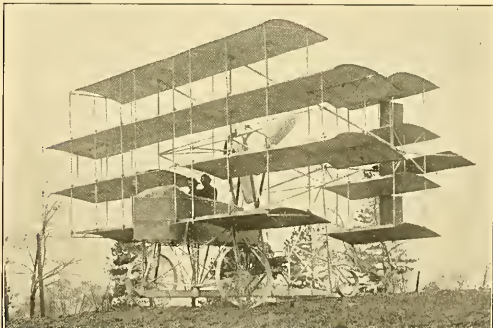

Three-quarter view of the Jacobs multiplane. Note the quadrumplane main cell and lifting tail with elevator in the rear, the large 42-inch landing wheels and the roomy cabin for passengers. The two propellers, which are mounted on the same axis, are driven separately through belt transmission by two motors.

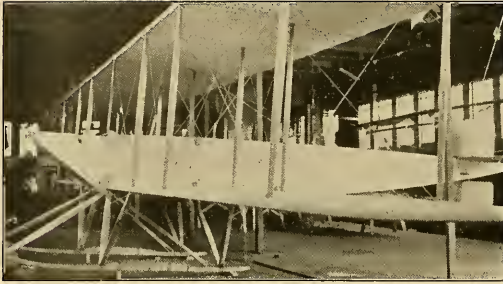

Side view of the new Burgess military tractor, showing the main biplane cellule, the fuselage, the landing skids without the wheels attached and the tail and rudders in the rear.

rudder, which consists of four small vertical surfaces, two above the fuselage and two below. The landing chassis is a particularly strong and businesslike structure, consisting of two stout skids, which extend well forward to protect the propeller. The wheels, which are of small size, are fitted with very large tires and attach to the skids Wright fashion. The power plant consists of an 8-cylinder V air-cooled 70 H. P. Renault motor, which drives through under gearing a large Chauviere tractor propeller.

In addition the machine is equipped with a very complete wireless set for receiving and sending messages, the current being generated by a small dynamo, which is placed underneath the fuselage and is driven by the engine.

The Burgess-Wright shown was of the regular two-passenger type, capable of being started from the seat and fitted with a 6-cylinder 50 H. P. silenced Kirkham motor in place of the usual 35 H. P. Wright.

The workmanship on both the two-step hydro-aeroplane and the biplane itself was excellent and called forth favorable comment.

#### Schill.

Paul Schill, of the Max Ams Company, exhibited a large Farman type hydro-aeroplane equipped with a 100 H. P. 8-cylinder Max Ams motor, which could be cranked from the seat. This biplane had a covered in cabin with seats for three persons. The hydro-planes were fitted to the regular skid struts and were of the single step type. The general dimensions are as follows: Spread 50 feet (top), lower plane 36 feet, chord 6 feet 8 inches, length over all 26 feet, pontoons 15 feet long 2 feet wide and 1 foot deep, propeller 1 foot diameter, 8 feet pitch, weight 1,100 pounds.

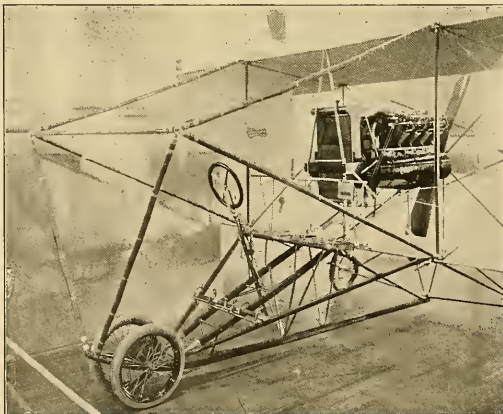

View showing the landing gear fitted to the new Curtiss military biplanes. Note the curved skid and two shock absorbing wheels in front.

#### Coffyn.

Frank T. Coffyn exhibited the hydro-aeroplane with which he has been making such wonderful flights above the waters of lower New York. As a type this machine is of the regular standard Wright pattern, but fitted with Coffyn's own hydroplanes. In this respect it is interesting to note that Coffyn was the first man to successfully fit double hydroplanes to an aeroplane.

Another improvement which has been made is the fitting of a starting crank to permit starting the motor from the front without having to turn the propellers.

#### Christmas.

The Christmas Aeroplane Company showed an interesting and original biplane which attracted more than usual attention owing to the fact that arrangements had already been made with the United States Government for the transportation of a sack of mail from New York to Washington immediately after the Show. The number of this route is officially known as 607,002. It was announced that Paul Peck would be the aerial postman. The wings of this biplane are set at a double dihedral angle with an opening about two feet wide in the centre of the top plane, this is for the relief

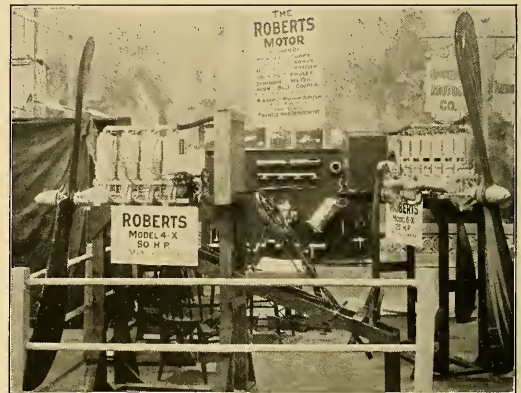

THE ROBERTS MOTOR COMPANY'S STAND.

of air currents, while the rear edges of the wings are extremely flexible. It is claimed that this combination produces practically an automatically balanced machine with, it is stated, a gliding factor of about 18.

The seats for the aviator and passenger are placed just in front of the motor, which is situated in the centre between the two main planes. The controlling gear consists of a semi-circular wheel, which by rotating works the ailerons, while a twisting movement of the whole on its axis turns the vertical rudder, and a fore and aft movement operates by warping, the large horizontal rudder in the rear. The motor used is a 7-cylinder 50 H. P. Cyro.

#### Gressier.

The Gressier Aviation Company exhibited a well built "Canard" type machine, which was fitted with a 50 H. P. Gnome. This machine has an elevator way out at the front of the fuselage, while the main planes and motor are in the rear. The seats for pilot and passenger are situated just in front of the main biplane cellule. The controlling gear was quite novel and attracted considerable attention.

The biplane shown was fitted with three skids and six Farman type shock absorbing wheels, but it is intended to fit three hydroplanes for water use. The chief advantage of this tailless machine lies in the fact that there are no outriggers in the rear within proximity to the propeller, which would be likely to be carried away in the event of a propeller breaking. Another important point is that there is no surface in the rear, depending largely for its support upon

the blast of the propeller, and in consequence there is no chance for a tail slide in the event of the propeller stopping.

#### Rex.

The Rex Monoplane Company's stand formed quite a centre of attraction for the reason that there was to be found a new original all-American monoplane. This machine has a long graceful fuselage, which carries at its front end the motor and gasoline tank, the wings and the pilot's seat, and at its rear, the flat non-lifting tail plane and elevator flaps with the vertical rudder immediately behind them. The landing gear was quite novel, and consisted of a single skid and two shock absorbing wheels. These wheels were attached to the fuselage through telescopic tubes having springs inside them to absorb shocks. The axle was also strapped to the landing skid by rubber bands, the whole forming a very flexible and efficient shock absorbing landing gear.

The main planes have a peculiar reverse curve in them, and are pivoted to a centre upright in the fuselage, thus permitting of warping the whole wing instead of only the tips. The controlling gear consists of a wheel and column which by turning operates the warping, while pushing back and forth works the elevator. Steering is by foot yoke.

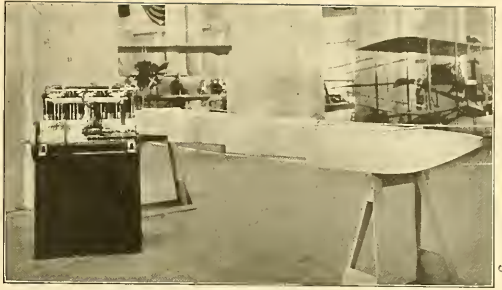

THE NEW SIX CYLINDER, 60 H. P. WRIGHT MOTOR AND THREE-STEP WRIGHT HYDROPLANE.

people comfortably. The landing chassis consists of one long centre skid having two large 48 inch wheels in front and a single swivelling wheel in the rear. Contrary to usual practice these wheels are not fitted with pneumatic tires, but instead have a broad flat strip steel rim. Landing shocks are taken care of by spring and pneumatic plungers. The control consists of a wheel mounted on a vertical column, which operates by a rotating motion the ailerons, fore and aft movement the elevator and a twisting of the whole column, wheel and all, round its axis, the vertical rudder. The general dimensions are as follows: Spread 37 feet, length 29 feet 8 inches, height 17 feet.

#### Gallaudet.

The Gallaudet Engineering Company exhibited a new speed monoplane, which held the attention of the spectators by reason of its peculiar design, which gives the machine the appearance of a flying projectile, and hence it has been named the "Bullet."

The fuselage is torpedo shaped, haing a section four feet square at the point where the aviator sits and tapering sharply to a point in the front and more gradually toward the rear. The nose of the machine is made up of sheet aluminum haing a series of holes stamped in it to permit of efficient cooling of the 14-cylinder Gnome, which it houses. The main planes attach to the centre of the fuselage in a position just behind the engine, while at the rear of the fuselage are the small triangular shaped elevator and the vertical rudder. At the extreme rear is a three bladed Paragon propeller, which is driven through shafting by the motor in the nose. The general dimensions of the machine are as follows: Length over all, 20 feet 6 inches; spread, 32 feet; width of wings, 8 feet wide at the body tapering slightly toward the tips.

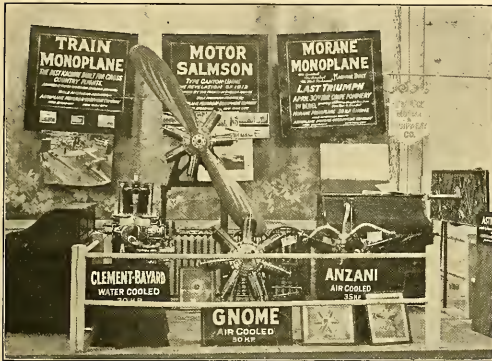

THE AEROPLANE MOTORS AND EQUIPMENT COMPANY'S STAND.

#### Antoinette.

Harry S. Harkness exhibited the Antoinette monoplane with which he carried the first war despatch on February 7th, 1911. This machine was fitted with an 8-cylinder 50 H. P. Antoinette motor and Normale propeller.

#### Baldwin.

Captain Thomas S. Baldwin showed the biplane with which he has toured in many parts of the globe. As a type this machine is a cross between an early Farman and a Curtiss, and is one of the few existing machines which retains the use of a double horizontal tail and double elevator in the rear. The power plant consists of a 60 H. P. 8-cylinder Hall-Scott motor.

#### Multiplane Ltd.

The Multiplane Limited, of Atchison, Kansas, showed a large quadruplane built under the patents of H. W. Jacobs and R. Emerson, already well known engineers in railroad transportation. Owing to its novel design and large size this machine was the cynosure of all eyes. The machine is of the headless type, having four main planes in front with four lifting tail planes in the rear and an elevator immediately behind. The propellers, of which there are two mounted on the same axis, are placed midway behind the main planes and are driven by leather covered flat steel belts from two 8-cylinder 80 H. P. staggered V type air cooled motors. Owing to its large surface this machine is naturally designed for weight carrying, and for that reason is fitted with a large cabin having a double row of seats, capable of holding five



THE BABY ENGINE COMPANY'S STAND, SHOWING 1, 2 AND 4-CYLINDER BABY GASOLINE ENGINES AND BABY BIPLANE.

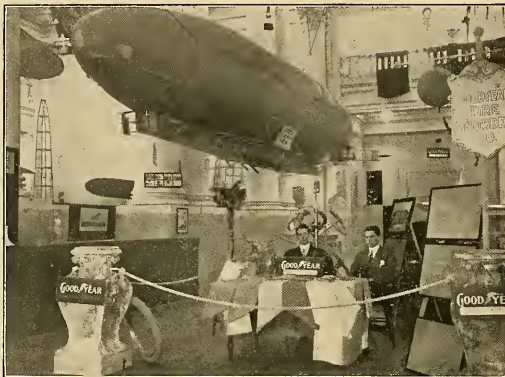

View of the Goodyear Tire and Rubber Company's stand, showing their exhibit of cloths, tires, springs, etc., and also the 25-foot scale model of the dirigible balloon "Akron."

#### Twombly.

Mr. Irving W. Twombly exhibited a Blériot type monoplane which was fitted with one of his 45 H. P. 7-cylinder air-cooled revolving motors. The chief novelties of this monoplane lie in the use of a wooden spring axle in the front, which supports the main two landing wheels and the fitting of a wooden spring in the rear, which carries the tail wheel. The main planes are covered with transparent celluloid in the vicinity of the body for the purpose of affording the pilot a good view of the ground immediately below and in front of him.

Another exhibit of Mr. Twombly's was a shock absorbing safety harness of his own invention for strapping aviators in their machines. This harness is so constructed as to prevent the aviator from being lurching out of his seat, and yet at the same time permitting him to quickly detach himself from the harness in case of emergency.

#### Nieuport.

The Aero Club of America exhibited a 50 H. P. Gnome Nieuport. As this machine is so well known and was so fully described in the August, 1911, number of AIRCRAFT, further description at this time is unnecessary.

#### Queen.

The Queen Aeroplane Company exhibited two machines, one an aero boat designed by Grover C. Loening, and the other a Blériot type monoplane equipped with a 30 H. P. Anzani motor.



The above picture, which shows a wax figure wearing the Twombly shock absorbing harness, depicts the way in which this is worn, and also shows the manner in which the harness is detached by pulling out the cotter-pin.

The aero boat is a distinct and novel departure from usual hydro-aeroplane construction, consisting as it does of a light aluminum covered boat, to which are attached in front on an upright structure the main wings, with the motor and propeller just behind them. The boat structure tapers towards the rear and is curved upwards so as to support the combination horizontal and vertical rudder. The power plant consists of a 50 H. P. Gnome, which is placed in the boat proper and drives through a chain the propeller, which is just behind and a little above the main planes. The controlling arrangement is quite novel, and consists of two horizontal levers resembling the tillers of a boat, which the operator grasps one in each hand. Steering upward is accomplished by pulling both the levers upward, while pushing downward on them deflects the machine. Steering to the right and left is accomplished with the same levers by pulling one forward and pushing the other backwards, or vice versa. A foot lever works the ailerons.

#### National.

The National Aero Company exhibited a well constructed Blériot type monoplane, which was equipped with a 4-cylinder 40 H. P. Rubel "Gray Eagle" motor and Rubel propeller. The motor was fitted with an acetylene self-starter, which was controlled from the seat. In addition this company exhibited a complete line of well made monoplane fittings.

#### American.

The American Aeroplane Company exhibited a large monoplane with a very low centre of gravity. It was fitted with two 50 H. P. 2-cycle air-cooled revolving motors and self starters, and it is designed to fly with either motor and to carry six to ten persons.

#### ACCESSORIES AND MOTOR EXHIBITORS.

##### The B. F. Goodrich Company.

Special "Lumina" aeroplane cloth and Goodrich tires.

##### Captain Baldwin.

Captain Thomas Baldwin exhibited two Hall-Scott motors, one a 4-cylinder 40 H. P., the other an 8-cylinder 60 H. P., as well as a complete line of his well known aeroplane and balloon fabrics.

##### W. F. Mangels Company.

Device for teaching aviation and testing aeroplanes.

##### Mead Engine Company.

Exhibited a new type 4-cylinder rotary valve water-cooled motor of 50 H. P., which attracted considerable attention and elicited much favorable comment.

##### Diamond Rubber Company.

Aeroplane wheels and special cloths.

##### The White Aeroplane Company.

Showed a fine display of scale as well as flying models, together with glider and model supplies.

##### Electric Speedometer Company.

Hopkins Electric tachometers, or engine revolution counters.

##### Marburg Brothers Incorporated.

Exhibited a complete line of Mea magnetos and S. R. O. ball-bearings.

##### B. F. Sturtevant Company.

Exhibited three 6-cylinder 60 H. P. water-cooled motors, one of which was fitted with a large and efficient muffler. They also showed a 4-cylinder 40 H. P. motor, and in addition exhibited a complete line of the parts used in their motors.

##### E. J. Willis Company.

Showed a very complete exhibit of parts and accessories and also one 8-cylinder V type 80 H. P. Frontier motor and one 4-cylinder 40 H. P. Rotary valve Frontier, as well as 4 and 6-cylinder Elbridge engines. Their exhibit of parts included such things as post sockets, bed rails, turnbuckles, etc., and also complete Farman and Curtiss running gears.

##### J. A. Crayn and Company.

American Agents for "Magnalium."

Exhibit showed cylinders, castings and parts of Magnalium

used by most of the successful motor builders. A few of the motors using Magnalium being Roberts, Kirkham, Elbridge, Twombly, American Motors and Aviation Co., Parker Motor Co. and Baby Engine Co.

#### Twombly Motors Company.

Showed one 7-cylinder air-cooled rotary motor of 40 H. P. and one of 50 H. P., both having mechanical intake and exhaust valves operated by a unique cam, which does away entirely with all cam gears. The operation of this motor was fully explained by means of a small wooden working model.

#### United States Tire Company.

Aeroplane tires and fabric varnishes.

#### Frederick C. Lambert.

Working model of his Duplex monoplane.

#### Maximotor Makers.

Exhibited a new 4-cylinder water-cooled 70 H. P. military type Maximotor having both mechanical intake and exhaust valves. This motor was fitted with a three bladed Diana "Spiron" propeller and was capable of being started with a hand crank. In addition they showed one of their improved 4-cylinder 40 H. P. 1912 types.

#### Diana Aeroplane Company.

Exhibited two and three bladed "Spiron" propellers.

#### H. L. F. Trebert Engine Works.

Exhibited one 6-cylinder Trebert "Justrite" rotary motor of 50 H. P. and one 8-cylinder sliding piston valve motor of 100 H. P. The "Justrite" rotary is a valveless 4-cycle motor, having the cylinders set parallel to the axial shaft.

#### Pennsylvania Rubber Company.

Aeroplane wheels, tires and cloths.

#### Newmastic Tire Company.

Unpuncturable airless tires.

#### P. B. Porter.

Booking stand for Stevens and Beatty (S. & B.) air line.

#### Edward Durant

Demonstrated the gyroscope and its influence and application in aeronautics.

#### Goodyear Tire and Rubber Company.

Exhibited aeroplane wheels, tires, cloths, life preservers, Farman, Wright and Eleriot rubber springs, 25 foot scale model of the Goodyear dirigible "Akron," model of the U. S. Scout Balloon, several aeroplane models, as well as a section of the wing fabric which was used by Robert G. Fowler throughout his transcontinental flight. A special feature was an exhibition of scale blue print drawings of dirigible and spherical balloons.

#### A. Leo Stevens.

Exhibited a small one-passenger light weight balloon which was named the "Midget," as well as various balloon baskets and ballooning accessories.

#### The Aeroplane Motors and Equipment Company.

Showed a very complete exhibit of imported aeroplane motors, motor parts, accessories, and Astrol varnishes, as well as some exceptionally fine photographs of the latest Morane and Train monoplanes, for which they have the American agency. The motor exhibit comprised two 50 H. P. Gnômes, one 2-cylinder opposed water-cooled Clement Bayard of 30 H. P., one 3-cylinder air cooled 35 H. P. Anzani, and one 4-cylinder V type water-cooled Anzani of 35 H. P.

#### Roberts Motor Company.

Showed two model 4 X-50 H. P. motors and one model 6 X-75 H. P., as well as a very complete exhibit of the various parts which enter into their construction. A special feature which attracted considerable attention was the mounting of one of the model 4 X motors on a stand representing the engine and seating section of a Curtiss biplane, showing the manner in which the engine was controlled by the pilot.

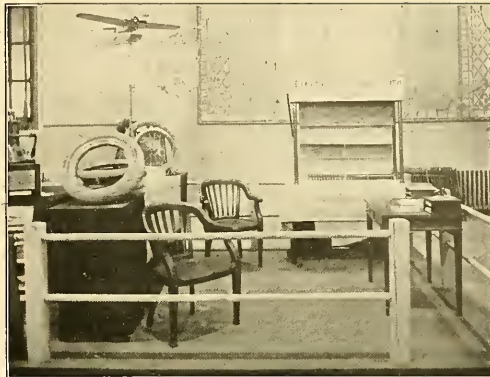

THE B. F. GOODRICH COMPANY'S STAND.

#### F. A. O. Schwartz.

Showed a complete line of aeroplane models and flying toys.

#### Gibson Propeller Company.

Showed an interesting exhibit of their propellers from the first up to the latest improved designs.

#### Baby Engine Company.

Exhibited a baby biplane equipped with one of their single cylinder motors, which they state has flown a considerable distance, and also a complete line of miniature gasoline engines of both air and water cooled types, ranging in power from one-half to two H. P. These engines are of the 2-cycle type and are built with either 1, 2 or 4 cylinders, according to H. P. They are used to drive model aeroplanes, boats and small electric lighting outfits.

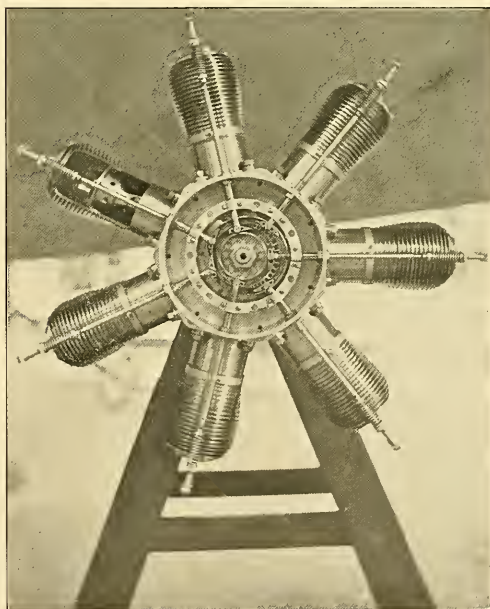

Front view of the new 50 H. P. Twombly rotary motor, which weighs complete only 100 pounds, and has both mechanical intake and exhaust valves operated by the peculiar sliding cam arrangement shown. Lubrication is by force feed, only a small quantity of high grade automobile oil being used.

**Macomber.**

Macomber Rotary Engine Sales Company exhibited a 50 H. P. 7-cylinder air-cooled rotary motor having the cylinders running parallel to the axial shaft.

**Dr. H. W. Walden.**

Exhibited a collection of photographs showing interesting views of his monoplane in flight and on the ground.

**Max Ams Machine Company.**

Exhibited two 8-cylinder V type 100 H. P. water cooled motors.

**The National Aero Company.**

One 4-cylinder 40 H. P. air cooled Gray Eagle motor and one 6-cylinder air cooled 60 H. P. Gray Eagle motor.

**MODELS.**

**New York Aero Model Club.**

Showed a fine collection of models made by the members, and also a glider and a number of cuts and trophies.

**John Carisi.**

Exhibited a model monoplane of original design and excellent construction. The power plant consisted of single cylinder Baby gasoline engine.

**F. L. Herreshoff and Dr. C. Dederer.**

Exhibited a monoplane model which recently broke the world's record for models rising from the ground by flying a distance of 1,184 feet.

**Julius Brown.**

Exhibited a very interesting monoplane model designed for safety. It is equipped with devices for keeping it automatically stable.



THE CARISI MONOPLANE MODEL WHICH IS EQUIPPED WITH A SINGLE CYLINDER 1/4 H. P. BABY GASOLINE ENGINE.

**Kalman Leon.**

Model monoplane equipped with safety parachute attachment.

**Wm. A. Crawford Frost.**

Model, showing special balancing device.

**Ernest P. Vincent.**

Showed a model of a staggered triplane equipped with three hydroplanes

**Henry E. Ragot.**

Exhibited an automatic device for stopping model gasoline engines while in flight by short circuiting them at a predetermined and set time.

# A METHOD OF COMPUTING THE EFFICIENCY OF LATERAL CONTROL SYSTEMS

By Albert Adams Merrill

The coefficient of efficiency of lateral control systems is represented by the fraction

$$\frac{\text{Tipping force (foot pounds)}}{\text{Loss of kinetic energy (per cent)}}$$

Consider only the reactions which occur on one square foot of surface at the tip of each wing. Assume the span of each machine to be the same, also the weights of the machines, and assume the lift and drift to be concentrated at the tips. With these conditions the only variables will be those due to specific differences in the control systems. Now assume the horizontal component of the thrust to be constant during the operation of tipping then DV square for each tip will be constant when D equals pounds per sq. ft. and V equals m. p. h.

Start with the single Wright surface at 6 degrees, 50 m. p. h., and use the following table taken from Eiffel.

Angle.	Lift.	Drift.
4.....	3.876	0.458
6.....	4.590	0.510
8.....	5.406	0.612

Compute DV<sup>2</sup> of each tip—  
 Log D (6° at 50 m. p. h.)... 9.7075702-10  
 Log V<sup>2</sup> (50 m. p. h.)..... 3.3979400

Log DV<sup>2</sup>..... 3.1055102 constant  
 Change the angle of incidence of the right tip from 6 to 8 left tip from 6 to 4. Compute right tip—  
 Log D (8° at 50 m. p. h.)... 9.7867514-10  
 Log V<sup>2</sup> (50 m. p. h.)..... 3.3979400

$$\frac{2}{3.1846914}$$

Now from our hypothesis the thrust is constant, hence with this change of angle V square must decrease. But D varies as V<sup>2</sup> hence D will decrease at the same rate as V<sup>2</sup>, and so log V<sup>2</sup> will decrease one-half the difference between (1) and (2).

	3.1846914
	3.1055102
2)	.0791812
	.0395906
Log V <sup>2</sup> ..	3.3979400
Log new V <sup>2</sup> ..	3.3583494
V..	47.772 m. p. h. speed of right tip.

This means that at 47.772 m. p. h. and 8 degrees the energy consumed should be equal to the energy consumed at 50 m. p. h. and 6 degrees. We prove

as follows:

Log D (8° at 50 m. p. h.)	=	9.7867514-10
Log 47.772 <sup>2</sup>	=	3.3583494
		13.1451008-10
Log 50 <sup>2</sup>	=	3.3979400
		9.7471608-10
Log D (8° at 47.772 m. p. h.)	=	3.3583494
Log 47.772 <sup>2</sup>	=	3.1055102

This agrees with the old DV square and proves the work.

Do the same with the left tip and we find its speed increases to 51.362 m. p. h. This, of course, happens when there is no offset. Knowing the new speeds and angles of both tips we get the following table:

	Speed.	Lift.
Right tip 6°.....	50	4.59
Right tip 8°.....	47.772	4.9349
Left tip 4°.....	51.362	4.0901
Left tip 4° with offset.....	47.772	3.5382

You will note that without the offset the machine tips to the left but turns to the right. This is the fallacy of the positive angle, and to prevent an accident the rudder is used as an offset to retard the left tip. With the offset the machine flies straight and is tipped for a left turn.

Now the tipping force is the difference in lift between the tips, which is 4.9349—3.5382=1.3967 and  $\frac{50^2-47.772^2}{50^2}$ =0.08713

The coefficient of efficiency therefore is  $\frac{1.3967}{0.08713}$ =16.03

Now consider the system which I advocate. In this system the ailerons normally rest parallel to the surrounding air stream, are movable only to a negative angle relative to said air stream, and only on one side at a time. Assume a Blériot number 11 surface and two flat ailerons each one-tenth the area of the wing to which it is attached. Proceed as above. Lift and drift at 50 m. p. h.

	Angle.	Lift.	Drift.
Blériot No. 11.....	6	4.59	0.51
Flat aileron 1-10 sq. ft.....	16	0.51	0.153
Surface 6° aileron 0° at 50 m. p. h.			
Log D	=	9.7075702-10	
Log 50 <sup>2</sup>	=	3.3979400	

3.1055102 this is constant

Move the left aileron to a negative angle of 16°.  
 D of surface = 0.51  
 D of aileron = 0.153

Total D	=	.663
Log D	=	9.8215135-10
Log 50 <sup>2</sup>	=	3.3979400
		3.2194535
		3.1055102 constant
2)		11.39433
		.0569716
Log 50 <sup>2</sup>	=	3.3979400
Log new V <sup>2</sup>	=	3.3409684
V=		46.825 m. p. h. speed of left tip

From this we find the lift of the tip to be 4.0257, the downward pressure of the aileron to be 0.4473, the net lift of left tip being 4.0257—0.4473=3.5784.

With my system the machine always tips and turns in the same direction, that is why it is safe. It never needs an offset, and that is why it is efficient. When resistance is put in on the left tip the machine turns to the left, but there will be a point the speed of which will not change. This point is called the axis of oscillation or center of percussion. If the weight of the machine was equally distributed along the span the axis of oscillation would be one-sixth the span from the center. I have assumed it to be so in a flying machine. Therefore when the speed of the left tip drops to 46.825 the speed of the center of gravity only drops to 49.207 and the speed of the right tip rises to 51.387. Compute the lift of right tip and we get 4.8860. Tipping force=4.8860—3.5784=1.3076. Loss of energy =  $\frac{50^2-49.207^2}{50^2}$ =.03148

$\frac{1.3076}{.03148}$ =41.537 coefficient of efficiency.

As a matter of fact the weights of a flying machine being concentrated, the axis of oscillation will be very much nearer the center than one-sixth the span, hence my system will be more efficient than these figures show.

Below I give the ratings of all four systems, the figures representing the coefficients of efficiency:

Farman.....	3.638
Curtiss.....	7.276
Wright.....	16.03
Merrill.....	41.537

What would happen to a cyclist if when he tipped to the left he turned his front wheel to the right? Yet that is just what is done with warping wings. To cause a boat in a gust, we turn it back to the wind? Yet that is just what is done by warping wings.

Two other interesting facts against the positive angle are that with the positive angle the total lift is less than with the negative angle. This is somewhat of a paradox, but can be proved from the above figures, and it is of course due to the reaction of speed. To cause by the offset. Another interesting fact is that the positive angle and its

offset reduces the speed quicker than does the negative angle, and the tipping force with the positive angle is at its maximum at the first instant, getting less and less the longer you hold the warp, whereas with the negative angle the tipping force is at its minimum at the outset, getting larger and larger the longer you hold the warp, this inevitably follows from the fact that with the negative angle you slow down the wing you want to lower while with the positive angle you slow down the wing you want to raise, surely a stupid thing to do.

It is understood of course that in this system

that I advocate, ailerons or warping tips can be used, the essential point being that normally they must offer no resistance to flight being called into play solely for the purpose of regaining lateral stability. Only one side should be changed at a time, and that of course the high side, where the aileron should be moved from zero into a sufficiently large angle to get the proper reaction. When stability is regained the aileron is allowed to drop back to a position where it offers nothing but skin friction. In this way we get a more efficient system than Etrich has.

# GENERAL NEWS

By D. E. Ball

## The Wright Company's Dividend

According to the New York American of May 15th, for the third successive year the executive committee of the Wright Aeroplane Company have voted an annual dividend of about 20 per cent. It is expected the action of the executive committee will be ratified at an early meeting of the Board of Directors, of which Mr. Wilbur Wright is chairman.

The Wright Aeroplane Company is a million dollar corporation, and was organized by the Dayton inventors. There are now but sixteen stockholders in the company. If the directors approve of the action of the executive committee a total of almost \$600,000 will have been paid to the Wright Company's stockholders in the past three years.

It is also stated that the Wright Company has already sold 14 machines so far this year, and have taken orders for almost twice as many more, of which number only 8 are for the United States Army, and the balance for persons who are taking up flying for recreative and other purposes.

## Kinloch, Missouri

Now that Spring has arrived in earnest the Aero Club of St. Louis flying field at Kinloch has taken on the appearance of feverish activity. All through the winter, practically the only flying that was being done was by pupils of the Benoist School of Aviation. At the present time the Benoist School has eight or ten students, and are qualifying one a week regularly for pilot license, having qualified Ed Korn week before last, Frank M. Bell last week and have Peter Glazer, of Billings, Montana, ready to try out any time the Aero Club officials are on the field.

Wm. H. Blackley, of Minneapolis, Minnesota, has a new Wright type machine finished, which he has tried out a time or two, but has not as yet made an extended flight.

Moran's Blériot-Antoinette is still in the hangar where it was put last winter, but Moran expects to start experimenting actively within the next week or two.

Frank M. Bell and J. W. Eclair have bought a new tractor type Benoist monoplane, and are starting on an extended tour of Europe with the parachute jump from an aeroplane.

Ray Benjamin, of Binghamton, New York, has ordered a new Benoist tractor on which delivery is promised May 15th, and Ed Korn has also ordered a tractor, delivery May 20th.

J. Nick Sparling, who has conducted experiments and a school from time to time at Washington Park, across the river from St. Louis, in Illinois, has built a new tractor type machine, but so far it has not been very successful in its preliminary tests.

The Universal Aerial Navigation Company have about completed their large Helicopter aeroplane. They have just installed two one hundred horsepower Emerson motors, and they expect to be able to lift several tons with this, and make a successful trip to New York or any other place at the first tryout. At the present time, however, their greatest activity has been confined to selling stock.

## California News

By Ernest Ohrt.

On April 14th, Farnum T. Fish flew from San Diego to the Dominguez aviation field, making the entire flight, a distance of 130 miles, over the Pacific Ocean at a height of about 7,000 feet. This flight is believed to have established a new over-ocean record.

An aviation meet was held at Eureka, Cal., on April 21, an aeroplane mail service being one of its features.

S. Doi, the Japanese aviator, has made several flights at Easton, Cal., on a bamboo Curtiss type machine of his own construction. This machine is perhaps one of the lightest known, as it weighs but 500 pounds, including operator and motor.

Didier Masson, the French aviator, was successful in making a flight from San Rafael to Vallejo, recently, carrying a bag of mail and also a special letter from the Mayor of the former town to that of the latter. In the recent days Masson has been making flights in different Californian

towns on Saturdays and Sundays, and is reported to have engagements in the East for the entire summer season.

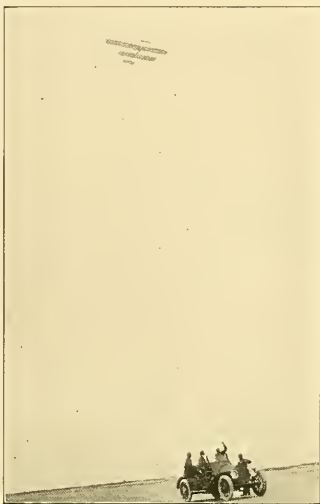

AVIATOR F. STUDESKY, OF THE NATIONAL AEROPLANE COMPANY, FLYING THE BEECH NATIONAL BIPLANE, 52 FEET SPREAD, AT GALVESTON BEACH.

The new aviators who have taken their licenses at the Curtiss Aviation Camp, at San Diego, are M. Kondo, a Japanese, who has the distinction of being the first licensed aviator of his nationality; J. Kaminski, a Polish; Mohan Singh, of Bombay, India, who has spent several weeks at San Diego field, and although there was nothing in his work while a pupil to mark him as a coming air wonder, he showed by his behaviour while in the air during the various stages of his instruction that his nerve was of the right sort to carry him safely through ordinary contingencies, and was con-

gratulated by Lieut. Towers on having earned his license, and K. Takeishi, also a Japanese.

Miss Julia Clark, of Chicago, who has been a pupil of the Curtiss school at San Diego during the past three months, will try for her license shortly and will no doubt be successful as she has many times in practice of late, flown in such a manner as to demonstrate her right to recognition as an aviatrice. Already Miss Clark has made flights of fifteen minutes' duration, cutting right and left turns and making perfectly balanced landings, taking the course of any altitude, showing by her work that she is mistress of her planes.

Among other events of interest in aviation is the closing of the United States Naval experimental station on North Island, which disappeared on May 1. The two big tents in which were housed a Wright and Curtiss hydroplane and a Curtiss biplane were taken down by working party from the cruiser Maryland, in port at the time, and taken to the naval academy at Annapolis.

## The Aeronautical Society

The Aeronautical Society held its first meeting in its new quarters, 304 West 58th street, New York, on Thursday evening, May 9th. This was the annual meeting of members for the ensuing year. The following elections were recorded: President, Louis R. Adams; Vice-Presidents, George S. Brandt, Orville Wright, Captain W. Irving Chambers, Isaac Guggenheim, Captain Thomas S. Baldwin; General Secretary, Arnold Krukenman; Treasurer, John E. Sloane; Directors—Lawrence E. Dare, Herman A. Metz, Charles K. Hamilton, Thomas A. Hill, Leo Stevens, Lee S. Burridge, J. C. Mars, Ernest V. Lallier, William J. Hammer, Charles W. Howell, Wilbur R. Kimball, James M. Beck, C. Azro Stiles, Colonel W. C. Church, Hugo C. Gibson, John J. Maloney, and Admiral Robert E. Peary.

A general "house warming" was held on May 23rd, a dinner being served at 8 o'clock in the Reisenweber Cafe in the same building which was reserved for this occasion. The dinner included the lady friends of the members, and special music, souvenirs, etc., were provided.

New applications for membership are being received by the secretary continuously.

The Coupe Pommeroy, one of the most important aeroplane contests of the year, has been won by Bedel on a Morane monoplane, for which machine the Aeroplane Motors and Equipment Company are the American agents. The conditions of this contest are the longest flight, in a straight line, between sunrise and sunset. Bedel took first place, with 800 kilometres. Prevost was second, flying a Deperdussin and, Hamel third on a Blériot. Among the other contestants was Vedrines, who met with a mishap, his machine being wrecked.

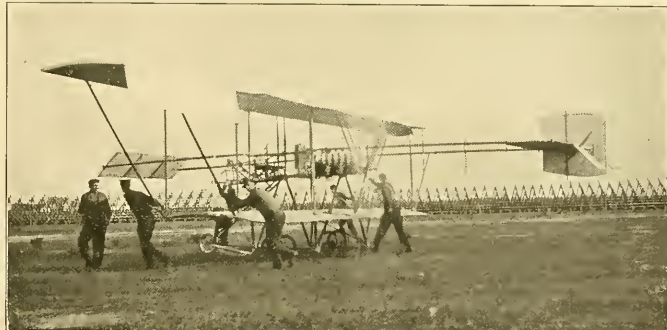

The National Aeroplane Company's of Chicago Beech biplane, said to be the largest biplane flying in America. This machine, with a Roberts six, has given good results, so far, as a cross country flyer and good climber.

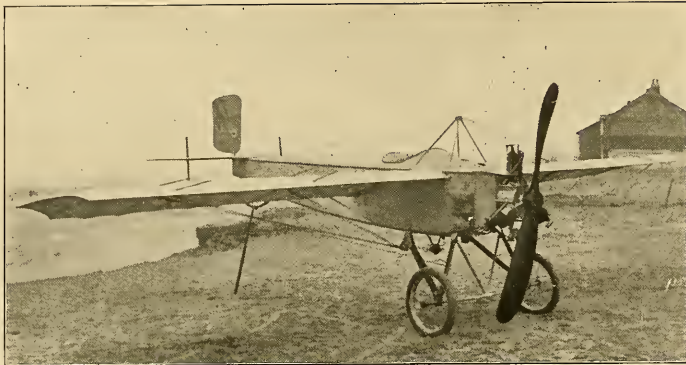

The new 30 H. P. Caudron monoplane, a remarkably fast and efficient little machine which has been doing some wonderful flying lately. It was on a monoplane of this make, but fitted with a 40 H. P. Anzani, that Ewen recently crossed the English Channel. Mr. George M. Dyott, instructor at the Sloane Aeroplane Company's school, will fly one of these machines in this country.

George M. Dyott, who will take charge of the Sloane School of Aviation, has just returned from Europe. The Aero Club of Great Britain has appointed Mr. Dyott a member of the Gordon Bennett team. He has made arrangements in Paris for a racing monoplane, capable of over 100 miles an hour. This machine will probably be equipped with a 140 H. P. Anzani motor. It will

splendid new machine of special construction having been built for him. In the meantime, Beachey will make flights on a hydro-aeroplane with which he will, no doubt, duplicate other daring aeroplane feats.

The Aero Club Italiano U. S. A., who have their headquarters in New York and already

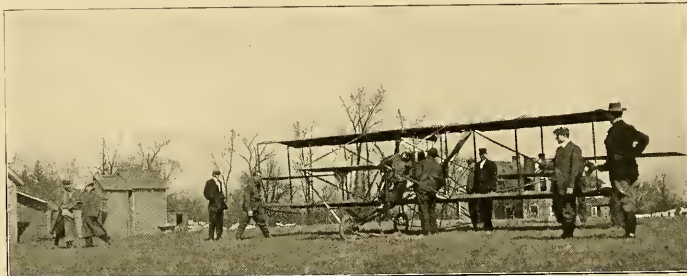

Students at the Milwaukee School and College of Aviation preparing for a flight at their flying grounds. Rudolph A. Silverston, the head of the institution, is standing at the extreme right.

be brought over early in the summer, and will probably be seen in several of the meets which will take place this summer.

Lincoln Beachey recently returned from Porto Rico, and on Decoration Day intends opening the flying season at Rockingham Park, Salem, N. H. He will continue to operate the Curtiss biplane, a

boast of 64 active members, gave a ball at the Murray Hill Lyceum, New York, on the evening of April 25th. Among the well known Italians present, who are members of the club, were A. C. Triaca, Ing. G. De Simone, C. Chiantelli, E. Pollak, G. Paisoli, A. Leo Stevens, Dott. V. Viggiano, Dott. G. Di Santi, Alfred Bolognesi, F. Bergamini, R. Perretta and S. A. Mascia.

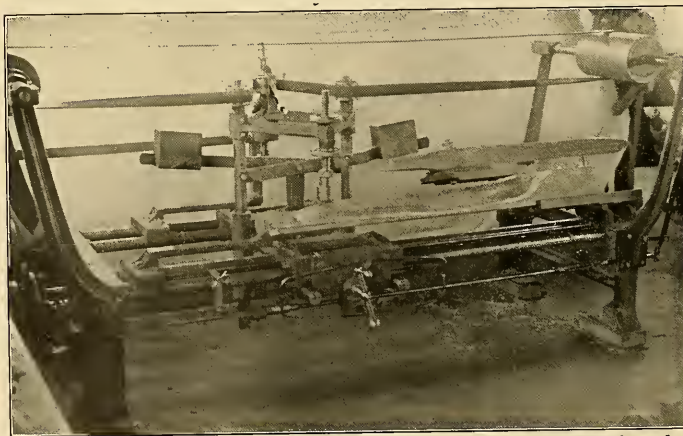

New machine designed and built in the Curtiss Aeroplane Co.'s plant at Hammondsport for rapid and accurate building of propellers. The block in the foreground is a pattern by which the propeller on the other side of the machine is being machined.

Probably the first dog to enjoy an aeroplane trip was that taken aloft by Robert G. Fowler at Spartanburg, S. C., on April 20. It was a bulldog belonging to J. P. Gwyn, an attorney of Spartanburg. It was intended at first by Mr. Fowler to give the dog a ride free of charge, but the business ability of Charles L. Young, Fowler's business manager, cropped out and a passenger fee of \$50 was charged for the ride, which lasted about 22 minutes.

The delivery of two lectures by Earle L. Ovington, comprised a very interesting feature of the Aeronautical Show. These lectures were illustrated by stereopticon views made from photographs taken of Mr. Ovington while in flight in various parts of the United States.

Mr. Ovington also addressed the entire student body of the Worcester Polytechnic Institute recently, including the professors. This institute is doing some real work for the progress of aviation, having a magnificent propeller plant, of which Professor Gallup is in charge, and who will shortly publish data accumulated on propeller tests. This contingent naturally proved a very enthusiastic audience.

Harold J. Jane and Louis A. Horn, of 3800 Harrison avenue, Cheviot, Cincinnati, have organized a model aeroplane club for the purpose of experimenting with various models in contests, and would like to meet with other interested parties in Cincinnati who are desirous of joining the club.

A report to the effect that a French officer recently lost his life through his eye-glasses becoming frosted, has resulted in a rule that United States Army officers who fly in aeroplanes for any other purpose than to read, will be barred from the aeronautical division of the signal corps.

On May 20th, Arch Freeman, in a Wright biplane, flew over Fort Hinch and Fort Banks, Boston, and then up the harbour over the battleships Rhode Island and New Jersey, dropping toy bombs which consisted of sixteen ounces of flour. Freeman flew at a height of about 500 feet and dropped three bombs, one hitting a range finder, another a gun and the third the embankment.

## CORRESPONDENCE

SORSOGON, Sorsogon, P. I., Jan. 2, 1912.

MR. A. W. LAWSON,

Editor AIRCRAFT.

MY DEAR MR. LAWSON—I am glad you sent me this timely reminder, as certainly do not wish to have my subscription lapse.

I certainly am interested in aeroplanes, and, though I weigh 255 avoirdupois, I still have hopes to make a flight some time.

I met Bud Mars at Manila last year during his engagement at the Philippine Carnival, which was the first and only flight I ever saw. His work made a profound impression upon all Americans, Spaniards and Filipinos.

The cause of aviation has thousands of ardent enthusiasts here in the Philippines, and we boast one locally owned and operated "red bird" purchased by Mr. Shimming of Capt. Baldwin.

Capt. Baldwin and Bud Mars are all to the good and we hope to see them again.

Sincerely,

HOWARD LONG,

Division Superintendent.

PARIS, April 22, 1912.

DEAR SIR—I take the liberty of informing you of the movement which has been created in France to present the army with aeroplanes. Although the French government has already appropriated large sums for their "fourth arm" it was not considered sufficient, and, first of all, through the influence of the sporting paper, "L'Auto" of Paris, and afterwards of all the leading papers, appeals were made to the people and they liberally responded, sending in their contributions to different committees who had charge to receive them. Besides, aeronautical lectures, aviation meets and theatrical shows were given and are still given for the benefit of this purpose.

You will find enclosed a clipping of "Le Matin" of Paris giving you an idea of the daily contributions and the total of these to date, and although this movement has been started only about a month ago, you will notice that the total amounts to quite a sum already.

If our government won't appropriate the necessary funds for buying aeroplanes for the army, why can't the American people imitate the French and raise the necessary funds themselves? The Germans have started doing this with success.

Therefore, Mr. Lawson, I beg of you to use your influence through the columns of your honorable magazine, the "AIRCRAFT" to try and stir up our people and make the "AIRCRAFT" be to the United States what "L'Auto" was to France in creating this movement, which I'm sure will be taken in favor by all our aero clubs, newspapers, etc., who will try their best towards this purpose. Hoping, sir, that you will take this into careful consideration, I remain,

Respectfully yours,

R. H. BLANQUET.



**Description of the American Aeroplane Supply House's Single Seater Monoplane and New Dual Control System**

The American Aeroplane Supply House manufacture four types of monoplanes, namely, a single seater, a passenger carrier, a racer and a military machine. Below we append a short description of the 50 H. P. single seater.

**GENERAL DIMENSIONS.**

Span, 29 feet 6 inches; length over all, 24 feet 10 inches; chord of wing, 6 feet 10 inches; stationary stabilizer, 10 feet 6 inches by 2 feet 1 inch; inverse curve elevator flaps (two), 3 feet 10 inches by 1 foot 9 inches; rudder, 3 feet by 2 feet 9 inches; motor, 4-cylinder 50 H. P. water-cooled Roberts; propeller, Gibson; weight complete with water and accessories and 5 gallons of gasoline, 650 pounds; speed, 60 miles an hour.

**FUSELAGE.**

The fuselage is of the box girder type. The ash longitudinals are joined in the centre with square steel tubes eight inches long, which permit the fuselage to be taken apart for transportation. The four members are 1 1/2" square at the front tapering down to 3/4" at the back. The fuselage is 28 inches wide and 27 inches deep at the front and tapers down by graceful curves to a point at the stern and 12 inches deep at the stern post. Ash struts spaced every 2 1/2 feet strengthen the fuselage.

**THE MAIN PLANES.**

The main planes have a spread of 29 feet 6 inches; have a cord of 6 feet 10 inches and a camber of 4 1/4 inches. Each wing is built up on two ash spars 3/4"x2 1/2". The ribs are spaced 13 1/2 inches apart and are of 1 Beam section.

**THE TAIL.**

Special attention is directed to the inverse tail, to the use of which the machine owes a great deal of its success. It will be noted that the elevating plane has just the reverse curve to that of the stabilizer. The elevating planes are hinged to the stabilizer. The vertical rudder swings between the two ends of the elevating planes.

**LANDING CHASSIS.**

The landing chassis is of the well known Blériot type and needs no further description.

**THE CONTROL.**

The controlling arrangement is of the regular Blériot cloche and foot lever type.

The Passenger Carrying and the Military monoplanes are, however, equipped with the double control system illustrated in the accompanying photographs and described below, which enables both the pilot and passenger to operate the machine.

**DESCRIPTION OF THE DUAL CONTROL.**

The double control system is similar to that suggested in the January AIRCRAFT, and is designed to allow a comfortable seating arrangement for both the pilot and passenger.

The seats of the passenger carrying monoplanes are so arranged that the passenger sits directly in front of the pilot. There is not enough room between the two seats for the use of the Bell lever controls, which are being used in the single seater monoplanes; and while two of these controls could be used by spacing the seats further apart, it would require the use of a great number of pulleys for the wires to run over; but as we pointed out, pulleys are unreliable, and realizing this the designer has evolved a dual control, that would have the same movements as the Bell lever control, but which would entirely eliminate the use of pulleys. In this the designer has been successful and has produced a dual control, very simple in construction, consisting of twin steering levers which enables the pilot and the passenger, or both, to retain control of the machine at all times.

This dual control consists of two vertical levers spaced 28 inches apart, and each lever is constructed of oval steel tubing, 3/8 inch thick by 1 1/4 wide by 27 inches long. To the top of each lever is attached at an angle of 30 degrees an eight inch mahogany steering wheel, in which hand holes have been provided for the convenience of the pilot.

These two vertical levers pass through three-inch holes in the wood floor; and thence through 5/8 inch by 2 inch slots, cut in a two inch steel tube, 24 inches long, that is attached below the floor, being supported from both ends by aluminum brackets, in which brackets the two inch steel tube revolves. The two vertical levers project six inches beyond the centre of this two inch steel tubing; which itself is two inches below the wood floor. These two levers are each fastened to the two inch steel tube with a 1/4 inch bolt on which the levers pivot, thus permitting the levers to be moved forward and backward, which movement operates the elevators. Directly behind the first vertical lever a twelve inch steel rocker lever is brazed to the two inch steel tubing underneath the floor, to which wires connect with another 12 inch steel rocker lever of the warping gear of the lower pylon, and a movement to either side of either vertical lever and forces the two inch steel tube to revolve, and thus warp the main planes. Double wires connect the two vertical levers together, six inches below and above the bolts on which these levers pivot.

The vertical rudder is controlled by the feet same as on the single-seater, and the second foot control lever is fastened to the floor beneath the forward seat. These are also connected together with double wires.

It is surprising that the above control system is considerably lighter than would be supposed, as it weighs but two pounds more than the "Bell Control Lever."

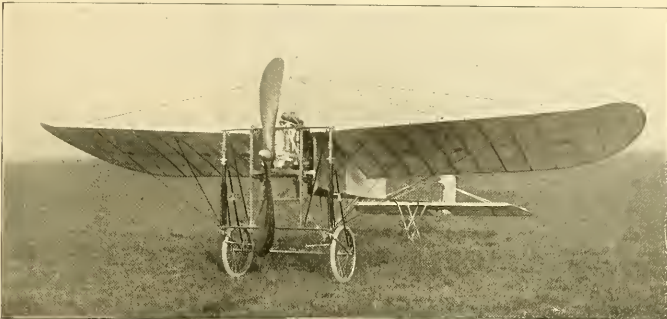

THREE-QUARTER VIEW OF THE AMERICAN AEROPLANE SUPPLY HOUSE'S MONOPLANE.

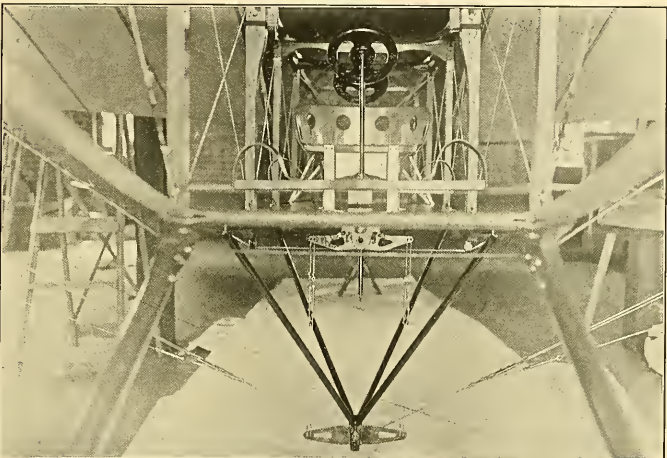

FRONT VIEW OF THE NEW DUAL CONTROL, SHOWING THE WARPING LEVERS AND DOUBLE WIRING.

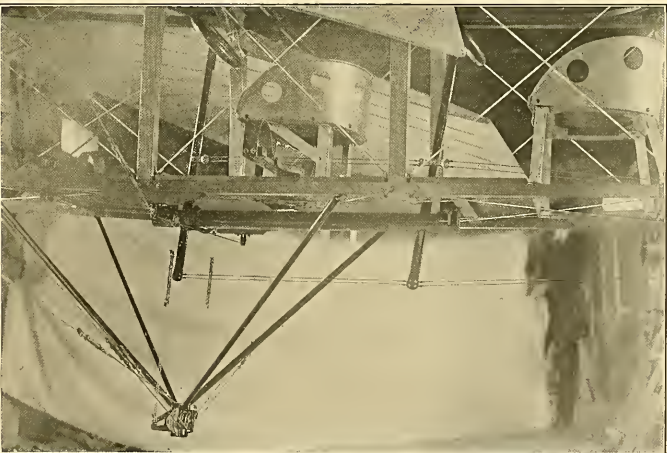

SIDE VIEW OF THE AMERICAN AEROPLANE SUPPLY HOUSE'S NEW DUAL CONTROL, SHOWING THE WORKINGS OF THE DOUBLE CONTROLS.

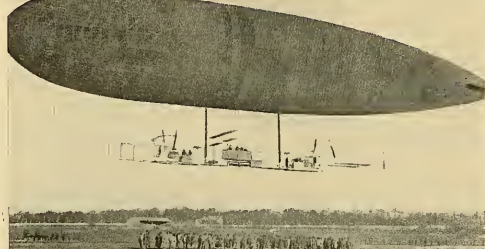

THE NEW FRENCH MILITARY DIRIGIBLE CAPTAINE FERBER UNDERGOING TRIALS.

# Foreign News

BY

R. H. BLANQUIE

## Austria

Austria is to hold an international aviation meeting at Vienna from June 23 to 30, under the auspices of the Imperial and Royal Aero Clubs. The prizes will comprise about 200,000 kronas (about \$476,000). The time of the meeting is chosen with a view to the congress of the Federation Aéronautique Internationale at Vienna and the finish of the Berlin-Vienna cross-country flight.

## Belgian Congo

The Belgian Colonial Office has decided to send the Belgian aviator Lescaerts, with a Farman, to the Belgian Congo to see whether flying machines can be used to advantage in the colony and also to study the possibility of establishing an aviation centre and school there.

## Bavaria

Bavaria's Army has been enriched by an aviation company attached to the Aeronautic and Automobile Troops. The new unit is to be stationed at Oberschleissheim, near Munich where a ground is being laid out for practice. The strength of the company, including officers and non-commissioned officers, amounts to sixty men, who will all be instructed in practical aviation work.

## England

The War Office after many months of inaction has now decided to form its "Fourth Arm." More than 25 machines have been ordered from the following firms: Bristol Aeroplane Company, Deperdussin, Howard-Flanders, Farman, Nieuport, several of which will be delivered early in June. In the new programme formed by the War Minister, 364 aviators will be needed by the army, while 40 will be put at the disposition of the navy. The aviators needed by the Government will be trained at the Salisbury Plain aviation school and the Royal Aircraft factory will attend to all repairs.

The first handicap aeroplane race at the Brooklands aerodrome was pulled off on April 13th. Tom Sopwith had the honors of the scratch, giving 39 seconds to E. Fisher on a Flanders monoplane; 2 mins. 28 secs. to F. Raynham on a Burgess Wright biplane; 3 mins. 12 secs. to H. Spencer on his Spencer-Farman biplane and 4 mins. 35 secs. to C. Pizey on a Bristol biplane. The start was made without any incident. Pizey, profiting by his handicap, arrived first, followed closely by Sopwith, Fischer, Raynham and Spencer. The race was cross-country, and the distance both ways was ten kilometres.

Mr. Holt Thomas, who has just secured the English license for the Farman biplane, will open a new school of aviation at Hendon.

On April 24th, two English aviators, Corbet Wilson and Leslie Allen, started out in an attempt to cross the Irish Sea. Wilson started from Fishguard (Wales) and succeeded in reaching Elboworthy (Ireland) a distance of about 100 kilometres. Allen, who started from Holyhead has not since been heard of and the conclusion is that he fell in the sea while crossing.

Aviator Hewitt distinguished himself by crossing the St. George canal in a monoplane on April 26th. He left Holyhead, at Phenix Park and arrived at Dublin, making the trip in 1 hr. 15 mins.

## France

A new Deperdussin aviation school has been opened at Bordeaux. Three hangars have been erected and four machines have been sent there for initial use.

Marcel Hanriot recently passed the second part of his pilot's military license by attaining a height of 1,500 metres, his time in the air being 1 hr. 21 mins. This he accomplished on a Hanriot monoplane with a 50 H. P. Gnome motor.

After visiting several aviation schools, six Turkish officers finally chose the R. E. P. where they

will start in training immediately with the intention of becoming pilots.

Guillaume Busson, chief pilot of the Deperdussin school at Pau, was a candidate for the Pommeroy Cup and 7,500 francs which finishes at the end of May. Busson chose the course from Pau to St. Cyr, a distance of 735 kilometres. This he covered in one day, making stops at Poitiers and Tours. This gained him second place, Bedel beating him with a flight of 800 kilometres.

M. Millerand, Minister of War, passed the first review of the military aeroplanes at Villacoublay where he was received by General Roques and Colonel Hirschauer, inspector general of military aviation. In all there were 26 machines comprising several types.

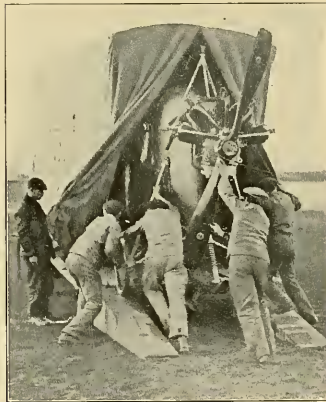

A MILITARY R. E. P. BEING PUSHED INTO ITS ROAD TRANSPORT WAGON.

"Captain Ferber," one of the army dirigibles, left his hangar at Issy-les-Moulineaux, at 8:15 one morning recently for Toul, where it arrived safely at 2:20 P. M.

Lieut. Mailfert won the first part of the Michelin Aero Target contest, held at Chalon-sur-Marne, by dropping 2 out of 14 bombs in the target at a height of 250 metres. The duration of his flight was 38 minutes. He was flying a Farman machine, Gnome-engine.

On April 18th, Paulhan flew from Hendaye, where he had been flying for two days, to Saint-Jean-De-Luz on a Curtiss Triad hydroplane. After he had given several performances there he went to St. Sebastian (Spain), where he thrilled the crowds for two days.

## PEKIN-PARIS RACE.

"Le Matin," of Paris, which has organized many races and circuits heretofore, has organized another one which will be the longest and most difficult ever before attempted. The conditions made so far are as follows:

Engagements.—That the race may come off, five aviators shall have regularly enrolled themselves and paid a forfeit of five thousand francs which will be reimbursed if the start shall have taken place from Peking.

Prize: 155,000 francs offered by "Le Matin" to which will be added other prizes.

Date: It will take place next September, as from information gathered from the meteorological stations of Siberia and Russia it has been gathered

that the rainy season is over by that month in those countries as well as in China.

Course: Two courses are being considered; one following the railroad and passing by Moukden, Karbin up to Lake Baikal; the other by the desert of Gobi, by which it is possible to reach Lake Baikal more directly. The latter course is favored by Prince Borghese and Cormier, both of whom participated in the Peking-Paris automobile race. Amongst those already enrolled are Bielioucvak and Tetard.

Up to March 14, 1912, the Blériot schools have turned out 200 civil aviators, 61 French Military aviators and 16 foreign military aviators, a total of 277 pilots. They have special methods of teaching which enable pupils to master the art in a very short time. Among the civil aviators there are 16 Americans, 11 Englishmen, 17 Italians, 6 Belgians, 6 Swiss, 3 Chilians, 12 Russians, 3 Swedes, 2 Peruvians, 3 Turks, 2 Roumanians, 2 Austrians, 2 Spaniards, 1 Mexican, 1 Greek, 1 Dutchman, etc.

Hamel, the English aviator, left Compiegne on his Blériot, taking with him Miss Davies as passenger, on his return trip to London, and after successfully re-crossing the Channel landed at Canterbury. It is the intention of this aviator to make a circuit of Paris-Bruxelles-London-Paris, shortly.

Baron Shigeno, a Japanese, has constructed a metallic biplane of his own design which he has named the "Wakori." It is propelled by a rotary wing "Cynos" which measures two metres and turns 1,400 R. P. M. It has a 60 H. P. Anzani motor which gives the little biplane a speed of more than 100 kilometres an hour. The Deutsch Cup, which is open to all aviators, will go to the aviator who accomplishes in the fastest time the following circuit of 200 kilometres: Saint Germain, Senlis, Meaux, Melus, Saint Germain, Tahuteau and Helen recently made attempts for this cup, Tahuteau's time over the course being 1 hr. 47 mins. 48.45 secs. on his Morane monoplane fitted with 50 H. P. Gnome, while Helen was successful in covering it in 1 hr. 39 mins. 19.45 secs., thus beating Tahuteau by 8 mins. 29 secs. Frey will also make an attempt.

Up to April 28th the sum total of the public subscription for the purpose of purchasing aeroplanes for the Army, amounted to 300,018 francs (\$60,000).

Col. Hirschauer, formerly in command of the *sapeurs aéroliers* at Versailles, has been officially appointed to succeed General Roques, as Inspector General of Military aeronautics. In view of Col. Hirschauer's knowledge of aviation his appointment bids fair to do a lot of good for French Military aviation.

Owing to the number of accidents which have recently occurred to French military aviators, the Minister of War has issued a special order, which states that officers and men selected for aviation work must be physically fit and in particular have good eyesight. Attention is also called to the necessity of special examinations of machines and parts, while, should the weather conditions entail any risk, no flying is to be attempted.

Henry Farman, who has been experimenting with a monoplane of his own design for some time past, has now got it perfected to his satisfaction, and on April 20th decided to test it in practice, bravely by taking a trip to his brother's works at Buc. Accompanied by his foreman, de Rain, who weighs only 200 pounds, and with enough gasoline and oil for a three hours' flight, he set out from Chalon at 4:30 P. M. and flew the distance of 200 kilometres to Buc in one hour and a half. The motor used was a 50 H. P. Gnome and the speed a little less than 140 kilometres per hour. It is interesting to note that both Henry and Maurice Farman are consistently flying and experimenting on their own machines, which probably accounts for the steady progress made by them and incidentally emphasizes their faith in their own product.

**THE JUVISY MEETING.**

Contrary to the general belief, exhibition flying and aviation meetings, although generally lasting but a few days, still continue to draw large crowds in France, and, judging from the success of the recent week-end meeting held at Juvisy, April 21st, they promise to become quite popular during the summer.

The meeting was organized by the Syndicate des Aviateurs with the object of initiating a fund for the benefit of the dependants of those who have lost their lives in aviation. A crowd of 25,000 attended and saw plenty of flying. The programme consisted of five events: the Championship of the Seine, a ten mile race to Montlery and back, starting and landing, gliding, boat dropping. The morning was taken up with the arrival of several of the competitors in their aeroplanes. Andre Frey on his new Harriot arrived from Rheims at a terrific speed on one of the new Harriot monoplanes. He was followed by Verrier who came from Luncville on a Farman, Mahieu on a Voisin from Issy, Legagneux on a Blériot from Corbeaux-Bru, Brindjov des Moulins on a Morane from Villacoublay and Bussou on a Deperdussin from Issy.

The start of the competitors were somewhat delayed on account of a tricky wind, but at 3 o'clock Legagneux went up for an exhibition flight. Soon after he landed the wind began to die down a bit and practically all the aeroplanes ascended.

The principal event of the day, the Championship of the Seine, 10 kilometres cross-country and return, was gained by Frey in 9 mins. 1 sec., Tabuteau being second (Morane), Verrier, and Brindjov third in 10 mins. 37 secs. This event was a brilliant debut for the new Harriot and proved a revelation to those present.

After this race flying was practically continuous, the aviators taking part being Legagneux (Blériot); Bussou (Deperdussin); Lieut. Faucompe (M. Farman); Frey (Harriot); Tabuteau and Brindjov (Morane); Verrier (Morane); Mahieu (Voisin); Chas. Nieuport (Nieuport); Pischoff (Pischoff); Demazel (Caudron); Ladougue (Ladougue) and Koenig and Divitain (Goupe).

**Germany**

There will be a "Round About Berlin" flight at the end of August as the Imperial Aero and automobile clubs and the Berlin Aeronautical Society are joining forces to promote such a flight to be open only to flyers and machines of German extraction. The route leads from Johannisthal to Lindenberg, Schulzendorf, Spandan, Potsdam and Teltow. On the first day the aeroplanes will have to pass over a captive balloon stationed at an altitude of 500 metres during the circuit; on the second day the route has to be covered twice, with an intermediate landing at Johannisthal.

The German War Office has ordered a new Zeppelin airship to be delivered to them by July at the latest. The military authorities demand a speed of sixteen to seventeen metres per second. Apart from this the new vessel is to be built on exactly the same lines as the Zeppelin II, which was taken over recently by the military authorities. The new craft is to be of the A. 5 series. If the Schutte Lanz airship tests result satisfactorily, this cruiser will be purchased as well. There is great curiosity as to the outcome of these trials as the Schutte Lanz has been coming on for years without having arrived. M. 4. is expected to be ready in the early summer months as well. It will be noticed that the activity in Germany is unsurpassed.

A number of Frankfurt gentlemen have presented an aeroplane to the German Emperor for army purposes. This machine is to be known as the "Frankfort".

It is reported that the German Minister of the Navy intends ordering a Zeppelin dirigible for the use of the fleet.

The total of the subscription for the purpose of purchasing aeroplanes for the Government, has already reached a million marks.

Naval aviation is in full swing at Dantzig. One naval officer made five flights on April 15th on an Albatross biplane carrying passengers on each trip.

Following the example set them by Messrs. Henkell of Champagne fame, the Rhenish-Westphalian Electricity Works have placed the sum of 100,000 marks at the disposal of the German War Office for the purchase of aeroplanes.

**Indo-China**

Aroused to enthusiasm by the flights of a Blériot recently made at Saigon, an Aero Club has now been formed there to promote interest in and to advance the cause of aeronautics in the French colonies.

**Italy**

Cobioni on a Caproni monoplane fitted with a 50 H. P. Anzani recently made a non-stop flight from Somma Lombardo to Adria, a distance of 330 kilometres.

A new military dirigible, the M.-I. will make its initial flights at Bracciano. This is the largest dirigible yet constructed by the engineering corps of the Italian Army.

The Italian Aero Club at Rome, has received 20,000 francs from the City of Venice for the purchase of an aeroplane which will be named the "San Marco." The City of Turin has given an aeroplane and four hangars, while the King has given 100,000 francs and a paper of Milano, 20,000



THE SMALL CAUDRON BIPLANE, FITTED WITH ONLY A 30 H. P. 3-CYLINDER Y-TYPE ANZANI, GETTING OFF THE GROUND QUITE EASILY WITH TWO ABOARD. NOTE THE PASSENGER SITTING ON THE PLANE.

francs for the same purpose. The subscription committee have decided that a part of the money shall be reserved for the construction of dirigibles.

**India**

The Gazette of India reports that the Government of that great territory promulgated on September 30, 1911, "An act to control the manufacture, possession, use, sale, import and export of airships." The act authorizes the Governor General in council or the local government, subject to the control of the Governor General in Council, to regulate or prohibit, except in accordance with such licenses as may be granted for the purposes, the manufacture, possession, use, sale, importation and exportation of all airships. If it be deemed expedient or necessary to the public welfare, or the Governor General may prohibit absolutely or subject to conditions the importation or exportation of airships of all kinds. For the infraction of the terms of the act the penalty shall be imprisonment for a term of not longer than six months, or a fine of not more than 1,000 rupees (\$324) or both, and the airship may be declared forfeited.

Lieut. D. D. Haskard, of the Garrison Artillery, stationed at Karachi, India, is said to be importing one Bristol biplane and five Bristol monoplanes. Lieut. Haskard is the first officer of the Indian Army to take a course in aeroplaning, and it is presumed that these machines are brought either for the Indian Army or with a view to interesting the Government of India therein.

**Mexico**

Consul General Arnold Shanklin of Mexico City reports that aeroplanes imported complete are classified for duty by the Director General of Customs under tariff No. 253 of the customs tariff of Mexico, which reads as follows:

Articles not specially mentioned of iron, steel or tin plate, tinned, nickelled, covered with copper or brass, painted or galvanized with zinc, wholly or in part, the weight of each article exceeding 10 kilos, duty per kilo, legal weight, 0.12 peso (per pound, \$0.028).

Should the wings be imported separately, however, duty would be charged under tariff No. 650, as follows:

**Russia**

The Sporting Committee of the Aero Club de Russie have fixed a definite programme of the circuit which is to be held this summer in the suburbs of St. Petersburg. The course is as follows: St. Petersburg, Tosno, Gatchino, Krasnoe-Sele, Peterhof, St. Petersburg. The distance is about 160 kilometres and must be covered in 1 hour and a half. Other interesting features have also been planned.

The council of the aero club have decided to ask the Federation Aeronautique Internationale that the annual congress be held in St. Petersburg in 1913 or 1914. It also decided to send one of its best aviators to Chicago to contest the Gordon Bennett Cup.

The military aviation school at Sebastopol, which is the only one in Russia, actually has in training 102 officers and 200 soldiers and possesses 55 aeroplanes.

**Spain**

Charles Weymann recently five Nieuport monoplanes at Madrid and flew one of them over the city, taking with him Colonel Vived y Vich as passenger. These monoplanes are destined for the Spanish Army.

**Switzerland**

The Swiss pilot Errice Cobioni who, on his Caproni monoplane lately broke speed records for 250 and 300 kilometres and of three hours, succeeded in crossing Lake Maggiore from Vizolatico to Locarno in 42 mins. 44 secs. at a speed of more than 110 kilometres an hour.

Before a considerable crowd and the Swiss military commission, Kimmerring flew at Promeils near Zurich, where his audacity and ability were loudly acclaimed.

Switzerland has nominated one balloon only for the Gordon Bennett balloon race at Stuttgart in October—the "Helvetia" with which the late Colonel Schack won the trophy in 1908, accompanied by Messner and Armbruster. The last-named aeronaut will pilot the balloon this year.



BARON SHIGENO

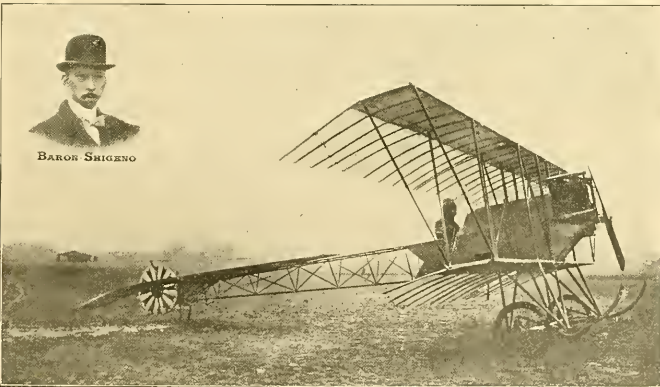

JAPANESE BIPLANE CONSTRUCTED BY BARON SHIGENO. THE FRAMEWORK IS BUILT ALMOST ENTIRELY OF STEEL TUBING.

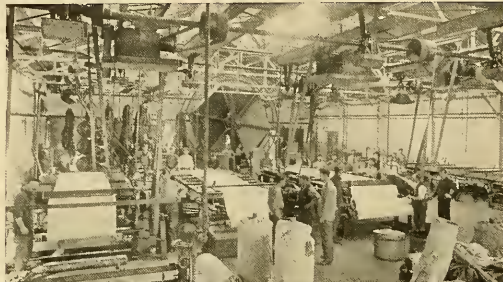

SPREAD ROOM AT THE GOODYEAR TIRE AND RUBBER CO. PLANT, AKRON, O., SHOWING THE MAKING OF BALLOON FABRIC.

A. Heinrich Brothers, of Baldwin, Long Island, have leased a piece of ground in that locality for the purpose of establishing an aeroplane school and experimenting grounds. The ground leased contains about 20 acres, and there are another 200 acres of clear ground adjoining the property which can be flown over. It is intended to open the Heinrich school on or about June 1st. Some good flights have been made recently by A. Heinrich in his latest monoplane.

The American Propeller Company, have leased for a number of years a fine factory at 243-249 Hamburg street, Baltimore, Md., where it is their intention to manufacture aeroplane propellers on a much larger scale than heretofore. The new factory covers about 10,000 feet of floor space, 5,000 feet of which they are fitting out with machinery now, leaving the rest available as the growth of the business warrants. It is the intention of the American Propeller Company to carry a large enough stock at all times to enable them to furnish propellers of any size upon demand.

The Elbridge Engine Company state that they have arranged with the leading manufacturers of aeroplanes in this country for inside prices on their products in quantities, and the benefit of close buying they offer to purchasers of the Elbridge Engine, so that they are now offering their engines for sale in combination with entire aeroplane outfits. If further details are wanted it might be well to write to the Elbridge Engine Company, Rochester, N. Y.

The Milwaukee School and College of Aviation are preparing plans for the erection of a new steel building to be 50 by 200 feet. The instructor of this school is the well known French pilot, Ignace G. Semeniouk, who will probably represent the Milwaukee School at the Chicago Meet next fall, it being the intention to send two biplanes and a monoplane to participate. Among the promising pupils now at the school are Roy Schmetz, Jack B. Knight, Ralph M. Kibbe, Bruce Foster and Glenn McWilliams.

James Means has publicly announced that he will give a cash prize of \$1,000 to be competed for by aviators using the James Means control, and anyone who is interested in the matter can obtain further details by opening up correspondence with Mr. Means at 196 Beacon street, Boston, Mass.

The Roberts Motor Company report that among their usual heavy monthly sale of motors, a 50 H. P. 4-cylinder model X motor has been delivered to Harry N. Atwood to be used in his Burgess-Wright hydro-aeroplane, and upon Mr. Atwood's recommendation they have sold a 4-cylinder motor to the General Aviation Company of Boston. From the present outlook the Roberts Motor Company anticipate a sale of about 300 of their aeroplane motors during the season of 1912.

The Goodyear Tire and Rubber Company, of Akron, Ohio, is going in to manufacture aeroplane and airship goods on even a larger scale than heretofore, believing as they do that the development of the aeronautical movement warrants it. It is their intention to build great American dirigibles which will compare favorably with the big airships of France and Germany. One of the dirigibles already built by this concern under the general supervision of Melvin Vaniman is the Akron, which is now being experimented with at Atlantic City, N. J., and later may be used in an attempt to cross the Atlantic Ocean.

Mr. F. H. Brauning states that the Gressier Aviators have been entered in the International Race to be held at Chicago the latter part of the

season. The machines entered are a Morane monoplane, 100 H. P. Gnome and a Voisin-Canard biplane that will be engine with 75 or 100 H. P. motor. Mr. Brauning is busy these days attending to the Gressier Aviation School at Belmont Park.

The Clawson-Hamilton Company, of Brattleboro, Vt., has been organized for the purpose of developing the aeronautical movement in New England. Officers of the corporation are: N. D. Clawson, president and general manager; Irah D. Spaulding, vice-president; R. L. Peltier, treasurer; George D. Wood, secretary.

The following horse power curves plotted from tests made upon both the four and six cylinder Sturtevant aeronautical motors direct connected to an absorption dynamometer shows the exceptionally high efficiency which these motors develop in operation.

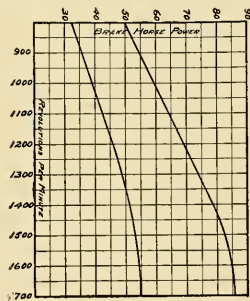

A comparison of the A. L. A. M. rating for motors of the same bore and stroke with the actual performance of these motors is very interesting.

4 CYLINDER  $4\frac{1}{2}$ " BORE  $\times$   $4\frac{1}{4}$ " STROKE.

A. L. A. M. rating.. 1332 R. P. M. equals 32 H. P.

Actual performance.. 1332 R. P. M. equals 50 H. P.

6 CYLINDER  $4\frac{1}{2}$ " BORE  $\times$   $4\frac{1}{4}$ " STROKE.

A. L. A. M. rating.. 1332 R. P. M. equals 48 H. P.

Actual performance.. 1332 R. P. M. equals 76 H. P.

It will be seen from the above chart that both motors reach the peak of their curves at about 1700 R. P. M., at which speed they develop 55 H. P. and 86 H. P. respectively.

The Diana Aero Company, of Detroit, state that their plant is now in good working order and that they have one machine in operation at their aviation field in Grosse Pointe, while two more machines are in course of construction, one of them being a hydro-aeroplane.

The Raub and Longo Balloon and Biplane Company, of Columbus, Ohio, has been organized and will handle aeroplane parts and supplies, this end of the business having been transferred to them by R. O. Rubel, Jr., and Company, of Louisville, Ky.

The Sloane Aeroplane Co. has purchased a passenger-carrying Deperdussin monoplane, of the type with which Marcel Provost made the record breaking trip between Paris and London. The machine will be delivered in a few weeks. It will be used in exhibition work and school work.

The Sloane Company will represent A. Deperdussin in America. They will also handle the Smith tachometer, which is the most reliable indicator made abroad.

Arrangements have been made with Anzani to handle his different types of engines in this country. He is now turning out eight styles of motors. They are two 3-cylinder types, of 35 and 40 H. B. respectively; four 6-cylinder types of 45, 60, 70 and 80 H. P. His newest types are a 10-cylinder, of 100 H. P., and a 14-cylinder motor of 140 H. P. These are all air cooled.

Mr. George M. Dyott will manage the Sloane School of Aviation. Several pupils have been enrolled, and the success of the school seems assured. Mr. Dyott has had a great deal of experience in exhibition and cross-country flying, so that he is competent to instruct. He also was an assistant instructor in the Deperdussin school, near Paris, for several months. Mr. Dyott is a graduate engineer, and well qualified to teach his pupils not only the handling of the machine, but also the construction and up-keep of the motors and aeroplanes.

Messrs. Thomas Brothers, of Bath, N. Y., manufacturers of aeroplanes, are the designers of a monoplane of original design, which is now nearing completion.

This monoplane has rounded wings of the Hériot type, but the arc or camber of the wings is a trifle less. The ribs are unusually strong without increased weight, and attached to the fuselage with improved fastenings and guyed with steel cables of greater strength than the steel bands commonly used in monoplanes.

The Thomas monoplane will not depend upon wing warping for stability. Ailerons will be attached to the outer rear edge of the wings and a new control system will be used entirely different from those used on any other monoplane.

With its flat wings and small head resistance, the Thomas monoplane is expected to prove very speedy, and its first trials will be awaited with interest.

While the need of a starting device on an aeroplane has always been noticeable, it is especially necessary in the hydro-aeroplane. Very soon after launching the first Burgess Co. and Curtis hydro tail fall this new device for starting was applied. It has been used about six months, and with a number of small changes in construction now represents a most advanced method of starting an aeroplane engine, because of its extreme simplicity of operation, small chance to get out of order and also being fool-proof as well.

Its operation is simple. The operator is supplied with a starting handle, and when ready to start his hydro closes the throttle or retards the spark, and leaving his seat, steps back into the plane and inserts same in a socket attached to the device on the large sprocket.

A quick lift of this handle turns a four-cylinder motor past two compressions and starts the motor under low speed, which hardly moves the hydro through the water. The operator has plenty of time therefore to resume his seat and grasp his levers before the aeroplane is speeded up with the throttle.

The great success with which the E. J. Willis Company has met in the aeronautical supply business indicates that the demand for aeronautical supplies in this country is continually on the increase, and therefore means that more machines are being built now than ever before. This company handles everything from a turnbuckle to a motor, and recently made a sale of one of the Frontier motors to Jack Roodis, who owns a large sheep station at Kootamand, New South Wales, Australia, the same to be used in a Far-

man type machine. Moreover, the E. J. Willis Company informs us that they have already sent out over 12,000 copies of their 1912 catalogue.

**W. E. Boughton**, of Washington, D. C., has become associated with the Sloane Aeroplane Company of New York, and will hereafter act as their representative in the District of Columbia.

Ives de Villers, who recently went abroad in the interests of the **Aeroplane Motors and Equipment Company** of New York, has returned after arranging for his company to represent several of the big aeroplane, motor and fabric manufacturers of France. One of the leading spirits of this enterprising concern is J. A. D. McCurdy, the celebrated aviator, which in itself augurs well for the future success of the company.

**Henry C. Cooke**, manufacturer of aeroplanes, reports that he has already sold two Cooke biplanes (Curtiss 1912 type), and has prospects for several more orders.

M. D. Clawson, of Brattleboro, Vt., a recent graduate of the Curtiss school of San Diego, has placed an order with the **International Aeronautic Construction Company** of Jamaica, New York, for a Curtiss type 26 ft. machine to be equipped with a 75 H. P. Roberts motor, which will be flown by aviator Spaulding. This company placed an order with the Roberts Motor Company, during the Show, for the first 125 H. P. Roberts motor turned out.

# Aerial Construction Company

OF NEW YORK

481-483 PARK AVENUE

**Designers and Builders of Aeroplanes and Propellers of All Types**

WRITE US FOR PRICES, ETC.

Note Change of Address - 481-483 Park Ave., N. Y. City



## Rubel School of Aviation

**OFFERS MORE INDUCEMENTS** to students than any other aviation school in America.

Instructions in flying Monoplanes and Biplanes. Room and board can be had at our dormitory on the Aviation grounds.

Our private Aviation Park is at the disposal of amateur and professional aviators. Motors and hangars for rent. Write for school booklet and terms. We can guarantee engagements to competent graduates. Visit us before you enroll.

R. O. RUBEL, Jr. & CO., Inc. 1600 Floyd St., Louisville, Ky

**CAPT. BALDWIN** has just returned from his **SECOND** tour around the world with an aeroplane, without any serious accident, during his exhibitions.

Always using the

### "Willoughby Patent Double Rudders"

for steering his machine.

The safety of this method of steering (in the vertical plane) has been demonstrated without a doubt.

## Aeronautical Books

OF ALL DESCRIPTIONS

**LAWSON PUBLISHING CO.**

37 East 28th Street New York

## A Cash Prize of One Thousand Dollars for Something Over Four Hours Flying

I offer a **Cash Prize of One Thousand Dollars** to be competed for by aviators using the **JAMES MEANS CONTROL** described on pages viii and ix of *Science*, N. Y., March 1, 1912; also in *Aeronautics*, N. Y., Feb. 1912, p. 46; *Nature*, London, Feb. 29, 1912, pp. 588-9; *Deutsche Luftfahrer-Zeitschrift*, Berlin, 1912, No. 5, p. 113, and in other journals.

Public flying of not less than four hours total will be required. This time will be divided; there are to be three flights of not less than half an hour each, one of not less than one hour, and one of not less than ninety minutes.

Certain conditions, not severe, attach to this offer. I will send copies of these on request.

**JAMES MEANS, 196 Beacon St., Boston, Mass.**

# N A I A D Aeronautical Cloth

Manufactured Especially for Aeroplanes and Used by Aviators of Prominence

**LIGHT, STRONG, AIR-TIGHT**

AND  
**MOISTURE-PROOF ON BOTH SIDES**

Sample Books, including Data and Prices, sent on request

**THE C. E. CONOVER CO.**

101 Franklin Street - - New York

## "Expanding Pitch" Propellers



Are used by all discriminating Aviators who want **efficiency**. They are sold on their merits and backed with a binding guarantee.

**The Propeller that propels.** It's the propeller you'll eventually use.

Write for illustrated catalogue, printed in five colors, telling how they are made. It's free for the asking.

**R. O. RUBEL, Jr. & CO., Incorporated**  
1600 Floyd Street LOUISVILLE, Ky.

## AEROPLANE RADIATORS

IN STOCK OR TO ORDER

SEND FOR PRICE LIST **EL ARCO RADIATOR CO.** 6 EAST 31st St., NEW YORK

# CLASSIFIED ADVERTISING

15 CENTS A LINE

SEVEN WORDS TO LINE

CASH WITH ORDER

## FOR SALE

IF you want passenger balloons, dirigibles, captives or aeroplanes; large stock; immediate shipment; any size built to order. Teach purchaser to operate. Exhibitions furnished throughout United States and Canada. G. L. Bumbaugh, builder and operator, Indianapolis, Ind., U.S.A.

## MUST SELL--FINE MONOPLANE

1911, cross country type, two seater, Blériot, 100 H. P. engine, full equipment. A. V. Reyrburn, Jr., 5305 Delmar Boul., St. Louis, Missouri.

FOR SALE—Quick. Fine Curtiss Copy, Mahogany finished. New; best material; good shipping cases. First \$50 closes deal. W. Lee Hunt, Kissimmee, Fla.

THIRTY perfect photographs, world-known aviators, machines, flights, etc.; interesting, authentic, descriptions, \$1; six photographs, 25c. Aero Specialty Co., Revere, Mass.

FOR SALE—Three pair Sprockets and 38 feet of Chain, suitable for double propeller aeroplane; all in first class condition; practically new. M. A. Schmitt, 584 Eagle St., Buffalo, N. Y.

\$200 takes a 36 ft. Curtiss type Biplane (without engine), or will exchange for motor cycle, or what? "A." 1519 East 63rd St., Chicago, Ill.

AERONAUTICAL SUPPLIES—Imported wire strainers, clamps, eye bolts, etc.; pamphlet AMCO on application. Aero Motion Company, Wright Building, St. Louis, Mo.; exclusive agents Societe Des Moteurs Gnome, Paris, France.

CURTISS latest improved type (Pigeon tail) 1912 Model. Made over 300 very successful flights 1,000 ft. high, 30 miles cross-country. My construction is strongest in the world. New, complete, ready to fly, tested and guaranteed, including free lessons to buyer, \$2,500. Buy direct from Builder and Aviator of 10 years' experience. H. C. Cooke, Aviator and Builder, 127 West 64th St., New York City.

BLUE PRINTS, showing the most economical and simple aeroplane running gear ever designed. Inexpensive, easy to construct, low head resistance and will save you many breakages. Two large sheets showing all details, one dollar. M. S. Lewis, 830 Isabella St., Oakland, Calif.

## FOR SALE

FOR SALE—Holbrook aeroplane motor, 1911 model, 35 H. P., four cylinders, four cycle, water cooled, weight 200 lbs.; complete with El Aero Radiator, G. & A. Carburetor, Atwater-Kent Unispark and three propellers; price \$300. Guaranteed first class condition. Wm. Schroeder, Route 2, Gladstone, Minn.

AERONAUTICAL supplies. Everything for the list aeroplane at lowest prices. Send for price list. American Aviation Co., Inc. 2937 N. Lawlunde Ave., Chicago, Ill.

HOW TO control an aeroplane. Used by the largest schools. The only book ever written on this subject. Price 50 cents. Aviators' Exchange, 58 West Washington St., Chicago, Ill.

## POSITIONS WANTED

ENERGETIC, reliable and honest young man, age 19, weight 115 lbs., desires position as aviator's assistant. Has plenty nerve and his ambition is aviation. Has read some good books on aviation and built models that fly. Possess some knowledge of gasoline engines, also monoplane and biplane construction. Will go anywhere and will give services for expenses with prospects of learning to fly. F. J. Podlaha, Jr., Westbrook Farm, Oakdale, Long Island, N. Y.

A YOUNG MAN, age 18, desires position as an aviator's assistant, with prospects of learning to fly. Address Louis Fenouillet, 132 West 47th St., New York City.

CAPABLE, reliable and active young man, with 4 years' practical experience in locomotion, wants a responsible position in aerial navigation; possess a good knowledge of construction work and controlling devices of the leading machines; make any offer; moderate salary to start; (age 26). Address Locomotion, Box 757 AIRCRAFT.

## MISCELLANEOUS

WANTED—Licensed Aviator for Curtiss Biplane—long time contract. State lowest salary, experience and press notices. Address Box 763, AIRCRAFT.

## MISCELLANEOUS

UNLIMITED practice and one-sixth interest three machines for \$400. Aviators' Exchange, 58 West Washington St., Chicago, Ill.

WANTED—Aviation Apprentices to operate latest type racing monoplanes. Instruction free. Box 762, AIRCRAFT.

WANTED—MAN, GOOD CHARACTER, EXPERIENCE. TO FLY STANDARD-TYPE BIPLANE, NEW. Address, A. M., 1010 South Plum St., Pine Bluff, Arkansas.

## CO-OPERATION WANTED

WANTED—Partner to act as manager during coming exhibition season for half the profits, by party who will furnish and operate Curtiss type; must have some experience in business and also enough capital to get things started; this is an exceptionally good offer to the right man; first class references furnished and required. Box 761 AIRCRAFT.

CAPITAL wanted to patent and build aeroplane that will fly three hundred miles per hour. Will give 49 per cent. of patents. I will guarantee to fly across Atlantic in twelve hours. Address A. Harbottle, 18 Eldert St., Brooklyn, N. Y.

CAPITAL WANTED—\$15,000 to form a new company to build a lately patented, high-speed monoplane that is automatically balanced and acts as a parachute in case the motor stops while in the air. The machine itself acts as the parachute and has absolutely no umbrella-like or auxiliary parachute attachment. Address: Monoplane, P. O. Box 66, Station D, New York City.

## LEGAL NOTICE

AS I am manufacturing Aeroplanes, I desire to give notice to all persons that are using my "Patent Rudders" with inverse and simultaneous action, and also my "Patent Semi-automatic engine control," that it is my intention in the future to ask a small "Royalty" from them. Hugh L. Wiloughby, Sewall's Point, Florida.



## Learn to Fly

NOW'S THE TIME. Flying graduation GUARANTEED. French method instruction; mechanic course. We positively have the only REAL Aviation School; two aviation fields, three factory buildings, aeroplanes, motors, etc., and the LARGEST aviation field in America. Motor, propeller, construction and flying thoroughly taught. Send for a home study course; FREE lesson.

### STANDARD AVIATION COMPANY

1309 Manhattan Bldg. Chicago, Ill.

## COOKE BIPLANES

*Curtiss Improved 1912 Type (Pigeon Tail)*  
Perfect fliers. No freak construction. Ten years' experience. Strongest in the world. Amply powered (Roberts Motors.)  
Anybody can fly these machines. One ready for immediate delivery. **\$2,500**  
Free Instruction to Buyer

H. C. COOKE, 127 West 64th St. NEW YORK CITY

## "GRESSIER AVIATORS"

Now conducting finest equipped School in America  
FARMAN MORANE BLERIOT VOISIN-HYDRO  
Using only Gnome and Anzani Motors  
LET ME SHOW YOU. GET MY RATES  
Address F. H. BRAUNINGER, No. 263 W. 69th St., N. Y.

## CHICAGO AERO WORKS

H. S. RENTON Proprietor  
164 North Wabash Avenue  
AEROPLANES ACCESSORIES MOTORS PARTS  
WHEELS HARDWARE PROPELLERS  
ESTABLISHED 1909. First in Chicago and the Middle West  
Aviators Taught. Flights Furnished. Send Stamp for Catalog.

# The Call

# Aviation Engine

Four Cycle, Water Cooled, Opposed Cylinders  
THE GREATEST KNOWN THRUST PER  
RATED HORSEPOWER

WRITE FOR CATALOGUE

## THE AERIAL NAVIGATION Co.

OF AMERICA  
GIRARD, KANSAS

**BAMBOO** Special Grades of Bamboo for AERONAUTIC WORK Reed, Rattan and Split Bamboo for Models. All sizes in stock. Tonka Rattan for Skids, 1 1/4 inch and under, any length.  
**J. DELTOUR, Inc.**  
 804 Jefferson St. Hoboken, N. J.

**"MANN" MODEL**  
 Holds all "Official" World's Records  
*Distance 4,200 feet Duration 100 seconds*  
 Acknowledged by three nations to be the most wonderful model flyer ever made. We are sole agents.  
 English models, plans, supplies and gasoline engines. Nomic engines. It will pay you to get free list from the pioneer English firm, A. MELCOMBE & CO. American Branch, 2102 Seventh Ave., Seattle, Wash.

**PATENTS**

**PATENTS THAT PROTECT AND PAY**

Advice and Books Free. Rates Reasonable. Highest References. Best Services.

WATSON E. COLEMAN, Patent Lawyer  
 622 F St., N. W., Washington, D. C.

**PATENTS SECURED or Fee Returned**

Send sketch for free search of Patent Office Records. How to Obtain a Patent, and What to Invent, with list of Inventions Wanted and Prizes offered for Inventions sent free. Patents advertised free.

We are experts on AIRSHIPS and all patents and technical matters relating to AERIAL NAVIGATION.

VICTOR J. EVANS & CO. Washington, D. C.

**Just the Information We Need**

**WEBSTER'S NEW INTERNATIONAL**  
 -THE MERRIAM WEBSTER

Every day in your talk and reading, on the street car, in the office, shop, and school some new question is sure to come up. You seek quick, accurate, encyclopedic, up-to-date information.

This NEW CREATION will answer all your questions with final authority.  
 400,000 Words Defined. 2700 Pages.  
 6000 Illustrations. Cost \$400,000. The only dictionary with the new divided page. A "Stroke of Genius."

Write for specimen pages, illustrations, etc. Mention this publication and receive FREE a set of pocket maps.

**C. & C. MERRIAM CO.**  
 Springfield, Mass. U. S. A.



**WANTED**

A good business manager by two aviators owning their own machines. Give previous experience, references, etc.

F. J. Southard, Atlas Hotel, Dayton, Ohio



PROPELLERS for model aeroplanes; light, smooth aluminum blades, variable pitch; steel shaft accurately and securely attached; 3 1/2 in. 10c., 6 in. 25c., 8 in. 35c., 10 in. 50c., 12 in. 75c. Post-paid. Low quantity prices. Jersey Skeeter Aeroplanes 25c.

LINCOLN SQUARE NOVELTY WORKS  
 Department B 1931 Broadway, New York

**DETROIT AERO POWER PLANT**  
 COMPLETE \$300 READY TO RUN  
 INCL. PROPELLER-CARBURETOR-BOSH MAGNETO. OIL PUMP-CABLE-SWITCH-MOUNTING BOLTS.  
 IS GUARANTEED TO 210 LBS. MIN. STATIONARY THRUST 150 LBS. MAX. WEIGHT (COMPLETE) 36 HOURS DELIVERY

LIFT AND FLY CURTIS BYPLANES BLERIOT II MONOPLANES DEMOISELLE MONOPLANES OR CRAFTS OF SIMILAR MAKE

**DETROIT AEROPLANE CO.**  
 DETROIT MICHIGAN



**J. C. (BUD) MARS, NOW BOOKING**

—ADDRESS—

17 N. La Salle Street, Chicago, Ill.

The **SELF-STARTING 50 H.P. ALBATROSS**

Has three distinct new features  
**It starts automatically from seat**  
**It has a starting handle for emergency**

It can run for miles without a drop of gasoline

**Price**  
 COMPLETE  
**\$650**

Catalog free  
 (Stamps not desired)

**ALBATROSS COMPANY**  
 DETROIT Michigan



## Aeronaut Leo Stevens

Controlling the Greatest Flock  
of Licensed Aviators  
in America

Operating the Leading and Best Make Machines  
in the world

If you contemplate Flying at your place, communicate direct.

Box 181 Madison Square

New York, U. S. A.

Phone Chelsea 235

## “ROOLD”

FOR SAFETY HELMETS  
AVIATION SUITS  
UNBREAKABLE GLASS GOGGLES

“*EVERYTHING FOR THE AVIATOR*”

50 Avenue de la Grande Armee, PARIS

Official Contractors to the French and Russian Armies

Apply for Catalogue “P” of the  
**Moteurs Rotatifs**

(Rotary Motors)

# FIEUX

For Aeroplanes

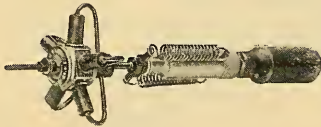

Works and Offices:

57 Rue Cambronne, Paris, France

**AGENTS WANTED**

Agents Wanted in all the Principal Towns of the  
United States, Canada, Mexico and South America

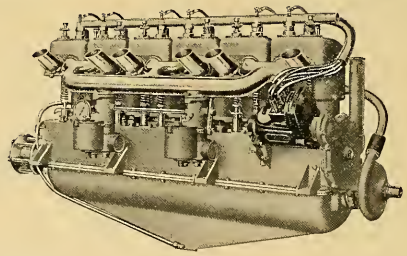

## Sturtevant Aeronautical Motor

FOUR AND SIX CYLINDER  
Four Cycle—Water Cooled—Automobile Type

An Aeronautical Motor built for service  
under all conditions and at extreme angles.

Heavy enough to be durable—light enough for  
flying. Lightness secured by refinement in design  
and in those parts best suited to give lightness.  
No vital parts weakened to secure light weight.

Entire design tends to eliminate trouble-producing  
parts. There are no push rods—no rocker arms.

The valves located in the side are instantly re-  
movable for re-grinding. No danger from broken  
valves. The exhaust valves are equipped with  
lifters to permit coasting in air.

All the gears are enclosed and run in oil. The  
high-tension Mea Magneto permits easy starting  
with retarded spark.

A muffler may be furnished if desired which makes  
the motor practically noiseless.

The normal speed of 1200 R. P. M. may be re-  
duced by throttle to 300 R. P. M.

*A Dependable, Durable Motor backed  
by the STURTEVANT Guarantee.*

Ask for Catalog 200-1

**B. F. STURTEVANT COMPANY**

HYDE PARK, BOSTON,  
MASSACHUSETTS.

Offices in all Principal Cities.



## TWO YEARS IN THE LEAD ON AEROPLANE FABRICS



A few years ago aviators were wont to experiment with most any kind of aeroplane fabric.

But the aviator of 1912 won't do such experimenting. He won't endanger himself, his machine and his success by risking fabric of uncertain performance.

He will continue to choose **Goodyear Aeroplane Fabric**—that fabric which has passed the experimental stage—that is 2 years in the lead of others—fabric which time and thousands of tests have proved will not shrink, stretch, break or rot—in short, fabric which comes mighty close to perfection.



Goodyear Aeroplane Fabric is rubberized, hence its steadfastness. It is soaked and saturated, thru and thru with pure Para rubber. And the fabric used is the costliest kind of cotton and linen. Unlike plain, varnished or treated fabrics, Goodyear won't shrink when dampened; won't relax when warm and dry; won't mildew and rot. That's why nearly every aviator of note will have none but Goodyear fabric on his machine. Furnished with metallic finish to match aluminum plated machines.

### OUR OTHER AEROPLANE PRODUCTS

Goodyear Aeroplane Tires, used by the world's most famed bird men, are least apt to puncture, can never be jerked loose and they'll land your machine lightly and easily—very little jar to the occupant or delicate mechanical parts of the machine.

The Goodyear Rubber Shock Absorber, another of our inventions, has won exceptional popularity.

We build balloons complete in all types, and guarantee unusually prompt deliveries.

Drop us a line to-day, stating which of our products you are interested in.

**The Goodyear Tire & Rubber Co.**  
AKRON, OHIO

Branches and Agencies in 103 Principal Cities  
**MORE SERVICE STATIONS THAN ANY OTHER TIRE**



## BENOIST BIPLANES

TYPE XII.

Three Models

- School Machine
- Cross Country Machine
- Military Machine

Also operate the  
**Benoist School of Aviation**  
For further particulars address  
**BENOIST AIRCRAFT CO.**  
6630 Delmar Blvd., St. Louis, Mo.

## WIRE

Aviator Wire supplied in 12 sizes with a plate finish, making soldering easy. This wire is specially drawn from extra quality high grade steel. Also Aviator Cord of twisted wire.

**John A. Roeblings Sons Co.**  
TRENTON, N. J.

## HEINRICH

### Monoplanes and Mono-Biplanes

TUITION, \$250

On Private Field

MADE IN FOUR SIZES

Write for Illustrated Booklet

HEINRICH BROS., Baldwin, L. I., N. Y., U. S. A.

FOR IMMEDIATE DELIVERY, complete wood and metal parts for single surface Curtiss type including 50 yards No. 2C Naiaid Aeronautical Cloth, three 20" x 2" wheels, 6" hubs, 3/8" knock out axles.

PRICE, \$175.00.  
25 to 30 H. P. Motor, air cooled, with Schebler carburetor. PRICE, \$200.00.

All of the above for \$365.00. Let us tell you about it.

Prices on double surface headless, Goodyear fabrics, wheels and supplies. Motor of the two and four cycle type, water cooled, with two or three blade propeller, on request.

**WOLVERINE AERONAUTIC COMPANY**  
DETROIT, MICH.

## AERO WIRE WHEELS

BUY FROM MANUFACTURER AND SAVE MONEY

20 x 2 1/4" Wheels—6" Hub—\$4.00 with tire **\$6.00**  
20 x 3" Wheels—6" Hub—4.75 with tire **8.25**  
FARMAN TYPE Gears complete—Price **42.50**

Stock size Hubs—6" wide, 3/4 or 1/2" knock-out axle or bushed to fit 1" axle—to fit 1 1/4 and 1 1/2 special HYDRO-FLOATS and 34 inch Floor Wheels.

Don't fail to write for complete list of Wheels and Prices. We make any size or type.

Deposit required on orders; Balance C. O. D.—examination allowed.

**J. A. WEAVER, Jr.** 132 West 50th Street  
NEW YORK CITY

## BALDWIN

### VULCANIZED PROOF MATERIAL

For Aeroplanes, Airships, Balloons. First Rubberized Fabric on the market. Lightest and strongest material known. Dampness, Heat and Cold have no effect. Any Strength or Color.

### "RED DEVIL" AEROPLANES

That anyone can fly. Free Demonstrations.

### HALL-SCOTT MOTORS

Eastern distributor. 40 h. p. 4-cyl.; 60 and 80 h. p. 8-cyl., on exhibition at Frank Schumacher's, 164 W. 46th Street, New York. All motors guaranteed. Immediate delivery.

### EXPERTING

Will install a Hall-Scott free of charge in anyone's Aeroplane and demonstrate by expert flyer. Expert advice. Planes balanced.

CAPT. THOMAS S. BALDWIN  
Box 78 Madison Sq. P. O., New York

## AEROPLANES

My **Rotating Vanes** balance better than brains,  
Over seas and the streams;  
My **Parachute shade's** for the birdmen staid,  
In their noonday dreams.

From my **Blades** are shaken the dews that waken  
The rainbows one by one,  
As I burst thru the shroud of a sunlit cloud, in  
Oh—the wild race I run!

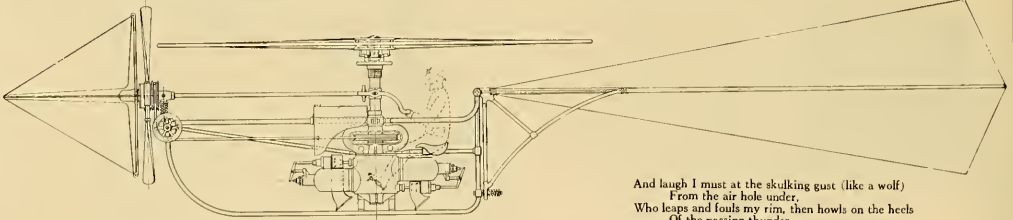

JOSEPH E. BISSELL, Box 795, Pittsburg, Pa.

And laugh I must at the skulking gust (like a wolf)  
From the air hole under,  
Who leaps and fouls my rim, then howls on the heels  
Of the passing thunder—  
As away I go (either fast or slow) thru the depths  
Of an azure sea,  
Over rocks and the rills and the valleys and hills,  
Oh, **rapture to fly!** and be free—

Seventy per cent. of record-breaking American flights with American Aeroplanes were made with propellers bearing this name

# CHARAVAY

We will tell you why if you ask us.

SLOANE AEROPLANE CO.

1731 Broadway, NEW YORK CITY

AGENTS:

Eames Tricycle Co., San Francisco and Los Angeles; National Aeroplane Co., Chicago; W. E. Boughton, Washington, D. C.

## Diana Spirons

In 2 Grades

PLAIN—A No. 1 whitewood or similar light, tough material; shellaced, waterproofed and varnished.

POLISHED—A No. 1 walnut or similar hardwood wrapped in fine silk and brought to high piano finish.

**Spirons** have been tested at peripheral speeds above 347 miles per hour without slightest sign of strain.

3-99 BALDWIN AVE.

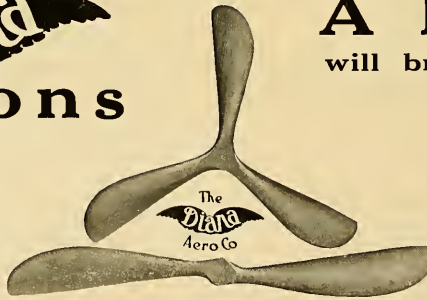

## A Postal will bring you leaflet

IF YOU WANT

- |                             |   |          |
|-----------------------------|---|----------|
| 1. Less vibration           | } | THAN     |
| 2. Greater speed range      |   | ANY      |
| 3. Better flying efficiency |   | 2-BLADER |

Then you are interested in the 3-blader or Tri-Spiron

Let us quote on your machine

DETROIT, U. S. A.

## The New 6 Cylinder 50 Horse Power Gray Eagle Motor

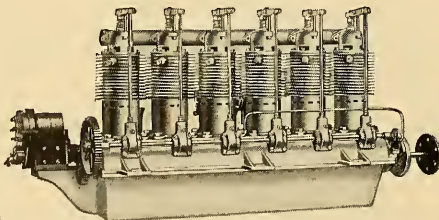

Will fly your aeroplane in any kind of weather. It's built especially for aviators who want a powerful and reliable motor for exhibition flying.

Consumes but three gallons of gasoline per hour running at 1050 to 1100 R. P. M. and develops 325 pounds thrust.

Why don't you ship your plane to our private Aviation Park and try one? Free use of grounds and motor without any obligations on your part is our liberal offer.

We'll demonstrate to your own satisfaction that a 6 cylinder 50 H. P. Gray Eagle Motor, selling for \$675, will fly your plane as well as any \$1500.00 motor on the market.

Users of Gray Eagle Motors are satisfied. Why not let us satisfy you?

Write for special catalogue on motors.

4 Cylinder 30-40 Horse Power  
**\$485.00 Net**

6 Cylinder 50 Horse Power  
**\$675.00 Net**

Complete equipment of Bosch Magneto, Schebler Carburetor and Oiler included. Visit our two factories and Aviation Grounds before you purchase a motor. Gray Eagle Motors have flown monoplanes and biplanes in states from New Jersey to California and Oregon. Complete list of all the users gladly furnished.

Orders placed now will receive prompt delivery. Every motor is fully guaranteed.

R. O. RUBEL, JR., & CO., (Incorporated)

1600 Floyd St., Louisville, Ky.

# Genuine Brand New Farman Biplane

Fitted with 50 H. P. Gnome Motor  
and Hydro-plane

—  
READY FOR WATER OR LAND.  
IMMEDIATE DELIVERY.

For Further Information Apply to

## CLIFFORD B. HARMON

315 Madison Ave., - - New York, N. Y.

# THOMAS AEROPLANES

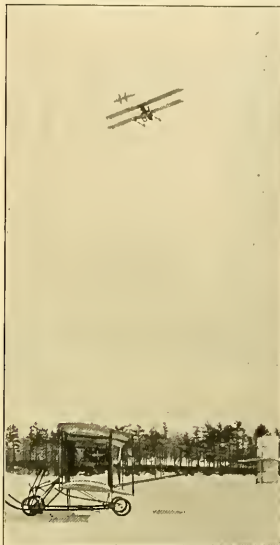

School and Training Grounds, Bath, N. Y.  
**THOMAS BROTHERS,**

*Designed  
To Suit the  
Requirements of*

- The Conservative Flier
- The Sportsman
- The Yachtsman
- The Exhibition Flier
- The Speed Fiend

*Equipped with  
the following  
Power Plants:*

- 35 H. P.
- 50 H. P.
- 70 H. P.
- 120 H. P.

Write for 1912  
Catalog and

*Learn WHY  
Thomas 'Planes  
Are Reliable, Safe  
And Comfortable*

**Bath, N. Y.**

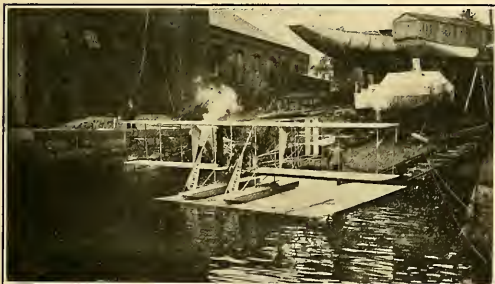

"THE PASSING OF THE YACHT"

## Marblehead Flying School Re-Opens

Hydroaeroplanes used exclusively. You can learn without delay. The Burgess factory adjoins the flying station. Aeroplanes for exhibition, military and sporting use under construction. All leading motors used. Pupils secure not only training, but latest information concerning construction and design.

**INSTRUCTORS:**

**HOWARD W. GILL      PHILIPS W. PAGE**  
**CLIFFORD L. WEBSTER**

All Licensed Aviators

New Booklet just printed will give you full particulars

**THE BURGESS COMPANY & CURTIS**

Box A

MARBLEHEAD, MASS.

## Duplex Propellers

Lines and curves productive of highest efficiency.  
Laminated and hand made. Select materials.

## Duplex Monoplane Surfaces

Type Nieuport. Streamline form entering edge.  
Flexible trailing edge. Slight dihedral angle  
built in. Up-to-date warping arrangement.

For details and prices apply to

**FRANK HERBST  
ENGINEERING WORKS**  
Wilmington, N. C.

\$1200 to \$4800



DUPLICATE PARTS

SAVE 50% **COST** SAVE 75%

# Buy a REX Monoplane and Save

\$500 to \$1000 on Purchase.

\$250 Tuition Fee to Learn to Fly.

50% to 75% on Maintenance.

The REX, with its interchangeable wings, makes it possible to enter Speed, slow and passenger contests during the same day. **WHAT OTHER AEROPLANE CAN DO THIS?**

Remember, we **Guarantee Before** delivery to fly the REX at **Least 1000 Feet High** and **10 Miles** across country.

We Supply an Extra Pair of Racing Wings with each REX.

We Duplicate Parts at Absolute Cost, a Saving of 50% to 75% in Maintenance.

**THE REX MONOPLANE CO.**

**South Beach, S. I., N. Y.**

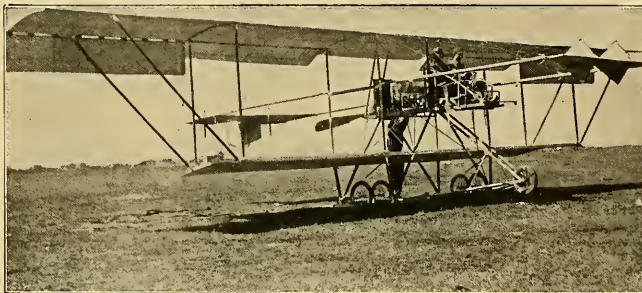

Showing double control school machine built in our Chicago factory. Width 52 feet.

## NATIONAL AEROPLANE COMPANY

606 South Michigan Avenue, Chicago  
Harvester Building

**Manufacturers  
Exhibitors  
School of Aviation**

**REFERENCES:**

Dun or Bradstreet  
Corn Exchange National Bank, Chicago

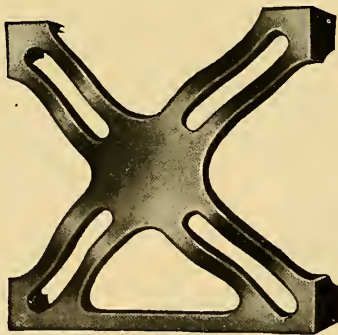

MANUFACTURERS OF  
**AEROPLANE PARTS** in Brass, Steel  
and Aluminum

Engine Mountings for any Motor

Also Copper and Brass Tanks  
of any Description

Steel Tube Frames to Order

**RELIANCE AUTO PARTS  
MANUFACTURING CO.**

244-250 W. 49th Street New York City

Telephone 5135 Bryant

# HOTEL CUMBERLAND

NEW YORK

Broadway at 54th Street



Headquarters for Avi-  
ators and Automobilists.

*New and Fireproof*

Strictly first class.  
Rates reasonable.

**\$2.50**  
**With Bath**  
and up

Send for booklet.

Ten Minutes' Walk to Thirty  
Theatres

**H. P. STIMSON**

Formerly with Hotel Imperial

**AERO MOTORS**

*MUST BE RELIABLE*

**FOX**

**De Luxe Motors**

Are sold on 30 days'

**FREE TRIAL**

You must be satisfied before you pay.

*Write today for catalog and propositions for trial*

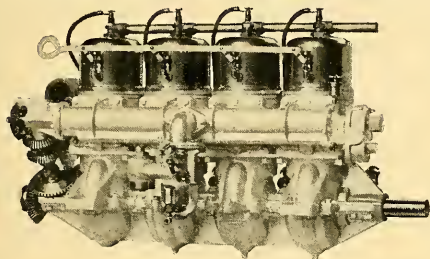

60 H. P. Fox De Luxe Motor

**The DEAN MFG. CO.**

225 FRONT STREET

"South Cincinnati"

NEWPORT, KY.

**BARGAIN DAYS!**

MR. AEROPLANE BUILDER, ENGINE MAKER and AVIATOR, read every word of this advertisement! It puts money in your pocket. Here is your chance to get the finest Propellers in the world at 1/3 regular prices. Practically a give-away to encourage aviation.

**FOR ONE MONTH** from date of issue of this Magazine we will sell you any of our regular Standard Stock Propellers, taken from the racks, tested, guaranteed against all defects, for 1/3 of the list price, cash in advance; you pay express charges. Not more than three Propellers to one purchaser.

There are some as used by: Baldwin, Harmon, Beatty, Moissot, Garros, Audemars, Barrier, Stone and the Wright Bros. Any of these notables will testify to this.

Sizes in stock:

Diameters—6 ft., 7 ft., 7 ft. 6 ins., 8 ft., 8 ft. 2 ins., 8 ft. 6 ins. and 9 ft.  
Pitches—2 ft. 9 ins., 3 ft., 4 ft., 4 ft. 9 ins. 5 ft., 6 ft., 7 ft., 8 ft. and 11 ft.  
and many intermediate sizes.

The above are suitable for planes or engines of: Baldwin, Gaome, Bleriot, Anzani, Nieuport, Renault, Wright, Hall Scott, Red Devil, Roberts, Gyro, Elbridge, Kirkham, A. S. H., Wittemann, Rex, Queen, Frontier, Twoobly, Max Ams, Gressier.

Send at once or they will all be gone.

120 Propellers ready for delivery, representing value over \$7,000 going for \$2,000. That ought to help some. It means keeping \$66 in your pocket of every hundred you would have spent.

**GIBSON PROPELLER CO.**

HUGO C. GIBSON, President and General Manager

197th Street and Amsterdam Avenue

FORT GEORGE

NEW YORK CITY

Telephone 6762 Audubon

**... The Wittemann Biplane ...**

HAS A REPUTATION, NOT ONLY FOR PACE, BUT FOR QUALITY AND SERVICE

Write for information of 1912 Biplane with our new auxiliary stabilizer.

If you want to build a machine of your own design or parts thereof, we can help you to make it successful. Some parts of your plane can be made of steel. We rid you of the annoyance of constant repairs and insure absolute safety.

Send us your specifications and requirements and secure our quotations.

Large stock of steel fittings, laminated ribs and struts of all sizes carried in stock.

Own a Wittemann Biplane Glider; the best, the safest, easiest to operate, and enjoy flying in a moderate form.

**YOUR OPPORTUNITY**

Two single cover biplanes for immediate delivery; slightly used, perfect condition with 8 Cyl. 60 H. P. Hall Scott power plant.

Write for Particulars.

Write for Catalogue.

**C. & A. WITTEMANN**

Aeronautical Engineers

The Oldest aeronautic manufacturing concern in the United States

Established 1906.

Works: Ocean Terrace and Little Clove Road.

Staten Island

New York

# ADVERTISERS' INDEX

## AEROPLANE BARGAIN

Clifford B. Harmon..... 133

## AEROPLANE MANUFACTURERS

Aerial Construction Company..... 127  
 American Aeroplane Supply House..... 107  
 Baldwin, Captain Thomas S..... 131  
 Benoist Aircraft Company, The..... 131  
 Burgess Company & Curtis..... 133  
 Cooke, H. C..... 128  
 Heinrich Brothers..... 131  
 National Aeroplane Company, The..... 134  
 Rex Monoplane Company, The..... 134  
 Sloane Aeroplane Company, The..... 105  
 Standard Aviation Company, The..... 128  
 Thomas Brothers, Messrs..... 133  
 Wittmann, Messrs. C. & A..... 135  
 Wright Company, The..... 106

## AVIATORS

Mars, J. C. (Bud)..... 129  
 Gressier Aviators, The..... 128

## BALLOONS

Goodyear Tire and Rubber Company, The..... 131  
 Aeronaut, Leo Stevens..... 130

## BAMBOO

Deltour, J., Incorporated..... 129

## BOOKS

The Lawson Publishing Co..... 127  
 G. & C. Merriam..... 129

## CLASSIFIED

Classified Advertisements..... 128

## DESIGNER

Bissell, Joseph E..... 132

## EXHIBITION

Aeronaut Leo Stevens..... 130  
 Milwaukee School and College of Aviation, The..... 104  
 National Aeroplane Company..... 134  
 Wright Company, The..... 106

## FABRICS

Baldwin, Captain Thomas S..... 131  
 Conover Company, The C. E..... 127  
 Goodyear Tire and Rubber Company, The..... 131

## GLIDERS

Wittmann Brothers..... 105

## HELMETS

Rood..... 130

## HOTELS

Hotel Cumberland..... 134

## MODELS

Lincoln Square Novelty Works, The..... 129  
 L. Melcombe & Co..... 129

## MODEL MOTORS

Ficux..... 130

## MOTORS

Aerial Navigation Company of America..... 128  
 Aeroplane Motors and Equipment Company..... 110  
 Albatross Company..... 129  
 Curtiss Motor Company, The..... 137

## MOTORS (Continued)

Dean Manufacturing Company, The..... 135  
 Detroit Aeroplane Co..... 129  
 Elbridge Engine Company, The..... 105  
 Frontier Iron Works, The..... 106  
 Paul Lacroix Automobile Co..... 104  
 Maximotor Makers..... 107  
 Roberts Motor Company, The..... Back Cover  
 Rubel, R. O., Jr., & Co..... 132  
 Sturtevant Company, The B. F..... 130  
 Wright Company, The..... 106

## PATENTS

Coleman, Watson E..... 129  
 Evans, Victor J., & Co..... 129

## PROPELLERS

American Propeller Company, The..... 108  
 Diana Aeroplane Company (Spiro)..... 132  
 Gibson Propeller Company, The..... 135  
 Frank Herbst Engineering Works..... 133  
 Rubel, R. O., Jr., & Co..... 127  
 Sloane Aeroplane Company (Charavay)..... 132  
 Wolverine Aeronautic Company, The..... 131

## RADIATORS

El Arco Radiator Company..... 127

## SCHOOLS

Benoist Aircraft Co..... 131  
 Burgess Co. & Curtis..... 133  
 Gressier Aviators..... 128  
 Heinrich Brothers..... 131  
 Milwaukee School and College of Aviation, The..... 134  
 National School of Aviation, The..... 134  
 Rubel, R. O., Jr., & Co..... 127  
 Standard Aviation Co..... 128  
 Sloane Aeroplane Company..... 105  
 Wright Company, The..... 106

## STABILIZERS

James Means..... 127  
 Willoughby..... 127

## STEEL TUBING

Reliance Auto Parts Manufacturing Company..... 134

## SUPPLIES AND ACCESSORIES

Aeroplane Motors and Equipment Co..... 110  
 Chicago Aero Works..... 128  
 Frank Herbst Engineering Works..... 133  
 Paul Lacroix Automobile Co..... 104  
 Reliance Auto Parts Manufacturing Co..... 134  
 Rood..... 130  
 Willis Company, The E. J..... 108  
 Wolverine Aeronautic Company, The..... 131

## TANKS

Reliance Auto Parts Manufacturing Company..... 134

## TIRES

Goodyear Tire and Rubber Company..... 131  
 Willis Company, The E. J..... 108

## VARNISH

Aeroplane Motors and Equipment Co..... 110

## WHEELS

Weaver, Jr., J. A..... 131

## WIRE

Roebing's Sons Company, The John A..... 131

# Curtiss Motors

are designed and built solely to meet the requirements of aviation.  
They are not a make-shift.

The requirements have been studied under actual flying conditions  
---not merely estimated.

The service that you receive is perfect---not temporarily, but always.  
It exceeds your expectations.

*There are reasons for this SUPERIORITY.*

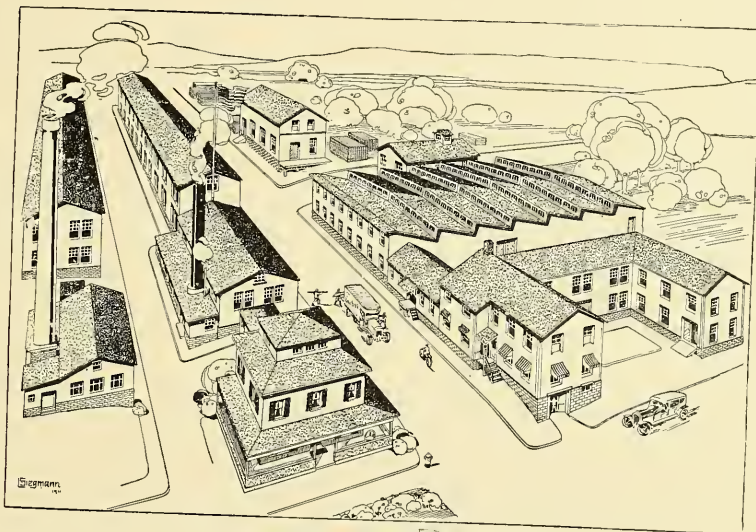

THE HOME OF CURTISS MOTORS

Modern Machinery  
Skilled Workmen

Up-to-the-Minute Methods  
The Best of Materials

*Accomplishments are OUR PROOF*

8 cyl. 75 H. P.

4 cyl. 40 H. P.

IMMEDIATE DELIVERIES

Catalog X gives full particulars. Get your copy to-day

**THE CURTISS MOTOR CO., Hammondsport, N. Y.**



**BENOIST SCHOOL PUPILS**



**A.B. LAMBERT IN BENOIST-ROBERTS**

# Another Big ROBERTS Success

## ROBERTS POWERED BENOIST TRACTOR PROVES EXCELLENT FLYER

(TELEGRAM)

The Roberts Motor Co., Sandusky, Ohio. St. Louis, April 24, 1912.  
 Edward Korn, of Sidney, Ohio, qualifies for pilot license in Benoist Biplane powered with 6 X Roberts Motor, to-day.  
 Tony Jannus carried passengers in new 1912 Benoist tractor powered with Roberts 6 X as usual. The motors work perfectly.  
 C. H. WASHAM.

**EDWARD KORN WRITES:**

The Roberts Motor Co., Sandusky, Ohio. St. Louis, Mo., April 27, 1912.  
 Gentlemen: This is to advise that I qualified for my pilot's license, April 24th, in a Benoist Biplane powered with my Roberts Six X. The perfect working of my motor at all times gave me extreme confidence, which assisted me materially in executing the necessary manoeuvres to obtain my license.  
 I have also flown my Curtiss and headless Farman types with your four-cylinder motors very successfully.  
 I am certainly well pleased with your motors in every particular. The workmanship and finish is excellent and I believe that you have the best motor on the market to-day.  
 Yours very truly,  
 (Signed) EDWARD KORN.

*Our New Catalog is just out. Want a copy?*

**THE ROBERTS MOTOR CO.,** 1463 COLUMBUS AVENUE  
 SANDUSKY, O., U. S. A.

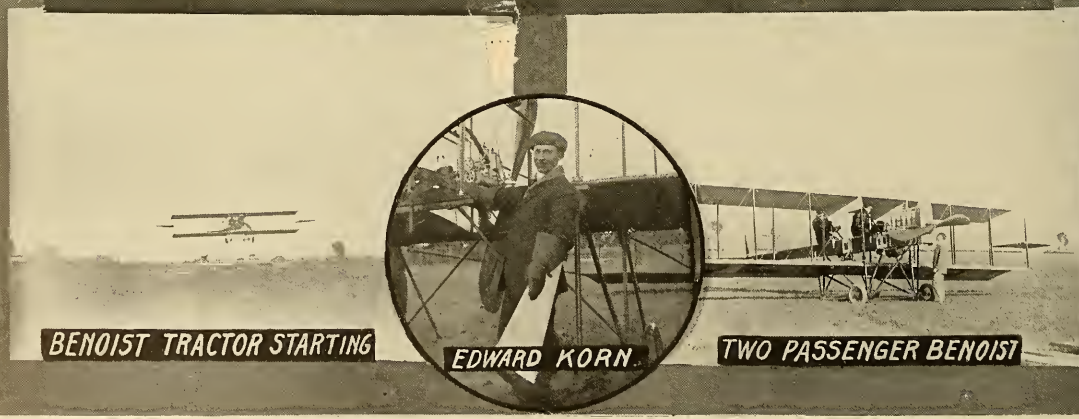

**BENOIST TRACTOR STARTING**

**EDWARD KORN**

**TWO PASSENGER BENOIST**



# AIRCRAFT

Vol. 3 No. 5

JULY, 1912

15 Cents a Copy



START OF A BALLOON CONTEST IN GERMANY

Old-fashioned ballooning, popularly known as "The Sport of Kings," is still indulged in to a large extent in Germany, where not only is the spherical balloon utilized for sporting purposes, but the scientists use it for ascertaining, studying and recording the various causes and effects of air currents, etc., under all atmospheric conditions.

# BOOKS

We have compiled a list of the very best aeronautical books written in the English language and offer them for sale to our readers. Earnest students of Aerial Flight should read every book in this list.

Make all Drafts, Express or Post Office Orders payable to

THE LAWSON PUBLISHING CO., 37-39 East 28th Street, New York, U. S. A.

- |  |        |  |      |
|--|--------|--|------|
| <b>Art of Aviation</b> , by Robert W. A. Brewer. A hand-book upon aeroplanes and their engines, with notes upon propellers, accompanied by twelve valuable folding plates illustrating various types of machines and motors.....                       | \$3.50 | <b>Aerodynamics</b> , by F. W. Lanchester. Constituting the first volume of a complete work on aerial flight, with appendices on the velocity and momentum of sound waves, on the theory of soaring, flight, etc.....  | 6.00 |
| <b>Artificial and Natural Flight</b> , by Sir Hiram S. Maxim. Being a description of his own experimental work and the development of flying machines generally.....   | 1.75   | <b>Aeroductics</b> , by F. W. Lanchester. Constituting the second volume of a complete work on aerial flight, with appendices on the theory and application of the gyroscope, on the flight of projectiles, etc.....   | 6.00 |
| <b>Pocketbook of Aeronautics</b> , by H. W. L. Moedebeck. Containing many features of aerial travel; a splendid text-book for the beginner or the aeronautical engineer.....   | 3.25   | <b>All the World's Airships</b> , by Fred T. Jane. Being the first annual issue, containing photographs of almost every flying machine built up to 1909.....   | 5.00 |
| <b>Vehicles of the Air</b> , by Victor Loughheed. One of the very latest aeronautical books, covering almost every detail of the science of aviation.....  | 2.50   | <b>How It Flies</b> , by Richard Ferris, B. S., C. E. The story of man's endeavors to fly and of the inventions by which he has succeeded. Illustrated by over 150 half-tones and line drawings showing the stages of development from the earliest balloons to the latest aeroplanes.....   | 1.20 |
| <b>Aerial Navigation</b> , by A. F. Zahm. A book written by one of the world's great scientists who has made an extensive study of the aeronautical subject for the past 20 years.....   | 3.00   | <b>Flying Machines, Construction and Operation</b> , by W. J. Jackman.....   | 1.50 |
| <b>Airships in Peace and War</b> , by R. P. Hearne, with an introduction by Sir Hiram Maxim. A popular account of the progress made by the different countries of the world in aircraft.....   | 3.50   | <b>Aeroplane Patents</b> , by Robert M. Nelson. A work embodying many useful hints and data relating to patents especially adapted to inventors and manufacturers interested in heavier-than-air flying machines.....  | 2.00 |
| <b>Aerial Navigation To-day</b> , by Chas. C. Turner. A finely illustrated work on the principles of Ballooning, Aviation, Aerial Law, Military Aeronautics, the aerial ocean and the industrial side of flight.....                                   | 1.50   | <b>The Aeroplane</b> , by T. O'B. Hubbard. An elementary text book of the principles of dynamic flight....   | 1.00 |
| <b>The Problem of Flight</b> , by Herbert Chatley. A most instructive work, written principally for aerial engineers.....  | 3.50   | <b>Birdflight as the Basis of Aviation</b> , by Otto Lilienthal. A contribution towards a system of aviation compiled from the results of numerous experiments.....  | .80  |
| <b>The Force of the Wind</b> , by Herbert Chatley. A scientific treatise, dealing with the subject of wind pressure in relation to engineering.....  | 1.25   | <b>The Aeroplane, Past, Present and Future</b> , by Claude Grahame-White and Harry Harper. Containing information, useful and entertaining, with chapters on various phases of aviation by many well known airmen.....   | 3.50 |
| <b>How to Build an Aeroplane</b> , by Robert Pettit. Translated from the French by T. O'B. Hubbard and J. H. Ledchoer. 8vo. cloth, 131 pp., 93 illustrations.....  | 1.50   | <b>Flying Machines Today</b> , by Wm. D. Ennis, M. E. Treatise on principles of various types of aircraft with 123 illustrations.....  | 1.50 |
| <b>Monoplanes and Biplanes: Their design, construction and operation</b> , by G. C. Loening. This is a very complete and practical work on aeroplanes that fly.....  | 2.50   | <b>Mechanics of the Aeroplane</b> , by Captain Duchenne. A Study of the Principles of flight.....  | 2.25 |
| <b>Principles and Design of Aeroplanes</b> , by Herbert Chatley. The very latest text book on Aeroplanes, containing many general details and mechanical drawings.....   | .50    | <b>My Three Big Flights</b> , by André Beaumont. In which the noted Bleriot pilot narrates in a most interesting manner, his various experiences and describes three notable events which he won....   | 2.50 |
| <b>My Airships</b> , by Santos-Dumont. The thrilling story of this intrepid Brazilian's wonderful success in aerial navigation, told in an entertaining way, free from technicality. With 55 full-page pictures from photographs. 12mo. 400 pages..... | 1.50   | <b>Law of the Air</b> , by Harold D. Hazeltine. A series of three lectures delivered by the author in the University of London, in which the problem of national and international law relating to air space is discussed.....   | 1.50 |
| <b>Handy Man's Workshop and Laboratory</b> , by A. Russell Bond. A popular work on almost everything pertaining to the every-day life of the mechanic. 370 illustrations and two chapters relating to flying.....                                      | 2.00   | <b>Practical Aeronautics</b> , by Chas. B. Hayward. An up-to-date treatise on dirigibles and aeroplanes covering their historical development, analysis of standard types, their design, construction and operation; the aerical motor and the theory and practise of successful flight..... | 3.50 |
| <b>The Conquest of the Air</b> , by A. Lawrence Rotch. A subject treated by an accepted authority in a manner appreciated by a popular, as well as a scientific audience.....  | 1.00   | <b>Building and Flying an Aeroplane</b> , by Chas. B. Hayward. A book of invaluable assistance to the amateur builder, with instructions for building, flying, methods of control, etc.....  | 1.00 |
| <b>Airships Past and Present</b> , by A. Hildebrandt. A general sketch of the past and present state of the art, together with its problems, presented in a way that can be understood by everybody.....   | 3.50   | <b>Aircraft, Volume 1</b> .....  | 3.50 |
| <b>Charts of the Atmosphere</b> , by A. Lawrence Rotch....   | 2.00   | <b>Aircraft, Volume 2</b> .....  | 3.50 |



**The only perfect  
Rubberized Cloth.  
The distinctive  
aluminum finish  
adds the final touch**

*Stays tight, bright and clean  
under all weather conditions*

**Send to-day for our New  
Booklet and Samples of  
"LUMINA."**

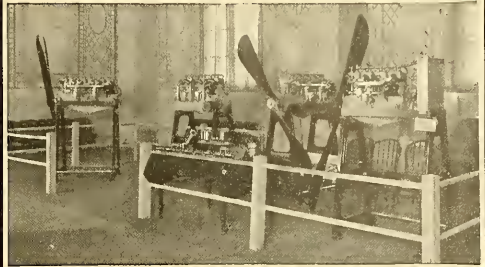

At the Aeronautical Show, Grand Central Palace, N. Y., the

## **Sturtevant** REG. U. S. PAT. OFF. **AERONAUTICAL MOTOR**

received very favorable comment.

The sane design, embodying as it does only tried principles of gasoline motor practice, combined with the rigid, careful construction, produces a motor that is at once durable, dependable and highly efficient.

Conservatively rated at 40 H. P. and 60 H. P. respectively, both the four and six cylinder motors show much better power delivery than this.

They run continuously hour after hour without depreciation in power delivery.

Catalogue No. 200-K describes these motors in detail. Sent upon request.

### **B. F. STURTEVANT CO.**

Hyde Park

Boston, Mass.

AND PRINCIPAL CITIES OF THE WORLD

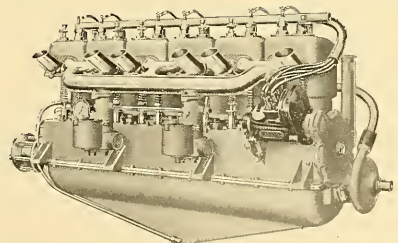

# FRONTIER MODEL A

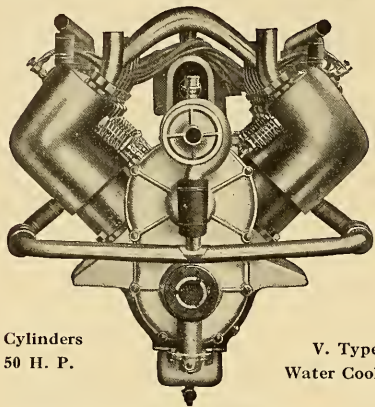

8 Cylinders  
50 H. P.

V. Type  
Water Cooled

Four and three quarter lbs. per actual Horse Power

**Simple**  
**Reliable**  
**Durable**

Reliability and durability coupled with minimum weight, consistent with absolute safety, are the important points of superiority combined in the FRONTIER Aero Motor of quality.

Our claim for distinction lies in the unique and well balanced design and the mode of fuel supply, giving equal and never-failing power for all altitudes and temperatures.

Embodied in its construction are these essentials:

- Highest grade of workmanship.
- Best materials.
- Experienced and capable engineers.
- Perfect shop equipment for manufacture.

Catalog and Price List on Application

**E. J. Willis Co.**

85 Chambers Street, New York Agents

**Frontier Iron Works**  
BUFFALO

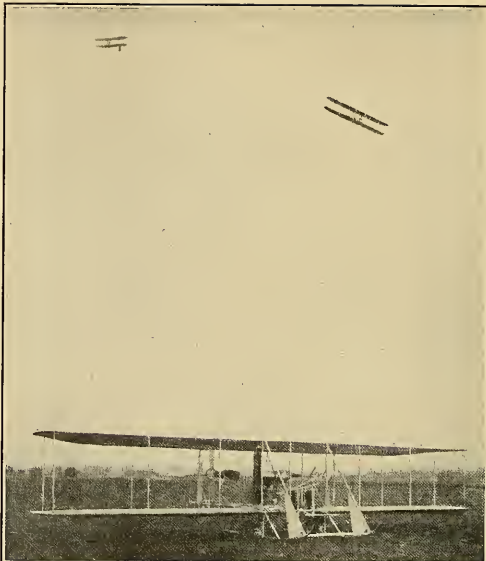

# The Wright Flyer

## 1912 MODELS

In addition to those features which in the past have made Wright Flyers famous for efficiency and reliability, the new models can be furnished with **Automatic Control, Silent Motors, and Hydroplanes.** These special features make the 1912 machine unusually attractive to sportsmen.

## EXHIBITION MACHINES

For exhibition work we have other models especially adapted to high winds and small fields. It was with a stock "EX" Model that Rodgers made his wonderful flight from coast to coast. Reliability means dollars to the exhibitor.

## WRIGHT SCHOOL OF AVIATION

Training consists of actual flying, in which the pupil is accompanied by a competent teacher. No risks and no expense whatever from breakage. The most famous flyers in America are graduates of our school and include such names as

- |                |                |                  |
|----------------|----------------|------------------|
| Lieut. Arnold  | Drew           | Lieut. Rodgers   |
| Atwood         | Elton          | Parnalee         |
| Brookins       | Lieut. Foulois | Page             |
| Brindley       | Fowler         | Reynolds         |
| Bonney         | Gill           | Simmons          |
| Beatty         | Lieut. Lahm    | Turpin           |
| Burgess        | Lieut. Milling | Welsh            |
| Coffyn         | Mitchell       | Webster          |
| Capt. Chandler | C. P. Rodgers  | and many others. |

Our School at Dayton is now open and pupils may begin training at once if they wish. By enrolling now you can reserve date most convenient to you for training. Write for particulars.

## THE WRIGHT CO.

Dept. "B"

DAYTON, OHIO

# AVIATORS WANTED



TO THE COMPETENT GRADUATES WE FURNISH A STANDARD-TYPE AEROPLANE PRACTICALLY WITHOUT COST

We Are the Real Western Pioneers

## WE TEACH FLYING ON (CURTISS, FARMAN, BLERIOT) MACHINES

NO BREAKAGE CHARGED

We manufacture any type Aeroplane and make a specialty of Hydro-Aeroplanes. All our machines are GUARANTEED TO FLY and guaranteed as to material and workmanship.

Home Study Course (Theory and Aerodynamics). Construction Course (Aerial Engineering). Aero-Motor Course. Flying Course. Our Basic Patents give us protection. Our prices are the lowest. Full and honest value. Flying exhibitions booked for coming season.

Send for our Special Offer No. 2 to-day.

### Milwaukee School & College of Aviation

S. E. Cor. Grand Avenue and Fifth Street MILWAUKEE, WIS.  
School-Shops, Hangars, Flying Field, foot of 6th Ave., West Allis, Wisconsin.



Farman Running Gears Complete as Above \$47.50

## Aeronautical Supplies

Everything to build any type flying machine

New catalogue with working drawings of Curtiss, Farman and Bleriot type machines, now ready for distribution and will be mailed free upon request to all interested parties. Write for quotations.

### A FEW IMMEDIATE DELIVERY PRICES

- Curtiss Seats - \$5.50
- Oval Post Sockets - \$0.17
- Curtiss Steering Wheels - \$9.00
- 5 Gallon Tanks - \$6.15
- Out Rigger Fittings - \$0.29
- Aluminum Pulleys with Brass Bushings
- 2" - 2 1/2" - 3" - 25c., 30c., 40c.
- Aviator Caps - \$1.25
- Wheels and Tires complete Eclipse Hub
- 20 x 2 1/4" - \$6.75
- 20 x 3" - \$9.50

Free with every \$50.00 order for Aeronautical Supplies

### FLEECE LINED AVIATOR CAP

**E. J. WILLIS CO.,** 85 CHAMBERS STREET  
67 READE STREET

Tel. 3624 Worth

NEW YORK CITY

# 15 POINTERS

For Maximotoring Your Plane

1. Lowest gasoline consumption. (50 h. p., 3 3/4 gal. per hr.; 75 h. p., 5 gal.)
2. Oil sight-jacketed intake manifold.
3. Self-priming oil pump.
4. Cylinder bolts.
5. Connecting rod bolts.
6. Crankshaft. (All of imported chrome nickel steel).
7. Semi-steel cylinders and pistons (30% steel).
8. Hand holes in crankcase.
9. Gears enclosed.
10. Auxiliary exhaust.
11. Engine supports on bridge principle.
12. Pyramidal cylinder flange.
13. Very best radiators and propellers.
14. Double magneto.
15. Ball bearings.

The 15 combined (and many of them individually) cannot be had with any other engine in Europe or America.

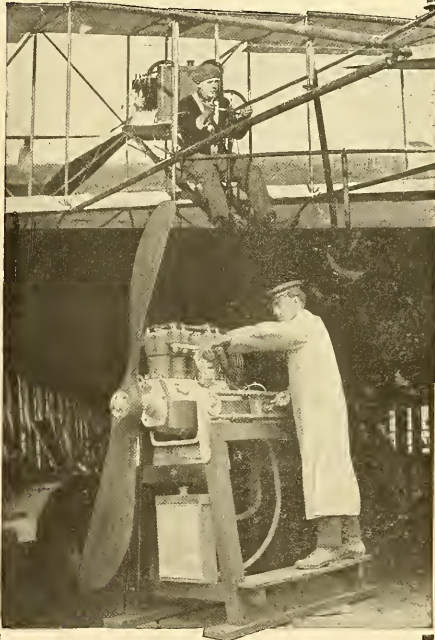

TESTING THE



A score of MAXIMOTORED planes and dirigibles the world over are shown in our New Catalogues. We have one for you.

5 MAXIMOTOR models this year, 50-140 h. p.; 4, 6 and 8 cyl. Special engines for exhibiting, touring and military flying.

MAXIMOTOR MAKERS  
DETROIT  
52 CRANE AVENUE

DEPT. 19

## INVESTIGATE FIRST

Satisfy yourself you are dealing with a responsible concern before paying your money.

**WE GUARANTEE** our machines, workmanship, materials, etc., superior to those of any other constructed here or abroad regardless of price paid.

Immediate and prompt delivery on standard machines.

"Nieuport," "Bleriot," "Farman" and "Curtiss" types. Hydroplanes; speed, single, passengers, weight-carrying, or specially constructed to your own design and specifications.

"Complete with suitable power plant purchaser selects or prefers, demonstrated in flight." "Complete without power plant," or "Complete in the Knockdown." Will accept orders on specified time delivery under forfeiture.

We invite your personal inspection of the best equipped plant in the U. S. All types in course of construction. Unexcelled opportunity to acquire full shop, construction and flying course, on any type Monoplane or Biplane.

SEEING IS BELIEVING. CALL IF POSSIBLE OR WRITE.

## INTERNATIONAL AERONAUTIC CONSTRUCTION CO.

Factory, Hollis, L. I.  
Main Line L. I. R. R.

Office, P. O. Bldg.  
Jamaica, N. Y. City

Flying Grounds  
Nassau Boulevard

## GRAY EAGLE MOTORS

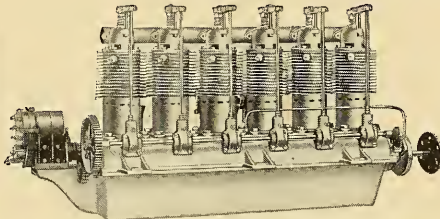

May now be purchased direct from the factory. A very compact, complete and efficient power plant for aeroplanes at a nominal cost. Gray Eagle Motors are flying planes daily—Ask the man who owns one.

Model D - 4 - 35 H. P.

\$485.00 Complete

Model E - 6 - 50 H. P.

\$675.00 Complete

Write for Circulars.

Kemp Machine Works

Muncie, Indiana

Strength  
Efficiency



Design  
Durability

Patented March 14, 1911; July 25, 1911; October 17, 1911; Others Pending

Highest Endorsements by the French as well as America's Leading Aviators

### DIDIER MASSON

Licensed by AERO Club of France. Masson-Gnome Biplanes.  
Management of Ivan R. Gates

Clinton, Iowa, May 20, 1912.

This tribute of the celebrated French aviator, M. DIDIER

MASSON, now in this country, is an example of the

voluntary endorsements which we almost

daily receive.

American Propeller Company,  
243-249 Hamburg Street,  
Baltimore, Md.

GENTLEMEN:

Enclosed please find some pictures of the Paragon Propeller mounted on the Gnome engine in our machine. I have also enclosed some pictures of Mr. Masson and the new military biplane.

I wish to state in behalf of Mr. Masson, that in our four years' experience in this business, we have found no other propeller equal to the Paragon in strength, efficiency, design, durability and appearance, which, I think, covers all the good qualities a propeller should have.

We wish to thank you very much for your considerate and courteous treatment in taking care of our orders. Your promptness is greatly appreciated, and if there is any way we can favor or assist you in a business way, we will be pleased to do so.

Thanking you again for past favors, I remain,

Yours very truly,

IVAN R. GATES,

Manager for Didier Masson.

Mr. J. A. D. McCurdy writes that the PARAGON is the only American propeller he can honestly recommend. Mr. Charles F. Willard writes that PARAGON is the *synonym of perfection* in propeller construction.

In a recent letter, Mr. Ivan R. Gates writes: "I will bet money that your oak and spruce propeller will stand more thumps and hard knocks without breaking than any other propeller on the market to-day." There's a reason: You can see the reason when you see the propeller. Ask for our special guarantee against breakage *from any cause*. Don't put your money into *wood* alone; get our engineering advice and we will *absolutely guarantee the results*.

Our booklet will tell you something of *practical results* obtained by practical men. Where shall we send it?

AMERICAN PROPELLER COMPANY, Baltimore, Md., U. S. A.

New and enlarged factory, 245-251 E. Hamburg Street

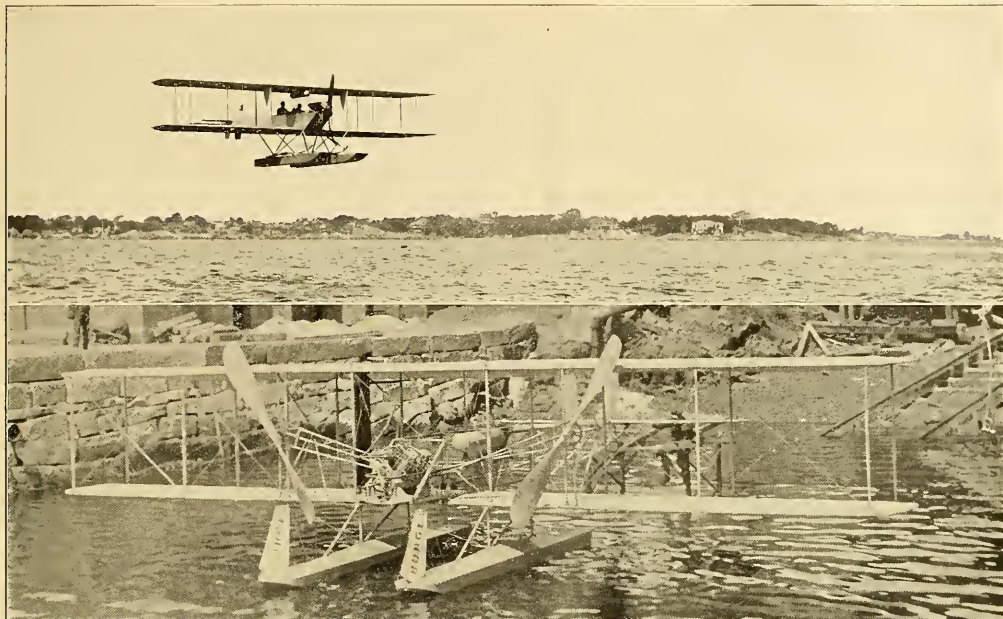

Two views of the latest Burgess machines. The top picture shows the 70-H. P. Renault military tractor in flight with Mr. Burgess at the controls, while below is seen Howard W. Gill's double tractor Burgess, which has been especially designed to compete for the Gould prize.

**CONTENTS---JULY, 1912**

Real Ships of the Air . . . . .	T. R. MacMechen	143
Wilbur Wright Gone . . . . .		146
Angle Indicator . . . . .	Ladis Lewkowicz	147
Editorial . . . . .	Alfred W. Lawson	148
Pioneers of Aviation . . . . .	Baron Ladislas d'Orcy	150
Foreign News . . . . .	R. H. Blanquie	151
German News . . . . .	Stella Bloch	153
Suggested Design for a Practical Hydro-monoplane . . . . .	Walter H. Phipps	154
The New Benoist Tractor Screw Biplane . . . . .		156
The Trade . . . . .		157
General News . . . . .	D. E. Ball	158
Book Review . . . . .		161
Information for Aeroplane Builders . . . . .	Albert S. Heinrich	162

**AIRCRAFT**

ALFRED W. LAWSON  
*President and Treasurer*  
 ERNEST C. LANDGRAF  
*Secretary*

**Published Monthly by The Lawson Publishing Company**  
 37-39 EAST 28th STREET, NEW YORK, U. S. A.  
 Telephone, 5017 Madison Square

ALFRED W. LAWSON  
*Editor*  
 WALTER H. PHIPPS  
*Asst. Editor*

**TERMS TO SUBSCRIBERS**

In the United States, Mexico, Puerto Rico, Guam, Philippine Islands, Hawaiian Islands, Cuba (including Postage), \$1.50 per year.  
 Fifteen Cents the Copy, of All News Dealers.  
 Foreign Subscriptions, Two Dollars per year.  
 In changing order give old as well as new address.  
 Advertising copy must be in hand by the 1st of month previous to date of publication.  
 Only high-grade advertisements of thoroughly reliable firms are solicited.

**WHEN YOUR SUBSCRIPTION EXPIRES**

One month before a subscription expires we enclose a renewal blank on which you will write your order for the renewal.  
 WHEN FIRST NOTIFIED that your subscription will expire, you should send your renewal at once, in order not to miss a number. New subscriptions which are received by us on or before the 15th of any month will begin with the issue of that month. If received after that date they will begin with the following month's issue. We cannot enter subscriptions to begin with back numbers. One month's notice is necessary before a change of address can be made.

*Entered as "second-class matter" February 18, 1910, at the Post Office, at New York, N. Y., under Act of March 3, 1879. Copyright, 1912, by the Lawson Publishing Co.*

*"Aircraft" is registered as a trade-mark by the U. S. Patent Office, under date of August 9th, 1910.*

**Aeroplane Motors & Equipment Co.**

1780 BROADWAY, NEW YORK

Telephone 1335 Columbus

63 AVENUE CHAMPS ELYSÉES, PARIS

**IMPORTERS**  
**G NOME**  
50 H.P. 70 H.P. 100 H.P. 140 H.P.  
**IN STOCK**

*We carry in stock all Spare Parts*

**S  
O  
L  
E**

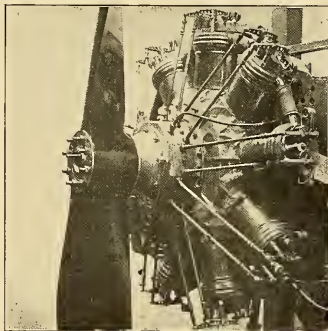

**SALMSON MOTOR**



**MORANE MONOPLANE**



**TRAIN MONOPLANE**

**A  
M  
E  
R  
I  
C  
A  
N**

**A  
G  
E  
N  
T  
S**

**ASTROL VARNISH**

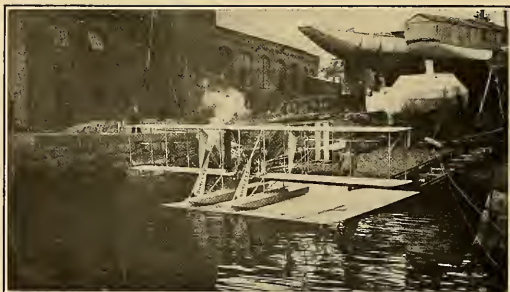

**Burgess Summer Training  
School Now Open**

The Hydroaeroplane has the call for 1912.

Unequaled facilities are provided for instruction in the operation of the marine flier over Marblehead harbor and the bay adjoining. By giving training at our manufacturing headquarters we offer pupils an opportunity, at no extra cost, to become thoroughly familiar with the details of construction and design, and ensure against delays. Course consists of FOUR HOURS actual flying. We provide hydroaeroplane for license test. No breakage expense.

**INSTRUCTORS:**

**HOWARD W. GILL      PHILLIPS W. PAGE  
CLIFFORD L. WEBSTER**

All Licensed Aviators

Booklet with full particulars furnished on request.  
Aeroplanes for military, sporting and exhibition purposes ready for prompt delivery.

**BURGESS COMPANY & CURTIS**  
MARBLEHEAD, MASSACHUSETTS

**FOX De LUXE AERO MOTORS**

**Exclusive Features**

- (1) The Fox Fourth Port Accelerator.
- (2) Rotary Valve Free from Back Pressure.
- (3) Average Weight 4 lbs. per Horse Power.

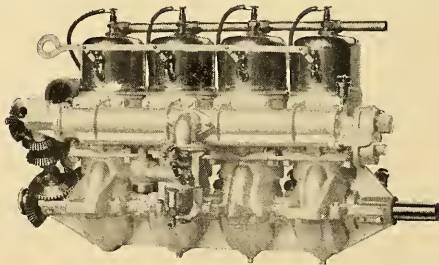

INTAKE SIDE.

Type 4 c. c. 60 H. P. Fox De Luxe Motors.

Built in 3 Sizes—45 H. P., 60 H. P. and 90 H. P.  
of 3, 4 and 6 Cylinders.

**THE BEST AERO MOTOR EVER PRODUCED**

LET US PROVE IT.

WRITE TO-DAY FOR CATALOGUE.

**The Dean Mfg. Co.**

225 A. Front St.

Newport, Ky.



# AIRCRAFT

Vol. 3, No. 5

NEW YORK, JULY, 1912

15 CENTS A COPY  
\$4.50 A YEAR

## REAL SHIPS OF THE AIR

By T. R. MacMechen

T. R. MacMECHEN, and Carl Dienstbach, were the first writers on aeronautics, to assemble in proper relation all the elements that make up the new science of air navigation and to point out the correlative part that meteorology, climatology, aerodynamics, aerostatics, ballooning practice, bird flight and wireless telegraphy play in the art of navigating aircraft. In 1907, these writers were the first to predict in detail the various uses of both airships and aeroplanes with their armaments and tactics in warfare; predictions that have up to this time been confirmed by actual practice in military maneuvers, and in war. They were among the first to predict the commercial future of the airship, which predictions are now being daily verified in Germany. On the subject of the airship, they are the recognized authorities in America and their long list of articles in the leading magazines have covered the entire field of aeronautics with such rare insight, reinforced by competent technical and engineering knowledge, that their writings have even influenced, to some extent, the building of airships in Europe. These articles will form the foundation of what should prove to be one of the most comprehensive and enlightening books on aerial navigation that has ever been published.

THE new war air ship, "Zeppelin III," with Prince Henry of Prussia and Count Zeppelin on board, recently lived out a tremendous gale during a round trip between Bremen and Hamburg. Immediately, the foreign correspondents of the American press began to re-manufacture public sentiment by sending cablegrams

Right here let us define our meaning of a ship. What is a ship? It is a solid structure, a hull built up of ribs and strakes all braced from the inside. It has decks, like the floors of a house connected by stairways, and the screw propellers and rudders that drive and guide it are fastened rigidly to the outside of the hull. This is a ship, irrespective of the principle that makes it float.

An iron ship is sustained on the water by the air inside of her hull—an iron being 800 times lighter than water. The air ship is sustained in the air by hydrogen gas, which is sixteen times lighter than air; sixteen to one is as good as unlimited to one.

It is not generally understood that the "Zeppelin" of today is a ship; it is sustained by displacing more than its own weight in the air that supports it, in fact, it is heavier than air every time that it starts on a trip. Its gas chambers are only inflated to about three-fourths of their capacity to allow for the full expansion of gas after the ship has been driven up dynamically by the action of the engines and propellers, the flat top and under surface of the hull acting as an aeroplane, which now gives the air ship a lift of from one and a half to two tons, nearly half the weight of the air ship's own cargo.

The distinction between an air ship and a dirigible balloon is that a dirigible balloon is exactly what the name implies—a flexible gas bag—not in the slightest degree different from the ordinary drifting balloon, except in the shape of the bag, which in the dirigible is long and pointed instead of round; otherwise

it could not be driven and steered through the air. But it is still a balloon because its entire volume of gas is held in one envelope, whereas, in a Zeppelin air ship, the gas is contained in twenty-two separate and independent chambers inside of the rigid hull, which perform exactly the same functions as the air tight compartments inside of an ocean liner. It will sink only if it leaks badly. Neither the air

which stated that "this brilliant exploit has rehabilitated the air ship as a competitor of the aeroplane."

The only new point in this latest performance by a Zeppelin air ship is the proof that it could do what no aeroplane could possibly accomplish—he perfectly handled in a storm that far exceeded a velocity of 35 miles an hour. This ignorance that Zeppelin air ships have frequently outlived storms of 45 miles an hour shows how little popular understanding has comprehended anything of real ships of the air which must do the decisive things in warfare or commerce.

For ages men have dreamed of great passenger carrying ships of the air, running at higher speed than any other form of transportation vehicles over distances that separate continents. Such ships have already arrived, although we have failed to make the distinction between them and balloons. A "Zeppelin" is as much of a ship as any that travel the ocean.

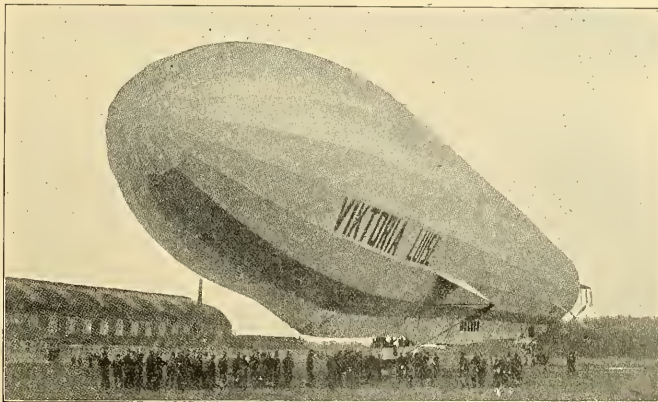

"Viktoria Luise," the latest and largest passenger Zeppelin, is 512 feet long and carries 32 passengers for 30 hours; without passengers and converted for war purposes, her flying range is 1,400 miles, a distance that would carry her over the entire British Isles and over all French Territory.

ship or the ocean ship are in the slightest danger of sinking, except by collision or grounding.

The advantage of the air ship is that her sustaining compartments are always closed, whereas those of the water ship must always remain open for the crew or passengers to pass through, and in many cases of accident are found open, as in the *Titanic* disaster.

The bursting of two whole compartments in a "Zeppelin" does not necessarily mean that the ship will sink, as this loss of lift is compensated for by the aeroplane action of its hull whenever it is driven at full speed; and when driven at full speed, it burns its own fuel so rapidly that this, acting the same as the casting of ballast, is continuously lightening the ship and thus compensates for all loss of lift. This is what the airman calls "Balancing the ship." In twenty-four hours a "Zeppelin" does not lose one-thirtieth as much of her lift (gas) as it gains in lift through this continuous burning of fuel, which is constantly lightening the ship and thus restoring the balance.

The lay mind usually thinks that the air ballonets or air chambers inside of a dirigible balloon have something to do with sustaining that sort of craft. These air chambers simply maintain the rigidity of the flexible bag whenever it loses gas through the action of the sun or change in elevation; otherwise the bag would lose its shape and it could not be steered perfectly. The air ballonets do not prevent the loss of the dirigible's lift.

A Zeppelin air ship has no air ballonets because its hull maintains its rigidity permanently by means of air spaces between the hull gas chambers and the hull which keep the gas at normal temperature whenever the air ship is driven at a speed of above 42½ miles an hour—a speed that all the "Zeppelins" now exceed. At this speed, which is made by all of the new ships, the breeze

passing through the ventilators at the bow, prevents the gas from expanding on the hottest days of the year. This means that the "Zeppelin" is now unsinkable from any cause in her principle of construction; she will sink only if destroyed in battle during war or other abnormal conditions. If a dirigible balloon is punctured it meets the same fate as the French military dirigible, "Republique," that crashed to earth when a broken propeller

plunged into her bag, which burst under the pressure of her own gas.

The "Zeppelin's" speed finally proves that it is a real ship. In twelve months Count Zeppelin has built five of these great craft, each one larger and more powerful than the preceding one; each larger ship has been more perfectly steered than its predecessor because the successively greater engine power makes it easier to handle a ship in the a. r. the same as

greater power gives better control of the ship on the water. With greater power, Count Zeppelin has attained perfect dirigibility in 40-mile winds, but there was a still more important reason for increasing the size of his ships. Count Zeppelin has also proportionately increased his engine power to insure absolute control of the gas at all times. If the motors break down, the gas begins to deteriorate; as long as the engines maintain their speed, the gas is perfectly controlled. As this depended upon reliable engines he has built a motor that runs for 36 hours at full speed; it cannot break down, as every part of the motor is duplicated. This means that if the carburetor gets out of order, a duplicate carburetor enables it to go right on working. The engine has a great many automatic devices, among them two pumps which force the fuel to exactly the right places, even if the air ship is standing on its beam ends, consequently the "Zeppelin" runs upward into the air or comes down, at an angle of 45 degrees. It rises from the ground to a mile in the air in five minutes. What this means in warfare is seen at once from the fact that it takes the fastest monoplane, carrying two men, fully 23 minutes to gain the same height. The "Zeppelin" is the only air machine in the world that rises and comes down in a straight line, and after it has attained the height of a mile it can travel there for 36 hours, while the fuel of smaller craft lasts for only a few minutes after rising to a mile.

All of these advantages the "Zeppelin" could not possess except through colossal proportions—the engines themselves each weigh a half ton—and as three of them are carried by every air ship, it is not at all probable that all would ever break down at the same time.

A "Zeppelin's" enormous capacity enables it to carry the comforts that a modern public demand in traversing long distances

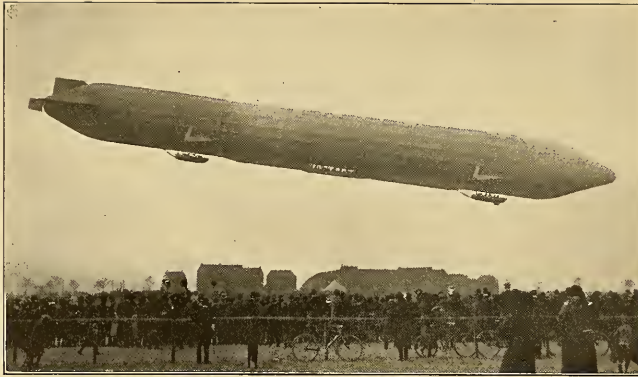

Airship "Deutschland II" descending at full speed over Dusseldorf. Note the passenger cabin under the centre of the ship with the passengers looking out of the windows. Zeppelins now carry the German mails.



Dining service is one of the regular features of the Zeppelin ships, and passengers traveling by the air route can have their meals served to them in the same manner as aboard a Pullman car on American railroads.

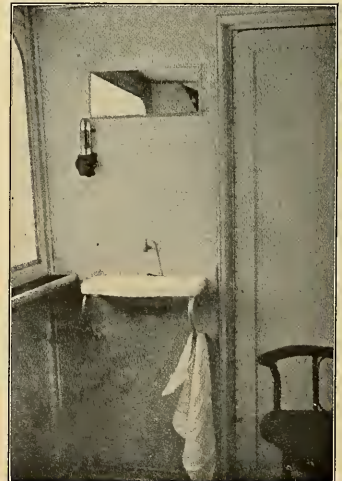

Wash rooms added to the latest Zeppelins show that no detail necessary to the welfare of the passenger is omitted.

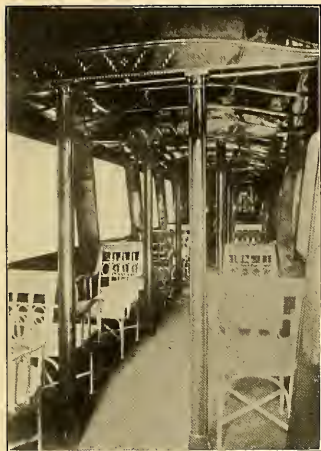

Interior of the Zeppelin passenger cabin, finished in mahogany. It is as sumptuous as a Pullman palace car. Easy wicker chairs are at the plate glass windows. Dining tables are set up between each of the two chairs at meal times. The buffet and lavatory are at the end of the cabin. The "Viktoria Luise," the latest passenger Zeppelin, has accommodations for 32 passengers.

ward to in ships of even greater size.

The air ship "Hansa," which is being built for passenger service over the North Sea this year, has a length of 537 feet; the next largest "Zeppelin" can not be less than 563 feet, as each additional section has a standard scale 26 feet in length.

The rapidity with which we are approaching enormous structures in the air will be appreciated from the fact that the German Navy has already ordered from Count Zeppelin an aerial battleship to be not less than 563 feet long. It is significant that the regulations imposed by the naval contract for this monster provide that it shall be so staunch that it can weather any seas, winds or climate. It will have five engines of a combined 550 horse power. This ship is designed for service over the waters surrounding Germany. It is not therefore a difficult matter to conceive an air ship that will be able to cross the Atlantic Ocean. It will be proportionately larger, safer, faster and more economical. The size of an ocean-crossing "Zeppelin" will approximate about 700 feet in length and this length is not the limit to which these ships can be safely built; in fact, it is very definitely known by the Zeppelin engineers, that there are no reasons whatever for not building them 1,300 feet long. With such proportions increasing seaworthiness and all other ship-like qualities are assured.

Other nations now realize that Count Zeppelin has built a real ship of the air, because they have knowledge of the fact that he has already mounted guns of long range on top of its hull and this can only be done on a solid structure where the guns are permanently pivoted to move easily at the gunners' command in any di-

rection, the same as on a naval vessel. The shock of recoil is taken up by the huge mass of the ship, which now weighs about 25 tons, the weight of a small sea yacht. In fact a "Zeppelin" fires guns of the same calibre and power as those which can be fired from a yacht of the same weight.

In 1908, the writer called attention to the fact that the Krupps were experimenting with a gun which fired a shell of two-inch calibre. This work has been carried forward until, during the early part

of 1911, Erhardt, the well-known gun maker of Dusseldorf, Germany, aided by Major Goebel, a retired officer of the German Army, has perfected a cannon of 600 to 800 pounds, to be fired from the top of a Zeppelin hull. This would not be possible unless the "Zeppelin" was a ship with all the solidity necessary to withstand the shock of recoil.

It is obvious that a "Zeppelin" could carry this gun on the top of its hull since each of its ring sections, even before the ship is inflated, support the weight of two men; in the aggregate, this makes the frame strong enough to support a weight of nearly two tons. After the craft is inflated with gas, the tremendous upward pressure of the gas reinforces the strength of the frame until it easily carries on its top two and one-half tons—guns and ammunition. The "Schwabens" on a recent trip from Berlin to Gotha, carried two tons of wet snow on top of its hull. Erhardt and Major Goebel have also perfected a mechanism on the new guns that takes up nearly all of the recoil, which makes it felt even less than the vibration of the motors. The present "Zeppelin" carries two of these cannon on top of the hull, two long machine guns of fifty pounds each in its cars, and fourteen machine rifles weighing ten to fourteen pounds apiece for repelling aeroplanes.

The French and English Governments have complete knowledge of this great aircraft and acknowledge the superiority of the "Zeppelin" because of its armament. General Cherfils, the noted French military writer, has stated that because of the Zeppelin construction, its speed and its armament neither dirigible balloons or aeroplanes will be able to get near it, and that because of the guns mounted on



The rigid airship "Schuette-Lanz I (Zeppelin type)" in process of construction by the German Air Navy League, and now used in the German Army. Note the fine engineering displayed in the construction of the wooden ribs and metal bracing which is all socketed to withstand collisions.



Airship "Deutschland 11." Note steep slant at which Zeppelin passenger airships land. These ships always rise and descend at angles of 13 to 45 degrees.

the top of the hull it can sweep clean a wide radius around it. With its ability to lift a great number of passengers, of guns, its great wireless range, its ability to travel at night and of operating unseen, and the ease with which it can communicate its own successes to the German general staff, thereby enabling the commander to alter his plans and strike accordingly, constitutes a

menace which the French Government can no longer ignore and means the building of a great counteracting aerial fleet in France.

It is evident, therefore, that the "Zeppelin" is, after all, not only a real ship of the air, but the only real ship of the air thus far tried and proven.

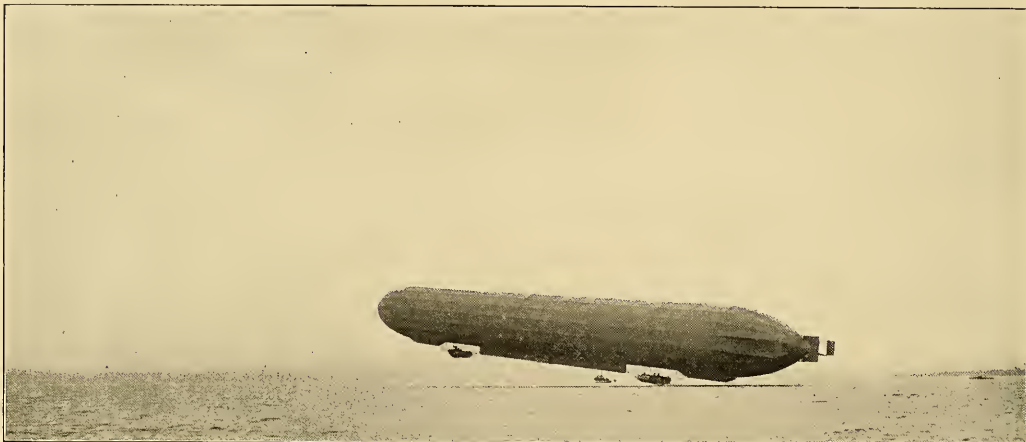

AIRSHIP "DEUTSCHLAND" RISING FROM THE SURFACE OF LAKE CONSTANCE—ITS MOTOR CARS ARE BOATS. COUNT ZEPPELIN HAS BUILT ALL HIS RIGID AIRSHIPS TO OPERATE OVER BOTH LAND AND SEA.

## WILBUR WRIGHT GONE

**ONE-HALF** of the mental force that conceived, constructed and operated the first heavier-than-air machine to fly, has passed beyond the confines of humanity.

Wilbur Wright, the elder of two remarkable brothers whose work was so indissolubly related

a few seconds later left the end of the rail and took its course up into the air under a combined impulse of its propellers and a strong wind meeting the machine, remained aloft for a few seconds, they saw the birth of human flight. (It may be well to state here something that has not been recorded before and upon information given to the Editor of AIRCRAFT nearly two

years ago, by Miss Katherine Wright, that it was Orville and not Wilbur who made the first flight.) From that time on it was merely a question of development. But the Wright brothers were not content with proving that human flight was possible; they were still anxious to add something to the knowledge of the human race and continued to improve and study the science of aerodynamics with even more enthusiasm and indefatigability than they had shown previously, with the intention of making flying safe and practical as well as spectacular.

that neither must be given more credit than the other, died at 3:15 o'clock on the morning of May 30th, 1912, at Dayton, Ohio, after a brief period of typhoid fever, and the human race thereby lost one of its greatest inventors.

There is no question about the position Wilbur Wright naturally takes among the great public benefactors, and, together with Orville, must be set in close proximity to such immortals as Gutenberg, Watt, Fulton, Stevenson, Edison, Bell, etc., in fact, as aerial navigation develops and little by little nature's secrets are unravelled by geniuses yet to come, and heavier-than-air machines are made to do useful work for mankind, the Wright brothers will become more and more appreciated until their position in the Hall of Fame must even be set higher than the others.

These men were the first to actually defy the laws of gravitation in a mechanically propelled device heavier than the air, which they accomplished on the seventeenth day of December, 1903, with a motor-driven biplane at Kitty Hawk, N. C., and when those who were holding the machine let go, after it had been placed upon the old-fashioned starting rail, and it ran down the track and

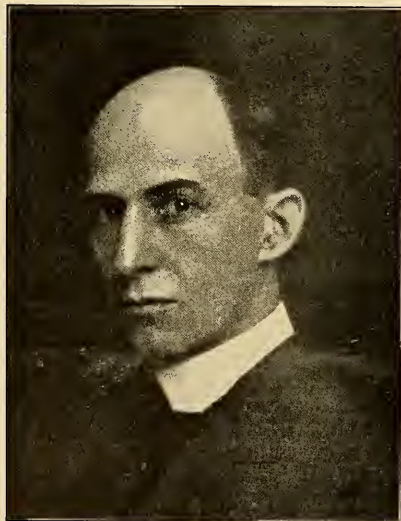

THE LATE WILBUR WRIGHT

and through him we can look for much improvement in mechanical flight during the great many years we hope he will be with us.

# ANGLE INDICATOR

By LADIS LEWKOWICZ

**LADIS LEWKOWICZ**, the well known aviator, has been a close student of aviation for the last 15 years. He was born in Russian Poland in 1883, but was educated in Paris. He interest in aeromatics was aroused by the Ader experiments. He was a manufacturer of flying toys in France and the United States before he took up aviation. He learned to fly a Bleriot monoplane at Issy les Moulineaux in 1907 and has since flown in all parts of Europe and America. In Europe his flights are well remembered for his daring with light powered engines. He is a very careful flyer, but has obtained such wonderful control of his aeroplane that he generally flies until his opposite becomes exhausted and then volplanes to earth. His daring flights last Summer on Long Island were the astonishment of Americans, he being the first aviator to fly over New York City in a monoplane, which flight he made on July 8, 1911. He has made the longest volplane in the history of aviation; his engine stopped when he was over New York City at an altitude of about 9,000 feet, from which height he volplanned to the Hackensack Meadows on the opposite side of the Hudson River, about 5 miles.

It is of the greatest importance to be able to know positively by means of an accurate instrument at what angle the aeroplane is ascending, volplaning or banking, than to depend entirely upon one's judgment.

In fact, without an angle indicator it is absolutely impossible for the aviator to balance himself while flying on a dark

prevent any oscillation of the pendulum, which always takes a perpendicular position.

When the aeroplane is ascending, the pendulum will move toward the aviator and the point of the pendulum will indicate the angle. In case the indicator is placed at a distance which prevents the aviator seeing in the cup the angle at which he is ascending, a looking-glass has been attached which will show the angle at all times.

The pendulum operates in every direction, showing the exact angle of the aeroplane. The numbers marked on the cup show the dividing line of safety and dangerous flying. For instance, when ascending, the pendulum should always be in a perfect straight line with the numbers, as in this way it will show that the aeroplane is climbing perfectly when the pendulum deviates from that line in either direction, then it is dangerous, for the machine is climbing and banking at the same time. When the pendulum moves to the right or left, the aeroplane is banking in the same direction, and if it goes on one side and forward, it shows that the aeroplane is banking and descending at the same time.

To make an angle indicator all that is necessary is to spin a brass cup to one-quarter of a complete circle, attach it to a little stand of any description that will hold it on the aeroplane, make it black by the gun metal process, divide the cup into degrees from the bottom centre upward (one-

night, as in the case of Howard Gill who recently, while trying to fly at night, fell backward because he was unable to know at what angle he was ascending.

Most experienced engine men can tell you the number of revolutions an engine is making by its sound, but every first-class aeroplane should have a competour or tachometer in front of the aviator to show him the exact number of revolutions made by his engine in order that he may notice any slight variation in its running, and enable him to make suitable preparations for a landing in case the engine shows signs of trouble, instead of waiting until the trouble arrives.

There is no doubt that a great many of the deaths already charged up to aviation were caused by the aviator discovering when it was too late, that he was ascending, descending or banking at too steep an angle, whereas if he had had an instrument in front of him, showing the exact angle, he could have been saved.

For this reason I have developed the "Angle Indicator," and am giving herewith a full description of how it works and can be made, in the hopes that it may help to make aviation safer.

This indicator is designed to be placed in front of the aviator attached to the aeroplane so as to have the pendulum dead centre when the aeroplane is in flying position. It is composed of a cup which is a perfect part of a complete circle; it can be from one-quarter of a circle up to one-third of a circle; inside the cup the degrees are marked by lines running around it; the first line shows 10 degrees, the second line 20 degrees, etc. The pendulum, which is the only movable part of the instrument, is an arm mounted on a large ball, which rests on three small balls, which brings it to the centre of the cup. At the lower end of the pendulum there is a weight which is so calculated as to

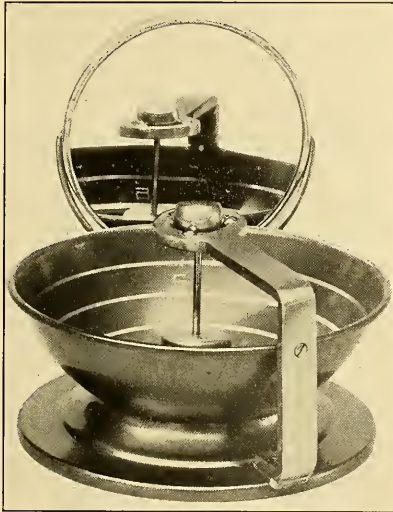

Front view of the Lewkowicz indicator showing the position of the pendulum when the machine is flying about level.

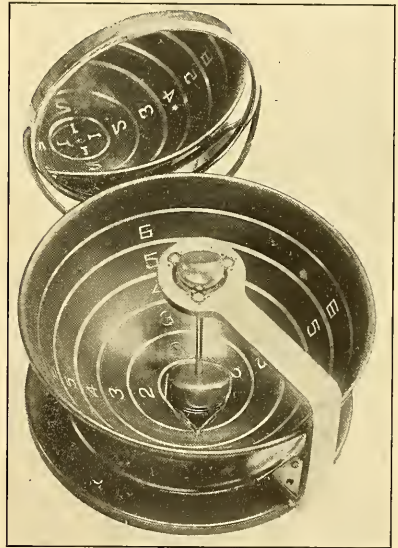

Top view, looking into the Lewkowicz indicator, showing the pendulum moved towards the aviator and indicating the angle at which the machine is climbing.

quarter of the complete circle will make 45 degrees in every direction). Take a piece of sheet metal, bend it to form an arm to support the pendulum and set it upon three small balls, securing this arm so that the pendulum will hang at dead centre. The part of the pendulum resting on the three balls must be a large perfect ball and the bottom weight twice as heavy as the top ball. One must be careful to place the arm at exactly a height of one-half the diameter of the circle in order to make a perfect angle indicator. By arranging a metal part inside of the cup that will obstruct the pendulum you will then know when the danger angle is reached and be able to avoid trouble. The danger zone should be set 5 degrees inside of the safety limit.



### GERMAN AIRSHIPS.

**L**AST December we called attention editorially to the remarkable success attained by one of Zeppelin's passenger carrying air ships and advocated intercity air line service being established right here in the United States of America.

Since then we have learned that several big financiers in this country are "considering" the project and that Horace Wild has actually imported a small Parseval from Germany for passenger carrying excursions and advertising purposes in and around Chicago.

In order to facilitate, if possible, and hasten somewhat the conclusions to be arrived at by the gentlemen of means who are "considering" the establishment of air ship lines in this country, we are publishing in this number an article entitled "Real Ships of the Air," written by T. R. MacMechen, one of the greatest exponents of the lighter than air type of air craft to be found in the Western Hemisphere and will supplement that article with a few facts herewith that may prove interesting to our readers if not sufficiently persuading to the financiers to cause them to immediately invest their ducats in the latest and greatest of all transportation lines.

It is not generally known even among the aeronautically inclined in this country, to what extent the development of the lighter than air craft has reached, especially in Germany, which country undoubtedly leads the world in this respect.

The Germans are a great people. They are as far in advance of the Americans and English in the science and practise of air transportation as the Americans and English are in advance of the Arabs in the science and practise of land transportation, and by reason of this fact, if war broke out today between Germany and England, the odds would be so overwhelmingly in favor of Germany that it would be like a well trained regiment with gatling guns fighting against a tribe of savages with bows and arrows, and just as the savages could not realize the inferiority of their weapons until tried against modern guns, neither does it appear that English or Americans will realize the inferiority of their old-fashioned weapons until they are tried against the new and wonderful machines and the advanced methods of the Germans.

While American newspapers only see fit to record

the fatalities of aviation and aerostation in the most blood curdling way and thus help to retard actual progress in the development and the attainment of knowledge relating to and the utilization of nature's greatest gift to mankind, the Germans are quietly operating their great air ship lines daily in all parts of the Empire in the same way and with as much system as we operate our steamboat and railway lines in this country.

Germany leads the world in air ships and almost leads it in aeroplane development as well.

In case of war breaking out today, we believe that not only could Germany whip France but that it could also invite England into the melee at the same time and whip them both together, and such a result would be accomplished because the Germans would be masters of the air and in all future wars the masters of the air will be the masters of the earth. (This statement is made notwithstanding the French Government has twenty-one dirigibles and over 200 aeroplanes now in use. Only about fifteen of the dirigibles, however, could be counted on for serious service, and even the best of the French dirigibles would be useless, we believe, if pitted against the great rigid air ships of Germany).

At the present time the German government have in use three army "Zeppelins"—"Z1," "Z2," and "Z3," besides having in subsidy the three passenger carrying Zeppelins—"Schwaben," "Viktoria Luise" and "Hansa," making six altogether.

It also owns two great rigid "Schuette-Lans," 1 "Seimens-Schuckert," the largest non-rigid air ship in the world, 7 "Parseval" non-rigids, the largest ("P 10") being almost equal in size to the "Seimens-Schuckert," 8 "Gross" dirigibles which are officially designated as "M 1," "M 2," "M 3," etc., making altogether a grand total of twenty-four air ships capable of delivering punishment to the enemy by destroying railroads, military supply depots and at night fortifications or sleeping armies.

And this list does not include about twenty or thirty small dirigibles owned by private concerns, such as the Suchard, Clouth, Reuthenberg, the Reidinger craft, etc., that could be put into service for scouting purposes in case of war.

Beside all this the government have ordered two more Zeppelins—one for the Navy and one for the

Army—and one more Seimens-Schuckert and a great rigid steel frame air ship without hanging cars,—passengers, crew and engines all being carried inside of the hull—now being constructed by the Motor-Aeronautic Society of Berlin, and to cap the climax, twelve of the largest cities in Germany have each raised subscriptions for the purpose of purchasing and presenting to the government twelve additional war Zeppelins, so that by 1914 the German government is practically assured of at least eighteen of these great battleships of the air (“Zeppelins”) and enough of the other makes to form a fleet of about 100 lighter than air craft altogether.

If you add to this a flock of 1,000 or 2,000 war aeroplanes, which the Germans will undoubtedly have in operation by 1914, manned by the most efficient military men, both aeroplane and air ship men knowing the physics of the air, its currents, etc., as well as naval experts know the water, together with great air ship and aeroplane stations located in all of the most strategic parts of Germany and great national aerial laboratories whose operators will be in constant touch with weather conditions in every direction and all altitudes, and capable of furnishing their fighting airmen with information that will aid them in taking advantage of nature's forces to help them as well, it must readily be seen by even the dullest of minds, the tremendous superiority of the Germans over any other country that starts a row with them, especially when taking into consideration that the Germans also have a great army and navy to back them up.

Speed is one of the most important factors in connection with the large German air ships. The “Seimens-Schuckert” makes forty-two miles an hour with 550 H. P. generated from four primary and one secondary engine. The Parseval “P 10” has 500 H. P. and runs at forty-two miles an hour. The “Schuette-Lans” with 500 H. P. is capable of making forty-three miles an hour. All of the “Zeppelins” run forty-three miles an hour or better—the speed of the “Schwabens” and “Viktoria Luise.” These two air ships carry 480 H. P., three engines combined, but the two war ships “Z 2” and “Z 3,” with three engines give 490 H. P. and make a speed of forty-seven miles an hour, the greatest speed yet made by air ships. But the latest government specifications for the new naval air ship require a speed in excess of fifty miles, which means the installation of a fourth engine.

But the scare of war is not the only reason that the Germans are building gigantic air ships. They are looking forward to control the skies in commerce as well. Already, and for some time past, as we have frequently mentioned in the columns of *Aircraft*, air ship service is made to pay handsome dividends on the money invested in their construction and operation. The big passenger carrying Zeppelin “Schwabens,” earned in the neighborhood of \$100,000 in one season's service, and as the life of these Zeppelins, with care and barring disasters, is over fifteen years (the “Z 1”

has been in service since 1906 and is not only in good condition today but just recently she was lengthened by the addition of a whole new compartment making her faster and better than before), sufficient leeway is allowed big corporations to make enormous profits.

With the increased construction facilities of the Zeppelin works and a great reduction in the cost of motors, fabrics, metal parts, gas, etc., caused by the growth of the industry in Germany, a “Zeppelin” now costs from \$125,000 to \$140,000. The gas there costs two cents a cubic foot and as the “Schwabens” requires about 20,000 cubic feet of gas, the cost of its inflation, which will last for two months, is about \$400.00, so that the fares from the first eight passengers at \$50.00 per head, on the first trip pays for the gas used by the ship for two months, and as a Zeppelin will carry thirty-two passengers a trip, allowing but one trip a day for the two months, makes nearly 2,000 passengers carried for \$100,000 in fares. So it will be seen at a glance, as far as the cost of the gas supply is concerned, it is insignificant in comparison to the amount of fares collected.

The crew consists of a captain, first and second officers and twelve men who work in relays and whose combined wages will amount to about \$1,500 per month. Of course there is the expense of erecting the steel hangars at each end of the route, just as steam ships must have docks and railroad stations, and the cost of the construction and operation must be taken into consideration just as the railroad and steam ship companies must take their stations and docks into consideration when building and operating their lines; but it must be remembered that these hangars are permanent.

In Germany the cities help the air ship companies by building these steel sheds for docking purposes. In 1911 Count Zeppelin laid before the Mercantile Institute of Hamburg, plans for a North Pole expedition, calling attention to the fact that this expedition was for the purpose of training “Zeppelin” crews to navigate the air over large bodies of water with the ultimate intention of crossing the Atlantic Ocean, the frozen ice of the north affording better opportunities to learn the causes and effects of the air currents over water, etc., and still permitting easy landings when necessary while gaining this knowledge. These plans called for large air ship docks both at Hamburg and Spitzbergen and the mercantile associations immediately agreed to build the necessary sheds in the interest of the commerce of Germany in general and the progress of their city in particular. The docks in Hamburg are already completed and when Count Zeppelin arrived aboard the “Z 3” on the morning of June first, at Hamburg to dedicate the docks after sailing the air for ten hours and covering a distance of about 500 miles between Friedrichshafen and Hamburg, 300,000 people took a holiday, and together with Prince Henry of Prussia, who is the official head of all of the government aeronautical forces of Germany, made that day one of extraordinary celebration and rejoicing.

# PIONEERS OF AVIATION

By Ladislav d'Orcy

## II. SAMUEL HENSON AND JOHN STRINGFELLOW

**BARON LADISLAV D'ORCY**, Hungarian by birth and Frenchman by education and sympathies, newspaper man and aviator, explorer and aeronautical expert, has been in close contact with aviation since its start in France by the first flights of Santos-Dumont. When but 17 years old, he led exploring parties into the interior of Albania, where he spent over three years charting unknown parts of that country; after a long voyage through central Europe the victorious Young Turk revolution found him in Constantinople as a war-correspondent and in 1910 he went on a year's travel to investigate the political and social conditions of India, China and Japan. What free time this strenuous life was leaving him, he spent it in studying aerodynamics, an endeavor his ample knowledge of languages—French, English, Italian, German and Hungarian, besides exotic ones—greatly facilitated. Baron d'Orcy is now writing a "History of Aviation" dealing with many important experiments which have never been made public heretofore. He is a life member and delegate of the National Aerial League of France, and the New York correspondent of the Parisian aeronautical daily L'AERO.

SIR GEORGE CAYLEY'S remarkable contribution toward the solution of artificial flight (see AIRCRAFT, Vol. 2, page 267), which really laid the foundation of the aeroplane theory passed, as could be expected, entirely unnoticed by the scientists of his time; and it was only in 1840 that a young enterprising English engineer,

and below the planes from their extremities to posts fixed in the center, thus giving the craft a great rigidity. The car contained a cabin for the passengers, the supplies and a steam engine of 25 to 30 H. P., which was to drive two propellers mounted behind the main planes. The total weight of the machine would have been about 3,000 pounds.

That Henson had a very correct knowledge of the needs of a practical flying machine is further emphasized by the fact that he had provided a vertical fixed keel of canvas above and between the main planes in order to assist the transverse stability, and that the surface of the planes could be decreased or increased according to the wish of the aviator.

Still, in spite of these promising qualities, the Ariel was never constructed at all, owing to the lack of capital.

In an article written for the *Popular Science Review* of 1869 Mr. F. W. Breary, Honorary Secretary of the Aeronautical Society of Great Britain, relates as follows Henson and Stringfellow's experiments:

"The fact is, the machine was never constructed; for after two abortive attempts to manufacture models at the Adelaide Gallery, which should represent the dimensions before named, he rejoined his friend (Stringfellow) at Chard, and the two together commenced their experiments under a variety of forms. . . . However, in 1844, they began the construction of a model; Henson attending chiefly to the wood or framework and Stringfellow to the power, and after many trials adopted steam. This model, completed in 1845, measured 20 feet from tip to tip of wing, by 3½ feet width, giving 70 feet sustaining surface in the wings, and about 10 feet more in the tail. The weight of the entire machine was from 25 to 28 pounds. . . . An inclined plane was constructed, down which the machine was to glide, and it was so arranged that the power should be maintained by a steam engine working two four-bladed propellers, each three feet in diameter, at the rate of 300 revolutions per minute.

"A tent was erected upon the downs, two miles from Chard, and for seven weeks the two experimenters continued their labours. . . . Many trials down inclined wide rails showed faulty construction, and its lightness proved an obstacle to its successfully contending with ground currents."

The failure of these experiments caused Henson to give up further investigation about flying machines, and shortly after he left Great Britain with his wife for the United States, where he seems to have settled in Texas. Not so Stringfellow, who did not lose his faith in an ultimate success and kept on modifying his models until he succeeded in making one of them fly by its own power.

This extremely interesting fact is disclosed in the same article we have referred to above, as follows:

"In 1846 he (Stringfellow) commenced a small model for indoor trials, and although very imperfect, it was the most successful of his attempts; the sustaining planes were much (Continued on Page 161.)

neer, Samuel Henson, began experimenting with small model aeroplanes at Chard. While we do not possess any creditable record of these early experiments, we must presume that they were rather promising, for Henson soon got in touch with a colleague of his, Mr. John Stringfellow, and communicated to him the results of his experiences; upon which the two men decided to go to London and build there a full-sized man-carrying machine.

For this purpose they organized in 1842 an Aerial Transit Company, which was to furnish them with the necessary funds for the construction of their so-called Aerial Steam Carriages, the first of them to be named the "Ariel." That the publicity end of the enterprise was well attended to is shown by the fact, that shortly afterwards thousands of prints and engravings, showing the Ariel in full flight over cities were sent throughout the United Kingdom and even over the Continent, where they aroused great interest and a still greater expectation, so much so that people even considered the feasibility of a flight across the Atlantic Ocean.

As a matter of fact, this experiment was well worth consideration, if one realizes that, according to the drawings available at present, the Ariel was to be a real aeroplane, which embodied most of the actual monoplanes' characteristics up to their smallest details and constituted thus the most marvelous anticipation on modern invention the world ever has seen.

If we follow up the scientific papers of that time, we see that the Ariel was to consist of a central body shaped like a boat and mounted on three wheels so as to enable it to start running on the ground; this body or car carried on each side a slightly

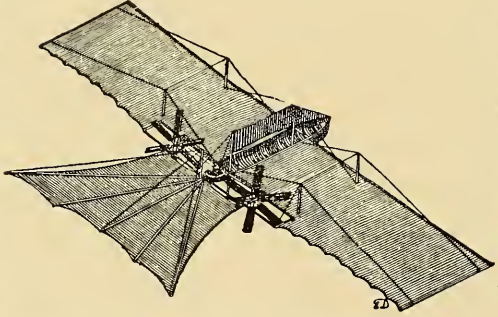

Henson's double propeller, steam driven monoplane, designed in 1842.

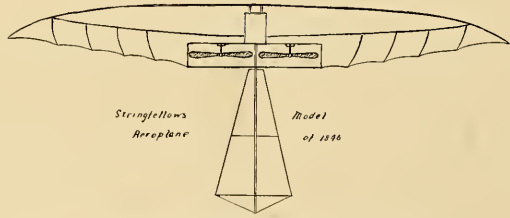

Plan view of Stringfellow's model of 1846.





THE NEW HENRY FARMAN MONOPLANE.

Henry Farman on his new monoplane just starting with his foreman, de Courtois, on a 140 kilometre cross-country test flight. Although Farman has been experimenting with monoplanes for some time past, it is only recently that he has got them working to his liking.

# FOREIGN NEWS

BY

R. H. BLANQUIE

## Austria

Giovani Vidmer, the young Austrian aviator, recently renewed his exploit of last year, crossing the Adriatic Sea on his 70 H. P. Gnome-Bleriot. He left Trieste and landed at Venice, after having covered the distance of 125 kilometres above the sea in 1 hour 18 minutes.

## Belgium

Henry Crombez, the Belgian aviator, renewed Roll's feat by crossing the English Channel back and forth without stopping on May 21. He left Nieupoort-Bains, Belgium, on his Deperdussin-Gnome 50 H. P., and headed for Calais, and from there headed straight for Dover. After having encircled that city three times he headed back for Calais, and from there went on to Nieupoort-Bains, his starting point. This wonderful flight was made at a height of 1,500 metres, and the total distance of 240 kilometres was covered in 2 hours 20 minutes.

## Canada

Aviation is attracting the attention of the customs.

Consul General John G. Foster of Ottawa reports that according to the Canadian Commissioner of Customs, aeroplanes on importation into the Dominion are dutiable under tariff No. 453, which reads as follows:

Telephone and telegraph instruments, electric and galvanic batteries, electric motors, dynamos, generators, sockets, insulators of all kinds; electric apparatus not otherwise provided for in the tariff; boilers not otherwise provided for in the tariff and all machinery composed wholly or in part of iron or steel not otherwise provided for in the tariff, and iron and steel castings, and iron or steel integral parts of all machinery specified in this item.—British preferential tariff, 15 per cent. ad valorem; intermediate tariff, 25 per cent. ad valorem; general tariff, 27½ per cent. ad valorem. Imports from the United States are subject to the general tariff, 27½ per cent. ad valorem.

## England

The officers of the military section of the "Royal Flying Corps" are to receive salaries as follows: The director of the central school of aviation, \$6,000 a year, besides being lodged. The commanders of the seven battalions, a little more than \$6,200 a day, which makes nearly \$2,400 a year. The pilot officers \$5,000 a day and the officers detached to take a course at the aviation school will have besides their regular pay an indemnity of \$1,000 a day.

A Harriot school has been formed at London under the name of "The British Harriot Company."

The "Daily Mail" of London has organized a series of exhibition meetings which will last thirteen weeks and will be held through Western England and Wales.

The dirigible "Beta," piloted by Lieut. Maitland, flew before the King and Queen at Aldershot on May 18th. The following aviators also flew: Captain Lorraine on Deperdussin; Captain Barrington Bennett on a Nieuport; Captain Burke; M. de Havilland and Lieut. Fox on British-made machines. The King and Queen heartily congratulated the aviators for their bravery. The design and construction of the new military tractor biplane is largely due to the efforts of Geoffrey de Havilland, to whom due credit should be given.

At the Hendon aerodrome week end meetings continue to be held with great success, exhibition flying and cross-country races being indulged in by Grahame-White, Gustav Hamel with Miss Davies as passenger, Lewis Turner, James Valentine, S. F. Cody, Ewen, Hucks, Moorehouse and others.

At a meeting on June 8th an \$1-mile race around London was held and was won by Gustav Hamel with Miss Trehawke Davies as a passenger. This flight netted him a purse of \$1,250 and a gold cup offered by the *Daily Mail*. Tom Sopwith finished first, but was disqualified for fouling.

## France

On April 27th, at Chartres, Frantz, chief pilot of the Savary school, succeeded in passing his military brevet in three days, at a height of 1,000 metres.

On April 28th, at Les Mureaux, a naval officer tried out the new Nieuport-Gnome hydroplane, which gave excellent results.

Two new entries were registered for the Le Matin Pekin-Paris race. These were Andre Frey, who will pilot a Harriot monoplane, and Allard, who will pilot a Caudron biplane.

On May 1st, Helen, on a Nieuport 70 H. P. Gnome, won the "Deutsch Cup," which went to the aviator making the best time in covering the circuit of Saint-Germain, Senlis, Meaux, Melun and Saint-Germain, which encircles Paris. Helen covered the distance in 1 hour 35 minutes at a speed of 126 kilometres an hour.

The new dirigible "Bayard-Clement number five," left its hangar at La Motte-Breuil on May 1st at 6 A. M. to make its trial flight and returned an hour later after having given entire satisfaction. This dirigible has a capacity of 9,000 cubic metres, and is equipped with two 125 H. P. motors, which give it a speed of 55 kilometres an hour.

A new hydro-aeroplane built by Verrier and tried out by Denhaut on the Seine River at Juvisy has given satisfactory results.

On May 7th, Vidart on a Deperdussin monoplane flew from Lyons to Nangis, a distance of 400 kilometres, in 5 hours.

Experiments with wireless telegraphy were recently made on a Savary biplane, which was piloted by Frantz, before a military commission at Chartres, which proved entirely satisfactory.

Nardini, the Italian aviator, who was expelled from France, left for England on May 11th by the aerial route on his Deperdussin monoplane. He started out from Villacoublay and landed at the aerodrome at Dover the next day, after having made a stop at Calais. He crossed the channel at a speed of 120 kilometres an hour.

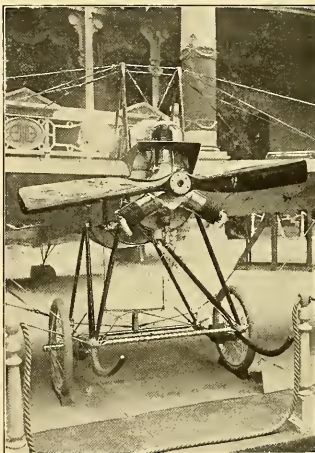

The Deperdussin school type machine, which is fitted with a 3-cylinder 28 h. p. V type Anzani. One of these monoplanes is used in this country by the Sloane Aviation School.

the mark at Curley Point. W. B. R. Moorehouse in a Kadley Moorehouse monoplane was given second place and James Valentine, Bristol monoplane, third place.



The new enclosed body Avro monoplane. The pilot sits low down inside the fuselage and looks out through the transparent non-inflammable windows. Why the engine has been so placed that it throws oil all over the windows and makes extended flights an impossibility is certainly a mystery. The new Rich enclosed monoplane shown on the next page has the engine placed high up in the fuselage in such a position that the oil is thrown back along the top and not directly onto the windows.

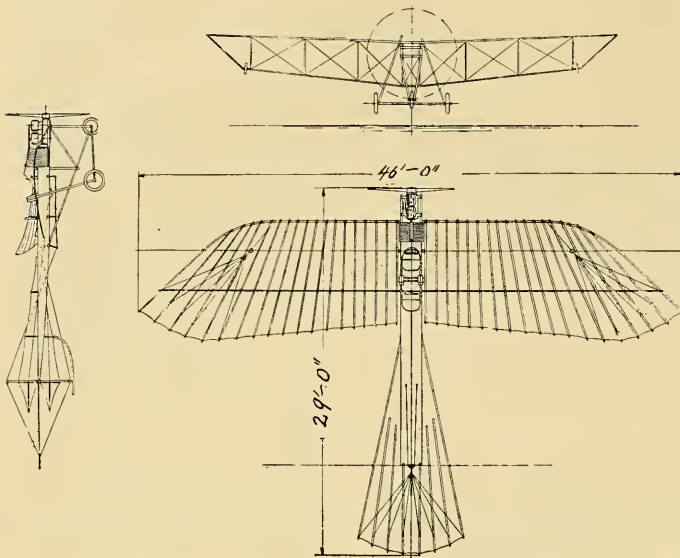

FRONT, TOP AND SIDE VIEW DRAWINGS OF NEW GERMAN GOEDECKER MONOPLANE.

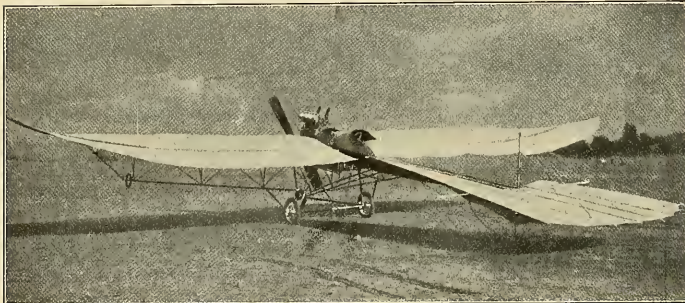

Rear view of the Goedecker monoplane "Stormbird." Note the novel three-wheel shock absorbing landing gear and also the trussing of the wings.

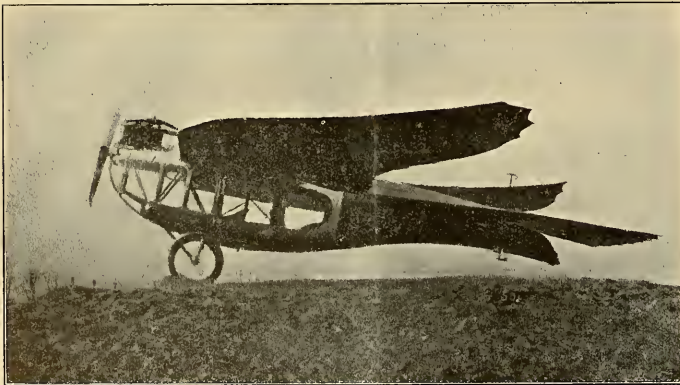

Side view of the new Etrich enclosed monoplane. Note the position of the engine high up in the nose of the fuselage, where it cannot throw oil all over the transparent windows of the car below. For originality of design, excellence of construction, wonderful stability and splendid achievements there are probably no monoplanes that can excel the regular Etrich machines, and for this reason this latest product of Igo Etrich will be watched with interest.

On returning from his trip to the United States, May 17th, Louis Blériot gave his impressions regarding aviation in that country, and said that the American public, and especially the American press, does not take sufficient interest in aviation and appeared greatly disappointed at the state of aviation affairs in America.

On May 21, the Clement-Bayard III, broke the world's altitude record for dirigibles by ascending at a height of 2,900 meters. The record was formerly held by the "Adjutant Reau" at a height of 2,150 meters.

Barra has abandoned the terrestrial biplane for a marine biplane, and will pilot a Curtiss hydro-aeroplane. In addition, two other well known French pilots have been converted to the Curtiss hydro-aeroplane; these are Mollin and Meschic, both well known monoplane flyers.

Hamel recrossed the English Channel on May 21 still in the company of Miss Davies, on his new tandem Blériot. He left Issy-les-Moulineaux, and after being obliged to land at Saint Martin, crossed the Channel and finally landed at Eastchurch, on the Island of Sheppey.

### Garros Wins "Circuit d'Anjou" Race

The big meet of the Aero Club of France, the "Circuit d'Anjou," was held on June 16 and 17. Owing to wind and rain on the first day Garros was the only competitor to complete the necessary three laps of the Circuit. On the following day, June 17, in spite of the still bad flying weather, Garros succeeded in accomplishing the last four laps. The distance covered was 683 miles, and the circuit flown round seven times was from Angers to Cholet, to Saumur, to Angers. Owing to the awful weather the flight occupied 15 hours 4 min. The entered machines and scheduled time of departures were as follows:

1. Deperdussin, 9 hrs.
2. Morane-Saulnier, 9 h. 2.
3. Bréguet, 9 h. 4.
4. H. M. Farman, 9 h. 6.
5. Bréguet, 9 h. 8.
6. Blériot, 9 h. 10.
7. Morane-Saulnier, 9 h. 12.
8. Sommer, 9 h. 14.
9. Sommer, 9 h. 16.
10. R. E. P., 9 h. 18.
11. Morane-Saulnier, 9 h. 20.
12. Morane-Saulnier, 9 h. 22.
13. Nieuport, 9 h. 24.
14. Hanriot, 9 h. 26.
15. P. Zens, 9 h. 28.
16. Astra, 9 h. 30.
17. Borel, 9 h. 32.
18. Astra, 9 h. 34.
19. Zodiac, 9 h. 36.
20. Nieuport, 9 h. 38.
21. H. M. Farman, 9 h. 40.
22. Deperdussin, 9 h. 42.
23. Nieuport, 9 h. 44.
24. H. M. Farman, 9 h. 46.
25. Caudron, 9 h. 48.
26. R. E. P., 9 h. 50.
27. Ladougue, 9 h. 52.
28. Deperdussin, 9 h. 54.
29. Morane-Saulnier, 9 h. 56.
30. R. E. P., 9 h. 58.
31. Blériot, 10 h.
32. Sommer, 10 h. 2.
33. Hanriot, 10 h. 4.
34. Blériot, 10 h. 6.
35. Deperdussin, 10 h. 8.

On May 30th, Hamel once more crossed the English Channel. He started out from Harellet, near Boulogne, and an hour and a quarter later landed gracefully at the aerodrome at Eastchurch, having covered the distance of 110 kilometres. This makes the seventh time that Hamel has succeeded in crossing the channel.

Curious trials were made under the direction of Lieut.-Colonel Estienne of the military establishment of aviation at Vincennes, on board an express train. A Blériot monoplane, placed on a truck with its wings spread, was put in flying condition on board a flat car of a train which ran at a speed of 110 kilometres an hour. All flying manoeuvres were gone through, such as warping of the wings, etc., and all the parts of the Blériot withstood the trials perfectly.

### Germany

A new model of dirigible will be built at Duisburg. The bag, which measures not less than 300 meters in length, will be divided in three compartments. Ten motors, giving a total capacity of 1,000 H. P., will propel it. Its carrying capacity will be 100 people, and the cabins will be heated by steam.

A sum of 25,000 marks has been given by the city of Osnaburg for the purchase of a military aeroplane.

**Circuit of the Upper Rhine**

Civil Engineer Hirth, considered by the Germans as their best aviator, was the only one who succeeded in completing the course going from Strasburg to Metz, without stopping. He covered the entire distance of 130 kilometres in 89 minutes. Count Folskeel arrived second at Metz, taking 15 hours 28 minutes. Several others also arrived the next day. The second stage of the circuit, Metz-Barrebuick, was again won by Hirth, covering the distance in 1 hr. 35 mins. The sixth and last stage of the circuit, Firburg-Constanze, was won by Hirth, who classed himself first for the circuit. The others classed themselves as follows: Second, Bahrens; third, Wolfskeel; fourth, Mahnke.

**Hirth Wins Berlin-Vienna Race**

The aeroplane race from Berlin to Vienna, run under the auspices of the Imperial Aviation Society and the Austrian Aero Club, on June 9th, was won by the German aviator, Helmuth Hirth, carrying as a passenger Lieutenant Scheller, of the German army. Hirth, with his companion, covered the distance from the German capital (330 miles in a direct line) in 395 minutes (6 hrs 35 minutes) actual flying time.

The three Austrian officers, Lieutenants Blaschke, Müller (alias Csakay) and Bergmann, were forced to land on the way here from Breslau. Lieutenant Csakay was the best performer in the first stage of the contest, from Berlin to Breslau, about 200 miles, which he accomplished in 2 hours 58 minutes.

Hirth in the course of his flight flew over the Altwater Mountain range in Moravia, which rises to an altitude of 4,887 feet.

The airship "Zeppelin III," made a trip from Hamburg to Bremen on June 2nd with Count Zeppelin in command. Prince Henry of Prussia and Burgomaster Burchard were passengers. Owing to a storm no landing was made at Bremen, and after varying its course several times the "Zeppelin III," returned to Hamburg about nine o'clock in the evening.

**Germany**

By Stella Bloch

Friedrichshafen, the home of the Zeppelins, is to witness the erection of an aeroplane plant in the near future, as Herr Kober, one of Count Zeppelin's most successful engineers, is constructing a flying machine he hopes will be successful. The Count is both financially and actively interested in the enterprise.

A new German endurance country record has been set up by Lieut. Canter, accompanied by Lieut. von Delten, on an Erlich-Rumppler-Taube A 6, with a 70 H. P. Mercedes motor. The aeroplane is the property of the military department and started from Doberitz at quarter to five in the afternoon, landing at Naumburg after a flight of 3 hours, 10 minutes.

Interesting comparisons were made at Mayence, during the quick start tests of aeroplanes, when the huge Zeppelin cruiser "Viktoria Luise" participated, to get a comparative idea of speed. Without throwing out any ballast, the "Viktoria Luise," with its crew of nine, five passengers, 700 kilogrammes of petrol and 1,300 kilogrammes of water ballast, mounted to a height of 1,000 metres within five minutes, whilst the best aeroplane only attained an altitude of 500 metres in the same period.

The aeroplane built by the H. R. II. Prince Siegmund of Prussia came to grief at Potsdam-Bornstedt aviation ground. The pilot, Kanitz, was caught by an air current whilst effecting a turn and pressed down to the ground, thereby severely damaging the apparatus; the pilot, however, escaping with a few scratches.

The Imperial Diet has granted a sum of 200,000 marks for the erection of a National Aeronautic and Aviatie Laboratory, and has also granted a subsidy of 50,000 marks for initial expenses. The new institute will devote itself to technical research and with all questions pertaining to the use of aerial craft.

The "Schwabens" passenger cruiser, built by Count Zeppelin, accomplished its two hundredth trip on May 31, in these trips 5,000 passengers have been carried and 2,500 kilometres, reckoned as the bird flies, covered in all.

A new German altitude record was put up during the national week at Johannisthal, from May 24th to 31st, by Abramowitsch, carrying a passenger, in which flight he attained a height of 2,000 metres. Ellery von Gorrissen won the Emperor's Altitude Prize with 880 metres, after close running with Rosenstein, who reached 650 metres. Official figures are not yet at hand, but Abramowitsch tops the list with a total of 14 hrs. 30 mins. with a Wright machine, K. A. G. motor; Rupp-Albatross comes second with 11 hrs. 3 mins.

The long list of Zeppelin achievements has been topped by the nocturnal journey from Friedrichshafen, on Lake Constance, to Hamburg during the night from May 31st to June 1st, when the distance of 660 kilometres was covered in ten



A German "Skimmer," or small one-passenger boat fitted with an aeroplane attachment and driven for short distances by two very powerful rubber band motors. The craft is an experimental one, and is designed for testing the efficiency and stability of various kinds and shapes of planes.

hours and a half. As it was full moon, all the towns en route were awake to greet the aerial monster "L. Z. 3" as it passed in its majestic flight. Remarkably enough, the sight of a Zeppelin creates an impression on the spectators that no other make can rival—heightened by the touch of romance connected with the life of its inventor, General Count Zeppelin, fighter in the Civil War of North America, the dashing patrol rider of the Franco-Prussian War and the man who held to his airship constructions in the teeth of an early opposition that would have broken down and thwarted most men.

The Suchard airship, destined for a transatlantic voyage, stood its first tests on June 1st very satisfactorily. Dr. Gans and Herr Bracker, the promoters of the tour, were on board, as were Lieut. Schulz, Capt. Juergens and Herr Albers, who will help to pilot the vessel on its arduous journey.

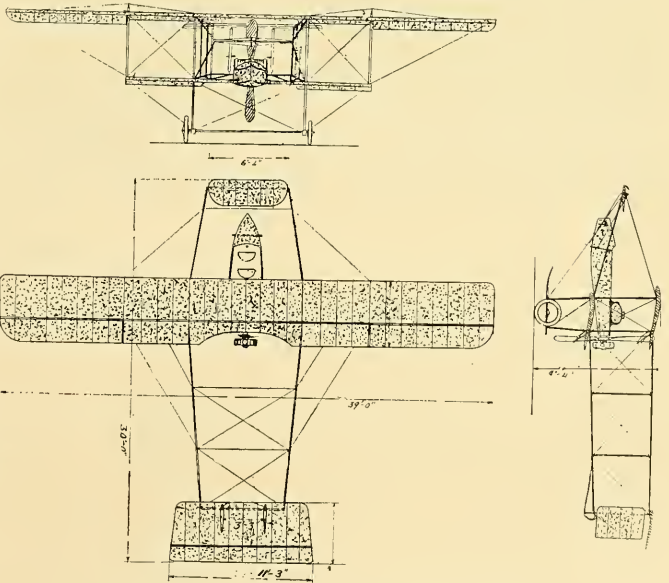

SCALE DRAWINGS OF THE NEW "TYPE DE COURSE" SOMMER BIPLANE.

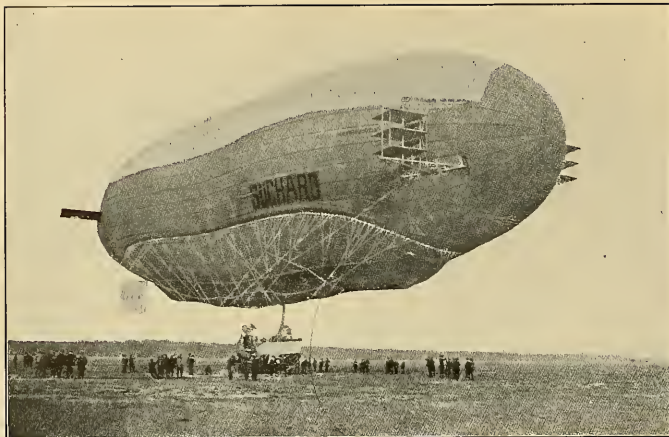

THE TRANS-ATLANTIC DIRIGIBLE "SUCHARD" ABOUT TO START ON HER RECENT SUCCESSFUL TRIAL FLIGHT AT JOHANNISTHAL, BERLIN.

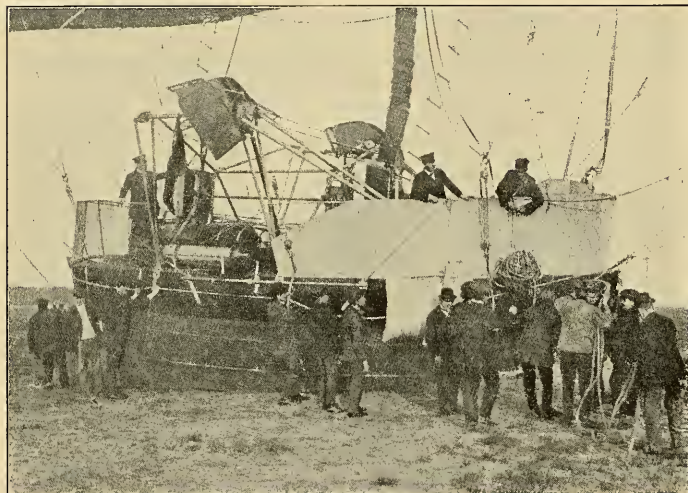

THE COMBINED MOTOR BOAT AND GONDOLA OF THE "SUCHARD."

**Holland**

Conver, at Assen recently, made a very good flight on a Blériot-Anzani above the city at a great altitude, taking with him a Dutch officer as passenger.

**Italy**

Her Majesty the dowager Queen Margherita, has subscribed 20,000 francs for the aerial fleet. The Central Committee has decided that the dirigible fleet, which now numbers three, will be raised to seven within the next three months. The Minister of War has ordered the Deputy Montu to form a corps of volunteer aviators, which shall be ready at all times to unite itself with the army corps of aviators in case of need. This corps will participate at the manoeuvres every year.

**Russia**

The military aviation school of Sebastopol is actually going forward in the construction of a new aerodrome, which will be situated at a distance of 20 kilometres north of Sebastopol and will cost 400,000 roubles (\$192,000).

**Spain**

On May 12th, Marc Bonnier received three Nieuport monoplanes, which were ordered by the Spanish government. While making a two hours' flight, with a 50 H. P. motor and carrying a load of 210 kilograms, he flew over Madrid at a height of 1,500 meters for an hour with his mechanic, Andrieux, as passenger.

Pierre Lacombe, flying a Deperdussin monoplane fitted with a 50 H. P. Gnome, made a beautiful flight at Ta'alla, reaching a height of 1,500 metres over the mountains in a gale.

**Dr. Gans' Transatlantic Trip**

Dr. Gans' trip across the Atlantic is a demonstration of what an airship of very moderate size can do in the way of conserving its endurance for a distance of over 3,000 miles. If Dr. Gans' ship, the "Suchard," which is not more than one-third as large as the Zeppelin, can last for 3,000 miles, a Zeppelin that carries more than three times the amount of gas and conserves it much better because of a double envelope, which is to say carries it two months under much more trying conditions, overlaid, can easily cross the Atlantic Ocean when it is built of sufficient size. Jos. Brucker is a German-American, and is the father of the idea of the use of the Trade Winds on which to cross the Atlantic Ocean. Three years ago he went to Germany to raise the money to carry out his trip and there met Dr. Gans, who became interested in Brucker's idea, constructed the type which should carry out his idea. The Suchard's trial flights have proved entirely successful. The ship is being packed up and will be sent to Tenerife, there to remain until they start on their flight next March, carrying a crew of six, including Dr. Gans, Joseph Brucker and Dr. Eugene Alt, assistant director of the Bavarian Meteorological Bureau. The commander is Capt. Willey Joerdens, an experienced airship captain. The navigator will be a retired naval officer, besides an engineer. The ship's 220 H. P. is divided between two motors of the approved Parseval type. The Suchard is practically a Parseval airship, and its most novel feature is a motor boat that carries the engines, crew, propellers and entire equipment. It can be cut loose instantly from the gas bag, and at this instant the belly of the gas bag is torn open by the rip cord and the gas immediately escapes; the bag drops and is towed to land. This provides for bringing the entire airship back in case the crew is forced to take to the sea to finish the trip. T. R. Mac-Mechen, of New York, is one of the business partners of the American expedition, and sole agent and general manager as well.

**SUGGESTED DESIGN FOR A PRACTICAL HYDRO-MONOPLANE**

By Walter H. Phipps

Probably most of our readers have noticed the tendency in the construction of present day hydro-aeroplanes to adhere to the biplane type rather than the monoplane form. This is undoubtedly because the ordinary rear propeller biplane lends itself to the proper attachment of floats without the necessity of re-designing and rebuilding the whole machine, while

the tractor monoplane, although it can be easily fitted with hydro-planes, is difficult to handle on the water and especially dangerous in alighting, owing to its tendency to dive and entrap the pilot

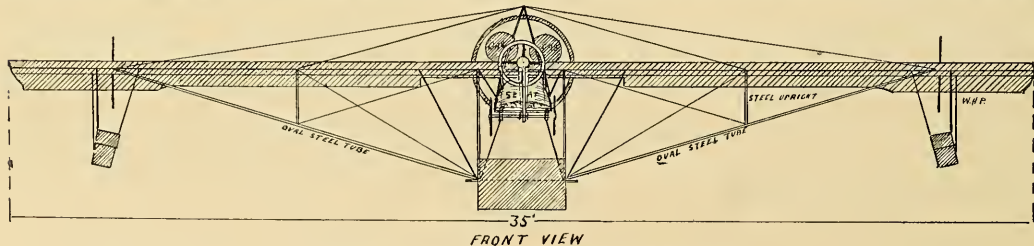

DIAGRAMATIC FRONT VIEW OF THE SUGGESTED DESIGN FOR A HYDRO-MONOPLANE. (Not to the same scale as the accompanying drawings.)

# Suggested Hydro-Monoplane

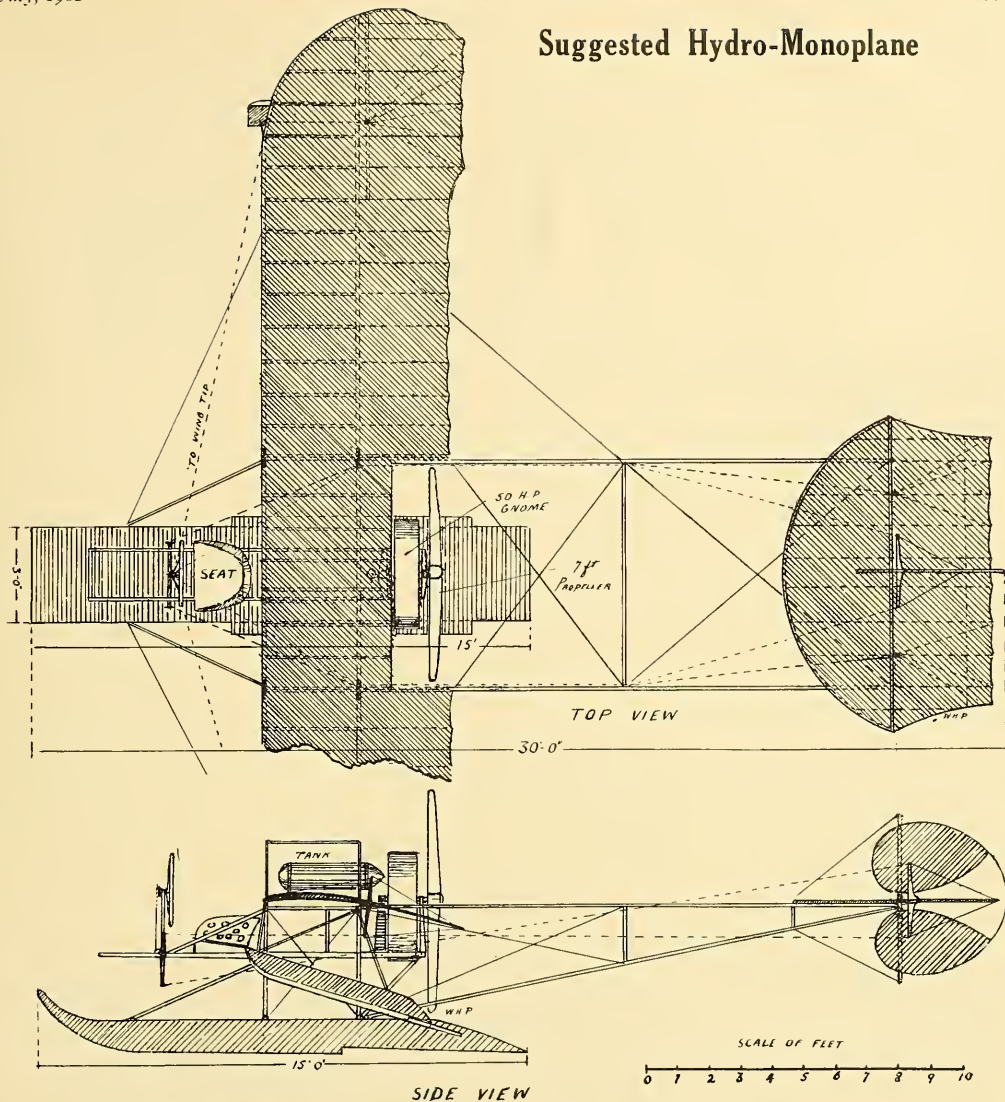

SCALE DRAWINGS OF THE SUGGESTED HYDRO-MONOPLANE. TOP AND SIDE VIEW OF THE MACHINE.

in the fuselage, this same drawback applying to all present day types of hydro-aeroplanes using a covered-in fuselage body.

It will readily be seen from these facts that a hydro-monoplane must be so designed as to eliminate the disadvantages of the tractor types and at the same time retain the advantages of the rear propeller biplane types, and it was with this object in view that the writer evolved the accompanying design.

For the sake of clearness, each section is described separately with an explanation of the suggested changes and functions of each. It is hoped that this method of procedure—like the one adopted in describing the suggested land monoplane in the January *AIRCRAFT*—will also lead to discussions and improvements and attract attention to the special requirements of a hydro-monoplane.

### SEATING AND ENGINE SECTION.

In building a monoplane it is necessary to have a strong and rigid central section to which to attach the planes. In tractor screw machines this usually consists of a long fuselage extending back

to and supporting the tail, but as it is obviously impossible to use a central rear propeller on a machine having a fuselage it becomes necessary in evolving a rear propeller monoplane to substitute some other arrangement for supporting the planes, and this can be done as on the early Curtiss monoplane and Walden machines by making the landing gear, seating and engine section practically all one rigid unit, to which the planes can be attached and braced. This arrangement, if used on a hydro-monoplane, would tax the strength of the float as well as present difficulties of assembly and dissembling for transportation, and for these reasons (as will be noticed in the accompanying drawings) a small rectangular framework supporting the engine and seat has been substituted instead.

### PLANES.

Glancing at the accompanying drawings, it will be noticed that the wings are of the Caudron type, having the front part rigid while the rear half is flexible and arched down considerably when the machine is not in flight. This arrangement of wing construction, while presenting many

advantages in land machines, presents even more on a water machine, these being: The downwardly arched flexible rear edge of the wings aids in getting off the water at a lower speed than would the usual rigid surface, and yet at the same times does not retard its flying speed, as the rear edge flattens out considerably in flight, thus changing the angle without materially affecting the lift.

This is the reason that the little Caudron monoplane with only 90 square feet of surface is capable of getting off and alighting on the ground at a much slower rate than its flying speed of 85 to 90 miles an hour, this same point, of course, applying to the water monoplane illustrated herewith.

In addition, the flexibility of the wings aids in producing increased stability, by reason of the fact that the planes bend upward when struck by head-on gusts, thereby allowing the gusts to pass on without greatly affecting the balance, and also this flexible edge can be warped for preserving lateral balance.

The main plane of the suggested hydro-monoplane is designed to be built in three sections, and has a span of 35 feet and a chord of 6 feet, which, allowing for the narrowness of the central section, gives a

supporting surface of nearly 200 square feet, which should be ample, considering that the weight of the whole machine, including 50 H. P. Gnome or other light but powerful aeronautical motor, should not be over 600 pounds, and perhaps with careful construction even less. The Curtiss 75 H. P. hydro-biplane weighing 850 pounds.

**BRACING.**

The wings are braced from above in the usual manner by wires running from a pylon mounted on the engine section to suitable anchorages on the main-spars, but in place of the usual wire braces underneath, small oval steel tubes have been sub-

stituted to give added strength and rigidity to the whole, thereby making wings, floats and all, one solid rigid structure.

**FLOATS.**

In the accompanying design the machine is shown fitted with a single main pontoon, for purposes of strength and rigidity, but there is absolutely no reason why two pontoons could not be substituted, especially when it is taken into consideration that they could be braced to the central section as well as the engine frame. As will be noticed the pontoon is of the single step type with air vent to facilitate quick rising from the water, and has the nose turned up to prevent

diving. At the tips of the wings are fitted two auxiliary pontoons to prevent the ends of the wings touching the water.

**CONTROL.**

The controlling arrangement consists of flexible warping tips, a warping tail and a split double vertical rudder. These controls could be operated by any of the usual methods, but for simplicity's sake they are here shown connected up to a Dréguet type three-in-one control, which actuates by a fore and aft movement the elevator, sideways movement, the wing tips, while turning the wheel, steers the machine.

**THE NEW "BENOIST" TRACTOR SCREW BIPLANE 1912 TYPE**

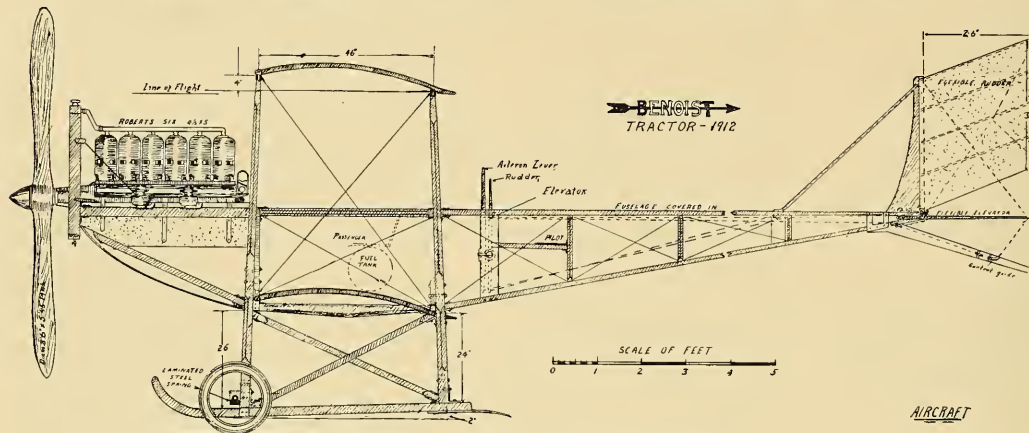

SIDE VIEW SCALE DRAWING OF THE 1912 BENOIST TRACTOR BIPLANE.

The new Benoist tractor machine, known as type twelve, is the result of the last several months' application to the refinement of details, and close attention to accomplishing many small improvements over the preceding machines. While these improvements considered separately and alone would not have marked a very great difference from the two passenger school machine of 1911-12 style, all of them in an aggregate gives one an impression that the machine is a new type entirely.

Like the older machine, it uses steel springs instead of rubber shock absorbers. These have not been changed at all, as they have been found to be very successful, in fact so successful that some of the European manufacturers have copied them with certain variations several times in the last few

months. An accompanying photograph shows these springs very plainly. The six cylinder Roberts motor is set clear out in front, and with the radiator mounted between the tractor and the engine, which makes a very compact assemblage. The ailerons are very large, (each one having twenty square feet of surface. The tail is non-lifting, and like the rudder and ailerons, flexed for control.

This machine is a two-passenger, and will carry enough gasoline for a two hours flight with both seats occupied. It is one of the first American machines in which comfort has been considered in the seating of passengers, as both seats are wide and roomy, and the lower part of the passengers' bodies are protected from the wind because of the depth of the fuselage.

There is, however, but very little head-rest-

ance, as the radiator, engine, passenger and aviator are all mounted tandem fashion in the stream line body. The standard machine is equipped with twenty by four inch Clincher tires, and covered all over with Goodyear No. 10 cloth, the standard gasoline tank holding fifteen gallons, and being mounted inside of the engine frame carrying an air pressure of two pounds. This assemblage eliminates a great amount of the danger from fire as a result of a smashup, in which the gasoline tank is hung above the engine, thereby breaking the gasoline lead, and setting fire to the wreckage.

The general dimensions are as follows: Span, 35 feet; length over all, 24 feet; chord, 4 ft. 9 ins.; area of main planes, 240 sq. ft.; area of elevator, 26.6 sq. ft.

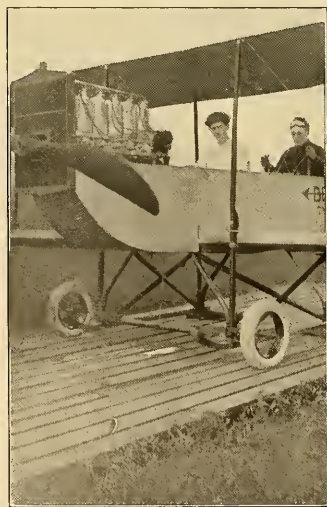

Detail view of the new Benoist tractor biplane, showing the nose of the fuselage, position of the Roberts motor and the novel two-spring and leaf spring landing gear.

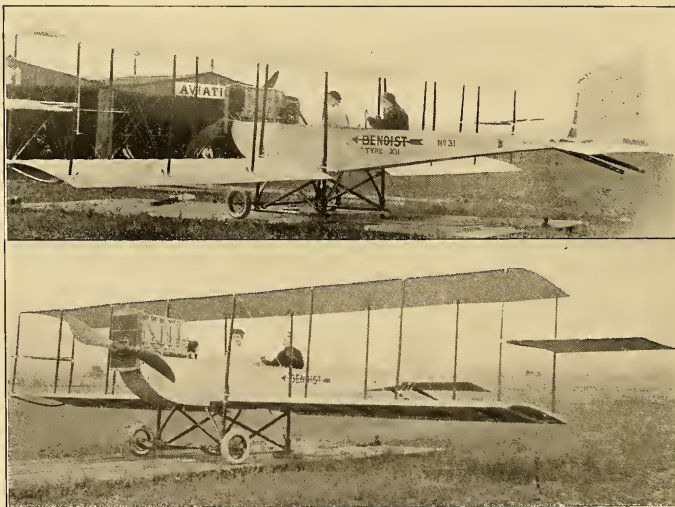

Two views of the new Benoist tractor. Note that the tail, rudder and ailerons are flexible, and are warped for controlling the machine.



FRONT VIEW OF THE AMERICAN AEROPLANE SUPPLY HOUSE'S NEW FACTORY AT HEMPSTEAD, LONG ISLAND.

## THE TRADE

The Fox de Luxe Aero Motor, shown in the cut, has been designed and built by the Dean Mfg. Co., Newport, Ky., and is the result of nine years of experience in gas engineering. The following detailed description by Mr. A. G. Dean is of interest, showing the recent development of aero motor design, material and construction, and what is to be looked for along this line.

**PRODUCTION:** We will assume that you are familiar with the construction of two-cycle motors of the three-port type, where there is no valve or spring on the motor. The design of the Fox De Luxe aero motor for 1912 has combined the advantages of the three-port motor and the two-cycle two-port motor, by the use of what is known as a rotary valve.

**DESCRIPTION OF THE ROTARY VALVE:** This rotary valve is located on the right hand side of the motor, and is in the form of an aluminum manifold, connecting all cylinders. The valve proper is a bronze casting in cylinder form inside of this manifold. The rotary valve shaft is a part of this casting with the shaft extending at both ends with end bearings, which are a part of the manifold. The rotary valve shaft is driven by a short shaft at the forward end of the motor through two sets of gears, carefully meshed with a gear on the rotary shaft and a gear on the crank shaft.

**MAGNETO:** The magneto is located at the forward end of the motor, and is driven through gears by the same short shaft which drives the rotary valve.

**WATER CIRCULATION:** The water circulation on this 60 H. P. model CC is extremely simple. The rotary gear pump is located at the rear end of the rotary valve manifold, and is direct driven by the rotary valve shaft without additional gears. The water circulation passes from the pump along the under side of the rotary valve manifold. Distribution of water is made to each cylinder without additional piping connection, as it is a part of the rotary valve manifold which is easily connected and can be readily removed from the cylinders. The circulation of water passes around the exhaust port of each cylinder and reaches the cylinder head, where it is taken off at the highest point, and returned through a manifold across the top of the cylinder heads.

A close inspection of the above description and cuts will bring out a number of special features on this new type CC Fox de Luxe motor. The location of the rotary valve is in such a position that it is not subject to pressure, either from the crank case or from the cylinders, since the ports at the time of compression in the crank case, and during the power stroke in the cylinder are covered by the piston.

On the upward stroke of the piston the rotary valve manifold is uncovered by the ports in the piston, and fuel is drawn into the crank case, when on the downward stroke, the intake port in the cylinder is uncovered, the compressed charge in the crank case passes directly into the cylinder without creating back pressure on the rotary valve, as is done in other designs.

It can readily be seen that there is a marked advantage in having the rotary valve operate freely and not subject to any back pressure, either from the cylinder or the crank case. The use of the Fox fourth port accelerator shown in the photograph insures a full crank case charge, even at the high speed of 1600 R. P. M., at which speed this motor is guaranteed to run continuously.

**Messrs. Thomas Brothers,** of Barb, New York, report that Walter E. Johnson made three very successful flights at Middleboro, Ky., on May 24,

25 and 26, flying one of the Thomas Model 10-A biplanes.

**The B. F. Goodrich Company,** of Akron, Ohio, is one more of the large concerns which have already made their success in the automobile industry, to enter the aeronautical field. This company is now making a specialty of aeroplane and balloon cloth. This cloth they are advertising extensively all over the world under the name of "Lumina," claiming that it has a great many special points of excellence not contained in other makes. It might be well for the reader who is interested in the subject to write to the B. F. Goodrich Company for a sample of this cloth, which they offer to send free of charge.

**Mr. Frederick H. Brauning** states that on Sunday, June 24, at Belmont Park, the Gressier "Duck" had a successful tryout and created a favorable impression by the easy manner in which it arose from the ground and flew through the air. This is the first machine of the Canard type to fly in America.

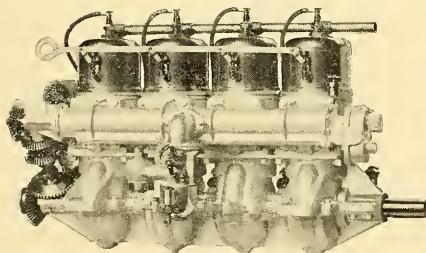

THE FOX DE LUXE AERO MOTOR.

**The American Aeroplane Supply House** inform us that they are prepared to make immediate deliveries of four of their Blériot type monoplanes, two of which are passenger carrying monoplanes and the other two single-seaters. One of each of these machines is now set up in their factory at Hempstead, New York, and they invite prospective purchasers to pay them a visit and examine in detail the design and workmanship of their machines.

**The National Implement and Vehicle Show,** which will hold an exposition at Peoria, Ill., on September 27th to October 5th, have included an aviation programme and would like to hear from all those who are interested in the same. Communications can be addressed to Eugene Brown, chairman of the aviation committee.

**The Mars-Fowler Aviation Company** has been organized in Kansas City with two of its members well-known aviators—"Bud" Mars and Robert C. Fowler. Fowler recently made some remarkable flights over Kansas City in order to show the inhabitants the capabilities of an aeroplane.

**The R. O. Rubel, Jr., Co.,** of Louisville, Ky., owing to a shortage of working capital, have made an assignment. The Grey Eagle Motor, which they have been exclusive agents for in the past two years, they had marketed direct from the **Kemp Machine Works** of Muncie, Ind., the manufacturers of Grey Eagle Motors. The Kemp Machine Works reports business very brisk, four 6-cylinder motors have been sold in the last two weeks, one

of which went to Mr. H. Peterson, of Nome, Alaska. The Kemp Co. are now enlarging their plant and expect to double their output of motors in the very near future being unable to keep up with the orders on the new 6-cylinder 50 H.P. motor at the present time.

**The California Aviation Company** report that students are being graduated from their school continuously, some of the recent graduates being Albert S. Fry, Orvan Meyerhoffer, Thaduis S. Kerns, Francis, Von Ofen, Udious, etc.

**Maximotor Makers** of Detroit report that the aeroplane of the Detroit company of the Michigan Naval Reserves is now equipped with the model 1 Maximotor at the flying grounds on Fox Creek.

There are now from 1 to 8 Maximotors in each of the 27 States of the Union, besides others in a number of foreign countries.

The National Vulcanizing Company has just received its Military Model G, Maximotor for long cross-country flying.

The Military Maximotors are made in three models—G, a 4-cyl. of 70 h. p.; H, a 6-cyl. of 105 h. p., and J, an 8-cyl. of 140 h. p. These were intended chiefly for army use on government aeroplanes. They are equipped with clutch, flywheel, muffler and self-starter.

However, the Model G on exhibition at the recent New York Show attracted a great deal of attention from exhibition aviators who at once saw the exceptional features of the engine for cross-country and inter-city work.

The demand has led Maximotor Makers to put these motors on the market without the muffler, clutch, etc., especially for exhibition flying.

Maximotors have been recently sold to the Kuhnert Aerial Construction Co., Hackensack, N. J.

Graham & Gandy, Auto Mfg. Co., of San Francisco, Cal.  
Allen Perkins, Missoula, Mont.  
G. P. Blackiston, Canton, O.  
Snyder Aeroplane Co., Osborn, O.  
F. Beckwith, Mineola, N. Y.

In addition to their "Spiron" business, the **Diana Aero Co.,** of Detroit has its hands full with aeroplane and hydro-aeroplane orders.

**W. J. Snow,** the well-known Iowa balloon exhibition man, has received his first hydro-aeroplane—a Diana 32-footer.

This plane has its elevator in the rear, controlled by a hand lever. The 5½ ft. span wings are warped by another hand lever. The rudder is guided by a foot lever. The magneto circuit is governed by a push button in the top of the elevator lever. The struts at the ends of the wings are fitted with ball and socket brackets to increase the flexibility.

The planes are double covered with No. 8 Good-year fabric.

The running gear is of the Farman type. For use on the water, the wheels are replaced by the pontoons, which are fastened to the skids.

The 70 H. P. engine and single propeller are placed in the usual position behind the aviator.

At its factory on Baldwin Ave., Detroit, the Diana Company has two other planes almost complete. One of these is a headless, while the other is equipped with front elevator.

The headless plane is for river flying during Detroit's great Cadillac week in July.

We have just received a copy of a new catalogue issued by the **Roberts Motor Company,** of Sandusky, O., which shows a most remarkable development in not only aeronautical motors, but in the complete methods adopted by the aeronautical manufacturers to market their engines.

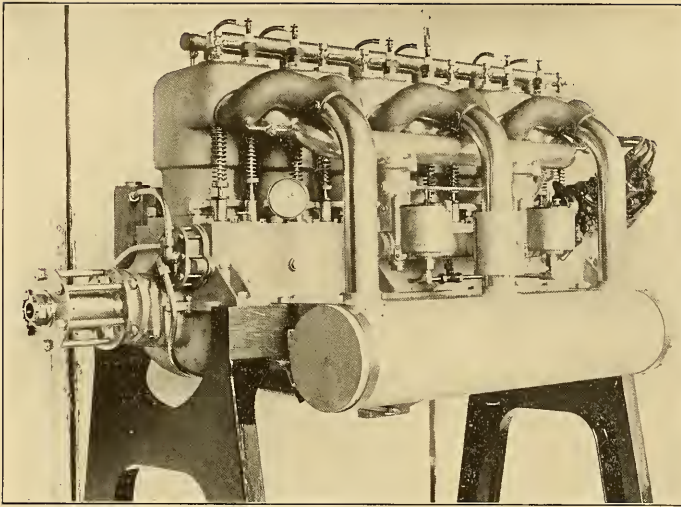

The new 6-cylinder 60 H. P. Sturtevant water cooled motor fitted with muffler and exhaust heated carburetor. The muffler, which is a very efficient silencer, weighs complete only 18 pounds, and is so designed that there is practically no loss of power occasioned by its use.

This catalogue tells first of the achievements accomplished by the Roberts motor; secondly, treats on the difference between the 2 and 4 cycle motors, and thirdly, gives a very interesting and technical description of the Roberts motor, how it works, how it is made and illustrates the different aeroplanes in which it is installed. Those interested in details should write to the Roberts Motor Company for a copy of this catalogue.

The careful attention to details as well as the general excellence of design of the **Sturtevant Aeronautical Motor** was favorably commented upon by visitors at the recent Aeronautical exhibition in New York. The comfort of the aviator and the peace of the public at large are assured by the use of the muffler with which these motors are equipped. The loss of power due to attaching a muffler is slight, not exceeding 5 per cent, while only the inconsiderable extra weight of 18 pounds is added.

When the utmost is required of the motor, the muffler may be instantly detached and the motor run without it.

The ability to efficiently muffle the engine makes it especially desirable for driving high speed motor boats and hydroplanes, a field to which this motor is particularly adapted.

The makers realize that the aeroplane of the immediate future will require a motor which can be efficiently muffled. For this reason the Sturtevant Company have adhered to the 4-cycle automobile type, and do not use auxiliary exhaust ports. The muffler is not furnished as an auxiliary of secondary consideration, for the purchaser to attach as best he can but as a part of the motor itself.

The **Dean Mfg. Co.**, of Newport, Ky., are pleased to report a very large demand for their new type 4 CC, 60 h. p. Fox DeLuxe Aero Motors. This motor weighs 240 lbs., including magnets and two separate carburetors; and is rated at 60 h. p., but actually develops 65 h. p. on the block.

Among recent orders are—one for Mr. Bumbaugh, of Indianapolis, which was delivered about two weeks ago; one for F. Kaiche, of The Standard Aviation Co., of Clearing, near Chicago, Ill.; one

for Mr. Hulbert, of Jeffersonville, Ind., which will be delivered next week; one for the Sealer Co. and the Society of Aeronautical Engineers, of Philadelphia, which latter already have one of our 24 h. p., 4-cyl. Fox DeLuxe motors, bore and stroke 3 1/2". The Phillips Co., of Somerville, Mass., have also placed their order for delivery July 1st.

At this time the best delivery possible on this type of motor is four weeks from receipt of order, although within 30 days The Dean Company expects to be in a position to make much quicker delivery.

The **International Aeronautic Construction Company** reports business exceptionally good this season, their factory force being taxed to their utmost capacity to produce machines to comply with the time requirements of orders received. They state that they have already turned out three Curtiss type machines, one Farman type as well as several special machines. Amongst recent orders was one for an Avro type tractor biplane, which is to be fitted with a 60 H. P. motor.

The **Frontier Iron Works**, of Buffalo, N. Y., is apparently in the aeronautical motor building trade to stay and they are now arranging to have their motors represented by big concerns in the different cities in the United States. They have already selected their New York City representative, and in the future the well known and exceptionally successful supply house of E. J. Willis will look after their New York business.

**Didier Masson**, the famous French aviator, who has been making exceptionally fine exhibition flights in all parts of America during the past two years, is extremely liberal in his praise of the Paragon Propeller which he has been using on most of his flights, and for which he gives credit, to a large extent, for his success. This propeller is manufactured by the well known concern, The **American Propeller Company**, of Baltimore, Md. Mr. Masson's representative, Mr. J. W. Mason, is also entitled to a great deal of credit for the latter's success as well.

The various schools of the **Curtiss Aeroplane Company** continue to turn out qualified aviators in large numbers, and the notable part of it is that these students come from almost every country in the world, which might be taken as an indication that sooner or later the American made flying machine is going to be marketable in many foreign countries as well as at home.

**Captain Thomas Baldwin** is living up to his long established reputation for stability by the continuance of aeroplane construction on even a large scale than heretofore. The Baldwin biplane, besides being used in the Philippine Islands, Japan and China, has many American owners as well. Captain Baldwin is at present developing some very remarkable young aviators, who will comprise his exhibition flyers on a round the world trip, which will be begun in a short time. Captain Baldwin's most recent protégé is Cecil Peeli, who is but eighteen years of age. He recently made a 45 mile trip at an altitude varying from three thousand to five thousand feet after but five actual flying lessons.

## GENERAL NEWS

By D. E. Ball

### New England Notes

New England activity this year more than ever before has centered about the aeroplane manufacturing plant at Marblehead, where the Burgess-

Curtis pilots have been flying daily since early spring and where the inhabitants of the little town have become as familiar with aviation as with automobiles. Near by, at Saugus, Atwood is

operating a school. Squantum is being used chiefly as an experimental field, and a number of inventors have machines there.

Aerodrome flying in New England began on Memorial Day at Rockingham Park, Salem, N. H., and at Atwood Park, Saugus, Mass. Beachey and Charles F. Walsh, Curtiss aviators, provided the entertainment at Rockingham, their stunts solving a large crowd that had expected to see automobile racing, for which the track was unfit.

The same day 5,000 people attended the meet at Saugus, where Atwood carried mail from a field station as a special courier of the Lynn post office. It required 12 minutes to transfer the mail to the office. By ordinary routes it would have required half an hour. The fliers on Memorial Day were Harry N. Atwood, George A. Grey, Philip W. Page and Frank J. Terrell. The next day Arch. Freeman took charge of the mail and Beachey participated in the flying, having come down from Salem. Beachey in an 80 H. P. Curtiss raced three motorcycles for three miles, overtaking them repeatedly. High flying, daring *cofs plans* and general exhibition work was also indulged in.

### Mineola and Nassau Boulevard

There was much activity at both the Mineola and Nassau Boulevard fields during the last month. In spite of the fact that many of the sheds were being torn down at Nassau and the place was generally upset, those who remained to the last got in some good work and fine flying was accomplished by Beatty, Dyott, Sherwood, Boyd, Morok and others.

Beatty is still busy turning out pupils and incidentally making some record breaking passenger carrying trips. S. P. Beckwith has recently graduated from the Beatty school, passing his license tests in a high wind. George M. Dyott, instructor at the Sloane Aeroplane Company's



Mr. Harry Brown, who has lately been doing some remarkable flying in a Wright biplane over his own private grounds at Hicksville, L. I.



school, was kept busy with the Deperdussin monoplanes. In teaching pupils Mr. Dyott uses a passenger-carrying machine to give them the feel of the air before letting them take the smaller machine out by themselves. This is one of the few monoplane schools exclusively using this system; the usual method of procedure being to give the pupils control instruction on the ground and then let them go out and cut grass and hop around as best they can.

Oliver Sherwood made many flights on the Church biplane by way of training for his successful flight over New York on May 31.

Charles Morok and others associated with him have been testing out the new Morok monoplanes and biplanes and some excellent flights have been made.

Ed. Boyd, although a novice in handling monoplanes, has made some excellent practice flights on the Rex Blériot type monoplane. On May 27th he tried a more extended trip, but his motor stopped at a height of 600 feet, and in gliding down he miscalculated his distance and ran into Sherwood's shed, slightly damaging both his own and Sherwood's machine.

In the afternoon of the same day, at Mineola, Frank Boland, in his original biplane, was the only one out and made several circuits of the field in spite of a strong and gusty wind, which threatened to upset him every second.

Capt. Thomas S. Baldwin has tried out his new biplane and made several short flights in it. It is now headless and has the motor and propeller in the rear. The longitudinal control consists simply of a single flap elevator hinged to a small flat non-lifting tail. The top plane has a greater span than the lower one, while the landing gear is on the Wright order. In spite of the fact that the new Baldwin has only been built a few weeks, Captain Baldwin is breaking in two flyers on the machine, these being Frank Schrober and young Cecil Peoli, both of whom promise to become really fine flyers and should bear watching. Cecil Peoli, who is only 18 years of age, took to flying like a duck to water and astonished the aviation colony at Mineola by flying high and making circuits of the field at his third or fourth flight on the machine.

Kemmerle has been flying his Curtiss type, equipped with the two cycle Kimball motor, which is over three years old, and was first used in Wilbur Kimball's experimental helicopter at Morris Park.

S. S. Jerwan has been kept busy instructing pupils on the Blériot type monoplanes.

One of the most interesting and promising machines which has arrived at the Mineola field is the Spaurinour monoplane, which has an automatic lateral balancing device, and is fitted with a hand cranked 2-cycle motor of original design. The monoplane has automatic compensating wings for lateral balance, the wings being so attached to the fuselage that they and the underguy wires hang loose while the machine is at rest, but immediately assume their proper position as soon as the machine is in motion, when they line up evenly and stay so until a gust strikes one side of the machine, when the whole wing on the side struck by the gust immediately moves up and changes the angle of incidence of the opposite one, thus restoring the balance, when the wings immediately come back to their proper position. In addition there are pedals controlling the wings so that turning can be accomplished. While it would appear that this method of balancing would necessitate the use of complicated and weighty mechanism, in reality it has been worked out so nicely that the whole machine is even lighter than the ordinary monoplane.

The writer had the privilege of seeing the inventor, who is a novice at flying, try out this machine, and it was a revelation to him the way in which it handled both in the air and on the ground. Figure eights on the ground being one of its usual performances. The landing gear, which is quite light and is of original design, is without doubt one of the most efficient ever fitted to a monoplane, for it repeatedly withstood nankake landings and sideswipes that would have left the ordinary monoplane a wreck. The landing arrangement consists of a central skid with two auxiliary side skids and two shock absorbing wheels, and is similar to the arrangement suggested in the January, 1912, AIRCRAFT.

Miss Quimby's new 70 H. P. Military tandem biplane arrived at the grounds and was admired by many. An illustration of this type of machine will be found on this page. Miss Quimby recently tried out the monoplane, but slightly damaged it owing to the fact that she was unable to handling such a powerful machine. Miss Quimby has since got this machine well in hand and has made several flights with passengers on it.

The Christmas biplane has been fitted with a 6-cylinder Roberts, and has been making practice flights in the hands of Clinton O. Hadley at a height of 500 feet.

On June 11th, Cecil Peoli, who had previously only made six flights, rose three thousand feet in the air on the new Baldwin and flew for 35 minutes, finishing up with a glide from two thousand feet.

Miss Harriet Quimby also flew her 70 H. P. military tandem Blériot for forty minutes, carrying S. S. Jerwan as a passenger.

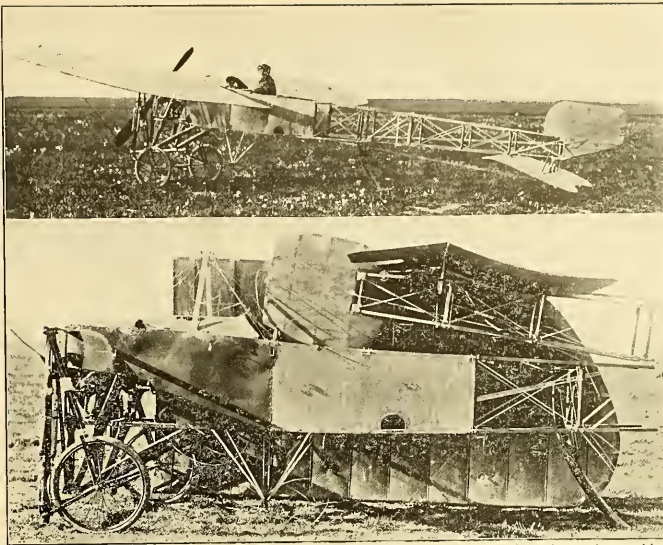

Two views of the new demountable military type Blériot. The top view shows the machine ready for flight, while below it is seen folded up ready to enter its transport wagon. A machine of this type, but without the collapsible fuselage, is being flown in this country by Miss Harriet Quimby, who is now under the management of Leo Stevens.

### Hydro Takes Doctor to Injured Boy

On June 9th a hydro-aeroplane was used by a doctor in answering an emergency call. Dr. P. L. Alden, of Hammondsport, was suddenly summoned to attend the son of Edwin Petrie, who had been seriously hurt at Urbana, a small town situated across the lake from Hammondsport. He decided that as it was imperative to reach the boy in the shortest possible time, he would fly across, and so summoned Hugh Robinson, who immediately brought out the Curtiss hydro-aeroplane and whisked him over the lake in a few minutes.

### Eleven Gould Prize Entries

The \$15,000 Gould prize competition for a double engine aeroplane is to be held on July 4th, probably in the vicinity of New York, and the following entrants have been received: Alphas Aeroplane Company, Boston, Mass.; Double biplane of the following surface type. Howard Gill, Boston, Mass.; Biplane. H. Curtis, Manchester, Mass.; Burgess biplane. The Boland Aeroplane and Motor Company, Rahway, N. J.; Biplane. Edward J. Elsas, Kansas City, Mo.; Biplane. H. W. Mattom, 217 West 120th street, New York; Multiplane. Macleod Multiplane Company, Richmond, S. I.; Multiplane. Charles H. Barleigh, South Brunswick, Maine; Multiplane.

George W. Beatty, Mineola, Long Island; Biplane.

Grover Cleveland Loening, on behalf of the Queen Monoplane Company, Fort George, New York; Monoplane.

John P. Conkling, 125 East 23rd street, New York City; Biplane.

### Vaniman Tries Dirigible

On June 1st, at Atlantic City, Melvin Vaniman made an unexpected flight in his dirigible balloon "Akron" (see photo and description in AIRCRAFT, Vol. 2, page 349), which he had up over the sea and city for 35 minutes before returning to the hangar. The dirigible, however, met with a slight mishap when a rope became entangled in one of the propellers and the craft dove to the water, but rose again and was able to regain her shed after Mr. Calvin Vaniman, Melvin Vaniman's brother, had climbed out along the propeller shattering and planed down the rough edges of the propeller.

### Wright Suit Postponed

Owing to the recent death of Wilbur Wright, the suit brought against the Curtiss-Herring Company and Glenn H. Curtiss by the Wright brothers for alleged infringement of patent, has been indefinitely postponed. The case was scheduled for a hearing in the United States Court on June 7th at Buffalo, but upon request of attorneys Judge Hazel granted the adjournment.

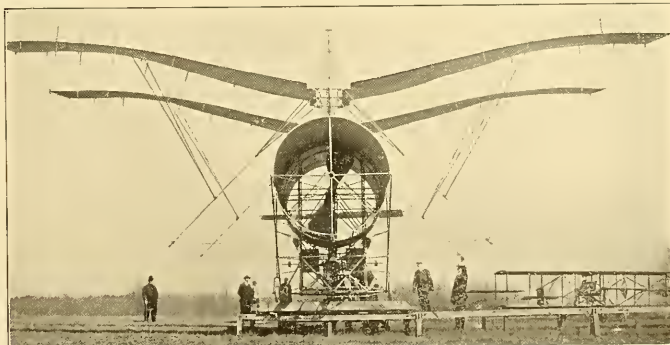

A NEW TYPE OF FLYING MACHINE BEING EXPERIMENTED WITH BY DR. RUDOLPH SILVERSTON, OF MILWAUKEE, WIS.

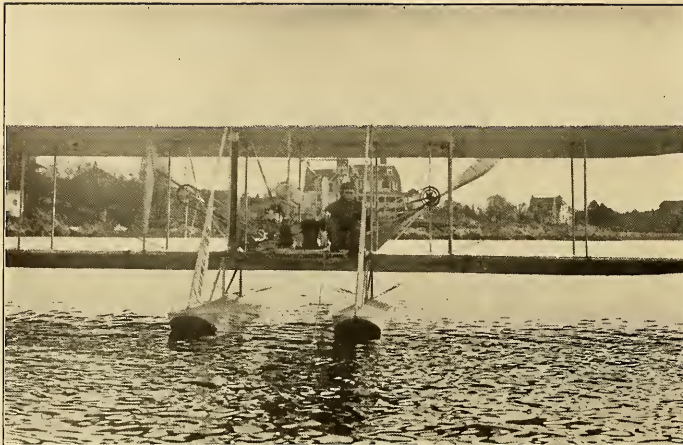

Phillips W. Page with motion picture camera mounted on a Burgess hydro-aeroplane at the Burgess training school station, Marblehead, Mass.

### Farnum T. Fish Flies from Chicago to Milwaukee

On May 26th, Farnum T. Fish flew from Chicago to Milwaukee to take part in a meet in a Wright machine, carrying a consignment of silk. He made the journey in two hours and six minutes, landing safely in Lake Park, where he was greeted by a tremendous crowd.

Fish left Chicago at nineteen minutes after eleven in the morning on the journey of 80 miles, flying four miles in front the lake and at a great height, he passed over Racine forty minutes after 12. Nearing Milwaukee, he was flying at an altitude of 6,000 feet. His gasoline gave out and he gradually descended during the last five miles. He arrived at twenty-five minutes after one.

Ignace Semitouk, the instructor of the Milwaukee College of Aviation, was flying to meet Fish when his engine stopped high in the air. In volplaning his machine struck a telegraph wire and caused him to fall. Semitouk escaped with slight bruises, but the aeroplane was wrecked.

### Yale Meet

Yale's successful aviation meet came to a close on May 26th after some brilliant flights by Lincoln Beachey and Howard W. Gill. In his final flight Gill's Burgess-Wright machine almost turned over as it struck the baseball diamond and the landing gear was damaged.

Beachey added interest when he appeared in woman's garb, "Jim" Donnelly, the Yale policeman, was announcer and informed the big audience that "Madame Helene," a French aviatrix, would make the next flight. Mr. Beachey was attired in a skirt, a Yale jersey, with "1912" on his bosom and a big blonde wig. He received great applause as he rose in his Curtiss biplane, and not until his wig fell off as he was alighting from the machine did the spectators recognize him.

### Arrested for Landing in Park

Recently both Farnum T. Fish and Max Lillie were arrested for making landings in Grant Park, Chicago, the former on May 17th, the latter on May 30th. Lillie had flown in his Wright machine from the Cicero field with a passenger, but on account of engine trouble was compelled to land in the Park, whereupon he was hauled off to the police station in a patrol wagon and only released on bail.

William Piceller, an Italian, and one of the first graduates of the Beatty aviation school has also been granted a license from the Italian Aero Club. This makes Piceller one of the few Italian licensed pilots to operate a Wright biplane.

F. W. Kemper, another graduate of the Beatty school, recently put up something of a record, when he successfully passed his license tests in 17 minutes.

### Army Notes

On June 8th tests were made at College Park with the Lewis automatic gun, fitted to one of the army Wright biplanes. The biplane was flown by Lieut. Milling, while the gun was operated by Captain Chandler, and so successful was he in aiming that he easily picked off one target after another and clearly demonstrated the great value of the invention and greatly impressed the army officials and others present at the trials.

### Al Welsh and Lieut. Hazelhurst Killed

On June 11th Second Lieut. Leighton W. Hazelhurst and Albert L. Welsh were killed at College

Park when the new Wright machine they were putting through the final military tests suddenly dove to the ground from a height of 70 feet, killing both the aviators instantly. The cause of the accident has not as yet been determined, although it is stated that the biplane with its heavy load was not equal to the sudden dip Welsh made and in consequence collapsed.

### Paul Peck Breaks American Endurance Record

On May 25th Paul Peck broke the American endurance record at Nassau Boulevard by flying for 4 hours 23 minutes 15 seconds in his Columbia headless biplane. The previous American record was held by Howard Gill, who flew on his Wright machine for 4 hours and 16 minutes at Kinloch, Mo.

While Peck's flight does not compare in duration with some of the French endurance flights, which, by the way, have usually been made on large specially prepared machines, it is none the less noteworthy owing to the fact that the machine was a small size standard biplane, and not a specially built machine. In addition to this, the latter part of the flight was made in a terrific rain, wind and electric storm, and darkness, which made the last half hour of Peck's flight one of the most spectacular and daring ever achieved. It was only after he had broken the record and a fire signal lit that he decided to come down.

### Sherwood Flies Over New York

On May 31st, Oliver B. Sherwood surprised the residents of upper New York by flying over their heads on his way to Hackensack, N. J. Sherwood landed in the evening from the Nassau Boulevard aerodrome at seven minutes of seven, with his motor working perfectly, and headed off in the direction of Queens, thence over Lakeville to Whitestone, crossing the East River at 138th street and passing over Manhattan at an altitude of about 3,000 feet. At a point over Riverside Drive Sherwood began descending gradually to his destination at Hackensack. The machine used was a Church headless biplane. The trip lasted about 30 minutes.

On June 1, at North Yakima, Wash., Phillip O. Parmelee, one of the original Wright exhibition flyers, and one of the best biplane pilots in America, was killed in a tractor biplane of his own design, after being warned not to attempt the flight on account of the high and tricky wind.

Miss Quimby will give a limited number of exhibitions in this country and Canada during the remainder of the 1912 season under the management of A. Leo Stevens, who is her sole representative.

Rear Admiral Bradley A. Fiske, who recently made a flight in a hydro-aeroplane at Salem, urges aeroplanes for battleships, and believes that the battleships of the North Atlantic Squadron, consisting of eight ships, should each be provided with twelve aeroplanes.

Rear Admiral Fiske says the great problem of war is the destruction of the foreign trade of the enemy, and believes this problem has been solved by the development of the aeroplane.

Professor Willis L. Moore, lecturing before the Royal Institution of London, on June 1st, predicted that the time would come when the weather bureaus would have the added responsibility of mapping daily air routes for passenger carrying

aeroplanes. He also forecast that United States meteorological stations would be equipped with aviators and aeroplanes, and that by the use of kites on windy days and aeroplanes on quiet days, instruments would be sent aloft to register the pressure, temperature and direction and force of the winds, which when telegraphed to the central office would enable the forecaster to construct a weather map on, say, the two miles level up in the fine air where the energy of the storm must be the most intense.

On June 5th, Mr. W. Starling Burgess, head of the Burgess Company, and Curtis, Marblehead, Mass., fulfilled all of the tests necessary to qualify for an aviator's license in a hydro-aeroplane.

Fred DeKor, an aviator, paid a visit to Miss Louise Gattor, of Cedar Grove, Houston, Texas, recently in his machine and took her for a ride through the air.

It is reported that an Army aeroplane is to be stationed on Liberty Island, New York Harbor, where the Signal Corps has a small force under Captain Charles S. Wallace. This machine will be of the marine or hydro-aeroplane type long used by the navy, but as yet not acquired by the army. Two officers have been sent to Hammondsport, N. Y., to learn the navigation of the hydro-aeroplane under Glenn H. Curtiss, and Major Samuel Reber, signal officer of the Department of the East, also is to learn to fly.

Aviator Masson has recently been making some splendid flights at Baldwin Park, Quincy, Ill., in his Masson biplane, which he operates with great skill.

Announcement has been made that the Aeronautical Society will open, on July 1st, at Aerial Island, New York, their aeroplane field. This location affords an ideal stretch of territory for land flying and the facilities for hydro-aeroplanes on the ocean front.

Baron Ladislas d'Orey, who is now compiling a history of aviation, including all the great pioneers of the past, was nominated on May 23rd a delegate of the National Aerial League (Ligue Nationale Aérienne). Baron d'Orey, who has been doing a great deal in the course of the movement, intends shortly to return to France.

### Flight Over Pittsburg

The first flight of an aeroplane over the city of Pittsburg was accomplished Saturday afternoon, June 15th, by Earl Sandt on a headless Curtiss biplane. The aviator passed over the downtown section at an altitude of between 2,000 and 3,000 feet, and the flight was witnessed by thousands of Pittsburgers. The exhibition was given under the auspices of the Pittsburg "Post," which newspaper stated editorially in the morning that it was extremely gratified not only with the success of the flight but also with the evidences of public appreciation for its efforts to please the people and afford them an opportunity of seeing something they had never seen before.

### A Remarkable Letter

Curtiss Aviation Camp,

North Island,

San Diego, Cal., June 11, 1912.

The Curtiss Aeroplane Co., Hammondsport, N. Y.

Gentlemen—I have the honor to report the complete destruction of the practice machine, "Julia," this morning. The only thing left of her is the engine, skid, diagonals and the three wheels. It is the most unique accident that has ever been attempted, guess.

We had been flying her, giving instructions to the new pupils, and after the wind came up this morning I let Barlow take her down the long course on a straightaway flight, with full throttle to test her flying powers, since we had just overhauled the engine. He landed at the lower end of the long course, turned around and was starting the engine to return. In some unaccountable manner the throttle had been left in a wide open position, he having stopped the engine with the switch previously. When he started the propeller she was alone with the throttle wide open, she immediately forged ahead at full speed, and he was unable to catch her or stop her, consequently with the controls all free, she rose into the air gradually, attaining a height of about 75 feet, and flew perfectly level in this condition at this height for nearly three-fourths of the long course, which, as you know, is about a mile long, wherefore she must have flown approximately three-fourths of a mile without anyone in the machine to control it at all. This is a remarkable feature, in my opinion, and reflects most unusual credit upon the control system of the Curtiss aeroplane, that it not only flew on a level keel, but also she stabilized herself perfectly, until apparently struck by a gust of wind, which tipped her to the left, and she came down to the left at an angle of about 45 degrees, in which position she struck the ground. The machine didn't come any way near turning over, but she certainly did bust herself up completely. Yours truly,

Signed,

J. W. McCLASKEY.

## BOOK REVIEW

"Practical Aeronautics" by Charles B. Hayward, with introduction by Orville Wright; cloth bound, 750 pages. Profusely illustrated, with photographs and line drawings. Price \$3.50. (American School of Correspondence.) This book is one of the most complete works issued to date on aeronautics, and is especially valuable to students of and enthusiasts in aviation.

## SOME OF THE CONTENTS

Introduction; Balloons; Dirigibles; Theory of Aviation; Elementary Aerodynamics; Internal Work of the Wind; Gliding and Soaring; Types of Aeroplanes; Scale Drawings and complete instructions for building Curtiss, Blériot and other types; Motors; Propellers, etc.

"The Mechanics of the Aeroplane," by Captain Duchene, translated by John H. Ledebor and T. O. E. Hubbard. A study of the Principles of Flight. Price \$2.25. (Longmans & Company.)

Although the science of flight is still in its infancy, it has already assumed such important proportions as to have rendered it desirable to present, in collected and concise form, the principles on which it is based. Captain Duchene's work deals, firstly, with the broad principles of aerodynamics and aerostatics; secondly, with their application to practical flight; and, in the third place, with the various conditions and manoeuvres in flight. The treatment, though strictly scientific, is entirely based on elementary mechanics and mathematics, thus fitting the work for students of every degree. The necessary formulas are maintained in their simplest shape. A large number of examples are worked out, and practical methods of calculation relating to aeroplanes.

The first part of the work deals with the support of the aeroplane in still air, and the various factors of speed, weight, thrust, motive power, lifting efficiency, wing area, with gliding flight, with starting and alighting. The second portion is devoted to a careful consideration of the several problems of stability and turning; the third to the effect of wind, regular and irregular, on the aeroplane and its stability. A concluding section treats of the theory, design and application of propellers.

This book consists of 231 pages and is illustrated with diagrams and photographs.

"My Three Big Flights," by André Beaumont, the noted Blériot pilot. Price \$2.50. Cloth bound. Contains 136 pages and is illustrated with 60 photographs. (McGraw-Hill, New York.)

In this work the author tells how he first became interested in aviation, describes the trials and tribulations of his apprenticeship and narrates in a clear and concise manner the experi-

ences encountered in his flights and how he won the Paris-Rome race, the European Circuit and the British Circuit races.

**Etude Raisonnée De L'Aeroplane and critical description of existing machines.** By Jules Boreaux (Gauthier Villars). Paper cover, 497 pages and many illustrations and diagrams. Price 15 francs.

The book is printed in French and is of a technical nature, but is written in such a clear manner that it can be understood by almost anybody understanding French and possessing a knowledge of mathematics. Summary of contents:

Preliminaire. L'Aviation en 1911. Le Salon de décembre 1910. Le bilan de 1910. Les divisions de l'Ouvrage. Les conclusions.—LIVRE I.—Les lois de la Résistance de l'air sur les surfaces.—Chap. I. Okrajation, Prémable. La grandeur de la vitesse. Ses variations avec: les Dimensions de la surface, la Vitesse de translation, l'Inclinaison de la surface, la Forme de la surface.—Chap. II. Okrajation, Prémable. L'application de la Résistance. Résultats numériques et conclusions.—Chap. III. L'Expérience. Recherches sur la Grandeur, le point d'application, les lois de la Résistance totale. Surfaces en mouvement: 1° Déplacement orthogonale Généralités et formules. Mouvement circulaire. Mouvement rectiligne. 2° Déplacement oblique. Généralités et formules. Expériences. Surfaces immobiles; Principe de relativité; Résistance orthogonale. Résistance oblique, Répartition des pressions. Etude des surfaces courbes. Laboratoire aérodynamique de M. Götting, Laboratoire de Koutching, Laboratoire de Göttingen.

**Jahrbuch der Luftfahrt 2. Jahrgang 1912.** By Anshert Voorreede. A most complete review of the progress in aviation during the last year. The book contains several hundred photographs and complete working drawings of the latest dirigibles and aeroplanes, together with construction details, descriptions of motors and in fact everything connected with aviation. The work comprises 775 pages and is published by J. F. Lehman, Munich. Table of contents:

1. Luftschiffe. 2. Flugzeuge: a) Allgemeine, b) Eindecker, c) Zweidecker, d) Dreidecker, 3. Luftfahrzeug-Motoren; Propeller für Luftschiffe und Flugzeuge. 4. Gleitflieger und Drachen. 5. Freiluft- und Fesselballone. 6. Luftschiffwerke, Luftschiffhäfen, Luftschiffwerften. 7. Fortschritte in der Erzeugung von Ballongas. 8. Kampf- und Bekämpfungswaffen der Luftfahrt. 9. Flugplätze und Fliegerschulen. 10. Wissenschaftliche Forschung; a) Wissenschaftliche Fortschritte der Flugtechnik; b) Die wissenschaftlichen lufttechnischen Institute. 11. Orientie-

ring und Navigation. 12. Die bedeutendsten deutschen Patente auf dem Gebiete der Luftschiffahrt und Flugtechnik. 13. Zusammenstellung der flugsperrlich bedeutendsten Ergebnisse in der Zeit vom 1. November 1910 bis 1. November 1911. 14. Die Entwicklung des Militärflugwesens. 15. Vereinswesen. 16. Bezugsquellenverzeichnis.

"Building and Flying an Aeroplane," by Charles B. Hayward. Cloth bound, 137 pages. Illustrated with many photographs and line and detail working drawings. Price \$1.00. (American School of Correspondence.) The book deals with the construction and operation of aeroplanes and is of great value to those contemplating building or flying aeroplanes. Contents:

Rubber-Band Driven Models. Motor Driven Models. Building a Glider. Learning to Glide. Building a Curtiss, Frame Construction, Running Gear, Control, Propeller, Assembling, Building a Blériot Monoplane, Fuselage, Truss Frame, Running Gear, Wings, Control, New Blériot Features, Art of Flying, School Methods, Use of Glider, Grass Cutting, Control in the Air, Accidents and Their Lessons, Statistics, Causes of Accidents, Amature Aviator.

The National Press Association of New York has just gotten out a new edition of Webster's Home, School and Office Dictionary, illustrated, which has been made to contain only the words that are in general use. It defines clearly and distinctly the so-called common words with a sprinkling of technical terms such as are likely to be needed. Attention is especially called in the preface to the glossaries of aviation and automobile, the aviation glossary having been edited by

Alfred W. Lawson, editor of AIRCRAFT, and the automobile glossary having been edited by Julius Chase, editor of "Motor." The work also contains a very interesting table of synonyms and antonyms as well as a most complete vocabulary of commercial and legal terms. The dictionary is based upon the unabridged dictionary of Noah Webster, LL.D., and its editor in chief is Harry Thurston Peck, Ph.D., Litt.D., LL.D., who was assisted by the following: Charles F. Johnson, Ph.D., professor in Trinity College, Hartford, Conn.; G. L. Meader, Ph.D., professor in the University of Michigan; J. S. F. Tatlock, Ph.D., assistant professor in the University of Michigan; Alfred W. Lawson, editor of AIRCRAFT; John C. Rolfe, Ph.D., professor in the University of Pennsylvania; Robert Gordon Grant, A. M., Ph.D., Heidelberg University; Robert A. Rowland, Ph.D., late professor in Teachers' College; Lillian H. de Bois, instructor in the Wharton Combined School, Philadelphia; Julian Chase, Ph.D., editor of "Motor."

## PIONEERS OF AVIATION (Continued from Page 150)

like the wings of a bird. They were 10 ft. from tip to tip, feathered at the back edge and curved a little on the under side. The plane was 2 ft. across at the widest part; sustaining surface, 17 sq. ft.; and the propellers were 16 in. in diameter, with four blades occupying three-quarters of the area of the circumference, set at an angle of 60°. The cylinder of the steam engine was 3/4 in. diameter; length of stroke, 2 in., bevel gear on crankshaft giving 3 revolutions of the propeller to one of the engine. The weight of the entire model and engine was 6 lbs., and with water and fuel it did not exceed 6.5 lbs.

"The room which he had available for the experiments did not measure above 22 yards in length and was rather contracted in height, so that he was obliged to keep his starting wires very low. He found, however, upon putting his engine in motion, that one-third the length of its run upon the extended wire, the machine was enabled to sustain itself; and upon reaching the point of self-detachment, it gradually rose until it reached the farther end of the room, where there was a canvas fixed to receive it. Frequently during these experiments it rose after leaving the wire as much as 1 in 7.

"Stringfellow then went to Cremorne Gardens with the two models, but found the accommodations no better than at home. It was found that the larger model (Henson's) would run well upon the wire, but failed to support itself when liberated. Owing to unfulfilled engagements as to room, Mr. Stringfellow was preparing for departure, when a party of gentlemen, unconnected with the gardens, begged to see an experiment and finding them able to appreciate his endeavors, he got up steam pretty high and started the small model down the wire. When it arrived at the spot where it should leave the wire, it appeared

to meet with some little obstruction and threatened to come to the ground, but it soon recovered itself and darted off in as fair a flight, as it was possible to make, to a distance of about 40 yds., farther than which it could not proceed.

"Having now demonstrated the practicability of making a steam engine fly, and finding nothing but a pecuniary loss and little honor, this experimenter rested for a long time satisfied with what he had effected."

As can be seen from the above article, which forms part of Mr. Breary's official report to the Aeronautical Society, constituting therefore an absolutely trustworthy record, Henson and Stringfellow's early work in aviation cannot be too highly appreciated.

While they failed in their attempt to build the huge aeroplane they had promised to the world, it is to them that goes the honor of having produced the first model aeroplane to fly by its own power and what more, by steam, a performance that was not to be repeated afterwards for half a century; and if we consider that the only scientific basis the two inventors could work upon was Sir George Cayley's theory of the aeroplane, and that the steam engine was still in its experimental stage, we cannot but admiringly record their splendid achievement.

Much remained yet to be said about the problem of mechanical flight; the transverse and longitudinal control were still to be solved; so was the question of a powerful and light motor; but with the means they possessed, Henson and Stringfellow achieved what was humanly achievable at that time; they created an aeroplane model and a sufficiently light motive force that would make it fly. Therefore Henson and Stringfellow rank equal among the greatest pioneers of aviation.

# CLASSIFIED ADVERTISING

15 CENTS A LINE

SEVEN WORDS TO LINE

CASH WITH ORDER

## FOR SALE

## MUST SELL—FINE MONOPLANE

1911, cross country type, two seater, Blériot, 100 H. P. engine, full equipment. A. V. Reyburn, Jr., 5305 Delmar Boul., St. Louis, Missouri.

**HOW TO** control an aeroplane. Used by the largest schools. The only book ever written on this subject. Price 50 cents. Aviators' Exchange, 58 West Washington St., Chicago, Ill.

**CURTISS** latest improved type (Pigeon tail) 1912 Model. Made over 300 very successful flights 1,000 ft. high, 30 miles cross-country. My construction is strongest in the world. New, complete, ready to fly, tested and guaranteed, including free lessons to buyer, \$2,500. Buy direct from Builder and Aviator of 10 years' experience. H. C. Cooke, Aviator and Builder, 127 West 64th St., New York City.

**MOTOR**, eight-cylinder, 45 horse power, Mea magneto and propeller. First class condition; must sacrifice on account of aviator's death. No reasonable offer refused; can be seen. Mrs. L. Rosenbaum, 167 St. Ann's Ave., Bronx, New York.

**THREE** second-hand engine and fan propellers, good as new. LeBron Adams Aeroplane Co., Omaha, Nebr.

## FOR SALE

**FOR SALE**—Wm. R. Gordon's 5 new types, 20 sizes, Monoplanes, Biplanes, Hydro-Monoplanes and Biplanes, Aeroplanes, Boys' Monoplane, sport, torpedo, war and passenger craft, storm proof, 1 or 2 motors, 1, 2, 3 or 4 propellers, 3, 5 and 7 sections, speed 5 to 150. Price \$1,250 to \$100,000. Capacity 100 to 5,000 lbs. Full course sand and water. First ten \$500 each. Regular rates, hydros, \$500; small 1 motor craft, \$300; Motormen, \$250. Factory and 10% acre field. Aerial Ship Yard, Kinloch, Mo.

**AERONAUTICAL SUPPLIES**—Imported wire strainers, clamps, eye bolts, etc.; pamphlet AMCO on application. Aeromotion Company, Wright Bldg., St. Louis, Mo.; exclusive American agents Societe Des Moteurs Gnome, Paris, France.

**FOR SALE**—50 H. P. Bradley Aeroplane Motor, 8 cylinders, Bosch Magneto, Perkins carburetor. Guaranteed. Price \$1,000. Address J. O. Eberhard, Jr., Bulletin Building, Philadelphia, Pa.

## POSITIONS WANTED

**A YOUNG MAN**, age 18, desires position as an aviator's assistant, with prospects of learning to fly. Address Louis Fenouillet, 132 West 47th St., New York City.

## MISCELLANEOUS

**NOTICE**—Manufacturers, dealers; please send catalog and other details of aeroplanes, motors, propellers, accessories, etc. Ehrlich, 2106 Daggett St., Philadelphia, Pa.

## MISCELLANEOUS

**WANTED**—MAN, GOOD CHARACTER, EXPERIENCE TO FLY STANDARD-TYPE BIPLANE, NEW. Address, A. M., 1010 South Plum St., Pine Bluff, Arkansas.

**WANTED**—Agencies for model aeroplanes and supplies. Catalogs and samples from wholesale dealers. Whitmore Aero Co., 1818 Webster St., Omaha, Neb.

## CO-OPERATION WANTED

**CAPITAL** wanted to patent and build aeroplane that will fly three hundred miles per hour. Will give 49 per cent. of patents. I will guarantee to fly across Atlantic in twelve hours. Address A. Harbottle, 18 Eldert St., Brooklyn, N. Y.

**WANTED**—Party to furnish capital for a pilot license; would divide flying profits. Address Samuel S. Yarrington, 2510 West 18th St., Wilmington, Del.

**RARE OPPORTUNITY**—Young Jewish American, 21, having improvement for biplane, containing feature of maintaining lateral stability without infringing Wright (warping) or Curtiss (ailerons) machines, desires capital to build and patent. M. M. Meizelle, 728 N. 24th St., Camden, N. J.

**CAPITAL WANTED**: To build a monoplane steered and balanced by propellers, which gives the plane more stability, being able to carry a heavier weight than others. George Kunick, 340 Beckman Avenue, Bronx, New York.

## A City Hotel at the Seashore HOTEL NASSAU Long Beach, L. I.

ON THE FINEST BEACH NORTH OF FLORIDA  
Electric Trains from Pennsylvania Station, 34th Street

Phone 100 Long Beach

MERRY & BOOMER, Managers

## Information for Aeroplane Builders

By ALBERT S. HEINRICH

The following tests will be of great value to anyone building or contemplating building an aeroplane. All the wire used in these tests, with the exception of test No. 4, was steel piano wire. The turnbuckles are those imported and sold by the Aeromotion Co. of America. All the connections of the piano wire were made with the customary ferrule joint, care being taken to make the eye in the wire round, and the ferrule just large enough to barely slip over the wire, the tighter the ferrule fits over the wire the stronger the joint will be.

Test No. 1 was made with No. 28 steel wire and a No. 5 turnbuckle, and the wire broke in the eye of the wire at 1,600 lbs. The turnbuckle had a 2 3/4" barrel.

Test No. 2 was made with No. 33 wire and a No. 6 turnbuckle, with a 2 3/4" barrel. The eye of the turnbuckle broke out at 1,100 lbs., and when the wire itself was tested it broke at 1,875 lbs.

Test No. 3 was made with No. 45 wire and No. 7 light turnbuckle, with a 3" barrel, and the eye broke out of the turnbuckle at 1,450 lbs.

Test No. 4 was made with a No. 7A heavy turnbuckle and 3/8" Roebling wire rope. This joint was made much the same as the other tests, with the exception that after the ferrule was slipped over the wire a long end was left projecting, which was turned back and run through the eye of the wire, and then bound down with copper wire, and then soldered. The solder slipped when this joint was tested, and the wire broke in the eye at 1,600 lbs.

Test No. 5 was made with an all steel turnbuckle, with a 3" barrel, and as the eye of the turnbuckle was of such size that nothing large enough to break it out could be put in it, just the turnbuckle was tested, and broke in the stem at 2,600 lbs.

All the above tests show that the turnbuckles should be made much heavier in the eye, as the threads were all perfect after the tests, showing that the strain was not great enough to stall the threads, and that the eyes could only stand half the strain of the rest of the turnbuckle.

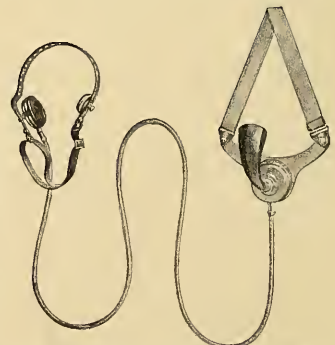

Aviation dictagraph or aeroplane telephone, used on some of the French military machines to facilitate an observer giving instructions to the pilot, at present made necessary by the noise of the engine.

**DETROIT AERO POWER PLANT**  
 COMPLETE \$300 READY TO RUN  
 INCL. PROPELLER-CARBURETOR-ROSH MAGNETO.  
 OIL PUMP-CABLE-SWITCH-MOUNTING BOLTS.  
 IS GUARANTEED TO  
 210 LBS. MIN. STATIONARY THRUST  
 158 LBS. MAX. WEIGHT (COMPLETE)  
 36 HOURS DELIVERY



MODEL 1912

LIFT AND FLY  
 CURTIS BYPLANES  
 BLE RIOT XI MONOPLANES  
 DEMOISELLE MONOPLANES  
 OR CRAFTS OF SIMILAR MAKE

**DETROIT AEROPLANE CO.**  
 DETROIT MICHIGAN

**BAMBOO** Special Grades of  
 Bamboo for AERONAUTIC WORK  
 Reed, Rattan and Split Bamboo for Models.  
 All sizes in stock. Tonka Rattan for Skids,  
 1 1-4 inch and under, any length.

**J. DELTOUR, Inc.**  
 804 Jefferson St. Hoboken, N. J.

**BARGAIN SALE**  
 BLE RIOT TYPE MONOPLANE  
 CAN BE SEEN ASSEMBLED AT  
 481-483 Park Avenue, New York

**J. C. (BUD) MARS, NOW BOOKING**  
 ADDRESS  
**17 N. La Salle Street, Chicago, Ill.**

**Principles and Design of Aeroplanes**  
 By Herbert Chatley  
 A text book on Aeroplanes, containing many  
 details and drawings.  
 Price, 50 Cents  
 Lawson Publishing Co.  
 37-39 East 28th Street New York City

**LEGAL NOTICE**

AS I am manufacturing Aeroplanes, I desire to give notice to all persons that are using my "Patent Rudders" with inverse and simultaneous action, and also my "Patent Semi-automatic engine control," that it is my intention in the future to ask a small "Royalty" from them. Hugh L. Wiloughby, Sewall's Point, Florida.

**PATENTS**

**PATENTS THAT PROTECT AND PAY**  
 Advice and Books Free. Ratea Reasonable. Highest References. Best Services.  
**WATSON E. COLEMAN, Patent Lawyer**  
 622 F St., N. W., Washington, D. C.

**PATENTS SECURED or Fee Returned**

Send sketch for free search of Patent Office Records. How to Obtain a Patent, and What to Invent, with list of Inventions Wanted and Prizes offered for Inventions sent free. Patents advertised free.  
 We are experts on AIRSHIPS and all patents and technical matters relating to AERIAL NAVIGATION.  
**VICTOR J. EVANS & CO.** Washington, D. C.

**ALBATROSS COMPANY**  
 DETROIT, MICH.



*Free Fare*

Extends herewith its invitation to a birthday party of their city, Detroit.

The Splendid **WATER CARNIVAL CADILLAQUA**

July 22 to 28

Agents Wanted Everywhere

50 H. P. Six-Cylinder Self-Starting Albatross

to all agents and purchasers of Albatross Engines from any point in the U. S. or Canada to our city during this celebration.

Come and see the Boat Races, Pageants and Fireworks. See the Albatross made and tested. Take a vacation and have the time of your life. Without De la Motte de Cadillac—no Detroit; and without Detroit—no

**ALUMINA AEROPLANE FABRIC** "LIGHT AS A FEATHER" "BEAUTIFUL AS DAY"  
 Finest Imported Linen, thoroughly Waterproofed, and then coated with Aluminum. Heat and Moisture proof.  
 Strongest and Most Durable Aeroplane Cloth on the Market. Our Prices will surprise you.  
 SEND FOR SAMPLES AND PRICE LIST, AND BE CONVINCED.  
**THE AERIAL NAVIGATION COMPANY OF AMERICA**  
 GIRARD, KANSAS

## SLOANE SCHOOL OF AVIATION IS NOW IN OPERATION

FOR \$300 we guarantee to make a pupil competent to pass the military license test. **GEORGE M. DYOTT**, our instructor, is one of the first and best certified European aeroplane pilots. He carried President Madero in Mexico.

**DEPERDUSSIN** Monoplanes, which we sell exclusively in America, hold practically all world's speed records, and are the safest and most economical aircraft.

**CAUDRON** Monoplanes, which we sell exclusively in America, are the speediest and best built craft of their type produced in France.

**ANZANI** Motors, with which we equip our aeroplanes and which we sell exclusively in America, give more result per horse power than any foreign motors and are low priced.

**SLOANE AEROPLANE CO.**

'Phone 5421 Columbus 1731 BROADWAY, N. Y. CITY

## SUPPLIES

at Prices that make friends. Send 6c. for 22 page illustrated catalogue.



NEW YORK AERONAUTICAL SUPPLY CO.  
50 BROADWAY, NEW YORK

## COOKE BIPLANES

**Curtiss Improved 1912 Type (Pigeon Tail)**  
Perfect fliers. No freak construction. Ten years' experience. Strongest in the world. Ample powered (Robertis Motors.)  
Anybody can fly these machines. One ready for immediate delivery **\$2,500**  
Free Instruction to Buyer  
H. C. COOKE, 127 West 64th St. NEW YORK CITY

## Learn to Fly



**N**OW'S THE TIME. Flying graduation GUARANTEED. French method instruction; mechanic course. We positively have the only REAL Aviation School; two aviation fields, three factory buildings, aeroplanes, motors, etc., and the LARGEST aviation field in America. Motor, propeller, construction and flying thoroughly taught. Send for a home study course; FREE lesson.

## STANDARD AVIATION COMPANY

1309 Manhattan Bldg. Chicago, Ill.

**CAPT. BALDWIN** has just returned from his **SECOND** tour around the world with an aeroplane, without any serious accident, during his exhibitions.

Always using the

**"Willoughby Patent Double Rudders"**

for steering his machine.

The safety of this method of steering (in the vertical plane) has been demonstrated without a doubt.

## Aeronautical Books

OF ALL DESCRIPTIONS

**LAWSON PUBLISHING CO.**

37 East 28th Street New York

## AERO WIRE WHEELS

BUY FROM MANUFACTURER AND SAVE MONEY

20 x 2 1/4" Wheels—6" Hub—\$4.00 with tire **\$6.00**  
20 x 3" Wheels—6" Hub—4.75 with tire **\$8.25**  
FARMAN TYPE Gears complete—Price **42.50**

Stock size Hubs—6" wide, 3/8 or 1/2" knock-out axle or bushed to fit 1" axle—to fit 1 1/4 and 1 1/2 special HYDRO-FLOATS and 3 1/4 inch Float Wheels.

Don't fail to write for complete list of Wheels and Prices. We make any size or type.

Deposit required on orders; Balance C. O. D.—examination allowed.

**J. A. WEAVER, Jr.** 132 West 50th Street NEW YORK CITY

## CHICAGO AERO WORKS

H. S. RENTON 164 North Wabash Avenue  
Proprietor  
**AEROPLANES** ACCESSORIES MOTORS PARTS  
WHEELS HARDWARE PROPELLERS  
ALSO MODELS AND MODEL STOCK  
ESTABLISHED 1909. First in Chicago and the Middle West  
Aviators Taught. Flights Furnished. Send Stamp for Catalog.

ACCESSIBLE QUIET ELEGANT  
For Business Men, Families and Tourists

THE

# SOUTHERN HOTEL

54th Street, near Broadway

## NEW YORK

FIREPROOF MODERN

PERMANENT AND TRANSIENT

In the heart of the theatre and shopping district. Cars pass the door for all railroad stations. Parlor, Bedroom and Bath, \$3.50, \$4 per day and up. Single Room and Bath, \$1.50, \$2.00 per day and up. Double Room and Bath, \$2.50, \$3.00 per day and up.

Special Rates by the Week

Restaurant a la Carte European Plan

**J. G. VENETOS, Proprietor**

SEND FOR BOOKLET

## AEROPLANE RADIATORS

IN STOCK OR TO ORDER

SEND FOR PRICE LIST EL ARCO RADIATOR CO. 6 EAST 31st St., NEW YORK

# Aeronaut Leo Stevens

Controlling the Greatest Flock  
of Licensed Aviators  
in America

Operating the Leading and Best Make Machines  
in the world

If you contemplate Flying at your place, communicate direct.

Box 181 Madison Square

New York, U. S. A.

Phone Chelsea 235



# BENOIST BIPLANES

TYPE XII.

Three Models

- School Machine
- Cross Country Machine
- Military Machine

Also operate the

**Benoist School of Aviation**

For further particulars address

**BENOIST AIRCRAFT CO.**

6630 Delmar Blvd., St. Louis, Mo.

# DIANA SPIRON

The 3-bladed or tri-Spiron  
Eliminates Vibration  
Saves Power

Get the Folder

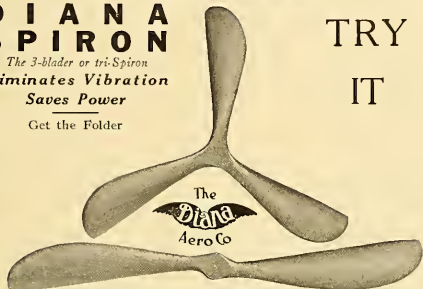

TRY  
IT

3-99 Baldwin Ave., Detroit, U. S. A.

# GOOD YEAR AEROPLANE TIRES



are made in same factory, by same experts as famous "No-Rim-Cut" Auto Tires. They are most enduring. The special construction makes them light and resilient. Absorb landing shocks and strains exceptionally well. Made in 3 types—No-Rim-Cut, Single Tube, and Clincher, in all standard sizes.

We also manufacture Rubberized Aeroplane Fabric, Aeroplane Rubber Shock Absorbers, including Heriot type, also Balloons of all types. Write us which of these products you are interested in.

At the New York Aero Show, fifty-eight per cent (11 out of 19) of all modern American Aeroplanes had Goodyear equipment.

Farnam Fish, with Goodyear aeroplane, flying from Chicago to Milwaukee in 2 hrs. 6 min.

**THE GOODYEAR TIRE & RUBBER COMPANY, Akron, Ohio.**

Branches and Agencies in 103 Principal Cities. More Service Stations Than Any Other Tire. We Make All Kinds of Rubber Tires, Tire Accessories and Repair Outfits. Main Canadian Office, Toronto, Ontario. Canadian Factory, Bowmanville, Ont.

Study This With a Glass  
IT'S WORTH IT

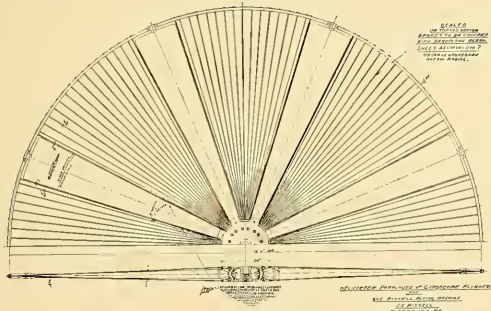

# JOS. E. BISSELL

P. O. Box 795

PITTSBURG, PA.

# FRED'K BRAUNINGER of "GRESSIER AVIATORS"

Begs to announce opening of School at Belmont Park, flying Gressier Canard, Bleriot, Morane, Farman, Curtiss; using only Gnome and Anzani Motors.

FOR TUITION AND EXHIBITION RATES ADDRESS

263 WEST 69th STREET, NEW YORK CITY

# HEINRICH

## Monoplanes and Mono-Biplanes

TUITION, \$250

On Private Field

MADE IN FOUR SIZES

Write for Illustrated Booklet

HEINRICH BROS., Baldwin, L. I., N. Y., U.S.A.

Seventy per cent. of record-breaking American flights with American Aeroplanes were made with propellers bearing this name

# CHARAVAY

WE WILL TELL YOU WHY IF YOU ASK US

**SLOANE AEROPLANE CO.**

**1731 Broadway, NEW YORK CITY**

AGENTS:

Eames Tricycle Co., San Francisco and Los Angeles; National Aeroplane Co., Chicago; W. E. Boughton, Washington, D. C.

\$1200 to \$4800

THE  
REX MONO-PLANE CO.

South  
Beach, S. I.  
N. Y.

DUPLICATE PARTS

at

SAVE  
50%

COST

SAVE  
75%

## Buy a REX Monoplane and Save

\$500 to \$1000 on Purchase.

\$250 Tuition Fee to Learn to Fly.

50% to 75% on Maintenance.

The REX, with its interchangeable wings, makes it possible to enter Speed, slow and passenger contests during the same day. **WHAT OTHER AEROPLANE CAN DO THIS?** Remember, we **Guarantee Before** delivery to fly the REX at **Least 1000 Feet High and 10 Miles** across country.

We Supply an Extra Pair of Racing Wings with each REX.

We Duplicate Parts at Absolute Cost, a Saving of 50% to 75% in Maintenance.

THE REX MONOPLANE CO.

South Beach, S. I., N. Y.

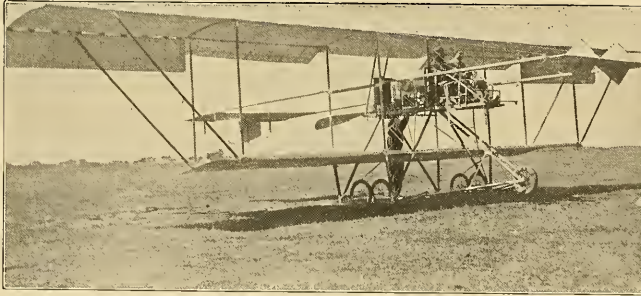

Showing double control school machine built in our Chicago factory. Width 52 feet.

## NATIONAL AEROPLANE COMPANY

606 South Michigan Avenue, Chicago  
Harvester Building

Manufacturers  
Exhibitors  
School of Aviation

### REFERENCES:

Dun or Bradstreet  
Corn Exchange National Bank, Chicago

## WIRE

Aviator Wire supplied in 12 sizes with a plate finish, making soldering easy. This wire is specially drawn from extra quality high grade steel. Also Aviator Cord of twisted wire.

**John A. Roeblings Sons Co.**  
TRENTON, N. J.

## BALDWIN

### VULCANIZED PROOF MATERIAL

For Aeroplanes, Airships, Balloons. First Rubberized Fabric on the market. Lightest and strongest material known. Dampness, Heat and Cold have no effect. Any Strength or Color.

### "RED DEVIL" AEROPLANES

That anyone can fly. Free Demonstrations.

### HALL-SCOTT MOTORS

Eastern distributor. 40 h. p. 4-cyl.; 60 and 80 h. p., 8-cyl., on exhibition at Frank Schumacher's, 164 W. 46th Street, New York. All motors guaranteed. Immediate delivery.

### EXPERTING

Will install a Hall-Scott free of charge in anyone's Aeroplane and demonstrate by expert flyer. Expert advice. 'Planes balanced.

CAPT. THOMAS S. BALDWIN  
Box 78 Madison Sq. P. O., New York  
**AEROPLANES**

## HOTEL CUMBERLAND

NEW YORK

Broadway at 54th Street



Headquarters for Avi-  
ators and Automobilists.

*New and Fireproof*

Strictly first class.  
Rates reasonable.

**\$2.50**  
With Bath  
and up

Send for booklet.

Ten Minutes' Walk to Thirty  
Theatres

## H. P. STIMSON

Formerly with Hotel Imperial



# New Weston Hotel

Madison Avenue at 49th Street  
NEW YORK

Modern fire-proof and high-class hotel in every respect.

A quiet and convenient location, one block from 5th Avenue.

Near theatres, clubs and select department stores.

## Special Summer Transient Rates

Large Single Outside Room - - -	\$1.50
Large Single Outside Room and Bath -	2.00
Large Double Outside Room and Bath -	3.00
Parlor, Bedroom and Bath - - - -	4.00

Restaurant a la Carte, Moderate Prices

GEORGE L. SANBORN, Proprietor

Formerly Hotel Cumberland and Hotel Navarre.

# NAIAD Aeronautical Cloth

Manufactured Especially for Aeroplanes and Used by  
Aviators of Prominence

LIGHT, STRONG, AIR-TIGHT

AND

MOISTURE-PROOF ON BOTH SIDES

Sample Books, including Data and Prices, sent on request

THE C. E. CONOVER CO.

101 Franklin Street - - New York

FOR IMMEDIATE DELIVERY, complete wood and metal parts for single surface Curtiss type including 50 yards No. 2C Naiad Aeronautical Cloth, three 20" x 2" wheels, 6" hubs, 3/8" knock out axles. **PRICE, \$175.00.**

25 to 30 H. P. Motor, air cooled, with Schebler carburetor. **PRICE, \$200.00.**

All of the above for \$365.00. Let us tell you about it.

Prices on double surface headless, Goodyear fabrics, wheels and supplies. Motor of the two and four cycle type, water cooled, with two or three blade propeller, on request.

**WOLVERINE AERONAUTIC COMPANY**  
DETROIT, MICH.

# ... The Wittemann Biplane ...

HAS A REPUTATION, NOT ONLY FOR PACE, BUT FOR QUALITY AND SERVICE

Write for information of 1912 Biplane with our new auxiliary stabilizer.

If you want to build a machine of your own design or parts thereof, we can help you to make it successful. Some parts of your plane can be made of steel. We rid you of the annoyance of constant repairs and insure absolute safety.

Send us your specifications and requirements and secure our quotations.

Large stock of steel fittings, laminated ribs and struts of all sizes carried in stock.

Own a Wittemann Biplane Glider; the best, the safest, easiest to operate, and enjoy flying in a moderate form.

## YOUR OPPORTUNITY

Two single cover biplanes for immediate delivery; slightly used, perfect condition with 8 Cyl. 60 H. P. Hall Scott power plant.

Write for Particulars.

Write for Catalogue.

## C. & A. WITTEMANN

Aeronautical Engineers

The Oldest aeronautical manufacturing concern in the United States.

Established 1906.

Works: Ocean Terrace and Little Clove Road.

Staten Island

New York

**A KHAKIED DUDE 'ILL DO!** For th' "**STIFF-WING**" Meat---That's True?

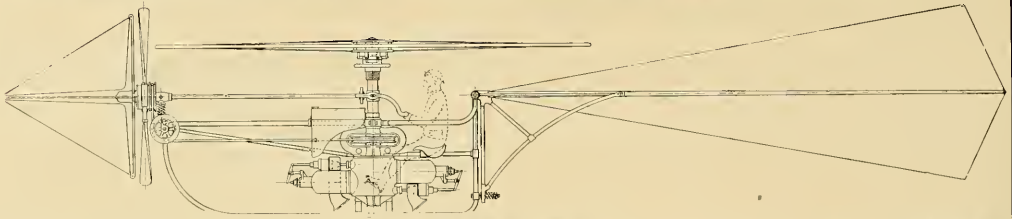

But th' world 'ill **FLOP** when th' **HELI-"COP"** goes ramblin' round in **BLUE**  
**JOS. E. BISSELL** Box 795 **PITTSBURG, PA.**

## YOU CAN WIN THE MOST OF THE \$100,000

Offered in the GREAT AMERICAN CIRCUIT RACE by using one of our

# BLERIOT MONOPLANES

**We sold more successful Bleriot Type Monoplanes in 1911 than all other manufacturers combined**  
 Our BLERIOT TYPE MONOPLANES are in every way suited to contest and exhibition work, including speed, altitude, distance and duration, cross country and cross city flying, where thorough, reliable strength and high efficiency are so vitally important.

**SINGLE SEATERS PASSENGER-CARRYING MONOPLANES RACING MONOPLANES**  
**ALL PASSENGER CARRYING MONOPLANES ARE EQUIPPED WITH A DUAL CONTROL SYSTEM**

A few of the most prominent owners of our BLERIOT TYPE MONOPLANES are:  
 A. C. MENGES, Memphis, Tenn. J. ALBERT BRACKETT, Boston, Mass. WILLIE HAUPT, Philadelphia, Pa.  
 E. J. MARLEY, Sumner, Miss. G. B. McNAMARA, Norton, Mass. CHAS. W. SPENCER, Phila. Pa.

Visit our factory and examine in detail the **EXCELLENT DESIGN and CONSTRUCTION** of our Monoplanes

**AMERICAN AEROPLANE SUPPLY HOUSE** 137-143 Jackson St., Hempstead, L. I., N. Y.  
 Telephone 427 Hempstead

# PROPELLERS

If you really want  
**T H E B E S T**

## GO TO GIBSON

He takes the trouble to find out what *is* best. You can call, 'phone or write him; address

**GIBSON PROPELLER CO.**

FORT GEORGE PARK

197th St. and Amsterdam Ave., New York

Phone Audubon 6762

## Duplex Propellers

Lines and curves productive of highest efficiency.  
 Laminated and hand made. Select materials.

## Duplex Monoplane Surfaces

Type Nieuport. Streamline form entering edge.  
 Flexible trailing edge. Slight dihedral angle built in. Up-to-date warping arrangement.

For details and prices apply to

**FRANK HERBST**  
**ENGINEERING WORKS**  
 Wilmington, N. C.

# THE CURTISS SUMMER TRAINING SCHOOL AT HAMMONDSPORT, NEW YORK



ONE OF THE CURTISS TRAINING GROUNDS

**New Hangars, New  
Equipment, Experienced  
Instructors.**

**Aeroplane and  
Hydroaeroplane  
Courses.**

*The Curtiss Schools are  
the largest in America.*

*Seventeen pupils obtained  
their pilots' licenses at  
our San Diego School be-  
tween January first and  
March fifteenth.*

*Summer classes are filling  
rapidly.*

**WRITE OR WIRE YOUR ENROLLMENT TODAY**  
*PRICES AND PARTICULARS UPON REQUEST*

*Largest  
Builders of  
Complete  
Aeroplanes  
in the world*



**ALL NATIONALITIES ARE REPRESENTED AT THE CURTISS SCHOOLS**  
(One of the Graduating Classes.)

**THE CURTISS AEROPLANE CO.**  
HAMMONDSPORT, NEW YORK

# FLIES HEAVIEST AMERICAN BIPLANE

*A New Triumph for the Roberts Model 6-X*

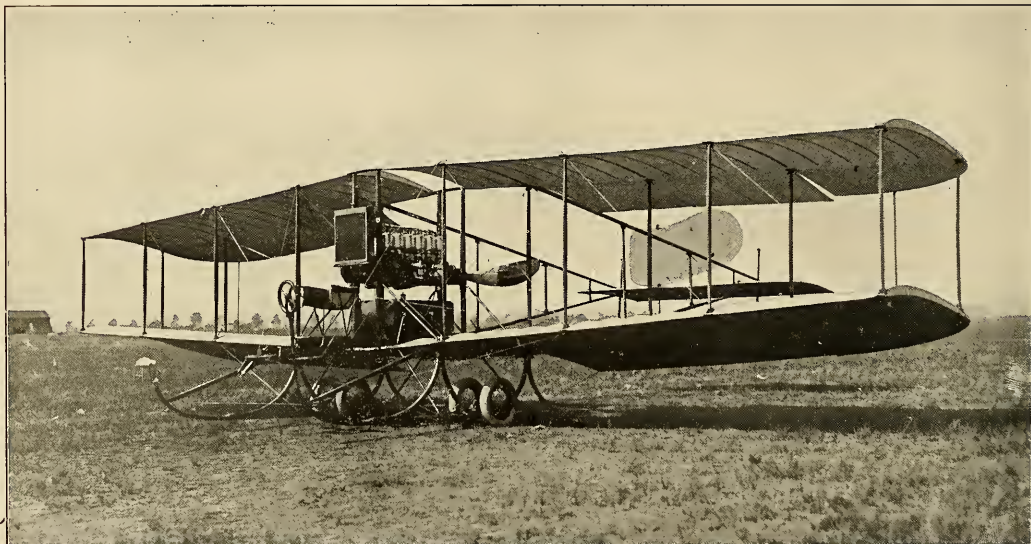

## **THE CHRISTMAS BIPLANE—ROBERTS 6-X 75 H. P. MOTOR**

This machine, with aviator and full load of fuel, weighs 1800 lbs.

### **READ THE FOLLOWING LETTER:**

The Roberts Motor Company,  
Sandusky, O.

MINEOLA, L. I., June 1, 1912

Gentlemen: It gives us pleasure to state that your Roberts six is a wonder. Your engine drives the machine sixty miles an hour, which is the record for a machine of this size. The engine works perfectly, never missing a stroke. The Christmas biplane in which your six is installed is 40' by 6.5' chord.

Respectfully yours,

CHRISTMAS AEROPLANE CO.

*SEND FOR NEW CATALOG TODAY*

# **THE ROBERTS MOTOR CO.**

**1463 Columbus Avenue, Sandusky, Ohio.**

# AIRCRAFT

Vol. 3 No. 6

AUGUST, 1912

15 Cents a Copy



A FLOCK OF LAND AND WATER BIRDS

Scene at the Curtiss Training School at Hammondsport, N. Y., showing three land aeroplanes and three hydro-aeroplanes. At the far end can be seen the latest Curtiss flying yacht

# Monoplane Flyers Are in Demand

There are more competent biplane flyers than there are positions for their services. There are less good monoplane flyers than there are positions. This is the time to earn the big money in flying monoplanes. In exhibitions the monoplane commands from 70 to 100 per cent. more compensation than the biplane. In the

## Sloane School of Aviation

monoplane flying is taught on a genuine famous Deperdussin Machine. The course is an exact duplicate of the course given by the Deperdussins at Rheims, France. The tuition fee is

# \$300

for the full course. If the pupil completes the course without breakage 10 per cent. of the tuition fee is refunded. A guarantee of \$250 for breakage is required. The pupil is made competent to comply with the most rigid license test.

**No bond of any kind is required when the pupil flies for his license.**

Of the seven pupils who entered the school during the first month one was certified as proficient after three weeks of the course. He finished without any breakage whatsoever.

Visit the school. It is located on the famous Long Island flying field near New York.

**DEPERDUSSIN MONOPLANES** are the safest and most efficient flying machines in the world. Hold 90 per cent. of the world's records.

**CAUDRON MONOPLANES** are safe and tremendously speedy. Best for exhibitions.

**ANZANI MOTORS** hold the unique record of giving tremendous speed, reliability, efficiency and safety. No fatal accident during the year has occurred with an Anzani Motor.

**WIRE**

**'PHONE**

**WRITE**

# SLOANE AEROPLANE CO.

1731 BROADWAY, N. Y. CITY

'Phone 5421 Columbus

Agents Eames Tricycle Co., San Francisco and Los Angeles; W. E. Boughton, Washington, D. C.



**LUMINA**  
AEROPLANE CLOTH  
SYSTEM CONTINENTAL  
THE B. F. GOODRICH CO., AKRON, OHIO

**The first Aeroplane Cloth with the ALUMINUM finish manufactured in America.**

*Never Shrinks  
Waterproof  
Always Tight  
Bright and Clean*

**Send for our New  
Booklet and Samples of  
"LUMINA"**



Philips W. Page flying in Burgess-Wright Machine equipped with 40-H. P. Sturtevant Motor

The Latest and Best principles of gasoline motor construction, carefully tested and proved by the foremost builders of engines in this country and abroad are found in the

**Sturtevant**  
REG. U. S. PAT. OFF.

## AERONAUTICAL MOTORS

A four-cylinder 40-horsepower STURTEVANT motor was used by Page in a Burgess biplane flown by him during the Boston Aviation meet; although used in every event during the entire meet absolutely no repairs or adjustments were made on the motor, which operated perfectly, carrying the plane to altitudes of over 5000 feet. Such absolute reliability is due to sound engineering principles in design and superior workmanship in construction. Ask for Catalog 200-O.

**B. F. STURTEVANT CO.**

Hyde Park

Boston, Mass.

AND PRINCIPAL CITIES OF THE WORLD



## FRONTIER MODEL A

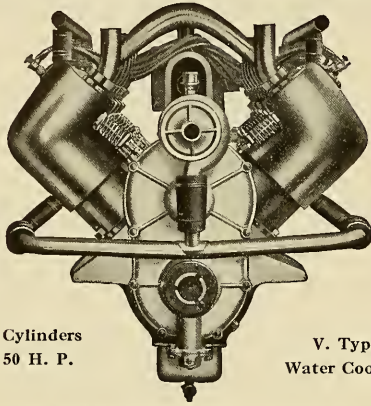

8 Cylinders  
50 H. P.

V. Type  
Water Cooled

Four and three quarter lbs. per actual Horse Power

## Simple Reliable Durable

Reliability and durability coupled with minimum weight, consistent with absolute safety, are the important points of superiority combined in the FRONTIER Aero Motor of quality.

Our claim for distinction lies in the unique and well balanced design and the mode of fuel supply, giving equal and never-failing power for all altitudes and temperatures.

Embodied in its construction are these essentials:

Highest grade of workmanship.  
Best materials.  
Experienced and capable engineers.  
Perfect shop equipment for manufacture.

Catalog and Price List on Application

**E. J. Willis Co.**

85 Chambers Street, New York Agents

**Frontier Iron Works**  
BUFFALO

## Wright Hydro-Aeroplane School Now Open at GLEN HEAD, L. I.

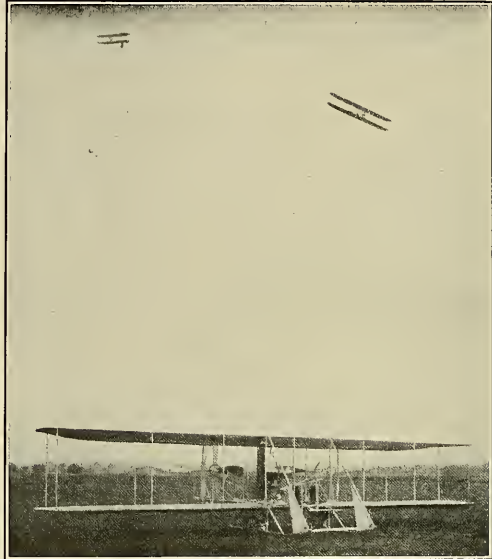

## Wright Flyers

### 1912 MODELS

In addition to those features which in the past have made Wright Flyers famous for efficiency and reliability, the new models can be furnished with **Automatic Control, Silent Motors, and Hydro-planes.** These special features make the 1912 machine unusually attractive to sportsmen.

### EXHIBITION MACHINES

For exhibition work we have other models especially adapted to high winds and small fields. It was with a stock "EX" Model that Rodgers made his wonderful flight from coast to coast. Reliability means dollars to the exhibitor.

### WRIGHT SCHOOL OF AVIATION

Training consists of actual flying, in which the pupil is accompanied by a competent teacher. No risks and no expense whatever from breakage. The most famous flyers in America are graduates of our school and include such names as

Lieut. Arnold	Drew	Lieut. Rodgers
Atwood	Elton	Parmalee
Brookins	Lieut. Foulis	Page
Brindley	Fowler	Reynolds
Bonney	Gill	Simmons
Beatty	Lieut. Lahm	Turpin
Burgess	Lieut. Milling	Welsh
Coffyn	Mitchell	Webster
Capt. Chandler	C. P. Rodgers	and many others.

Our Schools at Dayton and New York are now open and pupils may begin training at once if they wish. By enrolling now you can reserve date most convenient to you for training. Write for particulars.

## THE WRIGHT CO.

Dept. "B"

DAYTON, OHIO



# BLERIOT MONOPLANES

The Most Successful Aeroplanes in all the Great Cross-Country Races of 1910 and 1911

**SINGLE SEATERS**

**PASSENGER-CARRYING MONOPLANES**

**RACING MONOPLANES**

Our BLERIOT MONOPLANES are in every way suited to contest and exhibition work, including speed, altitude, distance and duration, cross country and cross city flying, where thorough, reliable strength and high efficiency are so vitally important.

## ALL PRICES REDUCED

**FOR ONE MONTH ONLY**

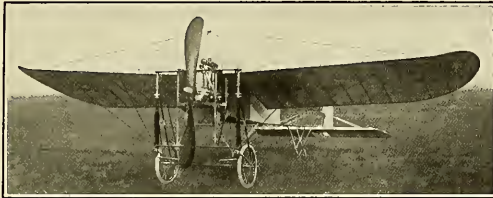

ONE OF OUR 1912 MODELS

Single Seater Monoplanes, from \$1,500 to \$ 900  
 Passenger-Carrying " from 1,900 to 1,200  
 Racing " from 2,000 to 1,300

We have three of our Monoplanes on hand ready for

## IMMEDIATE DELIVERY

**We sold more successful Blériot Type Monoplanes in 1911 than all other manufacturers combined did**

A few of the most prominent owners of our BLERIOT TYPE MONOPLANES are:

A. C. MENGES, Memphis, Tenn.  
 E. J. MARLEY, Sumner, Miss.

J. ALBERT BRACKETT, Boston, Mass.  
 G. B. McNAMARA, Norton, Mass.

WILLIE HAUPT, Philadelphia, Pa.  
 CHAS. W. SPENCER, Phila., Pa.

Visit our factory and examine in detail the **EXCELLENT DESIGN and CONSTRUCTION** of our Monoplanes

ILLUSTRATED CATALOGUE W, GIVING FULL DETAILS, FREE FOR THE ASKING

## American Aeroplane Supply House

137-143 JACKSON ST. Telephone 427 Hempstead HEMPSTEAD, L. I., N. Y.

Has  
**Flown**  
**Wright**  
 (genuine)  
**Curtiss**  
**Bleriot**  
**Farman**  
**Train**  
**Antoinette**  
**Dirigibles**  
 and  
**Speed Boats**

USED  
 THE  
 WORLD  
 OVER  
 FOR  
 YEARS



### OILING SYSTEM

Pump; Drive Rod; Pipe to Oil Sight Jacket; Distributing Pipes to Cylinders.

1. Oil always at a good working temperature.
2. Intake warmed enough to prevent "carburetor freezing."

Just a few more reasons for that other quantity-produced aero-

# YOU WOULDN'T

take chances with an engine you know to be poorly lubricated. Yet you know that at the high speeds of aviation the oil soon becomes boiling hot; as thin as water. That means efficient lubricating and a big waft of steaming oil.

By the MAXIMOTOR system the oil is pumped from the base reservoir, through the ice-cold jacket around the intake manifold and thence distributed to the cylinders.

### RESULTS

3. Oil circulation in plain view above carburetor.
4. Oil pump continually self-priming in bottom of reservoir.

# NO

wonderful record over every motor in the world.



## EVER HAD A FATAL ACCIDENT

If you want a good motor, write

MAXIMOTOR MAKERS  
 DETROIT  
 52 CRANE AVENUE

DEPT. 20

# WHY PARAGON LEADS



## TWENTY REASONS:

It is the **only patented propeller** on sale.

It is protected in every feature by numerous patents issued and others pending.

It is the **only factory-made propeller** made by a patented process and special machinery.

It is the **only propeller** in which the grain and texture of the wood is exactly duplicated in the blades.

It is the **only propeller** without "flat grain" wood, being all "edge grain" and therefore certain not to warp.

It is the **only propeller** that is doubly laminated at the hub and in the wide part of the blade.

It is the **only propeller** with tough and heavy wood where toughness is required and having light-weight interior of spruce or cherry.

It is the **only propeller** that is also a fly-wheel with heavy material in the rim. It eliminates vibration.

It is the **only propeller** with reinforcing in the blade ends.

It is the **only propeller** having curved dowels inserted edgewise through the blades.

It is the **only propeller** that cannot be split clear to the hub and beyond repair.

It is the **only propeller** that will cut grass, twigs, bushes, ice and water without being broken or badly worn.

It is the **only propeller** progressively improved—showing marked progress over the propellers of years gone by.

It is the **only propeller** built to a scientifically plotted and patented pitch curve.

It is the most efficient propeller in the world—the only propeller unqualifiedly endorsed by prominent French and American Aviators.

It is the **only propeller** guaranteed to be perfectly suited to the power that is to turn it and to the load that it is to drive—when we are given this information.

It is the **only propeller** insured against total loss by accident and repaired free for thirty days.

It is the **only propeller** that a wise aviator can afford to use. Works better and lasts longer than any other kind.

It is the easiest to buy and the hardest to find fault with.

It is the **cheapest propeller** in the world, built on honor and sold on merit, yet priced no higher than the old-fashioned, unpatented kind.

Can anything more be desired? We guarantee and furnish not the propeller alone but perfect satisfaction and highest results as well.

Write for prices, booklet and information sheet.

*Special agency propositions now open to established parties.*

**American Propeller Company**  
NEW LARGE FACTORY  
245-251 E. Hamburg Street  
BALTIMORE, MARYLAND

# FOX De LUXE AERO MOTORS

## Exclusive Features

- (1) The Fox Fourth Port Accelerator.
- (2) Rotary Valve Free from Back Pressure.
- (3) Average Weight 4 lbs. per Horse Power.

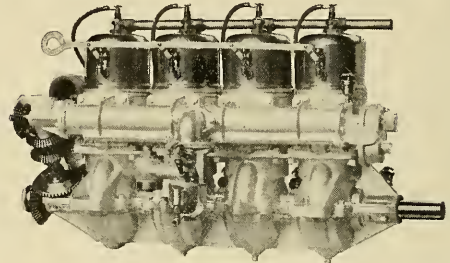

INTAKE SIDE.

Type 4 c. c. 60 H. P. Fox De Luxe Motors.

Built in 3 Sizes—45 H. P., 60 H. P. and 90 H. P. of 3, 4 and 6 Cylinders.

## THE BEST AERO MOTOR EVER PRODUCED

LET US PROVE IT.

WRITE TO-DAY FOR CATALOGUE.

**The Dean Mfg. Co.**

225 A. Front St.

Newport, Ky.

# AVIATORS WANTED



TO COMPETENT GRADUATES WE FURNISH A STANDARD-TYPE AEROPLANE PRACTICALLY WITHOUT COST

We Are the Real Western Pioneers

**WE TEACH FLYING ON**  
(CURTISS, FARMAN, BLERIOT)  
**MACHINES**

NO BREAKAGE CHARGED

We manufacture any type Aeroplane and make a specialty of Hydro-Acroplanes. All our machines are GUARANTEED TO FLY and guaranteed as to material and workmanship.

Home Study Course (Theory and Aerodynamics). Construction Course (Aerial Engineering). Aero-Motor Course. Flying Course. Our Basic Patents give us protection.

Our prices are the lowest. Full and honest value. Flying exhibitions booked for coming season.

Send for our Special Offer No. 2-to-day.

**Milwaukee School & College of Aviation**

S. E. Cor. Grand Avenue and Fifth Street

MILWAUKEE, WIS.

School-Shops, Hangars, Flying Field, foot of 64th Ave., West Allis, Wisconsin.

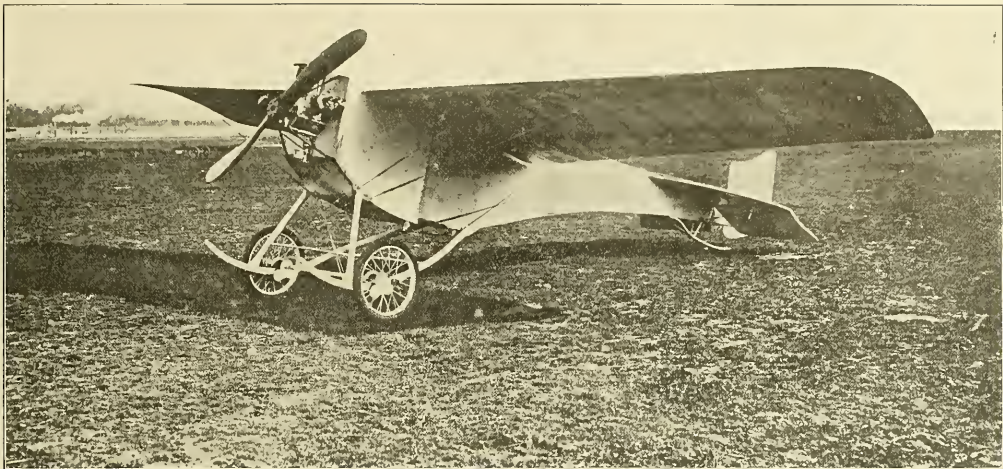

Ladougné's monoplaner, "La Colombe." A new machine which, although only fitted with a 30 H. P. Anzani, has given excellent results in recent test flights. The general dimensions are: Span, 28 ft.; length, 24 ft.; supporting surface, 172 sq. ft.; weight, 528 lbs. A larger and more powerful machine of this type has been constructed and in recent trials with passengers aboard proved itself a very fast and efficient flyer.

**CONTENTS---AUGUST, 1912**

A New Method of Lateral Balance . . . . .	Philip Wakeman Wilcox 175
Why I Made Money at Exhibition Flying . . . . .	Earle L. Ovington 177
Some Air Ship Facts . . . . .	T. R. MacMechen 178
Pioneers of Aviation . . . . .	Baron Ladislas d'Orcy 179
Editorial . . . . .	Alfred W. Lawson 180
Danger of the Lifting Tail . . . . .	W. H. Phipps 182
Problems of the Boston Meet . . . . .	Denys P. Myers 183
Eye-witnesses' Reports on Miss Quimby's Accident . . . . .	184
(a) Leo Stevens, Hugh L. Willoughby, Earle L. Ovington and A. A. Merrell Reports . . . . .	184
The Mattullath Patent Case . . . . .	Denys P. Myers 185
Foreign News . . . . .	R. H. Blanquie 186
The Trade . . . . .	189
General News . . . . .	D. E. Ball 190

**AIRCRAFT**

ALFRED W. LAWSON  
President and Treasurer  
ERNEST C. LANDGRAF  
Secretary

Published Monthly by The Lawson Publishing Company  
37-39 EAST 28th STREET, NEW YORK, U. S. A.  
Telephone, 5017 Madison Square

ALFRED W. LAWSON  
Editor  
WALTER H. PHIPPS  
Asst. Editor

**TERMS TO SUBSCRIBERS**

In the United States, Mexico, Puerto Rico, Guam, Philippine Islands, Hawaiian Islands, Cuba (including Postage), \$1.50 per year.  
Fifteen Cents the Copy, of All News Dealers.  
Foreign Subscriptions, Two Dollars per year.  
In changing order give old as well as new address.  
Advertising copy must be in hand by the 1st of month previous to date of publication.  
Only high-grade advertisements of thoroughly reliable firms are solicited.

**WHEN YOUR SUBSCRIPTION EXPIRES**

One month before a subscription expires we enclose a renewal blank on which you will write your order for the renewal.  
WHEN FIRST NOTIFIED that your subscription will expire, you should send your renewal AT ONCE, in order not to miss a number. New subscriptions which are received by us on or before the 15th of any month will begin with the issue of that month. If received after that date they will begin with the following month's issue. We cannot enter subscriptions to begin with back numbers. One month's notice is necessary before a change of address can be made.

Entered as "second-class matter" February 18, 1910, at the Post Office, at New York, N. Y., under Act of March 3, 1879.  
Copyright, 1912, by the Lawson Publishing Co.  
"Aircraft" is registered as a trade-mark by the U. S. Patent Office, under date of August 9th, 1910.

# Haul Carroix Automobile Co. Aviation Dept.

## AEROPLANE MOTORS AND EQUIPMENT

New York, 1780 Broadway

TEL. 1335 COLUMBUS

Paris, 63 Avenue Champs Elysees

# IMPORTERS

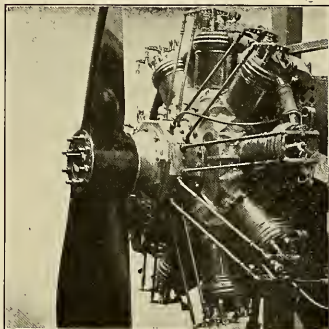

SALMSON MOTOR (Canton-Unné Type)  
90 H. P. 120 H. P.

SOLE  
AMERICAN  
AGENTS

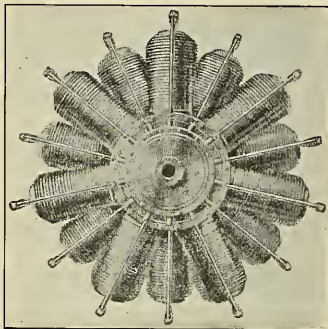

GNOME, 50-70-100-140 H. P.

IN STOCK  
AT  
NEW YORK



MORANE MONOPLANE  
Fastest Monoplane Built

SOLE  
AMERICAN  
AGENTS



TRAIN MONOPLANE

IN STOCK  
AT  
NEW YORK

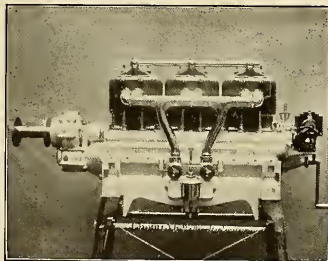

CHENU AVIATION MOTORS  
60 H. P. 100 H. P. 200 H. P.

SOLE  
AMERICAN  
AGENTS

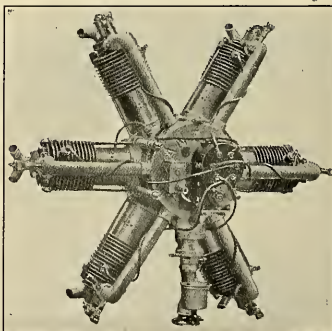

ANZANI, 35-60-80-100 H. P.

IN STOCK  
AT  
NEW YORK

NO MORE RUBBER CLOTH

### ASTROL VARNISH

Used by All the Manufacturers Abroad

Sole American Agents

### HELMETS

and Everything Else in  
Imported Supplies

# AIRCRAFT

Vol. 3. No. 6

NEW YORK, AUGUST, 1912

15 CENTS A COPY  
\$1.50 A YEAR

## A NEW METHOD OF LATERAL BALANCE

By PHILIP WAKEMAN WILCOX

**PHILIP WAKEMAN WILCOX** was born in New York City June 19, 1884, and first became interested in aeronautics in 1904, when Israel Ludlow was making his experiments with a Glider on the Hudson River. In 1908 he became president of the Columbia University Aero Club, and while at Columbia during the year 1909-1910 designed and built a full-sized aeroplane as a Civil Engineering thesis subject. This machine was the only machine ever built by any university to make successful flights, which it did during the summer of 1910. During the winter of 1910-1911 Mr. Wilcox, allied with Mr. H. M. Horton, conducted a series of wireless telegraphy experiments, and succeeded in receiving and sending messages without a ground wire. Mr. Wilcox is the inventor of a number of other devices besides the equalizer described, one being a gyroscopic balancing device, weighing about 10 lbs., which as far as steps have gone is successful. He also was the originator of the spring turnbuckle lock, used on a large number of present day aeroplanes. He has also made a specialty of photography from an aeroplane and has worked out a method of computing the distances and altitudes required for photographing buildings, etc.

ing a turn.

Also, if desired to dispense with the vertical rudder altogether a means for steering the machine to the right or left, in a



PHILIP WAKEMAN WILCOX AT WORK IN HIS LIBRARY.

manner similar to that employed by a bird, namely to increase the resistance of one end over the other.

To sum up the device described will enable the operator to do the following things:

1. Balance the machine laterally without in any degree affecting the forward flight of the machine. The forward resistances of the ailerons being exactly equalized.

2. To be able to control at will the resistance of the ailerons so that they may vary from equality to the entire resistance on either aileron, the opposite aileron offering no resistance.

The pictures of the model shown are trick photographs, inas-

**T**HE device which I am attempting to describe has for its aim, a method whereby the ailerons when in operation will in no way offset the flight of an aeroplane, otherwise than in the manner for which they are designed; to rotate the machine about a longitudinal axis either to balance the machine laterally or to bank it while mak-

ing as in a number of cases two exposures were made on the same negative in order to show more than one position of the moving parts, in order to be better able to describe the movements.

Figure 1 shows the mechanism disassembled to show the parts.

The ailerons are marked L and R and are pivoted at m and n.

A is the main lever pivoted to the aeroplane at O.

P is a link with a slot running through the center from end to end. In this slot fits a pin pivoted on the end of the hand lever A. The relative position of the link P and the pin at the end of the lever A is controlled by the bell crank C pivoted at the opposite end of the lever A.

S and T are rocker arms which, when in position are pivoted to the aeroplane upon the same pivot, so that in the normal position one covers the other completely.

The rocker arm S is connected to the aileron L by crossed wires.

The rocker arm T is connected to the aileron R by direct wires.

The rocker arm S is rigidly connected to the top of the link P by a rod X.

The rocker arm T is rigidly connected to the lower part of the link P by a rod Y equal in length, etc., to the rod X.

Figure 2. This shows the lever in a position to operate the ailerons L and R. It is assumed that the desired position of R is up and that of L, down, but the aileron R has assumed an angle of approximately 45° with the horizontal, while that of L is only 15° with the horizontal. It is obvious that R would have a much greater resistance than L so we want this greater resistance to force R down to 30° and L from 15° to 30°, in which case the angles would be equal and thereby equalized, and furthermore we want to accomplish this automatically, without our bothering with it.

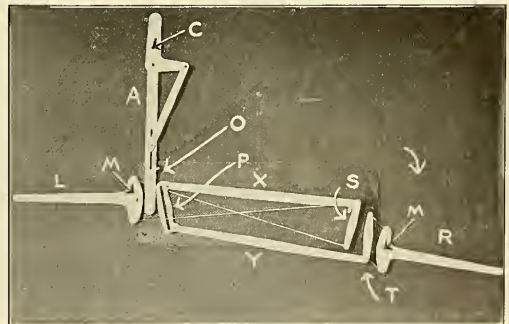

Fig. 1.

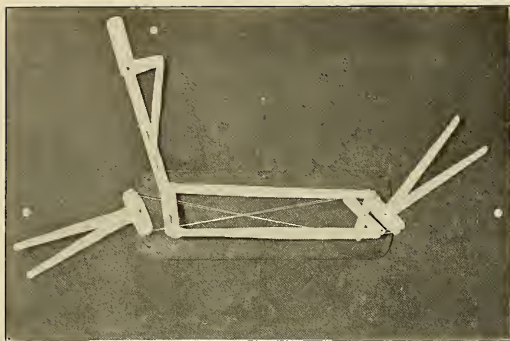

Fig. 2.

As R goes down it rotates the rocker arm T which in turn pushes the rod Y.

As L goes down it rotates the rocker arm S in the opposite direction and pulls on the rod.

The combined effect being to rotate the link P about the pivot at the end the lever A.

During this operation the rod Y is in compression and the rod X is in tension, but as soon as the ailerons assume equal angles, both rods are in compression. The link P is pivoted at its center so the movement of the thrust on X times the leverage of the link, "exactly equals and is opposite to the movement of the thrust on the rod Y times by leverage of the link."

Any variation of the thrusts of the rods will cause motion of the link about its pivot, which will continue until the movements are again equalized. The resultant force due to these movements will be through the pivot on the link in the direction

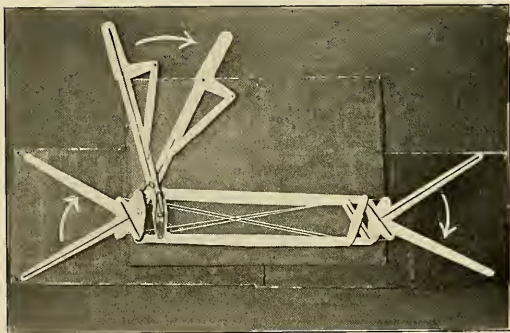

Fig. 3.

of the thrusts opposing the thrust of the aviator's arm, or similar to the resistance which a man feels in operating any such lever while in flight.

It is thus shown that the resistance of the ailerons are automatically equalized, without the intervention of the operator.

Figure 3. Shows the lever thrown from one extreme to the other, showing the ailerons working in the same manner as the old Curtiss up and down system.

Figure 4. Shows the bell crank C at both extremes showing the link being pivoted first at one extremity and then at the other.

Figure 5. Shows the effect of moving the lever with the link being pivoted at one extreme. The entire motion taking place with one aileron L the same as if the end of the lever A were rigidly attached to the rod X and moving the lever back and forth rotates the rocker arm S which in turn rotates the aileron L in an opposite direction.

The aileron R is held in place by the air pressure above and

below it, and moving the lever A back and forth has no effect whatsoever on it, as it is now loosely connected with it, and the only effect that moving the lever A has is to increase or decrease the angle between the link and the rod Y, as is shown in the photo.

By moving the bell crank C in the opposite extreme the link would be in such a position that only aileron R would be affected by moving the lever A and aileron L would be unaffected or the entire operation would be reversed.

By moving the bell crank C any degree between the central position and either extreme we can control the relative resistance of the ailerons by controlling the relative angles to the horizontal. If we should desire to make a turn to the left we would move the bell crank C in the position shown in Fig. 5 and operate the lever A. This would cause the machine to bank and the resistance introduced on the left side would cause it to turn

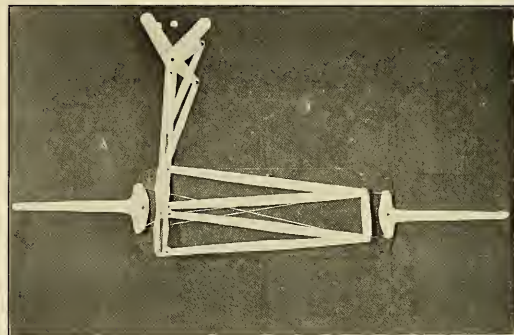

Fig. 4.

towards the left. I know positively that this resistance is sufficient to turn the machine, due to my experience with a machine using ailerons of the Farman type where only the ailerons of one end are used at a time.

In this case, with the apparatus described, the resistance would take place, first in operating the ailerons in making the bank and secondly in using the ailerons to return to a level keel.

Patent applications for this or similar equalizing devices were filed early in 1910 by three parties besides myself, and we have lately come to an agreement regarding the issuing of the patent.

The case referred to, was upon one occasion when learning to fly, I operated the ailerons on one side at a very decided angle. Although that side did go up, at the same time the machine turned so suddenly to that side, that before I could correct the turning the machine struck the ground.

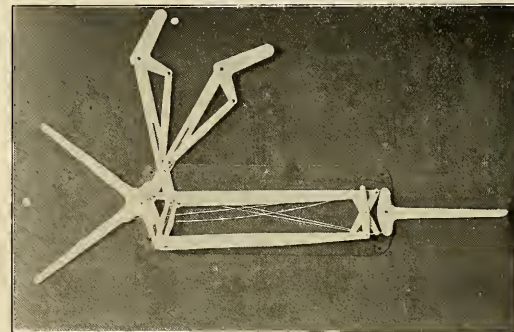

Fig. 5.

# WHY I MADE MONEY AT EXHIBITION FLYING

By EARLE L. OVINGTON

**H**AVE often been asked why I made money flying an aeroplane at exhibitions, while many other aviators were unsuccessful. To be sure I have not made the fortune in aviation that a few men have made who came into the field a year or two earlier, and who did very much more flying. I do think, however, that I have obtained an unusually large amount per mile of flying, i. e., when the total number of miles flown is taken into consideration in connection with the net receipts. Looking at the matter purely from a financial standpoint, I attribute my success primarily to four reasons.

First, I obtained a machine which I thought was the very best for my purposes, namely a 70 H. P. Monoplane. I chose this machine rather than a biplane, because I realized that in exhibition work I would often be in competition with others, and hence speed was an important factor. Incidentally the monoplane always appealed to me more strongly than the biplane. A monoplane, too, appeals to the imagination, and in exhibitions that goes a long way. There are also comparatively few monoplane aviators in America, while there are a large number of men who can operate a biplane. The first thing I did then, was to choose a standard high grade machine, and pay a good price for it. As a business investment, that's the best I ever made.

Second, I hired the best mechanics to take care of my aeroplane that I could find. I had an expensive motor and so I employed three men who knew that motor backwards and forwards, and could take it down "in their sleep." I have often left my faithful mechanics at six o'clock in the evening just taking the motor out of its frame, to come down the next morning and find it was already in place, after having been taken entirely to pieces during the night. I have been quite apprehensive at times when I have seen pistons, connecting rods, cylinders and valves strewn all over the floor in apparent confusion. But I found by experience that order always followed chaos. I learned to have absolute confidence in the ability of my mechanics, and I have often stated that much of my success was due to their faithful efforts.

Third, I was always most careful to inspect my machine before making a flight, with the result, that although I made over one hundred



A remarkable picture of exhibition flying taken at Columbus, Ohio. From top to bottom are Earle L. Ovington in a Blériot monoplane; Phil Parmalee, Wright biplane; Tom Sopwith, Howard Wright biplane, and Captain Tom Baldwin in his Red Devil biplane.

flights, I never broke a single thing in my monoplane, nor a single wire, although I have smashed other machines not so carefully inspected. I will say that this record is very unusual, and is largely luck, but not entirely so. My machine was always in perfect shape before it left the ground. After my mechanics got through tuning it up, I would go over it very carefully myself and see that every wire emitted just the right note when I plucked it, as one plucks a banjo string. Every exhaust valve had just the right lift, and opened at just the right time. By kneeling down behind each of my supporting planes I could squint along the trailing and entering edges and find out whether the two were parallel, as they should be. Placing a level on the wings I ascertained if the dihedral angle was correct. I paid particular attention to the anchoring of the various important wires. Of course I examined the control very carefully to see that it was perfectly free and in good working order. I made up my mind early in the game that if I was going to be killed in the air it would not be my fault. I also had the theory that many were killed on account of their own carelessness.

Fourth, I very seldom made a public flight for nothing. I had entered exhibition flying as a business, as well as a pleasure.

I had invested a certain amount of money in an aeroplane, and had spent a considerable sum in expenses during my six months' schooling. I wanted to get a good return on that investment, and I managed my affairs as if I were running a business. I don't mean to say that I didn't do a lot of free flying, for I did, but it was only on my home aerodrome. In other words, at Belmont Park or Nassau Boulevard I would often go out, but there were never very many people to view me. And usually I had some good reason for making a flight. This flying long distances across country with nothing to show

for it but a little glory, and perhaps a broken machine or two, never appealed to me. It wasn't that I didn't want to do it, for no one loves flying better than I do, nor was it because I did not care to take the risk, for I have taken about as many risks as the next fellow. I was looking at the matter purely from a business standpoint, and I did not want to take the chance of smashing my machine, and thus putting it out of

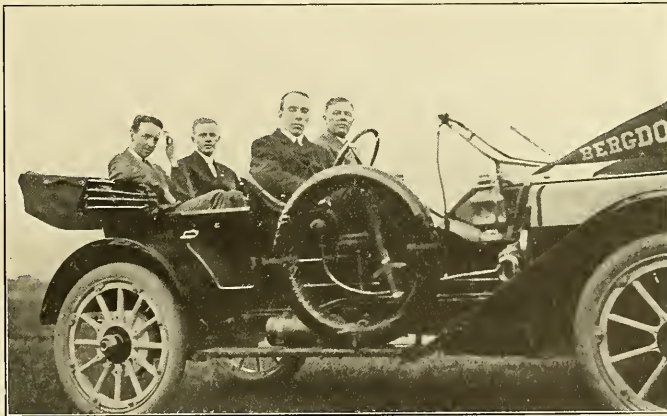

FOUR FAMOUS EXHIBITION FLYERS. FROM LEFT TO RIGHT: TOM SOPWITH, PHIL PARMALEE, EARLE L. OVINGTON AND CAPTAIN TOM BALDWIN.

commission as a money-earner unless there was some adequate reward in view.

Personally I am of the opinion that the cream has been skimmed from exhibition flying. I don't mean to say that money will not be made in exhibition flying, for the public will go to see aeroplane races even as they go to see automobile races now. However, the remuneration will not be anywhere near as great as it has been in the past. Furthermore, I had an expensive machine operated by an engine which cost me a lot of money to keep up and taken care of by mechanics who needed quite a little of the "long green" when pay day came around. If I had had a machine which was less expensive to buy and cost less to operate and take care of, I might possibly have felt differently on the subject.

At the beginning the remuneration was pretty good, and of course at the Boston meet I had no kick coming, for by winning the Boston Globe Tri-State race I made \$10,000 in three hours and six minutes. That's at the rate of nearly a dollar a second.

## SOME AIRSHIP FACTS

By T. R. MacMechen



THE recent destruction of Count Zeppelin's Airship "Schwabens," and Melvin Vaniman's dirigible, "Akron," does not deal a serious blow to the development of the lighter-than-air-craft, as the lay mind is given to understand by reporters' versions and untutored editorials in most American newspapers.

The first newspaper reports were that the "Akron" exploded, which was not a fact and the cable dispatches also stated that the "Schwabens" had exploded, which likewise was not a fact.

Official reports from Director Colman, who is the business head of the German Air Navigation Company, which operates the Zeppelin passenger airships, says there was no explosion and also states that the accident was not due to any fault of the airship.

In fact the basic cause of the accident lay in the deficiency of proper docking facilities. Incidentally, it might be well to note here that all of the past accidents to the Zeppelin airships were caused either by poor docking facilities or by poor handling, both of which deficiencies can be overcome with time and knowledge.

Furthermore, it may be well to mention here that there has never been a single man killed through a Zeppelin accident.

The Schwabens came to grief in docking at an antiquated airship shed at Dusseldorf, Germany, on June 28th, 1912, which shed was built in 1909 when navigation of the air was not as well understood as it is now.

In fact its position was actually in the centre of a circle in which the winds were in a constant waring state and consequently blowing from all directions, naturally making the docking of an airship about as difficult as it would be to undertake the docking of a boat in the swirling waters of the Niagara rapids.

The newspapers reported that the accident happened while the Schwabens was at anchor entirely unmanned. This is not correct as the official report states that Captain Duerr was on board the ship and even the steward was at his accustomed place in the cabin.

The wind had been coming up and as it was broken and irregular, the ship began tugging at its mooring cable. Captain Duerr had given the order to cut loose and start the motors but at that instant he noticed that electric friction had been created at the bow of the ship by the strain it had been subjected to by the variable gusts of wind.

A small flame had started to burn the outer envelope. It

At some of the meets, however, where the first prizes were \$300.00, the second \$150.00 and the third \$50.00 or none, it would not have paid me to even enter the contest, and although I was right there at the meet, I didn't do so.

I firmly believe in the future of the aeroplane, and I am confident that there is a legitimate use for it. But, it is not necessary to reduce flying to a circus performance in order to make money.

Let me suggest to those who may possibly be considering exhibition flying that perhaps it would be better in the long run to study aero-dynamic engineering with an object of ultimately building aeroplanes or learning to become an aviator, having in mind to become an instructor at one of the big schools. If, however, you do become an exhibition flyer you should manage your affairs as you would an ordinary business, as it is only by carefully following sound business principles that you will be able to make a success of exhibition work. Incidentally this remark applies to almost any other walk in life which you may undertake.

was too late, however, to get up into the air. The captain and the crew then jumped for their lives and the flame, driven by the strong wind, swept over the entire length of the ship.

The newspapers reported that the ship broke loose, this again is not correct; it swung at anchor. If it had not been for the sparks inside of the bow, there would have been no disaster as the ship would have been steered high up above the tempestuous atmospheric conditions just as a great ocean vessel steers out into the great expanse of deep waters when these waters become dangerously rough.

A short time ago the Viktoria Luise had a similar accident while riding at anchor at the same sheds; a few of her strakes broke, but no great damage was done.

Director Colmann points out that to insure safety of the Zeppelin ships while at their anchoring places, it is now necessary to build revolving sheds along the Rhine valley which will enable the ships to enter while moving against the wind, no matter in which direction it is blowing. Revolving sheds are now successfully used by the Siemens-Schuckert airships. The Zeppelin people are fully alive to the necessity of obliterating the causes of different accidents which come up from time to time, which is shown by the constant improvement of their ships, sheds and crews.

The German Air Navigation Company will continue the passenger-carrying service with the Hansa and Potsdam. This company has the support of the Emperor and the German people as a whole. In fact the Imperial Chancellor, who had been a frequent passenger on the Schwabens, has made a statement that not only will the Conquest of the Air go on, but that it will be only a matter of a few years when air transportation will be as universally adopted as either water or rail transportation.

It is understood that the loss of the Schwabens does not fall upon the Zeppelin Construction Co., the airship being insured by an English Company for \$162,000, and not only this, but on her 364 trips, she paid for the entire operating expenses of the Air Navigation Company for one year and also paid for the loss of the airship Deutschland.

The Zeppelin engineers are now working on a "Neutralized Balloon Cloth" that cannot be electrified and it is understood that hereafter the entire hull of Zeppelin airships will be covered with this cloth. Furthermore, a metal has just been perfected that will withstand the impact of bullets; this metal, which is as thin as sheet tin and on which striking bullets will spread like sealing wax, will be used as armor on the cars and the entire under surface of Zeppelin war airships.



In regard to the Vaniman disaster negligence and imperfect engineering theories were the prime factors. In fact all of Vaniman's experiments showed lack of following along the lines of experiments made by the great pioneers of airship constructions and taking advantage of both their successes and failures.

In the May issue of AIRCRAFT an article appeared, written by Mr. Vaniman, in which he gave his plans for the construction of a new dirigible in which the envelope would be made of a new woven steel fabric of his own invention, that would maintain a constant level in flight by retaining its gas in a hermetically sealed envelope indefinitely, and while the Akron must not be identified with his proposed new airship, there is still no question but that his recent experiments were dominated by his newer theory.

The fact is that the Akron burst through the expansion of the gas caused by the sudden and probably unexpected appearance of the sun, causing the inadequacy of the safety valves which should have permitted the excessive pressure of the gas to escape more quickly than it apparently did. The bag burst, it did not explode, there was no ignition of

the gases to cause the explosion otherwise the balloon would have burned.

It is comparatively easy for those who are familiar with the technics of airships to point out the faults which led up to the Vaniman disaster. In the first place the Akron was of faulty design, the gas bag for one thing not shaped to make high speed, the reason for this was that its motor was too weak for the size of the bag, the result being that the dirigible moved too slowly to enable its rudders to hold the bag down and thereby preventing it from ascending or descending as the Zeppelins do with their rigid hulls and high power. Another serious fault was the method Vaniman used in manufacturing hydrogen, this method long since was abandoned by airship constructors in Europe, owing to the fact of its weakening the texture of the envelope.

If Vaniman, influenced by his new theory, was attempting to retain his gas in the Akron, the pressure on the bag when it rose to 2,000 feet, would have amounted to ninety-five one-hundredths of a pound, which no engineers in Europe would dare put into practice.

## PIONEERS OF AVIATION

By LADISLAS d'ORCY

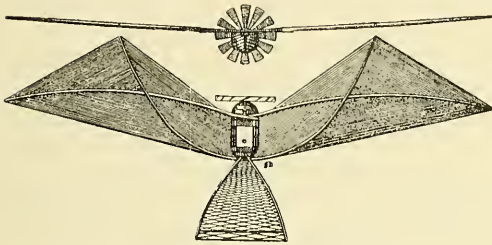

Top and rear view drawings of Du Temple's aeroplane. This machine was fitted with wheels, had the propeller in front and was driven by a steam engine.

### III. FELIX AND LOUIS DU TEMPLE.

**W**ITH the failure of Henson's spectacular enterprise and the abandonment of Stringfellow's experiments, aviatic work in Great Britain came to a standstill, that was to last for nearly twenty years. However, the IDEA of materializing mechanical flight by means of the aeroplane could not be blotted out of the minds of a small aeronautic élite, which sprang up soon afterwards in France and many enthusiastic experimenters are seen at work at this early period of Aviation's History.

Among the earliest and most persistent attempts towards the attainment of artificial flight in France, is that of the two brothers Félix and Louis du Temple, who spent over twenty years investigating and constructing flying machines and although their venture was not successful, it brought forth another invention of immense value to the naval world, the multitubular boiler.

In the year 1857, Messrs. Félix and Louis du Temple, both retired officers in the French Navy applied for a patent on a single surface aeroplane, which was to rise from land and water alike. Following are the details of this machine, as given by the patent specifications: a boat shaped, watertight body of steel tubing that is covered with tarred cloth contains a motor that might be either steam or electric and develops 6 H. P.; this motor drives a six bladed tractor-propeller of 12 ft. diameter; two wings of 55 ft. total spread and made of oiled canvas stretched over a frame of wooden ribs, are set at an angle of incidence, that can vary according to the needs from 3% to 35%; back of the body is the controlling apparatus, which consists of a stabilizing tail for the elevation and a rudder for the horizontal direction. The

whole machine is mounted on three springy roller-legs, which can be folded up during the flight and lowered again for landing; its total weight was to attain about 2,000 pounds.

This patent contains also a very correct theory of bird flight, explaining all the manoeuvres necessary to rise, to find support in the air and to glide safely to earth again. The patent also specifies, that "the center of gravity lies always beneath and in the perpendicular of the center of pressure. Stability in bird flight is possible alone under this condition."

Hereafter numerous experiments were conducted by Messrs. Du Temple for the purpose to ascertain the practicability of artificial flight; first a motorless man-carrying aeroplane was built in form of a boat fitted with wings, and this machine when launched over an inclined platform erected on the beach of Cherbourg proved to be fairly stable; then various small working models were experimented with so as to determine the best stabilizing device; these little aeroplanes, which were driven by clockwork, succeeded in making many short flights; but their stabilization was never solved in an entirely satisfactory way and it often happened, that they capsized while in the air.

Nevertheless the construction of a full sized machine, as described in Messrs. Du Temple's patent, was also begun and pushed vigorously along up to its completion in 1874; then the lack of a sufficiently light motor stopped further progress for two years; but the persevering genius of Louis du Temple overcame also this obstacle by the invention of a light weight steam engine fitted with a multitubular boiler, that was soon to be adopted on the speedy gunboats of the French Navy. In this engine the weight was brought down to 18 lbs. per horse-power, a marvelous achievement for the time being.

In spite of all these improvements, in spite of the twenty years spent in relentless study and observations of bird flight, Messrs. Du Temple's aeroplane was never a success; for while this machine contained a number of interesting details, which were successfully used on later aeroplanes, it could never raise itself from the ground and this only owing to its great weight, for the principles governing its construction were promising enough.

Being the first aeroplane built and experimented with in France and embodying various original ideas, like the mounting of the propeller in front of the wings, the collapsible landing gear, and the flexible rear edge of the wings, Messrs. Du Temple's flying machine deserves well to go down in history as the prototype of the XX. century monoplanes.

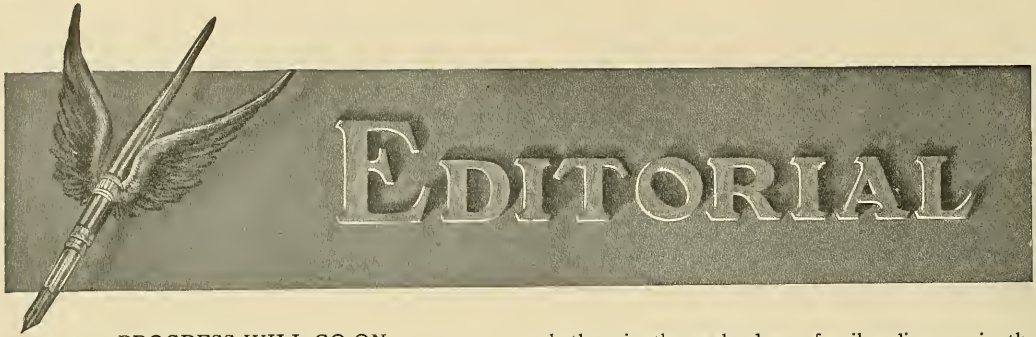

### PROGRESS WILL GO ON.

**I**N an article on page 178 of this month's AIRCRAFT T. R. MacMechen, the American authority on airships, has explained some facts concerning the recent Schwaben and Akron disasters to which we wish to add a few more facts herewith.

First, the destruction of the Schwaben and the Akron will have no more effect in retarding the growth of air navigation than the destruction of the Titanic and other steamships and steamboats will have in retarding the growth of water navigation, nor the thousands of wrecks on railroads will have in retarding the growth of land transportation.

In fact, wrecks on land, water or in the air have a reverse effect by teaching men to construct better and safer vehicles and learn to operate them more efficiently.

It is the disaster that actually force improvements, and the child-like ignorance displayed by the great majority of newspaper editors and magazine editors, even those professing to be technical and scientific, not only demonstrate their absolute lack of knowledge concerning what is being done by the great developers of the aeronautical movement, but it also shows their lack of even ordinary reasoning powers; their news reports and editorials on this subject usually have about as much sense as one might expect from reports and editorials written by a chimpanzee on the weights and construction and the usefulness of the various bodies flying through space. The editors know not of what they write; they hand out opinions without knowing the facts; without knowing the elementary principles of their subject; therefore their opinions are worse than worthless.

Last year the Schwaben made 134 trips and this year it made 229 trips, making a total of 364 trips altogether, prior to the time it was destroyed; last year it covered a distance of 11,004 miles, this year 17,000 miles, making a total of 28,004 miles covered altogether; last year it carried 1,500 people, this year 4,445 people, making a total of 6,045 passengers altogether. The Schwaben, as a passenger carrying ship of the air, not only paid all of its own expenses of construction and operation, but it also paid the expenses to the company for the loss of the steamship Deutschland as well, and we would like to know

whether, in the early days of railroading, or in the early days of steamboating, if such a record could be shown.

In the first stages of railroading wrecks were of such frequent occurrence and men, women and children were killed in such tremendous numbers, that a great many people of those days openly avowed that the railroad was an invention of the devil himself. And even now, after more than fifty years of railroading, just recently, and within ten days, three terrible railroad wrecks took place in America in which 43, 21 and 13 people were killed respectively, besides several hundreds being injured, YET RAILROADING GOES ON. Then again, there was one recent steamship disaster, the Titanic, in which over 1,600 people were destroyed, and this mind you, after we have had steamboating for over a century, STILL STEAMBOATING GOES ON, and we tell you here plainly that even if there are as many disasters in the air in the future as there have been on water and land during the past, AIRCRAFT WILL GO ON, notwithstanding all of the silly statements from the pens of old fogey editors existing in all parts of the globe.

### WONDERFUL AIRSHIP DEMONSTRATION.

**T**HE VIKTORIA LUISE, one of the big passenger carrying Zeppelin ships of the air, has just been purchased by the German Government for \$125,000, following her third great over sea demonstration. Starting from Kiel and going down the Elbe River to the sea, she cruised all over the outlying islands during the trip of 400 miles over the ocean. While at sea she sighted the Hamburg-American Liner "America" on her way to the United States, and the big airship which was forty miles away in the offing, easily overtook her and descended until her lengthy bulk overshadowed the entire steamer.

In fact the Viktoria Luise flew through the air for thirty miles with only about sixty feet separating her from the "America's" masts while imitating every movement of the steamer, as she went to port or starboard, but always completely covering her.

This demonstration was for the purpose of proving to naval officers aboard the airship that a supply ship among the naval fleet can easily furnish both fuel and gas to the naval airship at sea, thus prolonging the endurance of the airship indefinitely. This means

that the airship does not have to return to shore for supplies. Compare this radius of action to anything that an aeroplane is doing as an auxiliary, to what any naval fleet can do and we immediately begin to realize Germany's tremendous superiority in the air for either scouting or fighting on either land or sea. And furthermore this wonderful demonstration of the airship's capabilities is only an inkling of what can be expected with time and natural development.

#### AMERICANS EXPORTING FLYING MACHINES.

IT will not be long before flying machines, as well as airships, improved and made much safer and easier to handle, will be utilized extensively in every civilized and uncivilized country in the world, and we are particularly anxious that as the industry goes on and the demand for machines increase that American concerns will be in a position to reap the harvest of a large export trade. In order to do this they must not only manufacture the best machines, but must have the facilities for manufacturing them and handling them on a large scale.

Furthermore their products must be advertised in all parts of the world and this feature, of course, can best be accomplished through the advertising columns of AIRCRAFT, which magazine is read by the aeronautically inclined in practically every country on the face of the earth.

No concern can expect to grow up in a day, nor can it expect to gain the confidence of the buying public in a day; it requires time, honest effort and judicious and persistent advertising to make any concern permanently successful, whether it be in the aircraft industry or in any other industry.

It is, therefore, of very great pleasure for us to call attention to one American firm who are becoming eminently successful as exporters of American made machines to all parts of the world, and this is the Curtiss Aeroplane Company of Hammondsport, N. Y.

The Curtiss Aeroplane Co., have already sold to the Russian Imperial Navy, three hydro-aeroplanes and an extra motor. All these have been shipped to that country, and Mr. C. C. Witmer is now in Russia demonstrating and instructing the officers in the operation of the machines. One other Curtiss hydro-aeroplane has also been sold to Mr. S. O. Ochs of the Russian American Importing Co., of St. Petersburg, Russia.

Oberingieur Kober, of Friedrichshafen, Germany, has purchased a Curtiss aeroplane. Two Curtiss hydro-aeroplanes and an extra motor have been sold to the Japanese Imperial Government and three of their officers are enroute to Hammondsport for instructions.

The Italian government has placed an order for three Curtiss hydro-aeroplanes with the Curtiss representative in France, Mons. Louis Paulhan, delivery of these machines to be made on the first of August.

Further than this, the Curtiss hydro-aeroplane is now being used by the great French aviators Paulhan, Barra, Mollin and Mesquich, and we understand that

a great many English, German, Austrian and Russian professional aviators are about to give their orders for this machine.

In fact according to Mr. H. C. Genung, vice-president and manager of the Curtiss Aeroplane Co., a great many other export sales are now pending and will probably be closed up in the near future, all of which goes to prove that an American concern can compete successfully in the aeroplane business as well as in any other business, with the manufacturers of any other country in the world.

We urge, therefore, once again, all American manufacturers to not only put their business in such shape that they can manufacture machines just as good as the foreigners, but that they can go right into the world's market and get their proper share of the business. The world's market is growing larger and larger each year and the American concerns must grow with it. Their success, however, depends principally upon the quality of their product, the length of time they have been in business and the widespread publicity given to their concern.

#### NEW IDEAS FOR AVIATORS.

THERE are thousands of ways in which the professional aviator can make money for years to come in the exhibition business if he will just use his brain to originate and execute new ideas. One of the newest methods of advertising by aeroplane was just recently adopted by the Daily Mail of London. This most up-to-date newspaper throughout the entire world established the "Daily Mail Flying Tours" in which they have sent their aviators flying all over Great Britain giving public demonstration of what an aeroplane can do.

First, they sent out M. Salmet with a Bleriot on a trip extending about two months which proved so successful that they engaged E. H. Ewen to operate a Caudron biplane to tour an entirely different section, then they put on B. C. Hucks with a Bleriot to cover another section, and finally they engaged Grahame-White, Hamel, Hubert Fisher and Lieut. Parke for the same sort of work.

The advertising received through this method proved so great that the London branch of the International Correspondence School, who teach aeronautics as one of their courses, sent out J. C. Slack on a similar tour to demonstrate not only that machines would fly, but that the International Correspondence School cater only to practical as well as theoretical instructors. The aviator distributed advertising matter as well as giving demonstrations.

We are pleased to note that our suggestion in the March number of AIRCRAFT has been followed by the organization of an Aviators Association recently in Chicago. The success of this organization, however, depends primarily upon its formulating rules permitting none but aviators to become eligible for membership.

# The Danger of the Lifting Tail and its Probable Bearing on the Death of Miss Quimby

By WALTER H. PHIPPS

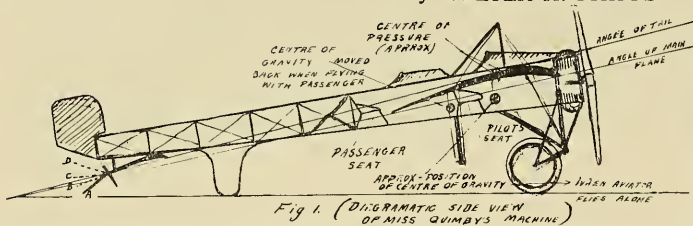
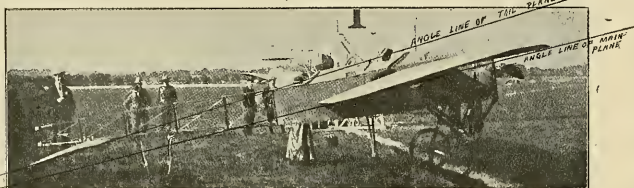
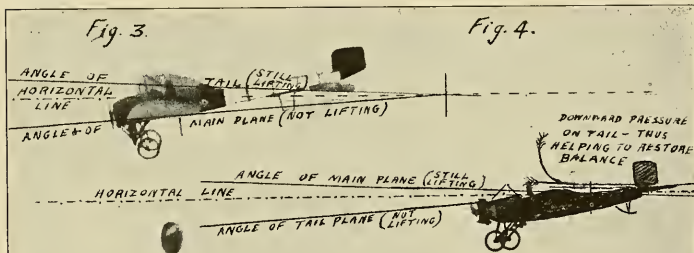

Fig. 1. (DIAGRAMMATIC SIDE VIEW OF MISS QUIMBY'S MACHINE)

Side view of the new lifting tail two-seater Blériot, showing how the passenger sits behind the wings in such a position as to throw considerable weight on the rear of the machine, thus necessitating a lifting tail. The drawing also shows the tail set at a greater angle than the main plane.



PHOTOGRAPH OF NEW BLERIOT SHOWING THE TAIL SET AT A GREATER ANGLE THAN THE MAIN PLAINES.



In Fig. 3 is seen a Blériot two-seater lifting tail monoplane with two aboard (the passenger is crouched down under the rear cockpit to cut down resistance) descending on a turn and as shown by the lines drawn on the photograph, the tail is at a positive angle to the line of flight, while the main plane is at a negative angle. It will thus be seen that the faster this machine descends the more the tail will lift.



The two photographs above, which illustrate a lifting and a non-lifting tail machine in descent, form an excellent comparative study of the action of pressure on the main and tail planes and prove conclusively the correctness of the theory advanced in the accompanying article.

In Fig. 3 is seen a Blériot two-seater lifting tail monoplane with two aboard (the passenger is crouched down under the rear cockpit to cut down resistance) descending on a turn and as shown by the lines drawn on the photograph, the tail is at a positive angle to the line of flight, while the main plane is at a negative angle. It will thus be seen that the faster this machine descends the more the tail will lift.

In Fig. 4 is seen a Caudron non-lifting tail monoplane descending, and as shown by the lines drawn through the planes, the tail is at a negative angle to the horizontal line of flight, while the main plane is at a positive angle. It is therefore apparent that there is a downward pressure on the tail and an upward pressure on the main planes, which helps to restore the balance and not to destroy it as on the Blériot.

While the recent death of Miss Quimby who, with her passenger, Mr. W. P. Willard, was thrown out of her machine when it dove from a height of 1,500 feet at the Boston Meet, came as a great shock to the writer, it was, however, not entirely unexpected, for only recently discussing the merits and demerits of Miss Quimby's new machine with Ladis Lewkowicz, a Blériot pilot who has had much experience with lifting tail machines, the writer predicted a similar accident and drew attention to the mysterious fall of the late Capt. Echemann, one of the best French Military Blériot pilots, who was killed in descending when his machine, which was the first of the new type flown by Miss Quimby, suddenly assumed a vertical position in the air, and descending in a sweeping arc, struck the ground just as the machine was reversing so that the wheels were not even harmed.

This accident, like the subsequent one which befell Miss Quimby, was undoubtedly caused, or at any rate, aided by the action of the lifting tail, and in the following it will be the endeavor of the writer to explain the danger of this type of tail.

In order to get a clear understanding of the theories advanced herein, it is advisable to make reference to the accompanying drawings.

In figure 1 is seen a diagrammatic side view of Miss Quimby's machine, and it will be noticed that the passenger seat is placed behind the aviator and not over the centre of pressure, it is thus apparent that in order to properly balance the machine it is necessary to carry a passenger, or else an equivalent weight in ballast. If, however, the aviator desires to fly alone, he does not, as would be supposed, change the angle of the fixed stationary tail, but merely lessens the lift of the tail by keeping the elevator flap up a few inches in the position C.

It will thus be seen that for every change in weight carried in the passenger's seat, the elevator has to be moved into a different position, and that therefore it not only acts as an elevator but as a lifting tail as well.

From the foregoing it is readily apparent that a machine of this type has not the slightest degree of automatic longitudinal stability, and that for this reason, alone, if none other, is an extremely tricky and dangerous type to handle. This fact is clearly emphasized when it is taken into consideration that such experienced pilots as Gustav Hamel, B. C. Hucks and Miss Harriet Quimby had considerable difficulty in learning to fly this type machine.

Turning now to the action and danger of the lifting tail itself, I will first begin by stating certain habits of the present day machines and endeavor to point out the important part the tail plays in causing them.

At the present most aeroplanes, especially monoplanes, have a decided tendency, under certain conditions, to either dive when descending sharply or else stall when climbing too steeply. Now in both cases this is due to either the improper distribution of weight, or a poor design of tail.

In the case of a diving machine the tail lifts too much, while with the stalled one it lifts too little. It can, therefore, readily be seen that the whole success of the longitudinal balance of an aeroplane lies in the proper distribution of weight and the correct design of tail, and that this very important member should only be called upon to act as a stabilizing damper, preventing the machine from either diving too steeply or stalling and not under any circumstances as a lifting plane.

In order to accomplish this it must be either a flat or slightly negatively inclined surface, but never a lifting surface for the reason outlined in the following:

In figure 1 is shown a diagrammatic side view of a lifting tail machine, and it will be noticed that the tail plane is curved and arched down at a slightly greater angle than the main plane. Now let us assume that the machine is flying level, in which case the load on the main plane and tail are balanced; suppose now, as shown in Figs. 2 and 3, the machine is suddenly pointed down, even though for a glide—what happens? The pressure on the main plane is diminished and the speed of the machine is increased by reason of the action of gravity and lessened resistance, with the result that should the angle of descent become too steep (either through a wind gust striking the tail or negligence on the part of the aviator in not leveling out before the CRITICAL angle is reached); it is impossible to get the tail down even though the elevator be pulled up. This is owing to the fact that the faster the machine falls the more the tail lifts (because it is set at a greater angle than the main plane), until the slight pressure under the main plane is sufficient to tip the machine through a vertical position and throws the occupants out unless, of course, they are strapped in.

In descending, such a type of machine will describe a large sweeping arc with the tail rising higher and higher until the aeroplane reverses itself in the air, oftentimes landing on its back.

It is this very action of a lifting tail machine descending in such a manner that proves the truth of the assertions advanced herein, and also probably explains the cause of the deaths of John B. Moisant, F. Blanchard, Jules Noel, René Vallon, Valdemar, Kimmerring, W. Smith, Lefevollet, Lieut. Edmund Boerner and others, all of whom were killed while attempting steep glides in lifting tail machines.

Following this explanation are articles by Denys P. Myers, Earle Ovington, A. A. Merrill, Hugh L. Willoughby and A. Leo Stevens, who were present at the Boston meet and have written their versions of the accident. It is noticeable that the reports differ as to the cause of the accident, Ovington and Myers attributing it to the control column foisting the rudder wire, Willoughby to a guy wire breaking, Leo Stevens to the passenger leaning forward to talk with Miss Quimby, while Merrill attributes the accident to much the same cause as the writer.

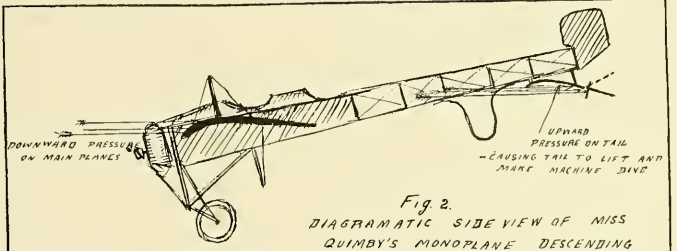

While Ovington's, Willoughby's and Stevens' report might explain the particular accident in question, they do not, as can readily be seen, explain the many similar accidents in which there was no passenger carried and the machines were intact when they fell.

## PROBLEMS OF THE BOSTON MEET

By Denys P. Myers

The third aviation meet held at the Quantum Field, prepared two years ago by the Harvard Aeronautical Society, passed into gloomy history on July 6. The management faced a deficit of about \$25,000, had conducted the affair in the face of a constructive Aero Club of America, had lost its manager through an accident and had run its latter course with constantly recurring monetary difficulties always to the fore between the aviator and manager.

It added nothing worthy to aviation history, but presented some problems that merit attention of themselves. Notwithstanding the rather dismal failure of the venture, the affair developed an idea that may go far toward placing exhibition flying on a proper footing. When the bottom fell out of things on account of Manager Willard's death and the management—mostly promoters—began their vain struggle to come out whole an essential fault of their organization was laid bare to some of those personally interested in aviation. Why not organize a club of us who are interested in flying to run these things in later years?" asked one, and the suggestion has taken shape. The result is a Boston Aero Club, composed of aviators and others, and if another public meet is held these men will personally subscribe or secure the necessary guarantees, while the personal supervision of the contests by such men will assure events that are well conducted.

That is the obvious position for the Aero Club of New England to have assumed, but that organization, more than its peers elsewhere, is inclined to be a clique of balloonists who make occasional flights to land in treposts or some not so fertile Yankee. The new club intends to specialize in popularizing aeronautics, and thus will occupy a field of its own. That is one of the purposes of the International Federation, which, according to its statutes, assumes control of contests and contests in all words. In the United States the Aero Club of America represents that responsibility, but there are two other phases of aeronautics worthy of organized attention. These are distinct popularizing and scientific study. The latter is receiving separate attention from the Aeronautical Society and the Boston organization of the same name; the former receives casual mention from most organizations, but chiefly the Aero Club is semi-technical. There is the starting of a club designed primarily to encourage aviation in a community is worth while, and the example is worthy of consideration elsewhere.

Two other points of connection with the Boston meet must be mentioned: the trouble with the Aero Club of America and the Quimby monoplane accident.

The first brings up the question of a central authority which was raised in these columns in October, 1911, when it was suggested that the Aero Club of America be invested with sufficient legal status through national incorporation and its decrees absolute and unquestionable. The Boston facts were that the meet was sanctioned, and on that understanding the management engaged by contract over a dozen aviators, practically all of whom were licensed pilots. Whether or not the early sanction, based on a statement of the proposed contests, rules of the course, etc., was made contingent upon a financial showing of responsibility is of little consequence, since it is well known that any meet sanctioned by the central body must satisfy its demands of financial responsibility in regard to prize money and satisfying aviators' contracts. The Boston management was in so unenviable financial conditions that it offered these guarantees only the day before the meet opened. Wintrop M. Southworth, assistant secretary of the Aero Club of America, made this statement:

"Sanction for the Boston meet was refused be-

cause no guarantee was received satisfactory to the officers of the Aero Club that the licensed aviators who were to compete would receive the \$19,000 in prize money which it was announced would be furnished by the promoters of the meet. For the meet, two years the Harvard Aeronautical Society has controlled this meet. This year there are different promoters. In their application three months ago they submitted rules and a program which were satisfactory and they were given until noon to-day to come forward with a guarantee in the matter of prize money. A guarantee was made, but not a satisfactory one.

"The Aero Club's action will not necessarily call off the meet, but if one is held it will be of different character than planned. The promoters may hold exhibition flights, paying aviators for their work, but there can be no competition for prize money."

It would seem from this statement that the satisfaction expressed in respect to the rules and program was contingent upon a subsequent financial showing, in the opinion of the Aero Club; but whether that was understood by the management cannot be known, since Willard, who had all arrangements in charge, is dead. However, he issued a statement in which he asserted that the Club was "assuming unwarranted authority" in demanding the "turning over of the business conduct of the meet to the Aero Club of America," which, be it noted, was not even suggested.

Prof. R. W. Willard, of Harvard, New England representative of the Club, was ordered by telegram to notify the aviators officially that the meet was unannounced, and did so on its first day, after the aviators had signed contracts for appearance, had themselves been satisfied as to the financial arrangements and had gathered from all over the country to fulfill their contracts. Official individual notices did not arrive until later, and whether the fliers themselves had decided to flout the authority which gave them their licenses and live up to their contracts. Most of them were of the opinion that the money involved in the contracts was more desirable than a pilot's license.

Here, of course, is a pretty kettle of fish, and it looks as though the question is not whether it is going to be kept but how it is to be cooked. Competition for prizes, the only one of competition over which the Club assumes control, was observed for a few days at the meet, and then things went to smash, so that during the last half of the meet the question uppermost in the minds of the aviators was not whether they were winners or losers but whether they were to get any money at all. Finally, the aviators attempted to run the affair for themselves as a commercial proposition and put their own men in charge. Most of the prize events untried, with the bulk of the flying exhibition in character. Probably every aviator will be glad enough to get a contract price for his work and will be willing to waive a right to the prize money as such. In such a case, the whole affair takes on the aspect of exhibition flying, over which the Aero Club of America could have no control. But it did not start with that aspect, and at the beginning the defiance of the Club's order by the pilots was unmistakable.

The pilots affected were summoned to appear at the Aero Club of America for trial of the case on July 16, and it should be obvious from the above that the Club officials have a complicated situation to thresh out.

It is not yet known what considerations actuated the contest committee of the Club and how much of the complicated series of facts was deemed pertinent by it, but its decision was for the suspension of the pilots' licenses until December 31. It was thus entirely, even to have made them not re-issuable. The actual decision is, under the cir-

cumstances, justified as a proper exercise of central authority. The aviators whose licenses are suspended for the rest of the year are Charles N. Hamilton, Lincoln Beachey, Glenn L. Martin, Phillips W. Page, Paul W. Peck, Arch Freeman and J. F. Terrill.

On July 1, the second flying day of the meet, Harriet Quimby in her 70-horse-power Blériot flew the course to Boston Light and return with William A. P. Willard, manager of the meet, as passenger. She had been flying at about 1,000 feet, but had reduced her height to about 1,000 to make the round of the course preliminary to landing. At the westerly end of the course, while over the water, the spectators saw the machine suddenly point downward, and the body of Willard sail through space in front of the machine, to be followed immediately by that of Miss Quimby. Five thousand people were horrified at the sight, most of whom did not realize at first the tragic significance of the spectacle. Both Willard and Miss Quimby were probably dead before they reached the water of Dorchester Bay, from which the bodies floated as launches were tritubing out.

We who remain do not forget to pay our tribute of eulogy to these of our martyr dead. It is more fitting that we seek the cause than ourselves express what everybody feels in his heart when these things occur. The lesson Miss Quimby and Willard died to teach is apparently directed at the builder, though it has been charged up to Nature. Careful consideration of all facts and theories leads me to place the blame on the manufacturer. In this I agree with Earle Ovington, who himself had the first opportunity to examine the machine, which itself was little damaged.

All agree the machine was rounding to glide to the getaway, that is, veering, or on the point of veering, to the left. All agree that the machine itself pointed down at the time Willard was catapulted out. The machine itself landed in the water a few hundred feet from the victims of the accident, and as its propeller was going, it is probably indisputable that its controls were set to guide it where it fell. Further, it overturned, indicating perhaps a negative position of the horizontal rudder in respect to the sharp angular trajectory.

What Ovington found when he examined the machine as it fell was that the wire actuating the rudder was caught over the lower end of the vertical control lever, which, with the wings caught, he believes is that Miss Quimby, noticing a gust of wind, moved the vertical warping lever sharply to the right, the starboard wind at the same time pressing on the rudder and loosening the left duplicate lever. One of these, he thinks, caught on the lower end of the vertical control lever, which end would be to the left, since the lever itself had been thrown right. The catching of the controls is checked when, in that position and position, Release from his weight of 190 pounds encouraged the downward pitch and threw the aviatix out.

Along the same line, the Boston Aeronautical Society has issued a statement asserting the cause of the accident to be due to the lack of fore and aft stability to counteract rotation on the center of gravity of the machine. This is no doubt true as a tendency, but it is not a cause. There is no doubt that it does not consider the fact of the caught rudder wires.

Those who blame Nature for the accident introduce an air pocket, a thin retic hole in the air, which must have been extremely large to have

given the machine so notable a dip as it undoubtedly had. A machine traveling 60 m. p. h. passes through 88 feet of air a second, and it seems unreasonable to suppose that atmospheric conditions constantly encountered could become so intense in any given second of time and 88 feet of space as to captivate two people out and clear over the propeller. It is to be regretted that the victims were not strapped in, for they would

then have been able to keep their places and might have made a safe landing, even though straps have their own elements of disadvantage. The lesson that reasonably can be learned from this tragedy relates to construction of the control apparatus, every member of which should be separated from every other, and that possible confusion can result. Certainly no wire on which the tension is temporarily released should be so

placed that it can interfere in any way with the pilot's control. The matter of the machine rotating fore and aft on its center of gravity is one bringing up broader questions of construction, no less important. But entangled control wires is a detail easily remedied, and one to which in this case aviation probably owes the loss of one of its most accomplished devotees and one of its worthy enthusiasts.

## Eyewitnesses' Reports of Miss Quimby's Accident

### Report of A. Leo Stevens

The tragic death of Miss Harriet Quimby and William A. P. Willard, who fell in midair from Miss Quimby's Blériot monoplane at Boston July 1, has aroused universal speculation on the cause of that most unfortunate mishap.

All sorts of theories have been advanced, but as in the case of every similar tragedy, theories alone have remained to account for the happening. That "thing" which happened away up there 2,500 feet above the horror-struck watchers below, never will be described. It has only added one more to the "mysteries" of deaths in the air. Out of all the maze of conflicting opinions two or three seem to have gained prominence over the others: That something "went wrong" with some factor in the monoplane's control or machinery; that a sudden wind-puff whipped it out of Miss Quimby's control; that Miss Quimby became a victim of sudden mental panic, or even fainted.

Knowing as I do the machine's condition before the night, I discard the first theory. Knowing Miss Quimby as I do, I emphatically reject the third theory. The second theory I consider so purely speculative that I cannot seriously entertain it.

I saw the flight. It was one of the most beautiful performances I ever had seen Miss Quimby or any other aviator make. At all times until the accident occurred she had the Blériot under perfect control, and she had gained an altitude of about 1,000 feet, she swung the nose of the Blériot out toward the Boston Light. It was a perfect day, and the sun shined on the monoplane, which looked like a huge dragonfly speeding seaward far up in the air, until it grew smaller and smaller, finally becoming the least bit of a speck, which later became a speck of blue sky. In a little while the speck again enlarged, and Miss Quimby must have been at least 7,000 feet in the air when she circled the light, for on the out part of the head she had a large propeller, which grew larger and larger until she was out of the Blériot again shaped itself against the blue sky, we could see that Miss Quimby was coming down, flying at a speed of about 85 miles an hour.

When the monoplane reached a point over the grounds it was about 2,500 feet up. At this height Miss Quimby passed over the field, and a quarter of a mile beyond made a turn to come back.

Suddenly that "something" happened. The Blériot made a sudden dip, nose pointed downward, tail thrust upward, and for a moment we saw a body—Willard's, but itself upward out of the machine, apparently hurling fifty feet in the air, describe an arc, then come plunging downward well ahead of the machine.

Instantly Miss Quimby righted the machine, but a moment later the Blériot again dipped, stood in a perpendicular position with its nose down and the tail up, then turned completely over. Then Miss Quimby, flung from her seat, dropped, her body whirling over and over. She was plunging downward even before Willard's body struck.

As we know of the accident is what we saw. But it was not simply "something" or "some" thing caused it. I believe my theory of that cause is the most reasonable. I believe the accident was caused by the sudden straining forward based upon my knowledge of the machine and my close personal acquaintance with Miss Quimby and Mr. Willard and their personal characteristics.

In the first place the Blériot was made to carry two persons—an operator and one passenger. Without the passenger the operator must be placed at the point of weight of sand or other ballast. This is imperative, as otherwise the machine is thrown out of balance and cannot be controlled. An appreciable amount of that weight forward is highly disastrous, showing a backward has little or no consequence. This is because the Blériot travels with the tail elevated at quite an angle. The weight, when added forward of the point of balance, therefore raises the nose downward, while the tail rises at a sharper angle. Then the machine plunges, and unless the weight is immediately replaced, dives downward and weight merely tends to drag the tail down from the what, but does not throw the machine out of control.

The hood of Miss Quimby's machine had been removed to permit of easy access to her seat. Being worn her seat and the passenger's had been laid a board, before he entered the machine and even

after he had climbed aboard, was not to leave his seat under any circumstances. This warning I was very particular to give, because I knew him to be a man of sudden ideas. Many a time while talking with him I have known him to suddenly leap from or lean forward in his chair to communicate an idea that had flashed into his mind. I was fearful of such sudden impulses and effervescent enthusiasm he should suddenly leap from his seat to communicate with Miss Quimby. This I knew would be an exceedingly dangerous thing to do. I received his assurance that he would "sit tight."

Now, then, this is what I believe really happened. I believe that as the flight drew to its close, the Blériot, after a most successful and splendid performance, for a moment forgot the danger of moving, and suddenly stretched forward over the deck to shout a word of congratulation.

Miss Quimby, unable to see what was going on behind her, had no warning of Willard's movement until his shifted weight caused the machine to dip and the tail to flip upward. That same flip caused her, I believe, to throw Willard into the air. I noticed that as he came down, feet first, body rigid, his position was such as would be assumed by one attempting to crouch over the deck of the machine.

That Miss Quimby even for an instant lost her head is disproven by her instantaneous attempt to right the machine. Not only as her manager but the general public knew her as a woman of great coolness and judgment, and an operator of extraordinary ability. With Willard's weight gone—a weight absolutely necessary to the control of the monoplane—she was pitted against a circumstance over which no aviator, no human ingenuity or knowledge or skill or practice could have control. Only for an instant could she catch the machine in its sudden plunge. Her subsequent overturning was a mechanical consequence that could not be obviated owing to the construction of the machine.

### Report of A. A. Merrill

The writer, who held an official position at the third annual Boston Aero Meet, had charge of the contests on July 1st, and happened to be looking at Miss Quimby's machine when the accident occurred. He saw it fall, and wishes to state here what, in his opinion, caused it.

On July 1st there was exceptionally fine flying with three Curtiss and three Wright machines in the hands of the time. This brought the enthusiasm to a very high pitch. At about 10:30 Miss Quimby came out to do some exhibition flying, but, feeling the effects of the general excitement, decided to fly to Boston Light with Mr. Willard as a passenger. The course was set, and the machine got away easily. After gaining altitude the machine went off to the light. On the return, Miss Quimby was flying very high and she circled the course only once before starting to glide to the ground. The head of the machine was pointed downward for the glide, but instead of holding a safe gliding angle, the angle grew steeper and steeper until it happened to become nearly vertical. When in this position the air, striking on top of the surfaces, acted as a brake, and the forward motion of the machine was suddenly checked, and Mr. Willard pitched forward. The loss of weight made it impossible for Miss Quimby to regain control, and she was thrown forward immediately afterwards. Neither occupant of the machine was strapped in. It had been, it is possible that with the increased speed and nose dive, control of the machine might have been regained.

It is useless to discuss whether anything broke in the air. The condition of the machine in the water can give not one atom of reliable evidence as to what happened in the air. Moreover what happened must vary with the particular conditions even with the machine intact. The fault is inherent in all existing machines, but especially in monoplanes. The fault is this: When the angle of incidence of either monoplane or biplane is changed from positive to negative, or when the bow of the machine is pointed down, a change in the air pressure on the fixed surfaces is caused, which tends to turn over the machine and can only be checked by the rear elevator before the diving rotation has gone too far. This system of surfaces, whether monoplane or biplane, is inherently dangerous.

There is a system, however, that is inherently safe. It is composed of two surfaces of equal area placed tandem in such a manner that when zero the angle of the rear surface is minus two and one-half degrees. With such a system when

the bow is pointed down a downward pressure on the top of the rear surface depresses the tail and raises the bow, making it impossible to dive as Miss Quimby did. This is the only system in which no matter what position the machine may be in, the air pressure on its fixed surfaces tends to right it, never to upset it. Existing machines are like the old high bicycle, the system mentioned above is like the safety bicycle. Moreover, Eiffel's experiments with this system show that between the angles of +5 and 15 it is more efficient than a monoplane.

There are then three reasons for the accident, leaving out entirely a break in the machine. First, Miss Quimby dived too abruptly. Second, she did not quick enough in throwing up the rear elevator, and third, the machine's construction had no fore and aft stability and she and her passenger were not strapped in.

It is high time that builders wake up to the fact that the flying machine of the present is unsafe and will not be purchased by the public, and the sooner they begin to study the experiments of Eiffel the sooner they will be in a position to put on the market a machine that will be safe and which can be sold.

### Earle L. Ovington's Report

Dear Mr. Lawson—I enclose a newspaper description of the recent terrible accident to Miss Quimby and Mr. Willard at Squantum. As manager of the aviation course, I had unusual facilities for making prompt examination of the wreckage and I wish to make the following report in the hope that all monoplane constructors will avoid such a construction as existed in Miss Quimby's monoplane.

Referring to the rough sketch which I enclose, which is a plan view of the machine upside down as it rested in the water, I found that one of the two left-hand control wires (all of the Blériot control wires are in duplicate) had caught over the lower end of the warping lever. Of course the warping lever, as the rudder control wires should either have been put further from this warping lever, or else been run through sleeves at this point, so as to prevent them becoming entangled with it.

The reason this has not happened before in a Blériot monoplane is because the warping lever as used in Miss Quimby's machine was not the conventional Blériot "cloche" which was a feature of my seventy horse power monoplane and all others I have ever seen. I noticed this departure from conventional Blériot practice when I examined the construction of the machine before the fight. I have also called this matter to the attention of Blériot's attention in a letter under this date.

It is some satisfaction to know definitely the cause of this accident, and to assure you that I hardly think there is a chance of me being mistaken.

This was the first one to examine the wreck, and this rudder wire was caught over the control lever which I looked at the machine. And from what happened in the air, for I saw the whole accident, I am convinced that this was the difficulty. At such a position the construction should not have been such that this wire could get into a position, but looped over the control lever, whether in the air or at any other time. It is too bad that all aeroplane accidents do not leave such a clear record of their cause. Very truly yours,

EARLE L. OVINGTON

### Hugh L. Willoughby's Report

From my position on the field at the Boston meet, I had a very good opportunity of seeing the sad accident to Miss Quimby and Mr. Willard. It is my opinion that it was caused by the parting of the under forward truss wire, and an accident which has happened to many monoplanes. The truss wire has such a bad angle of truss that in the past of the Antoinettes" it was deemed best to put in a heavy rod with a breaking strain of twenty tons.

I spent an hour with the mechanic when he was assembling this latest "army passenger-carrying Blériot."

There were three points in construction that I criticized most severely.

1st. That the under truss wire that I spoke of was not attached to a band instead of a "cable" (Bundle of wire).

My objection to "cables" on any part of an airplane has always been that they cannot be soldered with an iron.

Any telegraph lineman will tell you what a strong acid would do to his work in a few months if being sealed up between the wires, under the solder.

2nd. The method used in attaching this wire (or cable) to the beam, from what I could see, was cupped into a conical ferrule with solder in a similar way that the wire shrouds are soldered into a turnbuckle on board a yacht (now obsolete), but not near the proportions of material was used for this purpose.

And 3rd, The weak construction of the attenuated tail, a change recently adopted since the

Deperdussin monoplane made her record breaking speed.

This miserable speed mania is responsible for ninety per cent. of the accidents, and Miss Quimby had it as badly as most of the men. Hamilton standing at my side when Mr. Willard struck the water turned to me and said, "That's the way your beautiful French monoplanes always act." Like Capt. Baldwin and myself, Hamilton has no use for headless machines.

If Miss Quimby and Mr. Willard had been equipped with "safety harness," the probabilities are that there would have been no loss of life, as the aeroplane righted and glided for a moment, and the bodies reached the water so far ahead of the plane.

The small amount of damage done to it seems to prove this statement.

HUGH L. WILLOUGHBY.

## THE MATTULLATH PATENT CASE

By Denys P. Myers



CHIEF JUSTICE SHEPARD of the District of Columbia Court of Appeals has just published a decision rendered in April which registers another stage in the fight against the prior patents of the Wright brothers, which as a matter of fact made aviation possible. Ostensibly, the case involves the widow of Hugo Mattullath, administratrix of his estate, and as such seeking to revive an application for a patent filed by him on January 8, 1900, and on which the last office action was taken October 3, 1902. On November 23, 1910, Mrs. Mattullath filed a petition to revive the application, pleading unavoidable delay in the interval to overcome the statutory stipulation that no more than one year shall elapse between periods of prosecuting a patent right. Chief Justice Shepard reversed the decision of the Commissioner of Patents, which was to the effect that the delay was avoidable and that the application could not be reinstated.

As yet, the Mattullath patent is not granted, but the decision—if not itself reversed—orders the Commissioner of Patents to consider the Mattullath application again, making it further incumbent upon him to study it as a patentable invention as of 1900, though if granted the period of monopoly under it will run from the actual date of issuance. The case is similar to the Selden case in respect to automobile engines, and the opinion of the Patent Office is that it opens up a wide vista of annoying revivals of patent applications, if upheld. That, however, is a point of interest chiefly to inventors.

The significance of the situation in respect to aviation in general is that the timidity supposed to have been engendered in the breasts of American aeronautical inventors, manufacturers and pilots by the undoubted validity of the Wright prior patent may now be complicated by the emergence of a second similar right. Independents have been considerably put out by the insistence of the Wright Company on its rights under its patent, which has given currency to a feeling that their pioneer work was retarding development. If the Mattullath application should be granted, it is likely that it would become the prior patent in respect to some features of dynamic flight, the Wrights concern and its licensees would be liable for infringement, perhaps, and the independents would find their individual progress conditioned on satisfying the claims of two prior patents.

The Mattullath patent application came to notice in the suits for preliminary injunction by the Wright Company against Curtiss and Paulhan in 1910, when it was sought to show that the Wrights themselves were infringers. A paragraph in the latter decision is the only description available of the mechanism which Mattullath worked out. Said the court:

"Mattullath: This was an abandoned patent containing full specifications which described six lateral and supplementary planes, three on a side, which were adjustable to different angles and were to be used to promote stability. At the rear was 'a rudder secured on a vertical shaft.' It does not appear whether this rudder was fixed or not, and the application does not include any use of the rudder to counteract the effect of the differential in the angle of incidence of the supplementary planes. The defendant's brief says that this rudder was to enable the machine 'to wheel to

right or left.' I can find nothing of the sort in the specifications, but for the purpose of the argument I shall assume that the vertical rudder was in fact adjustable. \* \* \* At most, Mattullath's designs were purely experimental, and did not give the public that benefit to which it was entitled if the patent in suit is to be held to be anticipated and without consideration. In the absence of some showing, which is not suggested, that the complainants borrowed any ideas from Mattullath, his discoveries must be held to be no anticipation."

That opinion at the time was simply by the way. On March 10, 1900, when the application was first filed, the Commissioner of Patents, in the course of a letter suggesting modifications, said:

"The construction is regarded as inoperative for the purpose intended and therefore not useful within the meaning of the patent law. \* \* \* Applicant has disclosed no new principle or construction which would on its face exempt his device from the difficulties of his predecessors in this line. However plausible applicant's theory may be, \* \* \* actual demonstration of operativeness will be required before the grant of a patent."

Such a test was never made, Mattullath having died while the claims of the application were in process of amendment; but it is possible that one of the picturesque incidents of aviation will be an actual flying test of the apparatus before the Patent Office finally acts on the work of this pioneer of twelve years ago.

As the case appeared in court, it dealt primarily with the technical status of the application in the Patent Office and only incidentally with its aviatinal features. The decision seems to be based upon an altruistic feeling on the part of the Chief Justice, who says that "its denial would work a great hardship, unjustified by her conduct, upon the penniless widow of a deceased inventor of merit who died almost at the point of success, leaving the invention as his only property."

Mattullath, it seems, had been very secretive about this invention and, though he lived in New York, had engaged Detroit attorneys to prosecute his claim, leaving them no record of his home address. The Patent Office learned of the inventor's death, probably through the newspapers, and rescinded the power of attorney. Mrs. Mattullath wrote several letters to men interested in aviation to learn if he had anything worked out in that line. They did not know of anything or did not reply and until 1909 nothing further was done. Then she attempted to have the original application reinstated, but owing to poverty met some delay. The case technically hinged on whether she slept upon her rights from 1902 or 1903 till 1910 when she began to figure at the Patent Office as the administratrix of her deceased husband.

It is interesting to note that, from the only description available, the Mattullath invention,—which seems to have been without an engine—does not apparently conflict with the Wright patent, which basically secures stability by warping the wings, the control being so arranged as to effect other stabilizing movements at the same time. The Mattullath principle seems to involve a plurality of ailerons and apparently did not contemplate a connection between the control of the "six lateral supplementary planes" and the vertical rudder.

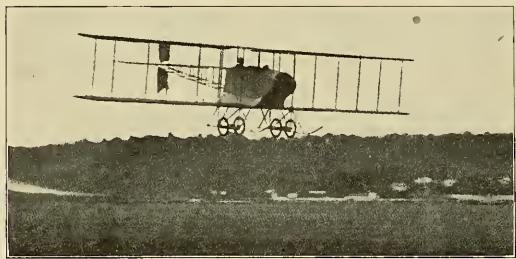

TOM SOPWITH MAKING AN EXPERIMENTAL FLIGHT WITH HIS LATEST TRACTOR BIPLANE OF HIS OWN CONSTRUCTION.

# FOREIGN NEWS

BY  
R. H. BLANQUIE

## Austria

World's Record for Altitude Flight with a Passenger.

It is reported that at the international aviation meet at Vienna on June 29, Lieutenant Miller, known as Czaky, reached an altitude of 4,200 metres (13,776 feet), carrying a passenger.

The previous altitude record with a passenger was made by Marcel Prevost at Courcy, 8,858 feet. Roland G. Garros holds the individual record of 33,828 feet.

## England

The Royal Aero Club of England has named delegates to its different centers of aviation, whose duties will be to send them detailed reports on all the accidents that happen from now on. The centers of aviation are Eastchurch, Salisbury, Brooklands, Hendon, Manchester and Freshfield.

The British Admiralty has started to put the Eastchurch Aviation school in running shape, as this school is destined for the training of the naval section of the Royal Flying Corps.

Floats have been adapted on the Deperdussin monoplane, making it a hydro-aeroplane. While testing it with only a 25 horse power motor, it rose and alighted on the water with the greatest facility.

Fourteen aviators have just recently obtained their pilot's license, having undergone the necessary tests successfully. Thirteen flew monoplanes and the other a biplane. The number of aviators licensed so far by the Royal Aero Club is 231, including the above 14.

The dirigible "Gamma" was damaged while making a flight at Aldershot in honor of the anniversary of the king's birth.

The Admiralty has passed on an order for several monoplanes from the English Deperdussin Monoplane Agency.

On July 7th Claude Grahame-White made the first cross-channel hydro-aeroplane flight. He flew from Boulogne to Folkestone, carrying a passenger. After giving several exhibitions at Folkestone before twenty thousand people, he started for Hendon, but was forced to land in a field near Sidcup owing to engine trouble.

It is announced that Louis Paulhan and Claude Grahame-White have arranged to give a number of exhibitions with the Curtiss hydro-aeroplane at various places on the coast of France and England. A special demonstration of these machines by Messrs. Paulhan and Grahame-White has been arranged for the benefit of King George of England.

At the recent wedding of Claude Grahame-White and Miss Dorothy Taylor at Widford, on June 27, several aviators flew over to witness the ceremony. Pierre Verrier on a Maurice Farman arrived with Miss Christich, who carried a bouquet which she presented to the bride. Hucks in a Blériot circled around the church and showered confetti over the bride and groom before descending to the lawn.

## France

The army dirigible "Captain Ferber" continues to make daily flights of reconnaissance along the eastern frontier. This dirigible has already more than a hundred flights to its credit.

Collix, on his "Canard" Voisin hydro-aeroplane, succeeded in making many beautiful flights at Saint-Raphael. Rising from the deck of the cruiser "La Foudre" with a passenger and 220

kilos of extra weight, he flew for 25 minutes at a height of 200 meters and alighted at a few meters from the cruiser and was hauled on deck. This hydro-aeroplane is the first to be delivered to the government.

In a lecture given at the "Ecole Supérieure d'Aéronautique," Commandant Renard classed as follows the accidents which befell the aeroplanes in 1911: 23% of the accidents were due to a lack of aptitude on the part of the aviators, 13% due to an insufficiency of their instruction, 6% due to an excessiveness of vivacity, 6% due to negligence or imprudence, 13% due to defects in the construction of the machines, 20% due to an insufficiency in the solidity of the machine, thus leaving only 10 to 12% of the accidents due to atmospherical conditions.



JEANNIN, ONE OF THE LEADING FLYERS OF GERMANY, SEATED IN AN AVIATIK BIPLANE.

Kimmerling, the famous pilot, met his death while trying out a new monoplane specially built for the "Circuit Anjou." He was flying at Mourmelon when suddenly the machine dove head first to the ground, killing its pilot and passenger. One report has it that one of the wing guys gave way, while another states that he descended too steeply and could not get the tail down. If such was the case this is probably another accident that can be attributed to the dangerous effect of the lifting tail.

Colonel Hirschauer, permanent inspector of military aviation, said in a recent speech that he had received the 1800th demand from officers and soldiers to become aviators in the military corps.

Former pupils of the lamented Wilbur Wright, amongst whom are Count de Lambert, Tissandier, etc., recently met at the Aero Club and decided to commemorate the memory of the celebrated aviator by the erection of a bust.

Lieut. de Marmies recently flew with a passenger in a strong wind from Paris to Verdun, a distance of 285 km. in one hour and fifty minutes, representing a speed of 145 km. an hour, at a height of 1,200 meters on a Farman biplane.

The new army dirigible "Conte," built by the Astra Co., broke the world's dirigible height record while making the height trial imposed by the Minister of War, attaining a height of 3,950 meters. This dirigible has a volume of 6,500 c. m., and is propelled by two Chenet motors, each 75-100 H. P.

The National Committee of Aviation has received from Mr. Moe, consul of France at Yokohama, the sum of 3,167 francs, representing the total of subscription opened amongst the French colony of this city.

Hucks, an Englishman, taking as passenger Mr. H. Barlow on the latter's Blériot monoplane, recently left Paris and after stopping at Hardelet for two days, crossed the channel and landed on the island of Sheppey.

Guillaux, on a Caudron biplane fitted with a 50-60 H. P. Anzani motor, with Mr. Ramsay as passenger, went from Issy-les-Moulineaux to Hendon (England).

## French Court States Aviators are Free to Fly Anywhere

In the suit brought to restrain Maurice Farman and his pupils from flying over the estates adjoining his aerodrome at Buc, judgment has been handed down that aviators were free to fly over any land and could only be held responsible for any damage they might do by landing on or destroying property.

René Bedel, an experienced aeroplane pilot and the holder of the Pommeroy Cup for cross-country flying, which he won from Jules Vedrines, met his death on July 9th, before the eyes of several thousand French troops who were assembled on the reviewing ground at Mourmelon-le-Grand, near Châlons-sur-Marne.

Bedel, who had come in his monoplane from the Villacoublay aerodrome, near Paris, to participate in the manoeuvres, arrived about the camp after a fine flight. He was about to descend when his monoplane struck the telegraph wires, which the prevailing breeze evidently prevented him from seeing. His machine capsize and Bedel was thrown to the ground. The motor of his aeroplane fell on his body and he was badly crushed.

## Exposure Fails to Injure Aeroplane

To ascertain whether it is necessary to shelter aeroplanes from the weather, a night was spent at other times when they are not in use, Mr. Maurice Farman left one of his machines exposed for twenty days at the Buc aerodrome. The experiment, which was concluded on June 28th, proved that a machine can be kept in a high state of efficiency under these conditions. The machine was inspected daily by a military committee. Flights were made daily with the aerodrome. When the trips were ended the wheels of the machine were placed in two holes, so that the aeroplane rested on its ski-like runners. Leather coverings were placed on the propeller and motor, the levers were carefully tied and the aeroplane was fastened to the ground by means of ropes and stakes. Under these conditions the aeroplane was subjected to here cold and wind, and it was found on the twentieth day that it flew as well as on the first. From a military standpoint the results of the experiment are very interesting, for it will no longer be necessary to transport sheets or tents, and a large number of men to dismantle and place the machines in condition again for flight.

The Pekin-Paris race organized by "Le Matin" has been put off to the first of May, 1913, instead of September first, 1912, for two reasons: 1st, the different constructors who have enrolled their



machines in the race would not have them ready by that time. 2nd, all information concerning the course could not be gathered.

The sum of the national subscription for buying aeroplanes for the army amounts to over 3,500,000 francs (\$700,000).

The elimination trials for the team to represent France in the forthcoming Gordon Bennett Aviation Cup race at Chicago were recently run off and the following aviators qualified: 1st, Verdines on a Daperdussin, who completed the 125 mile course at a speed of 105 miles an hour; 2nd, Maurice Prevost, Daperdussin, 99.3 miles an hour, and André Frey, Hanriot monoplane, 89.4 miles per hour.

**Laganeux on New Paul Zens Monoplane Breaks Two-Passenger Speed Record**

On July 5th at Compiegne, Laganeux on the new Paul Zens monoplane (a picture of which will be found on this page), broke the world's speed record for a flight with a passenger. He covered 50 kilometres in 23 minutes 59 seconds, and 110 kilometres in 48 minutes and 3 seconds. The distance covered in exactly an hour was 124 kilometres, 385 m.

When his machine had run out of gasoline he had succeeded in breaking the record for 150 kilometres, covering the distance in 1 hour 13 mins.

Upon alighting Laganeux declared himself enchanted with the way in which his new mount handled, especially during the latter part of the flight when the wind was quite strong and gusty.

It goes without saying that this is a remarkable performance for a new machine but little heard of, and judging from this it should bear watching.

**The Circuit d'Anjou**

The Circuit d'Anjou, where the Grand Prix de l'Aero Club de France took place, included the following course; Angers-Sannur-Cholet-Angers, representing a distance of 1,101 km. 877, which was to be covered in two days. The total of the prizes were to be 100,000 francs, and the winners were to be the ones that covered the entire distance in the fastest time, carrying passengers were given an allowance on time.

Thirty-five machines were enrolled, thus representing an average of three machines from each of the French makes, but for different reasons only 28 were allowed to leave.

On the first day a gale blowing at a speed of 20 meters a second, that is at 72 km. an hour, prevailed, causing most of the aviators to decide not to leave the ground. Daperdussin, Esnault-Pelterie and Dreguet signed an agreement not to allow their pilots to go up. However, it did not stop Garros, Brindejone, Leganeux, and Hamel, Espanet and Hamel from showing their audacity, ability and courage. Out of that number only Garros and Brindejone finished the first day's course, that is, three times around the circuit, the others not being able to finish for different causes. Unfortunately, Brindejone, arriving four minutes after closing time, could not class himself, thus leaving all the honors to Garros and permitting him to be the only one having the right to run for the prize on the morrow.

**TIME CIRCUIT BY CIRCUIT.**

First Circuit (157 km.: 411).

	Starting Time	Arrival Time	Time.
	H. M. S.	H. M. S.	H. M. S.
Espanet .....	9:45:00	11:34:48	1:48:48
Hamel .....	9:56:00	12:11:53	2:15:53
Garros .....	9:06:00	11:45:38	2:39:38
Brindejone .....	12:18:55	1:52:07	1:33:12

Espanet leaves with Helen's machine. Brindejone leaves with Bobba's machine. The time allowed for the taking of one passenger for Espanet is 1h. 45m. 40s. and for Hamel 1h. 59m. 55s.

Second Circuit (314 km.: 822).

	Starting Time	Arrival Time	Time.
	H. M. S.	H. M. S.	H. M. S.
Garros .....	12:14:00	3:12:56	2:29:56
Espanet .....	1:05:00	5:38:42	2:39:42
Brindejone .....	2:59:00	5:38:42	2:39:42

Third Circuit (473 km.: 233).

Garros .....	3:45:00	6:02:58	2:17:58
Brindejone .....	5:45:00	7:34:00	1:49:00

	Total Time.	Official.	Real.
Garros .....	7:56:58	7:27:32	
Brindejone .....	9:13:42	6:01:54	
Official time for Brindejone for two circuits only .....		7:24:42	

He finished the third lap but four minutes after closing time. Second Day of the Meet.

So that the meeting would not be an entire failure another prize was formed, and called by the aviators "Prix de Consolation," and was to cover the circuit three times. The following firms took part: Morane-Saulnier, Hanriot, Astra, Niuport, Henry Farman, Caudron, Borel and Bleriot, in all represented by 46 aviators.

Garros left at 9 A. M. to finish the remainder of the race, that is four more times around the circuit, and succeeded in finishing toward 6 P. M., thus covering 1,101 km. 877 in two days and winning also the speed prize of 20,000 francs.

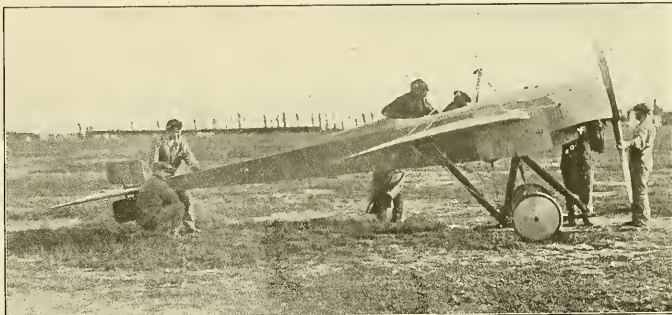

The Zens monoplane, fitted with an 80 h. p. Gnome engine, which was piloted by Leganeux with a passenger in the Circuit d'Anjou and which recently broke the world's speed record for a flight with a passenger. Note the flat camber of the main planes and the simplicity of the landing chassis. The machine has a very neat appearance, which is suggestive of great speed. It will be noticed that the engine is placed rather far forward.

**Consolation Prize.**

First—Espanet, prize, 25,000 frs.; machine, Niuport, passenger, one; real time, 4h. 31m. 1s.; official time, 3h. 52m. 18s.

Second—Bobba, prize, 10,000 frs.; passenger, none; machine, Morane-Saulnier; real time, 4h. 21m. 42s.; official time, 4h. 21m. 42s.

Third—Brindejone, prize, 7,500 frs.; machine, Morane-Saulnier; passenger, none; real time, 4h. 32m. 21s.; official time, 4h. 32m. 21s.

Fourth—Garros, prize, 5,000 frs.; machine, Bleriot; passenger, none; real time, 5h. 53m. 45s.; official time, 5h. 53m. 45s.

Fifth—Gaubert, prize, 2,500 frs.; machine, Astra-Wright; passenger, one; official time, 6h. 40m. 49s.

M. Barra continues to make excellent flights on the Curtiss hydro-aeroplane. On July 4th he left Juan les Pins at 6 a. m., and landed at Hyeres at 7:30 a. m. for petrol. Leaving at 8:30 a. m., he reached Marseilles at 9:15 a. m., having covered a distance of 265 kiloms. over the sea. The following morning he left for Lyon, intending to pass Avignon and Valence. Unfortunately he fell into the water only 32 kiloms. from his starting point. He was unharmed, and his aeroplane was only slightly damaged.

**Germany**

The German military authorities have started decidedly to organize a military aviation school at Dohberitz. The chief instructor of this school will be Commandant Lehman, who will have under his orders one captain and three lieutenant instructors, also charged to make all necessary researches for the development of military aviation. The officers chosen up to now have been barred off the list of the regiments to which they belonged and will from now on have exclusive charge of the school at Dohberitz.

Notwithstanding the bad weather, the dirigible "Victoria-Louise" recently risked the voyage from Dusseldorf to Rothausen and Essen, but after flying two hours turned around and came back to the starting point.

The dirigible "Charlotte" (Parseval system) also tried a flight from Hertze to Muersten, but had to regain its hangar at Wanne.

The dirigible "Schuette-Lanz," after being repaired, left Mannheim, went toward the Rhine up to Mayence, flew to Wiesbaden, Frankfurt Daumstadt, Worms and returned to Mannheim after staying in the air for five hours and covering 260 km.

The aerial manoeuvres at Cologne ended by a remarkable flight by the dirigible Z-11. Leaving its hangar on Bickendorf toward 1:30 A. M., it landed at Coblenz at 11:30, after flying over Mannheim for an hour.

Twenty thousand people witnessed the meeting of Rothausen in which the aviators Stoephasius, Sclator and Mueran made many successful flights. Stoephasius on a Grade monoplane made a night of 43 minutes, reaching a height of 750 meters.

The Grand Duchess of Hesse has organized in favor of the national subscription for the military aviation, an aerial postal service which operates regularly between Frankfurt and the principal neighboring cities.

A new aero car has been built for the use of the German Army. On its second flight it flew 30 minutes at a height of 500 meters and at a speed of 120 km. an hour.

The dirigible "Schwaben" (Zeppelin system) arrived at Mayence, carrying 200,000 postal cards.

The Kaiser has given a prize for the first German hydro-aeroplane meet, which will be held from August 29 to September 5. On June 28th the great German passenger airship "Schwaben" was destroyed at Dusseldorf when she caught fire just about as she was to start on a trip. A detailed report and explanation of this accident is given by Mr. T. R. MacMechen on page 178 of this issue.

**German News**

By Stella Bloch.

Germany's first naval aerial cruiser will be finished by October at the latest. It is not yet settled whether it will be stationed at Kiel or Hamburg, as the Admiralty does not possess a hangar of its own, and for the present the airship will abide in a privately owned shed. The crew needed to operate the navy Zeppelin is under-

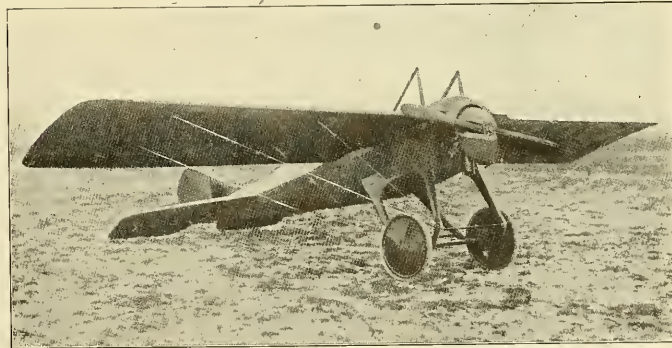

The new single-seater Daperdussin racer. Note the torpedo shaped fuselage, round nose plate mounted on the propeller, streamline landing gear struts, and disc wheels.

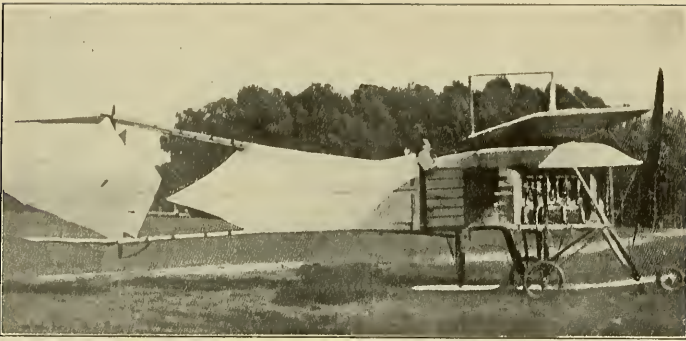

THE NEW CODY MONOPLANE, A NOVEL AND ORIGINAL MACHINE WHICH IS FITTED WITH A 120 H. P. MOTOR. NOTE THE PECULIAR FUSELAGE AND BIPLANE ELEVATORS AND RUDDERS IN THE REAR.

going a course of instruction at Frankfurt, and consists at present of three officers and twelve men. Fraulent, Louis Möhring, a young Berlin lady, met with an accident whilst attempting to gain her pilot's diploma at Gelsenkirchen, near Essen. In landing she touched the ground with the right wing of her Gracie monoplane and was buried beneath the machine, escaping, however, with comparatively light injuries, whilst the plane was totally destroyed.

June has been a black month for aviation throughout the world, as a large number of valuable lives have been lost. Germany, too, has a sad share in the list, for Lieutenant von Falkenhayn met with a fatal accident on the 21st of that month at Doberitz. The young dragon officer was regarded as one of the best of the coming men, and had been sent by the War Office to Mulhouse to take his pilot's degree. He accomplished this on June 3rd and returned to Doberitz for a practice flight on the evening of the fatal day on his 100 h. p. Argus motor Aviatik monoplane, and after several fast circuits at an altitude of 300 metres he began to descend. Whilst about eighty metres from the ground the onlookers noticed that the machine was at a tremendously steep angle, the motor working through-out, and in that moment the acroplane came dashing down with a fearful crash, throwing the pilot, who was immediately killed, out of the seat. As an examination of the motor showed that it was working to the very last, it is believed that the deceased was weary of fighting the wind and incautiously landed at a steep angle, a little bit of manoeuvring that is very popular on account of its sporty appearance, but that has been responsible for a number of catastrophes. Only a few days later the Aviatik Company suffered another severe loss. Whilst their lead pilot, Arnold, was making an altitude flight on a machine destined for the War Department he was caught in a severe gust of wind at an elevation of about 250 metres. His acroplane turned completely over in the air, the pilot was thrown out and picked up dead, whilst the shattered machine caught in some trees and had to be pulled down to earth.

It seems, alas! as though my lengthy list of mishaps were not to end, for on June 30th poor Benno Koenig, one of the most brilliant aviators Germany has ever had, succumbed to the dreadful injuries he suffered during an accident on landing at Biddstedt, near Hamburg. After a successful landing in the evening Koenig, who had some time ago passed from the bi to the monoplane, made a short and successful ascent, when his motor suddenly ceased acting. He landed in a glide and had touched the ground when his machine gave so violent a jerk that it turned over and flung Koenig onto the steering apparatus. Koenig struggled to his feet and then dropped down unconscious. Two hours later Koenig was dead, aged but twenty-seven. Koenig was formerly a mechanic of Wienziers, but soon displayed so much talent that the Albatross Co. bought him, and on his taking his diploma in December, 1910, he became their instructor. The names of his pupils include some of the best German pilots. His own first flight was on a biplane, the German Cirrus in 1911, which he won on an Albatross biplane with a 70 h. p. Gnome motor, and after that he was in great demand at all meetings and exhibition flights. The large new German military airship P. 10, which is being constructed by the Reserve Airship Building Co., will carry two machine guns and also bomb dropping tubes.

Experiments are already being conducted with projecting missiles from the military aircraft cruiser P. 3.

The airship Z. 3 now carries a machine mounted at the foremost point of the gangway.

### Italy

A group of 101 girls of Milan has promised the committee for the aerial fleet to gather 20,000

frances for the construction of an aeroplane, which will be named the "101." These figures represent the number of cannon shots fired for their annual holiday. Their subscription has already reached 5,000 francs.

The Central Committee at Rome, for the aerial fleet, has already gathered the sum of 2,070,000 francs (400,000). An Italian residing at Buenos Ayres gave 40,000 francs for the purchase of two aeroplanes. One will be called the "Francesco" and the other will bear the name of the soldier who will have died in the most heroic fashion in the present Italian-Turko war. The "Corriere del Sera" has received from the Italian colony of Rio de Janeiro 20,000 francs for the purchase of an aeroplane that will bear the name of that city.

### Philippine Islands

#### Special Correspondence.

#### Aviation Headquarters,

Pt. McKinley, P. I., May, 1912.

The first aeroplane to be sent to our island possessions for use of the army arrived in February on the "Manchuria." The machine is a standard Wright type "B" 1911 model, and has all the latest improvements. Lieut. F. P. Lahm, of the aviation squad, and who took instructions from Mr. Wilbur Wright, on the first machine the government purchased, in 1908-9, was detailed as the available aviator. Two men, Corporal Vernon L. Burge and Kenneth L. Knitzel, were ordered from the aviation squad at San Antonio, Texas, to the islands to set up the machine and maintain same. Work was delayed about a month owing to the contractors not finishing hangars. On March 14th the machine was brought to Ft. McKinley and the assembling of same started. In about two days the machine was ready for flight, which was quick work, considering that the machine was completely "knocked down" and that the men detailed to help had never seen an acroplane before.

The hangar is located on the polo field, which is the only available place near Manila. While the field is large enough it is situated poorly for aviation purposes, being in a sort of valley. It makes flying dangerous and more difficult, as on the field the wind may not be blowing, but as soon as the valley is cleared strong currents are liable to be encountered, but notwithstanding this there has been some good flying.

As Lieut. Lahm has been with his regiment the past three years, and naturally out of practice and touch of the machine, he naturally confined himself to "grass cutting" and low flying until he had become accustomed to the control, which is somewhat different from that of the original machine on which he learned to fly.

The machine has been in operation daily since being assembled and has some good flights to its credit. At times the lieutenant has had trouble getting two men up, although the motor seemed to give unusual power.

On April 5th Lieut. Lahm began instructing Corporal L. Burge to operate the machine. After less than three hours actual handling of controls he was operating machine alone, and has since been graduated as proficient. Corporal Burge is the first enlisted man to operate an acroplane in the Philippines, his quick mastery of it will probably go a long way toward teaching other enlisted men. Corporal Burge has been on aviation work since 1907, when the first squad was organized and were given instructions in ballooning under the veteran balloonist A. Leo Stevens. He was later with the dirigible purchased from Capt. Baldwin, and was also present at early tests of the Wrights at Ft. Myer in 1908-9. When the machine was sent to San Antonio, Texas, in the winter of 1909 under Lieut. B. D. Foulis he

accompanied it. He was also on duty on the Mexican border with the "Calliope" machine, in which Lieut. Foulis and Phil. Parmelee flew from Laredo to Eagle Pass, Texas, establishing a record for that time for a non-stop passenger flight. When the government decided to send a machine to the Islands Corporals Burge and Knitzel were picked for their long experience on the Wright machine. He is very young, being just past 21 years of age.

So far there have been but few accidents and but one worthy of note, which happened on May 8, when Lieut. Lahm had a fall of 200 feet and consequently a narrow escape from death. After making two flights of 3 and 16 minutes each with the machine working perfectly he made several attempts to rise with Corporal Burge, but the engine failed to give sufficient power. He then rose alone, and after a 12 minute flight he cut off power at about 200 feet, intending to make a long glide to the field. As he failed to head the machine down it slowed up and was floating slowly downward when a gust of wind raised his left wing and turned the machine to the right. Not having the proper head-on speed the machine failed to answer the control, and began to spiral on a very dangerous angle. The machine made three complete spirals and struck head-on with a crash, half of the machine landing in the Tagine River and half on the bank. Lieut. Lahm was only slightly bruised by the crash, but the machine was badly damaged, but was repaired in less than three days by the detachment. The engine was torn from its bed and it was sent to the Signal Corps machine shop for overhauling.

Flying has been resumed again, owing to the fact that there is a spare motor here.

While "grass cutting" and practicing on May 18th Corporal Burge had a slight mishap, breaking the right lower wing. It was operating from the meadow seat, the wing being heavier and out of balance. As he was leaving the ground the right wing dropped, and being too close to the ground to right same and owing to the fact that a cross wind made it worse the wing touched the ground, whirling the machine completely around and breaking several ribs, but doing no further damage to machine or operator.

Lieut. Love, Signal Corps, is also being instructed in the operation of the machine and is progressing nicely.

The rainy season will soon be on hand and will probably delay the flying game for several months at least. The machine will probably be used during manoeuvres next year.

Mr. Schenminger, the Manila aviator, will leave soon for New York to attend the Baldwin school of instruction, as he owns one of Capt. Baldwin's "Red Devils."

K. L. Knitzel left in April for the States, where he will take his discharge and take instructions under Mr. O. C. Simmons, aviator for R. J. Collier, and was formerly mechanic under Lieut. Ben. D. Foulis, who succeeded in flying an Aero and intend to have one for the International Meet in Chicago.

### Russia

Ruzere, the French aviator, delivered two hydro-aeroplanes, Canard, Voisin-Gnome engine, to the Imperial marine and gave a few lessons to Lieut. Stankovsky, who succeeded in flying by himself after his second lesson. A few days after both flying a Canard Voisin left Sebastopol and flew over the Russian fleet, making a flight of 30 km.

Jesnow experimented, with success, at the aviation field of Odessa an invention of his, which is a device permitting to start the motor without any outside help.

A special Russian mission is at present in France inspecting different types of aeroplanes suitable for service in the Imperial Russian Army. The members of this mission are General Gelin, Chief of the General Staff; Admiral Il. S. H. Prince Lieven, Chief of the Naval General Staff; General Thybeckoff, Director of Aeronautics; Col. Count Ignatoff, Col. Skakov, and Lieut. Villacoubert and Bue were General Manoury, Military Governor of Paris; and Col. Hirschauer, Ins. Gen. of Aeronautics. At Villacoubert they inspected twenty-three aeroplanes in line, Labouret on the Astra biplane, Gohé on the Neupont, and Moranc on the Morane-Saulnier all made flights. Several soldiers also made ascents. We also visited Bue's Bowyer (Gnome biplane); B. Farman sheds, afterwards watching several pilots in the air.

### Spain

A very successful meeting was held at Barcelona, which greatly appreciated by the Spanish public. The majority of the aviators were French, and amongst them the Bowyer (Gnome biplane); Borel (hydro-aeroplane); Sanchez-Ibera, Pomiet (Borel monoplane); Laurens (Iperdussini monoplane), etc. One of the big features of the meeting were the flights over the water by Benoit on his hydro-aeroplane.

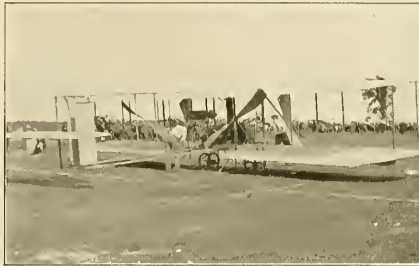

THE ABOVE PHOTOGRAPH SHOWS A BURGESS BIPLANE FITTED WITH A FOUR-CYLINDER 40 H. P. STURTEVANT MOTOR, WHICH RECENTLY MADE SOME SPLENDID FLIGHTS.

## THE MADE

The Imperial Japanese Navy has recently placed an order with the **Curtiss Aeroplane Co.**, at Hammondsport, N. Y., for three hydro-aeroplanes, and three Japanese navy officers sailed from Tokio on July 3rd, en route for Hammondsport, where they will be taught to fly them.

Mr. Charles C. Witmer recently sailed for Europe to deliver and to demonstrate one Curtiss hydro-aeroplane sold to the chief engineer of the Zeppelin Airship Co., at Friedrichshafen, Germany, and three hydro-aeroplanes sold to the Russian Navy at Sebastopol, has finished his demonstrations at Friedrichshafen with an hour's flight with a passenger over Lake Constance, the Zeppelin Airship Co.'s works and the city of Friedrichshafen. He carried Herr Kober, the purchaser, as a passenger.

Louis Paulhan, the French aviator and builder of aeroplanes, and Claude Graham-White, the well-known English expert, have arranged to give a number of exhibitions with the Curtiss hydro-aeroplanes at various places on the coasts of France and England. A special demonstration of these machines by Messrs. Paulhan and Graham-White has been arranged for the benefit of King George of England, at Paris, and the European agent for the Curtiss hydro-aeroplanes.

A record in the number of flights for a single day was established at the Curtiss Aviation Camp, at Hammondsport, N. Y. There are 144 pupils learning to fly at Hammondsport, and these, together with two instructors, made a total of 240 flights during the day, 126 of them being with the four-cylinder practice machine, 64 with the eight-cylinder practice machine, and 60 with the hydro-aeroplane on Lake Keuka. Some of the pupils made flights with both the land and water machines. A hundred or more flights are made practically every day of the week except Sunday, at Hammondsport. On the particular day referred to, a full barrel of gasoline and four gallons of oil were used up by the pupils and instructors in the 240 flights.

During the first month of its existence the **Sloane School of Aviation**, at Hempstead Plains, enrolled seven pupils. One of these, I. S. Herbert, graduated in three weeks after he began to take his lessons on the Deperdussin Monoplane. The other pupils are W. Leonard Bonny, one of the famous Wright flyers, I. G. Gibbatick, a very clever sixteen-year-old boy, T. E. Steptoe, Guy Morton, W. E. Roberts and W. L. Tombsly. The price of \$300 for the course proved exceedingly attractive. Unlike any other school, no charge whatever is made for the use of the machine when the pupil flies for his license. Nor is it required that the pupil put up the breakage guarantee in cash.

A new catalogue has just been issued by the **Wolverine Aeromatic Co.**, of Detroit, Mich., which will prove of interest to all those who take more than a casual interest in aviation, or intend buying or building an aeromatic. As has been mentioned before, this company has supplied aeroplanes to the Chinese Revolutionary party and the catalog shows one of these machines in China manned by Chinese. In addition the catalogue illustrates different types of aeroplanes and parts and should be in the hands of every aviation enthusiast.

The **Kemp Machine Works**, of Muncie, Ind., manufacturers of the Gray Eagle Aero Motors, report a large output of motors lately and state that there is more of a demand for their six cylinder motors for exhibition work and hydro-planes than any other type.

**American Aeroplane Supply House**, of Hempstead, N. Y., report that in view of the great success they had with their cross-country model of the Bleriot type monoplane, and in order to thoroughly interest the American buyer in this type of machine, they have selected the new their Single Seater Monoplane to \$900 and their

passenger-carrying monoplane to \$1,200, and their racing monoplane to \$1,300, for a short time only in order to stimulate the monoplane business in America.

**A. Heinrich Bros.**, of Baldwin, L. I., builders of high grade speed boats and runabouts, as well as the well known Heinrich Mono-Biplane, have been experimenting lately with their latest type machine with various styles of motors in order to decide the proper motor to use as a standard for their machines.

**Maximotor Makers**, of Detroit, Mich., state that the representatives of the Russian and Rumanian governments have been negotiating with them for the equipment of army planes with Maximotors, and that a six-cylinder military type of 105 H. P. ordered by the Rumanians is well under way.

The new military **Maximotors** with their equipment of clutch, combination auxiliary exhaust and muffler, double ignition and self-starter are arousing a great deal of attention among army officials.

Aviation engines are not manufactured in Russia or the Balkan States—Bulgaria, Serbia and Rumania, though most of them have more army aeroplanes than the United States. Representatives of the Balkan powers state that they have for a long time been looking for reasonably priced four-cylinder, water-cooled engines at least as reliable as the **Gnome**. The many types of European engines which their military aviators have used are not altogether satisfactory, they assert.

The Aero Exhibition Company's two new Curtiss and two Bleriot planes are being **Maximotored** in time to fill the Company's exhibition schedule for the late summer and fall months. The 45-56 h. p. **Maximotored** Curtiss now flown by Fred June is almost identical in construction with the plane used by John P. C. Kuck, locally known as the "Hydro King." It was with the **Maximotored** plane that he made his famous flight over Detroit's East Side manufacturing and residence district last fall.

The noted "Hudley-Blood" biplane formerly powered with a 2-cycle engine has been purchased by S. F. Heckwith of Mineola. This plane has been transformed into a tractor by Edward Craibree for the original work he has put on the remodeled plane. For a number of years he has been a close student of aeronomics from the scientific side. He has done considerable research work in bird flight, bird anatomy and especially the mechanism and stream line form of bird wings from photographs and sections prepared in wax. Mr. Heckwith, who has obtained his license on the Wright plane with Geo. Beatty is to do the preliminary flying. A number of flights between the supervision of Captain Wroughton. It is one of the finest types of this kind ever produced.

**Captain Hugh L. Willoughby**, who has been the pioneer in sporting marine activities, as well as in aeronomics, will fly his Pelican Biplane at Newport, R. I., in August. This craft has been built at the factory of the Sloane Aeroplane Co. under the supervision of Captain Willoughby. It is one of the finest types of this kind ever produced.

The **Aeroplano Motors and Equipment Company**, of 1780 Broadway, have been since July 8th a part of the **Paul Lacroix Automobile Company, Inc.** They are importing **Gnome**, **Chevroler**, **Anzani** motors, which they will carry in stock. They are outside of these three standard makes of motors, sole American agents for the **Simson** (Canton-Tinné type), **Chevroler** motors for the **Morane-Saulnier** monoplane, which machine, in the latest circuit abroad, the Circuit Anjou, made the fastest time. They are also sole American agents for the **Train** monoplane, which obtained much large publicity in the European circuit. They are importing all the

standard aeronautical supplies, as **Astral** varnish, for which product they are sole American agents, aviation helmets, etc.

The **Diana Spiron** has been adopted on a good number of planes already, though these new type aerial screws have been on the market only a few months.

Now that the company has obtained data from the Roberts Engine Co. as to the conditions under which its engines give the best results, arrangements are being made for the equipment of a large number of Roberts with Spirons.

France, which has been leading the world in aviation almost from the beginning of the new industry, has definitely pointed the way to the 3-blader.

The newest army Breguet (considered the world's ideal military biplane) is equipped with the 3-blader. Breguet planes are furnished the armies of France, England, Russia, Holland, Sweden and Italy.

It is very interesting to note that the new Nicuprot hydro-aeroplane also flies with the 3-blader.

Among the advantages of this type screw are that it permits of the use of a much smaller diameter than the 2-blader. This cuts down the necessary height of the chassis and greatly reduces head resistance. The 3-blader is also, of course, very easy on the engine and practically eliminates vibration.

During the third annual Boston Aviation Meet, held at the Harvard Aviation Field at Squantum, from June 29th to July 6th, a **Sturtevant** aeronautical motor was used by Phillips Ward Page in a Burgess biplane. Mr. Page used a four-cylinder 40 H. P. Sturtevant motor, and experienced no engine trouble whatsoever throughout the entire week. In all about fifteen flights were made during the meet without any adjustment to the motor. In Mr. Page's first flight he flew to a height of 5,000 feet, and on coming down he said that the motor had worked perfectly, which all goes to prove that American made motors are now up to the standard previously set by the big French concerns.

A ten hour non-stop test of a Sturtevant 6 cylinder 60 H. P. Aeronautical motor was recently made for the buyers of the motor, a western aeroplane company. The engine was equipped with a Sturtevant propeller 8 1/2 ft. in diameter and was tested without the muffler and on a stand constructed for measuring the thrust of the propeller. The speed and thrust were observed at frequent intervals and the total oil and gasoline consumption measured. The mechanics in charge of the test were not allowed to touch the motor and during the entire run of ten hours, no adjustments were made. The motor ran perfectly without missing a single explosion. Oil was supplied every two hours by means of a hand pump.

A summary of the results of the test is given below:  
Motor started 9:20 A. M. RPM 1237 Thrust 475 lbs.  
At 7:10 P. M. RPM 1203 Thrust 440 lbs.  
Motor stopped 9:20 P. M.  
Total oil used 4.75 gallons.  
Total Gasoline used 65 gallons.

**Leo Stevens**, manager for Harry Bingham Brown, the well known English pilot who is operating the Wright biplane, announces that he is now booking parachute drops by Rodman Law from Brown's machine as an exhibition attraction.

Mr. William F. Cline broke what he claims is the world's record for a continuous flight in a hydro-aeroplane at Cavuga Lake Park, near Rochester, N. Y., recently. He says that he was able to make his flight of one hour, fifty-eight and three-quarter minutes because he used a **Charavay Propeller**. This is the propeller produced by the Sloane Aeroplane Co.

# GENERAL NEWS

By D. E. Ball

## Great American Circuit

Owing to the general lack of interest in aviation in the cities of the Middle West, designated as controls of the American Air Circuit of 1912, resulting in their failure to assure financial support sufficient to cover prizes large enough to attract aviators, the Board of Governors of the Aero Club of America decided, at a meeting held on July 10th, 1912, to call off the race.

Chicago, early in the movement, assured its portion of the money desired. Detroit, Dayton and Akron also responded well, but it was impossible to secure from the other controls the amount of money required.

## New England Notes

With money appropriated by renewal of last year's schedule of expenses, it is expected that the Eastern Division of the army and the militia of New York, New Jersey, Connecticut, Maine and Vermont will hold manoeuvres between Danbury and New Haven, Conn., from Aug. 10 to 20, the distinctive feature to be the use of biplanes by the attacking Blue army. The machines in use at College Park will be employed, the military aviators performing reconnoitering service.

William Van Sleet, of Pittsfield, Mass., and Jay E. Benton, of Boston, opened the Aero Club of New England balloon season on June 23 by a flight from Pittsfield to Springfield. The members of this club devote themselves chiefly to ballooning as a sport.

George A. Gray, of Boston, who fulfilled the conditions for an aeroplane pilot's license at the Burgess-Curtiss school recently, indulges in a falling for the number 23, of supposedly sinister meaning. He was born on September 23, began his aeronautical career on September 23, lives at 223 Newbury street, Boston, and got his license on June 23.

## Governmental Licenses

At a meeting of the Aero Club of Pennsylvania, held on May 10, 1912, the following preamble and resolutions were unanimously adopted:

WHEREAS, Several of the individual States have already considered or passed statutes for the regulation and control of the navigation of the air, and

WHEREAS, The conflicting statutes in the different States regulating automobile traffic and licenses show what may be expected if the control of aerial navigation is left to the individual States, and

WHEREAS, The navigation of all water ways is, and always has been under the control of the Federal Government, and

WHEREAS, The science and practice of aerial navigation has now reached a state of development which places it among the means of inter-state communication, and

WHEREAS, The regulation and control of all interstate communication is vested in Congress by the express provisions of the Constitution, therefore be it

Resolved, By the Aero Club of Pennsylvania that it strongly urges upon Congress the necessity for the passage of a National Statute for the regulation and control of the navigation of the air by all forms of air-craft, and for the issuing of licenses under governmental supervision, to competent aviators.

A true copy.

H. V. G.,

President.

Attest,

GEO. S. GASSNER,

Secretary.

## Makes Long Flight in Hydro-Aeroplane

William Cline, on July 7th, at Rochester, made a fine over-water flight covering 101 miles at an altitude of 2,100 feet in one hour and fifty-eight minutes.

## Navy Aviators Make Moonlight Flight

On June 28th Lieutenant J. H. Towers, U. S. N., made a successful flight by moonlight in his Curtiss hydro-aeroplane, flying from the battleships at anchor in Baltimore harbor to Annapolis, a distance of about twenty-six miles, in twenty-eight minutes. Lieutenant Towers carried Lieutenant I. F. Dorch as a passenger. Lieutenant Towers flew over the ships, which belong to the second division of the Atlantic fleet, and alighting on the water, talked with officers on various ships. Lieutenant Towers made the trip by daylight on his Wright machine. Lieutenant Towers stated that he had no difficulty in his night flight except in estimating the distance above water, which necessitated unusual care in alighting. He laid his course by the light-houses.

At Rochester, N. Y., on June 25th, Fred C. Eells, in a hydro-aeroplane flight over Irondequoit Bay, flew seventy-three miles in one hour and four minutes at an average speed of fifty-nine miles an hour. The flight was cut short when his supply of gasoline gave out, and he landed to the bay.

This flight, though well sustained, was exceeded by Lieutenant Elyson's flight over Chesapeake Bay, October 25th last, travelling 112 miles in a hydro-aeroplane without a stop in 122 minutes, and by Harry N. Atwood, in December last, flying from Point of Pines, Mass., to Narragansett Bay, 130 miles in 165 minutes.

## Curtiss Flying Boat a Big Success

The new Curtiss "flying boat," which Mr. Glenn H. Curtiss first tried out at San Diego, Calif., last winter with some success, has been reconstructed along different lines, and is now being used daily at Hammondspert, N. Y., on Lake Keuka.

The great objection to the "flying boat" tried at San Diego, was the double-tractor feature, necessitating a chain gear. The new "air boat" has but one propeller, as on the standard Curtiss biplane.

Mr. Curtiss himself has made a great number of flights in the new type of hydro-aeroplane, carrying passengers on many of them. Among those who have gone up as passengers with the designer and builder of the first and latest hydro-aeroplane are Hugh Robinson and Beckwith Havens, who are themselves expert operators of the water-aeroplanes.

The machine differs radically from the Curtiss hydro-aeroplane now in use. The operator and passenger sit low down in the body of the float, side by side, well in front of the motor, which is placed just beneath the top plane. They are protected against splashing by a spray hood. The boat is fitted directly to the lower plane, which it is claimed, improves the stability and flying qualities of the machine and makes it much easier to handle on the water.

There is no front elevator, and the rudder and rear elevator are attached to the end of the float. No bamboo whatsoever are used and the machine is thus stronger, more compact and simpler than anything thus far designed by Curtiss.

Mr. Curtiss declares the new machine handles easy both in the air and on the water, and he believes that it is an improvement in many ways over the Curtiss design in use by the United States Navy.

The amphibious craft is driven by an 80 h. p. Curtiss motor. The boat is 26 feet long, 3 feet wide and has a depth of hull about equal to the width. The planes are five and a half feet deep and thirty feet wide, and the operator and passenger sit well down in the hull and are protected from the spray by a collapsible water-proof hood. The boat itself is so strongly built that it can be beached with safety, even through a high surf, and is capable of being handled the same as a fisherman would handle his dory. It may be

hoisted afloat, like a motor boat, or anchored to a buoy like a yacht.

## Aviator Havens Joins State Guard

The New York National Guard has a real professional aviator enlisted in the ranks, and therefore takes lead over all other States in practical aviation. Beckwith Havens, a young man of excellent social connections in Dutchess County, who has been making exhibition flights throughout the United States during the past year for the Curtiss Company, recently took oath and his name was enrolled as a private in the First Company, Signal Corps, N. Y. S. N. G.

Efforts are being made to provide an aeroplane for Havens to use in the grand manoeuvres next month, in which the New York and Connecticut State Guards will oppose the Regulars in Connecticut. If these plans are carried out Havens will prove of great benefit to the Guard, as he is recognized as one of the most competent flying men in this country. Mr. Havens has given up professional flying with the aeroplane, but will use a Curtiss hydro-aeroplane during the summer on Long Island, and in connection with yachting and motor boat races along the Atlantic Coast.

"I recognize the hydro-aeroplane as the salvation of aviation," said Havens. "There is very little danger in flying over water, provided the operator is competent, and I am certain that type of aircraft will grow in popularity with yachtsmen and others interested in water sports."

## Flights at the Signal Corps Aviation School, College Park, for the Year Ending June 30, 1912

Since the Army Aviation School was established in June of last year, its officers have had 259 hours and 15 minutes of actual flying. This includes all flights up to June 30 of this year. During this period the number of individual flights was 1,500. From January 1 to June 30, 781 flights were made, taking 130 hours and 12 minutes. These figures do not include practice hops.

## New Army Pilot

Lieutenant Harry Graham, one of the new aviators at the army aviation school at College Park, Md., made two flights by himself in the Wright biplane, on July 10th.

Only one officer remains to be instructed, Lieutenant L. C. Rockwell, who joined the school recently. He is taking instructions daily.

## At Chicago

By S. R. BRUSTMANN.

The Aero Club of Illinois has leased a strip of Clarendon Beach, on Lake Michigan, near Wilson Avenue, to be used as an aquaplane station. Although the Cicero field of the Club is considered one of the most active aerodromes in this country, hydro-aeroplaning has been sadly neglected, the field being so far removed from water. The acquisition of Clarendon Beach will add impetus to this side of the sport in this city. It supplies a long-felt want, and sportsmen who have heretofore taken but light interest in aviation will find much in this new water sport to take up their time.

The latest pilot to establish headquarters at Cicero is Hillery Beachy, brother of Lincoln Beachey, the Curtiss flyer. He has been engaged as pilot by a Chicago sportsman who has purchased two machines for private use. Antony Janus, chief instructor at the Benoist School of Kinloch Park, is also expected to come to Chicago. This will bring the number of flyers on this field to 30.

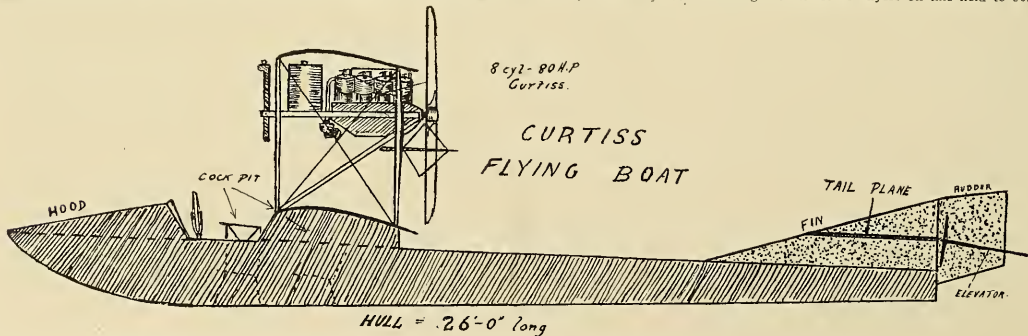

SIDE VIEW SKETCH OF THE NEW CURTISS "FLYING BOAT," WHICH IS BEING SO SUCCESSFULLY FLOWN AT HAMMONDSPERT, N. Y.

Max Lillie's new Wright has been delivered and he is again one of the most active men on the field. In addition to handling his pupils he is doing a big passenger carrying business, taking aloft an average of five passengers a day. Lillie's old machine was destroyed by a windstorm in Wisconsin, while returning from Lake Geneva with Charles Dickinson as passenger. He was forced to land on account of motor trouble, and the storm arose while he was away looking for help.

**Mineola and Westbury Fields**

The Nassau Boulevard aerodrome has now been definitely abandoned as an aviation field, and the sheds moved over to the new field at Westbury, whither most of the machines have been moved also, although, of course, some have become scattered.

During the past month at Mineola, good flying has been accomplished by Cecil Peoli on the headless Baldwin, George Schmitt on a Baldwin type, Chalmers on his Roberts engine Curtiss type, and by Bonner and Hunt on 50 H. P. Gnome monoplanes, while Miss Miller has learnt to fly an Anzani engine Blériot type.

At the Westbury Field, George W. Beatty has been teaching pupils on his rebuilt Wright, and incidentally doing a little work for a moving picture concern by reeling off photos of the surrounding country.

George W. Dyott, instructor for the Sloane Aeroplane Company, has been kept busy instructing pupils on the Deperdussin monoplanes, and so successful has he been, that several of the pupils are now flying the machine alone.

W. Leonard Bonney flew the school Deperdussin alone after only three lessons, while W. Irving Twombly is now making extended flights with it.

**The Akron Disaster**

At Atlantic City on July 2nd the huge dirigible with which Melvin Vaniman had planned to cross the ocean, came to an untimely end, when during an early morning practice flight, the bag suddenly burst, due to the sudden expansion of the gas from the rays of the sun. (See T. R. MacMechen's explanation of this accident on page 178 of this issue.)

Besides Melvin Vaniman there were four others aboard the dirigible at the time of the disaster, these being Calvin Vaniman, Walter Guest, Fred Elmer and George Bourillon. It is believed that all five men were killed by the force of the explosion before they ever struck the water.

Up to the time of writing, only the bodies of Calvin Vaniman and George Bourillon have been recovered. It is believed that the others were washed out to sea, for when the car, which had fallen in shallow water off Brigantine Beach, was recovered, no sign of the others were to be seen. Since writing the above the bodies of Melvin Vaniman and Fred Elmer were recovered four miles from the scene of the wreck.

On July 9th, at Boston, Farnum T. Fish lost control of a biplane in which he and John McGee of Pawtucket, R. I., were flying at Point of Pines. The machine dropped from a height of 200 feet into the water, but neither Fish or McGee were injured and were soon rescued. The biplane was badly damaged.

The Wright Company has decided to open a hydro-aeroplane school in the vicinity of New York on the water front of the Glenwood Country Club, at Glen Head, L. I. The location is said to be admirably adapted for water flying and is a rendezvous for Connecticut and New York yachtsmen, and as such, will offer an excellent opportunity for converting the yachtsmen to the joys of hydro-aeroplanning.

On July 10th George Mestach, while attempting to make a flight in his monoplane, fell when he reached a height of only twenty feet, striking a fence, and was slightly injured.

At Winnipeg, Manitoba, Mr. Crawford-Frost, whose combination aeroplane and parachute model exhibited at the New Grand Central Palace Aero Show attracted much attention and called forth many favorable comments, has been conducting a series of tests with it and recently dropped the model from a height of 25 feet with an egg in the passengers' seat. It is stated that the machine dropped so gently that the egg was not broken.

During the recent water carnival at Detroit, Mich., a race was held between Walter Brooks, in a Burgess-Wright biplane, and the famous speed boat, Kitty Hawk II. The race was held over the Detroit Motor Boat Club's ten-mile course "round Belle Isle," and was won by Walter Brooks, who, in spite of the unfavorable weather conditions, defeated the boat by 70 seconds.

Ladislas d'Orey, the well-known historian of aviation, who is writing a series of articles for AIRCRAFT, is leaving this country for France on the French Line steamer "Rochebeau," where he will resume his journalistic work.

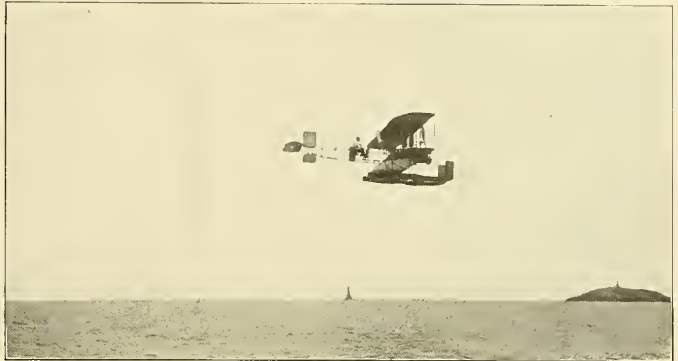

HOWARD W. GILL FLYING HIS DOUBLE-ENGINE HYDRO-AEROPLANE ABOVE THE WATERS OF MARBLEHEAD BAY.

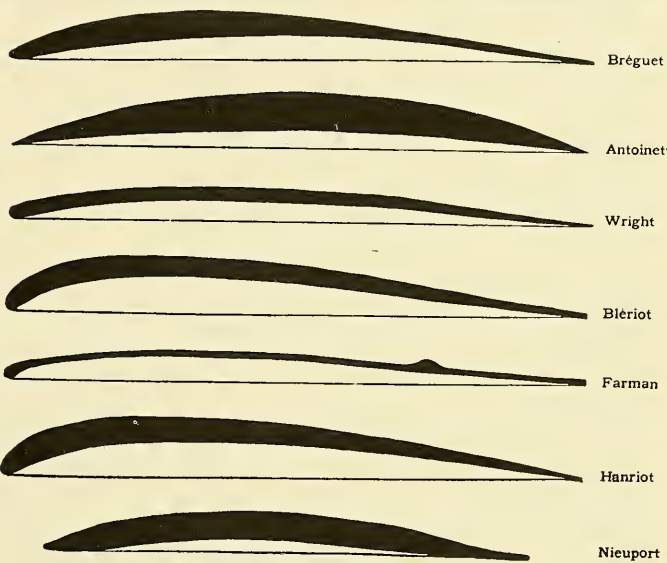

SOME LEADING TYPES OF AEROPLANE SURFACE CURVES.

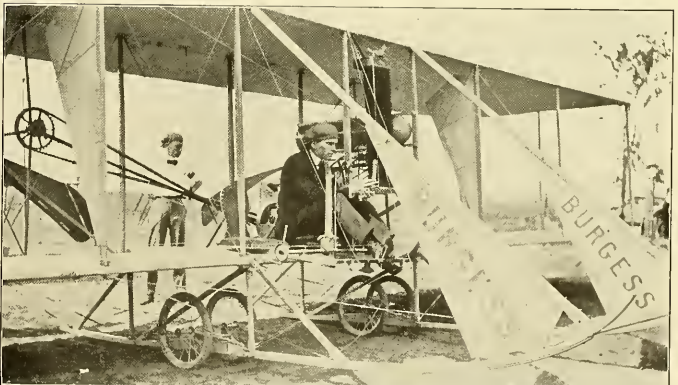

PHILLIPS W. PAGE SEATED IN HIS BURGESS-WRIGHT BIPLANE, WHICH IS EQUIPPED WITH A STURTEVANT 40 H. P. MOTOR.

## THE CALL OF PROGRESS

Air transportation is the next great step in Man's Economic development. It has arrived at the exact time economic conditions warranted it—just at the time it became necessary.

Evolution does not begin its work with perfection, neither does it give a baby a man's knowledge nor the human race its greatest intelligence in infancy. Therefore, little by little man has been permitted to learn and utilize natural laws for transportation purposes.

The ox, the horse, the elephant, etc., all became enslaved when man's primary economic intelligence asserted itself and when that spark of intelligence expanded with time and experience, greater and more enlightened means became necessary and the result was that steam railroads, electric railways and automobiles came into use on land and sailing vessels, steamships and motor boats on the water.

Each came in its proper order like a child passing through the kindergarten, public school, high school, college, etc.

Man's primary schooling in the science of transportation therefore, is now over and he faces the stern reality of a post-graduate course. **AND THE POST-GRADUATE COURSE OF TRANSPORTATION IS AIR NAVIGATION.**

Everything that happens, happens just at the right time—just at the time intended for it to happen in the great universal scheme of which we know so little—and so it happens that air navigation has begun and a new and greater responsibility has been put upon mankind—**THE MASTERY OF THE AIR**—and just as man has mastered land transportation and water transportation, so he will eventually master air transportation.

A new era is opening up in which the man who shows fear of riding through the air on well made and properly manned vehicles, will be considered as ludicrously cowardly, as the foolish old men and women who were afraid to ride on steamboats, railroads or automobiles when those vehicles were first introduced to the public.

So first get this point fixed in your mind, **THAT AIR TRANSPORTATION IS HERE AND THAT OUR WORK IS TO DEVELOP IT.** Next get it into your mind that Europe, and especially Germany is far in advance of America in the utilization of the new method of transportation and third, **that AIR TRANSPORTATION IN GERMANY HAS ALREADY BEEN PUT UPON A PAYING BASIS.**

With these facts understood, therefore, I believe that the time has arrived when the American people should be given a practical demonstration of the commercial importance of air navigation.

Aircraft of any kind has its limitations until such time as its usefulness can be proved **AND AS THEY ARE PROVING IT IN GERMANY, SO SHOULD WE PROVE IT HERE IN AMERICA.**

One passenger carrying airship in Germany made

364 trips, covered 28,004 miles in the air and carried 6,045 passengers and earned enough money to pay the entire running expenses of the company for the year.

**IF THEY CAN DO IT IN GERMANY WHY CANNOT WE DO IT IN AMERICA?**

We can, but some one must take the lead, some one must show the way, some one must **PROVE** that it can be done.

I have repeatedly called attention to others through the Editorial Columns of AIRCRAFT that the time to operate great passenger carrying airship lines in America had arrived and urged others to take the lead in their establishment, and as there is apparently no one in this country who cares to undertake the herculean task, I have finally decided to take the lead myself.

Personally, I believe that the spectacle of a great Zeppelin Airship running between New York, Philadelphia, Baltimore and Washington every day, carrying passengers on schedule time, would be the greatest education to the American people in the possibilities of Air Navigation and the greatest incentive for practical business men to enter the movement for commercial reasons that could possibly be given.

A ship of this kind could be run at a profit by carrying thirty passengers at a time and making the round trip daily, if necessary.

In one year such a ship could be made to pay the cost of its own construction and the cost of its hangars as well as the operating expenses, including, of course, its insurance, which in case of disaster would naturally cover the original cost.

During the past four years, I have given all of my time and a good deal of money to the aeronautical movement of America and have been a close student of the progress made from every view point, and I am more thoroughly convinced to-day than ever before, that air-travel will continue to go forward until it is as common in practice as land or water travel is to-day. So in order to do my share toward its further development and because I want to see America eventually lead the world in this wonderful science, I am now ready to give both my time and money toward establishing an "Airship" line between New York and Washington.

To establish such a line, however, requires a great deal of money as well as knowledge to make it a success, for that reason I make this call for co-operation that we may combine our money and efforts to start the great work—money is the essential thing, without it nothing can be accomplished.

It seems to me that there must be enough men interested in the development of air transportation in America to co-operate with me and make the great plans I have in view a reality.

Patriotism, love of progress and chances of great financial rewards should be the incentive to communicate with me upon the subject.

ALFRED W. LAWSON.

**Mexican Officers to Fly**

Lieutenants Alberto Salinas and Gustavo Salinas, of the federal army of Mexico, have been detailed by the Mexican government to receive lessons in aviation. The young officers are the son and nephew of the Governor of Coahuila, Mexico. They hope to return to the army in a few weeks as pilots of the monoplanes which Mexico has ordered, two of which are already in active service with civilian aviators in General Huerta's command.

**Out of Racing, Says Orville Wright**

"We are entirely out of the racing game and are now confining our attention exclusively to the construction of the regulation machine," said Orville Wright to-day when asked as to a report that he was building a high power biplane for the coming international races. "We are teaching a man to fly at our training quarters at Simms Station, but beyond this the reports are unfounded."

Mr. Wright also said that the statements that have been made to the effect that special machines are being constructed for use in the Chicago races have no basis in fact. It is well known that many interested in aviation unsuccessfully urged the brothers before the death of Wilbur Wright to undertake the building of a defender for America. Wilbur Wright, however, persistently opposed the development of speed in these contests to the neglect of passenger carrying, lifting and climbing qualities.

The Aero Club of America has voted to issue under special tests certificates to be known as "expert aviators' certificates," and the Contest Committee of the club is now engaged in preparing the list of requirements for this test. All aviators wishing to obtain this certificate must first be brevetted under the rules of the International

Aeronautical Federation. This "expert aviator's certificate" will not in any way conflict with the International Aeronautical Federation license, but will, for this country, go a step further. Pending the announcement by the Contest Committee of the various tests to which the applicants will be subjected, it may be said that there will be an age limit beyond that of 18 years now specified. The applicant will probably be required to undergo a physical examination and will be required to fly further and higher than for his International Aeronautical Federation license.

**Special Correspondence**

By F. B. Silva-Netto.

Hongkong, 1st June, 1912.

Mr. W. B. Atwater, who failed to launch his hydro-aeroplane from the Pacific Mail Steamer "Mongolia," made three successful flights in his Curtis hydro-aeroplane before a very large crowd of spectators who lined the Yokohama Pier, Dhu and the Pacific Mail reservation on May 11th. Prior to this Mr. Atwater made a few unsuccessful attempts. The flights were witnessed also by hundreds of foreigners and a delegation from the Imperial Japanese Navy Department and from the Naval Station at Yokosuka. Among the Japanese officials who were present were Prince swache, representing the Imperial family; Baron Saito, Minister of the Navy; Vice Minister of the Navy, Takarabe, Vice Admiral Baron Uryu and Captain Nagahara, the aerial expert of Japan.

About 3 P. M. Mr. Atwater mounted the seat and with the assistance of his mechanic got the craft into readiness to fly. After running on the surface of the water for about 250 yards the hydro-aeroplane ascended into the air amidst loud applause above a flotilla of Japanese torpedo boats

about three miles out in the bay. The aeronaut steered the plane northward and passed over the French cruiser Duplex, and after a long sweep to the southward descended, reaching the same spot from which he started. The speed attained was about 50 miles per hour and the estimated altitude about 300 to 400 feet above sea level. In his third flight he took with him as a passenger Captain Umekita, of the Yokosuka Dockyard, who acted in response to the call for volunteers. The exhibition was organized by Mr. Young, manager of the Curtiss Co.

With the advent of Mr. Atwater on his tour of China and the Philippines, and the people in the Far East will be given the first opportunity to witness a hydro-aeroplane flight by a Los Angeles aviator of considerable renown in the realm of birdmen.

From Yokohama, Mr. Atwater will go to Shanghai, possibly Peking as well, and then to Manila, reaching there about the Gorgous Fourth.

I enclose four pictures illustrating the aviator's attempt to fly from the steamer "Mongolia."

I regret to have to report an accident which befell the American aviator, Atwater, who was sent to a hospital in Tokio on the 25th ult. In an exhibition flight between Tokio and Yokohama the machine got out of order, forcing him to glide to the surface about 2 1/2 miles from the coast of Gaishiwara, injuring his right leg and arm. I sincerely hope the injuries will not be so serious as to mar his plans, but will only mean a slight delay, as Shanghai and Manila are included in his itinerary. If Mr. Atwater should think of abandoning his program keen disappointment will be felt.

P. S.—I shall write about China and India in my next.

**PRINCIPLES and DESIGN of AEROPLANES**

By HERBERT CHATLEY

A text book on Aeroplanes, containing many details and drawings.

Price, 50 Cents

Lawson Publishing Co.

37-39 East 28th St., New York City

**CHICAGO AERO WORKS**

H. S. RENTON  
Proprietor

164 North Wabash Avenue

**AEROPLANES**

ACCESSORIES MOTORS PARTS

WHEELS

HARDWARE PROPELLERS

ESTABLISHED 1909.

First in Chicago and the Middle West

Aviators Taught.

Flights Furnished. Send Stamp for Catalog.

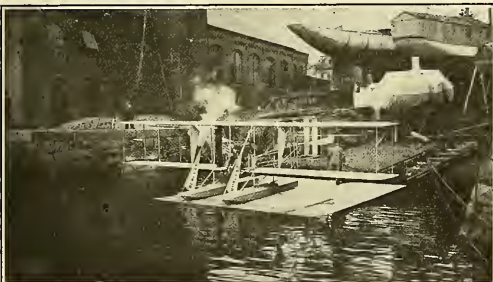

"THE PASSING OF THE YACHT"

**Burgess Flying School**

Hydroaeroplanes used exclusively. You can learn without delay. The Burgess factory adjoins the flying station. Aeroplanes for exhibition, military and sporting use under construction. All leading motors used. Pupils secure not only training, but latest information concerning construction and design.

INSTRUCTORS:

HOWARD W. GILL PHILLIPS W. PAGE

All Licensed Aviators

New Booklet just printed will give you full particulars

THE BURGESS COMPANY & CURTIS  
MARBLEHEAD, Box A MASSACHUSETTS



Farman Running Gears Complete as Above \$47.50

**Aeronautical Supplies**

Everything to build any type flying machine  
New catalogue with working drawings of Curtiss, Farman and Bleriot type machines, now ready for distribution and will be mailed free upon request to all interested parties.  
Write for quotations.

**A FEW IMMEDIATE DELIVERY PRICES**

- Curtiss Seats - \$5.50
  - Oval Post Sockets - \$0.17
  - Curtiss Steering Wheels - \$9.00
  - 5 Gallon Tanks - \$6.15
  - Out Rigger Fittings - \$0.29
  - Aluminum Pulleys with Brass Bushings - 2" 2 1/2" 3" - 25c., 30c., 40c.
  - Aviator Caps - \$1.25
  - Wheels and Tires complete Eclipse Hub - 20 x 2 1/2" - \$6.75
  - 20 x 3" - \$9.50
- Free with every \$50.00 order for Aeronautical Supplies

FLEECE LINED AVIATOR CAP

**E. J. WILLIS CO.,** 85 CHAMBERS STREET  
67 READE STREET  
Tel. 3624 Worth NEW YORK CITY

# CLASSIFIED ADVERTISING

15 CENTS A LINE

SEVEN WORDS TO LINE

CASH WITH ORDER

**FOR SALE**

**MUST SELL--FINE MONOPLANE**

1911, cross country type, two seater, Bleriot, 100 H. P. engine, full equipment. A. V. Reyburn, Jr., 5305 Delmar Boul., St. Louis, Missouri.

**N**EW Motor, \$750; Roberts 4 X motor complete, new, in perfect condition. M. F. H. Governeur, Wilmington, North Carolina.

**C**URTISS latest improved type (Pigeon tail) 1912 Model. Made over 300 very successful flights 1,000 ft. high, 30 miles cross-country. My construction is strongest in the world. New, complete, ready to fly, tested and guaranteed, including free lessons to buyer, \$2,500. Buy direct from Builder and Aviator of 10 years' experience. H. C. Cooke, Aviator and Builder, 127 West 64th St., New York City.

**F**OR SALE—Wm. R. Gordon's 5 new types, 20 sizes, Monoplanes, Biplanes, Hydro-Monoplanes and Biplanes, Aerial Ships, Boys' Monoplanes, sport, torpedo, war and passenger craft, storm proof, 1 or 2 motors, 1, 2, 3 or 4 propellers, 3, 5 and 7 sections, speed 5 to 150. Price \$1,250 to \$100,000. Capacity 100 to 5,000 lbs. Full course land and water. First ten \$500 each. Regular rates, hydros, \$500; small 1 motor craft, \$300; Motormen, \$250. Factory and 1/2 acre field. Aerial Ship Yard, Kinloch, Mo.

**F**OR SALE—New eight cylinder Hall Scott sixty H. P. Motor, with propeller; guaranteed perfectly; price \$1,000. R. Trember, 167 Penn st., Brooklyn, N. Y.

**FOR SALE**

**F**OR SALE—Finished woodwork, steel sockets and bedrail clamps, for Curtiss type Aeroplane, ready to assemble; without running gear; \$30, crated. J. L. Wolfe & Son, 251 Connecticut Ave., Bridgeport, Conn.

**C**URTISS latest improved type (Pigeon tail) 1912 Model. Made over 300 very successful flights 1,000 ft. high, 30 miles cross-country. My construction is strongest in the world. New, complete, ready to fly, tested and guaranteed, including free lessons to buyer, \$2,500; without power plant, \$700. Buy direct from Builder and Aviator of 10 years' experience. H. C. Cooke, Aviator and Builder, 128 West 65th St., New York City.

**A**ERONAUTICAL supplies, Curtiss type ribs, \$4.00 per doz., sockets, 10 cents each. Send for complete list of bargains. American Aviation Co., Incorporated, 2957 N. Lawndale, Chicago, Ill.

**S**EVEN CYLINDER Rotary Motor, built special for monoplanes. Big bargain for some one. Wm. Berry, 1552 Payne Ave., Cleveland, Ohio.

**F**OR SALE—Cheap, 2 pontoons for hydroaeroplaning, 12 feet long, 20 inches wide, 9 inches high; accommodate any aeroplane; made many successful flights with same. Price \$80; forty with order, balance C. O. D. A. J. Taylor, 534 E. 102d St., Cleveland, Ohio.

**F**OR SALE—50 H. P. Bradley Aeroplane Motor; 8 cylinders, Bosch Magneto, Perkins Carburetor. Guaranteed. J. O. Eberhard, Jr., Bulletin Building, Philadelphia.

**CO-OPERATION WANTED**

**C**APITAL wanted to patent and build aeroplane that will fly three hundred miles per hour. Will give 49 per cent. of patents. I will guarantee to fly across Atlantic in twelve hours. Address A. Harbottle, 18 Eldert St., Brooklyn, N. Y.

**E**XCEPTIONALLY good opportunity for promoter or party with capital to develop United States, French, British, Canadian and other foreign patents of a stability device (without warping wings, for aeroplanes, which guarantees: Non-collapsibility, increased lifting power, staying in the air when stopping motor, stronger construction of machines, etc. Inventor and owner of patents cannot give proper time to development of invention, but may sell above patent rights; also plans and model of new type dirigible airship to responsible party. Address M. Kalaba, 29 Cottage pl., New Rochelle, N. Y.

**Y**OUNG Jewish American, having improvement for biplane without infringing Wright or Curtiss machines, desires financial assistance to build and patent. M. M. Meizelle, 728 N. 24th St., Camden, N. J.

**POSITIONS WANTED**

**A** YOUNG MAN, age 18, desires position as an aviator's assistant, with prospects of learning to fly. Address Louis Fenouillet, 132 West 47th St., New York City.

**M**ONOPLANE Aviator and Designer—Three years' experience. Desires position with responsible firm or individual. Box 764, AIRCRAFT.

**PATENTS THAT PROTECT AND PAY**

Advice and Books Free. Rates Reasonable. Highest References. Beat Services.

WATSON E. COLEMAN, Patent Lawyer  
622 F St., N. W., Washington, D. C.

**PATENTS SECURED or Fee Returned**

Send sketch for free search of Patent Office Records. How to Obtain a Patent, and What to Invent, with list of Inventions Wanted and Prizes offered for Inventions sent free. Patents advertised free.

We are experts on AIRSHIPS and all patents and technical matters relating to AERIAL NAVIGATION.

VICTOR J. EVANS & CO. Washington, D. C.

**LEGAL NOTICE**

**A**S I am manufacturing Aeroplanes, I desire to give notice to all persons that are using my "Patent Ridders" with inverse and simultaneous action, and also my "Patent Semi-automatic engine control," that it is my intention in the future to ask a small "Royalty" from them. Hugh L. Willoughby, Sewall's Point, Florida.

**J. C. (BUD) MARS, NOW BOOKING**

ADDRESS

**17 N. La Salle Street, Chicago, Ill.**

**BAMBOO Special Grades of**

**Bamboo for AERONAUTIC WORK**

Reed, Rattan and Split Bamboo for Models. All sizes in stock. Tonka Rattan for Skids, 1 1/4 inch and under, any length.

**J. DELTOUR, Inc.**

804 Jefferson St. Hoboken, N. J.

**BARGAIN SALE**

BLERIOT TYPE MONOPLANE CAN BE SEEN ASSEMBLED AT

481-483 Park Avenue, New York

**DETROIT AERO POWER PLANT**

COMPLETE \$300 READY TO RUN

INCL. PROPELLER-CARBURETOR-BOSH MAGNETO, OIL PUMP-CABLE-SWITCH-MOUNTING BOLTS.

IS GUARANTEED TO 210 LBS. MIN. STATIONARY THRUST (150 LBS. MAX. WEIGHT COMPLETE) 36 HOURS DELIVERY

LIFT AND FLY CURTIS BYPLANES BLERIOT II MONOPLANES DEMOISELLE MONOPLANES OR CRAFTS OF SIMILAR MAKE

DETROIT AEROPLANE CO. MICHIGAN

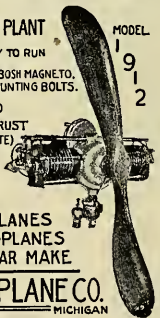

Seventy per cent. of record-breaking American flights with American Aeroplanes were made with propellers bearing this name

# CHARAVAY

WE WILL TELL YOU WHY IF YOU ASK US

**SLOANE AEROPLANE CO.**

**1731 Broadway, NEW YORK CITY**

AGENTS:

Eames Tricycle Co., San Francisco and Los Angeles; National Aeroplane Co., Chicago; W. E. Boughton, Washington, D. C.



**SUPPLIES** at Prices that make friends. Send 6c. for 22 page illustrated catalogue.



**NEW YORK AERONAUTICAL SUPPLY CO.**  
50 BROADWAY, NEW YORK

**“ROOLD”**

---

FOR SAFETY HELMETS  
AVIATION SUITS  
UNBREAKABLE GLASS GOGGLES

---

**“EVERYTHING FOR THE AVIATOR”**

50 Avenue de la Grande Armee, PARIS  
Official Contractors to the French and Russian Armies

**COOKE BIPLANES**

*Curtiss Improved 1912 Type (Pigeon Tail)*  
Perfect fliers. No freak construction. Ten years' experience. Strongest in the world. Ample powered (Roberts Motors). Anybody can fly these machines. One ready for immediate delivery **\$2,500**

Curtiss Type Planes, no Power Plant, \$650 and up  
Free Instruction to Buyer

H. C. COOKE, 127 West 64th St. NEW YORK CITY

**BLERIOT MONOPLANES**  
(GENUINE)

Winners of ALL the European Contests in 1911

---

In 1909---The First Aerial Crossing of the Channel.  
In 1910---The “Circuit de l’Est.”  
In 1911---The Paris-Rome Race (1st and 2d.)  
The European Circuit (1st and 2d.)  
The English Circuit (Daily Mail Race.)  
The Belgian Circuit.  
The Saint Petersburg, Moscow Race.  
The Valencia Alicante Race.  
The London to Paris non-stop Raid, etc., etc.

---

WORKS AND OFFICES: - - 39, Route de la Révolte à Levallois - - PARIS  
and Belfast Chambers, 156 Regent St., LONDON

FRANCE  
AVIATION SCHOOLS: Etampes, near Paris during Summer  
Pau, during Winter

ENGLAND  
Hendon, near London

**ALUMINA AEROPLANE FABRIC** “LIGHT AS A FEATHER”  
“BEAUTIFUL AS DAY”

Finest Imported Linen, thoroughly Waterproofed, and then coated with Aluminum. Heat and Moisture proof.  
Strongest and Most Durable Aeroplane Cloth on the Market. Our Prices will surprise you.

SEND FOR SAMPLES AND PRICE LIST, AND BE CONVINCED.

**THE AERIAL NAVIGATION COMPANY OF AMERICA**  
GIRARD, KANSAS

**AEROPLANE RADIATORS**

IN STOCK OR TO ORDER

SEND FOR PRICE LIST **EL ARCO RADIATOR CO.** 6 EAST 31st St., NEW YORK

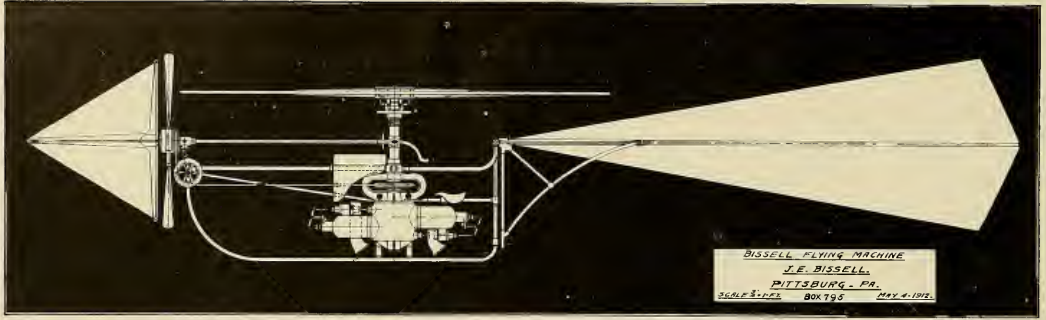

O Joy of creation, to be!  
 Dictator—O'er Land and the Sea—  
 Over ships and the guns of the World,  
 And the sons of men on the Earth, under me.

O Woe to the despot, as well!  
 As the "yahoo" below who rebel—  
 I shall not leave one trace of the Battleship race,  
 And could blow all the cities to—well? Smithereens.

## A City Hotel at the Seashore

# HOTEL NASSAU

### Long Beach, L. I.

ON THE FINEST BEACH NORTH OF FLORIDA  
 Electric Trains from Pennsylvania Station, 34th Street

'Phone 100 Long Beach

MERRY & BOOMER, Managers

## HEINRICH

### Monoplanes and Mono-Biplanes

TUITION, \$250

On Private Field

MADE IN FOUR SIZES

Write for Illustrated Booklet

HEINRICH BROS., Baldwin, L. I., N. Y., U. S. A.

## ALBATROSS ENGINES

MADE IN TWO SIZES

**50 H. P. 6-cyl. Aircooled**

Weight 250 lbs. Price \$650.00 complete

**100 H. P. 6-cyl. Watercooled**

Weight 300 lbs. Price \$850.00 complete.

CATALOG FREE. AGENTS WANTED

**ALBATROSS CO., Detroit, Mich.**

## AERO WIRE WHEELS

BUY FROM MANUFACTURER AND SAVE MONEY

20 x 2 1/4" Wheels—6" Hub—\$4.00 with tire \$6.00  
 20 x 3" Wheels—6" Hub— 4.75 with tire 8.25  
 FARMAN TYPE Gears complete—Price 42.50

Stock size Hubs—6" wide, 3/8 or 1/2" knock-out axle or bushed to fit 1" axle—to fit 1 1/4 and 1 1/2 special HYDRO-FLOATS and 3 1/4 inch Float Wheels.

Don't fail to write for complete list of Wheels and Prices. We make any size or type.

Deposit required on orders; Balance C. O. D.—examination allowed.

**J. A. WEAVER, Jr.** 132 West 50th Street  
 NEW YORK CITY

## Learn to Fly NOW'S THE TIME.



French method instruction; mechanic course. We positively have the only REAL Aviation School; two aviation fields, three factory buildings, aeroplanes, motors, etc., and the LARGEST aviation field in America. Motor, propeller, construction and flying thoroughly taught. Send for a home study course; FREE lesson.

**STANDARD AVIATION COMPANY**  
 1309 Manhattan Bldg. Chicago, Ill.

CAPT. BALDWIN has just returned from his SECOND tour around the world with an aeroplane, without any serious accident, during his exhibitions.

Always using the

### "Willoughby Patent Double Rudders"

for steering his machine.

The safety of this method of steering (in the vertical plane) has been demonstrated without a doubt.

# Aeronaut Leo Stevens

Controlling the Greatest Flock  
of Licensed Aviators  
in America

Operating the Leading and Best Make Machines  
in the world

If you contemplate Flying at your place, communicate direct.

Box 181 Madison Square

New York, U. S. A.

Phone Chelsea 235



# BENOIST DIPLANES

TYPE XII.

Three Models

- School Machine
- Cross Country Machine
- Military Machine

Also operate the  
Benoist School of Aviation

For further particulars address

**BENOIST AIRCRAFT CO.**  
6630 Delmar Blvd., St. Louis, Mo.

# DIANA SPIRON

The 3-bladed or tri Spiron  
Eliminates Vibration  
Saves Power.

Get the Folder

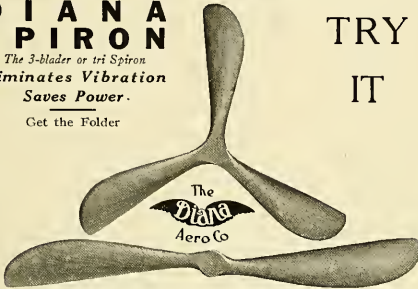

3-99 Baldwin Ave., Detroit, U. S. A.

TRY  
IT

# GOOD YEAR

AKRON, OHIO

## NO-RIM-CUT AEROPLANE TIRES

CAME TO BE THE CHOICE OF MODERN AVIATORS FOR THESE REASONS:

They take terrific land-shocks without blowing out. And no shock can loosen them. Easy to apply. No hooks to rust and freeze into tire. Last much longer than single-tube tires. \* Send postal today for latest catalog of Goodyear Aeronautic supplies. It shows the No-Rim-Cut, the Clincher Aero Tire, the Reinforced No-Rim-Cut, the Clincher Aero Tire, Goodyear Aeroplane Fabric, the Goodyear Blotter, Farman and Wright Type Shock Absorber; and Goodyear Balloons of all types. Address,

**The GOODYEAR TIRE & RUBBER CO.**  
AKRON, OHIO

Branches and Agencies in 103 Principal Cities  
We make All kinds of Rubber Tires, Tire  
Accessories and Repair Outfits  
Main Canadian Office, Toronto, Ont.; Canadian  
Factory, Bowmanville, Ont.



ACCESSIBLE QUIET ELEGANT  
For Business Men, Families and Tourists

THE

# SOUTHERN HOTEL

54th Street, near Broadway

# NEW YORK

FIREPROOF MODERN

PERMANENT AND TRANSIENT

In the heart of the theatre and shopping district.  
Cars pass the door for all railroad stations.  
Parlor, Bedroom and Bath, \$3.50, \$4 per day and up.  
Single Room and Bath, \$1.50, \$2.00 per day and up.  
Double Room and Bath, \$2.50, \$3.00 per day and up.

Special Rates by the Week

Restaurant a la Carte European Plan

**J. G. VENETOS, Proprietor**

SEND FOR BOOKLET



# New Field Open To You

THE American School of Correspondence makes it easy for you to get the technical knowledge necessary to become an expert aviator. Like all books published by this great technical school, the volumes described below are the most thorough and practical that have ever been printed—right down to the minute—just off the press.

## Practical Aeronautics

By CHAS. B. HAYWARD

Member, The Aeronautical Society; Formerly Engineering Editor, "The Automobile"

With Introduction by ORVILLE WRIGHT

An exhaustive, up-to-date treatise on dirigibles and aeroplanes, covering their historical development, analysis of standard types, their design, construction, and operation, the aeronautical motor, and the theory and practice of successful flight.

800 pages, 6 1/2 x 9 1/2; 310 illustrations

Price, \$3.50

## Building and Flying an Aeroplane

By CHAS. B. HAYWARD

A practical handbook for the amateur covering the building of small models and of full-sized gliders and machines. Detailed drawings are given with dimensions of all parts, the methods of shaping the struts and ribs, the form of running gear, the form and size of ailerons and rudders, the stretching of the fabric, the mounting of the motor and assembling of the complete machine. General instructions for flying are carefully laid down; the method of making a start, the conditions under which flights should be undertaken, methods of control, banking on the turn, and what to do in case of failure of any part or the stopping of the motor.

160 pages, 5 1/2 x 8 1/2; fully illustrated

Price, \$1.00

On Sale at All Leading Book Stores

Published by

AMERICAN SCHOOL OF CORRESPONDENCE, Chicago

\$1200 to \$4800

**THE**

X

**REX**

**MONO-PLANE CO.**

South Beach, S. I. N. Y.

**DUPLICATE PARTS**

at

**SAVE 80% COST SAVE 78%**

## Buy a REX Monoplane and Save

**\$500 to \$1000 on Purchase.**

**\$250 Tuition Fee to Learn to Fly.**

**50% to 75% on Maintenance.**

The REX, with its interchangeable wings, makes it possible to enter Speed, slow and passenger contests during the same day. **WHAT OTHER AEROPLANE CAN DO THIS?** Remember, we **Guarantee Before** delivery to fly the REX at Least 1000 Feet High and 10 Miles across country.

**THE REX MONOPLANE CO. South Beach, S. I., N. Y.**

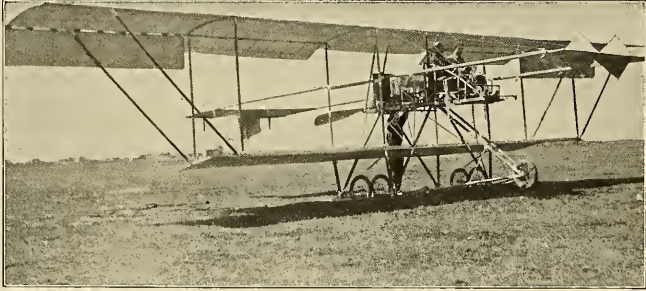

Showing double control school machine built in our Chicago factory. Width 52 feet.

# AEROPLANE

**NATIONAL COMPANY**

606 South Michigan Avenue, Chicago  
Harvester Building

**Manufacturers**

**Exhibitors**

**School of Aviation**

**REFERENCES:**  
Dun or Bradstreet  
Corn Exchange National Bank, Chicago

# WIRE

Aviator Wire supplied in 12 sizes with a plate finish, making soldering easy. This wire is specially drawn from extra quality high grade steel. Also Aviator Cord of twisted wire.

**John A. Roebings Sons Co.**

TRENTON, N. J.

# BALDWIN

**VULCANIZED PROOF MATERIAL**

For Aeroplanes, Airships, Balloons. First Rubberized Fabric on the market. Lightest and strongest material known. Dampness, Heat and Cold have no effect. Any Strength or Color.

**"RED DEVIL" AEROPLANES**

That anyone can fly. Free Demonstrations.

**HALL-SCOTT MOTORS**

Eastern distributor. 40 h. p. 4-cyl.; 60 and 80 h. p., 8-cyl., on exhibition at Frank Schumacher's, 164 W. 46th Street, New York. All motors guaranteed. Immediate delivery.

**EXPERTING**

Will install a Hall-Scott free of charge in anyone's Aeroplane and demonstrate by expert flyer. Expert advice. Plans balanced.

CAPT. THOMAS S. BALDWIN  
Box 78 Madison Sq. P. O., New York

## AEROPLANES

# HOTEL CUMBERLAND

NEW YORK

Broadway at 54th Street



Headquarters for Aviators and Automobileists.

New and Fireproof

Strictly first class.  
Rates reasonable.

\$2.50

With Bath  
and up

Send for booklet.

Ten Minutes' Walk to Thirty Theatres

## H. P. STIMSON

Formerly with Hotel Imperial

# New Weston Hotel

Madison Avenue at 49th Street  
NEW YORK

Modern fire-proof and high-class hotel in every respect.

A quiet and convenient location, one block from 5th Avenue.

Near theatres, clubs and select department stores.

## Special Summer Transient Rates

- Large Single Outside Room - - - \$1.50
- Large Single Outside Room and Bath - 2.00
- Large Double Outside Room and Bath - 3.00
- Parlor, Bedroom and Bath - - - 4.00

Restaurant a la Carte, Moderate Prices

GEORGE L. SANBORN, Proprietor

Formerly Hotel Cumberland and Hotel Navarre.

# NAIAD Aeronautical Cloth

Manufactured Especially for Aeroplanes and Used by  
Aviators of Prominence

LIGHT, STRONG, AIR-TIGHT

AND  
MOISTURE-PROOF ON BOTH SIDES

Sample Books, including Data and Prices, sent on request

THE C. E. CONOVER CO.

101 Franklin Street - - New York

Official Aeronauts for the CHINESE ARMY  
AND PRACTICAL AVIATORS

WE MANUFACTURE AND DEAL IN  
AEROPLANES, MOTORS AND  
ALL AERONAUTICAL SUPPLIES

Everything an Aeronaut needs and wants we can furnish  
at lowest prices. We guarantee everything we sell  
Send 5 cents in stamps for Catalogue

**WOLVERINE AERONAUTIC CO.**

Office and Factory : Detroit, Mich.

# ... The Wittemann Biplane ...

HAS A REPUTATION, NOT ONLY FOR PACE, BUT FOR QUALITY AND SERVICE

Write for information of 1912 Biplane with our new auxiliary stabilizer.

If you want to build a machine of your own design or parts thereof, we can help you to make it successful. Some parts of your plane can be made of steel. We rid you of the annoyance of constant repairs and insure absolute safety.

Send us your specifications and requirements and secure our quotations.

Large stock of steel fittings, laminated ribs and struts of all sizes carried in stock.

Own a Wittemann Biplane Glider; the best, the safest, easiest to operate, and enjoy flying in a moderate form.

## YOUR OPPORTUNITY

Two single cover biplanes for immediate delivery; slightly used, perfect condition with 8 Cyl. 60 H. P. Hall Scott power plant.

Write for Particulars.

Write for Catalogue.

**C. & A. WITTEMANN**

Aeronautical Engineers

The Oldest aeronautic manufacturing concern in the United States.

Established 1906.

Works: Ocean Terrace and Little Clove Road.

Staten Island

New York

## INVESTIGATE FIRST

Satisfy yourself you are dealing with a responsible concern before paying your money.

**WE GUARANTEE** our machines, workmanship, materials, etc., superior to those of any other constructed here or abroad regardless of price paid.

Immediate and prompt delivery on standard machines.

"Nieuport," "Bleriot," "Farman" and "Curtiss" types. Hydroplanes; speed, single, passengers, weight-carrying, or specially constructed to your own design and specifications.

"Complete with suitable power plant purchaser selects or prefers, demonstrated in flight." "Complete without power plant," or "Complete in the Knockdown." Will accept orders on specified time delivery under forfeiture.

We invite your personal inspection of the best equipped plant in the U. S. All types in course of construction. Unexcelled opportunity to acquire full shop, construction and flying course, on any type Monoplane or Biplane.

*SEEING IS BELIEVING. CALL IF POSSIBLE OR WRITE.*

## INTERNATIONAL AERONAUTIC CONSTRUCTION CO.

Factory, Hollis, L. I.  
Main Line L. I. R. R.

Office, P. O. Bldg.  
Jamaica, N. Y. City

Flying Grounds  
Nassau Boulevard

## GRAY EAGLE MOTORS

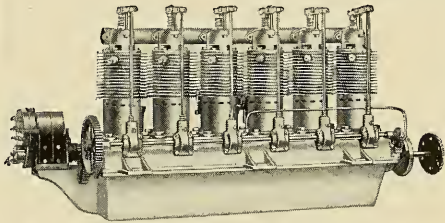

Are in a class to themselves. The air cooled motor is in demand for aviation power plants because it means less weight and less resistance for your plane with the bother left out. The use of pumps, connections, radiator and water not necessary. Let us convince you of the merits. Economy of fuel. Efficient in power. Strength and reliability. Moderate price. Write for particulars.

**TWO MODELS**

Model E - 6 - 50 H. P.

Model D - 4 - 35 H. P.

\$675.00

\$485.00

**Kemp Machine Works**

**Muncie, Indiana**

## PROPELLERS

If you really want  
**THE BEST**

## GO TO GIBSON

He takes the trouble to find out what *is* best. You can call, 'phone or write him; address

## GIBSON PROPELLER CO.

FORT GEORGE PARK

197th St. and Amsterdam Ave., New York

Phone Audubon 6762

## Duplex Propellers

Lines and curves productive of highest efficiency.  
Laminated and hand made. Select materials.

## Duplex Monoplane Surfaces

Type Nieuport. Streamline form entering edge.  
Flexible trailing edge. Slight dihedral angle built in. Up-to-date warping arrangement.

For details and prices apply to

## FRANK HERBST ENGINEERING WORKS

Wilmington, N. C.

# THE CURTISS SUMMER TRAINING SCHOOL AT HAMMONDSPORT, NEW YORK



ONE OF THE CURTISS TRAINING GROUNDS

**New Hangars, New  
Equipment, Experi-  
enced Instructors.**

**Aeroplane and  
Hydroaeroplane  
Courses.**

*The Curtiss Schools are  
the largest in America.*

*Seventeen pupils obtained  
their pilots' licenses at  
our San Diego School be-  
tween January first and  
March fifteenth.*

*Summer classes are filling  
rapidly.*

**WRITE OR WIRE YOUR ENROLLMENT TODAY**  
*PRICES AND PARTICULARS UPON REQUEST*

*Largest  
Builders of  
Complete  
Aeroplanes  
in the world*



**ALL NATIONALITIES ARE REPRESENTED AT THE CURTISS SCHOOLS**  
*(One of the Graduating Classes.)*

**THE CURTISS AEROPLANE CO.**  
**HAMMONDSPORT, NEW YORK**

# Licensed Pilot Praises Roberts

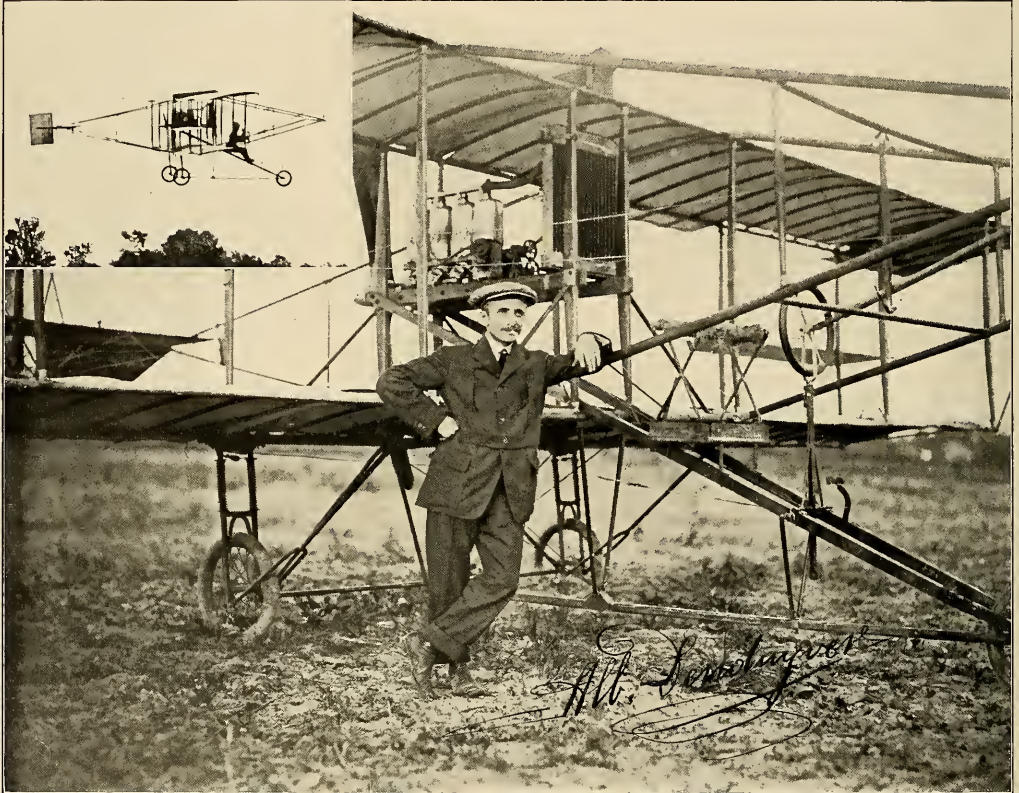

ALBERT DENDUYVER IN GRAY EAGLE BIPLANE—ROBERTS 4 X

THE ROBERTS MOTOR CO.,  
Sandusky, Ohio

LOUISVILLE, KY., June 19th, 1912.

Gentlemen: Yours of the 17th inst. has been received and it affords me much pleasure to testify to the performance of the Roberts Motor in my recent flight in Louisville.

I have flown in Europe since 1910 with the Gnome, Anzani and Argus motors, so that from my past experiences in this line I am well qualified to speak. This flight with the Roberts Motor was my first in the United States, and I want to say that I am pleased with its running qualities. After this flight, which was of twenty minutes' duration, the motor was carefully examined, and it was not one whit hotter after this run than it would have been after a three-minute run.

In my opinion the Roberts is an ideal motor, and it certainly is a pleasure to fly a machine propelled by such a motor.

I am mailing you photographs of the flight. My license is No. 43, issued by the Belgian Federation Internationale.

Yours very truly

ALBERT DENDUYVER, Licensed Aviator,  
Louisville, Ky.

GET OUR 36-PAGE CATALOG. WRITE TO-DAY

## THE ROBERTS MOTOR COMPANY

1463 Columbus Avenue

Sandusky, O., U. S. A.



# AIRCRAFT

Vol. 3, No. 7

SEPTEMBER, 1912

15 Cents a Copy

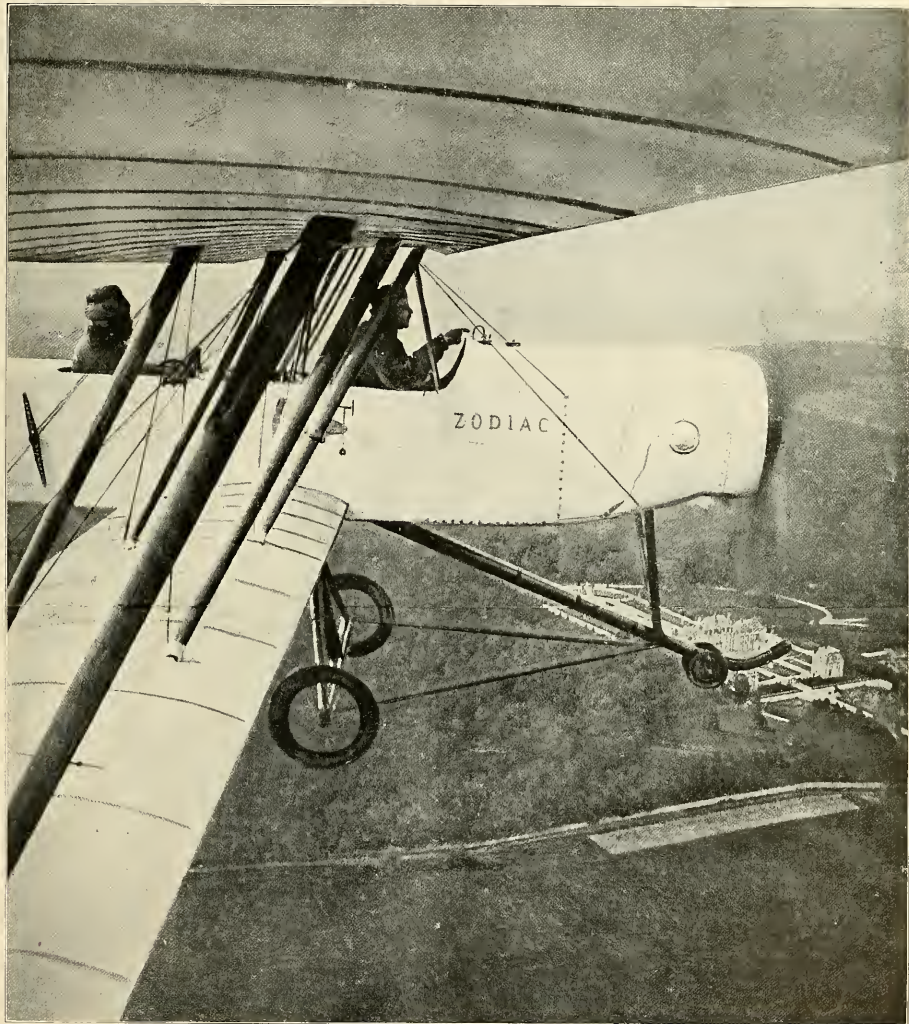

## PHOTOGRAPHING THE LAND-CREEPERS BELOW

M. Andre Schelcher and M. Deboutelle, pilot, on board a Zodiac biplane, passing over the chateau and Park de Breteuil, France, at a height of 900 feet.

This remarkable photograph, which was taken by the aviators themselves, depicts the joys and pleasures of flying in a manner only to be rivaled by the actual accomplishment and gives the layman his first real impression of flying.

# Monoplane Flyers Are in Demand

There are more competent biplane flyers than there are positions for their services. There are less good monoplane flyers than there are positions. This is the time to earn the big money in flying monoplanes. In exhibitions the monoplane commands from 70 to 100 per cent. more compensation than the biplane. In the

## SLOANE SCHOOL OF AVIATION

monoplane flying is taught on a genuine famous Deperdussin Machine. The course is an exact duplicate of the course given by the Deperdussins at Rheims. The tuition fee is



70 H. P. DEPERDUSSIN FOR ONE OR TWO PASSENGERS

### Deperdussin Monoplanes

are the safest and most efficient flying machines in the world. Hold 90 per cent. of the world's records.

### Caudron Monoplanes

are safe and tremendously speedy. Best for exhibitions.

### Anzani Motors

hold the unique record of giving tremendous speed, reliability, efficiency and safety. No fatal accident during the year has occurred with an Anzani Motor.

# \$300

for the full course. If the pupil completes the course without breakage 10 per cent. of the tuition fee is refunded. A guarantee of \$250 for breakage is required. The pupil is made competent to comply with the most rigid license test.

**No bond of any kind is required when the pupil flies for his license.**

Of the seven pupils who entered the school during the first month one was certified as proficient after three weeks of the course. He finished without any breakage whatsoever. It is an every-day occurrence for pupils in our school to fly over 15 minutes and at an altitude of 1,000 feet.

Visit the school. It is located on the famous Long Island flying field near New York.

WIRE

'PHONE

WRITE

# SLOANE AEROPLANE CO.

1731 BROADWAY, N. Y. CITY

'Phone 5421 Columbus

Agents Eames Tricycle Co., San Francisco and Los Angeles; W. E. Boughton, Washington, D. C.



**LUMINA**  
AEROPLANE CLOTH  
SYSTEM CONTINENTAL  
THE B.F. GOODRICH CO., AKRON, OHIO

**The first Aeroplane Cloth with  
the ALUMINUM finish manu-  
factured in America.**

*Never Shrinks  
Waterproof  
Always Tight  
Bright and Clean*

**Send for our New  
Booklet and Samples of  
"LUMINA"**

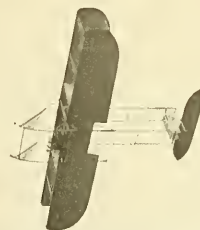

Philips W. Page flying in Burgess-Wright Machine equipped with  
40-H. P. Sturtevant Motor

The Latest and Best principles of gasoline motor construction, carefully tested and proved by the foremost builders of engines in this country and abroad are found in the

**Sturtevant**  
REG. U. S. PAT. OFF.

## AERONAUTICAL MOTORS

A four-cylinder 40-horsepower STURTEVANT motor was used by Page in a Burgess biplane flown by him during the Boston Aviation meet; although used in every event during the entire meet absolutely no repairs or adjustments were made on the motor, which operated perfectly, carrying the plane to altitudes of over 5000 feet. Such absolute reliability is due to sound engineering principles in design and superior workmanship in construction. Ask for Catalog 200-P.

**B. F. STURTEVANT CO.**

Hyde Park

Boston, Mass.

AND PRINCIPAL CITIES OF THE WORLD



## FRONTIER MODEL A

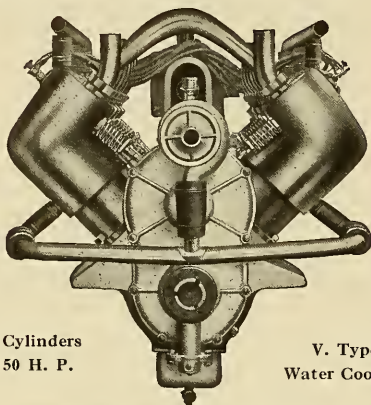

8 Cylinders  
50 H. P.

V. Type  
Water Cooled

Four and three quarter lbs. per actual Horse Power

## Simple Reliable Durable

Reliability and durability coupled with minimum weight, consistent with absolute safety, are the important points of superiority combined in the FRONTIER Aero Motor of quality.

Our claim for distinction lies in the unique and well balanced design and the mode of fuel supply, giving equal and never-failing power for all altitudes and temperatures.

Embodied in its construction are these essentials:

Highest grade of workmanship.  
Best materials.  
Experienced and capable engineers.  
Perfect shop equipment for manufacture.

Catalog and Price List on Application

**E. J. Willis Co.**

85 Chambers Street, New York Agents

**Frontier Iron Works**  
BUFFALO

## Wright Hydro-Aeroplane School Now Open at GLEN HEAD, L. I.

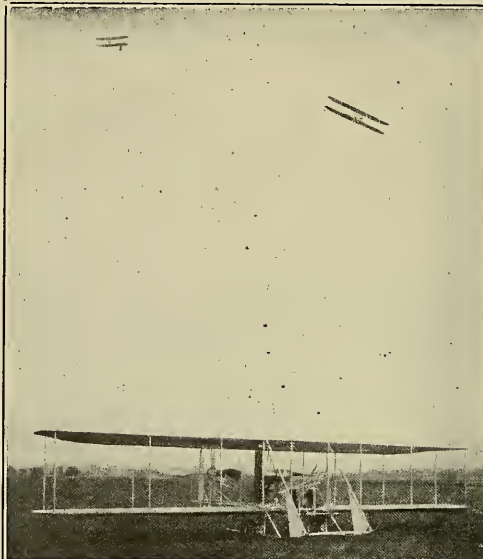

## Wright Flyers

### 1912 MODELS

In addition to those features which in the past have made Wright Flyers famous for efficiency and reliability, the new models can be furnished with **Automatic Control, Silent Motors, and Hydro-planes.** These special features make the 1912 machine unusually attractive to sportemen.

### EXHIBITION MACHINES

For exhibition work we have other models especially adapted to high winds and small fields. It was with a stock "EX" Model that Rodgers made his wonderful flight from coast to coast. Reliability means dollars to the exhibitor.

### WRIGHT SCHOOL OF AVIATION

Training consists of actual flying, in which the pupil is accompanied by a competent teacher. No risks and no expense whatever from breakage. The most famous flyers in America are graduates of our school and include such names as

Lieut. Arnold	Drew	Lieut. Rodgers
Atwood	Elton	Parnalee
Brookins	Lieut. Foulois	Page
Brindley	Fowler	Reynolds
Bonney	Gill	Simmons
Beatty	Lieut. Lahm	Turpin
Burgess	Lieut. Milling	Welsh
Coffyn	Mitchell	Webster
Capt. Chandler	C. P. Rodgers	and many others.

Our Schools at Dayton and New York are now open and pupils may begin training at once if they wish. By enrolling now you can reserve date most convenient to you for training. Write for particulars.

**THE WRIGHT CO.**  
Dept. "B" DAYTON, OHIO



Farman Running Gears Complete as Above \$47.50

### Aeronautical Supplies

Everything to build any type flying machine  
New catalogue with working drawings of Curtiss, Farman and Blériot type machines, now ready for distribution and will be mailed free upon request to all interested parties.  
Write for quotations.

**A FEW IMMEDIATE DELIVERY PRICES**

- |                                       |                              |
|---------------------------------------|------------------------------|
| Curtiss Seats - \$5.50                | Oval Post Sockets - \$0.17   |
| Curtiss Steering Wheels - \$9.00      |                              |
| 5 Gallon Tanks - \$6.15               | Out Rigger Fittings - \$0.29 |
| Aluminum Pulleys with Brass Bushings  |                              |
| 2" - 2 1/2" 3" - 25c., 30c., 40c.     |                              |
| Aviator Caps - - - \$1.25             |                              |
| Wheels and Tires complete Eclipse Hub |                              |
| 20 x 2 1/4" - - - \$6.75              | 20 x 3" - - - \$9.50         |

Free with every \$50.00 order for Aeronautical Supplies

**FLEECED LINED AVIATOR CAP**

**E. J. WILLIS CO.,** 85 CHAMBERS STREET  
27 READE STREET  
Tel. 3624 Worth NEW YORK CITY



### HILLERY BEACHEY

flying Brooks Biplane at Chicago with both hands off controls.

Let us send you our literature fully describing the types of aeroplanes we have developed.

- HYDRO-AEROPLANE**
- BIPLANE**
- TRACTOR-BIPLANE**
- MONOPLANE**

Popular priced machine fully equipped

**\$1500.00**

Immediate delivery; correspondence solicited.  
Alexander Hamilton, Constructing Engineer

### BROOKS AEROPLANE COMPANY

409 Rust Ave., Saginaw, Mich., U. S. A.

# 6 MONTHS TO PAY

HALF THE PRICE OF A

## 1912 MAXIMOTOR

PROVIDED ORDER IS RECEIVED BEFORE SEPT. 30.

The exhibition men admit there is a lack of good aviators with good planes for the great number of county fairs, resort programs and reunions the next few months.

We know of a number of good flyers who haven't quite enough of the "necessary" in pocket to get a good engine. And there are others in that position. This is their opportunity. A first-class, reliable engine is all they need to "make good."



MAXIMOTORED CURTISS AT SPOKANE  
One of many hundreds of MAXIMOTOR flights the world over.

MAXIMOTOR MAKERS  
DETROIT  
52 CRANE AVENUE

Dept. 21

25% with order  
50% C. O. D. and  
50% in 6 months at  
5% interest.

- |                         |        |
|-------------------------|--------|
| Model E, 4 cyl. 50 h.p. | \$1200 |
| " F, 6 " 75 "           | 1600   |
| " G, 4 " 70 "           | 1500   |
| " H, 6 " 105 "          | 2000   |
| " J, 8 " 140 "          | 2500   |

Complete with Radiator and Propeller

FULLY GUARANTEED

Get the Motor now. Make your share filling dates this Fall

One new man cleared \$10,000 with his MAXIMOTOR in 3 months. WHY CAN'T YOU?

# NINETEEN HUNDRED TWELVE Aviation Events

**CHICAGO, U. S. A.**

Under the Auspices of The Aero Club of Illinois

**Gordon Bennett World's Championship Aeroplane Race**  
September 9, Clearing, Ill.

**Four Day International Aviation Meet**  
September 12, 13, 14, 15, Cicero Flying Field

**First International Hydroaeroplane Purely Competitive Meet Ever Held**  
**Also Duration Aeroplane Flying**  
September 16, 17, 18, 19, 20, 21, Grant Park, Chicago

## \$24,000 in Prizes Guaranteed

DIVIDED

**Hydroaeroplanes, \$7,050**  
**Speed, Land, \$4,600**

**Duration, \$9,000**  
**Contest, Land, \$2,400**

**Special Prizes, Land, \$950**

Every flyer paid pro rata for time he is in the air. Open to licensed aviators of the world.

Entrance Fee \$25. Entries close September 7—Midnight

**THE AERO CLUB OF ILLINOIS,** **AUDITORIUM**  
Chicago, Illinois



Six famous American aviators who did air scouting service during the recent army manoeuvres in the vicinity of New York. Soaring above the contesting armies at an altitude of from 2,500 to 3,000 feet, they watched every movement of the troops below like mammoth hawks and recorded their movements with an accuracy which astonished the war veterans.

The work of this small aviation squad proved of inestimable value during the mimic war game. They were able to trace their way in the air over miles of wooded country and winding roads and locate every detachment and every move of the enemy. In fact they demonstrated that the old-fashioned ambush is a thing of the past.

From left to right are Lieutenants Graham, Fotlois, Milling and Gieger, Private Havens and Captain Hennessy.

### CONTENTS—SEPTEMBER, 1912

Aeroplane Safety For One Dollar . . . . .	Ladis Lewkowicz	207
\$24,000 Cash Prizes at Chicago Meet . . . . .	S. R. Brustmann	209
Editorial . . . . .		210
The Gull Versus the Wind . . . . .	Will Simmons	212
The Advance Toward Aerial Law . . . . .	Communicated by Denys P. Myers	215
The National Balloon Race . . . . .		215
A Suggested Design for an Aeroyacht . . . . .	Walter H. Phipps	216
A Letter From England . . . . .	D. E. Ball	217
Foreign News . . . . .	R. H. Blanquie	218
Table of Machines Entered for the British War Office Trials . . . . .		221
Scale Drawing of the Bristol Monoplane . . . . .		222
The Trade . . . . .		223
General News . . . . .		224

## AIRCRAFT

ALFRED W. LAWSON  
President and Treasurer  
ERNEST C. LANDGRAF  
Secretary

Published Monthly by The Lawson Publishing Company  
37-39 EAST 28th STREET, NEW YORK, U. S. A.  
Telephone, 5017 Madison Square

ALFRED W. LAWSON  
Editor  
WALTER H. PHIPPS  
Asst. Editor

#### TERMS TO SUBSCRIBERS

In the United States, Mexico, Puerto Rico, Guam, Philippine Islands, Hawaiian Islands, Cuba (including Postage), \$1.50 per year.  
Fifteen Cents the Copy, of All News Dealers.  
Foreign Subscriptions, Two Dollars per year.  
In changing order give old as well as new address.  
Advertising copy must be in hand by the 1st of month previous to date of publication.  
Only high-grade advertisements of thoroughly reliable firms are solicited.

#### WHEN YOUR SUBSCRIPTION EXPIRES

One month before a subscription expires we enclose a renewal blank on which you will write your order for the renewal.  
WHEN FIRST NOTIFIED that your subscription will expire, you should send your renewal at once, in order not to miss a number. New subscriptions which are received by us on or before the 15th of any month will begin with the issue of that month. If received after that date they will begin with the following month's issue. We cannot enter subscriptions to begin with back numbers. One month's notice is necessary before a change of address can be made.

Entered as "second-class matter" February 18, 1910, at the Post Office, at New York, N. Y., under Act of March 3, 1879.  
Copyright, 1912, by the Lawson Publishing Co.

"Aircraft" is registered as a trade-mark by the U. S. Patent Office, under date of August 9th, 1910.

# BLERIOT MONOPLANES

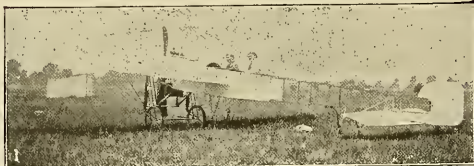

One of our 1912 Passenger-Carrying Monoplanes, duplicate of which is set up at our factory for inspection.

**WE HAVE THREE OF OUR BLERIOT MONOPLANES ON HAND READY FOR IMMEDIATE DELIVERY**

Our BLERIOT TYPE MONOPLANES are in every way suited to contest and exhibition work, including speed, altitude, distance and duration, cross-country and cross-city flying, where thorough reliable strength and high efficiency are so vitally important.

**WE SOLD MORE SUCCESSFUL BLERIOT TYPE MONOPLANES IN 1911 THAN ALL OTHER MANUFACTURERS COMBINED DID**

Visit our factory and examine in detail the EXCELLENT DESIGN and CONSTRUCTION of our Monoplanes

ILLUSTRATED CATALOG FREE.

SEND FOR IT TO-DAY

**American Aeroplane Supply House**  
137-143 Jackson St. Hempstead, L. I., N. Y.

Telephone 427 Hempstead

*Paul Lacroix Automobile Co., Aviation Dept.*

Tel. Columbus 1335

**Aeroplanes, Motors and Equipment**

1780 Broadway,

63 Avenue Champs Elysees Paris

New York

AGENTS FOR

# G NOME

50 H. P. 70 H. P. 100 H. P. 140 H. P.

## IN STOCK

AVIATION MOTORS

**ANZANI—RENAULT—SALMSON**

Immediate Delivery

AVIATORS' HELMETS, ASTROL VARNISH  
and Everything Else in Imported Supplies

WRITE [FOR [CATALOGS] AND PRICES

## FOX De Luxe Aero Motors

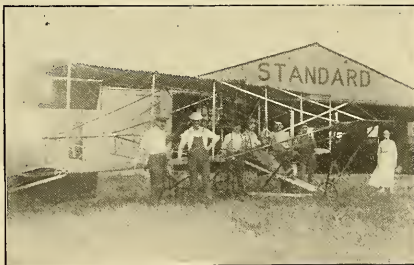

**60 H. P. Fox Motor in Raiche's Plane**

at Standard Aviation  
Field, Chicago, Ills.

4 cyl.—235 lbs.—60 H. P.

**The result of 10  
years of  
GAS ENGINE  
manufacturing**

Write for Catalog

**THE DEAN MFG. CO.**  
2536 Front Street Newport, Ky.

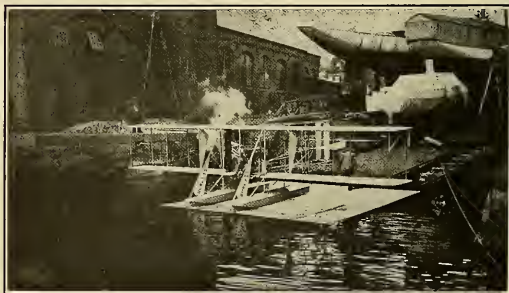
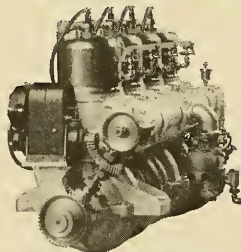

"THE PASSING OF THE YACHT"

## Burgess Flying School

Hydroaeroplanes used exclusively. You can learn without delay. The Burgess factory adjoins the flying station. Aeroplanes for exhibition, military and sporting use under construction. All leading motors used. Pupils secure not only training, but latest information concerning construction and design.

INSTRUCTORS:

HOWARD W. GILL PHILLIPS W. PAGE

All Licensed Aviators

New Booklet just printed will give you full particulars

**THE BURGESS COMPANY & CURTIS**  
MARBLEHEAD, Box A MASSACHUSETTS



# AIRCRAFT

Vol. 3. No. 7

NEW YORK, SEPTEMBER, 1912

15 CENTS A COPY  
\$1.50 A YEAR

## AEROPLANE SAFETY FOR ONE DOLLAR

By LADIS LEWKOWICZ

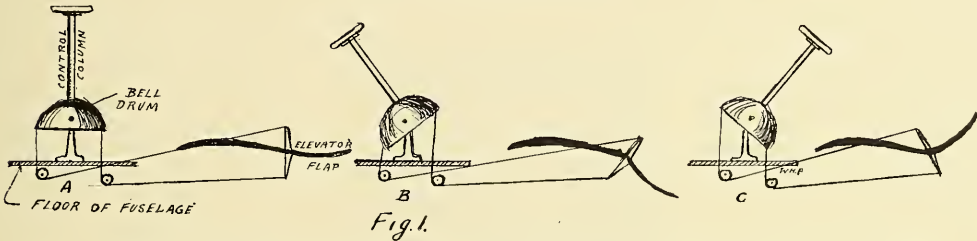

Fig. 1—Diagram of the Blériot control showing how the present arrangement permits of excessive movement of the control column.

**R**N reading the title of this article one may smile and ask what the small sum of one dollar can do to make aviation safer when thousands of dollars are spent continuously in the construction of aeroplanes without any great advancement being made toward safety.

As an aviator, who has made a study of aeroplanes under all sorts of conditions, it is my intention to state here, without fear of contradiction from builders of successful machines, that one dollar spent as herein directed will make our present-day aeroplanes immeasurably safer than they are now.

Looking over the list of fatal accidents, I notice the names of a number of my personal friends, and analyzing the cause of their accidents, it is sorrowful to find that although their lives have been sacrificed for a great cause, still several of them **should** and **would** have been spared if the constructors of aeroplanes would have spent One Dollar more for safety.

In writing this article, my object is to attract the attention of every designer and constructor, and to show him how easily he can make his aeroplane safer.

The progress of aviation during the past four years has

been marvelous, but unfortunately, like all branches of human development along transportation lines, it has paid its debt to martyrdom. The question arises, however, was not this debt paid larger than necessary? Was it not possible to have spared a number of lives? I regret to state that it was possible, but no effort was made in that direction owing to the craze for speed at the expense of safety. Now that general demand is for safety, the question is put squarely up to the designer and constructor and he is asked to produce safer machines.

I am obliged to recall the death of several good friends to explain my point, and to show that their lives could have been spared by the means I advocate here. The accident to my friend, John B. Moisant, on the 31st of December, 1910, was due to his aeroplane descending at too steep an angle. He was thrown clear out of his machine. The same accident happened to Ely in 1911 and the recent accidents to Welsh at Washington and to Miss Harriet Quimby were due, in each case, entirely to a steep descent which caused the aeroplane to throw the aviators out, or crush them underneath. I am citing here only these accidents because their victims were

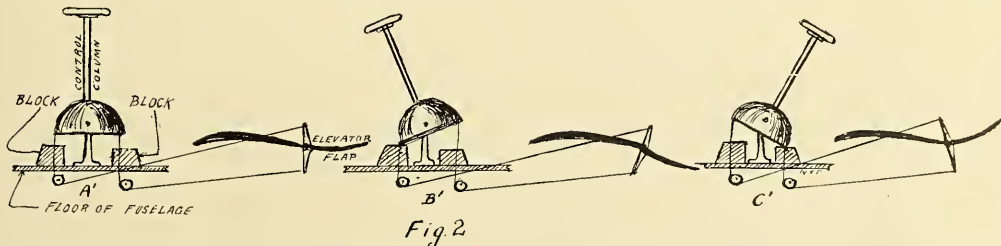

Fig. 2—Diagram of the Blériot control fitted with block stops mounted on the fuselage floor to prevent excessive movement of the control column.

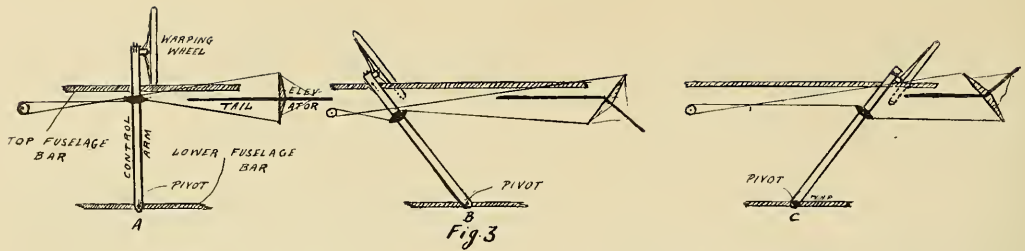

Fig. 3—Diagram of the Deperdussin control showing the excessive range of control permitted by the present arrangement.

well known all over the world and caused the general impression that flying was too dangerous. Were those accidents avoidable? Yes, they were, and so were many others, and so are many similar accidents avoidable providing means are devised to prevent the aeroplane descending at too steep an angle. The means I advocate are very simple indeed—merely a common sense process of having the controls of the aeroplane so arranged as to give freedom to the aviator to take care of his machine under every condition, **but no more**. I contend that it is fruitless to put an aeroplane in the hands of an aviator, no matter how experienced he may be, with the controls so arranged as to allow the machine to go up at an angle of 45 degrees when the limit of safe flying is an angle of 10 degrees, or to go down at an angle of 80 degrees when the limit of safety is 30 degrees.

Every constructor **KNOWS OR SHOULD KNOW** the safety angle at which his aeroplane will fly, no matter what engine is utilized for motive power, and so construct his controls that they cannot be worked farther than **SUCH DETERMINED SAFETY FLYING ANGLE**. This means that ninety-nine per cent. of the aeroplanes flying to-day should have their controlling devices provided with **STOPS** which will allow a margin of safety in flight and prevent the inexperienced aviator from putting the controls in a dangerous position and also prevent the experienced but foolhardy airman from doing stunts instead of flying properly, and, therefore, these stops will prevent the inexperienced or the reckless pilots from hurting or killing themselves.

When taking into consideration other mechanical devices, such as automobiles, street cars, etc., and when it is understood how quickly a way was found for the protection against mechanical drawbacks which meant loss of time and money, it seems strange that in such a wonderful creation as flying machines, no such steps have so far been taken. Why? Is it possible that the cost of a mechanical device is more important than human life?

In an ordinary street car, which is run by anybody, the designer and builder has devised means to start the car easily, and has constructed the controlling devices in such a way that there are a number of stops made to put the motor in full motion, and by so doing prevent mechanical troubles and thereby loss of time and money. In any automobile there

are several distinct stops found in the controlling devices, to put the automobile in proper motion, which stops are so designed and arranged as to relieve the operator of **GUESSWORK**, and after he is acquainted with the controlling devices he puts them in position and feels certain that everything is in perfect condition. Nothing is left but a simple mechanical positive motion.

On the contrary, in the aeroplane **EVERYTHING** has been left so far entirely to the experience of the aviator. Controlling devices are put in his hands with twice or three times more margin of control than necessary to make flying safe, and his experience and good judgment is relied upon to always work them perfectly. The result is that the aviator gets reckless and uses such controls to a larger extent than advisable either for excitement or exhibition stunts, and thereby meets with accidents.

It should be the duty of every aeroplane designer and builder to properly figure the angle at which his aeroplane can go up and come down safely and construct these controlling devices in such a manner that they could not be used at a greater angle. By doing so every constructor will be working for the safety of aviation.

An aeroplane which can safely go up under any conditions at an angle of 10 degrees and come down at an angle of 25 degrees, should not have its controls arranged so that it can go up at an angle of 45 degrees or come down at an angle of 80 degrees.

To sum up, therefore, proper stops must be put on the aeroplane to prevent it from ascending or descending at a greater angle than necessary, and these **STOPS** can be fixed on any aeroplane for the small sum of **ONE DOLLAR**, the cost of material and labor. The result will be that the inexperienced aviator will run less chance of getting into trouble through lack of experience, and the experienced aviator will not get into trouble through his over-confidence, and the reckless and foolhardy aviator will not be able to make his aeroplane do fancy stunts for which it was not intended, and so many different kinds of accidents will be avoided.

I am willing to help anyone who may desire further information as to how to make his aeroplane safe through safety stops, and invite criticism from successful designers, as in my

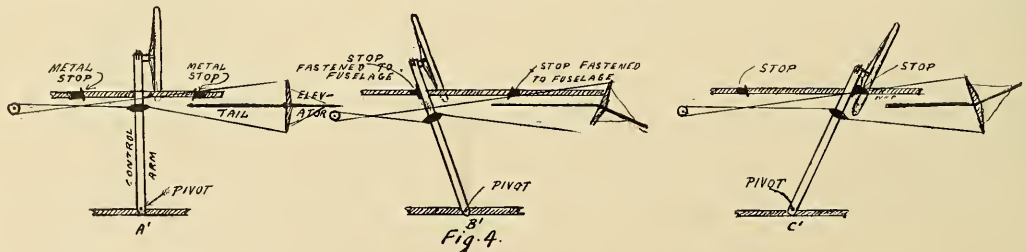

Fig. 4—The Deperdussin control fitted with metal plate stops on the sides of the fuselage to prevent excessive movement of the control.

opinion this will be the only way to bring aviation, as it now exists, in the realm of practicability where it belongs, and put it within the reach of everybody.

I further challenge any successful constructor to a full and open discussion of the question, if his views are not in accordance with mine.

Designer and constructor of the aeroplane, think of it, for one dollar you can make your aeroplane safer by adopting this system. Do it for the aviator's sake, for your own sake, and for aviation's sake, thus stimulating progress and establishing reliability, and by so doing put the aeroplane in the hands of the many instead of the few.

## \$24,000 CASH PRIZES AT CHICAGO MEETS

### International Gordon Bennett Cup Race to Be Staged September 9th

By S. R. BRUSTMANN



HE Clearing field at Chicago will be the scene of the Fourth International Gordon Bennett Cup Race, to be held September 9. Here, on a two and one-half mile course, thirteen of the world's greatest pilots representing six countries, will battle for the \$15,000 trophy now held by the Aero Club of America. Forty teams and two hundred men have built a course two and one-half miles long and six hundred feet wide, which is considered the safest flying course yet laid out and has cut down the dangers encountered on other cup courses practically 25 per cent.

The pilot of the American Cup Defender has not yet (as we go to press) been decided upon. The Aero Club of Illinois has six men under consideration. The name of the chosen pilot for the Club's 160-horse power Burgess monoplane will not be announced officially until the day before the race. It is rumored, however, that Norman Prince will fly the machine.

The second international competitive meet under the auspices of the Aero Club of Illinois will closely follow the Gordon Bennett cup race. These contests will cover ten days, from September 12 to 21. The program includes four days of flying at Cicero and six days of competitive hydro-aeroplane contests at Grant Park, the first to be held in this country.

The cash prizes will aggregate \$24,000. This fund is divided as follows:

For aeroplanes, \$16,950, split up as follows: For purely speed contests, \$4,600 on Cicero field; for contests of skill at Cicero, \$2,400; for duration, \$9,900, of which \$4,000 is for Cicero flyers and \$5,900 for Grant park aviators; special prizes for reliability contests at Cicero, \$950.

For hydro-aeroplanes, \$7,050, divided into \$1,000 for duration to assure all aviators a part of the fund if they fly, and \$6,050 for contests.

A special prize of \$200 is offered for the greatest number of passengers carried 500 feet or more in the air; \$250 is given

for each of the contests in which aviators vie for duration in single flights, carrying one, two and three passengers.

A feature of the Cicero program will be the issuance of master pilot licenses by the Aero Club of America. The tests will be observed by Chicago representatives of that body.

The Cicero program is as follows:

Sept. 12—Exhibition flying for duration; accurate landing from 1,000 feet without motor for \$300 prizes; mail delivery in a net for \$300 prizes; twelve and four-tenths miles handicap race for biplanes for \$575 prizes; twelve and four-tenths miles race for monoplanes for \$575 prizes. Duration, passenger carrying and tests for the superior pilot license of the national aero club.

Sept. 13—Exhibition flying; glide for accurate landing from 1,000 feet level at sudden signal from ground for \$300 prizes; quickest get away to five hundred feet with aviators and mechanics started twenty feet away from their machines at the starting gun, for \$300; twelve and four-tenths mile race with a passenger, handicapped, for biplanes, \$575; similar race for monoplanes, with passenger, same prize; duration, passenger carrying and superior brevet tests.

Sept. 14—Exhibition flying; mail delivery and bomb dropping, each for \$300 prizes; twelve and four-tenths mile scratch biplane race for \$575; similar race for monoplanes for same prize.

Sept. 15.—Exhibition flying; accuracy landing from 1,000 feet without motor, for \$300; bomb dropping for \$300, and the long race of the meet, for twenty-four and eight-tenths miles, a handicap event in which both monoplanes and biplanes will take part, for prizes of \$1,150.

The following is a list of the foreign entries for the cup race and who are also entered in the Cicero contests. At the last minute, however, there are likely to be some changes made.



James S. Stephens, Vice-President of the Aero Club of Illinois and General Manager of the 1912 meet. Mr. Stephens is one of the most active men working toward the general development of aviation in America.

### LIST OF CONTESTANTS FOR GORDON BENNETT CUP RACE SEPTEMBER 9

(SOME CHANGES PROBABLE)

Country.	Pilot.	Name of Machine.	Type.	Motor.	H. P.
England	Claude Grahame-White	Nieuport	Monoplane	Gnome	140
England	Gustav Hamel	Blériot	Monoplane	Gnome	140
England	George Dyott	Deperdussin	Monoplane	Gnome	100
France	Jules Vedrines	Deperdussin	Monoplane	Gnome	140
France	Maurice Prevost	Deperdussin	Monoplane	Gnome	140
France	André Frey	Hanriot	Monoplane	Gnome	140
France	Alternat—M. Busson	Deperdussin	Monoplane	Gnome	100
	(not certain)				
America	Norman Prince	Burgess	Monoplane	Gnome	160
	(not certain)				
America	Weymann or Gallaudet	Nieuport	Monoplane	Gnome	100
Holland	Jan Wynnalén	Oertz	Monoplane	Gnome	100
Switzerland	Edmund Audemars	Blériot	Monoplane	Gnome	100

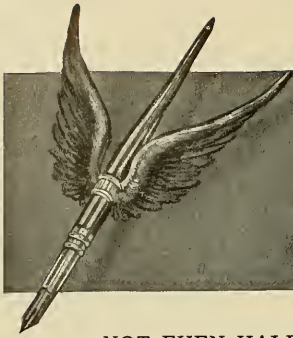

# EDITORIAL

## NOT EVEN HALF A LOAF.



HE United States Congress has seen fit to notice aviation again, thanks to a devoted band of Representatives who have the interest of the country and the science at heart. If the act printed in this issue of AIRCRAFT stands, the Army and Navy may each assign thirty officers to a permanent aviation service and the officers will be paid in accordance with the work they are expected to do. So far as the Army is concerned thirty fliers will have \$75,000 to spend on equipment, a ridiculously small sum. The aviation service of both arms of the military service should be separately organized, with appropriations adjusted according to the needs of the country and its dignity. Until that arrangement is effected, the United States will be floundering far behind all other military nations so far as aviation is concerned. That is why the action of the House increasing the pay of Army and Navy aviators gives the country not even the proverbial half a loaf, but barely a bit of crust.

But we have this little bit of crust, and presumably we should be grateful. Frankly, we do not envy the officials who are held for results and are given a possible aviation corps of thirty men for each service, with inadequate funds to carry out any reasonable scheme of development. It will not be their fault if results are few—as they must be under the circumstances. The most that can be expected is that a beginning will be made; that a few more machines will be purchased for the Government, that a few more officers will be assigned to aviation, and that those now on that tour of duty be permanently assigned. That is all the law just passed in the United States of America can offer in support of what the French proudly call the Fourth Arm. Congress has deigned to do something more than nothing. There is still pending a bill for a real Fourth Arm. If that bill were substituted for the present successful measure and at the same time broadened to include the Navy and Marine Corps, there would be a proposition worthy of the American Congress. Let us hope that was the ultimate purpose of Chairman Hay's motion to reconsider the bill that went through. Even after that the Government must spend real money on aviation, and it ought to appropriate a million this year for use next spring at the latest. It is time Congress recognized and acted on the fact that

aviation on land and sea is a practical adjunct to a fighting force.

## PROOF OF THE PUDDING.

THE United States has had a notion for some years that aircraft were of use in military operations. Abroad they have put the notion to the acid test of experiment, and it has not only stood the test but surpassed the expectations. In mid-August for the first time in this country, aviation has been called into service in the annual manoeuvres, giving the Army an opportunity to test the efficiency of the Fourth Arm, "The result has been very satisfactory," says the Army and Navy Journal, "showing that the aeroplane will be an important factor in future wars." The statement sounds old and stale to airmen, but its significance lies in the fact that it has at last been demonstrated in America under conditions designed to test both machine and aviator.

The Signal Corps men who have been operating in Connecticut will write full reports of their operations; these will be published by the Government; and they will provide proof positive to a doubting Congress that the United States needs a proper aviation corps. At Bridgeport the aerial scouts told General Bliss, in charge of the manoeuvres for the Army, on his return to camp where he had been and what he had been doing, much to his surprise. Thus it was driven home to him in a dramatic way that aircraft was a thing to reckon with. Congress needs an object lesson which the General didn't; and it remains for the official reports to force it to take notice. The facts speak for themselves. The audience ought to be held in its seats while the talking is going on.

## FURTHERMORE.

WHILE both the newspaper reports and the official reports of the success met with in the recent military operations in the vicinity of New York, is all very interesting, still there are some points which ought to be brought to the attention of both the high army officials and congress in connection therewith that should cause them to think more seriously about this subject than they probably otherwise would.

To begin with, in these army manoeuvres, there were but four machines used, and we believe that no well

regulated army in real battle would consider a body of four scouts on land, as being sufficient to make any very great showing. They would probably use four hundred scouts on foot, horseback and in automobiles, therefore, to test aeroplane scouting on an equal footing with land scouting, there should be, at least, the same number of aeroplane scouts, that is, of course, if aerial scouting with land scouting in point of efficiency, is to be compared. Moreover, these aeroplane scouts should have as much experience in air scouting as the land scout has in land scouting.

In the May number of AIRCRAFT, we pointed out that it takes at least two years to develop an air scout so that he will be actually useful in case of war, and in these army tests our point was substantiated by the fact that Lieutenant Foulois, who has had the most air scout training, did the most efficient work.

In fact the work of two or three of the other aviators was almost useless, not because the aeroplane was at fault, nor because the pilot did not know how to operate it, but because they lacked sufficient training in air scouting, and again, we point out that if the UNITED STATES want their aerial forces to be able to combat with the aerial forces of France, Germany, Austria, Russia and England, they must begin now to train a large body of military men to military aerial work.

Even with the ridiculously small and little trained force utilized in these army manoeuvres, still the work accomplished astonished, to a large degree, many of the old army officials.

At an altitude of from 2,500 to 3,000 feet and out of range of the land batteries, the air scouts were able to locate infantry, cavalry, wagon trains, etc., with the greatest of ease and furnish information concerning the formation of the troops below them to their own headquarters within half an hour after making the observation and when using the wireless signals, which was done with considerable success, their information was given instantaneously. The aviator actually drew a map of everything below him and the General in Command is said to have stated that the information received from the aeroplane scouts, was not only invaluable at the time, but that they would become absolutely indispensable in any future war operations.

Scouting was the only manner in which the aeroplane was brought into play during these army manoeuvres, but let us again call attention to some further information the high army officials and congress should be made aware of and that is that these aeroplanes can be used for other purposes besides scouting.

In case of real warfare, an opposing army could send their airmen right over the land forces and create tremendous havoc by cutting off their bases of supplies and ammunition; for this purpose special weight carrying aeroplanes could be designed and built that would each carry three or four men, a supply of explosives and the necessary implements for foraging purposes; they could land near out-of-the-way bridges and unless

these bridges were heavily fortified, they could blow them up; they could land in almost any place along the different railroads not protected and destroy them; they could cut off, by landing in isolated places, the telegraph and telephone wires, or they could even cut off the water supply of a city.

In fact had an opposing army been as near New York as the opposing army which attacked New York in the mimic warfare, backed up by five hundred aeroplanes and a dozen great Zeppelin type airships, manned by military experts with at least two years special training, the city of New York would have been absolutely helpless to combat them.

#### TIME—HONEST EFFORT—SUCCESS.

THE recent successful passing of the Army tests of the Burgess tractor hydroaeroplane, piloted by Phillips W. Page, demonstrates conclusively the fact that American built machines are the equal in construction and efficiency of any built on foreign shores.

The Burgess machine is a distinct type evolved from the Wright, Breguet and Avro machines and contains many of the best features of each, together with several original and improved Burgess ideas.

The builders of this machine, the Burgess Company and Curtis, deserve a great deal of credit for the persistence they have shown in gradually working from the ground up to one of the leading aeroplane concerns, not only of this country, but of the entire world.

This company began business about three years ago and during the first year met with very little apparent success, although the experience derived from the tests on the early machines while not remunerative, showed them the fallacy of building low-powered small machines and led them to experimenting with larger, more-efficient and higher-power machines, which ultimately ended in their present successful type.

The great success with which the Burgess Company and Curtis are now meeting with should be an incentive for the newer aeroplane manufacturers in this country and a decided lesson to them in the advantages to be gained from persistent efforts along a given line.

There is room in this country for at least fifty more such successful concerns as the Burgess Company and Curtis, but there is no short cut to success; concerns will have to work their way to the top of the ladder by a long tedious route and an honest performance of hard work.

The latest exhibition stunt in Europe for the professional pilot is to illuminate his hydro-aeroplane with different colored electric lights, furnished by a small storage battery, and fly at night about the summer watering resorts. It makes an extra attraction for the visitors at the resorts and the managers are willing to pay handsomely for the attraction.

If successful in Europe it should be worth trying in America and Asia.

# THE GULL VERSUS THE WIND

By WILL SIMMONS

**WILL SIMMONS** is an artist who devotes all his time to the study of animals and especially of birds. He is the son of the well-known mural painter, Edward Simmons. Born in Spain, he has been educated in England and France, and is of the Harvard class of 1905. The last ten years Mr. Simmons has spent abroad, chiefly in the zoological gardens of Paris and London, or in the forests of Fontainebleau and Brittany, studying painting and wild nature. He is a pupil of Jules-Lefebvre and of Alexander Harrison, and he has exhibited with success in the Paris Salons and in Boston. The actual transcribing of the movements of animals by lines instead of by words requires a complete understanding of these movements, if only by the subconscious mind. For what the animal does in reality, the artist must do in imagination; but it remains for him to translate a second time what he has learned, into prose. It is from a close study of the movements of birds during fifteen years that Mr. Simmons today writes of them as the original "Aircraft."

**I** READ an article by William Brewster, in the "Auk" of January, 1912, where he says that a change in the center of gravity may account for the flight of sea gulls when sailing straight into the wind, even a gale.

I did not know then that the flight of birds was a problem to scientists; and this article of Brewster's and this article of Brewster's

called to mind the remarks of Darwin on the flight of condors (Voyage of the Beagle), which I shall quote later.

Now I had for some years studied the flight of birds for my painting; so I searched my notes and sketches, and by comparison with photographs, have come to write this abstract.

I pray the reader to excuse my unscientific manner and broad statements; for I have tried to come at the basic causes of flight by eliminating all minor elements; but I do hope that there will be found in this theory some truth which competent scientists may later amplify.

We wonder at the effortless progress of birds, especially of sea gulls when they sail without moving their wings into the teeth of a gale. And the reader may have watched them following a ship, sure and unconcerned in the warfare of the elements. In all ages of the past, men have wondered at their bold flight, and to-day they wonder still.

But let us see what this effort and progress is. It is evident that progress, or speed, results from two things, the force of propulsion, and the resistance overcome.

It follows that if resistance were annulled, there might be infinite speed, even without great force of propulsion.

For the sake of simplification, I will divide the resistance of the air into two:—the "resistance," on the head and bend of the wing, and "wind-force," the deflecting force of the air on the various planes.

Thus we eliminate unimportant factors, such as side friction (which can be included under "resistance"), and the cur-

rents of air which form about a bird's body in flight; for we also in walking form currents about us, but these are unimportant to our progress either as cause or effect.

And now to trace the force of propulsion, in which effort plays a varying role.

Let us take as a model a kite, of the simplest kind, with one plane and a tail; for it is indeed a bird simplified and tied down to earth. Broadly speaking, the important forces acting on a kite are two;—the wind, and the pull of the string. Apart from the weight of the tail, the weight of a kite is inconsiderable; even "resistance" will be comparatively small. If the wind is strong enough, the kite mounts; if the wind and the string exert the same force, the kite is stationary; but notice that if one pulls on the string, the kite darts forward into the wind, if only for a short space.

Similarly a gull at sea may remain poised and still in the teeth of the wind; or he may soar; or he may dart into the wind. One may have noticed, moreover, that a gull descends straight down by stages, as if with difficulty, though he may plunge headfirst; and that he does not go backward without turning around; also that a kite behaves in a very similar manner.

From this it would follow that a gull obeys the same laws as a kite. The important forces, then, which act on the gull are two:—the wind, and the pull of gravity. When the gull soars, it is because the wind is stronger than gravity; when he is poised, it is equal to gravity; and when the pull of gravity is stronger, the gull sails into the wind; only, not being tied down, he keeps on.

But let us examine these two forces.

In a kite, the force of the wind tends to lift the plane; it also keeps the kite headed to the wind, like a weathercock, by acting on the tail; and this tail by its weight

keeps the kite-plane inclined.

Now the downward pull of the string appears nearly perpendicular; but the mainstring is divided, before reaching the kite-plane, into several strings, of which two are important to us:—

the string to the extreme front, and the string to the extreme rear of the plane.

Thus we may consider the pull of the string divided at this point into two. The string to the front is very short, while the string to the rear is long; thus the force on the front will be nearly vertical, while the force on the rear relatively horizontal. That is to say, the string exerts upon the kite-plane a forward as well as a downward pull.

And so if the wind, lifting the plane, neutralizes this double

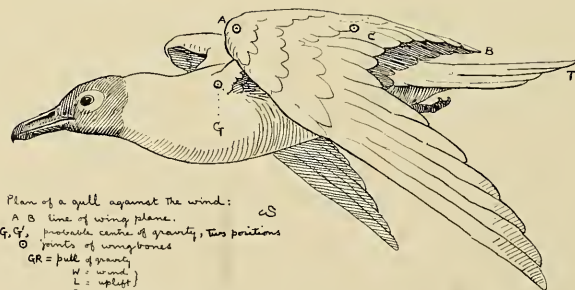
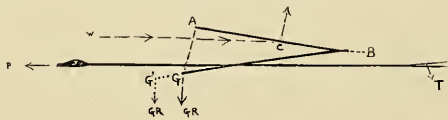
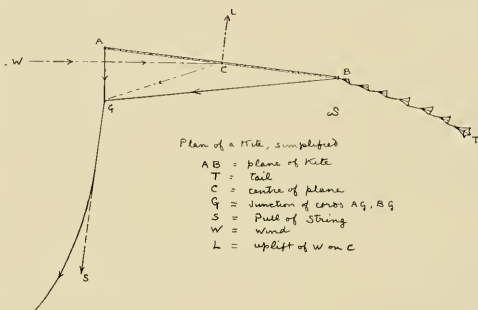

Plan of a gull against the wind:

- AB line of wing plane.
- G, G' points centre of gravity, two positions
- G'' points of gravity
- GR = pull of gravity
- W = wind
- L = uplift
- P = Progress
- T = Disposition of wind on tail.
- C = centre of plane. =  $4\frac{1}{2}$

big 2

pull, the kite is stationary. But if the stringpull is greater than the wind, the vertical or downward part will tend to counteract its opposite, the lift of the wind; and between these two contrary forces there would be left the horizontal part of the stringpull to send the kite forward into the wind. And a kite offers so little resistance, that it would not need great force to cause progress.

If this be the case, let us see how a gull may cause the force of gravity to exert a partly forward pull. Of the two forces acting on the gull the windforce on the tail tends to keep the body horizontal; as the plane of the tail, like a horizontal rudder, would resist any inclination of the body,—much as the "feathers" of an arrow tend to keep the arrow level. Also the wind keeps the gull headed to the wind; and, lastly, creates an uplift on the wingplane; that is, in all points acts as on a kite.

Now the force of gravity acts upon the gull at his centre of gravity, and then through his wingbone upon his wingplanes; so instead of string we have a lever, acting in much the same manner. For if the centre of gravity be sufficiently in advance of the centre of the wingplane, gravity would through this arm or lever exert a partly forward pull upon the plane; that is to say, the force exerted at the centre of the plane would be partly forward, as in a kite; furthermore, the more advanced the centre of gravity, the more horizontal the line of action of gravity on the planes and the stronger the forward pull.

Then the lifting windforce would tend to counteract the downward part of this double pull on the planes, leaving a horizontal force which would send the planes forward. And since the relation of the wings to the body is fixed, and since the windforce on the tail keeps the body horizontal, the gull itself would tend to move forward into the wind.

But we have not taken into account resistance, which is the wind itself;—this force is taken up in lifting and in steadying the gull, so that there would be only a very little resistance left, on the head and on the bend of the wing, to resist progress. Then that horizontal part of gravity which causes progress need not be great at all.

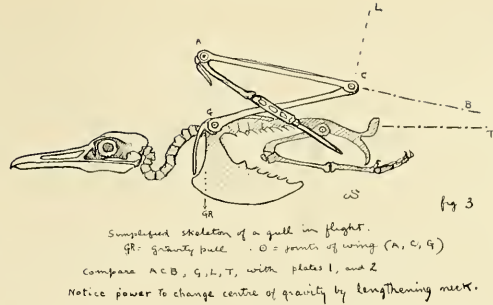

In short, it follows that the stronger the wind, the stronger the steadying action on the tail; thus allowing the centre of gravity to be placed farther forward; and so causing a stronger horizontal pull on the wingplanes; these would need less windlift; and the gull would require a stronger resistance to oppose its progress. So that his progress would be at least a constant quantity.

Strange, then, as it may appear, we have a force thus apparently exerting an exactly opposite action, which does not seem possible. But if we explain that it is gravity and not the wind which causes progress, we then have two forces (at right-angles to each other) who each act at nearly right angles to itself, the one to lift, the other to propel; and this is easier to believe.

Let us see if this principle, i. e., that it is gravity itself which causes progress, applies elsewhere. We have spoken so far only of a bird that is sailing into a wind. When birds fly in no wind they flap their wings with more or less regularity according to the conditions and the species of the bird. As far as I have been able to ascertain from photographs, and especially from having been obliged to actually follow their movement with my pencil in sketching, the wing beat is vertical; that is, at right-angles to the body of the bird.

The resulting action on the bird is an uplift and not a forward push. Then the wingbeat of a bird supplies the force necessary to counteract the vertical part of the gravity-pull, which in the case of a gull against the wind was supplied by the wind itself. Then, also, there would remain the horizontal part of gravity to send the bird ahead, the centre of gravity being in advance of the planes; and the resistance in no wind would be very small.

I think that this principle would explain any method of flight which may have been observed, but in one case its action is evident; and being true in one case, no wonder it is true in other cases. For when a gull "glides" downwards, it is unquestionably the pull of gravity that causes progress, the wingplanes offering more or less resistance to the downward part of the pull; so that a gull may "glide" at an angle near the horizontal.

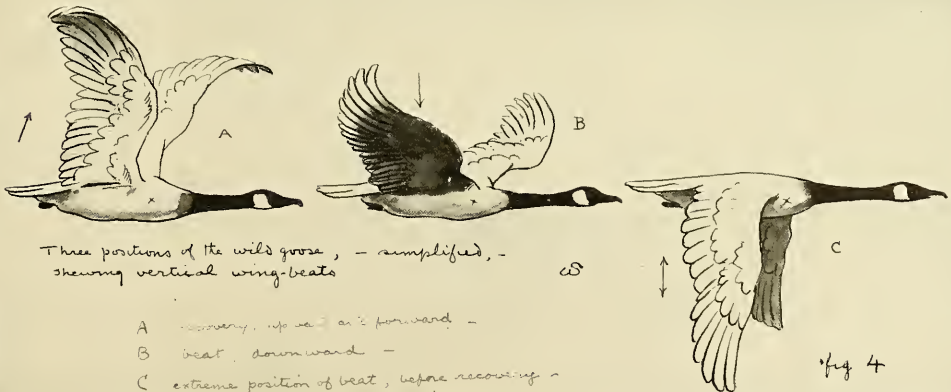

In fact, gravity itself, by the resisting angle of the wingplanes, seems to change its proper direction, when the angle of "gliding" is far enough from the horizontal. I might have used this case earlier to show how a gull sails into the wind, for he is then merely gliding, after all; but I have wished to emphasize the double character of the gravity-pull.

Here let me quote, in part, what Darwin said on seeing condors circling above him, never moving their wings. ".....The head and neck were moved frequently, and apparently with force; and the extended wings seemed to form the fulcrum on which the movements of the neck, body and tail acted.....The force to keep up the momentum of a body moving in a horizontal plane in the air (in which there is so little friction) cannot be great, and this force is all that is wanted. The movement of the neck and body of the condor, we must suppose is sufficient for this.."

Though I think Darwin assumed an initial force, yet he saw that it was momentum (i. e., gravity), caused by movements of the body and not the wings which caused progress, for these did not move. What a pity that Darwin did not further bend his great brain to this question.

his body back, so that there be no more forward pull, and with resisting wings he stops. But his impetus is so great that often he is carried far along the water, leaving a broad wake. And this very impetus shows how great has been the forward compared to the downward pull.

Let me say one more word for this principle. Anyone who is not too prejudiced by technicalities will see the great structural resemblance between birds and other animals, even ourselves. On the whole, we have the same system of construction,—bones and muscles that correspond and that, they say even, have been evolved from common forms. The action of bones and muscles is similar in various forms; and being subject all to the same natural laws, should not all then use the same forces in their motions?

Now it has been shown long ago that the walk of a man, the running or galloping of a quadruped, consists of a constant leverage forward of the

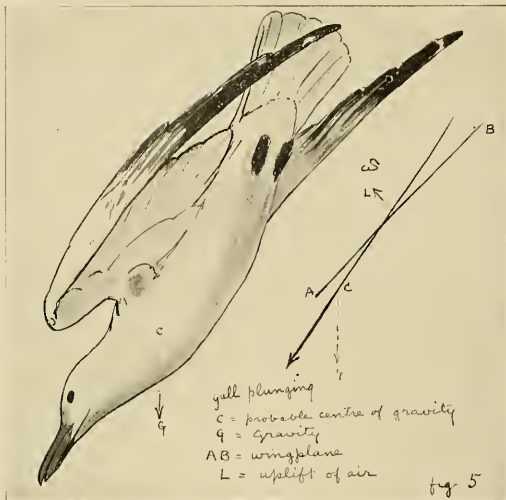

weight (i. e., the centre of gravity), and a constant placing of a leg to support it. In many quadrupeds the front legs move only as supports to the weight, which has been thrown forward by the hind legs.

But the wingbeat of a bird is nothing else:—a constant displacement of the centre of gravity, and a constant wingbeat to

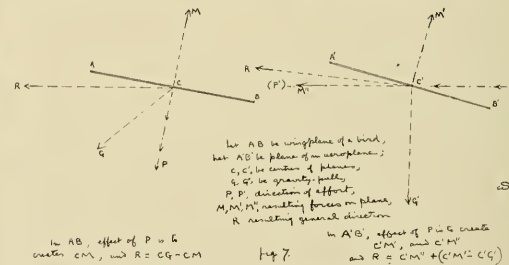

support it,—unless this wingbeat be rendered unnecessary by a strong wind.

For all animals and birds have gravity first, whether or not other forces come into play, and this gravity is the first factor in their locomotion.

Finally, then, it seems to me certain that birds progress by gravity alone; that effort on their part is only to counteract the vertical part of gravity, and this effort need not be great. Moreover, they use every current of air to aid them, by the nice adjustment of angles and planes and by a change in position of the centre of gravity. And so the great difference between the aeroplane and the bird is this:—that the bird flies forward by an upward effort, while the aeroplane flies upward by a forward effort. Also

If then it be gravity that sends ahead the bird, while his wings only lift him, so when an eagle starts from his perch on some tree top bending under his weight, he merely falls forward, and his wings bear him up;—when a wild goose rising from the water starts on his great journey of migration, he only raises himself enough to throw his weight forward onto his wings, and thus slowly mounts, and hour after hour is carried along, a part of his weight having been changed to impetus, and a part being taken up by the beat of his broad wings. And when the goose descends again out of the sky, and comes to alight, he throws

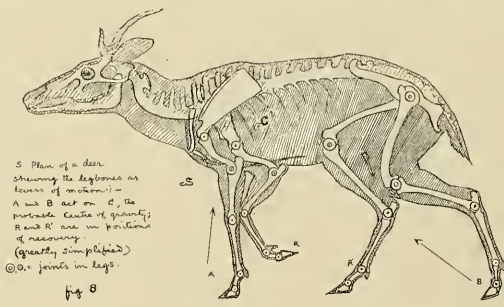



that the effort of the bird is small, and tends constantly to diminish as its momentum increases, while the effort of the aeroplane is great, and apparently continuous. And, lastly, the birds utilize every wind that comes, while to the aeroplane a wind is a danger and a hindrance.

Could not the aeroplane so displace its gravity-pull as to change in part its direction? For example, by throwing forward or backward at will the axle of the planes? Could we not turn all effort to raising a part of the weight, and let Nature do the

rest, as a bird? Why fly in the face of Nature, when others trusting use her favors?

In this essay I have spoken only of the flight of birds:—that of aeroplanes I must leave to those competent, hoping that this theory be of use to them.

When a truth seems so simple as to be almost incredible, one can only ask that it be followed up with a certain amount of faith, and without unnecessary criticism, so that the confusion which comes of complication may be avoided, and some real advance made.

## THE ADVANCE TOWARD AERIAL LAW

Communicated by DENYS P. MYERS

On Aug. 5 the national House of Representatives passed with division H. R. 17,256, originally introduced by Congressman Hardwick, of Georgia, and entitled, as passed, "An act to fix the status of officers of the Army, Navy and Marine Corps detailed for aviation duty, and to increase the efficiency of the aviation service." The conduct of the proceedings was by Mr. Hays, of Virginia, chairman of the Committee on Military Affairs, who filed a motion to reconsider after the passage of the bill. The amendments introduced and agreed to had the effect of including the Navy and Marine Corps within the scope of the original bill. The bill as passed is as follows:

Be it enacted, etc., That for five years from and after the passage and approval of this act the pay and allowances as are now or may be hereafter fixed by law for officers of the Regular Army, Navy and Marine Corps shall be doubled for such officers as are now or may be hereafter detailed by the Secretary of War or the Secretary of the Navy on aviation duty: Provided, That this increase of pay and allowances shall be given to such officers of each service only as are actual fliers of heavier-than-air craft, and while so detailed, as provided herein: Provided further, That not more than 30 officers of the Army and 30 officers of the Navy shall be detailed to the aviation service.

Sec. 2. That paragraph 2 of section 26 of an act of Congress approved February 2, 1901, entitled "An act to increase the efficiency of the permanent military establishment of the United States," shall not limit the tour of detail to aviation duty of officers below the grade of lieutenant colonel: Provided, That nothing in this act shall be construed to increase the total number of officers now in the Regular Army, Navy or Marine Corps.

Sec. 3. That all laws and parts of laws inconsistent with the provisions of this act be, and the same are hereby, repealed.

### INTERNATIONAL TREATY PROJECT.

The Commission on Aeronautic Law of the Federation Aéronautique Internationale met on May 18-19 in the rooms of the Aero Club de Belgique, Brussels, and, on the basis of the French decree published in translation in *Aéronautique*, March, 1912, drew up a project of international treaty which will be submitted to the governments of the world for action.

The report of the Commission was adopted at the meeting of the Federation at Vienna on June 20-21. As finally passed, the text was made to contain two articles not given below. One provides that "no modification may be made in the present treaty without the consent of all the other signatory states," which became Act 2; and the other, becoming Act 8, providing that an agreement will be arrived at between the various signatory states with a view to arranging a system of customs regulations applicable to aircraft." The Brussels text follows:

Article 1.—The subjects or citizens of each of the signatory States shall enjoy the advantages of the present treaty in all the other signatory States. They shall be bound by the obligations attendant thereon.

Art. 2.—Every State may, in what concerns it, denounce the treaty at any time.

Art. 3.—The provisions of the present treaty apply to aircraft. Aircraft comprise: free balloons, dirigible balloons and flying machines.

Art. 4.—Every aircraft pilot is allowed to circulate above the signatory States, to land thereon and ascend therefrom, provided the following papers are carried:—(1) A certificate of registration; (2) a F. A. I. pilot license. Each pilot must conform to the prescriptions of the present treaty and to the laws and regulations of the country where he may happen to be.

Art. 5.—Every aircraft must carry on both sides, in such a manner as to be plainly visible, the registration numbers which shall identify such aircraft as well as an indication of the country where the formalities of registration have been complied with.

Art. 6.—The name of the country where the formalities of registration have been complied with shall be indicated by the following letters:—Germany, D; England, G; Austria, O; Belgium, B; Egypt, EG; United States, U; France, F; Hungary, H; Norway, N; Holland, P; Argentine Republic, RA; Sweden, S; Switzerland, SS.

### RULES RELATING TO AERIAL NAVIGATION.

Art. 7.—Regulations re Lights.—The regulations concerning lights must be observed from sunset to sunrise in all weathers. The use of lights, other than those prescribed, is authorized, on condition that such lights are not exposed so as to be taken for the prescribed lights.

Art. 8.—Dirigibles.—A dirigible balloon under way, that is to say, moving under its own power, must carry:—(a) At the head, a brilliant white light arranged in such a manner as to throw an uninterrupted beam through a horizontal arc of 120 degrees, that is to say, from right ahead to 110 degrees on either side; (b) on the right, a green light arranged in such a manner as to throw an uninterrupted beam over the whole of a horizontal arc of 110 degrees, that is to say, from right ahead to 20 degrees abaft the beam on the right; (c) on the left, a red light arranged in such a manner as to throw an uninterrupted beam over the whole of the horizontal arc of 110 degrees, that is to say, from right ahead to 20 degrees abaft the beam on the left; (d) the three lights, white, green and red, must be visible in each vertical plane corresponding to their respective zones in each direction comprised between the vertical downwards and the line as nearly as possible approaching to the vertical and making an angle of 30 degrees above the horizontal; (e) in addition, the green and red side-lights must also be provided with shields or screens arranged in such a manner

that their light cannot be seen on the opposite side; (f) the white light must be visible at a distance of at least 4 kiloms., and the green and red side-lights at a distance of at least 2 kiloms., on a dark night with a clear atmosphere; (g) a dirigible balloon must in addition display a white light permanently arranged at the rear.

Art. 9.—Aeroplanes.—The rules relative to lights also apply to aeroplanes, but as a temporary measure of tolerance they are only obliged to carry a single lamp or beacon arranged in the rear.

Art. 10.—Free Balloons.—Free balloons must always carry a white light ready for use, and display the same on the approach of another aircraft.

Art. 11.—Audible Signals.—(a) During fog, mist, snow or heavy rains aircraft must, by day as well as by night, make use of powerful discontinuous audible signals; (b) in the same circumstances free balloons must also make use of such signals whenever they are in the neighborhood of motor-driven aircraft.

Art. 12.—Rules of the Road.—A motor-driven aircraft must always keep at a distance of at least 100 metres from another aircraft in every direction.

Art. 13.—Motor-driven aircraft must always keep out of the way of free balloons.

Art. 14.—Any motor-driven aircraft approaching another aircraft, in no matter what direction, must always take to the right unless it is and remains at a distance of at least 300 metres.

Art. 15.—Whenever a dirigible balloon stops voluntarily it must display a conspicuous black ball; in this case it is subject to the same rules as an aircraft under way.

If it is no longer under control owing to a breakdown of any kind, it must display two conspicuous black balls, placed vertically one above the other; in this case it shall be treated as a free balloon.

At night, in both cases, it shall only display a white light and be treated as a free balloon.

Art. 16.—Landing and Distress Signals.—When a dirigible balloon is about to land it must: By day, display a triangular red flag under the nacelle; and by night, wave a white light, or cause it to flicker, while burning the regulation lights.

Art. 17.—(a) In case of distress when above ground, as well as when above the sea, a dirigible balloon must: By day, display a triangular red flag under the nacelle and show the two superposed black balls mentioned in Art. 15; by night, wave a white light, or cause it to flicker, and at the same time extinguish the side-lights. By day as well as by night it must, in addition, make use of an audible signal; (b) A free balloon in distress must—by day, display a triangular red flag under the nacelle; and by night, wave a white light. It may, in addition, by day as well as by night, make use of an audible signal.

Art. 18.—Use of Ballast.—It is only permissible to use as ballast materials which are not likely to cause harm to third parties, such as fine sand or water.

## THE NATIONAL BALLOON RACE KANSAS CITY, JULY 27, 1912

Balloon.	Manned By.	Time of Start.	Landed At.	Time of Landing.	Distance (miles).
Uncle Sam.....	H. E. Honeywell, pilot R. Donaldson, aide	5 P. M.	Manassas, Va.....	3 A. M., July 29th.....	885
Kansas City.....	R. John Watts, pilot G. Gnisenberry, aide	6.01 P. M.	Bellville, Mich.....	5.34 P. M., July 28th.....	625
Drifter.....	Albert Holz, pilot Trautman, aide	5.45 P. M.	New Berlin, Wis.....	11.20 A. M., July 28th.....	425
Million Popula'n Club II	P. McCullough, pilot Hart, aide	5.20 P. M.	Spring Green, Wis.....	8.30 A. M., July 28th.....	370
Million Population Club I	J. Berry, pilot A. Von Hoffmann, aide	5.10 P. M.	Nord, Ills.....	4.00 A. M., July 28th.....	355
Goodyear.....	G. M. Bumbaugh, pilot Upson, aide	6.10 P. M.	Pola, Ills.....	5 A. M., July 28th.....	330
Cole.....	E. J. Custer, pilot A. Farrell, aide	5.35 P. M.	McGregor, Iowa.....	3.20 A. M., July 28th.....	325

# THE PROBLEM OF THE FLYING BOAT AND A SUGGESTED DESIGN FOR AN AEROYACHT

By WALTER H. PHIPPS

Judging from the recent performances of the first two successful flying boats, the Donnet-Leveque and the Curtis, it does not seem unreasonable to suppose that before long we will have specially designed aeroboats and aéroyachts, capable of extended trips in almost any kind of weather.

While the flying boat will ultimately prove greatly superior to the hydro-aeroplane, it must be admitted that in its present form it is not such a wonderful improvement over existing types, for while it has many advantageous features, it has likewise many drawbacks, chief and foremost amongst which is the danger of the passengers being entrapped in the hull, in the event of the machine flying or capsizing, as occurred in the recent narrow escape of that excellent pilot, André Beaumont, who while attempting to fly across the English Channel in his Donnet-Leveque aeroboat, was capsized and narrowly escaped drowning.

Another serious drawback of the present day flying boats is the position of the engine high up in the frame, which makes it difficult to get at and start, as well as presenting another and more serious drawback which is described herein.

It will readily be seen from the foregoing that the successful flying boat of the future must be so built as to absolutely prevent sinking under practically all conditions, and in order to accomplish this the weight of the passengers and motors must be so distributed in relation to the airtight compartments that no matter in what position the flying boat strikes the water, the hull proper will right itself in exactly the same manner as the self-righting and non-capsizable life boats now in use at some life saving stations.

To accomplish this the hull of the flying boat must be fitted with airtight compartments and the weight of the motor or motors placed low down in the boat and under no circumstances high up in the plane framework, as on most of the present day machines.

At the recent Aero Show at the New Grand Central Palace, New York, there was exhibited a flying boat in which the hull was left almost entirely open, and it was apparent and commented on by many that this arrangement was exceedingly dangerous, for should the machine ever dive or capsize, the open hull would immediately fill with water and the whole front part, which contained the aviator's seat, become submerged.

It will thus be seen that the problem of evolving a safe flying boat is not altogether an easy one, and calls for a careful consideration and study of the needs of this type of craft. It was with this object in view that the writer drew up the accompanying design for an aéroyacht in the hope of leading others to tackle the problem and make the long distance cruising aéroyacht a reality.

### THE HULL.

Glancing at the accompanying drawings, it will be noticed that the hull continues the whole length of the machine and forms a support for the tail and rudder at the rear. It is of the single-step type and divided into four airtight compartments. The seating and engine section is towards the front and covered by an enclosed cabin, which prevents water from getting in. The whole top of the cabin, which is designed to be built very light, is hinged so that it can be opened for ingress and egress. Two 60 H. P. motors are placed low down in the hull to the rear of the eight passenger seats in such a position that they balance the weight of the pilot and passenger in the two front seats, while the remaining seats are placed approximately under the center of pressure so that whether carrying one or all six passengers, the balance of the machine is not seriously disturbed. The two motors and their propelling systems are independent of each other, the one driving through chain transmission, a four-bladed central propeller,

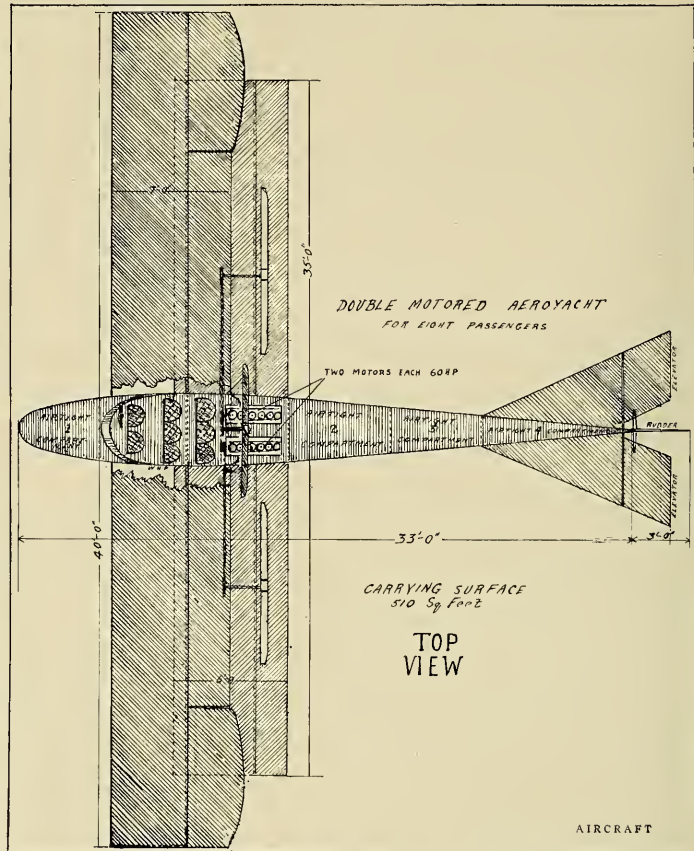

the other driving likewise through chain transmission two oppositely revolving propellers. It is probable that on larger machines a shaft drive would be preferable. The use of two motors would make this craft ideal for cruising, for should one motor break down, the machine could be easily propelled on the water by the other. Furthermore the planes could be so constructed as to be capable of being folded in quickly as on the Breguet, in which case the craft would be converted into a large cruising motorboat and could outride almost any storm.

### PLANES.

On a machine of this size it is desirable to have considerable lifting surface, and for this reason two sets of planes are shown fitted. These are set staggered fashion to secure a greater amount of fore and aft surface, and so improve longitudinal stability. The top plane measures 40 feet by 7 feet, while the lower plane is 35 by 6 feet, which gives a carrying surface, not counting the ailerons, of approximately 500 square feet, which should be ample, and figuring conservatively the lifting pressure at 4½ pounds per square foot,

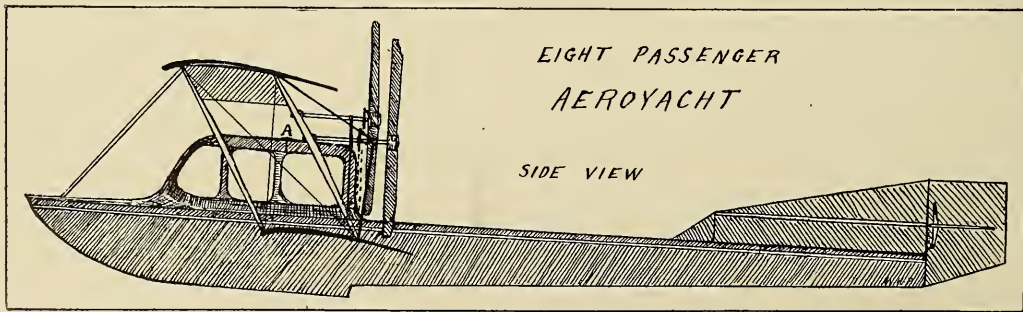

SIDE VIEW OF THE SUGGESTED AEROYACHT, SHOWING THE ENCLOSED CABIN, STAGGERED PLANES, DOUBLE PROPELLING SYSTEMS AND TAIL AND RUDDER ATTACHED TO REAR OF BOAT.

would give the machine a lifting capacity of 2,250 pounds. Assuming the weight of the average passenger is 150 pounds, eight passengers would weigh 1,200 pounds, which would leave 1,050 pounds for the weight of the machine and motors. Smaller planes, of course, could be used, but the speed would have to be greater, which is not desirable for water flying.

The top surface is wider than the lower one and carries ailerons at the ends. Vertical fins are attached to the top of the central uprights to counteract the drifting tendency of the hull.

**CONTROL.**

The controlling arrangement consists of ailerons, elevator flaps and a single vertical rudder, which

extends to the bottom of the boat to facilitate steering on the water. These controls could be operated by any of the usual methods, but for simplicity's sake a Breguet type three-in-one control would be preferable. This control actuates by a fore and aft movement the elevator, sideways movement, the ailerons, while turning the wheel, steers the machine.

# A LETTER FROM ENGLAND

By DAISY E. BALL

(Secretary of the Woman's Aeronautical Society of America)

London, July 20, 1912.

DEAR MR. LAWSON: Since my arrival in England on July 12 I have called on the Royal Aero Club of the United Kingdom, where I had an interesting talk with Mr. Harold E. Perrin, the Secretary, and on the Aeronautical Society of Great Britain, where I was kindly received by Mr.

organized meets are held, and in a talk with Mr. Grahame-White he informed me that the average attendance was from six to eight thousand persons on these days. At the meeting there to-day, programme of which I enclose, about three thousand only were present, owing to rainy weather. If a comparison may be permitted, there is no doubt but that the British public show more

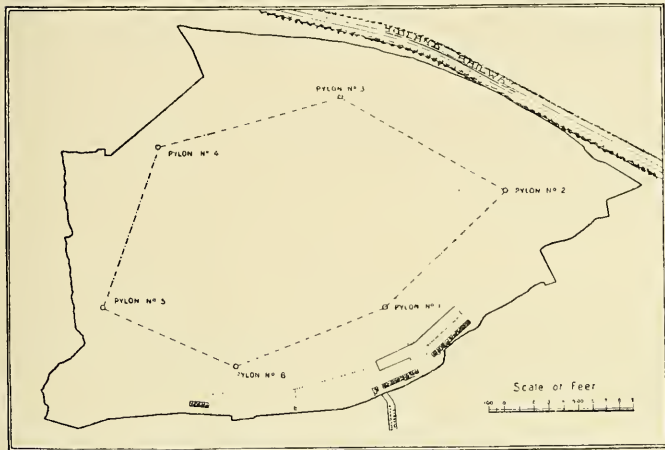

PLAN OF THE COURSE OF THE LONDON AERODROME AT HENDON.

T. O.B. Hubbard, who, besides being its secretary, is well known as an author of aeronautical works.

The Aeronautical Society of Great Britain was founded in 1866, and I am informed its membership now reaches the four hundred mark. It is more or less a technical institution, with every facility for students to acquire aeronautical knowledge\*. This privilege is granted on receipt of a payment of one guinea (five dollars) per year. Members' fees, however, are one guinea entrance and two guineas dues. An interesting feature of the Society is the memorial fund, now being collected in subscriptions, in honor of the late Wilbur Wright. The memorial is to take the form of a premium lecture on aeronautics to be delivered annually and to be known as "The Wilbur Wright Lecture." On looking down the list of subscribers, which includes the names of many of the nobility, I notice the name of Patrick V. Alexander, who is the biggest donor so far, having contributed one hundred pounds (\$500), and who paid a visit to AIRCRAFT some time ago. (See page 26, AIRCRAFT, March, 1910).

As well I paid courtesy calls on the various aeronautical publishing houses (Aeronautics, Flight, Aero and The Aeroplane). Mr. John H. Ledebour, Editor of Aeronautics, was most cordial in his welcome of a representative of AIRCRAFT, and very kindly gave me letters of introduction to officers of the various aeronautical organizations, which proved very useful.

The two chief aerodromes here are Brooklands and Hendon. On my brother and I visiting the former, which is at Weybridge, Surrey, an hour's journey out of "town," we found that there was very little flying going on, although there are a great many hangars and types of machines represented there, chief among which are the Bristol, Sopwith, Deperdussin and Avro schools. Brooklands has achieved its reputation through its motor race track, but as the boundaries are very voided it is not considered an ideal flying ground.

The London Aerodrome at Hendon, on the other hand, is undoubtedly one of the finest flying grounds extant, and is always the scene of great activity. The latter remark applies more especially to Thursdays and Saturdays, the afternoons of which are half-holidays in London. On these days

kindly interest in aviation than do their American cousins.

At Hendon I again met several of the aeronautic enthusiasts with whom I had come in contact earlier in the week, and Mr. Ledebour and Mr. Hubbert in particular, although acting in an official capacity, went out of their way to introduce me to representatives of the London press, members of which gave me a hearty welcome as a fellow press representative from across the water, and invited me to do honors in dispensing afternoon tea in the press marquee, a form of diversion popular here and essentially English.

In my conversation with Mr. Grahame-White he mentioned that the Hendon tract has been used as

a flying ground for the past two years, but that it acquired it a year ago. There are about forty hangars containing fifty machines, and ten more hangars are being constructed. In looking around a notice besides those of Grahame-White Aviation Company, Limited, four of the Aireratt Company, which construct the Maurice Farman, two of the Bleriot School, two of the British Deperdussin Company as well as those of Dreguet, Owen and others. The hangars are substantially built, large and well lighted.

The management of the aerodrome in establishing popular prices for admission at one shilling (25 cents), and for this small fee providing ample seating accommodation and music into the bargain, do much to encourage widespread interest.

The programme for this third July meeting consisted of a cross-country handicap, total distance out and back of 16 miles, with a prize to the winner of silver trophy and 20 sovereigns (\$100), and a second prize of 10 sovereigns. This event was open to all types of aeroplanes, and the entrants were Pierre Verrier on a Maurice Farman biplane, 70 H. P., Renault, and Jules Nardini (50 H. P. Gnome Deperdussin), H. J. D. Astley (50 H. P. Gnome Bleriot) monoplanes. Astley won this event, Verrier being second.

Event number two was a grand speed handicap with same amounts offered in prizes, with an additional third prize of five sovereigns. The entrants for this race were Nardini, Verrier and Desoutter, the latter flying a Bleriot 35 H. P. Anzani. Nardini won this, he beating Desoutter (second) by seven seconds. Verrier, although last, made very good time in his biplane.

Exhibition and passenger flights were in vogue the whole afternoon, machines being constantly in the air. Mr. Lewis W. F. Turner on a Grahame-White biplane and Mr. Grahame-White himself participating in these events. Passenger flights may be booked on the grounds, the charge being two guineas per head.

The foregoing description of the activities at Hendon is but a fair sample of what is to be seen there every Thursday and Saturday, and when such meets are organized flying may also be witnessed every day.

The thousands of people daily in attendance, all of whom pay a small admission fee, testify more than anything else to the enthusiasm and popularity shown in aviation in England, and the gate receipts and sale of programmes, to say nothing of the revenue derived from teas, etc., served on the grounds in no small measure ensure the financial success of the London Aerodrome, which I left with a pervading impression of jovial good fellowship, and intermingling sounds of whirring of engines, the clatter of tea cups, clapping of hands and the crescendo and descendo of band music.

Sincerely,  
D. E. BALL.

\*A quarterly journal, purely technical, is published by the Society.



Scene at the London aerodrome, showing part of the crowd which usually attends the very successful week-end meetings. The two machines shown are a Caudron on the left and a Bleriot on the right.



THE OLD AND THE NEW SCOUTS OF THE MEXICAN ARMY.

# FOREIGN NEWS

BY  
R. H. BLANQUIE

## Algeria

The Grand Prize of Oran, of a value of 5,000 francs, (\$1,000), offered by that city for the first flight above the immense mountain separating Oran from the Mediterranean Sea, was won by Services, who, officially controlled, rose to a height of 2,000 meters on a Deperdussin 50-h. p. Gnome monoplane.

## Austria

During the "Vienna International Aviation Meeting," Lieutenant-Aviator Blaschke broke two World's altitude records on a Lohner-Arrow biplane, which are as follows: Height alone and with one passenger, 4,360 meters, (14,300 feet), (old record, Prevost, 2,700 meters); height with two passengers, 3,880 meters, (old record, Prevost, 2,000 meters). The government has purchased this record-breaking aeroplane for the sum of 35,000 kr., (\$7,290), and has ordered ten similar machines. The "aerial fleet" is actually composed of four dirigibles and sixteen aeroplanes. A national subscription, to provide the Austrian army with an adequate fleet of aeroplanes, has been started.

As showing his great interest in aviation the Austrian Emperor recently gave an audience to Lieut. Blachke, whose record altitude flights were a feature of the Vienna Meeting. His Majesty also inquired into the officer's circumstances, and hearing that he was engaged, at once added a necessary \$5,000 to complete the bride's dowry so that the marriage might not be further delayed. Lieut. Blachke's fiancee, Fraulien von Osakay, has made several flights with her future husband.

## Belgium

Several Henry Farman type biplanes, built for the army, passed successfully the tests imposed upon them. Their tested speed attained was 105 k. l. m. and they reached a height of 500 meters in 6' 30" with a full load.

The national subscription for presenting aeroplanes to the army has reached 6,866 francs, (\$1,373).

The dirigible "Ville de Bruxelles" made an hour flight recently over Brussels. Count d'Hespel left Brussels on a Deperdussin-Gnome monoplane, and reached Ostend 54' later, flying continually at a height of 1,200 meters. The distance between those two cities is of 124 km.

The competition for hydro-aeroplanes which was to have been held from September 1st to the 9th at Tamise has been postponed to the following week and will be held from the 7th to the 16th.

## Bulgaria

The government which sent several officers to the Bleriot schools in France, has received its first monoplane of this make for its army. The machine is a XXI type fitted with a 70-h. p. motor.

## England

The "Aeronautical Society of Great Britain" has opened a subscription to fund a memorial to the late Wilbur Wright as an appreciation of his great work and also to some small recognition of the support he gave to the society. The memorial is to take the form of a Premium on Aeronautics to be delivered annually and to be called the "WILBUR WRIGHT LECTURE."

Several flights over the fleet at the Naval Review at Portsmouth were made by Commander Samson, Lieutenant Spencer Grey and Lieutenant L'Estrange Malone on Short tractor hydro-aeroplanes.

The "Aerial Tours" organized by the "Daily Mail" for the purpose of educating public opinion in the importance of flying are being successfully carried out by Messrs. Hucks, Ewen, Hamel, Nar-

dini, Salmel, Lieutenant Parke, etc., who are flying throughout the country.

The army dirigible "Gemma" recently flew from Aldershot for Chatham, but was unfortunately brought down by a storm at Worwood Scrubs and was docked there in the "Daily Mail" hangar. The week end meetings at the London Aerodrome (Hendon), organized by the Grahame-White Aviation Co., Ltd., are being noted for their high class of flying and this accounts for their great popularity. On Saturdays specially interesting events are disputed, such as handicap, relay and cross-country races, etc., and Sundays are specially devoted to exhibition and passenger-carrying flights. Among the large number of aviators that have been flying here lately are Hamel, Grahame-White, Hucks, Valentine, Verrier, Moineau, Nardini, Mrs. Stocks, Desoutter, etc.



A reader of AIRCRAFT in Honolulu sent the above picture to us with the following remarks:

"This is a snapshot of Clarence Walker of California flying in his Curtiss type biplane, at Hilo, Territory of Hawaii. This snapshot was taken at sunset. On the following day Mr. Walker gave a very good exhibition, but had a bad smash-up, which wrecked the biplane. Walker escaped with very slight injuries."

Henry Salmel on his Bleriot-Gnome has again crossed the Bristol channel, from Weston to Cardiff, and flew before the King and Queen at the last named city.

Verrier, on a Maurice Farman 70-h. p. Renault, recently flew from Hendon, with a passenger, to Brighton and from there to Portsmouth, where he flew over the fleet for over two hours, returning late to Hendon.

The Central Flying School at Upavon was inat-

guated by the arrival of Captain Fulton, R. F. A., on a new Avro biplane.

A new hydroaeroplane, officially known as S. 43, has been delivered to the Naval Wing of the Royal Flying Corps at Eastchurch, by the Short Bros.

The Military Aeroplane Competitions will be held on Salisbury Plain in August. The official list of entries given out by the War Office read as follows:

Name of Firm.	No. of Aeroplanes.
Hanriot (England) Ltd.	2
Vickers, Ltd.	1
Louis Bleriot	2
A. M. Roe & Co.	2
Breguet Aeroplanes, Ltd.	2
Coventry Ordnance Works, Ltd.	2
British and Colonial Aeroplane Co., Ltd.	4
L. Howard-Flanders, Ltd.	1
Martin and Handasyde	1
Aerial Wheel Syndicate, Ltd.	1
Mersey Aeroplane Co.	1
British Deperdussin Aeroplane Co., Ltd.	2
Aircraft Manufacturing Co., Ltd.	1
C. E. Kny, Esq.	1
Jacob Lohner and Co.	1
A. M. Harper	1
Piggott Bros. and Co., Ltd.	1
Handley Page, Ltd.	1
Armand Deperdussin	2
S. F. Cody, Esq.	2
Societe Anonyme des Aeroplans Borel	1

A "National Aviation Fund" of One million shillings, (\$250,000) has been opened by the Aero League to provide prizes and awards of all kinds to manufacturers, inventors, and others with a view to fostering aerial navigation throughout Great Britain, and encouraging the development of a purely British aeronautical industry, and hastening the improvement of existing types of machines, in order to render them safer and more suitable to the conditions peculiar to these islands.

The Aero Section of the Society of Motor Manufacturers and Traders decided at their last meeting that an aeronautical show should be held in London in May, 1913.

## FORBIDS SEA FLYING WITHOUT PONTOONS.

Constructors of marine aeroplanes are much encouraged by the rapid spread of the use of such craft in Great Britain, where water flying promises to outstrip aviation over land. Further stimulation has been given to Hydroaeroplane in the adoption of a resolution by the Royal Aero Club, forbidding aviators from attempting flights over the sea, beyond the three mile limit, unless suitable precautions have been taken to render their aircraft capable of flotation.

This action has been taken by the Royal Aero Club, so that, in the event of an aviator having to descend on the water, there may be a reasonable chance of his being rescued and thus avoid, so far as possible, a recurrence of the fatal accidents which have happened through flights over the sea having been attempted by aviators on machines that are not capable of floating. The Royal Aero Club feels it is against the best interests of aviation that unnecessary risks should be incurred, and it will be constrained to take such action as may appear necessary or desirable against any aviator neglecting to take suitable precautions.

## France

A hydroaeroplane school is to be established at Brest by the Savary Aeroplane Co.

Barras, on a Triad-Curtis hydroaeroplane, flew over-water from Juan-les-Pins to Marseilles, a distance of 256 km., and is thereby the first to make a city to city over-water flight on a hydroaeroplane in France.

Armand Deperdussin, the well-known monoplane constructor, was recently made Chevalier of the Legion of Honor.

The race, Paris-Amiens-Paris, was won by Molla on a R. E. P. 80-h. p. Gnome. The distance of 280 km. was covered in 2 hours 27 minutes. Gastinger on a Clement-Bayard monoplane fitted with a 70-h. p. Gnome was second and Lenard on a Blériot-Anzani, third.

A hydroaeroplane meeting will take place from the 26th to the 28th of August in the bay of St. Malo, 38,000 francs (\$7,000), will be distributed in prizes. Among the many events will be a race from the Bay of St. Malo to the Isle of Jersey and back.

Entries were closed on July 27th and those received are as follows:

- 1 Robert Esnault-Pelterie (R. E. P.)
- 2 Astra-Train.
- 3 "Societe anonyme des Etablissements Nieupport."
- 4 Sanchez-Besa.
- 5 Sanchez-Besa.
- 6 "Societe des aeroplans Horel."
- 7 Donnet Leveque.
- 8 Deperdussin.
- 9 Maurice Farman.
- 10 Astra.
- 11 "Societe Paulhan" (Triad-Curtiss).
- 12 "Societe Paulhan" (Triad-Curtiss).

Beaumont, the winner of the "Paris-Rome" race and the "Circuit of England" has re-entered aviation after having taken a long rest. He is now flying the new Donnet-Leveque hydroaeroplane, which has given astonishing results from the beginning.

Petty Officer Delage on the 25th of July made several flights from the deck of the cruiser "La Foudre" on a Nieupport hydroaeroplane, with one and two passengers and although he landed on quite a rough sea, the Nieupport behaved perfectly.

Captain de Filippi, under-chief of the aeronautical service in Italy, and Captain Scott, commander of the Italian military dirigibles, just returning from Tripoli, arrived on the 6th of July at the Paulhan hydroaeroplane school at Jangleux. Plans to learn to pilot the Curtiss hydroaeroplane. Enza Rossi, the Italian sportsman, and Sorando Vrugaben are also learning to master the same machine.

The next Aeronautical Show will be held at the Grand Palais from the 26th of October to the 26th of November next.

Lieutenant Bousquet while competing for the "Aero Target Michel" succeeded in dropping nine out of fifteen bombs in the Target, thereby creating a new record. This record has since been beaten by the American Lieutenant Scott, who was declared the winner.

Fifty officers have been selected for service in the aviation corps; 4 captains, (one for dirigible service), 26 lieutenants; Cavalry, 6 lieutenants, (one for dirigible service); Artillery, 2 captains, 8 lieutenants; Colonial Infantry, 5 captains.

Lieutenant Cayla, on the navy's Voisin hydroaeroplane, flew from the deck of the cruiser "La Foudre", anchored in the St. Raphaels Road, to Cannes and returned alighting near the cruiser.

The World's sped records up to 150 km., with one passenger have been broken several times of late by Lesage, Freny and lastly again by Leveque, on the new Gnome monoplane, fitted with a 80-h. p. Gnome motor. His times are as follows: 10 km. in 2' 24" 45; 20 km. in 8' 31" 15; 30 km. in 13' 38" 25; 40 km. in 17' 44" 4; 50 km. in 22' 14"; 100 km. in 44' 36" 35; 150 km. in 1 hour 7' 10". His average speed was 134 k. p. h.

Pommet has created quite a novelty, on his Horel monoplane, by outlining it with small incandescent lamps of different colors, by means of storage batteries and flies with it at night. To the spectators it offers quite a strange but beautiful sight to see an illuminated artificial bird soaring through the air.

Vidart, on a Deperdussin-Gnome, flew over the tomb of the much-lamented Kimmerling at Dinvenchies, France, and dropped a floral wreath on it, which had the following words inscribed upon it: "From a Bird of France to the friend Kimmerling."

Among the foreigners actually learning to fly in the French aviation schools are: 6 Turks, 3 Servians, 3 Bulgarians, 2 Norwegians, 1 Siamese, etc. Most of those mentioned have been sent out by their respective governments.

A meeting, under the auspices of the Syndicate of the Military Press, was held at Juvisy and obtained a well-deserved success. Many interesting features were held, such as an 18 km. cross-country race, an aeroplane vs. balloon event, etc. The aviators that distinguished themselves the most were, Prevost, Gastinger, Champel, Ohre, Molla, etc.

**DIRIGIBLES.**

The Clement-Bayard III left La Motte Breuil at 6.15 p. m., and landed during the same evening at Issy-les-Moulineaux at 8.15 p. m. carrying 16 passengers. It also flew in company with the new army dirigible L'Eclairer-Conte, over the troops at Longchamps before President Fallieres, the Bay of Tunis, etc., and a crowd of 300,000 people on the 14th of July.

L'Eclairer-Conte recently left its hangar at Issy-les-Moulineaux, with 16 passengers at 6.11 p. m., returning the next morning at 10.42 and thereby staying in the air over 16 hours without



VIEW AT THE BROOKLANDS AERODROME SHOWING THE ENTHUSIASTIC PUBLIC ASSEMBLING AT THE GROUNDS BEFORE THE SHEDS ARE OPENED FOR THE START OF A WEEK-END MEET.

standing the fact that the wind at times, during the night, was blowing very strong.

The Clement-Bayard IV, while making trials for its acceptance by the government, also made a flight of 16 hours, leaving Paris at 8.23 p. m., it flew over Honneur and the English channel and returned by following the Seine up to Paris, the next day at 12.50 p. m.

The "Zodiacs," "Le Temps" and "Captain Ferber" have been making daily flights of reconnaissance along the eastern frontier.

**THE DEATH OF LATHAM.**

The latest reports, and which are no doubt authentic, of Hubert Latham, the aviator who quit flying about a year ago, state that at seven o'clock in the morning on June 25, Latham, accompanied by a native, was shooting on the right bank of the Charri River, near its junction with the Dahr Delamat, close to Gapes Rapids.

He had wounded a rhinoceros and was about to finish off the animal when his heavy calibre rifle burst. He seized another gun from a native and fired, killing the rhinoceros.

At this moment a buffalo, until then hidden in the tall grass, came into view. Latham, kneeling, fired again, but only wounded the buffalo, which charged and tossed him three times. The unfortunate young man gave one piercing shriek and fell dead. The body was brought to Fort Archambault the following day and buried there on June 30.

On July 23rd, a novel experiment was carried out by Henry Farman on his new small biplane. Late in the evening he left Chalons Camp and

flew to Paris, landing on some very rough ground by Noisy-le-Grand. With the help of a peasant he then dismantled the machine so that the overall width was only 3 meters, and it was towed by a motor car via the Rue de Rivoli and the Champs Elysees to the Palais de l'Automobile, where it was garaged. The speed of the new machine is given as 113 k. p. h., and it is said to be able to climb 100 meters in 50 seconds.

On July 24th, Granel on an R. E. P., made the first test for his superior certificate, on a course along the valley of the Aube, and he completed the tests on the 26th. Having been compelled by a storm to spend the intervening days at Troyes.

After having successfully transmitted wireless telegraph messages from his Farman aeroplane from St. Cyr to Meaux, Lieut. Mauger-Davarennes is experimenting with a view to sending messages over greater distances, and hopes eventually to be able to send them over distances 150 to 200 kilometers.

**FINE WORK ON TRAIN MONOPLANES.**

Quite some success has been achieved by the latest Train monoplane at the hands of military officers at Mourmelon, and M. Train has lately been giving his attention to hydroaeroplaning. The hydromonoplane built for him by the Astra Company made some very satisfactory trial flights at Meulan recently and one of them has been entered for the A. C. F. Competition at St. Malo.

At Mourmelon on the 25th of July, Lieut. Leveseur, on a Train monoplane made a two hours' trip at a very high altitude, passing over the circuit, Chalons, Vitry le Francois, Barbedue and Lack.

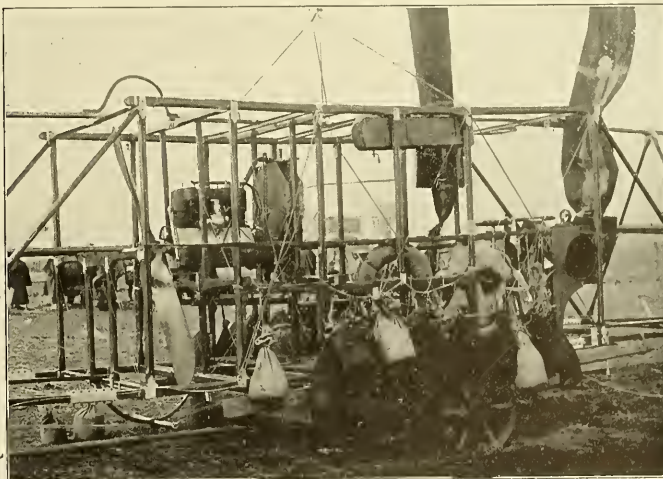

Chassis of an oriental military arsenal. These dirigibles are patented by the famous constructor Yamada and are supplied to the Chinese and Japanese governments. All are fitted equipped with American built Maximotors of 4 and 6 cylinders—40 to 75 h. p. This dirigible is about to rise for a test flight before army staff officials at the suburbs of Osaka.

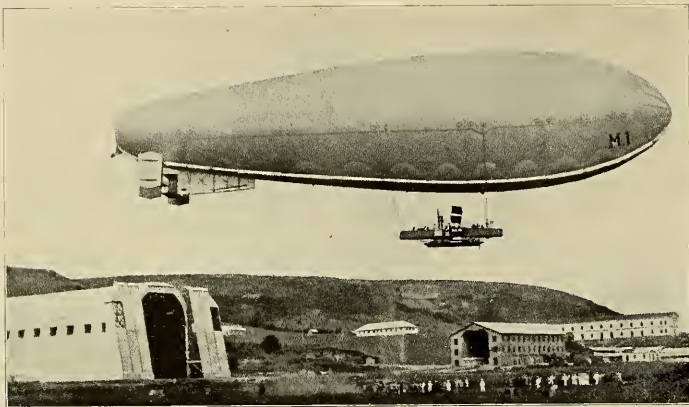

The new Italian military dirigible M. 1, which is equipped with two Fiat motors of 240 H. P. each. This ship will be stationed on one of the islands in the Adriatic Sea and will be held in readiness to fly over to Turkey and bombard Constantinople.

### Germany DIRIGIBLES.

On a recent flight the "Viktoria-Luise," left Hamburg at 6 a. m. and flew over Bremen at 7.55, reaching Hanover at 9.40. Here it descended in a race-course before an enthusiastic crowd of 100,000 people and after having landed its nine passengers, took on nine more and left for Hamburg at 10.12, where it arrived safely at 2 p. m.

The LZ XIII, which is being built exclusively for passenger-carrying, is almost completed. The LZ XIV ordered by the navy and the LZ XV, another dirigible for passenger-carrying, will be built shortly.

The military government has purchased the "Siemens-Schuckert," which has a volume of 13,600 cubic metres, a length of 120 metres and is engine by four motors of 120 h. p. each. In a trial flight it made 71 k. p. h.

The "Viktoria-Luise" made the trip from Hamburg to Frankfurt, a distance of 400 km. in seven hours.

There are actually throughout Germany twenty-seven dirigible hangars and five out of that number can accommodate two Zeppelins at the same time.

The Zeppelin "Viktoria-Luise" recently left Hamburg one morning at 6.15 and made a voyage above the sea, encircling the island of Heligoland and continued its way at 9.15 a. m. towards the south.

The military administration has ordered a Parseval which will be known as the P-4. Like the P-3, now at Koensberg, it will have a length of 90 meters and a capacity of 10,000 cubic meters.

Leaving Baden-Oos the Z-III made an 18 hour flight, passing over Metz, Baden-Baden and Strasburg.

The "Schutte-Lanz" left Mannheim on the 26th of July at 3.20 a. m. and arrived at Gotha at 9.15, a distance of 225 km.

### AEROPLANES.

Miss Charlotte Boehring, who is only 19 years old, has obtained her pilot's license at Kothenau in July.

An aeronautical show which is to be held at Kohn next Spring, is now being organized.

A naval aviation meeting, organized by the "Deutsche Fliegerbund" will take place in August. The Minister of the Navy has already granted 80,000 marks as prizes.

The Circuit organized by several sporting clubs, will be held during the latter part of August and comprises the following course: Berlin (Johannisthal), Lindenbergl, Schulzenhof, Spandau, Potsdam, Fehlow and Johannisthal, a distance of 96 km.

The Russian Princess Eugenie Schakonskaja, has successfully passed the tests required for a pilot's license, on a Wright biplane at Johannisthal.

The Emperor, in harmony with the Minister of War, has decided to organize a military competition which will take place next Spring. The conditions will be as follows:

1. That both aeroplanes and motors must be of German construction.
2. That each aeroplane must be two-seated and carrying a passenger.
3. That a weight of 200 kgs. must be carried in addition to the passenger.
4. That the pilot must be able to start his machine unaided.
5. That the minimum speed against a wind of 10 meters per second, shall be 70 km. p. h. (This implies a mean speed of 110 k. p. h. in a perfect calm). Besides each aeroplane must be capable of landing in a ploughed field and rising again without any outside help whatever.

The authorities of Dusseldorf have the intention of building a port for aeroplanes and dirigibles that would be, after the studied plans, the

largest in existence. It is thought that the city of Hanover, which has offered 600,000 marks for the construction of an aerial port, to be chosen as intermediary station of the line of aerial communications between Frankfurt and Hanover.

Fifteen to twenty aviators will take part in the autumn manoeuvres and will be divided between two adverse armies.

The German Minister of War has recently sanctioned the formation of a corps of volunteer aviators, very much on the lines of the motor volunteers. The members, who must be of German nationality and possess a German certificate, will place themselves at the disposal of the military authorities in time of war, and will be available for manoeuvres, etc. It is probable that some fifteen to twenty members will take part in the forthcoming manoeuvres.

At the recent meeting held at Leipzig, Hirth is said to have created a new world's height record. Unfortunately he took with him a barograph that did not register altitudes above 4,000 meters. However, it was given for examination to two university professors, who undertook to study what atmospherical pressure it was submitted to at the highest point of the race. They found that it answered to an altitude of 4,520 meters. This was informed the German Aero Club. As the Leipzig aerodrome is 100 meters above the sea, Hirth has then reached an absolute height of 4,420 meters above the ground, which would constitute a new world's record.

At the same meeting Schirmeister carried four passengers on a biplane for 33' 52" and Oelrich for 20' 40" hours 41". Both of these figures are new records.

The Aeronautical Society at Halberstadt and the military authorities will found aviation stations in the Harz region. There is now located at Halberstadt an aeroplane factory and an aviation school.

The number of certificated pilots in Germany in June, 1911, was 86. On June, 15th, 1912, the number had increased to 245.

### Greece

Lieutenant Cambreros on a hydroaeroplane, accomplished, navigating alternately, the crossing from Phalero to Hlira in 43', which is a distance of 80 km. as the crow flies.

### Holland

A British enterprise has opened a hydroaeroplane school at Schevmingen. Exhibitions are to be given all over the country with two W. II. tractor biplanes.

### Ireland

Land has been secured at Baldovle for flying purposes and it is proposed to use two Blackburn monoplanes, one a single seater fitted with a 50-h. p. motor and the other a double seater Blackburn type fitted with a 60-80-h. p. Green motor.

### Italy

Ronolo Manissero, the winner of the Milan-Turin race, will undertake to accomplish a circuit of Italy with a Morane biplane.

At Milan, Deryoe, a French aviator, made a flight over the city on a new military aeroplane, invented and built by an Italian engineer.

A curious accident befell Cardoni, who was flying on his hydroaeroplane over the Gulf of Spezia. While flying in the leeway of the cruiser "Danter-Aghtriero," which was undergoing speed trials, the draught completely capsize the machine, which fell into the sea, but fortunately the aviator was not hurt.

Brindejone des Moubinai, the well-known French aviator, on a Morane-Gnome monoplane, flew before the military commissioner and took up successfully seventeen officers as passengers.

The army dirigible M. J recently made a trip from Bracciano to Rome and back again. Details of the M. J: length, 85 meters; volume, 10,000 cubic meters; power, 2 motors of 240 h. p. each.

The Minister of the Navy is to make the following seaport hydroaeroplane stations: Venice, Taranto, Messine, Naples, Spezia and Genoa. The station of Venice is now ready and four hydroaeroplanes have been sent there. The government has sent orders to France for four other machines to be sent to the other stations.

The Treasurers of the Italian National Fund have received a further sum of \$5,895, which has been collected in the Italian schools to add to the \$10,800 already in the hand. The Italian colony at Monte Video in Uruguay has also forwarded \$5,000 to the fund.

### Japan

The Japanese navy will soon be in possession of one of the largest dirigibles in existence. It will have a length of 94 meters with a volume of 16,410 cubic meters. Its motive power will consist of 6 motors of 120 h. p. each and will drive a propeller which will thus give it a speed of 68 miles per hour. It will be of the Parseval semi-rigid type and able to lift 42 tons. As soon as it is completed it will be placed at the naval station at Yokosuka.



AVIATOR J. HECTOR WORDEN, WHO IS DOING SCOUT DUTY FOR THE MEXICAN FEDERAL ARMY IN AN AMERICAN MONOPLANE FITTED WITH A CHARNAVY PROPELLER.

**Spain**

Benoit gained the hydroaeroplane trophy and the Royal Nautical Cup, at the Barcelona Meeting, by his great performances on a Sanchez-Besa hydroaeroplane.

Among the aviators at the meeting held at Pampeluna were Jules Vedrines, on a Deperdussin 50-h. p. Gnome and Mme. Draincourt on a Candron biplane. The former won a cross-country race of 250 km. above the mountains.

**Switzerland**

At its last meeting, the Aero Club of Switzerland has appointed the following pilots to represent Switzerland in the Gordon Bennett Balloon Cup Race for 1912: P. Ambruzzi (Berne), R. O. Muller (Zurich), and V. de Beauclair (Zurich), Edmond Audemars, will defend the Swiss colors at Chicago.

The committee for the Geneva hydroaeroplane meeting has received the following entries: Beaumont (Donnet-Leveque), Barra or Molliens (Curtiss Triad), Rogere (Voisin) and from the Swiss aviator Rene Grandjean who will fly a special built Swiss hydroaeroplane, to compete for the general prize of 10,000 francs, (\$2,000).

Roger Sommer, who is conducting his experiments at Evian with his new hydroaerobus fitted with a Salmon system Canton-Unne 80-h. p. motor, has organized, after numberless requests, aerial services between Evian and Montreux, Evian and Lausanne.

**Tripoli**

Signor Saccidote, while making an aerial reconnaissance of the Turkish position in the vicinity of Bu Hamesh, was forced by engine trouble to land some distance outside the Italian lines. He made his way on foot, as rapidly as he was able, toward the nearest Italian entrenchment.

Troops were sent out and the aeroplane was recovered absolutely undamaged. A Turkish camp was bombarded by an Italian dirigible.

**Turkey**

The Turkish government had recently purchased two Hanlan (German) monoplanes for scouting purposes at the front.

**Morocco**

The French army lieutenants Tretarre, Do-Hu and Van der Vaero, on their Bleriot-Gnome monoplanes, flew in "escadrille" from Rabat to Casablanca without any accident.

**Philippine Islands**

Lieut. Frank P. Lahm, who as reported last month, was flying the Army Wright biplane at Fort McKinley, has taught two army men to fly it, thus giving Uncle Sam two more accomplished pilots. The first pupil of Lahm's to pass the examination test, which was identical with the F. A. I. test, was Corporal Burge, of the Signal Corps, U. S. Army, who after only a short training, successfully accomplished the necessary flights.

Lieut. Moss, E. Love, also of the Signal corps, is the other graduate. Lieut. Lahm is much elated at the success achieved by his two pupils and will soon start in other members of his signal corps detachment in instruction work.

**Russia**

Lieutenant Lybovski, who had left Sebastopol on the 15th of June, last, on a Nieuport 50-h. p. Gnome, finally arrived in St. Petersburg on the 11th of July. He had been obliged to stop over for a few days at Odessa for repairs to his aeroplanes. Leaving Odessa on the 23rd of June,

he arrived at his destination after having made a trip of 3,350 km. The same feat was accomplished by Lieutenant Andreash on a similar machine a few days later.

From the 10th of August to the 20th of September military competitions will be held at St. Petersburg. The machines entered for the three prizes of 30,000, 15,000 and 10,000 roubles, allowed by the War Department, must be entirely built in Russia and must be capable of carrying two passengers, the instruments and the necessary accessories, a provision of fuel and oil for a three hours' flight; they must be able to attain the height of 500 km. in at least fifteen minutes, have a speed of 80 k. p. h. and must accomplish, without landing, a flight of 1 hour, 30 minutes. Besides, they must present qualities adequate for the handling of fire-arms and the dropping of bombs.

On July 27th, while continuing his flight from Berlin to St. Petersburg, Abramovitch had a fall at Walk, between Riga and Pleskau. Pilot and passenger escaped injury, but the machine was so damaged that it took quite a time to effect repairs. In spite of the several mishaps encountered by Abramovitch, who is flying a German Wright, he is sticking to his task and slowly but surely making his way toward St. Petersburg.

**Scotland**

A Candron biplane fitted with a 35-h. p. Anzani motor, which has been bought by G. S. Wilson of the Edinburgh Evening News, has recently been at work at Lanark.

**South Africa**

John L. Weston, of Bradford, O. F. S., intends shortly to open a school at Bloemfontein where he has obtained very suitable ground. He has been doing some flying lately in Cape Colony.

**TABLE OF MACHINES ENTERED IN THE BRITISH WAR OFFICE TRIALS**

Name of Entrant.	Name of Machine.	Type.	Name of Pilot.	Area of Main Planes		Span.	Length.	Esti- mated Speed.	Make of Engine.	No. of Cyls.	H. P.	Type of Drive
				lbs.	sq. ft.							
Aircraft Co.....	Maurice Farman	Biplane.....	P. Verrier.....	1,250	380	51 8	39 6	55	Renault	8	70	Gear reduction
Bleriot, Louis.....	Bleriot	Monoplane	Perreyon	600	194	32 0	27 4	--	Gnome	7	70	Direct
Bleriot, Louis.....	Bleriot	Monoplane	-----	770	269	36 4	27 0	--	Gnome	7	70	Direct
Borel Societe des Aeroplanes British and Colonial	Borel	Monoplane	Chambenois	715	195	37 6	20 9	65	Gnome	7	80	Direct
Aeroplane Co., Ltd. British and Colonial	Bristol	Tractor biplane	C. H. Pixton	1,474	387	39 4	31 0	60	Gnome	14	100	Direct
Aeroplane Co., Ltd. British and Colonial	Bristol	Tractor biplane	G. England	1,630	387	39 4	31 0	57	Daimler-Mercedes	4	70	Chain reduction
Aeroplane Co., Ltd. British and Colonial	Bristol	Monoplane	H. Busteed	792	236	40 0	28 0	70	Gnome	7	80	Direct
Aeroplane Co., Ltd. British and Colonial	Bristol	Monoplane	J. Valentine	792	236	40 0	28 0	70	Gnome	7	80	Direct
British Deperdussin Co.....	Deperdussin	Monoplane	Lieut. Porte	830	248	39 8	22 7	--	Anzani	10	100	Direct
British Deperdussin Co.....	Deperdussin	Monoplane	M. Prevost	820	248	39 8	22 7	--	Gnome	14	100	Direct
Cody, F. S.....	Cody	Biplane	F. S. Cody	-----	-----	-----	-----	-----	Austro-Daimler	6	120	Chain reduction
Coventry Ordnance Wks.....	C. O. W.....	Tractor biplane	T. O. M. Sopwith	1,100	350	40 0	34 0	60	Gnome	14	100	Chain reduction
Coventry Ordnance Wks.....	C. O. W.....	Tractor biplane	T. O. M. Sopwith	1,200	300	35 0	32 0	68	Chenu	6	100	Gear reduction
Deperdussin (France).....	Deperdussin	Monoplane	Vedrines	1,600	256	40 7	22 0	70	Gnome	14	100	Direct
Deperdussin (France).....	Deperdussin	Monoplane	Busson	1,600	256	40 7	22 0	70	Gnome	14	100	Direct
Flanders, L. Howard, Ltd.	Flanders	Tractor biplane	W. R. Raynham	1,650	400	43 0	30 6	60	A. B. C.	8	100	Direct
Hanriot (England), Ltd.....	Hanriot	Monoplane	Sidney V. Sipe	981	221	-----	-----	78	Gnome	14	100	Direct
Hanriot (England), Ltd.....	Hanriot	Monoplane	M. Bielowuicic	981	221	-----	-----	78	Gnome	14	100	Direct
Kny, C. E.....	Mars	Monoplane	Lt. Bier	1,075	430	52 6	44 3	80	Mercedes	6	100	Direct
Lohner, J., and Co.....	Arrowplane	Tractor biplane	Lt. von Blasehke	1,584	---	52 0	31 0	73	Austro-Daimler	6	130	Direct
Martin and Handasyde.....	M. and H.....	Monoplane	Gordon Bell	1,250	310	42 6	28 0	75	Chenu	6	75	Gear reduction
Mersey Aeroplane.....	Mersey	Monoplane	R. C. Fenwick	795	225	35 0	25 6	65	Isaason	7	45	Gear reduction
Page, Handley, Ltd.....	H. P.....	Monoplane	H. Petre	-----	390	40 0	29 0	60	Gnome	7	70	Direct
Roe, A. V., and Co.....	Avro	Tractor biplane	Lt. W. Parke, R. N.	1,250	313½	36 0	30 0	65	Green	4	50-60	Direct
Roe, A. V., and Co.....	Avro	Tractor biplane	"Partridge"	1,250	332½	36 0	30 0	61	A. B. C.	8	85	Direct
Vickers, Ltd.....	Vickers	Monoplane	L. McDonald	-----	-----	-----	-----	-----	Gnome	14	100	Direct

THE 28 H. P. BRISTOL SINGLE SEATER MONOPLANE (SCHOOL TYPE)

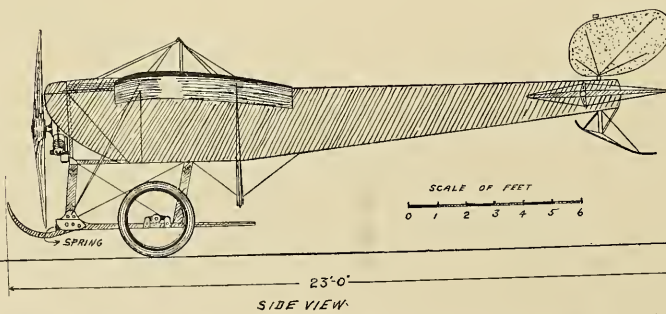
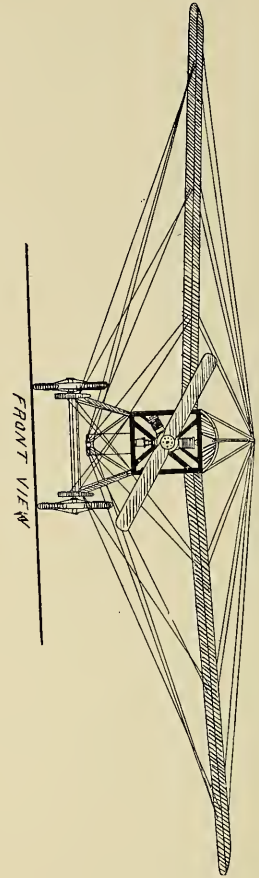
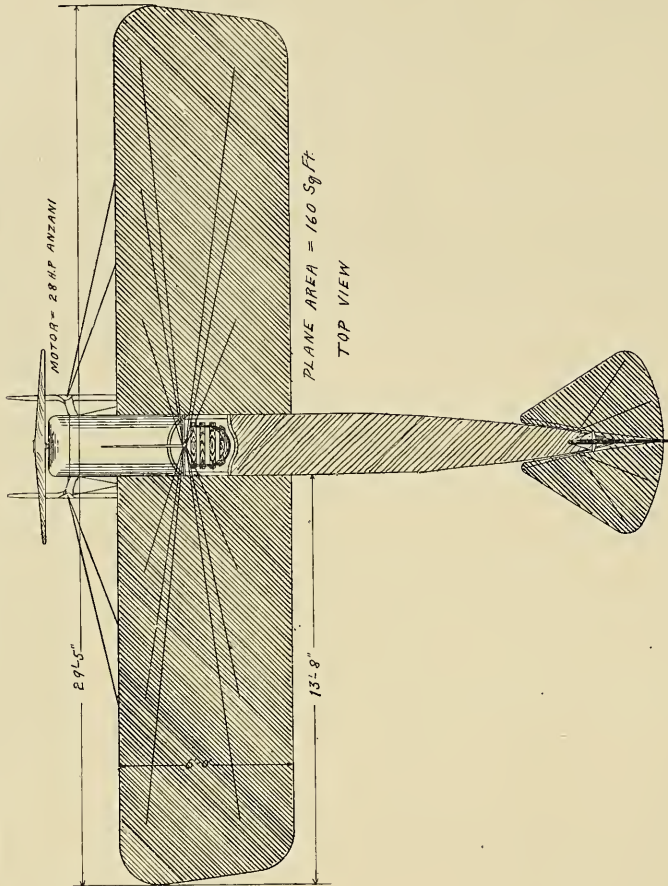

THE BRISTOL MONOPLANE



# THE TRADE

Mr. B. H. Dreyer in a 6 cyl. 50 H. P. Maximotored biplane, which has aroused great interest among the rich sugar planters of Hawaii. Mr. G. Schaefer, the owner, standing. Mr. Schaefer was attracted to the Maximotor through their advertisement in AIRCRAFT.

In "Lumina" Aeroplane Cloth, **The B. F. Goodrich Company**, of Akron, Ohio, have scored another undoubted success.

It was only to be expected that the combined experience of the principal European maker of aeroplane fabrics and of the oldest and largest American rubber manufacturing company should produce something out of the ordinary, and the new "Lumina" cloth at once forced its way into prominence, as is shown by the fact that at the recent New York Aero show, both Wright and Curtiss exhibited "Lumina" covered aeroplanes, the Curtiss Hydro-Aeroplane purchased for the Russian Navy, and the Burgess Biplane ordered for the United States Army, also bearing testimony to the exceptional qualities of the new covering.

"Lumina" is a beautiful fabric. It is not, however, on its appearance alone that "Lumina" claims approval. Made from the finest procurable long staple cotton, coated several times over with high-grade rubber solutions of various consistencies, and on one side again covered with aluminum, it becomes to all intents and purposes wind and weather proof.

The making of a suitable fabric for aeroplane purposes involves several good conditions. The canting of a plane is comparatively so slight that any warping or shrinking of the fabric will infallibly distort the frames, throwing them out of line and utterly upsetting the true direction of flight.

In "Lumina" all contingencies have been foreseen and provided for. "Lumina" will neither shrink nor stretch. The rubber coating and aluminum covering are incorporated with the fabric, making it thoroughly impervious to all climatic influences, with the further advantages that it does not crack nor show dirt, while repairs may be readily executed with ordinary rubber cement and without disfiguring the fabric.

The accompanying illustration shows a dainty hanger issued by The B. F. Goodrich Company, a copy of which will be sent to anyone interested. It is beautifully printed in colors, and our reproduction altogether fails to do it justice.

In conclusion we would say that "Lumina" Cloth is made by The B. F. Goodrich Company in their huge factory at Akron, Ohio, by special arrangement with the Continental Company of Hanover, Germany, who have a world-wide reputation as makers of this class of goods.

"Lumina" is thus not an experiment, but a proven success.

In addition to "Lumina" fabric the firm is maker of other fabrics and of rubber aeroplane accessories, including special aero tires. The house of Goodrich is so well known that articles bearing their name are everywhere recognized as setting forth an international standard of quality.

The following interesting bulletin has been received from the enterprising **Roberts Motor Company** of Sandusky, Ohio: "Weldon B. Cooke, the famous exhibition flyer, who has been flying in all parts of America and under all sorts of conditions, gives a large part of credit to the Roberts Motor for the great success with which he is meeting.

Mr. Joseph Richter is flying a biplane with a Roberts six, and reports that it shows even better power in comparison than the four cylinder.

The big Harper monoplane equipped with the Roberts six will probably be flying this month at the Hempstead Plains Aviation field.

The Benoist tractor hydro-aeroplane has surprised the wise ones by recently flying at Coeur Creve Lake, near St. Louis, as it has often been said that a tractor propeller was not practical in a hydro.

R. F. Coleman, of Omaha, Neb., is just completing a tractor which he has equipped with his Roberts four.

The Mars-Fowler Combination of Kansas City recently purchased the Benoist biplane from W. S. Adams, of Riverton, Wyo., with which Mr. Adams did considerable flying, with a Roberts 4-X.

The Benoist Aircraft Co. recently incorporated, expect to start the construction of five of their tractor biplanes with Roberts 6-X motors, in the near future.

Mr. Harry W. Powers is doing some excellent work with his hydro-aeroplane equipped with the Roberts six cylinder. This machine was originally equipped with a 4-X and did some excellent flying in spite of his small power.

The Brooks Aeroplane Co., of Saginaw, Mich., expect to enter two of their machines in the coming Chicago meet.

The Roberts Motor Company are shipping one of their six cylinder motors this week to the Matthewson Aeroplane Co. of Denver, Colo.



The B. F. Goodrich Company, of Akron, Ohio, are doing much to advertise the aeronautical movement as well as their aeroplane cloth by distributing broadcast the above illustration printed in colors in the shape of a hanger.

Mr. W. F. Semon, president of the **Frontier Iron Works**, of Buffalo, N. Y., sailed for Europe the 15th of August on the "America," for six weeks' stay in Germany, during which time he will study the latest foreign methods in air navigation.

New Britain, Connecticut, with only 34,000 population, is fairly hotbed of aviation activity. The fourth **Maximotor** in the town is being placed in the tractor biplane of J. P. Thompson. The others went to Krasting, Nelson and Nolan.

Charles K. Hamilton, a New Britain native, was the town's original birdman. Ever since his famous intercity flights even the schoolboys have given up marbles and tops for gliders and model aeroplanes.

"The important point in propeller design is not thrust, as often supposed. It is 'advance speed' combined with 'pulling' power or thrust," say the **Diana Spiron** constructors.

"A blade" is no more to be chosen simply because of its high thrust than a horse for a speedy rig on account of his ability to drag a heavy load. The pull is required in getting the machine started. After that, under ordinary conditions, efficiency depends on the 'advance speed.' Big thrust alone is useless. Take this instance from the Mineola aviation fields. A certain Farman type plane would do little more than rise off the ground with a propeller that gave 350 lbs. thrust. Another one designed for the machine was installed. It gave only 235 lbs. thrust, but once in the air, carried the plane at a good speed. Almost any professional aviator knows of such cases in his own experience.

The aerial screw must be designed so that at the normal speed of the plane it will progress with the slightest resistance—like a screw through a nut. Therefore, a screw of 100 per cent. efficiency would have no slip in flight, because no air would be thrown back by the blades. But, of course, this is impossible under actual conditions. Slip must be allowed for.

As a matter of fact, there is such a decrease of resistance to the blades revolving after flight has begun that the r. p. m. uniformly increases 100 to 200 over the revolutions on the ground.

"The desire for abnormal thrust has led to the designing of types of blades with such features as the 'differential' or 'expanding' pitch.

"There is no question that a differential or expanding pitch screw can be made to give more ground thrust. But has never been shown to give flying efficiency equal to the constant pitch type. The contrary has often been demonstrated. "A Curtiss biplane took a speed record with a screw of the general Diana type. Various 'expanding pitch' screws were tried. The speed dropped down in every case."

Two Japanese Navy officers have arrived in Hammondspont, N. Y., where they will learn to fly at the Curtiss School of Aviation. They are Lieut. Kono and Naval Engineer Nakama, and come direct from Tokio. A third officer will shortly join them in a course of instruction in the use of the Curtiss machines.

The Imperial Japanese Navy has only recently become interested in the hydro-aeroplane, and has purchased three from the **Curtiss Aeroplane Co.** The three officers who have been designated by the Japanese Minister of Marine, will take a thorough course of training under Mr. Glenn H. Curtiss' supervision.

The **Sloane Aeroplane Co.**, of New York, is busy these days turning out aviators from their well equipped school at Hempstead Plains. W. Leonard Bonney, Gus Gilpatrick, W. Irving Twombly, W. E. Roberts and Vermilyan Loving are the latest recruits to learn to fly their Deperdussin monoplane.

**Victor L. Tyler**, of Georgetown, Ind., reports that during the past month he has balanced several planes for amateur builders, all of whom were successful in their flights. Bennett, Can Race, at Chicago, last month's designs were for planes capable of passing military tests.

Owing to the fact that he has been ill since July 1st with typhoid fever and has just lately recovered therefrom, **Mr. Charles Morok**, who was chosen by the Aero Club of Belgium as their contestant for the Gordon Bennett Cup Race, at Chicago, on September 9th, will be unable to compete, and therefore has withdrawn his entry.

**Harry Bingham Brown**, the aviator, who has been doing considerable flying with a Wright biplane at Hicksville, Long Island, during the past few months, is now wearing one of A. Leo Stever's parachute equipments during his flights. Rodman

Law, the parachute jumper, recently made a parachute descent from Brown's aeroplane from a height of over 2,500 feet.

**Frederick C. Hild, of the American Aeroplane Supply House**, has lately learned to fly, and is daily making demonstration flights in one of the American Aeroplane Supply House single seater monoplanes equipped with a 50 H. P. Roberts motor at Hempstead Plains aviation grounds. Mr. Hild gives free demonstrations to prospective purchasers of these machines.

**The Brooks Aeroplane Co.**, of Saginaw, Mich., have lately increased their capacity for turning out machines and are now building hydro-aeroplane, biplane, tractor biplane and monoplane types. They have engaged the services of the well-known constructing engineer, Alexander Hamilton, for their engineering department, and Hillery Beachey, the celebrated aviator, as demonstrator of their machines.

Reports from aviators who are using the Stur-

tevant aviation motor, built by the **B. F. Sturtevant Co.**, of Hyde Park, Boston, Mass., in different parts of the United States, speak in the highest terms of its remarkable power, ease of operation and general staying qualities.

**Paul Lacroix** reports good business during the last month. In continuance of their policy of ready-for-shipment sales, they keep on hand several Gnome and Anzani motors as well as a complete assortment of imported aeronautical supplies.

## GENERAL NEWS

### New England Notes

The Connecticut manoeuvres, held at Bridgeport on Aug. 10-19, were participated in by a regiment of Regular infantry, one of cavalry, a battalion of artillery, a company of engineers, Field Company A, Signal Corps, U. S. Army, one aviation section, U. S. Army, and 18 regiments of New York, New Jersey, Massachusetts, Connecticut, Maine and Vermont National Guard troops, besides state cavalry, artillery, engineers and signal companies. The instructions for the aviation section were:

The aviation section, which will have immediate charge of aerial scouting and reconnaissance, will be attached to the headquarters of the chief umpire during the instructional period, and to the headquarters of the Blue forces during the final period.

During the instructional period specific scouting problems will be assigned to the pilots each day, requiring reports and maps of their reconnaissance. During the final period the commanding general of the Blue division will require the pilots to work on specific problems for information, requiring them in each case to make reports and submit maps of their fields of observation.

In order that the conditions of real war may be simulated, the pilot will rise to an elevation not less than two thousand feet above the ground before he begins his scouting and reconnaissance, and he will continue at that elevation until it is necessary to make a landing. To make sure that no information is obtained at a less elevation, the flight to rise to this elevation should be made, where practicable, away from the ground in which information indicates that the enemy is operating.

In order that the pilot may have information as to his elevation, each aeroplane will be supplied with a recording barograph with a six-hour clock movement, and at the beginning of the reconnaissance the time of lowering the pen on the paper will be recorded on the sheet. An aneroid barometer at the headquarters of the chief umpire will be read at fifteen minute intervals during the flight of the pilots, and on the pilot's return his barograph record will be checked up and the altitude determined by using Table No. 20, of the Smithsonian Meteorological Tables, 1907. As a further check, each umpire should note the time that an aeroplane is in his vicinity and estimate the altitude above the troops. It will be assumed whenever an aeroplane flies over troops or in their immediate vicinity that it is under rifle fire.

Aerial manoeuvres in consonance with these orders have been carried out successfully and have definitely demonstrated to the Regular Army officers the value of aircraft in military operations. Flying was done at about 3,000 feet and the aviators were able in all reconnaissances to bring back accurate, detailed and tactically valuable accounts of the opposing forces.

A feature of the manoeuvres which went wrong was the attempt to deliver the new Burgess-made hydro by the air route. The machine as it left Marblehead carried Lieuts. Roy C. Kirtland and Henry H. Arnold and, as laden, had a total load



Guy Gilpatrick, sixteen years old, who has been educated at Columbia Grammar School in New York. He is at present a pupil of the Sloane school at the Hempstead field. He expects to secure his pilot's license shortly and after some exhibition flying, will devote himself to the construction of an aeroplane. He will be the youngest monoplane pilot in the world.

of about 2,000 pounds. The load was too much for the engine, and a landing was made at Duxbury and the machine came down finally in Plymouth Bay, breaking the propeller and a piston. It had to be sent back to the factory for repairs.

Capt. Frederick B. Hennessy was in charge of the aviation work with Lieuts. Kirtland, Arnold, Harry Graham, B. D. Foulis, H. Geiger, T. DeW. Milling of the Regulars and Private Beck with Haven of the New York Signal Corps constituting the scout corps. The weather was unusually favorable for flights, which notably were made by Lieuts. Milling, Geiger and Foulis and Private Haven.

One day the aviation squadron was sent out from general headquarters to make a report of

an engagement near Berkshire. The aviators ascertained and located on the map the advance of the two forces, the deployment and position of their lines and reserves and the location and direction taken by the wagon trains; in fact, all that any commander would desire to know of any enemy's movements. The scene was 20 miles away from headquarters, which learned the facts within 15 minutes. Lieut. Foulis took the air on Aug. 12 and was up 10, 13 m. He flew above the whole field of operations and returned to headquarters with a full report of positions of troops, though the terrain near Bridgeport is very hilly and the same work by other methods would probably have kept a company of scouts engaged for a day. At another time all positions were mapped by aviators of both Blue and White within two hours, while Lieut. Graham, the official photographer, repeatedly took valuable tactical photographs from the air.

### Aerial Oil Engine Sought by Navy

In providing aeroplanes for the fleet the Navy Department will give special consideration to any efficient motor operated by fuel oil. An extra price or premium will be paid to contractors for an engine of this character.

Captain W. Irving Chambers, U. S. N., in charge of aviation in the navy, contends that a fuel oil engine would have distinct and considerable advantages over a gasoline engine for navy aeroplanes.

Aeroplanes with gasoline engines would require a gasoline supply to be kept aboard ship and in time of battle about the first thing done aboard ship would be to throw all the gasoline overboard. Gasoline constitutes a source of danger and is not stored below. Even the gasoline launchers would go overboard before a battle began.

With a fuel oil engine there would always be a ready supply for the aeroplanes aboard ship, and this would continue available even when the ship was in action against an enemy.

In addition to this advantage the fuel oil engine is regarded as more reliable and superior in other respects.

Concerning the engine section of the navy aeroplanes the requirements of the department say:

"The engine section should be a complete unit in itself with a minimum speed, the entire plant being assembled as far as practicable on common rugged foundation which can be readily removed or replaced with minimum disturbance of connections and minimum interference with control and other structural features."

### Beachey Makes Fast Climb in Biplane

At Hammondston recently, Lincoln Beachey in a try-out with a new model Curtiss biplane at the training grounds made a new quick climbing performance by ascending 6,500 feet in fifteen minutes. The descent was made in just one minute.

The Japanese Naval Attache, Commander Takeuchi, who is in Hammondston to inspect aeroplanes recently purchased by the Japanese navy, was very enthusiastic over the exhibition.

### Wright to Build Naval Aeroplane

At the office of the Wright Company in New York it was learned that the Wrights would submit an aeroplane to meet the requirements of the Navy Department. Experiments have already been made with the Wright weight biplane now on trial by the United States Army. This was equipped with floats, converting it into a naval or hydroaeroplane. With a few changes, it is believed, a machine of this type will pass the navy tests. Under the army specifications it was required to carry 450 pounds beside fuel and equipment. George W. Beatty, who is flying the biplane in the army trials, declares that it will carry 1,000 pounds.

In addition the Wrights are building several light scouting machines of one-third less flying surface than the weight carrier, designed to carry aviator alone, climb 600 feet a minute to high altitudes, observing an enemy and the surrounding country and quickly returning to port.

**New Burgess War Plane Passes Army Tests**

The new war plane built by the Burgess Company & Curtis successfully passed the last of its trials on August 8th. This machine is a tractor biplane equipped with a 70-h. p. motor and is the first military machine equipped with detachable floats, to meet the needs of coast defense work as well as inland flying.

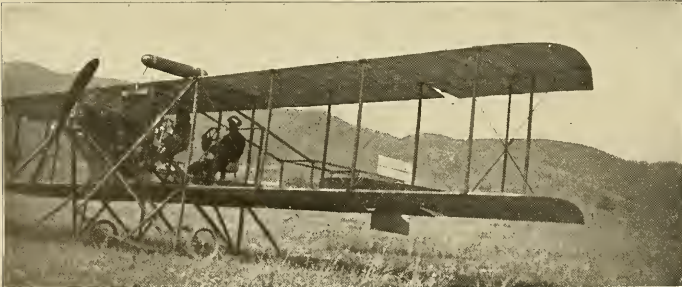

Mr. Floyd Smith and his wife seated in a tractor biplane of his own construction, with which he has been making some very successful flights from the Griffith Aviation Park, California.

The plane used by Smith was built with the assistance of Charles Day. It is equipped with two seats and also a dual control system for operating.

The couple will shortly make a short tour of the Middle West, entering the exhibition field.

On August 5th with Lieut. Roy C. Kirtland and Lieut. Harry R. Arnold present as representatives of the army, the new craft was given its duration tests. Phillips Ward Page kept the machine in the air two hours and four minutes. The army requirement was that the machine remain up two hours.

On August 7th the machine was given its climbing tests rising from the water. The requirements called for the machine to be able to rise 2,000 feet in 10 minutes, that is at the rate of 200 feet a minute. Page was again at the control and got the heavy biplane, with its 450 pounds additional weight, up to 2,050 feet within the time limit.

On August 8th the biplane was successfully put through the final tests of landing in and flying from a ploughed field. At the conclusion of the tests Lieut. Roy C. Kirtland, U. S. A., sent his recommendation to the War Department that the aeroplane be accepted.

**Urges Air Fleet in House**

At Washington on August 1st, Representative Sharp, of Ohio, told the House that the progress of aviation had virtually made helpless the fleets and armies of the world, and urged the appropriation of a liberal sum to establish an aerial fleet for the protection of the United States.

**Flies Over City**

After a flight from Mineola, L. I., across Manhattan, on August 3rd, J. Duratfour, a young French aviator, lost his way among the numerous railway tracks crossing the New Jersey meadows and was unable to find Hahokus, where a crowd of seven thousand waited in vain for his arrival until seven o'clock in the evening.

Duratfour who was driving a Morane-Borel passenger carrying machine, finally spied the hangar in the Kahner Aerodrome, Hackensack, while flying over the town and was welcomed there by Charles Hoefflich, an aviator recently from Mineola.

**Massachusetts Institute of Technology First in Country to Establish Aviation Course**

With A. A. Merrill, a graduate of the Wright school at Dayton, as lecturer, the Massachusetts Institute of Technology has established a course in aviation and aerodynamics. The lectures will begin in September and it is expected will be attended by a large number of special students.

This is the first American college to establish a regular course of this character and the experiment will be watched with a great deal of interest. Mr. Merrill has done very little flying, but he has been a deep student of the science of flight, since the Wright Brothers made their first flights.

On August 5th Tom Gunn, a Chinese pilot, made a biplane flight at Alameda, Cal., with General Lan Tien Woi, formerly in command of the Manchurian army of the Chinese Republic and now in this country to inspect the United States Army.

The general was then called on to give orders to turn and dips, which he did not seem to mind. When he alighted he announced unqualifiedly, that aviation would be introduced in the Chinese republican army. It is not unlikely that Gunn will be the aviator in chief.

On July 31st Lieut. Ellyson tried for the first time a new catapult device for the quick launching of aeroplanes from battleships, without the use of a long and bulky platform.

The catapult is fifteen feet long and is operated by compressed air and is designed to shoot the aeroplane off a small runway at such high speed that it rises almost immediately. At the first trial by Lieut. Ellyson, the catapult shot the Curtiss hydroaeroplane off the vessel so abruptly that the pilot was unable to control the biplane and fell sidewise into the water.

After the attempt Lieut. Ellyson announced that a change would be made in the valve through which the compressed air is applied, so that the propelling force would gradually accelerate rather than shoot out the machine with a sudden impact. He also explained that the slanting wind was a strong obstacle to a successful start.

**Army News**

Lieutenant L. O. Rockwell, U. S. A., who has not received a pilot's license, on July 31st, made fourteen flights at the Army Aviation School, College Park, Md., remaining in the air a total of one hour and thirty minutes. This is the best performance yet made by an unlicensed army officer. Lieutenant De Witt Milling, U. S. A., on successive flights of ten minutes each, treated Major General C. F. Humphreys, U. S. A., retired; Commodore James C. Gimmore, U. S. N., and Mr. C. E. Fiske to the experience of aeroplaning.

At Washington on August 7th, wireless messages flashed from an army aeroplane in full flight were received at a land station fifteen miles away during a test near the government's aviation field at College Park, Md. Lieutenant Benjamin D. Foulois flew the aeroplane and sent the radiograms, which were read at the aerodrome while he was in the clouds fifteen miles distant.

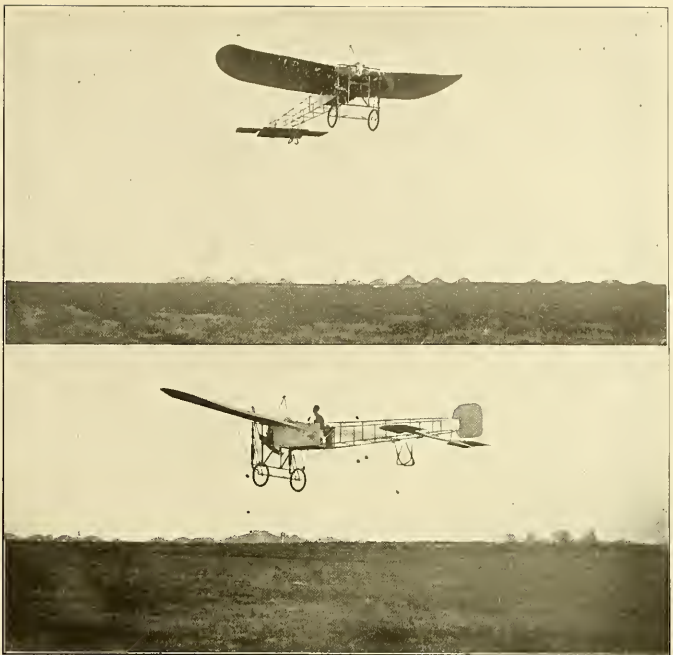

Mr. Frederick C. Hild, one of the directors of the American Aeroplane Supply House, giving actual demonstration tests in one of his American made Bieriot type monoplanes, fitted with a Roberts 4X motor, to prospective purchasers. Mr. Hild taught himself to fly this type of machine.

**Army Gets Baby Wright**

A baby Wright machine was received at the army aviation school on August 3rd and will be tested shortly. It is very small, having but a twenty-six foot spread. The minimum speed of the little machine is placed at sixty miles an hour.

**Mineola and Westbury**

During the past month the historic shed of the Aeronautical Society, which has been the incubator of so many of our successful aviators, was

torn down and removed to the society's new grounds on Staten Island. In spite of the removal of the shed there were several aviators who stayed at the field, these being Capt. Baldwin, Cecil Peoli, Dr. Henry Walden, Frank Fitzsimmons, Joe Stevensen, Oelsen and several Mexican officers, who are learning to fly monoplanes preparatory to taking delivery of several ordered by the Mexican government.

Frank Fitzsimmons, who only recently started in to learn to fly the Walden monoplane, has made great progress, and on August 1st made a cross-country flight around the neighboring towns,

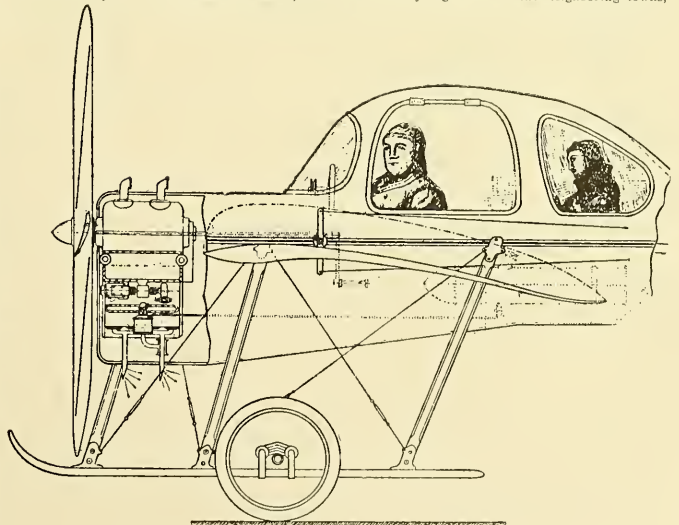

DESIGN FOR AN ENCLOSED MONOPLANE.

at an altitude of 1,000 feet, finishing up with a fine glide. After alighting he handed the monoplane over to William Heina, a Walden pupil, who took the machine out for practice and was flying about 20 feet from the ground when Spanour, who was out practicing in a monoplane of his own construction, stalled his machine in the air while trying to avoid a collision with him, and crashed down on top of his machine. Fortunately neither pilot was injured, although the monoplanes were practically wrecked.

The Walden monoplane is now being rebuilt, and hereafter will be fitted with a flexing rear tail and no front elevator.

Cecil Peoli, the young Baldwin flyer, who only recently returned to the field after giving an exhibition flight in Canada, was busy practicing with his headless Baldwin biplane and incidentally doing instruction and passenger-carrying work.

On August 5th Peoli took up Walter H. Phipps, assistant editor of AIRCRAFT, and made several circuits of the field, rising to a height of 600 feet and finishing up with a spiral and straight glide, terminating in one of the beautiful and easy landings for which Peoli is already becoming famed. Peoli intends to try shortly to break the American one-passenger altitude record and will have as his passenger his mother, who has already flown with him several times.

Joe Stevenson has a new biplane on the field, which was built by Steve Edwards, and is one of the finest constructed machines seen on the field in some time. It is designed with a flexing rear tail and is of excellent design and construction. The machine was first tried out by Peoli, who made a good flight in it, but found that the left side lifted more than the right. Stevenson next tried it, but panicked from a height of twenty feet, breaking an outer wing section.

After fitting a new section and putting the seat further forward, Joe Stevenson on August 5th again tried a flight, but it was apparent that the plane still lifted too much on the left. This was pointed out to him by Frank Fitzsimmons and the writer.

An examination revealed the fact that the left side ailerons were at a slight lifting angle which accounted for the rising of the left side. After the ailerons were adjusted Stevenson again made a test flight, and this time the machine flew beautifully and proved that for flying ability, as well as constructional skill, it is second to none, and should, once it is mastered, give a good account of itself.

#### WESTBURY FIELD.

Since the removal of the Aeronautical Society's

shed from Mineola several of the aviators who formerly stored machines there have moved over to the new field at Westbury, and altogether, with the new machines arriving and the large number already there, things are pretty active at Westbury, and good flying can be seen almost every day the weather permits.

On July 25th Edson F. Gallaudet tried out his 100 H. P. Gnome monoplane "Bullet," which was expressly designed to defend America in the forthcoming Gordon Bennett Aviation Race. A picture and description of this machine appeared in vol. 3, June issue.

Early in the morning, between 4 and 5 o'clock, Gallaudet determined to try the craft. If it successfully demonstrated its ability to fly 100 miles during an hour's continuous flight, the Aero Club of America was to pay the constructor \$10,000 and enter the machine in the Gordon Bennett aviation races.

When the motor was opened up the machine shot away at a terrific pace, and after a very short run rose from the ground at an angle of 75 degrees. At a height of 400 feet Gallaudet managed to right it, but it was apparent that the craft was uncontrollable, for it wobbled in a most alarming manner, and then suddenly dipped sidewise and descended with full power. It struck a wing first, which crumpled up and probably saved the pilot's life, for when he was pulled from the wreck it was found that while he was painfully hurt, none of his injuries were serious. As soon as Gallaudet recovered sufficiently he announced that he would immediately start work on a new machine, but that this time it would be a hydro-aeroplane.

At the Sloane School the pupils have made excellent progress. W. Leonard Bonney now handles the little Deperdussin with exceptional skill, and is getting the 28 H. P. machine up to heights of over 1,000 feet and flying for half an hour at a time. William Irving Twombly has successfully passed his license tests, while J. C. Gilpatrick, W. E. Roberts and T. E. Steptoe are making steady progress in their practice flights.

At the Gressier School there has been quite a bit of activity noticeable during the past month. William Walk, who has been practicing on the Gressier "Canard," came to grief when on July 29th he got caught in a squall which wrecked the machine, but fortunately without injuring the pilot. An unexpected appearance at the school was the Morane Borel monoplane, formerly flown by Mestach. This machine was tried out by Durafour, who experienced difficulty in handling it at the start, but once he got used to it made

some beautiful flights. On August 5th George M. Lyott took out the Gressier Anzani Eleriot and made a very good flight in it.

At the Morok Camp Henri St. Ives, the former Marathon runner, has been making tests with the Anzani tractor biplane.

William Chambers in his Roberts biplane, who formerly was at the Mineola field, and upon the tearing down of the Aeronautical shed flew his machine over to the new field, has not been letting it lay idle, for after making some splendid practice flights there he departed to fill an exhibition date.

Charles Baysdorfer is now flying his speedy little biplane, which is equipped with an eighty h. p. motor, and is handling it well. Peoli first tried it out and pronounced it very fast.

Horace Kemmerle and Walter Strookbine were also very busy practicing on their biplanes during the month, as was also Hild on his Roberts motored A. A. S. H. monoplane.

On Aug. 15 Grover C. Bergdoli, nineteen years old, a law student at the University of Pennsylvania and a member of a wealthy Philadelphia family, accomplished an aeroplane flight with a passenger from Philadelphia to Atlantic City, landing at the lower end of the resort without mishap. His passenger was Charles Krouse, a mechanic.

Bergdoli ascended five miles west of Philadelphia at half-past four o'clock A. M. and maintained a speed of about fifty miles an hour. He reached his highest altitude over Berlin, N. J., thirty miles from Philadelphia, reaching a height of 7,000 feet. The distance was about seventy miles.

J. Hector Warden, who is now a member of the flying corps of the Mexican Army, writes that while returning from his aviation scouting maneuvers, in a trolley car, met with a collision in which nine people were killed and about thirty injured. He says in part:

"We were right in the front end of the car that did the colliding. Everybody around us was seriously hurt and the motorman killed, but as all seats were filled we were standing in the aisle and so instead of being crushed were only thrown to the floor and so escaped with only an assortment of bruises. In the morning of the same day two children were killed on the tracks near the hotel and eighteen rebels were strung up a little ways from here. So you see it was quite an exciting day even for an aviator. Oh, I forgot to mention that two women killed each other in the market place that morning, too."

## PRINCIPLES and DESIGN of AEROPLANES

By HERBERT CHATLEY

A text book on Aeroplanes, containing many details and drawings.

Price, 50 Cents

Lawson Publishing Co.

37-39 East 28th St., New York City

## CHICAGO AERO WORKS

H. S. RENTON 164 North Wabash Avenue  
Proprietor

AEROPLANES ACCESSORIES MOTORS PARTS  
WHEELS HARDWARE PROPELLERS

ALSO MODELS AND MODEL STOCK

ESTABLISHED 1909. First in Chicago and the Middle West

Aviators Taught. Flights Furnished. Send Stamp for Catalog.

## HEINRICH

### Monoplanes and Mono-Biplanes

TUITION, \$250

On Private Field

MADE IN FOUR SIZES

Write for Illustrated Booklet

HEINRICH BROS., Baldwin, L. I., N. Y., U. S. A.

## AERO WIRE WHEELS

BUY FROM MANUFACTURER AND SAVE MONEY

20 x 2 1/2" Wheels—6" Hub—\$4.00 with tire \$6.00

20 x 3" Wheels—6" Hub—4.75 with tire 8.25

FARMAN TYPE Gears complete—Price 42.50

Stock size Hubs—6" wide, 3/8 or 1/2" knock-out axle or bushed to fit 1 1/4" axle—to fit 1 1/4" and 1 1/2" special HYDRO-FLOATS and 34 inch Float Wheels.

Don't fail to write for complete list of Wheels and Prices. We make any size or type.

Deposit required on orders; Balance C. O. D.—examination allowed.

J. A. WEAVER, Jr. 132 West 50th Street  
NEW YORK CITY

## AEROPLANE RADATORS

IN STOCK OR TO ORDER

SEND FOR PRICE LIST EL ARCO RADIATOR CO. 6 EAST 31st St., NEW YORK

# CLASSIFIED ADVERTISING

15 CENTS A LINE SEVEN WORDS TO LINE CASH WITH ORDER

**FOR SALE**

**MUST SELL--FINE MONOPLANE**

1911, cross country type, two seater, Blériot, 100 H. P., engine, hull equipment. A. V. Reyburn, Jr., 5305 Delmar Blvd., St. Louis, Missouri.

**FOR SALE**—Six cylinder Anzani motor, 60-H. P., latest type, good as new, big bargain. Address W. R. O.

**MODEL NIEUPORT** aeroplanes made from scale, are 2 feet long and weigh 3 ounces, equipped with nickel-plated rubber-tired wheels and aluminum fittings with demountable parts; price \$3.50, ready to fly; 2c stamp for particulars. K. A. Pouch, 83 Low Terrace, New Brighton, New York.

**FOR SALE**—Tractor Biplane equipped with 8-cylinder, 60 H. P. motor. Complete exhibition outfit. Owner going to Europe. Price, \$1,800. Address Tractor, c-o AIRCRAFT.

**FOR SALE OR TRADE**—60-horse power, 7 passenger Thomas Flyer touring car, late model. Will trade for good aeroplane. Address S. C. Allen, 1-6 Chase Block, Saginaw, Mich.

**GUARANTEED** genuine Glenn Curtiss aeroplane, good flying condition, pigeon tail, five new extra tires. Will ship for inspection. Big bargain \$275. J. Hays, 307 W. 37th St., N. Y.

**FOR SALE**

**PATENTS BRING WEALTH;**  
proof-books—advice free.  
Low rates, terms easy.

A. Wedderburn, Pat. Atty., Washington, D. C.

**CURTISS** latest improved type (Pigeon tail) 1912 Model. Made over 300 very successful flights 1,000 ft. high, 30 miles cross-country. My construction is strongest in the world. New, complete, ready to fly, tested and guaranteed, including free lessons to buyer, \$2,500. Buy direct from Builder and Aviator of 10 years' experience. H. C. Cooke, Aviator and Builder, 127 West 64th St., New York City.

**POSITIONS WANTED**

**A YOUNG MAN**, age 18, desires position as an aviator's assistant, with prospects of learning to fly. Address Louis Fenouillet, 132 West 47th St., New York City.

**GRADUATE** of Government Training School at Augusta, Ga., and College Park, Md., having Pilot's License, desires engagement for a few exhibitions in September or October as aviator, with prospect of purchasing machine at end of season. Address Lock Box 301, Tiffin, Ohio.

**CO-OPERATION WANTED**

**CAPITAL** wanted to patent and build aeroplane that will fly three hundred miles per hour. Will give 49 per cent. of patents. I will guarantee to fly across Atlantic in twelve hours. Address A. Harbottle, 18 Eldert St., Brooklyn, N. Y.

**AVIATORS WANTED**

**LEARN TO FLY**—\$100 required. Aviators' Exchange, 58 W. Washington Street, Chicago, Ill.

**WANTED**—Licensed monoplane aviator, preferably one who has operated the Nieuport wheel and skid lighting gear type. Address box 765 Aircraft.

**LEGAL NOTICE**

I desire to give notice to all persons that are using my "Patent Rudders" (Serial number 504107 U. S.), also France and England, and my "Semi-Automatic engine control," (Serial number 646300 U. S., France and England), that it is my intention in the future to ask a small royalty from them. Hugh L. Willoughby, Sewalls Point, Florida.

## PATENTS

THAT PROTECT AND PAY  
BOOKS, ADVICE AND SEARCHES FREE  
Send sketch or model for search. Highest References.  
Best Results. Promptness Assured.

**WATSON E. COLEMAN**, Patent Lawyer  
624 F. Street, N. W. Washington, D. C.

## PATENTS SECURED or Fee Returned

Send sketch for free search of Patent Office Records. How to Obtain a Patent, and What to Invent, with list of Inventions Wanted and Prizes offered for inventions sent free. Patents advised free.

We are experts on AIRSHIPS and all patents and technical matters relating to AERIAL NAVIGATION.

**VICTOR J. EVANS & CO.** Washington, D. C.

**"IDEAL" Plans and Drawings**

are accurate and are accompanied by clear, concise building instructions, postpaid at the following prices:  
Wright 3-foot Biplane . . . 25c  
Bleriot 3-foot Monoplane 15c  
"Oceit Feoll" Champion Racer . . . 25c

Curtiss Convertible Hydroaeroplane (new) . . . 35c  
"Ideal" three-foot Racer (new) . . . 15c

Complete set of five-\$1.00 postpaid.  
5 cts. bring our new 40-page fully illustrated Catalog of "Ideal" Model Aeroplane Supplies. (None free.)  
**IDEAL AEROPLANE & SUPPLY COMPANY**  
82-B West Broadway, New York

## J. C. (BUD) MARS, NOW BOOKING

—ADDRESS—

**17 N. La Salle Street, Chicago, Ill.**

## BAMBOO Special Grades of Bamboo for AERONAUTIC WORK

Reed, Rattan and Split Bamboo for Models. All sizes in stock. Tonka Rattan for Skids, 1 1/4 inch and under, any length.

**J. DELTOUR, Inc.**  
804 Jefferson St. Hoboken, N. J.

## GOOD YEAR

AKRON, OHIO  
Goodyear Balloons Aeroplane Accessories  
National headquarters for Spherical and Dirigible Balloons. Built complete. Highest quality. Also makers of Aeroplane Springs, Tires, and the famous Goodyear Rubberized Aeroplane Fabric. Write for booklet.  
**THE GOODYEAR TIRE & RUBBER CO.**  
AKRON, OHIO.

**DETROIT AERO POWER PLANT**

COMPLETE \$300 READY TO RUN  
INCL. PROPELLER-CARBURETOR-BOSH MAGNETO.  
OIL PUMP-CABLE-SWITCH-MOUNTING BOLTS.

IS GUARANTEED TO  
210 LBS. MIN. STATIONARY THRUST  
(58 LBS. MAX. WEIGHT (COMPLETE))  
36 HOURS DELIVERY

LIFT AND FLY  
CURTIS BYPLANES  
BLERIOT II MONOPLANES  
DEMOISELLE MONOPLANES  
OR CRAFTS OF SIMILAR MAKE

**DETROIT AEROPLANE CO.**  
DETROIT MICHIGAN

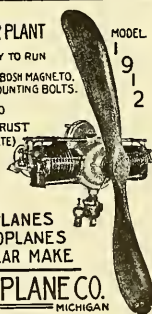

Seventy per cent. of record-breaking American flights with American Aeroplanes were made with propellers bearing this name

# CHARAVAY

WE WILL TELL YOU WHY IF YOU ASK US

**SLOANE AEROPLANE CO. 1731 Broadway, NEW YORK CITY**

AGENTS:

James Trieyck Co., San Francisco and Los Angeles; National Aeroplane Co., Chicago; W. E. Boughton, Washington, D. C.

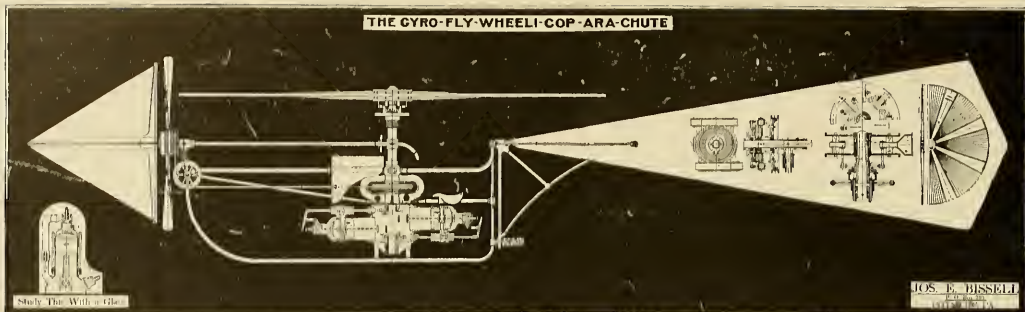

I heard the birdmen call me and I came,  
Nor questioned of the age, nor why, nor where;  
The tides of men I'll bear me— all the same  
I am content to wait— 'till man's to do and dare?

Though bid to journey high o'er Land and Seas—  
Perchance to breast the storms or either Pole,  
My occupants shall neither capsize, suffocate, nor freeze—  
They only needs must guide me, to the goal?

## ALUMINA AEROPLANE FABRIC "LIGHT AS A FEATHER" "BEAUTIFUL AS DAY"

Finest Imported Linen, thoroughly Waterproofed, and then coated with Aluminum. Heat and Moisture proof.

Strongest and Most Durable Aeroplane Cloth on the Market. Our Prices will surprise you.

SEND FOR SAMPLES AND PRICE LIST, AND BE CONVINCED.

## THE AERIAL NAVIGATION COMPANY OF AMERICA GIRARD, KANSAS

### SUPPLIES

Everything appertaining to Aviation. Quality and prices UNBEATABLE. Curtiss and Blériot parts our speciality, also unassorted planes. Road helmets in stock. Send for our 22 page illustrated catalogue.

Wheels with tires, wide hub, K. O. axle. 20" x 2 1/4" \$6.60. 20" x 3" \$9.25.



NEW YORK AERONAUTICAL SUPPLY CO.  
50 BROADWAY, NEW YORK

### Learn to Fly

NOW'S THE TIME.



Flying graduation GUARANTEED. French method instruction; mechanic course. We positively have the only REAL Aviation School; two aviation fields, three factory buildings, aeroplanes, motors, etc., and the LARGEST aviation field in America. Motor, propeller, construction and flying thoroughly taught. Send for a home study course; FREE lesson.

STANDARD AVIATION COMPANY  
1309 Manhattan Bldg. Chicago, Ill.

## COOKE BIPLANES

Curtiss Improved 1912 Type (Pigeon Tail)  
Perfect fliers. No freak construction. Ten years' experience.  
Strongest in the world. Amply powered (Roberts Motors.)

Anybody can fly these machines. One ready for immediate delivery. \$2,500

Curtiss Type Planes, no Power Plant, \$650 and up  
Free Instruction to Buyer

H. C. COOKE, 127 West 64th St.

NEW YORK CITY

CAPT. BALDWIN has just returned from his SECOND tour around the world with an aeroplane, without any serious accident, during his exhibitions.

Always using the

### "Willoughby Patent Double Rudders"

for steering his machines.

The safety of this method of steering (in the vertical plane) has been demonstrated without a doubt.

## GIBSON PROPELLERS

Did you read our "Bargain Day" ads in June? If not you lost one chance to save money.

But here is another. Not so many now. Only 53 in stock. It is up to you. We are doing our best for you and aviation.

### LIST OF SIZES IN STOCK AND PRICES FOR ONE MONTH ONLY

Dia.	Pitch	Rot.	Type	Price	Dia.	Pitch	Rot.	Type	Price
9"	7" or 6"	R	Reg.	\$50.00	9 1/2"	7 1/2"	R	B Gnome	\$47.50
8 1/2"	5"	L	Helice N	47.50	8 1/2"	4 7/8"	L	Farman	45.00
8 1/2"	5 3/4"	R & L	Gnome	45.00	8 1/2"	4"	R	Reg.	45.00
8"	5"	R & L	Reg.	45.00	8"	4 1/2"	L	"	45.00
8"	4"	L	"	45.00	7 1/2"	6"	R	"	40.00
7 1/2"	5"	R	"	40.00	7"	6"	R	R	35.00
7"	5"	R & L	"	35.00	7"	4"	R & L	"	35.00
7"	3"	R & L	"	35.00	6 1/2"	3 3/4"	L	Anzani	32.50
6 1/2"	2 1/2"	R	Anzani	32.50	6 1/2"	4 1/2"	R	Reg.	30.00
6 1/2"	4"	R	Reg.	30.00	6"	4"	R	"	30.00

Any other sizes to order. Pick out your sizes and state the rotation desired. Send the money and propellers will be shipped the same day if still in stock. We have proved our standing. Our propellers are the acme of accuracy and strength.

CASH OR MONEY ORDER GETS YOUR PROPELLER TO YOU QUICKER

Gibson Propeller Co.

Fort George Park, N. Y. City

## COMING EVENTS

Cast your shadow towards the

### "KING OF ATTRACTIONS"

**HARRY BINGHAM BROWN**

ELEVATING

ENGLISH PILOT

**FREDERIC RODMAN LAW**

In his **WRIGHT AEROPLANE** to a height of 4,500 feet, disposing of his human freight at a dizzy height, who descends by the aid of a parachute.

Every click of the watch a "**THRILLER**," something worth going miles to see.

No other act like it in the **WORLD**.

**MANAGERS BOOKING** will do well to address

**A. LEO STEVENS, Box 181 Mad. Sq., N. Y.**

## BENOIST BIPLANES

TYPE XII.

Three Models

School Machine

Cross Country Machine

Military Machine

Also operate the

**Benoist School of Aviation**

For further particulars address

**BENOIST AIRCRAFT CO.**

6630 Delmar Blvd., St. Louis, Mo.



## WHY?

THE REMARKABLE  
EFFICIENCY OF THE

**Wright & Gnome  
MOTORS**

One has a Flywheel

The other is a

That means elim-

ination of prop-

eller "flutter-

ing" and a great

saving of power.



3-99 Baldwin Ave., Detroit, U. S. A.

But you don't

have to buy a Gnome or carry a 40 lb. flywheel to get that wonderful flying efficiency.

## DIANA SPIRON

will give it

## ALBATROSS ENGINES

MADE IN TWO SIZES

**50 H. P. 6-cyl. Aircooled**

Weight 250 lbs. Price **\$650.00** complete

**100 H. P. 6-cyl. Watercooled**

Weight 300 lbs. Price **\$850.00** complete.

CATALOG FREE.

AGENT'S WANTED

**ALBATROSS CO., Detroit, Mich.**

ACCESSIBLE QUIET ELEGANT

For Business Men, Families and Tourists

THE

# SOUTHERN HOTEL

54th Street, near Broadway

## NEW YORK

FIREPROOF

MODERN

PERMANENT AND TRANSIENT

In the heart of the theatre and shopping district.

Cars pass the door for all railroad stations.

Parlor, Bedroom and Bath, \$3.50, \$4 per day and up.

Single Room and Bath, \$1.50, \$2.00 per day and up.

Double Room and Bath, \$2.50, \$3.00 per day and up.

Special Rates by the Week

Restaurant a la Carte

European Plan

**J. G. VENETOS, Proprietor**

SEND FOR BOOKLET

## AVIATORS WANTED



TO COMPETENT  
GRADUATES WE  
FURNISH A STAND-  
ARD-TYPE AERO-  
PLANE PRACTICAL-  
LY WITHOUT COST

We Are the  
Real West-  
ern Pioneers

**WE TEACH  
FLYING ON  
(CURTISS, FARMAN, BLERIOT)  
MACHINES**

NO BREAKAGE CHARGED

We manufacture any type Aeroplane and make a specialty of Hydro-Acroplanes. All our machines are **GUARANTEED TO FLY** and guaranteed as to material and workmanship.

Home Study Course (Theory and Aerodynamics). Construction Course (Aerial Engineering). Aero-Motor Course. Flying Course. Our Basic Patents give us protection.

Our prices are the lowest. Full and honest value. Flying exhibitions booked for coming season.

Send for our Special Offer No. 2 to-day.

**Milwaukee School & College of Aviation**

S. E. Cor. Grand Avenue and Fifth Street MILWAUKEE, WIS.

School-Shops, Hangars, Flying Field, foot of 6th Ave., West Allis, Wisconsin.

\$1200 to \$4800

THE  
**REX**  
MONO-  
PLANE  
CO.

South  
Beach, S. I.  
N. Y.

DUPLICATE PARTS  
at  
**COST**

SAVE  
50%

SAVE  
75%

## Buy a REX Monoplane and Save

\$500 to \$1000 on Purchase.  
\$250 Tuition Fee to Learn to Fly.  
50% to 75% on Maintenance.

We Supply an Extra Pair of Racing Wings  
with each REX.

We Duplicate Parts at Absolute Cost, a  
Saving of 50% to 75% in Maintenance.

The REX, with its interchangeable wings, makes it possible to enter Speed, slow and passenger contests during the same day. **WHAT OTHER AEROPLANE CAN DO THIS?** Remember, we **Guarantee Before** delivery to fly the REX at **Least 1000 Feet High and 10 Miles** across country.

THE REX MONOPLANE CO.

South Beach, S. I., N. Y.

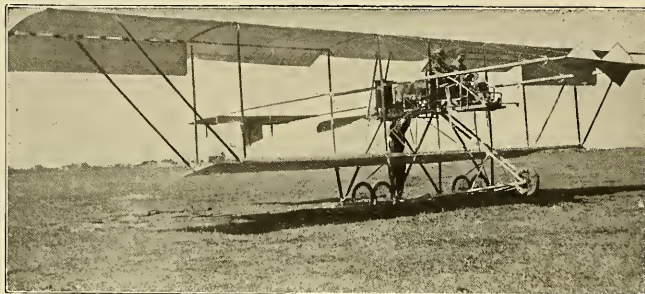

Showing double control school machine built in our Chicago factory. Width 52 feet.

**A** NATIONAL  
AEROPLANE  
COMPANY  
606 South Michigan Avenue, Chicago  
Harvester Building

Manufacturers  
Exhibitors  
School of Aviation

**REFERENCES:**

Dun or Bradstreet  
Corn Exchange National Bank, Chicago

## WIRE

Aviator Wire supplied in 12 sizes with a plate finish, making soldering easy. This wire is specially drawn from extra quality high grade steel. Also Aviator Cord of twisted wire.

**John A. Roeblings Sons Co.**  
TRENTON, N. J.

## BALDWIN

**VULCANIZED PROOF MATERIAL**

For Aeroplanes, Airships, Balloons. First Rubberized Fabric on the market. Lightest and strongest material known. Dampness, Heat and Cold have no effect. Any Strength or Color.

**"RED DEVIL" AEROPLANES**

That anyone can fly. Free Demonstrations.

**HALL-SCOTT MOTORS**

Eastern distributor, 40 h. p. 4-cyl.; 60 and 80 h. p., 8-cyl., on exhibition at Frank Schumacher's, 164 W. 46th Street, New York. All motors guaranteed. Immediate delivery.

**EXPERTING**

Will install a Hall-Scott free of charge in anyone's Aeroplane and demonstrate by expert flyer. Expert advice. \*Planes balanced.

CAPT. THOMAS S. BALDWIN  
Box 78 Madison Sq. P. O., New York  
**AEROPLANES**

## HOTEL CUMBERLAND

NEW YORK

Broadway at 54th Street



Headquarters for Avi-  
ators and Automobilsts.

*New and Fireproof*

Strictly first class.  
Rates reasonable.

**\$2.50**  
With Bath  
and up

Send for booklet.

Ten Minutes' Walk to Thirty  
Theatres

**H. P. STIMSON**

Formerly with Hotel Imperial



# "ROOLD"

FOR SAFETY HELMETS  
AVIATION SUITS  
UNBREAKABLE GLASS GOGGLES

*"EVERYTHING FOR THE AVIATOR"*

50 Avenue de la Grande Armee, PARIS

Official Contractors to the French and Russian Armies

# NAIAD Aeronautical Cloth

Manufactured Especially for Aeroplanes and Used by  
Aviators of Prominence  
LIGHT, STRONG, AIR-TIGHT

AND  
MOISTURE-PROOF ON BOTH SIDES

Sample Books, including Data and Prices, sent on request

THE C. E. CONOVER CO.

101 Franklin Street - - New York

## New Weston Hotel

MADISON AVENUE AT 49th STREET  
NEW YORK

Modern fire-proof and high class hotel in every respect. A quiet and convenient location, one block from 5th Avenue. Near theatres, clubs and select department stores.

### Special Summer Transient Rates :

Large Single Outside Room	- - - -	\$1.50
Large Single Outside Room and Bath	- - - -	2.00
Large Double Outside Room and Bath	- - - -	3.00
Parlor, Bedroom and Bath	- - - -	4.00

Restaurant a la Carte Moderate Prices

GEORGE L. SANBORN, Proprietor

Formerly Hotel Cumberland and Hotel Navarre

## Official Aeronauts for the CHINESE ARMY AND PRACTICAL AVIATORS

WE MANUFACTURE AND DEAL IN

AEROPLANES, MOTORS AND  
ALL AERONAUTICAL SUPPLIES

Everything an Aeronaut needs and wants we can furnish  
at lowest prices. We guarantee everything we sell  
Send 5 cents in stamps for Catalogue

## WOLVERINE AERONAUTIC CO.

Office and Factory : Detroit, Mich.

# ... The Wittemann Biplane ...

HAS A REPUTATION, NOT ONLY FOR PACE, BUT FOR QUALITY AND SERVICE

Write for information of 1912 Biplane with our new auxiliary stabilizer.

If you want to build a machine of your own design or parts thereof, we can help you to make it successful. Some parts of your plane can be made of steel. We rid you of the annoyance of constant repairs and insure absolute safety.

Send us your specifications and requirements and secure our quotations.

Large stock of steel fittings, laminated ribs and struts of all sizes carried in stock.

Own a Wittemann Biplane Glider; the best, the safest, easiest to operate, and enjoy flying in a moderate form.

## YOUR OPPORTUNITY

Two single cover biplanes for immediate delivery; slightly used, perfect condition with 8 Cyl. 60 H. P. Hall Scott power plant.

Write for Particulars.

Write for Catalogue.

## C. & A. WITTEMANN

Aeronautical Engineers

The Oldest aeronautic manufacturing concern in the United States.

Established 1906.

Works: Ocean Terrace and Little Clove Road.

Staten Island

New York

## INVESTIGATE FIRST

Satisfy yourself you are dealing with a responsible concern before paying your money.

**WE GUARANTEE** our machines, workmanship, materials, etc., superior to those of any other constructed here or abroad regardless of price paid.

Immediate and prompt delivery on standard machines.

"Nieuport," "Bleriot," "Farman" and "Curtiss" types. Hydroplanes; speed, single, passengers, weight-carrying, or specially constructed to your own design and specifications.

"Complete with suitable power plant purchaser selects or prefers, demonstrated in flight." "Complete without power plant," or "Complete in the Knockdown." Will accept orders on specified time delivery under forfeiture.

We invite your personal inspection of the best equipped plant in the U. S. All types in course of construction. Unexcelled opportunity to acquire full shop, construction and flying course, on any type Monoplane or Biplane.

*SEEING IS BELIEVING. CALL IF POSSIBLE OR WRITE.*

## INTERNATIONAL AERONAUTIC CONSTRUCTION CO.

Factory, Hollis, L. I.  
Main Line L. I. R. R.

Office, P. O. Bldg.  
Jamaica, N. Y. City

Flying Grounds  
Nassau Boulevard

## GRAY EAGLE MOTORS

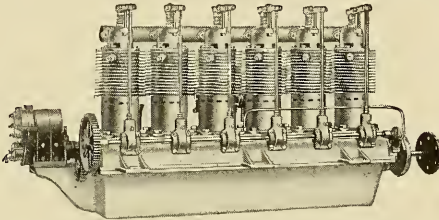

Are in a class to themselves. The air cooled motor is in demand for aviation power plants because it means less weight and less resistance for your plane with the bother left out. The use of pumps, connections, radiator and water not necessary. Let us convince you of the merits. Economy of fuel. Efficient in power. Strength and reliability. Moderate price. Write for particulars.

### TWO MODELS

Model E - 6 - 50 H. P.

Model D - 4 - 35 H. P.

\$675.00

\$485.00

**Kemp Machine Works**

- - -

**Muncie, Indiana**

# BLERIOT MONOPLANES

(GENUINE)

**Winners of ALL the European Contests in 1911**

In 1909--The First Aerial Crossing of the Channel.

In 1910--The "Circuit de l'Est."

In 1911--The Paris-Rome Race (1st and 2d.)

The European Circuit (1st and 2d.)

The English Circuit (Daily Mail Race.)

The Belgian Circuit.

The Saint Petersburg, Moscow Race.

The Valencia Alicante Race.

The London to Paris non-stop Raid, etc., etc.

**WORKS AND OFFICES: - - 39, Route de la Révolte à Levallois - - PARIS**  
**and Belfast Chambers, 156 Regent St., LONDON**

FRANCE

**AVIATION SCHOOLS: Etampes, near Paris during Summer**  
**Pau, during Winter**

ENGLAND

**Hendon, near London**

# THE CURTISS SUMMER TRAINING SCHOOL AT HAMMONDSPORT, NEW YORK



ONE OF THE CURTISS TRAINING GROUNDS

**New Hangars, New Equipment, Experienced Instructors.**

**Aeroplane and Hydroaeroplane Courses.**

*The Curtiss Schools are the largest in America.*

*Seventeen pupils obtained their pilots' licenses at our San Diego School between January first and March fifteenth.*

*Summer classes are filling rapidly.*

**WRITE OR WIRE YOUR ENROLLMENT TODAY**  
*PRICES AND PARTICULARS UPON REQUEST*

*Largest  
Builders of  
Complete  
Aeroplanes  
in the world*



**ALL NATIONALITIES ARE REPRESENTED AT THE CURTISS SCHOOLS**  
(One of the Graduating Classes.)

**THE CURTISS AEROPLANE CO.**  
**HAMMONDSPORT, NEW YORK**



FREDERICK C. HILD IN AMERICAN BLERIOT 4-X ROBERTS

# WHY PURCHASE EXPENSIVE MOTORS?

A Roberts 4-X fifty H. P. motor flies this monoplane, and it will fly yours. It weighs no more in flying trim than a revolving motor. Let us give you the figures to prove this.

## Read what Mr. Hild Says About the Roberts :

THE ROBERTS MOTOR COMPANY,  
Sandusky, Ohio

August 8th, 1912.

Gentlemen: Having recently installed one of your 50 H. P. Roberts Motors in one of our single seater Bleriot type monoplanes used as a [School Machine, we have found the motor very efficient and satisfactory just as we have other Roberts Motors that we have installed in our cross country type single seaters and passenger carrying monoplanes.

We are enclosing several photographs showing our monoplane in flight, the speed of which averages 65 miles per hour, which is far more than we had expected.

Very truly yours,

AMERICAN AEROPLANE SUPPLY HOUSE,

Per (F. C. Hild)

FCH-K

SEND FOR OUR HANDSOME 36-PAGE CATALOG TO-DAY

# THE ROBERTS MOTOR COMPANY

1463 Columbus Avenue

Sandusky, O.

# AIRCRAFT

Vol. 3 No. 8

OCTOBER, 1912

15 Cents a Copy

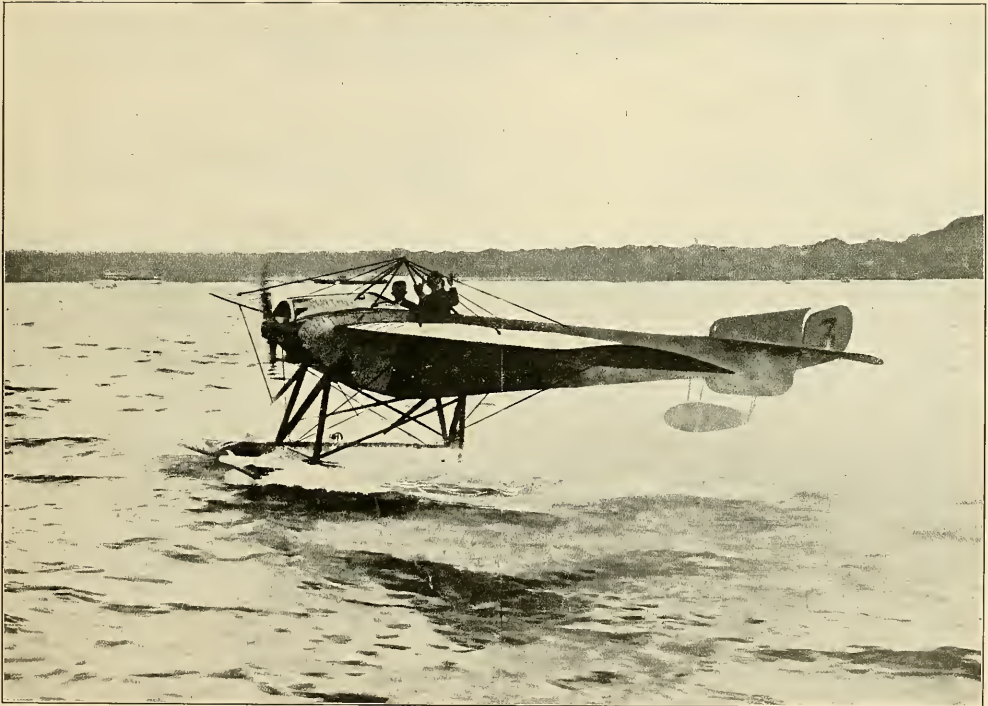

ONE OF THE LATEST EUROPEAN WATER-BIRDS

Weymann and a passenger just alighting on a 100 H. P. Nieuport hydro-aeroplane after winning the St. Malo-Jersey race, in which event he beat his nearest competitor by more than 30 minutes. It will be noticed that the machine has been fitted with two vertical fins in the rear, presumably to steady it while in the water and also to swing it around into the wind when struck by severe side gusts.

# Monoplane Flyers Are in Demand

There are more competent biplane flyers than there are positions for their services. There are less good monoplane flyers than there are positions. This is the time to earn the big money in flying monoplanes. In exhibitions the monoplane commands from 70 to 100 per cent. more compensation than the biplane. In the

## SLOANE SCHOOL OF AVIATION

monoplane flying is taught on a genuine famous Deperdussin Machine. The course is an exact duplicate of the course given by the Deperdussins at Rheims. The tuition fee is

### Deperdussin Monoplanes

are the safest and most efficient flying machines in the world. Hold 90 per cent. of the world's records.

### Caudron Monoplanes

are safe and tremendously speedy. Best for exhibitions.



70 H. P. DEPERDUSSIN FOR ONE OR TWO PASSENGERS

### Anzani Motors

hold the unique record of giving tremendous speed, reliability, efficiency and safety. No fatal accident during the year has occurred with an Anzani Motor

# \$300

for the full course. If the pupil completes the course without breakage 10 per cent. of the tuition fee is refunded. A guarantee of \$250 for breakage is required. The pupil is made competent to comply with the most rigid license test.

**No bond of any kind is required when the pupil flies for his license.**

Of the seven pupils who entered the school during the first month one was certified as proficient after three weeks of the course. He finished without any breakage whatsoever. It is an every-day occurrence for pupils in our school to fly over 15 minutes and at an altitude of 1,000 feet.

Visit the school. It is located on the famous Long Island flying field near New York.

WIRE

'PHONE

WRITE

# SLOANE AEROPLANE CO.

1731 BROADWAY, N. Y. CITY

'Phone 5421 Columbus

Agents Eames Tricycle Co., San Francisco and Los Angeles; W. E. Boughton, Washington, D. C.

# "LUMINA"

## AEROPLANE CLOTH

(SYSTEM CONTINENTAL)

### SIGHTLY

AND

### SERVICEABLE

### HIGHLY PRAISED

BY THE CURTISS AEROPLANE CO.

Hammondsport, N. Y., Aug. 31, '12

The B. F. Goodrich Co.  
Akron, O.

Gentlemen:

We take this opportunity of advising you of the complete satisfaction which we have received from the use of your "LUMINA" cloth.

We find the cloth is exceptionally easy to apply to the aeroplane frames and is particularly unaffected by the atmosphere. This cloth has been used on several of our instruction hydro-aeroplanes, and after two or three months of severe service the cloth appears as clean and taut as when new. In fact, the boys at the school have a habit of running the machines out in the rain to wash them off.

We heartily recommend it.

Yours very truly,  
THE CURTISS AEROPLANE CO.

(Signed) H. C. GENUING,  
Vice President and Mgr.

Send for Booklet and Samples

**THE B. F. GOODRICH CO.**  
AKRON, OHIO

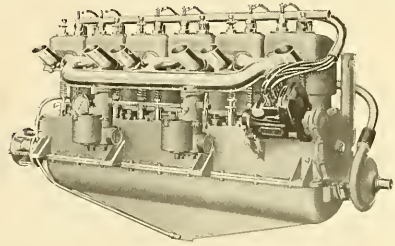

Ten weeks of daily service in a Hydro-Aeroplane at the training school of Burgess Company & Curtis, Marblehead, Mass., is the record of a four-cylinder

## Sturtevant

REG. U. S. PAT. OFF.

### Aeronautical Motor

Although subjected daily to the exceptional strain of use in a school machine, carrying passengers and being handled by novices, this motor is to-day giving the same never-failing service that it did when first installed.

All standard Burgess-Wright Biplanes and Hydro-Aeroplanes are NOW EQUIPPED WITH STURTEVANT MOTORS. These motors being fitted with muffler and starting crank for starting the motor from the seat.

4-cylinder 40 H. P.      6-cylinder 60 H. P.

Ask us for a catalog 200-P.

## B. F. STURTEVANT COMPANY

Hyde Park

Boston, Mass.

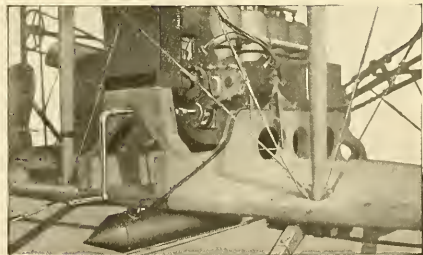

## FRONTIER MODEL A

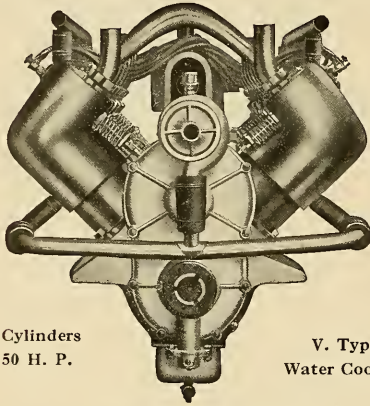

8 Cylinders  
50 H. P.

V. Type  
Water Cooled

Four and three quarter lbs. per actual Horse Power

# Simple Reliable Durable

Reliability and durability coupled with minimum weight, consistent with absolute safety, are the important points of superiority combined in the FRONTIER Aero Motor of quality.

Our claim for distinction lies in the unique and well balanced design and the mode of fuel supply, giving equal and never-failing power for all altitudes and temperatures.

Embodied in its construction are these essentials:

- Highest grade of workmanship.
- Best materials.
- Experienced and capable engineers.
- Perfect shop equipment for manufacture.

Catalog and Price List on Application

**E. J. Willis Co.**

85 Chambers Street, New York Agents

**Frontier Iron Works**  
BUFFALO

## Wright Hydro-Aeroplane School Now Open at GLEN HEAD, L. I.

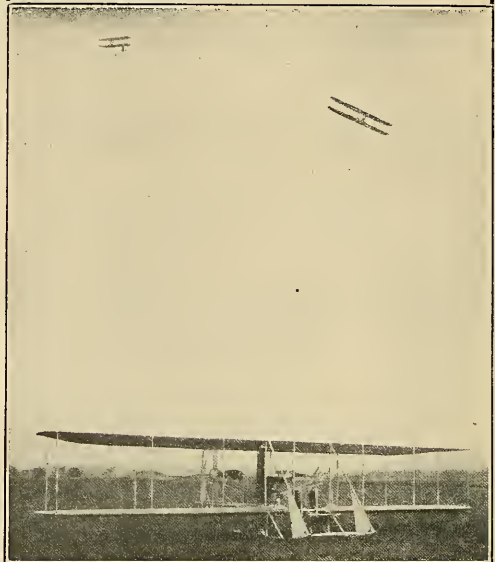

# Wright Flyers

## 1912 MODELS

In addition to those features which in the past have made Wright Flyers famous for efficiency and reliability, the new models can be furnished with **Automatic Control, Silent Motors, and Hydro-planes.** These special features make the 1912 machine unusually attractive to sportmen.

## EXHIBITION MACHINES

For exhibition work we have other models especially adapted to high winds and small fields. It was with a stock "EX" Model that Rodgers made his wonderful flight from coast to coast. Reliability means dollars to the exhibitor.

## WRIGHT SCHOOL OF AVIATION

Training consists of actual flying, in which the pupil is accompanied by a competent teacher. No risks and no expense whatever from breakage. The most famous flyers in America are graduates of our school and include such names as

Lieut. Arnold	Drew	Lieut. Rodgers
Atwood	Elton	Parmalee
Brookins	Lieut. Foulis	Page
Brindley	Fowler	Reynolda
Bonney	Gill	Simmons
Beatty	Lieut. Lahm	Turpin
Burgess	Lieut. Milling	Welsh
Coffyn	Mitchell	Webster
Capt. Chandler	C. P. Rodgers	and many others.

Our Schools at Dayton and New York are now open and pupils may begin training at once if they wish. By enrolling now you can reserve date most convenient to you for training. Write for particulars.

**THE WRIGHT CO.**  
Dept. "B" DAYTON, OHIO





Farman Running Gears Complete as Above \$47.50

**Aeronautical Supplies**

Everything to build any type flying machine

New catalogue with working drawings of Curtiss, Farman and Bleriot type machines, now ready for distribution and will be mailed free upon request to all interested parties. Write for quotations.

**A FEW IMMEDIATE DELIVERY PRICES**

- Curtiss Seats - \$5.50
- Oval Post Sockets - \$0.17
- Curtiss Steering Wheels - \$9.00
- 5 Gallon Tanks - \$6.15
- Out Rigger Fittings - \$0.29
- Aluminum Pulleys with Brass Bushings 2" - 2 1/2" - 3" - 25c., 30c., 40c.
- Aviator Caps - \$1.25
- Wheels and Tires complete Eclipse Hub 20 x 2 1/2" - \$6.75
- 20 x 3" - \$9.50

Free with every \$50.00 order for Aeronautical Supplies

**FLEECE LINED AVIATOR CAP**

**E. J. WILLIS CO.,** 85 CHAMBERS STREET  
67 READE STREET  
Tel. 3624 Worth NEW YORK CITY

**BLERIOT MONOPLANES**



One of our 1912 Single Seater Monoplanes, equipped with 50 H. P. Roberts Motor. Price as illustrated, \$2,100.

**IMMEDIATE DELIVERIES**

Our BLERIOT TYPE MONOPLANES are in every way suited to contest and exhibition work, including speed, altitude, distance and duration, cross-country and cross-city flying, where thorough reliable strength and high efficiency are so vitally important.

**WE SOLD MORE SUCCESSFUL BLERIOT TYPE MONOPLANES IN 1911 THAN ALL OTHER MANUFACTURERS COMBINED**

Visit our factory and examine in detail the EXCELLENT DESIGN and CONSTRUCTION of our Monoplanes

ILLUSTRATED CATALOG FREE. SEND FOR IT TO-DAY

**American Aeroplane Supply House**  
137-143 Jackson St. Hempstead, L. I., N. Y.  
Telephone 427 Hempstead

4, 6 & 8 CYL.

50, 70, 75, 105 & 140 H. P.

**RENT FOR HALF YEAR**

Under Our 6 Months' Credit Plan

Get details and Airman's Catalog **NOW**

MAXIMOTOR MAKERS  
DETROIT  
52 CRANE AVENUE

DEPT. 22

**MAXIMOTOR**

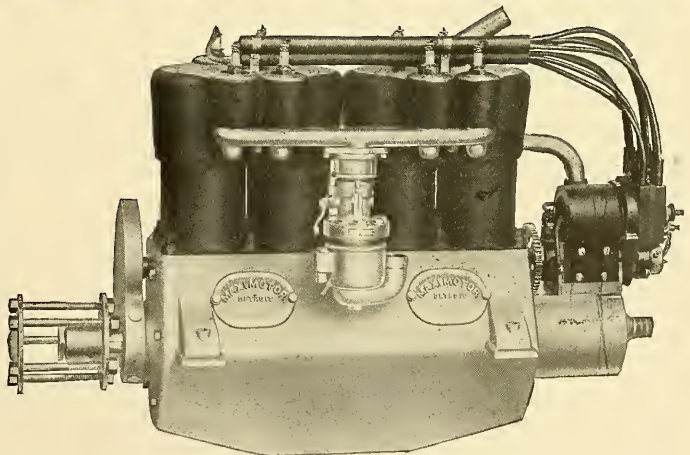

SIDE VIEW OF ENGINE ONLY

# THESE MEN MADE *Aircraft*

## The Greatest Aeronautical Magazine on Earth

They furnished the bone and sinew of the first three volumes of *Aircraft*, making them a work of reference of which none other extant is comparable.

This list not only includes the greatest Aeronautical writers in the world, but also the very greatest Aeronautical Scientists, Aeronauts, Aviators and Aeroplane and Balloon Builders as well.

### *These are the Contributors to AIRCRAFT*

Hudson Maxim	Clement Ader	Hon. George von L. Meyer (Sec'y of U. S. Navy)
A. Lawrence Rotch	Horace Geigh Hopkins	S. R. Brustmann
Denys P. Myers	Wm. F. Turnbull	Will Simmons
Sir Hiram Maxim	E. L. Buchanan	D. E. Connor
Louis Paulhan	H. A. Toolman	Van M. Griffith
Hiram Percy Maxim	H. La V. Twining	Baron Ladislas d'Orcy
Israel Ludlow	John M. Crowley	A. Heinrich
G. F. Campbell Wood	Claude Grabame White	Theo. H. Gibon
Walter H. Phipps	D. E. Ball	A. P. Herff
Edward H. Young	John Jay Ide	Emil Buerger
James S. Stephens	Henry A. Wise Wood	W. Nicholson Jennings
Hugo C. Gibson	Philip P. Baldwin	James E. Flew
C. G. Grey	Major S. Reber	Ernest Ohrt
John G. Hanna	Allred W. Lawson	Professor David Todd
Louis Bleriot	Cortlandt Field Bishop	H. O. Eiane
Arthur Wiener	T. R. MacMechen	D. W. Starrett
Robert Esnault Pelteric	Thomas Preston Brooke	Earle L. Ovington
Glenn H. Curtiss	Louis Breguet	A. F. B. Silvanetto
Augustus Post	S. H. Paterson	Lee S. Burridge
Brig.-Gen. James A. Allen	Henry Woodhouse	Wright Brothers
William R. Rummler	James V. Martin	Melvin Vaniman
Gustave R. Thompson	R. H. Blaque	Capt. W. Irving Chambers (U. S. Navy)
Charles K. Hamilton	Ladis Lewkowicz	Albert Adams Merrill
R. E. Honeywell	Philip Wakeman Wilcox	
Henry L. Call	A. Leo Stevens	
Hugh L. Willoughby		

☐ Bound in book-form and ready for the library table or shelves of individual or association, two volumes of AIRCRAFT are offered as a solid entity of incomparable value to the student of, and to the enthusiast in, matters aeronautic.

☐ As an ornament for any booklover's delectation, as well as a monument to the birth and to the lightning-like development of human flight, and as a faithful reflection of its intricate and amazingly-rapid history, these volumes of America's great magazine of aerial navigation, valuable as they are now, will in years to come, when travel by air has reached as advanced a stage as that by water has to-day, constitute an hereditary asset—literary, historical, scientific—of unique worth.

☐ It is "VOL. 1 and 2" of an Aeronautical Encyclopedia.

☐ A Reference which any library or club cannot afford to be without; one which every thinking individual requires for the accuracy and completeness of his information on the latest triumph of the genius of Man.

☐ The number of copies available for sale is very limited, owing to the scarcity of one or two of the numbers.

Price per copy, delivery to any part of the United States, prepaid:

Cloth Bound, \$3.50 Each Volume.

## THE LAWSON PUBLISHING COMPANY

37-39 EAST 28th STREET, NEW YORK, U. S. A.



The above picture shows Jules Vedrines and two views of his 140 H. P. Gnome motored Deperdussin monoplane in flight while winning the Gordon Bennett International Cup Race, at Clearing, near Chicago, Ill., on September 9th, 1912. Vedrines covered thirty laps of 4.14 miles each, or 124.8 miles altogether in 1 hr. 10 mins. 57 secs., or at the average speed of 105.5 miles an hour.

The left hand picture shows him going straight along the course while the right hand picture shows him turning at one of the pylons. The winning of this race makes Vedrines the world's champion and entitles the Aero Club of France to hold the world's championship trophy—the Gordon Bennett Cup—until won by some other country next year or after.

### CONTENTS—OCTOBER, 1912

Working With Nature . . . . .	T. R. MacMechen	239
Collisions of the Air . . . . .	Denys P. Myers	240
Some Leading Types of Hydro-aeroplanes and Aeroboats (Illus.) . . . . .		241
Editorial . . . . .		242
Structural Requirements for Safety in Ballooning . . . . .	Major Samuel Reber	244
Specific Gravity Tables on Hydrogen and Coal Gas . . . . .		245
The Chicago Meets . . . . .	S. R. Brustmann	246
Pictures—Chicago Meets . . . . .		247
Foreign News . . . . .	R. H. Blanquie	248
German News . . . . .	Stella Bloch	250
Working Drawings of the Nieuport Monoplane . . . . .		252
Some Facts Concerning the Nieuport Monoplane . . . . .	W. H. Phipps	253
General News . . . . .	D. E. Ball	253
Table of Machines in the Cicero Meet . . . . .		255

## AIRCRAFT

ALFRED W. LAWSON  
President and Treasurer  
ERNEST C. LANDGRAF  
Secretary

Published Monthly by The Lawson Publishing Company  
37-39 EAST 28th STREET, NEW YORK, U. S. A.  
Telephone, 5017 Madison Square

ALFRED W. LAWSON  
Editor  
WALTER H. PHIPPS  
Asst. Editor

#### TERMS TO SUBSCRIBERS

In the United States, Mexico, Puerto Rico, Guam, Philippine Islands, Hawaiian Islands, Cuba (including Postage), \$1.50 per year.  
Fifteen Cents the Copy, of All News Dealers.  
Foreign Subscriptions, Two Dollars per year.  
In changing order give old as well as new address.  
Advertising copy must be in hand by the 1st of month previous to date of publication.  
Only high-grade advertisements of thoroughly reliable firms are solicited.

#### WHEN YOUR SUBSCRIPTION EXPIRES

One month before a subscription expires we enclose a renewal blank on which you will write your order for the renewal.  
WHEN FIRST NOTIFIED that your subscription will expire, you should send your renewal AT ONCE, in order not to miss a number. New subscriptions which are received by us on or before the 15th of any month will begin with the issue of that month. If received after that date they will begin with the following month's issue. We cannot enter subscriptions to begin with back numbers. One month's notice is necessary before a change of address can be made.

Entered as "second-class matter" February 18, 1910, at the Post Office, at New York, N. Y., under Act of March 3, 1879.  
Copyright, 1912, by the Lawson Publishing Co.

"Aircraft" is registered as a trade-mark by the U. S. Patent Office, under date of August 9th, 1910.

# AVIATORS

## Will You Make Money?

---

*USE*

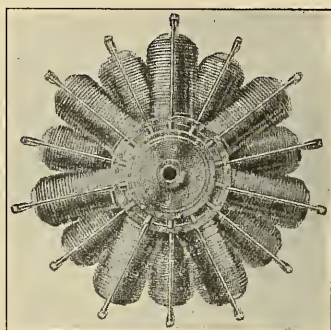

# GNOME

*HOLDS ALL WORLD RECORDS*

---

**AEROPLANES, MOTORS & EQUIPMENT CO.**

1780 Broadway

NEW YORK

Tel. Columbus 1335

---

=====**IMPORTERS**=====

# AIRCRAFT

Vol. 3. No. 8

NEW YORK, OCTOBER, 1912

15 CENTS A COPY  
\$1.50 A YEAR

## WORKING WITH NATURE

By T. R. MACMECHEN



THE all important feature of commercial air navigation has been established during the past year. It is simply the utilizing of Nature's forces to do most of the motive work of travel as migrating birds invariably do.

The migrating bird never starts on a long flight over the ocean except when the sequence of weather changes ensures great carrying winds. This has been proven by rigid investigation made by German naturalists during the past two years. The plover itself is not strong enough to fly a distance of 2,500 miles over the Atlantic ocean. Over the open sea, it has nothing but sight to guide it, and sight alone is not sufficient; but its sense of smell and feeling enables it to remain in the wind with which it started. The winds alone both carry and guide the bird.

During storm periods uniform currents of air travel great distances in nearly a straight line. Now, since the bird travels in them; what is to prevent an aircraft from travelling in them, just as a boat drifts down a stream of water.

The best students of bird craft now admit that the winds alone explain how the migrating bird covers these great distances in single flights. They do cover distances of thousands of miles because ornithologists—those who study bird craft—are posted all along the lines of the birds' habitual flights during the seasons in which they make these flights, and together they have reported that no migrating birds of the species they are watching, have been seen in their localities a few days after the arrival of the birds has been reported at their destination.

Now take the season in which the bird makes these flights. Consult meteorology and you will learn that at the same time the birds are making their long flights, the winds are travelling at high speed in the directions that the birds take.

Navigators of the air and aviators, before beginning their flights over great distances, have begun to watch for the regular sequence of weather situations that invariably bring strong winds. Henri Salmét, during the English coal strike which tied up all the trains and steamers, had a business engagement that required his immediate attention in Paris. He could not get there by the regular method of travelling, so he flew to Paris without any reference to weather. Salmét was not an observer of natural conditions. But Salmét accidentally happened on a storm situation whose swift current was blowing directly from the British Isles to the interior of France. He arrived in Paris in 2 hours and 57 minutes or at the rate of 222 miles in 177 minutes—ahead of the telegrams that he sent from London to announce his coming. This was a flight equal to the birds and it was performed in what we call a storm wind. The performance astonished the people in Paris. Scientists began to compare the period of his

flight with the meteorological conditions and found that Salmét had flown during a weather situation in which these storm winds always blow from the British Isles to France.

Bindejonc de Moulinais was so impressed with Salmét's performance, that he decided to fly from Paris to Berlin by deliberately watching for the change in the weather that always brings with it high storm winds blowing from France toward the interior of Germany. They were due on August 8th and arrived early on that morning. In spite of the protest of his friends, he soared from the ground in a 29-mile wind and on reaching 3,000 feet, was soon flying in the direction of Berlin at the rate of 95 miles an hour, and he was doing this without extra speed of his machine. He repeated Salmét's methods by remaining in the wind stream which enabled him to easily steer by compass. Even then he got about 20 miles off his direct course because flying above the clouds he could not reset his compass. If he had not been in the storm current that was moving so directly toward his goal, he would have gotten much farther off his course. As it was, he arrived over Cologne instead of over Bonn, thus traveling over 250 miles in 3 hours and 20 minutes. It is interesting to compare the distance and the speed of Salmét's performance with that of de Moulinais, both made in exactly similar weather situations. Salmét's performance was 222 miles in 2 hours and 57 minutes in a southerly direction; de Moulinais' was 250 miles in 3 hours and 20 minutes in a northerly direction.

De Moulinais flew up the Rhine Valley to Bonn and from there continued his travel toward Berlin, but on his way he could not steer to avoid a local thunder storm because he was ignorant of the path it would take. He got tangled up with its currents and was wrecked.

Now one month after Salmét's performance, the War Zeppelin II, with Count Zeppelin at the helm, left Friedrichshafen and crossed the entire territory of Germany to Hamburg, flying all the way in a previously calculated wind current. The ship covered the distance of 500 miles in 10 hours. This beat the railway time, and in speed and length of journey, almost equalled the birds. The airship had started, as all Zeppelins do, with a well defined weather situation.

These bird-like and ship-like performances have become the rule since we have learned that the bird-method of flying points to the only certain method of navigating the air. The weather changes about every three days and great air ships of the near future will always start on their voyages at the beginning of each favorable change of weather.

The speed of the airship has now reached 50 miles an hour and by getting into wind-river going in the right direction, it can cross the ocean so rapidly that we will arrive at our des-

tinations just before another weather situation begins to change the winds.

From the commercial point of view, aircraft are useless unless we can carry profitable loads for great distances and make better time than steamers. Flying against the wind will not revolutionize present travel because it will be slower than train or steamer; but it is perfectly simple to make our sched-

ule to fit the frequency of changes in the weather. These weather changes, as already pointed out, are so regular and close together that transportation by air can become as regular throughout the entire year as the sailings of vessels from port to port. In other words, we can fly every two or three days that the winds are favorable and rest in port during the days of unfavorable winds.

## COLLISIONS IN THE AIR

By DENYS P. MYERS



On September 14th, at Cicero aerodrome, near Chicago, Howard W. Gill, the well-known American aviator, was killed through a collision of his biplane and the monoplane driven by George Mestach, who was also injured, when both machines fell to the ground.

It was the seventh recorded collision of aircraft, and the occurrence makes timely a review of the subject. The first, in 1910, resulted in a lawsuit whose outcome is unknown. One proved fatal to both fliers; another injured a passenger and in another, the second mentioned, an aviator broke a leg. The fourth was a meeting of machines near the ground; in the fifth, one machine got the wash of another in the air, a collision of courses only. Out of sixteen men in the fourteen machines, three were killed and six injured, rather a surprisingly small proportion of casualties in a kind of accident deemed extra hazardous in aviation.

In September, 1910, Carl and August Warchalovsky were flying at Wiener Neustadt, Austria, August having Archduke Leopold Salvator as passenger. The machines collided and Carl had a leg broken. Neither aviator would accept responsibility for the collision and the affair came before the public prosecutor. Over a year later, September 27, 1911, the late Eugene B. Ely was flying at Canton, O., when a wind squall struck him at a height of a hundred feet and he lost control. Atwood at the moment was getting away in the dusk for a final flight and the machines collided a few feet from the ground, the tip of Ely's plane striking the other. Both machines went to the ground, Ely was knocked from his seat, cut about the head and received a black eye. On March 13, 1912, at Johannisthal, the machine driven by Schade, who was carrying a passenger named Badowski, struck violently another aeroplane driven by Rettinger. Both the aeroplanes were smashed and fell to the ground, the passenger, Badowski, being injured, while the two airmen escaped unhurt.

At Douai, France, on June 19, 1912, Capt. Dubois and Lieut. Albert Peignan, both officers in the French army and trained airmen, met tragic deaths when the biplanes they were piloting round the military flying ground came together with terrific force in mid-air. The two officers, who were close friends, were unable to see each other while flying as the early morning haze was very dense in the vicinity of the aerodrome. As they turned a curve their machines crashed as they were travelling at high speed. The wire stays and canvas wings became interlocked and the two biplanes crashed to the ground, where they were smashed into a mass of wreckage.

On August 1, 1912, at Garden City, U. S. A., two monoplanes driven by James Spainour and William Heina crashed together in mid air, one dropping on to the other, and came to the ground. The pilots were bruised and scratched when dragged from the wreckage.

France forbids fliers passing each other at less than 100 metres (328 feet) in any direction. Lieut. Buriz flying at 700 feet in a monoplane attempted to pass Lieut. Briey, flying a monoplane at 600 feet, on July 6 at Villacoublay. The higher machine is said to have forced a pocket of air downward, causing the Briey machine to lose its equilibrium. It crashed to the ground and Briey sustained slight injuries.

It is not without point to note also that contact with things other than aircraft have occurred. The Mexican aviator Francisco Alvarez struck a telegraph wire the other day while flying low along a railroad track. His monoplane turned a complete somersault and was wrecked, though he was not hurt. Last spring Védrienes nearly lost his life in a similar mishap, while Beaumont hit a fishing smack on his recent attempted cross-Channel flight from Paris to London. A wing was smashed in this accident.

Collision in the air, which these instances show to be a practical problem, will continue an exceptional incident in flying; but as the exception it offers difficulties of adjustment very similar to those which maritime interests have encountered and struggled with for years. As one of those events of unusual occurrence that are particularly difficult to cope with when appearing under the terms of a specific case, the necessity for proper regulations in regard to it can be clearly seen. It therefore seems worth while to recapitulate the work that has been done in respect to laying down rules: and, furthermore, the subject is introduced here with the hope that discussion will follow and result in definite suggestions.

Aerial and maritime collision bear a close analogy to each other, and there seems to be no reason why the admiralty rule of average should not be applied to colliding aircraft. Essentially referring to cargo, it divides responsibility for damage on the basis of responsibility for the accident. The further maritime collision rule that suit is brought where the ship is registered might be followed though that brings up the greater question of whether aerial law is to follow admiralty and be administered nationally. The rules to be adopted will probably be international, for the principal countries of the world are convinced that aerial traffic will not long be content with observing boundary lines and the diplomatic conference which ended without result is to be followed by another. That being the case, the international attitude of the rules proposed needs no apology.

In that time in the near future when aerial traffic becomes common, the free balloon will be put at a disadvantage, if, in fact, it is not rapidly abandoned. Its safety will lie in keeping out of the way of other craft by the only means available to it, controlling its height. An injunction to this effect was in the mind of the Aero Club de France in 1910 when it proposed a regulation that "free balloons should keep themselves at an altitude sufficient to avoid all collision or scraping (*traînage*) of a nature to cause damage."

Paul Fauchille elaborated his proposed code of rules in 1902 and for the first time contemplated collision in the air, then a wildly vivid dream. He worked out his statement on the basis of existing law. He knew only balloons, free or dirigible, at the time, but the provisions refer as well to aeroplanes. His basic scheme reads:

"In case of collision of aerostats (or aeroplanes) in any part of the atmosphere, the courts and laws for appraising and fixing the responsibility are those of the country of the aerostat (or aeroplane). When the two aerostats (or aeroplanes) are of different nationality, it shall be decided which of the two national legislations is competent, the rules being the same as in the case of collision between foreign ships on the high sea."

(Continued on Page 244.)

SOME LEADING TYPES OF HYDRO-AEROPLANES AND AEROBOATS

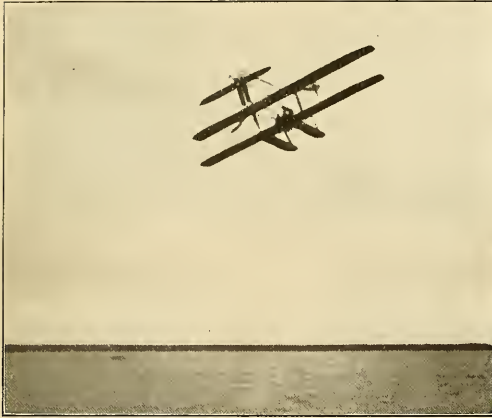

THE BURGESS-WRIGHT HYDRO-AEROPLANE IN FLIGHT.



THE NEW CURTISS AEROBOAT IN FULL FLIGHT ABOVE THE WATERS OF LAKE KEUKA.

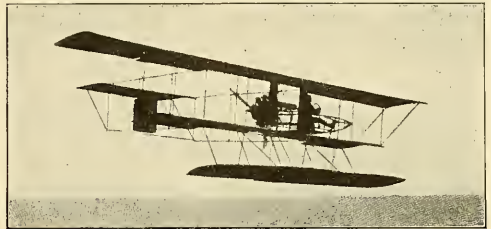

THE SALMSON ENGINED SANCHEZ-BESA ABOUT TO ALIGHT.



THE NEW CURTISS AEROBOAT FLYING WITH THREE ABOARD.

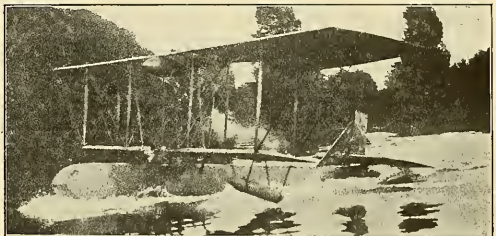

TWO VIEWS OF THE LATEST DONNET-LEVEQUE WITH WHICH BEAUMONT MADE HIS RECENT PARIS-TO-BOULOGNE TRIP.

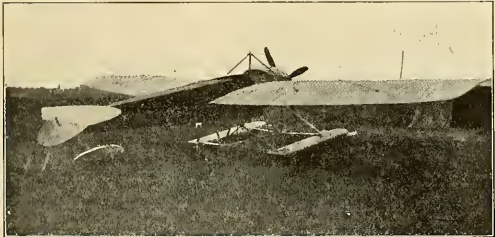

THE NIEUPORT HYDRO-MONOPLANE FLOWN SO SUCCESSFULLY BY WEYMAN AT THE RECENT ST. MALO MEET.



THE LATEST BOREL HYDRO-MONOPLANE.

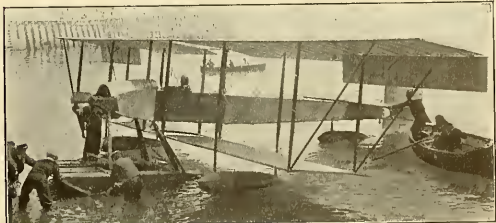

THE SHORT TRACTOR HYDRO-BIPLANE CONSTRUCTED FOR THE BRITISH NAVAL AUTHORITIES.



### AIRSHIP EVOLUTION.

**T**HE great Naval Zeppelin, now being built for the German admiralty will be quite different from all former Zeppelins. It will have no navigating cars; engines and crew will be carried inside the hull along with the gas chambers, giving the airship a perfectly smooth under surface. Of course, this will make the airship much swifter, as the outer hanging cars give some drag. It also greatly increases the airship's aeroplane effect. In other words, it adds to both the lift and speed of the craft.

According to specifications, this ship must make fifty-five miles an hour, but it is confidently expected that it will make sixty. It will be recalled that according to specifications, War Zeppelins I. and II., were expected to make thirty-eight miles an hour, and they made forty-seven and one-fourth, so it is not too speculative to expect a speed of sixty miles an hour from the new naval Zeppelin.

The experience gained by the *Viktoria Luise* on her series of trips over the North Sea and the Baltic Sea, has given the Zeppelin Engineers data necessary to increase the lifting capacity on the naval airship over water, and the data for improvement in its steering device to take advantage of great winds.

The tests of the *Viktoria Luise* and the *Hansa* over the Baltic Sea have proven these important points: First—That the airship can travel perfectly in complete darkness, attaining knowledge of its locality at all times by atmospherical localization. That is to say, it holds its position in the wind of known speed and direction at a fixed height above the water, finds its latitude and longitude by the stars and performs its course by the compass. Second—It has demonstrated that it can descend and scoop the water from the sea, therefore increasing its weight at any time it desires. Third—It has demonstrated that it can take gas and fuel from a ship on the ocean by lowering gas mains or cables for fuel. Fourth—It has been learned that the ship flies much steadier in higher winds over water than in lower winds over land. Fifth—It has been ascertained that the gas is much less affected by flying over water than flying over land, which is perfectly natural when we remember that the heat thrown off by the earth is much greater than that from the water. Sixth—All these demonstrations have corrected theory,

in reality they have turned theory into fact and are proving that the ocean is the most suitable for the airship's best performances. It will bring continents and people in closer proximity and relationship than ever before.

The rapid development of the airship for over sea transportation is further shown by the colossal naval airship which is now being built by a corporation of financiers in Berlin—a body of hard-headed business men, who have been thoroughly impressed by the demonstrations of the Zeppelins during the past two years. It is quite natural that Count Zeppelin's success should lead other engineers to design more elaborate airships along the same lines. One of these engineers, Herr J. Bornor, of Berlin, has designed this new giant, which will be 787 feet long with a beam of only 80 feet, which is approximately one foot of width to about ten feet of length, or the same scale on which Count Zeppelin has built all his airships.

Bornor intends to employ 6,500 horse power, distributed in thirty-two motors, and anticipates a speed of seventy-five miles an hour for his ship. There will be thirty compartments for the gas and each will be encased in a layer of nitrogen, which will protect the hydrogen from any atmospheric changes. This means that the hydrogen will retain its full lifting power indefinitely.

The new ship will carry 300 passengers and its most striking feature is that its engines, passengers and crew will be carried inside the hull, the same as the naval Zeppelin; the same as the steel airship now being built at Kiel. This makes it appear almost certain that the type of ocean crossing airship will be a huge torpedo-shaped craft.

The fact that the new ship will be 787 feet in length, which is 224 feet longer than the naval Zeppelin, fore-shadows tremendous sized airships during the next few years. In fact an ocean crossing airship approximately 1,000 feet in length and capable of carrying 400 passengers, has already been prophesied by T. R. Mac-Mechen, the American airship authority, to come within three years.

Another interesting development along the lines of aerial ships is that the airship *Hansa*, which is only 537 feet in length has two passenger cabins instead of one. This means that the long gangway of Zeppelin ships is gradually developing into one substantial and



complete deck as quarters for both passengers and crew. With this development will come the stateroom, the dining room, the lavatory and private living quarters for the captain and officers. The engine quarters will be distributed at exact distances apart along the bottom of the hull; the bottom of the hull will now become the strongest part of the whole ship, giving it a stiffening stability that will, in connection with the tremendous outer air pressure of the gas above, make the airship, for its purpose, as strong and steady as the greatest steel vessel on the ocean.

The plans for these great ships of the near future, indicate that they will be moored on the water in enclosed tanks, but it has been demonstrated on Lake Constance that a Zeppelin can descend and take the water as easy as a bird.

From all indications at present the first great lines of ocean crossing airships will undoubtedly be operated by such large steamship companies as the North German Lloyd and the Hamburg-American lines. In fact, the Hamburg-American Steamship Company now manages the Airship Hansa. They recognize their coming rival, and what is more natural than for seamen to handle airships over the ocean; they best understand ocean winds and their methods of navigation are now being used for ships in the air, so the seamen will graduate from the water to the air. Two of the present Zeppelin captains have been former naval captains, and most of the crew of the Zeppelins have been former sailors.

In short, airships of the future can be likened to our present ocean going steamships lifted above and passing through the air instead of the water, a good illustration of which appeared on the cover of AIRCRAFT in the March 1910 issue.

#### GORDON BENNETT CUP RACE.

**F**RANCE, after four conspicuous trials during four successive years, finally won the Gordon Bennett Cup at Clearing, near Chicago, on September 9th, 1912.

It was a glorious victory, although, strange to relate, there were no competitors. But, competitors or no competitors, the Frenchmen—among themselves—gave the greatest exhibition of speed flying ever seen in America or any other country. It was a marvellous performance and worth going around the entire globe to witness. Therefore, all honor to France and a million thanks to her noble airmen for coming to the United States to show Americans what real speed flying looked like.

Some of us Americans were of the opinion that all we had to do was to build a machine a few days before the race, pick out a man to fly it a few minutes before the race and then—WIN. We know better now.

This magazine has been repeatedly calling attention of Congress to the fact that if the United States army and navy were to keep pace with the armies and navies of other countries, airmen must be trained for several years before they could be expected to do efficient military work. What we have been saying in reference to the military end of it also applies to the sporting end

of aeronautics in this country. Flyers must be trained for the purpose.

It is just as ridiculous to suppose that a man who has been flying a machine capable of making 60 miles an hour could have been put suddenly into a machine capable of making 110 miles an hour and have operated it successfully, as it would be to expect a coal cart driver to drive a spirited race horse properly without any previous training. It could not have been done.

Therefore, even if the "large number of cooks who spoiled the American Cup Defender broth" had decided the machine was ready to fly, there was not an American flyer trained to pilot it, and it was well for the American movement that the Quixotic performance was not undertaken.

And, furthermore, if this country intends to try to win the Cup back again next year, the training of aviators for the event must be started at once, as well as the building of, not one, but several machines for the purpose.

#### LOOKING AHEAD.

**T**HE Austrian War Department has just given an order for ten Lohner-Daimler biplanes and twenty-four Etrich monoplanes.

The Admiralty has also acquired a Lohner-Daimler and a second one has been presented to it by the Bavarian Austrian Colony.

The original Lohner-Daimler biplane, which established the world's altitude record both with and without a passenger, was purchased by the government for \$10,300.

While we are not yet in receipt of the figures showing the full amount for the entire orders, presuming that the government will pay \$5,000 for each additional aeroplane, the Lohner-Daimler order would mean \$50,000 and the Etrich order \$120,000.

This information should act as a stimulant to the American manufacturer, who can look forward to such plums falling in his direction from the United States government within the next year or two, on condition, of course, that he is capable of making a machine equally as efficient as the foreigner, and it must not be forgotten either that ample preparation and reputation must be made beforehand by those who would catch the plums when they are ready to fall.

Through the efforts of Cortlandt Field Bishop, Glenn H. Curtiss went to France in 1909 and won the Gordon Bennett Cup for America and through the efforts of Cortlandt Field Bishop, Charles Terres Weymann went to England in 1911 and won the Gordon Bennett Cup for America.

In 1910 and 1912 Mr. Bishop gave no attention to these sporting events and America LOST.

One of the most promising young aviators in America at the present time is De Lloyd Thompson, an instructor of the Lillie-Thompson aviation school at Cicero. He pilots both biplane and monoplane with equal efficiency.

(Continued from Page 240.)

It was not until 1909 that collision was again considered and then the International Aeronautic Congress, which was held at Nancy, dealt at length with many questions arising out of the budding science of aeronautics. It summarized its work in a series of resolutions, the second of which provides "that with a view to avoiding accidents and collisions, the circulation of aircraft should be the subject of an international regulation passed, as far as possible, upon the international agreement, already long-tried, relative to collisions at sea, and taking account of the rules already practised in aerial navigation."

The Fauchille proposal of 1902 was presented to the Institute of International Law, a body including the foremost jurists of their type in the world. In 1910 they again studied the subject, but finished its consideration in 1911. Their decision is important because experience has shown that their scientific and careful scrutiny of a problem has repeatedly resulted in the adoption of their text with slight changes into international codes. They make a practice of studying unsettled questions of importance and for that reason their pronouncement on collision can be accepted as a good general basis for determining matters of aerial collision. The text reads:

"In case of collision occurring between aircraft of the same nationality in any part of the atmosphere, the courts and the laws competent for determining and fixing the responsibility are those of the country of these aircraft, to the exclusion of those of the subjacent State. When the two aircraft are of different nationalities, the same rules as in the case of collision of two foreign ships on the high sea will be followed to decide which of the two national legislations is applicable.

"An international set of regulations, annexed to the present convention, which will come into force at the same time and will remain in force until it has been modified by common agreement, will determine the special provisions intended to prevent collisions and to facilitate communication between aircraft. In establishing these provisions, the practice followed in maritime navigation will be the guide."

The regulations have not been worked out, but probably will not differ much from those adopted in France and printed in March AIRCRAFT. It is evident from the study given the subject that the tendency is to view collision from the standpoint of the sea. Let us hope that no tragedy of the air will bring the question into the forefront of those already being encountered by airmen.

## STRUCTURAL REQUIREMENTS FOR SAFETY IN SPHERICAL BALLOONING

By MAJOR SAMUEL REBER, U. S. A.

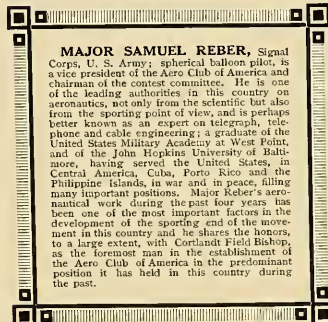

**MAJOR SAMUEL REBER**, Signal Corps, U. S. Army; spherical balloon pilot, is vice president of the Aero Club of America and chairman of the contest committee. He is one of the leading authorities in this country on aeronautics, not only from the scientific but also from the sporting point of view, and is perhaps better known as an expert on telegraph, telephone and cable engineering; a graduate of the United States Military Academy at West Point, and of the John Hopkins University of Baltimore, having served the United States, in Central America, Cuba, Porto Rico and the Philippine Islands, in war and in peace, filling many important positions. Major Reber's aeronautical work during the past four years has been one of the most important factors in the development of the sporting end of the movement in this country and he shares the honors to a large extent, with Corlandt Field Bishop, as the foremost man in the establishment of the Aero Club of America in the predominant position it has held in this country during the past.

THE experience of the past thirty years has fully proved that spherical ballooning is one of the safest of all known forms of sport. Thousands of ascensions have been made without an accident. One must not, however, imagine that the successful conduct and termination of an aerial journey can be accomplished without a skillful and experienced pilot and a balloon constructed in accordance with principles based on previous experience and the laws of mechanics governing the correct design of the various parts. The International Aeronautical Federation has prescribed certain conditions, that the materials of which a balloon is constructed should comply with in order that safety may be insured. Some of the conditions are based on the geometrical form of the balloon, others on its dimensions and nature of the gas filling, others on the strength of the materials required to resist the various stresses, and again others on experience. These various conditions are found in appendices I, V and VI, of the Regulations of the International Aeronautical Federation, 1909. As these regulations have not been translated into English and the values in the tables are based on the metric system, the writer has thought that it might be of some benefit under conditions and the formulae, based on our foot-pound system, will prove of value to our pilots and constructors.

The following in brief are the safety requirements of the International Aeronautical Federation: The material of the envelope should be impermeable and stand, as a proof pressure, double the maximum pressure that the envelope can be subjected to in service. All cordage should stand without rupture, three times the maximum strain that it can be subjected to in use. Valves in general should have two separate orifices; one for maneuver and the other for final deflation; the latter to be so arranged that when once opened it cannot be closed again without being dismounted.

The area of the orifice for maneuver should be such as to allow one-thirtieth of the total volume of the gas to escape during the first minute of opening. The orifice for final deflation of such area as to permit the escape of one-fiftenth of the total volume during the first minute. If the valve used has but one orifice its area should be that for final deflation unless the balloon is supplied with a rip panel in which case the area for maneuver will be sufficient. The length of the rip panel should be at least one-fifth that of the circumference of the balloon. The rip cord should be easily distinguished from the valve cord, colored red and terminate at its lower extremity in a flat strip one inch in width. The appendix should terminate in a cylinder whose minimum length should be four times its diameter. Orifices opening freely in the bottom part of the envelope are forbidden. Openings in this part of the envelope should be closed by short sleeves or valves. The walls of the basket should be of wicker work of a minimum height of thirty-two inches in the clear, the bottom of smooth planks of sufficient strength to resist shocks of landing. Each balloon should carry a guide rope whose minimum weight must be two per cent of the total ascensional force of the gas and also a strong, well-constructed anchor which may be omitted if the envelope is supplied with a rip panel. The approved dimensions of envelopes, approximate values which have been restated and their values for balloons of from fifteen to eighty thousand cubic feet tabulated by the writer.

$V = \text{volume of balloon in cubic feet.}$

$D = \text{diameter} = \sqrt[3]{\frac{6V}{\pi}}$

$C = \text{Circumference} = \pi D$

The following data is for hydrogen, sp. gr. 0.12; total ascensional force .071V; minimum weight of drag rope 2% of total ascensional force:

Area of valve to expend 1/30th of total volume in first minute.....	0.000049	D <sup>2</sup>
Diameter .....	0.00785	D <sup>1/2</sup>
Area of valve to expend 1/15th of total volume in first minute.....	0.000098	D <sup>2</sup>
Diameter .....	0.011	D <sup>1/2</sup>
Appendix:		
Minimum area in square feet.....	0.000015	D <sup>2</sup>
Diameter .....	0.004	D <sup>1/2</sup>
Minimum length of rectilinear portion of appendix is four times its diameter.		
The following data is for coal gas, sp. gr. 0.42; total ascensional force .046V; minimum weight of drag rope 2% of total ascensional force:		
Area of valve to expend 1/30th of total volume in first minute.....	0.00012	D <sup>2</sup>
Diameter .....	0.0123	D <sup>1/2</sup>
Area of valve to expend 1/15th of total volume in first minute.....	0.00024	D <sup>2</sup>
Diameter .....	0.0174	D <sup>1/2</sup>
Appendix:		

Minimum area in square feet.....	0.0000235	D <sup>2</sup>
Diameter .....	0.0054	D <sup>1/2</sup>
Minimum length of rectilinear portion of appendix is four times its diameter.		
D = Diameter of balloon,		
L = Minimum length of appendix as given in preceding table.		
Note—The air and the gas are supposed to be at the same temperature.		
HYDROGEN.		
Maximum difference of pressure between gas and air, in pounds per square foot.....	0.071(D+L)	
Proof pressure—twice the maximum difference of pressure.		
Maximum tension on material, per lineal foot, pounds.....	0.0177(D+L)	D
Maximum tensile strength of proof sample of material 2 inches in length, with factor of safety of 10 .....	0.0295(D+L)	D
Increase in tension on material due to one pound increase in pressure per sq. ft. at appendix.....	D/4	
Increase in tension on material for an increase of one foot in length of appendix, pounds.....	0.0177 D	
Necessary increase in minimum tensile strength in proof sample of material two inches in length, to withstand an increase of pressure of one pound per square foot at appendix.....	0.416 D	
Increase in tensile strength of 2-inch test piece of material required by an increase in length of appendix of one foot.....	0.0295 D	
COAL GAS.		
Maximum difference of pressure between gas and air, in pounds per square foot.....	0.046(D+L)	
Proof pressure—twice the maximum difference of pressure.		
Maximum tension on material, per lineal foot, pounds.....	0.0115(D+L)	D
Maximum tensile strength of proof sample of material 2 inches in length, with factor of safety of 10 .....	0.0191(D+L)	D
Increase in tension on material due to one pound increase in pressure per sq. ft. at appendix.....	D/4	
Increase in tension on material for an increase of one foot in length of appendix.....	0.0115 D	
Necessary increase in minimum tensile strength in proof sample of material two inches in length, to withstand an increase of pressure of one pound per square foot at appendix.....	0.416 D	
Increase in tensile strength of 2-inch test piece of material required by an increase in length of appendix of one foot.....	0.0191 D	

## HYDROGEN: SPECIFIC GRAVITY 12

Volume, feet.	Diameter, feet.	Circumference, feet.	Total ascensional force, lbs.	Valve to expend one-third of total volume of bal-loon in first minute.		Valve to expend one-fifth of total volume of bal-loon in first minute.		APPENDIX.											
				Minimum weight of drag rope, lbs.	Minimum area, sq. ft.	Minimum diameter, feet.	Minimum area, sq. ft.	Minimum diameter, feet.	Minimum area, sq. ft.	Minimum diameter, feet.	Minimum length rectilinear parts, feet.	Maximum difference of pressure between gas and air, pounds per sq. ft.	Proof pressure, pounds per square foot.	Maximum tension on material per lineal foot. Pounds.	Tensile strength of proof sample of material 2 inches in length, factor of safety 10 pounds.	Increase in tension on material due to increase of pressure per sq. ft. at appendix. Pounds per lineal foot.	Increase in tension on material for an increase of one foot of appen-dix. Pounds per lineal foot.	Increase in tensile strength of proof sample 2 inches in length to withstand increase of one pound per sq. ft. at appendix. Pounds.	Increase in tensile strength of 2-inch test piece of material required by increase of one ft. in length of appendix. Pounds.
15000	30.6	96.13	1065	21	0.25	0.56	0.50	0.80	0.43	0.74	2.96	2.38	4.76	18.05	30.08	7.65	0.54	12.75	0.90
19000	33.1	103.98	1349	27	0.31	0.62	0.62	0.88	0.54	0.84	3.36	2.59	5.18	20.19	33.65	8.28	0.59	13.80	0.98
20000	33.7	105.87	1420	29	0.32	0.63	0.64	0.90	0.57	0.86	3.44	2.63	5.26	22.24	37.07	8.43	0.60	14.05	1.00
25000	36.3	114.04	1775	35	0.40	0.69	0.80	0.99	0.72	0.96	3.84	2.85	5.70	25.77	42.95	9.08	0.64	15.13	1.07
30000	38.6	121.26	2130	43	0.45	0.75	0.90	1.06	0.86	1.05	4.20	3.04	6.08	29.33	48.88	9.65	0.69	16.08	1.15
35000	40.6	127.55	2485	49	0.52	0.80	1.02	1.13	1.00	1.13	4.52	3.20	6.40	32.48	54.13	10.15	0.72	16.91	1.20
40000	42.4	133.20	2840	57	0.57	0.85	1.14	1.20	1.14	1.21	4.84	3.35	6.70	35.62	59.37	10.60	0.75	17.67	1.25
45000	44.1	138.54	3195	63	0.63	0.89	1.26	1.26	1.29	1.29	5.16	3.50	7.00	38.28	63.80	11.03	0.78	18.38	1.30
50000	45.7	143.57	3550	71	0.69	0.93	1.38	1.32	1.43	1.36	5.44	3.63	7.26	41.59	69.32	11.43	0.81	19.05	1.35
55000	47.2	148.28	3905	78	0.75	0.97	1.50	1.38	1.57	1.42	5.68	3.75	7.50	44.37	73.95	11.80	0.84	19.67	1.40
60000	48.6	152.68	4260	85	0.81	1.00	1.62	1.42	1.72	1.49	5.96	3.88	7.76	47.14	78.57	12.15	0.86	20.25	1.43
65000	49.9	156.76	4615	92	0.86	1.04	1.72	1.48	1.86	1.55	6.20	3.98	7.96	49.40	82.33	12.48	0.89	20.80	1.48
70000	51.1	160.53	4970	100	0.91	1.07	1.82	1.52	2.00	1.61	6.44	4.08	8.16	52.12	86.87	12.78	0.91	21.30	1.52
75000	52.3	164.30	5325	107	0.97	1.10	1.94	1.56	2.15	1.67	6.68	4.19	8.38	54.91	91.52	13.08	0.93	21.80	1.55
*77696	52.9	166.19	5516	110	1.00	1.12	2.00	1.59	2.22	1.69	6.76	4.24	8.48	56.07	93.45	13.23	0.94	22.05	1.57
80000	53.5	168.07	5680	113	1.03	1.14	2.06	1.61	2.29	1.72	6.88	4.29	8.58	57.24	95.40	13.33	0.95	22.22	1.58

\* 2200 cubic meters.

## COAL GAS: SPECIFIC GRAVITY 42

Volume, feet.	Diameter, feet.	Circumference, feet.	Total ascensional force, lbs.	Valve to expend one-third of total volume of bal-loon in first minute.		Valve to expend one-fifth of total volume of bal-loon in first minute.		APPENDIX.											
				Minimum weight of drag rope, lbs.	Minimum area, sq. ft.	Minimum diameter, feet.	Minimum area, sq. ft.	Minimum diameter, feet.	Minimum area, sq. ft.	Minimum diameter, feet.	Minimum length rectilinear parts, feet.	Maximum difference of pressure between gas and air, pounds per sq. ft.	Proof pressure, pounds per square foot.	Maximum tension on material per lineal foot. Pounds.	Tensile strength of proof sample of material 2 inches in length, factor of safety 10 pounds.	Increase in tension on material due to increase of pressure per sq. ft. at appendix. Pounds per lineal foot.	Increase in tension on material for an increase of one foot of appen-dix. Pounds per lineal foot.	Increase in tensile strength of proof sample 2 inches in length to withstand increase of one pound per sq. ft. at appendix. Pounds.	Increase in tensile strength of 2-inch test piece of material required by increase of one ft. in length of appendix. Pounds.
15000	30.6	96.13	690	13	0.62	0.88	1.24	1.25	0.67	0.91	3.64	1.58	3.16	12.09	20.15	7.65	0.35	12.75	0.58
19000	33.1	103.98	874	17	0.76	0.97	1.52	1.37	0.85	1.03	4.12	1.71	3.42	14.16	23.60	8.28	0.38	13.80	0.63
20000	33.7	105.87	920	19	0.79	1.00	1.58	1.41	0.90	1.05	4.20	1.74	3.48	14.67	24.45	8.43	0.39	14.05	0.65
25000	36.3	114.04	1150	23	0.95	1.09	1.90	1.55	1.12	1.18	4.52	1.88	3.76	17.07	28.45	9.08	0.42	15.13	0.70
30000	38.6	121.26	1380	27	1.11	1.18	2.22	1.67	1.35	1.29	5.16	2.01	4.02	19.40	32.33	9.65	0.44	16.08	0.73
35000	40.6	127.55	1610	32	1.26	1.25	2.52	1.77	1.57	1.39	5.56	2.12	4.24	21.52	35.87	10.15	0.47	16.91	0.78
40000	42.4	133.20	1840	37	1.40	1.33	2.80	1.88	1.79	1.49	5.96	2.22	4.44	23.55	39.22	10.60	0.49	17.67	0.82
45000	44.1	138.54	2070	41	1.55	1.40	3.10	1.98	2.02	1.58	6.32	2.32	4.64	25.59	42.65	11.03	0.51	18.38	0.85
50000	45.7	143.57	2300	46	1.70	1.46	3.40	2.07	2.24	1.67	6.68	2.41	4.82	27.55	45.92	11.43	0.53	19.05	0.88
55000	47.2	148.28	2530	51	1.84	1.52	3.68	2.16	2.47	1.75	7.00	2.49	4.98	29.38	48.98	11.80	0.54	19.67	0.90
60000	48.6	152.68	2760	55	1.96	1.57	3.92	2.23	2.69	1.83	7.32	2.57	5.14	31.23	52.05	12.15	0.56	20.25	0.93
65000	49.9	156.76	2990	60	2.11	1.64	4.22	2.31	2.92	1.90	7.60	2.65	5.30	33.07	55.12	12.48	0.57	20.80	0.95
70000	51.1	160.53	3220	64	2.24	1.68	4.48	2.38	3.14	1.97	7.88	2.71	5.42	34.63	57.72	12.78	0.59	21.30	0.98
75000	52.3	164.30	3450	69	2.37	1.73	4.74	2.45	3.36	2.04	8.16	2.78	5.56	36.36	60.60	13.08	0.60	21.80	1.00
*77696	52.9	166.19	3574	71	2.44	1.76	4.88	2.49	3.49	2.08	8.32	2.82	5.64	37.31	62.18	13.23	0.61	22.05	1.02
80000	53.3	168.07	3680	73	2.51	1.78	5.02	2.52	3.59	2.11	8.44	2.84	5.68	37.86	63.10	13.33	0.61	22.22	1.02

\* 2200 cubic meters.

# THE CHICAGO MEETS

By S. R. BRUSTMANN

## Vedrine Wins Gordon Bennett Trophy.



ALTHOUGH thirteen entries were expected at Chicago to compete for the Gordon Bennett trophy on September 9, the day of the race found only three machines ready to start and these three represented France. The American entries, Paul Peck, Howard Gill and De

Lloyd Thompson, who were appointed just before the race, found themselves so outclassed that they did not deem it worth making a try for. It was finally a speed contest between the three Frenchmen, Jules Vedrines, Maurice Prevost and Andre Frey. Vedrines won, Prevost was a close second and Frey finished but twenty-three laps. However, it was the greatest exhibition of speed flying this country has ever seen.

The inaccessibility of the Clearing course kept the large crowds away. There were no grandstands; a wire fence surrounded the entire 4.14 miles of legitimate landing ground. The judges' and press stands were located on the north stretch, on both sides of these were enclosed spaces for members and automobiles and further to the east were the hangars. The verdict was unanimous among the authorities on flying that the course was the very best ever arranged for a flying contest anywhere in the world.

At 9:30 Monday morning, with scarcely 500 spectators about the course, Vedrines had his 140 H. P. Deperdussin wheeled to the starting line and a few moments later he was in the air. He made the first lap in 2 minutes and 24 seconds and averaged 103 miles an hour until the sixth lap. He then began to increase his speed. During the last laps he came down the stretches at 115 miles an hour and his best lap, the eighteenth, was made in 2 minutes and 18 seconds. After he was flagged at the end of the thirtieth lap he made an extra circuit of the course before alighting in front of the hangars. Here he was met by his compatriots and draped in the French flag; he was lifted to their shoulders. His time for the entire 200 kilometres or 124.8 miles was 1 hour 10 minutes and 57 seconds, which is an average of 105.5 miles an hour. This is slightly below his average for the French elimination trials which was 106 miles flat.

It now remained for Prevost in his 100 H. P. Deperdussin and Frey in his 100 H. P. Hanriot to make the trials. It was almost noon when Vedrines finished, and as a brisk breeze from the south had blown up, they decided to wait until later in the day.

Early in the afternoon Vedrines successfully attempted to lower the world's record for 20 kilometres. His time was 6 minutes and 56 seconds.

A little later, Prevost and Frey had their machines trundled from the hangars and they were started. Prevost's flying was remarkable, his cutting of the pylons and accurate banking was superior to that of Vedrines. He finished in 1 hour 13 minutes and 11 seconds. Frey unfortunately was forced to land during his twenty-third lap on account of engine trouble. His average speed for the 94 miles he finished was 93 miles an hour.

Vedrines left for France the day following the race, after thanking the officials of the Aero Club of Illinois for their courtesies extended to the French team during their stay.

With the trophy went the title of World's Champion Aviator, to which Vedrines is entitled. However, as styled by himself, they were "empty honors" which he acquired in this country.

The 160 H. P. Burgess racer, which was to defend the cup, was withdrawn for various reasons at the last moment. After it was declared unsafe it was in the course of rebuilding, which was not completed when racing time came.

## Chicago's Second International Meet.

September 11, the day before the opening of the Cicero contests, was marred by the unfortunate death of Paul Peck. He was practicing in his Columbia biplane and had reached a height of 1,000 feet when he attempted to descend in a spiral. Evidently the tail surface of his machine was too small to bring him to a level keel and he struck the ground in a vertical position.

Howard Gill met death the following Saturday in a collision with George Mestach, the Morane-Borel pilot. Mestach was slightly injured.

The opening day was blessed by ideal weather. The sun was shining from a cloudless sky and only a slight breeze stirred. At the opening of flying time, Glenn L. Martin, of Los Angeles, was in the air, followed by George Mestach, Antony Jannus, Charles Wiggins and Howard Gill. At 3:30 Max Lillie arrived at the field from Sandwich, Illinois, fifty-six miles distant.

After an hour of exhibition flying the accurate landing contest was held. This was won by Glenn Martin, flying his own Curtiss type machine. Jannus won the mail dropping contest and the 12-mile biplane handicap race which followed. Glenn Martin and Maurice Prevost, who piloted a Deperdussin "50," were the star attractions. Martin's handling of his biplane places him in the Lincoln Beachy rank.

Friday's program was similar to that of the day before. Martin again won the accurate landing contest and also the quick start, getting off the ground in 17 seconds after a run of twenty feet to his machine. DeLloyd Thompson won the 20 kilometre one-passenger race. Mestach was the only contestant in the monoplane event, taking first money.

Saturday crowds witnessed the first superior brevet tests, which included a non-stop trip to Aurora, thirty-two miles distant, and return. Glenn Martin and Max Lillie qualified. Thompson started for Aurora but was lost in the fog and landed 10 miles from the field.

Farnum Fish and Horace Kearney amused the throngs with their mild dips and glides. The day's flying ended with a biplane and monoplane race. George Mestach being the only contestant in the monoplane event it was decided to let him fly during the biplane race. It was toward the close of this event that the accident occurred ending with the death of Gill and injury of Mestach.

A thirty-five-mile wind blew quite steadily all day Sunday, the closing day at Cicero, and most of the machines kept to the ground. Max Lillie piloted his Wright into the wind late in the afternoon, followed by Fish, Martin and Kearney. Martin again was the star, winning the accurate landing and the bomb-throwing contests. Combating the wind was a contest in itself and the pilots who braved it were forced to their best to keep their machines on a proper keel.

## Time Gordon Bennett Cup Race Each Lap

	Start	1	2	3	4	5	6	7	8	9	10	11	12	13	14	15
Aviator	H.M.S.	M.S.	M.S.	M.S.	M.S.	M.S.	M.S.	M.S.	M.S.	M.S.	M.S.	M.S.	M.S.	M.S.	M.S.	M.S.
Vedrines, France	9:38:00	02:24	04:47	07:11	09:34	11:57	14:19	16:66	19:03	21:26	23:49	26:11	28:34	30:35	33:17	35:40
Prevost, France	4:24:20	02:23	04:38	07:83	09:23	11:48	14:12	16:37	19:01	21:25	23:51	26:16	28:42	31:08	33:35	36:01
Frey, France	4:22:06	02:43	05:26	08:06	10:47	13:27	16:09	18:51	21:33	24:13	26:54	29:36	32:21	35:04	37:45	40:28
		16	17	18	19	20	21	22	23	24	25	26	27	28	29	30
Aviator	M.S.	M.S.	M.S.	M.S.	M.S.	M.S.	M.S.	M.S.	M.S.	M.S.	M.S.	M.S.	M.S.	M.S.	M.S.	M.S.
Vedrines, France	38:02	40:23	42:40	45:05	47:27	49:48	52:08	54:28	56:49	59:10	61:30	63:51	66:12	68:24	70:56	
Prevost, France	38:27	40:52	43:18	45:40	48:12	50:38	53:06	55:34	58:02	60:31	62:59	65:28	67:57	70:26	72:55	
Frey, France	43:10	45:53	48:35	51:19	54:02	56:48	59:29	62:13	65:00							

Vedrines' average time for the 124.8 miles—105.5 miles an hour. Fastest lap, Vedrines in sixteenth—0:02:17.95.  
 Prevost's average time in 124.8 miles—1:00.05 an hour. Fastest lap—0:02:22.08.  
 Frey's average speed for 94.3 miles—93 miles an hour. Fastest lap—0:02:41.16.



The above pictures show Anthony Jannus piloting a Roberts motored Benoist tractor biplane in two of the many remarkable flights he made at the Chicago meet.

The left picture shows him carrying two passengers, while in the right picture three passengers can be distinctly seen.

The Benoist tractor biplane is an American product from beginning to end. It is built by the Benoist Aircraft Company of St. Louis, Mo., one of the leading aeroplane manufacturing companies of the United States.



The above picture is that of the 160 H. P. Gnome motored monoplane built by the Burgess Company and Curtis of Marblehead, Mass., for the purpose of entering the Gordon-Bennett Cup Race at Clearing, under American colors. It never started, for reasons mentioned elsewhere in this issue of AIRCRAFT. The editor of AIRCRAFT asked Orville Wright what was the matter with this machine, and his answer was, "Nothing at all is the matter with it." The trouble apparently was that there was too much "advice gratis" given from too many sources, while in addition there had been no American aviators trained to fly it.



This picture shows Vedrines just after alighting in his 140 H. P. Gnome motored Deperdussin monoplane after winning the Gordon Bennett Cup.

**The Grant Park Contests**

A thirty-mile cruise around the southern end of Chicago on Monday, September 16, marked the moving of aviation activities from Cicero to Grant Park. The six pilots who made the journey are Horace Kearney, Max Lillie, De Lloyd Thompson, Glenn Martin, Farnum Fish and Antony Jannus.

Wiggins in a Wright and Montero in a Elfriet made the flight from Cicero Tuesday morning. The unsettled weather caused a postponement of the regular contests for the day. In the afternoon, however, Engle braved the elements and went out over the lake, only to be lost in the fog.

Wednesday's program was also postponed on account of the unfavorable weather conditions. Although a stiff breeze was blowing off shore, part of Thursday's schedule was carried out. Beckwith Havens, Antony Jannus and Glenn Martin

were the contestants in a steeplechase race around the breakwater. Jannus was the winner. Ignace Semenouk made a trial flight that ended badly. Very little flying was done on Friday. W. C. Robinson in the Beech-National gave a very good exhibition.

A threatened strike by the aviators having been called off, they were out in force Saturday afternoon for the accumulated duration money. Lincoln Beachey, who was brought to Chicago for the last two days of the meet, was the star performer. He gave exhibitions of his wonderful control, and his capers thrilled the crowd the entire afternoon.

On Sunday, September 22, Havens won the ten-mile steeplechase and Jannus won the four-mile race around the crib. Tourner, Thompson, Lillie, Kearney, Robinson, Wiggins, Fish, Montero and Beachey all took part in the flying.

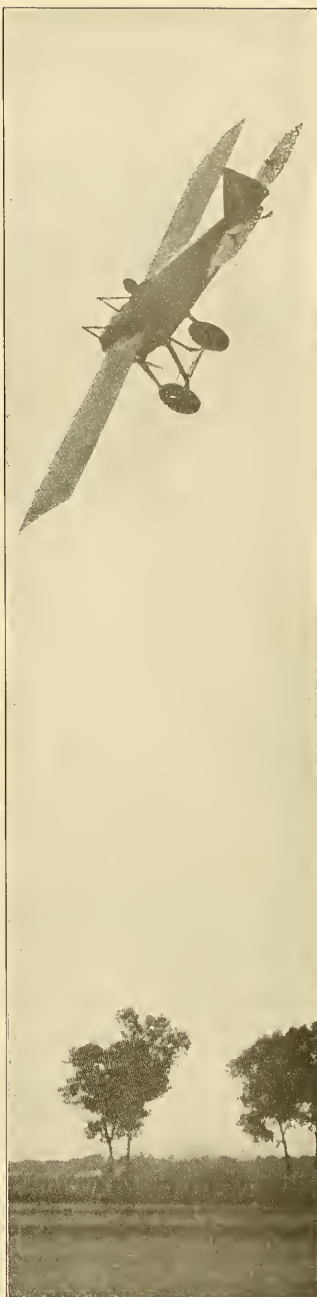

This remarkable picture shows the extraordinary control which Maurice Prevost exerted over his 160 H. P. Gnome motored Deperdussin.

Prevost during the race at Clearing, while only winning second place, nevertheless showed considerable more subtleness in the handling of his machine than did Vedrines, the winner, and it is believed by many of the experts that had Prevost been handling a 140 H. P. motored machine the same as Vedrines that he would have taken first prize.

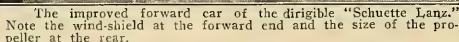

The improved forward car of the dirigible "Schuette Lanz." Note the wind-shield at the forward end and the size of the propeller at the rear.

# FOREIGN NEWS

BY  
R. H. BLANQUIE

## Austria

The Austrian War Office has placed an order for ten Lohner-Daimler biplanes and twenty-four Etrich monoplanes. The Admiralty has also acquired a Lohner-Daimler and a second has been presented to it by the Bavarian colony in Austria. We learn also that the pioneer of aviation in Austria, Wilhelm Kress, has been granted an annuity of 2,400 kroners by the municipal authorities of Vienna, this sum being further augmented by a considerable gift on the part of the Austrian Emperor, who only recently showed his interest in aviation by setting Lieut. von Blaschke in a position to marry. As is the case in Germany, all officers, before receiving permission to marry, must be able to show a certain income, whether coming from them or their fiancés. As both Blaschke and his fiancée, Franklin von Czaky (under whose name he flies) are poor it either meant waiting an indefinite number of years till he reached the grade of captain, when his pay would be increased, or of earning the necessary sum by aviation victories. On the Emperor receiving Blaschke after his victories in the Vienna week, his Majesty made inquiry into his private affairs, and on the officer frankly stating his intentions, the Emperor, whose delight in affairs of the heart has been testified to in the Imperial family, informed the overwhelmed young fellow that he would make up the missing capital out of his own purse.

According to the "Nove Freres Presse" the military administration has passed on an order for 34 aeroplanes, and the Minister of the Navy has received two hydro-aeroplanes.

## Australia

A military aviation school is being established at Dunkrom on Federal Capital territory. Two monoplanes and two biplanes are to arrive shortly and two pilots have been engaged. The principles will be similar to those used at the Central Flying School in England, and as officers—drawn from the militia establishments—qualify, it is proposed to found branches near the various state capitals and at other important points.

## Belgium

H. M. the King has sent 1,000 francs (\$200) to the National Committee of propagation in favor of the military aeroplane.

Below is a chronological list of officer aviators who have received their pilot licenses with the indication of the year, the military corps to which they belong and the aerodrome where the trials were passed:

In 1910: Lieut. Mentens, artillery, St. Job; Lieut. Sarteel, artillery, St. Job; Lieut. Nelis, engineering corps, Kiewit.

In 1911: Lieut. Lebos, engineering corps, Kiewit; Lieut. Dhams, cavalry, Kiewit; Lieut. Bronne, cavalry, Kiewit; Lieut. Moulins, engineering corps, Brasschaet; Lieut. Rochet, artillery, Brasschaet; Lieut. Soumoy, infantry, Brasschaet; Lieut. Hellingwerf, infantry, Genève.

In 1912: Lieut. Dechamps, engineering corps, Brasschaet; Lieut. Van Loo, infantry, Brasschaet.

On the 24th of August, Crombez, on a Deperdussin-Gnome engine monoplaner, flew from Neuport-Bains to Middelkerke, where a loving cup was presented to him.

## Bulgaria

Serious work is being undertaken toward furnishing the army with the aviators and the aeroplanes which it needs. A contest will soon be opened for officers and another for the soldiers who wish to pass into aeronautical service. Several orders for aeroplanes have already been placed. One for a Bleriot and a Voisin with France and for a Wright with Germany. Eight officers and 3 non-commissioned officers will be sent to the constructing firms to familiarize themselves with the machines. A second order for five aeroplanes is being considered. The aeroplanes that have been ordered are expected to take part in the coming manoeuvres.

## China

To commemorate the memory of the first aviator who flew in China and who was killed at Shanghai on the 6th of May, 1911, the name of Rene Vallon was given to one of the pretty streets in Shanghai, and a monument was also erected in his honor.

The Army disposes of a military aviation school, which has been transferred from Nankin to Canton, where an aerodrome and workshops have been established. The school actually possesses 5 aeroplanes and 28 aviators, and the instructor is Mr. Wilcox, an American, who was specially invited over to China by Dr. Sun-Yet-Sen. Most of the Chinese pupils are from Canton, and the majority of them have spent some time in the United States.

## England

Noel, on a Henry Farman biplane type "Circuit d'Anjou," and engine by a 80 H. P. Gnome, left Paris with the intention of reaching London on the same day, but due to the severe weather was forced to stop for some time at Boulogne, and on August 7th he crossed the English Channel at an average height of 2,000 meters in 20 minutes and flew directly to London (Hendon).

A camp for the Royal Flying Corps is to be opened at Wallingford, where about 30 aeroplanes and 2 dirigibles will be stationed for employment on the Cavalry training division at the Army manoeuvres.

Anzani has presented W. H. Ewen with a small gold medal in recognition of the excellent flight by the latter on a Caudron monoplaner fitted with a 45 H. P. Anzani motor, the first of its type.

The memorial window placed in "All Saints' Church" at Eastchurch, in memory of the late Hon. C. S. Rolls and Cecil Grace, was unveiled on the 29th of July by the Archbishop of Canterbury.

Mr. de Havilland has been carrying out experiments with a new biplane built by the Royal Aircraft Factory and fitted with a Maxim gun. The tests have so far proved very satisfactory.

S. F. Cody has received from the Lords of the Treasury a sum of \$25,000 as payment for the exclusive rights in the military use of his man-lifting kites. In exchange he is not to reveal his earlier designs or design kites for or to any foreign government.

Over three hundred subscriptions from lord mayors, mayors and chairman of council have already been received by the Aerial League as honorary treasurers of the Million Shilling Aviation Fund, and some 4,000 cards have been sent to them on their request.

On the 10th of August, F. K. McLean, piloting a short hydro-aeroplane, flew up the Thames from the Isle of Sheppey to Westminster Bridge, London, after a flight of two and a half hours through fog and smoke. On approaching London he flew underneath all of the bridges from Tower Bridge on. The next day he attempted a return journey, but failed, owing to damage incurred to one of his floats while starting.

Robert Slack, the International Correspondence School's pilot, completed on the 15th of August his 1,000 miles educational tour of England and Scotland on a Bleriot-Gnome by flying from Rugby to Hendon.

The poor weather which has been prevailing has not prevented successful week-end meetings at Hendon, which are as popular as ever. The "habitués" there lately have been Nardini (Deperdussin); Astley and Desouttes (Bleriot); Ewen and Marty (Caudron); Turner and Gates (Howard-Wright).

The Short Brothers have built a twin-engined tractor biplane. Apart from these features the machine is similar to their ordinary type.

Leaving Hendon at 7:45 A. M., on August 28th, J. D. Astley, on a Bleriot, with Miss Trehawke Davies as passenger, flew across the English Channel and reached Herdlet, 12 miles from Boulogne, in 1 1/2 hours. The distance, 100 miles, was covered in exactly one-half the time taken by the fastest train and boat service. They left at 12:45 P. M. and reached Issy-les-Moulineaux in 4 hours.

## Cody Biplane Defeats Monoplanes in British Army Tests

S. F. Cody, a former American citizen, but now a naturalized British subject, was declared on August 30th, the principal winner of the recent British Army Aeroplane tests which were open to the world, while the Deperdussin machine was second.

There were thirty-two entries of which eleven were French, two Austrian, and the remainder British machines. The outcome is the supremacy of the biplane type, though the monoplaner is a close second.

The test was one of motors as well as of aeroplanes and it is significant that first place went to a British flying machine equipped with an Austrian-Daimler 120 H. P. vertical water-cooled six cylinder engine, which triumphs over the French Gnome fourteen-cylinder rotary air-cooled type, hitherto everywhere a winner and which was used on nearly all the French machines in the contest.

In the difficult climbing test with load the British Cody biplane, with its weight of 2,150 pounds, besides fuel oil, pilot and passenger, ascended one thousand feet in three and one-half minutes, or one and one-half minutes less than the requirement. A few lighter machines in the contest achieved the feat in thirty to forty seconds less time.

Mr. Cody drove his own biplane in the trials against the most noted pilots in Europe, including Jules Vedrines, speed champion, and Maurice Prevost. He made a maximum speed of 72.4 miles an hour, or 17.4 miles in excess of the requirements, while in the range of speed contest he was able to fly successfully at 47 miles an hour, thus showing the wonderful range of speed this machine displays. His biplane was the second largest in area with 500 square feet of lifting surface. Speed, however, was only one of the requisites, endurance, weight lifting and other features being included.

The first prize, it may be said, went to the biggest engine, Mr. Cody's Austrian being rated at 120 H. P. The Deperdussin, second in the trials, was supplied with a 100 H. P. Gnome. The test also showed a very low consumption of fuel and lubricating oil for the winner, amounting in gasoline to six-tenths of a pint an hour for each horse power. Duplicate control and three hours' continuous flight with full load, including fuel and oil sufficient for four and one-half hours, were other requirements.

## Result of the Military Aeroplane Competitions

The Secretary of the War Office announces that the Army Council have decided, on the recommendation of the Judges Committee, to make the following award of prizes in connection with the recent Military Aeroplane Competition:

(a) Prizes open to the world for aeroplanes made in any country.

First prize (\$20,000) to S. F. Cody for Cody biplane (British) No. 31.

Second prize (\$10,000) to A. Deperdussin for Deperdussin monoplaner (French) No. 26.

(b) Prizes open to British subjects for aeroplanes manufactured wholly in the United Kingdom, except the engines:

First prize (\$5,000) to S. F. Cody for Cody biplane No. 31.

As no other British aeroplane completed all the tests, the two second prizes will be withheld, but the three third prizes of \$2,500 each are awarded to:

1. The British Deperdussin Company, Limited, for Deperdussin monoplane No. 21.
  2. The British and Colonial Aeroplane Company, Limited, for British monoplane No. 14.
  3. The British and Colonial Aeroplane Company, Limited, for Bristol monoplane No. 15.
- The following entrants, whose aeroplanes were submitted to the tests, will receive \$500 in respect of each aeroplane:
1. M. Ducrocq for Hanriot monoplane (French) No. 1.
  2. Ducrocq for Hanriot monoplane (French) No. 2.
  3. The Aircraft Company, Limited, for Maurice Farman biplane (French) No. 22.
  4. L. Blériot for Blériot monoplane (French) No. 4.
  5. L. Blériot for Blériot monoplane (French) No. 5.
  6. A. V. Roe & Company, Limited, for Avro biplane (British) No. 7.
- War Office, August 29th, 1912.

### British Warships to Be Fitted With Overhead Armor Plating

The four British armored ships to be begun this year will be fitted not only with overhead armor for protection against aerial attack, but also with guns of high velocity for attacking aircraft.

The gun is a combination of an anti-torpedo craft and anti-aircraft weapon. When required for work against surface vessels it has a range of 13,000 yards, with 21-pound shells. It can be elevated nearly 80 degrees, at which angle its effective height range is 9,000 yards. At a distance of four and a half miles it can send a shell to a height of 13,000 feet.

For use against aircraft a new type of strapped shell is used.

### France

#### FOURNEY MAKES NON-STOP FLIGHT OF 628 MILES IN 13 HOURS 18 MINUTES.

On September 14th, at Etampes, Fournay, the French aviator, competing for the Criterion Prize offered by the French Aero Club, made a notable flight, but failed to equal the record made by Helen last September. Fournay remained in the air thirteen hours and eighteen minutes, and covered 628 miles. There was a strong wind throughout most of the day and considerable rain, but notwithstanding the unfavorable conditions Fournay averaged 47 miles an hour. He used a biplane and is winner of the Criterion prize of \$2,000.

Helen's record, which was made on a Nieuport while competing for the Michelin Cup, is 776.86 miles in fourteen hours and seven minutes.

Fournay's flight to-day breaks the record for duration and distance without stop over a closed circuit. The previous record under these conditions was made by himself September 2, 1911, at Buc, France, when he covered 447.3 miles in 11 hours, 1 minute and 29 seconds.

#### Garros Makes Altitude Record of 16,240 Feet

Roland G. Garros, at Houlegate, on September 6th, eclipsed the old world's record for altitude by about 2,000 feet. Ascending in a monoplane, Garros went to a height of 16,240 feet. At this height the rarified atmosphere caused his engine to stop suddenly, and the aviator had to make a volplane to the ground. The previous record of 14,300 feet was made at Vienna, June 29th, by the Austrian aviator, Lieut. Blasek. In his flight the Austrian carried a passenger.

#### Legagneux Makes New Altitude Record of 18,635 Feet

Georges Legagneux, a French monoplane pilot, established a new world's record for altitude at the Villacoublay Aerodrome on September 17th. His Machine attained a height of 5,680 meters (18,635 feet) or more than three and one-half miles above the earth.

Legagneux ascended the first 1,000 meters (3,280 feet) in two and one-half minutes, and it took him five minutes for each of the next two mounts of 1,000 meters. The 4,000 meter mark (13,120 feet) was reached in seventeen and one-half minutes, and the machine rose to the 5,000 meter point (16,400 feet) in the next fifteen minutes. The full height of 5,680 meters was attained in a total of forty-five minutes. It took the aviator just ten minutes to descend. The airman carried a tube of oxygen, which he was obliged to use on reaching an altitude of 15,748 feet.

#### Air Squadron Flies Over City at Night

It is stated that a squadron of fifteen aeroplanes furnished with searchlights passed over Chartres, France, on September 16th, and that these machines were employed in the army manoeuvres taking place in that city.

Moulay Hafid, the ex-sultan of Morocco, on August 19th, at Vichy, was witnessed with great interest several exhibition flights by Gibert on a Sommer monoplane.

On August 22nd, Capt. Soudean, president of the military commission, took official reception of

4 Blériot biplanes, in tandem, and each fitted with a 70 H. P. Gnome.

Lefebvre, who has been silently working for two years on a new machine of his own design, flew with it for the first time on the 25th of August over the city of Rouen and encircled the spires of the Cathedral.

The hydro-aeroplane meeting held at St. Malo, from the 24th to 26th of August, and organized by the Automobile Club of France, was the biggest meeting of its kind ever held. Twelve well-known aviators on nine different types of machines took part. So much time was allowed for each passenger carried. The biggest event of the meeting was the race from St. Malo to the Isle of Jersey and back, a distance of 180 kiloms., which was won by Weymann, after a keen and interesting race with de Montjou as passenger, on a Nieuport hydro-monoplane. The official classing of the entire meeting is as follows:

1. Labourer (Astra, \$5,000, and the prize offered by the Minister of the Navy).
  2. Depoist (Sanchez-Besa), \$2,000 and the medal offered by the Minister of the Navy.
  3. Molla (R. E. P.), \$1,200.
  4. Renaux (Maurice Farman), \$800.
  5. Weymann (Nieuport), \$500.
  6. Mesguich (Curtiss-Paulhan), \$133.
- For the Speed Prize of the St. Malo-Jersey race and back, Weymann won \$600.

Esprit Delage, on the 29th of July, flew on a Nieuport hydro-aeroplane, with a passenger, for three hours over the fleet anchored in St. Raphael's Road and skimmed over the water around each warship.

Sanchez-Besa's 100 H. P. hydro-aeroplane has carried 5 passengers at one time with the greatest facility and left the water within 100 meters. The "Compagnie Transaérienne" has been organizing daily excursions with this machine at Aix-les-Bains, on the Bourget lake, since the 1st of August, being piloted by Dufour.

Lients, Battim and Varcin, each on a Maurice Farman biplane, have returned to the aerodrome of St. Cyr after an absence of six months, in which time they have accomplished many voyages of reconnaissance with the camp of Mailly as their centre. During that period of time they have covered over 20,000 kiloms. and have taken 600 officer observers as passengers, and all this without the slightest mishap to their machines.

On July 31st, Lieut. Nicand, on a M. Farman biplane, inaugurated an aërial postal service between Lunéville and Nancy, before several official persons.

Two new Breguet war planes fitted with 100 H. P. Gnômes were received on the 30th of July at the Aerodrome of La Bravelle by Captain Desbouches. Their speed over a 40 kilom. course with a full charge of 460 kgs. was 94 kiloms. per hour.

On July 24th Lieut. Pierra left Rheims on a Henry Farman biplane and flew to Crotoy without stopping, then to Dunkerque in the same morning, covering in all a distance of 370 kiloms. From there he went successively to Lille, Douai, Bayag, Hirson, Mezieres and then returned to Rheims,

after having made reconnaissances along the Belgian frontier from Dunkerque to Mezieres. This voyage represents a total distance of 800 kiloms.

Marquis de Lareinty-Tholoan left the aerodrome of Buc at 5 P. M. on August 2nd on a Maurice Farman biplane, and arrived at Trouville, his destination, after making two stops on his way, at 7:10 P. M.

The Army dirigible "Eclairneur-Conte" fitted with a Chéna motor, recently left its hangar at Issy-les-Moulineaux and sailed over Paris for several hours, carrying 14 passengers.

Madame Pellier successfully passed all the trials for her pilot's license on an Astra biplane, on August 3rd. In one of the trials she flew from the aerodrome of Villacoublay to Paris and over the Eiffel Tower at a height of 700 metres.

Moorhouse, the English pilot, left La Bravelle on August 4th on a Breguet biplane with two passengers and made a beautiful flight across the English Channel, thus creating a new record.

At the Astra Aerodrome of Villacoublay, Labourer has been experimenting with a new engine silencer which he has adapted to the motor of his Astra biplane. While flying with it at a height of 100 meters no sound of the engine was heard below.

On August 4th a very brilliant meeting was held at Brives and the public had the pleasure of witnessing wonderful flights by three virtuoses of the air: Garros (Blériot), Vedrines (Deperdussin) and Chambenois (Borel). The profits of this meeting went over to the National Aviation Committee.

A new Henry Farman military biplane has been undergoing trials at Buc in the presence of several military officers. Henry Farman has attained a speed of 100 kiloms. per hour with this little machine, carrying 250 kilogs. When this machine is folded it only has a length of 3 meters, a height of 2 meters and a width of 1.35 meters. It was taken apart and packed in 7 minutes and re-assembled in 15 minutes. In 2 minutes 12 seconds it reached the height of 300 meters.

The Organization Committee for the coming Circuit of France have adopted the following resolutions:

1. That the Circuit of France will be organized in the second half of May, 1913.
  2. That the patronage and the auspices of the Aero Club of France will be asked.
  3. That the event will be international.
  4. That a sum of 150,000—200,000 francs (\$30,000—\$40,000) shall be distributed in prizes.
- Two classings will be established.
1. To mono-seaters.
  2. To multi-seaters.

"André Beaumont" attempted a flight from Paris to London on a Dornier-Éveque air-boat, by following the courses of the Seine and the Thames on the 9th of August and succeeded in reaching Boulogne via Le Havre, where a slight accident forced him to await the morrow to continue the voyage. On the next day he met with a serious accident to his machine while starting off. He had just left the water and was flying about



"This picture of the passenger cabin of the Zeppelin airship 'Victoria Luise' was recently received by T. R. MacMechen from his co-worker, Carl Dienstbach. Mr. Dienstbach and Captain Hacker, of the 'Victoria Luise,' are seen together in the window at the extreme left. The lady and gentlemen are also passengers. Officers and sailors of the airship appear in other windows. Mr. Dienstbach has made several trips in the 'Victoria Luise,' notably a voyage in the air during a storm. He has been spending the summer in Germany, where he is gathering material for several important magazine articles by Messrs. MacMechen and Dienstbach."



The above two pictures show the aeroplane as it is now used in actual warfare in Mexico. Aviator J. Hector Worden, who is doing scout duty for the Mexican Federal Army, can be seen in the top picture all ready to start on one of his daily reconnaissances from headquarters. In the same picture note the commanding position of the artillery on the mountain in the rear. It is the Federal artillery, which has been the undoing of the rebels.

The lower picture is an example of the difficult landings necessary in military aviation. This landing, by the way, was made without breakage in delivering a message to a Colonel commanding troops who were firing from the cover of this cactus brush, and the landing had to be made in this place.

The monoplane used in this work by Aviator J. Hector Worden, division De Norte—Commanding Officer Colonel Caransa, vicinity of Torreon, Coah, Mexico, is a Moisant monoplane built by the American Moisant Company of New York and Hempstead Plains, Long Island, and is fitted with an American made Charaway Propeller, which is proof, to a large extent, that the American manufacturers of flying machines are capable of turning out equally as good, if not better, machines for war purposes than any other country in the world.

4 meters over it when a gust brought the machine suddenly down and caused it to hit the water so violently that the floats burst and the craft capsized. Apart from a good ducking Beaumont was not hurt.

The military aviation commission has taken official reception of 4 Hanriot-Gnôme engined monoplanes, which are to be used at the next manoeuvres.

In view of popularizing aerial touring, Etienne flew from Plessey to Saumua and then to Angers; Baron Pasquier from Etampes to Nevers and then to Vichy, and Count Larcinty-Tholozan from Trouville to Patoy, Etampes. All of these flights were accomplished on Bleriot monoplanes.

A hydro-glider has been experimented with at Soucient by Leyat. A towing speed of 12 meters per second is necessary for it to fly. The results have been so satisfactory that the establishing of a school for this sort of craft is being seriously considered.

The municipal authorities of Moulins have voiced a promise that a memorial will be erected in memory of the victims of the catastrophe which befell the army dirigible "Republique," which burst over Moulins on the 25th of September, 1909, while returning from the manoeuvres. The victims were Capt. Marchal, Lieut. Chauré and the Adjutants Reau and Vincenot.

Competing for the second part of the Pommeroy Cup, Brindejone des Moulinaux on a Morane-Saulnier monoplane, flew from Villacoubly to Hannover, Germany, on August 8th. It was his intention to fly directly to Berlin, but he could not continue owing to engine trouble, but in this flight covered a distance of 800 kilometers.

It has been announced that 50 aeroplanes and possibly 4 dirigibles will take part in the grand manoeuvres of 1912.

Mlle. Helene Dutrieu on a Henry Farman hydro-aeroplane, gave several excellent exhibition flights over the surf at Trouville on August 10th.

Experiments with dictaphones for the purpose of ascertaining their possible value in connection

with aerial scouting are now being conducted on several aeroplanes.

### Audemars Flies from Paris to Berlin

Audemars, the Swiss pilot, while qualifying for the Pommeroy Cup, flew from Paris (Issy-les-Moulineaux) to Berlin (Johannisthal), on a Bleriot-Gnôme. On the 18th of August he flew from Paris to Gelsenkirchen (Westphalia), and on the next day proceeded to Berlin, where he was received with much enthusiasm.

### German News

By Stella Bloch

The aeroplane constructed by H. R. H. Prince Siegfried of Prussia, which came to grief during its first trials, is out again and is proving extremely speedy, developing a speed of 100 kilometers an hour.

A flower day for the good of the Imperial Aerial Endowment Fund, called into being for the relief of the widows and orphans of deceased German aviators, will take place all through the Empire on October 20th with the exception of Berlin, where it was held on September 1-2.

The new naval Zeppelin will be stationed at Berlin-Johannisthal from October 1st, and will have as chief pilot Commander Hanne, who has been undergoing instruction since April and has passed his examination as a Zeppelin pilot in front of a commission headed by the Count himself.

Three Argentine officers have been ordered to Frankfurt by their government to be instructed in the operation of the two Euler biplanes bought by the Argentine.

The Gotha tournament ended in a clean sweep for Lindpaintner, whose Ago biplane took a first in all the four competitions, winning close on twenty thousand marks. Bomb throwing formed the nucleus of the whole meeting, and Lindpaintner managed to throw nine bombs into the 100 meter square which represented a bivouac. Gorrisen, who came in second, only hit twice.

The two German pilots who accompanied the Harlan monoplanes purchased by the Turkish War

Office, to Constantinople, Kentzel and Lieut. Jahnov, have carried out a number of flights on the 100 H. P. Argus motor planes over Johannisthal, carrying Turkish officers as passengers.

The German War Office has taken over three Rumpler-Doves and an Albatross biplane. All four new acquisitions are stationed at Johannisthal.

Early in August, Denell, a mechanic employed by the Rumpler Works, was killed by a propeller on which he was at work. It is believed that careless manipulation set the motor going and a blade of the propeller caught the unfortunate workman and injured him so severely that he died immediately.

According to estimates, the Leipzig Aerial week has ended in a loss of 18,000 marks. This sum, however, is covered by a guarantee fund.

An extraordinarily interesting sight was witnessed at Berlin on one of the last days of August when nine Rumpler-Doves, all manned by officers, arrived simultaneously at the Tempelhofer Field, coming from Doberitz. Unfortunately the machines were hindered in landing operations by the over enthusiasm of the huge crowd that had assembled to welcome them. The spectacle of the nine planes on high was an awe-inspiring one. The machines were in line in front of the field to await the Imperial Parade.

The national subscription in Germany for the purchase and furtherance of aeroplanes and aviation has now been closed. The sum collected is estimated at six million marks.

Lieut. Rier, the former Austrian military pilot, who participated in English events, has resigned from the Army and is now technical director of the Deutsche Flugzeugwerke at Leipzig.

"Z II," one of the military airships that were destined for the Imperial manoeuvres, has experienced an accident which puts it out of "raining" protest. Whilst being brought out of its Cologne hangar the soldiers ordered to hold it lost ground beneath their feet owing to the greasy, slippery surface caused by many days of continuous rain, and the vessel was pressed against the side of the shed, thereby causing an injury to the steering apparatus. The vessel mounted in order to effect a landing, and in coming back to earth two gas compartments were severely damaged and the propellers strained. The Zeppelin was dragged into the hangar, where repairs are being made. It is reckoned that at least two weeks will elapse before it can recommence its work.

The Inspector-General of the Traffic Troops has decreed that privates to the number of 143 are to be appointed to the various military stations to receive aerial instruction. Seventy-seven go to Doberitz, twenty-six to Strassburg, twenty-five to Metz and fifteen to Darmstadt.

A new altitude record for officer-pilots has been set up by Lieut. Reinhardt, of the Metz Aerial Station, on an Albatross biplane, fitted with a 100 H. P. Argus motor. Accompanied by Lieut. Scheibel, he attained an elevation of 2,250 meters on his journey from Metz to the Betsch Camp. The German record is 2,170 meters, set on June 19th by Hirth with Lieut. Schoeller as passenger.

We learn on the best authority that Director Boris Loutzkoy is preparing for a flight to St. Petersburg with Helmut Hirth as pilot. The machine with which this difficult undertaking was commenced is the Rumpler biplane built according to Director Loutzkoy's designs. It may be remembered that Director Loutzkoy constructed the famous motor-boat "Zariza" of 500 H. P. owned by the Emperor of Russia, which some years ago won the long distance race on the Rhine.

### DIRIGIBLES.

After an interval of nearly three-quarters of a year the Gross airships are to make a reappearance in German aeronautics. The semi-rigid vessels known in military circles as M I, II, III and IV are being completely reconstructed and are brought up to latest requirements in the shops of the Airship Battalion in Berlin. When finished they will resemble the M III, the fastest vessel of them all, which went with an accident during the manoeuvres last Autumn, when its envelope was consumed by fire. Fitted with a new envelope it will recommence work very shortly.

At the coming military manoeuvres the Zeppelin II will be attached to the 14th and 15th corps, and a Parsival to the 3rd and 12th corps.

The "Schuetze-Lanz," on July 29th, left Gotha at 4 A. M. and arrived at Johannisthal after having passed over Erfurt and Halle. This airship is one of the most important dirigibles which Germany possesses at the present day. Built to the shape of a torpedo, it has a length of 130 meters and a diameter of 18 meters. Its volume is 19,500 cubic meters, and it has a motive power of two 180 H. P. engines. The frame is built entirely of wood.

On July 31st the new Zeppelin "Hansa" made its first trial flight, piloted by Count Zeppelin. This airship is of the same type as the "Victoria-Luise" and has a volume of 600 cubic meters, a length of 148 meters, a motive power of three motors and encloses 18 small balloons each in separate compartments. On August 5th it left Friedrichshafen at 12 P. M., and at 4:30 A. M.



was sailing over Wurttemberg, where it was saluted by cannon shots. At 8:10 it was over Gettlingen (Bavaria), and a little later over Brelefeld (Westphalia). It finally arrived at Hamburg at 1:25 P. M., after having covered the distance of 700 .oms, without stopping. Its fastest speed during this voyage was 83 kiloms. 600 per hour.

A few days later it made a long voyage over the Baltic Sea. Having left its hangar at Fuhnsbüttel at 6:30 A. M. with 18 passengers on board, it arrived at Flensburg, after having sailed over the island of Eckelund for its return trip it met a squadron of cruisers and exchanged many salutes. At 2:36 P. M. it re-entered its hangar, after a flight of 8 hours.

On the 19th of August it made a three and a half hours flight from Fuhnsbüttel over Cuxhaven and the North Sea, and returned to its starting point by Ilamburg. Among the passengers on this trip were General Von Moltke.

On the 5th of August the Zeppelin "Viktoria Luise" left Frankfurt and alighted at Oos, near Baden-Baden, after a splendid voyage.

#### AEROPLANES.

Lieut. Rastener, with an officer of the staff as passenger, left the aerodrome of Doberitz on July 31st, at 5 A. M., and alighted at Hildesheim at 9 o'clock. The voyage represents a distance of about 250 kiloms.

Prince Henry of Prussia's recent invention is an aerial rapid firing gun, which can be placed on an aeroplane in such a way that it can be levelled without being lifted and without the use of a leveling instrument directed directly in front of the pilot's seat and mounted in the chassis of the aeroplane so that the cannon can be turned directly under the front elevator at a determined distance. The shots can be fired at an aimed object by the pilot above the front elevator. The lateral setting of the gun is executed by the lateral displacement of the aeroplane, according to what direction the pilot discloses his machine. All danger of its causing the aeroplane to capsize is averted by the fact that the gun recoils in the direction that the machine is flying.

At the hydro-aeroplane meeting held at Oerlingendamm, August 29 to September 5th, 83,000 marks were distributed in prizes, besides the Grand Prize of Honor offered by the Emperor, who is most enthusiastic.

An aeroplane construction material contest, with the object of assuring first-class material for all aeroplane building, is being arranged. This contest, which will be a national one, will commence immediately after the distribution of the National Fund for aviation.

Lieuts. Castem and Zimmermann, who had flown from Doberitz to Hildesheim, left the latter village on the 10th and returned safely to Doberitz, after having made a stop at Magdeburg.

During the next military manoeuvres an aerial postal service will be organized.

According to statistics given by the German press, Germany has actually 45 aviation schools, 27 dirigible sheds and 80 aerodromes.

A spherical balloon meeting held on the 14th of August, 35 out of 40 balloons made their departures.

The Rumpeler and the Harlan aeronautical construction firms are said to be overloaded with aeroplane orders from the Ministry of War.

#### Greece

Besides holding the Greek record with passenger, Alexander Caramanliaki, director and founder of the "Athens Independent," has also captured the Greek altitude record by ascending to a height of 2,140 meters on a Blériot military type monoplane.

#### Italy

Lieut. Rossi, of the Italian Navy, on August 4th, with Second Lieut. Colari as passenger, of a Nieuport 100 H. P. Gnome monoplane, left Gallarate at 6:10 A. M., and at a little before 7 o'clock passed over Turin, and at 7 o'clock exactly alighted in a vineyard, the aerodrome of Mirafiori, after having covered a distance of 110 kiloms., which were accomplished in 50 minutes, representing a speed of 132 kiloms. per hour.

#### Morocco

Lieut. Do Hu, on August 22nd, flew from Rabat to Casablanca on a Blériot in a single flight.

The French army lieutenants, Van den Vaero and Do-Hu, on Blériot-Gnome monoplanes, have renewed their feat by flying from Rabat to Fez. They left Rabat at 4:15 on the 15th of August and arrived at Fez at 6 o'clock, thus having covered the 200 kiloms. between Rabat and Fez at an average speed of 130 kiloms. per hour.

#### Romania

René Simon, the acrobatic champion of the Blériot, gave several exhibitions during the latter part of July at Costanza. His acrobatic flights above the Black Sea will always be remembered by the Romanians.

Prince Bibesco has taken the initiative of forming a national aerial league with the aid of several high persons, and has placed it under the high direction of the Minister of War. Its pur-

pose is to train aviators, to buy aeroplanes and put these to the disposition of the army.

The military authorities several months since organized a military aviation school and have purchased several aeroplanes for its equipment in France.

#### Russia

The Government has passed on an order for an "escadrille" of Morane enclosed biplane monoplanes, each to be fitted with an 80 H. P. Gnome engine.

The Committee of the Aero Club will buy, with a part of the national subscription fund, two Farman biplanes and two Nieuport monoplanes.

The naval administration is having an aerodrome constructed on the island of Golev, near St. Petersburg for the purpose of testing the use of aeroplanes against war ships. The government now owns five other aerodromes on which aviation schools have been established.

The government has taken possession of a new dirigible, which has been named the "Albatross," and which has a volume of 10,000 cubic meters and a mean speed of 75 kiloms. per hour.

Abramowitsch, who left Berlin on July 15, on a Wright biplane with an 85 H. P. N. A. G. motor, for St. Petersburg, accompanied by Herr Gieseler, reached the Russian capital on August 6th after a very chequered flight. Abramowitsch had calculated to land at St. Petersburg within a week at the latest, but a series of accidents upset all his plans. In any rate, he has the proud distinction of being the first to fly from Berlin to St. Petersburg, and the fact that he carried a passenger only makes this feat the more laudable.

The official test of the automatic parachute system Kotechukoff took place with astonishing results. A dummy weighing 76 kilogs was attached to the parachute and thrown into space from a height of 150 meters. Twelve meters below it opened and the recorded speed of its descent is 1 meter 65 per second.

Capt. Tolmachev has invented an howitzer capable of hitting a moving object up to the height of 1,000 meters. Experiments with it so far have proved most satisfactory.

#### Scotland

Rene Caudron flew on one of his aeroplanes fitted with an Anzani motor from the Naval Gardens over Edinburgh, Fortcathello, Leith, and sailed above the sea and the cliffs before 3,000 enthusiastic spectators on August 1st.

Considerable flying with hydro-aeroplanes over the lake at Windermere has been going on of late, and many delighted passengers have been taken up by Stanley Adams on his "Water Hen." Commander Samson, R. N., with a Deperdussin air-bus, and Grosspellet, with his hydro-monoplane, have also been flying there.

#### Spain

Maurice Pomet, on his illuminated Borel monoplane, made several night flights over the city of Santiago on August 15. This aeroplane is fitted with 50 H. P. Gnome motor and adorned with 1,758 incandescent lamps.

Engineer Lieut. Sant Rernan and Cavalry Lieut. Bornos have successfully passed trials for their pilot's licenses on British biplanes.

#### Switzerland

Beard, a young French aviator, gave several exhibition flights at Friburg on the 28th and 29th of July on a Blériot machine. On the 30th he flew over Berne at a height of 1,000 meters, and is consequently by this feat the first to fly over the Swiss capital.

There are actually 22 aviators who possess their pilots' brevet of the Federation Aeronautique Internationale in the Helvetic Republic. This number includes the following well known aviators: Audemars, Coboni, Maifer, Grandjean and Lieut. Bianchi.

The hydro-aeroplane meeting held at Geneva on Lake Lemán, August 19-20, was a marked success. The participants were Barra (Traid Curtis-Paulcan), Beaumont (Donnet-Leveque), Sommer and Grandjean (Sommer).

#### Tripoli

On August 11th an Italian dirigible went scouting over the Turkish entrenchments. Sailing for several hours at a high altitude, it went as far as Birtobas, and from there returned safely to its hangar.

#### Turks Capture Italian Aviators and Machine

The Turks, who on several occasions have tried vainly to smuggle into Tripoli an aeroplane for scouting purposes, are at last in possession of a machine through a mishap to Capt. Mozo, of the Italian Army, on September 11th.

He was making a flight from Zouara to Tripoli when the motor of his machine stopped and he was obliged to descend in a hostile country. He was made prisoner.

#### Foreign Goods Imported to America

A new concern, the Aeroplanes, Motors & Equipment Company, has been incorporated under the laws of New York State with a capital of \$20,000. This company which has been formed from the past Aeroplane Motors & Equipment Co. which was known to everybody in the aviation game, being the importers of the Gnome, Anzani, Renault and Salmson Motors, which concern was lately connected with the Paul Lacroix Automobile Co. Aviation Dept.

"Yves De Villers, is general Manager of the new "Aeroplanes, Motors & Equipment Company." Yves De Villers was previously, since 1909, President of the Aerial Equipment Company, and it was this company that imported the first Anzani and the first Gnome Motor in this country, and was lately connected with J. A. D. and A. L. S. McCurdy, with the Aeroplane Motors & Equipment Co., and the Paul Lacroix Automobile Co. Aviation Dept. It is presumed that under his general management, the Aeroplanes, Motors & Equipment Co. will do good business and give satisfaction to their customers.

They will import Gnome, Anzani, Renault and Salmson Motors, also the Train and Morane Monoplanes, and all supplies made for aviation. In France, as Astrol Varnish, that has met with such great success in this country, also the "Le Tek" Aviators Helmets, used exclusively by the U. S. Army.



The above picture was taken in Mexico, and it gives a good idea of the line of work from which the officers of the Federal Mexican Army expect the greatest efficiency from the aeroplane. The air scouts are sent out each morning 25 or 30 miles along the railroad track to see if any bridges or tracks have been destroyed or are being destroyed by the rebels. It can readily be seen how the aviator can witness the work of any foraging parties and return to camp with the information without any danger to himself, unless, of course, the motive power of his machine should fail.



# Some Facts Concerning the Nieuport Monoplane and a Description of the 70 H. P. Type

By WALTER H. PHIPPS

In view of the fact that the Deperdussin monoplane now holds most of the speed records and is generally considered the greatest monoplane extant, one is apt to think that the Nieuport is now a past name and no longer to be reckoned with as a contestant for World's speed honors. That there is considerable truth in this latter belief is fully avowed but he contends the reason for the Nieuports not doing so well in speed events of the past year, was simply because, since the death of Edouard Nieuport, the engineers of the company have considered the machine quite fast enough for all ordinary purposes and have made no attempt to sacrifice safety and carrying capacity for mere speed, as has been done with the new Deperdussin racers.

It must be remembered that the Deperdussin monoplanes did not attract attention as speed machines until after they had been remodeled along Nieuport lines, namely, fitted with a deep-chested and stubby fuselage, small tail and twin elevator flaps, and a simplified landing chassis, and that even then the first of the racers was not so much faster than the 100 H. P. Nieuport. It was not until the wing surface was cut down considerably, the fuselage rounded off to form a perfect streamline, and, if possible, a large cone plate attachment fitted to and around the hub of the propeller, and a very powerful motor fitted, that the Deperdussin was finally able to attain a speed of 106 miles an hour.

It is probable that were the present day Nieuports modified in such a manner, they would be every bit as fast as the Deperdussin racers and just as dangerous and hard to fly, and it is for this very reason that they have not been developed into freak racers.

There is not the slightest doubt that the Nieuport and the new Hanriot monoplanes, which are Nieuport copies, are the most remarkable monoplanes in use today, and the only machines capable to make great speed without sacrificing wing surface, carrying capacity and the ability to glide well. In addition they are capable of a considerable range of speed, and are easily controlled at a much slower rate than their normal flying speed.

A careful study of the accompanying scale work drawings of the 70 H. P. Nieuport will reveal the truth of the foregoing statements.

## GENERAL DIMENSIONS.

The principal dimensions are: Span 35 feet, 8

in.; length of fuselage 22 feet, 3 inches; spread of each wing, 16 feet 4 inches; chord at fuselage, 8 feet 2 inches; chord at wing tip 5 feet 6 inches; spread of tail 9 feet 6 inches; motor 7-cylinder, four-crank, Gnome.

## THE FUSELAGE.

The fuselage is of the covered-in type, and is principally remarkable for its great depth at the forward end of the machine, whence it tapers sharply back to the tail, the area of side resistance of the fuselage in front of the centre of gravity being approximately half that of the fuselage behind the centre of gravity. The fuselage is built up of wood, the joints being made in the manner shown in the accompanying drawings, and is entirely covered with fabric. A considerable amount of weight has been saved by channelling out the ash longitudinals, except at the points at which the cross members are attached. Owing to the depth of the fuselage in front, the pilot is provided with a very roomy cockpit, whilst in addition a species of scuttle dashboard, which raises him and the passenger, is practically entirely sheltered from the wind.

## THE MAIN PLANES.

The main plane, although having a framework built up in the usual way, is notable for a plane section which is quite different from that of other machines. The forms of this are shown in the accompanying drawings, whence it will be seen that the dipping front edge, properly speaking, is entirely dispensed with, and that the centre line of the section is practically horizontal over the first third of the wing.

A particularly neat method of attaching the bracing wires to the wing spars is employed on the Nieuport machine, and is illustrated in an accompanying drawing. It consists of two pressed steel plates, which entirely surround the substance of the spar and are held to it frictionally by the pressure of two bolts, that also serve to secure the consequent chordal members. The cables that stay the wings top and bottom.

In addition two small bolts run through the spars to prevent slipping. This arrangement is so arranged as to prevent one, as it obviates the necessity of weakening the spar to any appreciable extent, and at the same time furnishes an anchorage for the bracing wires, without interfering with the fabric covering of the

plane, through which, of course, the edges of the bolt plates protrude. The lower bracing wires from the wings are taken to the skid, whilst the upper ones are carried to a pyramidal mast, but of big steel tubing. On the top of the mast is a stud which supports the stranded wires that proceed from the front spar of the plane, whilst underneath this stud is a short length of steel tube through which passes a heavy gauge wire, which equalizes the wing warping effect by connecting the rear edge of one wing to that of the other. Objection to the use of a plain instead of a stranded wire for this particular purpose may be made by some designers. Certainly it is quite a heavy affair, but, on the other hand, is perhaps better fitted to withstand the friction caused by continually sliding through the tubular fairlead than is a stranded cable. At the same time, of course, it has to take practically no stress, except when the machine alights on the ground, when it has to take up part of the force produced by the momentum of the wings.

## THE TAIL.

The non-lifting tail plane is practically semi-circular, and enters the air circumference first, but on the older machines this was of triangular shape but of the same area as the new one, and the aerodynamic forces were equally either, but the semi-circular type makes the machine slightly faster. The two elevator flaps are likewise semi-circular, but have their circumference trailing. They are operated through cranks, the wires to which pass through slits in the tail plane. The framework of the rudder, tail plane, and tail flaps is entirely built up of very light steel tubes brazed together, and entirely covered by a tightly stretched covering of fabric.

## DETAILS OF THE LANDING CHASSIS.

The landing chassis, which is an extremely neat piece of work, and is, also, quite effective, and in addition with several others, consists of a pair of wheels and a single axle. The latter is supported by V-formed 3 in. oval steel struts from the lower longitudinal members of the fuselage, and is of light steel tubing of comparatively large diameter. The suspension of the wheels is extremely simple, the axle on which they are mounted being a single long laminated steel spring bolted with cord at each side to give it greater rigidity.

# GENERAL NEWS

By D. E. BALL

## The Burgess Cup Defender—Some Facts Regarding the Machine

(Letter from Burgess Company and Curtis.)  
After a number of unsuccessful attempts on the part of the racing clubs to persuade American manufacturers to independently design and enter machines for the Gordon-Bennet race, a Cup Defenders' Syndicate was formed in Chicago among the members of the Illinois Aero Club, which raised money sufficient to produce a racer.

It was not easy to decide upon the designer and builder of the racer, but W. Starling Burgess, president and chief designer of the Burgess Company, and Curtis was selected and early in June preliminary drawings were made up. In all the designing work Mr. Burgess was constantly assisted by Greely Curtis, who with the motor arrived from France, on August 3, the aeroplane was ready for the installation of the power plant.

It will be noticed that the racer is a monoplane with enclosed fuselage and a wing spread of 130 square feet. It weighs, including motor, net 775 pounds. The running gear was especially strong and adapted to the rougher fields of American tracks. The plane measures, fore and aft, about 22 feet and the spread of wing is 29 feet.

Very careful tests were made of all parts which went into the manufacture of the plane. The factory tests were conducted by the Boston Institute of Technology. The factor of safety in the air of five was figured on all wires and metal parts. As a final check as to its strength, the day before shipment two men were placed in the cockpit and two on the skids. The machine was then raised on horses from the wings at the points of the wire supports without any apparent give or strain.

The Wright-type wheel trucks on which the plane is mounted in the pictures shown were installed for practice flights. These were to be replaced by a single pair of covered wheels.

Early in July, Mr. Norman Price, representing the syndicate in Chicago, visited Marblehead for the purpose of finalizing an order with the Burgess Company for the design and construction of the Cup Defender. For more than four months

preceding overtures were made in various forms by the club of America and individual clubs and members, looking towards interesting American manufacturers in the construction of a racing machine.

At last, however, pressure, however, was brought to bear upon the Burgess Company to design and build an aeroplane suitable for the 160 H. P. Gnome power plant which had been purchased. Considerations of friendship finally prevailed upon Mr. Burgess and the Burgess Company agreed to design and build the aeroplane in six weeks, but at the same time took no responsibility whatever with regard to the furnishing of the aviator, either for the test flights or for the race.

This work was done at a great sacrifice to the company at this time of the year, the busiest one in a really very short season of activity. However, the machine was turned out and delivered within the time specified and shipped to Chicago with a large quantity of spare parts, also furnished. At the time the machine arrived there, the syndicate Mr. Burgess went to Chicago and placed himself at the disposal of the committee there without recompense, remaining in Chicago until after the race.

When the machine arrived there, a question as to who should drive it. No definite arrangements seem to have been made, and conditions were aggravated by the fact that, contrary to the Company's advice, the Wright system of control had been installed. After a number of days' delay it was finally decided that Mr. Glenn L. Martin, of Los Angeles, would undertake to drive the machine. He is the number of others interested in aviation, of course, immediately began to criticize certain details of design and construction. The use of single wires with a factor of safety of three was criticized, and so was the use of a large wing surface, 130 square feet, was said to be too large for the horse power. Some did not like the landing gear and others thought the tail was incorrect design, and so on.

Mr. Burgess has designed seven distinct types of aeroplanes in the last four years, every one of which has been sold to and flown by the racing clubs. He is the author of the previous design was the tractor biplane built for the United States Signal Corps, which passed its entire tests, in-

cluding climbing two hundred feet a minute and landing and leaving plowed ground without the slightest difficulty, even though other standard machines in this country, ordered under the same specifications, required from one to three months of adjustment and correction before acceptance.

Naturally when the request was made that smaller wings be furnished, the company believed that this was contrary to good judgment and was reluctant to aid in any changes made by those who perhaps lack the experience and skill which has been evident in the Burgess products. Small things were hastily put together in Chicago to meet Mr. Martin's requirement, even though the large wings had never previously been tested out. If it had been possible to thoroughly train a man in the large wings the question of smaller wings would have been, of course, in order, but with the horse power furnished the original design was by no means excessive in amount of surface and this feature naturally prevented the highest possible development which can only be reached by experiment.

In the meantime, day after day passed in Chicago without any real work being accomplished, other than racing by the club, and a great deal of clearing and the exchange of endless dissertations on racing by so-called experts.

The aeroplane arrived on August 20, and from that until the day of the race was not actually tried out, although the motor was found to be entirely satisfactory. The Burgess Company finally built a small set of wings, extra propellers and shipped sufficient parts to permit them to build an entirely duplicate machine, should it have been necessary.

The real difficulty in the whole episode is boiled down to three general criticisms.  
First—The lack of any real support by the Aero Club, looking towards the construction of a Cup Defender. As usual the Aero Club was quite willing to encourage and spend their money, but actual support was lacking.

Second—The disqualification of the best flyers in this country at a time when the choice of an aviator was quite as important as the choice of a machine.

Third—The construction of an aeroplane at the

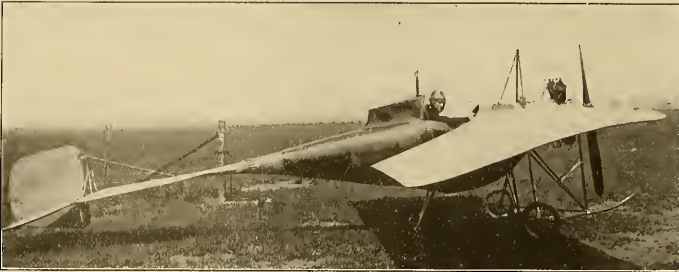

The Smith monoplane, which has been flying so speedily and well at the Cicero Field, Chicago. With the exception of the pressed fibre fuselage and the cloth covering of the wings, it is built entirely of steel. The motor is a 50 H. P. star shaped, air-cooled, stationary engine designed by Mr. Smith. This very interesting all-American monoplane is being flown almost daily by Otto Brodie.

eleventh hour without any plans for the training of the aviator in the two weeks which remained between the date of delivery and the race.

The relations between the leading members of the Syndicate and the Burgess Company have been most friendly and it is with the sincere regret of all concerned that the machine was not actually in the race.

### Curtiss Abroad

Stating that his foreign business has grown to such proportions that it requires his personal attention, Mr. Glenn H. Curtiss recently sailed for Europe aboard the "France" of the French Line. While in Europe he will demonstrate a Curtiss hydro-aeroplane destined for the German Government, confer with Russian and Italian Naval officials regarding orders from those governments,

sian Navy. The latter are now being demonstrated at Sevastapol by Charles C. Witmer, one of our aviators.

"In the past two months we have received additional orders from Russia, Germany and France. We have also received orders from Italy and England. Besides this European business the Japanese Government has purchased three hydro-aeroplanes from us for its Navy, and several officers are now at Hammondsport, N. Y., learning to operate the machines. The point I want to make is that the foreign Governments are building up vast aerial Navies, while our own country has only about a dozen aeroplanes."

Asked about the development of aviation commercially, Mr. Curtiss waxed enthusiastic over the success of the "flying boat," of which he is the inventor. "It is the one thing that makes aviation



Three-quarter view of the Brooks-Hamilton monoplane, which is designed to be successfully flown with low power and be capable of making extended cross-country trips and rough landings. Note the substantial double wheel and double skid landing chassis and peculiar shaped rattan skid under the rear non-lifting tail.

and arrangement for the introduction of the new Curtiss "flying boat" in Europe.

"In January, Mr. Fanciulli, of our company, took Hugh Robinson to Monte Carlo to demonstrate our hydro-aeroplane," said Mr. Curtiss, in discussing his trip at the pier. "While in France, Mr. Fanciulli sold two machines in that country and received an order from a German concern, besides selling three hydro-aeroplanes to the Rus-

safe as a sport," he said. "We have developed this 'flying boat,' as we call it, so that we can carry a ton of weight at a speed of over sixty miles an hour. The operator and passenger are as comfortably seated and shielded as in an automobile. The machine manoeuvres on the water a much faster rate of speed than the swiftest motor-boat, and it handles in the air just as easily as the regular aeroplane."

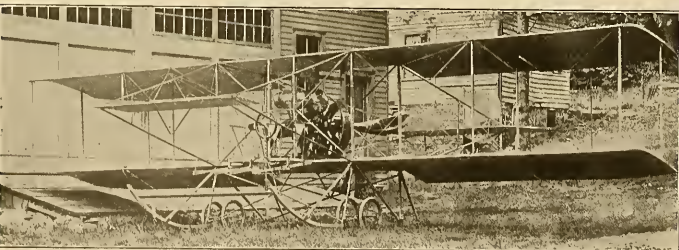

The latest product of the C. & A. Wittmann aeroplane factory on Staten Island—a two-passenger Gnome-driven biplane of superb workmanship. In the design of this machine, safety combined with fine flying qualities has been the chief aim, and in this respect a generous amount of steel tubing has been used, wires doubled and all nuts fastened and locked with cotter pins, so that on extended flights the aviator need never worry about nuts loosening up or wires pulling out. The general dimensions are as follows: Span, 34 ft. 6 ins.; length, 29 ft. 6 ins.; chord, 5 ft. 6 ins.; gap, 4 ft. 9 ins.; propeller Charavay, 8 ft. diameter; weight, 835 pounds.

### Hempstead Plains

(BY W. H. PHIPPS)

Considerable activity was noticeable at the new field during the past month, and good flying, on both monoplanes and biplanes was to be seen almost every day.

Charles Baysdorfer has been continuing his practice flights on his 80 H. P. headless Curtiss type and was flying almost every day the weather permitted. He has placed his engine further forward and fitted a short extension shaft which has greatly improved the balance and flying qualities of his excellent little machine.

On August 31st, George Dyott tried out the Rex monoplane, which had been especially equipped with a 50 h. p. Gnome to fill exhibition dates for the Morok Company. At his first attempt Dyott flew beautifully, putting the machine through every conceivable test and landing with a very pretty vol plane. After practising for several subsequent days, Mr. Dyott left to fill a date at Pittsburgh, but had the misfortune to run into a fence there when starting, and slightly damaged the front of the fuselage.

Eugene Godet was busy practising on the Zeiglin Curtiss type, preparatory to leaving for an extended tour in South America. Godet who was formerly one of the Curtiss fliers, only recently returned from a trip abroad, during which he made the principal flights and meets. He states that they have made wonderful progress in high-speed monoplanes and more especially in the development of large and powerful biplanes of the type of the Farman and Cody type, which have ample surface area and are built in a reasonably safe and quite capable of extended cross-country trips.

Mr. Ey has a very neat little headless biplane at the grounds, which is being fitted with a 50 H. P., 4-cylinder Maximotor. The machine has a Curtiss landing gear and Curtiss-type planes, set at a very slight angle, and a large flexing tail in the rear. In its present form the machine flies tail low, the little Maximotor develops enough power to fly it beautifully.

The Roberts-engine Schneider has been flying almost every day. The machine, thanks to the Roberts motor, is exceedingly fast and a very rapid climber.

The large 50-ft. spread Harper monoplane, one of the largest, if not the largest monoplane in the world, which is equipped with a 6-cylinder 60-80 H. P. Roberts motor, was given its trials during the month and has proved itself a capable flyer. Owing to its large size it flies somewhat loggy and is slow to respond to warping, owing to the fact that it is difficult to warp so large a plane and also because the wings taper towards the tips and, in consequence, there is the least surface at the end where there should be the most. It was proposed by Mr. Crabtree to overcome this by fitting large flexing wing tips, similar to the Etrich. This undoubtedly would be a great improvement, for if the wing tips were arched slightly upward, it would impart a large degree of inherent stability while greatly improving the aviator's control of the machine by reason of the increased leverage of the warping at the extreme tips of the wings.

As the machine stands today it is fitted with a large lifting tail à la Bleriot XI order, a type of tail since abandoned by Bleriot himself and by this country, except for one or two who are still building old-fashioned Bleriot copies. There is no doubt that if the balance of the Harper monoplane was slightly changed, i. e., passenger seat moved slightly forward so as to take some weight off the tail, a large stabilizing damper tail with flexing rear edge could be fitted which would give just arrangement and at the same time increase the fore and aft stability.

These suggestions are made in friendly criticism and for the good of the movement in general, and Harper or any others acquainted with this machine who are not entirely in accord with these views, will not hesitate to enter into a discussion and send in their criticisms.

In the Beckwith hangar, Mr. Crabtree is hard at work putting the finishing touches to the large tractor biplane he is constructing for Mr. Sydney Beckwith. This interesting machine, which is designed to carry two on long flights, is being equipped with a 6-cylinder 70 H. P. military Maximotor, and judging from the success of the Beckwith tractor with its 70 H. P. motor should give a good account of itself.

A new Caudron monoplane has arrived at the Sloat school, so that there are now three machines for school use, in all. During the absence of Bonney by the small Duperdussin for a few days, aviator Lewkowicz was in charge of the school and work was continued on the school Bleriot "Maggie." Upon Bonney's return he immediately set to work giving young Guy Kilpatrick his final instructions, with the result that the next day this very clever young pilot was able to pass his license tests. Peabody is another pupil who is progressing well.

Joe Stevenson, who met with a bad fall while filling an exhibition date recently has returned to the field and with his usual courage and persistence immediately started in rebuilding the damaged plane.

**Wright Air Ferry**

To demonstrate the possibilities of water flying the Wright Aeroplane Company announces that they will establish an aero-ferry between their aviation station and school at Glen Head and New Rochelle, N. Y., crossing Long Island Sound on a schedule at stated intervals, and carrying mail and passengers.

Their chief aviator at the Glen Head school is Charles Wald, of this city, who taught the Wright pupils at Dayton until a recent date. The craft is the first of the new Wright hydro-aeroplane models. The headquarters of the school are at the grounds of the Glenwood Country Club, members of which are much interested.

Wald made a successful flight in the hydro-aeroplane September 17th. The big biplane for fifteen minutes flew over Hempstead Harbor, up to the Glen Cove breakwater, circling over the cross sound ferryboat Rye Cliff as it came into the harbor and flying back again to Glenwood several times. For the most part the machine was at an elevation of more than two hundred feet.

It is stated that Roy Knabenshue has gone to Akron for the purpose of constructing a passenger carrying dirigible to be used between Los Angeles and Mount Lowe, Cal. The airship is to have accommodations for five passengers and will be 140 feet long.

An aviation school for instruction on the Wright machine, aeroplane and hydro-aeroplane, has been started in Stone Harbor, N. J., by the Philadelphia aviator, Marshall Earle Reid who during the early part of last month maintained a daily 20-mile mail route between Stone Harbor and Ocean City, N. J., for over a week. The fine beach will be used to a large extent as a field.

In the International Balloon Race, to be held in Germany the early part of October, Arthur T. Atherton, prominent balloonist and former president of the Aero Club of Pennsylvania, will act as aide to the pilot of Kansas City II, and will fly the Pennsylvania Club pennant in the race.

Aviator Malik, while flying at Shamokin, Pa., September 7th, was caught by a gust of wind which capsized his plane while at a height of 300 feet. The machine was wrecked, but Malik escaped death, being buried under the wreckage, but protected by the engine supports.

Lieutenant Thomas DeWitt Milling, a member of the army aviation school at College Park, Md., will probably leave for France in October, under orders of the War Department, to make a special study of French army aeroplane method. Lieutenant Milling is considered by his fellow-officers to be one of the best aviators in the world. He has had several years' experience in the operation of the Wright and Curtiss biplanes, and knows every part of their construction.

The Navy Department sent Lt. A. A. Cunningham, of the Advance Base School at Philadelphia, to Marblehead a short time ago, and his training was completed in five days under the instruction of Clifford L. Webster. He is now flying alone very successfully, having received 2 hrs., 59 min. training. This is but an example of the ease and quickness with which a man can be trained on the hydro-aeroplane.

J. T. G. Ellyson arrived recently for special training on the Burgess machine. He completed thirty minutes training on a Monday, and ninety minutes on a Tuesday, and now is flying alone.

Mr. Page completed a combination hydro-aeroplane and aeroplane date on August 29, at Barnstable, Mass., this being the second flying on Cape Cod and the first time with a hydro-aeroplane. In the morning four flights were made and in one hour and a half's time the machine was changed over and ready to fly for the afternoon's program, consisting of the release of carrier pigeons, parachute drop, etc.

Mr. Page is engaged to fly the hydro-aeroplane at Sturbridge, Mass., on September 12 to 14. At Rochester, N. H., with an aeroplane on September 24 to 27.

Repairs on the new war machine have been completed and it will go forward shortly to College Park.

**TABLE OF MACHINES USED IN THE CICERO MEET**

Weight in lbs. Area.

Aviator.	Make of Machine.	Length.	Span.	Chord.	Cap.	Area.	Empty.	Loaded.	Internal Balance.	Elevator.	Rudder.	No. of Cyl.	Bore.	Stroke.	Weight.	Speed.	
Beech, A. C.	Beech-National	36	39-24	4-11	5-8	356	1,000	1,500	Ailerons ...	30	12	Motor.					
Daugherty, Earl	I. A. C. Co.	30-0	47-35	5-2	5-0	500	1,150	1,750	Ailerons ...	24	14	Roberts 75	6	4 1/2	5	252	50
Fish, Farnum	Wright B.	29	38-6	6-2	5-4	480	950	1,350	Warp ...	30	15	Hall-Scott 80	8	4	5	290	38
Gill, Howard W.	Wright Ex.	27	32	5-0	4-6	330	1,020	1,420	Warp ...	24	9 1/2	Wright 32	4	4	4 1/2	185	55
Jannus, Anthony	Benoit	22-6	35	4-10	5	340	925	1,425	Fies'g Ail.	25	9	Hall-Scott 60	8	4	4	200	55
Kenny, Horace	Curtiss	24	24	4-2	4-6	210	750	1,200	Ailerons ...	18	9	Roberts 75	6	4 1/2	5	252	65
Lillie, Max	Wright B.	26-6	21	5-2	5	230	800	1,400	Warp ...	30	15	Hall-Scott 80	8	4	5	290	64
Martin, Glenn L.	Martin	29	38-6	6-2	5-4	480	950	1,350	Ailerons ...	18	7 1/2	Wright	4	4	4 1/2	185	38
Mestach, George	Bareil-Morane	21-4	32-10	6-0		176	680	1,080	Warp ...	16	12	Curtiss 75	8	4	5	300	65
Montero, J. R.	Bieriot	24	29-6	6-8		160	325	850	Warp ...	14	10	Conque 50	8	4 1/2	4 1/2	167	55
Prevost, Maurice	Deperdussin	24-2	27-8	5-9		150	550	850	Warp ...	14	6	Conque 50	7	4 3/8	4 1/2	167	55
Stolander, Carl	Curtiss-type	24	28	4-6	4-6	250	625	900	Warp ...	22	9 1/2	Wells-Adams	4	4 1/2	5	200	40
Thompson, DeLloyd	Wright B.	29	38-6	6-2	5-4	480	950	1,350	Warp ...	30	15	Wright	4	4	4 1/2	185	38
Wiggins, C. L.	Wright Ex.	27	32	5-0	4-6	330	850	1,200	Warp ...	24	9 1/2	Wright	4	4	4 1/2	185	50

**Albatross Engines**

Made in two sizes: **50 H. P. G-cyl. Aircooled**, weight 250 lbs., price **\$650.00** complete. **100 H. P. G-cyl. Watercooled**, weight 300 lbs., price **\$850.00** complete. CATALOG FREE. AGENTS WANTED.

**Albatross Co. Detroit, Mich.**

**HEINRICH**

**Monoplanes and Mono-Biplanes**

**TUITION, \$250**

On Private Field

MADE IN FOUR SIZES

Write for Illustrated Booklet

**HEINRICH BROS., Baldwin, L. I., N. Y., U. S. A.**

**PROPELLER FACTS**

Gibsons were the first on the market, and always best. **WHY?** Because of the care taken to make them good. We have discovered a wonderful advance in propellers, and we market them under the title of Worcester, because we made the tests at Worcester Polytechnic Institute. **THEREFORE, WE WILL SELL** the remainder of our stock of ordinary style propellers at 1/4 of our list prices. Get in quickly, only 40 left now. They are the best ordinary propellers obtainable. **GIBSON PROPELLER CO. Fort George Park, New York City**



**SUPPLIES**

at more than interesting prices. Bieriot and Curtiss K. D. outfits our specialty. Imported helmets in stock. Wheels with tires 20" x 2 1/4" \$6.60, 20" x 3" \$9.25. 22-page catalogue A sent upon receipt of 6 cents.

**NEW YORK AERONAUTICAL SUPPLY CO. 50 BROADWAY, NEW YORK**

**COOKE BIPLANES**

**Curtiss Improved 1912 Type (Pigeon Tail)** Perfect fliers. No freak construction. Ten years' experience. Strongest in the world. Ample powered (Roberts Motors). **Anybody can fly these machines. One ready for immediate \$2,500 delivery.** Curtiss Type Planes, no Power Plant, \$650 and up. **Free Instruction to Buyer** **H. C. COOKE, 127 West 64th St. NEW YORK CITY**

**AEROPLANE RADIATORS**

IN STOCK OR TO ORDER

**SEND FOR PRICE LIST EL ARCO RADIATOR CO. 6 EAST 31st St., NEW YORK**

# CLASSIFIED ADVERTISING

15 CENTS A LINE

SEVEN WORDS TO LINE

CASH WITH ORDER

## FOR SALE

## MUST SELL--FINE MONOPLANE

1911, cross country type, two seater, Blériot, 100 H. P. engine, full equipment. A. V. Reyburn, Jr., 5305 Delmar Boul., St. Louis, Missouri.

## PATENTS BRING WEALTH;

proof—looks—advise free.  
Low rates, terms easy.

A. Wedderburn, Pat. Atty., Washington, D. C.

FOR SALE—One Roberts 4x50 H. P. motor, complete, new; in perfect condition; \$675. M. F. H. Gouverneur, Wilmington, N. C.

FOR SALE—THE LATE MISS HARRIET QUMBY'S SLIGHTLY DAMAGED GENÈVE PASSENGER "BLÉRIOT" LATEST MODEL, WITH 70 H. P. Gnome Motor; GOOD AS NEW; NEW SPARE WINGS, AND MANY OTHER EXTRAS. AT A "BARGAIN" CAN BE SEEN AT 282 9TH AV., NEW YORK CITY. ADDRESS JOHN A. SLEICHER, LESLIE'S WEEKLY, 225 FIFTH AV., NEW YORK CITY.

FOR SALE—Cheap, complete hydro-aeroplane frame. H. C. Downey, Dobbs Ferry, N. Y.

## FOR SALE

CURTISS latest improved type (Pigeon tail) 1912 Model. Made over 300 very successful flights 1,000 ft. high, 30 miles cross-country. My construction is strongest in the world. New, complete, ready to fly, tested and guaranteed, including free lessons to buyer, \$2,500. Buy direct from Builder and Aviator of 10 years' experience. H. C. Cooke, Aviator and Builder, 127 West 64th St., New York City.

TRACTOR BIPLANE, with 50 H. P. 1912 Maximator. Fine workmanship. Will demonstrate flight. Bargain. Aviator going to college. Address Box 767, AIRCRAFT.

FOR SALE—My Curtiss type biplane equipment with 30 H. P. Kirkham motor, El Arco Radiator and several extras, guaranteed to be in the best of flying conditions, for \$700. For further particulars write to W. F. Zehler, 341 Swan st., Buffalo, N. Y.

ARTISTIC 4x3 aeronautical photographs, 6 for \$1; sample photo and complete list, 20c. Chas. I. Durso, 25 Mulberry st., New York City.

## POSITIONS WANTED

A YOUNG MAN, age 18, desires position as an aviator's assistant, with prospects of learning to fly. Address Louis Fenouillet, 132 West 47th St., New York City.

## CO-OPERATION WANTED

CAPITAL wanted to patent and build aeroplane that will fly three hundred miles per hour. Will give 49 per cent. of patents. I will guarantee to fly across Atlantic in twelve hours. Address A. Harbottle, 18 Eldert St., Brooklyn, N. Y.

ESTABLISHED manufacturer owning all the patents covering an indispensable part of all aeronautical equipment needs moderate capital to extend domestic and foreign trade. Enormous profits last year, but must expand to meet growth and changing conditions. Address Amerco, care of AIRCRAFT.

## AVIATORS WANTED

WANTED—An experienced aviator to fly my biplane. Answer at once by mail and give your lowest terms. Address W. F. Zehler, 341 Swan st., Buffalo, N. Y.

LEARN to Fly: \$100 required. Aviators' Exchange, 58 W. Washington st., Chicago, Ill.

## LEGAL NOTICE

I desire to give notice to all persons that are using my "Patent Rudders" (Serial number 504107 U. S.), also France and England, and my "Semi-Automatic engine control," (Serial number 646300 U. S., France and England), that it is my intention in the future to ask a small royalty from them. Hugh L. Willoughby, Sewalls Point, Florida.

## PATENTS

THAT PROTECT AND PAY

BOOKS, ADVICE AND SEARCHES FREE

Send sketch or model for search. Highest References.  
Best Results. Promptness Assured.

WATSON E. COLEMAN, Patent Lawyer  
624 F. Street, N. W. Washington, D. C.

## PATENTS SECURED or Fee Returned

Send sketch for free search of Patent Office Records. How to Obtain a Patent, and What to Invent, with list of Inventions Wanted and Prizes offered for Inventions sent free. Patents advertised free.

We are experts on AIRSHIPS and all patents and technical matters relating to AERIAL NAVIGATION.

VICTOR J. EVANS & CO. Washington, D. C.

### "IDEAL" Plans and Drawings



are accurate and are accompanied by clear, concise building instructions, postpaid at the following prices:

Wright 3-foot Biplane . . . 25c  
Blériot 3-foot Monoplane . . . 15c  
"Cecil Peell" Champion Racer . . . 25c

Curtiss Convertible Hydroaeroplane (new) . . . 35c  
"Ideal" three-foot Racer (new) . . . 15c

Complete set of five—\$1.00 postpaid.  
5 cts. brings our new 50-page fully illustrated Catalog of "Ideal" Model Aeroplane Supplies. (None free.)  
IDEAL AEROPLANE & SUPPLY COMPANY  
82-B West Broadway, New York

## J. C. (BUD) MARS, NOW BOOKING

—ADDRESS—

### 17 N. La Salle Street, Chicago, Ill.

## BAMBOO Special Grades of Bamboo for AERONAUTIC WORK

Reed, Rattan and Split Bamboo for Models. All sizes in stock. Tonka Rattan for Skids, 1 1/4 inch and under, any length.

J. DELTOUR, Inc.

804 Jefferson St. Hoboken, N. J.

## GOOD YEAR

AKRON, OHIO

Goodyear Balloons Aeroplane Accessories  
National headquarters for Spherical and Dirigible Balloons. Built complete. Highest quality. Also makers of Aeroplane Sutures, Tires, and the famous Goodyear Rubberized Aeroplane Fabric. Write for booklet.

THE GOODYEAR TIRE & RUBBER CO.  
AKRON, OHIO.

### DETROIT AERO POWER PLANT

COMPLETE \$300 READY TO RUN

INCL. PROPELLER-CARBURETOR-ROSH MAGNETO.  
OIL PUMP-CABLE-SWITCH-MOUNTING BOLTS.

IS GUARANTEED TO

210 LBS. MIN. STATIONARY THRUST  
158 LBS. MAX. WEIGHT (COMPLETE)

36 HOURS DELIVERY

LIFT AND FLY  
CURTIS BYPLANES  
BLÉRIOT II MONOPLANES  
DEMOISELLE MONOPLANES  
OR CRAFTS OF SIMILAR MAKE

DETROIT AEROPLANE CO.  
DETROIT MICHIGAN

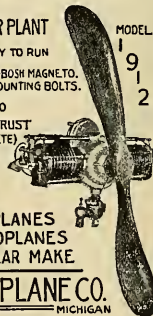

Seventy per cent. of record-breaking American flights with American Aeroplanes were made with propellers bearing this name

# CHARAVAY

WE WILL TELL YOU WHY IF YOU ASK US

SLOANE AEROPLANE CO.

1731 Broadway, NEW YORK CITY

AGENTS:

Emmes Tricycle Co., San Francisco and Los Angeles; National Aeroplane Co., Chicago; W. E. Boughton, Washington, D. C.

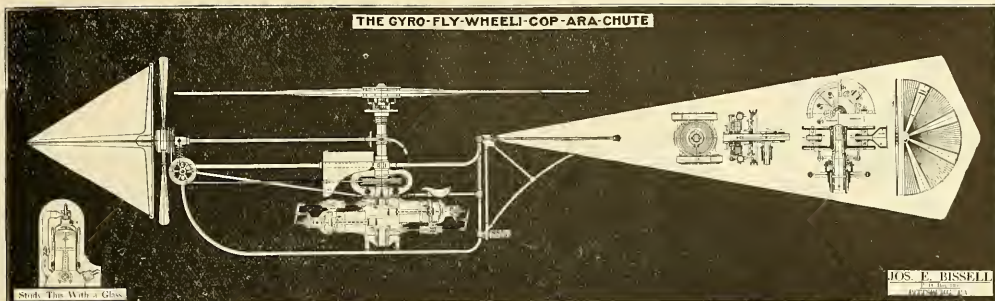

A TOAST TO 'M?'—TH' JACKASS WHO BUTTS OUT HIS SOUL  
 IN A RAID ON TH' PLANET STRAIGHT DOWN TH' "AIR-HOLE;"  
 WHICH SUGGESTS THIS REMARK—AND MY LANGUAGE IS PLANE—  
 THAT TH' "STIFF" WING SCHOOL'S SUCKERS—NOT BIRDMEN—JUST VAIN SUCKERS!

## ALUMINA AEROPLANE FABRIC "LIGHT AS A FEATHER" "BEAUTIFUL AS DAY"

Finest Imported Linen, thoroughly Waterproofed, and then coated with Aluminum. Heat and Moisture proof.  
 Strongest and Most Durable Aeroplane Cloth on the Market. Our Prices will surprise you.

SEND FOR SAMPLES AND PRICE LIST, AND BE CONVINCED.

### THE AERIAL NAVIGATION COMPANY OF AMERICA

GIRARD, KANSAS

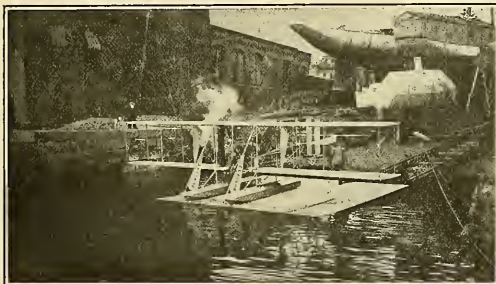

"THE PASSING OF THE YACHT"

## Burgess Flying School

Hydroaeroplanes used exclusively. You can learn without delay. The Burgess factory adjoins the flying station. Aeroplanes for exhibition, military and sporting use under construction. All leading motors used. Pupils secure not only training, but latest information concerning construction and design.

INSTRUCTOR:  
**PHILLIPS W. PAGE**

Licensed Aviator

New Booklet just printed will give you full particulars

**THE BURGESS COMPANY & CURTIS**  
 MARBLEHEAD, Box A MASSACHUSETTS

## CHICAGO AERO WORKS

H. S. RENTON Proprietor 164 North Wabash Avenue  
**AEROPLANES** ACCESSORIES MOTORS PARTS  
 HARDWARE PROPELLERS  
 WHEELS ALSO MODELS AND MODEL STOCK  
 ESTABLISHED 1909. First in Chicago and the Middle West  
 Aviators Taught. Flights Furnished. Send Stamp for Catalog.

**CAPT. BALDWIN** made two successful tours around the world with an aeroplane, without any serious accident, during his exhibitions.

Always using the  
**"Willoughby Patent Double Rudders"**  
 for steering his machine.

The safety of this method of steering (in the vertical plane) has been demonstrated without a doubt.

## AERO WIRE WHEELS

BUY FROM MANUFACTURER AND SAVE MONEY

20 x 2 1/4" Wheels—6" Hub—\$4.00 with tire \$6.00  
 20 x 3" Wheels—6" Hub— 4.75 with tire 8.25  
 FARMAN TYPE Gears complete—Price 42.50

Stock size Hubs—6" wide, 3/8 or 1/2" knock-out axle or bushed to fit 1" axle—to fit 1 1/4 and 1 1/2 special HYDRO-FLOATS and 3/4 inch Float Wheels.

Don't fail to write for complete list of Wheels and Prices. We make any size or type.

Deposit required on orders; Balance C. O. D.—examination allowed.

**J. A. WEAVER, Jr.** 132 West 50th Street  
 NEW YORK CITY

\$1200 to \$4800

THE  
**REX** MONO-  
 PLANE  
 CO.

South  
 Beach, S. I.  
 N. Y.

DUPLICATE PARTS

at

SAVE  
50%**COST**SAVE  
75%

## Buy a **REX** Monoplane and Save

\$500 to \$1000 on Purchase.

\$250 Tuition Fee to Learn to Fly.

50% to 75% on Maintenance.

The REX, with its interchangeable wings, makes it possible to enter Speed, slow and passenger contests during the same day. **WHAT OTHER AEROPLANE CAN DO THIS?** Remember, we **Guarantee Before** delivery to fly the REX at **Least 1000 Feet High and 10 Miles** across country.

We Supply an Extra Pair of Racing Wings with each REX.

We Duplicate Parts at Absolute Cost, a Saving of 50% to 75% in Maintenance.

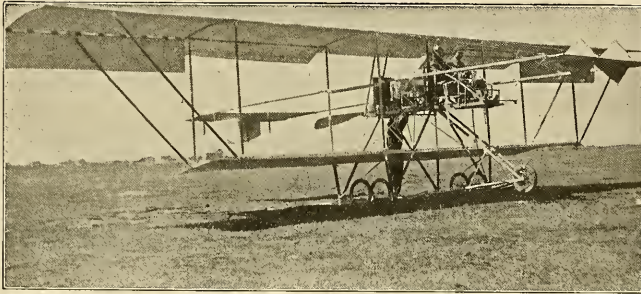
**THE REX MONOPLANE CO.****South Beach, S. I., N. Y.**

Showing double control school machine built in our Chicago factory. Width 52 feet.

## **A** NATIONAL AEROPLANE COMPANY

606 South Michigan Avenue, Chicago  
 Harvester Building

**Manufacturers  
 Exhibitors  
 School of Aviation**

**REFERENCES:**

Dun or Bradstreet  
 Corn Exchange National Bank, Chicago

## WIRE

Aviator Wire supplied in 12 sizes with a plate finish, making soldering easy. This wire is specially drawn from extra quality high grade steel. Also Aviator Cord of twisted wire.

**John A. Roeblings Sons Co.**  
 TRENTON, N. J.

## BALDWIN

### VULCANIZED PROOF MATERIAL

For Aeroplanes, Airships, Balloons. First Rubberized Fabric on the market. Lightest and strongest material known. Dampness, Heat and Cold have no effect. Any Strength or Color.

"RED DEVIL" AEROPLANES  
 That anyone can fly. Free Demonstrations.

### HALL-SCOTT MOTORS

Eastern distributor. 40 h. p. 4-cyl.; 60 and 80 h. p. 8-cyl. on exhibition at Frank Schumacher's, 164 W. 46th Street, New York. All motors guaranteed. Immediate delivery.

### EXPERTING

Will install a Hall-Scott free of charge in anyone's Aeroplane and demonstrate by expert flyer. Expert advice. \*Planes balanced.

**CAPT. THOMAS S. BALDWIN**  
 Box 78 Madison Sq. P. O., New York  
**AEROPLANES**

## HOTEL CUMBERLAND

NEW YORK

Broadway at 54th Street



Headquarters for Avi-  
 ators and Automobilists.

*New and Fireproof*

Strictly first class.  
 Rates reasonable.

**\$2.50**  
**With Bath**  
*and up*

Send for booklet.

Ten Minutes' Walk to Thirty  
 Theatres

## H. P. STIMSON

Formerly with Hotel Imperial



## COMING EVENTS

Cast your shadow towards the

### "KING OF ATTRACTIONS"

**HARRY BINGHAM BROWN**

ENGLISH PILOT

ELEVATING

**FREDERIC RODMAN LAW**

In his **WRIGHT AEROPLANE** to a height of 4,500 feet, disposing of his human freight at a dizzy height, who descends by the aid of a parachute.

Every click of the watch a "**THRILLER**," something worth going miles to see.

No other act like it in the **WORLD**.

**MANAGERS BOOKING** will do well to address

**A. LEO STEVENS, Box 181 Mad. Sq., N. Y.**



## BENOIST BIPLANES

TYPE XII.

*Three Models*

*School Machine*

*Cross Country Machine*

*Military Machine*

Also operate the

**Benoist School of Aviation**

For further particulars address

**BENOIST AIRCRAFT CO.**

6630 Delmar Blvd., St. Louis, Mo.

## "ROOLD"

FOR SAFETY HELMETS

AVIATION SUITS

UNBREAKABLE GLASS GOGGLES

*"EVERYTHING FOR THE AVIATOR"*

50 Avenue de la Grande Armee, PARIS

Official Contractors to the French and Russian Armies

## NAIAD Aeronautical Cloth

Manufactured Especially for Aeroplanes and Used by

Aviators of Prominence

LIGHT, STRONG, AIR-TIGHT

AND

MOISTURE-PROOF ON BOTH SIDES

Sample Books, including Data and Prices, sent on request

**THE C. E. CONOVER CO.**

101 Franklin Street - - New York

# C. & A. WITTEMAN

Aeronautical Engineers

Manufacturers of

BIPLANES

MONOPLANES

HYDRO-AEROPLANES

GLIDERS

PROPELLERS

PARTS

SPECIAL MACHINES AND PARTS BUILT TO SPECIFICATIONS

HALL-SCOTT MOTORS, 40-60-80 H. P.

**YOUR OPPORTUNITY**—One single covered Biplane for immediate delivery. Slightly used, with 8 cyl. 60 H. P. Hall-Scott Power Plant.

## FLYING AND TRAINING GROUNDS

Works: Ocean Terrace and Little Clove Road.

Established 1906

STATEN ISLAND, NEW YORK CITY

Tel. 717 Tompkinsville

## INVESTIGATE FIRST

Satisfy yourself you are dealing with a responsible concern before paying your money.

**WE GUARANTEE** our machines, workmanship, materials, etc., superior to those of any other constructed here or abroad regardless of price paid.

Immediate and prompt delivery on standard machines.

"Nieuport," "Bleriot," "Farman" and "Curtiss" types. Hydroplanes; speed, single, passengers, weight-carrying, or specially constructed to your own design and specifications.

"Complete with suitable power plant purchaser selects or prefers, demonstrated in flight." "Complete without power plant," or "Complete in the Knockdown." Will accept orders on specified time delivery under forfeiture.

We invite your personal inspection of the best equipped plant in the U. S. All types in course of construction. Unexcelled opportunity to acquire full shop, construction and flying course, on any type Monoplane or Biplane.

*SEEING IS BELIEVING. CALL IF POSSIBLE OR WRITE.*

## INTERNATIONAL AERONAUTIC CONSTRUCTION CO.

Factory, Hollis, L. I.  
Main Line L. I. R. R.

Office, P. O. Bldg.  
Jamaica, N. Y. City

Flying Grounds  
Nassau Boulevard

## GRAY EAGLE MOTORS

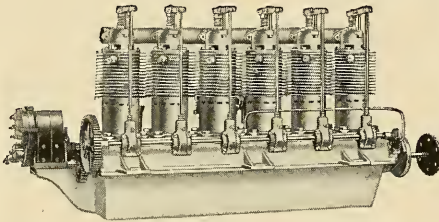

Having more bearing surface and less parts, meaning long life, smooth running and safety. Three months to pay for a Gray Eagle Motor will give the motor an opportunity to prove its merits. Particulars on application.

Model E-6 50 H. P.

Model D-4 35 H. P.

**Kemp Machine Works**

- - -

**Muncie, Indiana**

# BLERIOT MONOPLANES

(GENUINE)

**Winners of ALL the European Contests in 1911**

In 1909---The First Aerial Crossing of the Channel.

In 1910---The "Circuit de l'Est."

In 1911---The Paris-Rome Race (1st and 2d.)

The European Circuit (1st and 2d.)

The English Circuit (Daily Mail Race.)

The Belgian Circuit.

The Saint Petersburg, Moscow Race.

The Valencia Alicante Race.

The London to Paris non-stop Raid, etc., etc.

**WORKS AND OFFICES: - - 39, Route de la Révolte à Levallois - - PARIS**  
**and Belfast Chambers, 156 Regent St., LONDON**

**AVIATION SCHOOLS:** <sup>FRANCE</sup> Etampes, near Paris during Summer  
Pau, during Winter

<sup>ENGLAND</sup> Hendon, near London

# THE CURTISS SUMMER TRAINING SCHOOL AT HAMMONDSPORT, NEW YORK



ONE OF THE CURTISS TRAINING GROUNDS

**New Hangars, New  
Equipment, Experi-  
enced Instructors.**

**Aeroplane and  
Hydroaeroplane  
Courses.**

*The Curtiss Schools are  
the largest in America.*

*Seventeen pupils obtained  
their pilots' licenses at  
our San Diego School be-  
tween January first and  
March fifteenth.*

*Summer classes are filling  
rapidly.*

**WRITE OR WIRE YOUR ENROLLMENT TODAY**

*PRICES AND PARTICULARS UPON REQUEST*

*Largest  
Builders of  
Complete  
Aeroplanes  
in the world*



**ALL NATIONALITIES ARE REPRESENTED AT THE CURTISS SCHOOLS**

*(One of the Graduating Classes.)*

# THE CURTISS AEROPLANE CO.

HAMMONDSPORT, NEW YORK

# ROBERTS MOTORS

## Win at Chicago

Getting Big Money for Their Operators

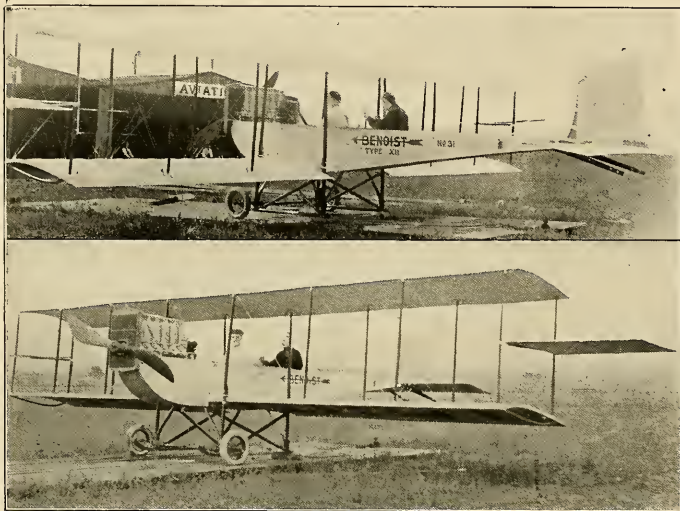

The consistent performance and freedom from trouble of the Roberts Motors at the recent Chicago meets elicited unstinted praise from every aviator there.

Roberts Motors are used in more exhibition work this fall than any other one motor.

---

SEND FOR FREE CATALOG TO-DAY

## THE ROBERTS MOTOR COMPANY

1463 Columbus Avenue

Sandusky, O.

# AIRCRAFT

Vol. 3 No. 9

NOVEMBER, 1912

15 Cents a Copy

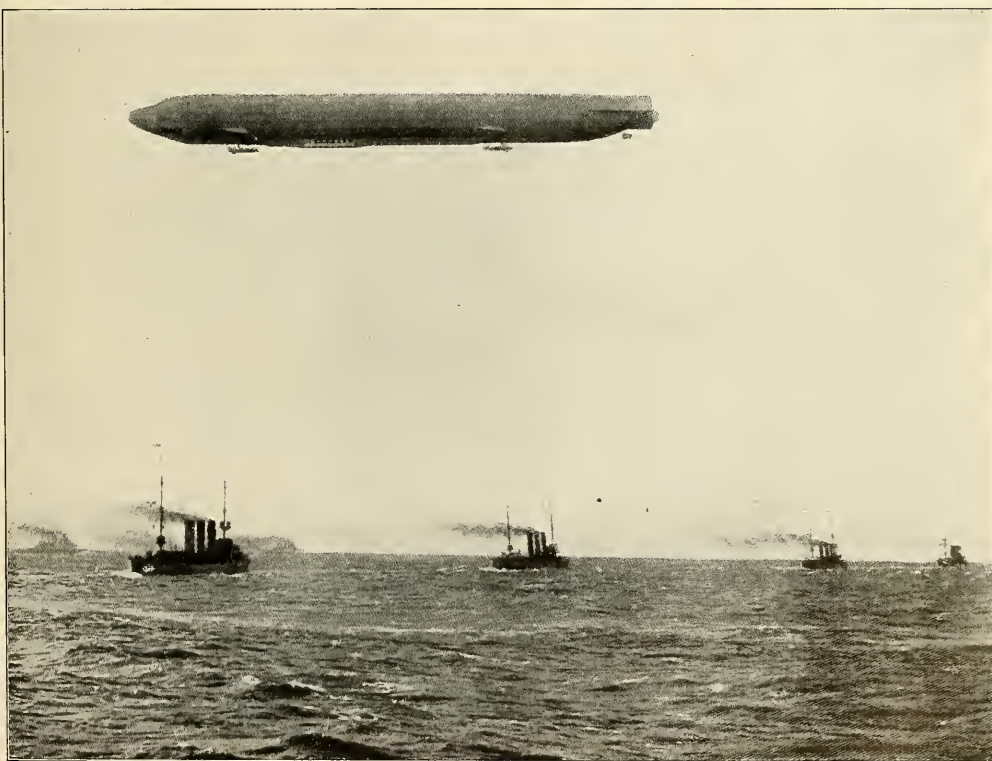

#### "HANSA" CIRCLING OVER THE GERMAN FLEET

Another great demonstration of the airship's ability to manoeuvre advantageously, was given during the "Kaiser Manoeuvres" near Heligoland in the North Sea recently, by the Zeppelin airship "Hansa" which circled above the war ships for half an hour while reviewed by the Emperor, and after exchanging salutes with the Kaiser's flagship, returned to Wilhelmshaven. Shortly afterward the "Hansa" went to Copenhagen and flew over the British squadron.

# SLOANE

## OUR CALIFORNIA SCHOOL

opens on November 15th at the famous Dominguez Field near Los Angeles. This ideal location for an Aeroplane School is adjacent to splendid living accommodations; a short ride from the ocean and twenty minutes from the heart of Los Angeles. All the most attractive and romantic points of interest of this storied region are in eye-shot from an Aeroplane over our Field. We are able to secure special rates for the accommodation of our pupils at hotels and in private homes. We will gladly make all reservations.

**FOUR DEPERDUSSIN MONOPLANES; TWO CAUDRON MONOPLANES;  
ONE BLERIOT MONOPLANE AND ONE SPEEDY BIPLANE  
WILL BE OUR SCHOOL EQUIPMENT.**

W. LEONARD BONNEY, one of the pioneer American Aviators, assisted by two notable flyers will constitute the teaching faculty. We teach exactly according to the methods used on the Plains of Champaign near Rheims, France. We use the same kind of machines with which Vedrines, the Deperdussin Flyer, won the World's Championship at Chicago. We have the most perfect imported Aeroplanes, use the most perfect Field and Shop teaching methods and are located on the most ideal spot in America. Our faculty and our equipment are sufficient to handle almost any number of pupils with thoroughness and expedition. Our pupils on Long Island have become aviators of notable skill in an average of six weeks. The cost is

### \$300 FOR THE COMPLETE COURSE

The pupil in our school is not discharged from his class until he has secured his pilot's certificate. There are no extra charges for anything. The pupil is also obliged to put up a guarantee of \$250 for breakage in addition to his tuition fee. This small bond covers his use of the machine when he flies for his certificate. When the pupil is discharged from the school the \$250 guarantee is refunded and he is given a rebate of ten per cent. of his tuition fee if he completes without breakage.

*There is a great demand for real monoplane flyers. We know it because we cannot secure enough efficient aviators for our own purposes. We guarantee no person a position because we are not able to judge ability until we have seen the candidate fly. But we aid every efficient pupil to secure profitable employment.*

*This is the time, the place and the school to secure the training that will equip you for the big work to be done next season. A monoplane won the Gordon-Bennett for France this year. A monoplane will win the Gordon-Bennett for America next year. We are going to build the Monoplane and we are looking for the champion who will drive it. Are you that man?*

We are arranging to carry passengers on a series of Aeroplane Cross-country Tours over California. Bookings are now being made.

Make your arrangements for the school and the Cross-country Tours as soon as possible. Only a limited number of persons will be accommodated in order that the work may be done right.

WIRE!

WRITE!

'PHONE!

# SLOANE AEROPLANE CO.

210 Merchants Trust Building  
Second St. & Broadway, Los Angeles, Calif.  
Phone Main 3674

1731 Broadway  
New York City  
Phone Columbus 5421

National Aeroplane Company  
606 S. Michigan Ave., Chicago, Ill.  
W. E. Boughton Washington, D. C.

# BOOKS

We have compiled a list of the very best aeronautical books written in the English language and offer them for sale to our readers. Earnest students of Aerial Flight should read every book in this list.

Make all Drafts, Express or Post Office Orders payable to

THE LAWSON PUBLISHING CO., 37-39 East 28th Street, New York, U. S. A.

- |  |        |   |      |
|--|--------|---|------|
| <b>Art of Aviation</b> , by Robert W. A. Brewer. A hand-book upon aeroplanes and their engines, with notes upon propellers, accompanied by twelve valuable folding plates illustrating various types of machines and motors.....                       | \$3.50 | <b>Aerodynamics</b> , by F. W. Lanchester. Constituting the first volume of a complete work on aerial flight, with appendices on the velocity and momentum of sound waves, on the theory of soaring, flight, etc.....   | 6.00 |
| <b>Artificial and Natural Flight</b> , by Sir Hiram S. Maxim. Being a description of his own experimental work and the development of flying machines generally.....   | 1.75   | <b>Aerodromettes</b> , by F. W. Lanchester. Constituting the second volume of a complete work on aerial flight, with appendices on the theory and application of the gyroscope, on the flight of projectiles, etc.....  | 6.00 |
| <b>Pocketbook of Aeronautics</b> , by H. W. L. Moedebeck. Containing many features of aerial travel; a splendid text-book for the beginner or the aeronautical engineer.....   | 3.25   | <b>All the World's Airships</b> , by Fred T. Jane. Being the first annual issue, containing photographs of almost every flying machine built up to 1909....   | 5.00 |
| <b>Vehicles of the Air</b> , by Victor Loughhead. One of the very latest aeronautical books, covering all the very latest detail of the science of aviation....  | 2.50   | <b>How It Flies</b> , by Richard Ferris, B. S., C. E. The story of man's endeavors to fly and of the inventions by which he has succeeded. Illustrated by over 150 half-tones and line drawings showing the stages of development from the earliest balloons to the latest aeroplanes.....        | 1.20 |
| <b>Aerial Navigation</b> , by A. F. Zahm. A book written by one of the world's great scientists who has made an extensive study of the aeronautical subject for the past 20 years.....   | 3.00   | <b>Flying Machines, Construction and Operation</b> , by W. J. Mackman.....  | 1.50 |
| <b>Airships in Peace and War</b> , by R. P. Hearné, with an introduction by Sir Hiram Maxim. A popular account of the progress made by the different countries of the world in aircraft.....   | 3.50   | <b>Aeroplane Patents</b> , by Robert M. Neilson. A work embodying many useful hints and data relating to patents especially adapted to inventors and manufacturers interested in heavier-than-air flying machines.....  | 2.00 |
| <b>Aerial Navigation To-day</b> , by Chas. C. Turner. A finely illustrated work on the principles of Ballooning, Aviation, Aerial Law, Military Aeronautics, the aerial ocean and the industrial side of flight.....                                   | 1.50   | <b>The Aeroplane</b> , by T. O'B. Hubbard. An elementary text book of the principles of dynamic flight....  | 1.00 |
| <b>The Problem of Flight</b> , by Herbert Chatley. A most instructive work, written principally for aerial engineers.....  | 2.50   | <b>Birdflight as the Basis of Aviation</b> , by Otto Lilienthal. A contribution towards a system of aviation compiled from the results of numerous experiments.....   | 2.50 |
| <b>The Force of the Wind</b> , by Herbert Chatley. A scientific treatise, dealing with the subject of wind pressure in relation to engineering.....  | 1.25   | <b>The Aeroplane, Past, Present and Future</b> , by Claude Grahame-White and Harry Harper. Containing information useful and entertaining, with chapters on various phases of aviation by many well known airmen.....   | 3.50 |
| <b>How to Build an Aeroplane</b> , by Robert Petit. Translated from the French by T. O'B. Hubbard and J. H. Ledebor, 8vo. cloth, 121 pp., 93 illustrations.....  | 1.50   | <b>Flying Machines Today</b> , by Wm. D. Ennis, M. E. Treatise on principles of various types of aircraft with 123 illustrations.....   | 1.50 |
| <b>Monoplanes and Biplanes: Their design, construction and operation</b> , by G. C. Loening. This is a very complete and practical work on aeroplanes that fly.....  | 2.50   | <b>Mechanics of the Aeroplane</b> , by Captain Duchenne. A Study of the Principles of flight.....   | 2.25 |
| <b>Principles and Design of Aeroplanes</b> , by Herbert Chatley. The very latest text book on Aeroplanes, containing many general details and mechanical drawings.....   | .50    | <b>My Three Big Flights</b> , by André Beaumont. In which the noted Bleriot pilot narrates in a most interesting manner, his various experiences and describes three notable events which he won....  | 2.50 |
| <b>My Airships</b> , by Santos-Dumont. The thrilling story of this intrepid Brazilian's wonderful success in aerial navigation, told in an entertaining way, free from technicality. With 55 full-page pictures from photographs. 12mo. 400 pages..... | 1.50   | <b>Law of the Air</b> , by Harold D. Hazeltine. A series of three lectures delivered by the author in the University of London, in which the problem of national and international law relating to air space is discussed.....  | 1.50 |
| <b>Handy Man's Workshop and Laboratory</b> , by A. Russell Bond. A popular work on almost everything pertaining to the every-day life of the mechanic, 270 illustrations and two chapters relating to flying.....                                      | 2.00   | <b>Practical Aeronautics</b> , by Chas. B. Hayward. An up-to-date treatise on dirigibles and aeroplanes covering their historical development, analysis of standard types, their design, construction and operation; the aeronautical motor and the theory and practise of successful flight..... | 3.50 |
| <b>The Conquest of the Air</b> , by A. Lawrence Rotch. A subject treated by an accepted authority in a manner appreciated by a popular, as well as a scientific audience.....  | 1.00   | <b>Building and Flying an Aeroplane</b> , by Chas. B. Hayward. A book of invaluable assistance to the amateur builder, with instructions for building, flying, methods of control, etc.....   | 1.00 |
| <b>Airships Past and Present</b> , by A. Hildebrandt. A general sketch of the past and present state of the art, together with its problems, presented in a way that can be understood by everybody.....   | 3.50   | <b>Aircraft, Volume 1</b> .....   | 3.50 |
| <b>Charts of the Atmosphere</b> , by A. Lawrence Rotch....   | 2.00   | <b>Aircraft, Volume 2</b> .....   | 3.50 |

## FRONTIER MODEL A

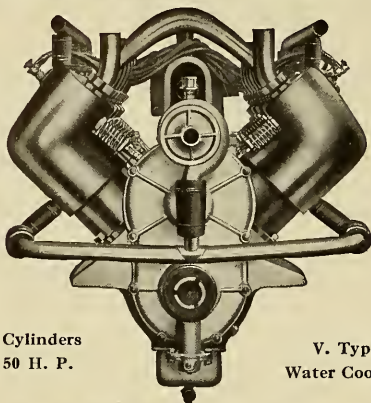

8 Cylinders  
50 H. P.

V. Type  
Water Cooled

Four and three quarter lbs. per actual Horse Power

# Simple Reliable Durable

Reliability and durability coupled with minimum weight, consistent with absolute safety, are the important points of superiority combined in the FRONTIER Aero Motor of quality.

Our claim for distinction lies in the unique and well balanced design and the mode of fuel supply, giving equal and never-failing power for all altitudes and temperatures.

Embodied in its construction are these essentials:

Highest grade of workmanship.  
Best materials.  
Experienced and capable engineers.  
Perfect shop equipment for manufacture.

Catalog and Price List on Application

**E. J. Willis Co.**  
85 Chambers Street, New York Agents

**Frontier Iron Works**  
BUFFALO

## Wright Hydro-Aeroplane School Now Open at GLEN HEAD, L. I.

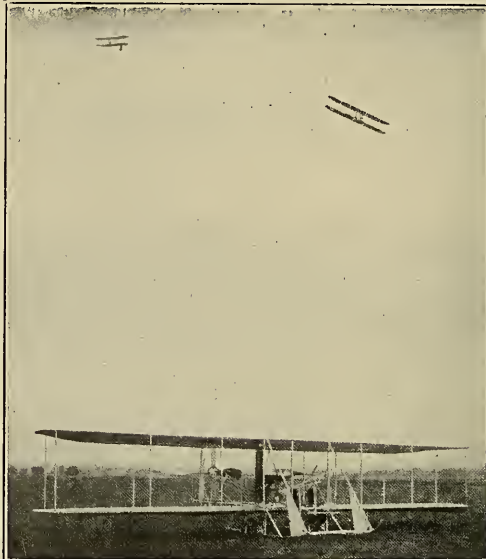

# Wright Flyers

## 1912 MODELS

In addition to those features which in the past have made Wright Flyers famous for efficiency and reliability, the new models can be furnished with **Automatic Control, Silent Motors, and Hydro-planes.** These special features make the 1912 machine unusually attractive to sportsmen.

## EXHIBITION MACHINES

For exhibition work we have other models especially adapted to high winds and small fields. It was with a stock "EX" Model that Rodgers made his wonderful flight from coast to coast. Reliability means dollars to the exhibitor.

## WRIGHT SCHOOL OF AVIATION

Training consists of actual flying, in which the pupil is accompanied by a competent teacher. No risks and no expense whatever from breakage. The most famous flyers in America are graduates of our school and include such names as

Lieut. Arnold	Drew	Lieut. Rodgers
Atwood	Elton	Parmalee
Brookins	Lieut. Foulis	Page
Brindley	Fowler	Reynolds
Bonney	Gill	Simmons
Beatty	Lieut. Labm	Turpin
Burgess	Lieut. Milling	Welsh
Coffyn	Mitchell	Webster
Capt. Chandler	C. P. Rodgers	and many others.

Our Schools at Dayton and New York are now open and pupils may begin training at once if they wish. By enrolling now you can reserve date most convenient to you for training. Write for particulars.

**THE WRIGHT CO.**  
Dept. "B" DAYTON, OHIO





Cecil Peoli, the young Baldwin aviator, flying an 80 H. P. headless Baldwin biplane at Milton, Pa., and making one of his quick rises from a small field. Mr. Peoli states that the quick rising capability of a machine is the main feature of its success for exhibition flying.

Although only 18 years old and an aviator of less than a year's standing, Peoli has proved himself to be one of this year's most remarkable flyers, and his success in the exhibition field places him amongst the greatest of American aviators.

Before taking up the flying of large machines he was a model enthusiast and the holder of many American model records. It was while engaged in his model experiments that he first attracted the attention of Capt. Tom Baldwin, who was not slow to recognize his natural aeronautic ability, and offered him a position as aviator.

In less than a month after learning to fly Peoli had redesigned the old front rudder Baldwin into a headless machine and thus greatly increased its speed and efficiency for exhibition work. While out on his recent flying tour he drew up the design for a machine capable of still better meeting the needs of exhibition and cross-country work, and at the time of going to press is busily engaged on its construction. Judging from the designs of the new biplane, it is safe to say it will create a stir in aviation circles.

**CONTENTS—NOVEMBER, 1912**

A New Principle in Flight . . . . .	Denys P. Myers	265
Marvellous Airship Advancement . . . . .	T. R. MacMechen	267
Editorials . . . . .		268
Oiling Gasoline Engines . . . . .	Dr. Leonard Keene Hirshberg, A. B., M. A., M. D.	270
Louis Bleriot . . . . .		270
Foreign News . . . . .	R. H. Blanquie	271
Change Place With Your Motor . . . . .	Walter H. Phipps	274
General News . . . . .	D. E. Ball	275
Book Review . . . . .		278
Correspondence . . . . .		279

**AIRCRAFT**

ALFRED W. LAWSON  
President and Treasurer  
ERNEST C. LANDGRAF  
Secretary

Published Monthly by The Lawson Publishing Company  
37-39 EAST 28th STREET, NEW YORK, U. S. A.  
Telephone, 5017 Madison Square

ALFRED W. LAWSON  
Editor  
WALTER H. PHIPPS  
Asst. Editor

**TERMS TO SUBSCRIBERS**

In the United States, Mexico, Puerto Rico, Guam, Philippine Islands, Hawaiian Islands, Cuba (including Postage), \$1.50 per year.  
Fifteen Cents the Copy, of All News Dealers.  
Foreign Subscriptions, Two Dollars per year.  
In changing order give old as well as new address.  
Advertising copy must be in hand by the 1st of month previous to date of publication.  
Only high-grade advertisements of thoroughly reliable firms are solicited.

**WHEN YOUR SUBSCRIPTION EXPIRES**

One month before a subscription expires we enclose a renewal blank on which you will write your order for the renewal.  
WHEN FIRST NOTIFIED that your subscription will expire, you should send your renewal at once, in order not to miss a number. New subscriptions which are received by us on or before the 15th of any month will begin with the issue of that month. If received after that date they will begin with the following month's issue. We cannot enter subscriptions to begin with back numbers. One month's notice is necessary before a change of address can be made.

Entered as "second-class matter" February 18, 1910, at the Post Office, at New York, N. Y., under Act of March 3, 1879.

Copyright, 1912, by the Lawson Publishing Co.

"Aircraft" is registered as a trade-mark by the U. S. Patent Office, under date of August 9th, 1910.

# THESE MEN MADE *Aircraft*

## The Greatest Aeronautical Magazine on Earth

They furnished the bone and sinew of the first three volumes of *Aircraft*, making them a work of reference of which none other extant is comparable.

This list not only includes the greatest Aeronautical writers in the world, but also the very greatest Aeronautical Scientists, Aeronauts, Aviators and Aeroplane and Balloon Builders as well.

### *These are the Contributors to AIRCRAFT*

Hudson Maxim	Clement Ader	Hon. George von L. Meyer
A. Lawrence Rotch	Horace Geigh Hopkins	(Sec'y of U. S. Navy)
Denys P. Myers	Wm. F. Turnbull	S. R. Brustmann
Sir Hiram Maxim	E. L. Buchanan	Will Simmons
Louis Paulhan	H. A. Toulman	D. E. Connor
Hiram Percy Maxim	H. La V. Twining	Van M. Griffith
Israel Ludlow	John M. Crowley	Baron Ladislas d'Orcy
G. F. Campbell Wood	Claude Grahame White	A. Heinrich
Walter H. Phipps	D. E. Ball	Theo. H. Gibon
Edward H. Young	John Jay Ide	A. P. Herff
James S. Stephens	Henry A. Wise Wood	Emil Buergin
Hugo C. Gibson	Philip P. Baldwin	W. Nicholson Jennings
C. G. Grey	Major S. Reber	James E. Plew
John C. Hanna	Alfred W. Lawson	Ernest Ohrt
Louis Bleriot	Cortlandt Field Bishop	Professor David Todd
Arthur Wiener	T. R. MacMechen	H. O. Eiane
Robert Esnault Pelterie	Thomas Preston Brooke	D. W. Starrett
Glenn H. Curtiss	Louis Breguet	Earle L. Ovington
Augustus Post	S. H. Paterson	A. F. B. Silvanetto
Brig.-Gen. James A. Allen	Henry Woodhouse	Lee S. Burrige
William R. Rummier	James V. Martin	Wright Brothers
Gustave R. Thompson	R. H. Blanque	Melvin Vaniman
Charles K. Hamilton	Ladis Lewkowitz	Capt. W. Irving Chambers
R. E. Honeywell	Philip Wakeman Wilcox	(U. S. Navy)
Henry L. Call	A. Leo Stevens	Albert Adams Merrill
Hugh L. Willoughby		

☞ Bound in book-form and ready for the library table or shelves of individual or association, two volumes of AIRCRAFT are offered as a solid entity of incomparable value to the student of, and to the enthusiast in, matters aeronautic.

☞ As an ornament for any booklover's delectation, as well as a monument to the birth and to the lightning-like development of human flight, and as a faithful reflection of its intricate and amazingly-rapid history, these volumes of America's great magazine of aerial navigation, valuable as they are now, will in years to come, when travel by air has reached as advanced a stage as that by water has to-day, constitute an hereditary asset—literary, historical, scientific—of unique worth.

☞ It is "VOL. 1 and 2" of an Aeronautical Encyclopedia.

☞ A Reference which any library or club cannot afford to be without; one which every thinking individual requires for the accuracy and completeness of his information on the latest triumph of the genius of Man.

☞ The number of copies available for sale is very limited, owing to the scarcity of one or two of the numbers.

Price per copy, delivery to any part of the United States, prepaid:

Cloth Bound, \$3.50 Each Volume.

## THE LAWSON PUBLISHING COMPANY

37-39 EAST 28th STREET, NEW YORK, U. S. A.

# AIRCRAFT

Vol. 3. No. 9

NEW YORK, NOVEMBER, 1912

15 CENTS A COPY  
\$1.50 A YEAR

## A NEW PRINCIPLE IN FLIGHT

By DENYS P. MYERS

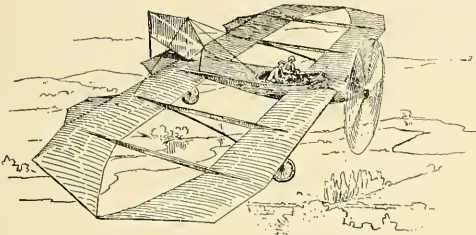

HOW A COMPLETE MACHINE MIGHT LOOK.

**M**Y DEAR MR. LAWSON: I have spent a day with a man who has convinced me by model demonstration and discussion of principles that he has gone far toward solving the problem of inherent stability, and notwithstanding the necessary AIRCRAFT editorial policy of dealing only with the many accomplished facts of aeronautics, it seems well worth while to give an account of this man's results. The thing that impressed me in witnessing numerous experiments and in a long talk and much questioning was that he has introduced a new set of principles into the problem of flight, principles which seem to be correct and which offer advantages in themselves not obtainable in present machines by any methods. I saw demonstrated models which to the practiced eye were inherently stable, fore and aft and laterally; which would right themselves when dropped upside down and then persist in gliding after righting themselves; which allowed the center of gravity to be moved within a space between a third and a quarter of the distance back from the leading edge, and which increased their gliding speed as the center of gravity was advanced; which glided at an angle of 1 in 8. These things I saw; we discussed many other possibilities, and experimented some.

The user of the new principle I have mentioned and the inventor of the machine embodying it is Robert D. Andrews, a well-known Boston architect and a present member of a Massachusetts board engaged in enlarging the State House. He is perhaps 55 years old, a studious, scientific man, diffident about making claims, though confident in his product and delighted that, as he hopes, it will enable America to make a contribution to aeronautic advance. The scientific men of the Boston Aeronautical Society have examined his principle, placed faith in it and issued a special bulletin upon it, and I am told that aeronautical engineers and physicists who have examined the matter have accepted the results as correct. The inventor has patents in France and Great Britain and one pending in the United States. Burgess has put the Andrews ideas into a full-sized machine which, how-

ever, has not been flown owing to a disposition on the part of the inventor to have its minor details more thoroughly worked out before mounting an engine upon it.

As a product, therefore, the machine is at present at a stage where AIRCRAFT could barely notice it, were it not for the new and apparently correct principles underlying its construction. It is these principles to which I want to draw your attention. The machine is described as a tandem monoplane with downwardly converging planes, i. e., inclined toward each other. Gustav Eiffel has experimented similar surfaces at his laboratory and found their fore and aft stability extremely efficient and the lift of the tandem greater than the sum of the lift of the planes separately. Figure 1 shows a paper glider embodying the new arrangement.

The Andrews principle is based upon the specific recognition and use of the elastic reaction of the air to the impact of a plane in gliding flight. In figure 2 a plane A-B is shown in section, with the air meeting it as indicated. As is well known, the air below the plane is compressed and that above is rarified. As the air passes beyond the plane, these compressed and rarified portions are left in direct conjunction and the compressed air expands most freely in the direction of least resistance, which is upward toward the partial vacuum above it. The energy of this reaction carries it upward until a condition the inverse of the first is created, and the upper air is compressed and the lower air is put into a state of tension. In a word, an oscillating impulse is set up in the air, which continues indefinitely until the energy causing it is dissipated. This is indicated by the dotted wave line in the diagram, which is the line of neutral density.

Now when a second plane—see figure 3, C-D—is placed behind the first plane at such a distance that its front edge exactly intercepts the line of neutral density as shown, it receives the rising impulse of the air in a way to utilize it to the fullest extent. The air under compression is retained beneath the plane while the air in tension sweeps its upper face, thus reproducing very closely the conditions of the first plane. Eiffel's figures indicate that nine-tenths of the energy lift in the air by the impact of the first plane may be regained in this way and utilized by the second plane. Under present

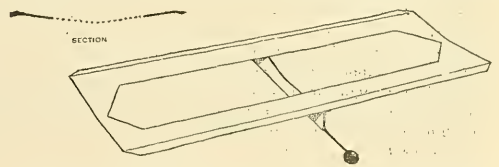
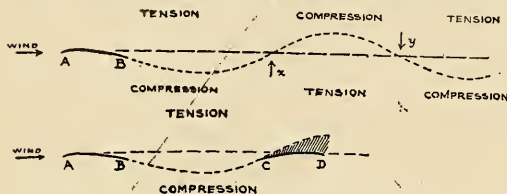

FIGURE 1—Andrews' Glider. Made of paper, 8" wide, 3" deep, with surfaces twice their own width apart. The pin slides in the fold, governing the centre of gravity.

conditions all this energy of re-action is allowed to go to waste.

It is important to observe that this reactive force which Mr. Andrews is the first to employ successfully is something wholly different from the direct force of the wind, and owes its origin to the conditions of compression and tension brought about by the forward plane. The wave line is indicative of a series of changing densities and is not to be confounded with the air stream or path in which the air particles move as a body.

Mr. Andrews believes that the support of an aeroplane in the air is due less to the air's inertia, or resistance to change of position or rate of motion, than to its distinctive properties as a gas. For example, a sheet of tin a foot square has a static pressure of  $1\frac{1}{2}$  pounds upon each square inch of surface, equal to one ton on each face. If the pressure of



FIGURES 2 AND 3—Top figure (2). The wake left behind in a single plane. The dotted wave line is the line of neutral densities. Lower figure (3). How a second plane is adjusted to take the wake. The plane C-D received the reaction in its upward trend at X in Fig. 2, and translates it into an upward and forward pressure. The hatched area is a graphical indication of the amount of pressure received.

the air upon its upper face were by some means wholly removed, the sheet would carry a ton of weight suspended beneath it. All that is needed to support a flat body in the air is that the pressure below shall exceed the pressure above by the weight of the object. This condition is brought about by the horizontal motion of a plane set at a slight angle of inclination. Volume for volume, the mass of an aeroplane and the mass of the air displaced by it are so greatly different, being at least in the ratio of 100 to 1, that in Mr Andrews' view the theory of the air's inertia as the important factor in aerial support is wholly inadequate to explain the facts. It is far more intelligible to say, unequal opposite pressures induce motion, and motion induces unequal opposite pressures and support. By this principle, all the operations of the flying machine from the ignition of fuel in the engine to the final means employed for its control, are accounted for.

In reply as to how he determined the relations of his surfaces, Mr. Andrews supplied the diagram shown in Figure 4. Here the line A-B is the total distance from front to rear. The points A-D and D-B are the foci of two ellipses, of which the portions coming above the line A-B constitute the sections of the two surfaces. The distance C-D is arbitrarily determined, and upon its amount depends the character of the surfaces. If it is small, the surfaces become flattened and spaced further apart. If large, the camber is deepened and the surfaces brought nearer together. Many experiments show this method to have a practical value, and it gives very closely the relation reported by Eiffel as most efficient.

The really important feature of the new system is its fore and aft stability. This is beyond question. Eiffel shows that the centre of pressure continuously advances until it passes over the front plane and becomes a downward pressure upon the rear plane. Thus whatever the angle of incidence, the effect is to support the front of the machine. Because the rear plane is equal in area with the front one, it has power enough to control it. If in forward motion the nose of the machine is accidentally depressed, the pressure on top of the rear plane brings it up again. If the machine tends to rear up, the back plane develops a constantly increasing lift which restores the machine to its normal flying position. By an analysis of the charts and figures recording the Eiffel experi-

ments, Mr. Andrews has deduced the extraordinary fact that at angles of incidence of  $6^\circ$  the lift of the rear plane equals that of the front one and that this lift then increases with the angle, so that at  $12^\circ$  incidence it exceeds that of the front plane by a very considerable amount. It is this automatically increasing lift of the rear plane as the angle of incidence increases to which reference is made in the following quotation from the Bulletin of the Boston Aeronautical Society:

"To make a flying machine stable, it must be designed so that any rotation about any axis will be opposed by a constantly increasing righting force which will come into existence with the disturbing force and will increase while the disturbing force decreases. Just this condition appears to exist with the Andrews system with regard to fore and aft stability, that is, rotation about the lateral axis. Any force tending to make the machine dive is opposed by a strong downward pressure upon the rear surface which brings the machine back to a safe position, and any force tending to raise the front surface is opposed by the sudden and great increase of lift in the rear surface which occurs under these conditions. The result of this would appear to be that the Andrews system will maintain an angle between its fore and aft axis and the surrounding air stream, which is approximately constant. This is shown by the gliding models which made a flight path which is straight and not undulating like the flight paths of other systems."

Mr. Andrews states that his experience with a great variety of models of this type leads him to believe that this system has a very large measure of lateral stability also, much more than exists in the present flying machine, and he thinks that with this design lateral stability attends fore and aft stability. Certainly the model flights which I saw were notably stable ones, laterally, and the fore and aft stability was to the eye all that was claimed for it. These flights were out of doors in a gusty wind, with a model of two and a half feet lateral spread and wholly without any vertical surfaces.

But it is the principle of the thing that is important for the aeronautic world. It was first made publicly known by Mr. Andrews on April 6, 1911, at the meeting of the Boston Aeronautical Society. Nine months later Eiffel published his account of his experiments made with tandem planes. After

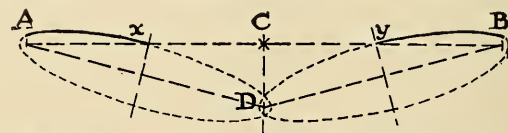

FIGURE 4—How the section of the surfaces may be determined. A-B is bisected and the length of C-D arbitrarily taken. A-D and D-B are bisected, and the intersections of their perpendiculars with A-B establish the width of the ellipses.

study of both the Andrews and Eiffel data the Boston Aeronautical Society voted on July 10, 1912, to give the matter the benefit of its indorsement, which was done in a bulletin of September 10, 1912. Thus the principle is vouched for. From all evidence, it has, as applied to flying planes, inherent advantages not possessed by any other system of planes. The sponsor society well states the case in saying:

"When a flying machine is in the air it is subjected to pressures which constantly vary in magnitude and direction. The result of this is that often the machine is placed in such a dangerous position that disaster is almost sure to follow. There is nothing in the design of existing machines to prevent their being placed in dangerous positions either by the wind or a mistake of the aviator. . . . Downwardly converging tandem surfaces appear to have characteristics which prevent their being placed in a dangerous position, at least so far as stalling or diving are concerned. Taking into account the theory as developed by Andrews, the flights of his models, and the accurate experiments made by Eiffel, this Society deems the Andrews system to constitute an advance in the art."

# MARVELOUS AIRSHIP ADVANCEMENT

By T. R. MACMECHEN

**T**HE intense rivalry between Count Zeppelin, Professor Schuette and Major Parseval in building airships is bringing us so much nearer the transatlantic airship that the world will not be able to keep pace with this progress in the next twelve months.

Just as this issue was going to press, Count Zeppelin's new naval airship accomplished a voyage in the air which lasted thirty hours. During this period the ship covered 1,200 miles over land and sea. This mileage is nearly one-half of the distance across the Atlantic Ocean. In America we should realize what this means. Two years ago, in its earlier stages of development, the dirigible was regarded as a "soap bubble" by uninformed Americans.

Professor Schuette, the designer, builder and operator of the great wooden hulled Schuette-Lanz airship was in America recently. He is the first of the great airship engineers to visit us; he made the statement to-day, German engineers can build an airship with sufficient speed and endurance to cross the ocean. Professor Schuette's only reason for delaying the first trip is that we need full information of what the winds are doing daily over the Atlantic. Dr. Schuette speaks with authority. He is a man who has arrived.

Major Parseval, the German airship engineer, whose ability is equal to that of Count Zeppelin and Professor Schuette,—in fact the designer and builder of the most successful of the non-rigid airship,—is now constructing a rigid airship such as Count Zeppelin originated and Professor Schuette has improved.

Major Parseval is a great engineer. Without doubt his rigid airship will be as successful as those of Count Zeppelin and Professor Schuette. Parseval's entry into the field of the rigid airship is simply a confirmation of the prediction that the rigid type is destined to be the commercial airship of the future.

Here are three of the greatest aeronautical engineers in full accord upon the correct principles of the practical airship. But the Germans are not alone in their clear vision. To-day, at Paris, French engineers have almost finished a rigid airship whose size has even been increased since they started to build it. Its builders uphold their judgment by a recent announcement that the rigid ship is the airship of the future.

They announce that it has become necessary to construct such an airship to uphold the sagacity of the French nation. This concerted movement should finally convince sceptical and backward America that civilization will certainly navigate the air with craft even vaster than ocean ships.

Professor Schuette has set three to five years as the period within which airships will be regularly crossing the Atlantic.

Count Zeppelin's voyage of thirty hours proves that Professor Schuette is right. Before this voyage, Professor Schuette had predicted that the war airship he is now building for the German government and which will be finished next month, will remain in the air for 48 hours. The new naval Zeppelin must still fulfill this prediction before it is accepted by the German Admiralty.

Professor Schuette's prophecy is founded on knowledge of development. The German War Office recently demanded airships that are capable of remaining in the air for at least two days; that they shall be capable of carrying 13 to 14 tons of cargo instead of 9 tons. Military demand is thus enforcing the appearance of the ocean crossing airship from four to five years sooner than its development would have warranted without this military impetus. Now, what has happened? Professor Schuette's new war airship will carry 14 tons of cargo weight. It will be 100 feet longer than his first successful dirigible. In one leap, he adds a hundred feet to his airship. This proves that the technical difficulties in airship construction have been overcome. Naval architects never dared to construct a craft of so much greater size in such a short period of development.

The natural result of military demand is a rivalry between Zeppelin, Schuette and Parseval, which is forcing the colossal airship twenty years earlier than our expectations.

The ocean crossing airship may already be on the stocks. The German engineer, J. Borner, has designed an airship 787 feet long with a beam of 80 feet. The important thing about this airship is that Herr Borner's plans and designs have been unreservedly endorsed by the greatest technical experts in Germany and Belgium. Indeed, a German-Belgian company is now being organized with sufficient capital to construct and operate this ship, which, it is frankly admitted, will be constructed for the specific purpose of carrying passengers between Europe and America. Borner's ship is a momentous advance in engineering over the ships of Count Zeppelin and Professor Schuette. It is fireproof; it has the tremendous power of 6,500 horse, which is more than doubly sufficient to handle the ship in a hurricane. The strength of this colossus for combating the elements in the air is equal to the strength of the greatest ocean steamer. Borner's design and size, based strictly on the development and performances of Zeppelin's ships, prove that the airship will have the endurance and resourcefulness to successfully perform the task of crossing the ocean.



The Schuette-Lanz wooden-hulled airship starting on her recent Berlin-Gotha-Manheim trip. The great new air cruiser encountered heavy storms during this passage but weathered them with the same ease as the best ocean liners weather the roughest seas. There were six passengers aboard, who were loud in their praise of the excellent manner in which Dr. Hunold handled the ship at all times during the journey.

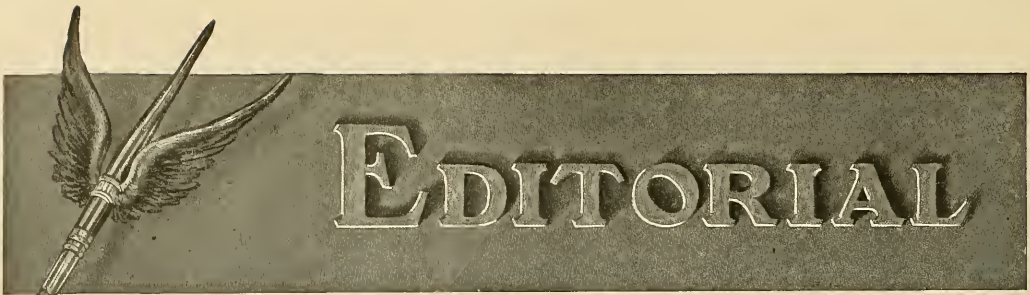

### FACTS vs. GUESS-WORK.

**T**WO dispatches recently reached our office simultaneously; one was from Cambridge, England, where the annual British Army manoeuvres were being held and which stated that the army manoeuvres this year had not only proved a dismal failure from a spectacular standpoint, but that they had to be abandoned altogether owing to the remarkable work done by the scouting of the airmen both in aeroplanes and airships.

The dispatch stated that neither army could make a move of any description without it being reported immediately and therefore nullifying the manoeuvre and making it impossible for either army to out-manoeuve the other, which practically eliminated entirely all of the old fashioned military field tactics of the past.

The other dispatch came from Washington and stated that the United States Navy was unafraid of airships and therefore there was no need—according to Admiral Twining and other navy officials—for special guns to repel the attacks of airmen, which was the answer to a previous dispatch from England stating that the four new British warships would be fitted with guns for protection against aircraft.

The American officials arrived at their conclusions without even making a practical test: they merely guessed at it and their conjectures along this line remind us of the stupid conjectures of the old foggy navy officials of half a century ago who were also unafraid of the proposed ironclads, which later developed into steel battleships, feeling absolutely secure that their old wooden frigates and their musty old methods could not be improved upon.

One of the peculiar features of the human brain is that it is capable of expansion up to a given point and then it steadily contracts into senile uselessness.

It is indeed regrettable to have to record the fact that the American people permit to hold high official positions, men whose mentality is in such a retroactive condition that they publicly denounce new forces as inadequate without trials and allow guess-work to take the place of demonstration and facts.

The dispatch from England recorded actual facts.

The dispatch from Washington was idle guess-work.

### SCHUETTE'S VISIT TO AMERICA.

**A**IRCRAFT'S propaganda work during the past year in the interest of airship development has finally resulted in bringing to this country on a tour of inquiry, one of Germany's leading airship builders.

Dr. Johann Schuette of Mannheim, a famous engineer, and inventor of the Schuette-Lanz wooden type rigid airship, who is now classed with Zeppelin and Parseval in importance, recently visited this country for the purpose of learning the exact aeronautical situation in America, during which time he held several conferences with Alfred W. Lawson and spent considerable time in the offices of Aircraft. Dr. Schuette promised to write an article for some future number of Aircraft regarding the construction of his great airship, but aside from that he made some most remarkable statements which it may be well to call to the attention of our readers at this time.

First: Mr. Schuette said that the people of the United States were very backward in understanding the great principles of air navigation and the possibilities of turning the great space above us into innumerable highways for transportation purposes and the great advantages to be obtained within the next two or three years commercially by financiers who have the foresight to get into the field immediately.

Second: That the surface of the science of meteorology has but been scratched and that eventually the composition and currents of the air together with the causes and effects of the changes thereof, will be understood as well or better by mankind in general than we at present understand electricity, etc.

Third: That it is only a matter of a few years before great airships will cross both the Atlantic and Pacific oceans as well as the various continents. In fact Dr. Schuette said that he could build an airship to-day that could cross the Atlantic ocean if necessary but that the Germans did not believe in rushing things; that they believe in going slowly and making each successive step with care and certainty. To cross the Atlantic ocean at the present time could answer no better purpose than giving a gigantic circus performance if successful, and creating more natural prejudice against the airship if unsuccessful. The American undertakes

big things before he has mastered little things, is the opinion of Dr. Schuette. He does not give the subject the profound study and attention necessary to bring it up to the highest state of perfection and usefulness.

Fourth: Dr. Schuette thinks that the American government should be more liberal in helping the aeronautical movement along by encouraging the industry to the extent of purchasing airships and aeroplanes and also that the government should subsidize responsible companies who build and operate airships for commercial purposes in which case the government would have the right to use these airships in case of war or during their annual manoeuvres.

Dr. Schuette says that the United States should have several big airships on both the Atlantic and Pacific coasts and also several in the vicinity of the Panama Canal. These airships could put out to sea for several hundred miles in either direction and by a system of wireless connection could give both the navy and land forces a day's advance information on the movements of the enemy's ships.

Dr. Schuette further stated that the development of the airship had gotten beyond weather interferences in the same way and to almost the same extent that the ships of the sea are beyond weather interferences. That is to say that in extreme and most unusual weather conditions the airship would probably meet with difficulties just as the ocean ships meet with difficulties in extreme and unusual conditions, but not more so.

Over in Germany, said Dr. Schuette, there are so many great airships flying about from place to place and carrying all the way from thirty to forty passengers that the sight has become so common to the people that they seldom look up when one is passing now-a-days.

It would require every page of this issue of Aircraft to tell all the interesting features of Dr. Schuette's several talks with the editor of Aircraft and we would hesitate considerably before publishing some of his predictions if made by any one except the great scientist who has accomplished such remarkable success in airship building already in Germany.

We have been wondering for a long time past, however, and we are still wondering why the American cannot keep pace with the German in airship building and commercial air navigation.

#### INDISPUTABLE EVIDENCE.

**W**ONDERFUL reports of airship progress continue to reach us daily from Germany, which reports, by the way, substantiate to a large degree the aerial prophecies of T. R. MacMechen, one of Aircraft's able writers and a man who has stood almost alone in America for years past advocating the feasibility of the lighter than air type of vehicle.

Just as we are going to press, cable reports from Germany state that the new naval Zeppelin has successfully covered its initial trial continuous distance

flight of 1,200 miles on a triangular voyage running (with and against the wind) from Friedrichshafen to Heligoland in the North Sea, thence across Northern Germany and part of the Baltic Sea to Danzig, thence back to Berlin, the entire trip occupying 30 hours, which was approximately an average speed of 40 miles an hour.

The endurance test of 48 hours, required by the government and also the speed test of the ship, has yet to be made.

The great ship carried 21 passengers and three tons of fuel. She was in wireless communication with military stations at Strassburg, Cologne, Frankfort, Osnabruck and Nordeich on the East Frisian coast. The reports stated that communication with Frankfort was established continuously for one and a half hours.

This trip was a wonderful performance, both in distance and time made aside from the wireless performance. The wireless, by the way, is not only useful but absolutely necessary for both war and commercial purposes in air navigation.

Late advices also inform us that since March 1st, 1912, and up to September 26th, 1912, the Viktoria Luise made 183 trips during 210 days, covering 25,681 miles altogether in 457 hours while carrying 3,902 passengers.

Furthermore, at the Gotha Tournament between airships and aeroplanes, the Viktoria Luise defeated the aeroplanes by rising more quickly to a higher level than the aeroplanes were able to reach with two men and armament.

On September 25th, at Lucerne, the dirigible "Parseval 6" closed a most successful season of passenger carrying service. During the 25 days of September this airship carried 335 passengers.

All German insurance companies have reached an understanding that makes it possible to insure Zeppelin airships at a negotiable rate. It is stated that this has been done solely in the interest of the great progress that is being made in air-navigation.

The air-harbor at Potsdam—the second largest in the world—is nearly finished. It is 577 feet long, 180 feet wide and 118 feet high. Each door weighs six tons. It holds two airships, one for war purposes and the other for passenger carrying service. The Zeppelin Company is the builder. The harbor cost about \$480,000. The entire ground around the shed has been sodded with grass to eliminate the air currents which are originated by the sun heating bare, sandy plains.

A new type of airship shed has been invented—better than revolving sheds—a round shed with doors at every point of the compass. But even cheaper and better is another type also invented recently: A half round shed with a door at the point, etc.

The above facts are offered herewith editorially as indisputable evidence of the continuous growth of the aeronautical industry.

# OILING GASOLINE ENGINES

By DR. LEONARD KEENE HIRSHBERG, A. B., M. A., M. D.

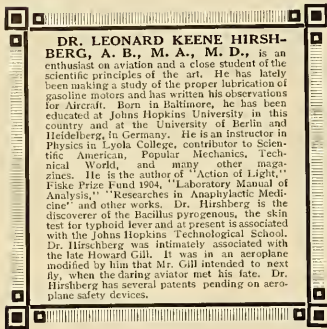

**DR. LEONARD KEENE HIRSHBERG, A. B., M. A., M. D.**, is an enthusiast on aviation and a close student of the scientific principles of the engine. He has lately been making a study of the proper lubrication of gasoline motors and has written his observations for *Aircraft*. Born in Baltimore, he has been educated at Johns Hopkins University in this country and at Berlin University and the University of Heidelberg, in Germany. He is an instructor in Physics in Loyola College, contributor to Scientific American, *Popular Mechanics*, *Technical World*, and many other magazines. He is the author of "Action of Light," "Fiske Prize Fund 1904," "Laboratory Cause of Analysis," "Researches in Anaphylactic Medicine" and other works. Dr. Hirschberg is the discoverer of the *Bacillus pyrogenus*, the skin test for typhoid fever and at present is associated with the Johns Hopkins Technological School. Dr. Hirschberg was intimately associated with the late Howard Gill. It was in an aeroplane modified by him that Mr. Gill intended to test fly, when the daring aviator met his fate. Dr. Hirschberg has several patents pending on aeroplane safety devices.

renheit, while in an internal combustion engine it rises as high as 2,640 degrees. In addition to this is the fact that the piston speed in a gasoline engine is far greater than in a steam engine. Just what happens to the lubricating oil in the operation of a gasoline engine is not precisely known; but there can be no question that a considerable portion of it burns and is discharged in the exhaust. How much of the oil is destroyed, and how much remains to attend to its proper duty as a lubricator depends on the composition of the oil used and the cooling arrangement of the motor.

That the destruction of the lubricator by combustion can not be altogether averted, no one questions. More or less oil must burn and must find its way in this oxidized state into the exhaust pipe. If this combustion can be made complete in so far as the burnt part of the oil is concerned, it follows that there will be less residue and less smoke. A heavy, thick oil, composed of fractions, with a high boiling point, will naturally be only burnt up in part. This would explain the almost universal demand for a cylinder oil that is not too thick and which also possesses a comparatively low boiling point.

The portion of the oil that burns must do so fully. Not a

**T**HE oiling of gasoline engines, and especially aviation motors, offers a problem decidedly different from that which confronts one in ordinary steam-engine practice. This is strikingly evident if you consider that the temperature in the cylinder of a steam engine may at most reach about five hundred degrees Fahrenheit,

trace of carbon deposit should be left in the cylinders. The more carbon there is in the oil, the more air is necessary for complete combustion. Oxygen, however, in a gasoline motor is a precious substance, and practically the entire supply drawn into the cylinder on the suction stroke is required for the combustion of the gasoline itself. The small amount not so employed is enough to complete the combustion of the oil, only when the latter does not contain much carbon. In Berlin, Germany, the Imperial Experimental Laboratory has just carried out successfully a number of important tests, to disclose the true situation. Unexpectedly valuable and economic properties of various lubricating oils were uncovered, which are especially valuable for aviation work. Two series of examinations were made; one upon oils extracted with acetone—which removes the heavy, tarry hydrocarbons—and the other with untreated oils.

It was discovered that the treated oils gave an exhaust free from odor, while the untreated oils produced pungent, smoky, excessively irritating odors, that often made both eyes and nose water. This certainly proves that the unpleasant smell during the exhaust is caused by the heavy hydrocarbons of thick oils. These experiments also prove that the various means taken or suggested to do away with the nuisance of foul smelling, smoking motors fail to solve the problem in the right way. It is less a question of absorbing or deodorizing the exhaust gases, and more a matter of correct selection of the oil best suited for the particular motor in which it is to be used. Such a selection should not be made by some sort of a rule of thumb method, but by a careful analysis founded upon the acetone extraction scheme.

Therefore, manufacturers of aviation motors and air-cooled engines in particular should begin at once the mixing of such oils on a scientific basis, so as to determine the most efficient and economical oil best suited for their special types.

It would seem that the steadily growing aeronautical industry offers a splendid opportunity for an oil specialist to make both fame and fortune by producing and marketing an oil expressly made to meet aircraft requirements.

## LOUIS BLERIOT'S WORK

Louis Blériot commenced his aeronautical researches in 1900 by the construction of a machine with flapping wings, and which did not give any results. He had forsaken aviation to look after his searchlight and automobile accessories concern, when Archdeacon succeeded in bringing him back to aviation. He then constructed a glider, which was tried, at the same time as that of Archdeacon, on the Seine river, between Sevres and Billancourt, by Gabriel Voisin. Then he experimented on Lake Enghien, a machine having elliptical cells mounted on floaters and equipped with two 24 H. P. Antoinette motors. The results obtained with this machine were not very satisfactory.

With a great deal of energy Blériot went back to work and completed the Blériot IV. This machine was propelled with the two motors of the preceding machine, but with two quadrangular. In a test by a mechanic this machine was wrecked.

Blériot then decided that from now on he would pilot his own machines, and undertook the construction of his fifth aeroplane. It was a monoplane, the first built by the famous constructor, who finally stuck to this type of machine.

The Blériot V. was composed of a fuselage covered with varnished silk, extending to the motor in the rear, driving a metallic propeller directly and supporting the rudders in the front. The machine recalled the aspects of a duck and was quickly baptized by this name, which, by the way, stuck to all machines having their rudder in the front.

The "Duck" was quickly replaced by a new machine called the "Libellule." It was a monoplane, having two pair of wings in tandem and mounted on a fuselage, having a length of six meters. A 30 H. P. motor drove a metallic propeller having four blades. This machine was covered with parchment paper, and each fore-plane was fitted with an aileron analogous to those found today on the Gray biplane, and which was used as the elevating plane. This machine was somewhat modified after its first trials, which were held at Issy. Blériot abolished all organs of longitudinal stability and equilibrium was obtained by the displacement of the pilot's body. On the 11th of July, 1907, it flew 25

meters; on the 25th of July 150 meters, and on the 6th of August it flew 140 meters at a height of 12 meters.

On the 17th of September a flight took place which has ended tragically. Blériot had decided to fly his machine 184 meters. The aeroplane left the ground at a speed of at least 90 k. p. h., but the absence of a stabilizer made it prance while at a height of 18 meters. The pilot shut off the fuel and the motor stopped dead. Then the "Libellule" began to fall, but Blériot, by displacing himself, succeeded in quickly bringing it back on even keel, but it landed roughly and was smashed. The aviator once more got out without a scratch.

Blériot did not rebuild his tandem monoplane, but went on building his seventh machine, which resembled in general aspect those of his new builds. The longitudinal stability was obtained by a mobile tail. The landing chassis was of the deformable triangle type such as is still to be found on the modern Blériots. It was engined by a 50 H. P. motor.

The chassis being too weak was the cause of numerous accidents to the propeller. We can name, however, a very successful flight of more than 150 meters, on the 29th of November; two of more than 400 and 500 meters on the 6th of December; one of 145 meters on the 18th, but in landing the tail wheel crashed, causing the machine to capsize and be damaged beyond repair.

Blériot then built a new monoplane, which flew under No. 8a. It was also engined by a 50 H. P. Antoinette motor; the longitudinal stability obtained by two shutters and the transversal stability by ailerons. The propeller was made of metal and had four flexible blades.

On the 17th of June, 1908, he flew it a distance of 400 meters at a height of four meters; on the 18th, twelve flights varying each from 400 to 500 meters; on the 22nd and the 23rd flights from 500 to 600 meters, and on the 24th a beautiful flight of 700 meters.

On the 29th of June, Blériot finally obtained the first official award by making a flight of 700 meters. He succeeded in making his first voyages on the 2nd, 3rd, and 4th of July. On the 6th he

stayed in the air 8 minutes 84 seconds at a height of 20 meters. This performance was officially controlled. On the 23rd of July he smashed this machine. He then rebuilt it under No. 8b and flew it in a strong wind before M. Barthou, then Minister of Public Works, but unfortunately the machine began to prance while in midair and fell, sustaining serious damages.

Blériot then decided to take his machine near Tournay. There he accomplished a flight of 7 km. on the 21st of October in a strong wind.

On the 30th this machine was damaged through the result of his machine being carelessly fastened up the commands of the control backwards. On the morrow he performed the first aerial circuit above the country. Leaving Tournay, he flew over to Arternay, a distance of 14 km. from his aerodrome. He stopped at the castle of Avillers, on account of magneto trouble, and a second time at the farm of Villiers. The very next day this machine was demolished.

Blériot then constructed two machines one right after the other, and which were not experimented with. Then he had his No. 9 constructed, which closely resembled his type of the present day, and which was tried out at Issy-les-Moulineaux on the 18th of January, 1909. He continued his experiments at Buc.

It was with a machine of this type that on the 25th day of July, 1909, Blériot crossed the English Channel in a flight that will always remain famous. He had won a few days before the cross-country prize.

Since, Blériot has created numerous types, and to relate the glorious "record" of the Blériot monoplanes, the wonderful performances they permitted to the Leblancs, Carros, Beaumonts, etc., would take us too far. They are things still fresh in our memories, and too great to be forgotten.

Blériot has known the legitimate glory reserved to those whom intelligence, will power and heroism have been consecrated to realize the antique dream and spread the field of action and the scientific patrimony of humanity.

Through courtesy of "Association Generale Aeronautique de France," "Association Generale By R. Letellier in French and translated by R. H. Blaquiere.



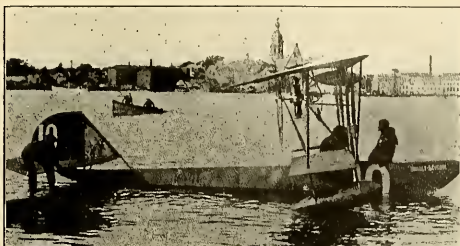

Side view of the latest Donnet-Leveque aerobato, which Beaumont flew so well at the Tamise Meet, Belgium. Notice the bow now turned up as suggested in the September, 1912 AIRCRAFT.

# FOREIGN NEWS

BY  
R. H. BLANQUIE

## EUROPE

In this year's military manoeuvres of all the leading European countries, aeroplanes and dirigibles played a most important and interesting part, and more than ever proved their great value as an additional arm to the army. In Germany the services rendered by the dirigibles were the most appreciated, while in France, England, etc., the aeroplanes proved to be the most valuable.

## Australia

Two rich Australian sportsmen, after having taken a practical course at the Bleriot School at Etampes, purchased three Bleriot monoplanes and secured the services of Marc Pourpe to help him demonstrate the possibilities of aerial navigation in their native country.

## Austria

Experiments with a new illuminating rocket were carried out at the aerodrome of Wiener-Neustadt, near Vienna, by Lieut Colonel Vzelac. While at a height of 600 meters on an Etlich monoplane piloted by Lieut. Summer, he shot a few of these rockets off, which brilliantly lit an area of 500 square meters. These experiments were renewed ten times, and each time gave the same satisfactory results.

An important invention has been adopted by the army, which permits aviators to transmit their observations to the commanding officer below without having to land. The notes taken are enclosed in a case provided with a substance which at the moment the case is released is ignited by friction. The substance gives off a dense smoke, and at the same time a flag of 20 feet long is unfurled to attract the attention of those below.

Following the movement created in France, Germany, Italy, etc., Austria has started a national subscription for an aerial fleet, and has collected 100,000 crowns (\$21,200).

## Belgium

The Minister of War has decided to include in the 1913 budget a credit for the sum of 500,000 francs (\$100,000) in favor of military aviation. This sum is to be used for the purchase of aeroplanes to form escadrilles in the fortified strongholds of Anvers, Liege and Namur. At present the Government possesses 10 aeroplanes and 12 officer-aviators.

The hydro-aeroplane meeting held at Tamise from September 17-17 on the Escout river, did much to improve and advance the new branch of aviation. Many well known aviators took part and caused each of the many events to be interesting and exciting from start to finish. The final official classing is as follows: 1, Chemet (Borel); 2, Benoist (Sanchez-Bona); 3, Renaux (M. Farman); 4, Beaumont (Donnet-Seveque); 5, Molla (R. E. P.); 6, Weymann (Nieuport); 7, Barra (Triad-Curtiss); 8, Lanser (Lanser); 9, Train (Train).

## China

Special correspondence by Silvanetto.

The Editor AIRCRAFT, New York.

Dear Sir—

I am pleased to report that after a long interval of inactivity Mr. Zee Yee Lee, the Chinese aviator graduated in England and Austria, made a successful flying exhibition at Kwangwan lately. The machine from start to finish. The final official classing is as follows: 1, Chemet (Borel); 2, Benoist (Sanchez-Bona); 3, Renaux (M. Farman); 4, Beaumont (Donnet-Seveque); 5, Molla (R. E. P.); 6, Weymann (Nieuport); 7, Barra (Triad-Curtiss); 8, Lanser (Lanser); 9, Train (Train).

The Chinese Army Aviation Corps had its inception during the revolution, but it was not practically brought into operation. The American instructor was very proud of his daring Cantonese would-be aviators, but no strategical flights were made. An offer of \$3,000 was made to a foreigner connected with the Van der Born Hong Kong aviation meet to fly over the imperialists' camps near Hankow, but it was rejected, as the game was not worth the candle. There seems to be very little inducement for aviators in the Far East, and I don't think Mr. Lee will succeed in stimulating much enthusiasm into his compatriots. The proposed aviation club is certainly a step in the right direction, and should be encouraged as much as possible to promote the art of aviation. The country surrounding Nanking is suitable for aeroplaning and hydro-aeroplaning, and the proposed club will certainly add a philip to aviation in the Far East.

India.—An Italian named Benetti is responsible for an assertion in the papers that Calcutta will be the centre of aviation in the Far East. He proposes to bring out a few Italian machines and start an aviation club at that port. The British Army has a few Bristol machines, and the headquarters, I am informed, will be made in Johore. I remain, dear sir, yours faithfully,

W. W. SILVANETTO.

## England

R. S. Slack, who has recently completed an educational tour of Britain in behalf of the International Correspondence Schools, has started with his Bleriot monoplane on a fresh I. C. S. tour throughout the southern part of England.

The first "Night Illuminated Flying Feet" ever held in the history of aviation took place at the London aerodrome (Hendon) on the 26th of September from 8 to 10:30 P. M. The aerodrome itself was a perfect blaze of light. The various enclosures, marquees, judge's box, pylons, etc., were clearly defined by innumerable lanterns and fairy lights. Powerful naval searchlights were set up throughout the course in front of the enclosures for the purpose of guiding the aviators in their flights through the night. The biplanes were outlined with numerous small electric lights fed on the C. A. V. system from portable accumulators placed in the body of the aeroplane, and carried rear and side lights as well as a powerful searchlight in the front. The monoplanes only carried a searchlight in the front and a light in the rear. Commencing at 8 P. M., both types of aeroplanes gave many exhibition flights. At times they would turn their lights partly off and then completely off, making their whereabouts known only by the whirr of their engines. At 9:30 P. M. a Naval bombardment was held, which consisted in destroying Barques (Calais), at 5:39 A. M. with the intention of flying to Biarritz in view of competing for the Pommeroy Cup. His first stop was made at Versailles at 8:30, the second one at Chateaufort, the third at Bordeaux and finally alighted at Contes (Biarritz), at 6:45 P. M. The total distance covered was 800 kilometres. Eight other attempts have been made since by other aviators for the cup.

## France (AEROPLANES.)

On the 30th of August, Bathiat, on a Sommer monoplane, Gnome engine, left the aerodrome of Barques (Calais), at 5:39 A. M. with the intention of flying to Biarritz in view of competing for the Pommeroy Cup. His first stop was made at Versailles at 8:30, the second one at Chateaufort, the third at Bordeaux and finally alighted at Contes (Biarritz), at 6:45 P. M. The total distance covered was 800 kilometres. Eight other attempts have been made since by other aviators for the cup.

Sixty-two aeroplanes were engaged to take part in the army manoeuvres at Pons. One side had monoplanes and the other side biplanes only; the list of the machines engaged is as follows: 28 Bleriot's, 14 M. Farman's, 7 H. Farman's, 9 Deperdussin's, 4 Hanriot's, 3 Borel's, 2 Nieuports and 2 Breguets.

On the 31st of August the Aero Club of France delivered the brevet of aviator number 1,000 to M. Carminati, of Brambilla, Italy. Up to present date the Federation Aeronautique Internationale has more than 2,000 aviators on its list.

The Gordon Bennett Cup in 1913 will be held under a different formula. The competitors will have to cover a distance of 200 kilometres over country where landings will be possible at any moment. In truth it will be a perfect cross-country race.

## Flies 570 Miles Across France in One Day

The French aviator, Pierre Daucourt, on October 6th, covered a distance estimated at about 570 miles, a new world's record for a single day's cross-country flight, in the contest for the Pommeroy Cup of 1912, which remains open until the end of the year.

Pierre Daucourt started from Valenciennes, near the Belgian border, at one minute before six o'clock in the morning and flew directly to Biarritz, near the southwestern extremity of France, arriving there at thirty-eight minutes after five in the afternoon. He made three stops to replenish his tanks.

A cash prize of \$1,500 goes with the cup, and flights must be made between sunrise and sunset. This flight places Daucourt first for the price, as his distance exceeds that of Bathiat and Bedel.

## Long Hydro-Aeroplane Flight by Weymann

It is announced that Charles T. Weymann, the American aviator, in a 100 H. P. Nieuport hydro-aeroplane, has broken the world's record for a hydro-aeroplane flight with a passenger. According to a cable dispatch Weymann, accompanied by his mechanic, flew from Antwerp, Belgium, to Vernon, France, a distance of 375 miles, being compelled to descend at the latter town for fuel.

Weymann left Antwerp at 6:35 o'clock on the morning of October 2nd, and passed Boulogne, France, two hours later. He continued his journey, flying over the Seine by way of Rouen, flying under the bridges crossing the river at that city. He proceeded to Paris, at his oil gave out and he made a safe descent at Vernon.

Colonel Hirschauser, chief of the aeronautical corps, has submitted to the Minister of War a new plan which would divide France into three great aeronautical divisions, with Versailles, Rheims and Lyons as their respective centres. Each division would be under the direction of a colonel, seconded by other officers, and they would have charge of aerodromes and aeroplane stations.

On September 8th, Fedieres, a new pilot of the Nieuport monoplane, left the aerodrome of Montpellier and flew over the cruiser "Foudre," at anchor four miles from the coast on the Mediterranean. The same evening Chevalier, chief pilot at the Nieuport school, also left the aerodrome at Montpellier and flew for a long while over the Mediterranean.

On the 18th of September, H. J. D. Astley, in company of Miss Davies, while attempting to fly from Paris to London on a Bleriot monoplane, made a dive from a view of competing for the Pommeroy Cup. His first stop was made at Lille. Although the machine was badly smashed, both aviators got out of the wreck without a scratch. During the fall Miss Davies set a fine example of real nerve by keeping her log book till the moment of the smash. The last records taken in it were: "Planning madly—dive to earth—2:20; bits of wood flying past us."

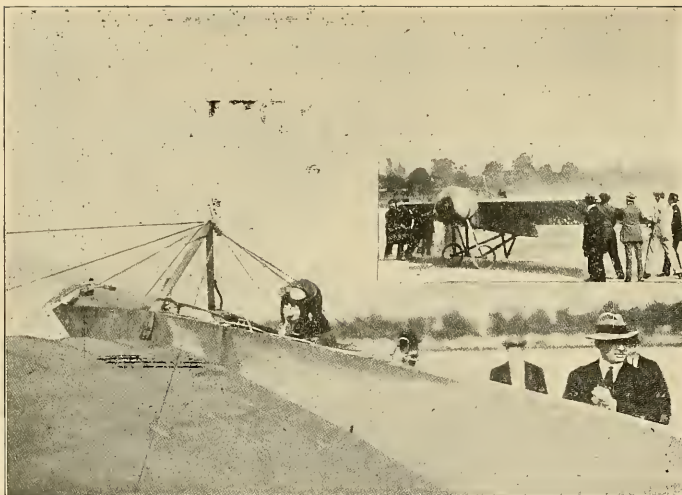

Two views of Georges Legagneux, starting in his recent world's record altitude flight of 18,635 feet. As will be noticed, Legagneux used a Morane-Saulnier monoplane, and not a Paul Zens, as stated in other magazines.

Legagneux has successfully flown more different makes of aeroplanes than any other person. In fact, he seems to have a penchant for testing out new machines. Previous to his establishing a new world's altitude record on a Morane-Saulnier, he made some speed records on a Paul-Zens monoplane, and at time of writing we hear of him making wonderful flights on a Schmitt machine, a new aeroplane, of which little is at present known. Including this latter, the machines Legagneux has flown number nine.

Jules Vedrines, the winner of the 1912 Gordon Bennett Cup, showed himself, upon his return home, highly pleased with the hospitality tendered him in the States. He says that the aerodrome at Clearing was the finest he has yet flown on.

#### Seventy-Two Aeroplanes in Review

The first review ever held of a complete aeroplane fleet took place on September 27th at Villacoublay, near Paris. No less than seventy-two French Army aeroplanes, with their full complements of pilots and observers and the attached division of motor trucks bearing supplies passed in review before the French Minister of War, Mr. Alexandre Millerand.

They were organized in nine squadrons, each including eight aeroplanes. The airmen and their craft had just returned from the great Army manoeuvres, at which they had achieved success, and they made an imposing display when lined up on the extensive parade ground.

Thousands were present and there was great enthusiasm among them as the aviators saluted the Minister of War.

Mr. Millerand made a speech, in which he dwelt on his and the nation's determination to keep France in the forefront of aviation. He urged the officers to refrain from seeking publicity, which, he said, could only be harmful to the service.

An extraordinary spectacle was presented at the close of the review when twenty aeroplanes rose in a flock, circled for a few moments over the parade ground and then sped off toward the east to resume their stations on the German frontier. The remainder of the fleet scattered in the course of the afternoon to various military posts.

George Legagneux, the great French aviator, who has successfully flown more different makes of aeroplanes than any other person, and who only recently established some new speed records on a Paul-Zens monoplane and a new world's altitude record of 18,635 feet on a Morane-Saulnier monoplane, does not, however, seem to have lost his craving for testing new machines, for almost immediately following his great altitude flight on the Morane we hear of him making wonderful flights on a Schmitt machine, a new aeroplane about which little is at present known. As a matter of general interest we publish the following list of machines which have been flown by Legagneux: 1, Captain Ferber biplane; 2, Zens biplane; 3, Voisin biplane; 4, Henri Farman biplane; 5, Sommer biplane; 6, Blériot monoplane; 7, Paul Zens monoplane; 8, Morane-Saulnier monoplane, and 9, Schmitt machine.

Daucourt, on a Borel monoplane, competed for the "Circuit of Paris" prize of 5,000 francs (\$1,000), which has been offered by the General Council of the Seine. It is open up to the 1st of December, 1912, and the prize will go to the aviator who covers the circuit the greatest number of times in the same day. Daucourt succeeded in covering it seven times, which represents a distance of 600 kilometres.

#### (DIRIGIBLES.)

The new Clement-Bayard "Fanny-de-Lome" successfully terminated all the tests imposed upon it by the government for its delivery to the army.

On its last test, on August 31st, it made a flight of 800 kilometres, remaining 20 hours in the air. Towards 10 A. M. it left La Motte-Beuville for the sea via Beauvais and arrived at Dieppe, where it flew over the city at an altitude of about 400 metres. Then it rose to a height of 1,400 metres, which it maintained over the following journey: Treport, St. Valery, Abbeville, Amiens, Montdidier and Soissons. During the entire night it kept encircling the course at Amiens, Abbeville and Soissons and re-entered its hangar at La Motte-Beuville at 6 A. M. the following morning.

The Astra "Adjudant-Reau" left Issy-les-Moulineux one morning at 8:30. After having encircled Pointoise it flew over Vanves, Chalais, Meridon, and returned to its hangar at 11 A. M.

On the 16th of September the Astra "Conte" left its hangar at 6 A. M. and landed the next morning, after having cruised the whole night in order to affect an adjustment of the propeller. It resumed its voyage after this work was accomplished and returned to Issy, where it was deflated and given a thorough overhaul, as it has been in service for five months.

In the near future four army dirigibles will be constructed by the four dirigible firms of Astra, Lebaudy, Clement-Bayard and Zodiac. They are to have a volume of 15-17,000 cubic metres and a mean speed of 70 kilometres per hour. They will each carry three crews, in which the middle one will be fitted with a rapid firing gun.

#### Germany

##### (DIRIGIBLES.)

On the 31st of August a Zeppelin type airship

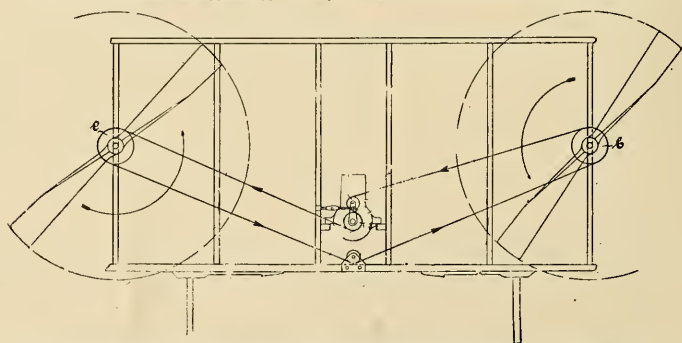

A German method of driving two propellers in opposite directions through a single chain transmission. This method of drive does away with the chief danger of a double chain transmission, for in the event of the single chain breaking it disconnects both propellers and permits of a safe glide.

was seriously damaged by singular circumstances. Just as it was being taken out of its hangar at Johannisthal a sudden violent gust of wind, threw it against the hangar, with the result that its rudder was smashed. Then pushed by its motive power and the wind, it swept and hit the smoke-stack of a nearby factory. The shock was so great that the chimney collapsed and the airship was cut in two. In the accident one of the crew had an arm broken and an officer was hurt in the face.

The eighth aerial station of Berlin is nearing its completion near Potsdam for the Zeppelin airships. The other stations are situated all around Berlin, and thus allow a dirigible to find a landing place without having to cross the city.

The government has ordered five new Parseval airships, to be built at the Parseval works at Bitterfeld.

The municipal council of Dresden has decided to build an aerodrome and a large hangar for dirigibles.

On September 13th the army airship "MIII" left Tegel at 5:30 A. M., on a secret mission. After making a landing at the Imperial manoeuvring grounds it returned to Tegel at 4 P. M.

A new aerodrome will be built shortly at Leipzig. This city has offered the necessary ground gratis for a length of 30 years, and a sum of 190,000 marks for its building. It will also give a yearly sum of 20,000 marks, beginning by next year, for the establishing of a Zeppelin Society and the erection of a large hangar.

#### Naval Zeppelin Flies For Thirty Hours

A successful 30 hour flight was completed on October 15th by the Zeppelin Naval dirigible. The dirigible landed at Berlin after flying across Germany from Friedrichshafen to the north coast, and then across the North Sea to the island of Heligoland, from whence she headed for Dantzig, on the Baltic Sea, and Berlin. She carried twenty-one passengers.

The Parseval firm, which has been hitherto building dirigibles of the semi-rigid type, has now adopted the rigid system. Although they will follow somewhat the Zeppelin lines, they will not have an aluminum framework, but one made of wood and similar to that of the "Schutte-Lanz."

After a decree passed on the 20th of August by the Secretary of the Postal Service, all airships of the "Aerial Navigation Society" must be equipped with a postal bureau, which shall have charge of the service of letters and postals on which special stamps will be affixed.

A meeting and conference was held recently at the Ministry of the Interior for the purpose of examining the credits which will be appropriated for aeronautical purposes in next year's budget. Representatives from the Ministry of War, Foreign Affairs and the Navy and Count Zeppelin were present. The following propositions were closely examined:

1. Increase of the subvention granted by the Imperial government to the Delag Society, who is exploiting the Zeppelin patents.

2. Order of new balloons.
3. Utility of constructing dirigible hangars.
4. Preparation of a law on the aerial fleet.

Such a law will be to the aerial fleet what the law of 1898 was to the navy. It will assure a methodical construction of a dirigible fleet, and will replace destroyed unities of an ancient type. It will also assure the maintenance of an aerial reserve fleet as well as the utilizing of private balloons in time of war.

On September 19th the "Hansa" left Hamburg for Copenhagen, where it alighted on the aerodrome of the city after having sailed over the English warships at anchor in the harbor. During the latter part of the day it returned safely to its point of departure.

The "Z III" left Gotha one morning at 9 A. M. for Metz, where it arrived at 2:30 P. M., after having covered the distance of 800 kilometres.

**(AEROPLANES.)**

Several chemists are reported to be working on a powder which would have the property of developing considerable smoke and which would permit ascensions from not being seen when in flight.

Germany is now second only to France in the extent of its aerial fleet. At present more than 100 aeroplanes are owned by the Ministry of War and 5 by the Ministry of the Navy. Sixty of these are Albatross biplanes, and another 30 are Etrich Rumpler monoplanes. Other machines are the Dornier monoplanes, Grade monoplanes (Saxon Army), Euler biplanes (Bavarian Army), Otto biplanes (16 of which are in the Bavarian Army), and D. F. W. monoplanes and biplanes. The foreign machines owned by the army are Bleriot, Antoinette, and the biplanes of the Hon. Henry Farman, Breguet, Pfefel, Lohner and Bristol biplanes.

Among the 24 aviators who took part in the recent Imperial manoeuvres several officer pilots were decorated by his H. H. the Kaiser with the fourth class of the Order of the Crown.

The "Circuit of Berlin" aeroplane race, which took place on the 20th and 21st of August, included the following suburban towns: Potsdam, Teltow, Johannisthal, a distance of 101 kilometres. The starts were delayed by a violent wind, which at times threatened to blow away everything in sight. Nevertheless from 3 P. M. on, Hirst, Boudard, Hartmann, Baierlein, Stupposchek and Kruger took the air. Out of that number only three succeeded in completing and the winner was Lieut. Kruger, who finished the 303 kilometres (circuit 3 times) in 3 hours 43 minutes.

The Minister of Public Works has formed a prize of 5,000 marks in favor of the constructor of the aeroplane which will rise in the air with the least motive power.

The "Gazette of Frankfurt" announces that the national subscription for aviation has reached 5,000,000 marks (\$1,246,000).

The hydro-aeroplane meeting at Heiligendamm took place on the 31st of August and was favored by fine weather. Lieut. von Goerissen, after a few successful flights, received his hangar and was succeeded by Buchner, who met with a slight accident while alighting on the water. Thelen closed the meeting by flying a few minutes above the cruise.

Rumpler, the well known aeroplane constructor, has offered a prize in the form of an aeroplane worth \$6,000, to the first German aviator who will in one day fly from Berlin to Paris on one of his machines.

The sum of 50,000 marks (\$11,900) offered as a prize by the German Emperor to the manufacturer of the best motor for aeroplanes constructed by a German manufacturer is now up for competition. The contest to determine the merits of the various motors was held on October 1st. The committee of sixteen, consisting of officials of the Department of the Interior, the Ministries of Marine and of War, the Ministry of Education, the technical schools, the automobile clubs, managed the competition. The trials will be held at Adlershof, in the vicinity of Berlin, and must be completed before January 15, 1913. The committee of award consists of seven professors in the leading scientific schools of Germany. Competing motors must (1) be manufactured by German manufacturers without the use of parts made abroad; (2) must be at least 50 and not over 115 horse power; (3) must be arranged for the propulsion of a propeller which in a 50 horse power motor must not make more than 1,450 revolutions a minute, and in a 115 horse power motor not more than six killos (132.5 pounds) per horse power, and aluminium and aluminium alloys must not be used in the construction of the piston and the driving rods.

In addition to the Emperor's prize of 50,000 marks (\$11,900) secured by a prize of 30,000 marks (\$7,140) is offered by the Imperial Chancellor, a third prize of 25,000 marks (\$5,950) by the Minister of War, and a fourth prize of 16,000 marks (\$3,980) by the Minister of Marine.

**Greece**

Alexander Caramanlik recently broke the Greek altitude record by reaching his former record of 2,140 metres to 3,050 metres. He reached this height in less than an hour and descended in a volplane in 11 minutes on a Bleriot biplane, and almost two hours later while flying from Athens his machine fell into the sea at Corinth and he was drowned.

**Holland**

A Royal Decree from Amsterdam announces that the Dutch soldiers enlisted in the army of the metropolis but who are detached in the colonial reserve to receive instruction to become aviators will be allowed to go abroad for this purpose. Having signed an engagement, upon their return, in the colonial reserve they will be appointed corporals or even sergeants by the commander of that same army.

**Ireland**

The failure of the Dublin-Belfast race was due to the unfavorable weather. This race was organ-

ized by the Aero Club of Ireland. During the latter part of the day Astley, Valentine, Antrim and Lieut. Porte succeeded in starting out, but were forced by the wind, rain and fog to come down on the way, and this disappointed the large crowd of spectators awaiting their arrival. Lieut. Porte's first prize of three hundred pounds (\$1,500) was divided between Astley and Valentine plus forty pounds (\$200) each for expenses. The fifty pounds (\$250) "Silver Star" prize plus forty pounds, went to Lieut. Porte, and a special prize of twenty-five pounds (\$125) plus forty pounds was given to Antrim.

Lieut. Schmet recently made an exhibition flight at Leppin Road, near the Hotel de Spectators, flying over Dublin from Phoenix Park and back over the Chief Secretary's residence.

**Italy**

At the military aerodrome of Aviano, Lieut. Montanari broke the Italian altitude record on a Bleriot-Gnome, and Captain Bonjovanni, on the same machine, broke the Italian altitude record with passenger by ascending to the height of 14,000 metres.

ANTONIO CAGLIANI MAKES VOYAGE BY AIR FROM PISA TO CORSICA.

On October 9th, Antonio Cagliani on a monoplane of his own design, made a flight over the Mediterranean from Pisa to Bastia, on the north coast of Corsica. He covered the distance of 95 miles in two hours and three minutes.

**Japan**

On September 18th a telegram was received at Frankfurt from Yokohama stating that the Parsval dirigible recently purchased by the Japanese government exploded in its hangar near Tokio on September 1st.

**Morocco**

Lieut. Du-Hu, of the French army, who has been doing considerable flying in Morocco, was recently bitten by a mad dog. To reach Casablanca, where he sailed for France to be treated at the Pasteur Institute, he flew from Rabat on a Bleriot-Gnome without any mishap.

**Norway**

The government having recognized the utility of aircraft in warfare, has purchased two Maurice Farman biplanes. These two aeroplanes have arrived at the aerodrome of Heradsbyrgheden, where they were successfully tested by Captain Sem Jacobsen and Thaulow.

**Philippine Islands**

(Special Correspondence.)

July 9th ended a most successful flying season in every respect. Lieut. Lahm made two nice flights over the fort at a height of 1,300 feet. Corporal Burge made two ten-minute flights over the fort at an average height of 1,300 feet. Lieut. Love also made a short flight. On his last flight Lieut. Lahm was practising landing on turn with dead motor, and on second loss so much headway that the machine dropped, breaking skids, tail and wings. As the rainy season had started it was decided to stop flying for a time and make necessary repairs during the rainy season. On his last flight Corporal Burge cut off engine 300 feet high and made a fine volplane to field.

Lieut. Lahm feels highly elated over the success of his two pupils, Lieut. Love, Signal Corps, and Corporal V. L. Burge, who have both qualified for a pilot's license. It had been intended to put them through the regular military aviation test, which was very difficult, had not the rain put a stop to operations.

Next year will see at least one new machine sent to the Islands, if not more. At least that is the expectation of Lieut. Lahm. No doubt next year's manoeuvres here will call for aeroplanes, and they should by all means have at least one new machine as the present one has been through some hard bumps, and while it is practically as good as ever, it should not be used for difficult cross-country flying. In this country where good flying is very scarce a small and swift machine is necessary.

Considering the unsuitable field and surrounding country the season has been remarkably lucky in regard to mishaps. The field is located between hills with high bamboos on them, and often the air conditions are considerably different above them than on the field, making landing and getting away very difficult if not dangerous, owing to currents. Lots of work has been done on the field this year, and it has nearly been doubled in length by having bamboo removed and some trees cut away.

On June 29th, after Lieut. Love and Corporal Burge had made short flights, Lieut. Lahm took the entire detachment for rides of 10 minutes over new 15 minute flights with Sergeant T. G. C. who weighs 182 pounds, and Lieut. Lahm 140. The machine lifted the 322 pounds with no apparent difficulty.

After Corporal Burge and Lieut. Love qualified, Lieut. Lahm let them do most of the flying. They hardly missed a day but what they had several flights, in which they practised figure eights with the motor at off. They were successful in this remarkably quick and were flying like veterans when the season closed.

Lieut. Lahm expects to open the season next fall with a practice run for the same men, and will take up the work where it was left off in the Spring.

**Portugal**

Colonel Albina de Costa, of the Brazilian army, has presented an aeroplane to the Portuguese government.

Garnier, a French aviator, has been engaged to give exhibition flights at Porto for the benefit of the shipwrecked fishermen in the Gulf of Biscay.

An Avro biplane to be fitted with a 50 H. P. Gnome engine has been ordered by the government.

**Russia**

NEW WORLD'S RECORD ON A WRIGHT.

Abramovitch, who has recently flown from Berlin to St. Petersburg, flew with four passengers for 45 minutes 54 seconds. This feat was performed on a Wright biplane, and constitutes a new world's record.

The Minister of War has been having several extra large hangars for aeroplanes erected on the aerodrome of Gatchina. These hangars are to be provided with a repair shop and a meteorological station for the study of atmospheric phenomena.

The military dirigible "Yastreb" met with an accident while flying over the aerodrome of Gatchina. It was caused by the escaping of gas from the bag which could not be accounted for. The airship stood vertically in the air and then fell on a row of trees, where it was seriously damaged. The crew of eight escaped without severe injuries.

The Aero Club of Russia organized a regular aerial postal service between St. Petersburg, Tzarsoike and Gatchina on September 14th.

**Scotland**

It is reported that the government intends establishing a station for hydro-aeroplanes on the Cape of Carlignose, in the Firth of Forth. Furthermore, it is said that this new base of operations would be only one of the many such stations which the Minister of the Navy proposes to establish on this coast. The other stations will most probably be at Harwich on the Isle of Brunswick and on the Midway river.

**South Africa**

Excellent flying is being done by Compton Paterson throughout the southern part of South Africa. Recently at Durban he gave several exhibition flights and took up many passengers, among whom were General Sir R. S. S. Baden-Powell, who happened to be inspecting the boy scouts of Durban at that time.

**Spain**

Ponnet, with his illuminated Dorel-Gnome monoplane, has been giving night exhibition flights throughout the country, and has met with much success.

"Andre Beaumont" on his 50 H. P. Gnome engine Donnet-Leveque aircraft, flew at Bilbao in the presence of King Alphonso, who showed great interest in the flight.

Legagneux and Garnier also gave exhibition flights at Bilbao subsequently.

**Switzerland**

Aviotti Spelterini left Interlaken in a balloon on August 29th, and after a voyage of 16 hours landed at Unterammergau, having crossed the Central Alps and the Bavarian Alps.

On September 2nd the hydro-aeroplane meeting at Lausanne closed after being most successful in every way. The final classing was as follows: Ernest Burri, first prize, 5,000 francs (\$1,000); Rene Caudron, second prize, 4,000 francs (\$800); Rene Grandjean, third prize, 3,000 francs (\$600).

Grandjean on a hydro-aeroplane of his own design and construction fitted with an Oerlikon 50 H. P. Swiss motor, holds the Eymard prize of 10,000 francs (\$2,000). He was also crowned in 1910. He covered the obligatory course, Chillon-Verseric, with the necessary stops at Ouchy, Rolle and Coppet in 56 minutes 16 seconds.

Maffer made some excellent flights at Lugano in the middle of September, and on one occasion flew his Bleriot monoplane to a height of 3,000 metres and then volplaned almost to the surface of Lake Luzano.

**Tripoli**

During the recent fierce combat between the Turkish and the Italian forces at Zozor, a flight of reconnaissance was successfully made by Captain Novelli on a Bleriot monoplane, who furnished the command of the Italian troops with valuable information.

\* \* \*

In a memorial issued in London by the Arbitration League protesting against the use of aerial vessels in war, the memorialists appeal to all Governments to foster international understanding against fighting in the air. Among the signers are Lord Coleridge, Sir A. Conan Doyle, Frederic Harrison, Sir Ernest Lodge, Sir William Osler, Sir William Ramsey and Alfred Russel Wallace.

# CHANGE PLACE WITH YOUR MOTOR

A Suggested Method of Increasing the Efficiency and Safety of Present Day Types of Biplanes  
By WALTER H. PHIPPS

It has often been argued by aviators and writers alike that there is little or no advantage to be gained in placing the engine of an aeroplane in front and the pilot behind in a protective fuselage, because in the event of a bad fall from a great height the aviator would be killed regardless of the position of his engine.

That there is considerable truth in this contention is apparent to everyone, but what about the fatal accidents that have occurred near the ground or while alighting? Could not and would not many of them have been avoided if the engine had been in front and the pilot protected by some sort of a protective touselage?

The answer is most assuredly "yes," as can be testified to by many who have witnessed similar accidents occurring with tractor machines and the engine behind types.

The main point, however, is not so much the position of the engine as the pilot, who should not, under any circumstances, be placed way out in the front of the machine, where he stands very little chance in the event of too steep a head on landing, a breakage of the landing carriage or the capsizing of the machine when on the ground.

A very sad but forcible illustration of the fallacy of placing the aviator in front was witnessed by the writer at Hempstead Plains on September 28th, when the regrettable accident occurred to John L. Longstaff, a British aviator, and his mechanic, Chevalier. The machine Longstaff flew was an old Farman type biplane, which had been fitted with a 50 H. P. star-shaped Anzani motor placed in back of the rear spar of the main cellule and attached rigidly into the frame and braced with two heavy wooden members in such a manner that it was practically a physical impossibility for the engine to come loose unless the whole of the machine was demolished. As the machine only had a single lifting surface in the rear, whereas originally it was designed with two to help support some of the weight of the motor, it was necessary, in balancing the machine, to place the pilot's seat a considerable distance in front and likewise move the passenger seat a bit forward.

Longstaff had re-balanced the craft and fitted a new propeller, and being desirous of carrying some friends as passengers, he took it out for a tuning-up flight with his mechanic as passenger. After making two good circuits of the field at a height of about 40 feet he started to descend, but could not pull up, and the machine hit the ground at a sharp angle, injuring Longstaff, who was in front, so seriously that he died soon after being removed to the hospital. (For explanation and comment on this accident see Hempstead Plains notes, page 277 of this issue). His mechanic, however, who was seated behind him and shielded by the forward seating structure and the pilot himself, was not so seriously injured, although he narrowly escaped being crushed by the motor when the machine, with the engine intact in the frame, rolled over and came to rest poised above him, supported only by a blade of the propeller (which had stopped in a vertical position), and the end of the wing.

On the same day at Hempstead a similar accident occurred to a Deperdussin monoplane driven by Gilpatrick. He had just risen from the ground with a passenger when his motor began mis-firing and the machine stalled and crashed to the ground, breaking a wing tip, the whole under-carriage and standing on its nose without even scratching the passengers. Had the passengers been seated on the front edge of this machine, as they do on some biplanes, there is not a doubt but that they would both have been seriously injured.

Comparative examples like the above could be related from almost every flying field in the country, and yet there are many who will tell you that it is foolish to change the position of the pilot and passengers on some present-day machines. The writer asks, is it foolishness to safeguard human life?

The lessons to be learned from the two accidents referred to are: (1) never place the pilot way out in the front of a machine in such a position that he receives the first impact; (2) always have the pilot's and passengers' seats as far back as practicable for a clear view, and in addition have the seats placed in a fuselage.

From the foregoing it can readily be seen that in the interests of safety it is advisable, when designing aeroplanes, to place the passengers in a protected position as far back from the front of the machine as will allow of a good view for military scouting or cross-country flying.

This has already been accomplished in tractor biplanes of the Avro, Astra, Breguet, Benoist, De Havilland, Kirkham, Pommer and Zodiac, etc., types, and accounts in a large degree for the growing popularity of tractor machines. While point for point the tractor biplanes have more advantages than the engine behind types (See article on Tractor Biplanes in May *AIRCRAFT*, Vol. III), they likewise have many objections, chief and foremost amongst which are: (1) the height of the machine in front owing to the position of the propeller; (2) the slip stream of the propeller; (3) the propeller itself is liable to breakage on landing and also offers an obstacle for military

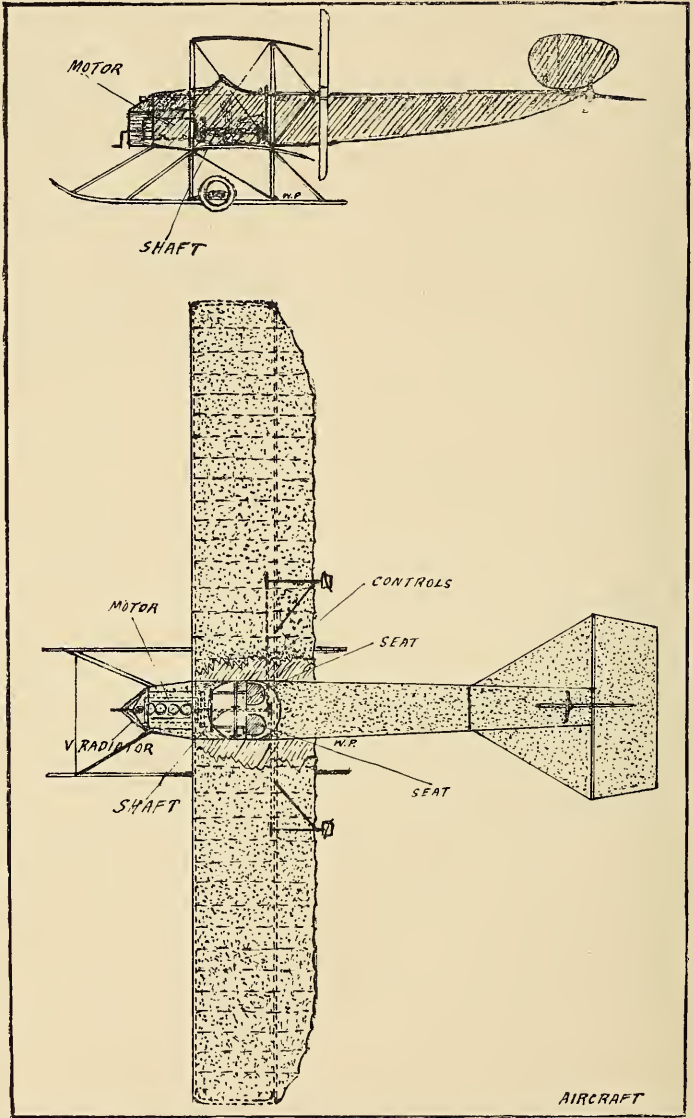

FIG. 1—SUGGESTED DESIGN FOR A WRIGHT TYPE MACHINE WITH THE MOTOR IN FRONT AND THE PASSENGERS BEHIND.

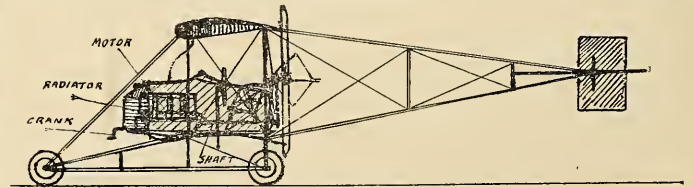

FIG. 2—SIDE VIEW OF A CURTISS TYPE WITH THE MOTOR IN FRONT.

use, as it does not permit of the proper use of a machine gun.

It will thus be seen that while the tractor biplane offers advantages for safety and speed, it still has the disadvantages recited above, and the question arises, why could not all biplanes (except those intended for special military scouting) be re-designed along the lines of the Oglivie-Wright or the De Pascoff and Donner monoplanes, which have the engine in front and the propeller or propellers in the rear? The answer is in the affirmative, and the accompanying drawings show how a Farman, Curtiss or a Wright or almost any other engine behind type could be re-constructed so as to have the engine in front and passengers behind.

This arrangement, aside from the safety point of view, would also increase the speed and efficiency of the machines (by reason of the decreased head resistance of the exposed passengers and motor, which is very great in the Wright and Curtiss), as well as adding materially to the comfort and security of the passengers.

Fig. 1 shows how a Wright type machine could be fitted with a fuselage carrying the motor in front and the two seats immediately behind it. This arrangement, while it necessitates the use of an extra shaft, has the following points to recommend it: (1) It permits of the use of a clutch. (2) It allows the aviator to start his motor from the front without fear of the machine getting away from him. (3) The fuselage protects the occupants and cuts down head resistance, thereby increasing the speed and efficiency of the machine.

Fig. 2 illustrates how a Curtiss type biplane could be re-constructed so as to have the motor in front and the passengers behind. As will be noticed a shaft runs from the motor to the back of the aviator's cabin, at which end it is fitted with a sprocket and drives a large central propeller at reduced speed through chain transmission.

Fig. 3 shows a side view of a headless Farman biplane and illustrates clearly the dangerous position of the pilot way out in front.

Fig. 4 shows a side view of the same Farman re-designed with the motor in front and the pilot and passenger behind in the protective cabin.

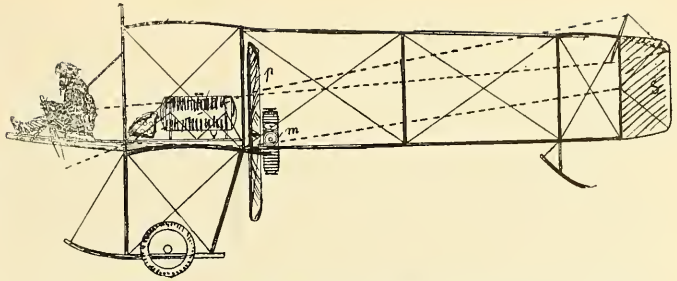

FIG. 3.—SIDE VIEW OF A HEADLESS FARMAN, SHOWING THE DANGEROUS POSITION OF THE PILOT.

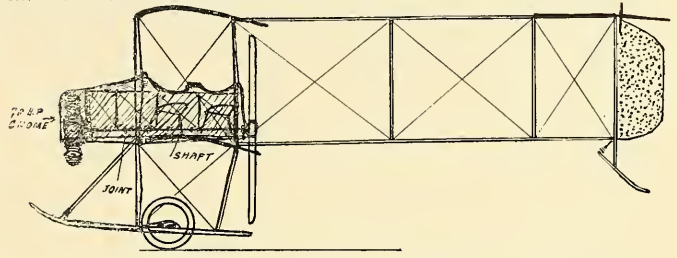

FIG. 4.—SIDE VIEW OF A REDESIGNED FARMAN, SHOWING THE PROTECTED POSITION OF THE PILOT AND PASSENGER.

## GENERAL NEWS

By D. E. BALL

### Large Crowd Attends Opening of Aeronautical Society's Grounds on Staten Island

On Columbus Day, October 12th, a crowd estimated at about twenty thousand attended the opening of the new grounds of the Aeronautical Society at Oakwood Heights, Staten Island and witnessed some very fine flying.

George W. Cressler, of this Wright gave two exhibitions of fancy flying, banking and spiraling in a very daring manner in spite of the strong wind.

Harry Bingham Brown took up Dillon Hoffman, who shot at toy balloons and was released from the hangars. On account of the strong wind blowing, it was very difficult for Brown to manoeuvre his machine into good range, so very few shots hit the balloons.

There was enthusiasm for every event, but the applause of the day went to Miss Louise Steiner, who drew the lucky number out of the 1,200 distributed in the grandstand, and was taken up for a flight by Beatty.

Miss Ruth Bancroft Law made a short flight in her Burgess-Wright, and impressed the crowd with her masterly control.

Horace Kemmerle in the Baldwin biplane attempted a flight, but landed without damage in the marshes outside the field, owing to his engine missing.

Frederick Rodman Law, rising as passenger with Harry Brown in his Wright biplane, ascended 4,000 feet, and from this height dropped with his parachute to safety in a pasture four miles north of the aviation field. The aeroplane appeared only as a small speck in the sky to the north when Law leaped from his seat with the parachute in his hands. It opened almost at once and made a graceful descent.

Four contests were held by the owners of miniature aeroplanes. Arthur Schley, of the New York Model Aero Club, broke a world's record. His three-foot model remained in the air 138 4/5 seconds.

Officers of the Aeronautical Society expressed satisfaction at the day's results and felt elated over the interest shown, which was substantiated by the gate receipts. This bids fair for the future success, both socially and financially, of the new grounds.

### Lieutenant Towers in Curtiss Hydro-Aeroplane Makes New American Endurance Record and World's Hydro-Aeroplane Record of 6 Hours 10 Minutes

At Annapolis, on October 6th, Lieut. John H. Towers, one of the first officers of the Navy to

take up aviation, made a flight on a Curtiss hydro-aeroplane over Chesapeake Bay, in which he remained continuously in the air for 6 hours, 10 minutes, 35 seconds, bettering the former American record for a continuous flight, set by Paul Peck, by nearly two hours. Peck, flying in a Columbia biplane at Nassau, Bonaventure, Long Island, in April of the present year, remained in the air 4 hours, 23 minutes, 38 seconds.

The duration record made by Lieut. Towers is official. Lieut. L. E. Dorch and Lieut. L. N. McNair acted as official observers. There were also several unofficial times, all of whom agreed with the authorized judges.

A conservative estimate of the distance covered by the flight is 359 miles, and this is double the distance by St. Croix Johnstone, who held the American record of 176 miles. There will, however, be no claim of a distance record, as the flight was not made over a definitely measured course. The accomplishment is considered none the less notable, however, particularly as it was made in a passenger-carrying machine of greater weight than the machines usually employed in record making for aviator alone.

Forty-two gallons of gasoline were consumed. It was carried in two regular tanks and a reserve tank. Lieut. Towers stated that his engine, a Curtiss, worked splendidly throughout the flight and was in perfect condition at the end. The descent was made only on account of the exhaustion of the gasoline.

The flight was made at altitudes of from 200 feet to 1,200 feet, the average being about 600 feet.

Lieut. Towers had some difficulty in cutting in the reserve fuel. It became necessary to let go his control while thus employed, and the machine was allowed to glide several hundred feet.

Samuel Barton made a 40-minute flight at Keyport, Perth Amboy, N. J., on September 22nd, on the Rippen-Barton hydro-aeroplane, which he handled with considerable skill. This machine is 41 1/2 feet spread, has a chord of 7 feet and gap 5 feet and is fitted with a Kirkham 60 H. P. motor. After several months of experimenting, a successful pontoon system has been evolved. The float is a wooden one of original construction. The side tanks are enameled galvanized tin, but rectangular instead of the usual round cross section, thereby obviating the use of a wooden skid attachment as the flat bottom of the tanks plane on the water at high speed.

David McCullough, while visiting at Hammondsport this summer, witnessed flights with the new Curtiss flying boat, and became so interested that he requested a ride with Mr. Curtiss. After the flight, Mr. McCullough's enthusiasm over the sport was so great that he immediately placed an order for an aeroboot with Mr. Curtiss, which is now

being built for him. The machine will carry three passengers, and have a speed of fifty-five miles an hour on the water and sixty miles an hour in the air. The engine will have a starting device and muffler and the boat will carry the regulation lights and anchor.

Attired in full uniform, William Kaiser, of Garden City, recently won a bet of \$300 by travelling the distance of seven miles in seven minutes as passenger in George W. Beatty's biplane to Rockville Centre, where the Southern New York Volunteer Firemen were having a tournament. An automobile followed the aeroplane, which took twenty-five minutes to make the run.

### Orville Wright Talks on Automatic Stability

In response to an enquiry as to his opinion of the Sperry gyroscope device, said to have been used by Glenn H. Curtiss to give automatic stability to aeroplanes, Orville Wright recently said: "While I have no faith in the principle upon which Mr. Sperry has based his conception, if he can demonstrate the device to be a permanent success I have no desire to detract from the glory to which he is entitled. As to wherein it lacks in essential details, I do not care to discuss now."

As to his own device, Mr. Wright said: "I do not expect to have it ready for the market before the beginning of the year, and any attempt at description of it now would only have the effect of leading other aeronautic experimenters to copy it. We have used the device frequently in flights, and, while it is susceptible to improvement, the results have been satisfactory."

### Commodore William E. Scripps Flies Hydro-Aeroplane

Commodore William E. Scripps, the noted engine builder and motor boat enthusiast, who was converted to the hydro-aeroplane by Walter Brookings during the Detroit Cadillac carnival, has been steadily practicing under the tutelage of Walter Brookings and is now master of the biplane, which he is handling alone. He has carried several passengers for flights recently, amongst whom are W. R. Kasher and Lee Counselman.

### Army Notes

In view of the difficulty of getting officers to become Army aviators, officials of the War Department will urge Congress to grant the military pilots more pay. Many Army officials think that the pay will have to be more than doubled if the aviation school is to become a popular branch of the service. The recommendation may take the form of double pay for the aviator and a pension for his family in case he is killed in an accident,



THE NEW CALL MONOPLANE, WHICH IS FITTED WITH A CALL MOTOR, MAKING A PRACTICE FLIGHT AT GIRARD, KANSAS, PILOTTED BY KYLE SMITH OF WHEELING. IT IS STATED THAT THIS MACHINE RISES AFTER A 150 FEET RUN WITH THE THROTTLE ONLY HALF OPEN.

### To Direct Artillery Fire From Aeroplane

Lieut. Henry H. Arnold and Lieut. Milling will leave soon for Fort Riley, Kansas, where important experiments regarding the efficiency of the aeroplane as a "spotter" in artillery fire will be made. Officers of the field artillery will endeavor to determine the exact usefulness of the aeroplane to the Army in this capacity.

Field artillery will be sighted to shoot at a target over a high hill at a distance of approximately two thousand yards. The aeroplane will remain as near as possible over the heads of the artillerymen at a height of more than two thousand feet. This height is necessary to place the aeroplane out of reach of the imaginary enemy's fire.

Following each shot Lieutenant Arnold will plot the point where the shell struck the ground on a small chart. The chart, attached to a lead ball, will be dropped to one side of the field and picked up by the gun crew. Each shot will be aimed according to the directions on the chart, which will show where the preceding one struck.

Officers of the army are divided in opinion regarding the usefulness of the aeroplane as a "spotter." They agree that if Lieutenant Arnold is able to make diagrams which will correct the fire of the field artillery its future success in this branch of warfare will be assured.

### Lieut. Arnold Takes Mr. Mackay's Prize for Military Scouting

Lieut. Henry H. Arnold successfully completed the reconnaissance tests for the Clarence H. Mackay trophy for army aviators at Washington on October 9th. His only opponent, Lieut. Thomas De Witt Milling, was taken ill soon after leaving the ground and was forced to withdraw. Lieut. Arnold flew over Washington at a height of 2,500 feet and for forty minutes covered a triangular territory between Fort Myer, Alexandria and Falls Church, Va. He finally located a body of troops several miles north of Fort Myer and returned to

the headquarters of the Army Aviation school, at College Park, with his information.

The judges, Lieut. Colonel Frederick Foltz, of the General Staff; Major Charles McK. Saltzman and Capt. Charles de P. Chandler, of the Signal Corps, and Dr. A. P. Zahn, were well pleased with the success of the test.

United States Army aviators who have passed the special army requirements and have been certified by the Secretary of War as entitled to the grade of "Army Aviators" are: Second Lieut. T. de Witt Milling, 15th Cavalry; Second Lieut. H. H. Arnold, 29th Infantry; Capt. C. de P. Chandler, Signal Corps; Capt. P. W. Beck, 12th Infantry; First Lieut. B. D. Foulis, 7th Infantry. The Army requirements are difficult and are as follows:

1. Attain an altitude of at least 2,500 feet, recorded by a suitable barograph.
2. Make a flight of at least five minutes duration with the wind blowing at the rate of at least fifteen miles per hour (indicated by an anemometer).
3. Carry a passenger to a height of at least 500 feet and on landing come to rest within 150 feet of a previously designated point on the ground. The combined weight of passenger and pilot must be at least 250 pounds.
4. Execute a volplane from an altitude of at least 500 feet with the engine completely cut off and cause the aeroplane to come to rest within 300 feet of a previously designated point on the ground.
5. Make a military reconnaissance flight of at least 20 miles for the purpose of observing and bringing back information concerning features of the ground or other matter which the candidate is instructed to report upon. This flight must be made at an average altitude of 1,500 feet.

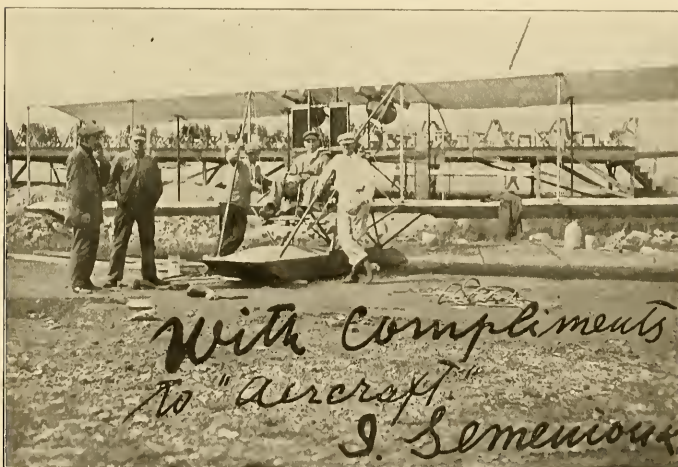

Ignatius G. Semencov, who is to be seen on the extreme left of the picture, is a licensed pilot of the Aero Club of France holding license number 326. He is a graduate of the Bleriot school at Etampes and distinguished himself abroad by flying a McLeckoff-Farman type biplane for two hours and a half at the Juvisy grounds in 1910. Since coming to this country he has been building and flying both monoplanes and biplanes.

The tests for "Military Aviators" will be conducted under the direction of the Chief Signal Officer of the Army, at such times and places, and before such board of officers as may be convenient. The names of officers who qualify and the date of such qualification will be reported to the Adjutant General of the Army.

### Pennsylvania News

By W. H. Sheahan

Grover C. Bergdoll successfully passed his tests for pilot's license at Eagle Aviation Field, near Philadelphia, September 10th, and license 169 was granted under date of September 25th. Bergdoll, flying his Wright machine, has made nearly two hundred flights, including many cross-country with the remarkable record of not having an accident.

Marshall Earle Reid will try for the long distance, non-stop hydro-aeroplane record with a passenger as soon as weather conditions are favorable. With Lieut. Commander H. C. Mustin, of the League Island Navy Yard, Reid will start from Cape May, N. J., and attempt the 94 mile flight and landing at the U. S. Navy Yard.

While flying his Curtiss machine at the Allentown, Pa., Fair, Aviator McCalley, of Harrisburg, reached an altitude of over 10,000 feet, which is believed to be a record for the State.

### Reid and Lieut. Mustin Adrift 16 Hours in Hydro-Aeroplane

On October 9th, Marshall Earle Reid with Lieut. Commander H. C. Mustin, left Cape May Point, N. J., in their aeroplane, bound for League Island, Philadelphia.

Twenty-two minutes after leaving Cape May Point and while at a height of about 100 feet the crank case of the engine cracked and the engine tore itself to pieces, setting the machine on fire. As best as he could, Reid volplaned to the water's surface, but in spite of his efforts the machine struck the water, prying a leak in one of the pontoons. As soon as the biplane had settled on the water, they turned their attention towards putting out the fire, which fortunately they succeeded in doing.

From the time they hit the water until picked up, sixteen hours later, Reid and Mustin took turns at sucking out the pontoon leakage. They floated all night, were nearly exhausted when rescued by an oyster boat the next morning.

### Aerobatic Flying Causes Walsh's Death

Charles E. Walsh, the daring Curtiss aviator, who had recently made quite a reputation for himself as a trick flyer, fell to his death at Trenton, N. J., on October 3rd, as a result of making too steep a spiral from a height of 2,500 feet. Walsh had been in the habit of making these spirals for some time past and never seemed to have any difficulty in controlling them or coming out of them, and in view of these facts it seems probable that owing to the tremendous and unnecessary strain to which he submitted the machine, some time finally became weakened and broke, thereby rendering the machine unusable. This accident, like many similar ones which have occurred, should serve as a lesson to other pilots to refrain from indulging in such foolhardy and unnecessary aerobatic flying.

On Monday, October 14th, in the balloon "Good-year," Mr. Walter Shulman, of the New York Aeronaautical Supply Company, made an ascension from Grant's Tomb, 128th St. and Hudson River, New York, in a strong wind and reported a beautiful view as the river was filled with small motor-boats that were visiting the large war ships at anchor.

Mr. Shulman made several sketches and took many photographs of the war ships and adjacent country while at a great height.

### California Notes

Mr. Victor Maxin is having a new plane of original type completed at his shop at 379 Golden Gate Ave., San Francisco, Cal. The machine includes many novel features and is of the Curtiss type plane, but the running gear is reversed, so that two wheels are in front and one in the rear and would be a Curtiss tractor with one propeller only. The engine is in front and the driver sits behind. He uses an engine of his own make and design, a six cylinder, two cycle rotary force fed through the cranking shaft. In this plane he has one of his 50 H. P. smaller type engines installed while experimenting, but as soon as he is through with his experiments he will install one of his 75 H. P. engines which he is now putting on the market. The engine is a very beautiful piece of work and he will probably have it on the market within a couple of months.

Mr. W. B. Jelinsky has just purchased a new propeller and has had his tri-plane overhauled and will take it out for trial in the near future at Ingleside Field.

Thaddeus S. Kearns has been practicing with his new machine at Sunset Field. He has made several ten minute flights.

Tom Gunn, the Chinese aviator, with Frank Bryant gave exhibition flights at Vallejo, October 5th and 6th.

P. Allhep tried out Kearsy's Curtiss machine September 27th and came down natsake style, smashing the propeller and a few other things.

J. F. Devillo has his machine out for the initial grass-cutting performances. His is a new type monoplane and he uses a Hobbes rotary motor.

Roy Francis, formerly with the San Francisco Aviators, is filling dates in Denver, Loveland and Morgan, Col., and Sydney, Neb., and also Douglas, Wis. These dates are filled for the Curtiss-Exhibition Company. He will return to the coast after filling his Douglas date.

O. Meyerhoffer, of the California Aviation Company, flew at Ukiah, September 12th. He used a Curtiss type machine with a Roberts motor.

Adolph Sutro made a few flights during the early part of September and came to grief on Friday the 13th, when he dropped about fifty feet, smashing his running gear and some of his planes. Sutro uses one of the biggest planes in the country, his upper plane having a spread of sixty-five feet, and the lower plane forty-five feet. It is of the twin tractor type and the large extensions on the upper planes are utilized for wauing.

The California Aviation Co. are building a Curtiss type biplane for M. Mellor, of Sacramento, single surface and a double surfaced headless Curtiss for R. O'Hanlon, 9 Plaza Cervantes, Manila, P. I. O'Hanlon will fly at the Manila Carnival the coming February.

### Kabitzke Drives Aero Scout to Success in Gale

With several camp fires forming a picturesque setting and marking the spot upon which it was safe to alight, William Kabitzke, one of the Wright demonstrators, successfully completed, on September 21st, two of the three official tests of one of the "speed scouts" which form the three machines which may be purchased by the government at the Army aviation field at College Park. His flights were delayed by the threatening gusts of wind which swept the field, and the last of the twenty minutes of his endurance flight was flown in the teeth of a 30-mile gale.

The first test which the demonstrator made when the wind had subsided to a degree which made flying safe was the speed flight. Rising from the ground at an opportune time, Kabitzke dashed through the air at a little better than 65.4 miles an hour. The official requirement is 65 miles an hour, and the speed scouts are guaranteed to make this speed. Owing to the fact that Kabitzke was flying at an altitude of several thousand feet, it was impossible to time him accurately, and it was said among the army officers after his flight that he had flown within a hundred feet of the ground his time would have been much faster.

The motor test, one of the hardest which the machines are forced to undergo, began shortly after 5 o'clock, and included a two-hour flight over the country. Circles around an altitude which varied between 3,500 and 4,000 feet, Kabitzke evoked the cheers of the many hundreds of people who journeyed to College Park to witness the tests, and the ease with which he handled the machine. Darkness came on as he flew, but wishing to fully demonstrate the staying powers of the aero which he was flying, he did not alight until some minutes after the two hour test was completed. It was completely dark when he alighted, and camp fires were started in a circle around the safest landing place, in order to guide him to a successful landing.

At College Park, Washington, on September 29th, Second Lieut. Lewis C. Rockwell, 10th U. S. Infantry, and Corporal Frank S. Scott, of the Signal Corps, were killed as a result of their machine suddenly diving from a height of 40 feet, when they were preparing to alight.

The cause of the regrettable accident is not known, although several possible explanations have been given. It is thought by some that in pulling the cord to shut the motor off after his descent from 400 feet, Lieut. Rockwell's lever inadvertently pushed his elevator forward and so increased the angle of his descent that he was unable to pull up again in the short space available. Other explanations are that the elevator jammed or the control wires broke, both of which are possible though not probably, seeing the care with which the machines are looked after. The official report on the accident, however, accredited the all to Lieut. Rockwell's defective eyesight, which caused him to misjudge his height.

Hundreds of spectators were thrilled at Washington on October 7th, when Hugh Robinson, while flying over the Washington Monument at a height of about 1,000 feet, suddenly dropped approximately 400 feet, aiming directly for the apex of the shaft. He riddled his machine when within a few feet of the top of the monument, however, and flew gracefully off to the army hydro-aeroplane station at the Washington barracks.

Miss Ruth Law, of Providence, who hopes to set an altitude record for women aviators at a mile above the earth, made a flight over Staten Island on October 6th, rising about 2,000 feet. Miss Law is a sister of Rodman Law, the daring young man who makes parachute drops from Harry Bingham Brown's Wright machine.



WILLIAM KABITZKE PUTTING THE BABY-BRIGHT MILITARY "SPEED SCOUT" THROUGH TESTS AT COLLEGE PARK, MD.

### Hempstead Plains

(BY W. H. PHIPPS.)

With the advent of the fine weather in October, following the cold spell the latter part of September, things were pretty active at the Hempstead Field.

The Sloane School was the centre of interest during the month for, in addition to the two machines already at the school, there arrived two more machines from France, one a large two-seater 60 H. P. Anzani Deperdussin of the latest type, the other a small 45 H. P. Anzani engine Caudron, which is capable of a speed of 80 miles an hour. In the absence of W. Leonard Bonney with the 35 H. P. Caudron, Mr. Sloane showed the confidence he places in the school graduates, for on September 27th he had Guy GilPatrick, the 17-year-old pilot, test out the large two passenger machine which he did very satisfactorily, although on the next day, September 28th, he met with a mishap when in getting off the ground with a passenger his motor started missing and let him down hard, breaking the landing chassis and a wing tip. These damages, however, were very excellently and quickly repaired, and on the following Saturday, October 5th, at the Military Review on the field, GilPatrick again had the machine out and made a beautiful flight before the assembled officers, rising at times to a height of 2,000 feet. On the following day GilPatrick outshined his former performances by rising to a height of 4,000 feet and flying for 40 minutes.

In addition to the fine flying of GilPatrick on the large machine there was considerable school work done on the small 3-cylinder Anzani Deperdussin. P. Reid, a new pupil, is progressing well and is now flying circuits, while Miss Firth is out practicing and should soon be making flights.

At the Moisant school instructor Jerwan was kept busy tutoring the many eager students and four machines were constantly at work whenever weather permitted. The two young Mexican officers, Gustave and Alberto Sihans, who recently graduated from the school, have left for Mexico, where they will do scout duty on Gnome-Moisants for the Mexican Federal Army.

On September 28th a regrettable and unnecessary

accident occurred. John I. Longstaff, a British Army officer, was flying the Gressier Farman type and after making two good circuits of the field his machine suddenly dove head first to the ground from a height of 40 feet, injuring Longstaff so badly that he died soon after being removed to the hospital. His mechanic, Chevalier, who was flying with him at the time, was painfully though not seriously injured. Judging from the manner in which the machine dove, it appears that this accident was another of those unnecessary ones caused by the jamming or breaking of some part of the control. To the writer, who was watching the machine at the time of the accident, it appeared that either one of the rear elevator wires broke and got caught in the propeller, or else the tip of the propeller caught the wire and so pulled the rear elevator flap sharply down, causing the machine to suddenly upend and dive. This belief was further substantiated by an examination of the wreck, which showed the propeller nicked and the broken end of the control wire wrapped around it.

On Saturday, October 5th, a Military Review was held at the field, all the machines being brought out and lined up in a straight line before the hangars for inspection by the officials of the National Guard. There were about 30 machines in line and they made a most imposing sight, which must have impressed the officers and the crowd present.

After reviewing the aeroplanes the officers were in turn taken up for short flights by George Beatty on his Wright machine. Colonel Cornelius Vanderbilt was the first passenger of the day, and he alighted full of praise for the aeroplane as a means of sport as well as war.

While Beatty was running his aerial taxi-cab service the crowd was treated to some fine flying by Guy GilPatrick on the passenger Deperdussin, Gustave Ey on his Maximotored biplane, the Moisant pupils in Moisant monoplanes, and P. Reid in the Sloane school Deperdussin.

Charles Baysdorfer's speedy little Curtiss type has been hard up the early part of the month, but is now flying again.

The Beckwith-Crabtree large 70 H. P. Maximotored tractor biplane is now completed and ready for its trials.

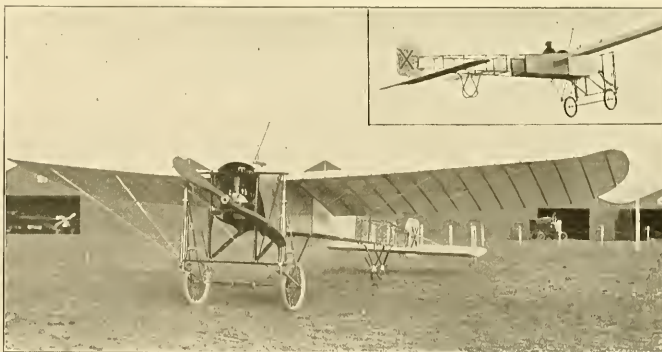

The Rex monoplane, which flies well with either a water-cooled or an air-cooled motor. The large picture shows the machine equipped with a six-cylinder Kirkham motor, while the insert illustrates the same machine in flight.



The above illustration shows J. Ramon Montero and his latest Blériot monoplane, the important feature of the machine being that Blériot is using the inverse curve tail again, and has abandoned the type of tail fitted to the late Miss Quimby's machine. As can be noticed there is an opening left between the rear end of the wing and chassis so that the pilot can see the ground accurately from almost any angle.

J. Ramon Montero is a Peruvian who took part in the recent Chicago meets, but who will leave for Peru on November 15, 1912, for the purpose of opening an aviation school in that country and teaching his fellow countrymen the art of flying.

Montero began to take his lessons in flying at Etampes, France, in October, 1911, but finished his course of instruction at Pau, France, later and obtained a license, number 766, from the Aero Club of France on March 9, 1912.

George Boyd, of the Rex Company, is constructing a neat double surfaced biplane, which has a slight reverse curve in the main planes. The Rex Blériot type monoplane is out on the road and is being flown very successfully by George Dyott, while their own original type monoplane is in the hangar awaiting a motor.

Frederick C. Hild, of the American Aeroplane Supply House, sustained a fall when he attempted to avoid some people on the field he stalled his monoplane and landed on a wing tip, fortunately without injuring himself.

An interesting demonstration of the military value of the Caudron monoplane for speedy scouting work is being arranged by the Sloane Aeroplane Company at Hempstead Field for the benefit of a group of U. S. Army and National Guard officers. The Caudron is a skybike craft that fades out of sight at an altitude of 2,000 feet. While the operator can see what is going on beneath him he is practically invisible to the people on the ground. The machine flies at the rate of 70 to 90 miles an hour with less horsepower than any aeroplane ever built. It is imported from France and is expected to be the next successful representative of France in the Gordon-Bennett cup race.

In the military demonstration two of the craft will be flown on Hempstead Plains by W. Leonard Bonney and by John Guy GilPatrick. Bonney, one of the pioneer aviators of America, has been flying the Caudron for several months. GilPatrick is one of the most interesting youthful products of the Hempstead Plains. He is only 16 years old, but holds a license as a pilot and is one of the best aviators in America.

Miss Agnes Firth, of Cambridge, Mass., began a course of tuition at the Sloane School of Aviation on the Hempstead Plains on October 3rd, with the ambition to become the first woman in the world to fly a Denerdussin monoplane. Miss Firth, who is a Wellesley girl, intends to own her craft and will fly in California this winter for sport. She is less than 18 years old, very pretty, dashing, cultivated and daring.

### Aviator Motoshisa Kondo Killed

Motoshisa Kondo, a graduate of the Curtiss School of Aviation at San Diego, Cal., where he secured his pilot's license in May of this year, was killed at 10:30 on the morning of October 6th by falling with his machine from an altitude of 200 feet near Savona, N. Y.

Kondo was flying from a field about 2½ miles west of Savona. This field is one mile long and free from obstructions. Kondo had made flights with the same machine at this field on Friday and Saturday, and expressed himself as highly pleased with the field and also the machine, and had declared his intention of going to Hammondsport and return this morning. He left the west end of the field and flew the entire length before attempting the turn. He was flying close to the road at an altitude of 200 feet when he turned to the right, which took him over the highway

and over a farmhouse and buildings, and had made the turn and started back towards the field, when for some unknown reason he pushed his control forward, sending his machine straight down over a barn. He came down until within 30 feet of the ground, when he changed his control and righted the machine, but struck the frame of a steel windmill about 10 feet from the ground. Kondo was thrown from the machine and instantly killed. As the machine was making a speed of 65 miles an hour, it is figured that the machine must have struck the windmill at the rate of 90 miles an hour. The impact was terrific, and Kondo was thrown clear of the

mass of twisted wreckage. The windmill, which was of steel angle iron construction, was nearly broken in halves, and buckled over the aeroplane wreckage. The farmer's wife narrowly missed being killed, as she was filling a pail with water under the windmill when Kondo made the turn and ran a distance of 30 feet when the aeroplane struck the windmill and piled the wreckage where she had stood. Mr. Kondo was a native of Osaka, Japan, and came to this country in June, 1903. He was born in December, 1885.

He was flying a Kirkham tractor biplane with a 70 horse power motor, which was a different type of machine than Mr. Kondo had been using. He intended to do exhibition work in the South and then take the machine out of the country. Mr. Kondo was an exceptionally brilliant man and very well read and entirely familiar with our country, having been here over nine years. His remains were taken in charge by Lieut. C. Yamada, of the Japanese Army, who is at Hammondsport.

### Types of Aeroplanes for Military Service

Notice to "AIRCRAFT" from the Chief Signal Officer. Until further notice, the intention of the Army aviation service is to purchase and use only two types of aeroplanes.

One type will be known as "Speed Scout" aeroplane. This type is desired particularly for strategical reconnaissance, carrying only one aviator without passenger, and having a radius of operation of about 100 miles and a speed of not less than 65 miles per hour. With this type of aeroplane a military aviator is expected to locate and report large bodies of troops. This machine should be capable of ascending at the rate of about 600 feet per minute.

The second type will be known as "Scout" machine. It is desired for reconnaissance service when hostile armies are in contact or approaching contact. This service requires a weight-carrying aeroplane, the crew consisting of two aviators, capable of relieving one another as observers; the aeroplane should be provided with radio equipment. This type of aeroplane should remain in the air at least three hours to permit the observers to locate smaller bodies of troops accurately upon a map, make sketches, military photographs, etc. The "Scout" aeroplane should have a speed of not less than 45 miles an hour; the maximum speed must not exceed 60 miles per hour. It should be capable of carrying a useful weight of 450 pounds, and with this weight ascend at least 2,000 feet in 10 minutes. The chassis must be designed so that it is capable of landing on and arising from soft ground, such as harrowed fields.

### Book Review

HIKE AND THE AEROPLANE. By Tom Graham. With four illustrations in two colors by Arthur Hutchins. Frederick A. Stokes Company, New York. Price \$1.00.

This aeroplane story is not only full of action, but is one of the few ever written by a man who is personally acquainted with aviators and the technicalities of the various makes of machines. It is a book written expressly for boys by one who understands them, and it will be highly appreciated.

Hike Griffin discovered an inventor with an aeroplane which had the greatest stability and speed ever known.

How he flew it across the Continent, rescued refugees, fought moonshiners, escaped from kidnapers with the help of his chum, Poodle Darby, and the War Department, saved a ranch from Mexican desperadoes, underwent hazing for his exploits when he went back to school in the Fall and won the football game—Tom Graham tells most graphically.

Captain Paul W. Beck, U. S. A., the famous military aviator.

"Tom Graham in 'Hike and the Aeroplane' has hit a vein which is certain to arouse in the boys of America that same interest which it aroused in me—a 'grown-up' boy.

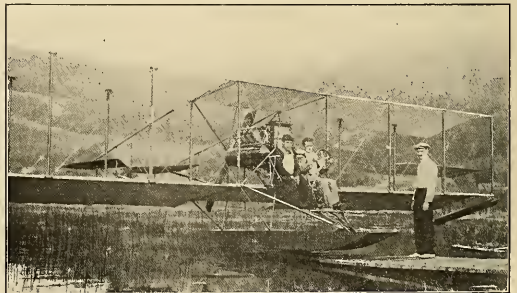

The new large surface Curtiss hydro-aeroplane which has been especially designed for quick climbing and weight carrying work. Several Japanese officers are now at Hammondsport learning to operate the hydro-aeroplane.



# CORRESPONDENCE

## An Aero-Dynamic Laboratory

By Dr. Leonard Keene Hirschberg, A. B., M. A., M. D. (Joins Hopkins).

In the Champs de Paris there has recently been installed an aero-dynamic laboratory where experiments relating to the degree of atmospheric resistance are made. An eminent engineer, while working over these experiments, verified a curious statement: that the pressure upon a square surface included thirty-seven degrees to the wind is one and one-half times stronger than that exerted on the same surface exposed at ninety degrees.

## Aeronaut Mack Praises Aircraft

Editor AIRCRAFT.  
Permit me to commend the article under the heading, "Structural Requirements for Safety in Ballooning," by Major Samuel Reber, which appears in the October issue of AIRCRAFT. The article appeals to me, as the best and most instructive which has ever come to my notice. A point worth noting is the laying aside of the metric system in the tables and formulae. Major Reber evidently realized the fact that AIRCRAFT is printed in the English language. Heretofore articles written on the subject of ballooning have either been too mushy or have contained too much of the "will-you-walk-into-my-parlor-said-the-spider-to-the-fly" scheme about them to be of any value to the aeronaut.

WM. R. MACK.

## Letter From The Morok Aeroplane Co.

October 11th.

Editor AIRCRAFT.  
We are just in receipt of a letter from our Mr. George M. Dyott which is fatal to an Alabama State Fair, Birmingham, Alabama, this week. Mr. Dyott sends the following particulars of the fatal accident to Joseph Stevenson, who was also to have flown there for its throughout this week: "Mr. Stevenson, flying a headless type biplane, sustained a fall at the Alabama State Fair at Birmingham about four o'clock P. M., October 7th. The engine and radiator pined out, returning the base of his skull. He died at three o'clock the following morning without having regained consciousness. Mr. Dyott states: 'I had seen the day before someone advised him to wait, which he did, but afterwards started too soon, in my opinion, from the far end of the field. He had to pass through some bad eddies, also to climb through some downward air currents, which were caused by the proximity of hills. His machine would not climb rapidly, and getting into a bad eddy, his machine sideslipped, crashing nose first to the ground from a height of about fifty feet.'"

Mr. Stevenson had a great many friends everywhere. His humor and his jovial way won him a place everywhere he went. I personally had occasion to know him very well, and therefore feel his loss exceedingly.  
The Alabama State Fair Association immediately raised a fund, amounting to \$233, which was presented to Mrs. Stevenson to defray funeral expenses. Yours very truly,

M. M. SLOSS, Secretary.

## Editor AIRCRAFT:

In your March issue you printed an article by Mr. Starrett which is very extraordinary. I think his observations are at fault and mean to try his wedge at the M. I. T. son. He would have us believe that a man is moving north with velocity X and an obstruction (out of the prow of his wedge) changes its direction so that it moves, say east, then its velocity is still X. Not according to the first law of motion. The energy tending to move the wedge back is represented by mass times the velocity, and the energy tending to move it forward must be an equal mass having an equal or rather greater velocity. If the wedge moves forward, where does this increased velocity come from? By changing the direction of a moving mass you always subtract something from its kinetic energy and to believe that it does, does what Mr. Starrett said it did, but if it did then it was because the wires were not exactly parallel with the air stream and a modifying component was introduced, as in some of the upward currents.

A. A. MERRILL.

Lawson Publishing Co., New York, N. Y.

Gentlemen—The report has reached us that a rumor is going around that another company will buy out the Sloane Aeroplane Co. If such a rumor reaches you, or has reached you, we wish to ask you to deny it absolutely. This company is not for sale. We will, however, be very glad to absorb any company that seems worthy of absorption. Yours very truly,

SLOANE AEROPLANE CO.

JOHN E. SLOANE, President.

## Test of the "Sturtevant" Aeronautical Motor

The accompanying table shows the results of three tests recently made at the B. F. Sturtevant Company's works on a Sturtevant six-cylinder aeronautical motor. The first was a fuel consumption test, lasting thirty minutes, and showing a fuel consumption per horse power hour of .04 pounds of gasoline. The second was a brake horse power test, lasting four hours and showing an average actual developed horse power of 63.85 at 1304 (average) R. P. M. The third was a maximum horse power test, in which the motor developed 86.3 actual horse power at 2037 R. P. M.

It is interesting to note that the six-cylinder motor upon which these tests were made is rated by the makers at sixty horse power at 1300 R. P. M.

During these tests absolutely no adjustment was made, and no one was allowed to touch the motor except to supply the oil necessary. As can be seen in the table which has been photographed from the original and reproduced here, the tests were made in the presence of witnesses, Lieutenant Cunningham, of the Navy Aviation Corps, witnessed the tests unofficially, and not as agent of the government.

BRAKE TEST OF STURTEVANT 6-CYL. AERO MOTOR No. 11  
DIRECT DEVELOPMENT OF HORSE POWER  
LUNEN OF BRASE ANN 3 Feet.      August 23, 1912.

Time	R.P.M.	W.P.	W.P.	Remarks
1:00	1304	63.85	7.00	Sturtevant 6-Cyl. Aero Motor
1:05	1304	63.85	7.00	Sturtevant 6-Cyl. Aero Motor
1:10	1304	63.85	7.00	Sturtevant 6-Cyl. Aero Motor
1:15	1304	63.85	7.00	Sturtevant 6-Cyl. Aero Motor
1:20	1304	63.85	7.00	Sturtevant 6-Cyl. Aero Motor
1:25	1304	63.85	7.00	Sturtevant 6-Cyl. Aero Motor
1:30	1304	63.85	7.00	Sturtevant 6-Cyl. Aero Motor
1:35	1304	63.85	7.00	Sturtevant 6-Cyl. Aero Motor
1:40	1304	63.85	7.00	Sturtevant 6-Cyl. Aero Motor
1:45	1304	63.85	7.00	Sturtevant 6-Cyl. Aero Motor
1:50	1304	63.85	7.00	Sturtevant 6-Cyl. Aero Motor
1:55	1304	63.85	7.00	Sturtevant 6-Cyl. Aero Motor
2:00	1304	63.85	7.00	Sturtevant 6-Cyl. Aero Motor
2:05	1304	63.85	7.00	Sturtevant 6-Cyl. Aero Motor
2:10	1304	63.85	7.00	Sturtevant 6-Cyl. Aero Motor
2:15	1304	63.85	7.00	Sturtevant 6-Cyl. Aero Motor
2:20	1304	63.85	7.00	Sturtevant 6-Cyl. Aero Motor
2:25	1304	63.85	7.00	Sturtevant 6-Cyl. Aero Motor
2:30	1304	63.85	7.00	Sturtevant 6-Cyl. Aero Motor
2:35	1304	63.85	7.00	Sturtevant 6-Cyl. Aero Motor
2:40	1304	63.85	7.00	Sturtevant 6-Cyl. Aero Motor
2:45	1304	63.85	7.00	Sturtevant 6-Cyl. Aero Motor
2:50	1304	63.85	7.00	Sturtevant 6-Cyl. Aero Motor
2:55	1304	63.85	7.00	Sturtevant 6-Cyl. Aero Motor
3:00	1304	63.85	7.00	Sturtevant 6-Cyl. Aero Motor
3:05	1304	63.85	7.00	Sturtevant 6-Cyl. Aero Motor
3:10	1304	63.85	7.00	Sturtevant 6-Cyl. Aero Motor
3:15	1304	63.85	7.00	Sturtevant 6-Cyl. Aero Motor
3:20	1304	63.85	7.00	Sturtevant 6-Cyl. Aero Motor
3:25	1304	63.85	7.00	Sturtevant 6-Cyl. Aero Motor
3:30	1304	63.85	7.00	Sturtevant 6-Cyl. Aero Motor
3:35	1304	63.85	7.00	Sturtevant 6-Cyl. Aero Motor
3:40	1304	63.85	7.00	Sturtevant 6-Cyl. Aero Motor
3:45	1304	63.85	7.00	Sturtevant 6-Cyl. Aero Motor
3:50	1304	63.85	7.00	Sturtevant 6-Cyl. Aero Motor
3:55	1304	63.85	7.00	Sturtevant 6-Cyl. Aero Motor
4:00	1304	63.85	7.00	Sturtevant 6-Cyl. Aero Motor
4:05	1304	63.85	7.00	Sturtevant 6-Cyl. Aero Motor
4:10	1304	63.85	7.00	Sturtevant 6-Cyl. Aero Motor
4:15	1304	63.85	7.00	Sturtevant 6-Cyl. Aero Motor
4:20	1304	63.85	7.00	Sturtevant 6-Cyl. Aero Motor
4:25	1304	63.85	7.00	Sturtevant 6-Cyl. Aero Motor
4:30	1304	63.85	7.00	Sturtevant 6-Cyl. Aero Motor
4:35	1304	63.85	7.00	Sturtevant 6-Cyl. Aero Motor
4:40	1304	63.85	7.00	Sturtevant 6-Cyl. Aero Motor
4:45	1304	63.85	7.00	Sturtevant 6-Cyl. Aero Motor
4:50	1304	63.85	7.00	Sturtevant 6-Cyl. Aero Motor
4:55	1304	63.85	7.00	Sturtevant 6-Cyl. Aero Motor
5:00	1304	63.85	7.00	Sturtevant 6-Cyl. Aero Motor
5:05	1304	63.85	7.00	Sturtevant 6-Cyl. Aero Motor
5:10	1304	63.85	7.00	Sturtevant 6-Cyl. Aero Motor
5:15	1304	63.85	7.00	Sturtevant 6-Cyl. Aero Motor
5:20	1304	63.85	7.00	Sturtevant 6-Cyl. Aero Motor
5:25	1304	63.85	7.00	Sturtevant 6-Cyl. Aero Motor
5:30	1304	63.85	7.00	Sturtevant 6-Cyl. Aero Motor
5:35	1304	63.85	7.00	Sturtevant 6-Cyl. Aero Motor
5:40	1304	63.85	7.00	Sturtevant 6-Cyl. Aero Motor
5:45	1304	63.85	7.00	Sturtevant 6-Cyl. Aero Motor
5:50	1304	63.85	7.00	Sturtevant 6-Cyl. Aero Motor
5:55	1304	63.85	7.00	Sturtevant 6-Cyl. Aero Motor
6:00	1304	63.85	7.00	Sturtevant 6-Cyl. Aero Motor
6:05	1304	63.85	7.00	Sturtevant 6-Cyl. Aero Motor
6:10	1304	63.85	7.00	Sturtevant 6-Cyl. Aero Motor
6:15	1304	63.85	7.00	Sturtevant 6-Cyl. Aero Motor
6:20	1304	63.85	7.00	Sturtevant 6-Cyl. Aero Motor
6:25	1304	63.85	7.00	Sturtevant 6-Cyl. Aero Motor
6:30	1304	63.85	7.00	Sturtevant 6-Cyl. Aero Motor
6:35	1304	63.85	7.00	Sturtevant 6-Cyl. Aero Motor
6:40	1304	63.85	7.00	Sturtevant 6-Cyl. Aero Motor
6:45	1304	63.85	7.00	Sturtevant 6-Cyl. Aero Motor
6:50	1304	63.85	7.00	Sturtevant 6-Cyl. Aero Motor
6:55	1304	63.85	7.00	Sturtevant 6-Cyl. Aero Motor
7:00	1304	63.85	7.00	Sturtevant 6-Cyl. Aero Motor
7:05	1304	63.85	7.00	Sturtevant 6-Cyl. Aero Motor
7:10	1304	63.85	7.00	Sturtevant 6-Cyl. Aero Motor
7:15	1304	63.85	7.00	Sturtevant 6-Cyl. Aero Motor
7:20	1304	63.85	7.00	Sturtevant 6-Cyl. Aero Motor
7:25	1304	63.85	7.00	Sturtevant 6-Cyl. Aero Motor
7:30	1304	63.85	7.00	Sturtevant 6-Cyl. Aero Motor
7:35	1304	63.85	7.00	Sturtevant 6-Cyl. Aero Motor
7:40	1304	63.85	7.00	Sturtevant 6-Cyl. Aero Motor
7:45	1304	63.85	7.00	Sturtevant 6-Cyl. Aero Motor
7:50	1304	63.85	7.00	Sturtevant 6-Cyl. Aero Motor
7:55	1304	63.85	7.00	Sturtevant 6-Cyl. Aero Motor
8:00	1304	63.85	7.00	Sturtevant 6-Cyl. Aero Motor
8:05	1304	63.85	7.00	Sturtevant 6-Cyl. Aero Motor
8:10	1304	63.85	7.00	Sturtevant 6-Cyl. Aero Motor
8:15	1304	63.85	7.00	Sturtevant 6-Cyl. Aero Motor
8:20	1304	63.85	7.00	Sturtevant 6-Cyl. Aero Motor
8:25	1304	63.85	7.00	Sturtevant 6-Cyl. Aero Motor
8:30	1304	63.85	7.00	Sturtevant 6-Cyl. Aero Motor
8:35	1304	63.85	7.00	Sturtevant 6-Cyl. Aero Motor
8:40	1304	63.85	7.00	Sturtevant 6-Cyl. Aero Motor
8:45	1304	63.85	7.00	Sturtevant 6-Cyl. Aero Motor
8:50	1304	63.85	7.00	Sturtevant 6-Cyl. Aero Motor
8:55	1304	63.85	7.00	Sturtevant 6-Cyl. Aero Motor
9:00	1304	63.85	7.00	Sturtevant 6-Cyl. Aero Motor
9:05	1304	63.85	7.00	Sturtevant 6-Cyl. Aero Motor
9:10	1304	63.85	7.00	Sturtevant 6-Cyl. Aero Motor
9:15	1304	63.85	7.00	Sturtevant 6-Cyl. Aero Motor
9:20	1304	63.85	7.00	Sturtevant 6-Cyl. Aero Motor
9:25	1304	63.85	7.00	Sturtevant 6-Cyl. Aero Motor
9:30	1304	63.85	7.00	Sturtevant 6-Cyl. Aero Motor
9:35	1304	63.85	7.00	Sturtevant 6-Cyl. Aero Motor
9:40	1304	63.85	7.00	Sturtevant 6-Cyl. Aero Motor
9:45	1304	63.85	7.00	Sturtevant 6-Cyl. Aero Motor
9:50	1304	63.85	7.00	Sturtevant 6-Cyl. Aero Motor
9:55	1304	63.85	7.00	Sturtevant 6-Cyl. Aero Motor
10:00	1304	63.85	7.00	Sturtevant 6-Cyl. Aero Motor
10:05	1304	63.85	7.00	Sturtevant 6-Cyl. Aero Motor
10:10	1304	63.85	7.00	Sturtevant 6-Cyl. Aero Motor
10:15	1304	63.85	7.00	Sturtevant 6-Cyl. Aero Motor
10:20	1304	63.85	7.00	Sturtevant 6-Cyl. Aero Motor
10:25	1304	63.85	7.00	Sturtevant 6-Cyl. Aero Motor
10:30	1304	63.85	7.00	Sturtevant 6-Cyl. Aero Motor
10:35	1304	63.85	7.00	Sturtevant 6-Cyl. Aero Motor
10:40	1304	63.85	7.00	Sturtevant 6-Cyl. Aero Motor
10:45	1304	63.85	7.00	Sturtevant 6-Cyl. Aero Motor
10:50	1304	63.85	7.00	Sturtevant 6-Cyl. Aero Motor
10:55	1304	63.85	7.00	Sturtevant 6-Cyl. Aero Motor
11:00	1304	63.85	7.00	Sturtevant 6-Cyl. Aero Motor
11:05	1304	63.85	7.00	Sturtevant 6-Cyl. Aero Motor
11:10	1304	63.85	7.00	Sturtevant 6-Cyl. Aero Motor
11:15	1304	63.85	7.00	Sturtevant 6-Cyl. Aero Motor
11:20	1304	63.85	7.00	Sturtevant 6-Cyl. Aero Motor
11:25	1304	63.85	7.00	Sturtevant 6-Cyl. Aero Motor
11:30	1304	63.85	7.00	Sturtevant 6-Cyl. Aero Motor
11:35	1304	63.85	7.00	Sturtevant 6-Cyl. Aero Motor
11:40	1304	63.85	7.00	Sturtevant 6-Cyl. Aero Motor
11:45	1304	63.85	7.00	Sturtevant 6-Cyl. Aero Motor
11:50	1304	63.85	7.00	Sturtevant 6-Cyl. Aero Motor
11:55	1304	63.85	7.00	Sturtevant 6-Cyl. Aero Motor
12:00	1304	63.85	7.00	Sturtevant 6-Cyl. Aero Motor
12:05	1304	63.85	7.00	Sturtevant 6-Cyl. Aero Motor
12:10	1304	63.85	7.00	Sturtevant 6-Cyl. Aero Motor
12:15	1304	63.85	7.00	Sturtevant 6-Cyl. Aero Motor
12:20	1304	63.85	7.00	Sturtevant 6-Cyl. Aero Motor
12:25	1304	63.85	7.00	Sturtevant 6-Cyl. Aero Motor
12:30	1304	63.85	7.00	Sturtevant 6-Cyl. Aero Motor
12:35	1304	63.85	7.00	Sturtevant 6-Cyl. Aero Motor
12:40	1304	63.85	7.00	Sturtevant 6-Cyl. Aero Motor
12:45	1304	63.85	7.00	Sturtevant 6-Cyl. Aero Motor
12:50	1304	63.85	7.00	Sturtevant 6-Cyl. Aero Motor
12:55	1304	63.85	7.00	Sturtevant 6-Cyl. Aero Motor
13:00	1304	63.85	7.00	Sturtevant 6-Cyl. Aero Motor
13:05	1304	63.85	7.00	Sturtevant 6-Cyl. Aero Motor
13:10	1304	63.85	7.00	Sturtevant 6-Cyl. Aero Motor
13:15	1304	63.85	7.00	Sturtevant 6-Cyl. Aero Motor
13:20	1304	63.85	7.00	Sturtevant 6-Cyl. Aero Motor
13:25	1304	63.85	7.00	Sturtevant 6-Cyl. Aero Motor
13:30	1304	63.85	7.00	Sturtevant 6-Cyl. Aero Motor
13:35	1304	63.85	7.00	Sturtevant 6-Cyl. Aero Motor
13:40	1304	63.85	7.00	Sturtevant 6-Cyl. Aero Motor
13:45	1304	63.85	7.00	Sturtevant 6-Cyl. Aero Motor
13:50	1304	63.85	7.00	Sturtevant 6-Cyl. Aero Motor
13:55	1304	63.85	7.00	Sturtevant 6-Cyl. Aero Motor
14:00	1304	63.85	7.00	Sturtevant 6-Cyl. Aero Motor
14:05	1304	63.85	7.00	Sturtevant 6-Cyl. Aero Motor
14:10	1304	63.85	7.00	Sturtevant 6-Cyl. Aero Motor
14:15	1304	63.85	7.00	Sturtevant 6-Cyl. Aero Motor
14:20	1304	63.85	7.00	Sturtevant 6-Cyl. Aero Motor
14:25	1304	63.85	7.00	Sturtevant 6-Cyl. Aero Motor
14:30	1304	63.85	7.00	Sturtevant 6-Cyl. Aero Motor
14:35	1304	63.85	7.00	Sturtevant 6-Cyl. Aero Motor
14:40	1304	63.85	7.00	Sturtevant 6-Cyl. Aero Motor
14:45	1304	63.85	7.00	Sturtevant 6-Cyl. Aero Motor
14:50	1304	63.85	7.00	Sturtevant 6-Cyl. Aero Motor
14:55	1304	63.85	7.00	Sturtevant 6-Cyl. Aero Motor
15:00	1304	63.85	7.00	Sturtevant 6-Cyl. Aero Motor
15:05	1304	63.85	7.00	Sturtevant 6-Cyl. Aero Motor
15:10	1304	63.85	7.00	Sturtevant 6-Cyl. Aero Motor
15:15	1304	63.85	7.00	Sturtevant 6-Cyl. Aero Motor
15:20	1304	63.85	7.00	Sturtevant 6-Cyl. Aero Motor
15:25	1304	6		

# CLASSIFIED ADVERTISING

15 CENTS A LINE

SEVEN WORDS TO LINE

CASH WITH ORDER

## FOR SALE

### MUST SELL--FINE MONOPLANE

1911, cross country type, two seater, Blériot, 100 H. P. engine, full equipment. A. V. Reyburn, Jr., 5305 Delmar Boul., St. Louis, Missouri.

### PATENTS BRING WEALTH;

proof-books—advice free.  
Low rates, terms easy.

A. Wedderburn, Pat. Atty., Washington, D. C.

**ROTARY AEROPLANE** engine, 40 H. P., 7 cylinder, weight 160 lbs. with propeller. Cheap. Landsman Motor Co., 1406 S. 18th St., St. Louis, Mo.

**FOR SALE**—Tractor biplane, 8 cylinder, 60 H. P. Motor; everything in first-class condition. Will sell separately or exchange for touring car. Apply F. Robinson, 191 Caledonia Avenue, Rochester, N. Y.

**ENGINE AND PLANE BARGAINS**—We are sacrificing many hundreds of dollars to close out immediately, 36-40 and 40-50 H. P. Exhibition biplanes; 50 H. P. Tractor. All three demonstrated flyers. Absolutely unused passenger Curtiss type with 75 H. P. Maximoto. Buy engines or planes separately. Address Box 767, Aircraft.

## FOR SALE

**CURTISS** latest improved type (Pigeon tail) 1912 Model. Made over 300 very successful flights 1,000 ft. high, 30 miles cross-country. My construction is strongest in the world. New, complete, ready to fly, tested and guaranteed, including free lessons to buyer, \$2,500. Buy direct from Builder and Aviator of 10 years' experience. H. C. Cooke, Aviator and Builder, 127 West 64th St., New York City.

**FOR QUICK SALE**—1 50 H. P. Maximoto, complete with radiator and propeller, \$450.00. 1 40 H. P. complete, \$350.00. Edward Miller, 480 Elmwood Ave., Detroit, Mich.

**FOR SALE**—My Curtiss type biplane equipment with 30 H. P. Kirkham motor, El Arco Radiator and several extras, guaranteed to be in the best of flying conditions, for \$700. For further particulars write to W. F. Zehler, 341 Swan st., Buffalo, N. Y.

**ARTISTIC** 4x5 aeronautical photographs, 6 for \$1; sample photo and complete list, 20c. Chas. I. Durso, 25 Mulberry st., New York City.

## POSITIONS WANTED

**A YOUNG MAN**, age 18, desires position as an aviator's assistant, with prospects of learning to fly. Address Louis Fenouillet, 132 West 47th St., New York City.

## CO-OPERATION WANTED

**CAPITAL** wanted to patent and build aeroplane that will fly three hundred miles per hour. Will give 49 per cent. of patents. I will guarantee to fly across Atlantic in twelve hours. Address A. Harbottle, 18 Eldert St., Brooklyn, N. Y.

**ESTABLISHED** manufacturer owning all the patents covering an indispensable part of all aeronautical equipment needs moderate capital to extend domestic and foreign trade. Enormous profits last year, but must expand to meet growth and changing conditions. Address Amerco, care of Aircraft.

## AVIATORS WANTED

**AVIATOR**—Licensed aviator of the Aero Club A of France, flying Blériot and Curtiss machines; constructor of a number of Blériot machines, wishes engagement. Two year's experience as aviator and mechanic aviator. Address Box 768 Aircraft.

## LEGAL NOTICE

I desire to give notice to all persons that are using my "Patent Rudders" (Serial number 504107 U. S.), also France and England, and my "Semi-Automatic engine control," (Serial number 646300 U. S., France and England), that it is my intention in the future to ask a small royalty from them. Hugh L. Willoughby, Sewalls Point, Florida.

## CUTS FOR SALE

### FOR YOUR CATALOGUES AND ADVERTISING LITERATURE

Half-tones appearing in any previous number of *Aircraft*, still in stock, for sale at the low rate of **5 Cents** per Square Inch, 75 Cents minimum. Sent Postpaid, for Cash Only.

Use This Form

SEND TO..... Half-tone Appearing in *Aircraft*

VOL..... PAGE..... POSITION.....

**LAWSON PUBLISHING COMPANY**  
37-39 East 28th Street NEW YORK



AN EARLY BLERIOT IN FLIGHT.

## Albatross Engines

Made in two sizes: **50 H. P. 6-cyl. Aircooled**, weight 250 lbs., price **\$650.00** complete. **100 H. P. 6-cyl. Watercooled**, weight 300 lbs., price **\$850.00** complete. CATALOG FREE. AGENTS WANTED.

**Albatross Co. Detroit, Mich.**

## PROPELLER FACTS

Gibsons were the first on the market, and always best. **WHY?** Because of the care taken to make them good. We have discovered a wonderful advance in propellers, and we market them under the title of Worcester, because we made the tests at Worcester Polytechnic Institute.

**THEREFORE, WE WILL SELL** the remainder of our stock of ordinary style propellers at 1/4 of our list prices.

Get in quickly, only 40 left now. They are the best ordinary propellers obtainable.

**GIBSON PROPELLER CO. Fort George Park, New York City**

## HEINRICH

### Monoplanes and Mono-Biplanes

TUITION, \$250

On Private Field

MADE IN FOUR SIZES

Write for Illustrated Booklet

**HEINRICH BROS., Baldwin, L. I., N. Y., U.S.A.**



## SUPPLIES

at more than interesting prices. Blériot and Curtiss K. D. outfits our specialty. Imported helmets in stock. Wheels with tires 20" x 2 3/4" \$6.60. 20" x 3" \$9.25  
**22-page catalogue AA—describing over 750 parts—sent upon receipt of 6 cents**

**NEW YORK AERONAUTICAL SUPPLY CO.**  
50 BROADWAY, NEW YORK

## COOKE BIPLANES

**Curtiss Improved 1912 Type (Pigeon Tail)**  
Perfect flyer. No freak construction. Ten years' experience. Strongest in the world. Ample powered (Roberts Motors).  
Anybody can fly these machines. One ready for immediate delivery **\$2,500**

Curtiss Type Planes, no Power Plant, \$850 and up  
Free Instruction to Buyer  
**H. C. COOKE, 127 West 64th St. NEW YORK CITY**

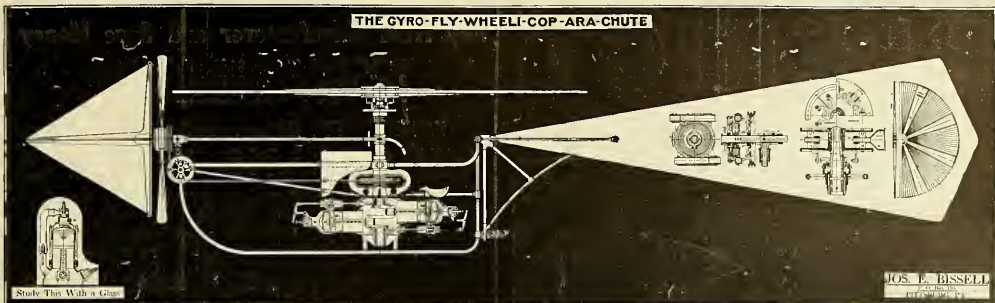

My **UNKNOWN**—but, my much affected, **FRIEND** ?  
No ordinary "**FOUL**" is **THIS** y'r homage claims—  
With honest pride I point from end to end,  
Tho crave its meed for not unselfish aims.

"From lowly train in life's sequestered scenes"  
**BEHOLD!**—Th' most **REFINDEST CUT** of all, **CONDEMNED**  
By George!—For "making good" it seems?—  
**THUS**, Progress breeds "**BIG-ASSUS**" for us all!

## CHICAGO AERO WORKS

H. S. RENTON  
Proprietor  
164 North Wabash Avenue  
**AEROPLANES** ACCESSORIES MOTORS PARTS  
WHEELS ALSO MODELS AND MODEL STOCK  
ESTABLISHED 1909. First in Chicago and the Middle West  
Aviators Taught. Flights Furnished. Send Stamp for Catalog.

## Aeronautical Supplies

Everything to Build Any Type Flying Machine  
New catalogue with working drawings of Curtiss, Farman and Blériot type machines, now ready for distribution and will be mailed free upon request to all interested parties. Write for quotations.

**E. J. WILLIS CO.**, 85 Chambers Street  
67 Reade Street  
Tel. 3624 Worth NEW YORK CITY

## PATENTS

THAT PROTECT AND PAY  
BOOKS, ADVICE AND SEARCHES FREE  
Send sketch or model for search. Highest References.  
Best Results. Promptness Assured.

**WATSON E. COLEMAN**, Patent Lawyer  
624 F. Street, N. W. Washington, D. C.

## J. C. (BUD) MARS, NOW BOOKING

—ADDRESS—

17 N. La Salle Street, Chicago, Ill.

## PATENTS SECURED or Fee Returned

Send sketch for free search of Patent Office Records. How to Obtain a Patent, and What to Invent, with list of Inventions Wanted and Prizes offered for Inventions sent free. Patents advertised free.  
We are experts on AIRSHIPS and all patents and technical matters relating to AERIAL NAVIGATION.

**VICTOR J. EVANS & CO.** Washington, D. C.

**BAMBOO** Special Grades of  
**Bamboo for AERONAUTIC WORK**  
Reed, Rattan and Split Bamboo for Models.  
All sizes in stock. Tonka Rattan for Skids,  
1 1/4 inch and under, any length.

**J. DELTOUR, Inc.**  
804 Jefferson St. Hoboken, N. J.

**DETROIT AERO POWER PLANT**  
COMPLETE \$300 READY TO RUN

INCL. PROPELLER-CARBURETOR-BOSH MAGNETO.  
OIL PUMP-CABLE-SWITCH-MOUNTING BOLTS.

IS GUARANTEED TO  
210 LBS MIN. STATIONARY THRUST  
150 LBS MAX WEIGHT (COMPLETE)  
36 HOURS DELIVERY

LIFT AND FLY  
CURTIS BY PLANES  
BLÉRIOT II MONOPLANES  
DEMOISELLE MONOPLANES  
OR CRAFTS OF SIMILAR MAKE

**DETROIT AEROPLANE CO.**  
DETROIT MICHIGAN

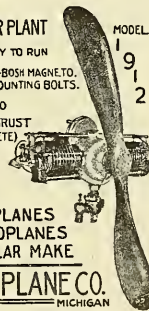

## "IDEAL" Plans and Drawings

are accurate and are accompanied by clear, concise building instructions, postpaid at the following prices:  
Wright 3-foot Biplane . . . 25c  
Blériot 3-foot Monoplane 15c  
"Cecil Peell" Chamois . . . 25c  
"The Racer" . . . 35c  
Curtiss Convertible Hydroaeroplane (new) . . . 35c  
"Ideal" three-foot Racer (new) . . . 15c  
Complete set of five-\$1.00 postpaid.  
5 cts. brings our new 40-page fully illustrated Catalog of "Ideal" Model Aeroplane Supplies. (None free.)  
**IDEAL AEROPLANE & SUPPLY COMPANY**  
82-B West Broadway, New York

## GOODYEAR

**Goodyear Balloons** Aeroplane Accessories  
National headquarters for Spheroidal and Dirigible Balloons. Built complete. Highest quality. Also makers of Aeroplane Springs, Tires, and the famous Goodyear Rubberized Aeroplane Fabric. Write for booklet.  
**THE GOODYEAR TIRE & RUBBER CO.**  
AKRON, OHIO.

Seventy per cent. of record-breaking American flights with American Aeroplanes were made with propellers bearing this name

# CHARAVAY

WE WILL TELL YOU WHY IF YOU ASK US

**SLOANE AEROPLANE CO.**

**1731 Broadway, NEW YORK CITY**

AGENTS:

Eames Tricycle Co., San Francisco and Los Angeles; National Aeroplane Co., Chicago; W. E. Boughton, Washington, D. C.

# BLERIOT

## MONOPLANES

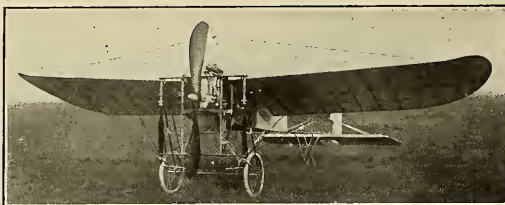

One of our 1912 Single Seater Monoplanes, equipped with 50 H. P. Roberts Motor. Price as illustrated, \$2,100.

**SPECIAL MACHINES BUILT TO ORDER.  
SUBMIT DRAWINGS FOR ESTIMATE.**

### IMMEDIATE DELIVERIES

Our BLERIOT TYPE MONOPLANES are in every way suited to contest and exhibition work, including speed, altitude, distance and duration, cross-country and cross-city flying, where thorough reliable strength and high efficiency are so vitally important.

**WE SOLD MORE SUCCESSFUL BLERIOT TYPE MONOPLANES IN 1911 THAN ALL OTHER MANUFACTURERS COMBINED**

Visit our factory and examine in detail the **EXCELLENT DESIGN and CONSTRUCTION** of our Monoplanes **ILLUSTRATED CATALOG FREE. SEND FOR IT TO-DAY**

**American Aeroplane Supply House**  
137-143 Jackson St. Hempstead, L. I., N. Y.  
Telephone 427 Hempstead

### Buy from Manufacturer and Save Money

20x2 $\frac{1}{4}$ " Wheel, 6" Hub, \$4.00, with Tire \$ 6.00  
20x3" Wheel, 6" Hub, \$4.75, with Tire \$ 8.25  
20x4" Wheel, 6" Hub, \$5.50, with Tire \$23.50

FARMAN TYPE GEARS, complete - \$42.50

### AEROPLANE WHEELS

HUBS—Stock, size 6" wide, 3/8 or 1/2" Knock out Axle or bushed to fit 1" Axle—1 $\frac{1}{4}$ "—1 $\frac{1}{2}$ "—1 $\frac{3}{4}$ " or 1 $\frac{5}{8}$ " Special.

TWO AERO BOAT PONTOONS—Weight 55 lbs.—each capable of floating 800 lbs.—per pair complete \$250.

J. A. WEAVER, Jr., 132 W. 50th St., New York

Don't fail to get our prices on Wheels and Tires. We make any size.

## BALDWIN

### VULCANIZED PROOF MATERIAL

For Aeroplanes, Airships, Balloons. First Rubberized Fabric on the market. Lightest and strongest material known. Dampness, Heat and Cold have no effect. Any Strength or Color.

### "RED DEVIL" AEROPLANES

That anyone can fly. Free Demonstrations.

### HALL-SCOTT MOTORS

Eastern distributor, 40 h. p. 4-cyl.; 60 and 80 h. p., 8 cyl., on exhibition at Frank Schumacher's, 164 W. 46th Street, New York. All motors guaranteed. Immediate delivery.

### EXPERTING

Will install a Hall-Scott free of charge in anyone's Aeroplane and demonstrate by expert flyer. Expert advice. "Planes balanced."

CAPT. THOMAS S. BALDWIN

Box 78 Madison Sq. P. O., New York

## AEROPLANES

# King Edward Hotel

## IN NEW YORK

At Broadway and Long Acre Sq.

145 to 155 West 47th Street

"The Very Heart of New York." Absolutely Fireproof

350 ROOMS 250 PRIVATE BATHS

Every Modern Convenience

European Plan Exclusively

### RATES:

Single rooms, hot and cold water	-	\$1.00-1.50
" rooms, private bath	-	\$2.00-2.50-3.00
Suite, parlor, bedroom and bath	-	\$4.00-5.00
" parlor, 2 bedrooms and bath	-	\$5.00-6.00
Each additional person in same room,		\$1.00 extra
Rooms for Maids and Valets	- - -	\$1.00

**VICTOR HOTEL COMPANY, Ltd.**

C. A. HOLLINGSWORTH, President  
NEW YORK CITY

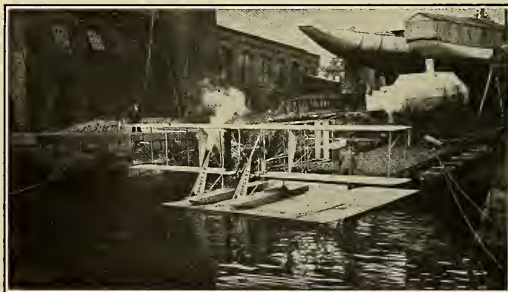

"THE PASSING OF THE YACHT"

## Burgess Flying School

Hydroaeroplanes used exclusively. You can learn without delay. The Burgess factory adjoins the flying station. Aeroplanes for exhibition, military and sporting use under construction. All leading motors used. Pupils secure not only training, but latest information concerning construction and design.

INSTRUCTOR:

PHILLIPS W. PAGE

Licensed Aviator

New Booklet just printed will give you full particulars

**THE BURGESS COMPANY & CURTIS**  
MARBLEHEAD, Box A MASSACHUSETTS

# HOTEL CUMBERLAND

NEW YORK

Broadway at 54th Street



Headquarters for Aviators and Automobilists.

*New and Fireproof*

Strictly first class.  
Rates reasonable.

**\$2.50**  
*With Bath*  
and up

Send for booklet.

Ten Minutes' Walk to Thirty  
Theatres

## H. P. STIMSON

Formerly with Hotel Imperial



# BENOIST BIPLANES

TYPE XII.

*Three Models*

*School Machine  
Cross Country Machine  
Military Machine*

Also operate the  
**Benoist School of Aviation**  
For further particulars address  
**BENOIST AIRCRAFT CO.**  
6630 Delmar Blvd., St. Louis, Mo.

# WIRE

Aviator Wire supplied in 12 sizes with a plate finish, making soldering easy. This wire is specially drawn from extra quality high grade steel. Also Aviator Cord of twisted wire.

**John A. Roeblings Sons Co.**  
TRENTON, N. J.

# C. & A. WITTEMAN

Aeronautical Engineers

Manufacturers of

BIPLANES

MONOPLANES

HYDRO-AEROPLANES

GLIDERS

PROPELLERS

PARTS

SPECIAL MACHINES AND PARTS BUILT TO SPECIFICATIONS

HALL-SCOTT MOTORS, 40-60-80 H. P.

**YOUR OPPORTUNITY**—One single covered Biplane for immediate delivery. Slightly used, with 8 cyl. 60 H. P. Hall-Scott Power Plant.

# FLYING AND TRAINING GROUNDS

Works: Ocean Terrace and Little Clove Road.

Established 1906

STATEN ISLAND, NEW YORK CITY

Tel. 717 Tompkinsville

## INVESTIGATE FIRST

Satisfy yourself you are dealing with a responsible concern before paying your money.

**WE GUARANTEE** our machines, workmanship, materials, etc., superior to those of any other constructed here or abroad regardless of price paid.

Immediate and prompt delivery on standard machines.

"Nieuport," "Bleriot," "Farman" and "Curtiss" types. Hydroplanes; speed, single, passengers, weight-carrying, or specially constructed to your own design and specifications.

"Complete with suitable power plant purchaser selects or prefers, demonstrated in flight." "Complete without power plant," or "Complete in the Knockdown." Will accept orders on specified time delivery under forfeiture.

We invite your personal inspection of the best equipped plant in the U. S. All types in course of construction. Unexcelled opportunity to acquire full shop, construction and flying course, on any type Monoplane or Biplane.

*SEEING IS BELIEVING. CALL IF POSSIBLE OR WRITE.*

## INTERNATIONAL AERONAUTIC CONSTRUCTION CO.

Factory, Hollis, L. I.  
Main Line L. I. R. R.

Office, P. O. Bldg.  
Jamaica, N. Y. City

Flying Grounds  
Nassau Boulevard

## NAIAD Aeronautical Cloth

Manufactured Especially for Aeroplanes and Used by  
Aviators of Prominence

LIGHT, STRONG, AIR-TIGHT

AND

MOISTURE-PROOF ON BOTH SIDES

Sample Books, including Data and Prices, sent on request

**THE C. E. CONOVER CO.**

101 Franklin Street - - New York

## "ROOLD"

FOR SAFETY HELMETS  
AVIATION SUITS  
UNBREAKABLE GLASS GOGGLES

*"EVERYTHING FOR THE AVIATOR"*

50 Avenue de la Grande Armee, PARIS

Official Contractors to the French and Russian Armies

# BLERIOT MONOPLANES

(GENUINE)

Winners of ALL the European Contests in 1911

In 1909—The First Aerial Crossing of the Channel.

In 1910—The "Circuit de l'Est."

In 1911—The Paris-Rome Race (1st and 2d.)

The European Circuit (1st and 2d.)

The English Circuit (Daily Mail Race.)

The Belgian Circuit.

The Saint Petersburg, Moscow Race.

The Valencia Alicante Race.

The London to Paris non-stop Raid, etc., etc.

WORKS AND OFFICES: - - 39, Route de la Révolte à Levallois - - PARIS  
and Belfast Chambers, 156 Regent St., LONDON

FRANCE

AVIATION SCHOOLS: Etampes, near Paris during Summer  
Pau, during Winter

ENGLAND

Hendon, near London

# THE CURTISS SUMMER TRAINING SCHOOL AT HAMMONDSPORT, NEW YORK



ONE OF THE CURTISS TRAINING GROUNDS

**New Hangars, New  
Equipment, Experi-  
enced Instructors.**

**Aeroplane and  
Hydroaeroplane  
Courses.**

*The Curtiss Schools are  
the largest in America.*

*Seventeen pupils obtained  
their pilots' licenses at  
our San Diego School be-  
tween January first and  
March fifteenth.*

**WRITE OR WIRE YOUR ENROLLMENT TODAY**  
*PRICES AND PARTICULARS UPON REQUEST*

*Largest  
Builders of  
Complete  
Aeroplanes  
in the world*



**ALL NATIONALITIES ARE REPRESENTED AT THE CURTISS SCHOOLS**  
(One of the Graduating Classes.)

**THE CURTISS AEROPLANE CO.**  
HAMMONDSPORT, NEW YORK

# THE KIRKHAM AVIATION MOTOR

## Again Demonstrates Superiority

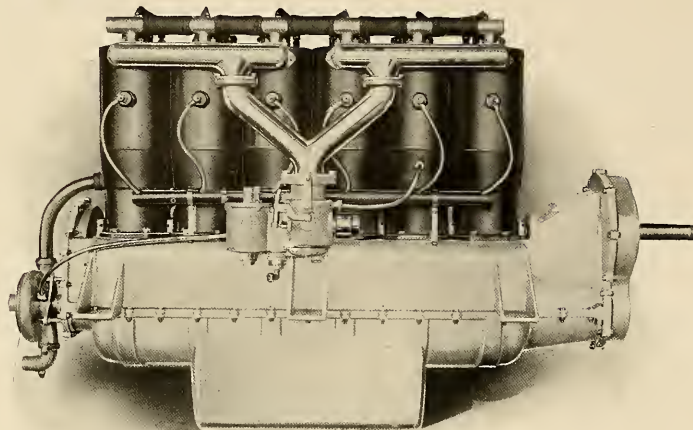

Model B-G-6 70-H. P.

KIRKHAM Aviation Motors are being used by a larger number of those flyers who are actually filling their engagements than any other American motor, and there is a reason for it. Read what Thomas Bros. say about it.

BATH, N. Y., September 17, 1912.

C. B. Kirkham,  
Savona, N. Y.

Dear Sir:—

You will doubtless be interested in hearing of the latest success we have achieved with your motor which we are using in one of our standard exhibition biplanes.

At the Aviation Meet, held at the New York State Fair, at Syracuse, N. Y., Sept. 9th to 14th, our Mr. Walter E. Johnson with one of your 65 h. p. motors made a clean sweep of the speed events, as the following official time indicates:

**Monday, Sept. 9th—10 MILE RACE.**

1st. W. E. Johnson,	65 HP. Thomas, Model 10 AX.	Time 10' 42½"
2nd. B. Havens,	75 HP. Curtiss,	Time 12' 10"
3rd. W. B. Hemstrought,	60 HP. Curtiss,	Time 14' 15½"

**Saturday, Sept. 14th—15 MILE RACE—\$1,000 Purse.**

1st. W. E. Johnson,	65 HP. Thomas, Model 10 AX.	Time 16' 11½"
2nd. C. H. Niles,	75 HP. Curtiss,	Time 16' 26½"
3rd. W. B. Hemstrought,	75 HP. Curtiss,	Time .....
4th. B. Havens,	75 HP. Curtiss,	Time .....

From the above figures you will see that our machine driven by your engine proved itself second to none.

We wish to express our complete satisfaction with the faultless manner in which the engine ran throughout the races and the regular time with which the machine ticked off each lap of the course.

It is worthy of notice that the Model 10 AX above mentioned has been in active use throughout two whole seasons making exhibition flights, and the planes were in poor condition.

**FACTS ARE TRUER THAN FICTION.**

Wishing you continued success, we are,

Yours very truly,

THOMAS BROS.,  
By O. W. Thomas.



# AIRCRAFT

Vol. 3 No. 10

DECEMBER, 1912

15 Cents a Copy



AMERICAN ENTERPRISE

The above picture shows a row of hangars at the Hempstead Plains Aviation Field, and a partial line-up of the Sloane School equipment, consisting of, from left to right, a Caudron monoplane, a passenger carrying Deperdussin, a single-seater Deperdussin, a school Blériot and a Curtiss type biplane.

# SLOANE

## OUR CALIFORNIA SCHOOL

opens on November 15th at the famous Dominquez Field near Los Angeles. This ideal location for an Aeroplane School is adjacent to splendid living accommodations; a short ride from the ocean and twenty minutes from the heart of Los Angeles. All the most attractive and romantic points of interest of this storied region are in eye-shot from an Aeroplane over our Field. We are able to secure special rates for the accommodation of our pupils at hotels and in private homes. We will gladly make all reservations.

**FOUR DEPERDUSSIN MONOPLANES; TWO CAUDRON MONOPLANES;  
ONE BLERHOT MONOPLANE AND ONE SPEEDY BIPLANE  
WILL BE OUR SCHOOL EQUIPMENT.**

W. LEONARD BONNEY, one of the pioneer American Aviators, assisted by two notable flyers will constitute the teaching faculty. We teach exactly according to the methods used on the Plains of Champaign near Rheims, France. We use the same kind of machines with which Vedrines, the Deperdussin Flyer, won the World's Championship at Chicago. We have the most perfect imported Aeroplanes, use the most perfect Field and Shop teaching methods and are located on the most ideal spot in America. Our faculty and our equipment are sufficient to handle almost any number of pupils with thoroughness and expedition. Our pupils on Long Island have become aviators of notable skill in an average of six weeks. The cost is

### \$300 FOR THE COMPLETE COURSE

The pupil in our school is not discharged from his class until he has secured his pilot's certificate. There are no extra charges for anything. The pupil is also obliged to put up a guarantee of \$250 for breakage in addition to his tuition fee. This small bond covers his use of the machine when he flies for his certificate. When the pupil is discharged from the school the \$250 guarantee is refunded and he is given a rebate of ten per cent. of his tuition fee if he completes without breakage.

*There is a great demand for real monoplane flyers. We know it because we cannot secure enough efficient aviators for our own purposes. We guarantee no person a position because we are not able to judge ability until we have seen the candidate fly. But we aid every efficient pupil to secure profitable employment. This is the time, the place and the school to secure the training that will equip you for the big work to be done next season. A monoplane won the Gordon-Bennett for France this year. A monoplane will win the Gordon-Bennett for America next year. We are going to build the Monoplane and we are looking for the champion who will drive it. Are you that man?*

We are arranging to carry passengers on a series of Aeroplane Cross-country Tours over California. Bookings are now being made.

Make your arrangements for the school and the Cross-country Tours as soon as possible. Only a limited number of persons will be accommodated in order that the work may be done right.

WIRE!

WRITE!

'PHONE!

# SLOANE AEROPLANE CO.

210 Merchants Trust Building  
Second St. & Broadway, Los Angeles, Calif.  
Phone Main 3674

1731 Broadway  
New York City  
Phone Columbus 5421

National Aeroplane Company  
606 S. Michigan Ave., Chicago, Ill.  
W. E. Boughton Washington, D. C.



Burgess-Wright equipped with Sturtevant 4-cylinder motor, as used by the U. S. Army

# Sturtevant RESULTS

## DETROIT

Wm. E. Scripps in his Burgess-Wright Hydro-Aeroplane with Sturtevant 40 H. P. motor equipped with muffler and starting crank has made flights almost daily for the past two months. On October 5th, 6th and 9th he took up thirty-one passengers.

## MARBLEHEAD

Four months of daily work in the school machine of the Burgess Company and Curtis. Still giving absolutely satisfactory service.

## WASHINGTON

At the Government Flying Grounds, the Sturtevant Motor is giving satisfactory service as attested by the following clipping from Washington Post:

Interest in the flight by Lieut. Graham was accentuated by the fact that the Burgess-Wright in which he was flying was the old Burgess-Wright which has recently been equipped at the army aviation school with a new Sturtevant engine, a make never used before. The engine behaved perfectly, and attained a speed of about 55 miles an hour, although it was not pressed by Lieut. Graham.

“Sturtevant motors are built for service. Constant, every day service, and they fulfill their mission.”

If you are looking for such a motor, ask for our catalog No. 200.

# B. F. STURTEVANT COMPANY

Hyde Park

Boston, Mass.

AND ALL PRINCIPAL CITIES OF THE WORLD

# Learn to Fly a Thomas

TUITION \$250—WRITE FOR BOOKLET

No Breakage Charged to Students

RELIABILITY SPEED ENDURANCE

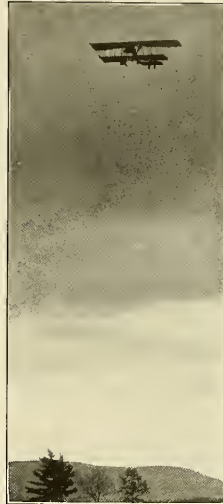

## Result of 4 Years' Experience

Walter Johnson flying his Thomas, in which he gained new American Endurance Record with passenger at Thomas School.

## Thomas Planes

Have proved that their design was correct from the

First

## Popular-Priced Machines

THOMAS BROS.  
BATH, N. Y.

# BLERIOT MONOPLANES

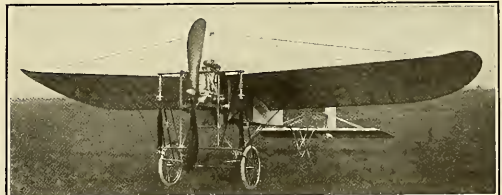

SPECIAL PRICE—Single-Seater Monoplanes, equipped with 50 H. P. Roberts Motor, as illustrated above . . . \$1,800

Tuition Free to Purchasers

## IMMEDIATE DELIVERIES

Our BLERIOT TYPE MONOPLANES are in every way suited to contest and exhibition work, including speed, altitude, distance and duration, cross-country and cross-city flying, where thorough reliable strength and high efficiency are so vitally important.

Visit our factory and examine in detail the EXCELLENT DESIGN and CONSTRUCTION of our Monoplanes

Learn to fly. We will teach you how. Tuition fee \$300. Free demonstration flights.

SPECIAL MACHINES BUILT TO ORDER  
SUBMIT DRAWINGS FOR ESTIMATE

ILLUSTRATED CATALOG FREE.

SEND FOR IT TO-DAY

# American Aeroplane Supply House

137-143 Jackson St.

Hempstead, L. I., N. Y.

Telephone 427 Hempstead

## FRONTIER MODEL A

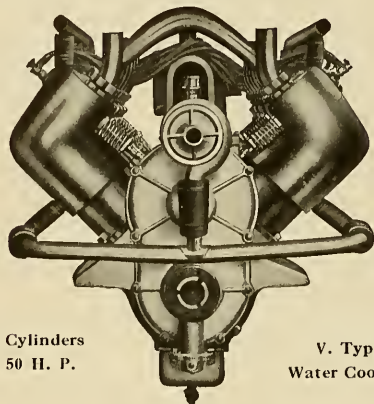

8 Cylinders  
50 H. P.

V. Type  
Water Cooled

Four and three quarter lbs. per actual Horse Power

## The Logical Aeroplane Motor

Mr. Geo. W. Beatty is now making successful flights with our motor in his Wright Machine at Hempstead field and is prepared to demonstrate same upon application.

Prospective buyers are invited to write us for appointment for flight and inspection.

Purchasers of the "FRONTIER" Motor will be refunded cost of transportation to Hempstead field within radius of 250 miles.

If you are in the market for a good motor investigate the "FRONTIER" and give us an opportunity to substantiate all we claim for it.

**Frontier Iron Works**  
BUFFALO

## Wright Hydro-Aeroplane School Now Open at GLEN HEAD, L. I.



## Wright Flyers

### 1912 MODELS

In addition to those features which in the past have made Wright Flyers famous for efficiency and reliability, the new models can be furnished with **Automatic Control, Silent Motors, and Hydroplanes.** These special features make the 1912 machine unusually attractive to sportsmen.

### EXHIBITION MACHINES

For exhibition work we have other models especially adapted to high winds and small fields. It was with a stock "EX" Model that Rodgers made his wonderful flight from coast to coast. Reliability means dollars to the exhibitor.

### WRIGHT SCHOOL OF AVIATION

Training consists of actual flying, in which the pupil is accompanied by a competent teacher. No risks and no expense whatever from breakage. The most famous flyers in America are graduates of our school and include such names as

Lieut. Arnold	Draw	Lieut. Rodgers
Atwood	Elton	Parmalee
Brookins	Lieut. Foulois	Page
Brindley	Fowler	Reynolds
Bonney	Gill	Simmons
Beatty	Lieut. Lahm	Turpin
Burgess	Lieut. Milling	Welsh
Coffyn	Mitchell	Wehster
Capt. Chandler	C. P. Rodgers	and many others.

Our Schools at Dayton and New York are now open and pupils may begin training at once if they wish. By enrolling now you can reserve date most convenient to you for training. Write for particulars.

**THE WRIGHT CO.**  
Dept. "B" DAYTON, OHIO



The above picture furnishes to some extent, an illustration of the greatest water sport produced during the history of mankind. It is as far above the ordinary motor boating or yachting as champagne is above ginger pop as a beverage.

The picture shows two of the new Curtiss flying boats and an hydro-aeroplane in the first race of the kind ever held. This race was arranged for the students and visitors at the Curtiss Aviation School at Hammondsport, New York, on the afternoon of October 28th, and it was the unanimous opinion of all present that the new and most wonderful of all aquatic sports must naturally take root in the hearts of great sportsmen until it is put into practise in every body of water throughout the entire world.

The sight of these three machines jockeying for a position, truly was inspiring and the remarkably close finish on the return trip while in the air stirred the blood of the sportsmen who witnessed the exhibition in a manner such as it is quite impossible to describe.

While the three machines were fitted with the same engine power, still the flying-boats proved superior in making the turns on the water, the rule of the contest being that the machines must round the buoy on the water and fly only between the starting and finishing points excepting the third lap which was the final.

### CONTENTS—DECEMBER, 1912

Practical Military Aviation . . . . .	Capt. J. H. Worden (Mexican Federal Army)	289
Editorials . . . . .		292
Aerial Supremacy . . . . .	Charles Faroux	294
Breaking the American Passenger-Carrying Endurance Record . . . . .	Walter E. Johnson	295
Foreign News . . . . .	R. H. Blanquie	296
German News . . . . .	Stella Bloch	296
Fourth Paris Aero Salon . . . . .	Walter H. Phipps	298
Criticism of the Nicuport Wing Curve . . . . .	David H. Wilson	302
Table of the Gordon-Bennett Balloon Race . . . . .		302
General News . . . . .		302

## AIRCRAFT

ALFRED W. LAWSON  
*President and Treasurer*  
ERNEST C. LANDGRAF  
*Secretary*

Published Monthly by The Lawson Publishing Company  
37-39 EAST 28th STREET, NEW YORK, U. S. A.  
Telephone, 5017 Madison Square

ALFRED W. LAWSON  
*Editor*  
WALTER H. PHIPPS  
*Asst. Editor*

#### TERMS TO SUBSCRIBERS

In the United States, Mexico, Puerto Rico, Guam, Philippine Islands, Hawaiian Islands, Cuba (including Postage), \$1.50 per year.  
Fifteen Cents the Copy, of All News Dealers.  
Foreign Subscriptions, Two Dollars per year.  
In changing order give old as well as new address.  
Advertising copy must be in hand by the 1st of month previous to date of publication.  
Only high-grade advertisements of thoroughly reliable firms are solicited.

#### WHEN YOUR SUBSCRIPTION EXPIRES

One month before a subscription expires we enclose a renewal blank on which you will write your order for the renewal.  
WHEN FIRST NOTICED that your subscription will expire, you should send your renewal AT ONCE, in order not to miss a number. New subscriptions which are received by us on or before the 15th of any month will begin with the issue of that month. If received after that date they will begin with the following month's issue. We cannot enter subscriptions to begin with back numbers. One month's notice is necessary before a change of address can be made.

Entered as "second-class matter" February 18, 1910, at the Post Office, at New York, N. Y., under Act of March 3, 1879.

Copyright, 1912, by the Lawson Publishing Co.

"Aircraft" is registered as a trade-mark by the U. S. Patent Office, under date of August 9th, 1910.



## MOISANT AVIATION SCHOOL

WINTER HEADQUARTERS AT

**U. S. Army Field  
Augusta, Ga.**

While our contracts with Foreign Governments may require the entrance of a considerable number of Army Officers, we have increased our facilities so as to afford ample accommodation to our regular pupils. Enrollments should, however, be made as promptly as possible.

Write for beautiful free booklet and address all communications to

**The Moisant International Aviators**

U. S. Rubber Bldg.

**Broadway and 58th St. New York**

## McDowell Rotary Motor

PATENTED

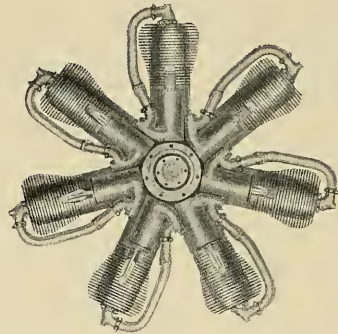

Operates on the 2-stroke principle, one exhaust port; full charge of gas pumped into head of cylinder at 15 lbs. per sq. inch. Brake test shows 1 H. P. to 5 cubic inches piston displacement at 980 R. P. M.

Made in any type motor. Each cylinder complete unit.

**Rights to manufacture motors for aeroplanes  
for sale**

**GEO. McDOWELL**

350 69th Street

Brooklyn, N. Y.

## King Edward Hotel

IN NEW YORK

At Broadway and Long Acre Sq.

145 to 155 West 47th Street

"The Very Heart of New York." Absolutely Fireproof

350 ROOMS 250 PRIVATE BATHS

Every Modern Convenience

European Plan Exclusively

### RATES:

Single rooms, hot and cold water	-	\$1.00-1.50
" rooms, private bath	- -	\$2.00-2.50-3.00
Suite, parlor, bedroom and bath	-	\$4.00-5.00
" parlor, 2 bedrooms and bath	-	\$5.00-6.00
Each additional person in same room,		\$1.00 extra
Rooms for Maids and Valets	- - -	\$1.00

**VICTOR HOTEL COMPANY, Ltd.**

C. A. HOLLINGSWORTH, President

NEW YORK CITY

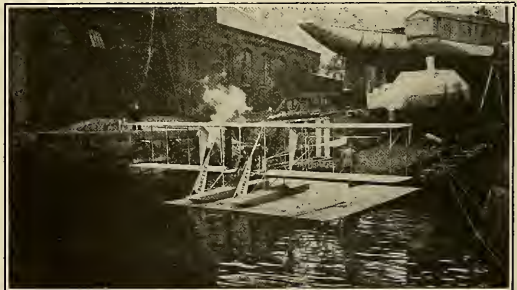

"THE PASSING OF THE YACHT"

## Burgess Flying School

Hydroaeroplanes used exclusively. You can learn without delay. The Burgess factory adjoins the flying station. Aeroplanes for exhibition, military and sporting use under construction. All leading motors used. Pupils secure not only training, but latest information concerning construction and design.

INSTRUCTOR:

**PHILLIPS W. PAGE**

Licensed Aviator

New Booklet just printed will give you full particulars

**THE BURGESS COMPANY & CURTIS**  
MARBLEHEAD, Box A MASSACHUSETTS

# AIR CRAFT

Vol. 3. No. 10

NEW YORK, DECEMBER, 1912

15 CENTS A COPY  
\$1.50 A YEAR

## PRACTICAL MILITARY AVIATION

By CAPT. J. H. WORDEN (Mexican Federal Army)

**CAPTAIN J. H. WORDEN**, of the Federal Mexican Army, enjoys the distinction of being the first and only aviator up to the present time to participate in actual warfare in the Western Hemisphere. He is a captain on the staff of General Huerta and is assigned to duty with the Division of the North with headquarters at Chihuahua. In his work he uses the Moisant military monoplanes, although he is also a biplane pilot. The Moisant machines he now uses are equipped with 50 and 100 H. P. motors, and have been in constant use by him in actual warfare during the past three months, having met with no serious accidents in the meantime. Captain Worden is a full-blooded American, being of Cherokee-Indian extraction, and was formerly a student of the Cadillo Indian school. He learned to fly at the Herriot school at Etampes, France, but his greatest experience prior to entering the Army was obtained through exhibition flying in the United States. Captain Worden has taken up aviation as a life's work, believing that no better channel exists through which both fame and fortune can be acquired by the ambitious, progressive and tenacious young man.

on the adaptability and limitations of the aeroplane in war, treating only upon the actual accomplishments and the opportunities for their use minus the spectacular features for the benefit of the press.

Here in Mexico the towns are very far apart and all railroads are single-track, the numerous rivers and deep mountain streams, though dry most of the year, are raging torrents during the rainy season, therefore requiring many bridges along the route; the rebels have made a practise of burning these bridges and destroying track along the route as shown by the accompanying photos, it only takes a few men to burn or blow up a bridge and retreat to the mountains (seldom more than a mile distant).

To station soldiers all along the road would require more than the standing army of Germany; scouts on foot or horse are impossible as every non-combatant is a rebel sympathizer by natural instinct regardless of the principles at issue, and would take every opportunity to lead troops into ambush or kill off individual

scouts. The only thing left for the government to do is just what they have done, that is, to detail a detachment of soldiers (numbering from twenty-five to one hundred and fifty) at all railroad stations and important points, to send an escort of soldiers with every train to protect the train and passengers. As the stations are at least twenty-five miles apart the officials do not know if the road has been cut till the train actually comes to the damaged point; to carry repairs and try to make repairs while enroute would be to invite the withering fire of the enemy safely concealed behind the rocks a short distance off; to try to drive them from their positions by a charge would be playing into their hands, as they always try to lead the federal soldiers into the bills so that another party can attack from the rear, leaving the train entirely at their mercy. Therefore the only course left open is for the train to make all haste back to the last station for reinforcements, provided a second bridge has not been burned in their rear, cutting them off entirely. Of course the uninitiated will ask what is the matter with the telegraph wires; but they are so cleverly handled and easily cut by the rebels that they do not enter into consideration at the place where damage has actually been done, in fact, false messages have assisted the rebels quite a little.

The above may seem to be a chronicle of Mexican troubles, and have no bearing upon aviation, but it serves as a demonstration of the practical use of the aeroplane, for what could be more simple or easy than for an aviator to start out ahead of the train and fly over the track and reconnoitre the threatened district, and if damage or danger is ahead, return and report the same in time for the train to turn back and wait for further orders. Special and a suitable number of troops could then be sent after the enemy and have a three or four hour start over the usual method, and possibly arrive in time to prevent the contemplated destruction of the road. Besides, an aerial scout would avoid a repetition of a recent catastrophe when eight hundred men were sent out to apprehend the

rebels quite a little.

The above may seem to be a chronicle of Mexican troubles, and have no bearing upon aviation, but it serves as a demonstration of the practical use of the aeroplane, for what could be more simple or easy than for an aviator to start out ahead of the train and fly over the track and reconnoitre the threatened district, and if damage or danger is ahead, return and report the same in time for the train to turn back and wait for further orders. Special and a suitable number of troops could then be sent after the enemy and have a three or four hour start over the usual method, and possibly arrive in time to prevent the contemplated destruction of the road. Besides, an aerial scout would avoid a repetition of a recent catastrophe when eight hundred men were sent out to apprehend the



The burning of this bridge five miles from camp was reported by aeroplane and repaired reached it and started work while the bridge was still in flames. La Guna, State Chihuahua, Mexico.

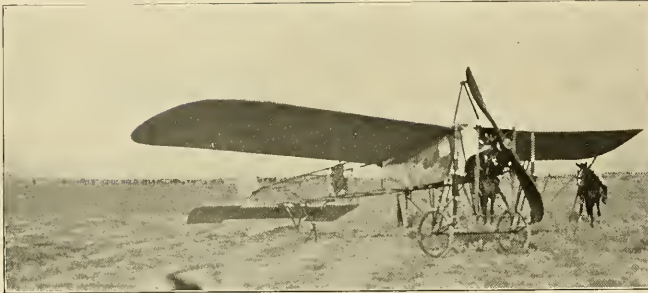

Troops in action near Torreón; Aeroplane Scout in rear waiting for orders.

rebels who had burned a big bridge, and who were afterwards found to be four in number; later two hundred men were sent on the same errand and were almost wiped out by a band of a thousand rebels, an aerial scout would have reported the strength of the enemy and this later catastrophe would have been averted and the value of the military aeroplane forever impressed upon the minds of the Mexican people. The case mentioned happened during October, on the Mexican Central Railroad at Escalon, between Chihuahua and Torreón.

A great deal of the success of the rebels here has been due to their understanding of the country and their ability to scatter when beaten and persecuted by the federals. They go in groups of two to six men, and later concentrate and reorganize at a previously arranged rendezvous. The federal soldiers being mostly from the south do not know this country and dare not break up in small bands to follow the rebels, so the best that can be expected is the capture of

five or six men, so that a federal victory and complete rout of the rebels as so often reported in the papers is of little consequence and has little effect; but if the rebels are victorious and the federals are routed it is a very serious affair and usually results in their capture and execution. Now as it is the regular tactics of the rebels to scatter when close pressed, and retreat to the hills, there to reassemble within twenty-four hours, it also serves to illustrate the value of the aeroplane, for the airscout could easily detect the general direction of the reassembling parties and anticipate the rendezvous. This information would be of inestimable value to the federal commander, for it would provide the means for breaking up the most successful, and in fact the only tactics which make a continuance of this war possible.

A recent case here (the details of which I am not at liberty to give) required six men with two cases of dynamite two miles behind the enemy's line, this would have been practically impossible without the aid of an aeroplane, but the men, unarmed and dressed in civilian clothes easily worked their way through and the sensitive cargo was delivered and the work for which it was intended was executed with every degree of success.

An aviator with a Farman biplane is reported to have been in the employ of the rebels last

grenadiers," etc., etc., but recently the opposite opinion seems to prevail and experts tell us that the size bombs or other explosives that it would be possible to carry in an aeroplane, would, when dropped, have only a local effect, and considering the inaccuracy of our aim, the value of the aeroplane for that purpose is negligible.

It is not my purpose to take issue with these experts upon a subject of which they are master and of which I know very little except in a general way; I will concede their claims relative to the physical effect of the explosives, but the effect

which they have failed to take into consideration is the moral effect upon the troops who are the object of attack. I will leave it to those who have made a special study of the subject to express the reason for the almost indescribable terror and natural instinctive fear the human animal has for dangers from which he has no protection. I speak advisedly and from experience when I say that this applies



The Moisant Army Aeroplanes and Equipment at the front. The cross indicates Capt. J. H. Worden.

to the aeroplane in war.

I believe that any officer will agree with me that at the critical moment in a battle a well directed attack upon the enemy from a unprotected side would be decisive, and certainly there is no protection from overhead. Also it might be well to remark at this time that while specially trained gunners can hit a target several miles away, an ordinary soldier put behind a big gun would be doing well to hit the side of a mountain only a mile off—the comparison obviously applies to the present bomb dropping tests.



Soldiers and camp followers escorting machine to hangar after one hour trip.



Therefore it is out of all reason to expect an aviator or even an army officer to throw bombs from an aeroplane with any degree of accuracy under present conditions. Neither aviators nor officers have ever been systematically trained for that work, and I very much doubt if any one man has ever dropped more than fifty practise bombs; and most of the trials have been in the nature of a small boy throwing stones at a bird. Give the airman a suitable mechanical device, give him the same time and training that it takes to develop an expert gunner in the navy, and the writer is of the opinion that an equal degree of efficiency will result, and then the aeroplane will have really become a dangerous destructive instrument of war from which magazines and Generals and their staffs will have to be protected.

Up to the present time many of the bomb dropping tests have been carried on by the aviator himself or by a passenger who was probably experiencing his first ride in the air. What could be more unfair than to pass judgment upon results so obtained? For the aviator to do his own bomb dropping is as practical as to expect a chauffeur, while driving at highest speed, to handle a gun which has been mounted upon his car.

One of the last points which I wish to bring out in favor of the aeroplane for military purposes is its utility as a director and observer

of artillery fire. When the artillery fire is directed upon a point directly within sight of the gunners, the aeroplane would be of very little service, but where there is a mountain intercepting the aeroplane will prove indispensable.

During the present revolution in Mexico the most decisive battle was fought at Bachimba, between Chihuahua and Torreon, the rebels were entrenched upon all the really strategic points so that the attacking federal forces were at a disadvantage, the artillery used up over one hundred thousand dollars worth of ammunition, yet at the termination of the battle there were less than three hundred men killed, and most of those were victims of close infantry fire. At first thought the reader would form the conclusion that the Mexican gunners were poor marksmen, but that is not the reason, for their average is very creditable, but in the battle in question the topography of the country made it necessary to place the artillery at a point where a view of the enemy's batteries was intercepted by a big hill upon which the in-

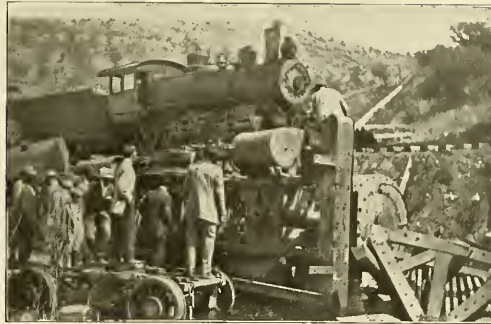

Engine turned over 50 miles from Chihuahua on North Western Railroad. First details of this accident were reported by officer transported by aeroplane.

fantry fighting took place. It is easy to understand the difficulties attending the directing of the firing and the consequent small damage done; but add to the moral effect these guns did have, the effect they would have had if the firing had been accurate, as it could have been by the aid of a well trained observer directing the fire from overhead, and the battle would have been quick, decisive, and probably final.

In writing the above opinions and experiences, I do not wish to create the impression that the aeroplane is the greatest factor in a campaign equipment,

nor that all a government has to do is to buy a few aeroplanes and engage a few exhibition flyers to handle them and then send them to the front and expect immediate results, such a course would be extremely impractical, for it would take an aviator two or three months to understand and adapt himself to military methods and have his mechanical organization perfected to an up-to-the-minute proposition so that he would be able to get out and deliver the goods without excuses.

The above mentioned organization should consist of one chief mechanic and ten soldier helpers, who would each have an assigned place in the raising or lowering of the hangar, in the assembling or dismounting of the machine, in holding the machine for a start, in transporting the machine by hand, and most important, in case of an accident each man should know just what tools he was to carry and what part of the machine he is to disconnect, all this takes time. Also it is very important to have an officer in command of the detail who is either a pilot himself or has had sufficient experience as a passenger to appreciate the limitations of our present-day machines and equipment. If other countries cannot afford to duplicate the French method of organization and equipment of their aviation division, then certainly they would do well to copy it on a basis proportionate to their available finances.

The last and probably the most important point of all which I wish to bring to your attention is the advisability of detailing officers for military aviation of an age to warrant mature judgment, and self-reliance at critical moments, men of serious purpose, not attracted by the temporary glory and publicity of being an aviator. Give a real fair trial under fair conditions, and it is the unqualified opinion of the writer that in the future the aeroplane will not only be an asset to an army, but an absolute necessity.



*Capt. J. Hector Worden  
Aviation Division Del Norte  
Mexican Federal Army.*



The fate of all prisoners on both sides and the fate especially promised to Capt. J. Hector Worden and his mechanic by the rebels, if caught, which proves that there are worse things that can happen than falling out of an aeroplane.



### WAR IN THE AIR.

**B**ECAUSE a man can fly a machine well does not necessarily mean that he has the power to forecast the future of aviation.

Recently a newspaper published the ideas of some English aviators in regard to future military service. Thomas Sopwith was quoted as saying:

"I do not want to think of fighting in the air; it means death to every man engaged. Think of going after a chap 2,000 feet in the air. When you get him you get yourself. It is all very well to sit and speculate about battles with guns and bomb throwing and all that sort of thing, but it is only a dream. All that anyone is doing is developing the aeroplane for scouting purposes, and they have a big job on hand in doing that. The aeroplane, for some time at least, is going to be nothing more nor less than the eyes of an army. It is true they are testing guns, but that is all in the experimental stage. And as matters stand the most the scouts can do is to try to keep their armies informed as to what was doing and keep out of one another's way. I am confident that the main work is the development of the aeroplane as a scout."

That is all very well, Tommy, on condition that the other fellow looks at it in the same light that you do, but what are you going to do about it if he is bent on getting rid of you and goes after you with guns? To be plain, suppose that your English army has 500 aeroplane scouts and believed as you do and did not arm, and suppose that the German who does not believe as you do arms the same number of scouts. Naturally the Germans want to give their army in the field as complete information as possible and naturally the German Army in the field does not want their tactics reported to the English Army. Don't you think that the first command to the German airscouts will be to clear the air as quickly as possible of the unarmed English airscouts? It surely would, and in order for the English airscouts to stay in the air and do any scout work at all, would lie in their capability of fighting back at their opponents, would it not? If so, why is not that a battle in the air or a skirmish or a fight or whatever you

wish to call it? And then isn't it a fact that the country which had the most efficient fighting air force would defeat and put out of existence its opponent and thereby hold the key to the whole situation? So there will be fighting in the air, Tommy, and there will be fighting just as soon as two such nations as France and Germany or Germany and England, or France and England decide to go to war.

Claude Grahame-White seemed to figure out things a little better than Sopwith. He is reported as having said:

"The first decisive battle between great powers of the future will be fought in the air. That battle will to a great extent decide the war and it will be won by the combatant that is best equipped with monoplanes and has the best corps of aviators. As to tactics, that will have to be decided by the early battles or after them. We can have all the manoeuvres that we wish, but no manoeuvres will produce the actual conditions of war; all that you might hold from now to doomsday would not.

"As I see it—and I have given the matter a great deal of thought—the aerial fleets will consist of three divisions; first, what might be called the batter type, made up of big craft which shall seek to clear the air; the second class, the smaller but infinitely faster scout machines, which will be protected by slower craft intended to keep their course clear—to act as flankers, as it were. All, I think, will be equipped with wireless.

"When the belligerents come into touch the heavier machines will probably get into action. These will carry five men—two pilots as a matter of precaution. With but one aboard there would be no one to take his place in the event of his being disabled. There will be a mechanician, two gunners and an officer in charge as observer. One of the gunners or the extra pilot or mechanician will work the wireless.

"When one or the other has sufficiently smashed the enemy to make the way reasonably safe the fast scouts will proceed to reconnoitre. These will carry but one passenger, who will act as observer and possible wireless operator, and in turn will be protected by the small lower powered machines in numbers—flocks, you might say—to keep the machines of the enemy away from the scouts, protect their courses and smother the

scouts or the big machines of the enemy should they come within range.

"The scout machines will in all probability send their reports by wireless to the cruisers or bigger machines because their wireless radius will probably be much smaller and not large enough to be highly efficient, the larger machines in turn to relay the messages to the General commanding."

That is very interesting as far as it goes, Claude, but you have forgotten apparently one of the most important features of the coming air battle, and that is the airship. A more clear and authoritative statement of what the airship can do in war could not be cited than the article "Aerial Supremacy" appearing on page 294 in this issue of AIRCRAFT. The author, Charles Faroux, is a former artillery officer of high rank in the French Army and at present is one of the most famous aeronautical technicians in France. He ranks as an authority on the subject with Eiffel and Alexander See.

The remarkable feature of M. Faroux' startling statement regarding the power of the airship in the next war, is that it almost repeats in many paragraphs, and practically confirms to a large extent, much that has been written by T. R. MacMechen for AIRCRAFT and other leading American magazines during the past three years.

AIRCRAFT is glad to be able to present M. Faroux' clear statement of the exact aerial war status of France and Germany. The fact that it gives to Germany the aerial supremacy both in airships, aeroplanes and pilots, also backs up our editorial on the subject on page 148, AIRCRAFT, July, 1912.

### GHOULS

**S**OME newspapers take fiendish delight in numbering every aviation casualty and in misinforming the public that death rides in every wind. Aviation is not a parlor pastime, but neither is it a juggernaut. In 1909 and 1910 one aviator lost his life for every 10,000 miles traveled in the air, and of the 32 fatal accidents 17 were due to imperfect construction of the machine and three to the imprudence of spectators. Only these out of 400 pilots licensed. About 8 per cent. were martyrs. In 1911, in France, there was but one death for every 100,000 miles traveled; there were 26 deaths and the licensed pilots numbered about 500 in the country. About 5 per cent. were martyrs that year. On a rough estimate we should say that more than 5,000 people have flown over 3,000-000 miles since aviation became a fact. Putting the casualties at 200, the martyrs are but 4 per cent. of the total number who have been in the air.

The public has been made to forget that Orville Wright, Glenn H. Curtiss, the Farmans, Bleriot, Cody and many other pioneers are alive, that Wilbur Wright was lost to aviation through terrestrial disease and Charles Voisin through an automobile accident. But the American press reports every

death of every aviator, experienced or amateur, and persists in considering aviation as news only as its danger is demonstrated by fatality. The public's memory of aviation has therefore become that of a sport into which one enters when bent only on death. The emphasis is wrong, vicious and destructive.

We mourn the heroes sacrificed in the conquest of the air, and we who are a part of the movement particularly have that right. We desire to see them honored as martyrs, not decried as merely foolhardy citizens. We protest against the quotidian pessimism of the press which fosters an erroneous opinion in the public mind, and, by its constant iteration of the dangers of aviation, creates a false and injurious attitude toward the whole science, art and business of aeronautics.

### PREPARE FOR 1913 HARVEST

**I**N short, simple, everyday English, we would point out to the manufacturers of all kinds of aeronautical supplies the mistaken idea they have regarding what they are pleased to term "the dead season." There is no dead season in the aeronautical industry. During the Summer months those engaged in aviation and ballooning are far too active to permit of that period being termed an "off season" for flying. And in the Fall and advent of Winter, what have we? As with the farmer who, harvesting over, collects his agricultural implements and houses them for general over-hauling and repairs during the Winter, so with the conscientious aviator. He, too, if he intends to lay up until the Spring, subjects his machines and equipment to a thorough over-hauling obtaining from the various manufacturers such parts as require to be replenished.

And where is the aviator who, after a season of successful flying does not intend to add to his stock of machines to meet with even greater success in the coming year? In such cases the ambitious flyer usually prefers to construct his own aircraft. The aviator therefore in this Winter season becomes a practical builder. He is an ambitious, progressive man, willing to spend his money to the best advantage. He becomes his own buyer, spending his own money, and a natural sequence is a personal effort on his part to get good value for money. In order to do this, he realizes that he has to make careful selection of products.

Now then, Mr. Manufacturer, here is where you can come in. The constructor desiring to get in touch with aeronautical manufacturers, naturally consults the latest advertisements of AIRCRAFT.

Without any possible shadow of doubt the Winter season is the preparatory season for a successful business year. Manufacturers should now publicly proclaim their products.

If you cease advertising you are forgotten; you are understood to be either retired or dead!

# AERIAL SUPREMACY

By CHARLES FAROUX, Formerly an Officer in the French Artillery Service, and at Present One of France's Great Aerial Technicians.

(Translated by T. R. MacMecken for Aircraft.)



HERE is the answer, impartial and courageous, to the question: "Is France supreme in the air?"

"NO, France does not actually possess the Aerial Supremacy. Only with great temerity, I dare today, to call public attention to a truth known only to a few initiated persons, a truth

which they desire to hide at any price.

"The past has taught France nothing. She has suffered sufficiently from that moral lassitude, which concealing our own weakness, has lulled the nation into treacherous security. Our ears are filled with clamor about our national enthusiasm, an enthusiasm that has only given us three millions of francs in this rich country after three months of collecting.

"The French have been told too frequently that they are, beyond dispute, the masters of the air. Frenchmen have believed it. They have believed that a great subscription was superfluous. Why has no one told them the truth? Not three, not thirty, but one hundred million francs would then have been raised. No less is needed to reconquer Germany's tremendous lead. And I will prove it.

"Let us begin with figures: The German Empire actually possesses, ready to take the air, 244 war aeroplanes. You have read correctly, two hundred and forty-four. But not that many pilots, you will object. And quickly, some one will again furnish the famous argument that the Teuton is not possessed of individual heroism. Let us look truth squarely in the face, and not play with formulas. The ranks of the German officers can count, as I write these lines, 391 diploma pilots, who when you read this will already have been increased by a half dozen units, for they do not sleep at Johannisthal.

"Thus, not only in numbers of war aeroplanes, but in pilots, Germany—taking only aviation into consideration, is our superior. I admit the value of personality, and I declare with the same strict impartiality, that our admirable military pilots are quite superior to German pilots. But is that enough to satisfy us?

"It is not from that quarter that comes the greatest danger. In the war of tomorrow, the aeroplane will play its chief part in scouting. To attempt to make it an actual, offensive weapon that is really efficient, is pure nonsense. We know that aerial war will be a naval war, simply lifted into the air.

"We have fallen into the gross error of devoting all our efforts to small units. La Fontaine's fable of the Lion and the Fly conveys its apt moral. Our people like to deceive themselves, for if the Lion had put his huge paw down, we would not have spoken again of the fly. Because we believed that the torpedo boat or the submarine would constitute a potent and effective offensive machine, we have relegated our navy to the fourth rank. Now we are frantically pouring millions, at last—into dreadnaughts. But how many years will we need to regain the place we once held?

"Yet this has happened in a nation where war's greatest genius made his dream a reality. So, it has been for nothing that Napoleon put into successful practice the method of heavy, powerful, irresistible masses—so, modern strategists abandon the former German method and return to the unfailling principles of the man who was greater than Caesar or Hannibal. Still, we have seen and understood nothing. On the day when the war gong sounds for opening the match between Lion and Fly, we will naively put our money on the insect.

"Listen to what France needs to be told, instead of being lulled with flattering phrases. Today, Germany possesses thirteen war dirigibles of formidable value. These are "aerial armorclads," equipped with enormous offensive power. They are armed with quick-firing guns of long range, placed above and on the sides of the hull, in positions that command the ground and the air.

"While we try, a few hundred feet above ground—a distance at which the vulnerability is great—while we try, I say, to project

a few timid hand grenades, the Germans, after two years of rigid training, have perfected methods of aiming from safe heights, from these aerial dreadnaughts. On Oct. 27th, 1911, the Zeppelin III, the first of the "armored cruisers of the air," also the first to be equipped with turrets, has maneuvered at 1500 meters high, during twenty hours, without a single landing.

"At a speed of 77 kilometers an hour, it ran for fourteen and a half hours along the whole French frontier: after which exploit, through a dense fog it directed itself towards Baden, and for five hours more, cruised above that city. The following day, while keeping at an altitude of 1800 meters (5,900ft.), where it is practically invulnerable, it shot to pieces, in seventeen minutes, the target, a silhouette of a village, arranged on the maneuvering ground, several kilometers out of Baden. The same methods have been equally successful at the artillery grounds at Juterbog and at the aerial school, at Metz.

"Krupp at Essen and Eberhard at Duesseldorf, have equipped the recent German aerial "armorclads" with cannon, weighing 250 kilograms (550 pounds), including their mountings which enable them to be trained in any direction. A silencer deadens the report and makes the flash invisible; the recoil is absorbed by the twenty-two tons of the terrible machine of destruction. In 140 consecutive trips, the dirigible Schwaben, recently destroyed but replaced by another, covered 20,000 kilometers and transported 2,500 passengers, without damage or accident. A load of twenty passengers can, in this new model, be replaced by artillery of a total weight of two tons of warlike equipment.

"Does any of us even know of the Schuette-Lanz? The first one launched hardly eight months ago, is 135 meters long and beside being equipped with two big cannon, and launching torpedoes of fifty pounds, is armed with ten machine rifles that allow it to repulse with ease, a sudden attack by aeroplanes. One of our most reputable military critics, who is at the same time, an officer of great value, told me recently: 'Against the German dirigibles, the aeroplane that risks itself at a distance less than 500 meters, is an aeroplane destroyed.' As to the methods of aiming, which are excellent, I refer you to certain articles that have unfortunately remained unnoticed, but which have been published in the *Artilleristische Monatshefte*. Their descriptions could not find space here, but we shall return to them in case of need.

"In addition to thirteen dirigibles belonging to the German General Staff, of which number will be increased to eighteen at the end of 1912, we have still to consider that all of the passenger Zeppelins and Parsevals are receiving or have received a subsidy from the Imperial Government, and will be placed at its disposal, in case of mobilization.

"What will France think of this preparation? We would never have known of it except by surprise and by reason of the most recent international complications. Germany, in precipitating her preparations, has revealed her superiority to attentive eyes. Let us state things as they are; in spite of her great technical advance and her great experience, France is in no way prepared for an aerial war. She has bent her efforts on the study of scouting, and blinded by easy successes, has completely neglected the fighting "armorclad." We must acknowledge that for attack and even for defense in the air, the aeroplane needs much greater capacity than the actual possibilities grant to it. Our fastest monoplane will be reduced to the part of carrying messages.

"Is it not bitter, to recall that the rigid dirigible is a French creation, because its real inventor, Maurice Spiess, was born in Alsace, before the war. Once more, we are menaced by our own weapons.

"Today the proof has been furnished. The German aerial fleet can be above Paris in four hours; and above London in eight hours. With their macarite shells, the new explosive, their cannon will

quickly rain a terrible panic on the population. The enormous dreadnaughts, cruising at great altitude, passing invulnerable above all troops and fortifications, will be able to fly for a long time above our territory.

"It is necessary to act. This admirable France, which has filled the world with astonishment and surprise by the suddenness of her resurrection, is still capable of making the same effort as that in 1896, with an artillery equipment that remains superior to that of German material.

"But it is necessary to reveal the full extent of the danger, that

we may not be answered by empty phrases. In the war of tomorrow, fifty aeroplanes, are far from being the same offensive power as a single aerial "armorclad."

What do we need? First of all, armorclads of the air, but also a far greater number of aeroplanes. Both machines are equally necessary. As far as both are concerned, Germany possesses a superiority in numbers. Let us treble, aye quadruple our army of aeroplanes, but let us build as fast as possible, thirty great aerial cruisers. It is not any longer a question of population, but of money and of will. We have the former; shall we lack in energy?

## BREAKING THE AMERICAN PASSENGER-CARRYING ENDURANCE RECORD

By WALTER E. JOHNSON

WALTER E. JOHNSON began flying with the Thomas Brothers, at Bath, N. Y., in August, 1909. From February, 1910, to the following year, he flew a low powered Thomas biplane in the summer. Also, during the following year, he flew a six-cylinder, 50 H. P. automobile motor, weighing 250 pounds. He made a number of notable flights with this machine, and, by June, 1910, secured exhibition work during the summer and fall, with a new Thomas biplane, equipped with a six-cylinder, 50 H. P. Kirkham motor. During the winter of 1911-12, Mr. Johnson instructed a number of pupils at the Thomas Aviation school. The Thomas brothers, in the meantime, had been experimenting and improving their machines. Mr. Johnson flew only in exhibition work from June until October, averaging two exhibitions each week; he made 67 flights of a possible 160—magneto trouble prevented two flights, and weather one during this time. Mr. Johnson's repair bill for the past two years, scarcely amounts to eighteen dollars; and, during the past year, he has not even so much as cracked a single strut. At the New York State Fair at which Mr. Johnson won all speed events, he proved himself an aviator of the first rank.

the top plane, which gave considerable stability and increased lift to the machine as well as aiding side balance by reason of the fact that the ailerons are attached to these over-hanging top planes and are therefore very effective.

In addition this method of using a large top plane I find has a tremendous advantage in landing as it gives the machine considerable parachute surface which comes in very handy in forced landings.

The chassis fitted to the machine was of an improved Farman-Wright type built mostly of steel tubing which made it very strong without adding materially to the weight. It is a noticeable feature that it is almost impossible to rip off the landing gear of this machine unless a very bad fall occurred. In all my experience

tremendous steering efficiency do not offer a large surface to side winds and therefore prevent the swaying tendency of the average machine today in a strong wind.

The outriggers which support the tail and rudders are of steel tubing re-enforced in the vicinity of the propeller in such a manner that should the propeller break and fly apart while in the air and the broken pieces hit the outriggers, they could do little damage outside of perhaps bending one. If wood is used for the outriggers in the event of a propeller flying apart it is very liable to go through the wood and rip the whole tail off or at any rate cut through the control wires and so cause a very serious accident. Although these outriggers have been strengthened, as mentioned, this

My desire being to break the American passenger-carrying endurance record made by George Beatty at Chicago, August 19, 1911, to which he remained aloft 3 hrs., 42 mins., 22½ secs., I decided to make the attempt on Thursday, October 31, from the field of the Thomas Aviation School at Bath, N. Y. I was successful in accomplishing what I undertook by remaining in the air 3 hrs., 51 mins., 15 secs., beating Mr. Beatty's record by 6 mins., 52½ secs.

I took along with me as passenger Arthur Blasair a mechanic of the Thomas school, who, by the way weighs 165 pounds avoirdupois. The flight was one of endurance, not only for the machine but for myself and passenger as well. A strong cold wind blew constantly throughout the entire flight and both my passenger and myself suffered intensely from cold. In fact, so cold was it, that it became necessary for us to be assisted from our seats upon landing.

The machine I used was a Thomas Headless biplane, built by the Thomas Bros. of Bath, N. Y., which contains, by the way, also constructed tractor biplanes, hydro-aeroplanes and monoplanes.

The machine is equipped with a 65 H. P. Kirkham six-cylinder motor, which did not skip an explosion during the long flight. A special tank, holding thirty gallons of gasoline, was hung from the upper plane, on the opposite side from the passenger. Entry remained to the tank after the landing to have carried us far over the four-hour mark. Two and one-half gallons of oil were used.

On the machine used no provision was made for accommodating a passenger with seat, and Blasair was forced to sit on a board, tied to the lower plane. The record was remarkable for the fact that it was made under such unfavorable weather conditions and at such a late time in the season. But for the intense cold there is no doubt but that I would have bettered the record by a full hour. I kept at a level of about 350 feet and travelled in a circle of about two miles in circumference. At no time did I throttle the motor, but travelled at full speed for the entire time, covering a distance of about 235 miles.

Shortly after beginning to fly I discovered to my dismay that I was not dressed warm enough, so I did the best I could to keep my blood in circulation by rubbing my legs and sitting on one hand and then the other. The time passed extremely slow and my watch seemed to beguile the movement to its hands.

At the end of an hour I signaled my mechanic to give the motor an additional gallon of oil he carried in a reserve tank, at his side, on the plane. The big fire which the spectators had built below appeared catalyzing with warmth and it made me hungry to see the watchers eating apples, etc. The splendid Kirkham motor was running steadily, it had not missed an explosion since we started, I thought my watch had stopped, the hands did not appear to move. The last half hour was excruciatingly tedious. When I started I expected to make it at least four hours, but nothing in the world could have kept me in the air longer arrayed in such light clothing and in such intensely cold weather.

Summing up my record flight, a great deal of the credit goes to the efficiency of the new type Thomas machine which I flew. This machine possesses the following advantages: There is a considerable distance between the two main planes which adds materially in lifting efficiency without having to use too large a lifting surface. Another feature which I found very advantageous was the over-hanging extensions to



Thomas Biplane used by Walter E. Johnson to break the American passenger-carrying endurance record.

with this machine I have never even broken a strut. The tail on the machine is of rather an unusual type and has the rudders directly connected to the elevator flap. That is to say that the rudder posts themselves act as king posts for the elevator. In place of the usual single rudder found on most machines, the Thomas biplane has four small rudders which, while giving precaution in this particular machine seems hardly necessary because the motor used was one of the latest type Kirkhams which drives a large efficient propeller at reduced speed through gear transmission from the engine crank shaft, thereby greatly lessening the danger of the propeller flying apart as it only turns at one-half the engine speed.

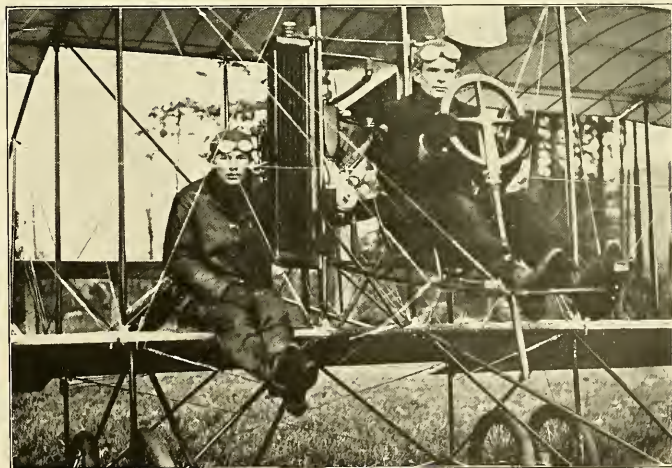

Walter E. Johnson and mechanic Arthur Blasair about to start on record flight.

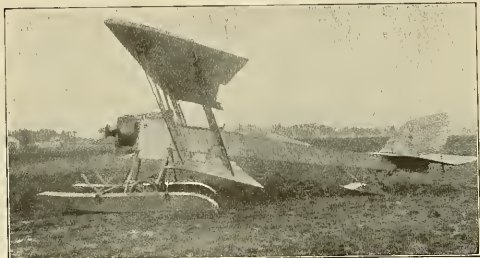

The latest Goupy Biplane, fitted with detachable floats for hydro-aeroplane work.

# FOREIGN NEWS

BY  
R. H. BLANQUIE

## Argentina

The Republic of Argentine has decided to re-organize its military aviation. The Aero Club has put at the disposition of the Minister of War and of the Navy, the grounds of the club, including seven hangars, a hydrogen plant and several scientific instruments. The pilots of the club have placed all other necessary elements as well as themselves at the disposition of the military authorities. A popular subscription fund was opened and several aeroplanes were bought.

A military aerodrome was officially inaugurated at Palermo on October 8th. Seven aeroplanes, three of which were Blériot monoplanes, took part and many successful flights were made, the President riding as a passenger.

## Austria

Captain Odolek of the Austrian Cavalry has demonstrated to a commission of military authorities, a parachute of his own invention for aeroplanes. The results were so satisfactory that the Minister of War has ordered a large number of these parachutes for the army. The parachutes are attached to the pilot's back and act automatically at the moment of danger; a pressure on the belt explodes a cartridge placed in the apparatus which causes it to open and lift the aviator from his seat, and then descend slowly towards the earth.

## Belgium

Lieut. Demaet on a Heery Farman biplane, recently left the aerodrome of Saint-Joh and although the weather was unfavorable made a voyage of 180 kilometres, passing by Anvers, Maline, Souvay, where he stopped, then to Namur, Ambloy, Namur, Circe and after a two hours' journey, he alighted near the royal castle of Augoua. H. R. H. the King, came and greeted heartily the young officer-aviator and invited him to dinner. The next morning it was the aviator's intention to leave at 5 A. M. and the King was there to see him off and helped him to refill his tank with fuel. The machine on which this voyage was accomplished was a Farman biplane, built in Belgium by the Bolckens firms of Aovers.

## Bulgaria

Before the outbreak of the war several Russian aviators placed themselves at the disposition of the Bulgarian army as well as ten Italian aviators. They all pilot French machines, Nieuport, Deperdussin and Blériot monoplanes and Farman biplanes.

An Austrian firm has received an order from the Bulgarian Minister of War for eight aeroplanes to be delivered immediately.

## Effimoff Drops Call for Surrender Into Desiged Adrianoale

The Russian Aviator Effimoff, now with the Bulgarian army, writes to his brother in Paris that the other day, when the Bulgarians thought they were on safe ground, with the enemy at some distance, he made a flight and discovered a Turkish force which he placed at 2,000 men.

He immediately returned to camp, made a report, and the Bulgarians precipitated a battle and exterminated the enemy.

Effimoff's latest flight had nearly a dramatic ending at the siege of Adrianople. He was quartered at Mustapha Pacha, thirty-five kilometres from Adrianople. He was ordered to make a reconnaissance, but the wind was up and his aeroplane was antique. He therefore was obliged to take forty minutes to cover the distance, and a high altitude was indispensable. On the trip the motor stopped, but at last by force of will and perseverance he arrived.

His mission was to throw manifestoes written in Turkish into the town, praying the population to surrender. He accomplished the task, and then suddenly discovered a multitude of soldiers firing into the air, but he was not hit. He returned to the camp when he discovered four bullet holes in the wings of his aeroplane.

## England

### Hawker Wins English Michelin Duration Flight

By a flight of eight hours, twenty-three minutes on a Sopwith-Wright machine, Mr. Harry C. Hawker, an Australian pupil of the Sopwith school, was the first place in the Michelin Duration Competition by defeating Mr. Raynham, who flew for seven hours, thirty-one and one-half minutes on the Avro enclosed biplane. The important feature of these flights is that neither of the two machines were built specially for the event, both of them being simply standard machines equipped with large gasolene tanks.

The plan of forming an aeroplane race from Great Britain to India will probably be postponed on account of the trouble which has arisen in the Balkan States. The idea of the race is being encouraged in India by several native princes. The Maharajahs of Fodhpur and Bikanni have offered two prizes of 3,000 and 4,000 rupies each. The following route has been proposed: London, Calais, Brussels, Cologne, Frankfurt, then along the Danube to Constantinople. From there to Koelch, Cilician, Aadaa, Alexandrette, Merken, following the Euphrates to Bagdad and along the Tigris to Basia. As the aeroplanes must be fitted with floats the itinerary will be continued by the Persian Gulf to Bushire and finally to Karachi. This event will represent a distance of 8,000 kilometres which is believed will take at least twelve days to accomplish.

The new dirigible "City of Cardiff" is now at Farnborough ready to fly. Its crew will be composed of naval officers and men who are now being trained at the Royal Flying School. This airship which is a little smaller in size than the "Beta" will be able to carry four passengers and will be used exclusively for naval reconnaissances. Its mean speed is of about forty miles per hour.

The new dirigible "Delta" successfully passed the reception trials on October 2, by making a speed of 64.360 kilometres per hour with seven passengers on board. This airship was completely transformed after its accident during the army manoeuvres and is now the largest English airship.

It is reported that the British Government has the intention of fitting most of its latest aeroplanes with rapid-firing guns for use not only against the enemy's troops but also against hostile aircraft.

The Motor Manufacturers and Traders Union has decided to hold an International Aeronautical Show during the month of February.

Another new airship the "Baby" passed all the necessary trials at Farnborough. It will be England's smallest dirigible and in size is half that of the "Beta" and one-tenth the size of the late "Mayfly".

James Valentine, the well known aviator who arrived there last year in the Circuit of England, proposes to accomplish by small laps the Circuit of Ireland. Following is a list of the towns in which he expects to stop at and give exhibitions during his trip: Mulligan, Cavan, Ennis-Killen, Sligo, Castlebarry, Galway, Limerick, Killarney, Cork, Waterford, Wexford and Drogheda.

A new naval station has been established at Cleethorpes by the Admiralty. This base has been created to guard the accesses to the Humber river which it commands by its position.

The Short brothers have developed a new hydro-aeroplane to the navy. It is a monoplane fitted with two 70 H. P. Gnome motors which drive independently two tractor propellers. It was tried by Commander Sampson who obtained very satisfactory results with it.

S. F. Cody, on his own biplane, won the English Michelin No. 1, which represents a sum of \$3,000, and which is awarded the English aviator on an English built aeroplane, who has succeeded before October 15th to accomplish a cross-country flight of 186 miles in the fastest time.

## France

### AEROPLANES

The committee chosen for the memorial to be erected in memory of the late Wilbur Wright recently met and chose the site at Farnobe at the intersection of the road from LeMans to Paris and the one from Anvoours to Saint-Calais.

M. Millerand, Minister of War, received on October 2, a delegation from the National Subscription Committee for Military Aviation, which came with the purpose of stating the results obtained to date. The total sum of the subscriptions received amounts to 3,223,473 franc 51 (\$644,695.10) of which 2,276,425 francs 82 (\$455,285.16) were deposited in the National Treasury. The Committee has placed the sum in the hands of the Minister of War which was intended by its donors for the purchase of eighty-nine aeroplanes.

The Minister of War in behalf of the Nation has accepted an aeroplane fitted with a 60 H. P. R. E. P. motor built and offered by Jacques Balsan, President of the A. G. Ae. of France.

In perfect harmony with the municipal authorities who will share in the 800,000 francs (\$160,000) expenses, the Minister of War has decided to establish an aviation field in the neighborhood of Orleans.

The Aero Club of France has decided with the municipal authorities of Sargatte (Pas-de-Calais) to erect a monument commemorative of the daring flights by the much lamented Hubert Latham above the English Channel.

On October 4, while competing for the Pommeroy Cup, Jaoiro on a 30 H. P. Gnome-Deperdussin monoplane left Calais at 6.20 A. M. and alighted after two stops at Coëtis-le-Bains at 5 P. M.

On November 1st "Andre Beaumont" on a Doonet-Leveque hydroaircraft flew at Beyons between a Swedish and a Danish mission. It is more than probable that the Doonet-Leveque firm will receive an important order from the Swedish government.

### DIRIGIBLES

The Astra dirigible "Adjutant Reac" on October 7th piloted by Captain Hirschauer, accomplished a two and a half hours flight above Issy, Paris, Englien, Saint-Ouen, Isle-d'Adam, Asnieres and Saint-Cloud.

The military airship "Adjutant Vicoen" of the aviation station of Touil while reconnoitering near the Eastern frontier sailed over the Rupt-de-Ménil valley and then over the Moselle valley. While flying above Arnaville, a German Zeppelin dirigible suddenly appeared on the other side of the border line which had come from the military hangar of Fresnoy near Metz. Both airships then flew for some time following one another's different manoeuvres and afterward left for their respective centers.

## German News

### BY STELLA BLOCH

Although a German firm, the Rumpler Company, had entered for the Paris Aero Salon, yet on information reaching them that a gallery stand had fallen to their lot, the managers very properly withdrew from exhibiting in Paris, as they felt that this position was hardly in keeping with the renewal of their machines. Last year both the Albatross and Aviatik companies were represented and received most favorable criticisms on all sides. It is believed that this fact had something to do with the space allotted to the Rumpler-Dove aeroplanes this time.

The Balkan hostilities have brought work in plenty for the Aviatik Company at Mulhouse, for not only did the Bulgarian War Ministry order a number of machines in October last Greece sent a war aviation unit of October for six planes, a pilot and two mechanics to be supplied for each machine. The government offered a salary of 5,000 marks per month for each pilot and 1,000 marks for the mechanics.

The South German Circuit was the event of the Aviatik month in October and went off quite success-

fully in spite of the storms and dense fogs the competitors had to struggle against. A striking feature of the circuit was the fact that the army pilots all seemed more at ease on biplanes; the first monoplane in the prize list for the military section is fourth only whilst in the civilian class Helmut Hirth's Rumpier topped the list. In fact, taking both categories as one Hirth was by far the best man present. He received the prize given by the Prince-Regent of Bavaria as well as 12,500 marks in cash, whilst his passenger, Lieut. Gravenstein, was awarded the prize of the Royal Bavarian Aero Club. Hirth's machine was his small 95 H. P. Mercedes motor, Mercedes motor, Argus motor, the Upper Rhenian Circuit and flew from Berlin to Vienna, etc. The fine work done by the Otto biplanes aroused general attention. Their quality is testified by the list of winners: Military section—1. Lieut. Vierling, 100 H. P. Otto biplane, Argus motor, passenger Lieut. Livy; 2. Lieut. Haller, 100 H. P. Otto biplane, Argus motor, passenger Lieut. Schmid; 3. Lieut. von Bietler, 85 H. P. Albatros biplane, N. A. G. motor, passenger Lieut. von Freyberg; 4. Lieut. Joly, 100 H. P. Rumpier Dove monoplane, Argus motor, passenger Lieut. Niemoeller; 5. Lieut. Reuhardt, Albatros biplane, 100 H. P. Argus motor, passenger Lieut. Mullich. Civilian section—1. Helmut Hirth, 95 H. P. Rumpier monoplane, Mercedes motor, passenger Lieut. Gravenstein, 100 H. P. Otto biplane, Argus motor, passenger Lieut. Dommel; 3. Lindpaintner, 100 H. P. Otto biplane, Argus motor, passenger Lieut. von Linsinger.

A sum of 100,000 marks has been presented privately to the German Emperor for the calling into being of a fund for the assistance of all military persons, be they officers, privates, doctors or officials, suffering injuries in connection with aerial work in service. The fund to be managed by the Emperor William Aviation Fund and the benefits accruing from it will be extended to the widows and children of military persons meeting with their death in aerial accidents or in consequence thereof.

An official report shows that the Viktoria-Luise has covered in a last year's excursions a total distance of 5,680 kilometres in 183 excursions thus giving it an average of 143 kilometres per excursion. It has carried during this period 3,902 passengers, an average of twenty-one passengers without counting its crew. Its average speed is of 56 kilometres per hour and its greatest speed 90 kilometres per hour. This aircraft has not been subject to a single mishap.

Naval authorities find themselves in delicate position toward German hydro-aeroplane constructors who have accused them of favoring an American contractor and the neglect of the home industry. The Berliner Tagblatt prints a denial from the Minister of the Navy although having recognized the fact that a Curtiss American hydro-aeroplane was bought at the close of the recent Monaco meeting. This aeroplane was transported at Putzig where it was tried and tested by officer aviators and compatriots of its inventor.

Lieut. Riley E. Scott, the American inventor of the bomb dropping device which won the "Aero Club de Michelin" held August last at Mourmelon, is to take an active part in the military contest of bomb dropping which will be held at Berlin and at Doerberitz.

Following is the final and general classing of the aviators which is part at the seven day meeting held at Johannisthal:

1. Starting event (Biplanes) 1. Rupp (Albatros) 44 meters 73; 2. Lindpaintner (Ago) 3. Briechner (Aviatik) 30 meters; 4. Stoeffler (Gorissen) 88.40 meters; 2. Krieger (Harlan).
2. Altitude (1,000 meters) Event: 1. Krieger (M. Jeanm) 14 minutes 47 seconds; 2. Bier (Mars).
3. Endurance Event: Seidlmayr (Wright) 7 hours 42 minutes; 2. Sluhns (Wright), 3. Friedrich (A. F. G.); 4. Hild (Dornier) 5. Grade (Grade).
4. Speed Event (45 kts.). 1. Schmidt (Turpedo) 7 minutes; 2. Krieger; 3. Stoeffler (U. C. U.).
5. Bomb dropping event—1. Stoeffler, 4 points; 2. Helen (Albatros) 2 points; 3. Schauenberg (A. F. G.) 2 points.
6. Altitude Event—1. Fokker (Fokker) 3,095 meters; 2. Duacetz (Harlan) 2,400 meters; 3. Stoeffler, 1,075 meters.

### Greece

At the beginning of the hostilities a Farman biplane reconnoitered the Turkish frontier before the invasion of the Grecian army. As no Turkish troops were visible within a radius of 80 kilometres the invasion was immediately decided and started.

### Italy

A Bulgarian consul recently announced that the Lieuts. Pareda Leopoldo and Amore Emidio, both attached to the Italian army, had recently volunteered to have offered their services to the Bulgarian government.

The national Committee for the benefit of military aviation has decided to spend \$400,000 of the National Subscription Fund toward a Military Trip Contest which will be held in April. Two-thirds of this sum will be reserved for the Italian constructors. The committee has also decided to order twenty-eight monoplane of the Bristol type, from local firms. In the trials the aeroplane which will have covered the determined time, height and speed, the voyage of Twino-Milano-Aviato, will be declared the winner and from its firm will be ordered seven aeroplanes of a similar type. Each competitor who will have finished the trip in a certain time will also receive an indemnity for his expenses.

The Military authorities are more than satisfied with the services rendered by the aeroplanes and dirig-

ibles during the war in Tripoli and are consequently having three new airships built in its aircraft factory at Vigna and del Valle—the "P-5," the "M-2" and the "G-1." The initials denote the size of the airship; "P" small; "M" average and "G" large. For the time being the "P-1," which has returned from Tripoli is now at Bracciano where it is experimenting daily with a new bomb, invented by Lieut. Briontempelli.

### Japan

The Japanese Government does not seem to have the least intention of remaining in the background as regards their "fourth arm" as they have recently ordered sixty aeroplanes and three dirigibles from two foreign firms.

### Madagascar

The National Aerial League of France has been informed through its delegate in this colony that the subscription opened in this country in favor of French Military Aviation amounted, to the end of August last, to 68,000 francs (\$13,600).

### Montenegro

Four Russian aviators left St. Petersburg on October 25th to enter into the service of the Montenegrin Army.

### Morocco

On October 7th, Commander Felix, the new chief of the aviation center of Casablanca, with Lieuts. Dohla and Van der Vaer, left Casablanca for Marrakech by the aerial route, on a Blériot monoplane.

### Norway

Consul General Charles A. Holder writes from Christiania that a splendid market in Norway for the sale of aeroplanes, especially hydroplanes, is overlooked by American manufacturers. Aeroplanes were introduced into Norway only six or eight months ago, when the army officials purchased two Hansa Farmy biplanes of the military type, with 70 H. P. Renault motors, and the navy officials bought a "Rumpier-Taube" with a 100 H. P. N. A. G. motor. Besides these machines a civil engineer in Christiania has purchased a "Grade" aeroplane and the Norsk Flyveselskab (Norwegian Aero Club) has bought a "Deperdussin" monoplane with 70 H. P. Gnome motor. The prices paid for these machines have not been announced. No others have been imported or sold. In the near future, it is stated, both the army and navy will be in the market for additional aeroplanes, as their value for war purposes is recognized by the department chiefs of the Norwegian army and navy. The general public also affords a splendid opportunity for the sale of aeroplanes, as their use as a sport particularly appeals to Norwegians, who are a sports-loving people, and with their "sking" are used to performing feats of balancing and flying through the air. Many people in Christiania can afford the sport of flying aeroplanes and hydroplanes; the latter much supplant, in part at least, the large number of small yachts constantly used on the harbors and fjords around Christiania.

Many yachtmen and others who devote much time to sports state that a reliable hydroplane, not too expensive, would find ready sale here if properly demonstrated. No manufacturer has as yet considered it worth while to demonstrate a machine in Christiania and the first who does so should find an excellent market. Names of members of the local aeroplane club may be obtained by addressing the secretary of the Norsk Flyveselskab, Herr Driftsbestyret Barth, Christiania Elektriske Sporvei, Christiania, Norway.

### Portugal

Poumet, on his illuminated fire-devil Borel-Gnome monoplane, gave a week's exhibition, meeting at Porto, where he astonished the natives by his daring flights above their city at night.

### Roumania

On October 7th at Bukharest, H. R. H. the King, invited Lieut de Malherbe, chief of the aviation centre

of Etampes (France) to the Army manoeuvres. During his stay he made many flights on a Blériot monoplane before military authorities.

The two Maurice Farman biplanes which were ordered by the National Committee of Aviation were successfully tried by the Marquis de Larenthy-Tholoan at Bukharest, who in fifteen days covered with these two biplanes more than 1,000 kilometres, took up thirty passengers and trained two pupils.

### Russia

The Nieuport monoplane, piloted by Lieut. Boutmy, was the first machine to finish the three most important tests during the Military trials at St. Petersburg. With a useful weight of 300 kilograms it attained a speed of 104 kilometers per hour and ascended 545 meters in less than seven minutes. The Army has adopted the Nieuport machine and will have 200 of these machines at the close of this year.

The last National Subscription Fund Committee in its report announced that up to September 12th, the total sum amounted to 96,915 roubles, 80 kopeks (about \$31,365).

Naval Lieut. Dibovsky, who has already distinguished himself by accomplishing a flight last year from Sebastopol to St. Petersburg on a Nieuport monoplane, has returned to the last named city with the intention of experimenting before a special military commission, with a new steered monoplane of his own invention.

The military trials which lasted six weeks closed on October 16. The Expert Committee, presided over by Colonel Onianov, provided that it was the results obtained by the foreign machines that were the most satisfactory. The following four aviators took part: Fokker, with a monoplane of his own construction, Ambravitch, with a Wright biplane, Bier and Erlich with a Hansa Farmy biplane, respectively. Of the Russian aviators on a Russian built aeroplane, Sikovsky obtained first place with 15 points out of 20 to his credit. The second place was captured by Amber-Volunsky on a Henry Farman biplane built by the "Dux" firm of Moscow, and the third place was won by Boutmy on a Nieuport monoplane also built in Russia.

The Minister of War has conceived a new plan for re-organizing the military aviation. It is his intention to create four aviation centres each having an escadrille of 6-8 aeroplanes, according to the importance of the centre. Each port on the Baltic Sea and the Black Sea will have 4 to 6 hydro-aeroplanes. The entire service will be placed under a general of the engineering corps.

### Servia

Two Henry Farman biplanes were received at Buc (France), by a military commission and members of the Servian legation.

### Tripoli

Lieut. Gaagha, with Lieut. Parenti as observer, performed a reconnaissance flight of 200 kilometres above Bergasi on a Breguet bi-monoplane. After exploring for one hour and a half above the oasis of Gazirias and Garasia they were suddenly surprised by a gale but managed to alight safely at their port of attack. During this flight Lieut. Parenti was able to gather much valuable information concerning the enemy's position.

### Turkey

Six lieutenants of the Turkish army left recently for their native country after having followed an aviation course at the Bristol school at Salisbury England.

The Turkish government has engaged four French aviators having their military brevets. They will receive \$1,000 per month each as salary for a minimum length of three months. Each aviator will have a mechanic who will receive \$200 per month, salary.

The first air victim of actual warfare was Nicholas Popoff, who was shot by the Turks while making a reconnaissance flight above Adrianople in the service of Bulgaria.



The Latest in Aviation. Professor Reissner flying his novel tail-first monoplane at the Johannisthal field, Germany, in a high wind. Note the peculiar planes with fins and rudders underneath.

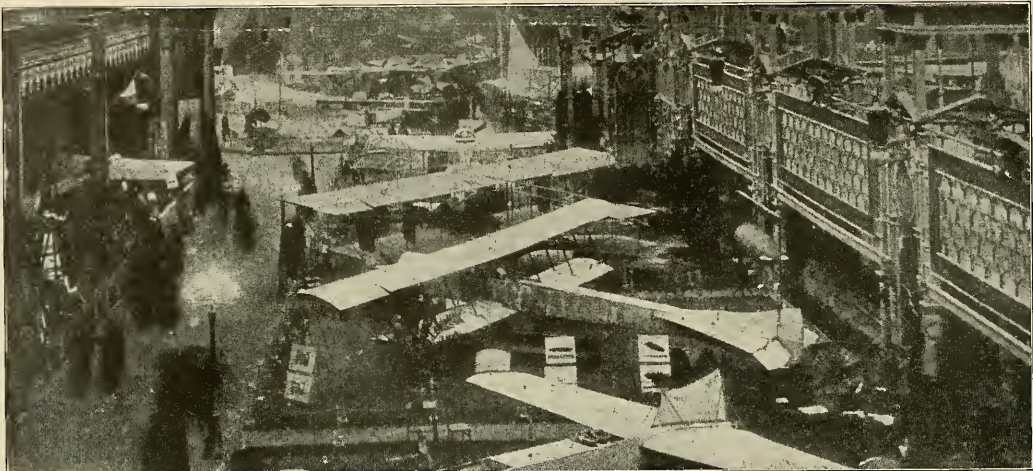

## THE FOURTH PARIS AERO SALON

By WALTER H. PHIPPS

The Fourth Paris Aero Salon was opened by M. Fallières, the President of France, accompanied by M. Millerand, Minister of War and M. Delcasse, Minister of the Marine at the Grand Palais, on October 26th.

While last year's salon drew tremendous crowds the attendance at this year's exhibit was even greater, so much so that during the evenings, it was almost impossible to get around and see all the exhibits, which numbered seventy-seven complete machines making an excess of thirty-four over those shown last year.

A noticeable feature was the marked improvement in construction and finish of the machines displayed over those of last year. The tremendous growth of the aviation industry in France was shown by the business-like manner in which the machines are turned out and the improved methods employed in their construction.

It was noticeable that metal is more and more replacing wood, in fact a large number of the aeroplanes had their frame-work almost entirely constructed of steel tubing, while practically every machine shown used considerable metal and aluminum in its construction. The covering of the wings of the modern machines has become an art in itself as much care and thought being exercised in putting on, tightening, varnishing and polishing the cloth as was formerly employed in the construction of whole machines. The landing chassis have in most cases been still further simplified and perfected, the aim being to cut down head resistance as much as possible without sacrificing good landing qualities. Fuselages have come into almost universal use, even the rear propeller blades—which are in the minority—now employ short fuselage cabins, so formed as to offer the maximum of protection to the aviator and passengers with a minimum of head resistance.

In the monoplanes and tractor biplanes the fuselages are mostly of torpedo shape and in a great many cases constructed of thin veneer wood strips and cloth glued together over forms, the whole being reinforced with a wrapping of very strong linen. In the new Bleriot, the torpedo fuselage has been built up of paper, cork and cloth, reinforced at the nose with sheet steel. In addition all the fuselages have been well padded and fitted with efficient wind and oil screens to ensure absolute comfort and the greatest possible safety for the occupants, while the engines have been fitted in the noses of the fuselages in such a manner that they are encased with as near a perfect streamline hood as possible, which at the same time allows of efficient cooling. Another point in connection with the fuselage machines has been the re-designing of the wings by cutting them away as far as possible near the body in such a manner that both aviator and passengers are afforded a perfect view of the ground under all conditions, and to still further aid the pilot and passengers' vision the very deep fuselages have been fitted with transparent inflexible celluloid windows on the sides and bottoms.

In most cases the machines shown were fitted with flat or non-lifting tails while Sommer, who still persists in using a lifting rear plane, evidently realizes its danger, for he has made provision for using it as an elevator in case of emergency, which is surely a good evidence of the fact that the constructors of the most successful machines are realizing that for the time being at any rate, the flat or non-lifting damper tail is the safest, although perhaps not the most efficient, as was pointed out by the writer in the October issue of "AIRCRAFT."

As an instance of the growing popularity of the hydro-aeroplane it was observed there were exhibited this year eleven machines of this type, seven of them biplanes and four monoplanes as against one lonesome Voisin Canard last year.

The large majority of the hydroaeroplanes consisted simply of the standard makes of aeroplanes to which auxiliary floats have been attached and not all of these have proved absolutely satisfactory. In most cases two main floats are used under the main planes with a small float in the rear. In the case of the Borel hydro-mono-plane the small rear float has been attached directly to the rear rudder and turns with it, thus greatly increasing the navigability of the machine on the water in starting and alighting and it was this seemingly small point which gave this machine such a tremendous advantage over the others at the recent Tarnise Meet and gained for it the first prize.

There were only a few examples of the flying boat type of hydro-aeroplanes shown, the Donnet-Leveque being the only tried and proven craft of this type. The Donnet-Leveque which resembles in a great many respects the latest Curtiss air-boat, carries its motor and propeller high up between the two planes the centre of thrust being two-thirds above the lower plane and for this reason the machine suffers the same draw-back that all high thrust aeroplanes encounter, viz., when the motor is running wide open, the thrust of the propeller which is above the centre of resistance, tends to force the top of the machine forward giving it a tendency to dive which is counteracted by the tail and elevator. In the event of the motor stopping suddenly the machine is relieved of this diving thrust and the tail immediately sinks and it requires quick action and skill on the part of the pilot to get his elevator flaps down quickly and force the tail up again so as to prevent stalling and tail slipping. This disadvantage could be overcome by fitting a three- or four-bladed high pitch propeller of small diameter which will allow of the motor being placed lower down between the main planes and consequently the propeller thrust will also be lowered into the position it should occupy. Of course placing the motor high up in the frame counteracts the low centre of gravity trouble of the early Donnet-Leveque's, but when the boat body is moved up a bit higher it has been done on the latest machine there should be no centre of gravity trouble caused by the lowering of the engine, especially when it is considered how stable and well the Wright machine flies, carrying all its weight of engine, pilot and passenger on the bottom plane, with blinker panels attached to overcome any swinging tendency.

Of the land machines exhibited forty-six were monoplanes, which clearly shows France's unshaken faith in the single deck type. The greatest care and thought has been expended in building up and bracing the wings of these monoplanes in such a manner as to eliminate as far as possible any more accidents due to wing wires breaking or planes bursting or collapsing. As a whole the majority of the machines have not changed much in design the improvements being chiefly confined to structural details and refinements aiding quick assembly and disassembly, which of course are more pronounced in those machines built especially for military purposes. As an example of what has been accomplished in this line there is the new Harriot-Pagny monoplane which is without doubt one of the finest pieces of aeronautical engineering work which has up to the present been constructed. This superb monoplane which is shown both in completed and

skeleton form is so designed that the complete 100 H. P. Gnome engine plant can be disassembled from the fuselage in sixty seconds, while the wings can be folded up against the side of the fuselage in five minutes without disturbing the adjustment of the main guy wires so that the machine can be transported on the road on its own wheels or in a small transport wagon in such a shape that upon arriving at its base of operation it can be gotten ready for flying in about ten minutes. In addition this machine when in flight carries a tool box which is equipped with a complete set of tools for repairing the motor and making adjustments or repairs on the machine itself, while also the box contains a full set of spare parts which it has been found are the most likely to give trouble on the motor.

The Farman biplanes of both the Maurice and Henry Farman types while not greatly changed in general appearances have been greatly improved both in construction and finish so that they now represent two of the finest examples of good, strong biplane construction extant.

The Nieuport firm since the death of Edouard Nieuport and the loss in addition of Nieuport's eldest aid, M. Pagny, who has joined the Harriot firm, have not made as much progress as they should, although they have in Mr. Henri de la Presnaye acquired a most able designer and engineer who is responsible for the latest 1913 type Nieuport shown which in refinement and general outline is a marked improvement over the 1912 type although, it is very weak and dangerous looking as regards the new landing chassis, and it is to be hoped that this landing gear is only temporary.

Louis Bleriot has evidently realized that in order to keep up with his ever growing and progressive competitors, he would have to change his regular modified cross-chained type which he has been constructing for the last three years and has produced a new monoplane with torpedo fuselage and single skid landing chassis which looks quite one of the most pleasing and business like machines at the show and should prove very speedy and efficient.

Louis Breguet has not changed his tractor biplanes with the exception of modifying the landing chassis and fitting it with four wheels in place of the usual three.

Armand Deperdussin seems to intend to build his standard machines with monocoque torpedo fuselages after the order of those fitted to his Gordon Bennett racers, for he exhibits on his stand an 80 H. P. cross-country machine of the monocoque type.

Borel, whose monoplanes while being very little heard of in the early part of this year have sprung greatly into prominence through their recent fine performance in the Tarnise Meets as well as the Pommeroy Cup event has also adopted the monocoque torpedo type fuselage on a racing machine exhibited on his stand and which has not yet been tried out.

The Caudron brothers in addition to showing an improved machine of their standard monoplane type exhibited a new hydro-bi-plane of their regular propeller in front type.

The other exhibitors, Astra, Besson, Bristol, Clement-Bayard, Goupy, Tubavion, R. E. P., Savary, Sommer, Train, Vinet, Voisin and Zodiac machines remain practically the same except for minor changes and structural details.

### LOUIS BLERIOT

Louis Bleriot exhibited three machines, one a 50 H. P. Gnome single seater, another a 70 H. P. Gnome



tandem two seater of their standard type and a new torpedo body machine which has yet to be tried. The new machine has a very racy appearance and altogether is a most pleasing design. The fuselage is of blunt torpedo design circular in section and carries the seat for the pilot and passenger in the front side by side. The construction of this fuselage is particularly interesting as it is probably the first time paper, cork and cloth have been utilized in forming the body of an aeroplane. This fuselage is built up over a frame in much the same manner as the Daperdussin body is constructed, the method being to apply layers of paper and cork glued together around a form, the whole being strengthened on the outside by a covering of tough cloth which makes a wall only six millimeters in thickness; this is very light but nevertheless affords strong enough for its purpose. The nose of the fuselage, however, is re-enforced with steel and is therefore able to carry the motor without any strain.

The landing chassis as has been stated is something altogether different from that heretofore used by Blériot and consists of a single skid and two-wheel landing device similar to the Niépport but carrying the wheels on electro-pneumatic plunger tubes instead of the single-leaf spring.

The tail is of the flat non-lifting type with floating twin elevator flaps and it is not protected by any sort of a skid, the rear extension of the central main skid serving as on the Niépport to hold the whole rear of the machine clear of the ground.

**BOREL**

Borel showed three machines, one a standard 50 H. P. single seater, a racing monocoque type with 80 H. P. Gnome and the other an 80 H. P. Gnome hydro-mono-plane of the type which gained first place at the Tamise meeting, piloted by Chenet. The single seater is of the regular standard type and needs no further description while the water machine is practically an enlarged copy of the regular land machine, fitted with two elongated steeps floats in front and the small steerable rear float already referred to. The water machine however is fitted with a starting arrangement which can be operated by the passenger.

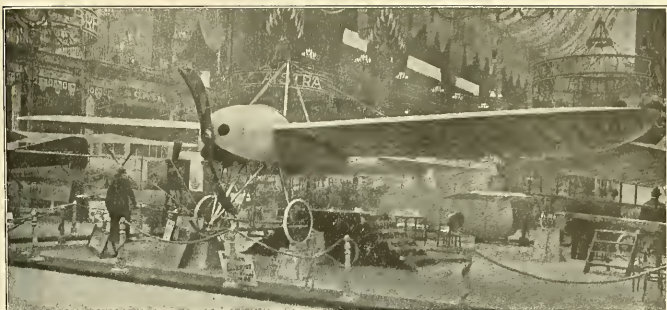

The latest Blériot Monoplane with Single Skid Landing Chassis, Torpedo Fuselage and Flat Non-Lifting Tail.

the floor and sides. The fuselage itself is of square section built up in the usual manner but has the top and bottom belted out with aluminum sheeting to give more of a streamline effect. On the top of the fuselage are two funnel-like streamline uprights which serve as top anchorages for the wings. The landing chassis consists of a double wheel and double skid arrangement which carries at its front extremities two small auxiliary wheels to protect the propeller and prevent capsizing. The wings which have to support in flight ten pounds to the square foot are of extremely strong construction and are braced underneath directly to the fuselage in front and to a small streamline pylon in the rear. The tail consists of a flat semi-

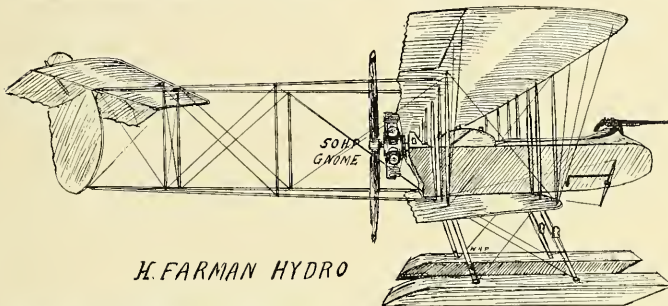

It consists of a drum mounted on a shaft and has a strap with a handle wrapped around the drum in such a manner that by pulling on the handle rotates the shaft, and turns over the motor through a short chain transmission. This device is of the type used with a release so that the drum remains stationary when the engine is running.

The new machine is a racer with monocoque fuselage built up of three-ply wood which is still further strengthened by longitudinal members inside. At its front end it carries an 80 H. P. Gnome fitted with a streamline dome.

The wings are of the racing Daperdussin type, broader at the tips than near the fuselage and have very little curvature and angle of incidence.

The chassis is of the type similar to the Daperdussin being formed of two sets of oval steel tubing arranged "V" shape. It has the further addition of two small skids.

The wings are braced in the front to this landing chassis, wires from the right hand wing running clear across to the left hand members of the chassis and vice versa, while the rear wing wires run through a small pylon underneath the fuselage. The wings on top are gaged to the dash board which is of steel construction built high in the centre to take the guy wires. The tail which is practically flat is of new style having a small stationary plane with flap elevators. A small vertical fin is placed in front of the split rear vertical rudder which is supported when on the ground by a small tail skid.

**BREGUET-R. E. P.**

On the Breguet stand was exhibited one of the latest type standard Breguet tractor biplanes and a new R. E. P. monoplane the makers of which have recently joined forces. Outside of being beautifully finished neither of these machines differs much from standard design with the exception that in the case of the Breguet a four-wheeled chassis has been substituted in place of the usual three-wheel type.

**BRISTOL**

The British and Colonial Aeroplane Company, makers of the Bristol biplanes and monoplanes, exhibited one of their latest military type monoplanes which did so well in the English Army trials at Salisbury Plain. This monoplane, which is the design of M. Coanda, a clever young engineer, is of unusual size and has a very deep fuselage with windows in

**FARMAN BROTHERS**

Henry and Maurice Farman showed two biplanes which were of excellent construction and design, one a Maurice Farman biplane of standard type but fitted with an improved passenger cabin having a transparent front, the other a Henry Farman hydro-biplane of the latest type. The hydro-biplane was shown resting on its floats in a shallow tank of water and attracted considerable attention. It is of the latest type with overhanging top planes and carries in the rear a single tail plane with twin elevator flaps and a large vertical rudder immediately between them.

The floats are of Pellier make, which are perfectly flat and very long. The engine which is only of 50 H. P. is now situated midway between the main planes, thus considerably shortening the landing struts and thereby making the machine much stronger and better suited for usage in rough seas. The passenger cabin has seats for three persons and carries at its nose a rapid firing gun which is operated by the passenger who now sits in front with the pilot behind him. As an example of the perfection already attained by hydro-aeroplanes this machine is intended to be operated at night as well as during the day and carries port and starboard beam lights as well as a tail lamp and should the necessity arise could be anchored over night in a harbor. The cabin is fitted with a fine wind shield in front and is as comfortable as an automobile. The seats are upholstered, and the floor covered with a thick carpet. The ailerons are now operated on the Curtiss principle, one up and the other down instead of on the drag flap principle used before.

**MORANE-SAULNIER**

On the Morane-Saulnier stand were to be seen three monoplanes, one fitted with an 80 H. P. Gnome, the other with a 70 H. P. Renault. The third machine was a light single-seater intended for scouting and despatch work and was fitted with a 50 H. P. Gnome. All three machines were of superb workmanship but differed in general design very little from those of last year. The 80 H. P. two-seater has the wings cut away near the body to allow of a clear vision for both pilot and passenger. The landing chassis consists of two sets of struts arranged "V" fashion having the two wheels mounted on a single axle stretched between them and fastened down with rubber shock absorbers in place of the rigid fitting employed last year. The tail used on the two double-seaters consists of two balanced elevators without any fixed stabilizing surface whatsoever, while the tail on the single-seater

circular stationary plane which carries a single elevator flap with a vertical rudder above.

**CAUDRON**

The two Caudron brothers, René and Gaston, exhibited two machines, one a Gnome driven monoplane of their regular standard type and the other a biplane fitted with combined floats and wheels. This machine is practically identical with their regular tractor biplane, differing only in that it has two floats and wheels in the front and two small tail floats in the rear. The outriggers are likewise slightly changed and now have nothing to do with the landing gear, being taken direct to the rear main beams of the biplane cellule. The two main floats which are patented by the Caudron brothers are of the single-step type and of such a construction that the landing wheels fit in slots cut in their rear in such a position that they do not offer any resistance to the water once the machine is fairly under way because as soon as the floats start to rise the wheels barely touch the water.

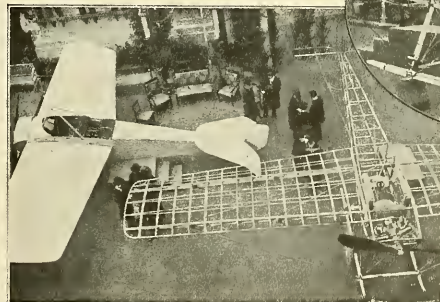

A general view of the Hanriot stand and a detailed view of the Hanriot Landing Chassis and Motor mounting.

is fitted with a flat stationary central plane and balanced elevators at each end.

The chief improvement however, has been in fitting a starting crank to the 80 H. P. Gnome in the double-seater machine so that the motor can now be turned over by the passenger in the front seat.

**NIÉPPORT**

On the Niépport stand were to be seen two machines

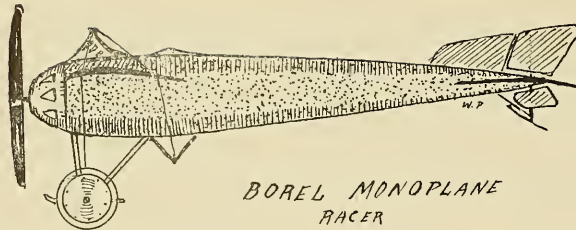

BOREL MONOPLANE  
RACER

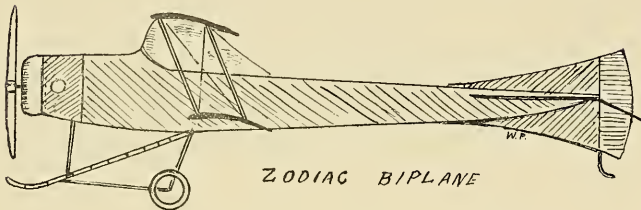

ZODIAC BIPLANE

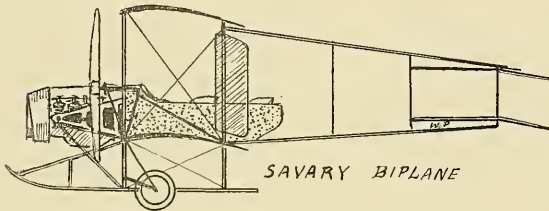

SAVARY BIPLANE

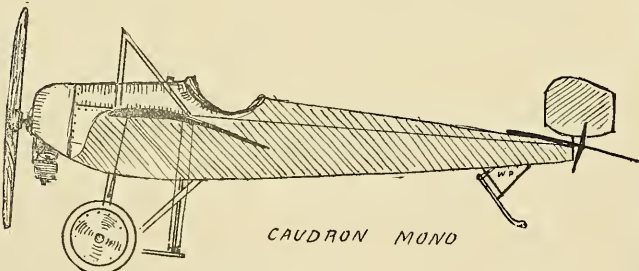

CAUDRON MONO

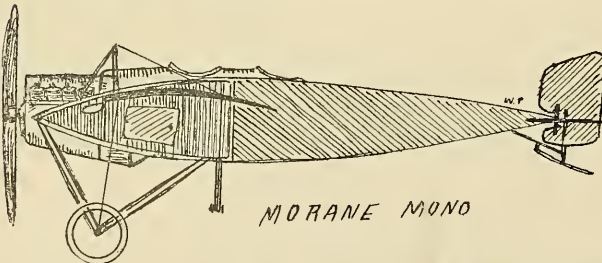

MORANE MONO

of the type which gained first place at the St. Malo meet. This machine, which is a 100 H. P. Renault engine tractor biplane, seats three people and is fitted with dual control. The main planes of the biplane cellule are built up along Wright lines and are warped for maintaining lateral balance. Fore and aft control is accomplished through elevator flaps attached to a large stabilizing rear plane. The machine is fitted in front with two large wide floats made by Tellier, the well-known French boat-builder while it carries at the rear a small tail float.

The general dimensions are as follows: supporting surface 516 square feet, span 41 feet, length 36 feet, engine 12 cylinder, 100 H. P. under-gear Renault.

#### BESSON

On the Besson stand was shown one of the novelties of the exhibit viz: a large tail first monoplane of original design, which owing to the peculiar mounting of the main plane in the rear above the fuselage and the box like structure underneath it supporting the motor earned for it the title of the "flying handsome cab." This machine has a long triangular steel tube fuselage which carries at its front end a small stationary lifting plane with slightly inverse curved elevator flaps attached to its rear edge, the whole front control arrangement resembling the inverse curve tail of the 1911 Bleriot.

The fuselage is left uncovered in the vicinity of the front rudder but is covered in at the rear to protect the pilot. The pilot sits just in front of the main plane as on the Vois-Caudron type. The landing chassis is entirely of steel, the struts used being large size oval tubing.

The general dimensions are as follows: Supporting surface 322 square feet; span, 45 feet 4 inches; length, 21 feet; engine 80 H. P. Gnome flying speed 60-62 miles an hour.

#### CLEMENT-BAYARD

On the Clement-Bayard stand were to be seen a large all steel tractor biplane and a 50 H. P. all steel monoplane. These machines attracted more than usual attention during the show as M. Guillaux the clever Clement-Bayard pilot made numerous trips over the Grand Palais in a monoplane similar to the one exhibited at the stand.

The biplane is a large military type of practically all steel tube construction. It is of the tractor type, fitted with a 14 cylinder Gnome which revolves under a cowl which is entirely separated from the fuselage by a partition designed to eliminate any possibility of the machine catching fire. As is now a common practise abroad in biplane construction, the upper plane is of greater spread than the lower one. Perhaps the chief point in the whole machine is the doing away with considerable wire bracing in the main cellule which is accomplished by using steel struts placed diagonally so that they not only support the planes but brace themselves and the whole structure itself without the use of the tremendous number of wires usually employed in the ordinary biplane.

General dimensions are: Supporting surface 538 square feet, span, upper plane 52 feet, over-all length of machine, 36 feet, engine H. P. Gnome, speed 58 miles an hour.

The Clement-Bayard monoplane in general appearance resembles the tractor biplane with the two main planes removed and monoplane wings attached to the fuselage. It has a very deep V section fuselage built up of steel tubes covered in front with canvas and in the rear with canvas. The landing gear, however, is altogether different from that used on the biplane and consists simply of two sets of struts ranged V fashion with the landing wheel attached to a single axle which is stretched across between them and strapped down by rubber shock absorbers. General dimensions are: supporting surface 172 square feet, span 30 feet, length 24 feet, engine 50 H. P. Gnome, speed 65 miles an hour.

#### D'ARTOIS

The d'Artois machines are new comers which attracted considerable attention owing to their originality. One is a biplane similar to the Breguet in the construction of the main planes, using single steel uprights and flexible struts. The fuselage which is rectangular in section comes to a sharp point in front and has a place for the operator's seat immediately in front of the main planes. The engine, a 50 H. P. Gnome, is carried behind the operator's seat in the fuselage which at this point is left uncovered. The propeller is in the rear of the fuselage behind the tail and rudder as on the Paulhan-Tatin torpille of last year and is driven from the engine direct by a long shaft. Altogether this machine is a most interesting design and its trials will be awaited with interest.

In addition to this biplane d'Artois exhibited a hydro-biplane something along the Donnet-Leveque lines but having the Breguet type main planes. The propeller is placed high up between the two planes as on the Donnet-Leveque but the engine a 50 H. P. Gnome is placed in the boat hull and drives the propeller which is four-bladed through a chain and sprocket transmission. The general dimensions of the hydro-biplanes are: Surface 280 square feet; length 25 feet; engine 50 H. P. Gnome. The general dimensions are: surface 280 square feet, spread 36 feet, length 24 feet, engine 50 H. P. Gnome, speed estimated 85 miles an hour.

#### MARSEILLAISE

The French Navy displayed a weird type of flying boat which it is stated is of Breguet-Tellier construction and while it is of absolutely original design and something quite different from anything heretofore constructed by Louis Breguet it nevertheless bears the ear marks of the famous builder's handiwork. It consists of a large central boat-shaped hull to each side of which are built auxiliary hydroplane fins.

one a military two-seater of the standard Nieuport type, the other a new single-seater racer with streamline fuselage. This machine, has a perfectly round streamline nose in place of the usual blunt front on the standard Nieuports and in addition has a new type landing gear which while essentially the same in principle as that used on last year's machines, is considerably lighter and much more dangerous owing to the

tendency of the skid tip catching and capsizing the whole machine in the event of a bad landing. The wing wires on the new machine run direct to the fuselage instead of to the landing gear as heretofore.

#### ASTRA

The Astra firm, makers of the Wright machines in France, exhibited one of their large hydro-biplanes

This hull supports at its front end a large single surface elevator immediately behind which is the monoplane main surface while at the rear is a universally jointed tail and rudder arrangement of the regular Breguet style. The body structure resembles somewhat a submarine and carries along its sides a pair of life preservers. The engine, a 120 H. P. Salmons (Capton-Union) type drives through gearing a large four-bladed tractor screw placed way out in front of the machine and inclined at a considerable angle, very much after the order of the propellers used on his early combination helicopter acroplanes.

**DRZIEWICKI**

M. Ratmanoff, the maker of the famous Normal propellers designed by M. Drzewicki, exhibited an original monoplane constructed to M. Drzewicki's design. The machine is a monoplane of the tail first type designed primarily to accomplish fore and aft automatic stability by having the front and rear planes inclined dihedrally towards one another, the front plane having considerable greater angle than the rear one. This arrangement which is found to work so well in acroplanes of the tail first type has been proved by M. Eiffel to give very good stability as well as by Mr. Andrews in this country, who has been working along similar lines and an account of whose experiments was given in the November 1912 issue of *Aircraft*.

The Drzewicki monoplane has a long rectangular fuselage, carrying at the front a single plane set at an angle and at the rear a large plane of somewhat lesser angle of incidence. The pilot and passenger sit immediately in the back of the front plane with the engine a 70 H. P. Later placed half way along the fuselage and driving through shafting a large two-bladed propeller placed at the very rear of the craft. The rudders are placed at the extreme tip of the main plane while the front plane is divided for steering both lateral and fore and aft stability.

**DOUTRE**

M. Doutré showed a Doutré biplane fitted with the Doutré stabilizer which is an arrangement for automatically securing fore and aft stability as described in Vol. 4, *"Aircraft"*, page 278. The biplane itself is of modified Farman type and is fitted with a 70 H. P. Renault motor.

**GOUPY**

The Goupy firm exhibited a hydro-biplane with staggered main planes but having a single tail plane and elevator flaps in place of the staggered biplane structure heretofore used as a tail.

The machine is of good design and looks very businesslike and from all appearances should be heard of in forth-coming hydro-acroplane meets.

**SAVARY**

M. Savary exhibited a standard double tractor biplane fitted with 70 H. P. Renault engine in front driving the two tractors through an excellent system of single chain transmission. The central skid and two castor wheels landing chassis is still retained as is the biplane tail and elevators in the rear and also the old system of blinker drag rudders at the extremity of the main planes.

**TUBAVION**

The Tubavion monoplane exhibited is simply a modification of the machine shown at last year's show. As its name implies it is constructed almost entirely of steel tubing; the main planes being made of canvas and Primard. It is an all metal monoplane, the wings and body being entirely of aluminum, in fact the only wood in the whole machine is that used in the two skids. Last year it was shown fitted with a water cooled motor mounted in the fuselage and driving a large propeller immediately behind the main plane through a sprocket and chain transmission as on the Pishoff monoplanes.

This year's machine, however, has a Gnome engine and propeller mounted on the long steel tube which forms the backbone of the whole framework. The general dimensions are 193 square feet, span 29 feet, engine 70 H. P. Gnome.

**VINET**

The Vinet firm exhibited an interesting monoplane having an underbody similar to the Train monoplane. A 50 H. P. engine is mounted immediately in front of the main plane and drives a two bladed tractor propeller direct. The gasoline tank is mounted on the top of the wings immediately behind the engine while the pilot and passengers sit below and a little to the back of the machine in the same position as on the Train monoplane. The passengers however, are well protected by the hull which has a dashboard in front and is entirely covered in all the way to the back where it carries the tail and elevator without the use of any auxiliary outriggers as generally employed on the Train, Grand and Demousselle types. The general dimensions of the Vinet machine are: supporting surface 193 square feet; spread 27 feet, length 20 feet, engine 50 H. P. Gnome and speed sixty-eight miles an hour.

**SOMMER**

Roger Sommer exhibited a biplane of the regular Sommer type the chief dimensions of which are as follows: surface 581 square feet, length 39 square feet, Engine Renault 75 H. P. and speed fifty-seven miles an hour. In addition he showed one of his standard type lifting tail monoplanes, which has now been fitted with a new safety control. In this machine an attempt has been made to overcome the danger of the lifting tail which was pointed out by the writer in the October 1912 issue of *"Aircraft"*, page 182.

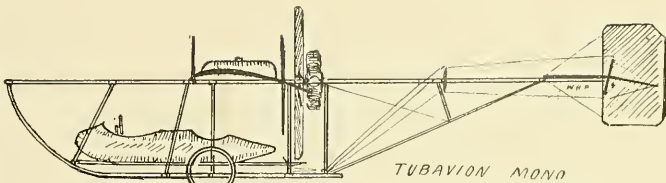

TUBAVION MONO

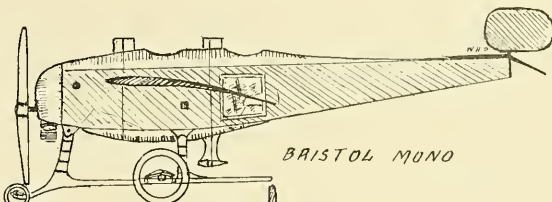

BAISTOL MONO

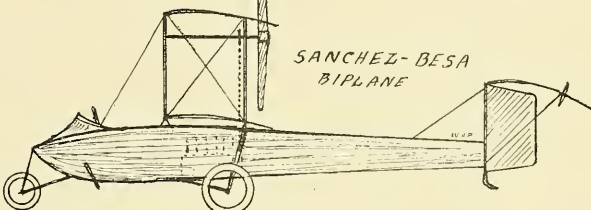

SANCHEZ-BESA BIPLANE

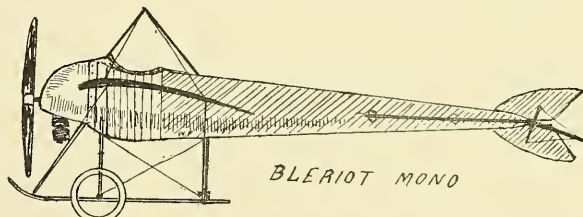

BLERIOT MONO

It is evident that Sommer has at last, since the death of his splendid pilot Kimmerring, come to realize the exact action of a lifting tail in exaggerating aid aiding a steep dive and in order to overcome this he has arranged his rear tail construction so that if the elevator flaps do not make the machine respond to its control properly the whole tail can be used as an elevator. When flying under ordinary conditions the control lever operates the flaps only but in the event of a steep dive, should the pilot find himself unable to pull the machine up again with the full movement of the elevator he can by pulling the lever still further back, change the angle of the whole tail. This movement is accomplished by the use of a special fitting which is connected to the elevator control by a steel tube. With the exception of this change in the tail and refinement of construction the Sommer monoplane remains practically unchanged from those of last year. General dimensions of the monoplane are: supporting area 172 square feet, span 27 feet, length 23 feet, engine 50 H. P. Gnome speed 66 miles an hour. It was announced that the new Sommer monoplane will be flown by René Simon and it would seem that if Simon is flying anything like he did at Belmont Park, he will need all the control he can get out of the elevators and tail combined, and perhaps a little more in addition.

**THE FRENCH GOVERNMENT'S EXHIBIT**

By way of showing the interest and importance the French Government places in aviation, the military authorities by leading their support contributed greatly to the success of this exhibition. Not only did they exhibit most of the types of machines used by the

military aviators but they also displayed a great many of the aeroplanes bought by popular subscription so that the people who helped contribute toward their purchase could see for themselves that their money had been well expended.

In addition the government had a special stand on which were displayed a group of Delahaye motor trucks with trailer wagons specially equipped for carrying large stocks of spare wings and all other necessary repair parts. There were likewise exhibited complete aeroplane transport wagons and large motor trucks fitted up with every conceivable tool necessary for building and repairing aeroplanes. In fact these trucks contained a better equipment for building and repairing aeroplanes than could be found in the complete plants of a large number of the aeroplane firms turning out machines today.

The military machines which were exhibited in the galleries made a very impressive showing and still further roused the French people's enthusiasm and patriotism. In one gallery were two Farmanes, three Moranes and three Deperdussin, one of the latter of which was presented to the government by the well known French actress, Madame Sarah Bernhardt. In another gallery were to be seen a Train, three Nieuports and a Savary. One of the Nieuports was bought by a subscription raised by one of the French newspapers, *"Le Petit Journal"*, and was christened "Captain Camine" in honor of the officer of that name who lost his life in the cause of aviation. Nearly all the machines purchased by popular subscription have been given distinctive names in most cases commemorative of some pioneer army aviator.

Other military machines shown were R. E. Ps., Haeberls, Caudros, Maurice Farmanes, Breguets Astras, etc.

# CRITICISM OF THE NIEUPORT WING CURVE

By DAVID H. WILSON

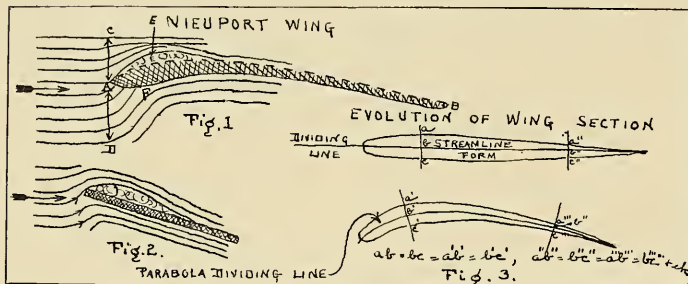

The wing section of the Nieuport monoplane has the entire stream-line curve below the dotted line A B (fig. 1.) This line represents a parabola which is the foundation on which the wing is designed. On the basis of this line all the curves of the wing section are formed.

The idea of so placing the stream-line curve is, as in the unsymmetrical covered-in fuselage of the Nieuport monoplane, to enhance the lifting effect with the aid of the head resistance of the wing itself. Aerodynamical drift is not meant. This apparently

results from the lifting effect of A F (fig. 1), and the vertical component of the air reaction impulse on F B, nullifying a part of the head resistance.

But according to Professor Montgomery with reference to an inclined plane in general, "A current of air approaching an inclined surface is deflected far in advance of the surface, and approaching it in a gradually increased curve, reaches it at a very abrupt angle." The following is due to an upward motion of the air, arising from the greater air pressure underneath the wing to the lesser pressure on top, causing

the approaching stream to rise upward. The action of the air current on a surface is clearly illustrated in Fig. 2.

In Fig. 1 the rising current is cut into two branches A D and A C, normally going in the same upward direction. But the former stream is restrained by the plane and the latter mounts up at almost its original angle which is greater than that of the top of the plane. Thereby, wasteful eddying is caused at E, decreasing the efficiency of the reaction impulse on the rear of the wing section, and thereby counterbalancing the little advantage this peculiar curve is supposed to have over the really logical form of birds' wings.

It is at once evident that at E is a splendid place to move the wing section into, a far better place than the space entirely below the fundamental parabola. But the effect of placing the entire wing section above would be to reduce the lift by the downward component that the stream-line form possesses. Therefore the one logical thing to do is to divide the intended stream-line form into two parts. The parts are applied to the fundamental parabola as indicated in Fig. 3.

I have thus shown that the proper wing section is a parabola forming the dividing line of a stream-line form made so as to receive the reaction impulse as efficiently as possible. This form of wing is approximated in modern aeroplanes, but exactly reproduced in birds, this fact being a check.

Birds in their race development tend to modify their form by producing less flesh on their bodies and wings where there is greatest pressure, and vice versa. This results in a practically non-resistant body and wings with great efficiency. Thus bird wings are of correct section.

If I have failed to make anything clear, I will gladly answer any correspondence.

## World's Distance Record Broken in 1912 Gordon Bennett Balloon Race Stuttgart, Germany, October 27th, 1912

Balloon	Country	Pilots	Time of Start	Landed	Distance (miles)
Picardie	France	Maurice Bienaine, pilot M. Rumpelmayer, aide	Oct. 27th, 4:08 P.M.	Near Moscow, Oct. 29th	1364
Honeymoon	England	Jean de Francia	Oct. 27th, 4:11 P.M.	Breslau, Germany, Oct. 28th	400
Busley	Austria	Capt. Frantz Mannsbarth	Oct. 27th, 4:15 P.M.	Near Budapest, Oct. 28th	450
Azura	Switzerland	R. O. Mueller	Oct. 27th, 4:20 P.M.	Lembachshof, L. Franconia, Oct. 28th	140
Hamburg III	Germany	F. Eimermacher	Oct. 27th, 4:25 P.M.	Germany	675
Andromeda	Italy	R. N. Sullib	Oct. 27th, 4:30 P.M.	Germany	680
Graf. Zeppelin	Denmark	Capt. Seidlin	Oct. 27th, 4:37 P.M.	Hostin, Bohemia, Oct. 28th	755
Ile de France	France	Alfred Le Blanc	Oct. 27th, 4:39 P.M.	Near Moscow, Oct. 29th	1240
Belgia II	Belgium	De Mudder	Oct. 27th, 4:43 P.M.	Russia	600
Frankfort	Austria	F. H. Lanhart	Oct. 27th, 4:45 P.M.	Rosenofskoy, Russia, Oct. 28th	755
Zurich	Switzerland	Victor de Beauclair	Oct. 27th, 4:49 P.M.	Russia	760
Reichsflugverein	Germany	Otto Korn	Oct. 27th, 4:52 P.M.	Dukchty, Russia, Oct. 28th	700
Libia	Italy	Nino Piccoli	Oct. 27th, 4:56 P.M.	Gross Gorzyn, Posen, Oct. 28th	425
Million Population Club	America	John Berry	Oct. 27th, 4:59 P.M.	Grambin, Oct. 28th	430
Bearn	France	C. Blandet	Oct. 27th, 5:03 P.M.	Russia	600
Murckelers	Belgium	F. Gerard	Oct. 27th, 5:10 P.M.	Near Riga, Russia, Oct. 28th	775
Astare	Austria	C. Von Siegmundt	Oct. 27th, 5:13 P.M.	Bielitz, Austria, Oct. 28th	350
Helvetia	Switzerland	Lient Song	Oct. 27th, 5:16 P.M.	Dantzic, Oct. 28th	533
Uncle Sam	America	H. E. Horywell	Oct. 27th, 5:21 P.M.	Past Dukchty, Russia, Oct. 29th	800
Dusseldorf II	Loaned by Germans to America	John Watts	Oct. 27th, 6:30 P.M.	Pskov, Russia	1000

## GENERAL NEWS

By D. E. BALL

### The Aeronautical Society Holds Second Successful Meet

On Election Day, November 5th, the Aeronautical Society held their second meet at the new grounds at Oakwood Heights, Staten Island, which was attended by a large and enthusiastic crowd. Five aviators took part and indulged in some fine flying which was highly appreciated by the spectators.

The afternoon's programme was opened with an exhibition of fancy flying by George Beatty in his Wright biplane, which lasted for about ten minutes. This was followed by several passenger flights by Beatty and Brown.

While Beatty was still in flight, Harry Bingham Brown ascended with a passenger for the purpose of giving a demonstration of aeroplane scouting during the course of which messages were dropped by the aid of small parachutes into the enclosure supposed to be military headquarters.

After landing, Brown took up Dillon Hoffmann, a sharp-shooter, who endeavored to shoot at small balloons which were released from the field. Brown however, was unable to manœuvre his machine into good range and very few of the balloons were hit.

After watching Brown's futile attempts at manoeuvring into range of the balloons, George W. Beatty decided to take a marksman along as his passenger and see

what they could do. Beatty was very much more successful in manipulating his machine and was able to get it within close range of the balloons with the result that his passenger shot nine out of ten.

Just before the shooting events, Cecil Peoli, who had been having difficulty in getting his 80 H. P. motor to run satisfactorily, finally managed to get it working in good order and made a short test flight. This was followed by a beautiful ascent to a height of two thousand feet at which altitude he cut off his motor and made a very steep descent to within 500 feet of the ground at which height he levelled off and sweeping over the field indulged in an exhibition of fancy flying, alighting after being up about twenty minutes.

This flight was immediately followed by Brown with a passenger who released carrier pigeons from the machine.

After Brown had landed Miss Law made her appearance and carried two ladies for trips, one of them being Miss Dorsey who drew the lucky grandstand ticket entitling her to a flight.

Further exhibition flights were made by Cecil Peoli, George Beatty, G. K. Hamilton and Miss Law. The day's flying was finished up by an altitude flight by Harry B. Brown, carrying as passenger Mrs. Isabelle Patterson, of Vancouver, B. C. in which he rose to a height of 45,000 feet before having to descend on account of darkness.

Peoli also made an attempt at this record, carrying his mother as passenger but was compelled to alight owing to the approaching darkness after rising 2,000 feet.

### Sandusky to Have Aviation Field

The Business Men's Association of Sandusky, Ohio, who own a large tract of land on the shores of Sandusky Bay immediately on the edge of the city have decided to turn a part of it into an aviation field which will be used for both land and water flying. It is intended to erect hangars in the near future and anyone interested should write to Mr. J. C. Hanser, Secretary of the Sandusky Business Men's Association. One of the first to announce his intention of locating at the field during the winter is Mr. Weldon B. Cooke the well-known California aviator.

### New Sturtevant Silent Motor Gives Good Account of Itself in Army Biplane

The four-cylinder Sturtevant motor installed in the Burgess-Wright Army biplane has been flying the machine well for some time past and is attracting considerable attention in military circles. It makes even the present day aeroplane practically ideal for scouting purposes.

### Hugh Robinson Joins Benoist

Hugh Robinson, formerly of the Curtiss Company, has bought an interest in the Benoist Aircraft Company of St. Louis, which Company is now bringing out a new type of flying boat, that will be radically different from anything on the market, as the result of the actual building and flying experience gained by Robinson and the Benoist Aviators during the past year.

The Benoist flying boat will very closely resemble the motor boat by reason of the fact that the motor and entire power plant, together with the passengers and operator, are all placed within the body of the boat itself. Exhaust of the motor will be carried out through an exhaust pipe and muffler, and motor will also be mounted within the boat in exactly the same manner as the motor boats. Propeller will be driven through sprockets and chains, and will be located in the planes in the same manner as standard aeroplane practice. The passengers will be placed behind the operator directly in the center of the planes, the same as on the regular Benoist Tractor Biplanes. The operator and passengers as well as the motor and entire power plant, will be protected from wind, water and cold by a hood, in very much the same manner as that of a racing automobile. The controlling system will be dual, allowing passengers to control machine if it is desired. The machine will have a carrying capacity by three passengers, besides the pilot, the same as the standard Benoist plane, which now holds the American record with three passengers and pilot, made at Chicago during the last International Meet, by Tony Janous.

The flying boat will have perfect manoeuvring ability on the water and a separate rudder working in the water in conjunction with the air rudder in the same manner as that of a motor boat.

The Benoist Company expects to have their first flying boat ready for trial in about two weeks, after which it will be taken to Washington for a demonstration before the representatives of the Government, who have expressed themselves as satisfied with the flying boat as the ultimate end of aviation. The Benoist flying boat will also be capable of landing on land and water. It being equipped with wheels which may be raised or lowered by operator at will, by means of a lever. This will make possible its use under any condition. The machine will be capable of carrying approximately one thousand pounds, equipped with a seventy-five horse-power motor.

### California News

Robert G. Fowler, the "coast-to-coast" aviator, has taken up the Cagle headless tractor biplane built by the Cagle-McClay Co. of Griffith Aviation Park, Los Angeles, California.

Fowler made his initial flight with the plane on October 19th, flying from the aviation park to the Cawston-Ostrich Farm in South Pasadena and return. This flight was made in thirty-one minutes but was repeated the next day when the time was lowered to 27 minutes.

The design of the machine follows closely to that of the planes manufactured by the same company for aviators Roy Francis, Phil O. Parmelee and Clifford Turpin. Being of the single tractor type. The upper plane has a spread of forty-one feet while the lower surface measures thirty feet. The five foot extensions can be readily detached thus increasing the speed of the machine. With the extensions the plane flies at a speed of sixty miles per hour.

Power is derived from a sixty horse power motor which drives a six foot propeller. The motor is equipped with an extra pump which has a capacity of about five gallons. A twenty-five gallon gasoline tank is located in the fuselage over the center of pressure. The machine is operated similar to the Farmar type with an exceptionally heavy control wiring system.

Fowler is greatly pleased with the new machine and has expressed himself as "more than satisfied with the plane's results."

### Lieut. Elyson Successfully Tests New Catapult Launching Device

A launching device invented by Captain Washington I. Chambers, chief of the Navy Aviation Corps intended for use on board battle ships, was proven a success at the Washington Navy Yard on November 12th, when Lieut. Theodore G. Elyson was launched into the air at a speed greater than forty miles an hour.

The device includes a slide thirty feet long, three feet wide and flat, mounted on a rail. A Curtiss hydro-aeroplane was placed on a little car, and then by means of a tackle arrangement worked by compressed air the aeroplane was hurled from the catapult. Although the slide was only two feet high, the aeroplane rose without touching the water, while the car dropped from the end of the slide.

"This device," said Glenn H. Curtiss, who witnessed the tests, "is the most important achievement since wheels were put on land machines. It is now possible and practicable to have the large ships of the navy equipped with aeroplanes. The catapult can be readily set upon top of a turret on board a big battleship and will not be in the way. It can be turned in any direction so that the aeroplane can be shot into the teeth of the wind."

"I have never seen anything prettier in my life than the getting away of Lieutenant Elyson. It was perfect and really undertaken under adverse conditions, for there was not a puff of air to assist the machine in rising."

"The simplicity of the catapult makes it valuable. It can be taken down and packed in a box eight feet square. On shipboard it would be very easy to furnish compressed air, and, although a small car was used, thoroughly greased rails would do just as well."

The possibilities of the aeroplane in scouting are

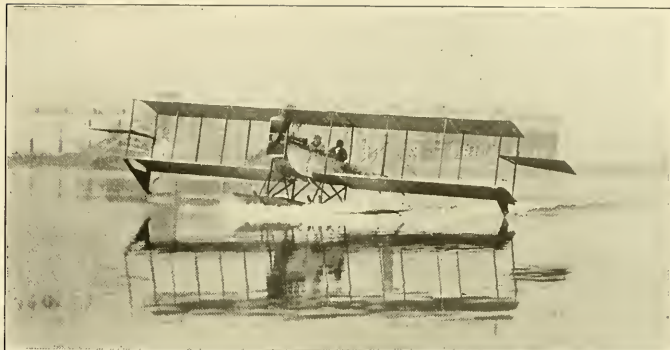

Anthony Janous starting his 1,970-mile hydro-aeroplane trip from Omaha, Neb., to New Orleans, La., on a standard 75 H. P. Benoist. At the time of going to press Janous has reached St. Louis, Mo., a distance of 771 miles from his starting point, having made stops at Nebraska City, Forest City, St. Joseph, Kansas City and Jefferson City.

unlimited, according to Captain Chambers. For instance, should the new Pennsylvania be equipped with a hydro-aeroplane it could be shot from the catapult when hundreds of miles from land. The aviator could make a circle of many miles from the ship, sighting vessels which to the war ship itself would be invisible.

Captain Chambers, who in addition to inventing this launching device has done much for aviation in America, believes that this country needs a National Aeronautic laboratory and has prepared an elaborate report to Congress on the advisability of immediately establishing one.

### Hempstead Plains

BY W. H. PHIPPS

In spite of the approaching cold weather activity at the Hempstead Field still continues, and with the exception of the departure of the Sloane aviators to California, all the others are remaining and good flying is to be seen as usual.

The chief center of interest during the month was the new Beatty-Wright type biplane which was fitted with an eight-cylinder V type Frontier motor. This very excellent machine was recently given its first trials and showed exceptional speed and lifting ability due to its splendid construction and the powerful motor. It was noticeable that Beatty flew this machine most of the time with the motor half throttled which speaks well for the efficiency of both plane and motor. With the throttle full open the speed attained was fifty-five miles an hour.

In speaking of the tests of his new machine, Beatty expressed himself as highly satisfied with the working of the Frontier motor and announced it as his intention to try to set up some new American records as soon as he had installed new chain guides on the machine.

Beatty's new machine is one of the best constructed

that has been seen on the field in some time and shows that in addition to his being a fine pilot he is also a constructor of exceptional merit. As a practical aviator Beatty realizes the exceptional strains to which aeroplanes are often subjected and for this reason has installed a complete system of double wired controls throughout the whole machine in addition to having greatly strengthened it at all vital points.

At the Moisant School, there has been considerable activity going on, instructor Jerwan being kept busy training half a dozen pupils amongst whom is a lady. The three Mexican officers, still at the school, have progressed rapidly during the last two weeks and one of them, Lieut. Horatio Ruiz, passed his license recently in exceptional style and is remaining in order to try for his expert's license before returning to his country. Lieut. Ruiz intends to fly a Moisant-Gnome from Hempstead to New York and back as his qualifying flight for his superior license.

Another pupil at the Moisant School who recently passed his license tests is Anthony Lankey of Philadelphia.

Prior to the closing of the Sloane School at Hempstead, some fine work was done by Leonard Bonney, the chief instructor, on the small Caudron monoplane and the large two-seater Deperdussin. On October 20th, Bonney was kept busy taking up passengers, amongst whom was Alfred W. Lawson, the editor of "AIRCRAFT," who expressed himself as delighted with the trip and the manner in which Bonney handled the machine. Young Guy Gilpatrick was also flying the large passenger Deperdussin during the month and carried many passengers. Miss Agnes Firth, the lady pupil has progressed well and was making straight flights on the small machine alone. Just before the removal of the school to California a new single seater Deperdussin, built in the Sloane shops, was brought to the field and given its tests which were very successful in every way and proved the American



Alfred W. Lawson about to take a spin in the air in a passenger-carrying Sloane-Deperdussin monoplane at Hempstead Plains, with Guy Gilpatrick at the wheel.

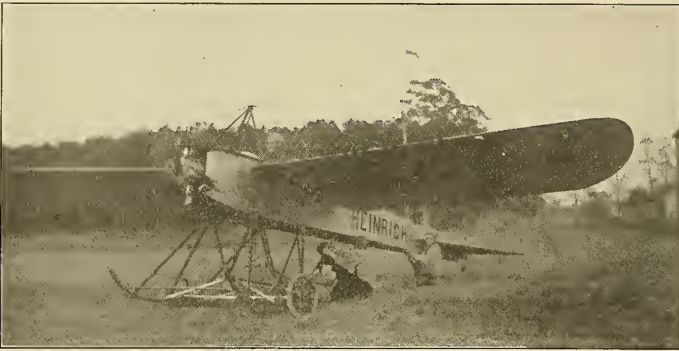

Albert Heinrich starting on a cross-country flight from his private flying grounds at Baldwin, Long Island, in a 35 H. P. Heinrich monoplane. Mr. Heinrich has made a great number of flights recently with this machine and on one occasion succeeded in carrying a passenger. Mr. Heinrich feels exceedingly enthusiastic over the performance of his machine, and hopes shortly to demonstrate superior qualities in this American-made monoplane.

built Deperdussin to be equal if not superior to the French bait machine.

Charles Baysdorfer has now joined the Sloane Company and will act as biplane instructor at the new school in California.

Frederick C. Hild of the American Aeroplane Supply House, has repaired his Bleriot type and is again out making successful flights some of which have been of over thirty minutes duration. On October 27th he made a half hour flight over part of Westbury, Hempstead and Mineola.

Progress on the Beckwith Maximotored tractor biplane has been somewhat retarded owing to the difficulty of getting special parts on order for this machine but as these have now come to hand and are being fitted, active tests are expected as we go to press.

William J. Harper, whose large fifty foot spread monoplane has attracted so much attention, completely wrecked his machine on November 5th when, in getting off the ground, his elevator control wire broke and the machine with the motor running full power climbed about forty feet and then dropped tail first to the ground, completely demolishing the rest of the machine and rolling over on its back fortunately without injuring the pilot.

#### Niles Flies 4 Hours 45 Minutes in Thomas Biplane with Kirkham Motor

On November 4th, Charles F. Niles, in a Thomas biplane equipped with a Kirkham motor flew for four hours, forty-five minutes, in an attempt to break the American duration record for aviator alone, at Bath, N. Y.

In this flight, Niles used the same machine and Kirkham motor in which Walter E. Johnson recently established a new American duration record carrying a passenger. Niles, however, was forced to land from a height of 7,000 feet on account of a burnt-out bearing and notwithstanding that and the fifty mile an hour wind which was blowing, made a pretty fair landing. Concerning his flight, Niles said, "I had to fight that wind from the time I left the ground. I was snug and warm back of the wind shield, but became tired sitting in one position. I found the aileron control and rudder system easily managed and effective, but to keep up the slightest movements, in such a wind, would wear on any man. The planes demonstrated their efficiency and I want to use the same machine in breaking the American Duration Record. I think it a case of hard luck that caused motor trouble. Very likely, a small particle of grit found its way into one of the bearings."

#### Cortlandt Field Bishop Back

Cortlandt Field Bishop, past master of the Aero Club of America and the man who really made the Club and kept it alive for several years by generously donating both time and money toward its support, and who is also a Vice-President of the International Federation Aeronautique, arrived in America on October 25th after an extended visit to Europe of several months duration.

While abroad, Mr. Bishop took an aerial voyage in the "Victoria Luise," one of the Zeppelin passenger carrying air cruisers and was enthusiastic over the remarkable manner in which the ships were handled, and the extraordinary ease with which they pass through the air between their various stations.

Mr. Bishop considers Germany the best equipped country in the world, aerially, for war purposes and feels certain that no other country could successfully combat her under present conditions.

#### Rodman Law Explodes Balloon and Descends With Parachute

On November 12th, Rodman Law made one of the most daring and spectacular parachute drops that has ever been undertaken. He ascended from the Palisades opposite Grant's Tomb, New York City in a hot air balloon to which two sticks of dynamite had been attached. When at a height of 500 feet above

the Hudson, he exploded the dynamite and blew the balloon in pieces descending safely by means of his parachute. This feat aside from its spectacular effect clearly has a practical value in aeronautics, as it heavily shows the feasibility of aeronauts being able to descend safely by means of the parachute from bursting balloons or dirigibles.

#### The Silent Sturtevant Motor

The accompanying photographs show the four-cylinder forty horse-power Sturtevant Aeronautical motor installed in a Burgess-Wright biplane and equipped with a muffler and starting crank, and the

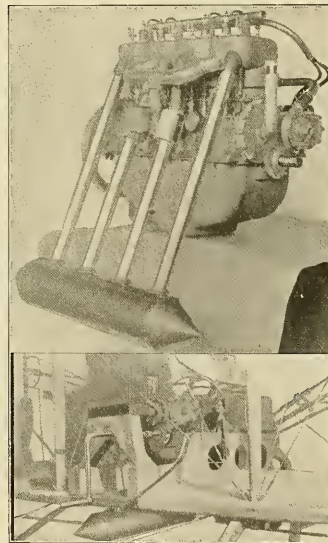

The Silent Sturtevant Motor.

motor equipped with muffler before being installed. It will be noticed that the muffler is situated beneath the lower plane, the exhaust pipes passing through the plane.

The crank is similar to the starting crank of an automobile and is arranged so that the motor may be started without the aviator leaving his seat. Sitting beside the engine, the aviator grasps the starting crank with his left hand, pushes it inward against a spring until it engages with the crank-shaft of the motor, then pulls toward him giving the motor a half turn in a clockwise direction and thus starting the motor. The motor starts with much greater ease than an automobile engine.

This Sturtevant motor, shown in the accompanying photograph is very interesting as it is the first motor to successfully fly a hydro-aeroplane when equipped with muffler and starting crank and carrying a passenger besides the aviator. This equipment is used by the Burgess Company and Curtis in their Aviation school at Marblehead, Massachusetts and is flown with a passenger practically every day.

When a four-cylinder Sturtevant motor is installed in a Wright type plane, the same size of sprockets are used as with the Wright four-cylinder motor. While the plane is stationary, the motor operates at 1390 R. P. M. and in the air it operates at nearly 1500 R. P. M. At 1400 R. P. M. the motor develops 48 H. P. on the dynamometer without the muffler, and 45 H. P. with the muffler, a reduction of only 6 per cent. in power with the muffler. The muffler completely silences the motor so that the only noise that is heard, when one is near the machine is caused by the propeller and chains. The gasoline consumption of this four-cylinder motor is four and one-half gallons per hour, while less than one-half gallon of lubricating oil is used per hour. There is provided in the motor a tank for carrying two gallons of lubricating oil which is sufficient for four hours flight and which fulfills the government specifications on oil carrying capacity. The weight of the complete power plant excluding the radiator oil, is 248 pounds.

The four-cylinder Sturtevant motor, similar to the type described above, is now being used by the Army at College Park Maryland, and another has recently been delivered to the Navy to be installed in a Wright Hydro-aeroplane.

The six-cylinder Sturtevant motor is of the same type as the four-cylinder, being fifty per cent. lighter in horsepower and in weight. The same starting crank and muffler arrangement are used with this as with the four-cylinder motor. One of these six-cylinder motors is now being installed in the new Burgess Hydro-aeroplane under construction for the Army at Marblehead, Massachusetts.

#### New England Notes

Several high school model aeroplane clubs have formed the Massachusetts Aeroplane League and will hold inter-school contests during the fall and winter months. The schools represented are Melrose, Waltham, Newton and Andover in the suburbs of Boston are being invited to join the league.

The formation of the league resulted from the activity of the Melrose club. The Melrose organization has elected as officers, Charles W. Eames, Fleet, Vice-President; and Earle Bean, Secretary and Treasurer.

Capt. Matthew A. Batson, formerly in charge of the Springfield (Mass.) army recruiting station has fitted a machine which he thinks embodies all the good points of the present ones together with several ideas of his own, which he believes will make the Batson aero-yacht the first practicable flyer ever built. He is so confident that he himself will be the pilot, though he has never been off the ground in an aeroplane.

Orders have been placed for most of the parts which will go into the first machine, and with the arrival of the news that the patents have been registered in all the foreign capitals, the secrecy which has surrounded the new craft will come to an end. F. C. Hyde, general manager of the Boston Navigation Company, who has been in Europe entering the patents in the European countries, is now back, and the first 90-foot machine is approaching completion.

The longest trip yet made by balloon from one point to another in New England ended on October 30, when Jay B. Benson of Boston and William Van Sleet of North Adams landed at Pittston, Me. They ascended from Pittsfield, Mass., at midnight in the balloon Springfield and in seven hours were almost always above the clouds and part of the journey must have been made over the ocean, for the sound of surf was heard by the aeronauts for an hour or more in the early morning. Their success would have enabled them to have continued far into the Maine woods had the direction of the wind been right. As it was the balloon penetrated about forty miles farther into Maine than has any other.

#### Burgess Notes

W. Starling Burgess arrived in Paris on October 24 to attend the French Aero Show and acquaint himself with the latest development of aeroplanes in Europe. This is a regular annual trio which has enabled Burgess to represent the last word in the universal development of the flying machine.

Lieutenants Ellyson and Cunningham of the United States Navy completed their training last month. Among the men now in training at the school is found Lieutenant L. H. Call, C. A. C. of the United States Army. Mr. Frazier Curtis of Los Angeles, Cal., and Mr. H. L. Brownback of Norristown, Pa. Lieutenants of the United States Army is expected immediately on his return from a furlough.

The special Burgess Hydro-aeroplane under construction for the War Department is about ready for final assembling. It contains many new features in detail construction, toward quickness in assembling and dissembling, accessibility of all metal parts as well as the exposure of vital members to easy inspection. Detailed description of the machine will be furnished later.

The new flying boat type with the Renault motor for the United States Navy is now in the designing room.

Orders for hydroplanes for present machines both for the Army and Navy, as well as a number of private customers are under construction in the boat department of the plant.

The Burgess Military 1912 machine has been entirely rebuilt by the United States Signal Corps and equipped with a Sturtevant motor completely modified.

The Navy has placed an order for a Sturtevant modified motor to go on their Wright machine, the installation to be done by the Burgess Company.

**Sloane Aeroplane Co.**

Arnold Kruckman, former Secretary of the Aeronautical Society, who created the Service Bureau of that organization for the purpose of safeguarding prospective pupils from fake aviation schools as one of its principal functions, has become affiliated with the Sloane Aeroplane Co., of New York, and was elected Secretary. Mr. Kruckman will be in charge of the Los Angeles activities of the Sloane Aeroplane Co.

Harry B. Wise, on the staff of the Sloane Aeroplane Co., has been appointed Superintendent of Equipment and Construction, in connection with the activities of the Company at Los Angeles. Mr. Wise is an expert aeronautical architect, engineer and motor specialist. He was for many years in charge of the activities of the Christy Motor Co. When Charles K. Hamilton began to tour the country with his aeroplane, Wise was in charge of the mechanical end. Later he was in charge of the aeroplanes and motors when the Moisant Company sent the International

Aviators on their tours around the United States and Mexico.

**Pennsylvania News**

J. B. McCalley, of the Harrisburg aviator, flew at Hagerstown, Md., on Oct. 20th. McCalley while flying at Bloomsburg, Pa., on October 20th, was forced to make a volplane by the stopping of his motor and landed on a fence.

Grover Bergdoll is flying his Wright machine at the Eagle Aviation Field, near Philadelphia every week. Bergdoll has lately purchased a hot air balloon and weekly ascensions with parachute drops are being made.

It is reported that Marshall Earle Reid, the Philadelphia aviator, has ordered an Airboat with 80 H. P. Gyro motor, to replace his Wright hydro-aeroplane which was wrecked last month while attempting the Cape May, N. J. to Philadelphia trip with a passenger.

Mr. Wilbur H. Kimball, one of the founders of the Aeronautical Society of New York, delivered a very

entertaining and instructive lecture on "Flying Machines, Past and Present," before the Aero Club of Pennsylvania at its club room in the Bellevue-Stratford, Philadelphia, November 1st.

Henry M. Neely delivered an illustrated lecture on Aviation before the Engineer's Club of Philadelphia, on November 16th. Mr. Neely spent the past summer visiting the leading aviation field and secured many excellent photographs.

**Elope in Biplane**

What is probably the first elopement by air occurred on October 26th when Art Smith, the Fort Wayne aviator, flew seventy-five miles with his fiancée, Miss Ann Cour in a Kirkham motored biplane from Fort Wayne, Indiana, to Hillsdale, Michigan, where they were married.

**Statement of the Ownership, Management, etc., of Aircraft**

Published monthly at 45th St. and Lexington P. O., required by the Act of August 24, 1912

Name of Editor—Alfred W. Lawson, Post Office address, 37 East 28th St., New York; publisher, The Lawson Publishing Company, 37 East 28th St., New York.

Owners—(If a corporation, give names and addresses of stockholders holding 1 per cent. or more of total amount of stock)—The Lawson Publishing Company, incorporated under the Laws of the State of New York.

**NAMES OF STOCKHOLDERS**

- Mrs. C. W. Crossman, New York.
- Mary E. Clement, Bala, Pa.
- Clarence A. Englad, New York.
- Edward C. Gough, Mt. Vernon, N. Y.
- Ida May Gifford, New York.
- Charles H. Heitman, Forest Park, L. I.
- Augusta S. Haviland, Forest Park, L. I.
- Alfred W. Lawson, New York.
- Bessie Sinclair, New York.
- William F. Uher, Jr., Mt. Vernon, N. Y.
- George F. Campbell Wood, Paris.

Known bondholders, mortgages, and other security holders, holding 1 per cent. or more of total amount of bonds, mortgages or other securities—NONE.

(Signed) ALFRED W. LAWSON, President.

The Lawson Publishing Company. Sworn to and subscribed before me this first day of October, 1912.

(SEAL) (Signed) ELSIE C. DUFF, Notary Public 89. Form 3526 5-6012 (My commission expires March 30, 1914.)

**== FREE ==  
Christmas Dinners**

**FOR 300 000**

**POOR PEOPLE**

**Will be supplied by The**

**Salvation Army** Throughout the United States

Will you help by sending a donation, no matter how small

**TO COMMANDER MISS B00TH**

**118 W. 14th St., New York City**  
Western States, Comm. Estll. 669 S. State St., Chicago

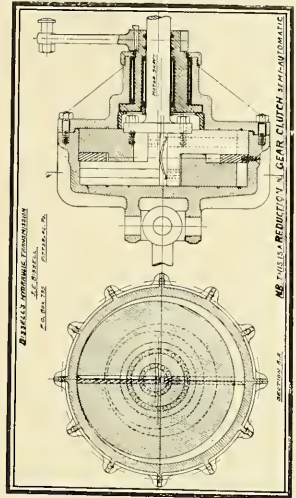

**HOTEL CUMBERLAND  
NEW YORK**

Broadway at 54th Street

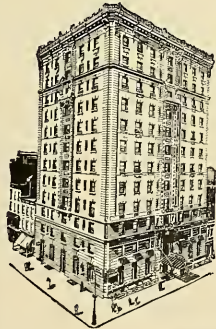

Headquarters for Aviators and Automobilists.

**New and Fireproof**

Strictly first class.  
Rates reasonable.

**\$2.50**  
**With Bath**  
and up

Send for booklet.

Ten Minutes' Walk to Thirty Theatres

**H. P. STIMSON**

Formerly with Hotel Imperial

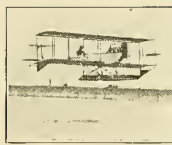

**The Benoit  
Hydro-aeroplane**

Won more prize money than any other competitor at the Chicago meet. If you had one you could do as well. Pupils trained at new Hydro Station at Creve Cover Lake.

FOR PARTICULARS ADDRESS

**BENOIST AIRCRAFT CO.,**

6630 Delmar Bl'vd

ST. LOUIS, MO.

**== WIRE ==**

Aviator Wire supplied in 12 sizes with a plate finish, making soldering easy. This wire is specially drawn from extra quality high grade steel. Also Aviator Cord of twisted wire.

**John A. Roeblings Sons Co.**

TRENTON, N. J.

# CLASSIFIED ADVERTISING

15 CENTS A LINE

SEVEN WORDS TO LINE

CASH WITH ORDER

## FOR SALE

## PATENTS BRING WEALTH;

proof—books—advice free.

Low rates, terms easy

A. Wedderburn, Pat. Atty., Washington, D. C.

**FOR SALE**—One Roberts 4x50 H. P. motor. New. Guaranteed perfect condition. Very cheap for cash. M. F. H. Gouverneur, Wilmington, North Carolina.

**CURTISS** latest improved type (Pigeon Tail) 1912 Model. Made over 300 very successful flights 1,000 ft. high, 30 miles cross-country. My construction is strongest in the world. New, complete, ready to fly, tested and guaranteed, including free lessons to buyer, \$1,500. Buy direct from Builder and Aviator of 10 years' experience. H. C. Cooke, Aviator and Builder, 127 West 64th St., New York City.

## FOR SALE

**FOR SALE**—Bleriot Monoplane without power plant in first class condition, would be a bargain at \$600.00 first check for \$400.00 takes it.

30 H. P. Detroit Aero Motor guaranteed in first class condition, \$125.00.

One 6½ ft. diameter x 4½ ft. pitch Detroit Aero Propeller, \$20.00.

One 7 ft. diameter x 5 ft. pitch Gibson propeller, \$30.00.

The above are bargains and you will have to act quickly to get them.

J. Horat, 827 Main Street, Lafayette, Ind.

**ROTARY AEROPLANE** engine, 40 H. P., 7 cylinder, weight 160 lbs. with propeller. Cheap. Landsman Motor Co., 1406 S. 18th St., St. Louis, Mo.

**FOR SALE**—Tractor biplane, 8-cylinder, 60 H. P. Motor, everything in first-class condition. Will sell separately or exchange for touring car. Apply F. Robinson, 191 Caledonia Avenue, Rochester, N. Y.

## POSITIONS WANTED

**A YOUNG MAN**, age 18, desires position as an aviator's assistant, with prospects of learning to fly. Address Louis Fenouillet, 132 West 47th St., New York City.

## MISCELLANEOUS

**WANTED**—A Curtiss type biplane. Must be cheap and in good condition. Write me what you have. George Schemerhorn, Eyota, Minn.

## AVIATORS WANTED

**AVIATOR**—Licensed aviator of the Aero Club of France, flying Bleriot and Curtiss machines; constructor of a number of Bleriot machines, wishes engagement. Two year's experience as aviator and mechanic aviator. Address Box 768 Aircraft.

## LEGAL NOTICE

I DESIRE to give notice to all persons that are using my "Patent Rudders" (Serial number 504107 U. S.), also France and England, and my "Semi-Automatic Engine Control," (Serial number 646300 U. S., France and England), that it is my intention in the future to ask a small royalty from them. Hugh L. Willoughby, Sewalls Point, Florida.



## HEINRICH

### Monoplanes and Mono-Biplanes

BUILT IN FOUR SIZES

Write for Illustrated Booklet

Make arrangements now to learn to fly at our Hydro-aeroplane School in the spring. Tuition \$250

HEINRICH PROPELLERS \$30 UP

HEINRICH BROS.

Baldwin, L. I., N. Y.

### AVIATORS—NOTICE

MAXIM ROTARY MOTORS—THE SIX-SHOOTER

Introduction Offer For a Short Time Only

Maxim Rotary Little Six	36	\$1500, for	\$750
Maxim Rotary Medium Six	50	\$1750, for	\$875
Maxim Rotary Big Six	75	\$2000, for	\$1000

Guaranteed and Demonstrated by

MAXIM ROTARY MOTOR COMPANY

379 Golden Gate Avenue San Francisco, Cal.

## COOKE BIPLANES

Curtiss Improved 1912 Type (Pigeon Tail)

Perfect flyers. No freak construction. Ten years' experience.

Strongest in the world. Ample powered (Roberts Motors.)

Anybody can fly these machines. One ready for immediate delivery \$2,500

One ready for immediate delivery complete Pope Toledo power plant guaranteed to fly \$1,500

Curtiss Type Planes, no Power Plant, \$650 and up

Free Instruction to Buyer

H. C. COOKE, 127 West 64th St. NEW YORK CITY

## BALDWIN

VULCANIZED PROOF MATERIAL

For Aeroplanes, Airships, Balloons. First Rubberized Fabric on the market.

Lightest and strongest material known. Dampness, Heat and Cold have no effect.

Any Strength or Color.

"RED DEVIL" AEROPLANES

That anyone can fly. Free Demonstrations.

HALL-SCOTT MOTORS

Eastern distributor. 40 h. p. 4-cyl.; 60 and 80 h. p., 8-cyl., on exhibition at

Frank Schumacher's, 164 W. 40th Street, New York. All motors guaranteed.

Immediate delivery.

EXPERTING

Will install a Hall-Scott free of charge in anyone's Aeroplane and demonstrate by expert flyer. Expert advice. "Planes balanced."

CAPT. THOMAS S. BALDWIN  
Box 78 Madison Sq. P. O., New York

## AEROPLANES

### Buy from Manufacturer and Save Money

20x2¼" Wheel, 6" Hub, \$4.00, with Tire \$ 6.00

20x3" Wheel, 6" Hub, \$4.75, with Tire \$ 8.25

20x4" Wheel, 6" Hub, \$5.50, with Tire \$23.50

FARMAN TYPE GEARS, complete - \$42.50

## AEROPLANE WHEELS

HUBS—Stock, size 6" wide, ¾" or 1½" Knock out Axle or bushed to fit 1" Axle—1½"—1¾"—1½" or 1½" Special.

TWO AERO BOAT PONTOONS—Weight 55 lbs.—each capable of floating 800 lbs.—per pair complete \$250.

J. A. WEAVER, Jr., 132 W. 50th St., New York

Don't fail to get our prices on Wheels and Tires. We make any size.



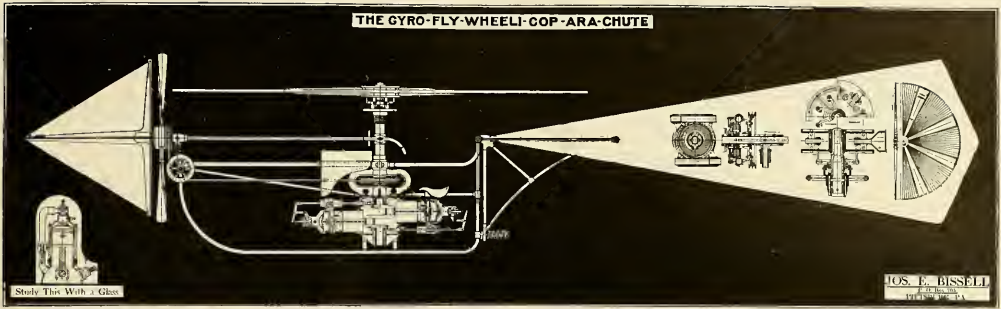

Fur **FLEW** told th' **BELLE** at parting way.  
Th' madding crowd rusht wildly o'er th' lea.  
A **BIRDMAN** "homeward" plods his weary way,  
And leaves this world for darkness and to me.

So fades th' splintering "**STIFF**" wing on th' sight,  
"Tho' all th' air a solemn stillness holds—  
He should have had a **HELI-COP**—that's **RIGHT?**—  
And lowsy tinklings lulled th' distant folds.

## CHICAGO AERO WORKS

H. S. RENTON 164 North Wabash Avenue  
Proprietor  
**AEROPLANES** ACCESSORIES MOTORS PARTS  
WHEELS ALSO MODELS and MODEL STOCK  
ESTABLISHED 1909. First in Chicago and the Middle West  
Aviators Taught. Flights Furnished. Send Stamp for Catalog.

## Aeronautical Supplies

Everything to Build Any Type Flying Machine  
New catalogue with working drawings of Curtiss, Farman and Blériot type machines, now ready for distribution and will be mailed free upon request to all interested parties. Write for quotations.  
**E. J. WILLIS CO.,** 85 Chambers Street  
67 Reade Street  
Tel. 3624 Worth NEW YORK CITY

## PATENTS

THAT PROTECT AND PAY  
BOOKS, ADVICE AND SEARCHES FREE  
Send sketch or model for search. Highest References.  
Best Results. Promptness Assured.

**WATSON E. COLEMAN**, Patent Lawyer  
624 F. Street, N. W. Washington, D. C.

## J. C. (BUD) MARS, NOW BOOKING

ADDRESS

17 N. La Salle Street, Chicago, Ill.

## PATENTS

SECURED or  
Fee Returned

Send sketch for free search of Patent Office Records. How to Obtain a Patent, and What to Invent, with list of Inventions Wanted and Prizes offered for Inventions sent free. Patents advertised free.  
We are experts on AIRSHIPS and all patents and technical matters relating to AERIAL NAVIGATION.

**VICTOR J. EVANS & CO.** Washington, D. C.

## BAMBOO Special Grades of

Bamboo for AERONAUTIC WORK  
Reed, Rattan and Split Bamboo for Models.  
All sizes in stock. Tonka Rattan for Skids,  
1 1/4 inch and under, any length.

**J. DELTOUR, Inc.**  
804 Jefferson St. Hoboken, N.J.

## DETROIT AERO POWER PLANT

COMPLETE \$300 READY TO RUN  
INCL. PROPELLER-CARBURETOR-BOSH MAGNETO,  
OIL PUMP-CABLE-SWITCH-MOUNTING BOLTS.

IS GUARANTEED TO  
210 LBS. MIN. STATIONARY THRUST  
150 LBS. MAX. WEIGHT (COMPLETE)  
36 HOURS DELIVERY

LIFT AND FLY  
CURTIS BYPLANES  
BLÉRIOT II MONOPLANES  
DEMOISELLE MONOPLANES  
OR CRAFTS OF SIMILAR MAKE

**DETROIT AEROPLANE CO.**  
DETROIT MICHIGAN

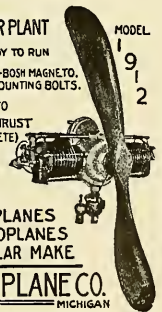

## "IDEAL" Plans and Drawings



are accurate and are accompanied by clear, concise building instructions, postpaid at the following prices:  
Wright 2-foot Biplane . . . 25c  
Blériot 2-foot Monoplane 15c  
"Cecil Peoli" Champion Racer . . . . . 25c  
Curtiss Convertible Hydroaeroplane (new) . . . 35c  
"Ideal" three-foot Racer (new) . . . . . 15c

Complete set of five—\$1.00 postpaid.  
5 cts. brings our new 40-page fully illustrated Catalog of "Ideal" Model Aeroplane Supplies. (None free.)  
**IDEAL AEROPLANE & SUPPLY COMPANY**  
82-B West Broadway, New York

## GOODYEAR

AKRON, OHIO  
Goodyear Balloons Aeroplane Accessories  
National headquarters for Spherical and Dirigible Balloons. Built complete. Highest quality. Also makers of Aeroplane Springs, Tires, and the famous Goodyear Rubberized Aeroplane Fabric. Write for booklet.  
**THE GOODYEAR TIRE & RUBBER CO.**  
AKRON, OHIO.

Seventy per cent. of record-breaking American flights with American Aeroplanes were made with propellers bearing this name

# CHARAVAY

WE WILL TELL YOU WHY IF YOU ASK US

**SLOANE AEROPLANE CO.**

**1731 Broadway, NEW YORK CITY**

AGENTS:

James Tricycle Co., San Francisco and Los Angeles; National Aeroplane Co., Chicago; W. E. Boughton, Washington, D. C.

## INVESTIGATE FIRST

Satisfy yourself you are dealing with a responsible concern before paying your money.

**WE GUARANTEE** our machines, workmanship, materials, etc., superior to those of any other constructed here or abroad regardless of price paid.

Immediate and prompt delivery on standard machines.

"Nieuport," "Bleriot," "Farman" and "Curtiss" types. Hydroplanes; speed, single, passengers, weight-carrying, or specially constructed to your own design and specifications.

"Complete with suitable power plant purchaser selects or prefers, demonstrated in flight." "Complete without power plant," or "Complete in the Knockdown." Will accept orders on specified time delivery under forfeiture.

We invite your personal inspection of the best equipped plant in the U. S. All types in course of construction. Unexcelled opportunity to acquire full shop, construction and flying course, on any type Monoplane or Biplane.

*SEEING IS BELIEVING. CALL IF POSSIBLE OR WRITE.*

## INTERNATIONAL AERONAUTIC CONSTRUCTION CO.

Factory, Hollis, L. I.  
Main Line L. I. R. R.

Office, P. O. Bldg.  
Jamaica, N. Y. City

Flying Grounds  
Nassau Boulevard

## NAIAD Aeronautical Cloth

Manufactured Especially for Aeroplanes and Used by

Aviators of Prominence

LIGHT, STRONG, AIR-TIGHT

AND

MOISTURE-PROOF ON BOTH SIDES

Sample Books, including Data and Prices, sent on request

THE C. E. CONOVER CO.

101 Franklin Street - - New York

## FOR SALE WRIGHT MODEL B

*Fully Equipped and in  
First Class Condition*

May be inspected in immediate vicinity of  
New York by appointment. Address

J. C. COOLEY, 122 East 82nd St., N. Y.

# C. & A. WITTEMANN

## Aeronautical Engineers

Manufacturers of

BIPLANES

MONOPLANES

HYDRO-AEROPLANES

GLIDERS

PROPELLERS

PARTS

SPECIAL MACHINES AND PARTS BUILT TO SPECIFICATIONS

HALL-SCOTT MOTORS, 40-60-80 H. P.

**YOUR OPPORTUNITY**—One single covered Biplane for immediate delivery. Slightly used, with 8 cyl. 60 H. P. Hall-Scott Power Plant.

## FLYING AND TRAINING GROUNDS

Works: Ocean Terrace and Little Clove Road.

Established 1906

STATEN ISLAND, NEW YORK CITY

Tel. 717 Tompkinsville

# Free Instruction in the Operation of the **CURTISS FLYING BOAT**

*Will be Given to Those Taking a Regular Course of Training at the*  
**Curtiss School of Aviation San Diego, Cal.**



First Hydroaeroplane Races at Hammondsport, N. Y. David McCulloch in his "Flying Boat" leads; he is accompanied by Mr. Curtiss. Lincoln Beachey is second, accompanied by Lansing Callan, while Francis Wildman, instructor at Hammondsport School, is third with the Standard Hydroaeroplane.

Among the men who have learned aviation at Curtiss Schools are: Lieut. T. G. Ellyson, now in charge of the aeroplanes of the U. S. Navy; Lieut. J. H. Towers, who just established a new World's Hydroaeroplane Record of 6 hrs., 10 min., 38 sec.; H. Robinson, who recently introduced the Hydroaeroplane in Europe and is now instructor in a Curtiss School; C. C. Witmer, now in St. Petersburg demonstrating Hydroaeroplanes in the Russian Navy and Army; Lieut. J. W. McClaskey, instructor in a Curtiss School; Lincoln Beachey, "The World's Greatest Aviator"; S. C. Lewis, now instructor in the Morane School in France; J. Lansing Callan, now an instructor in a Curtiss School; Francis Wildman, now instructor in a Curtiss School; Beckwith Havens, now a demonstrator; W. B. Atwater, now demonstrating to the Japanese Government; besides, a score of men who own their own machines and fly in contests and exhibitions, and a dozen others have taken positions with either manufacturers or exhibition concerns.

**O**UR San Diego (Cal.) Aviation Training Grounds, situated on North Island, in San Diego Harbor, are the finest in America, if not in the world. North Island is leased by us exclusively for aviation purposes, and comprises one thousand acres of flat, level sand, unobstructed by rock, tree or building, thus offering every advantage as a flying course. The Island is entirely private, yet within a few minutes of San Diego, one of the most progressive and attractive cities on the Pacific coast.

*The First Class Began Instruction December 1st  
Another Class Will Start January 1st, 1913*

A \$100.00 deposit will reserve a place for you in this class. Mail or wire it to-day.

Our Booklet "TRAINING" mailed upon request

**THE CURTISS AEROPLANE CO., Hammondsport, N. Y.**

# KIRKHAM

## The Dependable Aviation Motor



MR. AND MRS. ART SMITH  
The First Couple to Elope via Aeroplane

The accompanying cut shows aviator Art Smith and Miss Aimee Cour just starting on the first elopement via aeroplane, when they flew from Ft. Wayne, Ind., to Hillsdale, Mich., on Oct. 26, 1912, and were married.

It goes without saying that any man that will undertake a trip like this with his bride-to-be must have perfect confidence in his machine, and particularly his motor. But his **Kirkham Motor** had enabled him to fill 18 exhibitions, so he knew just what it would do. Can you say as much for the other kind?

The **Kirkham Motor** also holds the **American Endurance Record** for pilot and one passenger of 3 hrs., 51 min., 15 sec., just established by Walter E. Johnson, flying a **Kirkham** equipped Thomas Biplane, at Bath, N. Y., Oct. 31, 1912, the flight ending only on account of the extreme cold. Also on Nov. 2, 1912, Chas. Niles flew the same machine 2 hrs. 45 min.; and on Nov. 4, flying against the American duration record for pilot alone, he flew for 4 hrs. 15 min., stopping on account of burnt-out bearings, caused by stopping of oil pump.

This same motor was used all season by Mr. Johnson, and was the power that made possible his clean sweep of speed prizes at the New York State Fair, mentioned in previous advertisements.

There is a reason behind these performances that you ought to know before you purchase that New Motor. Booklet tells about the motor and is yours for the asking.

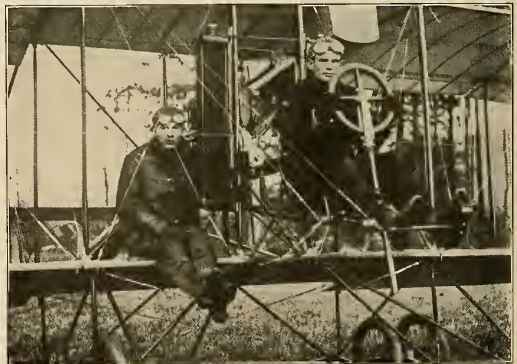

THE NEW RECORD MAN FOR FLIGHT WITH PASSENGER

C. B. KIRKHAM

Savona, N. Y.

# AIRCRAFT

Vol. 3 No. 11

JANUARY, 1913

15 Cents a Copy



A LADY'S PASTIME

The above picture shows Miss Agnes Firth, the beautiful and talented young Boston society girl, seated in the Caudron monoplane at the Sloane School, where she is learning to fly

# SLOANE

Records



Records

## 60 H. P. Anzani Deperdussin

Holder of the American Passenger Altitude Record—5006 ft. Time, 1 hour, 16 minutes, in use at

## OUR CALIFORNIA SCHOOL

on Dominguez Field, Los Angeles. We use the best field, the best methods and have the finest equipment in America. At our school you are instructed by the most advanced methods and by most capable instructors. Write us for terms.

### *We Sell and Use*

**DEPERDUSSIN MONOPLANES** which hold most of the world's records and are the safest machines built.

**CAUDRON MONOPLANES** are the most efficient and fastest of French Machines.

**SLOANE MONOPLANES.** The best and most successful American Machines. See them in our school.

**ANZANI MOTORS.** The best Aeronautical Motor made. Successful in both French and English Military Trials. Holds American passenger Altitude Record.

**GNOME MOTORS** are the best French rotary motors made.

**PARTS** for both motors and aeroplanes we have always in stock. **REPAIR WORK** on delicate motors a specialty. All our work guaranteed.

**AEROPLANES** and motors built to order in America's finest shop.

**WIRE!**

**WRITE!**

**'PHONE!**

## SLOANE AEROPLANE CO.

210 Merchants Trust Building  
Broadway & Second St., Los Angeles, Calif.  
'Phone Main 3674

1731 Broadway  
New York City  
'Phone Columbus 5421

National Aeroplane Company, 606 South Michigan Avenue, Chicago, Ill.

**NOISELESS AIRSHIP  
IN DRAB WAR PAINT**

WASHINGTON, Oct. 30.—Successful experiments with a noiseless motor are being conducted by the army signal corps at the aviation field at College Park, Md. Lieutenant Harry Graham is directing the tests, which promise to make the aeroplane a much more effective engine of destruction and more useful for scout duty.

The army aviators also are preparing to experiment with a new color scheme for the machines which, it is expected, will make them practically invisible either by day or night at a height of 250 feet.

—The above clipping from the New York Globe refers to one of the several

**Sturtevant**  
REG. U. S. PAT. OFF.

**Aeronautical Motors**

in use by the Army and Navy Aeronautical Corps.  
—The Sturtevant Aeronautical Motors are the first to operate satisfactorily with an effective muffler.  
—The sane design and sturdy construction commend them to anyone wanting a thoroughly high-grade, dependable Aeronautical Motor. Catalogue No.2003 gives full information

**B. F. STURTEVANT COMPANY**  
Hyde Park, Boston, Mass.  
and all principal cities of the world

We have a limited supply of booklets  
**"Elementary Science of Aerial  
Navigation"**

which have become a trifle soiled and self-worn; these regularly sell at 50c. each. We did not care to bring them with us from Kansas City, when we removed our entire plant to Garden City, N. Y., hence they have been left there for quick disposal.

This booklet starts at the very beginning of the aerial discoveries and inventions, giving the history of man's first attempts at flights and showing illustrations of the early models and the progress of this wonderful means of transportation, to its present-day perfection.

We will send you one, or as many as you want, on receipt of 14 cents a copy in advance, which may be sent in postage stamps. Address T. G. MCGURRIN, personally, 220 Temple Block, Kansas City, Missouri.

MOTOR CAR PUBLISHING COMPANY

**Learn to Fly a Thomas**

Winter Classes Now Starting  
TUITION \$250—WRITE FOR BOOKLET  
No Breakage Charged to Students

RELIABILITY SPEED ENDURANCE

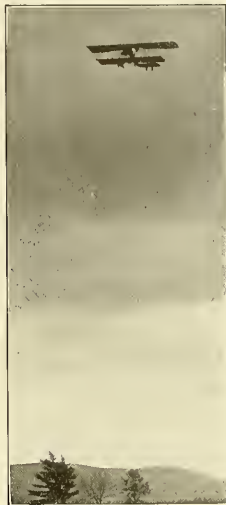

**Result of  
4 Years'  
Experience**

Walter Johnson flying his Thomas, in which he gained new American Endurance Record with passenger at Thomas School.

**Thomas Planes**  
Have proved that their design was correct from the **First**

**Popular-Priced  
Machines**

**Thomas Brothers  
Aeroplane Company**  
BATH, N. Y.



**The Benoist  
Hydro-aeroplane**

Won more prize money than any other competitor at the Chicago meet. If you had one you could do as well. Pupils trained at new Hydro Station at Creve Cover Lake.

FOR PARTICULARS ADDRESS

**BENOIST AIRCRAFT CO.,**

6630 Delmar Bl'vd

ST. LOUIS, MO.

**BLERIoT**

SPECIAL PRICE—Single-Seater Monoplanes, equipped with 50 H. P. Roberts Motor. **\$1,800**

Tuition Free to Purchasers

**IMMEDIATE DELIVERIES**

Learn to fly. We will teach you how. Tuition fee \$300. Free demonstration flights.

SPECIAL MACHINES BUILT TO ORDER  
SUBMIT DRAWINGS FOR ESTIMATE

ILLUSTRATED CATALOG FREE. SEND FOR IT TO-DAY

**American Aeroplane Supply House**

Telephone 427 Hempstead

HEMPSTEAD, L. I., N. Y.

**WIRE**

Aviator Wire supplied in 12 sizes with a plate finish, making soldering easy. This wire is specially drawn from extra quality high grade steel. Also Aviator Cord of twisted wire.

**John A. Roeblings Sons Co.**  
TRENTON, N. J.

JUST PUBLISHED  
**GASOLINE ENGINES**

Their Operation, Use and Care

BY A. HYATT VERRILL

The Simplest, Latest and Most Comprehensive  
 Popular Work Published on Gasoline Engines

320 PAGES 150 ILLUSTRATIONS

Describing what the Gasoline Engine is; its construction and operation; how to install it; how to select it; how to use it and how to remedy troubles encountered. Intended for Owners, Operators and Users of Gasoline Motors of all kinds.

This work fully describes and illustrates the various types of Gasoline Engines used in Motor Boats, Motor Vehicles, Aeroplanes and Stationary Work. The parts, accessories and appliances are described, with chapters on ignition, fuel, lubrication, operation and engine troubles. Special attention is given to the care, operation and repair of motors with useful hints and suggestions on emergency repairs and make-shifts.

A complete glossary of technical terms and an alphabetically arranged table of troubles and their symptoms form most valuable and unique features of this manual. Nearly every illustration in the book is original, having been made by the author. Every page is full of interest and value. A book which you cannot afford to be without.

PRICE, \$1.50

**Lawson Publishing Co.**

37-39 East 28th St.

New York City

**Wright Hydro-Aeroplane School**  
 Now Open at GLEN HEAD, L. I.

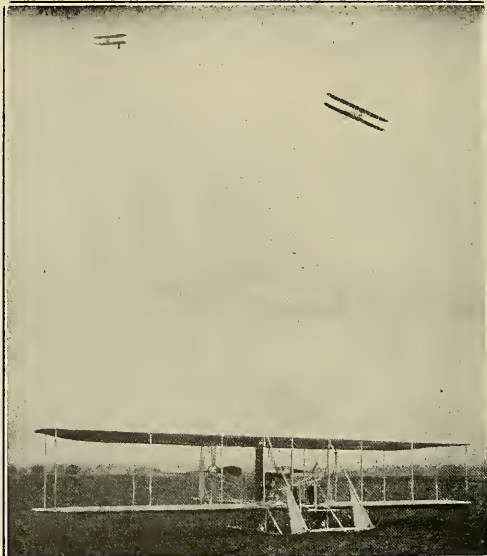

**Wright  
 Flyers**

1912 MODELS

In addition to those features which in the past have made Wright Flyers famous for efficiency and reliability, the new models can be furnished with **Automatic Control, Silent Motors, and Hydro-planes**. These special features make the 1912 machine unusually attractive to sportsmen.

**EXHIBITION MACHINES**

For exhibition work we have other models especially adapted to high winds and small fields. It was with a stock "EX" Model that Rodgers made his wonderful flight from coast to coast. Reliability means dollars to the exhibitor.

**WRIGHT SCHOOL OF AVIATION**

Training consists of actual flying, in which the pupil is accompanied by a competent teacher. No risks and no expense whatever from breakage. The most famous flyers in America are graduates of our school and include such names as

Lieut. Arnold	Drew	Lieut. Rodgers
Atwood	Elton	Parnalee
Brookins	Lieut. Foulois	Page
Brindley	Fowler	Reynolds
Bonney	Gill	Simmons
Beatty	Lieut. Lash	Turpin
Burgess	Lieut. Milling	Welsh
Coffyn	Mitchell	Webster
Capt. Chandler	C. P. Rodgers	and many others.

Our Schools at Dayton and New York are now open and pupils may begin training at once if they wish. By enrolling now you can reserve date most convenient to you for training. Write for particulars.

**THE WRIGHT CO.**  
 Dept. "B" DAYTON, OHIO

**HOTEL CUMBERLAND**

NEW YORK

Broadway at 54th Street



Headquarters for Aviators and Automobilists.

*New and Fireproof*

Strictly first class.  
 Rates reasonable.

**\$2.50**  
**With Bath**  
*and up*

Send for booklet.

Ten Minutes' Walk to Thirty  
 Theatres

**H. P. STIMSON**

Formerly with Hotel Imperial





Two views of the new 80 h. p. Curtiss Engine Tractor Biplane, built to the special order of Lincoln Beachey, at the Curtiss factory, at Hammondsport, N. Y. The machine was recently tried out at San Diego, and proved very speedy.

**CONTENTS—JANUARY, 1913**

The Schuette Lanz Airship	- - - - -	Johann Schuette	313
Gyroscopic Force in Aviation	- - - - -	D. W. Starrett	316
Pioneers of Aviation	- - - - -	Ladislav d'Orcy	317
Correspondence	- - - - -		318
Plan Drawings of the Gesa Monoplane	- - - - -		319
Foreign News	- - - - -		320
German News	- - - - -	Stella Bloch	320
Inherent Stability and how it is Achieved in the Fokker Monoplane	- - - - -	Walter H. Phipps	322
Scale Drawings of the Fokker Monoplane	- - - - -		323
World's Flying Records	- - - - -	Checked to December 15th, 1912, by D. E. Ball	324
American Aviation Records	- - - - -		326
General News	- - - - -		327

**AIRCRAFT**

ALFRED W. LAWSON  
President and Treasurer  
ERNEST C. LANDGRAF  
Secretary

Published Monthly by The Lawson Publishing Company  
37-39 EAST 28th STREET, NEW YORK, U. S. A.  
Telephone, 5017 Madison Square

ALFRED W. LAWSON  
Editor  
WALTER H. PHIPPS  
Asst. Editor

**TERMS TO SUBSCRIBERS**

In the United States, Mexico, Puerto Rico, Guam, Philippine Islands, Hawaiian Islands, Cuba (including Postage), \$1.50 per year. Fifteen Cents the Copy, of All News Dealers. Foreign Subscriptions, Two Dollars per year. In changing order give old as well as new address. Advertising copy must be in hand by the 1st of month previous to date of publication. Only high-grade advertisements of thoroughly reliable firms are solicited.

**WHEN YOUR SUBSCRIPTION EXPIRES**

One month before a subscription expires we enclose a renewal blank on which you will write your order for the renewal. WHEN FIRST NOTIFIED THAT YOUR subscription will expire, you should send your renewal AT ONCE, in order not to miss a number. New subscriptions which are received by us on or before the 15th of any month will begin with the issue of that month. If received after that date they will begin with the following month's issue. We cannot enter subscriptions to begin with back numbers. One month's notice is necessary before a change of address can be made.

Entered as "second-class matter" February 18, 1910, at the Post Office, at New York, N. Y., under Act of March 3, 1879. Copyright, 1912, by the Lawson Publishing Co.

"Aircraft" is registered as a trade-mark by the U. S. Patent Office, under date of August 9th, 1910.

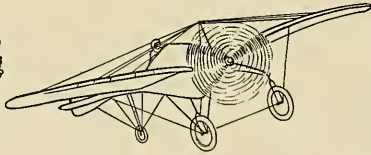

## MOISANT AVIATION SCHOOL

WINTER HEADQUARTERS AT

**U. S. Army Field  
Augusta, Ga.**

While our contracts with Foreign Governments may require the entrance of a considerable number of Army Officers, we have increased our facilities so as to afford ample accommodation to our regular pupils. Enrollments should, however, be made as promptly as possible.

Write for beautiful free booklet and address all communications to

**The Moisant International Aviators**  
U. S. Rubber Bldg.  
Broadway and 58th St. New York

## THE CURTISS AVIATION BOOK

By **GLENN H. CURTISS** and  
**AUGUSTUS POST**

Describes Curtiss' great flights; tells just how he planned his machines and what he believes the aeroplane will do in the future.

*Fully Illustrated, \$1.35*

**The Lawson Publishing Co.**  
37-39 East 28th Street  
NEW YORK

## King Edward Hotel IN NEW YORK

At Broadway and Long Acre Sq.  
145 to 155 West 47th Street

"The Very Heart of New York." Absolutely Fireproof

350 ROOMS 250 PRIVATE BATHS

Every Modern Convenience

European Plan Exclusively

### RATES:

Single rooms, hot and cold water	-	\$1.00-1.50
" rooms, private bath	- -	\$2.00-2.50-3.00
Suite, parlor, bedroom and bath	-	\$4.00-5.00
" parlor, 2 bedrooms and bath	-	\$5.00-6.00
Each additional person in same room,		\$1.00 extra
Rooms for Maids and Valets	- - -	\$1.00

**VICTOR HOTEL COMPANY, Ltd.**

C. A. HOLLINGSWORTH, President  
NEW YORK CITY

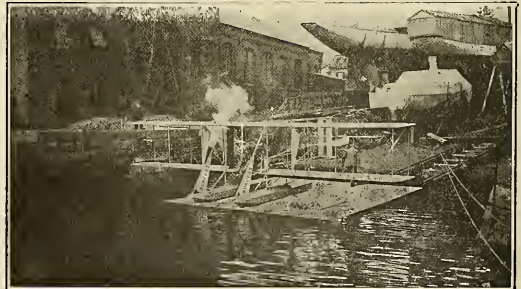

"THE PASSING OF THE YACHT"

## Burgess Flying School

Hydroaeroplanes used exclusively. You can learn without delay. The Burgess factory adjoins the flying station. Aeroplanes for exhibition, military and sporting use under construction. All leading motors used. Pupils secure not only training, but latest information concerning construction and design.

INSTRUCTOR:  
**PHILLIPS W. PAGE**  
Licensed Aviator

New Booklet just printed will give you full particulars

**THE BURGESS COMPANY & CURTIS**  
MARBLEHEAD, Box A MASSACHUSETTS

# AIRCRAFT

Vol. 3. No. 11

NEW YORK, JANUARY, 1913

15 CENTS A COPY  
\$1.50 A YEAR

## THE SCHUETTE-LANZ AIRSHIP

By JOHANN SCHUETTE

(This article was written specially for AIRCRAFT by Dr. Johann Schuette in German, and translated into English by Carl Dienstbach.)

JOHANN SCHUETTE occupies the chair of Naval construction at the Royal Technical School at Danzig, and ranks in importance with Zeppelin and Farseval in airship engineering, the latest and no doubt very greatest of all engineering methods yet adopted by mankind. He is the inventor of the Schuette-Lanz wooden type rigid airship built for German military purposes, and which will shortly be used for commercial purposes as well, through the establishment of passenger carrying air lines between various points in Germany, according to extensive plans now being arranged. Heinrich Lanz, who furnished the capital necessary to put into concrete form Schuette's great ideas, is one of the richest men in Germany. He is at the head of the mammoth concern of Heinrich Lanz, at Manheim, Germany, which for the past 54 years has been building all kinds of agricultural machinery, farm locomotives, traction engines, and stationary engines of various kinds, which are exported to almost every country in the world. That such a practical and successful business man as Heinrich Lanz has gone into airship construction should be good evidence in a large degree that the airship is here to stay with a bright future in store for it.

ONE of the first men to put at the disposal of aeronautical pioneers, money to further their work, was Heinrich Lanz, who, on the day of the historic misfortune at Echterdingen in August, 1908, came forward with a substantial contribution to the National Fund then raised, and during the following year through the "Lanz Prize of the Air," also

were caused through the building of the shed for the reason that no construction company had yet accumulated any knowledge or experience in the construction of such buildings, so in consequence of these delays the beginning of putting together the airship frame naturally had to be postponed.

The frame itself had been made in the meantime by the Berlin firm of Karl Huber, according to their designs and calculations, so that it was not until the latter part of October, 1909, that the real construction of the airship began. The frame of the hull which was ellipsoidal in form whose greatest diameter was in the centre of the total length, was completely mounted in the shed in January, 1910.

The construction consists of wooden parts, many times laminated and glued to be waterproof that have been pressed into the shape of plates and angles. After the scaffolding or cradle was removed, it was shown that the frame was too weak, especially with regard to crosswise strains, necessitating new calculations, the result of which was a series of very considerable strengthenings (shown in pictures No. 1, 2, 3, 4, page 314). Owing to this fact naturally the dead weight of the ship on which the original calculations have been based, also changed, influencing of course very considerably

considerably advanced the development of German aviation. He also decided in the latter part of April, 1909, to take up my plans and construct an airship of the rigid system on the island of Rheinau, near Mannheim, Germany.

It was believed that the time necessary for the construction of the projected airship of about 20,000 cubic meters displacement, together with a suitable hangar, would take about nine months to complete, and that the first ascension would take place during the latter part of 1909.

This hope, however, could not be fulfilled owing to a long series of unforeseen accidents and furthermore, the airship and the hangar could not be built for the original estimate,—the cost exceeded it several times over.

Our first delays

the other parts of the ship

The very difficult work of strengthening the original frame after its cradle had been removed, took another year of construction.

Contrary to many opinions published, the improved frame still consists of laminated wood. For instance, the bracing of the long tunnel pieces by ramie-chords had to be replaced by high quality steel wire, and fastening that to the wood required special devices. At last, however, these laborers were finished and very thorough

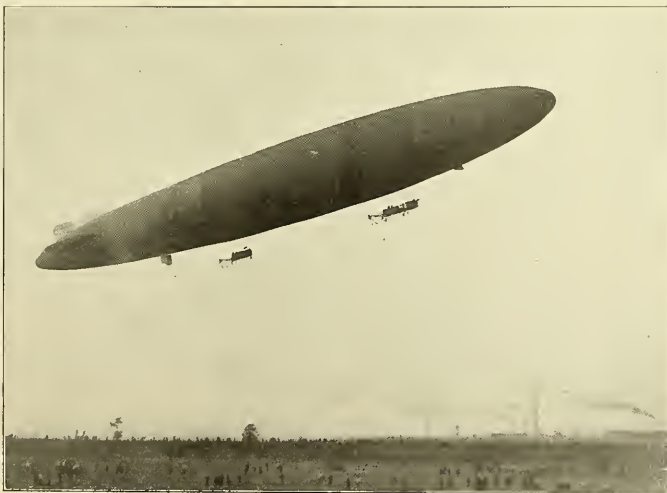

(Picture 7). The Schuette-Lanz wooden type rigid airship starting on one of her test trips against a strong wind. Attention is called to the position of the cars hanging by a flexible suspension which, contrary to predictions, have shown no sign of straining or buckling the frame but have, in fact, proved remarkably efficient in landing as their flexible attachment relieves their hull of all severe landing strain.

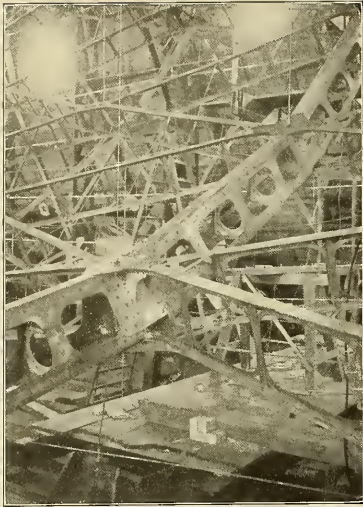

Picture 1 shows a detailed view of one of the joints of the cross-tracing of the Schutte-Lanz dirigible and illustrates how the framework had to be strengthened by the use of box-girder frame-work pieces in place of the light I-beam structures which it was originally planned to use and which, as can be seen by the distortion of the frame members in picture 3 were not strong enough for the purpose. All the wooden framework is constructed of thin laminated wooden strips built up in such a manner as to ensure a maximum of strength with a minimum of weight, and the above picture illustrates how this was accomplished.

page 315), principally of seamless tubes of high quality steel autogenously welded and riveted into binders, to serve in part as engine beds.

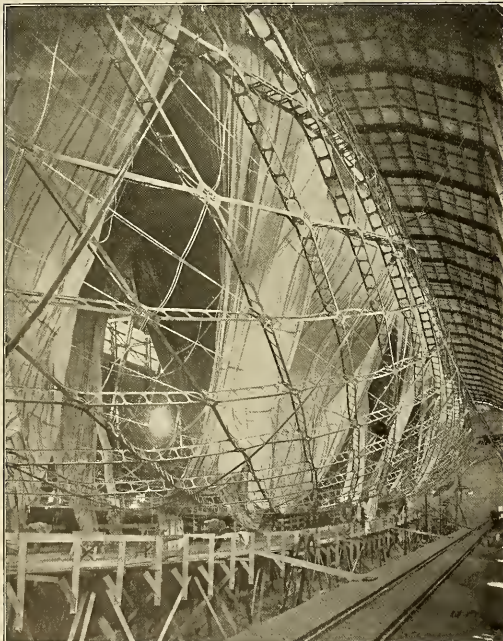

Picture 3 shows the original frame work before it had been strengthened with the box-girder pieces shown in Picture 1 and illustrates how the frame-work was sagging and several of the I-beam pieces buckling under the weight of the heavy covering.

strength tests proved conclusively that there was no more possibility of trouble by any breaking of the parts of the frame.

After this we began mounting the cars, but even with them, for the reasons mentioned, a change was proved necessary. The big single car, planned at first to have engines and living quarters, had to be divided into two cars to afford a more favorable distribution of the weight. These consist (see pictures 5, 6,

After the car question had likewise been solved, the preliminary experiments with the Mercedes motors, that lasted nearly two years, had also been completed. The engine arrangement originally planned of two four-cylinder motors coupled into a unit had been changed to two eight-cylinder motors each directly driving a propeller. Together these motors are able to give a normal power of 500 and a maximum of 540 brake horse power, giving a thrust to two four-bladed propellers, that drive the ship at 72 kilometres (45 miles) an hour.

The propelling arrangement chosen has proved very satisfactory, this wish to emphasize particularly, because there have been repeated criticisms of this arrangement which prophesied a tendency to "buck" and of the flexible suspension of the cars it necessitated, which

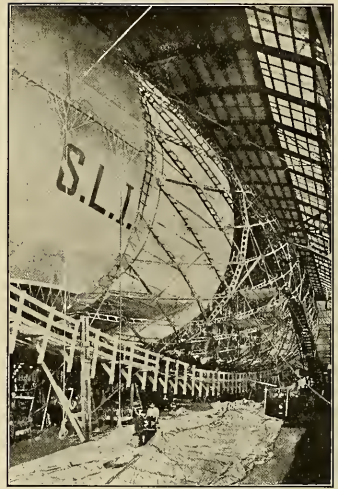

Picture 2 illustrates the dirigible nearing completion and shows how the gas chambers are placed inside the framework with an outer covering of strong rubberized weather proof cloth laced on the outside to form the outer covering of the dirigible and protect the inner balloons. As will be noticed the parts of the wooden frame-work are of considerable width and being placed edge up allow of a very efficient air space between the outer covering and the gas chambers. In the fore-ground two men can be seen examining one of the gas chambers while another mounted on a regulation German fire ladder is seen adding the final touches to one of the horizontal rudders.

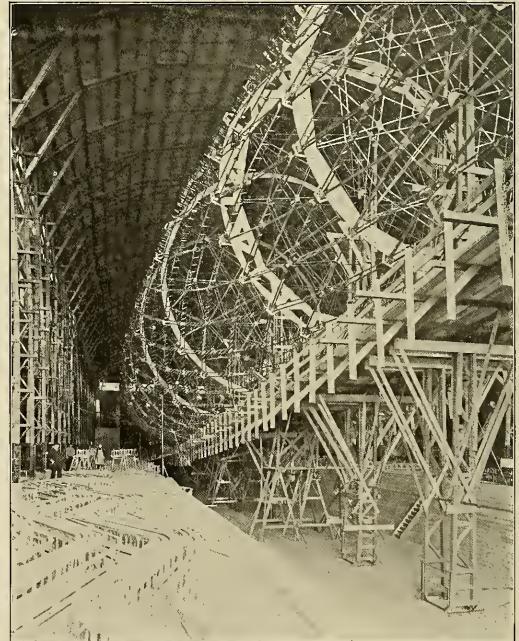

Picture 4 shows the frame-work being strengthened and illustrates how it had to be trussed and propped up on the inside by the specially constructed wheel braces shown in the inside of the hull. It can readily be seen that airship construction is an engineering feat of no mean magnitude.

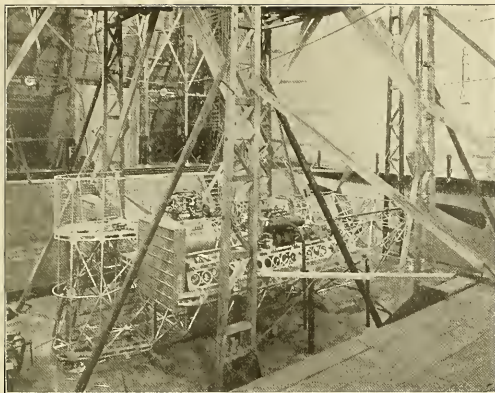

Picture 5 shows the double car which it was originally planned to suspend under the center of the dirigible. This plan however, had to be abandoned as it taxed the strength of the hull too greatly and it was found necessary to divide the big car into two smaller ones to afford a more favorable distribution of the weight. Note the passenger's quarters between the two engine sections.

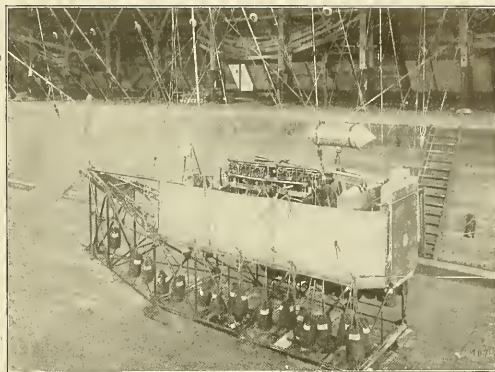

Picture 6 shows one of the cars as subsequently adopted. This car, which is the rear one carries simply the engine and propelling mechanism and is not intended to accommodate passengers other than the necessary crew. Note the large 3-bladed propeller and long shaft drive. Note how the car is simply attached by cords to the dirigible, thereby allowing considerable give in the case of bad landings. Attention is also called to the large motor which drives the three bladed propeller in the rear by a long straight shaft.

would be fatal to the steering and manoeuvring qualities as well as to the speed. In many trips, and even in very bad weather this arrangement has acquitted itself very well, especially in the case of difficult landings. (See picture No. 7, page 313).

A spacious forward platform is built in the front engine-car which houses the instruments and apparatus required for navigating the ship, such as steering wheels for the vertical and horizontal rudders, compass, electric recorders of gas temperature, barographs, engine telegraph, patent log and inclinometer, control for ballast and gas valves, etc.

This "captain's bridge" (see picture No. 8, page 315) will generally shelter the men required to navigate the ship. But it is roomy enough to accommodate comfortably five or six more persons. For eventual passenger-carrying trips a further platform can likewise be built in front of the rear car, in which eight more people may find living and sleeping quarters. The captain's car is equipped with a modern wireless telegraph instrument of the Telefunken type.

In its interior the ship carries accommodations for a total of about 2,000 liters of water ballast distributed at the foremost bow, in the front part, in the center, in the rear part and at the extreme rear end. In eighteen tanks arranged within the frame, 2,100 liters of benzine can be shipped. These are supplemented by two collecting tanks of 200 liters each and two reserve tanks of 260 liters each. As a matter of course all additional materials needed in running the engines, a reserve of cooling water, lubricating oil, cotton waste, etc. are carried.

As already mentioned (see pictures 9, 10, page 316) the suspension of the cars is non-rigid, that is to say, the cars may yield in a vertical direction if the ground is struck heavily and without intention, but only in a vertical direction, so that the force of the shock is not transmitted to the rigid frame. This arrangement has already served the ship three times. In one case, on April 13th, 1912, the shock of landing was so violent that seven people were spilled overboard and all the ballast and several pieces of equipment were lost. The sudden release of this tremendous weight caused the vessel to

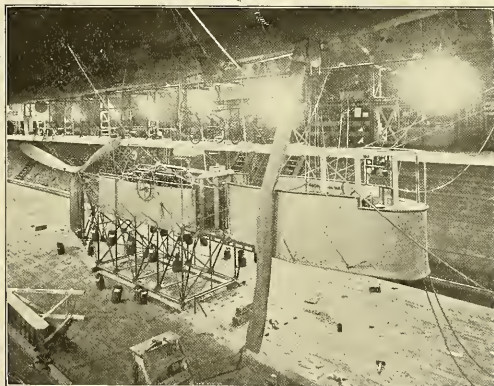

Picture 8. In this picture can be seen the forward car of the dirigible with the captain's cabin in front and the passengers' quarters immediately at the back of it while at the extreme rear is the engine room and propelling mechanism. Contrary to predictions the long shaft drive with the three-bladed propeller has proved very satisfactory. As can be noticed this car is also suspended by cords from the hull. This feature relieves the main frame from landing shocks.

shoot up in a fraction less than four minutes from 300 to 5,100 feet without suffering any damage and nobody was hurt through the accident. On the home trip of the ship from Berlin to Gotha last September it had to bear very heavy weather for eleven hours and had to be taken into the airship shed at Gotha during the storm, a feat made possible only through the extraordinary solidity of the frame and the holding and enduring devices fastened thereto. It has been acknowledged, that this landing of the Schuette-Lanz airship was the most difficult one an airship has ever made at Gotha.

Differing from other airships the vertical as well as horizontal rudders (see pictures 9, 10, page 316) of the Schuette-Lanz are single surfaces, preceded by rigid steadying fins. Due to this fact it is possible not only to considerably simplify the rudders, but also to make them smaller without losing in efficiency.

Since the end of October, 1911, the ship has covered about 3,000 miles and carried over 500 people. It must not be overlooked, however, that from the beginning of November, 1911, to the 13th day of April, 1912, and from the 13th of April, 1912, to the end of May, 1912, no trips were made.

For the use of the ship in war, in addition to the wireless equipment already mentioned, an armament is planned consisting of machine guns on top and in front of the hull and also on the cars.

The hull of the ship is subdivided into single gas chambers made of a double layer of long fibred cotton fabric with a layer of rubber inserted. As the parts of the wooden frame are of considerable width and are placed "edge up," a very efficient air cooling space against the sun's radiation is created between these gas chambers and the outer skin, which chiefly consists of very strong cotton fabric, rubber-coated and stained yellow. Also the wooden frame, being a poor conductor of heat, transmits the radiation much less to the gas cells than a metal frame. Each gas cell of course is provided with a safety valve which relieves the gas bag after it becomes taut during ascension. It was due to this provision that on April 13, 1911, the ship could ascend so very rapidly without suffering any harm. In less than four minutes an enormous

considerable width and are placed "edge up," a very efficient air cooling space against the sun's radiation is created between these gas chambers and the outer skin, which chiefly consists of very strong cotton fabric, rubber-coated and stained yellow. Also the wooden frame, being a poor conductor of heat, transmits the radiation much less to the gas cells than a metal frame. Each gas cell of course is provided with a safety valve which relieves the gas bag after it becomes taut during ascension. It was due to this provision that on April 13, 1911, the ship could ascend so very rapidly without suffering any harm. In less than four minutes an enormous



Pictures 9 and 10 show on the right the Schuette-Lanz airship leaving its hangar, and on the left the same dirigible starting off on a test flight. The picture on the left shows clearly the position of the under-hanging cars which as can be noticed are not rigidly attached to the hull but simply hang loosely from it. Attention is also called to the streamline shape of the hull which, in spite of the underhanging cars, allows the airship to attain a speed of 42 miles an hour.

quantity of gas was blown off unintentionally.

The Schuette-Lanz enterprise has cost up to date, about two million marks. This amount, however, has been expended in creating entirely new and original engineering methods and devices for airship building as well as the construction of the airships and hangars.

## GYROSCOPIC FORCE IN AVIATION

By D. W. STARRETT

**B**EFORE attempting to point out the fallacy of the dangers and benefits of gyroscopy in aviation, the writer will endeavor to clarify the subject with a few preliminary remarks. While gyroscopy is well understood, the terms by which the knowledge on the subject is conveyed to the non-scientific mind, are very technical.

There are only two forces known to man at the present time. These are gravity or centripetal and centrifugal forces. One may know them under the terms "attraction" and "repulsion"; again they are known under more scientific terms as "directivity" and "activity."

The Newton law shows that each particle of matter has an attraction for each other particle of matter in the cosmos. Allowing this to be basic, one may readily understand that its opposite law, repulsion, is its own product.

To show this in a simple way take three bodies of matter, each having the same number of electrons, and place them in a straight line a certain distance apart; the center body will be in perfect equilibrium, because the attractive force of its neighbors will be equal; yet one knows that there is an opposing strain produced by the attraction acting from opposite directions.

The same law shows that matter in motion or at rest will remain in that condition forever unless acted upon by some other force which will cause a change. This means that a wheel revolving about an axis has an inherent tendency to continue revolving in this plane. It also means that if while so revolving it move in a circle or a straight line, it would resist a power which acted to prevent its revolutions or to change, as a body, its direction of motion.

This same law acts upon matter in the form of human beings, animals, and plants with identical results. It is known when exhibited by animals and human beings as habit. One may say that when one is attempting to break a habit gyroscopic force is being set up.

When one attempts to change the plane of movement of a body there is always attending danger unless one knows how to do so and thereby avoids the dangers. As soon as the change is accomplished the gyroscopic force is gone because the new plane then becomes its field of action. This shows that the moment of change is the time of greatest danger.

One can say with reason that originally there must have been only one object in existence, because every line of reasoning leads to that ultimatum. And that one thing must have been a material object, because every exhibition of that one thing has been a material one. Hence the flow of centripetal and centrifugal forces must

be material. And being a material flow, an object placed within their current will act as, for instance, one placed within an air current. To illustrate: Take a board of any length and width and hold its edge directly against an air current; it will obey the law mentioned by having no tendency to change that position; but allow the board to swerve the least and it will have a tendency to present its greatest plane to the flow of the current.

The same principle makes rain drops round, because the greatest plane always presents itself at a right angle to its movement; shot is also made round, through this principle, by falling.

Take an ordinary top such as boys use, and note that, after being thrown it strikes the floor at some angle from a perpendicular line. It is revolving when it strikes the floor with as great a velocity as can come to it; yet, although its matter continues to move, under the law mentioned, at the angle with which it struck the floor, its weight is gradually lifted until its broadest surface takes an accurate right angle position to the flow of the forces mentioned.

Right here one should see the connection between the illustrations given and a power aeroplane. The aeroplane has a spinning top revolving under conditions similar to that mentioned. Its propeller in front is analogous to the point of the top upon the floor. The shaft is identical with the tops' axis, and all of the revolving parts of the engine are to its shaft what the tops' weight is to its axis.

Hence whenever the engine's shaft is inclined, the lower point becomes analogous to that of the spinning top. And its upper end, like that of the top, has a tendency to rise. If the propeller is the upper end the engine becomes the top's point. The propeller with its lighter body revolving in a much greater plane than the engine's weight, in proportion would have the same tendency.

To make it a little plainer:—Again view a top with its axis pivoted at the floor with a ball bearing socket, and extending through and below a sufficient distance to receive another top of like dimensions and weight, pointing upward.

The upper top would have the tendency to rise as before shown; the lower top would have a tendency to fall, first, because the upper top would assist it to move in that direction and, secondly, gravity would pull it in that direction and, thirdly, its broadest plane would seek the shortest route to a right angle position from a line drawn to the center of the earth from the center of its socket bearing.

One will not say that the boy's top and the aeroplane top are not identical when in action, as regards support, when one is conscious that the boy's is pivoted upon an aeroplane, the earth, sailing through gravitorial lines of force at the rate of about eighteen miles per second.

When the aeroplane has sufficient number of square feet of air passing under its planes, whether by its own speed or that of the wind or both, its "top" has as rigid a support as any object has whilst moving over the surface of the earth.

As the machinery is set upon aeroplanes at the present time, the lifting power of the centrifugal force acting "top like" has a tendency to pitch the front end of the aeroplane downward. The danger is less where the propeller is located in front, other conditions being equal.

When the aeroplane is sailing along and by turning or otherwise encounters a current of wind having approximately the same speed and direction, the supporting surface is suddenly taken from the planes; it is at this instant the aviator should be cognizant of the Newton law, because it resists at first the change, and then his engine in its revolving parts suddenly feels its release and flies, or has a tendency to do so, toward a position, as shown, analogous

to that of a spinning top after it has assumed its greatest centrifugal lift.

And, of course, it must be perfectly plain that where the engine with its revolving parts are located in front of the aeroplane and propeller, the danger is greater the moment it becomes the lower end. It will assist in the downward plunge, as illustrated. All revolving parts of an aeroplane machinery should be set in the position which they try to assume, namely, with their broadest plane of action at a right angle to a "spoke" of the earth.

To summarize:—The Newton law mentioned will cause a resistance to the tipping of an aeroplane regardless of the position of the revolving machinery. Gyroscopy, a combination of motions, will neither act as a menace to its safety, or prevent the plunging of the machine. Centrifugal force is the menace when the revolving machinery is placed horizontally upon the machine, and the factor of safety when placed in the position noted.

## PIONEERS OF AVIATION

By LADISLAS d'ORCY

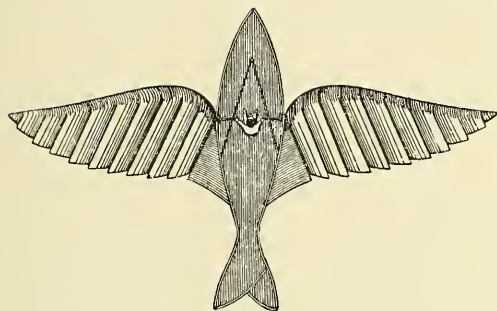

Fig. 1.—The Le Bris Machine.

### IV. CAPTAIN LE BRIS (1818-1872)

**T**HE aeroplanes which were either proposed or constructed by the first pioneers of the aviativ movement, such as Sir George Cayley, Henson and Stringfellow, the brothers Du Temple, were all provided with a mechanical motor for their propulsion through the air; and although it seems certain, that the latter's machine was to utilize also ascending air currents and perform thus the birds' soaring flight, still none of these forerunners was daring enough to trust their flying machine to the sole motive power of the wind. We have therefore to record an entirely novel feature in the remarkable soaring experiments, that were carried out by Captain Le Bris at Brest in 1857 and in 1868.

Captain Jean-Marie Le Bris was a French mariner, who had sailed in his younger days several times around the Cape of Good Hope and Cape Horn; there the continuous and regular soarings of the albatross attracted his attention, so much, that he soon decided to imitate bird flight in a machine copied on nature. Having captured one of these birds, he studied very carefully the structure of its wings and finally came to the conclusion, that he had discovered the secret of animal flight. In his own words, as quoted by M. Gabriel de la Landelle:

"I took the wing of the albatross and exposed it to the breeze; and lo! in spite of me it drew forward into the wind; notwithstanding my resistance it tended to rise. Thus I had discovered the secret of the bird! I understood the whole mystery of flight."

So when Le Bris returned to France and had become the captain of a coasting vessel sailing from Douarnenez (Finistere), where he was born in 1818 and where he had married, he designed and built with his own hands an artificial bird, that was shaped much like an albatross. (Fig. 1.)

Gabriel de la Landelle, the pioneer of the helicopter, who had seen this apparatus in 1876 at Brest, where it was then stored in the *dépot* of the Ponts-et-Chaussées, describes it as follows:

It consisted of a body in the shape of a "sabot" or wooden shoe, the front portion being decked over, provided with two flexible wings and a tail. The body was built like a canoe, being 13½ ft. long and 4 ft. wide at its broadest point, made of light ash ribs well stayed and covered on the outside with watertight cloth, so it could float. The wings were each 23 ft. long, so that the total span was 50 ft. and the supporting area about 215 sq. ft. The tail was hinged so as to steer both up and down and sideways and act as a stabilizer; but Le Bris added to this elevation control another very ingenious device, that was to permit at will the variation of the angle of flight. This consisted of two strong levers, that imparted through a transmission of pulleys and cords a rotary motion to the front edge of the wings, so that their incidence could be changed according to the needs. The cords ran over a little mast placed in front of the body, so as to increase the leverage. The whole apparatus, minus its operator weighed only about 92 lbs.

In 1857 a first trial was given this machine by Le Bris on a public road at Trefeuntec, near Douarnenez. Realizing the necessity of an initial velocity for leaving the ground, he chose a Sunday morning, when there was a good 10-knot breeze from the right direction and setting his artificial bird on a cart, he started down the road against the wind, the cart being driven by a peasant. Le Bris stood, his hands on the levers, upright in the canoe, that was held down by a rope passing under the rails of the cart and terminating in a slip knot fastened to the airman's wrist, so that with one jerk he could loosen it and let the rope run.

When they came to the right turn in the road, the driver was told to put his horse on a trot and Le Bris, pressing on his levers, slowly raised the front edge of the wings to a slight angle of incidence and loosened the fastening rope. Still, the bird did not rise, for the rope had been caught on a concealed nail, although it relieved the cart's weight so much, that the horse began galloping. Finally the rails of the cart gave away and the artificial bird rose into the air, much to the satisfaction of Le Bris, who said later, that he found himself perfectly balanced, going up to a height of nearly 300 ft. and sailing about twice that distance over the road.

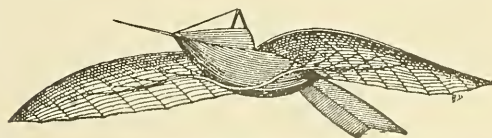

Fig. 2.—Le Bris' Second Machine.

But then an incident happened. At the last moment the running rope had whipped and wound around the driver's body, had lifted him from his seat and carried him up into the air. As soon as Le Bris became aware of this unexpected matter, he changed the angle of incidence and maneuvered so well in coming down, that the driver reached the soil entirely unharmed; but the equilibrium of the machine was no longer the same, because part of the weight had been relieved and Le Bris did not succeed in reascending. He controlled however his machine well enough to descend in a gentle glide and at the landing only slight damage was done to one of the wings, that struck the ground in advance of the other.

This daring feat aroused naturally much comment in Douarnenez, where the captain was considered a visionary by most of the people and a hero by others. Aerial locomotion had its enthusiasts even in those remote days.

Some time elapsed now, before Le Bris was able to repeat his exploit, after the apparatus had been repaired with the aid of some friends. This time the courageous skipper intended to start from a steam-boat under way, an excellent idea considering that in case of a mishap the machine was capable of floating and he was himself an excellent swimmer. But he was dissuaded by some friends and so he decided to gain his initial velocity by dropping from a height. For this purpose he erected on the brink of a quarry a mast with a swinging yard, which was to drop him; the apparatus was assembled on the bottom of the quarry and after Le Bris had mounted it, it was hoisted up aloft to a height of about 100 ft. A fresh breeze was blowing inland and the yard was swung so that the apparatus had to face both the wind and the quarry; and when Le Bris had reached by trial the proper balance, he raised the front edge of the wings, set the tail at a proper angle and tripped the suspending hook.

First the machine seemed to glide gently off toward the quarry; but it had scarcely reached the middle of the excavation, when a vertical gust struck it and made it tilt forward; and although the airman tried desperately to right his mount by the action of its tail, after some oscillations the artificial bird went almost vertically down to the bottom, where it was very badly damaged. Le Bris was saved from what seemed a certain death only by his cold blood, for when the machine hit the ground, he suspended himself to the mast and jumped upward, escaping thus with a broken leg only. After this accident Le Bris interrupted his experiments for over ten years, owing to the scarcity of his resources.

In 1867, however, a public subscription at Brest enabled him to build a second soaring machine and this is the one shown in Fig. 2. It was much like the first, only somewhat lighter, although a movable counterweight was added to it so as to assure automatic stability. When completed, this apparatus was publicly exhibited and attracted much attention; but the inventor no longer had the daring of youth and as M. de la Landelle relates it, "only once did he make a sort of an ascension from an inclined wagon, that was not in motion. He was on the levee of the port of commerce of Brest, the breeze was light and the gathered public impatient

through failure to realize that success depended wholly on the wind intensity. Le Bris was waiting for a gust that was to raise him; he thought it had come, worked his levers and presented his wings at the most favorable angle; but he only ascended a dozen yards, glided hardly twice that distance and after this brief effort came gently to the ground without any jerk."

After this third attempt of man flight, Le Bris changed his system of experimenting; following the advices of his friends, he tested his apparatus with ballast, instead of riding in it himself and this at once changed the conditions of equilibrium, as there was no human control over the varying angle of incidence. On one occasion, the breeze being just right, the apparatus rose up some 50 yds., with a light line attached and advanced against the wind as if gliding over it. Very soon the line became slack and the assisting sailors were greatly astonished, for the bird proceeded thus without waver some 200 yds.; but at the approach of a rising ground, which altered the direction of the air current, the bird began settling down, without jolt, very gently and alighted so easily that the grass was scarcely bruised. But a repetition of this test ended with a disaster. The bird had hardly risen into the air, when it pitched forward and fell down to its entire destruction. This mishap was probably due to the extremely unfavorable weather conditions on that day.

His friends claimed, that had the operator been aboard, he surely would have been killed; but Le Bris maintained, that had he controlled the machine, he could have avoided the wreck by altering the angle of incidence. He much blamed himself for having surrendered his better judgment and gave way to profound despair. For this was the end. His second apparatus was damaged beyond repair, his means were exhausted and he had to go back to his native village, where after serving with honor in the war of 1870-71, he became a special constable and was killed in March, 1872 by some ruffians whose enmity he had incurred.

Octave Chanute, the great investigator and promoter of soaring and gliding flight, pays in his "Progress in Flying Machines," the following tribute to Jean-Marie Le Bris:

"Le Bris had made a very earnest and upon the whole a fairly intelligent effort to compass sailing flight by imitating the birds. He finally failed for want of sufficient pecuniary backing and also, perhaps, for lack of scientific methods and knowledge, for even at that day Captain Bèlégue, a French naval officer, had called attention to the importance of securing longitudinal equilibrium, the lack of which caused the failure of poor Le Bris."

Truly, Captain Le Bris was the founder of the school of soaring flight; but, as he had not left any account of his experiments—the only narrative relating to them being found in the preited M. de la Landelle's "Dans les Airs"—his influence in aviation was purely ethical; he deserves, however, a great deal of credit for having demonstrated the practicability of soaring flight because of the inspiration he gave thus to the men that were to continue his researches.

## CORRESPONDENCE

Editor of Aircraft:—

I wish to express to you my appreciation of the courteous manner in which your journal has met a new issue in the history of aviation, and the skill shown by Mr. Myers in giving accurate expression to the views I hold upon the subject. My interest is primarily one of curiosity to know the causes of the air's support. I am pretty well convinced now that the obstacle to progress has been an inadequate conception of the physical processes of the air, and that attention has focussed too much upon effects and too little on causes. We want the physicists in the game as well as the engineers. We want a complete laboratory of the air to become masters of it. I hope your journal will press this matter.

I consider the article the best succinct description of the new scheme that has been written to date and would like to secure a wide distribution for it, abroad as well as at home. I shall be glad of any suggestion from you as to this, or any other phase of the matter that interests you.

Thanking you once more and with good wishes to Aircraft, I am

Very sincerely yours,

ROBERT D. ANDREWS.

Mr. Alfred Lawson,

Dear Sir:—

Enclosed you will find two views of Wetzig Bro. of Junction City in flight at Goodland on September

19-20, 1912. They have been making flights at Oakley, Logan and numerous other places as the elevation here is 4000 feet nearly; they have been having splendid results, it is a Benoit single surface. I think views are remarkably clear. They intend building a couple of planes this winter, and incorporating some original ideas.

I visited Overland Park at Kansas City; Fowler was on road filling dates booked by Young. Andrews was supposed to be down town waiting till he had a breakage repaired. McCallum was building some racing wings for the Berliot; Floyd Smith was to Sunday visit with McMillian, who is a Curtiss flyer, while there I saw part of Hogan's Dream and Calls Aspiration. If persistence counts for much those "Persistence Twins" may yet be called the "Heavenly Doublets."

Our wings were in a shed and destroyed by a fire. The Greer Automatic Stabilizer Patent has been granted; it beats anything I have ever run across, it surely does the huns. Will send a description later.

E. R. CARV,  
Norton, Kans.

By the way when we had Thorwald Andrews out on our Norton Fair he fell into same airhole Jack Frisbie hit and while he had no breakage, he abandoned the attempt. We were disappointed but rather it was that way than like Frisbie incident of last year.

The Lawson Pub. Co.,

Geneva, Wis.

I have had a study of the anatomy and flight of birds and air currents, their action, etc., for a number of years and would now like to become actively engaged in particularly the engineering part of aviation, but have no capital and would be pleased to know of some good way of doing same.

It seems that if each person interested in aviation should give what they could toward a common fund, sufficient amount could be raised to establish an aerodynamic laboratory, equal to any in Europe at least. I should like to help start a movement of this kind and have a plan by which I think it can be done and would like to have your opinion of the idea.

Should also be pleased to hear from any one looking for new plane designs or information on natural flight.

Thanking you in advance for your attention, I am

Very truly yours,

LLOYD D. VAUGHAN.

Tiffin, O.

R. 1

New Brighton, N. Y., November 27, 1912.

Editor of AIRCRAFT:

I have just read over Mr. Phipp's article on the proper position of the motor in an aeroplane in the November AIRCRAFT and he surely has got the right idea. It is a wonder to me that this change has not been made long ago by the manufacturers.



The only real objection that could be raised is that such a position for the motor leaves a more or less limited field of view for the aviator. This objection could, however, be obviated to a great extent by the use of transparent panes in the plane and shield.

The use of the elongated shaft and of the chain which has caused so much criticism is not nearly as bad as has been thought and it will generally be found that breakage in this part of the power plant is rare. I might add that a clutch could be added to considerable advantage.

I am in favor of the machine with a front motor and a rear propeller, and look forward to the time when this type shall come in to general use.

Yours sincerely,

RALPH S. BARNABY,  
November 26, 1912.

Dear Mr. Lawson:

I know very little about aviation and less about war, but I would like to know if the remarks which I am going to make might not be practical. Bombardment of a city by aeroplane would be expensive and slow, but if an aeroplane fleet could set a part of a city on fire containing wooden houses on the leeward side, the fire would probably spread. A fleet of aeroplanes would be able to set many houses on fire in one day and get away before a force of armed men could gather against them.

Instead of dropping bombs I should think it would be more effective to take a hundred pounds of small lead balls to a height of five or six thousand feet and throw them on the enemy below in hand balls.

A large German airship can carry two tons besides its crew; if these two tons consisted of crushed stone it might be spread over the enemy from a height of five thousand feet. Sixteen airships making three trips a day could thus drop one hundred tons of stone from a height of five thousand feet on an enemy every day. If any lives to tell the tale they would probably say it rained fire and brimstone out of heaven.

The stone could easily be spread around; but even if it could not, two tons of crushed stone in bulk landing in the midst of an army making a charge would be at least disconcerting.

Yours sincerely,

T. PITCAIRN.

P. S. A great advantage of the stone-dropping plane would be that it would cost next to nothing.

T. P.

**GASOLINE ENGINES.** Their Operation, Use and Care, by A. Hyatt Verrill, 320 pages, 150 illustrations, cloth. The Norman W. Healey Publishing Company, publishers.

This instructive and interesting book describes what the gasoline engine is; its construction and operation; how to install it; how to select it; how to use it and how to remedy all motor troubles. It also gives a complete glossary of technical terms and an alphabetically arranged table of troubles and their symptoms. It is intended for owners, operators and users of gasoline motors of all kinds.

**Eling O. Weeks Delivers Newspapers in Biplane**

On November 23d Eling O. Weeks in his 60 H. P. Curtiss engine Williams headless biplane, flew from Scranton, Pa., to Carbondale sixteen miles away, where he delivered several bundles of newspapers to carriers who were awaiting him. The flight was accomplished in fifteen minutes.

It is stated that Army officers are contemplating the adoption of a special type of flying machine as a means for rescuing persons from a disabled ship at sea. One of the three boards which are examining life-saving devices has been in session at Newport News, Va., and the aeroplane was one of the devices which were submitted for discussion. Other boards have been holding sessions in San Francisco and Manila and it is thought that the recent exploit of Sidas Christoferson's flying out over a wrecked vessel, will have its effect in inducing the boards to pass favorably on the adoption of the aeroplane as an aid to life savers.

The Ordnance Department of the Army has installed at Sandy Hook, New York, several 3-inch aeroplane guns of a special type calculated to hurl an explosive shell over three miles high and tests are to be made shortly with different kinds of shells. A carriage has been perfected so that the downward recoil of the gun can be taken up without injury to the gun or carriage and so that the gun will still retain the true alignment.

**Aero Club of Long Island**

At the Fifth Annual Meeting of the Aero Club of Long Island, Incorporated, elections were held with results as follows: Chas. Wald, President; Charles D. Spence, Jr., Vice President; William T. Newell, 2d Vice President; Henry J. Newton, Jr., Treasurer; Joseph K. Post, Secretary and John H. Lisle, Assistant Secretary.

Francis C. Wilson, speaker of the evening, gave an interesting and instructive paper on practical construction. The work outlined for 1913 includes the construction of several new machines of unique design.

**War Aeroplane as Christmas Gift**

Italian residents of Philadelphia, at a Thanksgiving celebration on November 28th, raised in fund for the purchase of a war aeroplane of the latest model which they will present to King Victor Emmanuel III, as a Christmas gift. More than six thousand members of forty-nine Italian societies participated in the celebration.

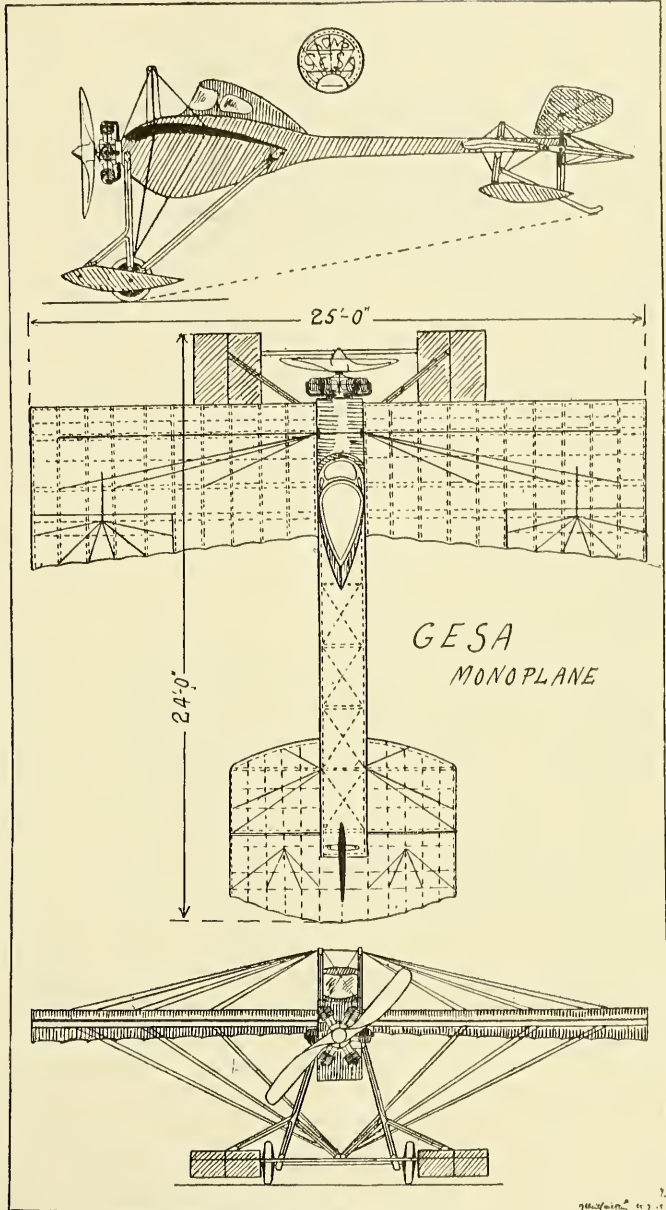

THE GESA HYDRO-MONOPLANE

The above drawings show a side, plan and front view of the GESA hydro-monoplane, an interesting Belgian machine constructed by Messrs. Girard and Salkin. As can be noticed the chief peculiarity of the mono-plane is the fuselage which is very deep in front thereby giving the machine the appearance of a flying fish. The front of the fuselage is entirely covered in, and is fitted with windows above and below, which allows the pilot to see clearly, and at the same time protects him from wind and rain, while in addition it protects him in the case of a capsizing of the machine either on the ground or in the water.

The pilot has access to the cabin through the top, but in the case of an accident, such as a capsizing, he can quickly get out through a door in the floor.

The wings of the machine are rigid, lateral stability being attained by ailerons, which arrangement allows of the strongest possible mono-plane wing bracing.

The landing gear consists of two wheels and two small but wide floats in front, while at the rear the tail is supported by a small skid and tail float.

The power plant consists of a 30 H. P. 6-cylinder Anzani motor, driving a 2.20 metre propeller. The general dimensions are: Length, 24 feet; spread, 25 feet; average wing chord, 6 feet.



The new 6 passenger, 74 foot spread Voisin hydro-aeroplane built to the special order of M. Deutsch de la Meurthe. As can be noticed the machine is at best simply a makeshift and is nothing more or less than an enlarged headless biplane structure with a clumsy boat attachment apparently stuck on as an afterthought.

# FOREIGN NEWS

## Africa

### GARROS BREAKS HEIGHT-RECORD, RISING 19,032 FEET

On December 11th, at Tunis, Roland G. Garros broke the world's altitude record by rising to a height of 19,032 feet or approximately 3.6 miles in a flight that lasted 1 hour and 11 minutes.

In our French notes of this issue we publish an announcement of Garros leaving France for Tunis with the intention of breaking the altitude record and stating that Garros had taken a Blériot machine with him for this flight, so that it seems quite probable this new height record was established on a Blériot monoplane in spite of the fact that Garros has been recently flying a Morane-Saulnier.

The best previous height record was that of 17,876 feet established by Georges Legagneux on September 17th, last at Villacoublay, France on a Morane-Saulnier monoplane.

It is rumored that Garros intends shortly to attempt to cross the Alps in his monoplane and that his recent altitude flights have been made by way of training for this daring feat.

## Argentina

### CORPORAL FELS FLIES FROM BUENOS AYRES TO MONTEVIDEO

On December 3d, Corporal Fels flew down the Plate River from Buenos Ayres to Montevideo, a distance of 128 miles. The Argentine Minister had him arrested for breaking the rule which prohibits an officer leaving his country without permission while on duty. He was, however, soon released and congratulated on his fine flight which constitutes a record for South America.

## Austria

### WIRE AND TURNBUCKLE TEST COMPETITION TO BE HELD IN VIENNA

The Oesterreichischen Flugtechnischen Verein has organized a competition to test the strength of wires, turnbuckles, terminals and fastenings, which is open to all nations, and entries may be made up to February 15th, 1913. Full information can be obtained by addressing the Secretary, Oesterreichischer Aero Club, Wien 1, Tuchlauben 3, Vienna, Austria.

## Bulgaria

The fate of Dr. Jules Constantin, a French aviator in the Bulgarian service, who was decorated by King Ferdinand for bravery, is described as follows: Dr. Constantin started from Surina village on his last flight over the Chataldja lines with the object of dropping bombs on the Turkish troops. His biplane went out of sight rapidly and some hours later was seen to descend near the Bulgarian camp. The aviator was found lying on the ground dead with a wound in his chest. The wings of the biplane had also been pierced by bullets.

The instruments showed that he had reached a height of nearly 4,000 feet. He had photographed the Turkish lines and evidently had been shot, but had strength to guide the machine back before he expired.

## China

### SPECIAL CORRESPONDENCE

The Editor "AIRCRAFT"  
New York.

Dear Sir:—

After writing you last on the 24th ult., I received news of an aviation fatality in the person of Mr. Fung Yue one of the pioneers of aviation as far as China is concerned.

Mr. Fung Yue the much talked of Chinese aviator from America demonstrated his aeroplane on Sunday the 25th August, to the Chinese Officials of the army and the soldiers outside the East Gate. There was a very large gathering and after lecturing on his machine in detail to the officers and the troops that surrounded him he mounted his biplane and made an abrupt rise above the trees but had to land immediately after. He made three attempts in all and in his last ascent to soar high above the trees the aeroplane dashed into a bamboo thicket and was badly damaged and the

aviator who fell with his machine heavily to the ground was seriously injured by bamboo sticks piercing his thigh and other parts of the body and became insensible. He was bleeding profusely and the wounds were at once attended to by the army surgeons present. He was conveyed in an ambulance to the nearest hospital which was somewhat distant from the scene of the disaster and the aviator expired after entering the hospital. The cause of the accident is not exactly known and may be due to lack of aviator's experience in handling the elevating gear and the depraved motor not working as smoothly as it should. The aviator's brother who was present at the exhibition was so shocked by the fatal accident that he fell unconscious. The place where the aviator met his death was enshrined and many admirers of the deceased aviator and believers of the art of aviation went there to worship for the repose of the soul of one of their compatriots who fell for the cause of aviation and his country. Later on services were held in a temple in the Eastern suburb and most of the high officials of the province were present. The remains of the deceased aviator were buried, at Wang Pa Hill among the graves of the revolutionary martyrs and the sum of \$1,000 mex. was granted as compensation to the family of the deceased aviator who is being so much lionised.

I am also informed that a pension of \$100 per annum is to be paid to his father. There is much enthusiasm in the matter and idea of course is to create an interest in aviation and encourage other mechanics to take to the winged art. The deceased aviator's assistant Chu Chuk Pan is I understand taking a great deal of interest in this line and he will no doubt repair the machine and make a few experimental flights which I hope will be successful. I enclose a photo of the deceased aviator on his Curtiss type biplane.

Yours faithfully,

F. B. SILVA-NETTO.

## Denmark

### TOURS DENMARK IN BIPLANE

In the space of fifteen days, M. Birch, flying a Maurice Farman biplane in Denmark, covered a total distance of about 2,500 kilos. Throughout the trip he was accompanied by his wife who occupied the passenger seat.

## England

An exhibition is to be given at Olympia, London, in February next, devoted exclusively to aviation. It will be held under the auspices of the Society of Motor Manufacturers and Traders (Ltd.), Maxwell House, Arundel Street, London, W. C.

In addition to aeroplanes, it is proposed to provide for the exhibition of hydroplanes and hangars, and special arrangements will be made for model flying, cinematograph displays, and other features of interest. Inasmuch as the show will be international, American manufacturers of aeroplanes will be able to exhibit their products.

## France

On November 16th at Etampes, Fischer was testing a Henry Farman biplane fitted with one of the new 9-cylinder Rhone rotary motors and made a flight of over an hour's duration. On November 25th, with the same machine and engine he made a try at the Ac. C. F. Criterium for the longest flight over closed circuit to be made in 1912. He started at 6:45 A. M. but after flying for two hours was forced to land due to some part of the machine loosening up. He, however, intends to make another trial in the near future.

### MME. DE LAROCHE FLYING AGAIN

Mme. de Laroche, the pioneer woman aviator who was injured at the 1909 Rheims Meet, has now resumed flying and is making some splendid flights on a new Sommer biplane.

### GARROS TO TRY FOR HEIGHT RECORD AGAIN

On November 27th Garros taking along a Blériot monoplane left France for Tunis where he intends in the near future to make an attempt to regain the height record and it is also rumored that he will follow this up with a flight from Tunis to Rome and after that with an attempt to fly across the Alps.

While testing a Donnet-Leveque biplane ordered by Mr. Jones of the Whitehead Turpedo Works of Fiume, Austria, André Benetton on November 22d, flew from the Donnet-Leveque's works at Besnon and followed the course of the river to Paris, turning over the Grand Palais he made his way back to Besnon. He had as passenger Koenig, the Austrian pilot, who is learning to fly the machine as the Austrian Government has ordered two Donnet-Leveques, one a 50 H. P. and the other an 80 H. P. machine.

Jules Vedrine has recently been making some extensive flights on a Deperdussin monoplane at Etampes and it is rumored that he is practicing for a long cross-country tour which he expects to make shortly.

### FARMAN BROTHERS EXCHANGE MACHINES AND FLY IN COMPANY

A novel scene was recently witnessed at the Buc aerodrome when Maurice Farman flew over and witnessed his brother Henry testing out a new machine. After Henry Farman had landed his brother expressed a desire to try the H. Farman biplane so they exchanged machines and the unusual sight was afforded of Maurice

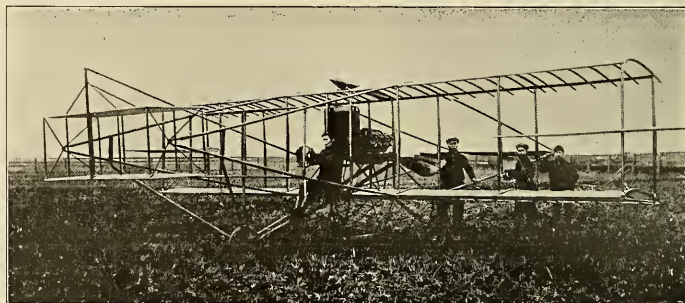

Fung Yue the first Chinese Aviator to lose his life in China is here shown seated in the bi-plane with which he fell owing to inexperience in handling the controls.

Farman flying a headless Henry Farman biplane while his brother was flying the Maurice Farman type.

On November 25th, Labarre, a French military aviator, flying a Train military monoplane, completed his tests for a French superior certificate, flying over a course from Mourmelon to Villacoublay and back. The interesting point in connection with this flight is the fact that it was accomplished on a Train monoplane which is one of the few present day machines having the pilot sitting way below the main plane as on the Santos-Dumont, Demouille. While this arrangement of placing the seats below the main plane has been admitted to offer observation advantages for military use, it has been severely criticised on account of its giving a machine a low center of gravity and in consequence a poor balance. Train, however, in spite of criticisms and prejudice, has stuck to the under-slung type of monoplane and by his persistent efforts has proved his machine to have merits and it seems as if he is about to reap his rewards as several Train machines have been recently purchased by the French Government.

#### THE VOISIN AERO-YACHT FLIES

On November 23d, with Ragere at the wheel, the hydro-aeroplane built by Voisin for M. Deutsch de la Meurthe was tested at Issy. With six passengers and the pilot on board, it rose from the ground in seventy yards but the landing chassis was somewhat damaged in landing. This mammoth biplane, a picture of which we show in our foreign news heading has a spread of seventy-four feet and is powered with a 200 H. P. Clerget motor. As can be noticed, the machine is far from a pleasing design and appears to be slapped together without taking into consideration the position or resistance of the float car.

#### FREY'S ACCIDENT

On November 21st, Andre Frey, the well-known French monoplane pilot, crashed at Rheims in a Hanriot monoplane sustained a fall and was so seriously injured that he died before reaching the hospital. Frey was one of France's ablest pilots having obtained his license as a Strassburg biplane in 1910. He afterwards flew various types of both monoplanes and biplanes. In 1911 he was third in the Paris to Rome to Turin race. He was the only competitor to attempt the stage from Rome to Turin during which he met with an accident while crossing the Apennines at Ronciglione, when he sustained very serious injuries which kept him out of actual flying for some time. This year he qualified as one of the three representatives of France in the Gordon Bennett Competition and in the course of his eliminating trials beat the speed records with one passenger.

Frey had recently been undergoing a period of instruction as a sapper in the reserve and each day had flown over to the military aerodrome at Rheims from the Hanriot school. On the 20th H. P. Hanriot monoplane on which Bielicvic had made some 250 flights. In the afternoon of November 21st, he started on a trip on the machine against the advice of his friends as the air was in a very disturbed condition. It was at a height of perhaps 200 feet when the machine ran into a very bad gust and dived. Frey evidently tried the machine would recover itself and probably hesitated too long before attempting to pull it up with the result that it crashed nose on to the ground and fatally injured the pilot. A military commission immediately examined the debris of the machine and found all the controls etc. intact, so that there appears to be no doubt it was the causes mentioned above that caused the accident and not a wing breakage as generally reported.

#### France

FRANCE TO SPEND \$5,000,000 ON AVIATION IN 1913

A recent dispatch states that France has appropriated \$5,000,000 to be spent on aviation in 1913 as against \$4,000,000 in 1912. Two hundred additional aircraft of all descriptions are to be purchased.

There are to be thirty-eight squadrons of scouting aeroplanes, each squadron comprising eight aeroplanes "in commission" with a spare one always kept in reserve. Twenty-seven of these squadrons will be field and eleven fortress squadrons and one will be attached to each army headquarters and to each army corps. Each cavalry division will be accompanied by three aeroplanes.

There will also be twenty dirigibles principally attached to the frontier fortresses and four armoured gun-carrying aeroplanes.

#### Germany

##### AIR FLEET FOR GERMANY

TWENTY ZEPPELINS ABLE TO REMAIN IN THE AIR FOUR DAYS TO BE BUILT

In theobbies of the Reichstag on November 28th a discussion centred on what is now regarded as the certain appearance of Germany's first aerial navy bill.

It is stated, on reliable authority, that the recommendations of the War Office and Admiralty include a provision for building, as the beginning of a German air fleet, twenty Zeppelin airships, each of about 925,000 cubic feet capacity, to be capable of travelling fifty-one miles an hour, and remaining aloft four days and four nights without an intermediate landing, and capable of carrying and discharging a ton of explosives.

#### German Notes

By Stella Bloch

Ellyer von Gorrisen set up a new passenger world's record on November 7th by taking up five passengers with him on his new Ago-Otto biplane with a 100 H. P. Argus motor. This is the same apparatus with which he took part at the Putzig hydroplane meet

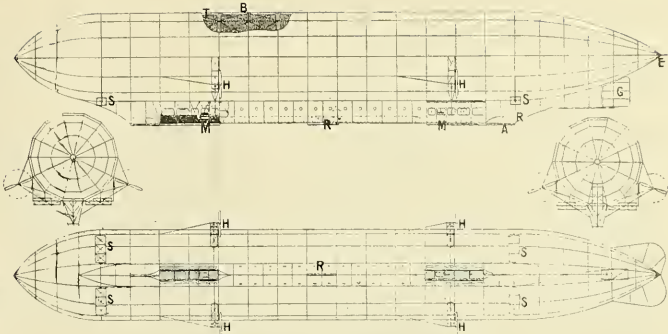

#### THE FRENCH RIGID AIRSHIP "SPIESS"

Diagrammatic drawings of the new French dirigible "Spieß" which is now ready for its trials. As will be noticed the ship is similar in general lines to the Zeppelin although it is not a copy of the Zeppelin, as its main features were patented in 1873. The total length of the airship is 344 feet, its greatest diameter 49 feet. The frame work of practically the whole dirigible is constructed of hollow wood, spars, cloth wrapped, which construction makes the airship very light, strong and flexible and more capable of standing shocks than a rigid metal frame. The hull is divided by twelve vertical divisions which divide the airship into thirteen distinct and separate gas chambers. The two cars of the Spieß are built right into the keel and are not hung below the hull as on the Zeppelin, this arrangement greatly cutting down head resistance as well as adding to the symmetry of the design. Each car carries a 250 H. P. Clenu engine which drives propellers through gear and shaft transmission. The letters on the drawings show as follows: T—a diagonal brace; B—one of the gas chambers; E—horizontal stabilizing plane; SS—elevator controls; MM—motors; G—rudder; HH—propellers; RR—reservoirs for water ballast; A—armament.

but without success. Gorrisen attained an elevation of fifty meters and stayed up twenty-three minutes. The total weight of the six persons and fuel amounted to 430 kilograms.

Melli Beese has commenced to build monoplanes on the Dove system which probably will go to swell the considerable number of machines belonging to the Army. The framework has been inspected already by a military commission.

There will be no Vienna to Berlin flight in 1913 as owing to the unsettled political conditions the Austrian committee cannot see its way to commence arrangements for this event. In its place an international meeting is to take place in June on the Vienna-Aspern ground.

Lieut. Geyer of the Strassburg military station has set up an excellent score for cross-country work with 1,400 kilometers within a period of four weeks, without the slightest mishap either to plane or motor. His best accomplishment was from Strassburg to Mullhouse, back to Strassburg and on to Metz. On the return journey he encountered dense fogs in the Vosges mountains, but covered the distance, one of 150 kilometers, in a hour 30 minutes on his Aviatik biplane.

Four more officers have taken their brevets at Berlin-Johannistal, three Albatross biplanes and one on a Rumpler. By the way, the military have acquired two more Doves which are now stationed at Doberitz.

A new world's altitude record for women was set on November 22d, at Berlin-Johannistal by Mlle. Galautschikoff the Russian aviatrix whom Abramowitch taught to fly on a Wright biplane. Steering a military type Pöcker monoplane, 100 H. P. Argus motor, the aviatrix reached the very respectable elevation of 2,200 meters, landing in a fine glide.

The Berlin Albatross Works are now about to build monoplanes as Hirth has entered the firm as a partner and will pay special attention to his own favorite type of machine. The War Office is said to have placed a considerable order with the works for monoplanes.

Lieut. Joly beat Hirth's cross-country record of 320 kilometers (Breslau-Vienna) on November 26th, when he flew a distance of 355 kilometers from Jüterbog to Rogowo, in 2 hours 30 minutes on a Rumpler-Dove with a 100 H. P. Argus motor. The German duration record stands at 4 hours and is in the possession of Lieut. Kastner.

The first hydro-aeroplane built by Count Zeppelin's old assistant, Engineer Kober, in the former Zeppelin hangar at Manzell near Friedrichshaus, is now undergoing a series of tests over Lake Constance. The first trial flight, carried out by the Swiss pilot Gsell, lasted 50 minutes and was most favorable.

An order for fifty new monoplanes and biplanes has been placed by the German War Office with domestic firms. This large number is to replace the machines that show manifold signs of wear and tear at the various flying stations in Metz, Strassburg, Cologne, Doberitz and Jüterbog where officers are trained in aviation work and breakages, therefore, are ordinary occurrences.

#### India

Consul Edwin S. Cunningham of Bombay writes that, anticipating the advent into India of airships, the Indian airship act was passed in 1911. Under that act the Governor-General in council is authorized to prescribe certain rules. A draft of the proposed rules has now been published. Invitations have been extended that objections and suggestions concerning the amendment of these rules will be received no later than October 15, 1912.

The proposed rules forbid anyone to possess or use an airship without a license, which may be obtained from certain designated officials. Before a license is issued particulars are to be filed giving the name, occupation, and residence of the applicant, and a description of the airship; that is to say, in the case of dirigibles, the type, the capacity of the envelope, over-all length, diameter, material of which the envelope is made and the name of the maker, carrying capacity

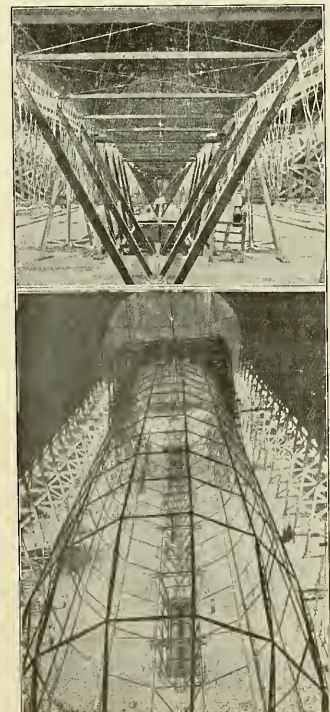

Two views of the framework of the rigid dirigible Spieß on top a view of the keel and nacelle construction and below a view of the hull in a partially completed state.



The Borel hydro-mono-plane being pushed into the water preparatory to making an over water trip. By its performances at the Tarnise meet and more recently the winning of the Pommeroy Cup, the latest type Borel mono-plane has sprung into a position second to none.

in weight and number of persons. In the case of aeroplanes the description shall include the type, whether tractor or propeller driven, span, total length fore and aft, height, total carrying capacity in weight in live load, including pilot, the disposal of seating accommodation, position of driver's seat, and whether fitted with dual control. The applicant shall also describe the engine, giving its cylinder and horsepower, whence the airship was obtained, where it will be kept, and

whether or not the applicant has obtained a license elsewhere.

The proposed rules prohibit carrying arms, explosives, ammunition, wireless telegraphic apparatus, carrier birds or photographic apparatus, though the local Government may grant permission to a licensee to carry carrier birds and photographic apparatus. They also provide for the inspection and search of airships by designated officials.

## Inherent Stability and How it is Achieved in the Fokker Mono-plane

By WALTER H. PHIPPS.

One of the really novel and successful machines brought out during the year is the new Fokker mono-plane constructed by Fokker a young Dutch engineer who has devoted considerable time in an endeavor to produce an automatically stable aeroplane and judging from the success of his latest machine it would seem that he has at any rate gone a long way toward achieving his aim.

As will be noticed from the accompanying drawings, the chief peculiarities of the Fokker mono-plane are the main planes which are set at a very pronounced V angle and also slope backward. The fuselage sets up high above the wings thereby bringing the center of gravity very high and it is this arrangement of placing the fuselage high with the wings below and at a very pronounced dihedral angle which was found to give the mono-plane such a splendid inherent lateral balance that no movable control is provided for maintaining the side balance.

Another advantage which it was found the high center of gravity produced, was that it aided automatic longitudinal stability by reason of the fact that the momentum of the high body and the drag of the low set planes produced an equalizing effect which tended to keep the machine on an even keel and what is still more important and has been proven by actual tests this arrangement in the event of the motor stopping causes the machine to automatically assume a good gliding position. The explanation of this being that when the machine is flying level the thrust of the motor equalizes the drag on the main planes but in the event of the motor stopping this thrust is removed and the drag of the main planes causes the lower part of the machine to slow up, so to speak, while the momentum of the fuselage and motor continues forward, thus automatically forcing the nose of the machine down and putting it into a gliding position. This is just the reverse of what happens with biplanes having a high center of thrust as on the Dornier-Leveque and Sanchez-Besa, etc. flying boats which exhibit a tendency to tail slide when the motor stops for the reason that when the thrust ceases the pressure drag on the top plane causes the top of the machine to slow up, while the boat and lower planes advance owing to momentum thereby producing just the opposite effect to that which occurs on the Fokker mono-plane.

Longitudinal stability is still further aided by the backwardly sloping wings similar to those used on the Dornier, Lohner-Pichl, Mars Albatross "Arrow Plane," etc., which produce considerable fore and aft stability owing to the fact that the weight of the machine is carried over a considerable fore and aft distance and at the same time the center of pressure is distributed over a greater distance and this checks the quick shifting of the center of pressure which is so detrimental to some present day machines. For these reasons the writer predicts that it won't be very long, in fact the tendency is already apparent, before the

large majority of machines will be fitted with backwardly sloping wings. Another advantage that this style wing presents is that it likewise aids lateral stability for since the wings slope backwardly their ribs slope dihedrally toward one another, and in the event of a side slip the wing on the low side presents a positive angle to the direction of descent while the high wing presents a negative angle, so that the motion of the machine sliding causes a lift on the low wing and a depression on the high one which thus automatically restores the balance and accounts for the fact that the Fokker mono-plane is not provided for any means of controlling the side balance. As an instance of Fokker's faith in his mono-plane it is interesting to note that he has repeatedly flown it in winds of over thirty miles an hour and quite recently broke the German altitude record by rising over 11,000 feet.

Turning now to a description of the machine itself the general dimensions are as follows: length 8 meters, spread 11 meters, chord 2.3 meters, motor 100 H. P. 4-cylinder water cooled Argus driving a Garuda propeller of 2.7 meters diameter.

### MAIN PLANES

The Main planes are quickly detachable and are attached at a very pronounced dihedral angle and are single surfaced of a similar construction to the early Farman planes having the spars and ribs fitting into pockets sewed in the cloth. The ribs themselves are remarkable in that they are perfectly flat with the exception of a slight curve near the leading edge.

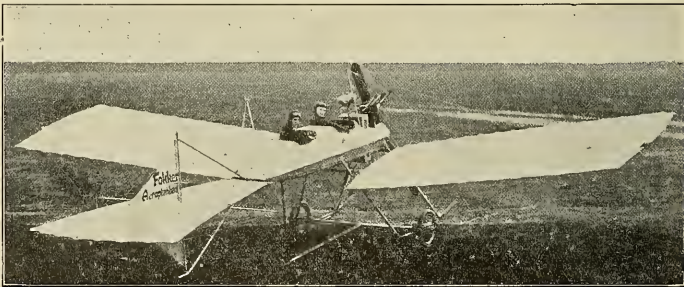

The Fokker automatically balanced mono-plane which has been making such wonderful flights in Germany and Russia during the past year and which has also put up several German height records, and just recently a world's altitude record for women of over 7,000 feet made by Mlle. Galantschikoff the Russian aviatrix on November 23, at Berlin-Johannisthal, on a 100 H. P. Argus motored Fokker mono-plane.

### Italy

#### DIRIGIBLE LOCATES AMERICAN FRIGATE SUNK OFF TRIPOLI IN WAR OF 1804

On November 27th, an Italian dirigible, while making observations above Tripoli, located the aged wreck of the American frigate "Philadelphia," which was sunk in the war of 1804.

Upon being informed of the discovery of the relic, Captain White Military Attache of the American Embassy in Rome, left immediately for Tripoli.

### Morocco

A splendid flight was recently achieved by Lieut. De-Hu when he flew from Casablanca to Marrakech in two days in his Bleriot. In making the return journey he was forced to stop for sometime at Ben Gueric on account of the weather.

### Philippines

Lieut. Frank P. Lahn has recently been making some excellent flights on one of the new Wright machines sent to the signal station at Camp McKinley, Manila. Thus far, no extensive flights have been made, but Lieut. Lahn, who is really the dean of the flying soldiers of the army, is regaining his familiarity with the machine, and some lengthy flights will soon be made. Lieut. Lahn will act as instructor for the junior officers in the islands.

### Roumania

The military aerodrome at Cotroceni, Bucharest has been abandoned in favor of the Prince Bibesco's Grounds. Lieut. Zorilens recently broke the Roumanian height record by climbing 2,500 meters. Lieut. Protopopescu has been doing some excellent flying on the military Bristol mono-plane and has carried several generals as passengers.

### Sicily

Roland Garros on December 16th, flew from Tunis to Sicily, a distance of 160 miles. He expects to fly on to Rome and probably across the Alps into France.

### THE FUSELAGE

The fuselage contrary to usual mono-plane practise does not extend all the way to the rear nor is it built up in box form. It is in reality simply an aluminum cabin mounted on two strong beams which extend forward and support the engine in front. The large flexing tail attaches to the rear of this cabin and is braced rigidly by a mast and wires leaving just the outer part flexible to be warped up and down to act as an elevator. The pilot sits in the rear with the passenger in front.

### RUNNING GEAR

The running gear consists of a double skid and two wheel arrangement of the usual type but its chief novelty lies in the fact that an extra central skid is attached at its rear so as to support the tail and relieve it from severe shocks in landing. For this reason it is hinged and its rear strut fitted with shock absorbers, as can be seen in the side view plan of the machine.

### CONTROLS

The Controls simply consist of a lever which works the elevator while the steering is done by a foot yoke. The transversal stability is automatic and is produced by the form of the wings.

### THE FOKKER MONOPLANE

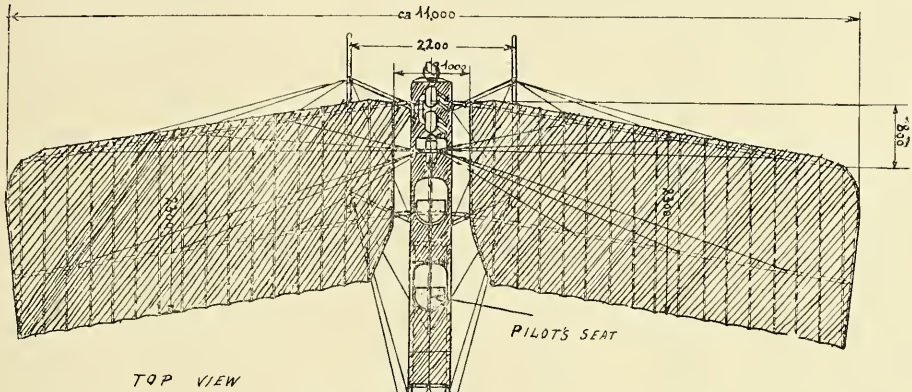
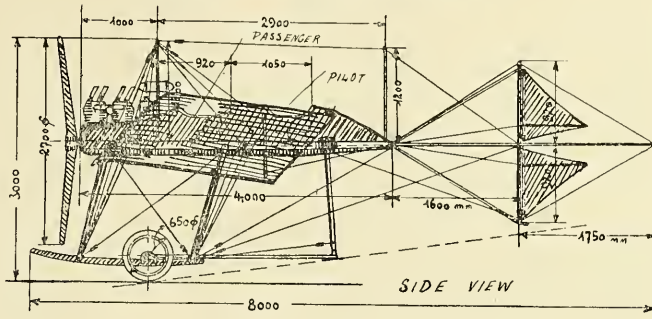

FOKKER  
MONOPLANE  
DIMENSIONS (METRIC)

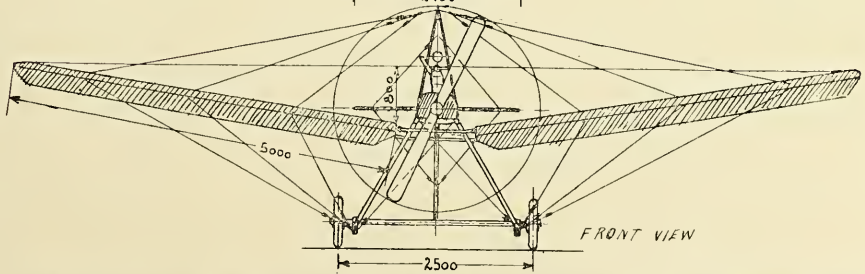

Side plan and front view drawings of the Fokker monoplane, which has inherent automatic lateral stability

# WORLD'S FLYING RECORDS

(In Closed Circuit without stops)

(Checked to December 15, 1912, by D. E. Ball)

## A.—SPEED

## 1.—Time on a Given Distance

(a) Aviator Alone

Distance		Holder	Place	Date	Machine	Motor	Time
Kiloms.	Miles						
5	3.107	J. Védrières	Clearing, Ill.	Sept. 9, 1912	Deperdussin mono	140 h. p. Gnôme	1' 44 1-5"
10	6.214	J. Védrières	Clearing, Ill.	Sept. 9, 1912	Deperdussin mono	140 h. p. Gnôme	3' 27 3-5"
20	12.427	J. Védrières	Clearing, Ill.	Sept. 9, 1912	Deperdussin mono	140 h. p. Gnôme	6' 56
30	18.641	J. Védrières	Betheny, France	July 13, 1912	Deperdussin mono	140 h. p. Gnôme	10' 33 4-5"
40	24.855	J. Védrières	Betheny, France	July 13, 1912	Deperdussin mono	140 h. p. Gnôme	14' 5 3-5"
50	31.068	J. Védrières	Betheny, France	July 13, 1912	Deperdussin mono	140 h. p. Gnôme	17' 37 3-5"
100	62.137	J. Védrières	Betheny, France	July 13, 1912	Deperdussin mono	140 h. p. Gnôme	35' 17 3-5"
150	93.205	J. Védrières	Betheny, France	July 13, 1912	Deperdussin mono	140 h. p. Gnôme	52' 52 4-5"
200	124.274	J. Védrières	Betheny, France	July 13, 1912	Deperdussin mono	140 h. p. Gnôme	1h. 10' 55"
250	155.342	M. Tabuteau	Pau, France	Mar. 1, 1912	Morane-Saulnier mono	50 h. p. Gnôme	2h. 07' 54 1-5"
300	186.411	E. Cobiono	Somma, Italy	Mar. 28, 1912	Caproni mono	50 h. p. Anzani	2h. 49'
350	217.479	P. M. Bourriquet	Buc, France	Dec. 31, 1910	R. E. P. mono	45 h. p. R. E. P.	4h. 17' 26 1-5"
400	248.548	P. M. Bourriquet	Buc, France	Dec. 31, 1910	R. E. P. mono	45 h. p. R. E. P.	4h. 54' 06 4-5"
450	279.616	P. M. Bourriquet	Buc, France	Dec. 31, 1910	R. E. P. mono	45 h. p. R. E. P.	5h. 30' 35 3-5"
500	310.685	P. M. Bourriquet	Buc, France	Dec. 31, 1910	R. E. P. mono	45 h. p. R. E. P.	6h. 07' 07 4-5"
1010	627.584	G. Fourny	Étampes, France	Sept. 11, 1912	M. Farman bi	80 h. p. Renault	13h. 18'
(b) Aviator and One Passenger							
5	3.107	Lieut. H. Bier	W.-Neustadt	Oct. 1, 1911	Étrich mono	50 h. p. Gnôme	2' 58"
10	6.214	G. Legagneux	Corbeaulieu, Fr.	July 20, 1912	Zens mono	80 h. p. Gnôme	4' 24 4-5"
20	12.427	G. Legagneux	Corbeaulieu, Fr.	July 20, 1912	Zens mono	80 h. p. Gnôme	8' 51"
30	18.641	G. Legagneux	Corbeaulieu, Fr.	July 20, 1912	Zens mono	80 h. p. Gnôme	13' 18 3-5"
40	24.855	G. Legagneux	Corbeaulieu, Fr.	July 20, 1912	Zens mono	80 h. p. Gnôme	17' 44 4-5"
50	31.068	G. Legagneux	Corbeaulieu, Fr.	July 20, 1912	Zens mono	80 h. p. Gnôme	22' 13"
100	62.137	G. Legagneux	Corbeaulieu, Fr.	July 20, 1912	Zens mono	80 h. p. Gnôme	44' 36 3-5"
150	93.205	G. Legagneux	Corbeaulieu, Fr.	July 20, 1912	Zens mono	80 h. p. Gnôme	1h. 7' 10"
200	124.274	Lieut. H. Bier	W.-Neustadt	Oct. 1, 1911	Étrich mono	100 h. p. Daimler	2h. 03' 49"
250	155.342	Lieut. H. Bier	W.-Neustadt	Oct. 1, 1911	Étrich mono	100 h. p. Daimler	2h. 39' 37"
(c) Aviator and Two Passengers							
10	6.214	E. Nieuport	Mourmelon	Mar. 9, 1911	Nieuport mono	50 h. p. Gnôme	6'
20	12.427	E. Nieuport	Mourmelon	Mar. 9, 1911	Nieuport mono	50 h. p. Daimler	11' 59 2-5"
30	18.641	E. Nieuport	Mourmelon	Mar. 9, 1911	Nieuport mono	50 h. p. Daimler	17' 52 3-5"
40	24.855	E. Nieuport	Mourmelon	Mar. 9, 1911	Nieuport mono	50 h. p. Daimler	22' 44 2-5"
50	31.068	E. Nieuport	Mourmelon	Mar. 9, 1911	Nieuport mono	50 h. p. Daimler	29' 37 2-5"
100	62.137	E. Nieuport	Mourmelon	Mar. 9, 1911	Nieuport mono	50 h. p. Daimler	59' 08"
(d) Aviator and Three Passengers							
10	6.214	G. Busson	Rheims	Mar. 10, 1911	Deperdussin mono	100 h. p. Gnôme	6' 16 3-5"
20	12.427	G. Busson	Rheims	Mar. 10, 1911	Deperdussin mono	100 h. p. Gnôme	12' 34 1-5"
30	18.641	G. Busson	Rheims	Mar. 10, 1911	Deperdussin mono	100 h. p. Gnôme	18' 48"
40	24.855	G. Busson	Rheims	Mar. 10, 1911	Deperdussin mono	100 h. p. Gnôme	25' 05 3-5"
50	31.068	G. Busson	Rheims	Mar. 10, 1911	Deperdussin mono	100 h. p. Gnôme	31' 23 1-5"
(e) Aviator and Four Passengers							
5	3.107	G. Busson	Rheims	Mar. 10, 1911	Deperdussin mono	100 h. p. Gnôme	3' 34"
10	6.214	G. Busson	Rheims	Mar. 10, 1911	Deperdussin mono	100 h. p. Gnôme	7' 08"
20	12.427	G. Busson	Rheims	Mar. 10, 1911	Deperdussin mono	100 h. p. Gnôme	14' 00 3-5"

## 2.—Distance in a Given Time

(a) Aviator Alone

Distance		Holder	Place	Date	Machine	Motor	Time
Kiloms.	Miles						
45.664	28.233	J. Védrières	Betheny, France	July 13, 1912	Deperdussin mono	140 h. p. Gnôme	15'
84.665	52.378	J. Védrières	Betheny, France	July 13, 1912	Deperdussin mono	140 h. p. Gnôme	30'
168.244	104.374	J. Védrières	Betheny, France	July 13, 1912	Deperdussin mono	140 h. p. Gnôme	1 hr.
227.454	141.333	M. Tabuteau	Pau, France	Feb. 23, 1912	Morane-Saulnier mono	50 h. p. Gnôme	2 hrs.
310.287	192.803	M. Tabuteau	Pau, France	Jan. 24, 1912	Morane-Saulnier mono	50 h. p. Gnôme	3 hrs.
325.905	202.508	P. M. Bourriquet	Buc, France	Dec. 31, 1910	R. E. P. mono	45 h. p. R. E. P.	4 hrs.
407.675	253.317	P. M. Bourriquet	Buc, France	Dec. 31, 1910	R. E. P. mono	45 h. p. R. E. P.	5 hrs.
490.	304.471	P. M. Bourriquet	Buc, France	Dec. 31, 1910	R. E. P. mono	45 h. p. R. E. P.	6 hrs.
522.935	324.936	M. Tabuteau	Buc, France	Dec. 30, 1910	M. Farman bi	60 h. p. Renault	7 hrs.
510.	316.899	G. Fourny	Buc, France	Sept. 1, 1911	M. Farman bi	60 h. p. Renault	8 hrs.
580.	360.395	G. Fourny	Buc, France	Sept. 1, 1911	M. Farman bi	60 h. p. Renault	9 hrs.
650.	403.89	G. Fourny	Buc, France	Sept. 1, 1911	M. Farman bi	60 h. p. Renault	10 hrs.
710.	441.173	G. Fourny	Buc, France	Sept. 1, 1911	M. Farman bi	60 h. p. Renault	11 hrs.
(b) Aviator and One Passenger							
24.805	16.413	Lieut. H. Bier	W.-Neustadt	Oct. 1, 1911	Étrich mono	100 h. p. Daimler	15'
66.639	41.406	G. Legagneux	Corbeaulieu, Fr.	July 20, 1912	Zens mono	80 h. p. Gnôme	30'
133.469	82.579	G. Legagneux	Corbeaulieu, Fr.	July 20, 1912	Zens mono	80 h. p. Gnôme	1 hr.
190.858	118.593	Lieut. H. Bier	W.-Neustadt	Oct. 1, 1911	Étrich mono	100 h. p. Daimler	2 hrs.
224.85	139.715	R. Level	Chartres	July 30, 1911	Savary bi	60 h. p. Labor Aviation	3 hrs.

## 3.—Greatest Speed, Whatever the Length of the Flight

(a) Aviator Alone

Holder	Place	Date	Machine	Motor	Speed per Hour	
					Kilom.	Miles
J. Védrières	Betheny, France	July 13, 1912	Deperdussin mono	140 h. p. Gnôme	170.77	106.069
(b) Aviator and One Passenger						
G. Legagneux	Corbeaulieu, France	July 20, 1912	Zens mono	80 h. p. Gnôme	135.952	84.296
(c) Aviator and Two Passengers						
E. Nieuport	Mourmelon, France	Mar. 9, 1911	Nieuport mono	50 h. p. Gnôme	102.855	63.911
(d) Aviator and Three Passengers						
G. Busson	Rheims, France	Mar. 10, 1911	Deperdussin mono	100 h. p. Gnôme	96.308	59.843
(e) Aviator and Four Passengers						
G. Busson	Rheims, France	Mar. 10, 1911	Deperdussin mono	100 h. p. Gnôme	87.251	54.215

## B.—GREATEST DISTANCE

## (a) Aviator Alone

Holder	Place	Date	Machine	Motor	Distance Kilom.	Covered Miles
G. Fourny	Étampes, France	Sept. 11, 1912	M. Farman bi	80 h. p. Renault	1010.668	628
Lieut. H. B. Barrington-Kennett	Salisbury Plain, Eng.	(b) Feb. 14, 1912	Aviator and One Passenger Nieuport mono	70 h. p. Gnome	401.495	249.477
Lieut. H. Bier	Wiener-Neustadt, Austria	(c) Oct. 4, 1911	Aviator and Two Passengers Etrich mono	100 h. p. Daimler	112.	69.593
G. Bussou	Rheims, Betheny, France	(d) Mar. 10, 1911	Aviator and Three Passengers Deperdussin mono	100 h. p. Gnome	50.	31.068
G. Bussou	Rheims, Betheny, France	(e) Mar. 10, 1911	Aviator and Four Passengers Deperdussin mono	100 h. p. Gnome	25.74	15.994

## C.—GREATEST DURATION

## (a) Aviator Alone

Holder	Place	Date	Machine	Motor	Duration of Flight
G. Fourny	Étampes, France	Sept. 11, 1912	M. Farman bi	80 h. p. Renault	13 hrs. 18'
J. Suvelack	Johannisthal, Germany	(b) Dec. 8, 1911	Aviator and One Passenger Rumpler-Etrich mono	50 h. p. Rumpler	4 hrs. 34'
J. Pietschker	Johannisthal, Germany	(c) Oct. 1, 1911	Aviator and Two Passengers Albatros bi	100 h. p. Argus	2 hrs. 19'
K. Grulich	Johannisthal, Germany	(d) Jan. 25, 1912	Aviator and Three Passengers Harlan mono	100 h. p. Argus	1 hr. 35'
Abramovitch	St. Petersburg, Russia	(e) September 24, 1912	Aviator and Four Passengers Wright bi	100 h. p. N. A. G.	45' 54"
H. Molla	Douzy, France	(f) Jan. 26, 1912	Aviator and Five Passengers Sommer bi	70 h. p. Gnome	1 h. 05' 48 1-5"

## D.—ALTITUDE

## 1.—Greatest Altitude

## (a) Aviator Alone

Holder	Place	Date	Machine	Motor	Altitude Meters	Attained Feet
*Legagneux	Issy-Villacoublay, France	Sept. 17, 1912	Morane Saulnier	80 h. p. Gnome	5,450	17,881
Lieut. Blaschke	Vienna, Austria	(b) June 29, 1912	Aviator and One Passenger Lohner-Arrow bi	120 h. p. Aus.-Daimler	4,360	14,300
Lieut. Blaschke	Vienna, Austria	(c) June 23, 1912	Aviator and Two Passengers Lohner-Arrow bi	120 h. p. Aus.-Daimler	3,580	11,756
Sablatnig	Berlin-Teltow, Germany	(d) Sept. 27, 1912	Aviator and Three Passengers Bomhard-Pfeil bi	125 h. p. Aus.-Daimler	1,120	3,673
Ellery von Gorrissen,	Johannisthal, Germany	(f) Nov. 7th, 1912	Aviator and Five Passengers Ago-Otto Bi	100 h. p. Argus	50	1,640

## 2.—Climbing (Upward Vertical Speed)

## (a) Aviator Alone

Holder	Place	Date	Machine	Motor	Altitude Meters	Time
R. Simon	Chicago, U. S. A.	Ang. 19, 1911	Blériot mono	50 h. p. Gnome	500	3' 35"
T. O. Sopwith	Chicago, U. S. A.	Aug. 19, 1911	Blériot mono	70 h. p. Gnome	500	3' 35"
C. Grahame-White	Nassau Boulevard, U. S. A.	(b) Sept. 30, 1911	Aviator and One Passenger Nieuport mono	70 h. p. Gnome	1,000 (3,280 ft.)	9'

## E.—CROSS COUNTRY

## 1.—Greatest Total Distance

C. P. Rodgers	New York to Pasadena, Cal.	Sept. 17-Nov. 8, 1911	Wright bi	35 h. p. Wright motor	4,017 miles
---------------	----------------------------	-----------------------	-----------	-----------------------	-------------

## 2 Greatest Distance in a Single Day

Pierre Daucourt	Valenciennes to Biarritz, France	October 6, 1912	Borel mono	Gnome	570 miles
-----------------	----------------------------------	-----------------	------------	-------	-----------

## F.—HYDRO-AEROPLANE

## 1.—Continuous Flight

Lieut. John H. Towers	Annapolis, Md., U. S. A.	Oct. 6, 1912	Curtiss Hydro-aero	75 h. p. Curtiss motor	6h. 10'
-----------------------	--------------------------	--------------	--------------------	------------------------	---------

## 2.—Greatest Total Distance (With Passenger)

Anthony Jannus,	Omaha to New Orleans, U. S. A.	Nov. 5th-Dec. 15, 1912	Benoist hydro-aero	75 h. p. Roberts	1,970 miles
-----------------	--------------------------------	------------------------	--------------------	------------------	-------------

\*As AIRCRAFT goes to press a cablegram states that Roland Garros on December 11, 1912, at Tunis, Africa, attained an altitude of 19,032 feet. These figures, however, may undergo some change before being officially recognized.

The student of aeronautical statistics, who desires a complete line of accurate records from the beginning of aviation should have in his library bound volumes of AIRCRAFT, Vol. I, Vol. II, Vol. III. All the great aeronautical statisticians of the world rely upon AIRCRAFT records for their information, and as a foundation upon which to build their own compilations.

These volumes can be purchased from The Lawson Publishing Company, 37 East 28th Street, New York, for the sum of \$3.50 each. A few years from now, these volumes, which also contain a complete history of the movement from its inception, will become priceless owing to their scarcity.

# AMERICAN AVIATION RECORDS

(In Closed Circuit, Without Stops)

(Checked to December 15, 1912)

## A.—SPEED

## 1.—Time on a Given Distance

## (a) Aviator Alone

<i>Kilom.</i>	<i>Miles</i>	<i>Holder</i>	<i>Place</i>	<i>Date</i>	<i>Machine</i>	<i>Motor</i>	<i>Time</i>
5	3.107	J. Védérines	Clearing, Ill.	Sept. 9, 1912	Deperdussin	140 h. p. Gnome	1' 44 1-5''
10	6.214	J. Védérines	Clearing, Ill.	Sept. 9, 1912	Deperdussin	140 h. p. Gnome	3' 27 3-5''
20	12.427	J. Védérines	Clearing, Ill.	Sept. 9, 1912	Deperdussin	140 h. p. Gnome	6' 56''
30	18.641	J. Védérines	Clearing, Ill.	Sept. 9, 1912	Deperdussin	140 h. p. Gnome	10' 45 4-5''
40	24.855	J. Védérines	Clearing, Ill.	Sept. 9, 1912	Deperdussin	140 h. p. Gnome	14' 19 1-5''
50	31.068	J. Védérines	Clearing, Ill.	Sept. 9, 1912	Deperdussin	140 h. p. Gnome	17' 51 4-5''
100	62.137	J. Védérines	Clearing, Ill.	Sept. 9, 1912	Deperdussin	140 h. p. Gnome	35' 40 1-5''
150	93.205	J. Védérines	Clearing, Ill.	Sept. 9, 1912	Deperdussin	140 h. p. Gnome	53' 18 4-5''
200	124.274	J. Védérines	Clearing, Ill.	Sept. 9, 1912	Deperdussin	140 h. p. Gnome	1 h. 10' 57''
250	155.342	St. C. Johnstone	Mineola, N. Y.	July 27, 1911	Moisant	50 h. p. Gnome	3 h. 32' 56 2-5''
(b) Aviator and One Passenger							
10	6.214	C. Grahame-White	Nassau B'lev'd, N. Y.	Sept. 30, 1911	Nieuport	70 h. p. Gnome	6' 13 2-5''
20	12.427	C. Grahame-White	Nassau B'lev'd, N. Y.	Sept. 30, 1911	Nieuport	70 h. p. Gnome	12' 26 3-5''
30	18.641	C. Grahame-White	Nassau B'lev'd, N. Y.	Sept. 30, 1911	Nieuport	70 h. p. Gnome	18' 42''
40	24.855	C. Grahame-White	Nassau B'lev'd, N. Y.	Sept. 30, 1911	Nieuport	70 h. p. Gnome	24' 49 4-5''
50	31.068	C. Grahame-White	Nassau B'lev'd, N. Y.	Sept. 30, 1911	Nieuport	70 h. p. Gnome	31' 01 3-5''
(c) Aviator and Two Passengers							
5	3.107	T. O. M. Sopwith	Chicago, Ill.	Aug. 15, 1911	Wright	30 h. p. Wright	6' 56 2-5''

## 2.—Distance in a Given Time

## (a) Aviator Alone

<i>Kilom.</i>	<i>Miles</i>	<i>Holder</i>	<i>Place</i>	<i>Date</i>	<i>Machine</i>	<i>Motor</i>	<i>Time</i>
168.244	104.374	J. Védérines	Clearing, Ill.	Sept. 9, 1912	Deperdussin	140 H. P. Gnome	1 hr.
141.97	88.216	St. C. Johnstone	Mineola, N. Y.	July 27, 1911	Moisant	50 h. p. Gnome	2 hrs.
214.57	133.327	St. C. Johnstone	Mineola, N. Y.	July 27, 1911	Moisant	50 h. p. Gnome	3 hrs.
283.628	176.238	St. C. Johnstone	Mineola, N. Y.	July 27, 1911	Moisant	50 h. p. Gnome	4 hrs.
(b) Aviator and One Passenger							
24.14	15	C. Grahame-White	Squantum, Mass.	Sept. 4, 1911	Nieuport	70 h. p. Gnome	15'
48.28	30	C. Grahame-White	Nassau B'lev'd, N. Y.	Sept. 30, 1911	Nieuport	70 h. p. Gnome	30'

## 3.—Greatest Speed Obtained, Whatever the Length of the Flight

## (a) Aviator Alone

<i>Holder</i>	<i>Place</i>	<i>Date</i>	<i>Machine</i>	<i>Motor</i>	<i>Speed per Kilom.</i>	<i>Hour Miles</i>	
Jules Védérines	Clearing, Ill.	Sept. 9, 1912	Deperdussin	140 h. p. Gnome	169.785	105.5	
(b) Aviator and One Passenger							
C. Grahame-White	Squantum, Mass.	Sept. 4, 1911	Nieuport	70 h. p. Gnome	101.762	63.232	
(c) Aviator and Two Passengers							
T. O. M. Sopwith	Chicago, Ill.	Aug. 15, 1911	Wright	30 h. p. Wright	56.263	34.96	

## B.—GREATEST DISTANCE

## Aviator Alone

<i>Holder</i>	<i>Place</i>	<i>Date</i>	<i>Machine</i>	<i>Motor</i>	<i>Distance Covered Kilom.</i>	<i>Miles</i>
St. C. Johnstone	Mineola, N. Y.	July 27, 1911	Moisant	50 h. p. Gnome	283.628	176.238

## C.—GREATEST DURATION

## (a) Aviator Alone

<i>Holder</i>	<i>Place</i>	<i>Date</i>	<i>Machine</i>	<i>Motor</i>	<i>Duration of Flight</i>
Lieut. John H. Towers	Annapolis, Md.	Oct. 6, 1912	Curtiss hydro-aero	80 h. p. Curtiss	6h. 10'
(b) Aviator and One Passenger					
Walter E. Johnson	Bath, N. Y.	Oct. 31, 1912	Thomas	65 h. p. Kirkham	3h. 51' 15''
(c) Aviator and Two Passengers					
T. de W. Milling	Nassau B'lev'd, N. Y.	Sept. 26, 1911	Burgess-Wright	30 h. p. Wright	1h. 54 42' 3-5''
(d) Aviator and Three Passengers					
Anthony Jannus	Cicero, Ill.	Sept. 14, 1912	Benoist	75 h. p. Roberts	1'

## D.—ALTITUDE

## 1.—Greatest Altitude

## (a) Aviator Alone

<i>Holder</i>	<i>Place</i>	<i>Date</i>	<i>Machine</i>	<i>Motor</i>	<i>Altitude Attained Meters</i>	<i>Feet</i>
L. Beachy	Chicago, Ill.	Aug. 20, 1911	Curtiss	75 h. p. Curtiss	3,548½	11,642
(b) Aviator and One Passenger						
Harry Bingham Brown	Oakwood Heights, N. Y.	Nov. 5, 1912	Wright	35 h. p. Wright	1,524	5,000

## 2.—Climbing (Upward Vertical Speed)

## (a) Aviator Alone

<i>Holder</i>	<i>Place</i>	<i>Date</i>	<i>Machine</i>	<i>Motor</i>	<i>Altitude Meters</i>	<i>Time</i>
R. Simon	Chicago, Ill.	Aug. 19, 1911	Blériot	50 h. p. Gnome	500	3' 35''
T. O. M. Sopwith	Chicago, Ill.	Aug. 19, 1911	Blériot	70 h. p. Gnome	500	3' 35''
(b) Aviator and One Passenger						
C. Grahame-White	Nassau B'lev'd, N. Y.	Sept. 30, 1911	Nieuport	70 h. p. Gnome	1,000	9'
					(3,280 ft.)	

## G.—CROSS-COUNTRY

## 1.—Greatest Total Distance

C. P. Rodgers	New York to Pasadena, Cal.	Sept. 17-Nov. 8, 1911	Wright bi	35 h. p. Wright	4,017 miles
---------------	----------------------------	-----------------------	-----------	-----------------	-------------

## 2.—Greatest Distance in a Single Day

C. P. Rodgers	Sanderson to Sierra-Blanca	Oct. 28, 1911	Wright bi	35 h. p. Wright	231 miles
---------------	----------------------------	---------------	-----------	-----------------	-----------

## H.—HYDRO-AEROPLANE

## 1.—Continuous Flight

Lieut. John H. Towers	Annapolis, U. S. A.	Oct. 6, 1912	Curtiss hydro-aero	80 h. p. Curtiss	Duration of Flight 6h. 10'
-----------------------	---------------------	--------------	--------------------	------------------	----------------------------

## 2.—Greatest Total Distance (With Passenger)

Anthony Jannus	Omaha to New Orleans, U. S. A.	Nov. 5-Dec. 15, 1912	Benoist hydro-aero	75 h. p. Roberts	1,970 miles (Following course of river)
----------------	--------------------------------	----------------------	--------------------	------------------	---



# GENERAL NEWS

By D. E. BALL

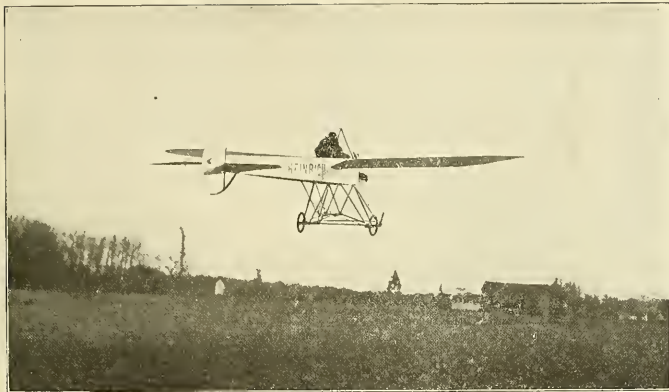

Albert Heinrich carrying a passenger in a 35 H. P. Heinrich monoplane at Baldwin, L. I.

## Fifty Aeroplanes May be Ordered by the U. S. Government in 1913

It is stated that the United States War Department plans to order approximately fifty aeroplanes to be used in 1913. Several new aeroplane stations are to be established in the United States as well as at Panama, Hawaii and the Philippines and the new machines ordered will be distributed according to the importance of the different stations. A number of hydro-aeroplanes will be included in the order and undoubtedly several will be stationed at the Panama Canal and also at Governor's Island, New York City, and in all probability in due time every important seaport will have its complement of both land and marine aeroplanes. The complete Government plans are as follows: 1. Five conveniently located training schools, known as "centers of aviation," to be located, one on the Atlantic coast, one on the Pacific coast, one on the Great Lakes, one on the Gulf coast, and one at some central interior point, and as many auxiliary centers as it may be possible to organize, with a view to having a school of instruction in each state. Each center will comprise sheds, workshops, storerooms, and barracks and will be both a place of instruction and a place on concentration for the squadrons. These "centers of aviation" are designed to train officers of the regular army and organized militia as aviators, to train enlisted men as aeroplane mechanics, to investigate and test aviation devices, to study meteorology as applied to aviation, wireless telegraphy as applied to aviation, military topography, sketching and reconnaissance from air craft, the dropping of projectiles from air craft, the use of small arms and machine guns from air craft, the design of military air craft, and all other matters tending to improve the military aviation service.

While the scheme outlined in paragraph 1 is that toward which the War Department desires to work, it is not intended to establish new posts or aviation fields for this purpose. The field at College Park, Md., now in use, and such existing posts and buildings as are available and suitably located will be utilized and the scheme developed as personnel and material become available.

2. The organization of three aviation squadrons as the complement for one field army of regular troops, this being an allowance of one squadron for each division (2) and one for the headquarters of the field army. It is expected to specialize for each field army a company or squadron of extra powered machines for a long-distance reconnaissance and to also specialize a number of machines for use in connection with the field artillery.

3. The organization of two squadrons for use in the Philippine Islands.

4. The organization of one squadron for use in Hawaii.

5. The organization of one squadron for use in Panama.

6. The organization of aero units for use at 14 groups of coast-defense stations in the United States, the equipment for these 14 stations not to be less than the equivalent of eight squadrons.

7. Organized Militia—All mobile troops in addition to the field army to be provided with aviation service from the organized militia, with the assistance of the staff of the five training schools ("aviation centers"); the allowance of aeroplanes to be in the same proportion as for the regular establishment—i. e., one squadron for each division of troops.

## California News

By O. S. T. Meyerhoffer.

Election year begins are beginning to hum in the aviation line. Aviators all over the states are flocking

back to civilization of God's favored land, California, where there is only one season the year round—summer. The Pasadena High School has added a course in aviation to its curriculum. Athletic instructor Diggins, who owns a biplane, will be instructor.

Mr. Thaddeus S. Kerns of Chico, Cal., has made several ten and fifteen minute flights at Sunset field. On November 2d he attracted general attention by flying over the Alameda-Reno football game and stopped the game for a while.

The California Aviation Co. is building two new school machines, both of the Curtiss type, one standard single surface and one headless double surface.

In the aviation game there are two kinds of aviators—aviators that fly in the air and aviators that fly in hot air. When the latter type don't make good, they as a rule get in trouble some way or another and do any old thing to make money. Aviator Didier Masson fell October 20th about 100 feet at Sunset field, Alameda, Cal., smashing a propeller, struts, wings, etc. He had the machine repaired immediately and changed the control to Curtiss and tried it out the following Sunday and then took her up several hundred feet when all at once he lost control and came tumbling down, totally wrecking the plane and doing some minor damage to the engine. Masson was treated at the Harbor Emergency Hospital and is now ready for more.

Aviator Robert H. Fowler, the only living coast to coast aviator, who has won international fame by flying from Los Angeles, Cal. to Jacksonville, Fla., started to fly from Los Angeles to San Francisco, but gave up the trip after a slight injury, which his machine received while landing near Bakersfield. On November 12th, Fowler, who was the star attraction at the Empress Theatre for that week, flew over the very heart of San Francisco, making several beautiful circles, then returning and landing at the Presidio from where he started.

C. A. Kelsey of 1601 Derby Street, Berkeley, Cal., was struck on the head by a propeller while testing out an engine, which he has perfected. He was knocked unconscious, the propeller cutting several deep gashes on his head. He is recovering.

Aviators take notice and all you bum chauffeurs also. For years you have held your nose in the air,

laughing at the poor boob that had to hire a horse and take their best girls buggy riding and how you used to look your horn as you passed them. How you used to honk, honk, when you saw some nice looking girls on the corner. Times have changed. Now it is, Ah, the aviator, isn't he handsome? I'd give my life if he'd take me for a ride. And when the aviators take them for a ride such a difference. When a girl takes objection to a "bum chauffeur" she gets out of the car and walks, or rides home on the street car. They never step off the airship until the aviator lets them. They never argue, they never tell the aviator that he is too busy. Fly the bum chauffeur.

Ed. Say, George, buy me an aviator highball.

George. What kind of a highball is that?

Ed. Bi plane whiskey.

## A PLAY IN TWO ACTS

Act One.

Ed. (Ringing up to George breathless). "Say George, have you heard about the last suicide. An aviator to New York took his best girl up in his flying machine and thought he was going to get a lot of notoriety by being the first man to propose in an airship, but the girl refused him and he took it so hard that he jumped out of the machine, 1000 feet in the air, being killed instantly."

George. "What became of the girl?"

Ed. "She was a chicken and she flew down."

Act Two.

George buying a drink.

The first Aviation meet held in San Francisco for over two and one-half years was held by the California Aviation Co. at Ingleside, on November 24th. The meet was well advertised and brought quite a good crowd, although the biggest crowd stayed on the hills on the outside. Roy Francis and Harry Crawford were the star attractions, but many amateurs participated, such as Professor Bolinsky with his triplane, Aviator J. F. De Villa with his Nieuport monoplane, Albert S. Frye, Curtiss type biplane; Gus F. Siegfried, Bleriot monoplane.

Roy C. Francis took Miss O'Brien, leading lady of the "Butterfly on the Wheel" at the Court Theatre across San Francisco Bay in his flying machine. Miss O'Brien is the first woman to fly across the bay. Francis started at Sunset field, flew over Goat Island, right over the business part of San Francisco, out around the Seal Rocks and landing on the Boulevard right outside the famous Sheahan's Cafe, amidst the cheers of thousands of spectators who had motored out to the beach to see the landing. Francis, who is probably the handsomest aviator, flying in the United States, was a real Hobson. After the landing he had to jump in an automobile and run away from the beach to escape the admiring members of the fair sex. Rumors were current that it was an aeroplane ejection, but both Mr. Francis and Miss O'Brien deny this emphatically.

Harry Crawford, who is flying for the California Aviation Co. made over city flights on Saturday, November 23d, advertising the Ingleside meet, dropping tickets. He flew from the coursing park straight down Market Street, circling the Call Building then after circling over the business section of the town, flew back to the coursing park. Crawford has one of the speediest machines in this part of the country and flies at an average speed of seventy-two miles per hour. On Tuesday, November 26th, he flew from Ingleside across San Francisco Bay and over to Sunset Field. The day before Roy Francis flew from Ingleside to the Presidio.

On November 19th, R. S. Fowler flew right over the heart of San Francisco, circling the town about five times. He started and landed at the Presidio. Fowler had his machine on the stage at the Empress Theatre, and played before a crowded house.

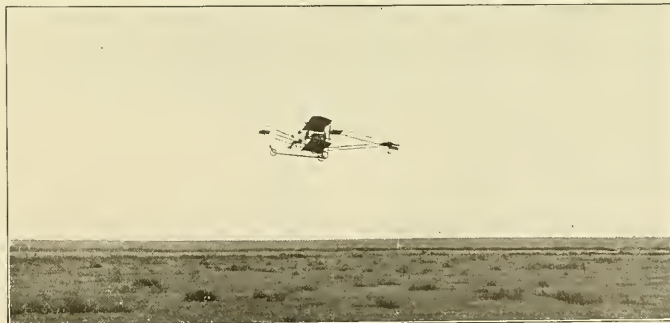

The single surface Benoist Biplane, of the Wetzlar Brothers, of Junction City, Kansas, making a flight at Oakley, Kansas. See E. R. Careys letter on page 318 of this issue.

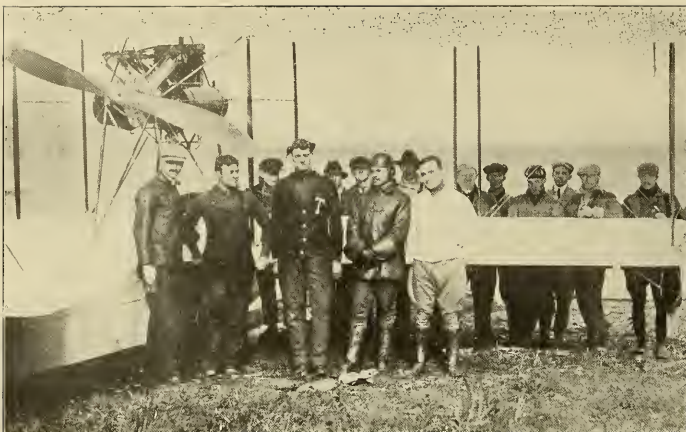

Glenn H. Curtiss and a group of army, navy and civilian students taken at the Curtiss Aviation school. Mr. Curtiss is seen standing on the extreme left in front of his latest type flying boat.

The Sloane School of Aviation is in active operation on Dominguez Field, Cal. It made a very successful debut November 23d and has been very active since then. The machines and equipment have caused a great deal of interest and comment all over the Pacific Coast. It is considered that this is the finest equipment ever seen in that part of the country.

On Thanksgiving Day John Guy Glipatic, the young graduate of the Sloane School, made a new passenger-carrying altitude record in the big 60 H. P. Military Type Deperduzz. This machine was equipped with an Anzani Motor and Charavay propeller. He was in the air an hour and sixteen minutes and attained an altitude of 5006 feet. The motor was perfectly cool and everything was in fine condition at the end of the flight.

W. Leonard Bonney, the chief instructor, has been doing a good deal of flying in fast Caudron Monoplanes in all parts of the country. He has become an expert in handling the 45 H. P. Anzani Caudron which is without doubt the fastest machine in the country. A few days ago he made a twenty-three mile flight from Dominguez Field to the ocean front, and back around Signal Hill in fifteen minutes. Last Saturday he was entered in a race from Los Angeles to Bloomington. He was to race against an automobile and a motorcycle. The start was made from the rifle range just outside of Los Angeles. The motor car was started first, then the motorcycle and last of all the speedy Caudron. Bonney made a remarkable flight and was well up on his competitors when near the end of the course he was caught in a terrific desert hurricane and sand storm. The weather bureau estimated that the wind was blowing eighty miles an hour at 2000 feet altitude. Bonney managed his machine magnificently in this tempest and made a brilliant landing within a mile of the end of the course. He displayed the most wonderful airmanship seen on the coast in a long time.

The Aero Club of California, at Los Angeles, will hold its "Fourth International Aviation Meet" during the month of January, 1913.

The dates have not as yet been definitely decided upon but the Meet will be held about the middle of January. Massive preparations have been under way for the past two months under excellent management so that a tremendous success is assured.

It is planned to hold the Meet on a strictly competitive basis offering prizes, a percentage of the receipts. No guarantees or advance money will be paid. Owing to the way in which the affair is being managed it is believed that the receipts will far exceed those of the 1912 Meet.

The Sloane Aeroplane Company expects to do some extensive cross country touring with their speedy machines. According to the officers of the Sloane Aeroplane Company there is nothing the matter with aviation in America at the present time.

#### Rotary Maxim Motor Tested

After a trial of the Rotary Maxim Motor in tractor type Curtiss biplane Mr. F. Shiller made arrangements to have a Maxim motor installed in his Nieuport type monoplane, while Mr. C. Hall who witnessed the tests immediately placed an order for one to be installed in his tractor biplane.

#### Aero Club of New England

Capt. Robert Bartlett, the captain of the Roosevelt, from which the Peary Arctic expedition made its trip to the North pole, was the principal speaker at the annual meeting of the Aero Club of New England and suggested a trip to the North pole by aeroplane.

"The quickest, safest and easiest way to reach the North pole, and at the same time entirely feasible is by aeroplane," said Captain Robert Bartlett. "An aeroplane can be taken to Cape Morris K. Jessup, which is but 381 miles from the pole by land.

From there it is but a question of four hours' flight with the newest machines. There is no difficulty in finding suitable landing places, the ice everywhere provides it. But there are no supplies, and the aviator must carry sufficient gasoline to make the trip and back.

"The ideal trip and the one which would remove all question of having been at the Pole would be to make the flight directly over the pole, continuing on to Cape Cheluskine, Siberia, which is 720 miles beyond the pole. I believe such a trip will be made, and that not long hence. The summer months of July and August would be ideal for such a flight, and I can see no serious difficulties which might not be sufficiently guarded against."

These officers were elected at the business meeting presided over by the retiring president, Jay B. Benton: President, Henry Howard, Boston; first vice-president, John J. Van Valkenburgh, South Framingham; second vice-president, J. Walter Flagg, Worcester; secretary, Alfred R. Shrigley, Boston; treasurer, William Carroll Hill, Boston; Directors, Nathan L. Amster, Jay B. Benton, T. E. Byrnes, H. Helm Clayton, J. Walter Flagg, Charles J. Glidden, Henry Howard, William Carroll Hill, G. S. Hayward, Alfred R. Shrigley, John J. Van Valkenburgh. Committees—Contests and balloons, Messrs. Glidden, Benton, Van Valkenburgh; Aeroplanes, Messrs. Howard, Clayton, Osgood; Membership, Messrs. Hill, Shrigley, Osgood; House and Library, Messrs. C. W. Borron, Byrnes, Amster; Entertainment, Messrs. Glidden, Shrigley, Hill; Foreign relations, Messrs. Howard, Glidden.

#### Pennsylvania News

E. O. Weeks is successfully flying the modified Curtiss type plane with the 60 H. P. Curtiss engine, built by Williams of Scranton.

Weeks' flying at the Aeronautical Society grounds when opened Oct. 12th at Oakwood Heights was very creditable. On Oct. 30th he made a 40 mile flight around Scranton. Good flights were also made on Nov. 11th and 23d. On the former date Weeks was up over forty-two minutes and at times was lost to view in the smoke and fog which hung over the city.

The Flying Boat which is being built for Marshall Earle Reid, the Philadelphia aviator, is nearing completion in Washington. It will be a Columbia machine with a three bladed Simmons propeller and 80 horsepower rotary motor with self starter.

Bergdoll, flew his Wright machine on December 1st at Eagle Aviation Field and when about to make a landing the crowd swarmed into the grounds directly in his path, with excellent judgment Bergdoll rose over their heads circled the field and landed at the far end of the grounds, taking his chance of smashing into a fence which he just cleared, in preference to running into the crowd. The usual balloon ascension with parachute drop was made immediately following the aeroplane flight.

The Aero Club of Pennsylvania held a smoker Oct. 6th at the Engineers' Club, No. 1317 Spruce Street, Philadelphia, and Arthur T. Atherholt, president of the club, who participated in the recent international balloon race from Stuttgart, Germany, related for the first time his experiences in the race, including his arrest in Russia as a German spy. In describing the landing of the balloon Dusseldorf II, in which he and John Watts, of the Kansas City Aero Club, narrowly escaped serious injury when it dropped on the snow-swept plains of Russia, he declared that of the 150 or more men who, after some hours, came to their rescue not one could read their passports, which were written in six languages, including Russian.

The brainy men of the country, he said, he found to be Jews, and through them the castaways were at last able to obtain some consideration. The meeting was presided over by President Clarence P. Tyne. Nominations were held for the annual election of officers, which will be held at next month's meeting.

#### Activity at the Lillie School

Notwithstanding the changeable weather of the past few weeks, there was considerable activity noticeable at the Lillie Aviation School at Kinloch, Mo., and much good flying was accomplished.

Amongst the number of pupils at the school there are several about ready to take their licenses, these being, Miss Uriel Johnstone, J. R. Carnes, Jesse Brazhous and James Colovos. The Lillie Winter School is now located at San Antonio, Texas, where a large equipment has been carried.

#### Albert Heinrich Carries Passenger in His Monoplane

On November 11, some very successful flights were made at Baldwin, Long Island, by Albert Heinrich in the Heinrich monoplane. In addition to making several successful flights alone, Mr. Heinrich for the first time, carried a passenger, making flights the whole length of the field.

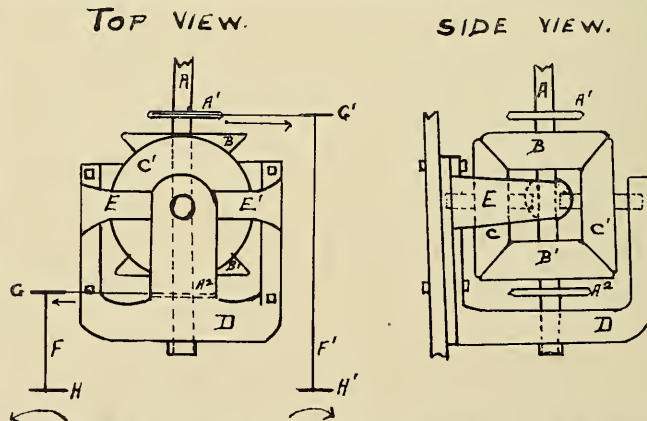

One of our readers, Mr. Frank A. Cerutti has sent in the above sketches showing a driving mechanism for revolving two propellers in opposite directions. The operation of the mechanism can be understood from the sketches but it is well to explain the different parts. A—engine shaft, A'—sprocket wheel fixed to shaft A to revolve therewith, A2—sprocket wheel fixed loosely to shaft A to revolve in an opposite direction; C, C'—bevel gears driven by gear B and in turn driving gear B'; D—frame to support lower end of gear C, upper end of gear C', bearing for engine shaft A; E, E'—part of frame D for supporting upper end of gear C and lower end of gear C'; F, F'—propeller shafts driven by gears C and C'; G being driven by sprocket A', and G being driven by sprocket A2; H, H'—propellers, H revolving anti-clockwise and H' revolving clockwise.

**Burgess Company and Curtis Notes**

The new Burgess Hydro-aeroplane for the U. S. Signal Corps is now being assembled. It represents a distinctive type of construction meeting the special demands of military use for reconnaissance and scouting purposes.

The operators are located in an enclosed nacelle well forward of the main planes and with no obstructions of any kind to their view. At the same time they are well protected from the weather by the location of their seats within the enclosed body.

The planes are of a new type of construction of very much greater strength than has heretofore been used. The hydro-aeroplane is powered with a 60 H. P. Sturtevant motor amply sufficed (as are all Burgess power plants) with a hand starting device for starting the engine without leaving the plane.

The aeroplane is supported in the water by two hydroplanes of a new type recently designed by Messrs. Burgess and Curtis. They are of the two-step variety, the two planes being set at widely varying angles to one another so that the aeroplane as it increases its momentum rises on its forward step and almost automatically falls back upon the rear of the boat, as speed increases throwing the planes at a very efficient angle for leaving the water. The rear step is concave in form and ventilated by a large air tube. The boat is built of copper and braced with Spanish cedar. Patents covering design are applied for.

The tail is very similar to that of the Burgess military weight-carrying aeroplane which was delivered to the Signal Corps during the last season. The hydro-aeroplane as a whole is built to conform to the regular Army specifications.

The design of the new hydro-aeroplane or Flying Boat was completed immediately upon Mr. Burgess' return from the Aero Show in France and he has been able to supplement his own ideas from the very careful study of the development in Europe during the last year. This machine is to be powered with a 70 H. P. motor and will be delivered early in the year.

Work on the standard machines is also progressing and one or two deliveries are expected to be made this month.

The single boat, Burgess design, and Sturtevant power plant for the Navy Wright aeroplane was delivered the latter part of November after extensive tests

proving for the first time that a single boat was thoroughly practical for certain work on an aeroplane having warping wings of the Burgess-Wright type.

It is noteworthy that the English Michelin Cup was won in 1912 by a Sopwith Burgess biplane which is an exact duplicate of the original Burgess-Wright which did such good work for Mr. Sopwith at the Nassau Boulevard Meet in 1911. Sopwith's original Burgess has since been in constant service in England and at the present time is doing splendid work in the hands of Mr. Raynham, a noted English flyer.

Burgess machines have recently been purchased by George A. Gray of Boston, a Wright pupil of last year, John F. McGee of Pawtucket, R. I., and Harry M. Jones of Providence, R. I.

Flying has been especially good since the middle of November. Among pupils training at Marblehead, Lieutenant Loren H. Call of the Coast Artillery and H. L. Brownback have completed their training and are flying the hydro-aeroplane alone.

Lieutenant E. L. Ellington of the Cavalry is in the midst of his training which should be completed within a few days.

The winter school will be located at Palm Beach, Fla., and will probably be in charge of Mr. Frank Coffin. The U. S. Signal Corps has arranged to have an Easter hydro-aeroplane winter station at the Burgess Camp. Lieutenants Call and Ellington will probably be detailed for this service.

**Jannus Makes Two World's Records**

Just as the last forms of this issue of AIRCRAFT go to press, Anthony Jannus completed his long trip down the Mississippi River from Omaha to New Orleans on December 15th, although his official entry into the city did not take place until December 16th.

This trip was begun on November 5th and during the first part of the trip Mr. Jannus took along Tom Benoist as passenger and the latter part of the trip he carried W. H. Trefis, Jr. as a passenger.

The approximate number of miles made, which included the various windings of the river, was 1,970, which trip makes two American as well as world's records. First, it is the greatest total distance made by an aeroplane with a passenger;

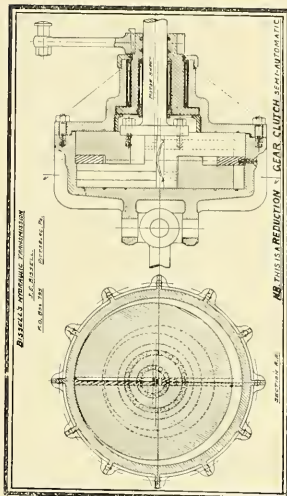

second, it is the greatest total distance made in a hydro-aeroplane either with or without a passenger.

These records were made on a Benoist 75 H. P. tractor biplane, built by the Benoist Aircraft Company of St. Louis, Mo.

**OUR WINTER SCHOOL**

is now running full blast on the Government Field at SAN ANTONIO, TEXAS

**THE REASONS WHY** you should enroll in the Lillie Flying School are because we have:

**The Best Instructors**—Max Lillie, De Lloyd Thompson, Andrew Drew, and C. M. Vought represent the highest flying ability and cleverest teaching talent in America.

**The Best Equipment**—Double control school machines equipped with Lillie-Wright duplicate levers which eliminate risk and delay the two greatest faults of other schools.



Showing Our System of Teaching by Duplicate Control Levers.

**The Best Field**—The Government Flying Field at San Antonio is the largest and best in the Country. The climate is ideal.

**The Best Record**—During the past season the Lillie School turned out more licensed pilots than any three other schools in the country combined.

FOR PARTICULARS ADDRESS

**THE LILLIE AVIATION COMPANY**

SUITE 301-302-303 LIGGETT BUILDING, ST. LOUIS, MO.

# CLASSIFIED ADVERTISING

15 CENTS A LINE

SEVEN WORDS TO LINE

CASH WITH ORDER

## FOR SALE

**CURTISS** latest improved type (Pigeon Tail) 1912 Model. Made over 300 very successful flights 1,000 ft. high, 30 miles cross-country. My construction is strongest in the world. New, complete, ready to fly, tested and guaranteed, including free lessons to buyer, \$1,500. Buy direct from Builder and Aviator of 10 years' experience. H. C. Cooke, Aviator and Builder, 127 West 64th St., New York City.

**COMPLETE PLANS**—Nieuport Monoplane, \$2.00; Deperdussin Monoplane, \$3.00; Wright Biplane, \$3.00; Aeroplane Rib Pattern, \$1. "Aviation," Lawrence, Kansas.

**TANDEM** Monoplane Glider; double surfaced wings; spread 20 feet; guaranteed man carrying, \$25; Knockdown, \$19; Plans, \$1. Wright Glider Plans, \$1. "Aviation," Lawrence, Kansas.

**MUST SELL IMMEDIATELY** 30, 50, 75 H. P. motors with or without Curtiss planes; great bargains. J. T. Patterson, 986 Trumbull, Detroit, Mich.

**FOR SALE**—Brand new 50 H. P. Albatross motor with carburetor and magneto for \$100. Walter Bengtson, Canby, Minn.

## FOR SALE

**FOR SALE**—Elietot Monoplane without power plant in first class condition, would be a bargain at \$600.00 first check for \$400.00 takes it.

30 H. P. Detroit Aero Motor guaranteed in first class condition, \$125.00.

One 6½ ft. diameter x 4½ ft. pitch Detroit Aero Propeller, \$20.00.

One 7 ft. diameter x 5 ft. pitch Gibson propeller, \$30.00.

The above are bargains and you will have to act quickly to get them.

J. Horat, 827 Main Street, Lafayette, Ind.

**ROTARY AEROPLANE** engine, 40 H. P., 7 cylinder, weight 160 lbs. with propeller. Cheap. Landsman Motor Co., 1406 S. 18th St., St. Louis, Mo.

**FOR SALE**—Tractor biplane, 8-cylinder, 60 H. P. Motor; everything in first-class condition. Will sell separately or exchange for touring car. Apply F. Robinson, 191 Caledonia Avenue, Rochester, N. Y.

## POSITIONS WANTED

**A YOUNG MAN**, age 18, desires position as an aviator's assistant, with prospects of learning to fly. Address Louis Fenouillet, 132 West 47th St., New York City.

## MISCELLANEOUS

**WANTED**—A Curtiss type biplane. Must be cheap and in good condition. Write me what you have. George Schemehorn, Eyota, Minn.

## AVIATORS WANTED

**AVIATOR**—Licensed aviator of the Aero Club of France, flying Elietot and Curtiss machines; constructor of a number of Elietot machines, wishes engagement. Two year's experience as aviator and mechanic aviator. Address Box 768 Aircraft.

## LEGAL NOTICE

I DESIRE to give notice to all persons that are assisting my "Patent Rudders" (Serial number 504107 U. S.), also France and England, and my "Semi-Automatic Engine Control," (Serial number 646300 U. S., France and England), that it is my intention in the future to ask a small royalty from them. Hugh L. Willoughby, Sewalls Point, Florida.



Exhibition Flying by Competent Aviators

## HEINRICH

### Monoplanes and Mono-Biplanes

BUILT IN FOUR SIZES

Write for Illustrated Booklet

Make arrangements now to learn to fly at our Hydro-aeroplane School in the spring. Tuition \$250

HEINRICH PROPELLERS \$30 UP

HEINRICH BROS.

Baldwin, L. I., N. Y.

## AVIATORS—NOTICE

**MAXIM ROTARY MOTORS—THE SIX-SHOOTER**

Introduction Offer for a Short Time Only

Maxim Rotary Little Six	36	\$1500, for	\$750
Maxim Rotary Medium Six	50	\$1750, for	\$875
Maxim Rotary Big Six	75	\$2000, for	\$1000

Guaranteed and Demonstrated by

**MAXIM ROTARY MOTOR COMPANY**

379 Golden Gate Avenue

San Francisco, Cal.

## COOKE BIPLANES

*Curtiss Improved 1912 Type (Pigeon Tail)*

Perfect flyers. No freak construction. Ten years' experience.

Strongest in the world. Amply powered (Roberts Motors.)

Anyone can fly these machines. One ready for immediate delivery

\$2,500

One ready for immediate delivery complete Pope Toledo power plant

\$1,500

intention to fly. Curtiss Type Planes, no Power Plant, \$650 and up

Free Instruction to Buyer H. C. COOKE, 127 West 64th St. NEW YORK CITY

# AVIATORS The ROOLD HELMET

is the only helmet adopted by the French, Russian, English, Italian, Turkish, Swedish and Norwegian Armies

## BEWARE OF IMITATIONS

Ask for the mark—ROOLD

**"EVERYTHING FOR THE AVIATOR"**

Write for Free Catalogue

ROOLD, 50 Avenue de la Grande Armees  
PARIS, FRANCE

## Buy from Manufacturer and Save Money

20x2¼" Wheel, 6" Hub, \$4.00, with Tire \$ 6.00

20x3" Wheel, 6" Hub, \$4.75, with Tire \$ 8.25

20x4" Wheel, 6" Hub, \$5.50, with Tire \$23.50

FARMAN TYPE GEARS, complete - \$42.50

## AEROPLANE WHEELS

HUBS—Stock, size 6" wide, ¾ or 1½" Knock out Axle or bushed to fit 1" Axle—1¼—1½—1¾ or 1½ Special.

TWO AERO BOAT PONTOONS—Weight 55 lbs.—each capable of floating 800 lbs.—per pair complete \$250.

J. A. WEAVER, Jr., 132 W. 50th St., New York

Don't fail to get our prices on Wheels and Tires. We make any size.

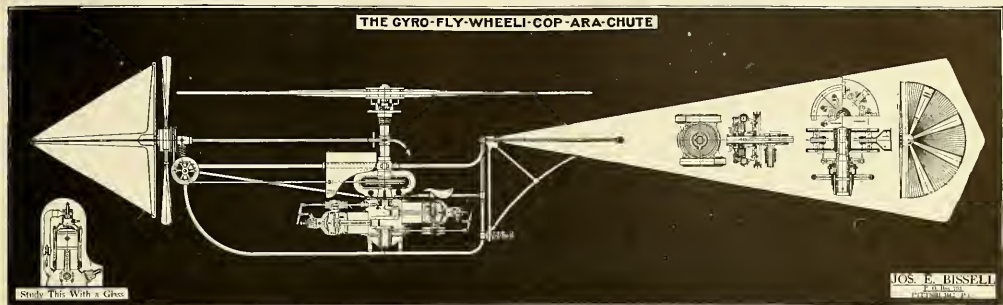

Have y'u ever heard of a stiff, "**WINGED BUCK**"  
Whom th' claim went "**DIPPY**," and "**FLEW**" amuck  
With an **ASS**? Poor **YORIC** I knew 'im! **WELL**,

With a **HELICO**, Peter?—He might Ha' **RAZED**, Hell!  
**BUTT!!** we heard 'im exclaim as he "**DOVE OUT**" o' sight!  
"**MERRY CHRISTMAS t' ALL**"—and t' all—"GOOD NIGHT!"

**CHICAGO AERO WORKS**  
H. S. RENTON Proprietor  
**AEROPLANES** ACCESSORIES MOTORS PARTS  
WHEELS ALSO MODELS and MODEL STOCK  
ESTABLISHED 1909. First in Chicago and the Middle West  
Aviators Taught. Flights Furnished. Send Stamp for Catalog.

**Aeronautical Supplies**  
Everything to Build Any Type Flying Machine  
New catalogue with working drawings of Curtiss, Farman and Blériot type machines, now ready for distribution and will be mailed free upon request to all interested parties. Write for quotations.  
**E. J. WILLIS CO.**, 85 Chambers Street  
67 Reade Street  
Tel. 3624 Worth NEW YORK CITY

**PATENTS**  
THAT PROTECT AND PAY  
BOOKS, ADVICE AND SEARCHES FREE  
Send sketch or model for search. Highest References.  
Best Results. Promptness Assured.  
WATSON E. COLEMAN, Patent Lawyer  
624 F. Street, N. W. Washington, D. C.

**J. C. (BUD) MARS, NOW BOOKING**  
ADDRESS  
**17 N. La Salle Street, Chicago, Ill.**

**PATENTS** SECURED or Fee Returned  
Send sketch for free search of Patent Office Records. How to Obtain a Patent, and What to Invent, with list of Inventions Wanted and Prizes offered for Inventions sent free. Patents advertised free.  
We are experts on AIRSHIPS and all patents and technical matters relating to AERIAL NAVIGATION.  
VICTOR J. EVANS & CO. Washington, D. C.

**BAMBOO** Special Grades of  
Bamboo for AERONAUTIC WORK  
Reed, Rattan and Split Bamboo for Models.  
All sizes in stock. Tonka Rattan for Skids,  
1 1/4 inch and under, any length.  
**J. DELTOUR, Inc.**  
804 Jefferson St. Hoboken, N.J.

**AIR CRAFT**  
**VOLUMES**  
**I. II. III.**  
Cloth Bound \$3.50 each  
**Lawson Publishing Co.**  
37 EAST 28th STREET  
NEW YORK, N. Y.

**"IDEAL" Plans and Drawings**  
are accurate and are accompanied by clear, concise building instructions, postpaid at the following prices:  
Wright 3-foot Biplane . . . 25c  
Blériot 3-foot Monoplane 15c  
"Cecil Peoli" Champion Racer . . . 25c  
Curtiss Convertible Hydroaeroplane (new) . . . 35c  
"Ideal" three-foot Racer (new) . . . 15c  
Complete set of five—\$1.00 postpaid.  
5 cts. brings our new 40-page fully illustrated Catalog of "Ideal" Model Aeroplane Supplies. (None free.)  
**IDEAL AEROPLANE & SUPPLY COMPANY**  
82-B West Broadway, New York

**GOODYEAR**  
AKRON, OHIO  
Goodyear Balloons Aeroplane Accessories  
National headquarters for Spherical and Dirigible Balloons. Built complete. Highest quality. Also makers of Aeroplane Springs, Tires, and the famous Goodyear Rubberized Aeroplane Fabric. Write for Booklet.  
**THE GOODYEAR TIRE & RUBBER CO.**  
AKRON, OHIO.

**Another Record for the CHARAVAY PROPELLER**  
American Passenger Altitude, 5006 Ft., 1 Hr., 16 Min.  
**SLOANE AEROPLANE CO.** 1731 Broadway, NEW YORK CITY  
AGENTS: Eames Tricycle Co., San Francisco; National Aeroplane Co., Chicago; W. E. Boughton Washington D. C.

## INVESTIGATE FIRST

Satisfy yourself you are dealing with a responsible concern before paying your money.  
**WE GUARANTEE** our machines, workmanship, materials, etc., superior to those of any other constructed here or abroad regardless of price paid.

Immediate and prompt delivery on standard machines.

"Nieuport," "Bleriot," "Farman" and "Curtiss" types. Hydroplanes; speed, single, passengers, weight-carrying, or specially constructed to your own design and specifications.

"Complete with suitable power plant purchaser selects or prefers, demonstrated in flight." "Complete without power plant," or "Complete in the Knockdown." Will accept orders on specified time delivery under forfeiture.

We invite your personal inspection of the best equipped plant in the U. S. All types in course of construction. Unexcelled opportunity to acquire full shop, construction and flying course, on any type Monoplane or Biplane.

*SEEING IS BELIEVING. CALL IF POSSIBLE OR WRITE.*

## INTERNATIONAL AERONAUTIC CONSTRUCTION CO.

Factory, Hollis, L. I.  
 Main Line L. I. R. R.

Office, P. O. Bldg.  
 Jamaica, N. Y. City

Flying Grounds  
 Nassau Boulevard

## N A I A D Aeronautical Cloth

Manufactured Especially for Aeroplanes and Used by  
 Aviators of Prominence

**LIGHT, STRONG, AIR-TIGHT**

AND

**MOISTURE-PROOF ON BOTH SIDES**

Sample Books, including Data and Prices, sent on request

**THE C. E. CONOVER CO.**  
 101 Franklin Street - - New York

## BALDWIN

### VULCANIZED PROOF MATERIAL

For Aeroplanes, Airships, Balloons. First Rubberized Fabric on the market. Lightest and strongest material known. Dampness, Heat and Cold have no effect. Any Strength or Color.

### "RED DEVIL" AEROPLANES

That anyone can fly. Free Demonstrations.

### HALL-SCOTT MOTORS

Eastern distributor. 40 h. p. 4-cyl.; 60 and 80 h. p., 8-cyl., on exhibition at Frank Schumacher's, 164 W. 46th Street, New York. All motors guaranteed. Immediate delivery.

### EXPERTING

Will install a Hall-Scott free of charge in anyone's Aeroplane and demonstrate by expert flyer. Expert advice. 'Planes balanced.

**CAPT. THOMAS S. BALDWIN**  
 Box 78 Madison Sq. P. O., New York

## AEROPLANES

# BLERIOT MONOPLANES

(GENUINE)

**Winners of ALL the European Contests in 1911**

In 1909--The First Aerial Crossing of the Channel.

In 1910--The "Circuit de l'Est."

In 1911--The Paris-Rome Race (1st and 2d.)

The European Circuit (1st and 2d.)

The English Circuit (Daily Mail Race.)

The Belgian Circuit.

The Saint Petersburg, Moscow Race.

The Valencia Alicante Race.

The London to Paris non-stop Raid, etc., etc.

**WORKS AND OFFICES: - - 39, Route de la Révolte à Levallois - - PARIS**  
**and Belfast Chambers, 156 Regent St., LONDON**

**AVIATION SCHOOLS:** **FRANCE**  
 Etampes, near Paris during Summer  
 Pau, during Winter

**ENGLAND**  
 Hendon, near London

# Free Instruction in the Operation of the **CURTISS FLYING BOAT**

*Will be Given to Those Taking a Regular Course of Training at the*  
**Curtiss School of Aviation San Diego, Cal.**



First Hydroaeroplane Races at Hammondsport, N. Y. David McCulloch in his "Flying Boat" leads; he is accompanied by Mr. Curtiss. Lincoln Beachey is second, accompanied by Lansing Callan, while Francis Wildman, instructor at Hammondsport School, is third with the Standard Hydroaeroplane.

Among the men who have learned aviation at Curtiss Schools are: Lieut. T. G. Ellyson, now in charge of the aeroplanes of the U. S. Navy; Lieut. J. H. Towers, who just established a new World's Hydroaeroplane Record of 6 hrs., 10 min., 38 sec.; H. Robinson, who recently introduced the Hydroaeroplane in Europe and is now instructor in a Curtiss School; C. C. Witmer, now in St. Petersburg demonstrating Hydroaeroplanes in the Russian Navy and Army; Lieut. J. W. McClaskey, instructor in a Curtiss School; Lincoln Beachey, "The World's Greatest Aviator"; S. C. Lewis, now instructor in the Morane School in France; J. Lansing Callan, now an instructor in a Curtiss School; Francis Wildman, now instructor in a Curtiss School; Beckwith Havens, now a demonstrator; W. B. Atwater, now demonstrating to the Japanese Government; besides, a score of men who own their own machines and fly in contests and exhibitions, and a dozen others have taken positions with either manufacturers or exhibition concerns.

**O**UR San Diego (Cal.) Aviation Training Grounds, situated on North Island, in San Diego Harbor, are the finest in America, if not in the world. North Island is leased by us exclusively for aviation purposes, and comprises one thousand acres of flat, level sand, unobstructed by rock, tree or building, thus offering every advantage as a flying course. The Island is entirely private, yet within a few minutes of San Diego, one of the most progressive and attractive cities on the Pacific coast.

*The First Class Began Instruction December 1st  
Another Class Will Start January 1st, 1913*

A \$100.00 deposit will reserve a place for you in this class. Mail or wire it to-day.

Our Booklet "TRAINING" mailed upon request

---

**THE CURTISS AEROPLANE CO., Hammondsport, N. Y.**

# KIRKHAM

## The Dependable Aviation Motor



MR. AND MRS. ART SMITH  
The First Couple to Elope via Aeroplane

The accompanying cut shows aviator Art Smith and Miss Aimee Cour just starting on the first elopement via aeroplane, when they flew from Ft. Wayne, Ind., to Hillsdale, Mich., on Oct. 26, 1912, and were married.

It goes without saying that any man that will undertake a trip like this with his bride-to-be must have perfect confidence in his machine, and particularly his motor. But his **Kirkham Motor** had enabled him to fill 18 exhibitions, so he knew just what it would do. Can you say as much for the other kind?

The **Kirkham Motor** also holds the *American Endurance Record* for pilot and one passenger of 3 hrs., 51 min., 15 sec., just established by Walter E. Johnson, flying a **Kirkham** equipped Thomas Biplane, at Bath, N. Y., Oct. 31, 1912, the flight ending only on account of the extreme cold. Also on Nov. 2, 1912, Chas. Niles flew the same machine 2 hrs. 45 min.; and on Nov. 4, flying against the American duration record for pilot alone, he flew for 4 hrs. 15 min., stopping on account of burnt-out bearings, caused by stopping of oil pump.

This same motor was used all season by Mr. Johnson, and was the power that made possible his clean sweep of speed prizes at the New York State Fair, mentioned in previous advertisements.

There is a reason behind these performances that you ought to know before you purchase that New Motor. Booklet tells about the motor and is yours for the asking.

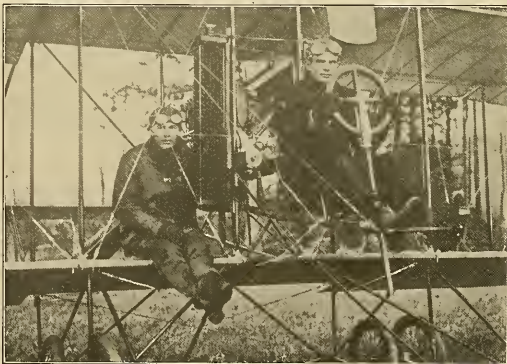

THE NEW RECORD MAN FOR FLIGHT WITH PASSENGER

C. B. KIRKHAM

Savona, N. Y.



# AIRCRAFT

Vol. 3 No. 12

FEBRUARY, 1913

15 Cents a Copy

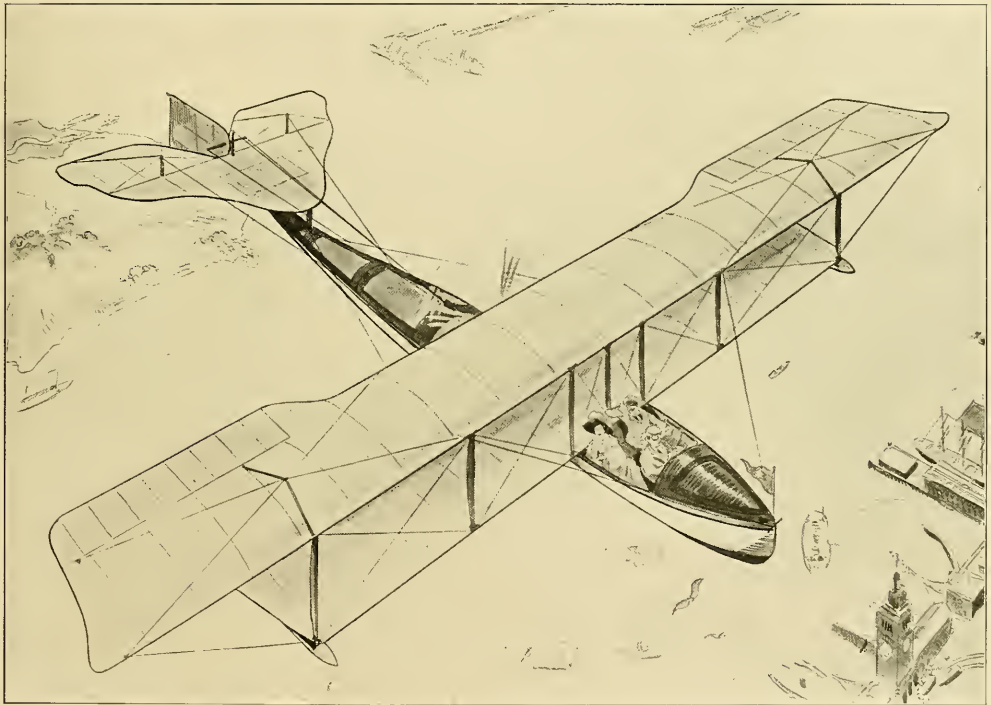

DESIGN OF THE NEW CHRISTOFFERSON FLYING BOAT

Besides being one of the most daring aviators in the United States, Silas Christofferson is also a constructor of considerable ability. He expects to bring out shortly a flying boat similar to the above design.

# SLOANE

Records



Records

## 60 H. P. Anzani Deperdussin

Holder of the American Passenger Altitude Record—5006 ft. Time, 1 hour, 16 minutes, in use at

## OUR CALIFORNIA SCHOOL

on Dominquez Field, Los Angeles. We use the best field, the best methods and have the finest equipment in America. At our school you are instructed by the most advanced methods and by most capable instructors. Write us for terms.

### *We Sell and Use*

**DEPERDUSSIN MONOPLANES** which hold most of the world's records and are the safest machines built.

**CAUDRON MONOPLANES** are the most efficient and fastest of French Machines.

**SLOANE MONOPLANES.** The best and most successful American Machines. See them in our school.

**ANZANI MOTORS.** The best Aeronautical Motor made. Successful in both French and English Military Trials. Holds American passenger Altitude Record.

**GNOME MOTORS** are the best French rotary motors made.

**PARTS** for both motors and aeroplanes we have always in stock. **REPAIR WORK** on delicate motors a specialty. All our work guaranteed.

**AEROPLANES** and motors built to order in America's finest shop.

**WIRE!**

**WRITE!**

**'PHONE!**

# SLOANE AEROPLANE CO.

210 Merchants Trust Building  
Broadway & Second St., Los Angeles, Calif.

'Phone Main 3674

1731 Broadway  
New York City

'Phone Columbus 5421

National Aeroplane Company, 606 South Michigan Avenue, Chicago, Ill.

# Sturtevant Aeronautical Motors

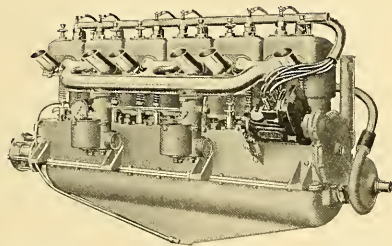

**T**HE principles incorporated in the design of Sturtevant Aeronautical Motors are only those which have been tried and proved in the best gasoline engine practice.

These motors are of the automobile type, water cooled. There is not a freakish thing about them. In construction the best materials and workmanship only are allowed, and they are rigidly inspected through each step of their construction. They give the same unflinching continuous service that a high grade automobile motor gives.

Catalog No. 2003 gives full details of their construction. Ask for it.

## B. F. STURTEVANT COMPANY

Hyde Park

Boston, Mass.

AND ALL PRINCIPAL CITIES OF THE WORLD

TUITION  
\$ 2.50

SCHOOL NOW  
OPEN



LEARN ON THE ICE! NO FIELD SAFER!  
RELIABILITY SPEED ENDURANCE THE RESULT OF SCIENTIFIC KNOWLEDGE BACKED BY 4 YEARS PRACTICAL EXPERIENCE

WRITE FOR BOOKLET  
BATH N.Y.

THOMAS BROS AEROPLANE CO.

## WIRE

Aviator Wire supplied in 12 sizes with a plate finish, making soldering easy. This wire is specially drawn from extra quality high grade steel. Also Aviator Cord of twisted wire.

**John A. Roebblings Sons Co.**  
TRENTON, N. J.

# Broadway Central HOTEL

Corner Third Street

*In the Heart of New York*

Special attention given to ladies unescorted  
SPECIAL RATES FOR SUMMER

*Our Table* is the foundation of our enormous business

AMERICAN PLAN, \$2.50 UPWARDS  
EUROPEAN PLAN, \$1.00 UPWARDS

Send for Large Colored Map and Guide of New York, FREE

TILLY HAYNES, Proprietor  
DANIEL C. WEBB, Mgr.,  
Formerly of Charleston, S. C.

The Only New York Hotel Featuring American Plan  
MODERATE PRICES  
EXCELLENT FOOD  
GOOD SERVICE

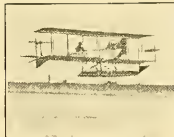

## BENOIST

Biplanes and  
Hydro-aeroplanes

Hold two world's records and three American records. The only American built machine that holds a world record.

SEND FOR BOOKLET

**BENOIST AIRCRAFT CO.**  
6630 Delmar Blvd  
ST. LOUIS, MO.

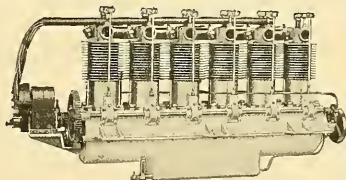

## Kemp Motors

Four new models of Kemp Motors for 1913. If you want an efficient and reliable motor for your plane why not have it to begin with? It will cost you less.

Model D-2 16 H. P.  
Model I-4 35 H. P.

Model H-6 35 H. P.  
Model J-8 75 H. P.

WE STILL HAVE A FEW OF NEW AND SECOND-HAND GREY EAGLE MOTORS AT BARGAIN PRICES

**KEMP MACHINE WORKS**  
MUNCIE, IN.

# AVIATORS The ROOLD HELMET

is the only helmet adopted by the French, Russian, English, Italian, Turkish, Swedish and Norwegian Armies

## BEWARE OF IMITATIONS

Ask for the mark—ROOLD

**"EVERYTHING FOR THE AVIATOR"**

Write for Free Catalogue

ROOLD, 50 Avenue de la Grande Armee  
PARIS, FRANCE

## Buy from Manufacturer and Save Money

20x21 $\frac{1}{2}$ " Wheel, 6" Hub, \$4.00, with Tire \$ 6.00  
20x3 $\frac{1}{2}$ " Wheel, 6" Hub, \$4.75, with Tire \$ 8.25  
20x4" Wheel, 6" Hub, \$5.50, with Tire \$23.50

FARMAN TYPE GEARS, complete - \$42.50

## AEROPLANE WHEELS

HUBS—Stock, size 6" wide,  $\frac{3}{8}$ " or  $\frac{1}{2}$ " Knock out Axle or  
bushed to fit 1" Axle— $1\frac{1}{8}$ "— $1\frac{1}{4}$ "— $1\frac{1}{2}$ " or  $1\frac{3}{8}$ " Special.

TWO AERO BOAT PONTOONS—Weight 55 lbs.—  
each capable of floating 800 lbs.—per pair complete \$250.

J. A. WEAVER, Jr., 132 W. 50th St., New York

Don't fail to get our prices on Wheels and Tires. We make any size.

# THE CONTINENTAL HOTEL

Chestnut Street Corner of Ninth

## PHILADELPHIA

*Remodeled* *Refurnished*

**400 ROOMS**

**200 With Bath**

*Rates \$1.50 to \$5.00* *European Plan*

THE BEST CAFÉ IN THE CITY

FRANK KIMBLE, Manager

## Wright Hydro-Aeroplane School Now Open at GLEN HEAD, L. I.



# Wright Flyers

1913 MODELS

In addition to those features which in the past have made Wright Flyers famous for efficiency and reliability, the new models can be furnished with **Automatic Control, Silent Motors, and Hydro-planes**. These special features make the 1913 machine unusually attractive to sportsmen.

## EXHIBITION MACHINES

For exhibition work we have other models especially adapted to high winds and small fields. It was with a stock "EX" Model that Rodgers made his wonderful flight from coast to coast. Reliability means dollars to the exhibitor.

## WRIGHT SCHOOL OF AVIATION

Training consists of actual flying, in which the pupil is accompanied by a competent teacher. No risks and no expense whatever from breakage. The most famous flyers in America are graduates of our school and include such names as

Lieut Arnold	Drew	Lieut. Rodgers
Atwood	Elton	Parmalee
Brookins	Lieut. Foulois	Page
Brindley	Fowler	Reynolds
Bonney	Gill	Simmons
Beatty	Lieut. Lahm	Turpin
Burgess	Lieut. Milling	Walah
Coffyn	Mitchell	Webster
Capt. Chandler	C. P. Rodgers	and many others.

Our Schools at Dayton and New York are now open and pupils may begin training at once if they wish. By enrolling now you can reserve date most convenient to you for training. Write for particulars.

**THE WRIGHT CO.**  
Dept. "B" DAYTON, OHIO



The above picture illustrates to some extent, the activity shown at one of our American aviation schools. This school, the Curtis, is located at North Island San Diego, California, and the equipment above represents seven of their land machines. In addition to these, however, there are also several hydro-aeroplanes and flying boats on the Island. The Curtiss Company states that during the year of 1912, forty-seven students graduated from their schools.

**CONTENTS—FEBRUARY, 1913**

A Recommendation to Congress	Alfred W. Lawson	337
Aerial Fleets and Expenditures of the Different Governments (table)		338
Comparative Details of German and French Dirigibles, Military and Private, Either Built or Being Constructed		341
Foreign News		342
Special Correspondence	A. F. B. Silva-Netto	342
German News	Stella Bloch	343
A Little Elementary Physics	Earle L. Ovington	344
Analysis of the Fokker Control	Albert Adams Merrill	345
The Benoist Flying Boat with Scale Drawing	Walter H. Phipps	346
General News	D. E. Ball	348
Drawing of the Rumpler Monoplane		349
Index		350
Construction Details		354
Letter Concerning Fokker Monoplane	Theod. Gibon	354

**AIRCRAFT**

ALFRED W. LAWSON  
*President and Treasurer*  
ERNEST C. LANDGRAF  
*Secretary*

**Published Monthly by The Lawson Publishing Company**  
37-39 EAST 28th STREET, NEW YORK, U. S. A.  
Telephone, 5017 Madison Square

ALFRED W. LAWSON  
*Editor*  
WALTER H. PHIPPS  
*Asst. Editor*

**TERMS TO SUBSCRIBERS**

In the United States, Mexico, Puerto Rico, Guam, Philippine Islands, Hawaiian Islands, Cuba (including Postage), \$1.50 per year.  
Fifteen Cents the Copy, of All News Dealers.  
Foreign Subscriptions, Two Dollars per year.  
In changing order give old as well as new address.  
Advertising copy must be in hand by the 1st of month previous to date of publication.  
Only high-grade advertisements of thoroughly reliable firms are solicited.

**WHEN YOUR SUBSCRIPTION EXPIRES**

One month before a subscription expires we enclose a renewal blank on which you will write your order for the renewal.  
When first notified that your subscription will expire, you should send your renewal at once, in order not to miss a number. New subscriptions which are received by us on or before the 15th of any month will begin with the issue of that month. If received after that date they will begin with the following month's issue. We cannot enter subscriptions to begin with back numbers. One month's notice is necessary before a change of address can be made.

Entered as "second-class matter" February 18, 1910, at the Post Office, at New York, N. Y. under Act of March 3, 1879.

Copyright, 1913, by the Lawson Publishing Co.

"Aircraft" is registered as a trade-mark by the U. S. Patent Office, under date of August 9th, 1910.



## MOISANT AVIATION SCHOOL

WINTER HEADQUARTERS AT  
**U. S. Army Field  
Augusta, Ga.**

While our contracts with Foreign Governments may require the entrance of a considerable number of Army Officers, we have increased our facilities so as to afford ample accommodation to our regular pupils. Enrollments should, however, be made as promptly as possible.

Write for beautiful free booklet and address all communications to

**The Moisant International Aviators**  
U. S. Rubber Bldg.  
Broadway and 58th St. New York

## THE CURTISS AVIATION BOOK

By **GLENN H. CURTISS** and  
**AUGUSTUS POST**

Describes Curtiss' great flights; tells just how he planned his machines and what he believes the aeroplane will do in the future.

*Fully Illustrated, \$1.35*

**The Lawson Publishing Co.**  
37-39 East 28th Street  
NEW YORK

## King Edward Hotel IN NEW YORK

At Broadway and Long Acre Sq.  
145 to 155 West 47th Street

"The Very Heart of New York." Absolutely Fireproof

350 ROOMS 250 PRIVATE BATHS

Every Modern Convenience

European Plan Exclusively

### RATES :

Single rooms, hot and cold water	-	\$1.00-1.50
" rooms, private bath	- -	\$2.00-2.50-3.00
Suite, parlor, bedroom and bath	-	\$4.00-5.00
" parlor, 2 bedrooms and bath	-	\$5.00-6.00
Each additional person in same room,		\$1.00 extra
Rooms for Maids and Valets	- - -	\$1.00

**VICTOR HOTEL COMPANY, Ltd.**

C. A. HOLLINGSWORTH, President  
NEW YORK CITY

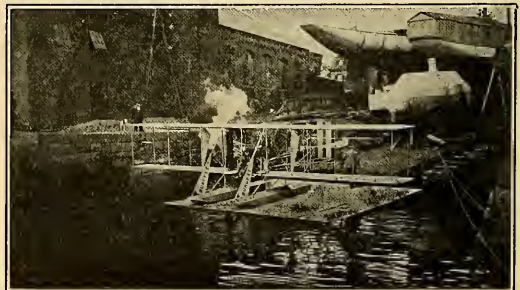

"THE PASSING OF THE YACHT"

## Burgess Flying School

Hydroaeroplanes used exclusively. You can learn without delay. The Burgess factory adjoins the flying station. Aeroplanes for exhibition, military and sporting use under construction. All leading motors used. Pupils secure not only training, but latest information concerning construction and design.

INSTRUCTOR:

**PHILLIPS W. PAGE**

Licensed Aviator

New Booklet just printed will give you full particulars

**THE BURGESS COMPANY & CURTIS**  
MARBLEHEAD, Box A MASSACHUSETTS

# AIRCRAFT

Vol. 3. No. 12

NEW YORK, FEBRUARY, 1913

15 CENTS A COPY  
\$1.50 A YEAR

## A RECOMMENDATION TO CONGRESS

By ALFRED W. LAWSON

(A copy of this message was sent to each member of the House of Representatives and the United States Senate. A copy was also sent to the President of the United States, to the Secretary of War and to the Secretary of the Navy.)

ALFRED W. LAWSON is an advocate of Natural Law in the fullest significance of the term. He is interested in everything in life which tends to enlarge the scope of human intelligence and usefulness. Science, literature, philosophy, art, music, economics, psychology, sport, travel, all receive a share of his attention. During the past five years, however, Mr. Lawson has devoted the greatest part of his time to the study of air transportation, and spent about \$100,000 towards its advancement in this country; an amount equal to that appropriated for aeronautical work by the United States Government. Mr. Lawson is the president of the Lawson Publishing Company of New York, and is the founder and editor of AIRCRAFT. He also established "Fly" in 1908, which magazine he edited for about a year. When the Aeronautical Manufacturers' Association was organized about two years ago Mr. Lawson was elected first vice president. He is the author of the economic-psychologic novel "Born Again," which has been published in many lands and languages.

TO the Members of the House of Representatives and the United States Senate:

"As a private citizen I beg leave to address you both individually and collectively upon a subject which I consider of vital importance to this glorious nation—upon a subject which, although new and little understood at present must, within a very short

with eyes in the back of his head, can see nothing to the fore and naturally scouts and denies the possibilities of progress of any nature whatsoever.

"I speak as one who has studied closely the lines of aircraft development, its possibilities and probabilities and calculated conservatively regarding the time necessary to overcome certain mechanical and human obstacles while attaining its natural and healthy growth. By knowing the facts and carefully weighing the theories, I have obtained a perspective from which my views on the subject should be as clear on what has already taken place and that which should follow—as effects follow causes—as it is possible for a frail mentality to acquire.

"I may say here that owing to my having acted in the capacity of editor in chief of two aeronautical periodicals during the past five years my opportunities have been unusually extended for obtaining authoritative information as well as the views of the best informed men throughout the entire world upon the different phases of the movement, which practically enables me to arrive at very substantial conclusions.

"So to begin with I will state that the time has now arrived for this nation to start the construction of a great aerial fleet both for offensive and defensive purposes. In fact, in view of the great progress already made by other nations along this line, further delay on our part must be considered little short of criminal negligence. Delay is jeopardizing the best interests of our people in general and the efficiency of our Army and Navy in particular. For every year we delay now two or more years will be required later to overtake other nations who now lead us and who are increasing that lead with every setting of the sun.

"As I write the United States of America stands thirteenth on the list of governments who have made expenditures for the purpose of aerial development. China still ranks below us, but so pitifully insignificant have been the American appropriations for this work that China could overtake and go beyond us in a day.

"It can be seen from the table which accompanies this address that Germany leads the countries of the world in governmental expenditures, having to date spent approximately \$10,000,000 for their aeronautical equipment, and if you will pause momentarily to compare Germany's \$10,000,000 with America's \$100,000 expenditure, you can see at a glance the awful inferiority of our position. For this amount Germany has acquired 310 aeroplanes, 22 dirigibles and 9 great military sheds as against 6 aeroplanes, 1 puny dirigible and 1 military shed of the United States Government.

"If you compare the United States position with that of France, it is almost as bad, as France has expended approximately \$8,000,000 for which they can show 280 aeroplanes, 19 dirigibles and 7 sheds.

"Russia, Italy, England, Japan, Brazil, Belgium, Greece, Bulgaria, and Spain also out-rank us in governmental work. Not only do these countries lead us but they are running away from us as a

period take its place at the very head of human interest and progress. I allude to aircraft and air navigation.

"I want to point out to you a few facts in connection with what has already been accomplished in this new method of transportation and what reasonable development may be expected in the immediate future, and I want to show you with facts and figures and argument just why it becomes necessary at this time for Congress to give this subject most careful consideration and bring to bear upon it that rare good judgment and foresight which anticipates and avoids difficulties with preparedness and thereby demonstrates the wisdom that distinguishes the pre-eminent minority from the eminent majority. In offering this address, gentlemen, I fully recognize the great number and variety of present day problems you have to occupy your time, and of course it would be unreasonable to expect that you had given any especial attention to the development or the possibilities of air transportation during its embryonic state; nor could you have been expected to do so when taking into consideration that the majority of our American publicists have seen fit to only spread broadcast the gruesome and sensational side of the subject and thereby harass American progress in contra-distinction to the attitude of the publicists of European countries who endeavor to educate their people in the scientific and industrial value of the movement.

"So I address you, gentlemen, as one who has given much time and thought to this great subject—a specialist in this line, you might say—and give you the benefit of five years, constant investigation of the matter summed up in the fewest possible words and relating only to that which concerns the people of the United States the most. I address you as one who knows.

"I speak not as the elastic dreamer who overleaps at a bound all the obstacles which naturally block up the passage-way of progress and which require years to remove, nor as the habitual doubter who,

greyhound can run away from a snail. Furthermore, almost every little second, third, fourth and fifth rate country in the world is showing more governmental activity in aeronautics than this government. For instance, as I speak, new reports have just reached me that little Belgium has decided to purchase 27 more aeroplanes, while such countries as Denmark, Greece, etc., are making preparations to acquire large numbers of machines in the near future.

"The haste made to equip aerially by these different countries and the feverish haste made by Germany and France in particular with Japan just getting a flying start, has far more significance than the average mind comprehends. There are great scientists and famous war strategists in harness today who will tell you that within a few years 'that country's air fleet which controls the air above will control the ground or water below,' and whether or not their predictions will be fulfilled, the fact remains that there are at least a half dozen countries who are now preparing for just such a state of affairs.

"The purpose of this address, however, is not to delve so much into the future as it is to show you just what exists at present and what could happen now in case war broke out between the aerially armed foreigner and the aerially unarméd United States. Germany, for instance, could play havoc with this country if war broke out today. Yes, within thirty days, they could have within our shores and right up over our heads, at least ten great armour-clad air cruisers of the Zeppelin and Schuette-Lanz types and 200 or more of the latest pattern war aeroplanes. How? You ask. The easiest way possible. These ten great air cruisers could be accompanied across the ocean by a flotilla of steamships with supplies just as a fleet of naval vessels are accompanied by "Colliers" and supply ships on their long voyages.

"They could be re-provisioned, re-gasolined and recharged with hydrogen gas as often as necessary en route by these supply ships, and again innumerable times while standing off our very shores, say a hundred miles away, and out of sight of our forts and fleets. \*These airships, which have a radius of action of about 1,200 miles and are capable of staying in the air for forty-eight hours without the necessity of having to be re-stocked with gasoline or hydrogen, could float over our forts and fleets as though they never existed and find their way right to the very hearts of our great cities. New York, Boston, Philadelphia, Baltimore or Washington could be put in a terrible state of panic by the very knowledge of these monsters being above them loaded with explosives and rapid firing guns such as all the latest German air cruisers are now fitted with.

"It would require but two or three of these great ships of the air to float over Washington and lay its magnificent public buildings in waste. They could pour down shot and shell, in fact tons of ignitable explosives right over the halls of Congress themselves, and the strangest part of the whole affair would be our absolute helplessness to prevent it. They could come and go by day or by night without opposition by merely rising high enough. All they would have to do would be to discharge their cargo of explosives and return

over our great fortresses without fear or harm to their ocean convoy, reload and repeat the operation as often as time would allow.

"Furthermore, while Germany also has a great naval fleet that could back them up, even this would be hardly necessary, for the reason that a few air scouts could find and remain in constant touch with our own war ships and by wireless telegraphy post their convoy steamships as to their location and movements, thereby enabling the cheaper unarmed supply ships to keep out of the way of the high priced war vessels.

"Besides the ten big powerful armour-clads of the air (Zeppelin and Schuette-Lanz types) each of the German supply ships would be accompanied by many hydro-aeroplanes to be utilized for scout work as well.

"Such feats could be performed today; what I am saying is not relating to the future. Germany has these airships now; they are armed, tried, proved, officered, manned and being experimented with constantly, and with each and every day's development Germany is getting nearer and nearer to the vital points of America

from a war view point while the great strides they have already made and are still making over there, are so far in advance of us that, even if we begin immediately to push forward it will require years before we can overtake them.

"I do not want to overload you with statistics, but cannot resist the temptation to call your attention to some figures recently compiled by the Zeppelin Company concerning the performances of their airships from January 1st, 1912, to December 1st, 1912, which will give some idea of the magnitude of air traffic as now practiced in Germany.

"Out of 334 days Zeppelin airships were operated during 308 days with the total number of hours in the air 1,167 during which time a distance of 41,145 miles were covered and 10,291 people carried (4,682 passengers and 5,609 crew).

"One single airship—the Viktoria Luise—made 225 trips with a total duration of 497 hours, covering 17,737 miles in an air-line and car-

ried 4,336 people (2,409 crew and 1,927 passengers).

"It might also be stated here that during all of these trips or any others made by the Zeppelin ships previously, there has never occurred one fatal accident—read again, very slowly and thoughtfully, during the many years of experimentation and in many cases accidents to the ships, of the hundreds of trips made and tens of thousands of miles covered and tens of thousands of passengers carried, not one life was lost from a Zeppelin airship—strange, isn't it, especially after your favorite editor has been repeatedly telling you how man's efforts to navigate the air was draining the population of the world.

\*The word airship should only be used when referring to a rigid dirigible, that is to say, it should depend upon a solid structure, a hull traced from the inside for its rigidity instead of depending on the pressure of the gas itself. It should have separate and independent gas chambers which should perform the same functions as the air-tight compartments of an ocean steamship, and be able to carry a large number of passengers.

It is about as foolish to call one of those little two or three passenger carrying, dirigible balloons an airship as it would be to refer to a two or three passenger carrying motor boat as a steamship. To call an aeroplane an airship shows absolutely no aeronautical breeding whatsoever.

## AERIAL FLEETS AND EXPENDITURES OF THE DIFFERENT GOVERNMENTS

(APPROXIMATE)

Country	Government Aeroplanes	Government dirigibles	Government expenditures
1. Germany	310	22	\$10,000,000*
2. France	280	19	8,000,000
3. Russia	120	10	5,000,000
4. Italy	80	7	3,000,000
5. England	50	6	2,500,000
6. Austria	30	4	1,000,000
7. Japan	25	3	800,000
8. Brazil	18	3	500,000**
9. Belgium	30	2	400,000
10. Spain	20	2	200,000
11. Bulgaria	20	0	180,000
12. Greece	12	0	150,000
13. United States	6	1	100,000
14. Denmark	6	0	80,000
15. Holland	5	1	70,000
16. Turkey	5	1	60,000
17. Mexico	5	0	40,000
18. Roumania	5	0	35,000
19. Norway	4	0	30,000
20. Argentina	3	0	25,000
21. Servia	3	0	25,000
22. China	1	0	15,000

\* While this estimate gives Germany credit for expending \$10,000,000 it should be understood that the German Reichstag last May provided \$30,000,000 in the Army and Navy Bill for "extraordinary expenses," so that it is just possible a much greater amount may have been expended for aerial purposes.

\*\* An appropriation has just been made according to a recent despatch not yet authenticated.

The figures in this table are given approximately for two reasons: First, because several of the governments mentioned are working as secretly as possible and, second, because each day brings a change somewhere by the addition of aeroplanes, dirigibles or appropriations. For instance, while Germany has 22 dirigibles still at the time this table is being compiled, there is a movement in the Reichstag to provide for the purchase of 20 new Zeppelins which, if accomplished, would change this total to 42 dirigibles. Also, before this table is seen by the public, another 50 aeroplanes may be added to their fleet. Word just received states that the government of Chili is planning to spend \$700,000 for the purchase of three dirigibles and twenty aeroplanes, as well as for the cost of equipment and operation.

A. W. L.



"It must be understood that with aircraft was born an entirely new science of engineering and navigating and that airship engineers and navigators of the air must be educated and developed with the same care and attention that is bestowed upon marine engineers and navigators—in fact more so, because it requires a higher developed mentality to succeed in the new order of things.

"Great air cruisers cannot be built in a day, neither can men be trained to man them in a day. It requires years of actual experimentation through a course of development from the seed upward.

"An idea prevailed in the British Navy a short time ago that an airship could be built by British engineers to equal or surpass the qualities of a German Zeppelin. Yes, the product of the English constructors, who had never built airships before, was to be as good or better than the product of the Germans who had spent years in the accumulation of practical experience in airship construction and operation. So an order was given to one of the largest engineering concerns in England for a great Zeppelin type, rigid airship. Well, the ship was built according to the specifications of some men who had spent much valuable time in figuring and theorizing but who unfortunately had had no actual training or experience, with the result that, while it looked like a Zeppelin, it acted quite differently when let loose into the great highway above. To be short, it lacked the main essentials of a Zeppelin—knowledge and experience gained from years of trials and failures—and upon one of its first test trials it came to an untimely end by breaking into two separate and distinct parts.

"Just what happened in England is just what would no doubt happen in America if one of our great engineers in some other line undertook to build a 'Zeppelin' or a 'Schuette-Lanz' without first passing through a long course of airship study, experimentation and some failures. Our greatest engineer in any other line would be a mere novice in airship construction. In fact, he would probably be worse than a novice because he would try to inject his old methods and principles into an entirely new dimension.

"So with Germany several years in the lead in airship construction and air navigation, enjoying the benefit of a great fighting fleet of air cruisers manned by crews trained right up to the minute and America without an air fleet, without airship constructors and without men educated and trained in air navigation, this country, in case of war with Germany would present about as pitiable a sight during the conflict as that presented by the savage Filipino tribesmen who undertook to fight with their bows and arrows and antiquated firearms, our trained American soldiers with their up-to-date quick firing guns.

"Now, if Germany with a great aerial fleet could blind us with a rain of fire and explosives from above to-day, Japan could do the same thing to-morrow, for that country is even now stealthily collecting a fleet of both aeroplanes and dirigibles, and what is more they are experimenting with them and training their best men to handle them. The Japanese fleet could lay off of any of our Western coast cities from Seattle to Panama and by utilizing the very latest up-to-date aeroplanes and airships could fly over our forts and fleets as though they never existed. Luckily for us Japan has not made the great strides in aerial methods that Germany has, yet. She started later; in fact she started later than the United States but within one short year she has outdistanced us in governmental appropriations for aeronautical work at a ratio of about 8 to 1.

"If Japan keeps up this ratio of aerial progress within the next five years and the United States persists in remaining inactive as it has done almost entirely during the past four years, Japan will have gained an advantage, from a war standpoint, which it will require at least from five to ten years of our best efforts to overcome, while, if war broke out between the two countries in the meantime, we surely would have to pay a terrible penalty for our procrastination.

"Not only does the expenditure of huge sums of money by the different governments for aerial purposes develop war strength for those countries but it also aids in the development of their industrial side as well. For instance, because the government of France spent several millions of dollars for the purchase of aeroplanes, the manufacturers of aeroplanes in France secured a tremendous advantage over the aeroplane manufacturers of the United States, for the simple reason that it gave the Frenchmen a home market to dispose of their machines and consequently that much more money

to carry on the work with. This naturally induced some of the greatest engineers in France to enter the industry, and when it was found that the government spent its money for flying machines, capital in quantity then became available for building and experimental purposes with the result that the American manufacturer with little or no capital at his disposal and no governmental market for his product, found great difficulty in trying to compete in the world's market with his French rival who was nursed, so to speak, upon governmental supplies during his infancy period. So it can readily be seen that the knife is cutting both ways against America. It cuts both in war and industry.

"Therefore, for the reasons mentioned and many other good reasons I could offer if I could but have your time and attention, I herewith recommend that Congress immediately appropriate the sum of \$10,000,000 for the purpose of creating an adequate American aerial fleet of both aeroplanes and airships, together with their necessary equipment as well as the cost of their operation.

"And furthermore, I recommend that Congress immediately pass a bill giving both the Army and Navy the power to enlist a sufficient number of officers and men to be educated in the theory and trained in the practice of aerial manoeuvres.

"I also recommend that the duty be taken off foreign airships (rigid dirigibles) for a period of two years from date in order to stimulate the importation of a few of these leviathans which would eventually lead to their construction in this country.

"And again, I recommend that suitable provision be made to subsidize airships either manufactured or operated by properly organized companies in the United States of America, that their ships of the air can be utilized by this government in case of war or during manoeuvres in times of peace. These airships, of course, at other times would be used for passenger carrying service between important points.

"While I recommend the temporary suspension of the tariff from airships (rigid dirigibles) for the reason that we have no concerns in this country who have demonstrated their ability to construct them, still I would like to have it distinctly understood that I am in favor of a heavy tariff being placed on aeroplanes, for the reason that there are a number of well organized, well equipped American concerns capable of building aeroplanes equally as good, if not better than the foreigners, and as home industries should be encouraged in the United States as they are encouraged in other countries, I furthermore recommend that every heavier-than-air-machine, whether it be of the over-land or over-water variety, purchased by the United States government, must be made in whole or in part entirely upon United States soil. For our air fleet, in war will eventually develop only that efficiency that we are capable of putting into it ourselves, and it is a thousand times better for this government to purchase now even a slightly inferior flying machine from a home manufacturer and thus enable him to enlarge and improve his efficiency with the use of the purchase money, than to buy a better machine from a foreign concern, thus enabling it to still further increase its power over the American manufacturer with the use of our capital. This rule should be made effective at least until such time as the infant industry in America has developed to a point where it can maintain its standard without favor.

"The policy of this country should be to have as efficient an air force as any other country in the world and in order to do so we must figure on overtaking the countries who are now leading us. To overtake Germany, for instance, would require at least five years' time, so that if this should be our aim, in order to do so by the year of 1919, we must arrange a progressive policy in aeroplane and airship addition which will permit us to catch up instead of falling further behind. At a very conservative estimate I place the German air fleet in the year of 1919 at more than 100 dirigibles and more than 1,500 aeroplanes so that if we intend to catch her or take a leading position with the great aerial powers of the world, it will be necessary for us to outline our policy and begin work along this line at once with these figures as the goal.

"No less than 150 aeroplanes and two rigid dirigibles should be added to our forces this year with at least three military airship sheds. One of these sheds should be erected in the Panama Canal Zone while one should be located somewhere along the North Atlantic Coast and the other somewhere on the Pacific seaboard.

"Above all things it should not be forgotten that suitable provision must be made immediately for the enlistment of a large enough force of officers and men to be thoroughly trained in up-to-date airmanship. At the present time Germany has over 300 trained aeroplane pilots in addition to several hundred trained men for the navigation of airships—an air force that altogether exceeds 600—whereas we have in our United States service less than a dozen trained airmen, and worse still, no provision has yet been made for that purpose. The few members that can be spared for that sort of work by the Signal Corps in the Army or those taken from the ranks of navy officers, make up our entire air force.

"It is to be hoped, therefore, gentlemen, that the foregoing recom-

mendations will receive your most earnest consideration and support, and that the position, honor and power of this country may not be further jeopardized through lack of progressive action.

"No man can serve his country in a more worthy manner than by adding his mite toward the development of Nature's latest and greatest gift to mankind—the power to navigate the air."

Respectfully submitted,

*Alfred W. Lawson*

## "HANSA" CIRCLING OVER THE GERMAN FLEET

"Another great demonstration of the airship's ability to manoeuvre advantageously, was given during the "Kaiser Manoeuvres" near Heligoland in the North Sea recently by the Zeppelin airship "Hansa" which circled above the warships for half an hour while reviewed by the Emperor, and after exchanging salutes with the Kaiser's flagship, returned to Wilhelmshafen. Shortly afterwards the "Hansa" went to Copenhagen and flew over the British squadron."—From November 1912 *AIRCRAFT*.

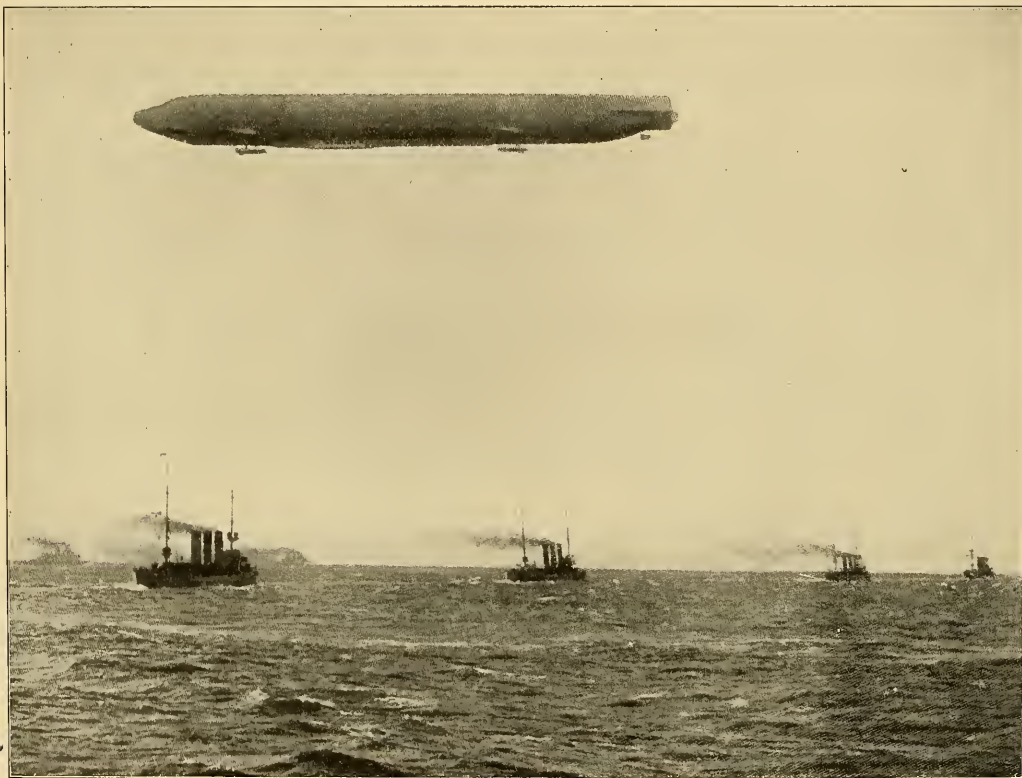

The airship in this picture—the "Hansa" is a fair sample of all of the Zeppelin ships. In case of war to-day, eight of them could be put into immediate commission, so that by adding two Schuette-Lanz, ten real war airships could be used for offensive purposes by Germany.

The above picture was apparently taken by the photographer for its picturesque effect, as it will be noticed that it is not so very far above the warships, and therefore in case they trained their guns upon it, it would probably be blown to pieces, so it might be well to state here that a Zeppelin airship is capable of rising two miles high and that up to the present time there have been no guns made capable of hitting an object at that altitude. Furthermore, by the time guns are made to shoot that high, if ever, airships will be made to go even higher, although this would hardly be necessary for, if sky color paint was used, as directed by *AIRCRAFT*'s Editorial on page 373, January 1912 issue, the airship would become completely invisible from below at less than a mile, so by muffling the engines there would then be left no method for the groundman or seaman to locate the airman, who would be a most dangerous and baffling foe, indeed.

It might also be well to state, however, that primarily airships are not made to fight battleships, although one could imagine by looking at this photograph that they could make it rather uncomfortable for a fleet below. These ships of the air can do more important work in other ways, such as flying over or around fleets and forts and doing their damage in unprotected localities, such, for instance, as the White House or the Halls of Congress in Washington, or by destroying the depots of ammunition or provisions to be used for the army in the field, or to blow up railroad bridges thus cutting off reinforcements or even by causing stampedes in the army by dropping explosives or shooting down at the men on the field. In fact, there are so many ways that these airships can be utilized in war that it would require a volume in itself to enumerate them. Two or three Zeppelins could put out of use the Panama Canal in a few hours.

The "Hansa" is 485 feet in length, has a gas capacity of 19,000 cubic metres, has three 145 H. P. engines and is capable of making 75 kilometres (46.602 miles) per hour. Besides its crew it can carry a useful load of three and one-half tons which may either be passengers or war munitions.

The only way to fight airships is with other airships or else with aeroplanes, and in either case years are required for the organization of a competent air force. Therefore, money and men must first be forthcoming through an act of Congress. Now is the time for that act.

COMPARATIVE DETAILS OF GERMAN AND FRENCH DIRIGIBLES, MILITARY AND PRIVATE, EITHER BUILT OR BEING CONSTRUCTED

Compiled by Alfred W. Lawson, with credit to Paris *Le Temps*, London *Aeronautics*, London *Flight*, T. R. McMechen, Walter H. Phipps, D. E. Ball

GERMAN DIRIGIBLES—Military

Name.	Year.	Factory.	Capacity, Cubic Meters.	Length, Feet.	Speed, k.p.h.	Engines.			Station.	Remarks.
						No.	h.	p.		
Z-I	1906	Zepplin	12000	446	58	2	85	Daimler	Metz	Army.
Z-II	1911	Zepplin	12000	400	57	2	100	Maibach	Cologne	Army.
Z-III	1912	Zepplin	12000	490	72	3	100	Maibach	Metz	Army.
Schutte-Lanz	1912	Schutte-Lanz	3000	430	75	2	270	Daimler	Mannheim	Army.
M-I	1908	Gross	2300	243	45	2	75	Koerting	Metz	Army.
M-II	1909	Gross	2300	243	46	2	75	Koerting	Cologne	Army.
P-I	1908	Parseval	4000	195	47	2	115	Daimler	Metz	Army.
P-II	1912	Parseval	4000	202	47	1	100	Daimler	Cologne	Army.
P-III	1912	Parseval	10000	282	60	2	160	Koerting	Koenigsberg	Army.
Siemens-Schuckert	1912	Siemens-Schuckert	12000	387	71	4	120	Daimler	Bresdorf	Army.
L-I	1912	Zepplin	22000	525	75	3	145	Maibach	Johannisthal	Navy.

PRIVATE

Hansa	1912	Zepplin	19000	485	75	3	145	Maibach	Hamburg	Passenger service.
Victoria-Louise	1912	Zepplin	18000	485	75	3	145	Maibach	Frankfort	Passenger service.
Potsdam	1913	Zepplin	20000	-----	-----	-----	-----	-----	Berlin	Passenger service.
P. L-1	1908	Parseval	3200	197	-----	1	85	Daimler	Bitterfeld	Passenger service.
Stolewerek	1910	Parseval	7500	223	-----	2	110	N. A. G.	Johannisthal	Passenger and adv. service.
P. L-9	1911	Parseval	1800	148	28	1	50	N. A. G.	Soc. Aerienne	Passenger service.
Ruthenberg-I	1910	Ruthenberg	1300	-----	-----	1	24	-----	Hamburg	Experimental.
Ruthenberg-II	1911	Ruthenberg	1700	150	-----	1	75	-----	Hamburg	Experimental.
Ruthenberg-III	1912	Ruthenberg	4000	214	-----	2	60	Fiat	Hamburg	Passenger or military service.
Clouth	1909	Clouth	2000	138	36	1	48	Adler	Cologne	Experimental.
Suchard	1911	-----	12000	249	-----	2	110	N. A. G.	Hamburg	For transatlantic trip.
Steffen	-----	-----	500	-----	-----	-----	-----	-----	Kell	For pleasure purposes.
Veeh	1913	Veeh	8000	246	-----	2	150	Schneeweis	Munich	Experimental.

UNDER CONSTRUCTION OR RECONSTRUCTION

Sachsen	-----	Zepplin	20000	-----	-----	3	145	Maibach	Friedrichshafen	Bought for army.
L-2	-----	Zepplin	20000	-----	-----	70	3	145	Maibach	Soc. Delag.
S. L-2	-----	Schutte-Lanz	28000	-----	-----	75	3	270	Daimler	For War purposes.
P. L-10	-----	Parseval	1800	148	-----	1	-----	-----	-----	Soc. Aerienne
P. L-12	-----	Parseval	8000	230	-----	2	110	-----	-----	Soc. Aerienne
P. L-14	-----	Parseval	10000	-----	-----	2	200	-----	-----	For the German army.
P. L-15	-----	Parseval	6700	-----	-----	2	110	-----	-----	For the Italian army.
P. L-16	-----	Parseval	10000	-----	-----	2	200	-----	-----	-----
P. L-17	-----	Parseval	10000	-----	-----	2	200	-----	-----	-----
P. L-18	-----	Parseval	10000	-----	-----	2	200	-----	-----	-----
P. L-19	-----	Parseval	10000	-----	-----	2	200	-----	-----	-----
M-1	-----	Gross	5200	-----	-----	2	100	-----	-----	Modified design, nearly ready
M-5	-----	Gross	5200	-----	-----	2	100	-----	-----	Modified design, nearly ready
M-6	-----	Gross	5200	-----	-----	2	100	-----	-----	Modified design, nearly ready

FRENCH DIRIGIBLES—Military

Fleurus	1912	Chalais-Meudon	6500	252	58	2	80	Clement-Bayard	Saint Cyr	-----
Ojonei-Renard	1910	Astra	4300	216	50	1	100	Panhard	Issy	For practice.
Liberte	1909	Lebandy	4800	255	45	1	120	Panhard	Chalais-Meudon	-----
Capitaine-Marchal	1911	Lebandy	7500	273	48	2	75	Panhard	Chalais	-----
Adjudant Vimenot	1911	Clement-Bayard	9000	292	54	2	160	Clement-Bayard	Verdun	-----
Le Temps	1911	Zodiac	2500	165	-----	1	70	Lavator	-----	From readers of Le Temps.
Dupuy-de-Lome	1912	Clement-Bayard	9000	292	54	2	125	Clement-Bayard	Mauberge	-----
Selle-de-Beauchamp	1911	Lebandy	8000	292	50	2	75	Panhard	Mousson	To be transferred to Manbeu
Adjudant-Renan	1911	Astra	8750	285	53	2	120	Brasilier	Verdun	-----
Lieutenant-Chauffe	1911	Astra	8850	285	53	2	120	Panhard	Issy-les-Moulineaux	From readers of Le Temps.
Eclairer-Cote	1912	Astra	6540	213	46	2	75	Chent	-----	On trial.
Capitaine-Ferber	1911	Zodiac	6440	219	54	2	90	Lavator	Epinal	-----
Commandant-Contelle	1911	Zodiac	9500	-----	-----	2	190	Lavator	-----	Taking delivery.
Spies-Rigid	1912	Zodiac	11000	341	-----	2	200	Chent	-----	Trials pending.

PRIVATE

Clement-Bayard VI	-----	Clement-Bayard	6200	-----	-----	58	2	90	Clement-Bayard	-----	In construction.
Astra-I	1908	Astra	4475	250	43	1	100	Clement	-----	-----	Compagnie Transaerienne.
Astra-Porres	1911	Astra	1600	195	56	1	55	Chent	-----	-----	Belonging to Societe Astra.
Croiseur-Transacien	1912	Astra	9000	-----	-----	56	2	150	Chent	-----	Compagnie Transaerienne.
Zodiac-III	1912	Zodiac	1600	139	-----	1	49	Ballot	-----	-----	Belonging to Societe Zodiac.

UNDER CONSTRUCTION OR RECONSTRUCTION

A	-----	Astra	17000	-----	-----	70	-----	1000	-----	-----	} Ordered under the budget of 5,000,000 frs. for 1913.
B	-----	Clement-Bayard	17000	-----	-----	70	-----	1000	-----	-----	
C	-----	Lebandy	17000	-----	-----	70	-----	1000	-----	-----	
D	-----	Zodiac	17000	-----	-----	70	-----	1000	-----	-----	
X	-----	-----	17000	-----	-----	70	-----	1000	-----	-----	Will be ordered after the trials of A, B, C and D.

The Zeppelin, Schutte-Lanz and Spies dirigibles are of the rigid type. The Gross, Ruthenberg, Veeh, Liberte, Capitaine-Marchal and Selle-de-Beauchamp are semi-rigid, and all of the others are non-rigid.

The military sheds in Germany are located at: Strasburg, Metz, Cologne, Koenigsberg, Reinickendorf (Berlin) (3). In construction Wilhelmshafen (for the navy) and Preslau.

The private sheds in Germany are located at: Friedrichshafen (2), Vos (Baden-Baden), Mannheim, Frankfort, Dusseldorf, Wanne, Munich, Gotha, Hambourg (2), Kiel, Bitterfeld (2), Reinickendorf (Berlin), Bresdorf, Potsdam, and Johannisthal (2).

The military sheds in France are located at: Maubeuge, Verdun (2), Toul, Epinal, Belfort and Reims.

The private sheds in France are located at: Issy-les-Moulineaux (2), Saint Cyr (2), Mousson, Lamotte-Breuille, Reims, Chalons-sur-Marne, Meaux, Melun. Under construction for the National Aviation Committee, about 32.

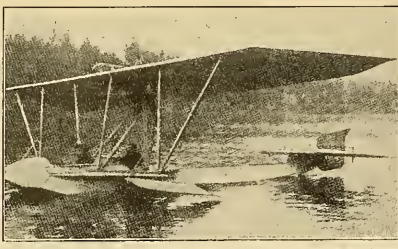

The new Denhaut flying boat which is equipped with a 50 H. P. Anzani motor placed high up just under the top plane. The machine resembles somewhat the Donnet-Lecroque aeroboot with the exception that the lower plane is very small, while single uprights only are used in joining the two planes together.

# FOREIGN NEWS

## Africa

The altitude record of Roland G. Garros of 19,032 feet made at Tunis December 11th, was accomplished on a Morane-Saulnier monoplane and not on a Bleriot as was at first thought. Garros had been trying to induce Louis Bleriot to build him a special type machine for altitude work, but this Bleriot refused to do and so Garros made arrangements with the Morane concern to use one of their machines. It is interesting to note that the monoplane used by Garros in his record altitude flight was the same 80 H. P. machine which took part in the Circuit d'Anjou race last summer.

## Argentine

Following the example of Brazil and Chili, the government of Argentina has decided to establish an aeroplane fleet and has started in by ordering three Curtiss hydro-aeroplanes.

## Australia

### THE AUSTRALIAN AEROPLANE SQUADRON

Official sanction for the formation of the Australian Aviation Corps has been given. The unit will consist of an aeroplane squadron, and its complete personnel will be four officers, seven warrant officers and sergeants, citizen forces, and enlistment, which will be voluntary, is to commence from January 1913. The course of instruction will include the following: The art of flying, including cross-country flights; the general principles of mechanics and aeronautics entering into the construction of aeroplanes; the construction, maintenance, and use of instruments, internal combustion engines, etc., forming part of the technical equipment of the corps; meteorology; observation in the air; air navigation and flying by compass; photography from air craft; signaling by all methods as applied to air craft, and instruction in types of airships and air craft of all nations. An aviation school will be established in the Federal Territory, at Duntroon, where an immense aerodrome will be constructed. The present pilot-aviator, Lieut. Harry Busted, has resigned his position, and Lieut. Harrison, an Australian, has been appointed to the post, at a salary of \$2,000 a year. Mr. Petre, an Englishman, has been appointed an assistant also at a salary of \$2,000.

## Belgium

In view of her peculiar international situation, her restricted territory, her position as a neutral buffer State between two powerful neighbors, Belgium is a country which should derive more advantages from an efficient, albeit small, air corps than almost any other country. The subject has recently been examined at considerable length in the *Congrès de P. P.* by M. Leon van den Plas, who advocates the immediate establishment of the following aviation centres:

- (1) Ostend for coastal reconnaissance—25 hydro-aeroplanes; 15 pilots.
- (2) Ghent for patrolling the region between the coast and Brussels—15 aeroplanes; 8 pilots.
- (3) Brussels for patrolling the central districts of Belgium—30 aeroplanes; 15 pilots.
- (4) Antwerp for fortress and reconnaissance work along the Scheldt—25 hydro-aeroplanes; 25 aeroplanes, and 30 pilots.
- (5) Liege to protect the Eastern frontier—50 aeroplanes; 30 pilots.
- (6) Namur for fortress work—50 aeroplanes; 30 pilots.
- (7) Saint-Hubert for patrolling the exposed south-east corner of Belgium—25 aeroplanes; 15 pilots.

The discrepancy between the number of machines and pilots at each centre is due to the fact that a number of machines will in each case be held in reserve to make good casualties and wear and tear. This gives a total of 245 aeroplanes and 143 military pilots. But in addition, and chiefly for night work (though M. van den Plas also contemplates offensive tactics), there should be a minimum of 10 dirigibles stationed in couples at Antwerp, Liege, Namur, Ostend, and Brussels.

## Chili

The chief of the Chilean staff has proposed to the government the organization of a military school of aviation and the establishment of an aerodrome. He also recommends that a number of aeroplanes and balloons and enough necessary accessories should be acquired at once. The cost is estimated at \$700,000.

## China

*Special Correspondence by A. F. B. Silva-Netto.*  
Editor Aircraft:

Mr. W. B. Atwater, the well-known exponent of the art of aviation made two successful flights at Woosung on the 24th of November with his Curtiss hydro-aeroplane. In his first flight he took a passenger with him and reached an altitude of about 2,000 feet and almost circumscribed the mouth of the Huang Pu in about sixteen minutes. Later in the afternoon he made a second flight, but without any passenger, lasting about twenty minutes. The exhibition which was in aid of the Wenchow Famine Fund was witnessed by about 8,000 people and the aviator received rounds of applause. Woosung is about fifteen miles from Shanghai, at the junction of the Huang Pu river.

## Brazil

On December 19th a bill was passed by the Brazilian Chamber authorizing the purchase of three dirigibles, twelve aeroplanes, six hydro-aeroplanes, and a battery of guns to use against aeroplanes and airships. Brazil is the first nation in South America to pro-

vide for an extensive war air fleet and following in her steps are Argentine and Chili, and several other South American countries as shown in table and list of air fleets on page 338 of this issue.

## England

### THE HANDLEY-PAGE ACCIDENT

On December 15th, Lieut. Wilfrid Parke, R. N. and his passenger Mr. Arkell Hardwick, manager of the Handley-Page company were killed while flying the 70 H. P. Handley-Page monoplane, from Hendon. The cause of the accident, as given by our English contemporary "The Aeroplane" is as follows: The machine left Hendon for Oxford about 11:45 A. M. and it was noticed that the 70 H. P. Gnome was not pulling well and in consequence the machine was slow in rising. However several flights outside the aerodrome had been accomplished with the engine in the same condition and as familiarity breeds contempt it was decided to start. The anerometer at the aerodrome registered a puffly wind of between twelve to twenty-two miles an hour, which of course would be equivalent to nearly thirty or thirty-five miles per hour higher up. It was noticed that as the machine neared Wembley the tail began to drop and though the pilot got the machine into a climbing position she continued to gradually package, as it were. When this started to take place the monoplane was little more than 200 feet up and she gradually sank to a height of 150 feet on approaching the Wembley golf links. Just as she reached the hill on which the golf links are, she turned to the left as if to come

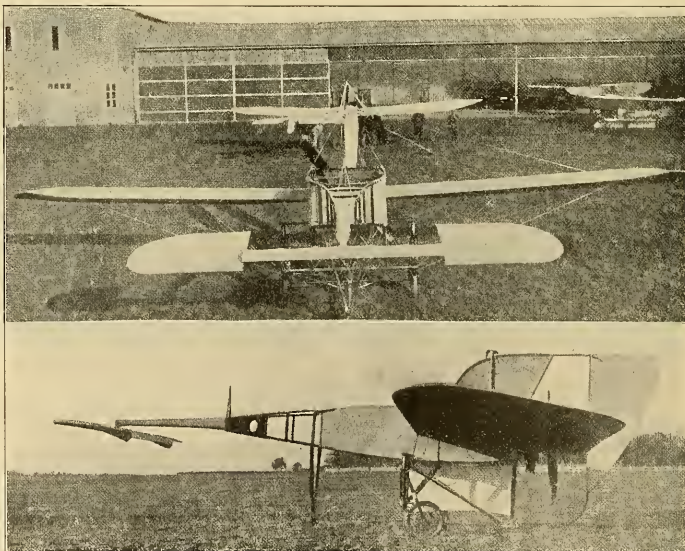

TWO VIEWS OF THE NEW BLERIOT-CANARD

The top picture shows a front view of the new machine and in the background the latest streamline tractor monoplane which was exhibited at the recent Paris Aero Salon. It is interesting to note that both of these machines have proved very successful in their trials.

The lower picture shows a side view of the Canard and illustrates clearly the position of the elevator way out in front with the main planes, motor and rudder at the rear.

back to the Hendon aerodrome and though she had turned down wind with the tail low before on several occasions in the aerodrome, it was a risky thing to attempt, in this case, over enclosed ground such as exists around Farnley. After turning and getting the wind behind him the pilot attempted to land on the golf links, probably because his engine failed altogether. The wind sweeping from the sides of a valley across which the wind was blowing. On the top of the ridge which the machine was approaching was a thick row of tall trees with the wind blowing over them. The wind sweeping from the sides of the trees would make a fierce up-current which would curl over like a wave on the beach and pour down into the valley making an almost vertical down current. The pilot, following the ridge and getting into the up-current and feel the front of the machine rise and would then endeavor to get the nose down to land as near as possible and avoid running across the links and hitting the club house or the fence on the other side. As he cleared the trees top still diving he would get into the down current and after that nothing could save him except a long dive and a powerful elevator to correct it. As it was they were only about fifty feet above the ground and nothing could save them. The machine crashed head on to the ground two miles and instantly and injuring Hardwick so seriously that he succumbed in a few minutes.

The lesson to be learned is that no one should fly across country except at a sufficient height and with an engine which has a plentiful reserve of power. If the engine shows signs of failing the pilot should land at once, but if the wind is from the wrong place he can pick out and if necessary, even at the risk of damaging the machine rather than endeavor to stagger home with a weak engine or attempt to land with a strong following wind.

#### LARGE SURFACE BIPLANE DEMONSTRATES ITS WIND-FIGHTING ABILITIES

Recently M. Verrier on a new British built Maurice Farman made one of the most remarkable flights in the history of aviation. Starting from Hendon with Lieut. Mapplebeck as passenger he headed for Farnborough intending to deliver his machine to the Royal Flying Corps. The wind was so strong that the average speed of the biplane was less than ten miles per hour over the ground and the anemometer at a Brooklands Flying Ground showed there was a wind blowing of from thirty-five to forty-five miles per hour and as the speed of the biplane is in the neighborhood of sixty-two miles an hour the wind must have been blowing at an average speed of fifty miles an hour higher up.

It was intended to fly to Farnborough but after flying an hour and thirty-five minutes and covering fifteen miles, the bell crank of the magneto stuck and the engine stopped. By a clever piece of gliding work Verrier managed to alight in a small cabbage field in spite of the force of the wind. As it was impossible to get out of the field again with a passenger Mr. Verrier went up alone after fixing the magneto and it took him thirty-five minutes to cover the remaining five miles to Brooklands, so that his actual flying time for the short distance from Hendon to London was two hours and ten minutes. This extraordinary flight proves conclusively that large surface slow speed biplanes are equally as capable of handling high winds as are the high speed monoplanes.

#### France

M. Delcasse, Minister of the Marine, has notified the Aero Club of France that a prize of ten thousand dollars will be offered by the French Government for a hydro-aeroplane which is to take place at Dieppe, near Havre during the coming summer, at the meeting when the trophy recently offered by Jack Schneider for air and water craft will be contested for. In addition to the prize the first two winning machines will be purchased by the government for \$12,000 and \$10,000 respectively.

Maurice Farman recently successfully tested a new and powerful type of aeroplane especially constructed to carry loads of provisions and ammunition. With a passenger he easily transported a load of 880 pounds.

A German aviator who landed at Maray-in his biplane on December 20th and whose machine was seized by the French military authorities as a German non-commissioned officer. After giving a satisfactory explanation of his landing in France and stating that he lost his way while flying to the fortress of Strassburg, he was released and he is to be sent to the command of Belfréste sent a detachment of a flying corps to assist him in the resumption of his flight.

#### THE NEW STREAMLINE BLERIOT FLIES SUCCESSFULLY

At the Bleriot flying ground at Buc on December 14th Perreyon was testing the new machine turned out by the Bleriot factory. This was the two seater side by side type which was shown at the recent Paris Salon and described in our show report in the December 1912 "Aircraft" machine was driven by a 20 H. P. Gnome and proved remarkably fast and steady in the air, while the single seat and pneumatic shock absorbing landing chassis proved very effective in landing.

#### NEW BLERIOT CANARD FLIES SUCCESSFULLY

On December 9th, the new Bleriot Canard, which is shown in the accompanying photos, was given its tests at Buc under the supervision of M. Bleriot, who occupied the passenger seat during the trials. The tests proved very successful in every way, the machine flying and handling better than the regular tractor type.

On January 10th at Buc, Maurice Chevallard carry-

ing three passengers in a biplane rose to a height of 4,921 feet, establishing a new world's record for altitude for an aeroplane flight with four aboard.

Amerigo with a passenger on his two seater R. E. P. Monoplane made a fast trip from Buc to Rheims in 1 hr. 20 mins. with a load of over 300 kilograms.

On December 10th Guillaux the elevet pilot of the Clemeat-Bayard monoplane completed his tests for a superior lievant. In the same machine with which he has made several flights over Paris, he started out from Issy and flew by way of Chartres and Orleans to Etampes and then back to Issy, a round trip of over 200 Kiloms.

Mlle. Marvingt in addition to doing some fine flying on her Deperdussin monoplane has been also giving a number of lectures. Recently she gave a lecture at Rheims on Alpine climbing and another on the last big game hunts of Latham. On December 13th, she made an hour's flight on the Deperdussin and later in the same day started from St. Cloud in a balloon landing near Compiegne.

At the Niouport School Sergeant St. Andre made a remarkable flight of over two hours' duration at a height of 2,000 metres on the little school Niouport which is fitted with only a 28 H. P. two cylinder Niouport engine. This is the same machine which recently rose to a height of over 11,000 feet and proves that if a machine is properly designed it can fly successfully with quite a low powered engine.

In a wind blowing forty-six miles an hour, Rene Caudron on December 17th carried out some remarkable tests with Caudron machines before a French military commission who visited Crotoy. In one of his tiny biplanes fitted with only a 28 H. P. motor he went up and flew successfully several rounds of the grounds in this veritable gale. Upon landing and preparing to take out another machine with a 70 H. P. motor, Capt. Destouches who headed the commission requested him not to attempt to fly again in such a wind.

#### German News

By Stella Bloch.

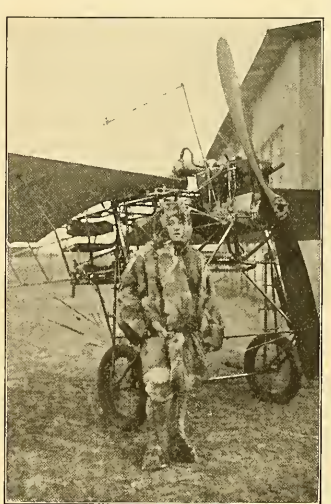

MELLI BEESE

One of the most picturesque figures in the German aviation world is that of the young Dresden sculptress, Fraulin Melli Beese who has proved herself worthy to rank prominently among the most successful pilots after passing through tribulations sufficient to turn a less determined woman or man for that matter from the idea of practical flying. It does not make pretty reading to hear the tales of her womanly struggles and, does not throw a pleasant light on the practices indulged in by male competitors against a rival of the other sex. For the sake of fair sport, it must be concluded that the misadventures complained of were the work of hangers-on, such as are found everywhere. Fraulin Beese herself states: My aviation career began on December 1st, 1910, with Ducloux on a Wright biplane, after I had studied the theoretical side of aviation for two whole years. Ten days later I came to grief owing to the snapping of a lever and sustained injuries. However, I made a relatively fast cure, but had to wait until the middle of May before I was permitted to fly. This tedious time of waiting was filled in by a practical course in motor and aeroplane building. As soon as I got on to a machine again, I followed Lieutenant van Mossner as observed in the Saxon Circuit on a Wright machine, but afterwards became his pupil. I was ready for my examination in a comparatively short time, but it was delayed so long owing to a lack of motors that I lost patience and passed to another system—the Etrich-Rumpler Taube monoplane. Here, I under-

went all possible sufferings which could be created for a competitor by less gallant male rivals—in short, complete sabotage. On September 9, 1911, it was at last rendered possible for me to gain my brevet as pilot of motor aircraft. On September 10, 1911, at the Autumn Week at Johannaisthal together with thirty-five male aviators, and gained a third and a fourth prize in the two competitions. At the same time I took up a world's duration trial for ornithopters and a passenger, namely 2 hours 20 minutes, as well as an altitude world's passenger record for women with my mother. I have founded quite recently an aviation school of my own at Johannaisthal which promises to be very successful. In the coming season I intend to compete in various events and also to make a series of exhibition flights.

#### GERMANS GIVE \$1,750,000 FOR AVIATION

Prince Henry of Prussia, the head of the Committee of the National Aviation Fund announced on December 10th that the total sum total made that day, \$1,750,000. On the following day it was announced that Count Zeppelin had determined to aid in collecting for an aero fleet and fifty of the most prominent aeronauts men of Germany formed a committee who will continue to receive subscriptions. This committee passed a resolution stating that the foremost task of the fund will be to contribute to also establish a station, they being necessary for the national defence. In connection with the fund there will be reserved a sum for accident and life insurance for aviators, while in addition it is intended to also establish a station at which aeroplane inventions may be tried out.

Sixty-one aviators carried out ascents numbering 1137 and lasting 138 hours of the twenty-four flying days during the month of November at the Berlin-Johannaisthal flying ground. The highest flight was made by Fokker on a Fokker monoplane with a score of ninety-two, while Bontard, piloting a Melli Dove spent the longest individual time in the air totaling 10 hours 53 minutes.

The formation of a purely amateur aviation club was discussed at Leipzig early in December and as soon as the club is organized the amateurs intend acquiring several standard makes of machines and it is hoped to qualify at least twenty pilots during the year.

A new German duration record was put up on December 5th at Berlin-Johannaisthal by Alfred Friedrich when he flew for 5 hours 39 minutes in a H. V. Rumpler Dove monoplane. The old record stood to Oederich in a flight of 3 hours 39 min. On December 5th Oederich flew from Leipzig to Doberitz accompanied by a passenger on a new Mers biplane which he offered to the military aviation station where a commission received the machine.

The year of 1913 will witness the erection of a new and station at Cuxhaven where a large airship shed will be put up for the many airships which are coming budget calls for sufficient money for the upkeep and manning of the station and its machines and it is proposed that the formation of a naval aerial corps be composed of 200 officers and men to be stationed at Cuxhaven.

On January 3d, Arthur Fallér established a new record for duration in a biplane carrying five passengers. His time was 3 hours 39 minutes, 10 seconds. The holder of the record was Henry Molla who in a Sommer biplane on Jan. 26, 1912 at Duizell, France, flew for 1 hour, 5 min. 48 sec.

On December 4th the Schuette-Lanz Z fulfilled all military tests by ascending to a height of 4,950 feet in fifteen minutes and by remaining at a height of between 3,000 and 3,800 feet for 4½ hours. From the ground up to 2,000 feet was done in 10 minutes but the ship averaged in bright sunshine above the fog.

An extended dispute between the German Airship Company and the British Insurance Companies in connection with the claims arising from the destruction of the Zeppelin airship Schwaben at Disseldorf on June 26th has been settled by compromise. The airship, which was insured on a valuation of about £20,000 and cost £12,000, was destroyed by a gust of wind and struck the shed into which it was hoped to place her. She then broke in two, the gas chambers began to empty, and the ship started to rise. The gas chambers burst and the bursting of the balloon under the terms of the insurance contract the risk of damage to the airship or its total destruction through explosion, the explosion of hydrogen or oxygen in the balloon was specifically excluded. The bursting of the balloon through the excessive filling of it with gas was not to be deemed an explosion.

Salzburg, the Austrian pilot, set up a new passenger altitude world's record at Berlin, allowing on September 27th whilst testing the new 125 H. P. Austrian Daimler motorized Bombard-Pfeil biplane. Carrying three passengers the apparatus remained aloft twenty-five minutes and rose to a height of 11,200 meters. The plane is intended for the German Navy.

Lieut. Hantelmann and Lieut. Zimmer recently flew from Berlin to Strassburg on a military Rumpler-Dove. Their flying time was 2 hours 10 minutes, but they were on the way many hours as the foggy weather forced them to make several intermediary landings.

The German and Danish Postal Departments are in communication regarding a regular airmail service between the two countries concerned. This may be regarded as the result of the recent visit the Hansa paid Copenhagen, as a Zeppelin cruiser will carry out the work. The Danish government proposes paying an annual subsidy, besides erecting a hangar near the capital.

A new Parseval has been completed at Bitterfeld for a foreign naval power and will be tested very shortly.

Considerable alterations have been made in the construction of the aerial cruiser which now resembles a trout in shape and is of aljivly hue, instead of its former yellow exterior, and the envelope has been entirely impregnated with aluminum. The two four-bladed propellers are driven by two six-cylinder Maybach motors, totalling 320 H. P.

The Johannistahl flying week brought a series of good, steady performances, none of which were particularly startling. In the durability contest the two Wrights, piloted by Sedelmayer and Mohns, bore off the honors with a series of seven hours forty-two minutes and seven hours thirty-nine minutes respectively. Schmidt, on a Torpedo monoplane, won the speed event over a distance of 15 kilometres and Fokker, steering his own make, the altitude prize, rising up to 3,096 meters.

**Italy**  
Roland G. Garros arrived at Rome on December 22, thus completing his long flight from Tunis, Africa. He left Tunis on December 18th, flying to Trapani a distance of about 180 miles over the Mediterranean. The second stage from Trapani to the mainland was completed on December 21st. In his last stage to Rome, Garros flew over the crater of Vesuvius.

A remarkable flight in a hydro-aeroplane across the Adriatic Sea from Venice to Trieste and back again to Venice was accomplished on December 21st by the French aviator George Chemet on a Borel hydro-monoplane. He took with him as passenger Major Gimocchio of the Italian Army. The total distance of the flight was about 160 miles.

**Japan**  
During the grand naval review in Yokohama, on

the 12th November, Capt. Kaneko piloting a Curtiss hydro-aeroplane in which a few days previous he sustained a nasty accident, made his appearance. He started from the Pacific Marine Wharf and flew over the battleship cruiser Chikuma to afford the Emperor an opportunity of witnessing for the first time in his life a spectacle of the kind, and then encircled over the entire fleet comprising of 113 vessels. Later on the Farseval dirigible also took a spectacular part in the naval review and after having swept around the whole fleet returned to the capital.

A. F. B. SILVA-NETTO.

**Paraguay**  
The first flight to take place in the Republic of Paraguay was made on November 25th, 1912, when a French aviator from Buenos Aires visited Asuncion for that purpose.

## SMALL ELEMENTARY PHYSICS

By EARLE L. OVINGTON

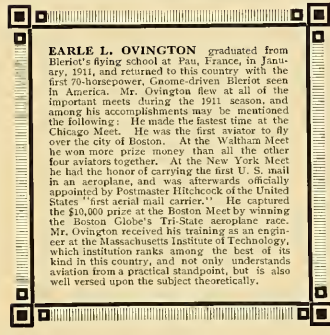

**EARLE L. OVINGTON** graduated from Cornell University, Ithaca, N. Y., in 1911 and returned to this country with the first 70-horsepower, Gnome-driven Bleriot seen in America. He made the fastest time at several important meets during the 1911 season, and among his accomplishments may be mentioned the following: He made the fastest time at the Chicago Meet. He was the first aviator to fly over the city of Boston. At the Waldham Meet he won more prize money than all the other four aviators together. At the New York Meet he had the honor of carrying the first U. S. mail in an aeroplane, and was afterwards officially appointed by Postmaster Hitchcock of the United States "first aerial mail carrier." He captured the \$10,000 prize at the Boston Meet by winning the Boston Globe's 101-State aeroplane race. Mr. Ovington received his training as an engineer at the Massachusetts Institute of Technology, which institution ranks among the best of its kind in this country, and not only understands aviation from a practical standpoint, but is also well versed upon the subject theoretically.

Some writers seem to be born critics and are never happy unless they are pulling some one's side elements to pieces. As far as I am concerned personally, however, I much prefer to construct in my writings rather than to pull down. I believe it is the duty of every one who has the required training to correct any misstatements which appear in print upon the subjects with which he is conversant. Of course that assumes that there is individual time to devote to the subject. And I believe such criticism to be constructive instead of the reverse.

A few weeks ago I came out in the press, both in America and in Europe, with some rather sharp criticisms of certain individuals who made rash statements which were absolutely untrue and which they were unable to scientifically prove. I took a very decided position with respect to the statements of one individual because he was not content alone with making misstatements regarding scientific facts, but must needs attack one of his competitors who happens to make a most successful motor embodying principles just the reverse of his.

In the January issue of *Aircraft* this subject is continued, and a dip is made by the author into elementary physics. But again there have been several misstatements made and as this subject of elementary physics is one with which every one connected with aviation should be acquainted, at least so far as the fundamental principles are concerned, I feel it my duty to call attention to the errors. I have no doubt that the author was absolutely sincere in his statements, but they are incorrect nevertheless and, hence, should not pass without criticism.

I refer to the article in January "Aircraft" entitled, "Gyroscopic Force in Aviation," by D. W. Starrett. I shall take up a few statements of Mr. Starrett's and show the errors of his judgment.

Mr. Starrett states, "There are only two forces known to man at the present time. These are gravity or centripetal and centrifugal force." There are gravity or centripetal and centrifugal forces, but there is also a matter of fact, there is no relation between the force of gravity and the so-called centripetal force. Furthermore, the so-called centripetal and centrifugal forces are not forces at all.

Let us consider a force of moment centrifugal force. If we have a ball of lead attached to a string and then whirl the string around our head, there is a tendency of the ball to fly away, but it is restrained and compelled to move in a circular path by the reaction along the string. This tendency of the ball to fly outward is called centrifugal force, and I shall show that it is not a force at all. It may be analyzed starting with Newton's first law of motion which states that the best definition I know of of Newton's first law of motion is as follows: "A body at rest will remain at rest and a body in motion will continue to move uniformly in a straight line unless and until some external force acts upon it."

Now a curved line, such as a circle, may be considered as comprising a series of infinitely small straight lines. A body moving in a circle, such as our ball of lead, has by virtue of its inertia a tendency to follow the prolongation of the small straight line in which it chances to be moving. Such a straight line is tangent to the curve or circle, and if, at any given instant, the string breaks, the ball of lead will move in a straight line along this tangent of the circle unless acted upon by some external force. Of course in actual practice gravity would act immediately, and the body would ultimately fall to the ground.

Our so-called centrifugal force, therefore, is not a force at all. The ball of lead, owing to Newton's first law of motion, tends to move in a straight line, and in doing so the effect of this so-called centrifugal force is produced, namely, there is a pull on the string. But as it does not produce, or tend to produce motion it is not a force (see later definition).

Now as to centripetal force. The ball does not move in a straight line, but follows the circle so long as the string remains unbroken. That is, the effect of the so-called centrifugal force is counteracted by the so-called centripetal force which again is not a force, but is simply the reaction along the string, i. e., the pull. (See later definition of force.)

Now let us refer to our fundamental definition of the word force. The best definition with which I am acquainted is as follows: "Force is a tendency to change the relative motion of the two bodies between which that tendency exists." Put in the form of a formula it is:

$$(1) F = ma$$

where:  
F = force  
m = mass  
a = acceleration

But in the case of our ball of lead moving in a circle

$$(2) a = v^2/r$$

$$\text{where: } v = \text{velocity} \\ r = \text{radius of circle}$$

Substituting this value for  $a$  in formula number (1) we have formula (3) as follows:

$$(3) Fc = mv^2/r$$

$$\text{where } Fc = \text{centrifugal force}$$

But since

$$(4) m = W/g$$

$$\text{where: } W = \text{weight} \\ g = \text{gravity}$$

we find by substitution the final formula for the so-called centrifugal force in terms which we can use in practise which is as follows:

$$(5) Fc = \frac{Wv^2}{gr}$$

where  $g$  equals 32.2 approximately.

Referring again to our ball of lead whirling in a circle and our fundamental definition of force, and the above formula, it is evident that centrifugal force, so-called, is not a force at all, nor is centripetal force. There are forces in physics for want of better ones. As a matter of fact, centrifugal force does not tend to produce motion in the ball of lead. The ball of lead has a tendency to move along a tangent to the circle, force is restrained from doing so by the string. Centrifugal force is the tendency of the ball to fly from the circle, and centripetal force is the restraining action of the string. Hence, Mr. Starrett's statement is absolutely erroneous.

As for his statement that there are but two forces known to man—this is equally fallacious, force being that which produces or tends to produce motion. We have many forces in the world, such as electricity, steam, muscular force, etc.

Later in his article Mr. Starrett connects centripetal and centrifugal forces with the fact that rain drops are round. The reason why rain drops are round, and why shot is round when dropped in a shot tower, is because of the surface tension. In the case of the rain

drop every molecule of the water attracts every other molecule, and the tendency of the molecules is to come as closely as possible together. A sphere is the geometric shape best satisfying this condition and, hence, they assume practically a spheroidal shape.

Why there should be all this mystery shrouding gyroscopic action is more than I can see. Some who pose as experts of the subject evidently do not understand the fundamental principles. Mr. Thomas Prestoo Brooke, for instance, says in one of his many writings on the subject, "Take a gyroscopic top. Set it sharply to the left, trying to keep the axis horizontal. Note that the forward end of the axis dives downward in spite of you. Tilt it quickly up and note that it swerves to the left."

Although Mr. Brooke poses as an expert on gyroscopic force, he has evidently never tried this very simple experiment. All any reader has to do is to purchase a gyroscopic top, such as sold in the toy stores, and try the experiment for himself, and he will see that the movement is just the reverse of that specified by Mr. Brooke. In other words, if you turn the top sharply to the left, trying to keep the axis horizontal, the forward end of the axis will rise, or tend to rise, and not move downward as stated by Mr. Brooke. Furthermore, if you tilt the top upwards, notice that it swerves to the right instead of to the left as Mr. Brooke states.

Prof. Edward Huntington gives the following simple rule to find which way a gyroscope moves under the above conditions. Prof. Huntington's rule is as follows: "Imagine the deflecting force to be exerted by the pressure of a flat board pushed against the spinning axle of the gyroscope, and note the direction in which the axle, if rough, would tend to roll along the board." (This will give the required direction of motion for that end of the axle.)

The first thing for the would-be aeronautical engineer to do is to thoroughly ground himself in regard to the fundamental principles of elementary physics, and only find this knowledge useful in aeronautic design, but in every-day life. The student need not master higher mathematics, nor need he read advanced works on the subject. A very good knowledge of physics indeed may be obtained from a very simple textbook entitled, "Elements of Natural Philosophy" by Eloy M. Avery, and published by Sheldon & Co., New York and Chicago. I do not know the price of the book, but it is not expensive and there is nothing whatever in it which cannot be understood by any man of ordinary intelligence. I find the copy which I possess dated 1895, and as I was only fifteen years of age at that time, this gives an idea of the simplicity of the book mentioned. And yet it covers, as far as most readers of "Aircraft" will probably wish to go, the fundamental principles of elementary physics.

After you have mastered this book if you want something more advanced, take Watson's "A Textbook of Physics" published by Longmans, Green & Co., New York. And if you really are fond of differential and integral calculus, you may peruse, for light reading (?) Lanza's "Applied Mechanics" published by John Wiley & Sons, New York. The two latter books I studied at college. The editor of "Aircraft" will no doubt be glad to quote on any of these books.

Let me conclude my remarks by giving the formula for obtaining the gyroscopic action in an aeroplane motor. It is as follows:

$$P = \left[ \left( \frac{v}{900g} \right)^2 \frac{Wv^2 N n}{a} \right]$$

where

P = pressure, due to gyroscopic force, on bearing in lbs.  
W = weight of motor in lbs.  
v = radius of gyration of motor about its axle in feet = approximately radius of motor  $\times$  (0.7)  
N = revolutions per minute of motor  
n = rate at which aeroplane turns, in revolutions per minute.  
a = distance, in feet, from center of motor, along axle, to one of the bearings.  
 $\gamma$  of course is 3.14 and  $g$  may be taken as 32.2.

# AN ANALYSIS OF THE FOKKER LATERAL CONTROL SYSTEM

By ALBERT ADAMS MERRILL

**I**N AIRCRAFT for January, page 322, there is an article written by Walter H. Phipps on the Fokker monoplane, in which it is stated that there is no manually operated lateral control system. Stability is maintained by a dihedral angle and a high c. g.

It is stated that some very good altitude records have been made with this machine, one of seven thousand feet by a woman, and the machine has been flown in winds of over thirty miles per hour. If these statements are founded on correct information this system would seem to be an improvement in the art.

In calm air the dihedral angle will maintain lateral stability since any rotation about the fore and aft axis will alter the magnitude of the lift of the wings so as to introduce a righting couple. Of course this couple is obtained at the expense of lift, since any rotation reduces the lift, the machine falls and stability is regained by this fall. Nevertheless a small loss of lift is little to pay if inherent lateral stability can be obtained.

With the dihedral the loss of lift is measured by the cosine of the angle between the entering edge and the horizon. Thus in Fig. 1 if B represents the tip of the horizontal wing AB, and B<sub>1</sub> the tip of the dihedral wing AB<sub>1</sub> then the lift of  $\frac{AB_1}{AB} = \frac{L}{R} = \cosine$  angle BAB<sub>1</sub>.

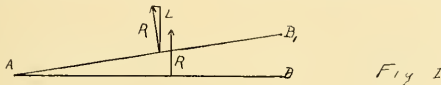

Fig. I

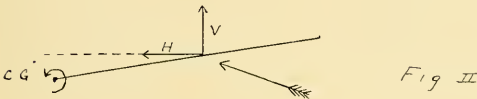

Fig. II

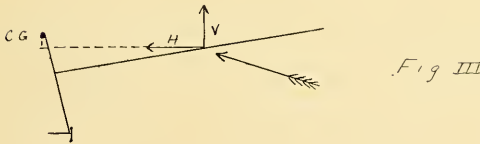

Fig. III

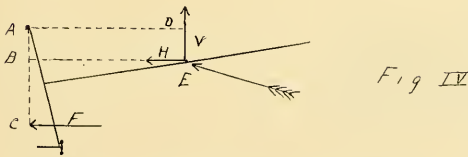

Fig. IV

In the Fokker monoplane this angle is approximately 9° and the cosine of 9° is 0.9877, therefore the loss of lift is less than 2%.

For practical flying a dihedral angle having a low c. g. (at or below the apex) is very dangerous because of the oscillations set up by a side gust. In dealing with the problem of stability one would suppose that the thing to do was to put the c. g. as far as possible below the center of support, but in aeroplanes this is wrong, because the center of side resistance is always close to the center of support and if the center of side resistance is far above the c. g. a side gust will cause a rotation about the fore and aft axis and set up a series of oscillations of a very dangerous nature. Fig. 2 shows a rotation started by a side gust. Note that the movements of the

H and V components of the gust have the same sign and therefore both tend to upset the machine.

If we raise the c. g. to the position shown in Fig. 3 it is evident that the moment of H is opposite in sign to the moment of V and hence H will offset V, the amount of the offset depending upon the relative magnitudes of H and V and the two moment arms. It is well to bear in mind the fact that the aspect ratio of a wing from the side is very low, therefore the H component will be larger relative to the V component, than it is with a high aspect ratio.

It is not possible to tell from the drawing of the monoplane as published, just where the c. g. is, but it is above the shoulder of the wing and possibly above the line joining the centers of area. Considering the effect of a side gust on the chassis, we find that a high c. g. increases the moment arm of this force, and this also helps to offset the V component. In Fig. 4 I have shown the system of forces which probably act in the Fokker monoplane, as a result of a side gust alone.

In Fig. 4, A represents the c. g. V and H are components of the resultant pressure, E is the center of pressure of the gust and F is the pressure on the chassis. In order that these three forces form a balanced system about A the following must hold:

$$F \times AC + H \times AB - V \times AD = 0$$

The aspect ratio from the side in this monoplane is about one-half and for this ratio Eiffel gives the maximum movement of the center of pressure to be 35% of the length. This makes a possible movement of E of more than 5 feet. Of course the turning around the fore and aft axis due to the gust is not measured entirely by the resultant of the gust times its moment arm, because the effect of the forward motion has to be considered. It is the resultant of all the pressures and the displacement of this resultant, which produces the turning movement. Nevertheless a large possible movement of E will be a disturbing factor. As E moves towards the tip, AD increases and AB decreases, which is the opposite to what is desired and a study of Fig. 4 will convince anyone that this system will not have inherent lateral stability, because at only one angle between the gust and the wing will the above equation be true.

The point of interest however is that with a high c. g. the magnitude of the disturbing factor is reduced, so that possibly the rudder can handle the machine by retarding the high side. I wish to call attention to a fact often overlooked, which is that the movement of a flying machine sideways is not dangerous provided there is not a rotation about the fore and aft axis; it is this rotation which is dangerous. This is why a low c. g. with a dihedral is dangerous, while a high c. g. is not dangerous.

Even if the c. g. is above the center of pressure (to forward motion) the machine may be stable. In a boat the c. g. is above the center of buoyancy yet a boat will be stable provided that when it tips, say to the right, the new center of buoyancy is to the right of the c. g. in which case the meta-center will be above the c. g. and the boat will return to the horizontal. Now it is possible to adjust a high c. g. to a dihedral so that in a calm and with a given rotation the side displacement of the center of pressure will produce always a righting couple, and in a wind a high c. g. is safer than a low one. Generally, in flying machines, the c. g. is below the center of pressure, yet this may be an error. In boats the c. g. is above the center of buoyancy yet they are stable.

However, it seems to the writer that a machine without any surfaces for controlling movement about the fore and aft axis will not be used generally, as it cannot possibly be as safe as one with such controls, nevertheless any system which reduces the need for conscious lateral control will give to the flying machine a practical value it does not have now.

With regard to fore and aft stability I would say that some late experiments of Eiffel seem to show that this is inherent in con-

verging tandem surfaces without loss of efficiency. Retiring wing tips such as Fokker uses are neither as stable nor as efficient as converging tandem surfaces.

In view of these late experiments of Eiffel and Fokker, it is possible that converging tandem surfaces, which by the way were first advocated for stability and efficiency by Mr. R. D. Andrews of Boston, a dihedral and a high c. g. will give to the flying machine a degree of stability now lacking and this calls to mind how very near Prof. Langley came to just this combination. Langley

had the tandem system, the dihedral and his c. g. was not low, but the chords of his surfaces were parallel, hence he did not have inherent fore and aft stability. His c. g. was not high enough so that the H component of the side gust passed below the c. g., hence his machine could not have had such lateral stability as Fokker's has.

The flying of the Fokker monoplane should be watched carefully to see if, in practice, a machine can be handled safely without lateral control surfaces.

## THE BENOIST FLYING BOAT

With Scale Drawings by WALTER H. PHIPPS



Three-quarters view of the Benoist flying boat showing the streamlined hull containing the motor placed directly under the centre section of the main planes and driving through a sprocket and chain transmission an 8 ft. 6 ins. diameter propeller placed about a foot below the top planes. It will be noticed that with the exception of the radiator, propeller and shaft there is practically no weight carried above the lower plane and, as pointed out, this arrangement while it aids stability on the water, it does not however improve the flying qualities of a machine as, at best, it makes steering in the air somewhat difficult owing to the fact that the centrifugal force produced in turning makes the hull swing outwards thereby tending to over-bank an aeroplane and making it necessary for the operator to counteract this force with his ailerons. Thus it will be seen that while a low centre of gravity aids stability on the water it detracts from the flying qualities and therefore it would seem that the solution of the flying boat problem will be to strike the happy medium and place the motor just on the top of the hull with vertical panels placed below the top surface to counteract any side-slipping tendency. In this way we would evolve a flying boat having a weight distribution analogous to a Wright biplane, which in spite of its low centre of gravity is one of the most stable machines extant.

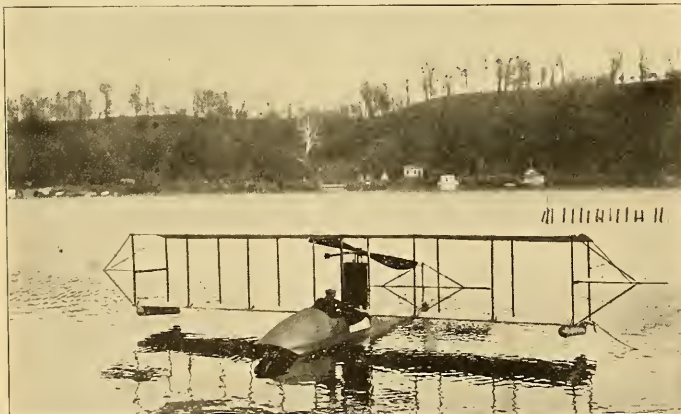

Front view of the new Benoist aeroboot, showing how a set of standard main planes were simply attached to a hydro-plane hull and a tail and rudder added at the rear, thus converting the standard Benoist biplane into a sea-worthy motor boat with wings and ailerons attached for flying work as well as high speed water skimming.

The new Benoist Flying Boat, as designed by Hugh L. Robinson and Tom Benoist, follows out a later tendency of both foreign and American manufacturers towards getting nearer and nearer to a motor boat with supporting planes simply attached for lifting work alone.

As will be noticed in the accompanying drawings and photographs the motor is placed low down in the hull of the boat, the same as in a motor boat. This arrangement of placing the motor of an aeroplane in the hull was suggested in the September 1912 Aircraft, page 216, and as pointed out has the advantage of greatly steadying a machine while in the water, as it does away with the pitching and swaying tendency due to the motor being placed high up above the hull which arrangement cannot help but make a flying boat top heavy and therefore extremely dangerous in landing.

The general outline or appearance of the boat part, follows the type originally gotten out by Donnet-Leveque. The only parallel however, is in appearance, as otherwise it differs considerably from any other flying boat made. The hull is twenty-two feet long from tip to bow, to rear of water rudder. Twenty-six inches wide, and twenty inches at the step. It has a displacement of two thousand pounds, and with the standard Benoist biplane wings, standard ailerons, and the tail modified some to suit the new conditions, will carry aviator and passenger with a hundred pounds of luggage.

The hull is constructed entirely of spruce three-eighths inch in thickness, with the seams backed with one-fourth by three-fourths strips. The boat has two heavy bed beams one and three-eighths inch thick, running completely through the boat from one end to the other. The bottom is laid on these beams, the braces radiating from the beams. The beams carry the engine, which is fastened on them the same as the engine carrying beams in the usual aeroplane. As these parts of a plane are built strong and heavy, to support the engine, there is of course a margin of weight left, which is put in these two heavy beams or keels, so that the boat is made strong and rigid while the complete assemblage still retains lightness of weight.

The direction of the boat while in the water, is controlled by a simple rudder, situated below the large air rudder. This makes the boat very easily managed, even in the water, regardless of how slow the speed may be.

The operator and passengers are protected by a curved hood, built up of wood and cloth, in a shape that tends best to fend the water and spray, this hood being carried back along the sides to the rear of propeller, where it forms a circular covering over the boat, keeping the water out entirely and presenting a neat appearance.

Instead of the cloth covering over the engine and machine parts, a regular aluminum hood is built to the same general lines as the balance of the covering.

The power plant in the present boat, consists of a six cylinder seventy-five horsepower motor, driving an 8½ ft. by 6 ft. pitch propeller. The propeller shaft is set up high, so as to allow plenty of propeller clearance above the boat. This shaft is set 16 inches below the upper advancing edge of main plane, and of course is set parallel with the line of flight. It is supported by two combined radial and thrust Hess-Bright ball bearings. The housings of these bearings being cast in a spider shaped bracket, from the legs of which radiate guy wires, that hold the shaft in an absolutely rigid position.

The propeller is driven through two sprockets. One on the engine shaft, and the other attached to the propeller hub. A three-fourths by one-half inch pitch Diamond chain is used.

The controls are the same as used on the regular type twelve Benoist Biplane, being a universal lever for lateral and fore and aft balance, operated with the right hand, and a lever for the left hand, moving in a fore and aft plane for the direction rudder. The direction rudder control wires are connected to both the air and water rudders, so that both of these operate either when moving in or out of water. The dimensions of the supporting planes are as follows:

Spread 32 ft., 2½ in. gap, 5 ft. regular Benoist curve; cord, 4 ft. 10 in. Goodyear cloth No. 10, used for covering.

The machine in trial flights, had no trouble in carrying the aviator and a passenger in circular flights, besides other luggage, amounting to about 100 pounds, and fifteen gallons of gas aboard. The gas tank is set under the engine hood, and cannot be seen in the photograph.



# THE BENOIST FLYING BOAT

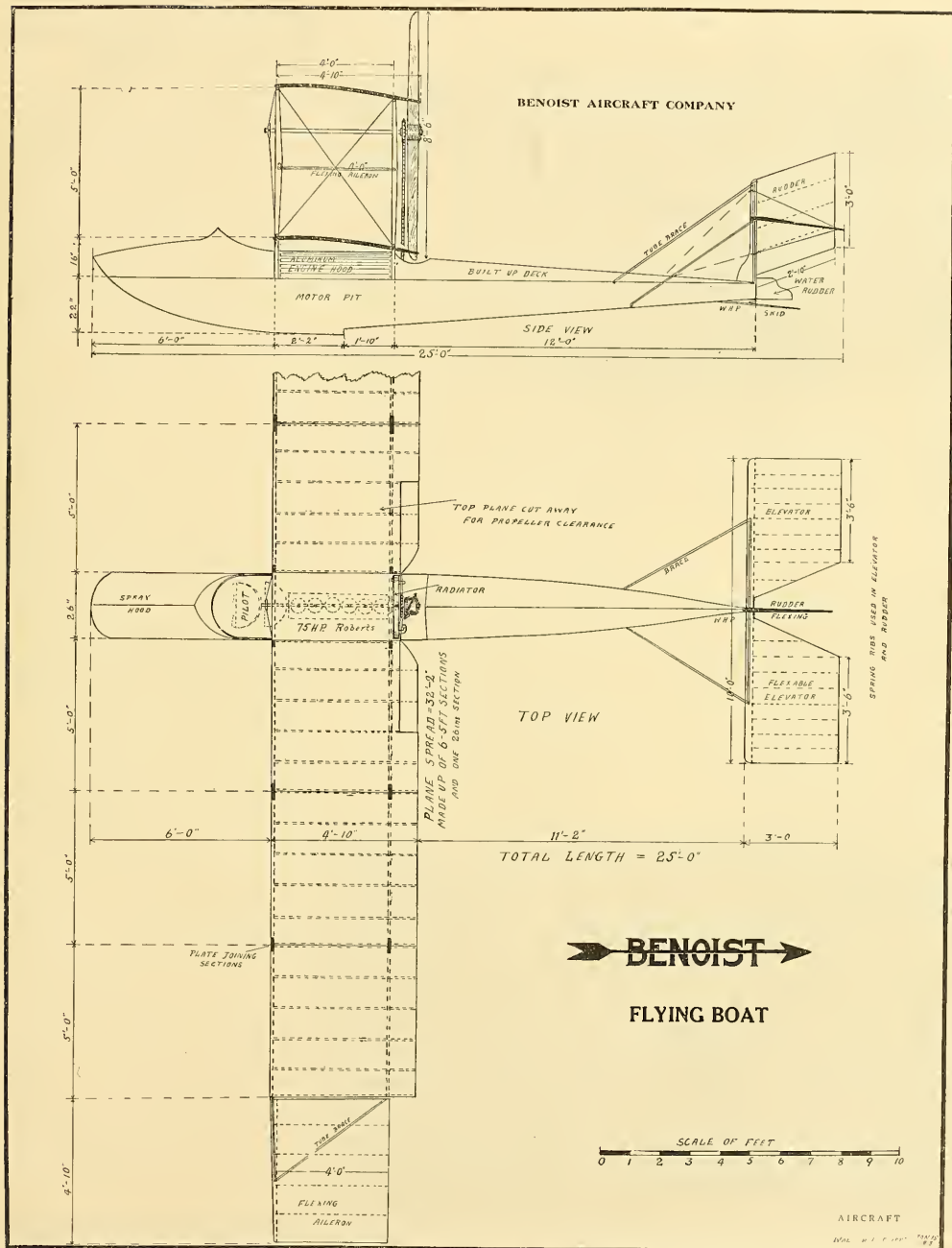

SCALE DRAWINGS OF THE TWO-SEATER TYPE

# NEWS IN GENERAL

By D. E. BALL



The above picture shows W. Leonard Bonney, the famous aeroplane pilot who formerly flew a Wright biplane, but who is now acting as chief instructor of the Sloane Aeroplane Company, flying both the Deperdussin and Caudron monoplanes.

## The Sloane Company

The Sloane Aeroplane Company has moved into a new, large fireproof factory in Long Island City. This building is located within short distance of Bowers Bay so that they will have every facility for hydro-aeroplane work. The factory is situated on a plot 100 x 100 and gives ample space for the assembling of machines and repairing of machines and motors.

The Panier Aerial Motor Works which is controlled by the Sloane Aeroplane Company will occupy the same building with their very complete machine equipment. This will give the Sloane Aeroplane Company a most complete aeroplane equipment. They will be in a position to turn out aeroplanes and motors in the shortest possible time and will be able to attend to all kinds of repair work. The Panier Company has made a specialty of repairing high grade aviation motors and supplying duplicate parts for them. This department is to be kept up and enlarged.

The Sloane Aeroplane Company carries in stock a full line of spare parts for Anzani and Gnome Motors, Deperdussin and Caudron monoplanes. Some of the aeroplanes now in use in their school were built by them.

## Meet to be Held at Owensmouth

The Owensmouth aviation meet is to be held in the new town of the San Fernando valley January 22 to 26 inclusive.

The meet will be managed by Van M. Griffith, secretary of the Aero Club of California.

Prof. H. LaV. Twining, president of the Aero Club of California, will be director of contests. Owensmouth was selected for this year's meet because of a number of peculiar advantages. The wonderful new boulevard through the San Fernando valley, built at a cost of \$500,000, is believed to be just the thing to attract the autoists, as the surrounding scenery of mountain and valley will give an exhilarating setting for the drives to and from Owensmouth.

The new wide-gauged electric line built into the valley by the Pacific Electric will give excellent facilities for spectators to visit a new country, only three-quarters of an hour away from the city, and for travel through some of the best scenery in Southern California.

All preliminary arrangements have been completed. Owners of land at Owensmouth have arranged to give all the facilities needed, the Pacific Electric has fallen in with the plans of Messrs. Griffith and Twining,

a number of aviators have signed for entry, more have promised to come in as soon as they get hold of set of articles, and negotiations are pending with practically all the aviators in this country.

The aviators who have already signed contracts are: Frank L. Champion, Jay Gage, Frank M. Stites, Fred J. Schumann, Earl Daugherty, William A. Heltlich, J. Floyd Smith.

Those who promised to consider contracts are: Glenn Curtiss with four machines and aviators and flying boat, Fred de Koor, Robert G. Fowler, Glenn L. Martin, Charles L. Wiggins, Grover Bell.

## Navy Flyers Leave for Cuba

United States Collier Sterling carrying two officers of the naval aviation corps, twenty-five petty officers and enlisted men, four machines and equipment, left Annapolis for Guantanamo, Cuba, on December 28th. The officers aboard were Lieut. B. L. Smith and Ensign G. DeC. Chavalier. The machines taken were two of the Wright and two of the Curtiss hydro-aeroplanes. Lieut. John H. Towers, who will be in charge of the camp left later on board one of the battleships accompanied by other officers of the naval aviation corps. Lieut. Towers stated that the work in Cuba will be along the lines of experiments in connection with launching aeroplanes from battleships, as well as experimental and instructional work.

## Curtiss Machine in Brazil

David McCulloch, of Newport, Pa., a graduate of the Curtiss aviation school, has gone south, taking with him one of the latest type Curtiss hydro-aeroplanes with which he will give demonstrations in the hopes of interesting the government of Brazil as well as other South American countries, and if successful he will establish aviation schools for the instruction of Army and Navy officers.

Besides three machines sold to the Argentine government, the Curtiss equipment is a shipping several more machines to South America.

## Aeroplanes Locate Submarines

Recent experiments at Annapolis have demonstrated the fact that the operators in aircraft can discover the presence of submarines and mines below the water without the use of glasses.

This in the opinion of naval officers will probably advance the plan of having aeroplanes as the part of the standard equipment of all the fighting craft in the United States navy.

## Aero Club of Pennsylvania

The annual election was held at the January monthly meeting of the Aero Club of Pennsylvania. The following officers were elected: President, C. E. Wynne; 1st Vice President, T. H. Dougherty, Jr.; 2d Vice President, W. D. Harris; Secretary, Geo. S. Gansner; Treasurer, L. Maresch; Directors, A. T. Atherholt, H. B. Hawkins, S. Wheeler, W. H. Sheahan, H. H. Knerr, Dr. S. C. Fall.

It was decided to move the headquarters of the Club from the Bellevue-Stratford Hotel to the Engineers' Club, 1317 Spruce Street.

A lengthy discussion regarding Federal control of aviation was held and a bill is being prepared to present to Congress.

A Henry Neely cup for best work in Aerial Photography for the year was awarded to H. H. Knerr. Thirty photographs were on exhibit. Mr. W. N. Jennings, whose admirable article "A New Aero Camera" appeared in "Aircraft" for December 1911, acted as judge in awarding the prize cup.

## Mother of Cromwell Dixon is Very Ill

Mrs. Cromwell Dixon, mother of Cromwell Dixon, the boy aviator who was killed a year ago while making an exhibition flight at Spokane, Wash., is critically ill with bronchial pneumonia at her home, 675 Denison Avenue, Columbus, Ohio.

## Aero Club of Philadelphia

The Aero Club of Philadelphia will hold its regular meetings on the second and last Saturday evenings of each month, starting February 8th, 1913. The membership of this club is strictly amateur in its composition, and any who may be interested in the sport are cordially welcomed to its membership.

The work as outlined for the coming year includes practical and scientific lectures on aeroplanes to be given before the club, and on the different subjects that the lecturer has made good in. The club plans to build a man-carrying glider before spring, and will build a full size machine as soon as its resources will permit its construction.

The members are enthusiastic and the club promises to become one of the most successful of its kind in the country. Meetings will be held on the above dates at 2208 Brown Street at 8 o'clock P. M. All who are interested are asked to communicate with its organizer, Mr. D. Earle Dunlap, at the above address.

## Albert Heinrich Mails Letters from Aeroplane

On January 9th, Albert Heinrich flew over the town of Baldwin, Long Island, and dropped a package of mail at the post office. In this package was a post-card addressed to "Aircraft" which was duly delivered.



This picture shows one of the many uses to which Silas Christofferson, the daring young Pacific Coast aviator puts his aeroplane to. The photograph shows him just after his return from one of his many duck hunting trips over Coos Bay, Oregon. Besides hunting in aeroplanes, Christofferson has also performed some remarkable feats, such as flying off the top of a building in Portland and flying out to a steamer in distress, besides making a dare-devil flight over the city of San Francisco during the night. Seated beside him is his brother, Harry Christofferson.

**Flying Boat Successfully Launched by Catapult Device**

On December 18th one of the large Curtiss flying boats operated by Lieut. Theodore G. Ellyson was shot from the new catapult launching device which was resting on rats. The boat easily flew upward after leaving the catapult.

It is firmly believed that the success of this new launching device will cause the naval authorities to install one on the turret of the new battleship "Pennsylvania" now under construction at the Washington navy yard.

Capt. Washington I. Chambers, inventor of the catapult, has already made tentative designs for placing permanent catapults on the tops of the turrets of all big American battleships.

Miss Ruth Bancroft Law who flies a Burgess-Wright biplane has opened an aviation school at the Clarendon Hotel, Sea Breeze, Florida.

**United States Government to Require Bodies on War Aeroplanes**

It is stated that the new specifications for aeroplanes to be purchased by the army in 1913 will not only demand machines of the utmost strength and reliability but will require a special type of fuselage for sheltering the aviator and passenger and necessary instruments.

In regard to the requirement of the enclosed bodies on the 1913 military machines, it is interesting to note that both the Wright and Curtiss companies have announced that they will have no difficulty in meeting the new specifications, in fact Curtiss has already constructed a tractor type fuselage machine, while Orville Wright has drawn up the designs for a new machine to be fitted with a streamline body.

**H. H. Hoover Organizing New Company to Manufacture Aeroplanes**

H. H. Hoover, late President of the Hoover-Conrow Company of Atlanta, Ga., is now hard at work organizing a new company having bought out the assets of the old company. The new organization will be located in Atlanta and the company will engage in the manufacture of aeroplanes paying particular attention to the Hoover 1913 model, a monoplane which contains many interesting features.

On December 18th Mr. Robert J. Collier handed in his resignation as President of the Aero Club of America and Mr. Alan R. Hawley was elected President in his place.

**More Pay for Officers Who Fly**

Without opposition the House January 16 adopted an amendment to the army appropriation bill proposed by the Military Affairs Committee by which officers who are detailed to the aviation corps will receive an increase of 50 per cent. in their pay during the time they are actually engaged in operating heavier than air machines. Representative Hay, of Virginia, Chairman of the committee, explained that this amendment was intended to encourage army officers to volunteer for this hazardous work.

**Kemp Motor Selling Well**

The Kemp Machine Works of Muncie, Ind., report that their business has been much more brisk than for the corresponding period last year, and that sales have been made all winter, whereas none were effected until the early Spring last season. This concern expects to be in a position to make deliveries of their new 1913 model Kemp Motor in the near future as these are well under way and will soon be ready for testing.

**The First Parcel Post Aviator**

On January 13th, Harry M. Jones, in a Burgess-Wright biplane, left Franklin Field, Boston, on an intended trip to New York carrying fifty pounds of parcel post mail. He reached Providence, Rhode Island, the first stop, in the afternoon, where he delivered the first parcel post package ever sent by aeroplane. Jones hopes to fly on to New York, making stops at New Haven and Bridgeport.

**Burgess Flying Boat to Have Stabilizer**

The new flying boat which is being built by the Burgess Company and Curtiss for the Navy Department and which will probably be finished early in February, is to be fitted with a Doure automatic stabilizer.

The flying boat will be much larger than the usual machines and fitted with a 70 H. P. Renault engine and has a carrying capacity of 600 pounds in addition to being able to carry three persons. It is also designed to be capable of remaining in the air for over four hours.

**Coast Defence Burgess Hydro-aeroplane Passes Tests**

On January 20th, a new type coast defence Burgess Hydro-aeroplane exceeded the government requirements when given its final tests in the presence of official representatives of the government at Marblehead, Mass. The last test was in climbing, the requirement being an ascent of 150 feet a minute. With Frank Coffey as operator the hydro made 210 feet a minute, with the handicap of an excess of 50 pounds weight over the 450 pounds required. The machine had met all other government requirements in previous tests. It will be sent immediately to Palm Beach for the use of government aviators.

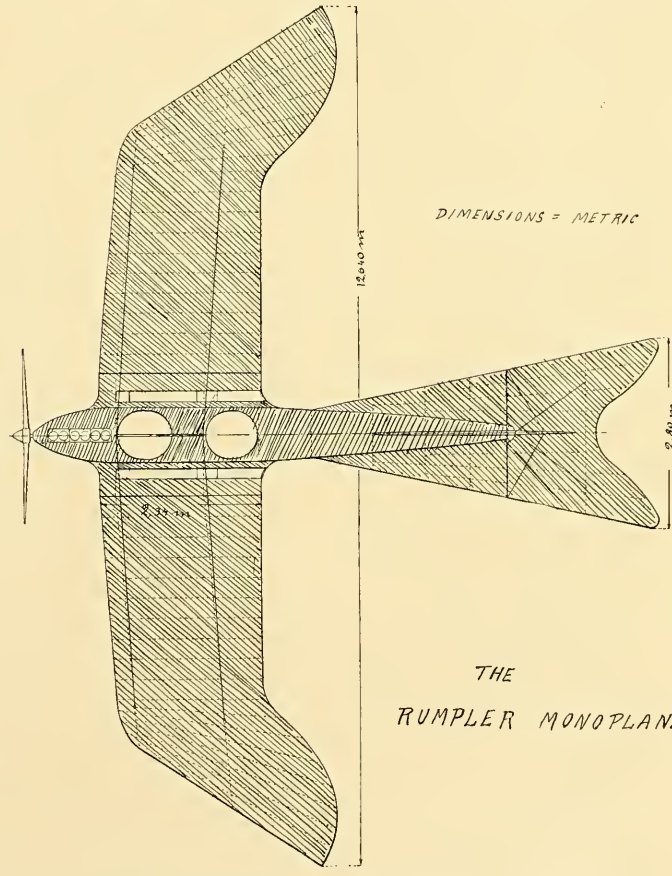
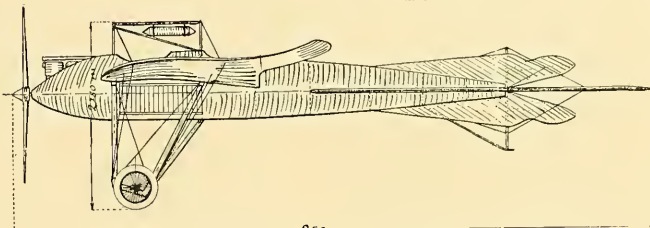
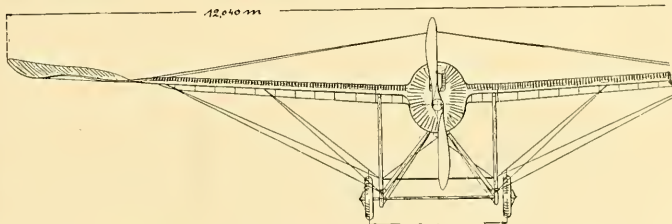

THE RUMPLER MONOPLANE

INDEX

A  
Abramovitch Makes Passenger Carrying Record. 273  
Accidents—  
Cause of, Bleriot Explains. 89  
Classing of Causes of (See France)..... 186  
Eyewitness' Report of Miss Quimby's..... 9, 89  
Fatal Aeroplanes..... 224  
Aerobic Flying Causes Walsh's Death..... 272, 296, 341  
"Adjutant Reau" (Notes concerning)..... 272, 296, 341  
"Adjutant Vincotto" (Notes concerning)..... 206, 341  
Advance Toward Aerial Law (Articles)..... 20, 215  
Advertisement Display per Dirigible (Illus.)..... 46  
Aerial Law, Advance Toward (Articles)..... 20, 215  
Aerial Oil Engine Sought by Navy..... 224  
Aerial Opportunities (Editorial)..... 11  
Aerial Supremacy (Article)..... 294  
Aeroduster Construction Company, The..... 53, 91  
Aerobats, The Curtiss (Illus.)..... 22, 190, 241  
Aerobats Skimmer, German (Illus.)..... 153  
Aerobats, Leading Types of (9 Illus.)..... 241  
Aerocraft, The Breguet Enclosed (Illus.)..... 15  
Aerodromes..... 15  
Hempstead Plains..... Cover No. 10  
Hendon, Plan and Scene of..... 217  
Villacoublay..... 109  
Aerodynamic Laboratory, An (Letter)..... 279  
Aeronautical Society of Women, The (See Club News)  
Aeronautical Society, The (See Club News)  
Aeronautical Society of Great Britain, The (See Club News)  
Aeronautical Manufacturers' Association—  
(Articles)..... 73, 113  
Banquet (Illus.)..... 215  
Aeronautical Show, The (Illus. Article)..... 114  
Aeronautical Accidents, Fatal (Table)..... 9  
Aeroplane as Used in Actual Warfare in Mexico (Illus.)..... 250  
Aeroplane Launching Catapult..... 225, 303, 349  
Aeroplane, Motor and Equipment Company..... 22, 53, 127, 90, 189, 251  
Stand at Show (Illus.)..... 117  
Aeroplane Safety For One Dollar (Illus. Article)..... 207  
Aero yacht, Design for an (Constructional Drawings)..... 216  
Aerocraft Flight, The Voisin..... 321  
Africa, Aeronautics in..... 320, 342  
Airboat, The Caudron (Illus.)..... Cover No. 3  
Aircraft, Statement of the Ownership of, etc. 305  
Air Ferry, Wright..... 258  
Air Fleet for Germany..... 321  
Airship Evolution (Editorial)..... 242  
Airship Facts, Some (Article)..... 178  
Airship, The Schutte-Lanz (Article)..... 313  
Airship Statistics, Table..... 341  
Airships (See Dirigibles)  
Airship Travel (Illus.)..... Cover No. 4  
Air Squadron Flies Over City at Night..... 249  
Air Travel, Revolutionizing (Article)..... 76  
Akron Disaster, The..... 191  
Albatross Company, The..... 82, 118  
Algeria, Aeronautics in..... 22, 53, 90, 189, 224  
American Aeroplane Supply House, Single Seater..... 123  
Description of..... 123  
American Aeroplane Supply House, Factory (Illus.)..... 157  
American Aviation Company, Inc., The..... 91  
American Enterprise (Illus.)..... Cover No. 10  
American Frontiers Company..... 22, 53, 91, 126, 189  
Americans Exporting Flying Machines (Editorial) 181  
American Aviation Records (See Records and Statistics)  
Analysis of the Farman Control, An (Article)..... 81  
Analysis of the Fokker Control (Article)..... 345  
Andrews, Robert D. (Letter from)..... 318  
Andrew's Glider, Diagrams of..... 265  
Angle Indicator..... 147  
Antoinette Surface Curve (Illus.)..... 191  
Appropriations, Naval..... 249  
Argentina, Aeronautics in..... 296, 320, 338, 342  
Armour Plating on British Airships, Overboard..... 215  
Army Aviator Requirements, Detailed..... 276  
Army News..... 19, 51, 89, 160, 224, 225, 275  
Army..... 224  
Army Tests, Burgess War Plane Passes..... 190  
Aviation School..... 225  
Gets Baby Wright..... 225  
U. S. A. Aviation Service..... 162  
Arnold, Lieut., Takes McMackay's Prize for Military Scouting..... 276  
Borel..... 160  
Astra Exhibit at Fourth Paris Aero Salon..... 300, 343  
Attention, Congress (Editorial)..... 74  
Audemars Flies from Paris to Berlin..... 280  
Australia, Aeronautics in..... 82, 248, 271, 342  
Austria, Aeronautics in..... 82, 124, 151, 186, 218, 248, 271, 296, 320, 338  
Austrian Biplane ("Vudobona") (Illus.)..... 45  
Autobiographies (See Biographies)  
Autographs..... 340  
Alfred W. Lawson..... 19  
D. Massou..... 278  
J. Ramon Montero..... 316  
Johann Schutte..... 291  
I. Senoussi..... 291  
Capt. J. Hector Wodette..... 275  
Automatic Stability, Orville Wright Talks on..... 275  
Aviation Dictionary (Illus.)..... 162  
Aviation Cup Race, 1912 International..... 52  
Aviation, Pioneers of (Articles)..... 150, 179, 316  
Aviators Should Organize (Editorial)..... 85  
Avro..... 10  
Military Biplane (Illus. Description)..... 85  
New Enclosed Body (Illus.)..... 151  
Scale, Drawing of..... 87  
B  
"Baby" English Dirigible..... 296  
Baby Engine Company, The (Illus. Stand at Show) 117  
Balance, A New Method of Lateral (Illus. Article) 175  
Baldwin, Capt. Thos. S. (Note)..... 158  
(Group Illus.)..... 177  
Hollows Biplane in Flight (Illus.)..... 263  
Ball, D. E. (Letter from and Articles by)..... 18, 50, 88, 121, 158, 190, 217, 253, 275, 302, 324, 327  
Balloons..... 15  
Long Distance Record..... 304  
New England Ballooning..... 304  
Start of Contest in Germany (Illus.) Cover No. 5  
Structural Requirements..... 244  
1912 International Balloon Race..... 302  
Banquets..... 113  
Aeronautical Manufacturers' Assco. (Illus.)..... 113  
Barcelona Meet..... 221  
Barnaby, Ralph S. (Letter from)..... 319  
Bathia Bath Vedrines Record..... 14  
Battalions, Three Aerial for American Army..... 81  
Bavaria, Aeronautics in..... 82, 242  
Beauchamp, Lincoln..... 51  
In Flight (Illus.)..... 224  
Makes Fast Climb in Biplane..... 311  
Two Views of Curtiss Engine Tractor Biplane Ennit to the Order of (Illus.)..... 109  
Bedel Starting on Flight at Villacoublay (Illus.) 109  
Beech National Biplane, The (Illus.)..... 121  
Bees, Mell (Illus.)..... 343  
Belgium, Aeronautics in..... 14, 45, 82, 151, 218, 248, 271, 296, 338, 342  
Belgian Congo, Aeronautics in..... 124  
Benoist Aircraft Company, The..... 156  
(Billus. Article)..... 346  
Flying Boat (Illus. Article)..... 327  
Single Surface Benoist Biplane (Illus.)..... 153  
Dirigible in Flight (Illus.)..... 300  
Berlin-Vienna Race, Walter E. Wright..... 74  
Besson Exhibit at Fourth Paris Aero Salon..... 151  
"Beta" Dirigible..... 74  
Big Business Ahead (Editorial)..... 80  
Biographies..... 80  
Chambers, Capt. W. Irving..... 150  
d'Orey, Ladislav..... 270  
Hirshberg, Dr. Leonard Keene..... 295  
Johnson, Walter E. W..... 337  
Lawson, Alfred W..... 147  
Lewkowicz, Ladis..... 145  
MacMecheen, T. R..... 313  
Maxim, Hudson..... 79  
Merrill, Albert Adams..... 244  
Myers, Denys P..... 313  
Ovington, Earle L..... 212  
Reber, Major Samuel, U. S. A..... 76  
Schnette, Johann..... 289  
Simmons, Will..... 212  
Wilcox, Philip Wakeman..... 296  
Gannan, Melvin..... 289  
Worcen, Capt. J. Hector..... 212  
Bird Flight, Gull vs. Wind (Illus. Article)..... 304  
Bishop, Cortland Field Book..... 296  
Blancq, R. H. (Letters from and Articles by)..... 122, 124, 151, 186, 218, 248, 271, 296  
Blaisir Arthur and Walter E. Johnson in machine (Illus.)..... 218  
Blaschke, Lieut., Establishes Height Record..... 90  
Bleriot—  
Note concerning..... 80  
Louis Bleriot Explains Cause of Monoplane Accidents..... 270  
Louis Bleriot's Work (Article)..... 301  
Bleriot Monoplane (Illus.)..... 342  
Bleriot-Canard (2 Illus.)..... 159  
Bleriot Demountable Military Type (2 Views) 159  
Exhibit at Fourth Paris Aero Salon..... 298  
Latest Bleriot Monoplane with Single Skid Landing Chassis..... 299  
J. Ramon Montero and His Latest Bleriot..... 278  
School Bleriot (Illus.)..... Cover No. 10  
Surface Aeroplane Curve (Illus.)..... 191  
Bloch, Stella (Articles by)..... 15, 83, 153, 187, 250, 296, 320, 343  
Bohand Biplane in Flight (Illus.)..... 50  
Bomb Throwing, Scott's..... 34  
Bonney W. Leonard in Machine (Illus.)..... 41  
Book Review..... 52, 161, 278, 279, 319, 354  
Borel..... 299  
Exhibit at Fourth Paris Aero Salon..... 322  
Hydro-Monoplane (Illus.)..... 241  
Hydro-monoplane (Illus.)..... 300  
Monoplane Racer (Illus.)..... 183  
Boston Meet, Problems of the (Article)..... 127  
Boughton, W. E..... 279  
Brake Test Sturtevant Motor (Illus.)..... 126, 157  
Brauminger, P. H..... 14, 338, 342  
Breaking the American Passenger-Carrying Endurance Record (Article)..... 295  
Breguet..... 15  
Enclosed Aerocraft (Illus.)..... 299  
Exhibit at Fourth Paris Aero Salon..... 291  
Military Biplane, three-seater (Illus. description)..... 85  
Surface Curve (Illus.)..... 191  
Tractor Biplanes Assembled (Illus.)..... 69  
Bristol Exhibit at Fourth Paris Aero Salon..... 222, 301  
British Monoplane, Scale Drawings of..... 222, 301  
British War Office Trials, Table of..... 221  
British War Ships Fitted with Overhead Armour Plating..... 249  
Brooks Aeroplane Company, The..... 224  
Brooks-Hamilton Monoplane, The (Illus.)..... 254  
Brown, Harry, in Wright Biplane (Illus.)..... 158  
Brustman, S. R. (Articles by)..... 190, 209, 246  
Bulgaria, Aeronautics in..... 218, 248, 296, 320  
Burning Bridge at Chinnahna Reported by Aero-Engineer..... 289  
Burgess Company and Curtiss—  
Notes Concerning..... 53, 126, 304, 329  
Letter from..... 53, 189  
Hydro-aeroplane (Illus.)..... 141  
Double Tractor (Illus.)..... 247  
Gordon Bennett Cup Racer (Illus.)..... 247  
Gordon Bennett Cup Defender (Letter)..... 243  
Hydro-aeroplane (Illus.)..... 160, 241  
Military Tractor Biplane (Illus.)..... 112, 116, 241  
War Plane Passes Army Tests..... 224  
Business at Summer Resorts (Editorial)..... 11  
C  
Cagliani Makes Voyage by Air from Pisa to Corsica..... 273  
California Aviation Co..... 157  
Call of News..... 18, 50, 51, 88, 121, 276, 303, 327  
Call of Progress (Article)..... 192  
Call Monoplane (Illus.)..... 276  
Canada, Aeronautics in..... 151  
Captaine Marché Dirigible..... 341  
Captaine Ferber Dirigible..... 341  
Cary, Monoplane Model (Illus.)..... 120  
Cary, E. R. (Letter from)..... 318  
Catapult Device for Quick Launching Tried Out..... 225, 303, 349  
Caudron—  
Rene Caudron Starting in Hydro-aeroplane (Illus.)..... Cover No. 3  
Biplane in Flight (Illus.)..... 125  
Exhibit at Fourth Paris Aero Salon..... 299  
Hydro-aeroplane (2 views of)..... 181  
Monoplane in Flight..... Covers Nos. 10, 11, 300  
Cerrutti, Frank A. (Sketches by)..... 328  
Chambers, Capt. Washington Irving—  
Article by..... 80  
Biography..... 80  
Change Place with Your Motor (Article)..... 274  
Channel Crossings (See English Channel Crossings)  
Charavay Propeller..... 189  
Chicago Aero Works..... 53  
Chicago Notes..... 190  
Chicago Meets..... 209, 246  
Chief Signal Officer's Notice to Aircraft..... 278  
Chief Aeronautics..... 82, 338, 342  
China, Aeronautics in..... 82, 248, 271, 320, 338, 342  
Chinese Pilot, Tom Gung Makes Flight..... 225  
Christmas Aeroplane Company..... 90  
Christmas Aeroplane Company Headless Biplane (Illus.)..... 115  
Christofferson Silas in Machine (Headless)..... 348  
Circuits..... 273  
Circuit of Berlin Race..... 152, 187  
Circuit of Anjou Race..... 249  
Circuit of France..... 246  
Circuit of Ireland..... 153  
Circuit of the Upper Rhine..... 296  
"City of Cardiff" Dirigible..... 126  
Clawson-Hayutin Company..... 300  
Clement-Bayutin..... 46, 219, 341  
Exhibit at Fourth Paris Aero Salon..... 15  
Machine in Flight (Illus.)..... 190  
Cline, William, Makes Long Flight in Hydro-aeroplane..... 341  
Club Dirigible..... 190  
Club News..... 16, 17, 88, 80, 121, 125, 186, 190, 218, 275, 296, 328  
Aeronautical Society..... 16, 88, 121, 275, 302  
Aeronautical Society of Great Britain..... 218  
Aeronautical Society of Women..... 296  
Aero Club of Illinois..... 148  
Aero Club of Kansas City..... 319  
Aero Club of Long Island..... 190, 348  
Aero Club of Pennsylvania..... 125  
Aero Club of Russia..... 16, 88, 121  
Aero Club of St. Louis..... 16, 88, 121  
Hydro-aeroplane Club of New Haven..... 16  
Intercollegiate Aeronautical Association of America..... 16  
Louisville Aero Club..... 16  
New England Aero Club..... 328  
Netherlands Aeronautical Association..... 300  
Philadelphia Aero Club..... 16, 348  
Royal Aero Club of the United Kingdom..... 186  
Royal Aero Club..... 16  
Code—  
Specific Gravity..... 245  
Code—  
Makes New English Record..... 188  
New Code, Aeroplane..... 188  
Cody Biplane Defeats Monoplanes in British Army Tests..... 248  
Code With English Michell, No. 2..... 296  
Coffyn, Frank, and Machine (Illus.)..... 19  
Collieux in Flight (Inset Illus.)..... 84  
Collisions in the Air (Article)..... 240  
Colonel Renard (Article)..... 341  
Commandant Curtiss' Dirigible..... 341  
Commercial Product, A (Editorial)..... 42  
Comparison of Aerial Supremacy of France and Germany (Article)..... 294  
Competitions, Result Military Aeroplane..... 248  
Congress, Attention (Editorial)..... 74

Congress, A Recommendation to (Article).....	337	"Sachsen".....	341	Five Passenger Record, World's.....	14
Conover, C. E.....	90	"Selle-De-Bouchamp".....	341	Flennus Dirigible.....	341
Constantin, Dr. Juics Killed in Warfare.....	320	"Schottic Lanz II".....	145, 220, 248, 250, 267, 313	Flight Over City.....	225, 249
Construction Details (Illus.).....		"Siemens-Schuckert".....	230, 341	Flies 570 Miles Across France in One Day, Pierre.....	
12, 49, 86, 153, 185, 222, 252, 319, 354		"Spiess".....	321, 341	Diaconot.....	271
Construction Drawings 12, 49, 86, 153, 155, 190, 216		"Steffen".....	341	Flight Over Pittsburgh.....	160
225, 252, 299, 300, 301, 319, 323		"Suchard".....	46, 154, 341	Flock of Land and Water Birds, A (Illus.) Cover No. 6	
"Coote" Dirigible Makes World's Height Record		"Vaniman".....	7, 159	Flying Boat.....	
(France).....	186	"Victoria Louise".....	143, 220, 341	Burgess Flying Boat.....	349
Contests, Grant Won by Fourry.....	247	"Ville de Bruxelles".....	218	Curtiss (Illus.).....	
Control, Analysis of the Farman (Article).....	81	"Yastrol".....	273	Curtiss Flying Boat, A Big Success.....	190
Control, Analysis of the Fokker (Article).....	345	"Zeppelin".....	46, 144, 220, 252, 341	Denhaut Flying Boat.....	342
Control, Computing Efficiency of Lateral (Article).....	120	Distance Records (See Records and Statistics).....		Side View Sketch of Curtiss (Illus.).....	190
Cooke, H. C.....	18	Document, Official Containing Application for		Two Curtiss Flying Boats in Race (Illus.).....	216
Cooke, Weldon B. (Illus.).....	18	Detail to Military Aviation Service.....	41	Suggested Eight Passenger Aero-yacht.....	216
Correction.....	354	Dollars, 24,000 Cash Prizes at Chicago Meets		Benoist Flying Boat (Illus.).....	346
Correspondence.....	47, 122, 160, 279,	(Article).....	209	Flying in Honolulu (Illus.).....	218
Cross Country.....	121	Donnet-Leveque Aero-boat (Illus.).....	241, 271	Fokker Monoplanes (Illus.).....	83
Crane, Louis L., Airship Transportation Company,		D'Orcy, Ladislas.....	39	Analysis of the Fokker Control (Article).....	345
The.....	90	(Articles by).....	150, 179, 317	(Description of).....	46
Criticisms, Prize Won by Fourry.....	249	(Biography of).....	150	(Scale Drawing).....	322
Criticisms of the Newport Wing Curve (Illus.		Dorner Monoplane (Illus.).....	150	Foreign Aero Clubs (See Club News).....	323
Article).....	302	Doyle, Exhibit at Fourth Paris Aero Salon.....	301	Foreign News (See Different Countries).....	
Cross-country Flights, News of		Doyle, Herbert C. (Illus.).....	91	14, 45, 82, 124, 151, 186, 218, 248, 271, 296, 320,	
46, 153, 160, 190, 225, 280, 271, 273, 319, 320, 321, 329		Drzewicki Exhibit at Fourth Paris Aero Salon.....	301	432	
Curtiss, Glenn H. and Group of Students (Illus.).....	328	Dziewicki-Belast Race.....	273	Foulois, Lieut. (Group Illus.).....	205
Curtiss Abroad.....	254	Dupuy-de-Lome Dirigible.....	272, 341	Fouroy Makes Non-stop Flight and Wins Critéri-	
Aeroplane Company.....	90, 158, 189, 223, 335, 348	Duraux, J. (Illus.).....	279	um Prize.....	249
Aero-boat (Illus.).....	241	Elyson, J. Flies Over City.....	225	Four Passenger Record, English.....	14
Douglas.....	19, 88	Duration Records (See Records and Statistics).....		Fourth International Gordon Bennett Cup Race	290
Engined Tractor Biplane (Two Illus.).....	190	Ebbinghaus, Ernst.....	53	Fourth Paris Aero Salon (Illus. Article).....	209
Flying Boat a Big Success.....	190	Editorials.....	10, 42, 74, 148, 180, 210, 242, 268,	Fowler, Robert G., in Biplane (Illus.).....	18
Gordon Bennett Racer (Illus.).....	115	Eiffeltop Drops Call for Surrender into Besieged	296	Fox de Luxe Aero Motor (Illus. Article).....	157
Hydro-aeroplanes (Two Inset Illus.).....	84	Eight Passenger Aero Yacht (Illus.).....	216	Fox de Luxe, Aeronautes in	
Landing Gear (Illus.).....	119	El Aero Radiator Company.....	126	45, 82, 124, 151, 186, 218, 249, 271, 296, 320, 338,	
Motor in Front Type (Illus.).....	274	Ehrhard Engine Company.....	122	343	
New Large Surface Hydro-aeroplane (Illus.).....	278	Elyson, Late Successfully Tests New Catapult		France, Aero Club of (See Club News).....	
Propeller Builder Machine (Illus.).....	122	Launching Device.....	303	French American Balloon Company.....	
Secrecy at Training School, Hammondport		Elope in Biplane.....	305	French Court States Aviators are Free to Fly	
(Illus.).....	77	Enclosed Aeroplanes.....	305	Anywhere.....	91
School Biplane (Illus.).....	319	Ero Aero-yacht (Illus.).....	151	French Decree, The (Editorial).....	100
Type Biplane (Illus.).....	319	Etrich (Illus.).....	152	French Governments Exhibit at Fourth Paris Aero	
Curves, Leading Types of Surface (Illus.).....	312	Endurance Records (See Records and Statistics).....		Salon.....	301
"Daily Mail" Exhibition.....	151	Engin Aeroplanes.....	14, 45, 82, 124, 151, 186, 218, 248, 271, 296, 320, 338,	French Military Dirigible "Capitaine Ferber"	
"Daily Mail" (See Races).....		Engine Turned Over Near Chihuahua and Re-		(Illus.).....	124
Danger of the Lateral Tail and its Probable Bear-		ported by Aeroplane (Illus.).....	291	Frey's Accident.....	321
ing on Death of Miss Quimby (Illus. Article)		English Channel Crossing 82, 151, 152, 186 (England)		Frontier Iron Works.....	22, 90, 158, 223
D'Artois Exhibit at the Fourth Paris Aero Salon		186 (France), 248 (England).....		Fung Yue First Chinese Aviator to Lose His Life	
Daucourt, Pierre, Flies 570 Miles.....	271	Etrich Monoplane (Illus.).....	47, 152	in China (Illus.).....	320
Day, Charles, Biplane Built by the Assistance of		Etrich (Illus.).....	152	Furtherments (Editorial).....	210
(Illus.).....	224	Euclidean Records (See Records and Statistics).....		G	
Deau Manufacturing Company.....	90, 158	Euler, Aeronautes in		Gallaudet Monoplane (Illus.).....	115
Decks, Upper and Lower of the Vaniman Airship		Headless Farman (Illus.).....	299	"Gamma" Dirigible.....	158
(Illus.).....	77	Headless Farman (Illus.).....	299	Gans, Dr. Transatlantic Trip.....	214
Delivers Newspapers in Biplane.....	319	Headsless Farman (Illus.).....	299	Gans, Dr. Transatlantic Trip.....	214
"Delta" Dirigible.....	296	Hydro-aeroplanes, Henry Farman (Illus.).....	83, 299	Garros Makes Altitude Records.....	249, 320
Denhaut Flying Boat (Illus.).....	312	Monoplane, Henry Farman (Illus.).....	151	General News.....	
Denmark, Aeronautes in.....	320, 338	Reassigned Farman (Illus.).....	275	German "Skinner" (Illus.).....	150, 224, 255, 275, 302, 348
Dependence.....		R. O. Kubel Jr. & Company (Illus.).....	294	German Air Navy League's "Schuette Lanz I"	
Gordon Bennett Winner (Two Illus.).....	237	Famous Pioneer, A (Editorial).....	177	(Illus.).....	145
Gordon Bennett Winner (Two Illus.).....	237	Farman.....	177	German Airships (Editorial).....	148
Gordon Bennett Winner (Two Illus.).....	237	Exhibition Flying, A Remarkable Picture of		German Machine, The Dorner Monoplane (Illus.).....	214
Gordon Bennett Winner (Two Illus.).....	237	(Illus.).....	177	German Method of Driving Propellers (Illus.).....	272
Gordon Bennett Winner (Two Illus.).....	237	Exhibition International Aviation.....	177	Germany, Aeronautes in	
Gordon Bennett Winner (Two Illus.).....	237	Exhibition Opportunities (Editorial).....	186	15, 46, 83, 125, 152, 187, 220, 250, 272, 296, 321, 338,	
Gordon Bennett Winner (Two Illus.).....	237	Exposure Falls to Injure Aeroplane.....	44	343	
Gordon Bennett Winner (Two Illus.).....	237	F		Cesa Hydro-monoplane (Scale Drawing).....	319
Gordon Bennett Winner (Two Illus.).....	237	Fable Plant, Balloon (Illus.).....	126	Chouls (Editorial).....	293
Gordon Bennett Winner (Two Illus.).....	237	Facts vs. Guess-Work (Editorial).....	126	Gibson, Theod. (Letters from).....	279, 354
Gordon Bennett Winner (Two Illus.).....	237	Factories.....	126	Gibson Propeller Company, The.....	53
Gordon Bennett Winner (Two Illus.).....	237	Famous Pioneer, A (Editorial).....	177	Gieger, Lieut. (Group Illus.).....	205
Gordon Bennett Winner (Two Illus.).....	237	Farman.....	177	Gill, Howard W. Flying Double Engined Hydro-	
Gordon Bennett Winner (Two Illus.).....	237	Exhibition Flying, A Remarkable Picture of		aeroplane (Illus.).....	191
Gordon Bennett Winner (Two Illus.).....	237	(Illus.).....	177	Gilder, The Andrews (Diagrams of).....	265
Gordon Bennett Winner (Two Illus.).....	237	Exhibition International Aviation.....	177	Goedecker Monoplane "Stormbird" (Illus.).....	232
Gordon Bennett Winner (Two Illus.).....	237	Exhibition Opportunities (Editorial).....	186	Goodyear Tire and Rubber Company.....	126
Gordon Bennett Winner (Two Illus.).....	237	Exposure Falls to Injure Aeroplane.....	44	Goodyear Tire and Rubber Company.....	126
Gordon Bennett Winner (Two Illus.).....	237	F		Balloons (Diagrams of).....	265
Gordon Bennett Winner (Two Illus.).....	237	Fable Plant, Balloon (Illus.).....	126	Goodyear Tire and Rubber Company.....	126
Gordon Bennett Winner (Two Illus.).....	237	Facts vs. Guess-Work (Editorial).....	126	Goodyear Tire and Rubber Company.....	126
Gordon Bennett Winner (Two Illus.).....	237	Factories.....	126	Goodyear Tire and Rubber Company.....	126
Gordon Bennett Winner (Two Illus.).....	237	Famous Pioneer, A (Editorial).....	177	Goodyear Tire and Rubber Company.....	126
Gordon Bennett Winner (Two Illus.).....	237	Farman.....	177	Goodyear Tire and Rubber Company.....	126
Gordon Bennett Winner (Two Illus.).....	237	Exhibition Flying, A Remarkable Picture of		Goodyear Tire and Rubber Company.....	126
Gordon Bennett Winner (Two Illus.).....	237	(Illus.).....	177	Goodyear Tire and Rubber Company.....	126
Gordon Bennett Winner (Two Illus.).....	237	Exhibition International Aviation.....	177	Goodyear Tire and Rubber Company.....	126
Gordon Bennett Winner (Two Illus.).....	237	Exhibition Opportunities (Editorial).....	186	Goodyear Tire and Rubber Company.....	126
Gordon Bennett Winner (Two Illus.).....	237	Exposure Falls to Injure Aeroplane.....	44	Goodyear Tire and Rubber Company.....	126
Gordon Bennett Winner (Two Illus.).....	237	F		Goodyear Tire and Rubber Company.....	126
Gordon Bennett Winner (Two Illus.).....	237	Fable Plant, Balloon (Illus.).....	126	Goodyear Tire and Rubber Company.....	126
Gordon Bennett Winner (Two Illus.).....	237	Facts vs. Guess-Work (Editorial).....	126	Goodyear Tire and Rubber Company.....	126
Gordon Bennett Winner (Two Illus.).....	237	Factories.....	126	Goodyear Tire and Rubber Company.....	126
Gordon Bennett Winner (Two Illus.).....	237	Famous Pioneer, A (Editorial).....	177	Goodyear Tire and Rubber Company.....	126
Gordon Bennett Winner (Two Illus.).....	237	Farman.....	177	Goodyear Tire and Rubber Company.....	126
Gordon Bennett Winner (Two Illus.).....	237	Exhibition Flying, A Remarkable Picture of		Goodyear Tire and Rubber Company.....	126
Gordon Bennett Winner (Two Illus.).....	237	(Illus.).....	177	Goodyear Tire and Rubber Company.....	126
Gordon Bennett Winner (Two Illus.).....	237	Exhibition International Aviation.....	177	Goodyear Tire and Rubber Company.....	126
Gordon Bennett Winner (Two Illus.).....	237	Exhibition Opportunities (Editorial).....	186	Goodyear Tire and Rubber Company.....	126
Gordon Bennett Winner (Two Illus.).....	237	Exposure Falls to Injure Aeroplane.....	44	Goodyear Tire and Rubber Company.....	126
Gordon Bennett Winner (Two Illus.).....	237	F		Goodyear Tire and Rubber Company.....	126
Gordon Bennett Winner (Two Illus.).....	237	Fable Plant, Balloon (Illus.).....	126	Goodyear Tire and Rubber Company.....	126
Gordon Bennett Winner (Two Illus.).....	237	Facts vs. Guess-Work (Editorial).....	126	Goodyear Tire and Rubber Company.....	126
Gordon Bennett Winner (Two Illus.).....	237	Factories.....	126	Goodyear Tire and Rubber Company.....	126
Gordon Bennett Winner (Two Illus.).....	237	Famous Pioneer, A (Editorial).....	177	Goodyear Tire and Rubber Company.....	126
Gordon Bennett Winner (Two Illus.).....	237	Farman.....	177	Goodyear Tire and Rubber Company.....	126
Gordon Bennett Winner (Two Illus.).....	237	Exhibition Flying, A Remarkable Picture of		Goodyear Tire and Rubber Company.....	126
Gordon Bennett Winner (Two Illus.).....	237	(Illus.).....	177	Goodyear Tire and Rubber Company.....	126
Gordon Bennett Winner (Two Illus.).....	237	Exhibition International Aviation.....	177	Goodyear Tire and Rubber Company.....	126
Gordon Bennett Winner (Two Illus.).....	237	Exhibition Opportunities (Editorial).....	186	Goodyear Tire and Rubber Company.....	126
Gordon Bennett Winner (Two Illus.).....	237	Exposure Falls to Injure Aeroplane.....	44	Goodyear Tire and Rubber Company.....	126
Gordon Bennett Winner (Two Illus.).....	237	F		Goodyear Tire and Rubber Company.....	126
Gordon Bennett Winner (Two Illus.).....	237	Fable Plant, Balloon (Illus.).....	126	Goodyear Tire and Rubber Company.....	126
Gordon Bennett Winner (Two Illus.).....	237	Facts vs. Guess-Work (Editorial).....	126	Goodyear Tire and Rubber Company.....	126
Gordon Bennett Winner (Two Illus.).....	237	Factories.....	126	Goodyear Tire and Rubber Company.....	126
Gordon Bennett Winner (Two Illus.).....	237	Famous Pioneer, A (Editorial).....	177	Goodyear Tire and Rubber Company.....	126
Gordon Bennett Winner (Two Illus.).....	237	Farman.....	177	Goodyear Tire and Rubber Company.....	126
Gordon Bennett Winner (Two Illus.).....	237	Exhibition Flying, A Remarkable Picture of		Goodyear Tire and Rubber Company.....	126
Gordon Bennett Winner (Two Illus.).....	237	(Illus.).....	177	Goodyear Tire and Rubber Company.....	126
Gordon Bennett Winner (Two Illus.).....	237	Exhibition International Aviation.....	177	Goodyear Tire and Rubber Company.....	126
Gordon Bennett Winner (Two Illus.).....	237	Exhibition Opportunities (Editorial).....	186	Goodyear Tire and Rubber Company.....	126
Gordon Bennett Winner (Two Illus.).....	237	Exposure Falls to Injure Aeroplane.....	44	Goodyear Tire and Rubber Company.....	126
Gordon Bennett Winner (Two Illus.).....	237	F		Goodyear Tire and Rubber Company.....	126
Gordon Bennett Winner (Two Illus.).....	237	Fable Plant, Balloon (Illus.).....	126	Goodyear Tire and Rubber Company.....	126
Gordon Bennett Winner (Two Illus.).....	237	Facts vs. Guess-Work (Editorial).....	126	Goodyear Tire and Rubber Company.....	126
Gordon Bennett Winner (Two Illus.).....	237	Factories.....	126	Goodyear Tire and Rubber Company.....	126
Gordon Bennett Winner (Two Illus.).....	237	Famous Pioneer, A (Editorial).....	177	Goodyear Tire and Rubber Company.....	126
Gordon Bennett Winner (Two Illus.).....	237	Farman.....	177	Goodyear Tire and Rubber Company.....	126
Gordon Bennett Winner (Two Illus.).....	237	Exhibition Flying, A Remarkable Picture of		Goodyear Tire and Rubber Company.....	126
Gordon Bennett Winner (Two Illus.).....	237	(Illus.).....	177	Goodyear Tire and Rubber Company.....	126
Gordon Bennett Winner (Two Illus.).....	237	Exhibition International Aviation.....	177	Goodyear Tire and Rubber Company.....	126
Gordon Bennett Winner (Two Illus.).....	237	Exhibition Opportunities (Editorial).....	186	Goodyear Tire and Rubber Company.....	126
Gordon Bennett Winner (Two Illus.).....	237	Exposure Falls to Injure Aeroplane.....	44	Goodyear Tire and Rubber Company.....	126
Gordon Bennett Winner (Two Illus.).....	237	F		Goodyear Tire and Rubber Company.....	126
Gordon Bennett Winner (Two Illus.).....	237	Fable Plant, Balloon (Illus.).....	126	Goodyear Tire and Rubber Company.....	126
Gordon Bennett Winner (Two Illus.).....	237	Facts vs. Guess-Work (Editorial).....	126	Goodyear Tire and Rubber Company.....	126
Gordon Bennett Winner (Two Illus.).....	237	Factories.....	126	Goodyear Tire and Rubber Company.....	126
Gordon Bennett Winner (Two Illus.).....	237	Famous Pioneer, A (Editorial).....	177	Goodyear Tire and Rubber Company.....	126
Gordon Bennett Winner (Two Illus.).....	237	Farman.....	177	Goodyear Tire and Rubber Company.....	126
Gordon Bennett Winner (Two Illus.).....	237	Exhibition Flying, A Remarkable Picture of		Goodyear Tire and Rubber Company.....	126
Gordon Bennett Winner (Two Illus.).....	237	(Illus.).....	177	Goodyear Tire and Rubber Company.....	126
Gordon Bennett Winner (Two Illus.).....	237	Exhibition International Aviation.....	177	Goodyear Tire and Rubber Company.....	126
Gordon Bennett Winner (Two Illus.).....	237	Exhibition Opportunities (Editorial).....	186	Goodyear Tire and Rubber Company.....	126
Gordon Bennett Winner (Two Illus.).....	237	Exposure Falls to Injure Aeroplane.....	44	Goodyear Tire and Rubber Company.....	126
Gordon Bennett Winner (Two Illus.).....	237	F		Goodyear Tire and Rubber Company.....	126
Gordon Bennett Winner (Two Illus.).....	237	Fable Plant, Balloon (Illus.).....	126	Goodyear Tire and Rubber Company.....	126
Gordon Bennett Winner (Two Illus.).....	237	Facts			

Gull Versus the Wind, The (Illus. Article)..... 212  
 Gyroscopic Force in Aviation (Article)..... 316

H

Hadley, Clifford O. in flight (Illus.)..... 5  
 Hall Scott Motor Car Company, The..... 22  
 Handley-Page Accident..... 342  
 Hangars, Illustrations of..... 69, 109, 219, Cover No. 10  
 Hanriot.....  
 Aeroplane Surface Curve (Illus.)..... 191  
 Stand at Fourth Paris Aero Salon (Illus.)..... 250  
 "Hansa" Dirigible (Illus.) Cover No. 9, 272 (Note)..... 541  
 Harlan Monoplane in Flight (Illus.)..... 190  
 Havelon, Beckwith Joins State Guard (Group Illus.)..... 203  
 Hawker Wins English Michelin Duration Flight..... 296  
 Height Records (See Records and Statistics)  
 Heiligendam Hydro-aeroplane Meet..... 273  
 Heinrich.....  
 Albert Heinrich Carries Passenger in Monoplane..... 328  
 Albert Heinrich in Flight with Passenger (Illus.)..... 327  
 Albert Heinrich Starting on Cross-Country Flight in His Hydro Monoplane (Illus.)..... 304  
 Article by Albert Heinrich..... 162  
 1912 Mono-Biplane, The Heinrich (Illus. Article)..... 12  
 Notes Concerning..... 22, 126, 189, 348  
 Scale Drawing of Heinrich School Type Monoplane..... 12  
 Helmet, The Rood Safety (Illus.)..... 43  
 Hempstead Plain News..... 254, 277, 303  
 Hennessy, Captain (Group Illus.)..... 205  
 Henson, Samuel and John Stringfellow Aviation Pioneers (Articles)..... 223  
 Hill, Frederick C., in Flight (Illus.)..... 270  
 Hirschberg, Dr. Leonard Keene, A. B., M. A., M. D. (Letter and Article by)..... 270, 279  
 Holland, Aeronautics..... 46, 154, 220, 273, 338  
 Honolulu, Flying in (Illus.)..... 218  
 Hoover-Corow Aeroplane Company, The..... 91, 349  
 Horton, Charles C., in Machine (Illus.)..... 16  
 Hydro-Aeroplanes.....  
 Caudron (Illus.)..... 83, Cover No. 3  
 Curtiss (Illus.)..... 22, 37, 84, 278, 287  
 Farman, Henry (Illus.)..... 83, 299  
 Goupy Biplane Fitted with Detachable Floats (Illus.)..... 296  
 Hydro-aeroplanes at Curtiss Training School.....  
 Leading Types of Hydro-Aeroplanes (Illus.)..... 241  
 Nieport, Weymann and Passenger Alighting in (Illus.)..... Cover No. 8  
 Suggested Design for Hydro-Monoplane (Illus.)..... 154  
 Wright Hydro-aeroplane (Illus.)..... 19  
 Hydro-aeroplane Contest at Monaco (Inset Page Illus.)..... 84  
 Hydro-aeroplanes at Offenburg, Germany..... 251  
 Hydro-airmanship or Airhoatmanship (Article)..... 80  
 Hydrogen—Specific Gravity (Table)..... 243

I

Ideal Aeroplane and Supply Company, The..... 90  
 Illinois Aero Club (See Club News)  
 Illuminated Flyer (Group Illus.)..... 271  
 Import Foreign Goods to America..... 251  
 Importance of Aeronautical Armaments (Article)..... 71  
 India, Aeronautics in..... 83, 125, 126  
 Indispensable Evidence (Editorial)..... 269  
 Indo-China, Aeronautics in..... 125  
 Information for Aeroplane Builders (Article)..... 162  
 Inherent Stability and How it is Achieved in the Fokker Monoplane (Article)..... 322  
 International Aeronautic Construction Company, The..... 22, 90, 127, 158  
 Intercollegiate Aeronautical Society (See Club News)  
 Intercollegiate Balloon Race (See Races)  
 International Aviation Exhibition in Germany..... 15  
 International 1912 Aviation Cup Race..... 52, 209  
 International Exposition Company, The..... 53, 90  
 Ireland, Aeronautics in..... 220, 273  
 Italy, Aeronautics in..... 125, 154, 188, 220, 251, 273, 297, 322, 338, 344

J

Jacobs Multiplane (Illus.)..... 115  
 Jannus, Anthony.....  
 In Flight (Illus.)..... 247  
 Makes Two World's Records..... 329  
 Starting His 1970 Mile Hydro-aeroplane Trip (Illus.)..... 303  
 Japan, Aeronautics in..... 220, 273, 297, 338, 344  
 Japanese Biplane (Illus.)..... 125  
 Jeannin, a German Flyer in Aviatik Biplane (Illus.)..... 186  
 Johannisthal Meet..... 297  
 Johannisthal Field (Illus.)..... 295  
 Johnson, Walter E., (Article by)..... 295  
 Thomas Johnson's Scout to Sorensen (Illus.)..... 295  
 In Machine (Illus.)..... 295  
 (Biography of)..... 73  
 Jones, Ernest L. (Portrait)..... 73

K

Kabitzke Putting Baby Wright Military "Speed Scout" Through Tests (Illus.)..... 277  
 Kabitzke Drives Aero Scout to Sorensen's Gale..... 277  
 Kansas City Aero Club (See Club News)  
 Kemp Machine Works, The..... 157, 189, 349  
 Kirkham Tractor Biplane, The New (Illus. Article)..... 17

L

"La Colombe" Monoplane (Illus.)..... 173  
 Lacroix, Paul..... 222  
 Ladougue's Monoplane "La Colombe" (Illus.)..... 173  
 Lady's Pastime, A (Illus.)..... Cover No. 11

Land and Water Birds, A Flock of (Illus.) Cover No. 16  
 Landing Gear, Curtiss (Illus.)..... 116  
 Large Crowd Attends Opening of Aeronautical Society's Grounds at Staten Island..... 175  
 Lateral Balance, A New Method of (Illus. Article)..... 273  
 Latest Goupy Biplane Fitted with Detachable Floats (Illus.)..... 296  
 Latest in Aviation, Prof. Reissner Flying Tail Aeronoplane (Illus.)..... 297  
 Launching Device for Aeroplanes..... 225, 303, 349  
 Lausanne Hydro-aeroplane Meet..... 273  
 Law.....  
 Advance Toward Aerial Law (Articles)..... 20, 215  
 Law, Rodman Explodes Balloon etc..... 304  
 Lawson, Alfred W.....  
 About to Take a Spin in the Air (Illus.)..... 303  
 Application by Stockholders..... 52  
 Article by..... 337  
 Editorials by..... 10, 42, 74, 148, 180, 210, 268, 292  
 Portrait of..... 73  
 Latham, Hubert Desires..... 219  
 "Le Bidaire" Machine (Two Illus.)..... 317  
 "L'Edaircur-Conte" Dirigible..... 218, 249, 341  
 Lectures, Ovington (Note)..... 249  
 Leagues Starting on Record Flight (Two Illus.)..... 272  
 Makes New Altitude Record Using Paul Zens Monoplane Breaks Two- Passenger Speed Record..... 187  
 "Le Tom" Dirigible..... 219, 341  
 Letter from England..... 217  
 Lewkowicz Ladis (Article by)..... 147, 207  
 (Biography of)..... 147  
 Liberte Dirigible..... 341  
 Lieutenant-Chaure..... 341  
 Lifting Tail, The Danger of the (Illus. Article)..... 182  
 Little Aviation School, Activity at the..... 328  
 Little's Elementary Physics, A (Article)..... 157  
 London-France Flights..... 45, 82, 152, 186, 248  
 Long, Howard (Letter from)..... 122  
 Long Distance Balloon Record..... 243  
 Long Hydro-aeroplane Flight by Weymann..... 271  
 Long Island Aero Club (See Club News)  
 Looking Ahead (Editorial)..... 243  
 Louisville Aero Club (See Club News)  
 "Lumina" Aeroplane Cloth (Illus.)..... 14

M

Mack, William R. Praises Aircraft (Letter)..... 279  
 Mackay Trophy Won by Lieut. Arnold..... 276  
 MacMechen, T. R. (Translation and Articles by)..... 143, 178, 239, 267, 294  
 (Biography of)..... 143  
 Manufacturer, A Straight Talk to the (Article)..... 273  
 Manufacture of "Lumina" Cloth, A Description of Maps—Plans of the London Aerodrome, Hendon, England..... 217  
 Marine Air Races (See Races)  
 Marcelline Exhibit at Fourth Paris Aero Salon..... 300  
 Mars-Fowler Aviation Company, The..... 157  
 Marvelous Airship Advancement (Article)..... 267  
 Massachusetts Institute of Technology Establish Aviation Course..... 225  
 Masson, Didier in Flight (Illus.)..... 158  
 (Note)..... 158  
 Maus, John B. (Portrait)..... 73  
 Maximo, Hudson (Article by)..... 71  
 (Biography of)..... 71  
 Maximotor Makers..... 157, 189, 223  
 Maximotored Biplane (Illus.)..... 223  
 McClaskey, J. W. (Letter from)..... 160  
 McLean, James..... 126  
 Meets.....  
 Barcelona Meet..... 221  
 Boston Meet..... 183  
 Brides Meet..... 249  
 Chicago Meets..... 209, 246  
 Cicero Meet..... 255  
 Heiligendam Hydro-aeroplane..... 273  
 Johnsthal Glider..... 125, 338  
 Johannisthal..... 295  
 Juvisy..... 127  
 Lausanne Hydro-aeroplane..... 273  
 Los Angeles..... 183  
 Monaco Hydro-aeroplane (Illus.) Cover No. 8  
 Monaco Hydro-aeroplane (Description)..... 82  
 Offenburg Hydro-aeroplane..... 271  
 Tams..... 39, 177, 344  
 Memorial, Wilbur Wright..... 296  
 Memorialists Appeal to Governments..... 273  
 Merrill, Albert Adams..... 81  
 Letters From and Articles By, 47, 81, 120, 279, 345  
 Report (Accident of Miss Quimby)..... 184  
 Method (German) of Driving Propellers in Opposite Direction (Illus.)..... 272  
 Method (Frank A. Cerruti) of Driving Propellers in Opposite Direction (Illus.)..... 328  
 Method of Computing the Efficiency of Lateral Control Surfaces (Article)..... 327  
 Meyerhofer, O. S. T. (Article by)..... 327  
 Mexico, Scenes in (Illus.)..... 251, 289  
 Mexico, Aeronautics in..... 125, 338  
 Michelin Duration Flight, English, Won by Hawker..... 296  
 Michelin Cross-country Flight Won by Cody..... 296  
 Military Aeroplane Competition..... 218  
 Military, Relating to 41, 31, 32, 71, 74, 79, 82, 111, 124, 151, 154, 220, 248, 276, 278, 289, 294, 296, 297, 303, 320, 327, 337, 349  
 Milling, Lieut. De W. (Group Illus.)..... 205  
 Mills, Captains..... 90  
 Milwaukee School and College of Aviation..... 33, 90, 126  
 Mincola.....  
 Aviation Field (Illus.)..... 89, 158, 191, 225  
 Model Cars Monoplane (Illus.)..... 120  
 Moisant Army Aeroplanes and Equipment at the Front (Illus.)..... 290  
 Moisant Monoplanes (Illus.)..... 250  
 Molla, Henri Makes Record..... 14  
 Monnet Meet (Illus.)..... Cover No. 13

Montero, J. Ramon with His Latest Bleriot (Two Illus.)..... 278  
 Montenegro, Aeronautics in..... 297  
 Morane-Saulnier Monoplane (Illus.)..... 109, 272, 300  
 Morane-Saulnier Exhibit at Fourth Paris Aero Salon..... 299  
 Morocco, Aeronautics in..... 221, 251, 273, 297, 322  
 Morok Aeroplane Company, The..... 91, 223  
 Motor (from)..... 279  
 Motors, Descriptions of..... 13, 17, 48, 157, 304  
 Motor.....  
 Test Chart (Illus.)..... 126  
 Test of Structure of Motor and Chart (Illus.)..... 179  
 Murphy, Miss M., in Biplane (Illus.)..... 28  
 Myers, Carl E..... 90  
 Myers, Denys P. (Letter and Articles by)..... 7, 20, 40, 50, 79, 111, 183, 185, 215, 240, 265  
 (Biography)..... 79

N

Nassau Boulevard News..... 89, 158  
 National Aeroplane Company, The..... 91  
 National Aeroplane Company's Beech Biplane..... 121  
 National Implement and Vehicle Show..... 217  
 National Balloon Race..... 155  
 National Subscriptions.....  
 Austria..... 276  
 France..... 291  
 Germany..... 343  
 Italy..... 297  
 Madagascar..... 297  
 Russia..... 297  
 Navy.....  
 Aerial Oil Engine Sought by Navy..... 274  
 Naval Appropriation (French)..... 272  
 Navy Zeppelin Flies Thirty Hours..... 274  
 Navy Aviators Makes Moonlight Flight..... 190  
 New England Aero Club (See Club News)  
 England Notes..... 50, 158, 190, 224, 304  
 New Ideas for Aviators (Editorial)..... 181  
 New Method of Lateral Balance, A (Illus. Article)..... 175  
 New Type Flying Machine (Illus.)..... 159  
 New Principle in Flight (Article)..... 297  
 New Six Passenger Wain Hydro-aeroplane (Illus.)..... 320  
 New York Aeronautical Supply Company, The..... 22, 53  
 Nieport.....  
 Exhibit at Fourth Paris Aero Salon..... 299  
 Hydro-aeroplane (Illus.)..... Cover No. 8  
 Hydro-monoplane (Illus.)..... 241  
 Scale Drawing of Two Passenger..... 252  
 Surface Aeroplanes Curve (Article)..... 302  
 Wing Curve, Criticism of..... 302  
 Niles Flies 4 hours 45 mins. in Thomas Biplane..... 304  
 Kirikham Motored..... 304  
 No Act to Grind (Editorial)..... 210  
 Nonic Engine Company, The..... 91  
 Norway, Aeronautics in..... 273, 297, 338  
 Norwich Business Men's Association, Inc..... 90  
 Not Even His Last (Editorial)..... 210  
 Notice to Aircraft from Chief Signal Officer..... 278

O

Oberdorfer Brass Company, The M. L..... 22  
 Obituary.....  
 Constantin, Dr. Jules..... 320  
 Frey, Andre..... 321  
 Kimmending..... 186  
 Latham, Hubert..... 219  
 Motohisa Kondo..... 278  
 Popoff, Nicholas..... 297  
 Quimby, Miss Harriet..... 184  
 Walsh, Charles F..... 276  
 Welsh, Al and Lieut. Hazelhurst..... 166  
 Wright, Wilbur..... 184  
 Oesterreichischer Aero Club (See Club News)  
 Offenburg Hydro-aeroplane Meet..... 251  
 Official Document for Military Aviation Service..... 41  
 Ohl Ernest (Articles by)..... 18, 50, 88, 121  
 Oiling Gasoline Engines (Article)..... 207  
 Old and New Scouts of Mexican Air (Illus.)..... 218  
 One of the Latest European Water Birds (Illus.)..... Cover No. 8  
 Oriental Military Airships (Illus.)..... 219  
 Organization Means Strength (Editorial)..... 75  
 Optimism vs. Pessimism (Editorial)..... 75  
 Ovington.....  
 Article by..... 39, 177, 344  
 Group Illus..... 177  
 Lectures..... 17  
 Report on Miss Quimby's Accident..... 184  
 Biography of..... 344  
 Page, Phillips W.....  
 Ready to Fly (Illus.)..... 53  
 in Hydro-aeroplane (Illus.)..... 191  
 in Burgess Wright (Illus.)..... 191  
 Parachute Jumping..... 32, 89  
 Paraguay, Aeronautics in..... 344  
 Paris Aero Salon (Illus. Article)..... 298  
 Parmalee, Phil (Group Illus.)..... 177, 341  
 Parseval Dirigible (Illus.)..... 46, 220  
 Passenger Carrying Records (See Records and Statistics)  
 Patents.....  
 German Patent Office..... 185  
 Mattulath Patent Case..... 46  
 Patent Status of Quimby's Accident..... 184  
 Wright Patents in Court..... 48  
 Patonize Home Industries..... 83  
 Faulhan Robinson Tour..... 160  
 Peck, Paul Breaks Aero Endurance Record..... 150  
 Pennsylvania Aero Club (See Club News)  
 Pennsylvania News..... 276, 305, 328  
 Pekin-Paris Race..... 124, 187  
 Peck, Cecil Flying Baldwin Headless Biplane (Illus.)..... 263  
 Philadelphia Aero Club (See Club News)  
 Philippine Islands, Aeronautics in..... 188, 221, 273, 322  
 Phlips, Walter H. (Articles and Drawings by)..... 12, 13, 14, 48, 85, 86, 114, 154, 182, 216, 222, 253, 254, 274, 277, 298, 303, 322, 347  
 Pioneers of Aviation (Articles)..... 150, 179, 316

Pitcairn, T. (Letter from).....	319	Schuette's Visit to America, Johann (Editorial).....	268	Tractor Screw Biplanes (Article).....	85
Pompery Cup.....	271	Scotland, Aeronautics in.....	221, 251, 273	The Trade.....	22, 53, 90, 157, 189, 223
Popoff, Nicholas, Shot While Flying.....	297	Scotts Bomb Throwing.....	297	Traio Machines, Fine Work on.....	219
Portugal, Aeronautics in.....	83, 273	Scott, G. B. (Letter from).....	218	Transatlantic Dirigible "Sachard" (Illus.).....	300
Potsdam Dirigible.....	341	Scrpps, Commodore Wm. E. Flies Hydro-aeroplane.....	275	Transatlantic Trip, Dr. Can's.....	153
Practical Military Aviation (Illus. Article).....	289	Sectional Drawing Showing Compartments in Vainamo Airship Decks (Illus.).....	275	Transporting French Aeroplanes (Illus.).....	182
Prevoist.....	14	Seiberling, F. A. (Portrait).....	738	Transporting Military R. E. P. (Illus.).....	82
Establishes World's Record.....	14	Servic, Aeronautics in.....	297, 338	Trailing via Airship (Illus.).....	Cover No. 2
In Flight (Illus.).....	247	Seventy-two Aeroplanes in Review.....	272	"Triad" M. Farman (Inset Illus.).....	84
Prepare for 1913 Harvest (Editorial).....	293	Shaw, Edward R., in Biplane (Illus.).....	178	Tripoli, Aeronautics in.....	15, 46, 83, 221, 251, 273, 297
Problem of the Flying Boat and Suggested Design for Aerocraft (Illus. Article).....	216	Shaw, Edward R., in Biplane (Illus.).....	178	Troops in Action Near Torreon (Illus.).....	290
Problems of the Boston Meet (Article).....	183	Shaw, Edward R., in Biplane (Illus.).....	178	Tubation Monoplane (Illus.).....	301
Progress Will Go On (Editorial).....	180	Shaw, Edward R., in Biplane (Illus.).....	178	Tunisia, Aeronautics in.....	46
Progressive Organization, A (Editorial).....	45	Shaw, Edward R., in Biplane (Illus.).....	178	Turkey, Aeronautics in.....	221, 251, 297, 338
Proof of the Pudding (Editorial).....	210	Shibege, Baron (Inset Illus.).....	126	Turks Capture Italian Aviator.....	221
Propeller Building Macbiae (Illus.).....	122	Short Tractor Hydro-biplane (Illus.).....	321	Twenty Zeppelins to be Built.....	321
Propellers, Standardizing.....	19	Sichy, Aeronautics in.....	222	Twin Steering Wheels, Curtiss School Biplane (Illus.).....	Cover No. 2
Q		Silva Netto, A. F. B. (Letters From) 193, 271, 320, 344.....	193, 271, 320, 344	Twining Mooplane (Illus. Description of).....	51
Queen Aeroplane Company's Aerobact (Illus.).....	115	Simmons, Will.....	212	Two Passenger Height Record.....	18
Quimby's Accident, Miss Harriet, Eyewitness' Report of.....	184	(Biography of).....	212	Two Passenger Duration Record.....	15
R		Six Famous American Aviators (Group Illus.) "Skinner" German one Passenger Boat (Illus.).....	205 153	Two Passenger Shock-Absorbing Harness for Aviator (Illus.).....	118
Races.....		Sloane Aeroplane Company, The.....	279	Twoably Rotary Motor (Illus.).....	119
Berlin-Vienna Race.....	153	(Letter).....	279	Tyler, Types of Aeroplanes for Military Service.....	223
Circuit of Berlin.....	273	Sloane Deperdussin with Guy Gilpatrick at the Wheel (Illus.).....	303	Ulich, Herr G. L., Makes World Duration Record.....	178
Circuit d'Anjou.....	152, 187	Sloane School, Miss Agnes Firth Seated in Caudron Monoplane at (Illus.).....	303	Urges Air Fleet in House Utilization (Editorial).....	225
Circuit of France.....	249	Sloane School Equipment, Partial Line-up of (Biography of).....	302	U. Vaniman, Melvin.....	76
Circuit of the Upper Rhine.....	153	Smith, Floyd and Wife Seated in Biplane (Illus.).....	224	(Article by).....	76
Daily Mail Race.....	151	Smith Monoplane (Illus.).....	254	Portrait of.....	76
Dublio-Belfast Race.....	273	Smith Monoplane (Illus.).....	254	Biography.....	76
Gordon Bennett Balloon Race (Table).....	302	Soldiers and Camp Followers Escorting Machine to England, etc. (Illus.).....	178	Dirigible.....	77
Gordon Bennett Cup Race, 1912. List of Contestants.....	209	Some Airship Facts (Article).....	178	Vaughan, Lloyd D. (Letter From).....	318
Intercollegiate Balloon Race.....	217	Some Leading Types of Hydro-aeroplanes and Aerobacts (9 Illus.).....	353	Verdries.....	318
International Aviation 1912 Cup Race 52, 209.....	215	Some Facts and Concerns Concerning Monoplane and Description of 70 H. P. Type (Illus.).....	253	Alighting After Winning Gordon Bennett Cup Race (Illus.).....	247
National Balloon Race.....	215	Some Facts Regarding the Burgess Cup Defender Sommer "Type de France" Biplane (Illus.).....	253	In Flight.....	45
Paris-Amiens-Paris.....	219	Sommer Exhibit at Fourth Paris Aero Salon 303	253	Inset Portrait.....	237
Raino Not Aim Bombs (Editorial).....	42	Sopwith Tom (Group Illus.).....	303	Portrait.....	134
Rath and Long Broom and Biplane Company 183	183	Sopwith with Making Experimental Flight (Illus.).....	186	Verp, Dirigible.....	241
Real Ships of the Air (Article).....	143	South Africa, Aeronautics in.....	221	Verret Makes Height Record.....	14
Reber, Major Samuel, U. S. A. (Article by).....	244	Spain, Aeronautics in.....	125, 154, 188, 221, 251, 273, 338	"Victoria Luise" (Illus. and Notes) 143, 220, 249, 251, 341.....	218
(Biography).....	244	Specific Gravity 12-Hydrogen (Table).....	245	"Ville de Bruxelles".....	218
Records and Statistics, 14, 15, 45, 46, 89, 160, 186, 187, 218, 219, 249, 271, 273, 275, 295, 302, 320, 324.....	244	Specific Gravity 42-Coal Gas (Table).....	245	Voisin-Caudron (Inset Illus.).....	283
America Aviation Records.....	89, 160, 275, 295, 326	Spies French Rigid Airship (Illus.).....	321, 341	Voisin Aerocraft Flies.....	321
Distance.....	271	Spies, The Latest Water (Illus.).....	Cover No. 3	Voisin Hydro-aeroplane Built to Order of "Deutsches de la Seaurthe" (Illus.).....	320
Duration.....	15, 175	Standard Aviation Company, The.....	22, 90	Walker, Clarence in Flight (Illus.).....	201
Height.....	14, 186, 218, 249, 320	Standardizing Propellers.....	19	War.....	318
Hydro-aeroplane.....	275	Starrett, D. W. (Articles by).....	8, 316	Armaments, Importance of Aeronautical (Article).....	71
Passenger Carrying.....	14, 46, 187, 271	Statistical Table of Accidents.....	9	British War Office Form Fourth Arm 124	124
Speed.....	14, 45, 187	Steffen Dirigible.....	341	German War Office Order Fourth Etrich Monoplanes.....	83
World's Aviation Records.....	14, 15, 45, 46, 187, 218, 324	Stevens, A. Leo.....	53, 189, 223	War Aeroplane as Christmas Gift.....	319
Reissner, Prof. Flying Novel Tail First Monoplane (Illus.).....	297	(Report on Miss Quimby's Accident).....	184	War in the Air (Article).....	292
Remarkable Letter, A.....	160	Stevens and Beatty Aviation School.....	53	Waterbolowski, Adolph, in Flight (Illus.).....	45
Renaux Starting in Flight (Illus.).....	84	St. Louis Aero Club (See Club News).....	52	War Bird, One of the Latest European (Illus.).....	Cover No. 8
R. E. P.....		Stockholders' Appreciation of Alfred W. Lawson Straight Dirigible.....	74	Water Sport (Illus.).....	287
Exhibit at Fourth Paris Aero Salon.....	299	Stoerch, John and Samuel Henson, Aviation Structural Requirements for Safety in Spherical Ballooning (Article).....	150	Weeks, Ellog O., Delivers Newspapers.....	319
Military R. E. P. Being Transported (Illus.).....	124	Stoerch, John and Samuel Henson, Aviation Structural Requirements for Safety in Spherical Ballooning (Article).....	150	Westbury Field News.....	191, 226
Reported by Aeroplane Scout (Illus.).....	289	Students of Aviation in P. in Flight (Illus.).....	121	Wetzig Erobes Record Biplane in Flight (Illus.).....	271
Reports of Eyewitnesses on Miss Quimby's Accident.....	184	Students and Glenn H. Curtiss (Illus.).....	128	Weymann Establishes Hydro-aeroplane Record.....	226
Resolution Introduced by Representative William C. Sharp in House of Representatives.....	52	Students of Milwaukee School Preparing for Flight (Illus.).....	122	Why I Made Money at Exhibition Flying (Article).....	177
Result Military Aeroplane Competitions.....	248	Sturtevant Company, The B. F.....	22, 48, 126, 158, 189, 224	Wilcox, Philip Wakeman.....	175
Review, Aeroplane.....	272	Sturtevant Motor Fitted with Muller (Illus.).....	158	Article by.....	175
Revolutionizing Air Travel (Illus. Article).....	76	Sturtevant Motor in Europe (Illus.).....	189	Biography of.....	175
R		Sturtevant Motor in Army Biplane Gives Good Account of Itself.....	302	Willis, Company, The E. J.....	22, 126
Aeroplane Company, The.....	53, 90	Sturtevant Motor Tests.....	279, 126	Willoughby, Hugh.....	22, 126
Gordon Bennett Race (Illus.).....	115	Successive Flyers Described.....	13, 49	(Report on Miss Quimby's Accident).....	184
Mooplane (Two Illus.).....	277	"Sachard" (Note and Illus.).....	46, 154, 341	Wilson, David H. (Article by).....	302
Richardson, George A. (Article by).....	127	Surface Curves, Some Lending Types of Aeroplane 191 Switzerland, Aeronautics in.....	191 46, 125, 221, 251, 273	Wittmann Two Passenger Biplane (Illus.).....	254
Roberts Motor Company, The, 22, 53, 90, 126, 157, 223.....	223	Tables.....		Wonderful Airship Demonstration.....	180
Stand at Show (Illus.).....	116	Aerial Fleets and Expenditures of the Different Governments.....	338	Worden, Capt. J. Hector.....	289
Robinson, Hugh, Demonstrating Hydro-aeroplane (Illus.).....	37	Armip Statistical.....	338	Article by.....	289
Joins Benoit.....	303	Fatal Aeroplane Accidents.....	9	Fate Promised to, by Rebels (Illus.).....	291
Rodger's Fatal Accident.....	45, 90	Gordon Bennett Balloon Race, 1912, 209.....	302	In Flight (Illus.).....	88
Rood Safety Helmet (Illus.).....	45, 90	Gordon Bennett Cup Race 1912, Entrants.....	209	Portrait of.....	291
Romania, Aeronautics in.....	251, 297, 322, 338	Gordon Bennett Cup Race 1912, Entrants.....	209	Ready to Start on Scout Duty in Plane (Illus.).....	291
Royal Aero Club of the United Kingdom Forbids Sea Flying Without Pontoons.....	218	Machines Entered in British War Office Trials.....	255	Signature of.....	291
Royal Aero Club of the United Kingdom (See Club News).....		Machines Used in Cicero Meet.....	255	Words We Use, The (Article).....	239
Rubel, R. O., Jr., and Company.....	22, 53, 90	Military Aviation Appropriation.....	275	World's Distance Record Broken in 1912 Gordon Bennett Balloon Race.....	302
Rumpler Monoplane (Scale Drawing).....	341	National Balloon Race.....	245	World's Aviation Records.....	14, 15, 45, 46, 186, 187, 218, 249, 271, 302, 324
Russia, Aeronautics in.....	46, 83, 125, 154, 188, 221, 251, 273, 297, 338	Specific Gravity 12-Hydrogen.....	245	Wright Company, The.....	
Russia Aero Club (See Club News).....		Specific Gravity 42-Coal Gas.....	245	Air Ferry.....	255
Rutbenberg's Dirigible.....	341	Records and Statistics.....	324, 325, 326	Biplane (Illus.).....	18, 19
S		Time Each Lap, Gordon Bennett Cup Race.....	346	Dividend.....	121
Sachsen Dirigible.....	341	Tabouat Establishes Speed Record.....	8	Latest Two Passenger (Illus.).....	115
Safety Appliances, Aeronautical.....	341	Tamime Meet.....	297	Letter.....	47
Control, The Lewkowicz (Illus.).....	207	Telegrams.....	18	Motor, New 6-cyl. and Hydro-aeroplane (Illus.).....	117
Helmet, The Rood (Illus.).....	45	Telephone, Aeroplane (Illus.).....	162	Patents in Court.....	88
Increasing Safety of Biplanes, A Suggested Method of.....	274	Tests.....		Orville Talks on Automatic Stability.....	159
Safety in Spherical Ballooning, Structural Requirements for (Article).....	244	British Army Tests.....	248	Surface Aeroplane Curve.....	159
Twoably Harness, The (Illus.).....	118	Burgess War Plane Passes Army Tests.....	224	To Build Naval Aeroplane.....	224
Sailing the Air with Wind Power (Article).....	40	Rotary Maxim Motor Tested.....	328	Wilbur's Portrait.....	146
Saling the Airman (Illus.).....	Cover No. 1	Sturtevant Aeronautical Motor.....	162	Wilbur Gene.....	146
Sandusky to buy Aviation Field.....	402	Wire and Turbuckle Competition to be Held in Vienna.....	320	Yale Aero Club (See Club News).....	160
Sanchez-Besa Biplane (Illus.).....	201	Thomas Biplane Used by Johnson (Illus.).....	295	Yanobrev Dirigible.....	273
Sanchez-Besa Hydro-aeroplane (Illus.).....	241	Thomas Brothers, The.....	90, 126, 157	Z	
Savary Exhibit at Fourth Paris Aero Salon.....	303	Three Aerial Battalions for American Army.....	51	Zens Monoplane (Illus.).....	187
Savary Biplane (Illus.).....	303	Time-Honored Host—Success (Editorial).....	211	Zeppelin Dirigibles (Illus. and Notes of).....	300
Saving Time (Editorial).....	40	Time-Visionary (Editorial).....	44	46, 144, 220, 250, 321, 341.....	341
Selle-de-Beauchamp Dirigible.....	341	Towers, Lieut., in Curtiss Hydro-aeroplane Makes American and World's Records.....	275	Zodiac Airship (Illus.).....	Cover No. 3
Semeniuk, I. With Macbiae (Illus.).....	276	Wire and Turbuckle Competition to be Held in Vienna.....	320	Zodiac Biplane (Illus.).....	354
Scale Drawings.....		Yale Aero Club (See Club News).....	160		
12, 49, 86, 87, 153, 155, 156, 190, 216, 222, 252, 319, 323, 347, 349.....		Yanobrev Dirigible.....	273		
Schill, Paul, Farman Type Hydro-aeroplane (Illus.).....	115	Z			
Schuette-Lanz Aerobact (Illus. Article).....	313	Zens Monoplane (Illus.).....	187		
(Notes and Illus.).....	145, 220, 248, 250, 267, 341	Zeppelin Dirigibles (Illus. and Notes of).....	300		
Schuette, Johann.....	313	Zodiac Airship (Illus.).....	Cover No. 3		
Article by.....	313	Zodiac Biplane (Illus.).....	354		
Biography of.....	313				
Signature of.....	316				

# CLASSIFIED ADVERTISING

20 CENTS A LINE

SEVEN WORDS TO LINE

CASH WITH ORDER

FOR SALE	FOR SALE	POSITIONS WANTED
<p><b>CURTISS</b> latest improved type (Pigeon Tail) 1912 Model. Made over 300 very successful flights 1,000 ft. high, 30 miles cross-country. My construction is strongest in the world. New, complete, ready to fly, tested and guaranteed, including free lessons to buyer, \$1,500. Buy direct from Builder and Aviator of 10 years' experience. H. C. Cooke, Aviator and Builder, 127 West 64th St., New York City.</p>	<p><b>ANTOINETTE AERO MOTOR</b> FOR SALE 70 H. P. water cooled, practically unused, fine condition. Regular price, \$4,000.00; going for \$400.00. Also 4 Bosch Magnets and a quantity of engine fittings. Address Box 800, care of "Aircraft."</p>	<p><b>A GAS ENGINE</b> expert, age 21, wishes position as an aviator's assistant with prospects of learning to fly. Address, E. K. Siemens, Rosenfeld, Box 63, Mantoba, Canada.</p>
<p><b>COMPLETE PLANS</b>—Nieuport Monoplane, \$2.00; Deperdussin Monoplane, \$3.00; Wright Biplane, \$3.00; Aeroplane Rib Pattern, \$1. "Aviation," Lawrence, Kansas.</p>	<p><b>TANDEM</b> Monoplane Glider; double surfaced wings; spread 20 feet; guaranteed man carrying, \$25; Knockdown, \$19; Plans, \$1. Wright Glider Plans, \$1. "Aviation," Lawrence, Kansas.</p>	<p><b>AVIATOR</b>—Licensed aviator of the Aero Club of France, flying Bleriot and Curtiss machines; constructor of a number of Bleriot machines, wishes engagement. Two year's experience as aviator and mechanic aviator. Address Box 768 Aircraft.</p>
<p><b>MUST SELL IMMEDIATELY</b> 30, 50, 75 H. P. motors with or without Curtiss plans; great bargains. J. T. Patterson, 986 Trumbull, Detroit, Mich</p>	<p><b>ROTARY AEROPLANE</b> engine, 40 H. P., 7 cylinder, weight 160 lbs. with propeller. Cheap. Landsman Motor Co., 1406 S. 18th St., St. Louis, Mo.</p>	<p><b>LEGAL NOTICE</b></p>
<p><b>FOR SALE</b>—Tractor biplane, 8-cylinder, 60 H. P. Motor; everything in first-class condition. Will sell separately or exchange for touring car. Apply F. Robinson, 191 Caledonia Avenue, Rochester, N. Y.</p>	<p><b>FOR SALE</b>—Brand new 50 H. P. Albatross motor with carburetor and magneto for \$100. Walter Bengtson, Canby, Minn.</p>	<p>I DESIRE to give notice to all persons that are using my "Patent Rudders" (Serial number 504107 U. S.), also France and England, and my "Semi-Automatic Engine Control," (Serial number 646300 U. S., France and England), that it is my intention in the future to ask a small royalty from them. Hugh L. Willoughby, Sewalls Point, Florida.</p>
<b>POSITIONS WANTED</b>		
<p><b>FOR SALE</b>—Clarkville, Tenn., Dec. 28, 1912.</p>	<p><b>A YOUNG MAN</b>, age 18, desires position as an aviator's assistant, with prospects of learning to fly. Address Louis Fenouillet, 132 West 47th St., New York City.</p>	<p>which is not entirely sufficient to prevent loss of equilibrium under all circumstances.</p>

Clarkville, Tenn., Dec. 28, 1912.

In "Aircraft" of January 1913, page 322 and 323, I see the article "Inherent Stability and How it is Achieved in the Fokker Monoplane." In this article it reads:

The chief peculiarities of the Fokker monoplane are the main planes which are set at a very pronounced V angle and also slope backward.

Please compare the drawings Fig. 3, 4 and 5 in my U. S. Patent No. 710,266 Sept. 30, 1902 and the drawings No. 1, 3 and 4 in my U. S. Patent 730,107 June 7, 1903. In these already about ten years old patents, main planes which are set at a very pronounced V angle and also slope backward are shown.

It took ten years until Mr. Fokker and other constructors caught on to the importance of that construction. Likewise only perfectly flat planes, as in

the Fokker monoplane, are already shown on my monoplane in the above named patents—none of the drawings show curved planes, all are perfectly flat. This is important for speed.

As to the difference of inherent and automatic stability the following is important:

In the article in the *Scientific American* of Dec. 17, 1910, "Distinction to be Made Between Inherent and Automatic Stability of Aeroplanes," it reads: "What is generally called automatic stability is only a certain inherent stability which is brought about by the outer shape of the aeroplane, while the real automatic stability is brought about by a device which exerts power."

Therefore the Fokker aeroplane has not inherent automatic stability as it is said in the description beneath the drawings of the article on page 323 in "Aircraft" of January 1913, but only inherent stability

which is not entirely sufficient to prevent loss of equilibrium under all circumstances.

A device is needed as explained in my above named patents and in "Aircraft" of Dec. 1911, page 342, "The Aeroplane Without Engine and Without Screw Propeller—a Gliding or Soaring Machine Automatically Balanced, Automatically Kept Head Against the Wind and Steered at Will of the Aviator."

Please let me hear from you.

Yours truly, THEOD. GIBON.

### CORRECTION

Page 326 January 1913 issue under "American Aviation Records," Cross-Country Flights, Greatest Distance in a Single Day, should be credited to Harry N. Atwood, who flew from St. Louis to Chicago August 14th, 1911, on a 35 H. P. Wright biplane. The distance covered was 283 miles.

## SOME CONSTRUCTION DETAILS

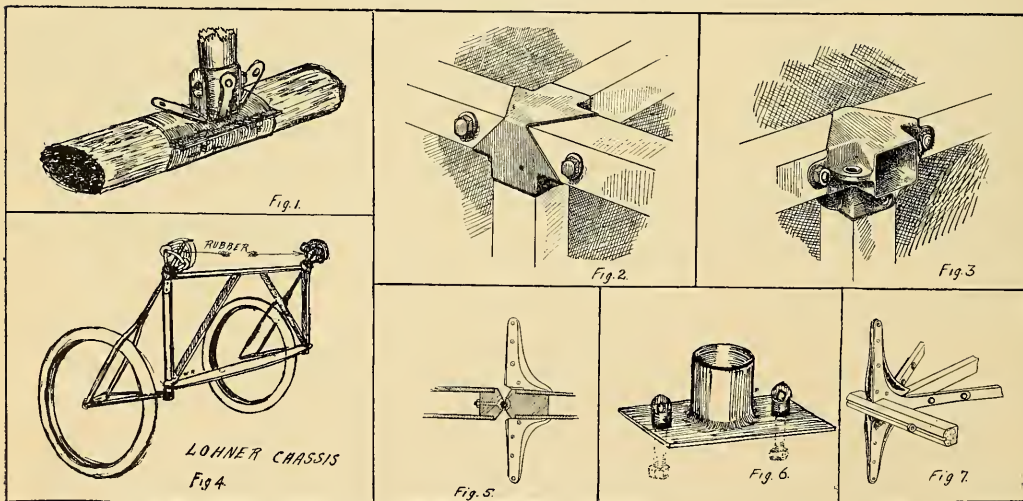

Fig. 1. shows a quick detachable upright socket made by the E. J. Willis Company, New York.

Fig. 2. shows a view of the pressed steel fuselage joint used on the Nieuport monoplane.

Fig. 3. illustrates another view of the pressed steel Nieuport fuselage joint.

Fig. 4. shows the novel landing chassis fitted to the Austrian Lohner-Pfeil biplanes and some of the latest Etrich monoplanes. It is similar in action to the Bleriot landing gear but with the important difference that the sliding collar of the Bleriot system is done away with and instead the tube running from the wheel axle passes through a socket at the head of the upright and is held down by rubber shock absorbers. The whole arrangement is so constructed that the wheels can turn in the same manner as on the Bleriot chassis.

Fig. 5. shows the elevator joint used on the English Martin-Handasyde monoplane.

Fig. 6. shows a pressed steel upright socket using eye-bolts as wire strainers.

Fig. 7. shows the method of attaching the elevator crank on a Martin-Handasyde monoplane.



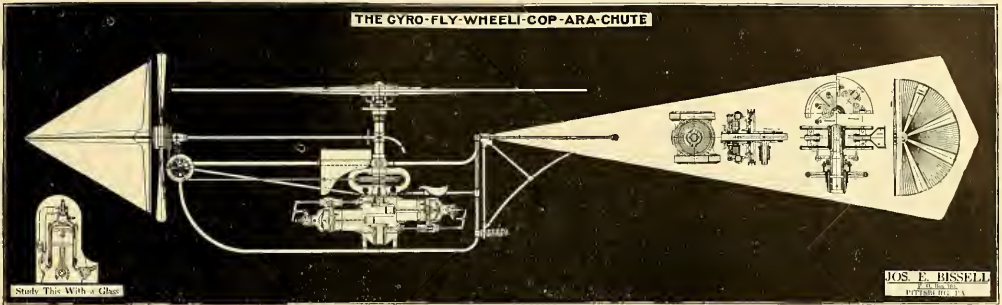

**DOUBT THAT THIS BIRD'S A FLIER;  
DOUBT THAT TH' THING 'LL MOVE;**

**IF Y'U DOUBT THAT THEN Y'RE A LIAR!  
FOR Y'U CAN'T TELL TH' TRUTH—BY JOVE!**



Exhibition Flying by Competent Aviators

## HEINRICH

### Monoplanes and Mono-Biplanes

BUILT IN FOUR SIZES

Write for Illustrated Booklet

Make arrangements now to learn to fly at our Hydro-aeroplane School in the spring. Tuition \$250

HEINRICH PROPELLERS \$30 UP

HEINRICH BROS.

Baldwin, L. I., N. Y.

## PATENTS

THAT PROTECT AND PAY

BOOKS, ADVICE AND SEARCHES FREE

Send sketch or model for search. Highest References. Best Results. Promptness Assured.

WATSON E. COLEMAN, Patent Lawyer  
624 F. Street, N. W. Washington, D. C.

## PATENTS SECURED or Fee Returned

Send sketch for free search of Patent Office Records. How to Obtain a Patent, and What to Invent, with list of Inventions Wanted and Prizes offered for Inventions sent free. Patents advertised free.

We are experts on AIRSHIPS and all patents and technical matters relating to AERIAL NAVIGATION.

VICTOR J. EVANS & CO. Washington, D. C.

## GOOD YEAR

AKRON, OHIO

Goodyear Balloons Aeroplane Accessories  
National headquarters for Spherical and Dirigible Balloons. Built complete. Highest quality. Also makers of Aeroplane Springs, Tires, and the famous Goodyear Rubberized Aeroplane Fabric. Write for booklet. THE GOODYEAR TIRE & RUBBER CO. AKRON, OHIO.

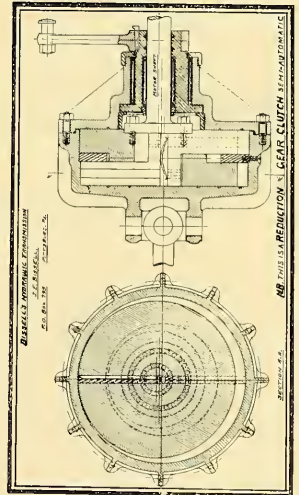

## AIRCRAFT

### VOLUMES

I. II. III.

Cloth Bound \$3.50 each

Lawson Publishing Co.

37 EAST 28th STREET

NEW YORK, N. Y.

### "IDEAL" Plans and Drawings

are accurate and are accompanied by clear, concise building instructions, postpaid at the following prices:  
Wright 3-foot Biplane . . . 25c  
Berlioz 3-foot Monoplane 15c  
"Cecil Peoli" Champion Racer . . . 25c

Curtiss Convertible Hydroaeroplane (new) . . . 35c  
"Ideal" three-foot Racer (new) . . . 15c  
Complete set of five—\$1.00 postpaid.

5 cts. brings our new 40-page fully illustrated Catalog of "Ideal" Model Aeroplane Supplies. (None free.)  
IDEAL AEROPLANE & SUPPLY COMPANY  
82-B West Broadway, New York

## Another Record for the CHARAVAY PROPELLER

American Passenger Altitude, 5006 Ft., 1 Hr., 16 Min.

SLOANE AEROPLANE CO.

1731 Broadway, NEW YORK CITY

AGENTS: Eames Tricycle Co. San Francisco; National Aeroplane Co. Chicago; W. E. Boughton Washington, D. C.

## COOKE BIPLANES

**Curtiss Improved 1912 Type (Pigeon Tail)**  
 Perfect flyers. No freak construction. Ten years' experience.  
 Strongest in the world. Amply powered (Roberts Motors).  
**Anybody can fly these machines.** One ready for immediate delivery **\$2,500**  
 One ready for immediate delivery complete Pope Toledo power plant guaranteed to fly **\$1,500**  
**Curtiss Type Planes, no Power Plant, \$650 and up**  
**Free Instruction to Buyer**  
**H. C. COOKE, 127 West 64th St. NEW YORK CITY**

## Aeronautical Supplies

**Everything to Build Any Type Flying Machine**  
 New catalogue with working drawings of Curtiss, Farman and Blériot type machines, now ready for distribution and will be mailed free upon request to all interested parties. Write for quotations.  
**E. J. WILLIS CO., 85 Chambers Street**  
**67 Reade Street**  
**Tel. 3624 Worth NEW YORK CITY**



## SUPPLIES

for all types of aeroplanes. **FIRST QUALITY GOODS AT LOWEST PRICES—OUR MOTTO.** This is building season. Send us your list of wants for estimate. 22-page catalogue AA—describing over 750 parts—sent upon receipt of 10 cents.  
**NEW YORK AERONAUTICAL SUPPLY CO.**  
**50 BROADWAY, NEW YORK**

## GASOLINE ENGINES—THEIR OPERATION USE AND CARE

By A. HYATT VERRILL

320 Pages \$1.50 150 Illustrations  
**LAWSON PUBLISHING COMPANY**  
**37 EAST 28th ST. NEW YORK**

## NAIAD Aeronautical Cloth

Manufactured Especially for Aeroplanes and Used by  
 Aviators of Prominence  
**LIGHT, STRONG, AIR-TIGHT**  
 AND  
**MOISTURE-PROOF ON BOTH SIDES**

Sample Books, including Data and Prices, sent on request

**THE C. E. CONOVER CO.**  
**101 Franklin Street - - New York**

## BALDWIN

### VULCANIZED PROOF MATERIAL

For Aeroplanes, Airships, Balloons. First Rubberized Fabric on the market. Lightest and strongest material known. Dampness, Heat and Cold have no effect. Any Strength or Color.

### "RED DEVIL" AEROPLANES

That anyone can fly. Free Demonstrations.

### HALL-SCOTT MOTORS

Eastern distributor. 40 h. p. 4-cyl.; 60 and 80 h. p. 8-cyl. on exhibition at Frank Schumacher's, 164 W. 46th Street, New York. All motors guaranteed. Immediate delivery.

### EXPERTING

Will install a Hall-Scott free of charge in anyone's Aeroplane and demonstrate by expert flyer. Expert advice. Planes balanced.

**CAPT. THOMAS S. BALDWIN**  
**Box 78 Madison Sq. P. O., New York**  
**AEROPLANES**

# BLERIOT MONOPLANES

(GENUINE)

Winners of ALL the European Contests in 1911

In 1909---The First Aerial Crossing of the Channel.

In 1910---The "Circuit de l'Est."

In 1911---The Paris-Rome Race (1st and 2d.)

The European Circuit (1st and 2d.)

The English Circuit (Daily Mail Race.)

The Belgian Circuit.

The Saint Petersburg, Moscow Race.

The Valencia Alicante Race.

The London to Paris non-stop Raid, etc., etc.

**WORKS AND OFFICES: - - 39, Route de la Révolte à Levallois - - PARIS**  
**and Belfast Chambers, 156 Regent St., LONDON**

FRANCE

**AVIATION SCHOOLS: Etampes, near Paris during Summer**  
**Pau, during Winter**

ENGLAND

**Hendon, near London**

# OUR WINTER SCHOOL

is now running full blast on the Government Field at  
SAN ANTONIO, TEXAS]

**THE REASONS WHY** you should enroll in the Lillie Flying School are because we have:

**The Best Instructors**—Max Lillie, De Lloyd Thompson, Andrew Drew, and C. M. Vought represent the highest flying ability and cleverest teaching talent in America.

**The Best Equipment**—Double control school machines equipped with Lillie-Wright duplicate levers which eliminate risk and delay the two greatest faults of other schools.



Showing Our System of Teaching by Duplicate Control Levers.

**The Best Field**—The Government Flying Field at San Antonio is the largest and best in the Country. The climate is ideal.

**The Best Record**—During the past season the Lillie School turned out more licensed pilots than any three other schools in the country combined.

FOR PARTICULARS ADDRESS

## THE LILLIE AVIATION COMPANY

SUITE 301-302-303 LIGGETT BUILDING, ST. LOUIS, MO.

# LEARN TO FLY



# AT THE CURTISS WINTER SCHOOL

THE BEST GROUNDS. THE BEST EQUIPMENT. THE BEST CLIMATE CONDITIONS FOR PRACTICE

## 47 GRADUATES IN 1912

*GREATER OPPORTUNITIES THAN EVER BEFORE. GET OUR PROPOSITION*

**CURTISS AEROPLANE CO., Dept. W., HAMMONDSPORT, N. Y.**



Lieut. Gieger, U. S. A., Observing Pilots' License Trial at Curtiss Training Grounds, San Diego, Calif.

# KIRKHAM

## The Dependable Aviation Motor



MR. AND MRS. ART SMITH  
The First Couple to Elope via Aeroplane

The accompanying cut shows aviator Art Smith and Miss Aimee Cour just starting on the first elopement via aeroplane, when they flew from Ft. Wayne, Ind., to Hillsdale, Mich., on Oct. 26, 1912, and were married.

It goes without saying that any man that will undertake a trip like this with his bride-to-be must have perfect confidence in his machine, and particularly his motor. But his **Kirkham Motor** had enabled him to fill 18 exhibitions, so he knew just what it would do. Can you say as much for the other kind?

The **Kirkham Motor** also holds the *American Endurance Record* for pilot and one passenger of 3 hrs., 51 min., 15 sec., just established by Walter E. Johnson, flying a **Kirkham** equipped Thomas Biplane, at Bath, N. Y., Oct. 31, 1912, the flight ending only on account of the extreme cold. Also on Nov. 2, 1912, Chas. Niles flew the same machine 2 hrs. 45 min.; and on Nov. 4, flying against the American duration record for pilot alone, he flew for 4 hrs. 15 min., stopping on account of burnt-out bearings, caused by stopping of oil pump.

This same motor was used all season by Mr. Johnson, and was the power that made possible his clean sweep of speed prizes at the New York State Fair, mentioned in previous advertisements.

There is a reason behind these performances that you ought to know before you purchase that New Motor. Booklet tells about the motor and is yours for the asking.

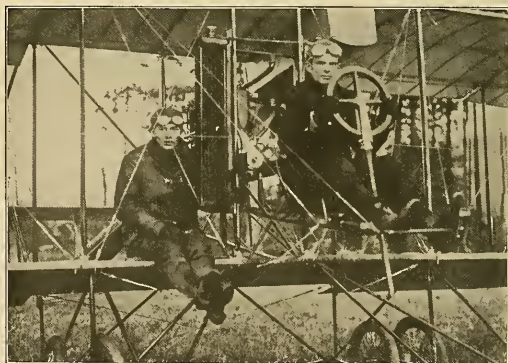

THE NEW RECORD MAN FOR FLIGHT WITH PASSENGER

C. B. KIRKHAM

Savona, N. Y.













SMTI'SCHIAN INSTITUTION LIBRARIES



3 9088 01550 1224