

UC-NRLF

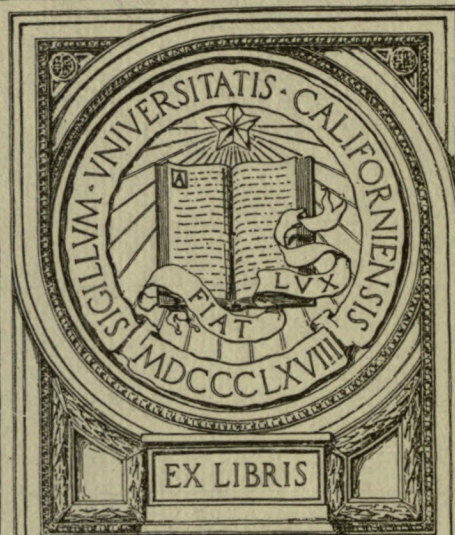

5C 13 911

GIFT OF
MICHAEL REESE



EX LIBRIS

UNIVERSITY OF CALIFORNIA

ELECTRIC GENERATORS.

BY

HORACE FIELD PARSHALL

AND

HENRY METCALFE HOBART.



LONDON :

OFFICES OF "ENGINEERING," 35 AND 36, BEDFORD STREET, STRAND, W.C.

NEW YORK :

JOHN WILEY AND SONS, 43, EAST NINETEENTH STREET.

1900.

[All rights reserved.]



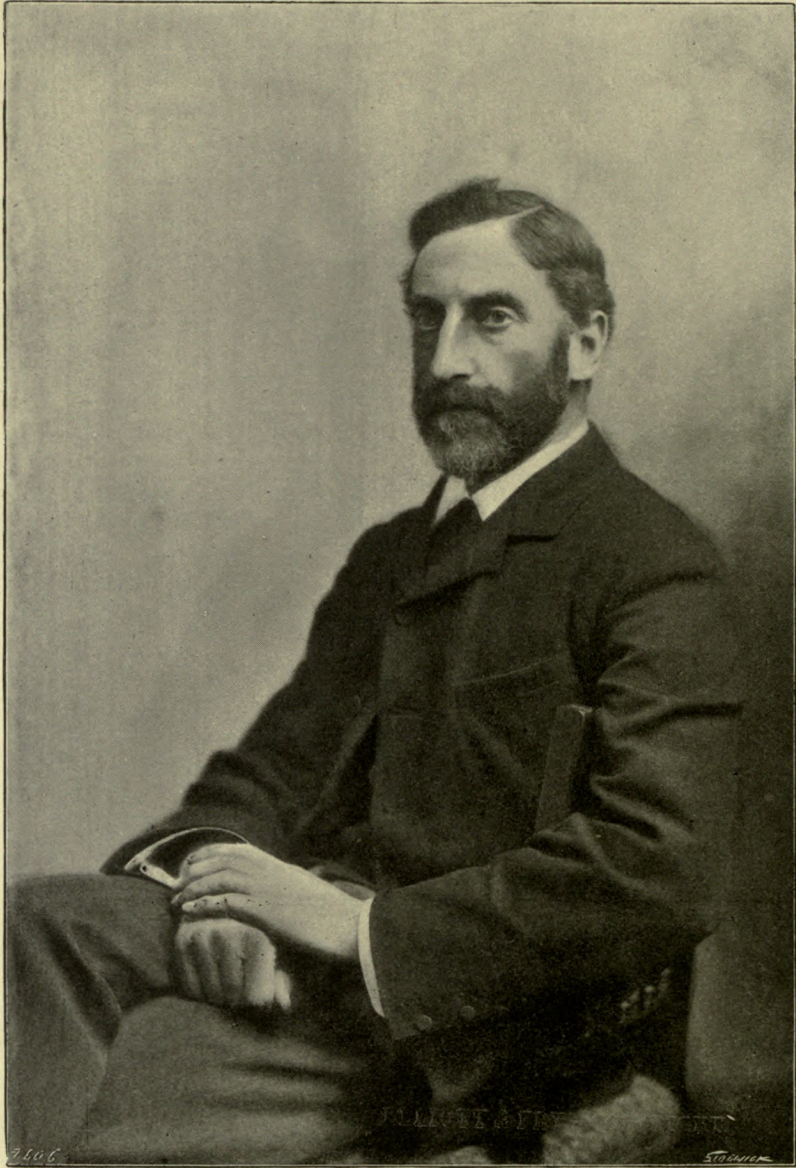

[From a photograph by Elliott and Fry

DR. JOHN HOPKINSON, F.R.S.

THIS BOOK IS DEDICATED, BY PERMISSION,

TO

THE LATE DR. JOHN HOPKINSON, F.R.S.,

THE FOUNDER OF THE

“SCIENCE OF DYNAMO DESIGN.”

TABLE OF CONTENTS.

PART I.

	PAGE
MATERIALS	1
TESTING OF MATERIALS	1
Conductivity Tests—Permeability Tests—Ring Method—Other Permeability Testing Methods—Methods not Requiring Ballistic Galvanometer—Determination of Hysteresis Loss—Conversion of Units—Hysteresis Losses in Alternating and Rotating Fields—Methods of Measuring Hysteresis Loss without Ballistic Galvanometer—Hysteresis Testers.	
PROPERTIES OF MATERIALS	14
The Magnetisation of Iron and Steel—Cast Iron—Malleable Cast Iron—Cast Steel—Mitis Iron—Nickel Steel—Forgings.	
ENERGY LOSSES IN SHEET IRON	28
Annealing of Sheet Iron—Deterioration of Sheet Iron—Effect of Pressure—Hysteresis Loss—Eddy Current Losses—Estimation of Armature Core Losses.	
INSULATING MATERIALS	38
Effect of Temperature upon Insulation Resistance—Description of Insulation Testing Methods for Factories—Description of Transformer for making Insulation Tests—Method of Test—Methods of Insulating Coils.	
ARMATURE WINDINGS	60
Continuous - Current Armature Windings—Ring Windings—Drum Windings—Multiple-Circuit Windings—Two-Circuit Windings—Formula for Two-Circuit Windings—Single Windings—Multiple Windings—Windings for Rotary Converters—Alternating - Current Armature Windings—Induction Motor Windings.	
FORMULÆ FOR ELECTROMOTIVE FORCE	78
Continuous-Current Dynamos—Alternating-Current Dynamos—Curve of E.M.F. Assumed to be a Sine Wave—Values of K for Various Waves of E.M.F. and of Magnetic Flux Distribution in Gap—Rotary Converters—Three-Phase Rotary Converters—Polyphase Machines—Electromotive Force and Flux in Transformers.	

	PAGE
THERMAL LIMIT OF OUTPUT	90
Magnets—Armatures—Internal and Surface Temperature of Coils—Heat Losses— C^2R due to Useful Currents in the Conductors—Foucault Currents—Hysteresis Loss in Cores—Heating and Efficiency of Railway Motors, Arc Dynamos, Constant Potential Dynamos—Commutator Heating—Friction Loss.	
DESIGN OF THE MAGNETIC CIRCUIT	115
Leakage Coefficient—Armature Core Reluctance—Air Gap Reluctance—Reluctance of Complete Magnetic Circuit—Estimation of Gap Reluctance—Reluctance of Core Projections—Calculation for Magnetic Circuit of Dynamo—Field Winding Formula—Application to Calculation of a Spool Winding for a Shunt-Wound Dynamo—Typical Magnetic Circuits—Magnetic Circuit of the Transformer—Magnetic Circuit of the Induction Motor—Examples.	
CONSTANT POTENTIAL, CONTINUOUS-CURRENT DYNAMOS	143
Armature Reaction—Application of Fundamental Considerations to the Proportioning of Dynamos—Influence of Armature Reaction in Two Extreme Cases—Conditions essential to Sparkless Commutation—Determination of the Number of Poles for a Given Output—Multiple-Circuit Windings—Two-Circuit Windings—Multiple Windings—Two-Circuit Coil Windings—Voltage per Commutator Segment as Related to Inductance—Inductance Constants—Practical Definition of Inductance—Description of Experimental Tests of Inductance—Illustrations of the Calculation of the Reactance Voltage.	
DESCRIPTION OF MODERN CONSTANT POTENTIAL, COMMUTATING DYNAMOS ...	179
1,500-Kilowatt, 600-Volt, Railway Generator	179
200-Kilowatt, 500-Volt, Railway Generator	190
300-Kilowatt, 125-Volt, Lighting Generator	201
250-Kilowatt, 550-Volt, Power Generator	215
CORE LOSSES IN MULTIPOLAR COMMUTATING MACHINES	228
ELECTRIC TRACTION MOTORS	232
Description of a 24 Horse-Power Geared Motor for a Rated Draw-Bar Pull of 800 lb. at a Speed of 11.4 Miles per Hour	233
Description of a 27 Horse-Power Geared Railway Motor for a Rated Output of 27 Horse-Power, at an Armature Speed of 640 Revolutions per Minute ...	242
Description of a 117 Horse-Power, Gearless Locomotive Motor for a Rated Draw-Bar Pull of 1,840 lb., at 23.8 Miles per Hour, on 42-in. Wheels ...	256
COMMUTATORS AND BRUSH GEAR	268
Contact Resistance of Brushes—Brushes of Various Materials, Copper, Carbon, Graphite.	

PART II.

ROTARY CONVERTERS	283
C^2R Loss in Armature Conductors of Rotary Converters—Single-Phase Rotary Converters—Windings for Rotary Converters—Three-Phase Rotaries—Six-Phase Rotaries—Interconnection of Static Transformers and Rotary Converters—Four-Phase Rotary Converters—Twelve-Phase Rotary Converters. Design for a Six-Phase, 400-Kilowatt, 25-Cycle, 600-Volt, Rotary Converter ...	311

Table of Contents.

ix

PAGE

Tabulated Calculations and Specifications for a 900 - Kilowatt, Three - Phase, Rotary Converter	329
The Starting of Rotary Converters	340
Synchronising Rotary Converters	345
Methods of Adjusting Voltage Ratio in Rotary Converter Systems	346
Running Conditions for Rotary Converters	351
Predetermination of Phase Characteristic Curves of Rotary Converters	351
“Surging” Effect	362
Compound-Wound Rotary	363
Series-Wound Rotary	365
Rotary Without Field Excitation	365
APPENDIX	367
Tables of Properties of Copper Wire of Various Gauges—Curve for Sheet Iron at High Densities—Curve of Properties of Various Metallic Materials.						
INDEX	373

ERRATA.

Page 1, line 9. *For* "in the metallic" *read* "in the magnetic."

Page 201, tenth line from bottom. *For* "Figs. 190 to 193" *read* "Figs. 207 to 210."

Page 230. *For* "Table LXIX." *read* "Table XLIX."

Page 255. *For* the page heading, "27 Horse-Power Geared Railway Motor," *read*
"117 Horse-Power Railway Motor."

Page 296. *For* the title of Fig. 372, *for* "Two-Circuit Winding" *read* "Six-Circuit Winding."

LIST OF ILLUSTRATIONS.

FIG.		PAGE
1	Permeability Bridge	6
2	Permeability Bridge	8
3	Cyclic Curve of Sheet Iron	9
4	Sample for Hysteresis Tester	11
5	Hysteresis Tester	12
6	Hysteresis Tester	13
7	Hysteresis Tester	15
8 to 11	Magnetic Curves for Cast Iron	19
12	Magnetic Curves for Malleable Iron	21
13	Mixtures of Steel and Cast Iron	21
14 and 15	Magnetic Curves for Cast Steel	21
16 to 19	Magnetic Curves for Cast Steel	23
20	Magnetic Curves for Mitis Iron	26
21	Magnetic Curves for Nickel Steel	26
22	Magnetic Curves for Wrought-Iron Forgings	26
23	Magnetic Curves for Steel and Wrought Iron	26
24	Magnetic Curves for Forgings and Steel Castings	28
25	Effect of Temperature of Annealing on Hysteresis Loss in Sheet Iron	30
26	"Ageing" Curves for Basic, Open-Hearth Steel	30
27	"Ageing" Curves for Acid, Open-Hearth Steel	30
28	"Ageing" Curves for Sheet Iron	30
29 to 32	"Ageing" Curves for Sheet Iron	32
33 and 34	Effect of Pressure upon Hysteresis Loss in Sheet Iron	33
35	Curves for Hysteresis Loss in Sheet Iron	34
36	Curves for Eddy-Current Loss in Sheet Iron	34
37	Characteristic Insulation Resistance Curve for Cloth	43
38 and 39	Transformer for Insulation Tests	43
40 to 44	Apparatus for Insulation Tests	44
45	Circuit Connections for Insulation Tests	48
46 to 51	Insulation Curves for "Mica-Canvas"	48 and 49
52 to 57	Insulation Curves for "Mica Long-cloth"	50 and 51
58 to 63	Insulation Curves for "Shellac'd Paper"	54
64 to 69	Insulation Curves for "Red Paper"	56
70	Gramme Ring Winding with Lateral Commutator	61
71	Multiple-Circuit, Drum Winding	64
72	Six-Circuit, Double Winding	65

FIG.		PAGE
73	Two-Circuit, Single Winding	67
74	Two-Circuit, Double Winding	69
75	Two-Circuit Winding for Three-Phase Rotary Converter	71
76	Six-Circuit Winding for Three-Phase Rotary Converter	72
77	Uni-Coil Single-Phase Winding	74
78	Uni-Coil Single-Phase Winding with Parallel Slots	74
79	Multi-Coil Single-Phase Winding	74
80	Y-Connected, Three-Phase Winding	74
81	Δ -Connected, Three-Phase Winding	74
82	Three-Phase, Non-Overlapping, Fractional Pitch Winding, with 14 Field Poles and 21 Armature Coils	74
83	Three-Phase Armature, 10 Poles and 12 Coils	76
84	Quarter-Phase Armature, 10 Poles and 8 Sets of Coils	76
85 to 87	Induction Motor Windings	76
88	Types of Winding	84
89	Rotary Converter Characteristic Curves	86
90 and 91	Form Factor Curves	87
92 to 96	Thermal Tests of a Field Spool	94
97 and 98	Thermal Tests of a Field Spool	94 and 95
99 to 112	Thermal Tests of Influence of Peripheral Speed on Temperature Rise	96 to 101
113	Armature Slot of a Large Alternator	105
114 to 116	Curves Relating to Core Loss in Railway Motor Armature	106 and 108
117	Curves of Rate of Generation of Heat in Copper by Resistance	110
118	Curve of Insulation Resistance of a Transformer at Various Temperatures	110
119 to 124	Leakage Factor Diagrams of Dynamos	120
125	Diagram for Illustrating Reluctance of Core Projections	123
126	Sheet Iron Curves for High Densities	126
127	Tooth Density Correction Curves	126
128 to 137	Typical Magnetic Circuits and their Saturation Curves	129 to 134
138	Magnetic Circuit of a Transformer	137
139	Curve for Calculating Hysteresis Loss in Transformer Cores	136
140	Curves for Calculating Eddy-Current Loss in Transformer Cores	136
141	Magnetic Circuit of Induction Motor	137
142 and 143	Curves of Distribution of Resultant Magnetomotive Force in Induction Motors	138 and 139
144 to 146	Diagrams of Distorting and Demagnetising Effects of Armature Current	147
147	Curves of Gap Distribution of Magnetic Flux with Various Leads of Brushes	148
148 to 160	Diagrams and Curves of Armature Inductance... ..	161 to 174
161	Diagram for Illustrating Reactance Calculations	175
162 to 166	Drawings of 1,500 Kilowatt Railway Generator	181 to 185
167 and 168	Saturation and Compounding Curves of 1,500 Kilowatt Railway Generator	188
169 to 183	Drawings of 200-Kilowatt Railway Generator	191 to 196
184 to 188	Results of Tests of 200-Kilowatt Railway Generator	202
189 to 206	Drawings of 300-Kilowatt Lighting Generator	204 to 213
207 to 210	Curves of Results of Tests of 300-Kilowatt Lighting Generator	213

List of Illustrations.

xiii

FIG.		PAGE
211 to 233	Drawings of 250-Kilowatt Electric Generator	216 to 226
234 to 236	Characteristic Curves of 250-Kilowatt Electric Generator ...	227 and 228
237 and 238	Diagram and Curve for Calculating Core Losses in Multipolar Com- mutating Machines	229
239 to 254	Drawings of 24 Horse-Power Geared Railway Motor ...	234 to 240
255 to 258	Characteristic Curves of 24 Horse-Power Geared Railway Motor ...	240
259 to 277	Drawings of 27 Horse-Power Geared Railway Motor ...	242 to 250
278 to 283	Characteristic Curves of 27 Horse-Power Geared Railway Motor	250 and 251
284 to 319	Drawings of 117 Horse-Power Gearless Railway Motor ...	253 to 264
320 to 323	Characteristic Curves of 117 Horse-Power Gearless Railway Motor ...	265
324 to 331	Commutators for Traction Motors	268 and 269
332 to 340	Commutators for Traction Generators	269 and 270
341	Diagram of Arrangements for Measuring Contact Resistance of Brushes	271
342 to 346	Curves of Properties of Commutator Brushes	271 to 274
347 to 352	Brush Holders for Radial Carbon Brushes for Traction Motors	275 and 276
353 and 354	Carbon Brush Holder for Small Launch Motor... ..	276
355 to 358	Carbon Brush Holders for Generators	276 and 278
359	Holder for a Copper Gauze Brush	278
360 and 361	Bayliss Reactance Brush Holder	279
362 and 363	Brush Holder Constructed of Stamped Parts	279
364 and 365	Holder for Carbon Brushes	279
366	Sine Curves of Instantaneous Current Values in Three Phases of a Rotary Converter	286
367	Diagrams of Instantaneous Current Values in Line and Windings of a Rotary Converter	287
368 and 369	Developed Diagrams of Rotary Converter Winding ...	288 and 289
370	Two-Circuit Single Winding for Single-Phase Rotary ...	295
371	Two-Circuit Singly Re-Entrant Triple Winding for Single-Phase Rotary	296
372	Six-Circuit Single Winding	296
373	Six-Circuit Single Winding for Three-Phase Rotary ...	297
374	Two-Circuit Single Winding for Three-Phase Rotary ...	298
375	Two-Circuit Singly Re-Entrant Triple Winding for Three-Phase Rotary	299
376	Six-Circuit Single Winding for Six-Phase Rotary ...	300
377	Two-Circuit Single Winding for Six-Phase Rotary ...	301
378	Two-Circuit Singly Re-Entrant Triple Winding for Six-Phase Rotary ...	302
379	Diagrammatic Comparison of Six-Phase and Three-Phase Windings ...	303
380	Inter-Connection of Static Transformers and Rotary Converter ...	304
381 and 382	"Double-Delta" Connection and "Diametrical" Connection ...	305
383	Six-Phase Switchboard	307
384	Six-Circuit Single Winding for Four-Phase Rotary ...	308
385	Two-Circuit Single Winding for Four-Phase Rotary ...	309
386	Two-Circuit Triple Winding for Four-Phase Rotary ...	310
387	Diagrammatical Representation of Conditions in Four-Phase Rotary Converter Winding	310
388 and 389	Connection Diagrams for Twelve-Phase Rotary Converter ...	311
390 to 393	Drawings of Six-Phase 400-Kilowatt Rotary	313 to 315
394 and 395	Curves of Six-Phase 400-Kilowatt Rotary	316
396 to 398	Drawings of Three-Phase 900-Kilowatt Rotary	331 and 332

FIG.		PAGE
399 to 402	Characteristic Curves of Three-Phase 900-Kilowatt Rotary	... 333
403	Diagram of Connections for Starting Rotary Converter by Compensator Method	... 341
404 and 405	Methods of Synchronising Rotary Converters	... 343
406 to 408	Three-Pole, 2,000 Ampere, 330-Volt Switch for Rotary Converters	344 and 345
409	Diagram of Connections for Using Induction Regulators for Controlling the Voltage Ratio in Rotary Converters	... 347
410	Diagram of Connections for Controlling the Voltage Ratio in Rotary Converter System by an Auxiliary Booster	... 348
411	Diagram of Connections for Controlling the Voltage Ratio on a Portion of a Rotary Converter System by an Auxiliary Booster	... 349
412	Combined Rotary Converter and Series Booster	... 350
413	Combined Rotary Converter and Auxiliary Synchronous Motor for Giving Adjustable Voltage Ratio	... 350
414 to 418	Phase Characteristic Curves of Rotary Converters	354 to 357
419 and 420	Distribution of Resultant Armature Magnetomotive Force over the Armature Surface of a Rotary Converter	... 358 and 359
421	Curves of a Series-Wound Rotary	... 363
422	Curves of a Rotary without Field Excitation	... 364
423	Curve for Sheet Iron at High Densities	... 372

LIST OF TABLES.

TABLE	PAGE
I. Data of Ten First-Quality Samples of Cast Steel	22
II. Data of Ten Second-Quality Samples of Cast Steel	24
III. Data of Twelve Samples of Mitis Iron	24
IV. Analyses of Samples of Sheet Iron and Steel	27
V. Results of Tests on "Ageing" of Iron	31
VI. Properties of Iron and Steel, with Special Reference to Specific Resistance	36
VII. Preece's Tests of Annealed Iron Wire	36
VIII. Influence of Carbon on Specific Resistance of Steel	37
IX. Influence of Silicon on Specific Resistance of Steel	37
X. Influence of Manganese on Specific Resistance of Steel	38
XI. Puncturing Voltage of Composite White Mica	38
XII. Insulation Tests on Sheets of Leatheroid	39
XIII. Summary of Qualities of Insulating Materials	42
XIV. Insulation Tests on "Mica Canvas"	47
XV. Insulation Tests on "Mica Long-Cloth"	52
XVI. Insulation Tests on Shellac'd Paper	53
XVII. Insulation Tests on Red Paper	55
XVIII. Subdivision of Windings for Rotary Converters	70
XIX. Drum Winding Constants	80
XX. Correction Factors for Voltage of Distributed Windings	81
XXI. Values for K in E.M.F. Calculations for Multi-Coil Windings	82
XXII. Values for K in E.M.F. Calculations for Multi-Coil Windings, with Various Pole Arcs	83
XXIII. Values for K in E.M.F. Calculations for Windings with Various Per- centages Spread	83
XXIV. Values for Voltage Ratio for Single and Quarter-Phase Rotary Converters	85
XXV. Values for Voltage Ratio for Three-Phase Rotary Converters	85
XXVI. Values of Number of Turns in Series between Collector Rings in Rotary Converters	87
XXVII. Values for Form Factor	88
XXVIII. Values for Form Factor	89
XXIX. Temperature Correction Coefficients for Copper	102
XXX. Current Densities in Copper and Corresponding Specific Rates of Generation of Heat in Watts per Pound	108
XXXI. Magnetic Flux Densities in Sheet Iron, and Corresponding Specific Rates of Generation of Heat in Watts per Pound	109
XXXII. Current Densities in Various Types of Apparatus	109

TABLE	PAGE
XXXIII. Calculation of Reluctance of Core Projections	125
XXXIV. Calculation of Reluctance of Core Projections	125
XXXV. Calculation of Reluctance of Core Projections	125
XXXVI. Test of Armature Reaction	149
XXXVII. Inductance Tests	160
XXXVIII. Inductance Tests	162
XXXIX. Inductance Tests	162
XL. Inductance Tests	162
XLI. Inductance Tests	163
XLII. Inductance Tests	164
XLIII. Inductance Tests	165
XLIV. Inductance Tests	167
XLV. Inductance Tests	167
XLVI. Inductance Tests	168
XLVII. Inductance Tests	168
XLVIII. Inductance Tests	171
XLIX. Core Loss Results	230
L. Tests on Graphite and Carbon Brushes	280
LI. Output of Rotary Converters	284
LII. Output of Rotary Converters	285
LIII. Armature C ² R Loss in Rotary Converters	290
LIV. Armature C ² R Loss in Rotary Converters	292
LV. Armature C ² R Loss in Rotary Converters	294

APPENDIX.

LVI. Table of Properties of Copper Wire—B. and S. Gauge	367
LVII. Table of Properties of Copper Wire—S. W. G. Gauge	368
LVIII. Table of Properties of Copper Wire—B. W. G. Gauge	369
LIX. Physical and Electrical Properties of Various Metals and Alloys	370

P R E F A C E.

THE present volume is an amplification of the notes of a series of lectures, delivered first by Mr. Parshall and continued by Mr. Hobart, at the Massachusetts Institute of Technology, some six years ago. The original notes met with so cordial an appreciation from Lord Kelvin, the late Dr. John Hopkinson and others, that the authors determined to follow out a suggestion made, and publish a book on the design of Electric Generators. The work of revising the original notes gradually led to the bringing together of an amount of material several times larger than was at first intended, and a comprehensive treatment of the subject prevented reducing this amount. In this form the work appeared as a series of articles in "ENGINEERING," during the years 1898 and 1899. The interest taken in the series, together with the fact that the experience of the Authors, covering as it does the period during which most of the modern types of machines have been developed, justifies the publication of the treatise, despite the present large number of books on the theory of commutating machines.

In dealing with the practice of designing, three sub-divisions can be finally made :—

The first may be taken as relating to the design of the magnetic circuit. The classical papers of Doctors John and Edward Hopkinson have dealt with this subject so completely that there remains but little to be written; and this relates chiefly to the nature and properties of the different qualities of iron and steel which may be used in the construction of the magnetic circuit.

The second sub-division considers the phenomena of commutation and the study of dimensions, with a view to securing the greatest output

without diminishing the efficiency. The theory of commutation has become better understood since electrical engineers began to deal with alternating currents and to understand the effects of self-induction. However, owing to the number of variables affecting the final results, data obtained in practice must be the basis for the preparation of new designs. In this work will be found a statement of such results, and numerical values experimentally obtained from representative commutating machines. One familiar with the theory of commutation can, with comparative certainty, from the values and dimensions given, design machines with satisfactory commutating properties.

The third sub-division relates to what we have termed the "Thermal Limit of Output," that is, the maximum output with safe heating. It can be fairly said that while the theory of all the losses in a commutating dynamo are understood, yet, with the exception of the $C^2 R$ losses, it is still a matter of practical experience to determine what relation the actual losses bear to what may be termed the predicted losses. It is invariably found that the iron losses are in excess of those which may be predicted from the tests made upon the material before construction. The hysteresis loss in the armature core is generally found to be greater, owing to the mechanical processes to which the material in the core has to be subjected during the process of construction. Owing, probably, in a large measure to a species of side magnetisation, the eddy-current loss is found to be greater than is indicated by calculations based upon the assumption of a distribution of magnetic lines parallel to the plane of the laminations. If the armature conductors are solid, the losses therein by Foucault currents may often be considerable, even in projection type armatures, especially when the projections are run at high densities. Under load losses, not including friction, there have to be considered the Foucault current loss in the conductors due to distortion, and the increased loss in the armature projections from hysteresis and eddy currents likewise due thereto. There is also the loss brought about by the reversal of the current in the armature coil under commutation. It is apparent, therefore, considering that each of these variables is dependent upon the form of

design, the material used, and the processes of construction, that only an approximate estimate as to the total loss can be made from the theoretical consideration of the constants. We believe, therefore, that these considerations will justify the length with which we have dealt with the thermal limit of output.

The various other sections give information which we have found indispensable in designing work. The General Electric Company of America, and the Union Elektrizitäts-Gesellschaft of Berlin, have kindly placed at our disposal the results of a large amount of technical experience, which have formed a very substantial addition to the results of our own work. We have endeavoured to show our appreciation of this liberal and, unfortunately rare, policy, by setting forth the conclusions at which it has enabled us to arrive, in a manner which we hope will render the work a thoroughly useful contribution to technical progress in dynamo design. Apart from the papers of the Hopkinsons, the treatise on *Dynamo Electric Machinery* by Dr. Sylvanus Thompson, has had the greatest influence in disseminating thorough knowledge of the theory of the dynamo. It was, in fact, after considering the contents of these works that we decided to prepare our treatise on the present lines; with the aim to supply, however imperfectly, a work which shall assist in applying to practice the principles already clearly enunciated in these treatises.

We acknowledge with pleasure the valuable assistance and suggestions which we have received from many friends in the preparation of the work.



ELECTRIC GENERATORS.

MATERIALS.

A CONSIDERABLE variety of materials enters into the construction of dynamo electric apparatus, and it is essential that the grades used shall conform to rather exacting requirements, both as regards electric and magnetic conductivity as well as with respect to their mechanical properties.

TESTING OF MATERIALS.

The metallic compounds employed in the metallic and conducting circuits must be of definite chemical composition. The effect of slight differences in the chemical composition is often considerable; for instance, the addition of 3 per cent. of aluminium reduces the conductivity of copper in the ratio of 100 to 18.¹ Again, the magnetic permeability of steel containing 12 per cent. of manganese is scarcely greater than unity.

The mechanical treatment during various stages of the production also in many cases exerts a preponderating influence upon the final result. Thus, sheet iron frequently has over twice as great a hysteresis loss when unannealed as it has after annealing from a high temperature. Cast copper having almost the same chemical analysis as drawn copper, has only 50 per cent. conductivity. Pressure exerts a great influence upon the magnetic properties of sheet iron.² Sheet iron of certain compositions, when subjected for a few weeks, even to such a moderate temperature as 60 deg. Cent., becomes several times as poor for magnetic purposes as before subjection to this temperature.³

It thus becomes desirable to subject to chemical, physical, and electromagnetic tests samples from every lot of material intended for use in the

¹ *Electrician*, July 3rd, 1896. Dewar and Fleming. ² See page 33, and Figs. 33 and 34.

³ See pages 30 to 32, and Figs. 26 to 32.

construction of dynamo-electric apparatus. This being the case, the importance of practical shop methods, in order that such tests may be quickly and accurately made, becomes apparent.

CONDUCTIVITY TESTS.

The methods used in conductivity tests are those described in text-books devoted to the subject.¹ It will suffice to call attention to the recent investigations of Professors Dewar and Fleming,² the results of which show that materials in a state of great purity have considerably higher conductivity than was attributed to them as the results of Matthiessen's experiments. Manufactured copper wire is now often obtained with a conductivity exceeding Matthiessen's standard for pure copper.

Copper wire, drawn to small diameters, is apt to be of inferior conductivity, due to the admixture of impurities to lessen the difficulties of manufacture. It consequently becomes especially desirable to test its conductivity in order to guard against too low a value.

The electrical conductivity of German silver and other high resistance alloys varies to such an extent that tests on each lot are imperative, if anything like accurate results are required.³

PERMEABILITY TESTS.

Considerable care and judgment are necessary in testing the magnetic properties of materials, even with the most recent improvements in apparatus and methods. Nevertheless, the extreme variability in the magnetic properties, resulting from slight variations in chemical composition and physical treatment, render such tests indispensable in order to obtain uniformly good quality in the material employed. Various methods have been proposed with a view to simplifying permeability tests, but the most accurate method, although also the most laborious, is that in which the sample is in the form of an annular ring uniformly wound with primary and secondary coils, the former permitting of the application of any desired

¹ Among the more useful books on the subject of electrical measurements are Professor S. W. Holman's *Physical Laboratory Notes* (Massachusetts Institute of Technology), and Professor Fleming's *Electrical Laboratory Notes and Forms*.

² *Electrician*, July 3rd, 1896.

³ A Table of the properties of various conducting materials is given later in this volume.

magnetomotive force, and the latter being for the purpose of determining, by means of the swing of the needle of a ballistic galvanometer, the corresponding magnetic flux induced in the sample.

DESCRIPTION OF TEST OF IRON SAMPLE BY RING METHOD WITH
BALLISTIC GALVANOMETER.

The calibrating coil consisted of a solenoid, 80 centimetres long, uniformly wound with an exciting coil of 800 turns. Therefore, there were 10 turns per centimetre of length. The mean cross-section of exciting coil was 18.0 square centimetres. The exploring coil consisted of 100 turns midway along the solenoid. Reversing a current of 2.00 amperes in the exciting coil gave a deflection of 35.5 deg. on the scale of the ballistic galvanometer when there was 150 ohms resistance in the entire secondary circuit, consisting of 12.0 ohms in the ballistic galvanometer coils, 5.0 ohms in the exploring coil, and 133 ohms in external resistance.

$$H = \frac{4 \pi n C}{10 l}; \quad \frac{n}{l} = 10.0; \quad C = 2.00;$$

$$\therefore H = \frac{4 \pi}{10} \times 10.0 \times 2.00 = 25.1,$$

i.e., 2.00 amperes in the exciting coil set up 25.1 lines in each square centimetre at the middle section of the solenoid; therefore $18.0 \times 25.1 = 452$ total C G S. lines. But these were linked with the 100 turns of the exploring coil, and therefore were equivalent to 45,200 lines linked with the circuit. Reversing 45,200 lines was equivalent in its effect upon the ballistic galvanometer to creating 90,400 lines, which latter number, consequently, corresponds to a deflection of 35.5 deg. on the ballistic galvanometer with 150 ohms in circuit. Defining K , the constant of the ballistic galvanometer, to be the lines per degree deflection with 100 ohms in circuit, we obtain

$$K = \frac{90400}{35.5 \times 1.50} = 1690 \text{ lines.}$$

The cast-steel sample consisted of an annular ring of 1.10 square centimetres cross-section, and of 30 centimetres mean circumference, and it was wound with an exciting coil of 450 turns, and with an exploring coil of 50 turns. With 2.00 amperes exciting current,

$$H = \frac{4 \pi}{10} \times \frac{450}{30} \times 2.00 = 37.7.$$

Reversing 2.00 amperes in the exciting coil gave a deflection of 40 deg. with 2,400 ohms total resistance of secondary circuit. Then with 100 ohms instead of 2,400 ohms, with one turn in the exploring coil instead of 50 turns, and simply creating the flux instead of reversing it, there would have been obtained a deflection of

$$\frac{2400}{100} \times \frac{1}{50} \times \frac{1}{2} \times 40 = 9.60 \text{ deg. ;}$$

consequently the flux reversed in the sample was

$$9.60 \times 1,690 = 16,200 \text{ lines.}$$

And as the cross-section of the ring was 1.10 square centimetres, the density was

$$16,200 \div 1.10 = 14,700 \text{ lines per square centimetre.}$$

Therefore the result of this observation was

$$H = 37.7; \quad B = 14,700; \quad \mu = 390.$$

But in practice¹ this should be reduced to ampere turns per inch of length, and lines per square inch ;

$$\text{Ampere-turns per inch of length} = 2 H = 75.4.$$

$$\text{Density in lines per square inch} = 6.45 \times 14,700 = 95,000$$

This would generally be written 95.0 kilolines. Similarly, fluxes of still greater magnitude are generally expressed in megalines. For instance,

$$12.7 \text{ megalines} = 12,700,000 \text{ C G S lines.}$$

¹ Although mixed systems of units are admittedly inferior to the metric system, present shop practice requires their use. It is, therefore, necessary to readily convert the absolute B H curves into others expressed in terms of the units employed in practice. In absolute measure, iron saturation curves are plotted, in which the ordinates B represent the density in terms of the number of C G S lines per square centimetre, the abscissæ denoting the magneto-motive force H. B/H equals μ , the permeability. In the curves used in practice the ordinates should equal the number of lines per square inch. They are, therefore, equal to 6.45 B. The abscissæ should equal the number of ampere-turns per inch of length. Letting turns = n , and amperes = C, we have—

$$H = \frac{4 \pi n C}{10 l}, \quad l \text{ being expressed in centimetres.}$$

$$\therefore \text{Ampere-turns per centimetre of length} = \frac{10 H}{4 \pi},$$

$$\text{Ampere-turns per inch of length} = \frac{2.54 \times 10 H}{4 \pi},$$

$$\text{Ampere-turns per inch of length} = 2.02 H.$$

Therefore ampere-turns per inch of length are approximately equal to 2 H.

OTHER PERMEABILITY TESTING METHODS.

The bar and yoke method, devised by Dr. Hopkinson, permits of the use of a rod-shaped sample, this being more convenient than an annular ring, in that the latter requires that each sample be separately wound, whereas in the rod and yoke method the same magnetising and exploring coils may be used for all samples. However, the ring method is more absolute, and affords much less chance for error than is the case with other methods, where the sources of error must either be reduced to negligible proportions, which is seldom practicable, or corrected for. Descriptions of the Hopkinson apparatus are to be found in text-books on electro-magnetism,¹ and the calculation of the results would be along lines closely similar to those of the example already given for the case of an annular ring sample.

METHODS OF MEASURING PERMEABILITY NOT REQUIRING BALLISTIC GALVANOMETER.

There have been a number of arrangements devised for the purpose of making permeability measurements without the use of the ballistic galvanometer, and of doing away with the generally considerable trouble attending its use, as well as simplifying the calculations.

Those in which the piece to be tested is compared to a standard of known permeability have proved to be the most successful. The Eickemeyer bridge² is a well-known example, but it is rather untrustworthy, particularly when there is a great difference between the standard and the test-piece.

A method of accomplishing this, which has been used extensively with very good results, has been devised by Mr. Frank Holden. It is described by him in an article entitled "A Method of Determining Induction and Hysteresis Curves" in the *Electrical World* for December 15th, 1894. The principle has been embodied in a commercial apparatus constructed by Mr. Holden in 1895,³ and also in a similar instrument exhibited by Professor Ewing before the Royal Society in 1896.⁴

¹ Also J. Hopkinson, *Phil. Trans.*, page 455, 1885.

² *Electrical Engineer*, New York, March 25th, 1891.

³ "An Apparatus for Determining Induction and Hysteresis Curves," *Electrical World*, June 27th, 1896.

⁴ "The Magnetic Testing of Iron and Steel," *Proc. Inst. Civil Engineers*, May, 1896.

Holden's method consists essentially of an arrangement in which two bars are wound uniformly over equal lengths, and joined at their ends by two blocks of soft iron into which they fit. The rods are parallel, and about as close together as the windings permit. In practice it has been found most convenient to use rods of about .25 in. in diameter, and about 7 in. long. Over the middle portion of this arrangement is placed a magnetometer, not necessarily a very sensitive one, with its needle tending to lie at right angles to the length of the two bars, the influence of the bars tending to set it at right angles to this position. Means are

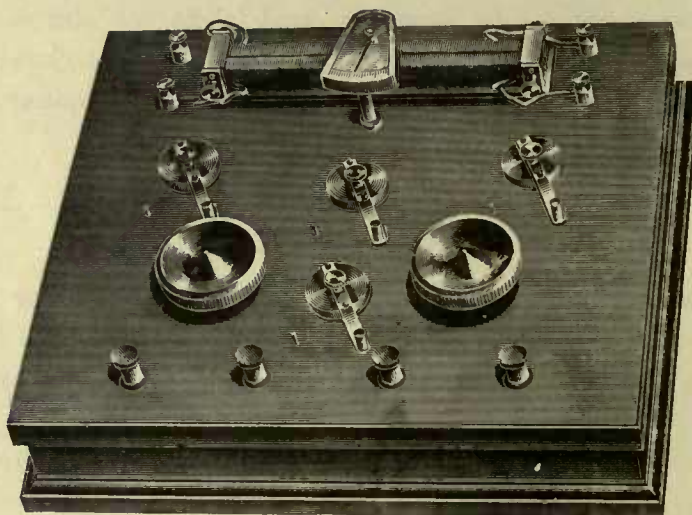

FIG. 1.

provided for reversing simultaneously, and for measuring, each of the magnetising currents, which pass in such directions that the north end of one rod and the south end of the other are in the same terminal block. It is evident that whenever the magnetometer shows no effect from the bars, the fluxes in them must be equal, for if not equal there would be a leakage from one terminal block to the other through the air, and this would affect the magnetometer. This balanced condition is brought about by varying the current in one or both of the bars, and reversing between each variation to get rid of the effects of residual magnetism.

For each bar

$$H = \frac{4 \pi n C}{10 l}$$

where

n = number of turns.

C = Current in amperes.

l = distance between blocks in centimetres.

As the same magnetising coils may always be used, and as the blocks may be arranged at a fixed distance apart,

$$\frac{4 \pi n}{10 l} = K$$

and

$$H = K C.$$

The B H curve of the standard must have been previously determined, and when the above-described balance has been produced and the magnetomotive force of the standard calculated, the value of B is at once found by reference to the characteristics of the standard. If the two bars are of the same cross-section, this gives directly the B in the test-piece, and H is calculated as described. The method furnishes a means of making very accurate comparisons, and the whole test is quickly done, and the chances of error are minimised by the simplicity of the process. The magnetometer for use with bars of the size described need not be more delicate than a good pocket compass. Although two pieces of quite opposite extremes of permeability may be thus compared, yet it takes less care in manipulating, if two standards are at hand, one of cast-iron and one of wrought iron or cast steel, and the standard of quality most like that of the test-piece should be used.

Sheet iron may be tested in the same way, if it is cut in strips about .5 in. wide and 7 in. long. This will require the use of specially-shaped blocks, capable of making good contact with the end of the bundle of strips which may be about .25 in. thick. In general the cross-sections of the test-piece and standard in this case will not be equal, but this is easily accounted for, since the induction values are inversely as the cross-sections when the total fluxes are equal. In Figs. 1 and 2 are shown both the Holden and the Ewing permeability bridges.

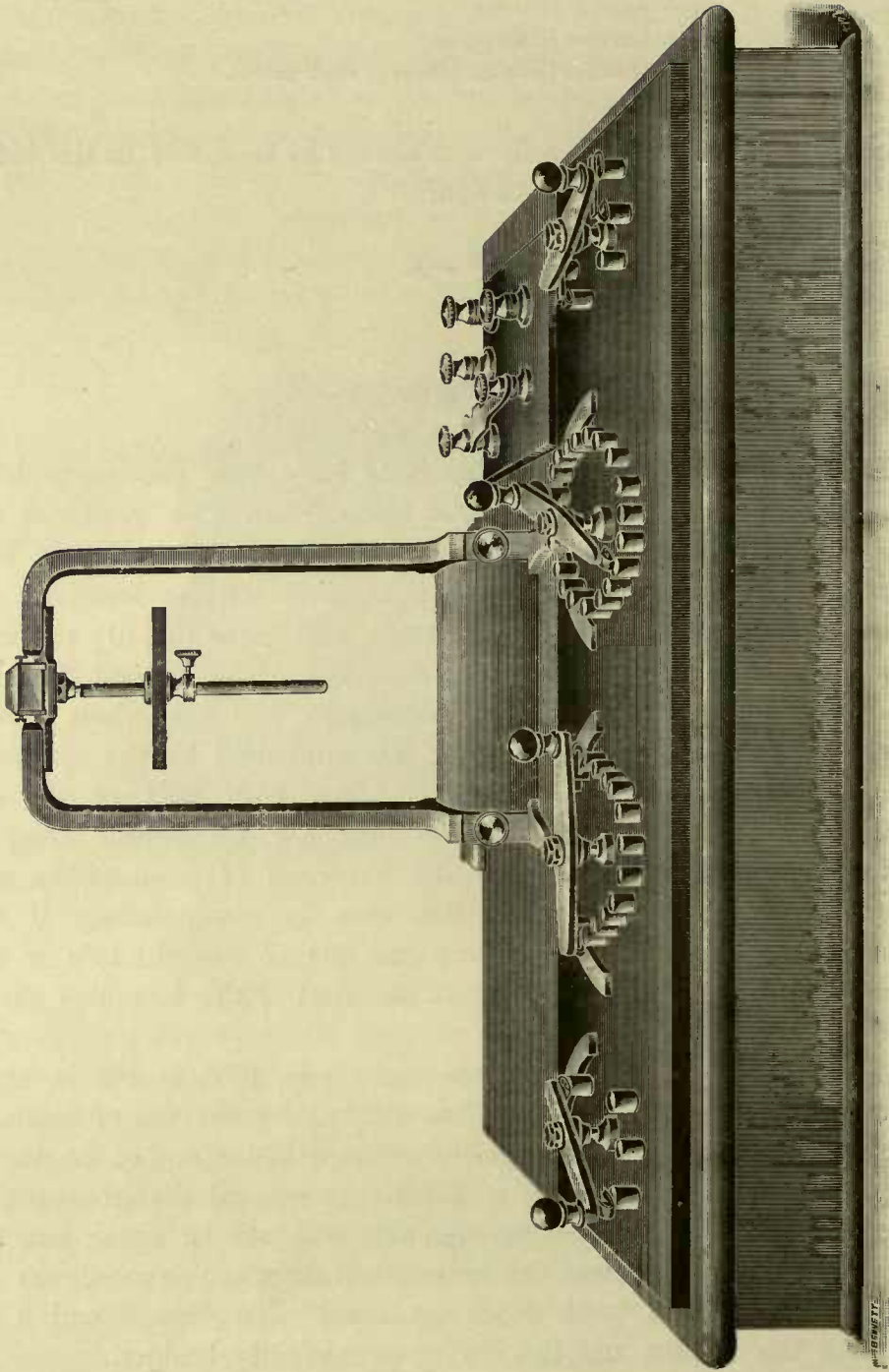
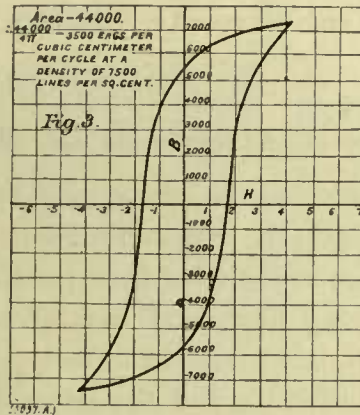

FIG. 2.

DETERMINATION OF HYSTERESIS LOSS.

The step-by-step method of determining the hysteresis loss, by carrying a sample through a complete cycle, has been used for some years past, and is employed to a great extent at the present time.—Such a test is made with a ring-shaped sample, and consists in varying by steps the magnetomotive force of the primary coil, and noting by the deflection of a ballistic galvanometer the corresponding changes in the flux. From the results a complete cycle curve, such as is shown in Fig. 3, may be plotted. If this curve is plotted with ordinates equal to B (C G S lines per square centi-



metre), and with abscissæ equal to H , $\left(\frac{4 \pi n C}{10 l}\right)$, its area divided by 4π (conveniently determined by means of a planimeter), will be equal to the hysteresis loss of one complete cycle, expressed in ergs per cubic centimetre¹; but in subsequent calculations of commercial apparatus it is more convenient to have the results in terms of the watts per pound of material per cycle per second. The relation between the two expressions may be derived as follows :

CONVERSION OF UNITS.

Ergs per cubic centimetre per cycle

$$= \frac{\text{Area complete cyclic curve}}{4 \pi}$$

¹ Fleming, *Alternate Current Transformer*, second edition, page 62.

Watts per cubic centimetre at one cycle per second

$$= \frac{\text{Area}}{4 \pi \times 10^7}$$

Watts per cubic inch at one cycle per second

$$= \frac{\text{Area} \times 16.4}{4 \pi \times 10^7}$$

Watts per pound at one cycle per second

$$= \frac{\text{Area} \times 16.4}{4 \pi \times 10^7 \times .282}$$

(One cubic inch of sheet iron weighing .282 lb.)

∴ Watts per pound at one cycle per second = .0000058 × ergs per cubic centimetre per cycle.

HYSTERESIS LOSSES IN ALTERNATING AND ROTATING FIELDS.

Hysteresis loss in iron may be produced in two ways : one when the magnetising force acting upon the iron, and consequently the magnetisation, passes through a zero value in changing from positive to negative, and the other when the magnetising force, and consequently the magnetisation, remains constant in value, but varies in direction. The former condition holds in the core of a transformer, and the latter in certain other types of apparatus. The resultant hysteresis loss in the two cases cannot be assumed to be necessarily the same. Bailey has found¹ that the rotating field produces for low inductions a hysteresis loss greater than that of the alternating field, but that at an induction of about 100 kilolines per square inch, the hysteresis loss reaches a sharply defined maximum, and rapidly diminishes on further magnetisation, until, at an induction of about 130 kilolines per square inch, it becomes very small with every indication of disappearing altogether. This result has been verified by other experimenters, and it is quite in accord with the molecular theory of magnetism, from which, in fact, it was predicted. In the case of the alternating field, when the magnetism is pressed beyond a certain limit, the hysteresis loss becomes, and remains, constant in value, but does not decrease as in the

¹ See paper on "The Hysteresis of Iron in a Rotating Magnetic Field," read before the Royal Society, June 4th, 1896. See also an article in the *Electrician* of October 2nd, 1896, on "Magnetic Hysteresis in a Rotating Field," by R. Beattie and R. C. Clinker. Also *Electrician*, August 31st, 1894, F. G. Bailey. Also *Wied. Ann.*, No. 9, 1898, Niethammer.

case of the rotating magnetisation. Hence, as far as hysteresis loss is concerned, it might sometimes be advantageous to work with as high an induction in certain types of electro-dynamic apparatus as possible, if it can be pressed above that point where the hysteresis loss commences to decrease; but in the case of transformers little advantage would be derived from high density on the score of hysteresis loss, as the density, except at very low cycles, cannot be economically carried up to that value at which the hysteresis loss is said to become constant.

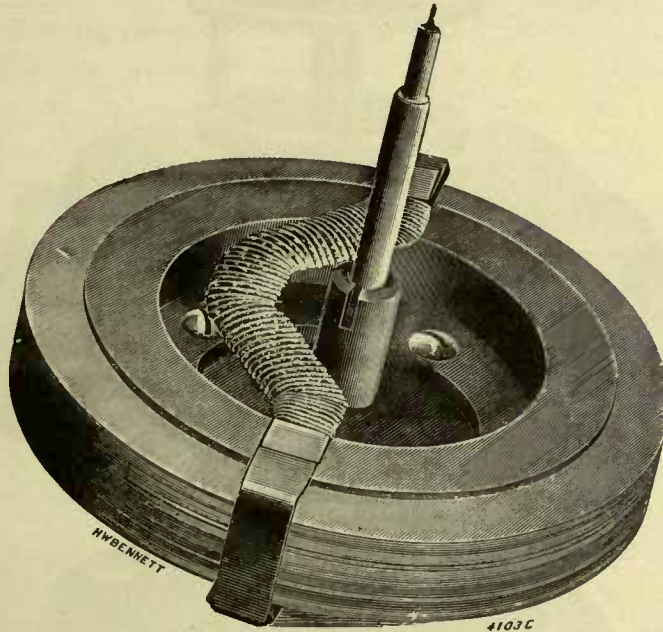

FIG. 4.

METHODS OF MEASURING HYSTERESIS LOSS WITHOUT THE BALLISTIC GALVANOMETER.

To avoid the great labour and expenditure of time involved in hysteresis tests by the step-by-step method with the ballistic galvanometer, there have been many attempts made to arrive at the result in a more direct manner. The only type of apparatus that seems to have attained commercial success measures the energy employed either in rotating the test-piece in a magnetic field, or in rotating the magnetic field in which the test-piece is placed.

The Holden hysteresis tester¹ is the earliest of these instruments, and

¹ "Some Work on Magnetic Hysteresis," *Electrical World*, June 15th, 1895.

appears to be the most satisfactory. It measures the loss in sheet-iron rings when placed between the poles of a rotating magnet, and enables the loss to be thoroughly analysed. The sheet-iron rings are just such as would be used in the ordinary ballistic galvanometer test (Fig. 4, page 11).

The rings are held concentric with a vertical pivoted shaft, around which revolves co-axially an electro-magnet which magnetises the rings. The sample rings are built up into a cylindrical pile about $\frac{1}{2}$ in. high.

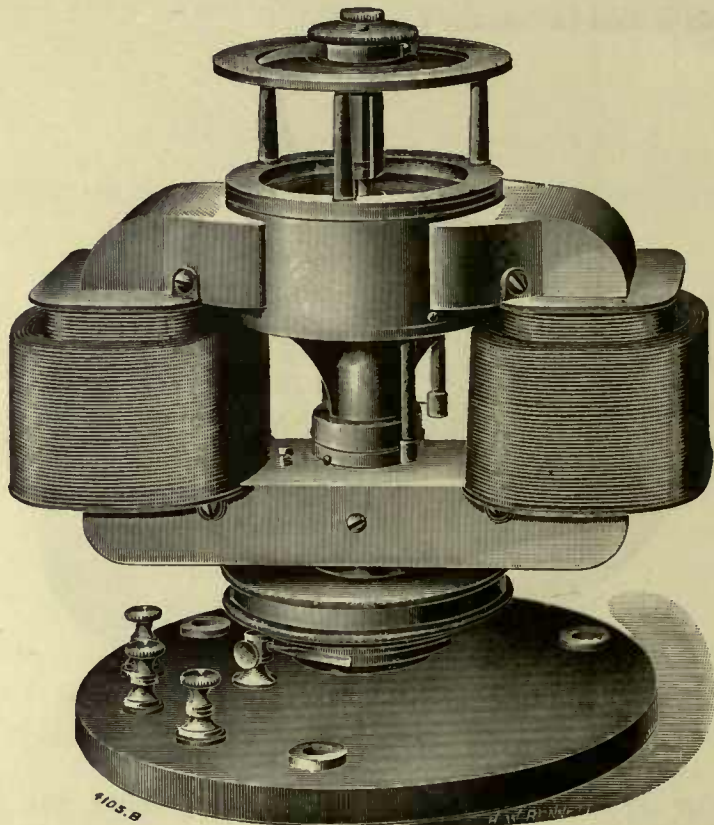

FIG. 5.

Surrounding but not touching the sample to be tested is a coil of insulated wire, the terminals of which lead to a commutator revolving with the magnet. The alternating electromotive force of the coil is thus rectified, and measured by a Weston voltmeter. Knowing the cross-section of the sample, the number of turns in the coil, the angular velocity of the magnet, and the constants of the voltmeter, the induction corresponding to a certain deflection of the voltmeter, can be calculated in an obvious manner.¹

¹ For electromotive force calculations, see another page in this volume.

The force tending to rotate the rings is opposed by means of a helical spring surrounding the shaft and attached to it at one end. The other end is fixed to a torsion head, with a pointer moving over a scale. The loss per cycle is proportional to the deflection required to bring the rings to their zero position, and is readily calculated from the constant of the spring.

By varying the angular velocity of the magnet, a few observations give data by which the effect of eddy currents may be allowed for, and the residual hysteresis loss determined; or, by running at a low speed, the eddy current loss becomes so small as to be practically negligible, and readings taken under these conditions are, for all commercial purposes, the only ones necessary. A test sample with wire coil is shown in Fig. 4, whilst the complete apparatus may be seen in Fig. 5, page 12.

A modification (Fig. 6) of this instrument does away with the adjust-

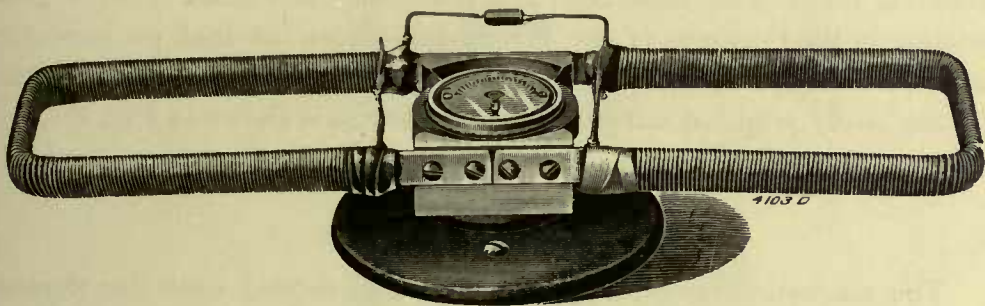

FIG. 6.

ment of the magnetising current and the separate determination of the induction for different tests. In this case the electro-magnet is modified into two of much greater length, and of a cross-section of about one-third that of the sample lot of rings. The air gap is made as small as practicable, so that there is very little leakage. A very high magneto-motive force is applied to the electro-magnets, so that the flux in them changes only very slightly with considerable corresponding variation in the current. With any such variation from the average as is likely to occur in the rings on account of varying permeability, the total flux through them will be nearly constant, with the magnetisation furnished in this manner. The sample rotates in opposition to a spiral spring, and the angle of rotation is proportional to the hysteresis loss. In general a correction has to be applied for volume and cross-section, as the rings do not, owing to variations in the thickness of the sheets, make piles of the same height. The

magnets are rotated slowly by giving them an impulse by hand, and the reading is made when a steady deflection is obtained.

EWING HYSTERESIS TESTER.

In Professor Ewing's apparatus¹ the test sample is made up of about seven pieces of sheet iron $\frac{5}{8}$ in. wide and 3 in. long. These are rotated between the poles of a permanent magnet mounted on knife-edges. The magnet carries a pointer which moves over a scale. Two standards of known hysteresis properties are used for reference. The deflections corresponding to these samples are plotted as a function of their hysteresis losses, and a line joining the two points thus found is referred to in the subsequent tests, this line showing the relation existing between deflections and hysteresis loss. The deflections are practically the same, with a great variation in the thickness of the pile of test-pieces, so that no correction has to be made for such variation. It has, among other advantages, that of using easily prepared samples. The apparatus is shown in Fig. 7.

PROPERTIES OF MATERIALS.

The magnetic properties of iron and steel depend upon the physical structure; as a primary indication of which, and as a specific basis for the description of the material, chemical analysis forms an essential part of tests. The physical structure and the magnetic properties are affected to a greater or less degree according to the chemical composition; by annealing, tempering, continued heating, and mechanical strains by tension or compression. The rate of cooling also influences the magnetic properties of the material; the permeability of cast iron, for instance, is diminished if the cooling has been too rapid, but it may be restored by annealing, the only noticeable change being that the size of the flakes of graphite is increased. The permeability of high carbon steels may also be increased by annealing and diminished by tempering, and that of wrought iron or steel is diminished by mechanical strain; the loss of permeability resulting from mechanical strain, may, however, be restored by annealing.

The effect on the magnetic properties, of the different elements entering into the composition of iron and steel, varies according to the percentage of

¹ *Electrician*, April 26th, 1895.

other elements present. The presence of an element which, alone, would be objectionable may not be so when a number of others are also present ; for instance, manganese in ordinary amounts is not objectionable in iron and steel, as the influence it exerts is of the same nature as that of carbon, but

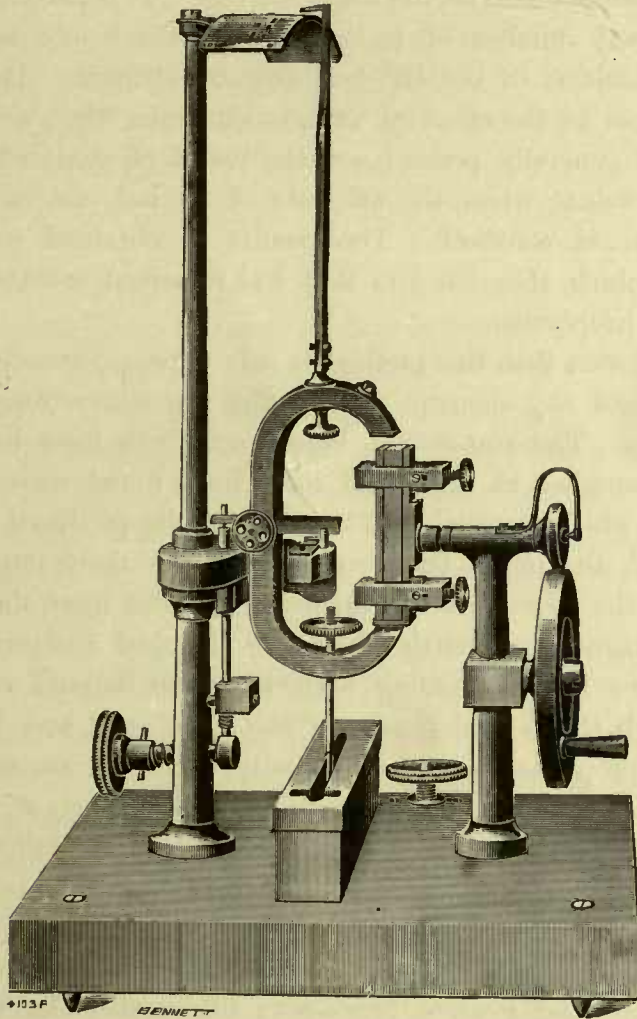

FIG. 7.

greatly less in degree. Some elements modify the influence of others, while some, although themselves objectionable, act as an antidote for more harmful impurities : as for instance, in cast iron, silicon tends to off-set the injurious influence of sulphur. The relative amounts and the

¹ *Electrician*, April 26th, 1895.

sum of the various elements vary slightly, according to the slight variations in the process of manufacture. On account of the more or less unequal diffusion of the elements, a single analysis may not indicate the average quality, and may not, in extreme cases, fairly represent the quality of the sample used in the magnetic test. It is necessary, therefore, to make a great number of tests and analyses before arriving at an approximate result as to the effect of any one element. The conclusions here set forth, as to the effect of various elements, when acting with the other elements generally present, are the result of studying the analyses and magnetic values when the amounts of all but one of the principal elements remained constant. The results so obtained were compared with tests in which the elements that had remained constant in the first test varied in proportion.

It will be seen that this method is only approximate, since variations of the amount of any element may modify the interactions between the other elements. The statements herein set forth have been compared with a great number of tests, and have been found correct within the limits between which materials can be economically produced in practice.

In general, the purer the iron or steel, the more important is the uniformity of the process and treatment, and the more difficult it is to predict the magnetic properties from the chemical analysis. It is significant to note that, beginning with the most impure cast iron, and passing through the several grades of cast iron, steel and wrought iron, the magnetic properties accord principally with the amounts of carbon present, and in a lesser degree with the proportions of silicon, phosphorus, sulphur, manganese, and other less usual ingredients, and that an excess of any one, or of the sum of all the ingredients, has a noticeable effect on the magnetic properties. Carbon, on account of the influence it exerts on the melting point, may be regarded as the controlling element, as it determines the general processes; hence also the percentage of other elements present in the purer grades of iron. However, its influence may sometimes be secondary to that of other impurities; as, for instance, in sheet iron, where a considerable percentage of carbon has been found to permit of extremely low initial hysteresis loss, and to exert an influence tending to maintain the loss at a low value during subjection to prolonged heating.

The properties of iron and steel require separate examination as to magnetic permeability and magnetic hysteresis. The permeability is of

the greatest importance in parts in which there is small change in the magnetisation; hence such parts may be of any desired dimension, and may then be either cast, rolled, or forged. On account of the electrical losses by local currents when the magnetism is reversed in solid masses of metals, parts subjected to varying magnetic flux have to be finely laminated. Thicknesses of between .014 in. and .036 in. are generally found most useful for plates, which must be of good iron to withstand the rolling process. Some impurities affect the hysteresis more than the permeability. Hysteresis tends towards a minimum, and the permeability towards a maximum, as the percentage of elements, other than iron, diminishes.

In the case of comparatively pure iron or steel, alloyed with nickel, it is found, however, that the permeability is increased beyond that which would be inferred from the other elements present. The purest iron has been found to have the highest permeability, yet the iron in which the hysteresis loss has been found smallest is not remarkable for its purity, and there was no known cause why the hysteresis was reduced to such a noticeable extent. The treatment of the iron, both during and subsequent to its manufacture, exerts a great influence upon the final result.

THE MAGNETISATION OF IRON AND STEEL.

Cast Iron.—Cast iron is used for magnetic purposes on account of the greater facility with which it may be made into castings of complex form. Considering the relative costs and magnetic properties of cast iron and steel, as shown in the accompanying curves, it is evident that cast iron is, other things being equal, more costly for a given magnetic result than cast steel. The great progress in the manufacture of steel castings has rendered the use of cast iron exceptional in the construction of well-designed electrical machines.

The cast iron used for magnetic purposes contains, to some extent, all those elements which crude iron brings with it from the ore and from the fluxes and fuels used in its reduction. Of these elements, carbon has the greatest effect on the magnetic permeability. The amount of carbon present is necessarily high, on account of the materials used, the process employed, and its influence in determining the melting point. In cast iron of good magnetic quality, the amount of carbon varies between 3 per cent. and 4.5 per cent.; between 0.2 per cent., and 0.8 per cent. being in a com-

bined state,¹ and the remainder in an uncombined or graphitic state. Combined carbon is the most objectionable ingredient, and should be restricted to as small an amount as possible. Cast irons having less than 0.3 per cent. of combined carbon are generally found to be of high magnetic permeability. Fig. 8 shows curves and analyses of three different grades of cast iron. The effect of different proportions of combined carbon may be ascertained by comparison of the results with the accompanying analyses. In Fig. 9 is given the result of the test of a sample carried up to very high saturation. It is useful for obtaining values corresponding to high magnetisation, but as shown by the analysis and also by the curve, it is a sample of rather poor cast iron, the result being especially bad at low magnetisation values. The cast iron generally used for magnetic purposes would be between curves B and C of Fig. 8.

Graphite may vary between 2 per cent. and 3 per cent. without exerting any very marked effect upon the permeability of cast iron. It is generally found that when the percentage of graphite approximates to the lower limit, there is an increase in the amount of combined carbon and a corresponding decrease of permeability. A certain percentage of carbon is necessary, and it is desirable that as much of it as possible should be in the graphitic state. Sulphur is generally present, but only to a limited extent. An excess of sulphur is an indication of excessive combined carbon, and inferior magnetic quality. Silicon in excess annuls the influence of sulphur, and does not seem to be objectionable until its amount is greater than 2 per cent., its effect being to make a casting homogeneous, and to lessen the amount of combined carbon. The amount of silicon generally varies between 2.5 per cent. in small castings, and 1.8 in large castings. Phosphorus in excess denotes an inferior magnetic quality of iron. Although in itself it may be harmless, an excess of phosphorus is accompanied by an excess of combined carbon, and it should be restricted to 0.7 per cent. or 0.8 per cent. Manganese, in the proportions generally found, has but little effect; its influence becomes more marked in irons that are low in carbon.

Figs. 10 and 11 show further data relating to irons shown in Fig. 8, grades A and C respectively.

Malleable Cast Iron.—When cast iron is decarbonised, as in the process for making it malleable, in which a portion of the graphite is

¹ Arnold, "Influence of Carbon on Iron," *Proc. Inst. C.E.*, vol. cxxiii., page 156.

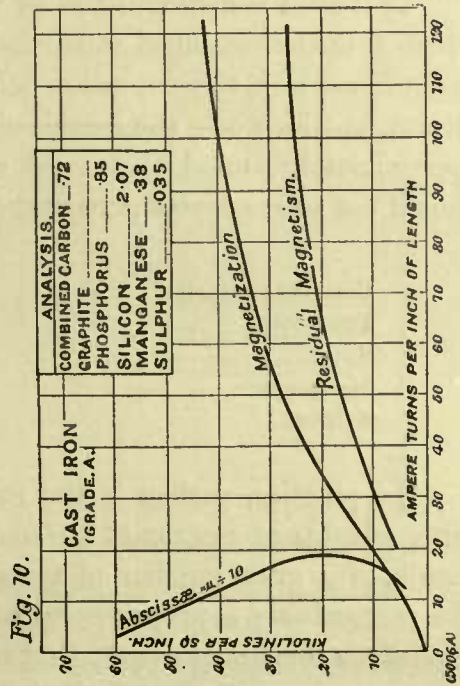
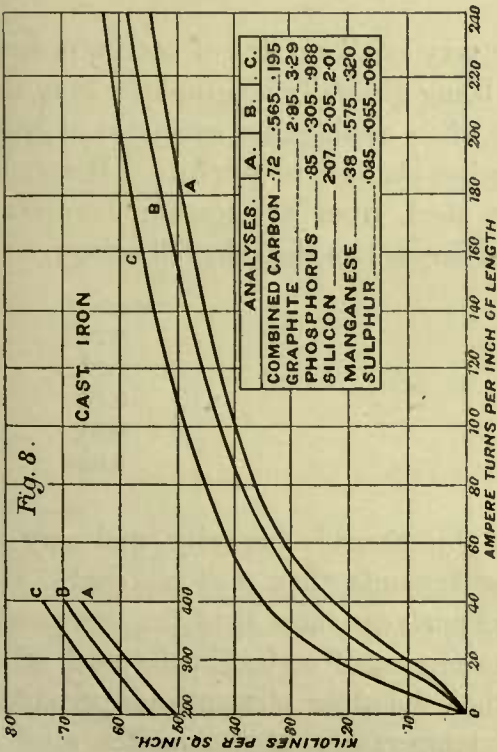
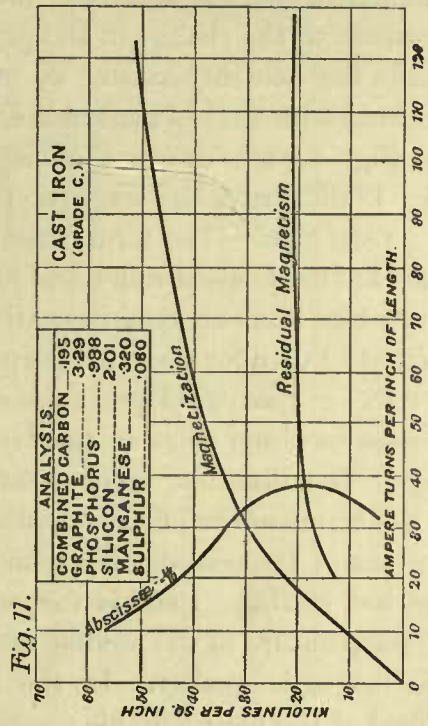
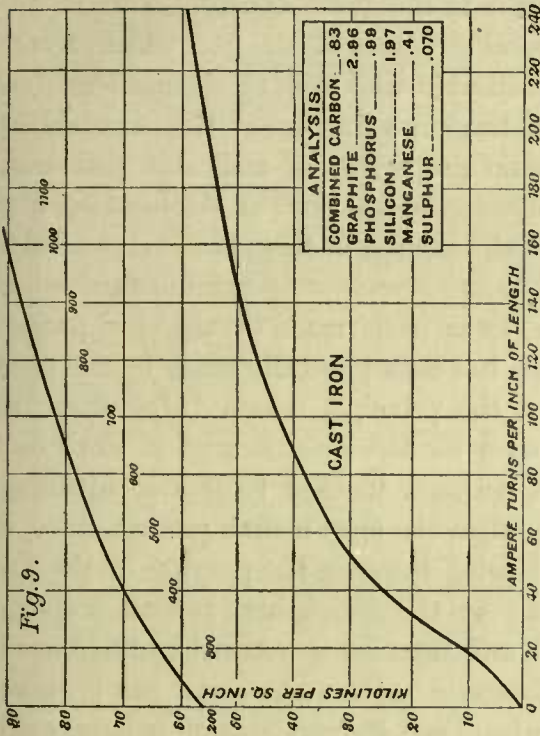

eliminated, there is a marked increase in the permeability. This is due, however, to the change in the physical structure of the iron which accompanies the decarbonisation, as unmalleable cast iron, of chemical analysis identical with that of malleable iron, has but a fraction of the permeability. In Fig. 12 are shown the magnetic properties of malleable cast iron; Fig. 13 illustrates the magnetic properties of mixtures of steel and pig iron.

Cast Steel.—The term “cast steel,” as used in this place, is intended to refer to recarbonised irons, and not to the processes of manufacture where there has been no recarbonisation, as in irons made by the steel process. Cast steel used for magnetic purposes has been generally made by the open-hearth or Siemens-Martin process, the principal reason being that this process has been more frequently used for the manufacture of small castings. The Bessemer process could, perhaps, be used to greater advantage in the manufacture of small castings than the open-hearth process, since, on account of the considerable time elapsing between the pouring of the first and last castings, there is frequently by the open-hearth process a change of temperature in the molten steel, and likewise a noticeable difference in the magnetic quality. In the Bessemer process the metal can be maintained at the most suitable temperature, and the composition is more easily regulated.

Cast steel is distinguished by the very small amount of carbon present which is in the combined state, there being generally no graphite, as in the case of cast iron, the exception being when castings are subjected to great strains, in which case the combined carbon changes to graphite. It may be approximately stated that good cast steel, from a magnetic standpoint, should not have greater percentages of impurities than the following :

								Per Cent.
Combined carbon	0.25
Phosphorus	0.08
Silicon	0.20
Manganese	0.50
Sulphur	0.05

In practice, carbon is the most objectionable impurity, and may be with advantage restricted to smaller amounts than 0.25 per cent. The results of a great number of tests and analyses show that the decrease in the permeability is proportioned to the amount of carbon in the steel, other conditions remaining equal; that is, that the other elements are present in the same proportion, and that the temperature of the molten steel is

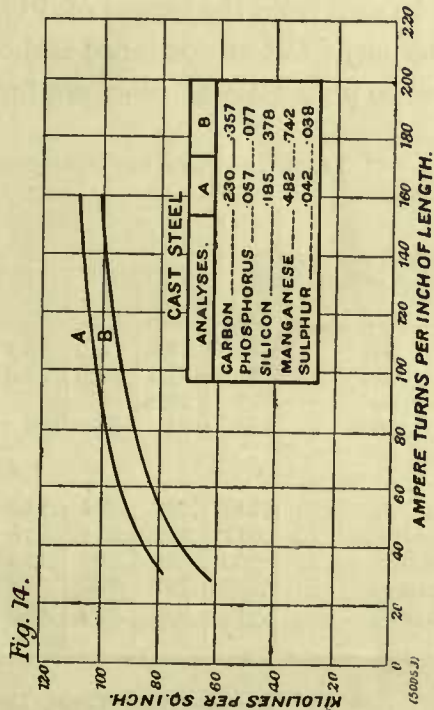
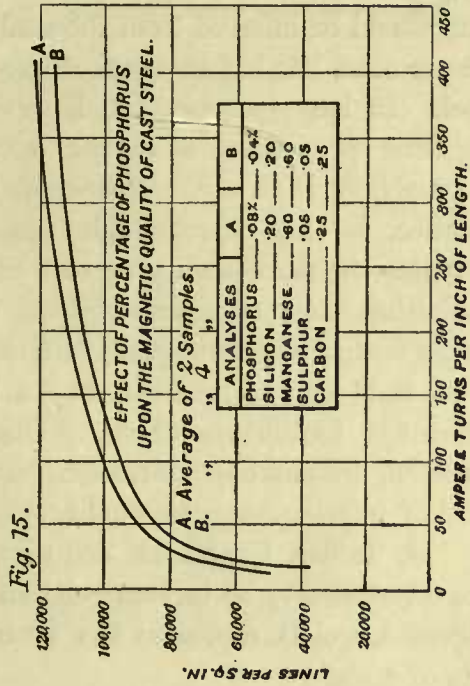
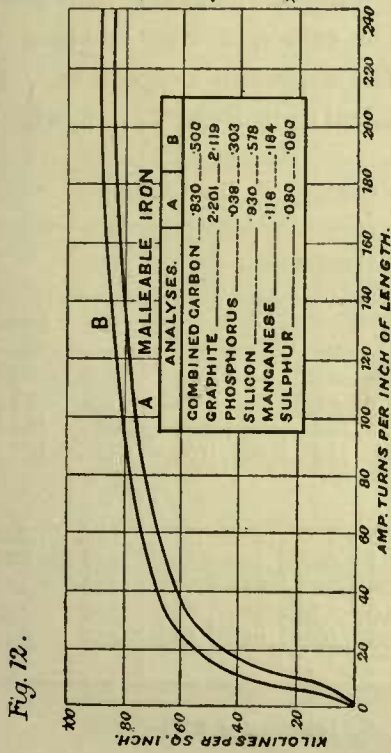
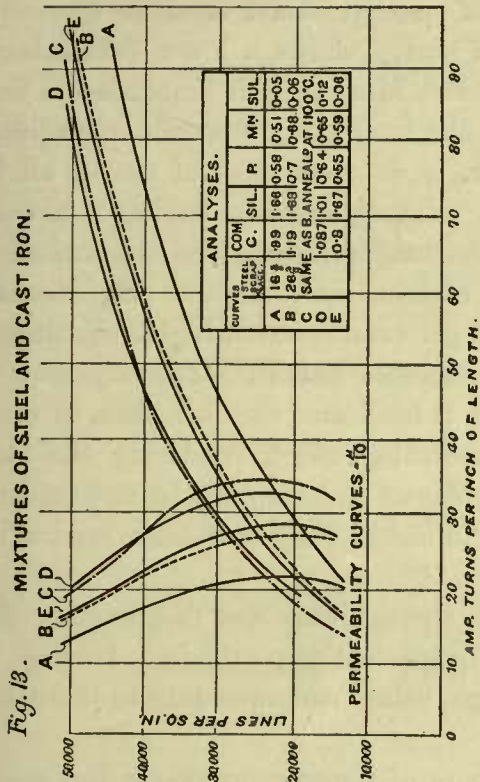

increased according to the degree of purity. Cast steel at too low a temperature considering the state of purity, shows a lower permeability than would be inferred from the analysis. Manganese in amounts less than 0.5 per cent. has but little effect upon the magnetic properties of ordinary steel. In large proportions, however, it deprives steel of nearly all its magnetic properties, a 12 per cent. mixture scarcely having a greater permeability than air. Silicon, at the magnetic densities economical in practice, is less objectionable than carbon, and at low magnetisation increases the permeability up to 4 or 5 per cent. ;¹ but at higher densities it diminishes the permeability to a noticeable extent. The objection to silicon is that when unequally diffused it facilitates the formation of blow-holes and, like manganese, has a hardening effect, rendering the steel difficult to tool in machining. Phosphorus and sulphur, in the amounts specified, are not objectionable ; but in excess they generally render the steel of inferior magnetic quality.

In Tables I. and II. are given the analyses and magnetic properties of what may be termed good and poor steel respectively. In Fig. 14, curves A and B represent the average values corresponding to these two sets of tests.

The extent to which the percentage of phosphorus affects the result, may be seen from the curves of Fig. 15. The curves of Fig. 16 show the deleterious effect of combined carbon upon the magnetic properties. The magnetic properties of steel are further illustrated in Figs. 17, 18, and 19.

TABLE I.—DATA OF TEN FIRST QUALITY SAMPLES OF CAST STEEL.

Ampere-Turns per Inch of Length.	Kilolines per Square Inch.										Average.
	1.	2.	3.	4.	5.	6.	7.	8.	9.	10.	
30	78.6	77.5	78.0	83.2	84.0	79.4	84.5	78.0	81.4	84.0	80.9
50	91.0	87.7	89.6	93.0	94.2	89.6	93.5	88.5	91.5	93.5	91.2
100	102	98.6	100	102	107	100	104	99.4	102	103	101.8
150	107	104	107	106	113	106	110	105	108	107	107.3
<i>Analysis.</i>											
Carbon240	.267	.294	.180	.290	.250	.200	.230	.170	.180	.230
Phosphorus071	.052	.074	.047	.037	.093	.047	.100	.089	.047	.057
Silicon200	.236	.202	.120	.036	.230	.173	.160	.150	.120	.195
Manganese480	.707	.655	.323	.550	.410	.530	.450	.390	.323	.482
Sulphur040	.060	.050	.050	.050	.030	.030	.040	.020	.050	.042

¹ See *Electrical World*, December 10th, 1898, page 619.

Fig. 17.

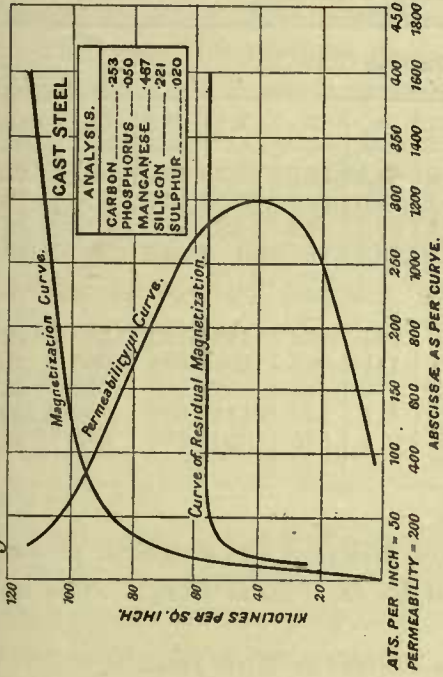

Fig. 19.

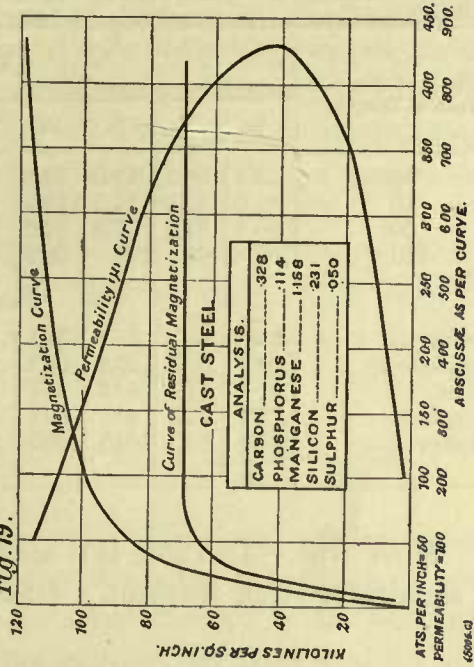

Fig. 16.

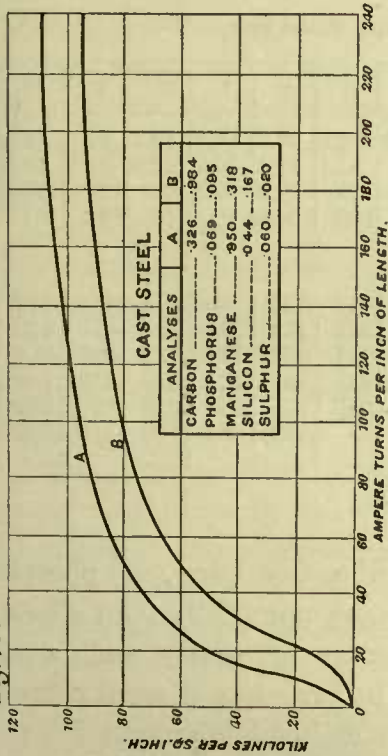
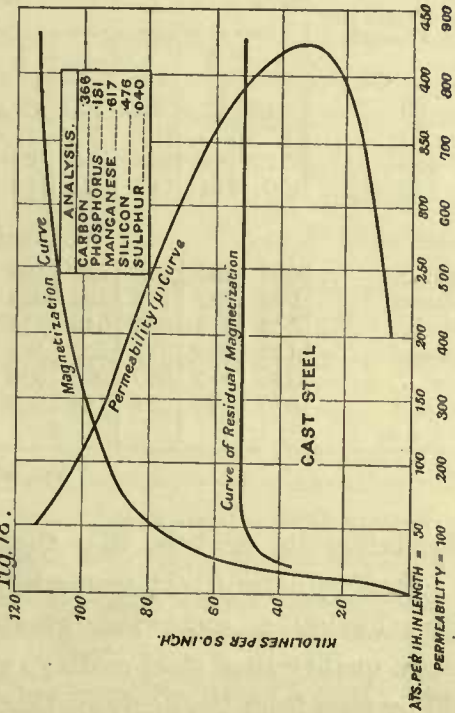

Fig. 18.



65964-d

TABLE II.—DATA OF TEN SECOND QUALITY SAMPLES OF CAST STEEL.

Ampere-Turns per Inch of Length.	Kilolines per Square Inch.										Average.
	1.	2.	3.	4.	5.	6.	7.	8.	9.	10.	
30	68.3	68.3	69.0	58.0	60.0	64.5	67.0	64.5	60.0	73.0	65.3
50	82.0	82.0	84.5	72.2	74.8	78.0	80.5	80.0	76.0	87.0	79.7
100	96.0	94.1	97.5	87.0	89.6	92.2	92.9	94.8	91.0	101	93.6
150	102	100	102	92.8	96.0	98.7	98.7	101	96.5	106	99.4
<i>Analysis.</i>											
Carbon250	.280	.195	.333	.337	.366	.409	.318	.702	.380	.357
Phosphorus087	.076	.028	.059	.045	.151	.063	.107	.084	.066	.077
Silicon210	.210	.683	.292	.302	.476	.444	.203	.409	.550	.378
Manganese790	.720	.815	.681	.642	.617	.640	1.636	.088	.790	.742
Sulphur...	.020	.030	.040	.060	.070	.010	.010	.030	.050	.030	.038

Mitis Iron.—In Table III. are given analyses and magnetic properties of aluminium steel, frequently referred to as “mitis iron.” The action

TABLE III.—DATA OF TWELVE SAMPLES OF MITIS IRON.

Ampere-Turns per Inch of Length.	Kilolines per Square Inch.											Average.	
	1.	2.	3.	4.	5.	6.	7.	8.	9.	10.	11.		12.
30	81.3	93.5	93.5	82.0	89.6	91.5	90.3	69.6	64.5	83.1	82.0	76.0	83.1
50	87.6	100	101	93.5	96.8	101	98.6	81.6	76.7	92.2	92.2	86.5	92.3
100	95.5	109	108	104	105	108	106	92.0	89.5	102	103	96.5	101.5
150	100	114	113	109	110	112	110	98.0	95.5	108	108	101	106.5
<i>Analysis.</i>													
Carbon065	.105	.106	.125	.136	.212	.214	.216	.235	.241	.242	.260	.180
Phosphorus083	.093	.112	.166	.053	.056	.052	.128	.065	.093	.094	.120	.093
Silicon073	.045	.050	.046	.111	.126	.111	.083	.122	.072	.099	.020	.080
Manganese112	.108	.099	.120	.191	.405	.401	.167	.107	.248	.253	.140	.196
Sulphur150	.050	.050	.050	.030	.040	.040	.010	.030	.030	.030	.030	.045
Aluminium079	*	.059	.183	.008	.273	*	.152	.055	.120	.119	.080	.113

* Not determined.

of aluminium in steel is, like that of silicon, sulphur, or phosphorus, of a softening nature. It seems to act more powerfully than silicon, the castings having a somewhat greater degree of purity and a higher magnetic quality than steel castings made by processes of equal refinement. It will be seen from the analyses that the aluminium is present in amounts ranging from 0.05 per cent. to 0.2 per cent., and that this permits of making

good castings with about one-half as much silicon and manganese as in ordinary cast steel. The amount of carbon, also, is generally somewhat less. An inspection of these tests and analyses of mites iron shows that they do not furnish a clear indication as to the effect of the various impurities. It will be noticed, however, that in those of poor magnetic qualities there is generally an excess of impurities, this excess denoting a lack of homogeneity and a greater degree of hardness than in those of good quality.

Mites iron is, magnetically, a little better than ordinary steel up to a density of 100 kilolines, but at high densities it is somewhat inferior. The magnetic result obtained from mites iron up to a density of 100 kilolines is practically identical with that obtained from wrought-iron forgings.

A curve representing the average of the twelve samples of Table III., is given in Fig. 20.

Nickel Steel.—Some of the alloys of steel with nickel possess remarkable magnetic properties.¹ A 5 per cent. mixture of nickel with steel, shows a greater permeability than can be accounted for by the analysis of the properties of the components. The magnetic properties of nickel alloys are shown in Fig. 21.²

Forgings.—Forgings of wrought iron are, in practice, found to be of uniform quality and of high magnetic permeability. In curves A and B of Fig. 22 are shown the magnetic properties of wrought iron, nearly pure, and as generally obtained, respectively. The former is made by the steel process at the Elswick Works of Messrs. Sir W. G. Armstrong and Co., Limited, but owing to its excessively high melting point, it is only manufactured for exceptional purposes. Curve D illustrates an inferior grade of wrought iron, its low permeability being attributable to the excess of phosphorus and sulphur. Curve C shows the properties of a forging of Swedish iron, in the analysis of which it is somewhat remarkable to find a small percentage of graphite.

For the wrought-iron forgings and for the sheet iron and sheet steel generally used, curve B should preferably be taken as a basis for calculations, although the composition of the sheets will not be that given

¹ For information as to the remarkable conditions controlling the magnetic properties of the alloys of nickel and iron, see Dr. J. Hopkinson, *Proc. Royal Soc.*, vol. xlvii., page 23; and vol. xlviii., page 1.

² Various investigations have shown that the permeability of steel is greatly lessened by the presence of chromium and tungsten.

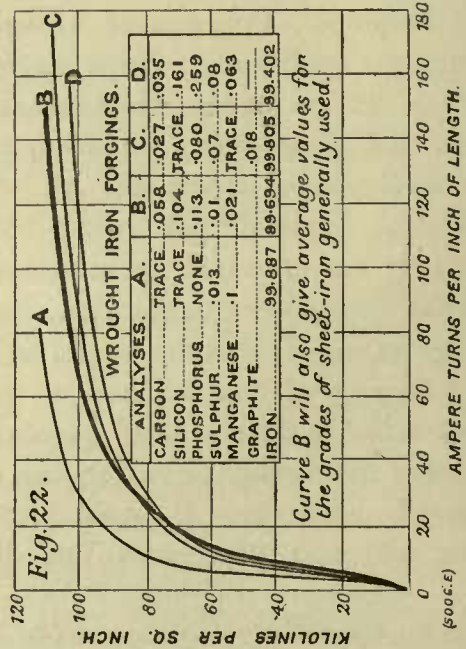
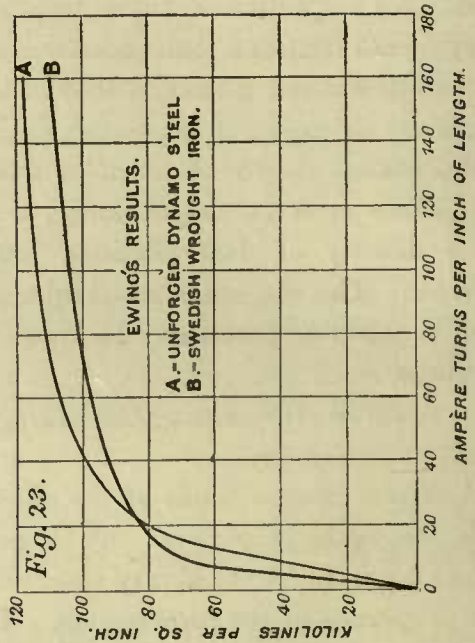
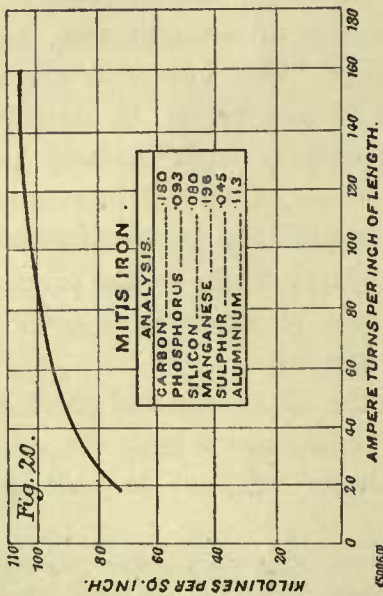
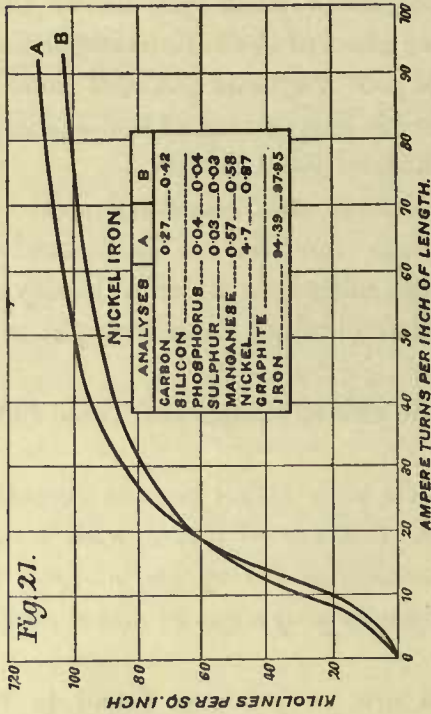

by the analysis. The composition of some samples of sheet iron and sheet steel, the results of tests of which are set forth on pages 30 to 32, is given in Table IV. Such material however is subject to large variations in magnetic properties, due much more to treatment than to composition.

TABLE IV.—ANALYSIS OF SAMPLES.

Brand.	Silicon.	Phosphorus.	Manganese.	Sulphur.	Carbon.
I.	.019	Not determined	.490	Not determined	.120
II.	.007	Not determined	.420	Not determined	.062
III.	.009	.083	.510	.026	.056
IV.	.003	Not determined	.570	Not determined	.044
V.	trace	.029	.020	trace	.050
VI.	.005	.059	.500	.048	.040
VII.					
VIII.	.003	.018	.490	.014	.052
IX.					
X.					

In comparing wrought-iron forgings with unforged steel castings, Professor Ewing notes¹ that the former excel in permeability at low densities, and the latter at high densities. This he illustrates by the curves reproduced in Fig. 23, in which are given results for Swedish wrought iron and for a favourable example of unforged dynamo steel by an English maker. He states that annealed Lowmoor iron would almost coincide with the curves for Swedish iron.

Professor Ewing further states that there is little to choose between the best specimens of unforged steel castings and the best specimens of forged ingot metal. The five curves of Fig. 24 relate to results of his own tests, regarding samples of commercial iron and steel. Of these curves, A refers to a sample of Lowmoor bar, forged into a ring, annealed and turned; B to a steel forging furnished by Mr. R. Jenkins as a sample of forged ingot metal for dynamo magnets; C to an unforged steel casting for dynamo magnets made by Messrs. Edgar Allen and Co. by a special pneumatic process; D to an unforged steel casting for dynamo magnets made by Messrs. Samuel Osborne and Co. by the Siemens process; E to an unforged steel casting for dynamo magnets made by Messrs. Friedrich Krupp, of Essen.²

¹ *Proc. Inst. Civil Engineers*, May 19th, 1896.

² *Proc. Inst. of Civil Engineers*, May 19th, 1896.

ENERGY LOSSES IN SHEET IRON.

The energy loss in sheet iron in an alternating or rotating magnetic field consists of two distinct quantities, the first being that by hysteresis or inter-molecular magnetic friction, and the second that by eddy currents. The loss by hysteresis is proportional to the frequency of the reversal of the magnetism, but is entirely independent of the thickness of the iron, and increases with the magnetisation. There is no exact law of the increase of the hysteresis with the magnetisation, but within the limits of magnetisation obtaining in practice, and those in which such material can be produced to give uniform results, the energy loss by hysteresis may be taken

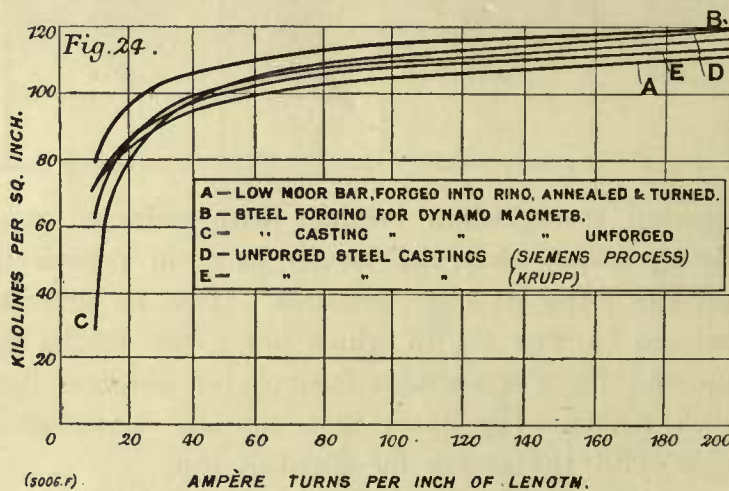

to increase approximately with the 1.6 power of the magnetisation, as was first pointed out by Mr. C. P. Steinmetz.¹

Professor Ewing and Miss Klaassen,² however, from a large number of tests, found the 1.48 power to be better representative at the densities generally met in transformers. Other extensive tests point to the 1.5 power as the average.³

The hysteresis loss is independent of the temperature at ordinary working temperatures, but from 200 deg. Cent. upward the loss decreases as the temperature increases, until at 700 deg. Cent. it has fallen to as low as from 10 per cent. to 20 per cent. of its initial value. Obviously this

¹ *Elec. Eng.*, New York, vol. x., page 677.

² *Electrician*, April 13th, 1894.

³ *Elec. World*, June 15th, 1895.

decrease at very high temperatures is of no commercial importance at the present time.¹

The magnitude of the hysteresis loss is somewhat dependent upon the chemical composition of the iron, but to a far greater degree upon the physical processes to which the iron is subjected.

Annealing of Sheet Iron.—The temperature at which sheet iron is annealed has a preponderating influence upon the nature of the results obtained. Extended experiments concerning the relation of hysteresis loss to temperature of annealing, show that the higher the temperature the lower the hysteresis loss up to about 950 deg. Cent.² Beyond this temperature deleterious actions take place; the surfaces of the sheets become scaled, and the sheets stick together badly. A slight sticking together is desirable, as it insures the iron having been brought to the desired high temperature, and the sheets are easily separated; but soon after passing this temperature (950 deg. Cent.), the danger of injuring the iron becomes great.

Curves A and B of Fig. 25 show the improvement effected in two different grades of iron, by annealing from high temperatures.³

Deterioration of Sheet Iron.—It has been found that the hysteresis loss in iron increases by continued heating.⁴ No satisfactory explanation of the cause of this deterioration has yet been given. Its amount depends upon the composition of the iron, and upon the temperature from which it has been annealed. The best grades of charcoal iron, giving an exceedingly low initial loss, are particularly subject to deterioration through so-

¹ *Tech. Quarterly*, July, 1895; also *Elek. Zeit.*, April 5th, 1894; also *Phil. Mag.*, September, 1897; also in a very complete and valuable paper by D. K. Morris, Ph.D., "On the Magnetic Properties and Electrical Resistance of Iron as dependent upon Temperature," read before the Physical Society, on May 14th, 1897, are described a series of tests of hysteresis, permeability, and resistance, over a wide range of temperatures.

² This temperature depends somewhat upon the composition of the iron, being higher the more pure the iron.

³ In this and much of the following work on hysteresis and on the properties of insulating materials, the authors are indebted to Mr. Jesse Coates, of Lynn, Mass., and to Messrs. R. C. Clinker and C. C. Wharton, of London, for valuable assistance in the carrying out of tests.

⁴ "On Slow Changes in the Magnetic Permeability of Iron," by William M. Mordey, *Proceedings of the Royal Society*, January 17th, 1895; also *Electrician*, December 7th, 1894, to January 11th, 1895. A recent very valuable contribution to this subject has been made by Mr. S. R. Roget, in a paper entitled "Effects of Prolonged Heating on the Magnetic Properties of Iron," read before the Royal Society, May 12th, 1898. It contains some very complete experimental data.

called "ageing." Iron annealed from a high temperature, although more subject to loss by "ageing," generally remains superior to the same grade of iron annealed from a lower temperature. This was the case in the tests corresponding to Figs. 26 and 27, but there are many exceptions.

Table V. shows the results of "ageing" tests at 60 deg. Cent. on several different brands of iron. It will be noticed that in the case of those brands subject to increase of hysteresis by "ageing," the percentage rise of the annealed sample is invariably greater than that of the

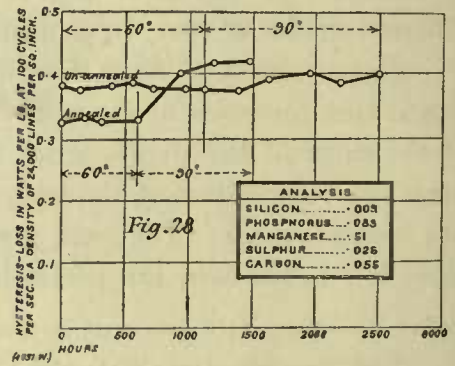
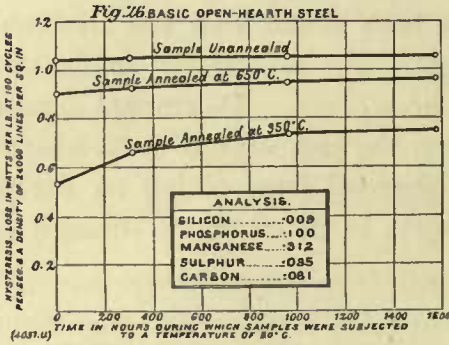
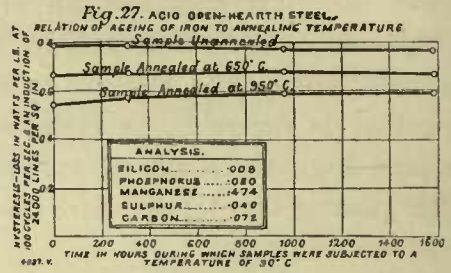
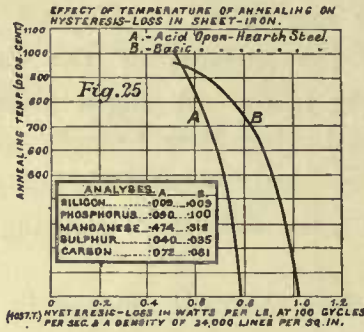

unannealed sample, and that often the annealed sample ultimately becomes worse than the unannealed samples.

Brands III., V., and VI., are the same irons whose "ageing" records are plotted in Figs. 28, 31, and 29 respectively.

From these investigations it appears that iron can be obtained which will not deteriorate at 60 deg. Cent., but that some irons deteriorate rapidly even at this temperature; and that at a temperature of 90 deg. Cent. even the more stable brands of iron deteriorate gradually. Consequently, so far as relates to avoidance of deterioration through "ageing," apparatus, even when constructed with selected irons, should not be allowed to reach a temperature much above 60 deg. Cent.

TABLE V.—RESULTS OF TESTS ON AGEING OF IRON.

(From Tests by R. C. Clinker, London, 1896-7.)

Temperature of ageing = 60 deg. Cent., except where otherwise stated.

The chemical analyses of these samples are given in Table IV., on page 27.

Brand of Iron.			Hysteresis Loss in Watts per pound at 100 Cycles per Second, and 24,000 Lines per Square Inch.					Increase in 1000 Hours. per cent.	
			Initial Loss.	After Ageing for					
				200 Hours.	400 Hours.	600 Hours.	800 Hours.		1000 Hours.
I.									
Unannealed	1.00	1.00	1.00	1.00	1.00	1.00	0
Annealed	0.41	0.43	0.43	0.43	0.43	0.43	5
II.									
Unannealed	0.46	0.46	0.46	0.46	0.46	0.46	0
Annealed	0.39	0.39	0.40	0.41	0.42	0.43	10
III.									
Unannealed	0.38	0.38	0.38	0.38	0.38	0.38	0
Annealed	0.33	0.33	0.33	0.33	0.37	0.39	18 ¹
IV.									
Unannealed	0.86	0.90	0.94	0.97	1.01	1.04	21
Annealed	0.42	0.50	0.58	0.66	0.74	0.83	98
V.									
Unannealed	0.35	0.40	0.43	0.45	0.47	0.49	40
Annealed	0.36	0.40	.45	0.50	0.53	0.55	53
VI.									
Unannealed	0.65	0.71	0.83	1.00	1.09	1.19	83
Annealed	0.39	0.41	0.49	0.62	0.78	0.90	130
VII.									
Unannealed	0.80	0.82	0.82	0.82	0.82	0.82	3
Annealed	0.43	0.44	0.45	0.45	0.45	0.45	6
VIII.									
Unannealed	0.36	0.36	0.36	0.36	0.37	0.37	3
Annealed	0.31	0.32	0.34	0.35	0.35	0.35	13
IX.									
			0.58	0.58	0.58	0.58	0.60	0.64	10 ²
X.									
			0.42	0.42	0.42	0.43	0.47	0.56	33 ³

¹ Temperature raised to 90 deg. after 600 hours.

² Temperature raised to 90 deg. after 650 hours.

³ Temperature raised to 90 deg. after 670 hours.

An examination of the results indicates that a rather impure iron gives the most stable result. It is believed that by annealing from a sufficiently high temperature, such impure iron may be made to have as low an initial hysteresis loss as can be obtained with the purest iron. The lower melting point of impure iron, however, imposes a limit; for such iron cannot, in order to anneal it, be brought to so high a temperature as pure iron,

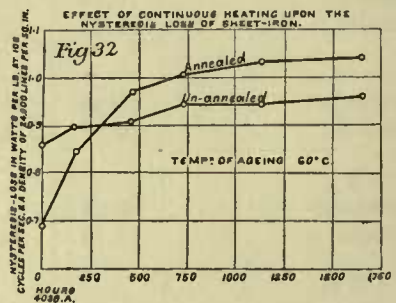
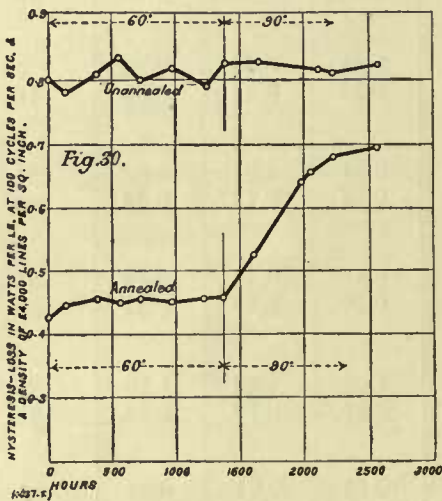
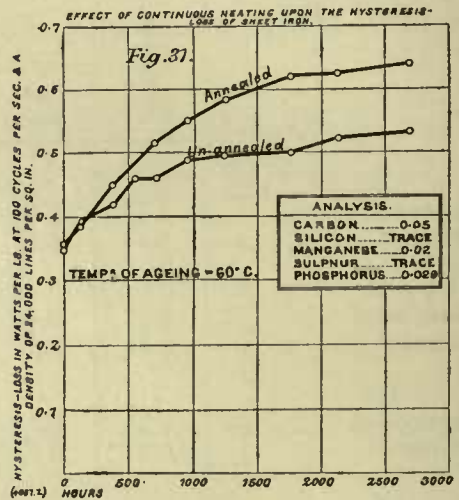
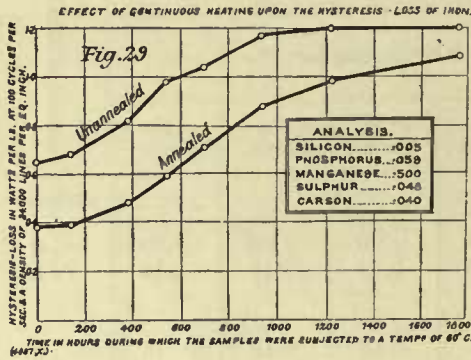

because the surface softens and the plates stick together at comparatively low temperatures.

The curves of Figs. 30, 31, and 32 represent the results of interesting "ageing" tests. In Fig. 30 the effect of a higher temperature upon the annealed sample is clearly shown.

Effect of Pressure.—Pressure and all mechanical strains are injurious even when of no great magnitude, as they decrease the permeability and increase the hysteretic loss. Even after release from pressure, the iron only partly regains its former good qualities. In the curves of Fig. 33 is shown

the effect of applying pressure to two different grades of iron, the measurements having been made after the removal of the pressure.

Another interesting case is that shown in the curves A, B, and C, of Fig. 34. These show the results of tests upon a certain sample of sheet iron, as it was received from the makers, after it had been annealed, and

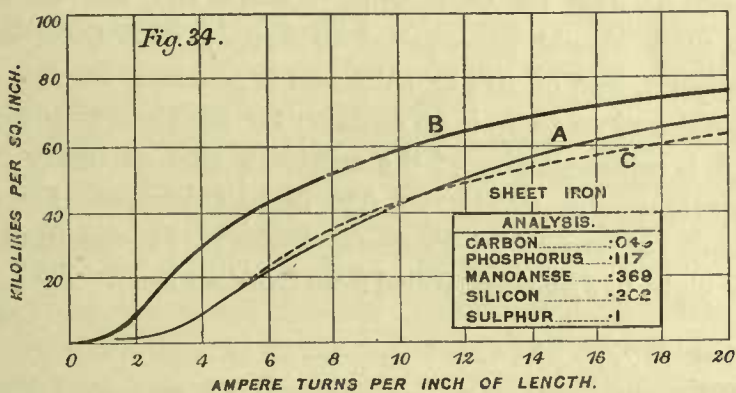
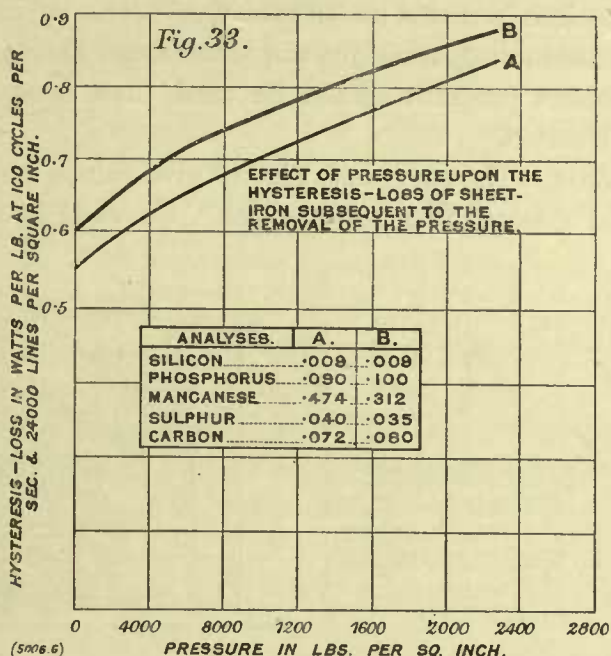

after being subjected to a pressure of 40,000 lb. per square inch, respectively. It will be seen that the annealing in this case materially increased the permeability, but that subjecting the sample to pressure diminished the permeability below its original value.

The value of the hysteresis losses while the iron is still under pressure is probably much greater. Mr. Mordey refers to a case in which a pressure

of 1,500 lb. per square inch was accompanied by an increase of 21 per cent. in the core loss. Upon removing the pressure, the core loss fell to its original value.¹ Re-annealing restores iron which has been injured by pressure, to its original condition.

This matter of injury by pressure, particularly so far as relates to the increase while the iron remains under pressure, is one of considerable importance, and in assembling armature and transformer sheets, no more temporary or permanent pressure should be used than is essential to good mechanical construction.

Hysteresis Loss.—The curves of Fig. 35 give values for the hysteresis losses that can be obtained in actual practice. Curve B is for sheet steel

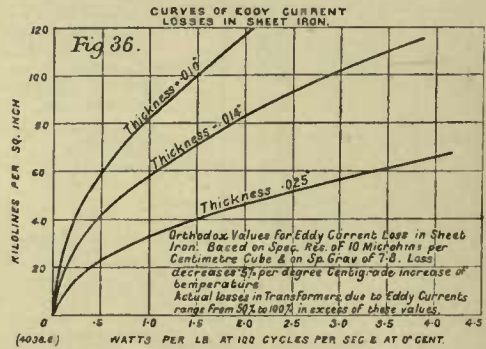
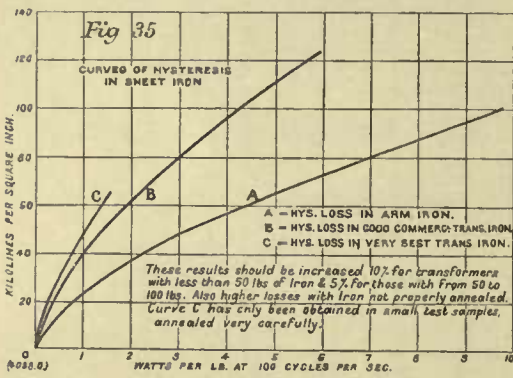

such as should be used for transformer construction, and all iron used in transformer work should be required to comply with these values. For transformer work, iron of .014 in. thickness is generally used.

For armature iron there is no occasion for such exacting requirements, and curve A is representative of the armature iron generally used. Iron for armatures is usually .025 in. to .036 in. in thickness. Curve C gives the best result yet secured by Professor Ewing. It was from a strip of transformer plate .013 in. thick, rolled from Swedish iron.² Its analysis was :

	Per Cent.
Carbon	.02
Silicon	.032
Manganese	trace only.
Phosphorus	.020
Sulphur	.003
Iron (by difference)	99.925

¹ "On Slow Changes in the Magnetic Permeability of Iron," by William M. Mordey, *Proceedings of the Royal Society*, January 17th, 1895.

² *Proceedings of the Institution of Civil Engineers*, May 19th, 1896.

This iron ages very rapidly. The iron of Fig. 28 is only 6 per cent. worse initially when annealed, and at 60 deg. Cent. it does not deteriorate. Its analysis has already been given.

EDDY CURRENT LOSSES.

In sheet iron the eddy current losses should theoretically conform to the formula :¹

$$W = 1.50 \times t^2 \times N^2 \times B^2 \times 10^{-10}$$

in which

W = watts per pound at 0 deg. Cent.

t = thickness in inches.

N = periodicity in cycles per second.

B = density in lines per square inch.

The loss decreases .5 per cent. per degree Centigrade increase of temperature. The formula holds for iron, whose specific resistance is 10 microhms per centimetre cube, at 0 deg. Cent., and which has a weight of .282 lb. per cubic inch. These are representative values for the grades used, except that in sheet steel the specific resistance is apt to be considerably higher.

Curves giving values for various thicknesses of iron are shown in Fig. 36.

Owing possibly to the uneven distribution of the flux, particularly at the joints, the observed eddy current losses are, in transformer iron, from 50 to 100 per cent. in excess of these values, even when the sheets are insulated with Japan varnish or otherwise.

Estimation of Armature Core Losses.—With regard to the use of curve A in the estimation of armature core losses, the values obtained from curve A may for practical purposes be considered to represent the hysteresis component of the total loss. To allow for other components of the total core loss, the values obtained from curve A should be multiplied by from 1.3 to 2.5, according to the likelihood of additional losses. Briefly, this large allowance for eddy current losses in armature iron is rendered necessary owing to the effect of machine work, such as turning down, filing, &c., these processes being destructive to the isolation of the plates from each other.

¹ For thicknesses greater than .025 in., magnetic screening greatly modifies the result. Regarding this, see Professor J. J. Thomson, London, *Electrician*, April 8th, 1892. Professor Ewing, London, *Electrician*, April 15th, 1892.

The curves in Fig. 36 are chiefly useful for transformer work, and are of little use in armature calculation, as they refer only to the eddy current losses due to eddy currents set up in the individual isolated sheets, and in armatures this often constitutes but a small part of the total loss.

The irons used for magnetic purposes have approximately the resistance and density constants given in Table VI.; in which are also given, for comparison, the corresponding values for very pure iron and for commercial copper :

TABLE VI.

—	Specific Resistance at 0 deg. Cent. Microhms per Centimetre Cube.	Increase in Resistance per deg. Cent.	Specific Gravity.	Pounds per Cubic Inch.
		per cent.		
Cast iron	100	.1	7.20	.260
Cast steel	20	.4	7.80	.282
Wrought iron and very mild steel	10	.5	7.80	.282
Nearly pure iron	9	.6	—	—
Commercial copper	1.6	.388	8.90	.322

Mr. W. H. Preece gives the Table, reproduced below, of values (Munroe and Jameson Pocket-book), which shows in a striking manner the dependence of the specific resistance of iron upon the chemical composition.

TABLE VII.—PREECE'S TESTS OF ANNEALED IRON WIRE.

Number of Sample	1.	2.	3.	4.	5.	6.	7.	8.
Carbon	0.09	0.10	0.15	0.10	0.10	0.15	0.44	0.62
Silicon	trace	trace	0.018	trace	0.09	0.018	0.028	0.06
Sulphur	„	0.022	0.019	0.035	0.03	0.092	0.126	0.074
Phosphorus	0.012	0.045	0.058	0.034	0.218	0.077	0.103	0.051
Manganese	0.06	0.03	0.234	0.324	0.234	0.72	1.296	1.584
Copper	trace	trace	trace	trace	0.015	trace	trace	trace
Iron	99.69	99.70	99.44	99.60	99.11	98.74	98.10	97.41
Ohm mile at 60 deg. Fahr. ...	4546	4502	4820	5308	5974	6163	7468	8033
Specific resistance (microhms per cubic centimetre at 0 deg. Cent.)	9.65	9.60	10.2	11.3	12.7	13.1	15.9	17.1
Specific resistance in microhms per cubic inch at 0 deg. Cent. ...	3.80	3.78	4.02	4.45	5.00	5.15	6.25	6.75
Resistance wire 1 ft. long and .001 in. in diameter at 0 deg. Cent.	57.9	57.5	61.2	67.7	76.2	78.5	95.5	103.0

No. 1. Swedish charcoal iron, very soft and pure.
 „ 2. „ „ good for P. O. specification.
 „ 3. „ „ not suited for P. O. specification.

No. 4. Swedish Siemens-Martin steel 0.10 carbon.
 „ 5. Best puddled iron.
 „ 6. Bessemer steel, special soft quality.
 „ 7. „ „ hard quality.
 „ 8. Best cast steel.

Although prepared in connection with telegraph and telephone work, it is of much significance to transformer builders, and points to the desirability of using as impure iron as can, by annealing, have its hysteresis loss reduced to a low value, since the higher specific resistance will proportionately decrease the eddy current loss. Such comparatively impure iron will also be nearly free from deterioration through prolonged heating. Of course its lower melting point renders it somewhat troublesome, owing to the plates tending to stick together when heated to a sufficiently high temperature to secure good results from annealing. Transformer builders in this country have generally used iron of some such quality as that of sample No. 1, and have been much troubled by "ageing." Most transformers in America have been built from material whose chemical composition is more like Samples 4, 5 and 6, and the transformers have been very free from "ageing." At least .4 per cent. of manganese should be present, owing to its property of raising the specific resistance.

Reference should here be made to a paper by M. H. Le Chatelier, read before l'Académie des Sciences, June 13th, 1898, in which is given very useful data regarding the influence of varying percentages of carbon, silicon, manganese, nickel, and other elements, upon the electrical resistance of steels. The results relating to the influence of varying percentages of carbon, silicon, and manganese are of especial importance, and are consequently reproduced in the following Tables :

TABLE VIII.—INFLUENCE OF CARBON.

Specific Resistance in Microhms per Centimetre Cube.	Composition.		
	C.	Mn.	Si.
10	0.06	0.13	0.05
12.5	0.20	0.15	0.08
14	0.49	0.24	0.05
16	0.84	0.24	0.13
18	1.21	0.21	0.11
18.4	1.40	0.14	0.09
19	1.61	0.13	0.08

TABLE IX.—INFLUENCE OF SILICON.

Resistance in Microhms per Centimetre Cube.	Composition.		
	C.	Mn.	Si.
12.5	0.2	...	0.1
38.5	0.2	...	2.6
15.8	0.8	...	0.1
26.5	0.8	...	0.7
33.5	0.8	...	1.3
17.8	1.0	...	0.1
25.5	1.0	...	0.6
32.0	1.0	...	1.1

TABLE X.—INFLUENCE OF MANGANESE.

Resistance in Microhms per Centimetre Cube.	Composition.		
	C.	Mn.	Si.
17.8	0.9 ...	0.24 ...	0.1
22	0.9 ...	0.95 ...	0.1
24.5	1.2 ...	0.83 ...	0.2
40	1.2 ...	1.8 ...	0.9
66 magnetic ...	} 1.	13.	0.3
80 non-magnetic ¹			

INSULATING MATERIALS.

The insulating materials used in dynamo construction vary greatly, according to the method of use and the conditions to be withstood. The insulation in one part of a dynamo may be subjected to high electrical pressures at moderate temperatures; in another part to high temperatures and moderate electrical pressures; in still another part to severe mechanical strains. No one material in any marked degree possesses all the qualities required.

Mica, either composite or solid, has been very largely used on account of its extremely high insulating qualities, its property of withstanding high temperatures without deterioration, and its freedom from the absorption of moisture. In the construction of commutators mica is invaluable. The use of mica, however, is restricted, on account of its lack of flexibility.

Moulded mica, *i.e.*, mica made of numerous small pieces cemented together, and formed while hot, has been used to insulate armature coils as well as commutators. Its use, however, has not been entirely satisfactory, on account of its brittleness.

Composite sheets of mica, alternating with sheets of paper specially prepared so as to be moisture proof, have been found highly suitable for the insulation of armature and field-magnet coils. The following Table shows roughly the electrical properties of composite sheets of white mica:—

TABLE XI.

Thickness.	Puncturing Voltage.	
0.005	3,600 to	5,860
0.007	7,800 „	10,800
0.009	8,800 „	11,400
0.011	11,600 „	14,600

¹ In another paper by the same author are set forth results showing the influence of tempering upon the electric resistance of steel. *Comptes Rendus de l'Academie des Sciences*, June 20th, 1898.

The other materials that have been found more or less satisfactory, according to method of preparation and use, are linen soaked with linseed oil and dried; shellaced linen, which is a better insulator than oiled linen, but liable to be irregular in quality and brittle; oiled bond-paper, which is fairly satisfactory when baked; "press board," which shows very good qualities, and has been used with satisfaction to insulate field-magnet coils.

Where linseed oil is to be employed, the material should be thoroughly dried before applying the oil.

Red and white vulcanised fibres are made by chemically treating paper fibre. They have been used as insulators with varying success, the main objection to them being their decidedly poor mechanical qualities, so far as warping and shrinking are concerned. This is due to their readiness to absorb moisture from the air. Baking improves the insulating qualities, but renders the substance brittle. Whenever it is necessary to use this material, it should be thoroughly painted to render it waterproof. The insulating quality varies according to the thickness, but good vulcanised fibre should withstand 10,000 volts in thicknesses varying from $\frac{1}{8}$ in. to 1 in., this puncturing voltage not increasing with the thickness, owing to the increased difficulty of thoroughly drying the inner part of the thick sheets.

Sheet leatheroid possesses substantially the same qualities, and is made according to the same processes as vulcanised fibre. A thickness in this material of $\frac{1}{64}$ in. should safely withstand 5,000 volts, and should have a tensile strength of 5,000 lb. per square inch.

TABLE XII.—TESTS ON SHEETS OF LEATHEROID.

Thickness.	Insulation Strength.	
	Total Volts.	Volts per Mil.
in.		
$\frac{1}{64}$	5,000	320
$\frac{1}{32}$	8,000	256
$\frac{3}{64}$	12,000	256
$\frac{1}{16}$	15,000	240
$\frac{1}{8}$	15,000	120
$\frac{3}{16}$	6,000	32
$\frac{1}{4}$	6,000	24

With such materials as vulcanised fibre and sheet leatheroid, increase in thickness is not necessarily accompanied by increased

insulation resistance, owing to the difficulty of obtaining uniformity throughout the thickness of the sheet. This is well shown in the tests of leatheroid sheets of various thicknesses, given in the preceding Table.

Hard rubber in various forms is sometimes useful, owing to its high insulating qualities. Its use is restricted, however, from the fact that at 70 deg. Cent. it becomes quite flexible, and at 80 deg. Cent. it softens.

Hard rubber should stand 500 volts per mil. thickness. Sheets and bars of hard rubber should stand bending to a radius of 50 times their thickness, and tubes to a radius of 25 diameters.

Slate is used for the insulation of the terminals of dynamos, &c. Ordinarily good slate will, when baked, withstand about 5000 volts per inch in thickness.

The chief objection to slate is its hygroscopic quality, and it requires to be kept thoroughly dry; otherwise, even at very moderate voltages, considerable leakage will take place. Where practicable, it is desirable to boil it in paraffin until it is thoroughly impregnated.

Slate is, moreover, often permeated with metallic veins, and in such cases is quite useless as an insulator. Even in such cases its mechanical and fireproof properties make it useful for switchboard and terminal-board work, when re-enforced by ebonite bushings.

Marble has the same faults as slate, though to a less extent.

Kiln-dried maple and other woods are frequently used, and will stand from 10,000 to 20,000 volts per inch in thickness.

The varnishes used for electrical purposes should, in addition to other insulating qualities, withstand baking and not be subject to the action of oils. Of the varnishes commonly used, shellac is one of the most useful. There are a number of varnishes on the market, such as Insullac, P and B paint, Sterling Varnish, Armalac, &c.

One of the special insulating materials readily obtainable that has been found to be of considerable value is that known as "vulcabeston," which will withstand as high as 315 deg. Cent. with apparently no deterioration. This material is a compound of asbestos and rubber, the greater proportion being asbestos. Vulcabeston, ordinarily good, will withstand 10,000 volts per $\frac{1}{2}$ in. of thickness.

As results of tests, the following approximate values may be taken:—

Red press-board, .03 in. thick, should stand 10,000 volts. It should

bend to a radius of five times its thickness, and should have a tensile strength along the grain of 6000 lb. per square inch.

Red rope paper, .01 in. thick, having a tensile strength along the grain of 50 lb. per inch of width, should stand 1000 volts.

Manilla paper, .003 in. thick, and having a tensile strength along the grain of 200 lb. per inch of width, should stand 400 volts.

TESTS ON OILED FABRICS.

Oiled cambric	.007 in. thick	stood from	2500 to	4500 volts.
„ cotton	.003	„	„	6300 „ 7000 „
„ paper	.004	„	„	3400 „ 4800 „
„	„	.010	„	5000 volts.

A number of composite insulations are in use, consisting generally of split mica strips pasted with shellac on to sheets of some other material. The principal ones are:—

1. Insulation consisting of two sheets of .005 in. thick red paper, with one thickness of mica between them, the whole being shellaced together into a compound insulation .015 in. thick. This stands on the average 3,400 volts.

2. Combined mica and bond-paper of a thickness of .009 in. had a breaking strength of from 2,000 to 3,000 volts.

3. Composition of mica and canvas. Mica strips are pasted together with shellac on to a sheet of canvas, and covered with another sheet of canvas shellaced on. The mica pieces are split to be of approximately the same thickness—about .002 in.—and lapped over each other for half their width, and about $\frac{1}{8}$ in. beyond, so as to insure a double thickness of mica at every point. Each row of strips is lapped over the preceding row about $\frac{1}{2}$ in.

The sheets thus prepared are hung up and baked for 24 hours before use. The total thickness should be taken at about .048 in., using canvas .013 in. This will stand about 3,000 R.M.S. volts.

4. Composition of mica and longcloth, made up with shellac in the same manner as preceding material.

5. White cartridge paper shellaced on both sides, and baked for 12 hours at 60 deg. Cent. The total thickness is .012 in., and it will stand about 1,500 volts per layer.

It will doubtless have been observed that the quantitative results quoted for various materials are not at all consistent. This is probably in

part due to the different conditions of test, such as whether tested by continuous or alternating current; and if by alternating current the form factor and periodicity would effect the results, and it should have been stated whether maximum or effective (R.M.S.) voltage was referred to. Continuous application of the voltage will, furthermore, often effect a breakdown in samples which resist the strain for a short interval. It is also of especial importance that the material should have been thoroughly dried prior to testing; though on the other hand, if this is accomplished by baking, as would generally be the case, the temperature to which it is subjected may permanently affect the material. It thus appears that to be thoroughly valuable, every detail regarding the accompanying conditions and the method of test should be stated in connection with the results.

The importance of these points has only gradually come to be appreciated, and the preceding results are given for what they are worth. It is true that some tests have been made which are more useful and instructive, and various materials are being investigated exhaustively as rapidly as practicable. Such tests are necessarily elaborate and expensive and tedious to carry out, but it is believed that no simple method will give a good working knowledge of the insulating properties of the material.

TABLE XIII.—SUMMARY OF QUALITY OF INSULATING MATERIALS.

	Electrical.	Thermal.	Mechanical.	Hygroscopic.
Mica	Excellent	Excellent	Poor	Excellent
Hard rubber	"	Poor	Good	Fair
Slate	Very poor	Good	"	Poor
Marble	Good	"	"	"
Vulcabeston	Fair	Excellent	"	Good
Asbestos	Good	"	Poor	"
Vulcanised fibre	"	Good	"	Poor
Oiled linen	Excellent	Fair	Fair	Fair
Shellaced linen	Good	"	Poor	Poor

EFFECT OF TEMPERATURE UPON INSULATION RESISTANCE.

The resistance of insulating materials decreases very rapidly as the temperature increases, except in so far as the high temperature acts to expel moisture. Governed by these considerations, it appears that the apparatus should, so far as relates to its insulation, be run at a sufficiently high temperature to thoroughly free its insulation from moisture. The

great extent of these changes in insulation resistance is very well shown in the accompanying curve (Fig. 37) taken from an investigation by Messrs. Sever, Monell and Perry.¹ It shows for the case of a sample of plain cotton duck, the improvement in insulation due to the expulsion of moisture on increasing the temperature, and also the subsequent deterioration of the insulation at higher temperatures.

DESCRIPTION OF INSULATION TESTING METHODS FOR FACTORIES.

The subject of testing insulating materials can be approached in two ways, having regard either to the insulation resistance or to the disruptive

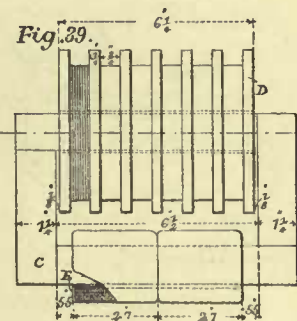
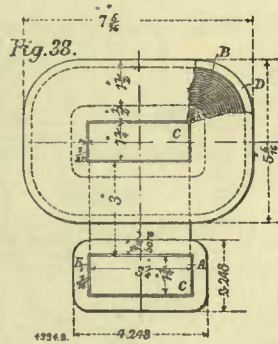
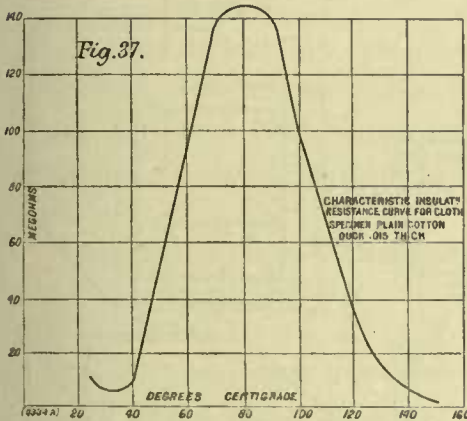

strength. Messrs. Sever, Monell and Perry, in the tests already alluded to, measured the former, but for practical purposes the latter is often preferable.

Various methods of testing insulating materials have been devised from time to time; but after many experiments on different lines the following has been evolved, and has been found very suitable for investigations in factory work. The apparatus required consists of:—

1. A special step-up transformer for obtaining the high potential from the ordinary alternating current low potential circuits. The design of this transformer is illustrated in Figs. 38 and 39, which are fully dimensioned.

¹ "Effect of Temperature on Insulating Materials," American Institute of Electrical Engineers, May 20th, 1896.

2. A water rheostat for regulating the current in the primary of the transformer. This consists of a glass jar, containing two copper plates immersed in water, the position of the upper one being adjustable.

3. A Kelvin electrostatic voltmeter, of the vertical pattern, for measuring the effective voltage on the secondary of the transformer.

4. A testing board for holding the sample to be tested. This, as shown in Figs. 40 to 43, consists of two brass discs $\frac{1}{8}$ in. thick and $1\frac{1}{2}$ in. in diameter, the inside edges of which are rounded off to prevent an excess of intensity at these points. These are pressed together against the sample by two brass strips, which also serve to apply the voltage to the

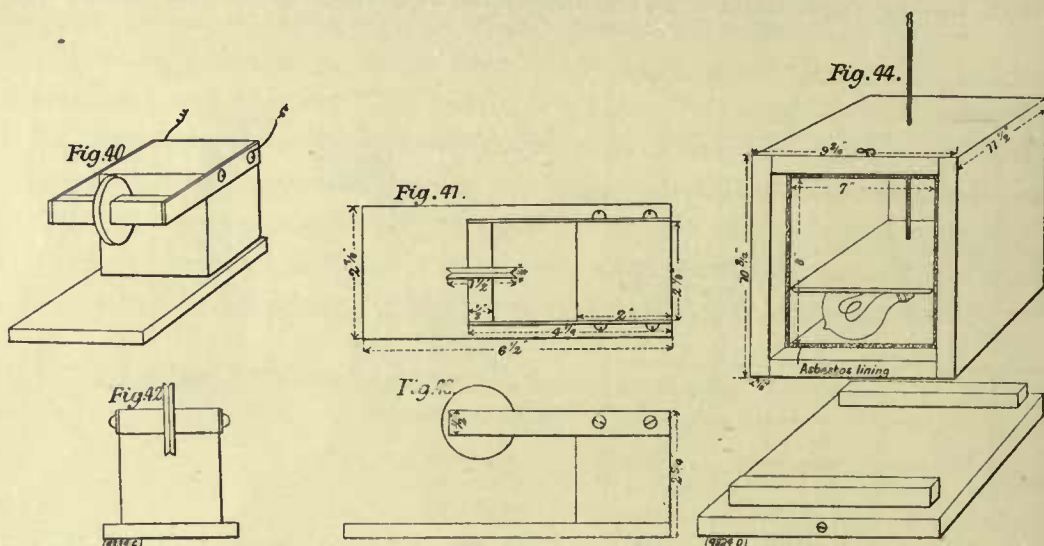

discs. The pressure between the discs is just enough to hold the sample firmly.

5. An oven for keeping the sample at the required temperature. It consists (as shown in Fig. 44) of a wooden box containing a tin case. There should be an inch clearance between the two, which should be tightly filled with asbestos packing all round, except at the front where the doors are. The tin case is divided horizontally by a shelf, which supports the testing board, while beneath is an incandescent lamp for heating the oven. Holes are drilled at the back to admit the high potential leads and lamp leads, and there is a hole in the top to admit a thermometer.

Adjustment of the temperature is made by having a resistance in series with the lamp, the amount of which can be adjusted till enough heat is generated to keep the temperature at the required value.

DESCRIPTION OF STEP-UP TRANSFORMER.

Core.—The core is of the single magnetic circuit type, and is built up of iron punchings $1\frac{1}{4}$ in. by $7\frac{3}{4}$ in., and $1\frac{1}{4}$ in. by $4\frac{1}{4}$ in., for sides and ends respectively, and .014 in. thick. Every other plate is japanned, and the total depth of punchings is $3\frac{1}{4}$ in., giving with an allowance of 10 per cent. for lost space, a net depth of iron of 2.92 in., and a net sectional area of 3.65 square inches. With an impressed E.M.F. of form factor = 1.25, the density is 36.4 kilolines per square inch.

The primary and secondary coils are wound on opposite sides of the core on the longer legs.

Primary Coils.—The primary consists of two coils form-wound, and these were slipped into place side by side. The conductor is No. 13 S.W.G. bare = .092 in. in diameter. Over the double cotton covering it measures .103 in., the cross-section of copper being .0066 square inch. Each coil consists of 75 turns in three layers, giving a total of 150 primary turns.

Secondary Coils.—The secondary is wound in six sections on a wooden reel, with flanges to separate the sections, as shown in Figs. 38 and 39. The conductor is No. 33 S.W.G. bare, .010 in. in diameter. Over the double silk covering it measures .014 in., the cross-section of copper being .000079 square inch. Each coil consists of 1,600 turns, giving a total of 9,600 secondary turns.

Insulation.—The primary coils are wrapped with a layer of rolled tape (white webbing) 1 in. by .018 in. half lapped and shellaced before being put on the core; they are slipped over a layer of "mica-canvas" on the leg. The secondary coils are wound direct on the wooden reel, which is shellaced; they are covered outside with two or three layers of black tape (1 in. by .009 in.), shellaced.

Advantage of this Type for Insulation Tests.—By having the primary and secondary on different legs, the advantage is gained that, even on short circuit, no great flow of current occurs, because of the magnetic leakage.

Connection Boards.—The transformer is mounted on a teak board, on which are also placed the secondary connection posts, as shown in Fig. 45. The primary leads are brought to another teak board, which is for convenience mounted on the top of the transformer. This board is fitted with fuses.

A number of samples may be tested simultaneously by connecting the testing boards in parallel, as shown in the diagram of connections given in Fig. 45. A is a single-pole switch in the main secondary circuit, and B, B, B are single-pole switches in the five branches.

The method of test is as follows: A number of samples 4 in. square are cut from the material to be tested, and are well shuffled together. Five samples are taken at random, placed between the clips of the testing boards within the ovens, and brought to the temperature at which the test is to be made. They should be left at this temperature for half an hour before test.

The apparatus may, of course, be modified to suit special requirements; but, as described, it has been used and found suitable for investigations on the disruptive voltage of various materials.

As an example of such an investigation, we give one in Table XIV. that was made to determine the effect of different durations of strain and different temperatures on the disruptive strength of a composite insulation known as mica-canvas.

Two hundred samples, measuring 4 in. by 4 in., were cut and well shuffled together, in order to eliminate variations of different sheets. Before test, all samples were baked for at least 24 hours at 60 deg. Cent.

METHOD OF TEST.

Five samples were placed between the clips of the testing boards, and the voltage on the secondary adjusted by the water rheostat to 2,000 volts, as indicated by a static voltmeter. Switch A was open and switches B, B, B closed (Fig 45). Switch A was now closed for five seconds, and if no sample broke down the voltage was raised to 3,000, and Switch A again closed for five seconds. This application of the voltage is practically only momentary, as the capacity current of the samples brings down the voltage slightly because of magnetic leakage in the transformer, five seconds not being a long enough interval to admit of re-adjusting the pressure to the desired value.

When any sample broke down, as indicated by the voltmeter needle dropping back to zero, it was disconnected from the circuit by its switch, B; it being easy to determine which sample had broken down by lifting switches B, B, B, one by one, till one of them drew out an arc.

The remaining samples were then subjected to the next higher voltage, and so on until all five samples had broken down.

TABLE XIV.—INSULATION TESTS ; MICA-CANVAS.

Temperature 25 deg. Cent.

Effective Voltage Impress'd	Duration 5 Seconds.					Duration 10 Minutes.					Duration 30 Minutes.						
	Number of Samples Unpierced.					Number of Samples Unpierced.					Number of Samples Unpierced.						
					percent.						percent.						percent.
2000	5	5	5	5	100	5	5	5	5	5	100	5	5	5	5	5	100
3000	5	5	5	5	100	5	5	5	5	5	100	5	5	5	5	5	100
4000	5	5	4	5	95	5	5	5	5	5	100	5	3	3	3	3	70
4500	5	5	4	5	95	4	2	5	5	80	5	2	2	3	3	60	
5000	4	5	4	5	90	1	1	3	3	40	4	1	1	1	1	35	
5500	4	4	3	5	80	0	0	3	2	25	2	0	0	0	0	10	
6000	3	2	2	3	50	0	0	2	1	15	2	0	0	0	0	10	
6500	3	1	2	1	35	0	0	2	0	10	1	0	0	0	0	5	
7000	1	0	1	0	10	0	0	1	0	5	1	0	0	0	0	5	
7500	0	0	1	0	5	0	0	0	0	0	1	0	0	0	0	5	
8000	0	0	1	0	5	0	0	0	0	0	1	0	0	0	0	5	

Temperature 60 deg. Cent.

2000	5	5	5	5	100	5	5	5	5	100	5	5	5	5	100
3000	5	5	5	5	100	5	5	5	5	100	5	5	5	5	100
4000	5	3	5	4	85	4	2	2	5	65	1	4	2	4	55
4500	5	3	5	3	80	1	2	2	3	40	1	3	2	4	50
5000	3	2	5	2	60	1	1	2	2	30	0	3	1	4	40
5500	1	2	5	1	45	0	0	1	0	5	0	3	0	2	25
6000	0	0	5	1	30	0	0	0	0	0	0	1	0	1	10
6500	0	0	0	0	0	0	0	0	0	0	0	0	0	8	5
7000	0	0	0	0	0	0	0	0	0	0	0	0	0	0	0
7500															
8000															

Temperature 100 deg. Cent.

2000	5	5	5	5	100	5	5	5	5	100	5	5	5	5	100
3000	5	5	5	5	100	5	4	5	5	100	5	5	5	5	100
4000	4	5	5	4	90	4	4	5	5	90	2	5	0	4	60
4500	4	5	4	4	85	3	3	3	3	60	1	3	0	2	35
5000	2	5	3	4	70	2	2	3	2	45	1	0	0	0	5
5500	1	5	2	3	55	1	1	2	2	30	0	0	0	0	0
6000	1	3	1	2	35	1	1	1	0	15					
6500	0	1	0	1	10	1	0	0	0	5					
7000	0	0	0	0	0	0	0	0	0	0					
7500															

A series of four tests, as above, were taken, making a total of twenty samples tested under the same conditions.

A set of twenty samples was tested with the impressed voltage kept constant for ten minutes, and another set, in which it was kept constant for thirty minutes.

A complete series of tests was made under the above three conditions—at three different temperatures—25 deg. Cent., 60 deg. Cent., and 100 deg. Cent. The samples were left in ovens for at least half

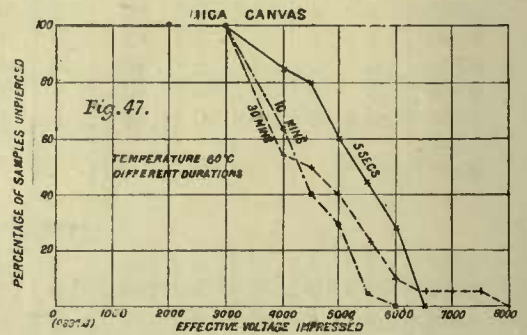
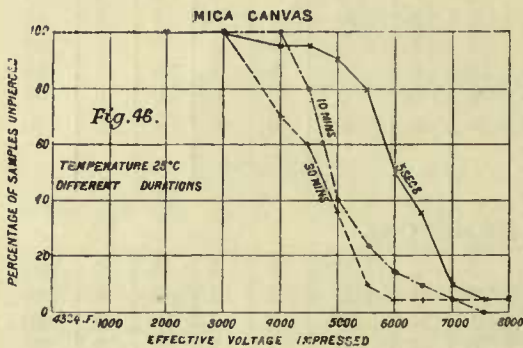
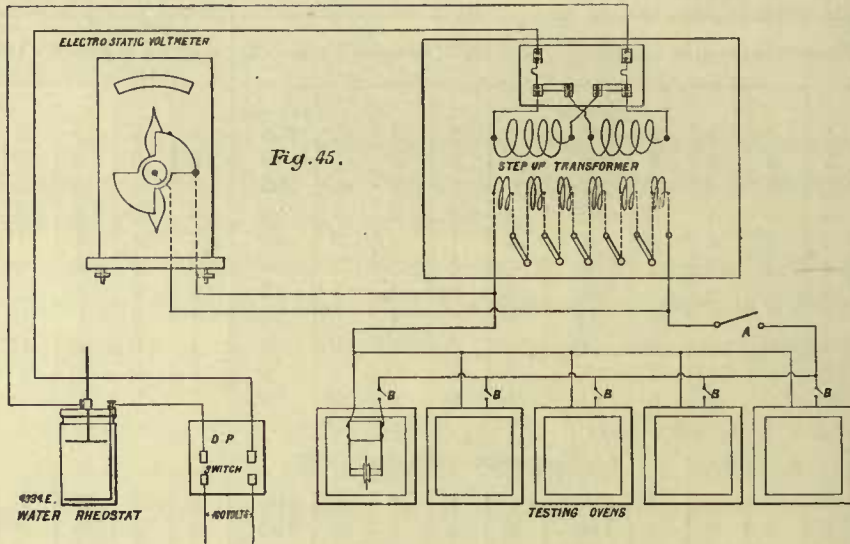

an hour, at approximately the right temperature, before being tested. The temperature during test did not vary more than 10 per cent.

The results of these tests are given in the Table above, and they are plotted as curves in Figs. 46 to 51, the effective (R.M.S.) voltage impressed as abscissæ, and the percentage of samples not broken down at that voltage as ordinates. In Figs. 46, 47, and 48 curves are plotted for same temperatures and different durations, while in Figs. 49,

50, and 51 they are plotted for different temperatures for the same duration.

As the form of the electromotive force wave would affect the results, and as it was impracticable to keep account of the same, the current being supplied by Thomson-Houston and Brush alternators running in parallel and at various loads, the effects were eliminated as much as possible by making tests on different sets of samples on different days.

It is evident from the results obtained that 3000 R.M.S. volts

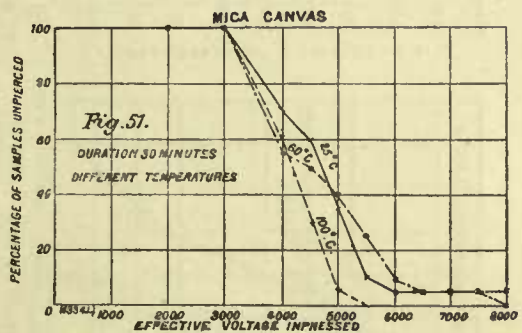
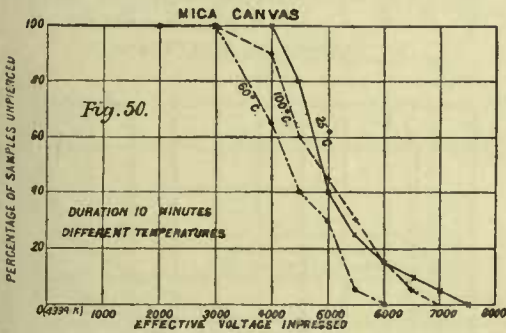
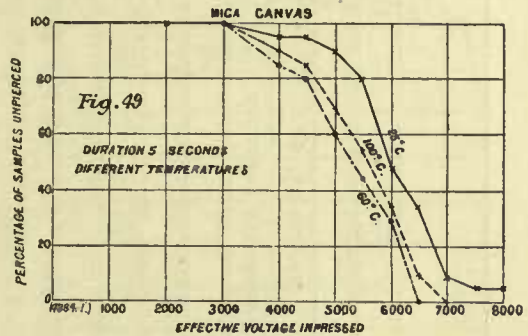
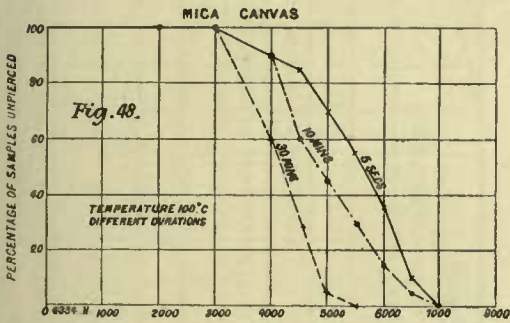

is the limit of safe-working voltage of this material under all conditions tried.

It would also appear from curves in Figs. 46, 47, and 48, that with the momentary application of the voltage, the material does not have time to get so strained as for a longer duration of the applied voltage, and that between the ten-minute and thirty-minute durations the difference is not so marked.

From curves in Figs. 49, 50, and 51, it seems that in the case of this material the temperature does not have much effect on the disruptive voltage, although at 60 deg. and 100 deg. the shellac becomes softened, and the sample may be bent back on itself without cracking.

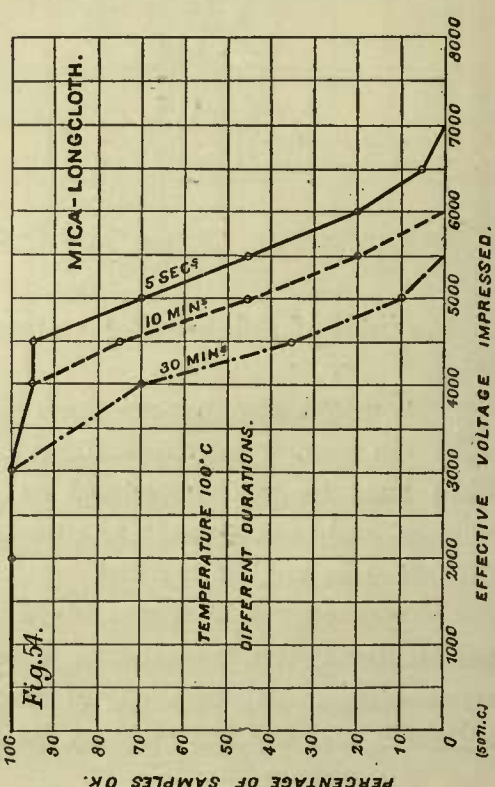
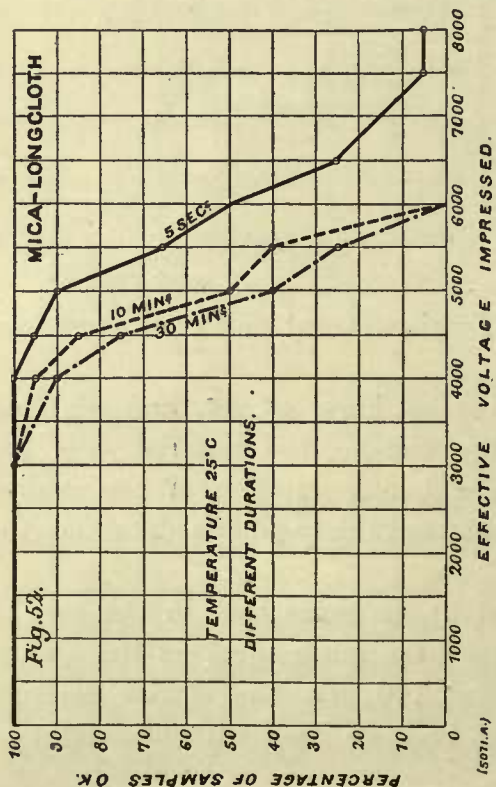
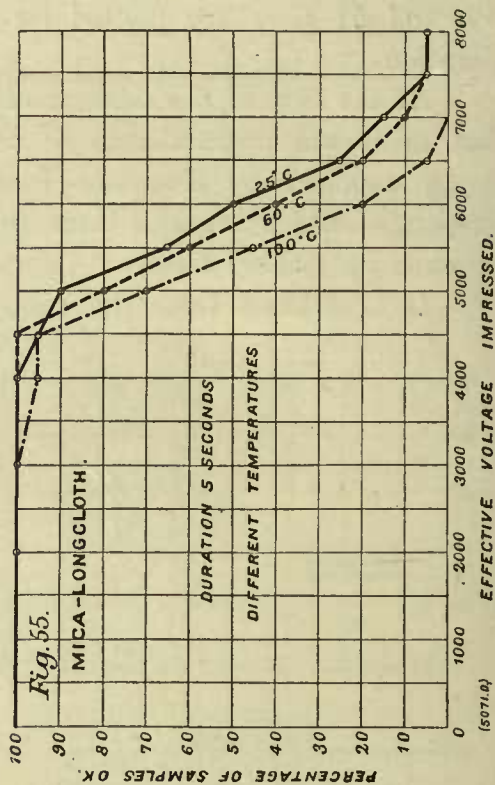
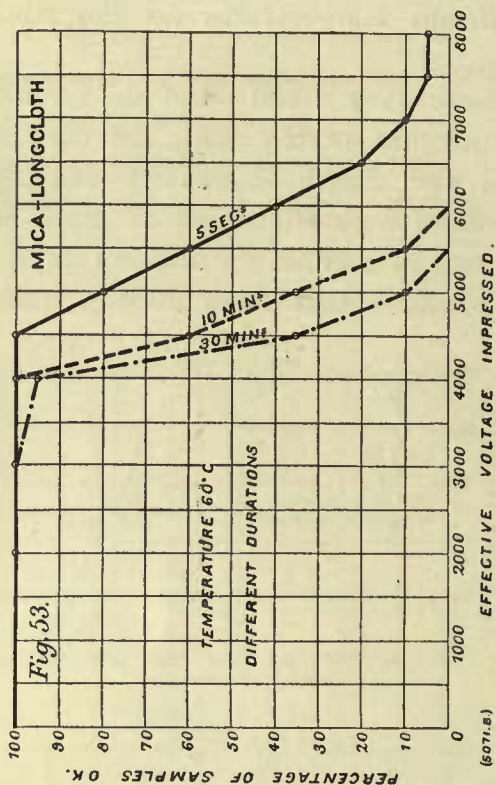

A corresponding set of tests was made on material called "mica long-cloth," which differed from the "mica-canvas" only in the nature of the cloth upon which the mica was mounted. The "long-cloth" is an inexpensive grade of linen serving merely as a structure upon which to build the mica.

The mode of manufacture is the same as that of "mica-canvas," except

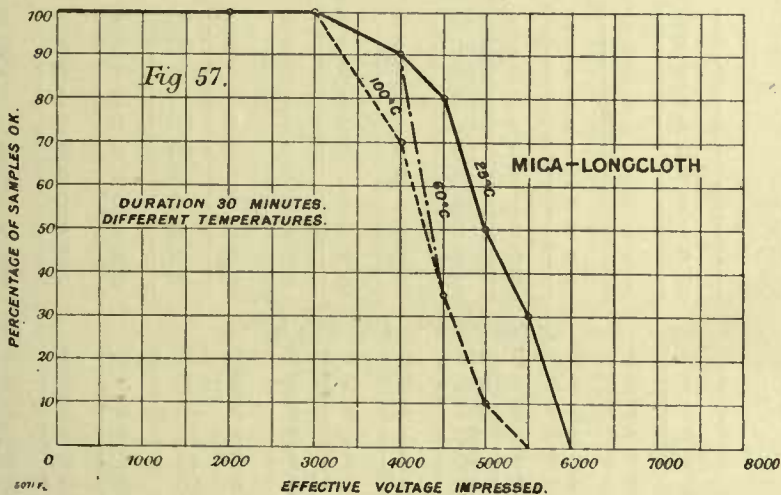
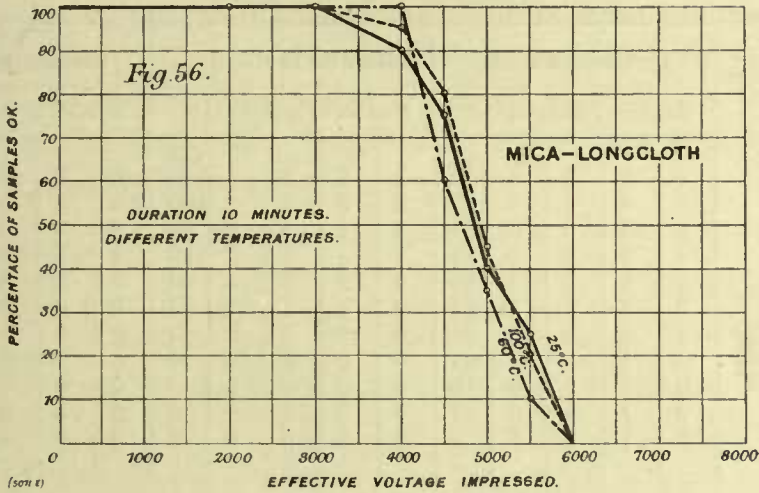

that the sheets of "long-cloth" are first impregnated with shellac and then dried. The mica is then put on in the same manner as with the "mica-canvas." The "long-cloth" is .0052 in. thick, and the mica varies from .001 in. to .009 in., but averages .002 in. The total thickness of the "mica long-cloth" completed, averages .025 in. This includes two sheets of "mica long-cloth," with interposed mica, the mica having everywhere at

least a double thickness. When made up, the sheets were placed for three or four hours in an oven at 60 deg. Cent. The sheets were then cut up into samples measuring 4 in. by 4 in., and were again baked for twenty-four hours before testing.

TABLE XV.—MICA LONG-CLOTH.

Temperature, 25 deg. Cent.

Effective Voltage Impressed.	Duration 5 Seconds.					Duration 10 Minutes.					Duration 30 Minutes.				
	Number of Samples O K.					Number of Samples O K.					Number of Samples O K.				
					Per Cent.					Per Cent.					Per Cent.
2000	5	5	5	5	100	5	5	5	5	100	5	5	5	5	100
3000	5	5	5	5	100	5	5	5	5	100	5	5	5	5	100
4000	5	5	5	5	100	4	4	5	5	90	5	5	4	5	95
4500	4	5	5	5	95	4	3	3	5	75	4	5	3	5	85
5000	4	5	5	4	90	3	2	1	2	40	2	1	3	4	50
5500	3	2	5	3	65	2	1	1	1	25	0	0	2	4	30
6000	2	2	4	2	50	0	0	0	0	0	0	0	0	0	0
6500	0	2	2	1	25	0	0	0	0	0	0	0	0	0	0
7000	0	2	1	0	15	0	0	0	0	0	0	0	0	0	0
7500	0	1	0	0	5	0	0	0	0	0	0	0	0	0	0
8000	0	1	0	0	5	0	0	0	0	0	0	0	0	0	0

Temperature, 60 deg. Cent.

2000	5	5	5	5	100	5	5	5	5	100	5	5	5	5	100
3000	5	5	5	5	100	5	5	5	5	100	5	5	5	5	100
4000	5	5	5	5	100	5	5	5	5	100	4	5	5	5	95
4500	5	5	5	5	100	3	3	1	5	60	2	2	1	2	35
5000	4	4	3	5	80	1	2	1	3	35	0	2	0	0	10
5500	3	4	2	3	60	0	0	0	2	10	0	0	0	0	0
6000	1	3	2	2	40	0	0	0	0	0	0	0	0	0	0
6500	1	2	0	1	20	0	0	0	0	0	0	0	0	0	0
7000	1	1	0	0	10	0	0	0	0	0	0	0	0	0	0
7500	0	1	0	0	5	0	0	0	0	0	0	0	0	0	0
8000	0	1	0	0	5	0	0	0	0	0	0	0	0	0	0

Temperature, 100 deg. Cent.

2000	5	5	5	5	100	5	5	5	5	100	5	5	5	5	100
3000	5	5	5	5	100	5	5	5	5	100	5	5	5	5	100
4000	5	4	5	5	95	5	5	4	5	95	5	3	3	3	70
4500	5	4	5	5	95	4	4	2	5	75	4	0	3	0	35
5000	4	3	4	3	70	3	1	2	3	45	1	0	1	0	10
5500	3	2	3	1	45	2	0	2	0	20	0	0	0	0	0
6000	1	1	1	1	20	0	0	0	0	0	0	0	0	0	0
6500	0	0	0	1	5	0	0	0	0	0	0	0	0	0	0
7000	0	0	0	0	0	0	0	0	0	0	0	0	0	0	0
7500	0	0	0	0	0	0	0	0	0	0	0	0	0	0	0

The results which are given in the Table and plotted as curves, show much the same character as those for "mica-canvas," the limit of safe working being about 3,000 R.M.S. volts as before. The results as plotted

in the curves support the former conclusion, that with five seconds duration of the application of the voltage, the material is not so much strained as by longer applications. As before, also, the temperature does not appear to affect the disruptive voltage.

These tests show the material to be quite as good electrically as "mica-canvas," nothing being gained by the extra thickness of the latter. The "mica-canvas" and the "mica long-cloth" had the same thickness of mica, but the canvas is so much thicker than the "long-cloth" as to make the total thickness of the "mica-canvas" .048 in., as against a thickness of only .025 in. for the "mica long-cloth." The insulation strength is evidently due solely to the mica.

TABLE XVI.—SHELLAC'D PAPER (Two Sheets).
Temperature, 25 deg. Cent.

Effective Voltage Impressed.	Duration, 5 Seconds.					Duration, 10 Minutes.					Duration, 30 Minutes.				
	Number of Samples O K.					Number of Samples O K.					Number of Samples O K.				
					Per Cent.					Per Cent.					Per Cent.
2500	5	5	5	5	100	5	5	5	5	100	5	5	5	5	100
3000	5	5	5	5	100	5	5	5	5	100	5	5	4	5	100
3500	4	4	4	4	80	4	5	2	3	70	4	4	2	5	75
4000	3	2	3	3	55	3	2	1	1	35	0	1	0	0	5
4500	2	1	2	1	30	1	0	0	0	5	0	0	0	0	0
5000	0	0	0	0	0	0	0	0	0	0	0	0	0	0	0
<i>Temperature, 60 deg. Cent.</i>															
2500	5	5	5	5	100	5	5	5	5	100	5	5	5	5	100
3000	4	5	4	5	90	5	3	5	5	90	4	4	4	5	85
3500	4	4	3	4	75	2	3	3	3	55	2	2	3	2	45
4000	2	3	3	3	55	1	0	0	0	5	0	0	0	1	5
4500	1	2	0	2	25	0	0	0	0	0	0	0	0	0	0
5000	0	0	0	0	0	0	0	0	0	0	0	0	0	0	0
<i>Temperature, 100 deg. Cent.</i>															
2500	5	5	5	5	100	5	5	5	5	100	5	5	5	5	100
3000	3	3	4	4	70	2	2	1	2	35	1	3	2	2	40
3500	2	1	3	2	40	2	0	1	0	15	1	2	0	2	25
4000	0	0	1	1	10	1	0	0	0	5	0	0	0	0	0
4500	0	0	0	0	0	0	0	0	0	0	0	0	0	0	0
5000	0	0	0	0	0	0	0	0	0	0	0	0	0	0	0

In the following set of tests the same method of procedure was employed, the material in this case being so-called "Shellac'd Paper," which consists of cartridge paper about .010 in. thick, pasted with shellac on both sides and then thoroughly baked. The average thickness when finished is about .012 in. This material is often used as insulation between layers of the windings of transformers, in thicknesses of from one to three

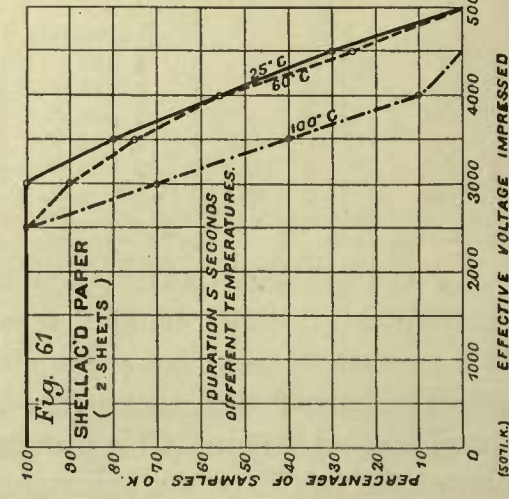
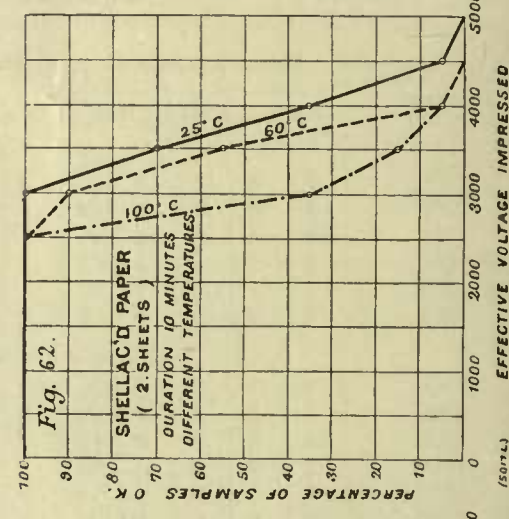
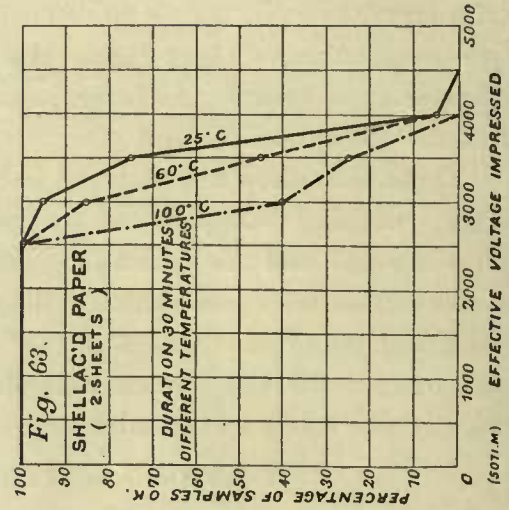
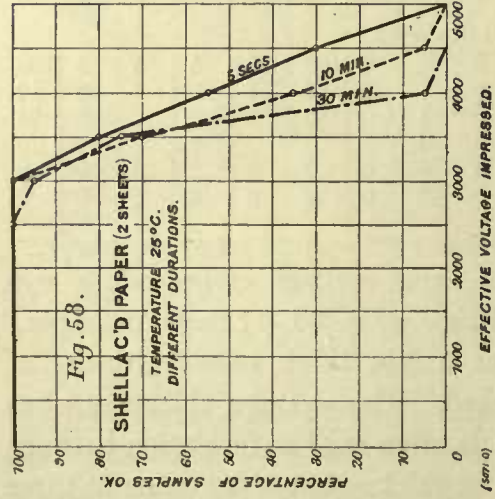
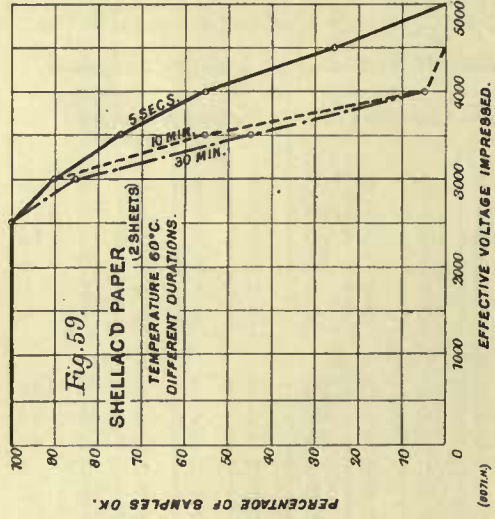
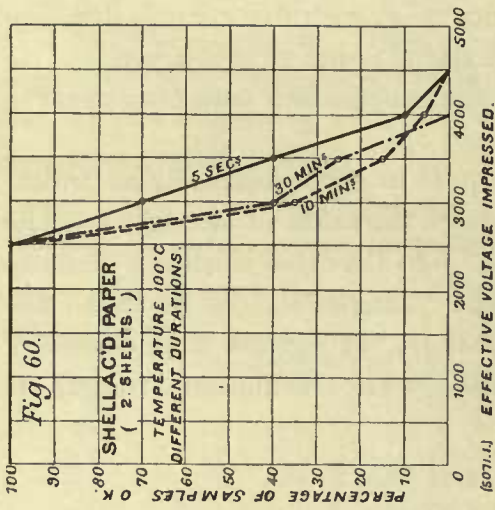

sheets, according to the voltage per layer. It was found convenient to test two sheets of the material together, in order to bring the disruptive voltage within the range of the voltmeter. The use of two thicknesses also tended to produce more uniform results. As will be seen, the duration of the application of the voltage, and the temperature up to 100 deg. Cent., exert a slight but definite influence upon the results. But at 100 deg. Cent. the shellac becomes quite soft.

The tests show that this material withstands a little over 1000 R.M.S. volts per single sheet, although in employing it for construction, a factor of safety of two or three should be allowed under good conditions, and a still higher factor for the case of abrupt bends and other unfavourable conditions.

Further tests showed the disruptive strength of this material to be proportional to the number of sheets.

Curves and Tables are given below of the results obtained in similar tests on a material known as "Red Paper." It is .0058 in. thick, and is of a fibrous nature, and mechanically strong; hence especially useful in conjunction with mica, to strengthen the latter.

TABLE XVII.—RED PAPER (Four Sheets).
Temperature, 25 deg. Cent.

Effective Voltage Impressed.	Duration 5 Seconds.					Duration 10 Minutes.					Duration 30 Minutes.				
	Number of Samples O K.					Number of Samples O K.					Number of Samples O K.				
					Per Cent.					Per Cent.					Per Cent.
2500	5	5	5	5	100	5	5	5	5	100	5	5	5	5	100
3000	5	5	5	5	100	5	5	5	5	100	5	5	5	5	100
3500	5	4	5	5	95	3	4	5	1	65	2	4	2	0	40
4000	4	0	1	3	40	0	0	0	0	0	1	0	0	0	5
4500	0	0	0	0	0	0	0	0	0	0	0	0	0	0	0
5000	0	0	0	0	0	0	0	0	0	0	0	0	0	0	0
<i>Temperature, 60 deg. Cent.</i>															
2500	5	5	5	5	100	5	5	5	5	100	5	5	5	5	100
3000	5	5	5	4	95	5	5	5	5	100	4	2	2	5	65
3500	0	1	2	1	20	3	1	1	0	25	0	1	1	1	15
4000	0	0	0	0	0	0	0	0	0	0	0	0	0	0	0
4500	0	0	0	0	0	0	0	0	0	0	0	0	0	0	0
5000	0	0	0	0	0	0	0	0	0	0	0	0	0	0	0
<i>Temperature, 100 deg. Cent.</i>															
2500	5	5	5	5	100	5	5	5	5	100	5	5	5	5	100
3000	5	5	5	5	100	3	2	2	3	50	3	3	2	1	45
3500	2	3	2	3	50	1	0	0	0	5	0	1	0	0	5
4000	0	0	0	0	0	0	0	0	0	0	0	0	0	0	0
4500	0	0	0	0	0	0	0	0	0	0	0	0	0	0	0
5000	0	0	0	0	0	0	0	0	0	0	0	0	0	0	0

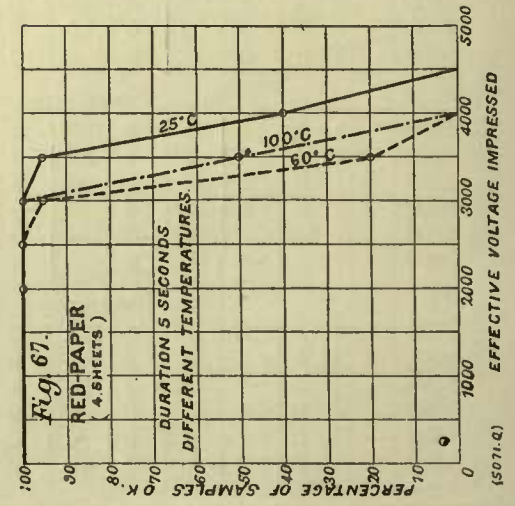
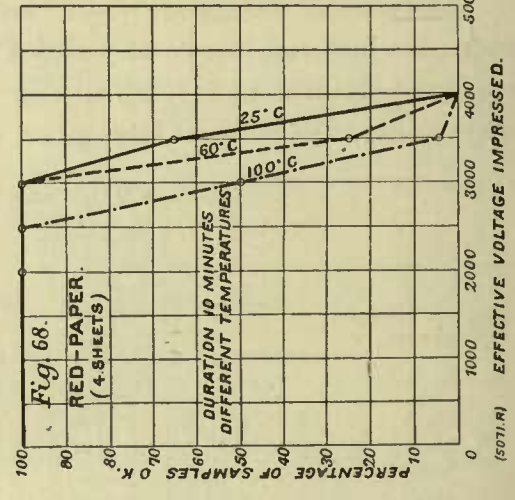
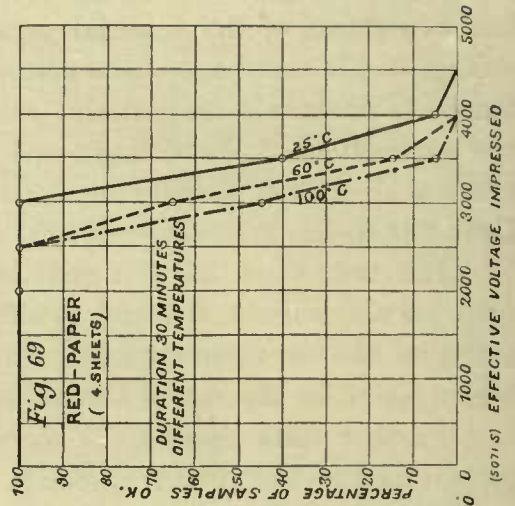
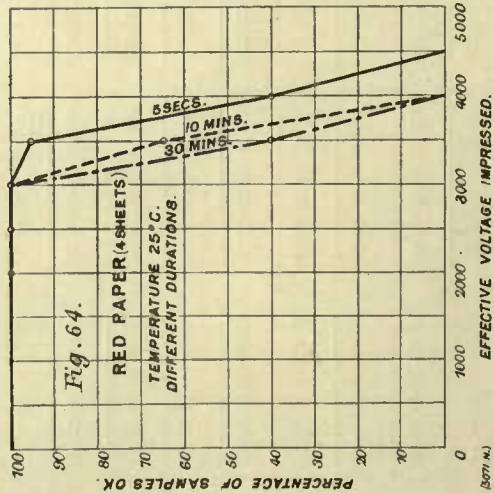
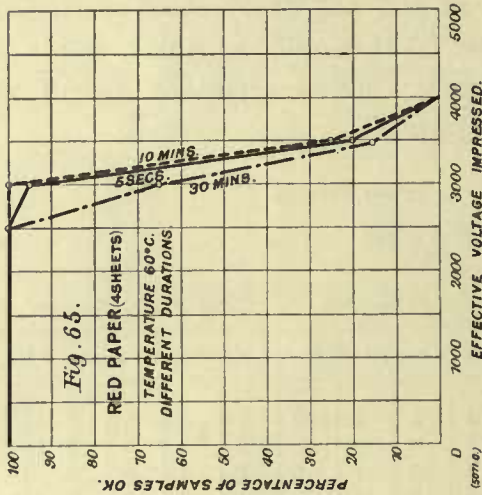
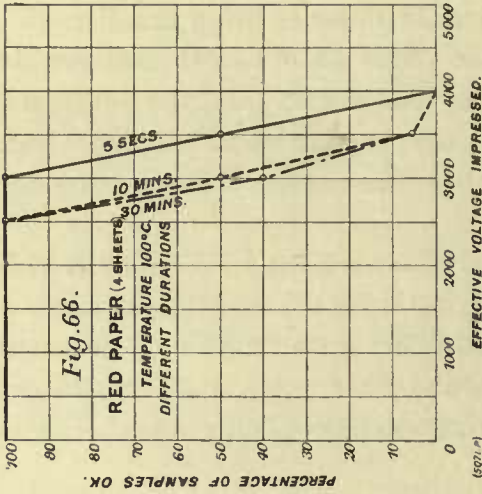

The method of test was the same as that employed in the case of the preceding set of tests on "Shellac'd Paper;" and for the reasons set forth in those tests, it was found in this case convenient to test four sheets of the material together.

An examination of the curves and Tables will show that the limit of safe working is 2,500 R.M.S. volts for four sheets, or 625 volts for a single sheet, other tests having been made which showed the breakdown pressure to be proportional to the number of sheets.

It also appears from the curves, that "Red Paper" has a more uniform insulation strength than the materials previously tested. As in the case of "Shellac'd Paper," it showed weakening of the insulation at a temperature of 100 deg. Cent.

From tests such as the four sets just described, very definite conclusions may be drawn. For instance, if it were desired to use "mica-canvas" as the chief constituent of the main insulation of a 2,000 volt transformer, which should withstand an 8,000 volt breakdown test, between primary and secondary, for one half hour, three layers of this composite insulation would be sufficient and would probably be inserted; though the chances would be in favour of its withstanding a 10,000 or 12,000 volt test if due attention is given to guarding against surface leakage, bending and cracking and bruising of insulation, and other such matters. A comparison with the tests on "mica long-cloth," would, however, show that a given insulation strength could be obtained with a much thinner layer.

There are on the market patented composite materials giving still better results. But they are expensive, and hence it is often impracticable to use them.

In designing electrical machinery, similar tests of all insulating material to be used should be at hand, together with details of their mechanical, thermal, and other properties, and reasonable factors of safety should be taken.

Armature coils are often insulated by serving them with linen or cotton tape wound on with half-lap. A customary thickness of tape is .007 in., and the coil is taped with a half over-lap, so that the total thickness of the insulation is .014 in. The coils are then dipped in some approved insulating varnish, and baked in an oven at a temperature of about 90 deg. cent. These operations of taping, dipping, and drying, are repeated a number of times, until the required amount of insulation is obtained. It has been found in practice that a coil treated in this manner,

and with but three layers of .007-in. tape (wound with half over-lap), dipped in varnish twice after the first taping, once after the second, and twice after the third, *i.e.*, five total dippings, and thoroughly baked at 90 deg. cent. after each dipping in varnish, withstands a high potential test of 5,000 R.M.S. volts, which is considered sufficient for machines for not over 600 volts. Armature coils insulated in the above manner are generally placed in armature slots lined with an oil-treated cardboard of about .012 in. in thickness; but this contributes but little to the insulation strength, serving rather to protect the thin skin of varnish from abrasion when forcing the coil into the armature slot. In this treatment of the coils, great care must be taken to see that the taping be not more than one half over-lap, and that the varnish does not become too thick through evaporation of the solvent. All coils should be thoroughly dried and warmed before dipping, as the varnish will then penetrate farther into them. The slot parts of coils are dipped in hot paraffin and the slots lined with oil- or varnish-treated cardboard, to prevent abrasion of the insulations. The greatest of care should be used in selecting insulating varnishes and compounds, as many of them have proved in practice to be worthless; a vegetable acid forming in the drying process, which corrodes the copper through the formation of acetates or formates of copper which in time lead to short-circuits in the coil. Some excellent preparations have their effectiveness impaired by unskilful handling. If, for instance, the first coat of the compound is not thoroughly dried, the residual moisture corrodes the copper and rots the insulations. By far the best method of drying is by the vacuum hot oven. By this method, the coils steam and sweat, and all moisture is sucked out. A vacuum oven, moreover, requires a much lower temperature, consequently less steam, and very much less time. Such an oven is almost a necessity where field spools have deep metal flanges, for in the ordinary oven, in such cases, the moisture simply cooks and steams, but does not come out. Cases have occurred where spools have been kept in an ordinary drying oven for ten days at a temperature of 90 deg. cent., and then the spools had to be further dried with a heavy current to sweat the moisture out. Field spools may be treated with tape and varnished in the same manner as armature coils, thus doing away with the needless metal flanges, and also saving space.

As further instances of taping and varnishing, may be cited the cases of some coils treated with the same kind of tape and varnish as already described. In one case, a half over-lapped covering of .007-in.

tape, giving a total thickness of .014 in., had seven successive dippings and bakings, resulting in a total thickness of tape and varnish of .035 in. Coils thus insulated withstood 6,000 R.M.S. volts. An insulation suitable for withstanding 15,000 R.M.S. volts consists in taping four times with half over-lap, and giving each taping three coats of varnish, making in all, eight layers of .007-in. tape, and 12 layers of varnish. The total thickness of insulation was then about .09 in. The quality of the tape, the thickness of the varnish, and the care in applying and drying the varnish, play an important part.

One disadvantage of this method of insulating armature coils by taping and impregnating with varnish and baking, consists in the brittleness of the covering; and a coil thus treated should preferably be warmed before pressing it into place on the armature.

Other methods of treating coils, such as dipping the slot part of the coil in shellac and then pressing it in a steam-heated press form, thus baking the slot part hard and stiff, have the advantage of rendering the coils less liable to damage in being assembled on the armature, and also make the coils more uniform in thickness. Coils thus pressed are subsequently taped and dipped in the way already described.

Coils may be treated in a vacuum, to a compound of tar and linseed oil, until they become completely impregnated. They are then forced into shape under high pressure. Coils thus prepared cannot be used in rotating armatures, as the centrifugal force tends to throw the compound out.

ARMATURE WINDINGS.

CONTINUOUS-CURRENT ARMATURE WINDINGS.

In the design of dynamo machines a primary consideration is with respect to the armature windings. Many types have been, and are, at present employed, but the large continuous-current generators now most extensively used for power and lighting purposes, as well as in the numerous other processes where electrical energy is being commercially utilised on a large scale, are constructed with some one of a comparatively small number of types of winding. Although the many other types may be more or less useful in particular cases, it will not be necessary for our present purpose to treat the less-used types.

The windings generally used may be sub-divided into two chief classes—one, in which the conductors are arranged on the external surface of a cylinder, so that each turn includes, as a maximum, the total magnetic flux from each pole, termed drum windings; the other, in which the conductors are arranged on and threaded through the interior of a cylinder, so that each turn includes as a maximum only one-half of the flux from each magnet pole; this is known as the Gramme, or ring winding.

One of the chief advantages of the Gramme winding is that the voltage between adjacent coils is only a small fraction of the total voltage, while in drum-wound armatures the voltage between adjacent armature coils is periodically equal to the total voltage generated by the armature. On account of this feature, Gramme windings are largely used in the armatures of arc-light dynamos, in which case the amount of space required for insulation would become excessive for drum windings. There is also the practical advantage that Gramme windings can be arranged so that each coil is independently replaceable.

Gramme-ring windings have been used with considerable success in large lighting generators, the advantage in this case being that the armature conductors are so designed that the radial ends of each turn at one side of the armature are used as a commutator; and with a given number of conductors on the external surface of the cylinder, the number of the commutator bars is twice as great as in the drum-wound armature—an important

feature in the generation of large currents. Having one commutator segment per turn, the choice of a sufficient number of turns keeps the voltage per commutator segment within desirably low limits. The use of a large number of turns in such cases, while permitting the voltage per commutator segment to be low, would entail high armature reaction, manifested by excessive demagnetisation and distortion, if the number of poles should be too small; but by the choice of a sufficiently large number of poles, the current per armature turn may be reduced to any desired extent. While it is necessary to limit the armature strength in this way, the cost

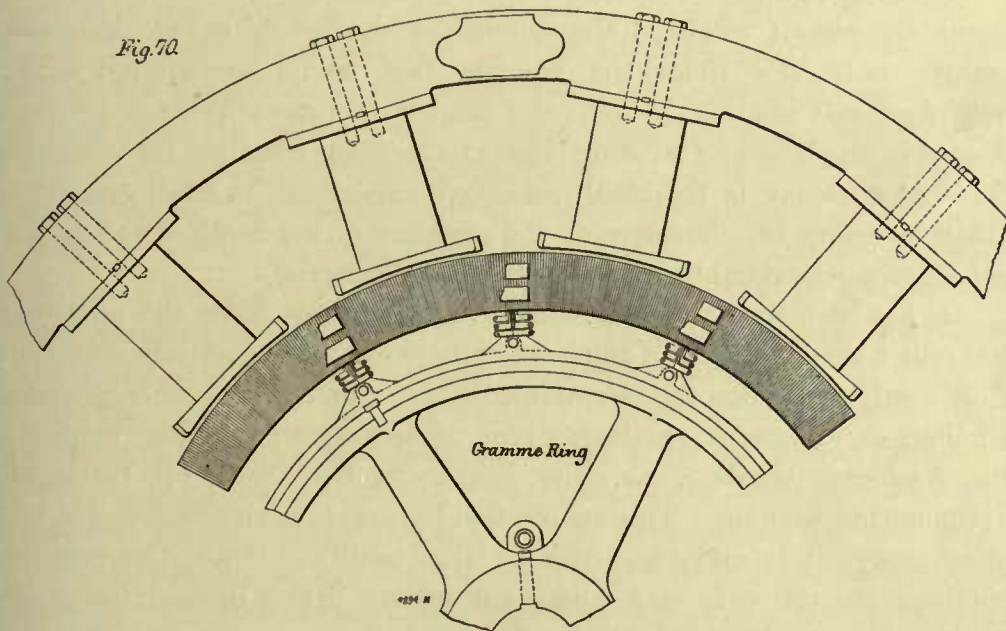

of the machine is at the same time increased, so that commercial considerations impose a restriction.

Fig. 70 is an outline drawing of the armature and field of a 12-pole 400-kilowatt Gramme-ring lighting generator, of the type just described. Machines of this type have been extensively used in large central stations in America, and it is one of the most successful types that have ever been built.

In small machines where, instead of two-face conductors, there is often a coil of several turns between adjacent commutator segments, the Gramme ring is, on the score of mechanical convenience, inferior to the drum winding; since, in the case of the latter, the coils may be wound upon a form, and assembled afterwards upon the armature core. This is only made

practicable in the case of a Gramme ring, by temporarily removing a segment of the laminated core. This plan has obvious disadvantages.

These two practical classes of windings, Gramme ring and drum, may be subdivided, according to the method of interconnecting the conductors, into "two-circuit" and "multiple-circuit"¹ windings. In the two-circuit windings, independently of the number of poles, there are but two circuits through the armature from the negative to the positive brushes; in the multiple circuit windings, there are as many circuits through the armature as there are poles.

Making comparison of these two sub-classes, it may be stated that in the two-circuit windings the number of conductors is, for the same voltage, only $2/N$ times the number that would be required with a multiple-circuit winding, N being the number of poles; hence a saving is effected in the labour of winding and in the space required for insulation. This last economy is frequently of great importance in small generators, either lessening the diameter of the armature or the depth of the air gap, and thereby considerably lessening the cost of material.

It has been stated that Gramme-ring armatures have the advantage that only a small fraction of the total voltage exists between adjacent coils. This is only true when the Gramme armature either has a multiple-circuit winding, or a certain particular type of two-circuit winding, known as the Andrews winding, *i.e.* the long-connection type of two-circuit Gramme-ring winding. This reservation having been made for the sake of accuracy, it is sufficient to state that multiple-circuit Gramme-ring windings are the only ones now used to any extent in machines of any considerable capacity; and, as already stated, these possess the advantage referred to, of having only a small fraction of the total voltage between adjacent coils.

DRUM WINDINGS.

In the case of drum windings, it is obvious that all the connections from bar to bar must be made upon the rear and front ends exclusively; it not being practicable, as in the case of Gramme-ring windings, to bring connections through inside from back to front. From this it follows that the face conductors forming the two sides of any one coil must be situated in fields of opposite polarity; so that the electromotive forces generated in

¹ This term applies to single armature windings.

the conductors composing the turns, by their passage through their respective fields, shall act in the same direction around the turns or coils.

Bipolar windings are, in some cases, used in machines of as much as 100 or even 200 kilowatts output; but it is now generally found desirable to employ multipolar generators even for comparatively small outputs. The chief reasons for this will be explained hereafter, in the section relating to the electro-magnetic limit of output.

Drum windings, like Gramme-ring windings, may be either multiple-circuit or two-circuit, requiring in the latter case, for a given voltage, only $2/N$ times as many conductors as in the former, and having the advantages inherent to this property. Owing to the relative peripheral position of successively connected conductors (in adjacent fields), two-circuit drum windings are analogous to the short-connection type, rather than to the long-connection type of two-circuit Gramme-ring windings. The multiple-circuit drum windings are quite analogous to the multiple-circuit Gramme-ring windings, the multiple-circuit drum possessing, however, the undesirable feature of full armature potential between neighbouring conductors; whereas one of the most valuable properties of the multiple-circuit Gramme-ring winding is that there is but a very small fraction of the total armature potential between adjacent conductors.

In Fig. 71 is given the diagram of a multiple-circuit drum winding. It is arranged according to a diagrammatic plan which has proved convenient for the study of drum windings. The radial lines represent the face conductors. The connecting lines at the inside represent the end connections at the commutator end, and those on the outside the end connections at the other end. The brushes are drawn inside the commutator for convenience. The arrowheads show the direction of the current through the armature, those without arrowheads (in other diagrams) being, at the position shown, short-circuited at the brushes. By tracing through the winding from the negative to the positive brushes, it will be found that the six paths through the armature are along the conductors and in the order given in the six following lines:—

$$- \left\{ \begin{array}{cccccccccc} 7 & 58 & 9 & 60 & 11 & 2 & 13 & 4 & 15 & 6 \\ 56 & 5 & 54 & 3 & 52 & 1 & 50 & 59 & 48 & 57 \\ 27 & 18 & 29 & 20 & 31 & 22 & 33 & 24 & 35 & 26 \\ 16 & 25 & 14 & 23 & 12 & 21 & 10 & 19 & 8 & 17 \\ 47 & 38 & 49 & 40 & 51 & 42 & 53 & 44 & 55 & 46 \\ 36 & 45 & 34 & 43 & 32 & 41 & 30 & 39 & 28 & 37 \end{array} \right\} +$$

In making the connections, each conductor at the front end is connected to the eleventh ahead of it; and at the back to the ninth behind

it. In other words, the front end pitch is 11, and the back end pitch is -9 . In practically applying such a diagram, the conductors would generally be arranged with either one, two, or four conductors in each slot. Suppose there were two conductors per slot, one above the other; then the odd-numbered conductors could be considered to represent the upper conductors, the lower ones being represented by conductors with even numbers. In order that the end connections may be of the ordinary

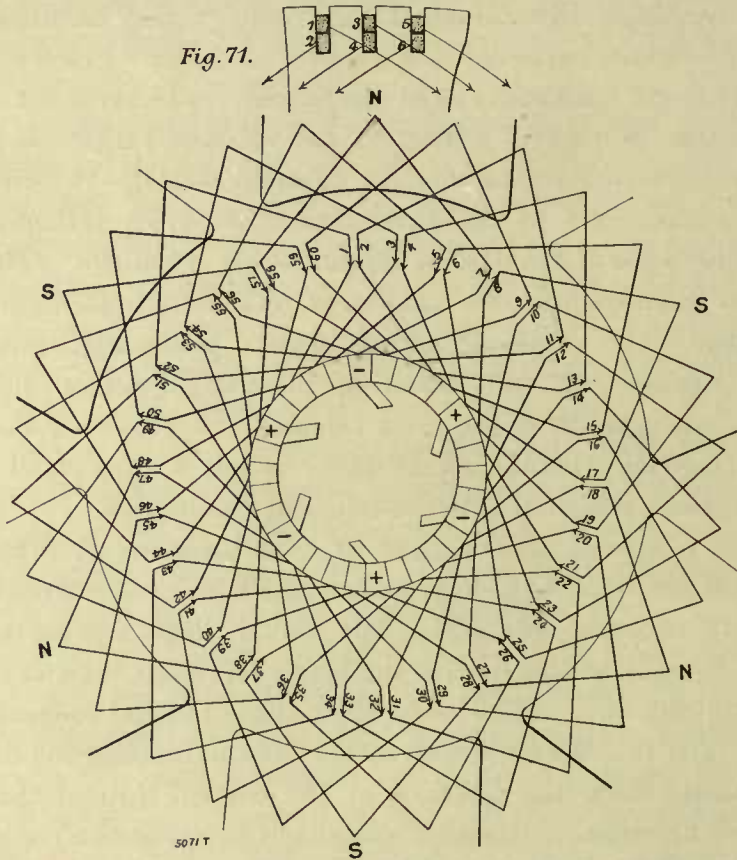

double-spiral arrangement or its equivalent, the best mechanical result will be secured by always connecting an upper to a lower conductor; hence the necessity of the pitches being chosen odd.

The small sketch at the top of Fig. 71 shows the actual location of the conductors on a section of the armature. There might, of course, have been only one conductor per slot; or, when desirable, there could be more than two. The grouping of the conductors in the diagram in pairs is intended to indicate an arrangement with two conductors per slot. But in subsequent diagrams it will be more convenient to arrange the face conductors equi-distantly.

The following is a summary of the conditions governing multiple-circuit single windings, such as that shown in Fig. 71 :

a. There may be any even number of conductors, except that in iron-clad windings the number of conductors must also be a multiple of the number of slots.

b. The front and back pitches must both be odd, and must differ by 2 ; therefore the average pitch is even.

c. The average pitch y should not be very different from c/n when c = number of conductors, and n = number of poles. For chord windings, y

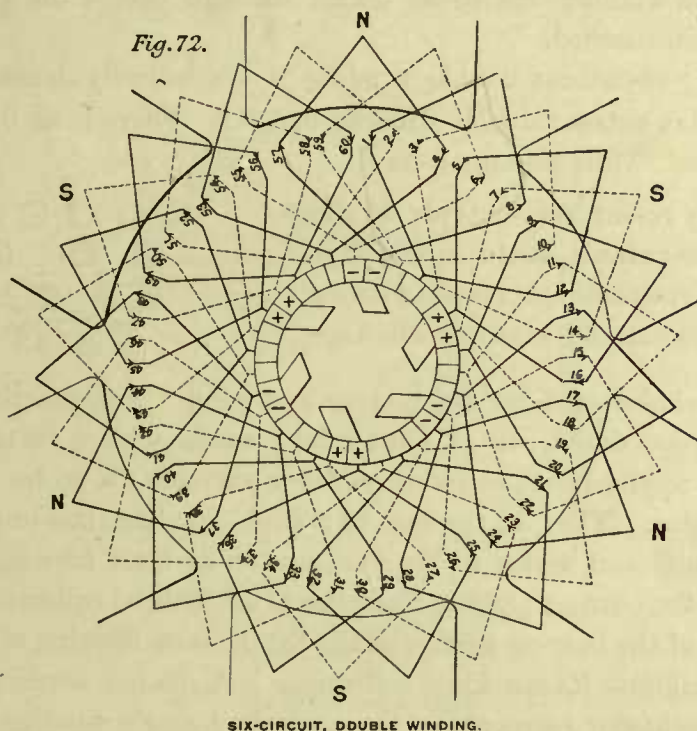

should be smaller than c/n by as great an amount as other conditions will permit, or as may be deemed desirable.

Multiple-circuit windings may also be multiple-wound, instead of being single-wound, as in the above instance. We refer to a method in which two or more single windings may be superposed upon the same armature, each furnishing but a part of the total current of the machine. The rules governing such windings are somewhat elaborate, and it is not necessary at present to go fully into the matter. In Fig. 72 is shown a six-circuit double winding. Each of the two windings is a multiple-circuit winding, with six circuits through the armature, so that the arrangement results in

only one-twelfth of the sixty conductors being in series between negative and positive brushes; each of the conductors, consequently, carrying one-twelfth of the total current. This particular winding is of the doubly re-entrant variety. That is to say, if one starts at conductor 1, and traces through the conducting system, conductor 1 will be re-entered when only half of the conductors have been traced through. The other half of the conductors form an entirely separate conducting system, except in so far as they are put into conducting relation by the brushes. If fifty-eight conductors are chosen, instead of sixty, the winding becomes singly re-entrant, *i.e.*, the whole winding has to be traced through before the original conductor is again reached.

A singly re-entrant double winding is symbolically denoted thus \odot , and a doubly re-entrant double winding by O O. There is no limit for such arrangements. Thus we may have

Sextuply re-entrant, sextuple windings,	○ ○ ○ ○ ○ ○
Triply re-entrant, sextuple windings,	⊙ ⊙ ⊙
Doubly re-entrant, sextuple windings,	⊖ ⊖
Singly re-entrant, sextuple windings,	⊖

by suitable choice of total conductors and pitch. In practice, multiple windings beyond double, or at most triple, would seldom be used. Such windings are applicable to cases where large currents are to be collected at the commutator. Thus, in the case of a triple winding, the brushes should be made of sufficient width to bear at once on at least four segments, and one-third of the current passing from the brush will be collected at each of three points of the bearing surface of the brush, such division of the current tending to facilitate its sparkless collection. A double winding has twice as many commutator segments as the equivalent single winding. Another property is that the bridging of two adjacent commutator segments by copper or carbon dust does not short-circuit any part of the armature winding, and an arc is much less likely to be established on the commutator from any cause.

TWO-CIRCUIT DRUM WINDINGS.

Two-circuit drum windings are distinguished by the fact that the pitch is always forward, instead of being alternately forward and backward, as in the multiple-circuit windings.

The sequence of connections leads the winding from a certain bar opposite one pole-piece to a bar similarly situated opposite the next pole-piece, and so on, so that as many bars as pole-pieces are passed through before another bar in the original field is reached.

A two-circuit single winding in a six-pole field is shown in Fig. 73. Two-circuit windings have but two paths through the armature, independently of the number of poles. Only two sets of brushes are needed, no matter how many poles there may be, so far as collection of the current

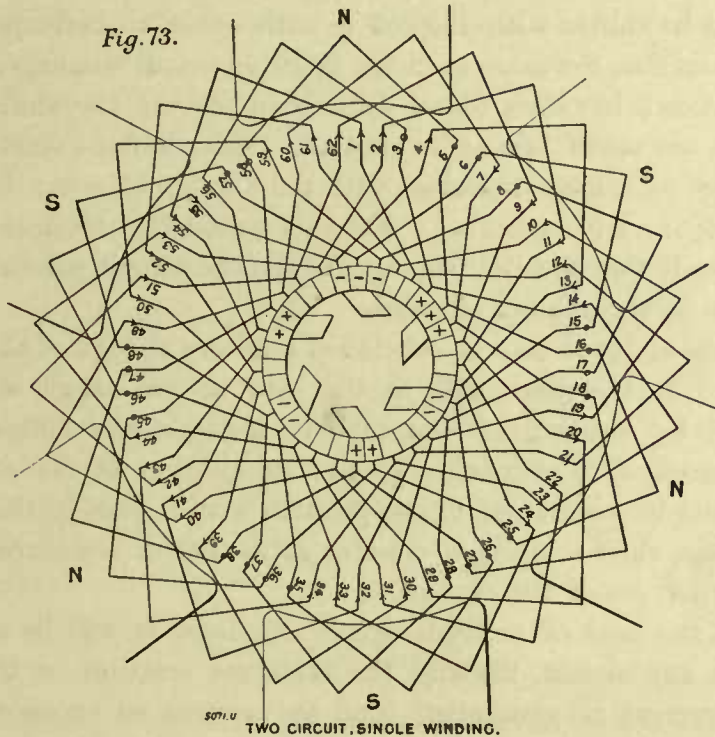

is concerned; but in order to prevent the commutator being too expensive, it is customary in large machines to use as many sets of brushes as there are pole-pieces. Where more than two sets of brushes must be used, that is, in machines of large current output, the advantages possible from equal currents in the two circuits have been overbalanced by the increased sparking, due to unequal division of the current between the different sets of brushes of the same sign.

An examination of the diagrams will show that in the two-circuit windings, the drop in the armature, likewise the armature reaction, is independent of any manner in which the current may be subdivided among

the different sets of brushes, but depends only upon the sum of the currents at all the sets of brushes at the same sign. There are in the two-circuit windings no features that tend to cause the current to subdivide equally between the different sets of brushes of the same sign; and in consequence, if there is any difference in contact resistance between the different sets of brushes, or if the brushes are not set with the proper lead with respect to each other, there will be an unequal division of the current.

When there are as many sets of brushes as poles, the density at each pole must be the same; otherwise the position of the different sets of brushes must be shifted with respect to each other to correspond to the different intensities, the same as in the multiple-circuit windings.

In practice it has been found difficult to prevent the shifting of the current from one set of brushes to another. The possible excess of current at any one set of brushes increases with the number of sets; likewise the possibility of excessive sparking. For this reason the statement has been sometimes made that the disadvantages of the two-circuit windings increase in proportion to the number of poles.

From the above it may be concluded that any change of the armature with respect to the poles will, in the case of two-circuit windings, be accompanied by shifting of the current between the different sets of brushes; therefore, to maintain a proper subdivision of the current, the armature must be maintained in one position with respect to the poles, and with exactness, since there is no counter action in the armature to prevent the unequal division of the current.

But in the case of multiple-circuit windings, it will be noted that the drop in any circuit, likewise the armature reaction on the field in which the current is generated, tend to prevent an excessive flow of current from the corresponding set of brushes. On account of these features (together with the consideration that when there are as many brushes as poles the two-circuit armatures require the same nicety of adjustment with respect to the poles as the multiple-circuit windings), the latter are generally preferable, even when the additional cost is taken into consideration.

In the section upon "The Electro-magnetic Limit of Output," it will be shown that the limitations imposed by the use of practicable electro-magnetic constants restrict the application of two-circuit windings to machines of relatively small output.

Two-circuit windings may be multiple as well as single-wound. Thus

in Fig. 74 we have a two-circuit, doubly re-entrant, double winding. An illustration of the convenience of a double winding, in a case where either one of two voltages could be obtained without changing the number of face conductors, may be given by that of a six-pole machine with 104 armature conductors. The winding may be connected as a two-circuit single winding by making the pitch 17 at each end, or as a two-circuit doubly re-entrant double winding, by making the pitch 17 at one end and 19 at the other.

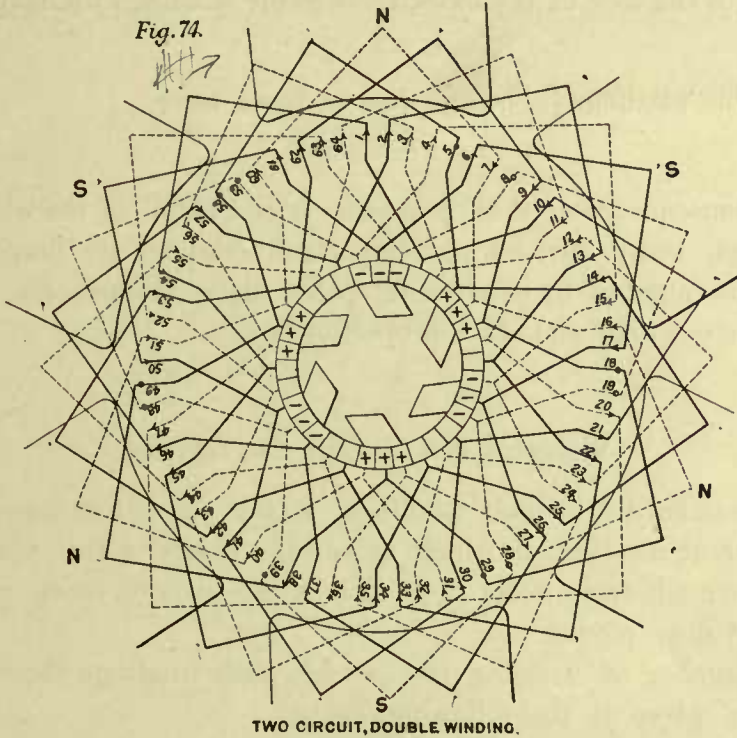

The second would be suitable for the same watt output as the first, but at one-half the voltage and twice the current.

FORMULA FOR TWO-CIRCUIT WINDINGS.

The general formula for two-circuit windings is :

$$C = n y \pm 2 m.$$

where

C = number of face conductors.

n = number of poles.

y = average pitch.

m = number of windings. or plex

The m windings will consist of a number of independently re-entrant windings, equal to the greatest common factor of y and m . Therefore, where it is desired that the m windings shall combine to form one re-entrant system, it will be necessary that the greatest common factor of y and m be made equal to 1.

Also, when y is an even integer the pitch must be taken alternately, as $(y-1)$ and $(y+1)$, instead of being taken equal to y .

Thus, in the case of the two-circuit single windings we have

$$C = n y \pm 2$$

and in double windings (m being equal to 2) we have

$$C = n y \pm 4.$$

As a consequence of these and other laws controlling the whole subject of windings, many curious and important relations are found to exist between the number of conductors, poles, slots, pitches, &c., and with regard to re-entrancy and other properties.¹

WINDINGS FOR ROTARY CONVERTERS.

As far as relates to their windings, rotary converters consist of continuous-current machines in which, at certain points of the winding, connections are made to collector rings, alternating currents being received or delivered at these points.

The number of sections into which such windings should be subdivided are given in the following Table :

TABLE XVIII.

	Two-Circuit Single Winding.	Multi.-Circuit Single Winding.
	Sections.	Sections per Pair Poles.
Single-phase rotary converter ...	2	2
Three-phase rotary converter ...	3	3
Quarter-phase rotary converter ...	4	4
Six-phase rotary converter ...	6	6

For *multiple* windings, the above figures apply to the number of

¹ $y - 3$ and $y + 3$, etc., also give re-entrant systems, but the great difference between the pitches at the two ends would make their use very undesirable except in special cases ; thus, for instance, it would be permissible with a very large number of conductors per pole.

sections per winding: thus, a three-phase converter with a two-circuit double winding would have $3 \times 2 = 6$ sections per pair of poles. In the case of the three-phase rotary converter winding shown in Fig. 75, which is a two-circuit single winding, connection should be made from a conductor to one of the collector rings, and the winding should be traced through until one-third of the total face conductors have been traversed. From this point, connection should be made to another collector ring. Tracing through another third, leads to the point from which connection

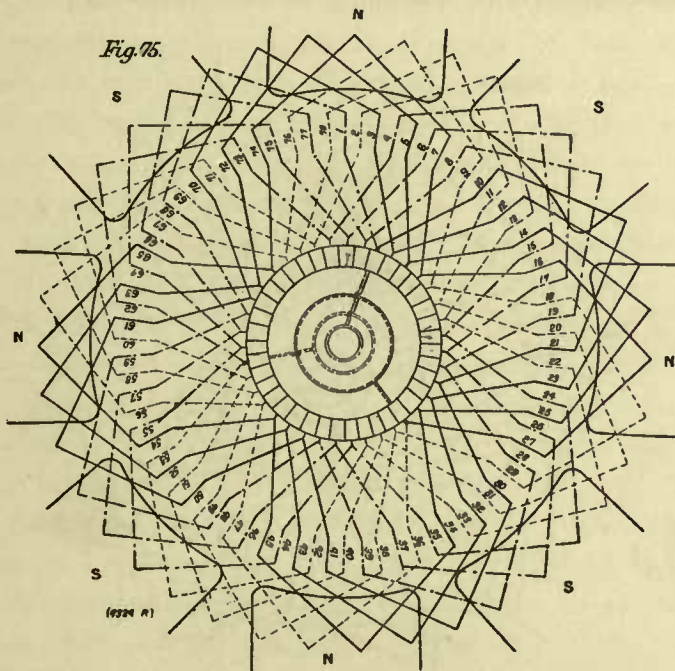

THREE-PHASE ROTARY CONVERTER, TWO-CIRCUIT SINGLE WINDING.

should be made to the remaining collector ring, between which and the first collector ring the remaining third of the total number of conductors would be found to lie. It is desirable to select a number of conductors, half of which is a multiple of three, thus giving an equal number of pairs of conductors in each branch. Where a multiple-circuit winding is used, the number of conductors per pair of poles should be twice a multiple of three. A multiple-circuit three-phase rotary converter winding is given in Fig. 76. Further information regarding the properties of rotary converters, and the resultant distribution of current in their windings, is reserved for the section on "Rotary Converters."

ALTERNATING CURRENT WINDINGS.

In general, any of the continuous-current armature windings may be employed for alternating current work, but the special considerations leading to the use of alternating currents generally make it necessary to abandon the styles of winding best suited to continuous-current work, and to use windings specially adapted to the conditions of alternating current practice.

Attention should be called to the fact that all the re-entrant (or closed circuit) continuous-current windings must necessarily be two-circuit or

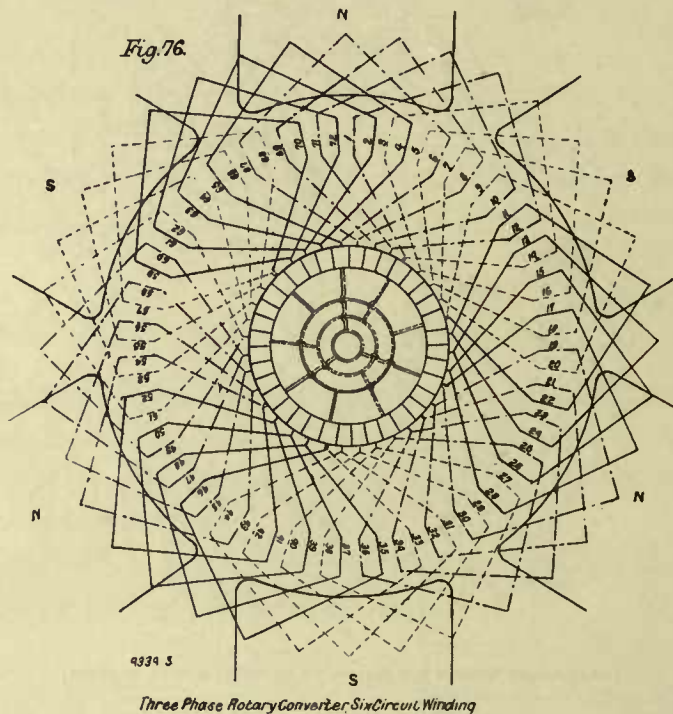

multiple-circuit windings, while alternating current armatures may, and generally do, from practical considerations, have one-circuit windings, *i.e.*, one circuit per phase. From this it follows that any continuous-current winding may be used for alternating current work, but an alternating current winding cannot generally be used for continuous-current work. In other words, the windings of alternating current armatures are essentially non-re-entrant (or open circuit) windings, with the exception of the ring-connected polyphase windings, which are re-entrant (or closed circuit) windings. These latter are, therefore, the only windings which are applicable to alternating-continuous-current commutating machines.

Usually for single-phase alternators, one slot or coil per pole-piece is used (as represented in Figs. 77 and 78), and this permits of the most effective disposition of the armature conductors as regards generation of electromotive force. If more slots or coils are used (as in Fig. 79), or, in the case of face windings,¹ if the conductors are more evenly distributed over the face of the armature, the electromotive forces generated in the various conductors are in different phases, and the total electromotive force is less than the algebraic sum of the effective electromotive forces induced in each conductor.

But, on the other hand, the subdivision of the conductors in several slots or angular positions per pole, or, in the case of face windings, their more uniform distribution over the peripheral surface, decreases the inductance of the winding, with its attendant disadvantages. It also utilises more completely the available space, and tends to bring about a better distribution of the necessary heating of core and conductors. Therefore, in cases where the voltage and the corresponding necessary insulation permit, the conductors are sometimes spread out to a greater or less extent from the elementary groups necessary in cases where very high potentials are used. Windings in which such a subdivision is adopted, are said to have a multi-coil construction (Fig. 79), as distinguished from the form in which the conductors are assembled in one group per pole-piece (Figs. 77 and 78), which latter are called unicoil windings.

In most multiphase windings, multi-coil construction involves only very slight sacrifice of electromotive force for a given total length of armature conductor, and in good designs is generally adopted to as great an extent as proper space allowance for insulation will permit.

It is desirable to emphasise the following points regarding the relative merits of unicoil and multi-coil construction. With a given number of conductors arranged in a multi-coil winding, the electromotive force at the terminals will be less at no load than would be the case if they had been arranged in a unicoil winding; and the discrepancy will be greater in proportion to the number of coils into which the conductors per pole-piece are subdivided, assuming that the spacing of the groups of conductors is uniform over the entire periphery.

But when the machine is loaded, the current in the armature causes reactions which play an important part in determining—as will be shown

¹ Otherwise often designated "smooth core windings," as opposed to "slot windings."

later—the voltage at the generator terminals; and this may only be maintained constant as the load comes on, by increasing the field excitation, often by a very considerable amount. Now, with a given number of armature conductors, carrying a given current, these reactions are greatest when the armature conductors are concentrated in one group per pole-piece

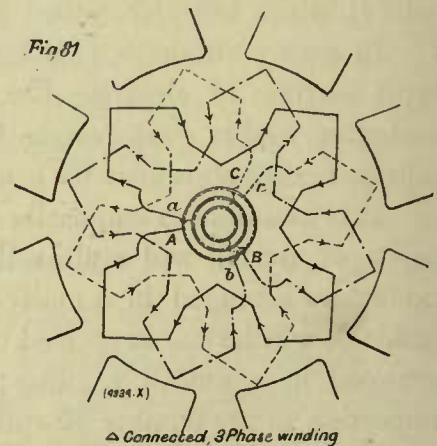
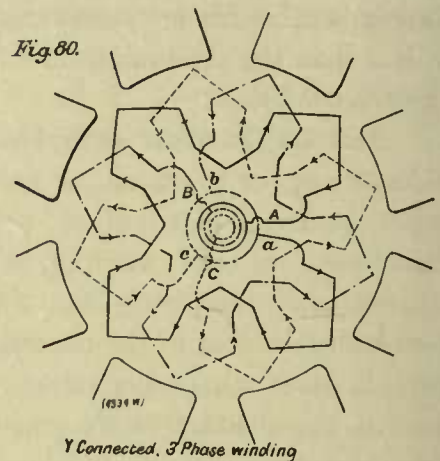
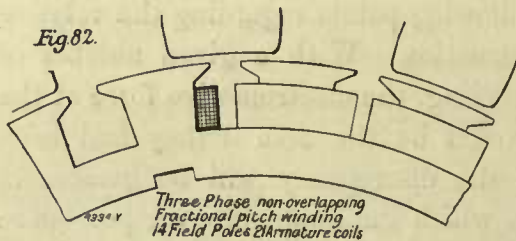
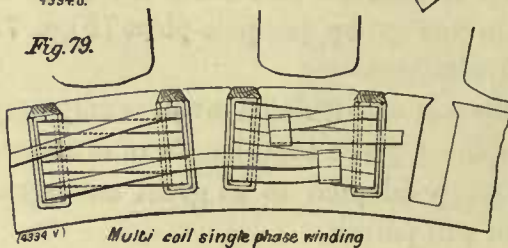
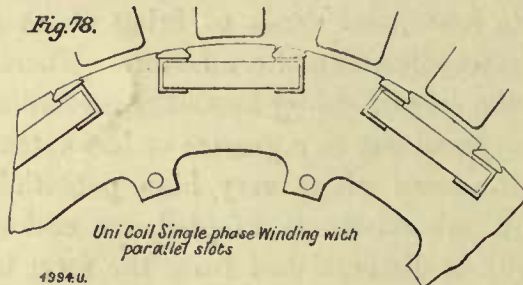
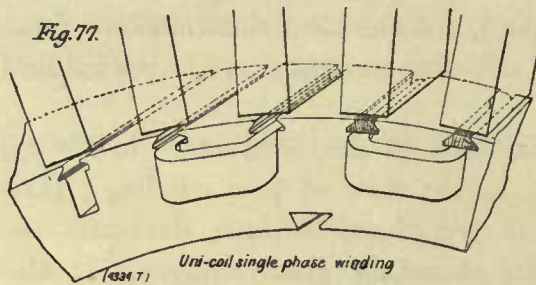

(Figs. 77 and 78); that is, when the unicoil construction is adopted; and they decrease to a certain degree in proportion as the conductors are subdivided into small groups distributed over the entire armature surface, that is, they decrease when the multi-coil construction (Fig. 79) is used. Consequently, there may be little or no gain in voltage at full load by the

use of a unicoil winding over that which would have been obtained with a multi-coil winding of an equal number total of turns, although at *no load* the difference would be considerable. This matter will be found treated from another standpoint in the section on "Formulæ for Electromotive Force."

Multi-coil design (Fig. 79) also results in a much more equitable distribution of the conductors; and, in the case of iron-clad construction, permits of coils of small depth and width, which cannot fail to be much more readily maintained at a low temperature for a given cross-section of conductor; or, if desirable to take advantage of this point in another way, it should be practicable to use a somewhat smaller cross-section of conductor for a given temperature limit. A final advantage of multi-coil construction is that it results in a more uniform reluctance of the magnetic circuit for all positions of the armature; as a consequence of which, hysteresis and eddy current losses are more readily avoided in such designs. A thorough discussion of this matter is given in the section relating to the design of the magnetic circuit.

The unicoil winding of Fig. 77 may often with great advantage be modified in the way shown in Fig. 78, where the sides of the tooth are parallel, enabling the form-wound coil to be readily slipped into place. The sides of the slots are notched for the reception of wedges, which serve to retain the coil in place. Parallel-sided slots become more essential the less the number of poles. For very large numbers of poles, radial slots are practically as good.

Fig. 80 shows a Y -connected unicoil three-phase winding; Fig. 81 differs from it only in having the windings of the three-phases Δ connected.

Fig. 82 gives a portion of a three-phase winding, with fourteen field poles and twenty-one armature coils (three coils per two-pole pieces). This is a representative of a type of windings known as fractional pitch windings, the relative merits of which will be discussed in the section on the design of polyphase generators. The diagrams in Figs 83 and 84 give two more examples of fractional pitch—polyphase windings.¹

INDUCTION MOTOR WINDINGS.

The windings of induction motors are not essentially different from many already described. In order to keep the inductance low, the

¹ See also British Patent Specification No. 30,264, 1897.

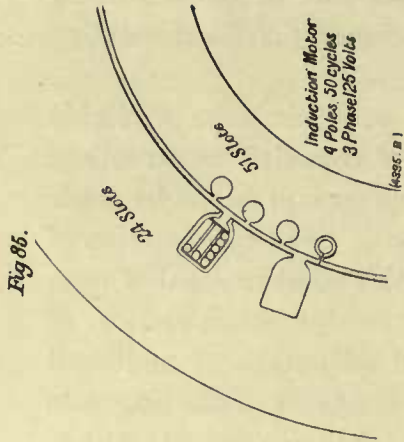

Fig. 85.

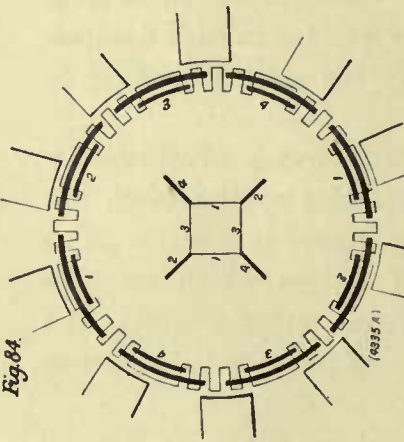

Fig. 84.

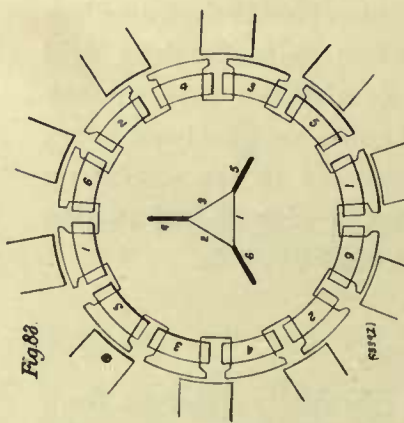

Fig. 88.

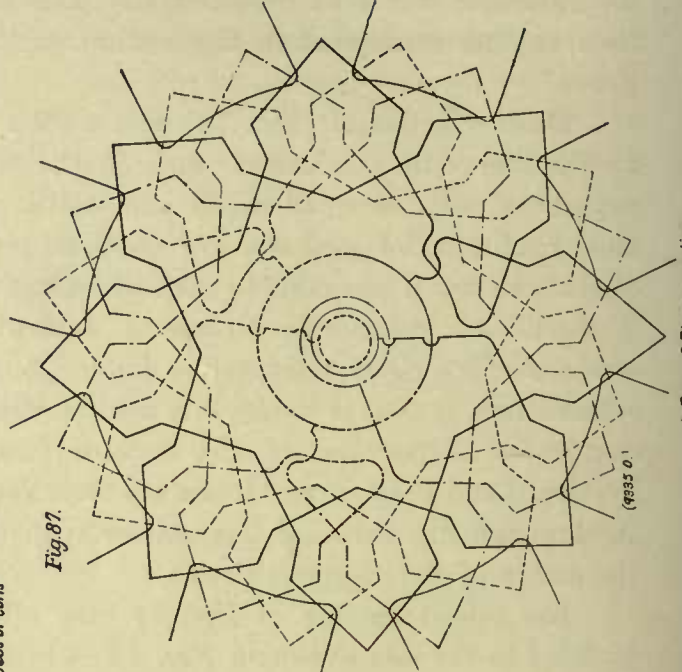

Fig. 87.

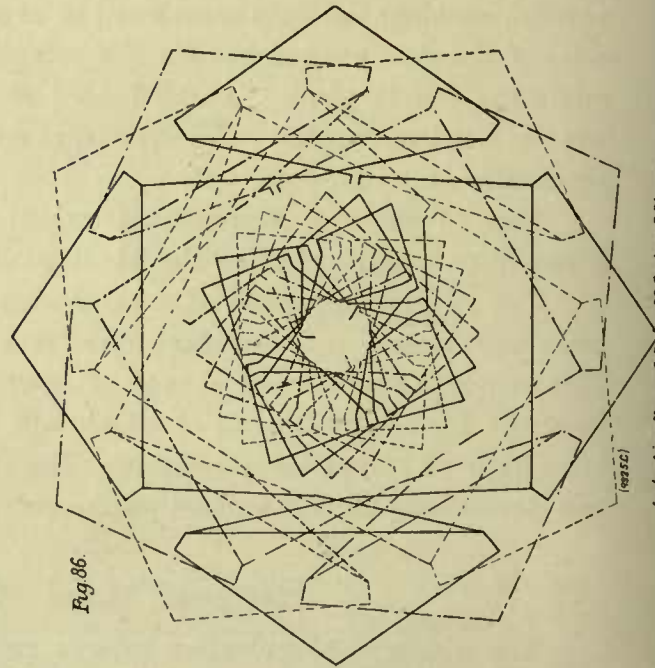

Fig. 86.

windings both for the rotor and stator are generally distributed in as many coils as there can be found room for on the surface, instead of being concentrated in a few large coils of many turns each. This becomes of especial importance in motors of large capacity; in smaller motors the windings may consist of comparatively few coils. This is the case in Fig. 85, where the stator winding of a $7\frac{1}{2}$ horse-power four-pole three-phase motor is divided up into two slots per pole-piece per phase. The rotor, whose winding is generally made up of few conductors, each of large cross-section, is often most conveniently arranged with but one conductor per slot, as shown in Fig. 85. The connection diagrams of these stator and rotor windings are given in Fig. 86. Fig. 87 gives a useful type of winding for either the stator or the rotor of induction motors, the conductors, represented by radial lines, being, in the case of the stator, generally replaced by coils.

The matter of induction motor windings will be more completely considered in the section devoted to the design of induction motors.

FORMULÆ FOR ELECTROMOTIVE FORCE.

In this section, the dynamo will be considered with reference to the electromotive force to be generated in the armature.

CONTINUOUS-CURRENT DYNAMOS.

The most convenient formula for obtaining the voltage of continuous-current dynamos is :

$$V = 4.00 T N M 10^{-8}$$

in which

V = the voltage generated in the armature.

T = the number of turns in series between the brushes.

N = the number of magnetic cycles per second.

M = the magnetic flux (number of C G S lines) included or excluded by each of the T turns in a magnetic cycle.

V, the voltage, is approximately constant during any period considered, and is the integral of all the voltages successively set up in the different armature coils according to their position in the magnetic field; and since in this case, only average voltages are considered, the resultant voltage is independent of any manner in which the magnetic flux may vary through the coils. Therefore we may say that for continuous-current dynamos, the voltage is unaffected by the shape of the magnetic curve, *i.e.*, by the distribution of the magnetic flux.

It will be found that the relative magnitudes of T, N, and M may (for a given voltage) vary within wide limits, their individual magnitudes being controlled by considerations of heating, electro-magnetic reactions, and specific cost and weight.

This formula, if correctly interpreted, is applicable whether the armature be a ring, a drum, or a disc; likewise for two-circuit and multiple-circuit windings, and whether the winding be single, double, triple, &c.

To insure, for all cases, a correct interpretation of the formula, it will be desirable to consider these terms more in detail :

T = turns in series between brushes,
= total turns on armature divided by number of paths through armature from negative to positive brushes.

For a Gramme-ring armature, total turns = number of face conductors.

For a drum armature, total turns = $\frac{1}{2}$ number of face conductors.

With a given number of total turns, the turns in series between brushes depend upon the style of winding, thus :

For two-circuit winding,

If single, two paths, independently of the number of poles.

If double, four paths, independently of the number of poles.

If triple, six paths, independently of the number of poles, &c.

For multiple-circuit winding,

If single, as many paths as poles.

If double, twice as many paths as poles.

If triple, three times as many paths as poles, &c.

$$N = \text{the number of magnetic cycles per second} \\ = \frac{\text{R.P.M.} \times \text{number of pairs of poles}}{60}$$

It has been customary to confine the use of this term (cycles per second) to alternating current work, but it is desirable to use it also with continuous currents, because much depends upon it. Thus N, the periodicity, determines or limits the core loss and density, tooth density, eddy current loss, and the armature inductance, and, therefore also affects the sparking at the commutator. It is, of course, also necessarily a leading consideration in the design of rotary converters.

Although in practice, dynamo speeds are expressed in revolutions per minute, the periodicity N is generally expressed in cycles per second.

M = flux linked successively with each of the T turns.

In the case of the

Gramme-ring machine, M = $\frac{1}{2}$ flux from one pole-piece into armature.

Drum machine, M = total flux from one pole-piece into armature.

(M is not the flux *generated* in one pole-piece, but that which, after deducting leakage, finally not only crosses the air-gap, but passes to the roots of the teeth, thus linking itself with the armature turns.)

Armature cores are very often built up as rings for the sake of ventilation, and to avoid the use of unnecessary material; but they may be, and usually are, wound as drums, and should not be confounded with Gramme-wound rings.

The accompanying Table of drum-winding constants affords a convenient means of applying the rules relating to drum windings.

TABLE XIX.—DRUM-WINDING CONSTANTS.

—	Class of Winding.	Number of Poles.							
		4.	6.	8.	10.	12.	14.	16.	
Volts per 100 conductors per 100 revolutions per minute and flux equal to one megaline	Multiple-circuit	Single	1.667	1.667	1.667	1.667	1.667	1.667	1.667
		Double	.833	.833	.833	.833	.833	.833	.833
		Triple	.556	.556	.556	.556	.556	.556	.556
	Two-circuit	Single	3.33	5.00	6.67	8.33	10.00	11.67	13.33
		Double	1.667	2.50	3.33	4.17	5.00	5.83	6.67
		Triple	1.111	1.667	2.22	2.78	3.33	3.89	4.44
Average volts between commutator segments, per megaline and per 100 revolutions per minute (independent of number of conductors)	Multiple-circuit	Single	.1333	.200	.267	.333	.400	.467	.533
		Double	.0668	.100	.1333	.1667	.200	.233	.267
		Triple	.0445	.0667	.0888	.1111	.1333	.1555	.1778
	Two-circuit	Single	.267	.600	1.068	1.668	2.40	3.27	4.27
		Double	.1333	.300	.534	.834	1.200	1.635	2.14
		Triple	.0888	.200	.356	.556	.800	1.09	1.42

ALTERNATING CURRENT DYNAMOS.

For alternating current dynamos it is often convenient to assume that the curve of electromotive force is a sine wave. This is frequently not the case; and, as will presently be seen, it is practicable and often necessary to consider the actual conditions of practice instead of assuming the wave of electromotive force to be a sine curve.

CURVE OF ELECTROMOTIVE FORCE ASSUMED TO BE A SINE WAVE.

The formula for the effective no-load voltage at the collector ring is :

$$V = 4.44 T N M 10^{-8},$$

this being the square root of the mean square value of the sine wave of electromotive force whose maximum value is :

$$V = 6.28 T N M 10^{-8}.$$

In order that these formulæ may be used, the electromotive force wave must be a sine curve, *i.e.*, the magnetic flux must be so distributed as to

give this result. The manner of distribution of the magnetic flux in the gap, necessary to attain this result, is a function of the distribution of the winding over the armature surface.

- T = number of turns in series between brushes.
- N = number of magnetic cycles per second.
- M = number of C G S lines *simultaneously* linked with the T turns.

The flux will be *simultaneously* linked with the T turns only in the case of uncoil windings, *i.e.*, windings in which the conductors are so grouped that they are all similarly situated in respect to the magnetic flux; in other words, they are all in the same phase.¹

The effective voltage at no load, generated by a given number of turns, will be a maximum when that is the case; and if the voltage for such a case be represented by unity, then the same number of conductors arranged in "two-coil," "three-coil," &c., windings will, with the same values for T, N, M, generate (at no load) voltages of the relative values, .707, .667, &c.; until, when we come to a winding in which the conductors are distributed over the entire surface, as in ordinary continuous-current dynamos, the relative value of the alternating current voltage at no load, as compared with that of the same number of turns arranged in a uncoil winding, will be .637 (which = $\frac{2}{\pi}$).

Tabulating these results we have :

TABLE XX.
Correction Factor for Voltage
of Distributed Winding.

Uncoil winding	... V = 1.000
Two-coil winding	... V = .707 × uncoil winding.
Three-coil winding	... V = .667 × " "
Four-coil winding	... V = .654 × " "
Many-coil winding	... V = .637 × " "

The terms uni-, two-, three-coil, &c., in the above Table indicate whether the conductors are arranged in one, two, three, &c., equally-spaced groups per pole-piece. The conditions are equivalent to the component electromotive forces generated in each group; being in one, two, three, &c., different phases, irrespective of the number of resultant windings into which they are combined.

¹ Fig. 88, on page 84, will be of assistance in understanding the nomenclature employed in designating these windings.

The values given in the Table may be easily deduced by simple vector diagrams.

Instead of using such "correction factors," the following values may be substituted for K in the formula $V = K T N M 10^{-8}$:

TABLE XXI.

	Values for K in Formula.	
	For Effective Voltage.	For Maximum Voltage.
Unicoil winding	4.44	6.28
Two-coil ,,	3.13	4.44
Three-coil ,,	2.96	4.19
Four-coil ,,	2.90	4.11
Many-coil ,,	2.83	4.00

(In all the preceding cases, as they apply only to sine wave curves, the maximum value will be 1.414 times the effective value.)

VALUES OF K FOR VARIOUS WAVES OF ELECTROMOTIVE FORCE AND OF MAGNETIC FLUX DISTRIBUTION IN GAP.

The relative widths and arrangement of pole arc and armature coil exert a great influence upon the magnitude of the effective (and maximum) voltage for given values of T, N, M, because of the different shapes of the waves of gap distribution and induced electromotive force. This is shown by the following Tables, where are given the values of K in the formula :

$$V = K T N M 10^{-8},$$

it being assumed that the magnetic flux M emanates uniformly from the pole face, and traverses the gap along lines normal to the pole face. This assumption being usually far from the facts, the following results must be considered more in the light of exhibiting the *tendency* of various relative widths of pole face and the various arrangements of armature coil, rather than as giving the actual results which would be observed in practice. The results are, nevertheless, of much practical value, provided it is clearly kept in mind that they will be modified to the extent by which the flux spreads out in crossing the gap from pole face to armature face.

The following Table applies to cases where the various components of the total winding are distributed equi-distantly over the armature.

TABLE XXII.—VALUES FOR K.

In the Formula $V = K T N M 10^{-8}$, where V = Effective Voltage.

Winding.	Pole Arc (expressed in per Cent. of Pitch).									
	10.	20.	30.	40.	50.	60.	70.	80.	90.	100.
Unicoil ...	12.6	8.96	7.28	6.32	5.66	5.17	4.78	4.46	4.21	4.00
Two-coil ...	8.96	6.32	5.17	4.21	4.00	3.64	3.40	3.12	3.00	2.83
Three-coil ...	7.30	5.15	4.21	3.84	3.55	3.35	3.08	2.90	2.76	2.55
Four-coil ...	6.32	4.44	4.00	3.72	3.45	3.24	3.02	2.83	2.63	2.45
Many-coil ...	3.93	3.79	3.63	3.44	3.27	3.08	2.88	2.70	2.52	2.32

When the coils are gathered in groups of a greater or less width, the values of K should be taken from Table XXIII. given below.

A better understanding of the nomenclature employed in these two Tables will be obtained by an examination of the diagrams in Fig. 88.

Probably the method used in obtaining these values (simple graphical plotting) is substantially that used by Kapp in 1889. The six values he gives check the corresponding ones in Tables XXII. and XXIII.

TABLE XXIII.—VALUES OF K.

In the Formula $V = K T N M 10^{-8}$, where V = Effective Voltage.

Spread of Armature Coil in per Cent. of Pitch.	Pole Arc (expressed in per Cent. of Pitch).									
	10.	20.	30.	40.	50.	60.	70.	80.	90.	100.
0	12.60	8.96	7.28	6.32	5.66	5.17	4.78	4.46	4.21	4.00
10	9.80	8.20	6.85	6.00	5.50	5.05	4.74	4.42	4.15	3.88
20	8.20	7.40	6.55	5.75	5.25	4.90	4.60	4.35	4.05	3.75
30	7.10	6.55	6.00	5.45	5.05	4.75	4.45	4.20	3.90	3.60
40	6.20	5.80	5.45	5.15	4.85	4.55	4.30	4.00	3.72	3.43
50	5.60	5.32	5.10	4.85	4.60	4.35	4.10	3.85	3.60	3.27
60	5.08	4.90	4.71	4.55	4.39	4.15	3.95	3.68	3.40	3.10
70	4.72	4.60	4.44	4.30	4.18	3.95	3.75	3.45	3.20	2.90
80	4.44	4.30	4.15	4.00	3.85	3.66	3.50	3.25	3.00	2.75
90	4.18	4.00	3.90	3.75	3.60	3.40	3.20	3.00	2.78	2.55
100	3.93	3.79	3.63	3.44	3.27	3.08	2.88	2.70	2.52	2.32

It thus appears that by merely varying the spread of the pole arc and the armature coil, there may be obtained for given values of T, N, and M, values of the effective electromotive force, varying from a little more than half the corresponding value for a sine wave, up to several times that value (in fact, with an infinitely small spread of pole arc, provided the flux could be maintained, an infinitely large value of K would be obtained). The maximum value increases at the same time, in a still greater proportion.

ROTARY CONVERTERS.

In rotary converters we have an ordinary distributed continuous-current winding, supplying continuous-current voltage at the commutator, and alternating-current voltage at the collector rings. The same winding, therefore, serves both for continuous-current voltage and for alternating voltage.

Suppose that such a distributed winding, with given values of T , N , and M , generates a continuous-current voltage V at the commutator. Imagine superposed on the same armature a winding, with the same number of turns T in series, but with these turns concentrated in a unicoil winding. For the same speed and flux, and assuming a sine wave curve of

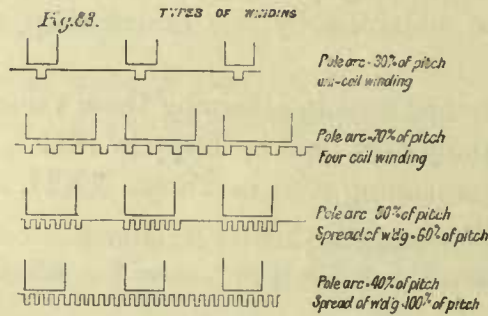

In the above diagrams, the slotted type of armature is represented. The application of the illustrations to the case of smooth core armature merely requires that the conductors be supposed to be grouped on the surface of the armature in the same relative positions as are shown by the position of the slots.
(832A)

electromotive force, this imaginary superposed winding would supply $1.11 V$, $\left(= \frac{\pi}{2\sqrt{2}} V \right)$ effective volts to the collector rings. But, re-arranging this same number of turns in a “many-coil” (distributed) winding, would, for the same speed and flux, reduce the collector ring voltage to

$$.637 \times 1.11 \times V = .707 \times V.$$

Therefore, in a distributed winding, with T turns in series, there will be obtained a continuous-current voltage V , and an alternating-current voltage $.707 V$, on the assumption of a sine wave curve of electromotive force.

But often the electromotive force curve is not a sine wave, and the value of the voltage becomes a function of the pole arc. Thus, examining the case of a single or quarter-phase rotary converter by the aid of the Tables for K , the results given below are obtained.

TABLE XXIV.—SINGLE AND QUARTER-PHASE ROTARY CONVERTERS.

Spread of Pole Arc in per Cent. of Pitch.	K in $V = K T N M 10^{-8}$ for Collector-Ring Voltage.	K for Continuous-Current Voltage.	Ratio of Alternating Voltage between Collector- Rings to Continuous- Current Voltage at Commutator.
10	3.93	4.00	.982
20	3.79	4.00	.947
30	3.63	4.00	.908
40	3.44	4.00	.860
50	3.27	4.00	.816
60	3.08	4.00	.770
70	2.88	4.00	.720
80	2.70	4.00	.675
90	2.52	4.00	.630
100	2.32	4.00	.580

THREE-PHASE ROTARY CONVERTERS.

An examination of three-phase rotary converters will show that the conductors belonging to the three phases have relative positions on the armature periphery, which may be represented thus :

2222211111111111333333333322222222211111111111333333333322222
3333333333222222222111111111113333333333222222221111111111

Consequently, it appears that the coils of one phase have a spread equal to 66.7 per cent. of the pitch. Observing also that each three-phase alternating branch has two-thirds as many turns in series between collector rings as has each branch, considered with reference to the commutator brushes, we obtain the following Table of values :

TABLE XXV.—THREE-PHASE ROTARY CONVERTERS.

Spread of Pole Arc in per Cent. of Pitch.	K in $V = K T N M 10^{-8}$ for Collector-Ring Voltage.	K for Continuous-Current Voltage.	Ratio of Alternating Voltage between Collector- Rings to Continuous- Current Voltage at Commutator.
10	4.89	4.00	.815
20	4.70	4.00	.785
30	4.53	4.00	.755
40	4.39	4.00	.732
50	4.25	4.00	.710
60	4.02	4.00	.670
70	3.82	4.00	.636
80	3.52	4.00	.585
90	3.26	4.00	.544
100	2.96	4.00	.495

The last column, giving the ratio of alternating-current voltage between collector rings, to continuous-current voltage at commutator, is the one of chief interest. This ratio varies from .495, when the pole arc is equal to the pitch, up to .815 with a 10 per cent. pole arc.

These results only apply to rotary converters when independently driven, unloaded, from some mechanical source, or when driven unloaded as a continuous-current motor. That is to say, the electromotive forces referred to are counter-electromotive forces. When driven synchronously, the ratio of the terminal voltages may be made to vary through a very wide range by varying the conditions of lag and lead of the current in

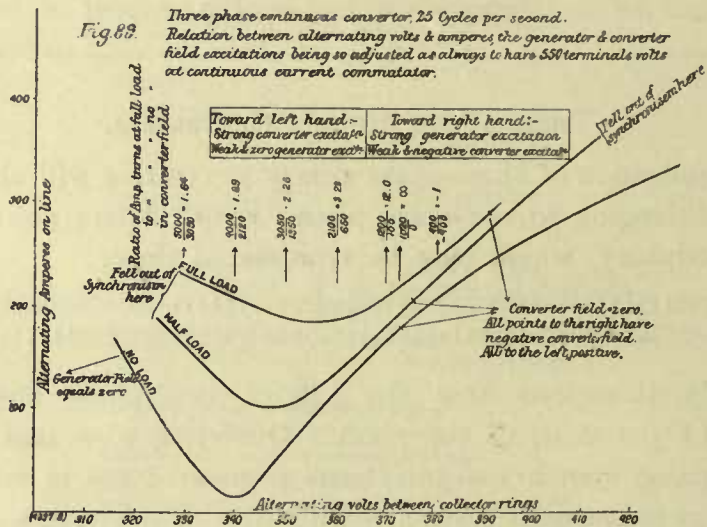

the armature. In Fig. 89 is given a curve showing through what a very extended range this ratio may be varied, according to the conditions of load and excitation.

TABLE XXVI.

Converter.	Proportion that T is of Turns on Arm.	
	2-Circuit Winding.	Multiple-Circuit Winding.
Single-phase rotary	$\frac{1}{2}$	$\frac{1}{2 \times \text{number of pairs of poles}}$
Quarter-phase rotary	$\frac{1}{2}$	$\frac{1}{2 \times \text{number of pairs of poles}}$
Three-phase rotary	$\frac{1}{3}$	$\frac{1}{3 \times \text{number of pairs of poles}}$

In rotary converters, Table XXVI. will be of assistance in determining the value of T (number of turns in series between collector rings).

Polyphase Machines.—In considering polyphase machines in general, it may be said that the most convenient way of considering the relations between V, T, N, and M, is to make the calculations for one phase. Thus in the case of a three-phase machine, one would calculate the volts per

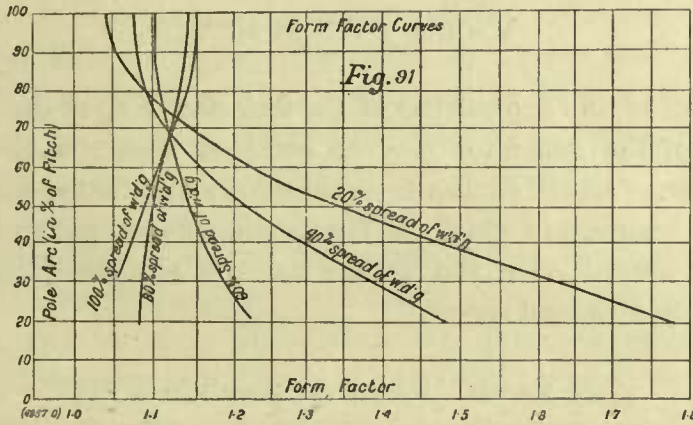
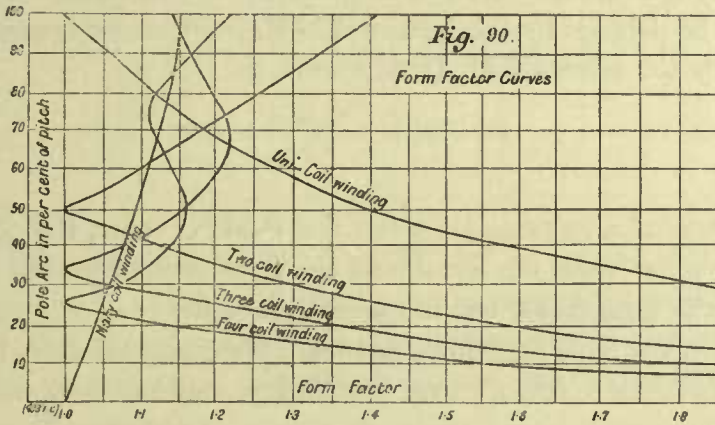

phase, by placing in the formula the turns in series per phase, for T. Then if the winding is "delta" connected, this will give also the volts between collector rings (since there is only the winding of one phase lying between each pair of collector rings). If, on the other hand, the winding is Y connected, the volts between collector rings will be $\sqrt{3}$, (1.732) times the volts per phase. Thus the calculation should be carried out with reference to one phase, the results of interconnecting the windings of the different phases being subsequently considered.

ELECTROMOTIVE FORCE AND FLUX IN TRANSFORMERS.

In the case of transformers, the relation between voltage and flux is dependent upon the wave form of the applied electromotive force, and determinations of these quantities involve the use of the term "form factor," proposed by Fleming.¹ He defines the form factor as the ratio of the square root of the mean of the squares of the equi-spaced ordinates of a curve, to the true mean value of the equi-spaced ordinates. The mean square value he denotes by the letters R.M.S. (root mean square), and the mean value by the letters T.M. (true mean).

$$\text{Form factor} = \frac{\text{R.M.S.}}{\text{T.M.}} = f$$

In the case of a rectangular wave, the R.M.S. value, the T.M. value and the maximum value are equal, and the form factor becomes equal to 1. In this case the form factor has the minimum value.

Peaked waves have high form factors. Denoting the form factor by f , the relation between voltage, turns, periodicity, and flux may be expressed by the equation

$$V = 4.00 f T N M 10^{-8}.$$

The extent of the dependence of the form factor upon the proportions and winding of the generator may be obtained from the two following Tables, the first of which applies to equidistantly distributed windings, and the second to windings in which the face conductors are gathered in groups more or less spread over the surface of the armature, these groups alternating with unwound spaces.

TABLE XXVII.—VALUES FOR FORM FACTOR (f).

Winding _c	Pole Arc (Expressed in Per Cent. of Pitch).									
	10	20	30	40	50	60	70	80	90	100
Uni-coil ...	3.33	2.24	1.82	1.58	1.41	1.29	1.19	1.12	1.06	1.00
Two-coil ...	2.24	1.58	1.29	1.12	1.00	1.10	1.18	1.26	1.34	1.41
Three-coil ...	1.82	1.29	1.06	1.08	1.15	1.21	1.22	1.19	1.17	1.15
Four-coil ...	1.57	1.12	1.07	1.13	1.16	1.14	1.11	1.12	1.17	1.22
Many-coil ...	1.02	1.04	1.06	1.08	1.09	1.11	1.12	1.14	1.15	1.15

¹ *Alternate Current Transformers*, vol. i., second edition, page 583.

TABLE XXVIII.—VALUES FOR FORM FACTOR (*f*).

Spread of Armature Coil in per Cent. of Pitch.	Pole Arc (Expressed in Per Cent. of Pitch.)									
	10	20	30	40	50	60	70	80	90	100
0	3.33	2.24	1.82	1.58	1.41	1.29	1.19	1.12	1.06	1.00
10	2.61	2.05	1.73	1.53	1.37	1.26	1.17	1.11	1.05	1.02
20	2.05	1.83	1.59	1.48	1.31	1.23	1.13	1.08	1.04	1.04
30	1.73	1.59	1.50	1.40	1.25	1.19	1.12	1.07	1.06	1.06
40	1.53	1.48	1.40	1.30	1.21	1.16	1.12	1.09	1.08	1.08
50	1.37	1.31	1.25	1.21	1.17	1.13	1.12	1.09	1.09	1.09
60	1.26	1.23	1.19	1.16	1.13	1.13	1.12	1.11	1.11	1.11
70	1.17	1.13	1.12	1.12	1.12	1.12	1.12	1.12	1.12	1.12
80	1.11	1.08	1.07	1.09	1.09	1.11	1.12	1.13	1.14	1.14
90	1.05	1.04	1.06	1.08	1.09	1.11	1.12	1.14	1.15	1.15
100	1.02	1.04	1.06	1.08	1.09	1.11	1.12	1.14	1.15	1.15

From the formula $V = 4.00 f T N M 10^{-8}$, it appears that for a given effective voltage *V*, the flux *M* may be low in proportion as the form factor *f* is high. This is a distinct advantage in the case of transformers, since their core loss is dependent upon the density of the flux circulating in their iron cores. If a given voltage can be obtained with a small flux, the transformer can be operated at a higher all-day efficiency. Commercial generators of different types differ often by 25 per cent. and more, as regards the form factor of their electromotive force waves. The pre-determination of the form factor thus becomes a matter of considerable interest in the design of alternating-current generators.

While, however, peaked waves insure low core losses for transformers on the circuits, they have the disadvantage that the maximum electromotive force is more in excess of the effective electromotive force than for the less peaked waves. It is, therefore, generally undesirable to so proportion a generator as to obtain an excessively peaked wave.

The curves of Figs. 90 and 91, page 87, correspond to values given in the Tables, and show the extent of the variations obtainable.

THERMAL LIMIT OF OUTPUT.

Viewed from a thermal standpoint, the maximum output of an electric machine is determined by the maximum increase of temperature consistent with good working. The limiting increase of temperature may be determined with respect to durability of the insulating materials used, the efficiency, and the regulation. The increase of temperature is commonly expressed by the ratio of the heat generated in watts, to the radiating surface in square inches, *i.e.*, watts per square inch radiating surface. The increase of temperature of any surface above the atmosphere, and therefore, also, the permissible expenditure of energy per square inch radiating surface, varies according to the nature of the surface, its speed, location, &c. For static surfaces, such as the surfaces of field magnets, the increase of temperature may be taken to be about 80 deg. Cent. per watt per square inch, as measured by a thermometer placed against the cylindrical surface. For cylindrical surfaces of the same nature, but rotated with a peripheral speed of about 3,000 ft. per minute, the increase of temperature per watt per square inch may be taken to be between 30 deg. Cent. and 40 deg. Cent. The increase of temperature per watt per square inch increases as the surface speed is diminished. Thus for smooth-core armatures the increase of temperature is about 25 per cent. greater at a peripheral velocity of 2,000 ft. than at a peripheral velocity of 3,000 ft. per minute. For ventilated armatures of ordinary design, *i.e.*, armatures with interstices, the increase of temperature is between 15 deg. Cent. and 20 deg. Cent. per watt per square inch for a peripheral speed of 3,000 ft. per minute, and between 10 deg. Cent. and 12 deg. Cent. for a peripheral speed of 6,500 ft. per minute.¹ The increase of temperature per watt per square inch varies somewhat with the temperature of the surface, but remains fairly constant for the temperatures used in practice.

In transformers submerged in oil in iron cases, the rise in temperature, as measured by the increased resistance of the windings, is about 35 deg. Cent. per $\frac{1}{10}$ watt per square inch of radiating surface of

¹ The increase of temperature, as determined from resistance measurements, will generally be from 50 per cent. to 100 per cent. in excess of these values. This is clearly shown in the various tests described in the following pages.

the iron case, at the end of ten hours' run. Before this time has elapsed, small transformers will already have reached their maximum temperature, but transformers of 25 kilowatts capacity and larger may continue increasing in temperature for a much longer period. However, transformers are seldom called upon to carry their full load for a longer period than 10 hours. The same transformers, without oil, will have 30 per cent. greater rise.

Large transformers are generally artificially cooled by forced circulation of oil, air, or water, the latter being circulated in pipes coiled about the transformers; and sometimes in the low potential coils of very large transformers, the conductors are made tubular, the cooling medium being forced through them. With artificially-cooled transformers, by using sufficient power for forcing the circulation, the rise of temperature may be kept down to almost any value desired. But, of course, the power applied to this purpose lowers the efficiency of the equipment.

Although constants such as those given above are very useful for obtaining a general idea of the amount of the increase of temperature, they should be used with discretion, and it should be well understood that the rise of temperature is greatly modified by various circumstances, such as:

Field-magnet coils—depth of winding; accessibility of air to surface of spools; force with which air is driven against spool surfaces; shape and extent of magnet cores on which coils are located; season, latitude, nature of location, *i.e.*, whether near boiler-room or in some unventilated corner, or in a large well-ventilated station, or under a car, &c.

Armature windings and cores—similar variable factors, particularly method and degree of ventilation; shape and details of spider; centrifugal force with which air is urged through ventilating ducts; degree of freedom from throttling in ducts; number of ducts; freedom of escape of air from periphery; and peripheral speed. Thus it will be readily understood that the values for rise of temperature per watt per square inch have to be determined from a number of conditions.

Small machines quickly reach the maximum temperature; large machines continue to rise in temperature for many hours. Hence the length of a heat run should be decided upon with reference to the nature of the apparatus and the use to which it is to be put. The heat should be distributed in proportion to the thermal emissivity of each part, with due regard to the permissible rise of temperature. Heating is of positive advantage, in so far as it is limited to temperatures that will keep the

insulation thoroughly dry, and thus tend to preserve it. But it is disadvantageous as regards preservation of insulation, in so far as it overheats and deteriorates it. The permissible temperature is thus dependent upon the nature of the insulation. In railway motors, the field conductors are insulated with an asbestos covering, as the location of the motors does not permit of their being sufficiently large to run cool under heavy loads.

MAGNETS.

The radiating surface of magnets of ordinary design, *i.e.*, those in which the diameter of the magnet coil approximately equals the length, is ordinarily taken to be the cylindrical surface; no account being taken of the ends, which in general are not very efficient for the radiation of heat; when, however, the magnets are very short, and the surface of the ends large, they should be considered.

ARMATURES.

Radiating surface of armatures in general, is taken to be the surface of those parts in which heat is generated, that are directly exposed to the air. Due allowance should be made for the different linear velocities of different portions of the armature windings. Thus in the ordinary Siemens type of armature the radiation per square inch, or thermal emissivity, at the ends, averages only about two-thirds that at the cylindrical surface, the difference being due to the difference in surface speed. In the case of armatures of very large diameter, the thermal emissivity at the ends becomes approximately equal to that of the cylindrical portion when the armatures are not very long. When the armatures have a length approaching half the diameter of the armature, the thermal emissivity at the ends may considerably exceed that midway between the ends of the armatures, unless special means for ventilating are resorted to.

In the "barrel" type of winding, now largely used, the end connections are approximately in the same cylindrical surface as the peripheral conductors, being supported upon a cylindrical extension from the spider. Here the entire armature winding revolves at the same peripheral speed, and is in the best position as regards ventilation.

The radiation of heat from an armature is not affected greatly by varying the surface of the pole-pieces, within the limits attained in ordinary

practice. If, however, the magnets are rectangular in section, and placed closely together, the radiation of heat from the armature may be considerably restricted. Further, unless the magnets are so placed with respect to each other that the heat of each is carried off independently of that of the others, special means for ventilating will have to be resorted to, and the values given above will not hold. Such constructions as the last two mentioned are not recommended for general practice.

EXAMPLE OF ESTIMATION OF TEMPERATURE RISE.

Diameter of a certain ironclad armature	= 35 in.
Length, over winding	= 25 „
Speed	= 360 revs. per min.
Internal diameter	= 18 in.
$35 \times \pi \times 25$	= 2750. sq. in.
$18 \times \pi \times 25$	= 1420. „
$\frac{\pi}{4} \times (25^2 - 18^2) \times 2$	= 470. „

Total radiation surface	= 4640. „

Peripheral speed = $\pi \times \frac{35}{12} \times 360$. = 3300. ft. per min.

If well ventilated by internal ducts, it should be very safe to take 22 deg. Cent. rise of temperature per watt per square inch.

		Watts.
Core loss	...	5000
Armature C ² R	...	2600

Total loss	...	7600

$\therefore \frac{7600}{4640} = 1.64$ watts per sq. in.

$\therefore 1.64 \times 22 = 36$ deg. Cent. rise of temperature at end of 10 hours' run at full load.

INTERNAL AND SURFACE TEMPERATURE OF COILS.

The importance of determining the internal temperature of coils, by resistance measurements, instead of relying upon the indications of a thermometer placed upon the surface, is well shown by the results of the following test. An experimental field-magnet coil was wound up with 2,646 total turns of No. 21 B.W.G., the winding consisting in 38 layers, from every pair of which, separate leads were brought out, to enable the

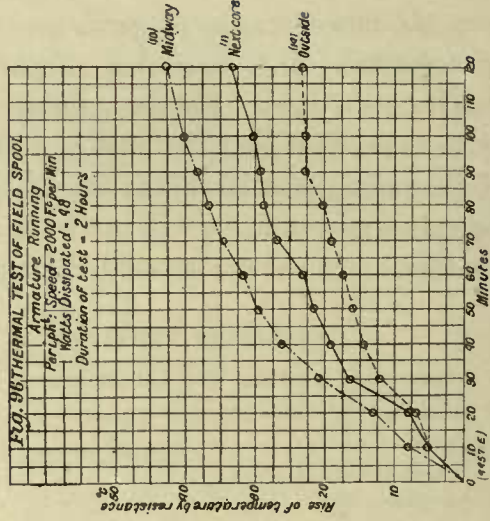
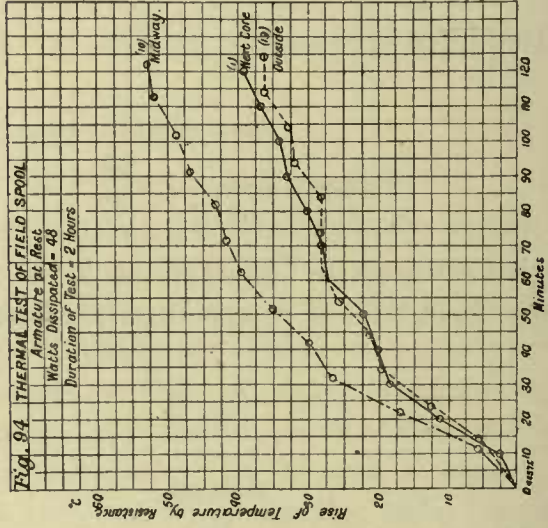
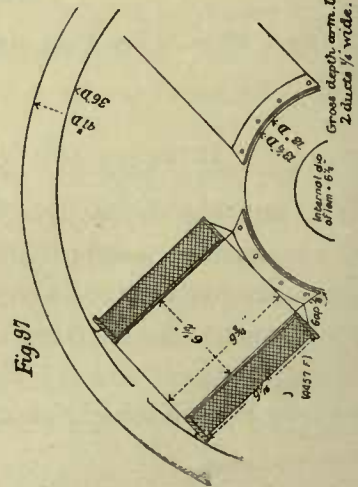
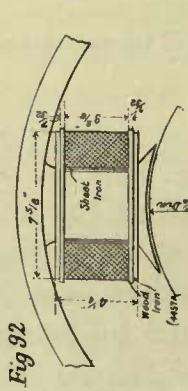
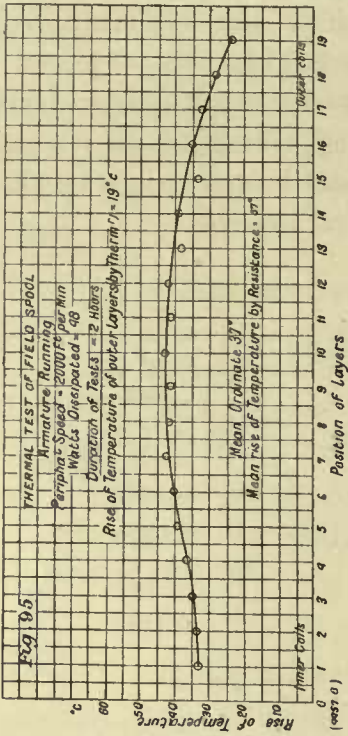
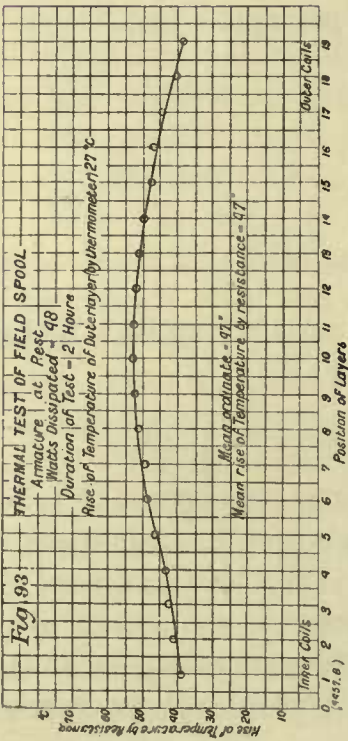

temperature of all parts of the coil to be determined by resistance measurements.

Two distinct tests were made, one with the armature at rest, and the other with the armature running at a peripheral speed of 2,000 ft. per minute. Each test lasted two hours, the current through the coil being maintained constant at one ampere throughout both tests. Every ten minutes a reading was taken on a voltmeter across each pair of layers, thus giving a record of the change in resistance as the test progressed. A dimensional sketch of the coil, pole-piece, and armature is given in Fig. 92, and the results of the tests are plotted in the curves of Figs. 93, 94, 95, and 96.

For the armature at rest (Fig. 93) shows the ultimate rise of

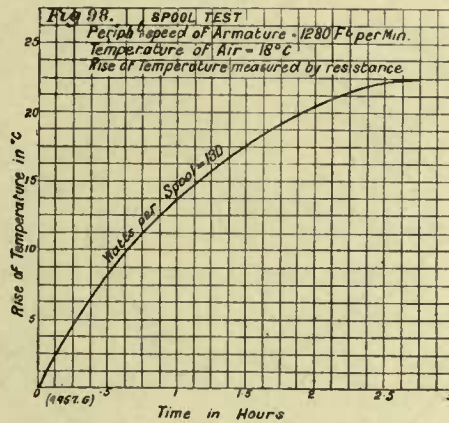

temperature in the different layers plotted against the positions of those layers; and Fig. 94 shows the rise of temperature in the innermost layers, the middle layers, and the outside layers, plotted against time. The curves show well that without the aid of the circulation of air set up by the rotation of the armature, the metal of the field-magnet core is as effective in carrying away the heat, as is the air which bathes the surface of the spool. For the armature running at a peripheral speed of 2,000 revolutions per minute, the results are plotted in the curves of Figs. 95 and 96. The latter figure shows that with the circulation of air set up by the rotation of the armature, the outside of the coil is maintained much cooler than is the inner surface adjoining the field-magnet core. But the most significant conclusion to be drawn from the tests is that shown by Figs. 93 and 95, namely, that the temperature of the interior layer of a coil may considerably exceed the

temperature corresponding to the average rise of resistance of the total winding.

In Figs. 97 and 98 are given respectively a sketch of the field-magnet and spool of a machine, and the result of a heat test taken upon it, in which the average temperature of the field spools was determined from time to time, by means of resistance measurements of the field winding.

The influence of the peripheral speed of the armature upon the constants for determining the temperature increase of field spools, as well

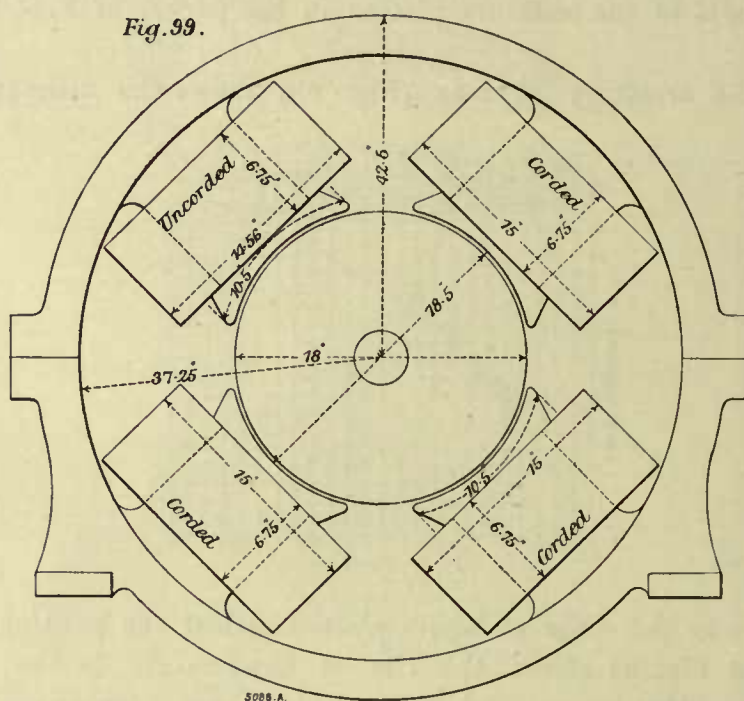

as the effect of covering the wire with a final serving of protecting cord, are clearly shown by the results of the following test made upon the field spools of a continuous-current generator of 35 kilowatts rated output. The tests were made with a wide range of field excitation, and the temperatures were determined both by thermometric and resistance measurements. The results afford a check upon the more general values given on page 90 for predetermining the temperature rise of spools.

In Fig. 99 is given a dimensional sketch of the machine, and in Figs. 100 to 111 are given curves of results of the various heat runs. The curves of Fig. 112 summarise the average results obtained.

Out of the four field spools, two only were under observation, *i.e.*, the top two. On one of these two spools the cording and insulation was taken off, and the winding exposed directly to the air; the remaining spools remained corded. For the purpose of measuring the outside temperature of the spools, thermometers were placed, for the one spool on the outside of the winding, and for the other spool on the outside of the cording; the third temperature measurement was determined from the resistance increase of the four spools in series. Thus, three temperature measurements were made:—

1st. On the outside of the uncorded spool, by thermometer.

2nd. " " corded " "

3rd. Increase of temperature of the four spools by resistance.

The four spools were connected in series, the amperes input being kept constant, and the volts drop across the four spools noted.

In the first case, the armature remained stationary, and results were obtained with .5, .75 and 1 ampere. These results are set forth in the curves of Figs. 100 to 105.

The armature was then revolved at a peripheral speed of 2000 ft. per minute, and temperature rises observed at .75, 1 and 1.25 amperes. In this case, a different procedure was adopted. On the temperature reaching a constant value with .75 ampere, the test was carried on, the amperes being raised to 1, and again, after reaching a constant value, to 1.25 amperes. At this point the temperature reached a value above which it was not advisable to go. Results of this test are set forth in the curves of Figs. 106 and 107.

Two further tests were carried out on similar lines, at peripheral speeds of 3,500 ft. and 4,800 ft. per minute, results of which are set forth in the curves of Figs. 108 to 111.

From the curves of Fig. 112, in which the average results of all these tests are summarised, it will be noted that a considerable increase of speed above 2,000 ft. per minute does not, for this machine, reduce the temperature rise to any very great extent.

On each of the curves a table is given, setting forth the working data, and the constants derived from the tests. It will be noted that the results are figured from the assumption that the watts dissipated remain constant, whereas in reality they vary as the temperature alters; but as this variation would complicate the calculations, these are based on the resistance at 20 deg. Cent., namely, 108 ohms per spool.

INFLUENCE OF PERIPHERAL SPEED ON TEMPERATURE RISE.

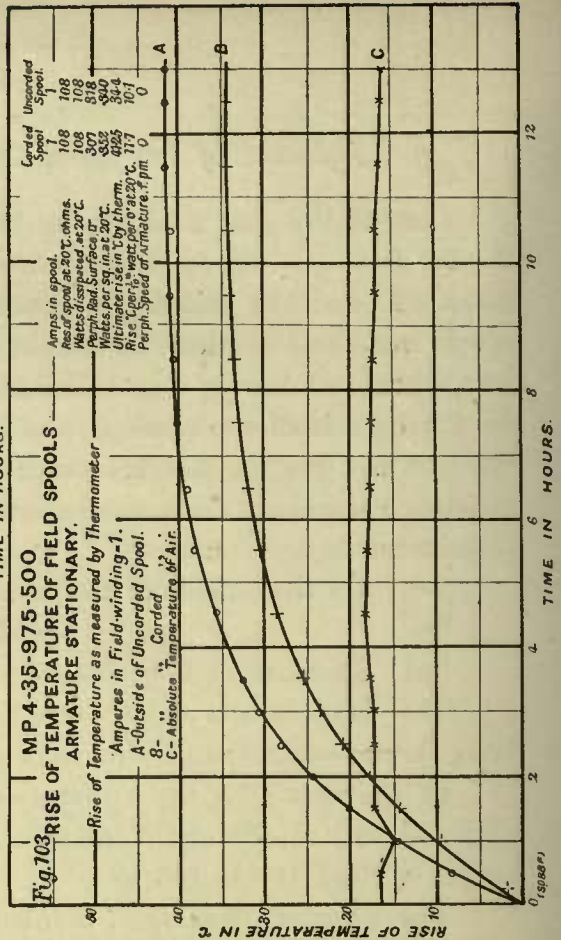
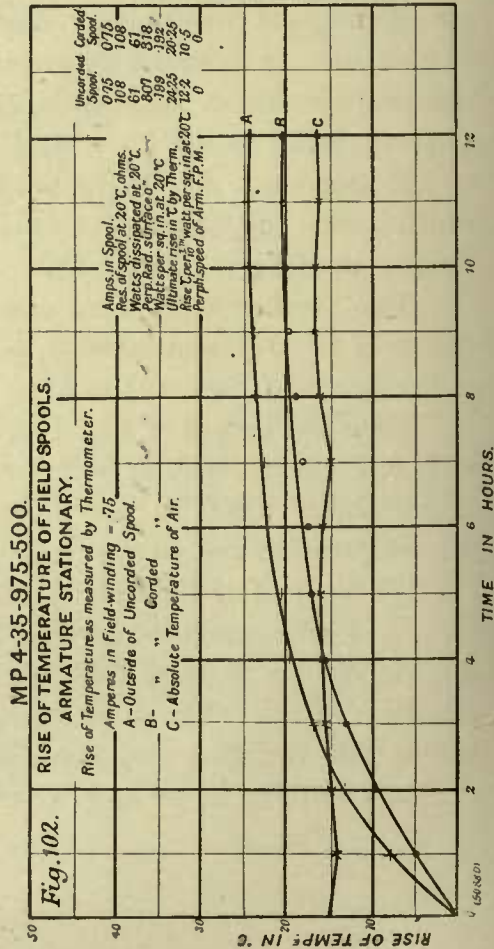
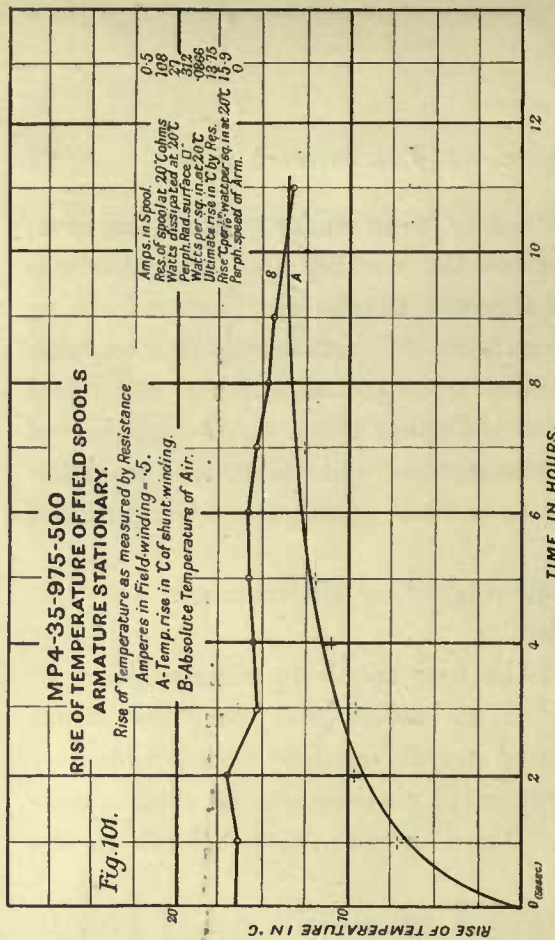
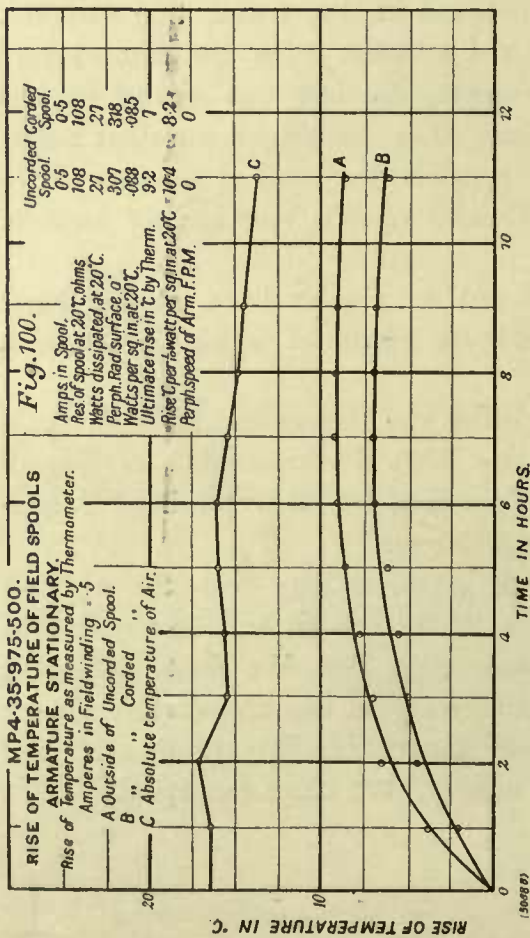

INFLUENCE OF PERIPHERAL SPEED ON TEMPERATURE RISE.

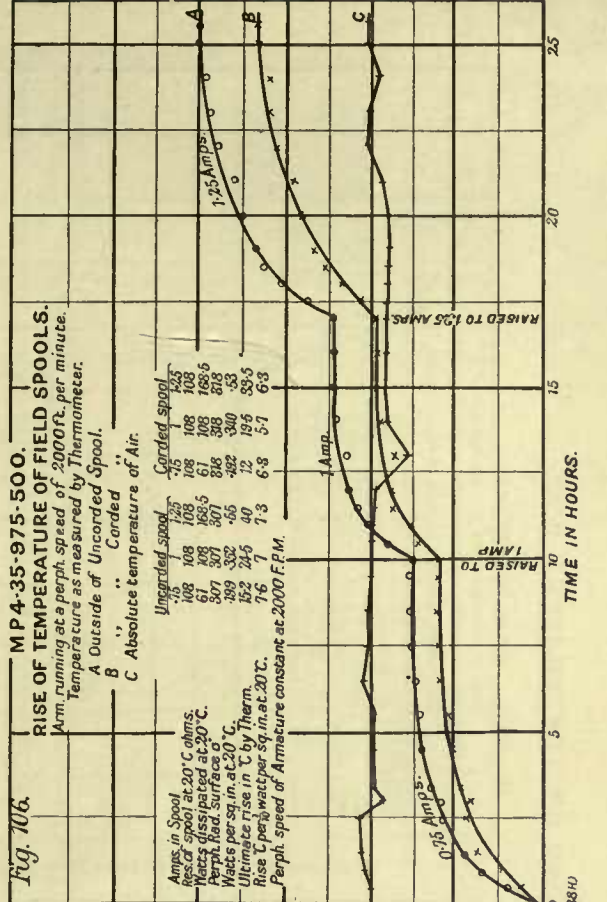
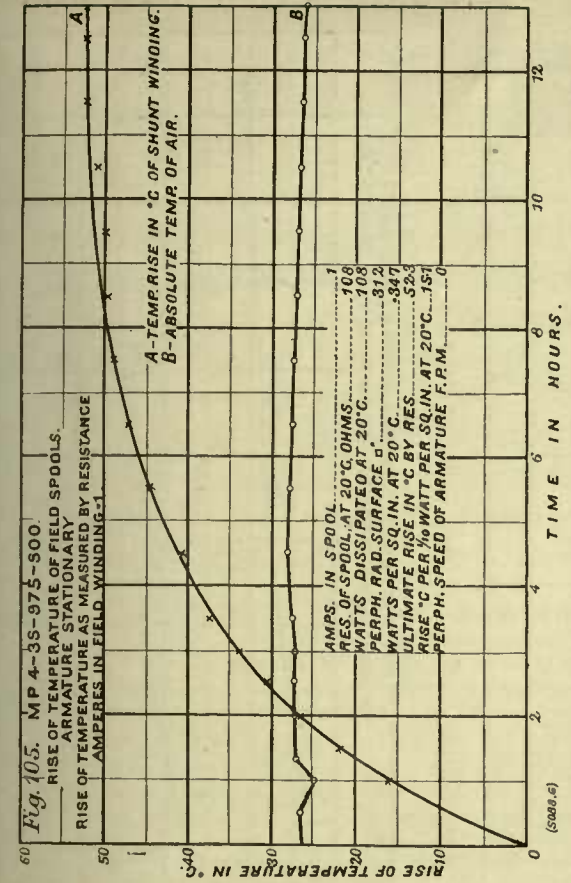
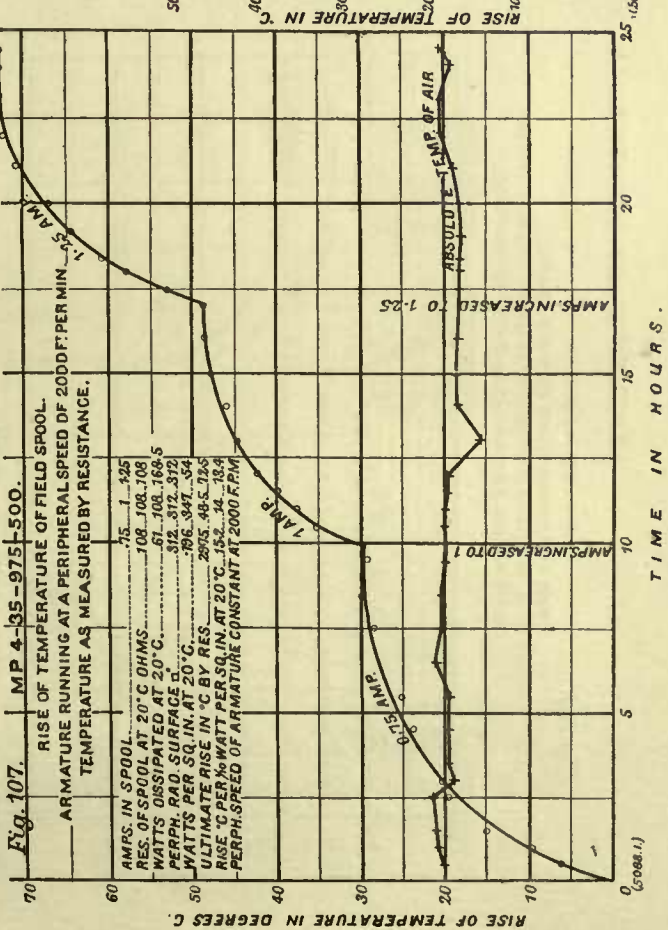
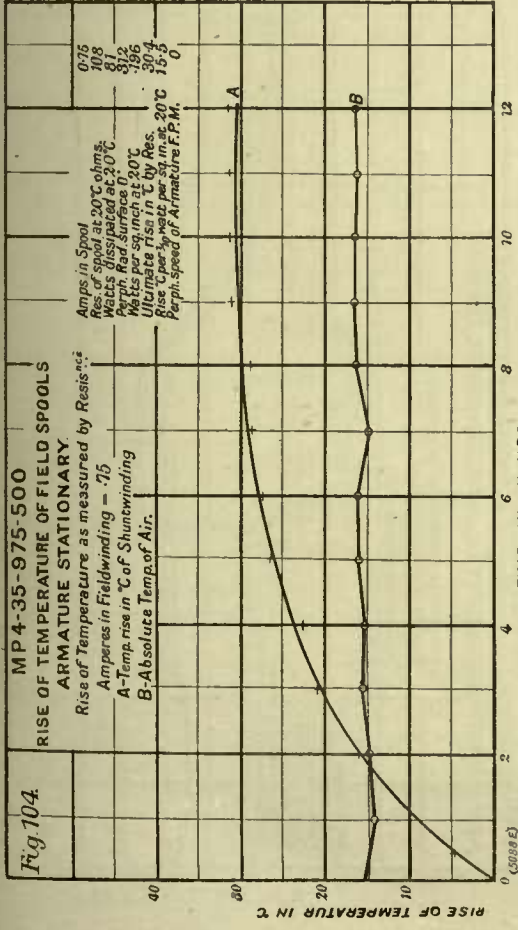

INFLUENCE OF PERIPHERAL SPEED ON TEMPERATURE RISE.

Fig. 108.

MP 4-35-975-500.
RISE OF TEMPERATURE OF FIELD SPOOLS.
ARMATURE RUNNING AT A PERIPHERAL SPEED OF 3500 FT. PER MIN.
TEMPERATURE AS MEASURED BY THERMOMETER.

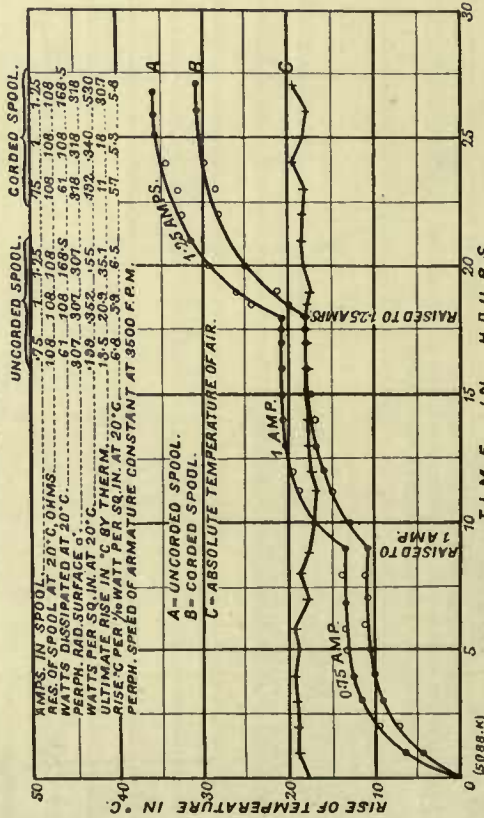

Fig. 109.

MP 4-35-975-500.
RISE OF TEMPERATURE OF FIELD SPOOLS.
ARMATURE RUNNING AT A PERIPHERAL SPEED OF 3500 FT. PER MIN.
TEMPERATURE AS MEASURED BY RESISTANCE.

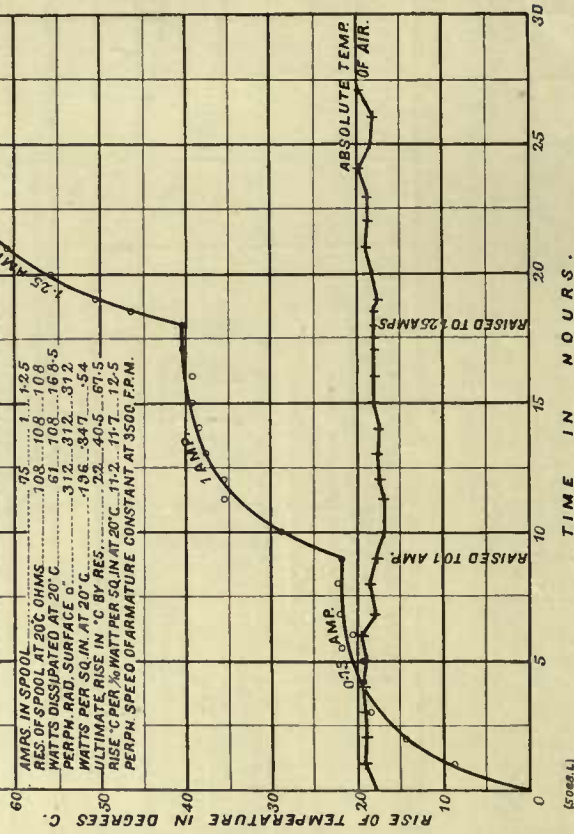

Fig. 110.

MP 4-35-975-500.
RISE OF TEMPERATURE OF FIELD SPOOLS
ARM. RUNNING AT A PERIPHERAL SPEED OF 4800 FT. PER MIN.

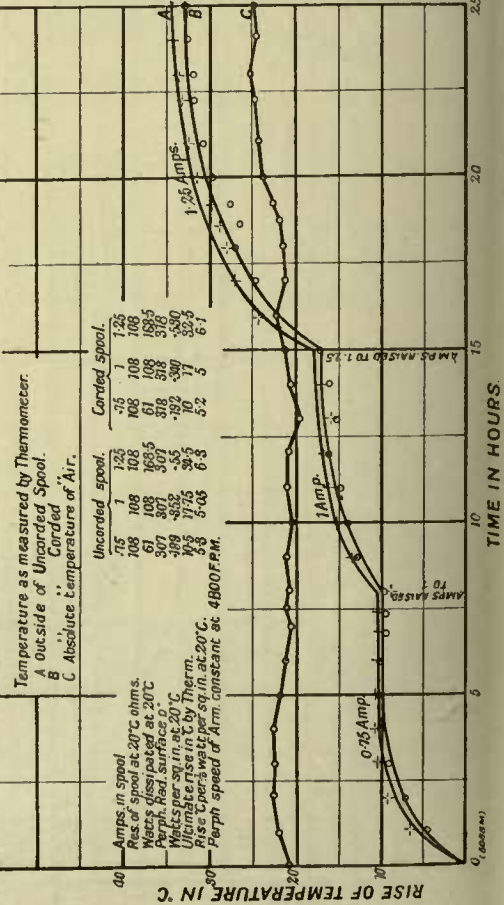
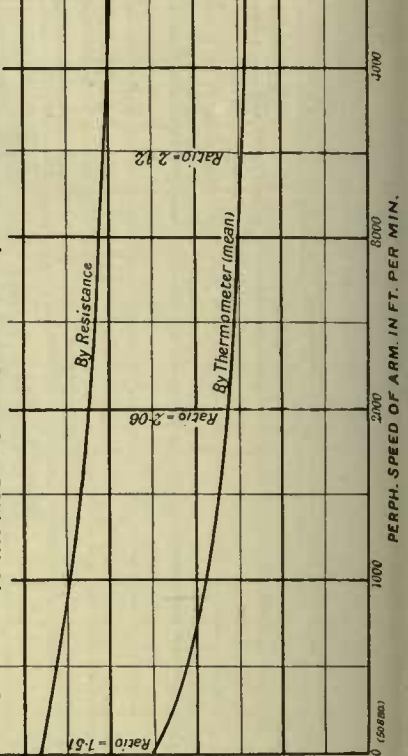
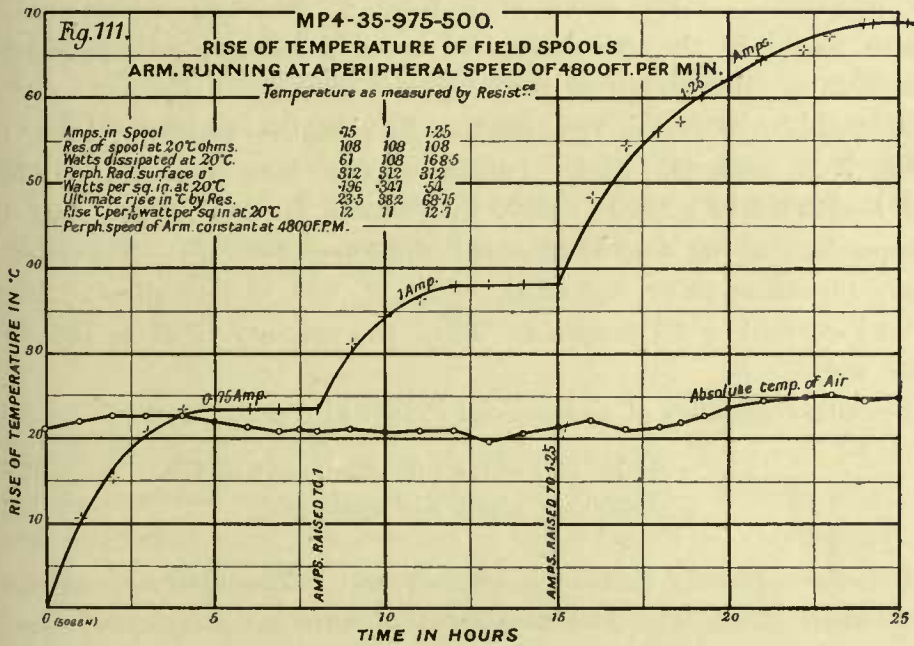

Fig. 112.



The peripheral radiating surfaces of the two spools differ, owing to the cording having been removed in the one case; therefore, in figuring on the thermometer measurements of the corded and uncorded spools, their respective radiating surfaces are used; but in the case of the measurements of temperature rise by resistance, a mean peripheral radiating surface is taken.

It should furthermore be noted that the higher the peripheral speed of the armature, the less is the difference between the temperature rise observed from thermometric readings on the surfaces of the corded and the uncorded spools.



The armature had two ventilating ducts, each one half-inch wide, through which air was thrown out centrifugally, after entering through the open end of the armature spider.

HEAT LOSSES— $C^2 R$ DUE TO USEFUL CURRENTS IN THE CONDUCTORS.

Heat generated, due to the current and resistance, is calculated directly from these two factors. The resistances should be taken to correspond to the temperature the conductors attain in practice. To determine this temperature, resistance measurements are much more reliable than thermometric measurements. For standard sizes of wire, the resistance is most conveniently determined by ascertaining from tables,

Example.—An armature has a conductor .60 in. by .30 in. = .180 square inches in cross-section. It has an eight-circuit double winding. Total turns = 800. Mean length of one turn = 60 in. Turns in series between brushes = $\frac{800}{8 \times 2} = 50$. Therefore, length of winding between positive and negative brushes = $50 \times 60 = 3000$ in. Cross-section = $8 \times 2 \times .18 = 2.88$ square inches. Therefore resistance at 0 deg. Cent. = $\frac{3000 \times .00000063}{2.88} = .000655$ ohms. Suppose the full-load current of 4000 amperes heats the armature conductors to 60 deg. Cent. Then the armature $C^2 R$ at 60 deg. Cent. = $4000^2 \times .000655 \times 1.25 = 13,100$ watts.

The Tables of properties of commercial copper wire is supplemented by a Table in the Appendix, giving the physical and electrical properties of various metals and alloys. This Table, used in connection with the others, permits of readily determining resistances, weights, dimensions, &c., of various conducting materials.

FOUCAULT CURRENTS.

In addition to the $C^2 R$ losses in the conductors, there are losses due to parasitic currents, often termed eddy, or foucault currents, when solid conductors, if stationary, are exposed to the influence of varying induction from magnetic fields; and whenever they are moved through constant magnetic fields, except in cases where the solid conductors are shielded from these magnetic influences.

In armatures with smooth-core construction, the conductors are not screened from the magnetic field, consequently there may be considerable loss in the conductors, from foucault currents. This loss has been found to vary greatly, according to the distribution and density of magnetism in the air-gap, and cannot be accurately predetermined.

In practice this loss is kept as small as possible; in the case of bar windings, by laminating the bars and insulating them from each other; or in the case of wire windings, by using conductors $\frac{1}{16}$ -in. or less in diameter, and twisting these into a cable. The amount by which the foucault current loss can be lessened in this last method is forcibly illustrated by the following example: The winding of a certain armature consisted of four

wires in parallel, each 0.165 in. in diameter. These conductors were replaced by 19 strands of cable having the same cross-section of copper, and the total loss of the armature was diminished by one-third.

In iron-clad dynamos, the conductors are more or less protected from eddy currents by being embedded in slots. This exemption from such losses depends upon the extent to which the teeth overhang, and upon the density in the teeth; very high density throwing part of the lines through the slots, instead of permitting them all to be transmitted along the teeth. Even where the tooth density is low, stranded conductors must sometimes be used in iron-clad armatures. As an instance, may be cited the case of an alternating current armature with a slot of the proportions shown in Fig. 113. Here solid conductors of the proportions shown were at first used, but the cross-flux set up by the armature current was perpendicular to the plane of the conductors, and excessive heating resulted from the eddy currents set up in the solid conductors. Stranded conductors should be used in such a case.

Stranded conductors are open to the objections of increased first cost, and of having from 15 per cent. to 20 per cent. higher resistance for given outside dimensions. This increased resistance is not entirely due to the lesser total cross-section of the component conductors, but also partly to their increased length, caused by the twist given them in originally making up the conductor. The stranded conductor, constructed, in the first place, with a circular cross-section, is pressed to the required rectangular section, in a press operated by hydraulic pressure. No precautions, such as oxidising, or otherwise coating the surface of the component wires, are necessary. The mere contact resistance suffices to break up the cross-currents.

Closely related to the losses just described, are the eddy current losses in all solid metal parts subjected to inductive influences. This occurs chiefly in pole-faces; but if the proportions of the armature are such that, in passing the pole-pieces, the reluctance of the magnetic circuit is much varied, eddy currents will be found throughout all solid parts of the entire magnetic circuit. Consequently, in such cases, not only the pole-pieces, but the entire magnetic yoke, should be laminated. Such a construction has been used in alternators, with the result that, especially in the case of uni-slot armatures, a very marked improvement has been made in efficiency and in heating.

In continuous-current machines, the surface of the armature is broken

up by a large number of small slots, and the disturbance is mainly local, the reluctance of the magnetic circuit, as a whole, remaining unchanged. Nevertheless, in such cases, the loss in the neighbourhood of the pole-face may be large, and will be found to depend chiefly upon the depth of the air-gap as related to the width of the slot opening. Instances have occurred in small machines, where increasing the depth of the air-gap from $\frac{1}{8}$ in. to $\frac{1}{4}$ in., has greatly modified the magnitude of such pole-face losses, Straight-sided armature slots give, of course, much greater losses in the pole-face than slots with overhanging projections, while if the slots are completely closed over, the loss is practically eliminated.

Pole-faces frequently consist of a laminated structure, cast in, or sometimes bolted on, to the upper portion of the magnet core. Another

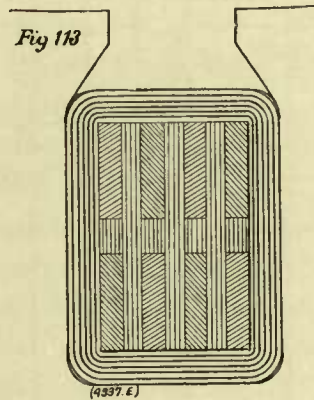

type of construction consists in laminating the entire magnet core and casting it into the solid yoke.

In the neighbourhood of conductors and coils which are the seat of high magneto-motive forces, solid supports, shields, and the like, should be avoided, unless of high resistance, non-magnetic material, such as manganese steel. For this reason spool flanges could also well be made of manganese steel.

Eddy-current losses in the sheets of armature cores are dependent upon the square of the density of the flux, the square of the periodicity, and the square of the thickness of the sheets. Also upon the care with which the laminations are insulated from each other. It is, therefore, important to avoid milling and filing in slots, as this tends to destroy the insulation, and makes a more or less continuous conductor parallel to the copper conductors. Consequently, the eddy-current loss is quite largely

dependent upon the relative magnitudes of flux, number of turns, and length of armature parallel to the shaft, as upon these quantities depends the volts per unit of length tending to set up parasitic currents in the armature core. Owing to the less amount of machine work, smooth-core armatures are much more apt to be free from parasitic currents in the core. The more such losses from eddy currents are anticipated from the nature of the design, the greater should be the safety factor applied to the value of the core loss as derived from the curves of Figs. 35 and 36 (see page 34).

Armature punchings should, when possible, be assembled without any milling or filing. Cases are on record where the milling of armature slots

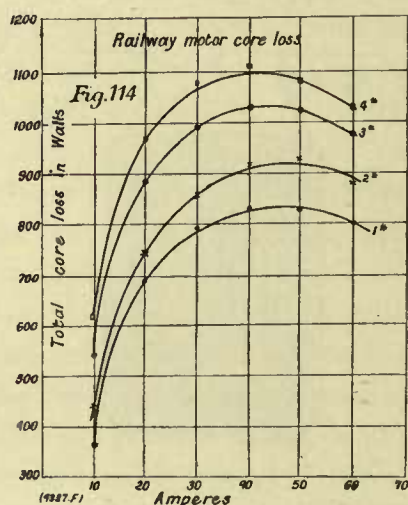

has increased the core loss to three times its original value, the metal removed by milling being merely a thin layer from the sides of the slot. Even light filing increases the core loss considerably. Most of the increase, in both these cases, is due to the burring of the edges making a more or less continuous conductor, although there is also a slight increase due to injuring the quality of the iron by mechanical shock.

In a modern railway motor, this matter was studied by testing the core loss at various stages of the process of manufacture. The curves of Fig. 114 represent the average results from tests of two armatures.

- Curve 1 was taken after assembling the punchings.
 „ 2 „ teeth were wedged straight.
 „ 3 „ slots were slightly filed.
 „ 4 „ winding.

The difference between curves 3 and 4 gives the eddy-current loss in the conductors. The particular shape of the curves possesses no especial significance in connection with the object of the investigation, and is merely due to the armature having been driven at the various speeds corresponding to the conditions of practice for the corresponding values of the current.

HYSTERESIS LOSS IN CORES.

The hysteresis loss in armature cores may be estimated directly from curve A of Fig. 35 (page 34), which represents the magnetic grade of iron generally used in armature construction. However, the temperature of annealing, and the subsequent treatment of the iron, materially influence the result.

In Fig. 115 (page 108) are given three curves of total core losses of three railway motor armatures.

Curve 1. Iron annealed after punching.

Curve 2. Iron annealed before punching.

Curve 3. Iron not annealed.

Nevertheless, it is very likely that in the case of a railway motor armature, the rough conditions of service soon largely destroy any temporary gain from annealing subsequent to punching.

In Fig. 116 the total core loss in the armature with unannealed iron has been analysed, and the hysteresis and eddy current components are shown in curves Nos. 2 and 3, the resultant loss being given in curve No. 1.

The question of core loss is not of vital importance in armatures, being of chief interest from the thermal standpoint. But with transformers it is of the utmost importance, as it is the controlling factor in determining the all-day efficiency. Special consideration will be given hereafter to the matter of core loss in transformers. At this point it will be sufficient to state that iron of at least as good quality as that shown in Curve B of Fig. 35, should be specified and secured. Even with sheets carefully japanned, or separated by paper, the eddy-current loss in transformers will be from once and a half to twice the theoretical value given in the curves of Fig. 36. This may, perhaps, be explained by supposing the flux not to follow the plane of the sheet, but to sometimes follow a slightly transverse path, thus having a component in

a direction very favourable for the setting up of eddy currents in the plane of the sheets. In Figs. 139 and 140, on page 136, will be found curves especially arranged for convenience in determining *transformer* core losses.

In addition to considering the subject of heating from the standpoint of degrees rise of temperature per watt per square inch of radiating surface, it is useful in certain cases to consider it on the basis of rate of generation of heat, expressed in watts per pound of material. Similarly to the manner in which the curves of Figs. 35 and 36 give the rate of generation of heat in iron by hysteresis and eddy currents, there are given in Fig. 117 curves showing the rate of generation of heat in copper,

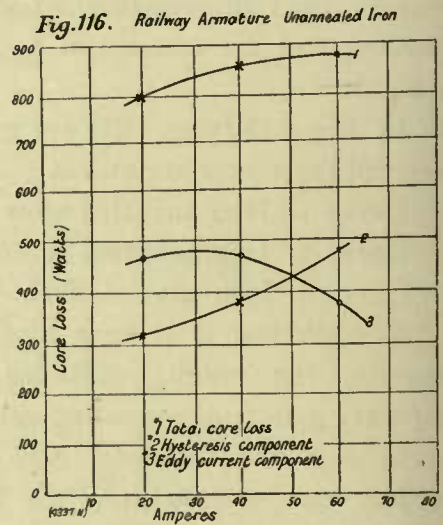
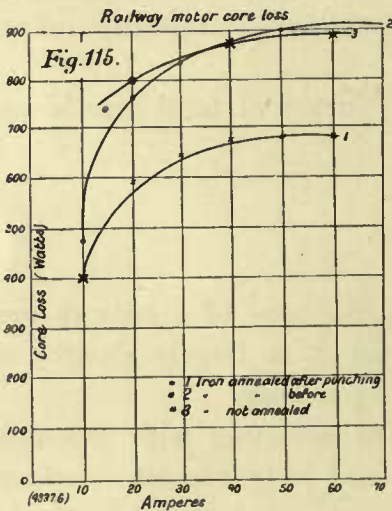

due to ohmic resistance. One's conception of the relative magnitudes of these quantities in copper and iron is rendered more definite by a study of the values given in Tables XXX. and XXXI. :—

TABLE XXX.—COPPER.

Current Density in Amperes per Square Inch.	Rate of Generation of Heat by Ohmic Resistance. Watts per Pound.					
	0 Deg. Cent.	20 Deg. Cent.	40 Deg. Cent.	60 Deg. Cent.	80 Deg. Cent.	100 Deg. Cent.
500	.50	.54	.58	.62	.67	.71
1000	2.00	2.15	2.33	2.48	2.68	2.84
1500	4.40	4.74	5.1	5.5	5.9	6.2
2000	7.9	8.4	9.1	9.8	10.6	11.2
2500	12.3	13.3	14.3	15.3	16.5	17.5
3000	17.7	19.0	20.6	22.8	23.7	25.0

TABLE XXXI.—SHEET IRON.

Flux Density (Kilolines per Square Inch).	Rate of Generation of Heat by Hysteretic Resistance (and by Ohmic Resistance to the Extent to which Eddy Currents are Present).			
	25 Cycles.	60 Cycles.	100 Cycles.	125 Cycles.
20	.10	.25	.44	.59
40	.27	.75	1.3	1.85
60	.56	1.5	2.8	4.0
80	.92	2.5	4.8	6.7
100	1.4	3.8	7.3	10.5
120	2.0	5.4	10.5	15
140	2.8	7.7	15	22

Table XXXI. should also be used in calculating iron losses at high densities, as it extends beyond the range of the curves of Figs. 35 and 36.

Smooth-core armatures can be run at higher current densities than iron-clad armatures, owing to the better opportunity for cooling. Likewise with iron-clad armatures, those with a few large coils have to be designed with lower current densities than those in which the winding is subdivided into many smaller coils.

In Table XXXII. are given some rough figures for the current densities used in various cases :—

TABLE XXXII.

					Amperes per Square Inch.
Small high-speed armatures	2500 to 3500
Large „ „	1500 „ 2500
Small low-speed armatures	1500 „ 2000
Large „ „	1100 „ 1600
Transformers with forced circulation of oil or air	800 „ 1500
Large transformers immersed in oil or air	500 „ 900
Small „ „	500 „ 1100

In the case of small transformers the current density could be very much higher without causing excessive temperature rise, but such transformers would have poor regulation. On the other hand, large transformers, when properly designed, have better regulation than is necessary, the current density being limited from thermal considerations. Although many large transformers are so poorly designed that a few hours' run at full load heats them up to above 100 deg. Cent., this is bad practice, as it causes deterioration both of insulation and of iron.¹ A rise of not more than 60 deg. Cent. should be aimed at, even with large transformers.

¹ See pages 29 to 32 for discussion of deterioration of iron at high temperatures.

The curve of Fig. 118 shows that even a rise of 60 deg. Cent. reduces the insulation resistance of a transformer to a small percentage of its resistance when cold. In other words, insulating substances have a very large negative temperature coefficient. In this case, where the insulating material was a composition of mica and cloth, the transformer being immersed in oil with which the insulation was thoroughly impregnated, the average temperature coefficient between 20 deg. Cent. and 80 deg.

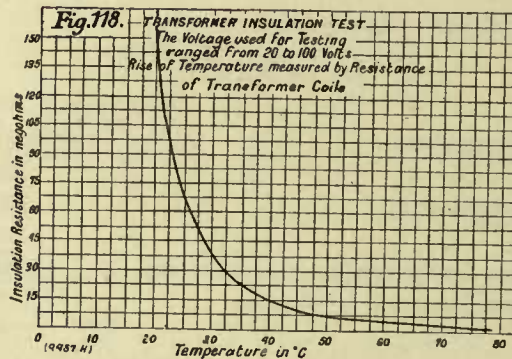
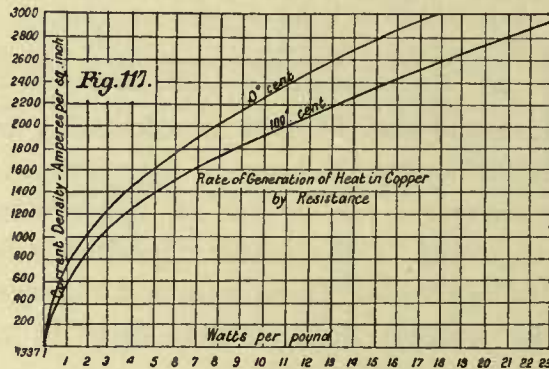

Cent. was $-.8$, that is, the insulation resistance increased 80 per cent. per deg. Cent. decrease of temperature. But the ability of this insulating material to withstand the disruptive effects of very high potentials is practically unimpaired. Consequently, it is important to distinguish carefully between the ability to withstand the application of high voltages and the insulation resistance, as measured in megohms. The insulation resistance in megohms returns to its original high value when the transformer is again cold.

RAILWAY MOTORS.

The necessity in this class of apparatus of having high efficiency at light loads (which is the condition under which railway motors operate the greater part of the time), requires that they shall be designed with an efficiency curve which quickly reaches its maximum, and falls off very much at larger loads. As a consequence, a good railway motor cannot be operated for long periods at its full rated drawbar pull, without reaching an excessive and dangerous temperature. The need for compactness also requires running at high temperature under the condition of long-sustained full load. In the section relating to the design of railway motors, this matter is more fully considered.

ARC DYNAMOS.

Arc dynamos are designed to maintain constant current, partly, and sometimes almost entirely, by inherent self-regulation. This requires a large number of turns both on field and armature, and in order to obtain reasonable efficiency, the conductors have to be run at very low-current densities. As a consequence, a properly designed arc dynamo will run much cooler than would be at all necessary from the thermal standpoint. Such a machine must be, of course, large and expensive for its output.

In apparent contradiction to the above statement stands the fact that almost all arc machines at present in operation run very warm. But this is because almost all arc machines as now in use have such low efficiencies, particularly at anything less than full load, as to render it extremely wasteful to continue them in service. By throwing them all out and installing well-designed apparatus, the saving in maintenance would quickly cover the expenses incurred by the change.

CONSTANT POTENTIAL DYNAMOS.

In constant potential dynamos it should be the aim to have the electromagnetic and thermal limits coincide. Forty or fifty degrees Centigrade rise in temperature during continuous running is generally considered entirely satisfactory, although the requirements for Admiralty and other Government work are usually more rigid. In constant-potential machines the efficiency is so high (especially when compared with the engine

efficiency) when the temperature limit is satisfactory, that the efficiency should seldom be a determining factor. Proper thermal and electromagnetic constants should be the limiting considerations.

In dynamos it is customary to quote the efficiency at the temperature reached by the machine at the end of several (generally ten) hours' run; but in the case of transformers, it is generally quoted at 20 deg. Cent. Nothing except prevailing practice justifies these contradictory methods.

COMMUTATOR HEATING.

The heating of the commutator arises from three causes — the mechanical friction of the brushes, the $C^2 R$ due to the useful current flowing across the contact resistances, and the heating due to the waste currents caused by short-circuiting of adjacent segments, and by sparking. Copper brushes may, under good conditions, be run up to a density of 200 amperes per square inch of contact surface, and even higher in small machines. Carbon brushes should preferably not be run above 40 amperes per square inch of contact surface, except in small machines, where, with good conditions, much higher densities may be used. The pressure need seldom exceed 2 lb. per square inch of brush-bearing surface, and a pressure of 20 oz. per square inch corresponds to good practice. In the case of railway motors this has to be considerably increased, because of the excessive jarring to which the brushes are subjected.

At a peripheral speed of commutator of 2,500 ft. per minute, which corresponds to good practice, the rise of temperature of the commutator will seldom exceed 20 deg. Cent. per watt per square inch of peripheral radiating surface for unventilated commutators; and with special ventilating arrangements depending upon centrifugal flow of air, this figure may be considerably improved upon. The total rise of temperature should preferably not exceed 50 deg. Cent. for continuous running at full load.

The contact resistance offered by carbon brushes at a pressure of 20 oz. per square inch of bearing surface, and at ordinary current densities and peripheral speeds, may be taken at .03 ohms per square inch of contact surface. That is, if there are, for instance, four positive and four negative brushes, each with 1.25 square inches of bearing

surface, the resistance of the positive brushes will be $\frac{.03}{4 \times 1.25} = .006$ ohms

and this will also be the resistance at the negative brushes; consequently, the total contact resistance will be .012 ohms from positive to negative brushes.

The contact resistance of copper brushes need not exceed .003 ohms, per square inch of contact surface, and with good conditions will be less.

In estimating the friction loss, the coefficient of friction at the standard pressure, and with the commutator and brushes in good condition may be taken equal to .3.

To illustrate the application of these constants in estimating the heating of a commutator, the case may be taken of a six-pole 120-kilowatt generator with a 30 in. diameter commutator, whose length, parallel to shaft, is 8 in., and which is furnished at each of its six neutral points with a set of four carbon brushes, each having a bearing surface of 1.5 in. \times .75 in. = 1.13 square inches. Consequently, there being twelve positive and twelve negative brushes, the total cross-section of contact for the current is $12 \times 1.13 = 13.5$ square inches.

The capacity of the machine is 480 amperes at 250 volts; consequently, the current density is 36 amperes per square inch. Taking the contact resistance at .03 ohms per square inch, the total contact resistance amounts to $\frac{.03}{12 \times 1.13} \times 2 = .0045$ ohms from positive to negative terminals. Therefore the $C^2 R$ loss is $480^2 \times .0045 = 1050$ watts. Pressure is adjusted to about $1\frac{1}{4}$ lb. per square inch. Total pressure $1.25 \times 13.5 \times 2 = 34$ lb. Speed = 300 revolutions per minute. Peripheral speed = 2360 ft. per minute. Therefore, foot-pounds per minute = $2360 \times 34 \times .3 = 24,000$ foot pounds = .73 horse-power = 545 watts.

	Watts.
$C^2 R$	= 1050
Friction	= 545
Allow for stray losses	= 100
Total commutator loss	= 1695

Radiating surface = $8 \times 30 \times \pi = 760$ sq. in.

Watts per sq. in. = $1695 \div 760 = 2.2$.

Figuring the rise at 20 deg. Cent. per watt per square inch, there is obtained :—

Total rise temperature = $2.2 \times 20 = 44$ deg. Cent.

Careful tests fail to show any considerable decrease in resistance of contact on increasing the brush pressure beyond 20 oz. per square inch, nor does it change very greatly for different speeds and current densities; at least not enough to be worth taking into account in the necessarily rough approximate calculations. It will, of course, be understood that when brushes or commutator are in poor condition, friction, $C^2 R$ and stray losses, are certain to greatly increase.

FRICION LOSS.

The loss through windage and bearing friction necessarily is very dependent upon the nature of the design and the method of driving. When the armature is directly driven from the engine shaft, and is not provided with an outboard bearing, the loss has to be shared by both engine and dynamo. With belt-driven dynamos a third bearing beyond the pulley is sometimes necessary. The loss due to belt friction is not properly ascribable to the dynamo. If the armature and spider are furnished with internal fans and flues, or other ventilating arrangements, the advantage in cooling thereby gained necessarily involves increased friction loss. In a line of high-speed alternators thus designed, the friction loss ranged from one per cent. in the large sizes up to three per cent. in the small sizes, the range being from 400 kilowatts to 60 kilowatts capacity, and the machines being belt-driven, the belt losses, however, not being included. The speeds were from 360 revolutions per minute for the 400 kilowatt, up to 1500 revolutions per minute for the 60 kilowatts.

Some similar continuous-current belt-driven generators, for rather lower speeds, had friction losses ranging from .8 per cent. in the 500 kilowatt sizes up to 2 per cent., or rather less, in the 500 kilowatt sizes.

Large direct-coupled slow-speed generators will have considerably less than 1 per cent. friction loss, and such machines for 1000 kilowatts and over should have friction losses well within $\frac{1}{2}$ per cent.

DESIGN OF THE MAGNETIC CIRCUIT.

In practice, the solution of magnetic problems is generally largely empirical, on account of the very great difficulty in calculating the magnetic leakage, as well as in determining the precise path which will be followed by the magnetic flux in those parts of the magnetic circuit which are composed of non-magnetic material, such as—in dynamos and motors—the air gap between the pole-face and the armature surface. In closed circuit transformers no such difficulties arise, and the determination of the reluctance of the magnetic circuit becomes comparatively simple.

Analogies between electric and magnetic circuits are misleading, since a magnetic circuit of iron located in air is similar to an electric circuit of high conductivity immersed in an electric circuit of low conductivity, the stream flow being proportional to the relative conductance of the two circuits. Moreover, in magnetic circuits the resistance varies with the flux in a manner dependent upon the form and materials of the magnetic circuit.

For the purpose of calculation it is assumed that the magnetic flux distributes itself according to the reluctance of the several paths between any two points. The difference of magnetic potential between two points is equal to the sum of the several reluctances between these points, multiplied by the flux density along the line over which the reluctances are taken. The permeability of air being unity, and that of iron being a function of the flux density, it follows that a proportion of leakage flux, or flux external to the core of an electro-magnet, increases with the flux density in the core, and with the magnetic force. Practically, the function of a magnetic circuit is to deliver from a primary or magnetising member a definite magnetic flux to a secondary member. Thus, in the case of a dynamo or alternator, the function of the field magnets or primary member is to deliver a certain flux to the armature; in the case of a transformer, that of passing through the secondary coils a certain magnetic flux. The secondary member reacts upon the primary member, and affects the effective magnetic flux according to the amount of current generated

in the secondary member. This reaction acts to change the magnetic flux in the secondary member in two ways, first by reducing the resultant effective magneto-motive force acting on the magnetic circuit; and, secondly, by affecting the magnetic leakage by altering the differences of magnetic potential and distribution of magnetic forces around the magnetic circuit.

In the case of a generator with brushes set with a forward lead, the reaction is such as to demagnetise the field magnets and increase the leakage.

In the case of a motor with brushes set with a forward lead, the reaction is such as to increase the flux through the armature by added magneto-motive force and diminished leakage.

In the case of an alternating-current generator, the reaction is such as to diminish the flux with lagging armature current, or with leading current to increase the flux.

In the case of a transformer with lagging current, the effect is to diminish the effect of the primary current, and with leading current to increase this effect.

As stated above, however, the leakage in general is affected according to the magneto-motive force between any two points. The effective flux in any magnetic circuit is equal to the resultant magneto-motive force divided by the reluctance of the magnetic circuit. Obviously, then, in the design of a magnetic circuit the effects of these reactions have to be carefully calculated. In the design of the field-magnet circuit of dynamos and alternators, the influence of the armature reaction on the effective magneto-motive force may be taken into consideration in the calculations by assuming a certain definite maximum armature reaction. These armature reactions will be discussed subsequently. Obviously, the flux density and magnetising force may in all cases vary very widely for a given total flux. Therefore, fulfilling equivalent conditions as to efficiency and heating, there is no fixed ratio between the amount of copper and iron required to produce a certain magnetic flux. The designing of a magnetic circuit may then be said to be a question of producing in the secondary member a given effective magnetic flux, and with a given amount of energy expended in the primary magnetic coils, and with a minimum cost of material and labour; and the most economical result is arrived at by means of a series of trial calculations. The energy wasted in the field magnets should not, in the case of continuous-current

machinery, generally exceed 1 or $1\frac{1}{2}$ per cent. of the rated output, the permissible values being dependent mainly upon the size and speed. In all cases there is, of course, the condition that the magnetising coils shall be so proportioned as not to heat beyond a safe limit.

In the case of transformers the condition becomes different. There is a constant loss of energy in the magnetic circuit, due to hysteresis. The amount of energy consumed in the magnetising coils at no load is negligible. At full load it is a considerable fraction of the total loss. Transformers are seldom worked at full load for any length of time, consequently the open circuit losses should be made consistent with the mean load of the transformer. The general design of the magnetic circuit of an alternating-current transformer may then be said to consist, for a given stated output, in securing a satisfactory "all day" efficiency and satisfactory thermal conditions for a minimum cost of material and labour, both the iron and copper losses being considered.

In the case of continuous-current dynamos, the armature reaction as a factor in determining the design of the field magnets, is of greater importance now than heretofore. Thorough ventilation of the armature has so reduced the heating, that from this standpoint the output of dynamos has been greatly increased. The general introduction of carbon brushes, and a more thorough knowledge of the actions in commutation, has greatly increased the output for good operation from the standpoint of sparking. Thus the magnetomotive force of the armature has naturally become a much greater factor of the magnetomotive force of the field magnets. Taking the magnetomotive force of the armature as the line integral through the armature from brush to brush, there are numerous examples of very good commutating dynamos in which the magnetomotive force of the armature at full load is equal to that of the field magnets. In several large dynamos designed by Mr. H. F. Parshall, which have now been in use for so long a time that there is no question as to satisfactory operation, the magnetomotive force of the armature at full load was 50 per cent. greater than the magnetomotive force of the field magnets; and the number of turns required in the series coils to maintain constant potential was approximately equal to that in the shunt coils to give the initial magnetisation. It is found in practice that the component of the armature magnetomotive force opposing the field magnets, *i.e.*, the demagnetising component, is from 18 to 30 per cent. of the total armature magnetomotive force. This corresponds to a lead of the brushes of from 9 to 15 per cent. of the

total angular distance between successive neutral points, *i.e.*, to an angular lead of from 16 deg. to 27 deg., the angular span of two magnetic fields (north and south) being taken as 360 deg.

The armature reaction, therefore, in modern practice greatly increases the amount of material required in the field-magnet coils and in the field-magnetic circuit, by increasing the economical length of the magnetic core and coils, which in turn tends to increase the magnetic leakage, and therefore to require greater cross-section of magnetic circuit. As yet, however, practice has not been sufficiently developed to reach the limit beyond which the total cost of the dynamo is increased, by increasing the armature reaction. The field magnet may, therefore, be considered, in general practice, a subservient member. The limit, of course, to the armature reaction is frequently reached in the case of such compound dynamos as are required to give an approximately constant potential over the whole working range.

In the case of alternators, the thermal limit of output has been increased by ventilation, as in commutating machines. By the introduction of a general system of air passages, shorter armatures have become possible, consequently natural ventilation of the armature has been vastly increased.

The tendency in recent practice has been to limit the output of alternators from the standpoint of inherent regulation, and the thermal limit of output has been generally determined to conform with the conditions laid down as to regulation and inductance. Alternators designed to work over inductive lines for power purposes are very frequently designed with one-half the armature reaction that would be used in the case of lighting machines.

A full discussion of the armature reaction of alternators will be given in a later section. It may be stated here, that in uni-slot single-phase alternators, the value of the reluctance of the magnetic circuit becomes very dependent upon the position of the armature slot with respect to the pole-face; hence the reluctance undergoes a periodic variation of n cycles per revolution of the armature, n being the number of field-poles. The variation is generally of so great an amplitude as to make it important to construct the entire magnetic circuit of laminated iron, otherwise the field frame becomes the seat of a very substantial loss of energy through eddy currents. Although this loss is less serious in multi-slot single-phase alternators and in poly-phase alternators, it should be carefully considered; and it will often be

found desirable in such machines to adopt a laminated construction of the entire field frame. Even in continuous-current machines, the loss may sometimes be considerable, being of greater value, the fewer the slots per pole-piece, the wider the slot openings and the shorter the air gap. But in continuous-current machines, there are almost always enough slots to insure the restriction of the magnetic pulsations to the vicinity of the pole-face, and hence it is often the practice to laminate the pole-faces only. But in all alternators, even with multi-slot armatures, present practice requires that the magnet cores, at least, shall be laminated for the entire length. The pulsations of the flux throughout the magnetic circuit, due to periodic variations in the reluctance, reach their greatest extent in the inductor type of alternator, and constitute one of the objections to most varieties of this type of alternator.

LEAKAGE COEFFICIENT.

The coefficient by which the flux which reaches the armature and becomes linked with the armature turns must be multiplied in order to derive the total flux generated by the field coils, is known as the "leakage coefficient," and in most cases is considerably greater than unity. It is evident that the "leakage coefficient" should increase with the load, since the armature ampere turns serve to raise the magnetic potential between the surfaces of the adjacent pole-faces, and tend to increase the component of flux leaking between adjacent pole tips and over the surface of the armature teeth above the level of the armature conductors. The annexed diagrams give the values of the leakage coefficients as determined from actual measurements for several cases. It will be noted that in Fig. 122 are given results both with and without current in the armature. (See Figs. 119 to 124.)

ARMATURE CORE RELUCTANCE.

The reluctance of the armature core proper is generally fixed by thermal conditions, which are dependent upon the density and periodicity at which the core is run, the reluctance being chosen as high as is consistent with the permissible core loss.

AIR GAP RELUCTANCE.

The reluctance between the armature core and the faces of the pole-pieces is determined by the space required by the armature conductors and the necessary mechanical clearance between the armature surface and the pole-faces.¹

RELUCTANCE OF COMPLETE MAGNETIC CIRCUIT.

The reluctance for a given length of magnetic circuit should be such that the combined cost of magnetic iron and magnetising copper is a minimum. The length of the magnetic circuit should be such that, with what may be termed the most economical densities, the cost of the copper and iron is a minimum. By magnetising copper is meant that amount of copper required by the magnetising coils to give, under fixed thermal conditions, that magnetomotive force that will maintain the proper flux

¹ In discussing the sparking limit of output of a smooth-core armature, it has been frequently asserted that the sparking limit of a generator is a function of the depth of the air gap. But the inductance of the armature coils when under commutation is not appreciably diminished by increasing the depth of the air gap, except in machines where the brushes have to be set forward into the near neighbourhood of the pole-tip, which is not necessary in well-designed generators. Therefore, the depth of the air gap has no relation to the magnetic sparking output, except in so far as it may alter the distribution of magnetism in the gap. Beyond a certain limit, increasing the depth of the air gap acts deleteriously on the sparking limit, since the distribution of the magnetic flux in the gap becomes such that the permissible angular range of commutation is very small. In the case of toothed armatures (which are now common practice), the air gap in good practice is made as small as is consistent with mechanical safety. The density in the projections is carried to a very high value, it being generally recognised that the greater the magnetic density at the pole-face, the greater armature reaction is possible without sparking. To satisfy this condition alone, a high density in the projections becomes necessary. It has, however, been pointed out that, with the projection normally worked out, magnetic distortion in the air gap may be made greatly less than in the case of a well-designed smooth-core armature. In the smooth-core machine the distortion in the gap is proportional to the armature reaction; whereas in the case of highly magnetised projections the distortion is greatly less than proportional to the armature reaction. Considered with relation to the inductance of the armature coils, it appears that the inductance of the coils becomes smaller and smaller as the magnetic reluctance in the circuit surrounding the coils becomes increased. All of these conditions may be included broadly by saying that for a given output there is a certain limiting minimum reluctance in the air gap, having regard both to distortion and self-induction. As will be shown later, however, sparkless commutation has to be considered not only in its relation to the inductance of the armature coils and to the strength of the reversing field, but also in respect to the nature of the collecting brushes. Generally speaking, visible sparking, or that external to the brushes, is least injurious to the commutator.

through the armature at full load. The densities should be taken to correspond with the full voltage generated by the armature. The proportions of the magnets should be taken to correspond with the magnetomotive force required at full load.

For a given density the magnet coils should be of a certain length; if too long, the cost of the iron will be excessive; if too short, the cost of the copper will be excessive, since the radiating surface of the coil will be too restricted. The depth of the magnet coil must, in practice, be restricted; otherwise, the temperature of the inner layers will become excessive.¹

ESTIMATION OF GAP RELUCTANCE.

The magnetomotive force (expressed in ampere turns) expended in maintaining a flux of D lines per square inch, across an air gap of length L (expressed in inches) is $.313 \times D \times L$. The proof of this is as follows:

$$D \text{ lines per sq. in.} = \frac{D}{6.45} \text{ lines per square centimetre.}$$

$$B = \frac{D}{6.45}.$$

For air

$$H = B.$$

$$H = \frac{D}{6.45}.$$

But $H = \frac{4 \pi n C}{10 l}$, l being length expressed in centimetres, and $n C$ being ampere turns (number of turns \times current).

$$\begin{aligned} n C &= \frac{10}{4 \pi} \times H \times l. \\ &= \frac{10}{4 \pi} \times \frac{D}{6.45} \times 2.54 L. \\ &= .313 \times D \times L. \end{aligned}$$

¹ The increase of temperature of the magnet coils should be determined by the increase in their resistance. Placing the thermometer on the external surface, unless the winding is very shallow, is not a satisfactory indication as to whether or not the inner layers may not be so hot as to increase the resistance of the coil so much that its magnetomotive force at a given voltage is greatly diminished.

RELUCTANCE OF CORE PROJECTIONS.

The armature projections between the conductors are generally magnetised well towards saturation, so that the determination of the magnetic force required for a given flux across this part of the magnetic circuit is of importance. The following method will be found useful:

The magnetic flux divides between two paths :

1. The iron projections.
2. The slots containing the conductors, and the spaces between the laminations.

The proportion of the flux flowing along each path is proportional to its magnetic conductance. There are several considerations which make the cross-section of the iron path small compared with that of the other paths.

1. In practice the width of the tooth is generally from 50 to 80 per cent. of the width of the slot.

2. The slot is broader in a direction parallel to the shaft than the iron portion of the lamination, because of the 25 per cent. of the length of the armature frequently taken up by insulation between laminations, and by ventilating ducts.

3. This 25 per cent. of insulation and ducts, itself offers a path, which in the following calculation it will be convenient to add to the slot, denoting the total as the air path.

It thus appears that although the iron path is of higher permeability, the air path has sufficiently greater cross-section, so that it takes a considerable portion of the flux ; and it will be readily understood that the resultant reluctance of the paths in multiple being considerably less, and the density of the flux being decreased at a point where the permeability increases rapidly with decreasing density, the magnetomotive force necessary for a given flux may be greatly less than that required to send the entire flux through the projections.

Let a = width of tooth.

„ b = „ slot. (See Fig. 125.)

„ k = breadth between armature heads, of iron part of lamination.

ak = cross-section of iron in one tooth.

$\frac{bk}{.75}$ = cross-section of slot (because 25 per cent. of the breadth of the armature is taken up by ventilating ducts and insulation between laminations, and the breadth of the slot exceeds that of the iron in the tooth by that amount).

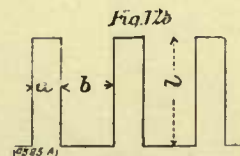

If in any particular design this proportion varies from 25 per cent., new calculations may be made, if the magnitude of the variation is sufficient to warrant it. Moreover, there is 25 per cent. of ventilating ducts and insulation in the breadth of the tooth itself. The cross-section of this will be $.25 \frac{a k}{.75} = .33 a k$. It will be convenient to add this to the slots, and denote the total as the air path.

$$\text{Cross-section of air path} = \frac{b k}{.75} + .33 a k = 1.34 b k + .33 a k.$$

This air path, therefore, takes in all paths except the iron lamination.

Let l = depth of tooth and slot.

„ N = lines to be transmitted by the combined tooth and slot, and

μ = permeability of iron in tooth, at true density.

Let the N lines so divide that there shall be

n in iron path, and $N - n$ in air path.

$$\frac{n}{a k} = \text{density in iron path.}$$

and

$$\frac{N - n}{1.34 b k + .33 a k} = \text{density in air path.}$$

$$\text{Conductivity of iron path} = \frac{a k \mu}{l};$$

$$\text{Conductivity of air path} = \frac{1.34 b k + .33 a k}{l}.$$

Now, the fluxes n and $N - n$ in iron and air will be directly proportional to the respective conductivities:

$$\frac{n}{N - n} = \frac{\frac{a k \mu}{l}}{\frac{1.34 b k + .33 a k}{l}} = \frac{a \mu}{1.34 b + .33 a}$$

$$1.34 b n + .33 a n = a \mu N - a \mu n;$$

$$n (1.34 b + .33 a + a \mu) = a \mu N;$$

$$\frac{N}{n} = \frac{1.34 b + .33 a + a \mu}{a \mu}.$$

Let B = true density in iron, and B^1 = density calculated on the assumption that the iron transmits the entire flux. Therefore, the ratio of N (the total lines) to n (those in iron), *i.e.*, $\frac{N}{n}$, will equal the ratio of B^1

(the density figured on the assumption that all the lines are in iron), to B (the actual density in iron).

$$\frac{B^1}{B} = \frac{N}{n} = \frac{1.34 b + .33 a + a \mu}{a \mu}$$

In Table XXXIII. are calculated some values of $\frac{B^1}{B}$ for different values of $\frac{a}{b}$.

TABLE XXXIII.

1. $\frac{a}{b} = 1$ (i.e., width tooth = width slot) $\frac{B^1}{B} = \frac{1.67 + \mu}{\mu}$.
2. $\frac{a}{b} = .75$ (" " $\frac{3}{4}$ ") $\frac{B^1}{B} = \frac{2.12 + \mu}{\mu}$.
3. $\frac{a}{b} = .50$ (" " $\frac{1}{2}$ ") $\frac{B^1}{B} = \frac{3.00 + \mu}{\mu}$.

The next step in this process requires reference to the iron curves of Fig. 126. From these curves Table XXXIV. is derived :

TABLE XXXIV.

Corrected Iron Densities.	—	Densities Figured on Assumption that Iron Transmits Entire Flux.		
		$B^1 \left(\frac{a}{b} = 1 \right)$	$B^1 \left(\frac{a}{b} = .75 \right)$	$B^1 \left(\frac{a}{b} = .50 \right)$
B.	μ .			
17,000	133	17,200	17,300	17,400
18,000	92	18,400	18,500	18,600
19,000	56	19,500	19,800	20,000
20,000	33	21,000	21,300	21,800
21,000	23	22,500	23,000	23,700
22,000	17	24,200	24,700	26,000
23,000	13	26,000	26,800	28,300

TABLE XXXV.—DENSITIES IN INCHES.

Corrected Iron Densities.	Densities Figured on Assumption that Iron Transmits Entire Flux.		
	$\frac{a}{b} = 1.$	$\frac{a}{b} = .75$	$\frac{a}{b} = .50$
Kilolines per Square Inch.			
110	111	112	113
116	119	120	121
123	127	128	129
129	136	138	141
136	145	149	153
142	156	160	168
149	168	173	183

In the curves of Fig. 127, the values of the densities in the Tables have been transposed into kilolines density per square inch, and are thus available for use in dynamo calculations, where the process simply consists in figuring the iron density as if the iron transmitted the entire flux, and obtaining from the curves a corrected value for use in figuring the magnetomotive force. The number of teeth to be taken as transmitting the flux has to be determined by judgment, and is influenced by the length of the gap. Generally, increasing by one, the number lying

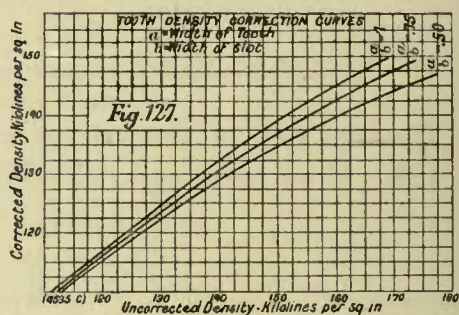
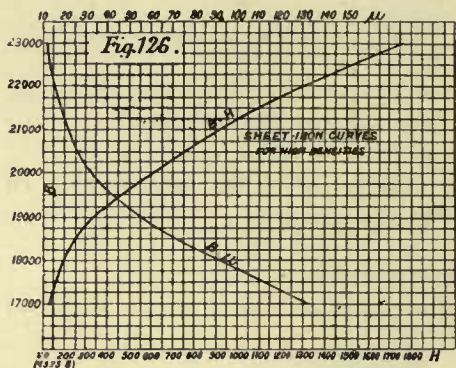

directly under the pole-face gives good results for machines with very small air gaps, while two or three extra teeth should be added for larger gaps.

CALCULATION FOR MAGNETIC CIRCUIT OF DYNAMO.

The following example of a very simple case may be of interest, as giving some idea of the general method of handling such problems:

A certain ironclad dynamo has an air-gap density of 40 kilolines (per square inch), the density in the magnet core is 90 kilolines, and in the magnet yoke 80 kilolines. The frame is of cast steel. The tooth density is 110 kilolines, and the armature density is 50 kilolines.

							in.
Length of gap	=	.25
„ magnet core (as related to the magnetic circuit)						=	10
„ yoke (corresponding to one spool)				=	6
„ tooth	=	1.5
„ armature (corresponding to one spool)				=	4

Required number of ampere-turns per spool at no load :

Ampere-turns for gap = $.313 \times 40,000 \times .25$ =	3130
Ampere-turns for magnet core (from curve A of Fig. 14, page 21)	
= 47×10 =	470
Ampere-turns for yoke = 29×6 =	170
Ampere-turns for teeth (from curve B of Fig. 22) = 150×1.5 =	230
Ampere-turns for armature core = 6×4 =	20
Total	4020

Therefore ampere-turns per pole-piece at no load = 4020.

It thus appears that, for practical purposes, it is much more direct to proceed as in the above example, than to go through a laborious calculation of the total reluctance of the magnetic circuit, incidentally bringing in the permeability and other factors, as described in many text-books.

FIELD WINDING FORMULA.

In making field winding calculations, the following formula is of great service.

$$\text{Lb.} = \frac{31 \times \left(\frac{\text{Ampere-feet}}{1000} \right)^2}{\text{watts}}$$

in which

Lb. = Pounds of copper per spool.

Ampere-foot = Ampere-turns \times mean length of one turn, expressed in feet.

Watts = watts consumed in the spool at 20 deg. Cent.

This formula is derived as follows :

Resistance between opposite faces of a cubic inch of commercial copper at 20 deg. Cent. = .00000068 ohms.

If length in inches = L, and cross-section in square inches = S, then

$$R = \frac{.00000068 L}{S}$$

$$S L = \frac{.00000068 L^2}{R}$$

Let l = mean length of one turn in inches.

t = number of turns.

$l t = L$.

$$S L = \frac{.00000068 l^2 t^2}{R}$$

$$= \frac{.00000068 C^2 l^2 t^2}{C^2 R}$$

$$\frac{C l t}{12} = \text{ampere-feet (ampere-turns} \times \text{mean length of one turn in feet).}$$

$$C l t = 12 \times \text{ampere-feet.}$$

$$C^2 l^2 t^2 = 144 (\text{ampere-feet})^2.$$

$$C^2 R = \text{watts.}$$

$$S L = \frac{.68 \times 144 \times \left(\frac{\text{ampere-feet}}{1000}\right)^2}{\text{watts}}$$

$$\text{Lb.} = .32 S L = \frac{.32 \times .68 \times 144 \times \left(\frac{\text{ampere-feet}}{1000}\right)^2}{\text{watts}}$$

$$\text{Lb.} = \frac{31 \times \left(\frac{\text{ampere feet}}{1000}\right)^2}{\text{watts}}$$

APPLICATION TO CALCULATION OF A SPOOL WINDING FOR A SHUNT-WOUND DYNAMO.

Thus, suppose the case of a machine for which it had been determined that 5,000 ampere-turns per spool would be required. Assume that the mean length of one turn is 4.0 ft. Then

$$\left(\frac{\text{ampere-feet}}{1000}\right)^2 = \left(\frac{5000 \times 4}{1000}\right)^2 = 400.$$

The radiating surface of the spool may be supposed to have been 600 square inches. After due consideration of the opportunities for ventilation, it may be assumed to have been decided to permit .40 watts per square inch of radiating surface at 20 deg. Cent. (it, of course increasing to a higher value as the machine warms up).

$$\therefore \text{watts} = 600 \times .40 = 240 \text{ per spool.}$$

$$\therefore \text{lb. copper per spool} = \frac{31 \times 400}{240} = 52 \text{ lb.}$$

This illustrates the application of the formula, but it will be of interest to proceed further and determine the winding to be used.

A six-pole machine will be taken, designed for separate excitation from a 250 volt exciter. In order to have room for adjustment, as well as to allow for probable lack of agreement between the calculated and actual values, it is desirable to have but 220 volts at the winding terminals under normal conditions of operation. This is $220/6 = 36.7$ volts per spool.

TYPICAL MAGNETIC CIRCUITS.

Fig 123

Gross depth arm. lam. - 11.8
4 ducts each 6 wide

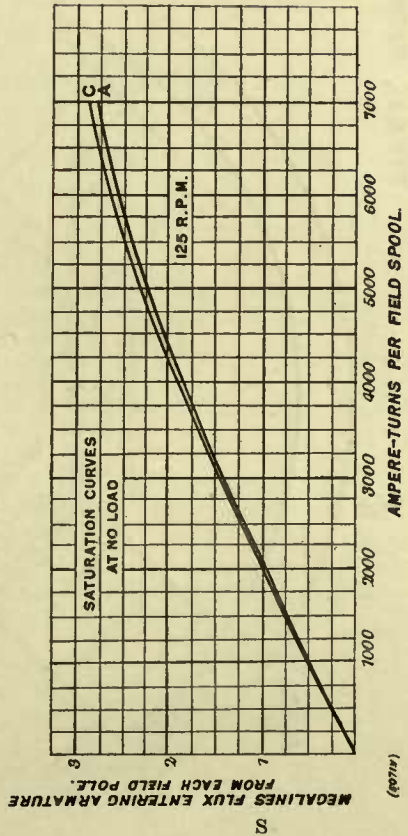
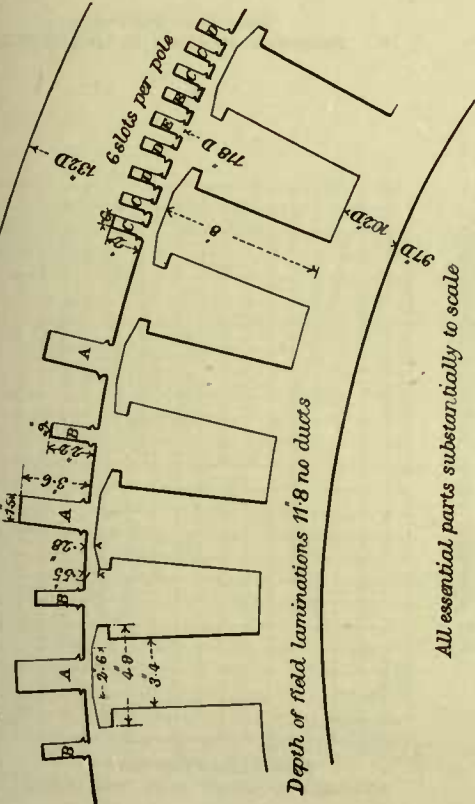
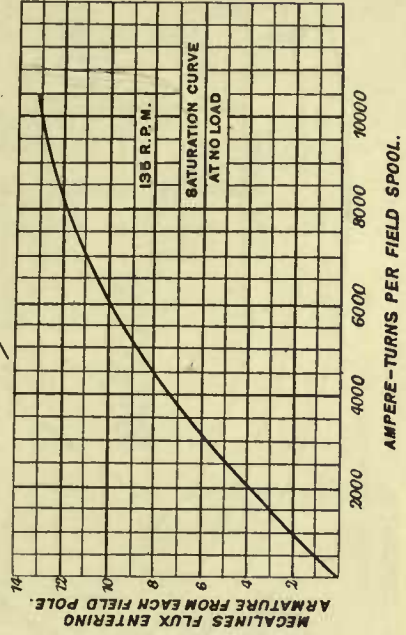
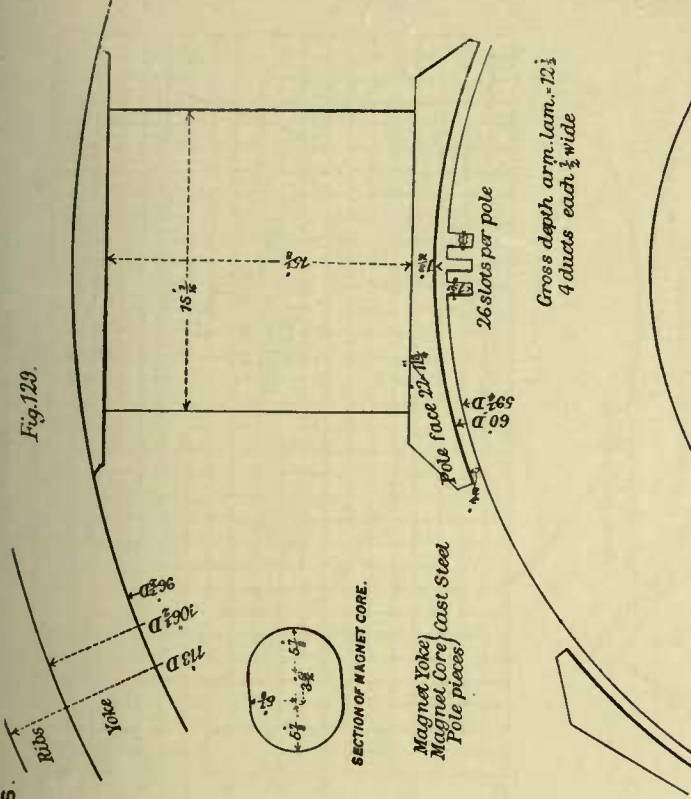

Fig. 129.



TYPICAL MAGNETIC CIRCUITS.

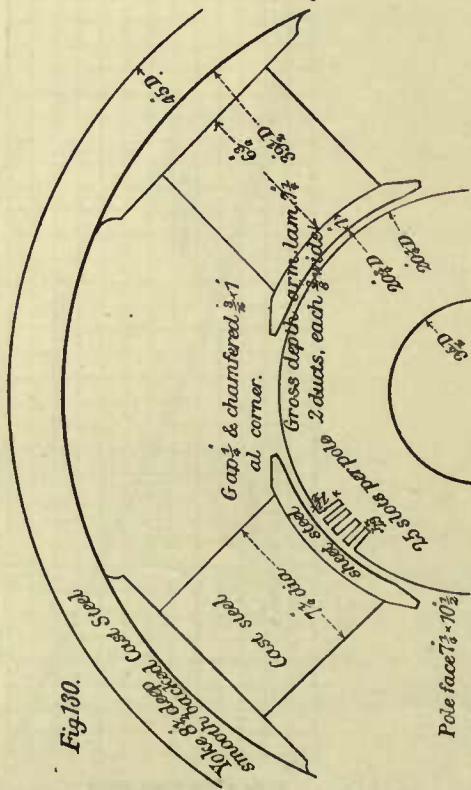

Fig. 130.

All essential parts substantially to scale

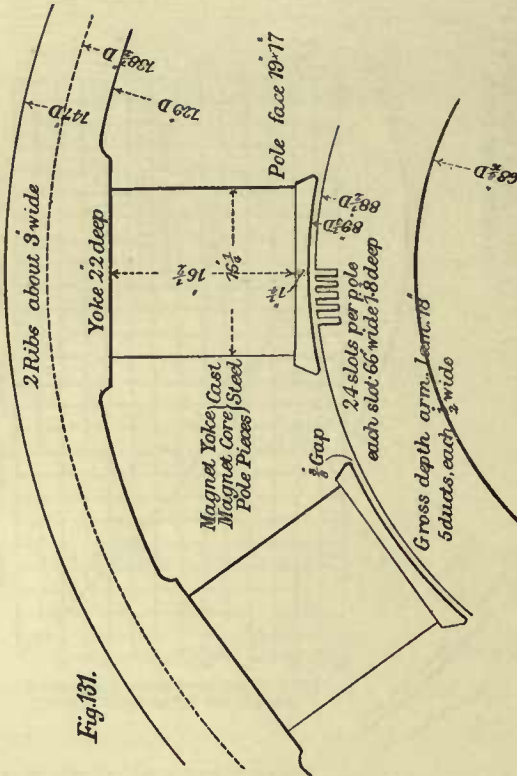
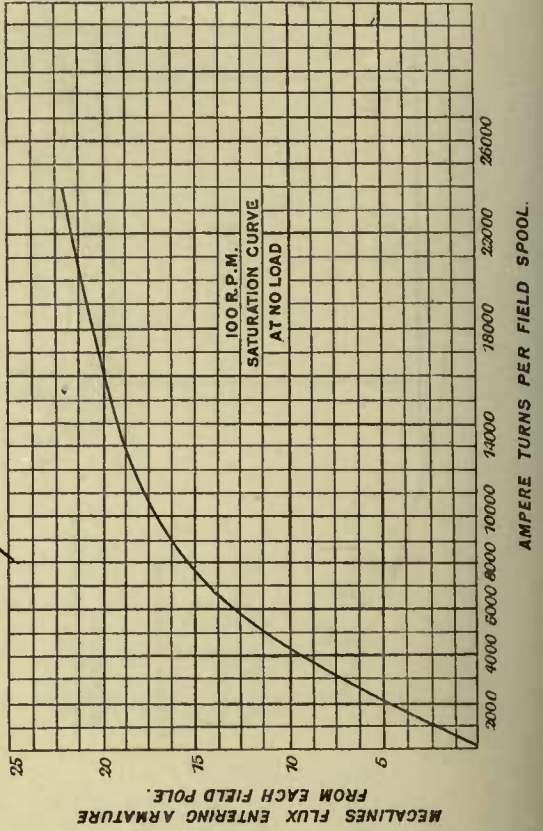
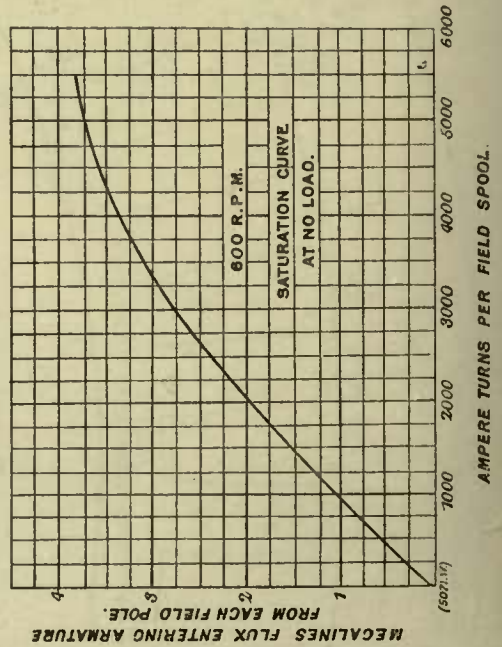

Fig. 131.



TYPICAL MAGNETIC CIRCUITS.

Fig. 133

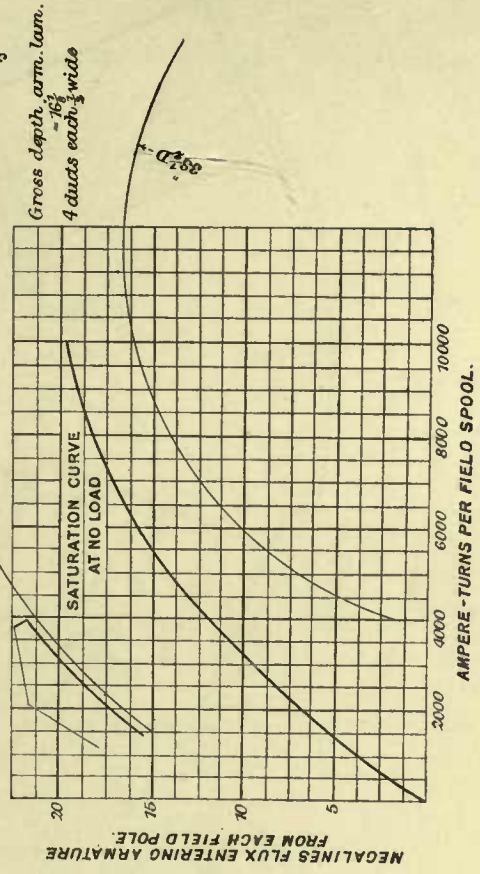
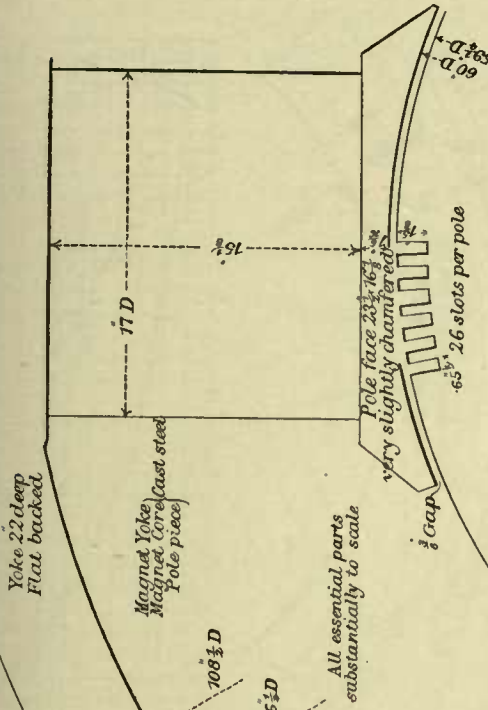
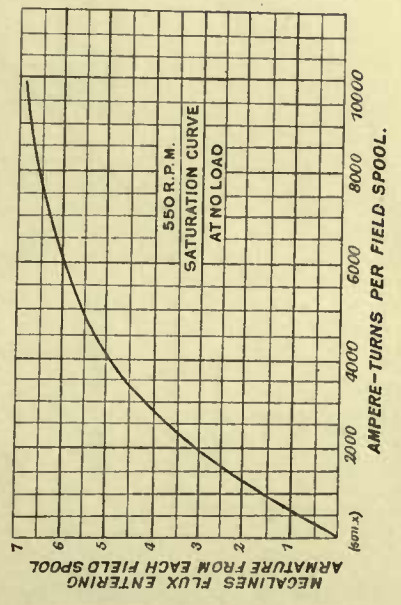
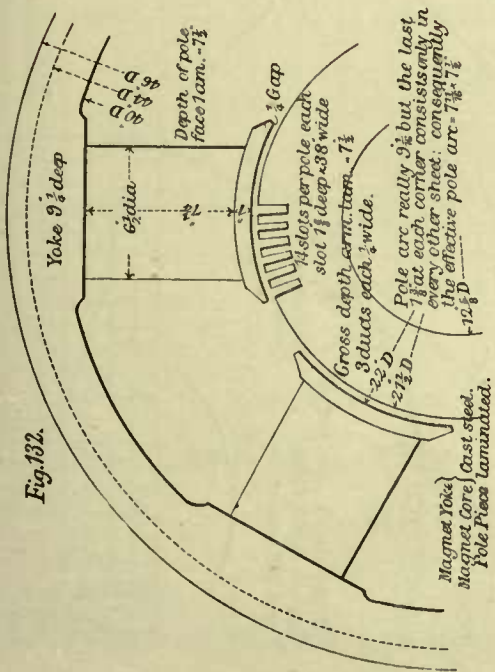
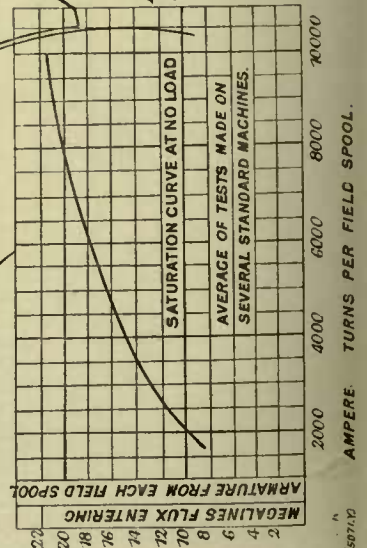
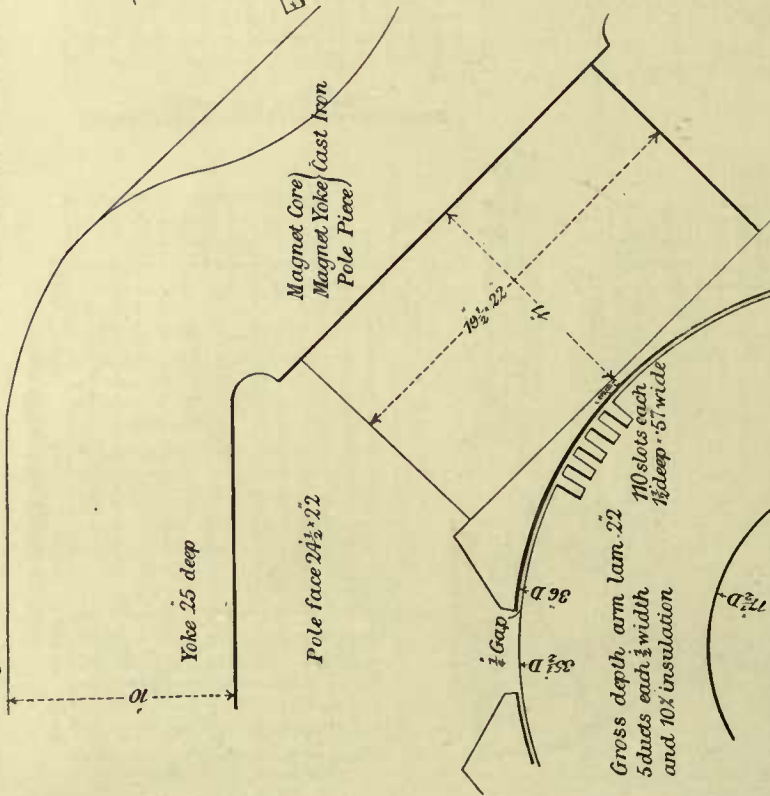

Fig. 132.



TYPICAL MAGNETIC CIRCUITS.

Fig. 134.



All essential parts substantially to scale.

Fig. 135.

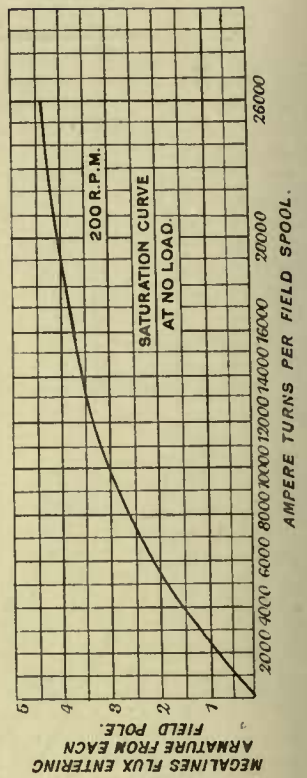
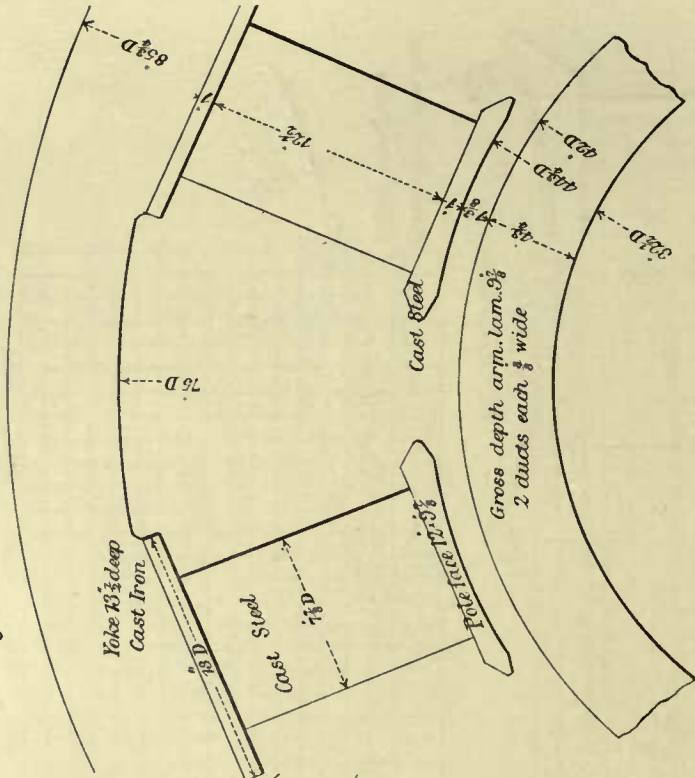

The conditions as regards ventilation indicate a rise of 30 deg. Cent. in the temperature of the spool winding under the conditions of operation. Then the watts per spool are :

$$1.17 \times 240 = 280 \text{ watts at } 50 \text{ deg. Cent.}$$

$$\text{Amperes} = \frac{280}{36.7} = 7.6$$

$$\text{Turns per spool} = \frac{5000}{7.6} = 655$$

TYPICAL MAGNETIC CIRCUITS.

Fig.136.

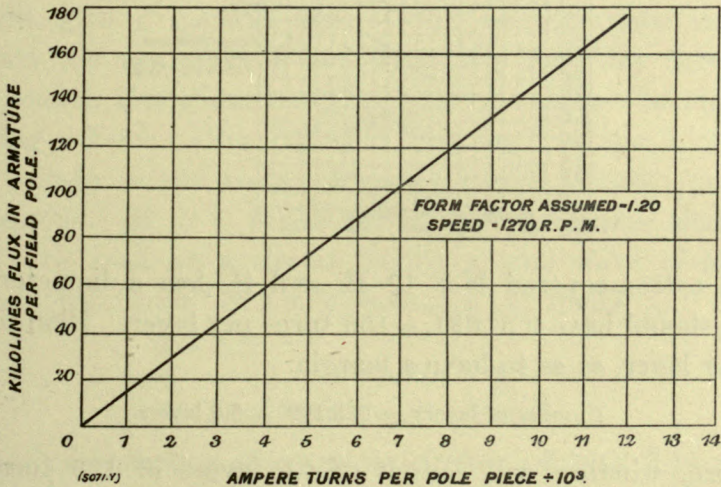
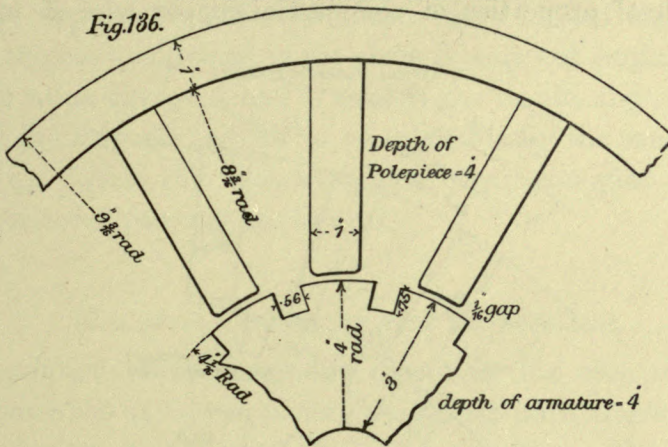

And as the mean length of one turn is 4.0 ft., the total length of winding is :

$$655. \times 4 = 2620 \text{ ft.}$$

$$\text{Pounds per 1000 ft.} = \frac{52}{2.62} = 19.8$$

From the Table of properties of commercial copper wire, it will be

found that No. 12 B. and S. has 19.8 lb. per 1,000 ft., and is, therefore, the proper size. Generally, the desired value for the pounds per 1,000 ft. does not come out very nearly like that of any standard size of wire. In such a case, the winding may be made up of two different sizes of wire, one smaller and the other larger than the desired size. Generally, however it is sufficiently exact to take the nearest standard size of wire.

Suppose the space inside the spool flanges to have been 10 in. long, then, after insulating, $9\frac{1}{2}$ in. would probably be available for winding. From the Table of properties of commercial copper wire it will be found

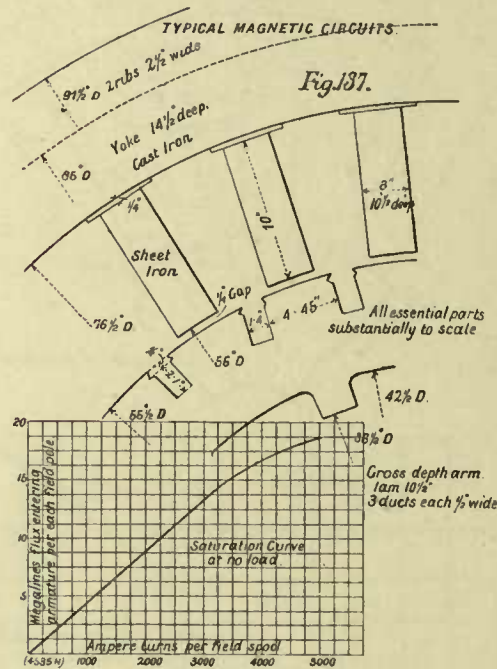

that double cotton-covered No. 12 B. and S. has a diameter of .091 in. Therefore it should have $9.5/.091 = 105$ turns per layer. Plan to take only 100 turns per layer, so as to have a margin.

$$\text{Number of layers} = 655/100 = 6.6 \text{ layers.}$$

Therefore, winding will consist of 6.6 layers of 100 turns each, of D.C.C. No. 12 B. and S., and will require 220 volts at its terminals when warm, it carrying 7.6 amperes.

Calculations relating to the compounding coils of machines will be given later, after the theory of armature reaction has been developed.

It is now proposed to give experimentally determined no-load saturation curves for several different types of machines, together with sufficient

of the leading dimensions of the machines to enable the results to be profitably studied and compared.

In the case of Fig. 128, two machines were tested. Same fields, but one armature having slots as shown at A and B, and the other as shown at C, D, and E. The armature coils used in the tests were those in slots A and C respectively. For figuring the flux in the case of A, the "form factor" was taken as 1.25. For C, the "form factor" was taken as 1.11. In the case of a winding at B, the results would probably have corresponded to an appreciably different "form factor" from that used for A. In the tests the coils contained in the slots B were not employed.

The saturation curves A and C exhibit the results and show the total reluctance of the magnetic circuit to be substantially the same for the two cases. In Figs. 129 to 137, inclusive, nine other examples are given, the necessary data accompanying the figures.

MAGNETIC CIRCUIT OF THE TRANSFORMER.

The calculation of the magnetic circuit in the case of transformers cannot, of course, be at all completely dealt with until the whole matter of transformer design is taken up in a later section. But the following example will give a general idea of the considerations involved, and will illustrate the use of B-H and hysteresis and eddy current curves :

Ten-kilowatt Transformer.—The magnetic circuit is shown in the accompanying sketch (Fig. 138). Primary voltage = 2,000 volts. Secondary voltage = 100 volts. Primary turns = 2,340, periodicity 80 cycles per second. $E = 4 \text{ F.T.N.M.} \times 10^{-8}$. Assume that the transformer is to be used on a circuit having a sine wave of electromotive force. The "form factor" of a sine wave is 1.11; hence

$$F = 1.11$$

$$2000 = 4 \times 1.11 \times 2340 \times 80 \times M \times 10^{-8}$$

$$M = 240,000 \text{ lines} = .24 \text{ megalines.}$$

Effective cross-section of magnetic circuit = $3.13 \times 3.13 \times .90^1 = 8.8$ square inches.

$$\text{Density} = 27.3 \text{ kilolines per square inch.}$$

First calculate magnetising component of leakage current. From curve B of Fig. 22 (page 26), we find that at a density of 27.3 kilo-

¹ Ninety per cent. of the total depth of laminations in iron, the remaining 10 per cent. being japan varnish or paper for insulating the laminations from each other.

lines, there is required about three ampere-turns of magnetomotive force per inch length of magnetic circuit.

Mean length of magnetic circuit = 59.5 in.

∴ Require magnetomotive force of $59.5 \times 3 = 179$ ampere turns.

There are 2,340 turns.

∴ Require a maximum current of $\frac{179}{2340} = .077$ amperes.

∴ R.M.S. current = $\frac{.077}{\sqrt{2}} = .054$ amperes.

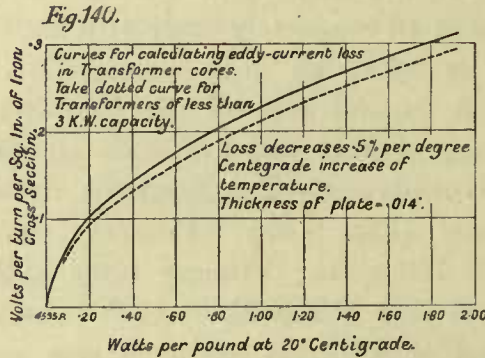
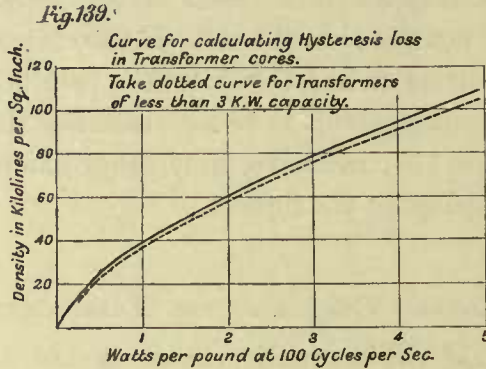

Next estimate core loss component of leakage current. Weight of sheet iron = $59.5 \times 8.8 \times .282 = 148$ lb. At 80 cycles and 27.3 kilolines, Fig. 139 shows that there will be a hysteresis loss of $.6 \times .8 = .48$ watts per pound.

Volts per turn per square inch of iron cross-section = $\frac{2,000}{2,340 \times 8.8} = .097$. From Fig. 140 the eddy current loss is found to be .21 watts per pound.

Consequently hysteresis and eddy current loss will be $.48 + .21 = .69$ watts per pound. Total iron loss = $148 \times .69 = 102$ watts. Core loss component of leakage current = $102 \div 2,000 = .051$ R.M.S. amperes.

Resultant leakage current = $\sqrt{.054^2 + .051^2} = .074$ amperes. Full load current = $\frac{10,000}{2,000} = 5.0$ amperes.

Consequently resultant leakage current = 1.4 per cent. of full-load current. Core loss = 1.02 per cent. of full-load rated output.

Example.—Find core loss and leakage current for the same transformer with the same winding when running on a 2,200-volt 60 cycles circuit.

MAGNETIC CIRCUIT OF THE INDUCTION MOTOR.

In Fig. 141 is represented the magnetic structure of a six-pole three-phase induction motor. The primary winding is located in the external

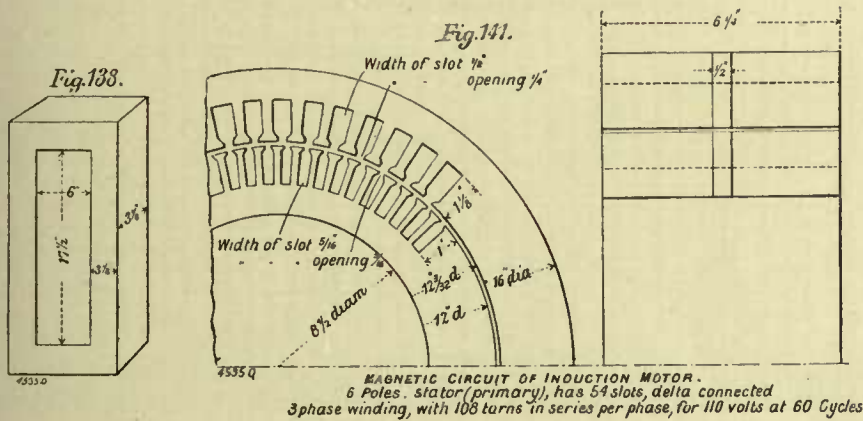

stator, which has 54 slots. There are 12 conductors per slot, consequently $12 \times 54 = 648$ total face conductors, 324 turns, and 108 turns in series per phase. The motor is for 100 volts, and 60 cycles, and its primary windings are Δ connected. When run from a sine wave circuit, we have

$$110 = 4 \times 1.11 \times 108 \times 60 \times M \times 10^{-8}$$

$$M = .38 \text{ megalines.}$$

Before proceeding to the calculations directly concerned in the determination of the magnetising current for the magnetic circuit of this induction motor, it will be necessary to study the relations between magnetomotive force and flux distribution in this type of magnetic circuit and winding.

In Fig 142, a portion of the gap face of the primary is developed along a straight line, and the slots occupied by the three windings are

lettered A, B, and C. The relative magnitudes of the currents in the three windings at the instant under consideration are given numerically immediately under the letters, and the relative directions of these currents are indicated in the customary manner by points and crosses. The instant chosen is that at which current in phase A is at its maximum, denoted by 1, the currents in B and C then having the value .5.

The curve plotted immediately above this diagram shows the distribution of magnetic flux in the gap, at this instant, on the assumption that the gap density is at each point directly proportional to the sum total of the magnetomotive forces at that point. Thus the magnetic line which, in closing upon itself, may be conceived to cross the gap at the points

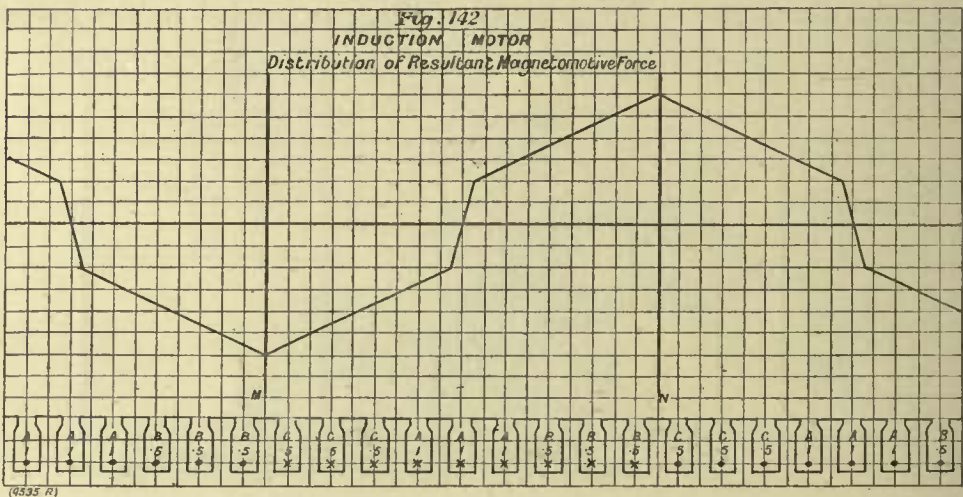

M and N, is linked with the maximum ampere turns. Taking the instantaneous current in conductors of phase A as 1, and in phases B and C as .5, and for the moment considering there to be but one conductor per slot, the total linkage of ampere turns with the line *m n* is $3 \times 1 + 6 \times .5 = 6$, and the maximum ordinate is plotted at this point with the value 6.

In the same way the other ordinates are plotted. From this curve it appears that the resultant of the magnetomotive forces of the three phases at the points M and N is two times the maximum magnetomotive force of one phase alone. This is a general property of such a three-phase winding.

Moreover, an analysis of the curve shows the maximum ordinate to be 1.6 times as great as the average ordinate. But this is only in this particular case. With different numbers of slots per pole-piece, this value would vary, and, owing partly to the increased reluctance in the high

density teeth, the curve would tend to be smoothed out and become less peaked. Consequently, the distribution of the flux density should be taken to have a sinusoidal form. Practical calculations of the magnetising current agree best with observed results when the maximum value of the air-gap density over the pole-face is taken equal to $\sqrt{2}$ times the average value.

The above considerations are sufficient, as they enable us to determine the maximum values of magnetomotive force and flux, and it is from such values that the maximum magnetising current is derived. But it will be of interest to refer also to Fig. 143, in which are represented the conditions one-twelfth of a complete cycle (30 deg.) later, when the current in phase B

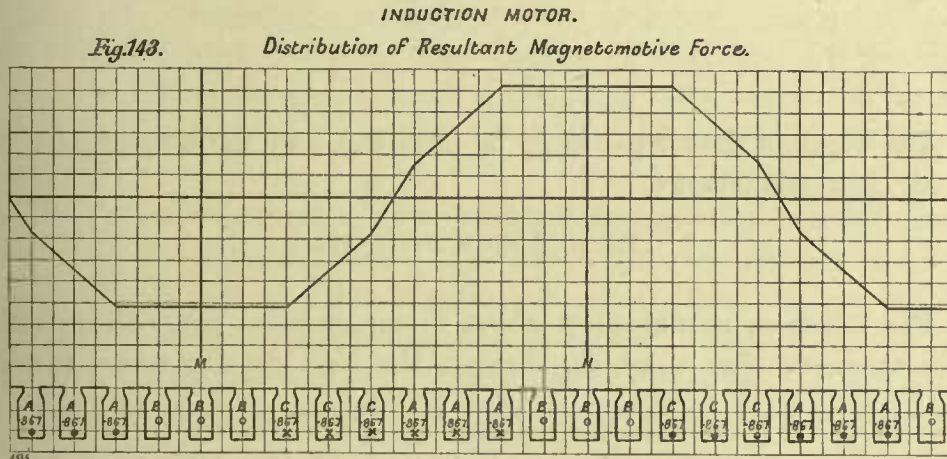

has become zero, the current in phases A and C having become .867. Figs. 142 and 143 represent the limiting values between which the resultant magnetomotive force fluctuates as the magnetic field proceeds in its rotatory course about the magnetic structure. Various experimenters have shown this small variation in intensity to be, in practice, practically eliminated. An examination of the diagrams of Figs. 142 and 143 shows that the maximum ordinates are 5.2 and 6 respectively, which corresponds to the theoretical ratio of

$$\frac{\sqrt{3}}{2} : 1 = 1 : 1.16.$$

From Fig. 141 the following cross-sections of the magnet circuit per pole-piece at different positions are obtained :

	Sq. In.
A. Cross-section air gap per pole-piece at face of stator, <i>i.e.</i> , surface area of exposed iron of projections	21
B. Ditto for rotor face... ..	21
C. Cross-section at narrowest part of projections in stator	10
D. Cross-section at narrowest part of projections in rotor	8
E. Cross-section in laminations back of slots in stator	10
F. Cross section in laminations back of slots in rotor	8

FLUX DENSITY.

	Average.	Maximum.
A.	18 kilolines	25 kilolines
B.	18 ,	25 ,
C.	38 ,,	54 ,,
D.	48 ,,	68 ,,
E.	—	38 ,,
F.	—	48 ,,

The depth of the air gap is $\frac{3}{64}$ in. (.047 in.), and the ampere-turns for the air gap amount to

$$.313 \times 25,000 \times .047 = 370.$$

For the iron, should allow about 8 ampere-turns per inch of length of the magnetic circuit, which, through the high density teeth, is about 9 in.

$$\text{Ampere-turns for iron} = 8 \times 9 = 72$$

$$\text{Total ampere-turns per pole-piece} = 370 + 72 = 442.$$

Magnetomotive force of the three phases is equal to two times the maximum ampere-turns per pole-piece per phase. There are 18 turns per pole-piece per phase, therefore, letting C = R. M. S. amperes per phase, we have

$$1.41 \times C \times 18 \times 2 = 442.$$

$$C = \frac{442}{1.41 \times 18 \times 2} = 8.7 \text{ amperes} = \text{magnetising current per phase.}$$

Taking the core loss at 300 watts, the friction at 150 ^{watts} volts, and the C² R loss running light, at 50 watts, gives a total power, running light, of 500 watts, or 167 watts per phase. Energy component of leakage current

$$\text{per phase} = \frac{167}{110} = 1.5 \text{ amperes.}$$

Resultant leakage current per phase = $\sqrt{8.7^2 + 1.5^2} = 9$ amperes.

Ditto per line leading to motor = $9 \times \sqrt{3} = 15.6$ amperes.

Letting power factor, running light, equal P, we have

$$P \times 9 \times 110 = 168$$

$$P = .17.$$

EXAMPLES.

The following examples relate to matters treated of in the foregoing sections:

1. A three-phase generator has 24 poles, 36 slots, 20 conductors per slot, Y connection. Volts between collector rings at no load and 500 revolutions per minute = 3500. What is the flux from each pole-piece into the armature, assuming the curve of electromotive force to be a sine wave? (For type of winding, see Fig. 82, page 74.)

2. A continuous-current dynamo has a two-circuit single winding (drum). Its output is 100 kilowatts at 550 volts. The current density in the armature conductors is 1200 amperes per square inch. It has 668 face conductors. Mean length of one armature turn is 75 in.

What is the cross-section of the armature conductors?

What is the resistance of the armature from positive to negative brushes at 60 deg. Cent.?

The dynamo has six poles. If the speed is 200 revolutions per minute, what is the magnetic flux entering the armature from each pole-piece?

3. A six-pole continuous-current generator with a two-circuit, single winding, gives 600 volts with a certain field excitation and speed. There are 560 face conductors, arranged two per slot in 280 slots. If this winding is tapped off at two points, equi-distant with reference to the winding, what would be the alternating current voltage at two collector rings connected to these points?

Assume the pole arc to be 60 per cent. of the polar pitch.

4. 100-kilowatt dynamo, 250 volts, 4 poles; 500 revolutions per minute; armature wound with a two-circuit, triple-winding; 402 face conductors arranged in 201 slots. Therefore $\frac{402}{2} = 201$ total turns. $\frac{201}{6}$

= 33.5 turns in series between brushes. $\frac{500 \times 2}{60} = 16.7$ cycles per second.

$$250 = 4 \times 33.5 \times 16.7 \times 10^{-8}.$$

∴ M = 11.2 megalines. Take leakage factor = 1.20.

Flux in magnet cores = $11.2 \times 1.20 = 13.5$ megs. Magnet cores of cast steel, and run at density of 95 kilolines per square inch, therefore cross-section = $\frac{13,500,000}{95,000} = 142$ square inches. Circular cross-section. Diameter = 13.5 in.

Length armature core parallel to shaft = 16 in., of which 12 in. is solid iron, the remainder being occupied by ventilating ducts and the space lost by the japanning of the iron sheets. Diameter armature = 30 in. Length air gap = $\frac{1}{4}$ in. Length magnet cores = 12 in. Length magnetic circuit in yoke = about 24 in. per pole-piece. Yoke of cast iron and run at density of 35 kilolines. Tooth density = 120 kilolines. Core density = 70 kilolines. Therefore, depth of iron under teeth = $\frac{11,200,000}{2 \times 70,000 \times 12} = 6.7$ in. Length magnetic circuit in armature = 10 in. per pole-piece. Pole arc measured along the arc = 17.5 in. Cross-section of pole-face = 16 in. \times 17.5 in. = 280 square inches.

$$\text{Pole-face density} = \frac{11,200,000}{280} = 40 \text{ kilolines.}$$

Ampere-turns per pole-piece for yoke...	=	24	\times	60	=	1400
Ampere-turns per pole-piece for magnetic core	=	12	\times	50	=	600
Ampere-turns per pole-piece for teeth...	=	1.5	\times	350	=	525
Ampere-turns per pole-piece for armature core	=	10	\times	12	=	120
Ampere-turns per pole piece for air gap	=	.25	\times	40,000	\times	.313 = 3130

Total ampere-turns per pole-piece at no load and 250 volts = 5775

CONSTANT POTENTIAL, CONTINUOUS-CURRENT DYNAMOS.

THE problems peculiar to the design of the continuous-current dynamo are those relating to commutation. The design of the magnetic circuit, and considerations relating to the thermal limit of output, to efficiency and to regulation, although matters of importance in obtaining a satisfactory result, are nevertheless secondary to the question of commutation; and they will consequently be considered incidentally to the treatment of the design from the commutating standpoint.

Under the general class of constant potential dynamos are included not only dynamos designed to maintain constant potential at their terminals for all values of the current output, but also those designed to maintain constant potential at some distant point or points, in which latter case the voltage at the generator terminals must increase with the current output, to compensate for the loss of potential in the transmission system.

In the commutating dynamo, great improvement has been made in the last few years in the matter of sparkless collection of the commutated current; in consequence of which, the commutator undergoes very little deterioration; and it is customary to require the dynamo to deliver, without harmful sparking, any load up to, and considerably in excess of, its rated output, with constant position of the brushes. This has been made necessary by the conditions of service under which many of these machines must operate; and the performance of such machines is in marked contrast to that of the dynamos of but a few years ago, in which the necessity of shifting the brushes forward in proportion to the load was looked upon as a matter of course. The change has been brought about by the better understanding of the occurrences during commutation, and to the gradual acquisition of data from which satisfactory constants have been deduced. One of the most important factors has been the very general introduction of high-resistance brushes, the use of copper brushes now generally being resorted to only for special purposes.

Radial bearing carbon brushes are now used very extensively, and although they were at first considered to be applicable only to high potential machines, where the quantity of current to be collected would not require too large and expensive a commutator, their use has been extended to low-voltage machines of fairly large output, the advantages being considered to justify the increased cost of the commutator. Various types of brushes have been developed, intermediate in resistance between carbon and copper, and different grades of carbon brushes, from high-resistance grades with fine grain for high potential machines, to grades of coarser grain and lower resistance for low potential machines. A corresponding development has been taking place in the design of brush-holding devices. In the construction of the commutator, care is now taken to insulate the segments by mica, which shall wear at as near as possible the same rate as the copper segments; and the construction of the commutator has now reached a stage where uneven bars and other sources of trouble of earlier days now no longer give concern. Of less importance, owing to the greatly increased durability of the modern commutator, are the modes of construction whereby sectors of the commutator may be renewed without disturbance to the remainder of the commutator. This is a method much employed in large commutators. Amongst the examples of modern dynamos which follow the discussion of matters of design, will be found illustrations of various types of commutator construction.

The advance thus briefly summed up, in the mechanical design and in the careful choice of material for brushes, brush holders, and commutators, has been in no small measure responsible for the improvement in commutating dynamos, and, when accompanied by correct electro-magnetic proportions, has enabled manufacturers to dispense with the many ingenious but complicated windings and devices arranged to modify sparking by making use of various electro-magnetic principles requiring auxiliary windings, subsidiary poles, and other additions. Some of these non-sparking devices accomplish their purpose very effectively; but, notwithstanding the care and ingenuity displayed in their application, it does not appear likely that it will be commercially profitable to resort to them, since the careful application of ordinary methods appears to have already brought the constant potential commutating dynamo to that stage of development where the thermal limit of output of armature and field is reached below that output where harmful sparking occurs. Further improvement rendering it permissible to use more highly

conducting brushes without encountering sparking, would of course result in a saving in the cost of the commutator, and from some source or other such improvement may appear. But as the saving can apparently only be effected at the commutator, it will not be sufficient in amount not to be more than offset by the increased cost of resorting to any of the auxiliary windings and devices yet proposed.

ARMATURE REACTION.

The study of the problems relating to sparking resolves itself down principally to the study of the reaction of the armature, which will now be considered and illustrated with relation to its influence upon the proportioning of commutating dynamos, the choice of windings, and, finally, by descriptions of some modern dynamos.

When discussing the formulæ for electromotive force and the design of the magnetic circuit, it was pointed out that considerations relating to armature reaction make it necessary to modify the conclusions arrived at when these phenomena are left out of consideration. The formula for the electromotive force $E = K T N M 10^{-8}$, has already been given. Additional conditions are, however, imposed by the necessity of giving T , the turns, and M , the flux, such relative values as to fulfil the conditions necessary to obtain sparkless collection of the current, and satisfactory regulation of the voltage, with varying load.

The requirements for commutating or reversing the current in the coil that is to be transferred from one side of the brush to the other, consist in so placing the brushes that when the coil reaches the position of short-circuit under the brushes, it shall have just arrived in a magnetic field of the direction and intensity necessary to reverse the current it has just been carrying, and to build up the reversed current to a strength equal to that of the current in the circuit of which it is about to become a part. In such a case, there will be no spark when the coil passes out from the position of short circuit under the brush. Now it is plain that, as the current delivered from the machine is increased, it will require a stronger field to reverse in the coil this stronger current. But, unfortunately, the presence of this stronger current in the turns on the armature, so magnetises the armature as to distort the magnetic field into a position in advance of the position of the brushes, and also to weaken the magnetic flux. The brushes must

therefore be shifted still further, whereupon the demagnetising effect of the armature is again intensified. Finally, a current output will be reached at which sparkless collection of the current will be impossible at any position, there being nowhere—by the time the brushes are moved to it—any place with sufficient strength of field to reverse and build up to an equal negative value the strong armature current, during the time the coil is passing under the brush.

These distorting and demagnetising effects of the armature current are made quite plain by the diagrams given in Figs. 144, 145 and 146, in which the winding is divided into demagnetising and distorting belts of conductors.

In Fig. 144 the brushes are in the neutral zone, and the current is distributed in the two sets of conductors, so as to tend to set up a flux at right angles to that which, the armature carrying no current, would be set up by the field. The resultant flux will be distorted toward the forward pole tip, considered with reference to the direction of rotation. Therefore, at this position of the brushes, the electromagnetic effect of the armature is purely distortional. Similarly, if, as in Fig. 145, the brushes were moved forward through 90 deg. until they occupied positions opposite the middle of the pole faces, and if in this position, current were sent through the brushes into the armature, (the armature with this position of the brushes being incapable of generating current), the electromagnetic effect of the armature would be purely demagnetising, there being no component tending to distort the field; and in any intermediate position of the brushes, such, for instance, as that shown in Fig. 146, the electromagnetic effect of the armature current may be resolved into two components, one demagnetising, and due to the ampere turns lying in the zone defined by two lines (*aa*) drawn perpendicularly to the direction of the magnetomotive force of the impressed field, and passing through the forward position of the two brushes, and the other component due to the ampere turns lying outside of the zone, and purely distortional in its tendency. Fig. 146, of course, represents roughly the conditions occurring in actual practice, Figs. 144 and 145 being the limiting cases, shown for explanatory purposes.

In this connection, the results will be of interest of a test of armature reaction under certain conditions. A small four-pole iron-clad generator of 17-kilowatt capacity, at 250 volts, with a four-circuit single-winding, was tested with regard to the distribution of the magnetic

flux in the gap. For this purpose the gap was divided up into a number of sections, from each of which successively an exploring coil was withdrawn. The coil was in circuit with a resistance box, and with the moveable coil of a Weston voltmeter. From the deflections and the total resistances of the circuit, the intensity of the flux at different portions of the gap was determined. These determinations were made with the armature at rest. As shown on the curves of Fig. 147, readings were taken, first with the field excited, but with no current in the armature, (curve A), and then with full-load current

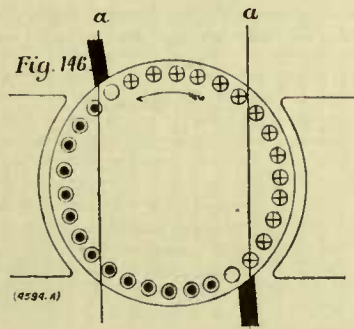
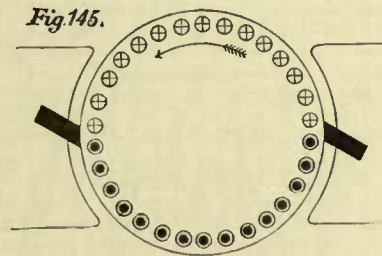
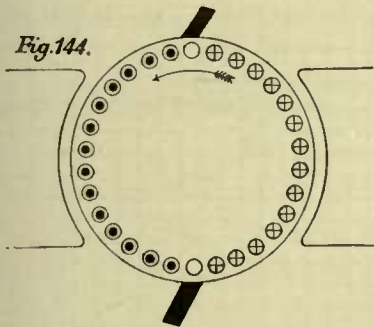

in the armature, and for various positions of the brushes. With the brushes at the neutral point (curve B), the distortion is at a maximum, but there is no demagnetisation. It would have been expected that the distortional crowding of the lines would have so increased the maximum density as to slightly diminish the total flux at the excitation used, this excitation being maintained at a constant value throughout the test. The integration of curves A and B, however, gives equal areas, consequently there was in this case no diminution of the total flux.

But when the brushes are shifted over to the middle of the pole face (curve E), the demagnetisation becomes very marked, as may be seen,

not only by the shape of the curve, but by its total area which is proportional to the total flux, but there is no longer any distortion. This last curve (curve E), representing the flux distribution corresponding to the position of the brushes at the middle of the pole face, should have been symmetrical, its lack of symmetry possibly being due to variation in the depth of the gap.

Dr. Hopkinson¹ has made experiments upon the distribution

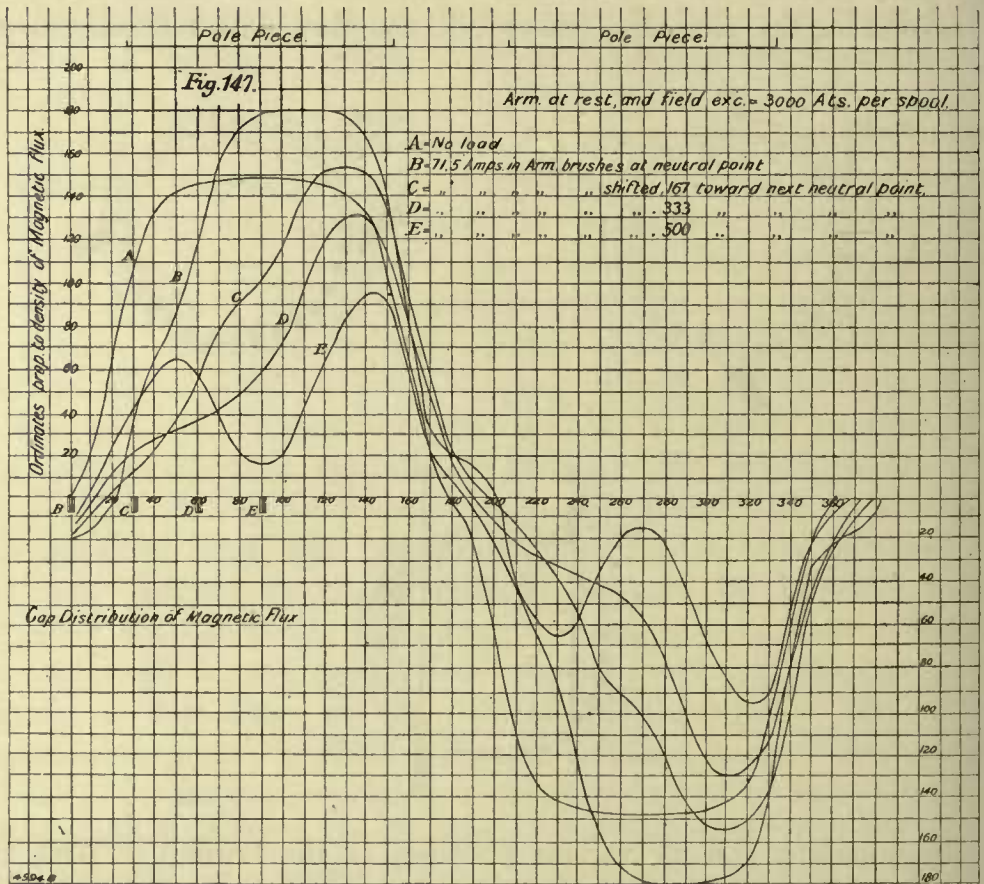

of the magnetic flux in the air gap of two Siemens Brothers' bipolar dynamos, the results of which correspond very closely with his calculations with reference to the influence of armature reaction. A similar analysis of the curves of Fig. 147 also confirms the theory of armature reaction. The machine experimented upon had a four-circuit

¹ "Original Papers on Dynamo Machinery and Allied Subjects." By John Hopkinson. Whittaker and Co., London, 1893.

drum-winding, with 79 coils of six turns each, in 79 slots in the periphery. There were, therefore, $\frac{79 \times 6}{4} = 119$ turns per pole piece on the armature. The armature current being 71.5 amperes, there were $71.5 \div 4 = 18$ amperes per turn; consequently, $119 \times 18 = 2140$ ampere turns per pole piece on the armature. The area of the curves, which are proportional to the flux entering the armature, are as follows :

- A. 49 square centimetres = 100 per cent.
- B. 49 " " = 100 "
- C. 36 " " = 74 "
- D. 27 " " = 55 "
- E. 20 " " = 41 "

For curves A and B, the demagnetising component is zero, there being, however, in the case of B, maximum distortion, which would have been expected to so increase the maximum gap density as to cut down the total flux due to the 3,000 field ampere turns per pole piece. This was not, however, the case.

In curves C, D, and E, the demagnetising component of the armature strength rose to $\frac{1}{3} \times 2,140 = 710$ at C, $\frac{2}{3} \times 2,140 = 1,420$ at D, and to the full strength of 2,140 ampere turns at E. These results can be tabulated as follows :

TABLE XXXVI.

1	2	3	4	5	6	7
Designation of Curve.	Percentage that Flux Entering Armature is of Total Flux at no Load. Determined from Area of Curves of Fig. 147.	Field Ampere Turns, Maintained Constant throughout the Tests.	Armature Ampere Turns, Maintained Constant throughout the Tests.	Demagnetising Component of Armature Ampere Turns Determined from Position of Brushes. See Diagrams of Figs. 144, 145, and 146.	Resultant Ampere Turns, Determined from Columns 3 and 5.	Percentage that Resultant Ampere Turns are of no Load Ampere Turns, Determined from Column 6.
A	100	3000	0	0	3000	100
B	100	3000	2140	0	3000	100
C	74	3000	2140	710	2290	76
D	55	3000	2140	1420	1580	53
E	41	3000	2140	2140	860	29

The large percentage of flux in curve E (41 per cent.), as compared with the small percentage of resultant ampere turns (29 per cent.), is explained by the fact that with the brush at the middle of the pole face,

as was the case in curve E, many of the armature turns are so situated in space as not to be linked with the entire flux, and consequently cannot be so effective in demagnetisation. In other words, the armature turns are uniformly distributed, instead of being concentrated in a coil placed so as to fully oppose the field coils. The extent of this non-effectiveness is proportional to the pole arc, but with the positions of the brushes which would occur in practice, the demagnetising component of the armature ampere turns would be fully effective.

It will be observed that for curves A, B, C and D, the proportion of flux to resultant ampere turns is very close.

APPLICATION OF THESE CONSIDERATIONS TO THE PROPORTIONING OF DYNAMOS.

If it were not for these effects, due to the electromagnetic reaction of the armature, the proportioning of dynamos would resolve itself into a determination of those values of T and M in the formula $E = KTNM \times 10^{-8}$, which would, with a minimum cost of material, give the desired current and voltage; suitable cross-section of copper and iron being chosen, to secure immunity from excessive heating. Thus suppose the problem should arise, of the best design for a 500-volt 100-kilowatt generator, to run at 600 revolutions per minute. The current output is 200 amperes. Let us try a two-pole drum winding with 10 face conductors. Then $T = 5$; $N = 10$; $500 = 4 \times 5 \times 10 \times M \times 10^{-8}$, $M = 250,000,000$ lines. The armature iron could not properly be run at more than 100,000 lines per square inch. Therefore, the cross-section of the armature = 2,500 square inches at least. It thus appears that the armature would have to be 50 in. in diameter and 50 in. long, or else some other equally extreme dimensions. The field turns would be of great length, and as the air gap density would be very high, there would be need for very many field ampere turns. Without carrying the calculations any farther, it is apparent that, as regards cost of materials alone, the machine would be poorly designed.

On the other hand, suppose the armature had 2000 face conductors. Then $T = 1000$; $500 = 4 \times 1000 \times 10 \times M \times 10^{-8}$, $\therefore M = 1,250,000$ lines. Necessary cross-section = 12.5 square inches as far as regards transmitting the flux. Therefore, the magnet cores would be 4 in. in diameter. But to have on the armature 2000 face conductors, each

carrying 100 amperes, would require a very large armature, probably as large a diameter as was necessary in the former case; but then it was a question of carrying a large magnetic flux, which determined the size of the armature. In this case we should have a very large weight of armature copper, but otherwise the material would not cost much, if we look no further into the matter of field copper than relates to that necessary to obtain the required flux at no load. But, nevertheless, on the score of material alone, some intermediate number of conductors would be found to give a more economical result.

INFLUENCE OF ARMATURE REACTION IN THESE TWO EXTREME CASES.

In the first case, that of the armature with only five turns, there would have been but $\frac{5 \times 100}{2} = 250$ ampere turns per pole-piece on the armature, which, as far as armature reaction effects are concerned, would be entirely negligible; but, as relates to the collection of the current, there would be $\frac{500}{2.5} = 200$ average volts between commutator segments, and this would have corresponded to such a high inductance per coil as to have rendered quite impossible the reversal of 100 amperes, 20 times per second, with any ordinary arrangement of commutator and brushes.

In the other case (that of the machine with 1000 armature turns), there would have been one volt per turn, a value which, with the methods of construction generally employed, would correspond to a very low inductance indeed; but there would have been on the armature $\frac{1000 \times 100}{2} = 50,000$ ampere turns per pole-piece, which would completely overpower the field excitation, and the design would be entirely out of the question.

We find, therefore, that while in the first case the armature reaction is small, the inductance per commutator segment is excessive. In the second case the inductance per commutator segment is small; the armature is altogether too strong. With but two poles, some intermediate value would have to be sought for both quantities; probably something like 100 turns would give a fairly good result.

CONDITIONS ESSENTIAL TO SPARKLESS COMMUTATION.

As a consequence of armature reaction and inductance, it becomes not only desirable but necessary to limit the armature strength to such an amount (at full load current) as shall not too greatly interfere with the distribution and amount of the magnetic flux set up by the magnet spools. It is furthermore necessary to make each armature coil between adjacent commutator segments of so low inductance as to permit of the complete reversal of the current by means of the residual flux in the commutating field. The location and amount of this residual flux is determined by the strength of the armature, and the position of the brushes and the reluctance of the gap. To best understand the method of fulfilling these conditions, attention should be given to the following illustrations, which lead up to a very definite method for assigning the most desirable electromagnetic proportions to constant potential dynamos, particularly with reference to the determination of the proper number of poles.

DETERMINATION OF THE NUMBER OF POLES FOR A GIVEN OUTPUT.

Suppose we want a 50-kilowatt 400-volt bipolar generator. We conclude to limit the armature strength to 3,000 ampere turns per pole-piece, and the volts per commutator segment to 16 volts (a very high limit).
 Amperes output = $\frac{50,000}{400} = 125$ amperes. Therefore, each conductor carries $\frac{125}{2} = 62.5$ amperes. Turns per pole-piece = $\frac{3,000}{62.5} = 48$, *i.e.*, 96 total turns. $\frac{400}{16} = 25$ commutator segments between brushes, or 50 total commutator segments. Therefore $\frac{96}{50} =$ about two turns per coil (*i.e.*, per commutator segment).

In the 100 kilowatt machine for the same voltage, to retain the same strength of armature, and the same volts per commutator segment, we must have only one turn per coil.

For these values of armature strength and volts per commutator segment we have now reached the limiting output, and the problem arises: What shall be done in the case of a machine of twice the size, in this case 200 kilowatts, if the type of winding remains the same? We cannot have less than one turn per commutator segment, so we find that in a bipolar

machine it will be necessary to either double the armature strength, in which case we can retain the low voltage per commutator segment, or we can double the voltage per commutator segment, and keep the armature strength of the same low value used in the previous cases; or we can compromise by raising both limits to a less extent. This latter plan is that which would be adopted to retain the bipolar design. But the result would be unsatisfactory as regards sparking, and even though it could be made passable at this output, the same question would arise with the next larger size. But by the use of a multipolar design, the difficulty is entirely overcome. Suppose we let our 200-kilowatt 400-volt machine, have four poles. Then there will be four paths through the armature, each carrying a quarter of the total current. Amperes output = $\frac{200,000}{400} = 500$ amperes.

Therefore amperes per conductor = $\frac{500}{4} = 125$. The turns per pole-piece = $\frac{3,000}{125} = 24$. We have, also, 24 commutator segments per pole-piece, giving $\frac{400}{24} = 16.6$ volts per commutator segment.

A machine can consequently be made to operate entirely satisfactorily, as regards sparking, by designing it with a proper number of poles.

MULTIPLE CIRCUIT WINDINGS.

With multiple-circuit windings, the armature strength and the volts per bar may be reduced to any desired extent by sufficiently increasing the number of poles. Thus, suppose that in a certain case the conditions given are that the armature strength of a 500-kilowatt 600-volt generator shall be 4,000 ampere-turns per pole-piece, and that there may be 15 volts per commutator segment. Then the number of poles would be determined as follows :

$$\text{Commutator segments per pole-piece } \frac{600}{15} = 40.$$

Therefore 40 turns per pole piece.

$$\frac{4000}{40} = 100 \text{ amperes per armature branch.}$$

$$\text{Full load current } \frac{500,000}{600} = 833 \text{ amperes.}$$

$$\text{Therefore we want } \frac{833}{100} = 8 \text{ poles.}$$

But suppose it were considered advisable that this generator should have only 3000 ampere-turns per pole-piece on the armature, and that it should have but 8 volts per commutator segment, then turns per pole-piece

$$= \frac{600}{8} = 75.$$

$$\text{Amperes per armature conductor} = \frac{3000}{75} = 40$$

$$\text{Therefore number of poles} = \frac{833}{40} = 20.$$

TWO-CIRCUIT WINDINGS.

But in the case of two-circuit windings, these values cannot be adjusted by changing the number of poles, for the reason that the current divides into two paths through the armature, independently of the number of poles, instead of dividing into as many paths as there are poles.

Suppose, for example, that it were desired to use a two-circuit winding in a 500-kilowatt, 600-volt generator, and to have 15 volts per commutator segment. Then :

$$\text{Number of segments per pole-piece} = \frac{600}{15} = 40.$$

$$\text{Full load amperes} = \frac{500,000}{600} = 833.$$

$$\text{Amperes per turn} = \frac{833}{2} = 417.$$

Therefore, ampere-turns per pole-piece on armature = $40 \times 417 = 16,700$.

This would be impracticable. To reduce this to 6000 ampere-turns, the turns have to be reduced, and consequently the commutator segments, to $\frac{6,000}{16,700} \times 40 = 14$ per pole-piece. There would then be $\frac{600}{14} = 43$ volts per commutator segment, which, with ordinary construction, would correspond to so high a reactance voltage in the short-circuited coil (in a machine of this output) as not to be permissible. Moderate values can only be obtained by interpolating commutator segments in accordance with some well-known method, or by the use of double, triple, or other multiple windings. Such methods generally give unsatisfactory results, and two-circuit windings are seldom used for machines of large output. When they are used, in such cases, exceptional care has to be taken to counteract

their objectionable features by the choice of very conservative values for other constants.

MULTIPLE WINDINGS.

But the use of multiple windings (such, for instance, as the double winding of Fig. 74), permits of employing two-circuit windings.

Thus, suppose in the case of the design of a 350-kilowatt, 250-volt generator, it appears desirable, when considered with reference to cost of material, or for some other reason, to use 14 poles; and that, furthermore, a two-circuit multiple winding is to be used. The question arises, how many windings shall be employed, in order to have only 9 volts per commutator segment, and to permit not over 5,000 ampere-turns per pole-piece on the armature?

$$\frac{250}{9} = 28 \text{ commutator segments per pole-piece.}$$

Therefore, 28 turns per pole-piece.

$$\text{Therefore, } \frac{5000}{28} = 180 \text{ amperes per turn.}$$

$$\text{Amperes output} = \frac{350,000}{250} = 1400 \text{ amperes,}$$

$$\frac{1400}{180} = 7.8$$

Therefore there must be eight paths through the armature from the positive to the negative brushes. Consequently, a two-circuit quadruple winding is required.

It may, however, be well to again emphasise the fact that poor results generally follow from the adoption of such windings, except in cases where a width of commutator can be afforded which permits of dispensing with all but two sets of brushes.¹ By adopting such a width of commutator, one of the savings effected by the use of multipolar designs is lost. By careful designing, two-circuit double and sometimes two-circuit triple windings have given good results.

¹ If only two sets of brushes are retained, the short-circuited set of conductors no longer consists of the two corresponding to one turn, but now includes as many in series as there are poles. A high reactance voltage is consequently present in this short-circuited set. The presence of the full number of sets of brushes, if correctly adjusted, *should* reduce this, but cannot in practice be relied upon to do so.

TWO-CIRCUIT "COIL" WINDINGS.

But two-circuit single windings can be very properly applied to machines of such small capacity, that, when good constants are chosen, they work out to have one or more turns per segment. It follows that, within certain ranges, any desired values of armature strength and volts per commutator segment may be obtained; not, however, by a suitable choice of poles, but by the use of a suitable number of turns between commutator segments. Suppose, for instance, a 10-kilowatt 100-volt generator, with an armature strength of 2,000 ampere turns per pole-piece, and with 5 volts per commutator segment.

Then

$$\text{Segments per pole-piece} = \frac{100}{5} = 20$$

$$\text{Full load current} = \frac{10,000}{100} = 100 \text{ amperes.}$$

$$\text{Amperes per conductor} = \frac{100}{2} = 50.$$

$$\text{Turns per pole-piece} = \frac{2000}{50} = 40.$$

$$\text{Therefore, } \frac{40}{20} = \text{two turns per commutator segment.}$$

If 3,000 ampere-turns had been permissible, we should have used $\frac{3,000}{2,000} \times 2 = 3$ turns per commutator segment.

Finally, it may be stated that two-circuit armatures are built multipolar mainly from considerations of cost, and should not be used for large outputs except in special cases.

Aside from the reasons dependent strictly upon the magnetic limit of output, it may be said that two-circuit windings are unsatisfactory whenever the output is so large as to require the use of more than two sets of brushes (in order to keep the cost of the commutator within reasonable limits), because of the two-circuit windings lacking the property of compelling the equal subdivision of the current among all the sets of brushes used. Selective commutation occurs, one set of brushes carrying for a time a large part of the total current; this set of brushes becoming heated. This trouble is greater the greater the number of sets of brushes, and the practicability of two-circuit windings may be said to be inversely as the number of poles. If, however, in *multiple*

circuit windings the part of the winding opposite any one pole-piece should tend to take more than its share of the current, the increased armature reaction and CR drop tends to restore equilibrium, this property constituting a great advantage.

VOLTAGE PER COMMUTATOR SEGMENT AS RELATED TO INDUCTANCE.

As already stated, the average voltage between commutator segments, although it can be relied upon to give good results, if care is used in special cases, is not a true criterion of the inductance of a coil. For, in different types, this expression may have the same value for coils of different inductances.

Thus, if the design is for an armature in which the conductors are located in holes beneath the surface, the inductance will be very high, and it would be necessary to limit the average voltage per commutator segment to a very low value. If the slots are open, the inductance will be somewhat lower, and in a smooth core construction with the winding on the surface, the inductance is very low. In this latter case, a much higher value for the average volts per commutator segment could be used.

The possible value also varies according to whether carbon or copper brushes are used. Carbon¹ brushes may be much less correctly set and still have sparkless commutation, due to the high resistance of the brush limiting extreme variation of current in the short-circuited coil, as well as because the brushes are not so subject to injury through this cause, as would be the case with copper brushes; consequently, the average volts per commutator segment may be permitted to be three or four times as great as with copper brushes, without endangering the durability either of the brushes or of the commutator; and on account of this, it is found desirable to increase the density in the

¹ There has lately been a tendency amongst some designers to attribute still other properties to high-resistance brushes, and even to maintain that they play an important part, not only in limiting the short-circuit current, but in accelerating the building up of the reversed current. However, one would feel inclined to hold that the main element in the commutating, *i.e.*, stopping and reversing of the current, is attributable to the influence of the residual commutating field; and that while the carbon brush aids in promptly arresting the original current, it is perhaps of still more importance in virtue of its possessing a certain inertness in combination with the copper commutator segments which renders the sparking

air gap to correspond with this higher inductance between commutator segments.

We have now shown that although the preliminary design for a commutating machine may be arrived at from the maximum permissible armature reaction and the number of commutator segments per pole necessary for good commutation, the average voltage between the commutator segments is not the ultimate expression as regards commutation. The ultimate expression must be in terms of the inductance of the coil or coils included between a pair of commutator bars.

In general, commutation occurs when a coil is in a feebly magnetised field, so that the inductance can be approximately calculated from the magnetomotive force of the coils, and the reluctance of the magnetic circuit around which the coils act. The frequency of reversal is determined from the thickness of the brush and the commutator speed.

The commutated current consists of two components: one a wattless magnetising component, and the other an energy current, due firstly to the dissipation of energy by $C^2 R$ loss in the coil, and secondly to eddy currents generated internally in the copper conductors, and in the surrounding mass of metal.

It follows from this that there is a loss increasing with the load in commutating machines due to the commutation of the currents. There

much less destructive than between copper brushes and copper segments. It has the property of burnishing the commutator, giving it a lustrous refractory surface.

The following bibliography comprises the most recent contributions to the discussion of the subject of sparking in commutating dynamos:

Weymouth; "Drum Armatures and Commutators."

Reid; "Sparking; Its Cause and Effects;" *Am. Inst. Elec. Engrs.*; December 15th, 1897. Also *The Electrician*, February 11th, 1898.

Thomas; "Sparking in Dynamos." *The Electrician*, February 18th, 1898.

Girault; "Sur la Commutation dans les Dynamos à Courant Continu." *Bull. de la Soc. Int. des Electr.*, May, 1898, vol. xv., page 183.

Dick; "Ueber die Ursachen der Funkenbildung an Kollektor und Bürsten bei Gleichstrom-dynamos." *Elek. Zeit.*, December 1st, 1898, vol. xix., page 802.

Fischer-Hinnen; "Ueber die Funkenbildung an Gleichstrom-maschinen." *Elek. Zeit.*, December 22nd and 29th, 1898, vol. xix., pages 850 and 867.

Arnold; "Die Contactwiderstand von Kohlen und Kupferbürsten und die Temperaturerhöhung eines Kollektors." *Elek. Zeit.*, January 5th, 1899, vol. xx., page 5.

Kapp; "Die Funkengrenze bei Gleichstrom-maschinen." *Elek. Zeit.*, January 5th, 1899, vol. xx., page 32.

Arnold and Mie; "Ueber den Kurzschluss der Spulen und die Kommutation des Stromes eines Gleichstromankers." *Elek. Zeit.*, February 2nd, 1899, vol. xx., page 97.

are also other load losses in commutating machines, brought about by the distortion and the increasing magnetisation in the iron, so that the hysteresis and eddy current losses increase from no load to full load, as also the eddy current losses in the armature conductors themselves¹ It has been generally assumed on the part of designers that these losses in the armatures of commutating dynamos do not increase with the load. This, however, is incorrect. The increase does exist, and is in general of the same nature as the increase in these losses in alternators, due to the load, although they may be restricted to a greater extent by proper designing. The effect of the induced eddy currents on commutation is often appreciable, since the frequency of commutation is generally from 200 to 700 cycles per second. For this reason, calculations on inductance in reference to commutation have to be considered with reference to the particular construction of the armature core. Constants as to inductance are, therefore, best determined by actual measurements. In practice, a good average expression is, that one ampere turn will give a field of 20 C.G.S. lines per inch of length of armature core.

It is convenient to assume this as a basis upon which to work out a design. As the design develops, the figures should be corrected according to the dimensions selected. This is the most satisfactory method, and several tests will be described, the results of which have a direct bearing upon the value of the constant. By a study of these results one may determine the most desirable proportions to give to the armature slot in order to bring the inductance down to, or even below, the value of 20 C.G.S. lines per ampere turn and per inch of length of armature lamination. In cases where it is impracticable to use such slot proportions as shall give the minimum value, the tests afford an indication of the value to be used. It is, of course, very desirable that such experiments should be independently carried out on the particular line of commutating dynamo with which the individual designer is concerned. In this connection, that is, in relation to inductance in commutating dynamos, interest attaches, not to the inductance of the armature winding as a whole, as in the case of alternating-current dynamos,² but to the

¹ See Fig. 114, on page 106, for experimental confirmation of this statement.

² Rotary converters contain the elements of both these types, and in their subsequent treatment it will appear that while the coil undergoing commutation should have the least practicable inductance, the inductance of the coils in series between collector rings must have a suitable value for reasons entirely other than those related to commutation.

inductance of those components of the winding which simultaneously undergo commutation at the brushes. In well-designed dynamos of this type such coils will, at the time of commutation, be located in the space between pole-tips, practically at the position of minimum inductance. The measurement of this inductance was the object of the tests now to be described.

PRACTICAL DEFINITION OF INDUCTANCE.

A coil has an inductance of one henry when it is situated in a medium of such permeability, and is so dimensioned, that a current of one ampere sets up a magnetic flux of such a magnitude that the product of the number of lines linked with the coil, by the number of turns in the coil is equal to 100,000,000. If the coil has but one turn, then its inductance, expressed in henrys, becomes 10^{-8} times the number of lines linked with the turn when one ampere is passing through it. If the coil has T turns, then not only is the magnetomotive force T times as great (except in so far as saturation sets in), but this flux is linked with T turns; hence the product of flux and turns, *i.e.*, the total linkage, the *inductance* of the coil, is proportional to the square of the number of turns in the coil.

DESCRIPTION OF EXPERIMENTAL TESTS OF INDUCTANCE.

First Experiment.—In Fig. 148 is shown a sketch of a commutating dynamo with a projection type of armature with a four-circuit single winding. The inductance of several groups of coils was measured with a 25-eyele alternating current, and the results, together with the steps of the calculation, are set forth in the following Tables.

TABLE XXXVII.—MINIMUM INDUCTANCE.

Conductors in position of minimum inductance are in the commutating zone, *i.e.*, midway between pole corners.

Number of Turns Under Test.	Amperes in these Turns.	Volts.	Impedance in Ohms.	Resistance in Ohms.	Reactance in Ohms.	Inductance in Henrys.	C.G.S. Lines per Ampere Turn and per Inch of Length of Lamination.
4	75	.594	.00790	.00692	.00388	.0000247	15.0
5	65	.728	.0120	.00865	.00708	.0000450	18.0
6	68	.944	.0139	.0104	.00930	.0000592	16.5

The air gap of this machine was afterwards shortened from its original depth of about .188 in. to about .1 in., and the inductance in the position of maximum inductance was again measured. In the position of minimum inductance, the values are unaffected by the depth of the air gap.

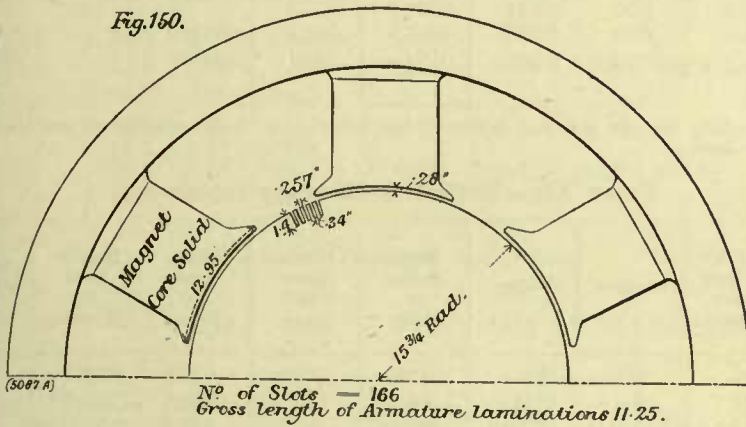
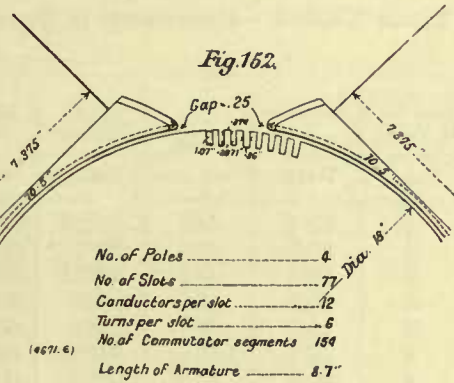
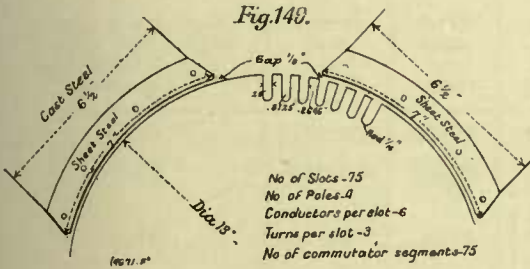
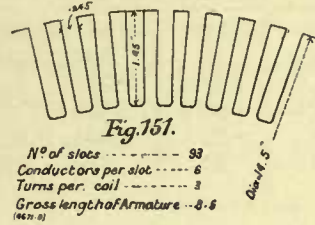
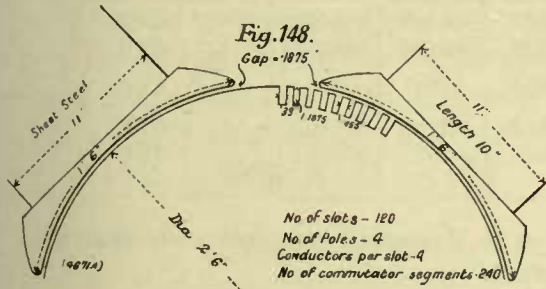

Second Experiment.—A commutating dynamo, illustrated in Fig. 149, has a four-circuit single winding consisting of 75 coils of three turns each, arranged in 75 slots. Tests with 25-cycle alternating current were made on the inductance of from one to five adjacent coils, and the results are set forth in Table XL.

TABLE XXXVIII.—MAXIMUM INDUCTANCE.

Conductors in position of maximum inductance are under the middle of the pole faces.

Number of Turns Under Test.	Amperes in these Turns.	Volts.	Impedance in Ohms.	Resistance in Ohms.	Reactance in Ohms.	Inductance in Henrys.	C.G.S. Lines per Ampere Turn and per Inch of Length of Lamination.
2	73	.391	.00535	.00346	.00407	.0000260	65.0
3	71	.730	.0103	.00529	.00890	.0000567	63.0
4	{ 60 } { 23 }	{ 1.095 } { .378 }	.0174	.00692	.0159	.000102	63.5
5	22	.594	.0270	.00865	.0256	.000163	65.0
6	22	.770	.0350	.0104	.0333	.000212	59.0

TABLE XXXIX.—CONDUCTORS IN POSITION OF MAXIMUM INDUCTANCE WITH SHORTENED AIR GAP.

Number of Turns Under Test.	Amperes in these Tests.	Volts.	Impedance in Ohms.	Resistance in Ohms.	Reactance in Ohms.	Inductance in Henrys.	C. G. S. Lines per Ampere Turn and per Inch of Length of Lamination.
1	80.5	.189	.00235	.00173	.00138	.00000876	87.6
2	40.0	.230	.00575	.00346	.00452	.0000288	72.0
2	78.0	.472	.00605	.00346			
3	20.5	.256	.0125	.00519	.0116	.0000735	81.5
3	39.0	.500	.0128	.00519			
3	76.5	1.02	.0133	.00519			
4	20.5	.432	.0210	.00692	.0202	.000129	80.5
4	38.0	.850	.0224	.00692			
5	19.5	.640	.0328	.00865	.0314	.000200	80.0
6	19.7	.915	.0465	.0104	.0452	.000288	80.0

Hence shortening the air gap has increased the inductance in the position of maximum inductance by about 27 per cent.

TABLE XL.—POSITION OF MINIMUM INDUCTANCE.

Number of Coils Under Test.	Number of Turns Under Test.	Amperes.	Volts.	Impedance in Ohms.	Resistance in Ohms.	Reactance in Ohms.	Inductance in Henrys.	C.G.S. Lines per Ampere Turn and per Inch of Length of Lamination.
3	9	63	2.25	.0357	.0309	.0173	.000110	15.5
4	12	58	3.00	.0518	.0412	.0308	.000197	15.6
5	15	52	3.70	.0710	.0515	.0482	.000307	15.6
<i>Position of Maximum Inductance.</i>								
1	3	61	.75	.0123	.0103	.00655	.000042	53
2	6	58	1.95	.0339	.0206	.0268	.000171	54
3	9	52	3.45	.0668	.0309	.0590	.000376	53
4	12	21	2.30	.111	.0412	.103	.000655	52
5	15	20	3.30	.165	.0515	.156	.00099	50

Attention should again be drawn to the fact that it is the minimum inductance, which corresponds to the inductance in the position of commutation, which is of chief interest in the present section.

Tables XXXVIII. and XXXIX., and the last half of Table XL., relating to the position of maximum inductance, are useful for a correct understanding of the relation of the proportions of the magnetic circuit of the armature coil to the resulting inductance, but are not directly applicable to the conditions obtaining during commutation.

Third Experiment.—Tests were made with 60-cycle alternating current upon the inductance of a six-pole commutating generator, the armature of which had 166 slots with a six-circuit single-winding of 166 complete coils, each of two turns. Fig. 150 gives the dimensions. The results are set forth in Table XLI.

TABLE XLI.—POSITION OF MINIMUM INDUCTANCE.

Number of Coils Under Test.	Number of Turns Under Test.	Amperes.	Volts.	Impedance in Ohms.	Mean Impedance.	Resistance in Ohms.	Reactance in Ohms.	Inductance in Henrys.	C.G.S. Lines per Ampere Turn and per Inch Length of Armature Lamination.
1	2	98.5	.46	.00467	.00465	.0015	.00439	.0000117	26.0
1	2	126.5	.585	.00463					
2	4	85.0	1.42	.0167	.0168	.0030	.0165	.0000440	24.5
2	4	95.7	1.62	.0169					
2	4	105.	1.79	.0169					
3	6	65.3	2.24	.0343	.0345	.0045	.0342	.000091	21.8
3	6	75.0	2.60	.0346					
3	6	87.0	3.00	.0345					
4	8	65.5	3.74	.0571	.0573	.0060	.0570	.000152	21.1
4	8	76.0	4.36	.0573					
4	8	87.0	5.00	.0575					

Position of Maximum Inductance.

1	2	89.8	.71	.0078	.0080	.0015	.0078	.0000208	46.3
1	2	95.2	.77	.0081					
1	2	111.8	.91	.0081					
2	4	71.0	2.24	.0316	.0312	.0030	.0310	.000082	45.6
2	4	78.0	2.42	.0310					
2	4	84.2	2.60	.0309					
3	6	72.3	4.68	.0648	.0644	.0045	.064	.000170	42.0
3	6	83.7	5.38	.0643					
3	6	89.3	5.74	.0643					
4	8	66.6	7.14	.1072	.1052	.0060	.105	.000279	38.8
4	8	77.0	8.32	.1062					
4	8	86.3	8.9	.1031					

Fourth Experiment.—This relates to the carcass of a 30 horse-power railway armature, the leading dimensions of which are indicated in Fig. 151. Only four coils, of three turns each, were in position in four adjacent armature slots. The armature was out of its field frame, which was equivalent to its being in the position of minimum inductance. The testing current was supplied at a frequency of 100 cycles per second. Gross length of armature lamination = 8.5 in. The results obtained are set forth in the following Tables :

TABLE XLII.—POSITION OF MINIMUM INDUCTANCE.

Number of Coils Under Test.	Number of Turns in these Coils.	Amperes in these Turns.	Volts at Terminals.	Impedance in Ohms.	Resistance in Ohms.	Reactance in Ohms.	Inductance in Henrys.	C.G.S. Lines per Ampere Turn and per Inch Gross Length of Armature Lamination.
1	3	55.5	1.11	.0200	.0085	.0181	.0000286	37.4
1	3	47.0	.94	.0200	.0085	.0181	.0000286	37.4
1	3	34.0	.68	.0201	.0085	.0182	.0000287	37.5
1	3	31.5	.62	.0195	.0085	.0176	.0000278	37.7
2	6	51.9	2.78	.0536	.017	.0507	.000080	26.2
2	6	42.5	2.27	.0536	.017	.0507	.000080	26.2
2	6	36.3	1.97	.0542	.017	.0513	.000081	26.5
2	6	31.4	1.71	.0545	.017	.0517	.000082	26.7
3	9	23.7	2.27	.0960	.026	.0924	.000147	21.4
3	9	18.9	1.84	.0974	.026	.0937	.000149	21.6
3	9	16.9	1.62	.0959	.026	.0921	.000146	21.2
3	9	15.8	1.50	.0947	.026	.0910	.000145	21.1
4	12	19.8	2.91	.147	.034	.143	.000227	18.5
4	12	15.9	2.51	.158	.034	.154	.000245	20.0
4	12	14.4	2.15	.149	.034	.145	.000230	18.8
4	12	12.4	1.88	.152	.034	.148	.000235	19.2
Mean of the four observations for three turns								37.5
" " six "								26.4
" " nine "								21.3
" " twelve "								19.1

Fifth Experiment.—Fig. 152 gives a sketch showing the leading dimensions of the dynamo experimented upon. The armature was in place in the cast-steel frame. Testing current had a periodicity of 100 cycles per second. The gross length of the armature lamination = 8.7 in. The results are given in Table XLIII.

TABLE XLIII.—POSITION OF MINIMUM INDUCTANCE.

Number of Coils Under Test.	Number of Turns in these Coils.	Amperes in these Turns.	Volts at Terminals.	Impedance in Ohms.	Resistance in Ohms.	Reactance in Ohms.	Inductance in Henrys.	C.G.S. Lines per Ampere Turn and per Inch Gross Length of Armature Lamination.
1	3	39.0	.838	.0215	.0065	.0205	.0000330	42.2
1	3	43.5	.941	.0216	.0065	.0206	.0000332	42.4
1	3	46.0	.992	.0216	.0065	.0206	.0000332	42.4
2	6	20.0	1.18	.0590	.0130	.0584	.0000924	29.5
2	6	21.5	1.24	.0577	.0130	.0562	.0000895	28.6
2	6	24.0	1.39	.0580	.0130	.0565	.0000900	28.8
2	6	25.0	1.45	.0581	.0130	.0565	.0000900	28.8
3	9	14.9	1.84	.124	.0195	.122	.000194	27.6
3	9	16.9	2.05	.122	.0195	.120	.000191	27.2
3	9	18.9	2.29	.122	.0195	.120	.000191	27.2
3	9	20.9	2.52	.121	.0195	.119	.000190	26.9
4	12	13.4	2.46	.184	.026	.182	.000290	23.2
4	12	14.8	2.74	.185	.026	.183	.000291	23.3
4	12	15.8	3.01	.190	.026	.188	.000299	23.9
4	12	18.3	3.44	.188	.026	.186	.000296	23.7
Mean of the observations with three turns								42.3
" " six "								28.9
" " nine "								27.2
" " twelve "								23.5

Sixth Experiment.—This experiment was made in respect to the inductance of an armature of a 25 horse-power tramway motor.

The following data applies to this armature :—

Diameter of armature	16 in.
Number of slots	105
„ coils	105
Turns per coil	4
Conductors per slot	12
Gross length of armature laminations	8 in.

The inductance tests were made with a current of a periodicity of 100 cycles per second.

Inductance measurements were made upon one, two, three, and four coils in series, and under the condition of minimum inductance, which was considered to correspond with the armature in air, and then with air gaps of various lengths arranged by a special pole-piece of laminated iron of the dimensions shown in Fig. 153, which shows the pole-piece in place, with pieces of leatheroid between it and the armature. Owing to this pole-piece being of the same radius as the armature, on

inserting the leatheroids a gap was obtained which was larger at the inner edge of the pole-piece than at the outer (see Fig. 153), so that in the calculations and curves a mean gap is given.

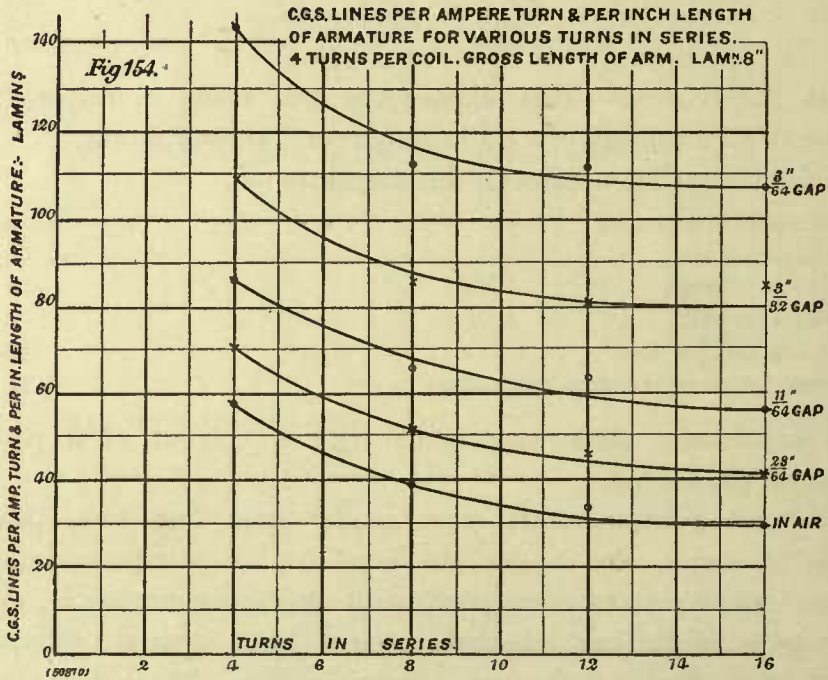
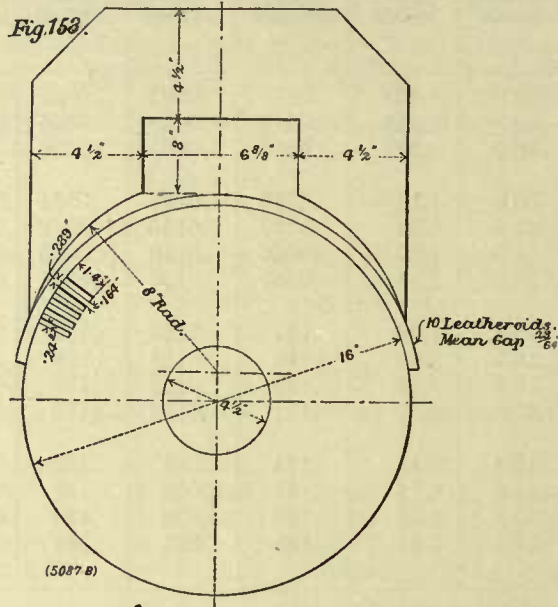

In Tables XLIV. to XLVII. inclusive, and in the curves of Figs. 154 and 155, are given the results of these tests.

TABLE XLIV.—ONE COIL OF FOUR TURNS PER COIL. RESISTANCE = 0.014 OHMS.

Amperes.	Volts.	Impedance.	Reactance.	Cycles per Second.	Inductance in Henrys.	C. G. S. Lines per Ampere Turn and per Inch Length of Armature.	Mean.	Mean Air Gap.
23.75	1.08	.0455	.0433	97	.0000710	55.5		in.
23	1.07	.0466	.0444	97	.0000728	57.0	56.6	∞
20.2	.945	.0468	.0466	97	.0000732	57.2		
23.5	1.325	.0562	.0549	99	.0000884	69.0		
22	1.268	.0576	.0558	99	.0000897	70.0	69.8	$\frac{23}{64}$
19.75	1.120	.0568	.0551	99	.0000887	69.3		
20	1.385	.0693	.0678	99	.000109	85.2		
22 5	1.56	.0694	.0679	99	.000109	85.2	85.5	$\frac{11}{64}$
24	1.675	.0698	.0684	99	.000110	86.0		
24 5	2.18	.0891	.0880	99	.000141	110.0		
20	1.725	.0863	.0852	99	.000137	107.0	108.2	$\frac{3}{32}$
22	1.91	.0868	.0857	99	.000138	107.8		
22	2.53	.1151	.1141	99	.000189	143.6		
20	2.29	.1145	.1137	99	.000183	143.0	142.5	$\frac{3}{64}$
18	2.03	.1128	.1119	99	.000180	141.0		

TABLE XLV.—TWO COILS OF FOUR TURNS PER COIL. RESISTANCE = 0.033 OHMS.

Amperes.	Volts.	Impedance.	Reactance.	Cycles per Second.	Inductance in Henrys.	C. G. S. Lines per Ampere Turn and per Inch Length of Armature.	Mean.	Mean Air Gap.
21	2.64	.1256	.1212	99	.000195	38.1		in.
19	2.42	.1274	.1230	99	.000198	38.7	38.2	∞
17.5	2.18	.1245	.1202	99	.000193	37.8		
17	2.85	.1676	.1645	100	.000262	51.3		
15.5	2.61	.1680	.1646	100	.000262	51.3	51.0	$\frac{23}{64}$
13	2.15	.1655	.1620	100	.000258	50.4		
13	2.81	.216	.213	100	.000340	66.4		
15	3.20	.213	.210	100	.000334	65.3	65.9	$\frac{11}{64}$
16.5	3.55	.215	.212	100	.000338	66.1		
12.5	3.48	.278	.276	100	.000440	86.0		
11	3.03	.275	.273	100	.000435	85.0	85.6	$\frac{3}{32}$
10	2.77	.277	.275	100	.000438	85.8		
10	3.59	.359	.358	99	.000576	112.5		
9	3.20	.356	.355	99	.000572	111.7	111.6	$\frac{3}{64}$
8	2.82	.353	.352	99	.000567	110.7		

TABLE XLVI.—THREE COILS OF FOUR TURNS PER COIL. RESISTANCE = .0473 OHMS.

Amperes.	Volts.	Impedance.	Reactance.	Cycles per Second.	Inductance in Henrys.	C.G.S. Lines per Ampere Turn and per Inch Length of Armature.	Mean.	Mean Air Gap.
15	3.68	.245	.240	99	.000386	33.5		in.
13.5	3.35	.248	.243	99	.000391	33.9	33.7	∞
12	2.96	.246	.241	99	.000388	33.7		
10	3.47	.347	.344	98	.000558	48.5		
9	2.98	.331	.328	98	.000533	46.3	45.8	$\frac{23}{64}$
8	2.45	.306	.303	98	.000492	42.7		
17	7.8	.458	.452	98	.000737	63.8		
15	6.75	.450	.447	98	.000726	63.0	63.2	$\frac{11}{64}$
14	6.3	.450	.447	98	.000726	63.0		
13	7.84	.603	.601	98	.000976	84.6		
12	7.08	.590	.588	98	.000958	83.3	80.8	$\frac{3}{32}$
10	5.32	.532	.530	98	.000863	74.7		
18	14.6	.812	.811	98	.001317	114.2		
16	12.5	.782	.781	98	.001270	110.1	111.1	$\frac{3}{64}$
15	11.6	.774	.773	98	.001255	109.0		

TABLE XLVII.—FOUR COILS OF FOUR TURNS PER COIL. RESISTANCE = .0637 OHMS.

Amperes.	Volts.	Impedance.	Reactance.	Cycles per Second.	Inductance in Henrys.	C.G.S. Lines per Ampere Turn and per Inch Length of Armature.	Mean.	Mean Air Gap.
19	7.42	.390	.385	100	.000613	29.9		in.
17	6.47	.380	.375	100	.000598	29.3	29.5	∞
14	5.32	.380	.375	100	.000598	29.3		
15	8.23	.544	.539	100	.000872	42.6		
13	7.06	.543	.538	100	.000871	42.6	41.5	$\frac{23}{64}$
11	5.48	.500	.495	100	.000802	39.2		
10	7.58	.758	.755	100	.00120	58.7		
9	6.64	.738	.735	100	.00117	57.3	56.1	$\frac{11}{64}$
8	5.40	.675	.672	100	.00107	52.3		
17	19.04	1.12	1.117	100	.00178	87.0		
15	16.25	1.082	1.079	100	.00172	84.2	84.8	$\frac{3}{32}$
13	13.75	1.057	1.054	100	.00170	83.2		
17	24.0	1.411	1.410	100	.00225	110		
15.5	21.3	1.375	1.374	100	.00219	107	107.5	$\frac{3}{64}$
14	19.0	1.356	1.355	100	.00216	105.5		

The curves in Figs. 154 and 155 are plotted from the above results.

No results are given for the position of zero air gap, since great inaccuracy was introduced by the pole-piece not making a uniform magnetic contact each time it was replaced.

Seventh Experiment.—The armature of a 20 horse-power railway motor characterised by an especially small number of slots (twenty-nine) was measured as to inductance, and it is interesting to note that despite the concentration of many turns in each slot, the inductance as expressed in terms of the number of C.G.S. lines per ampere turn and per inch

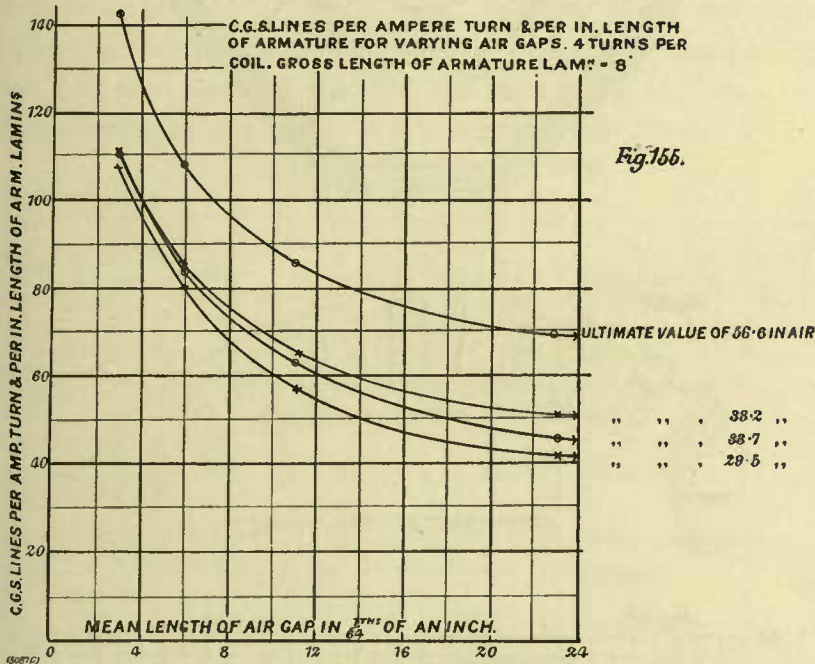

length of armature lamination, is but very little greater than in machines with many slots and but few conductors per slot.

The principal dimensions of the armature are given below, and in Fig. 156.

Diameter of armature	11 in.
Number of slots	29
,, coils	87
Turns per coil	6
Conductors per slot	36
Gross length of armature laminations	9 in.
Length of air gap average	$\frac{5}{32}$ in.

The values for the position of minimum inductance were taken with the armature out of its frame : *i.e.*, in air.

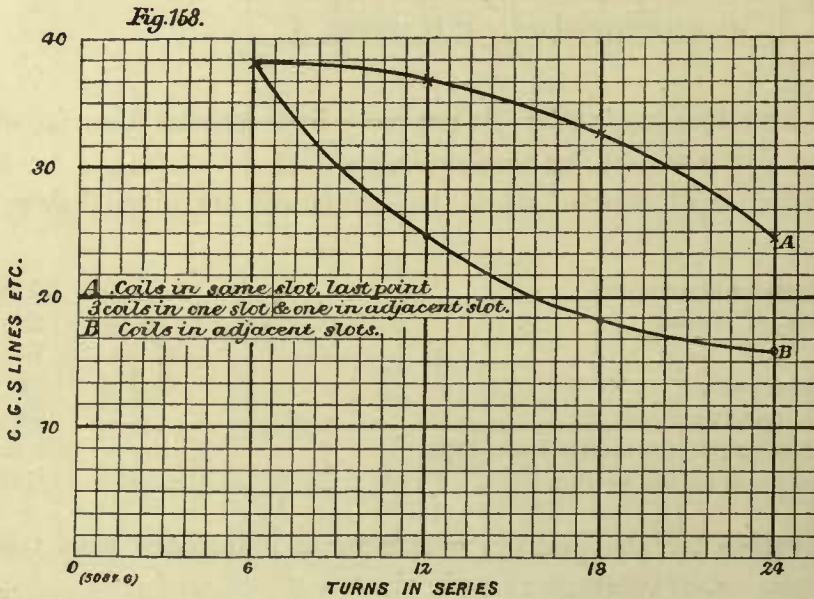
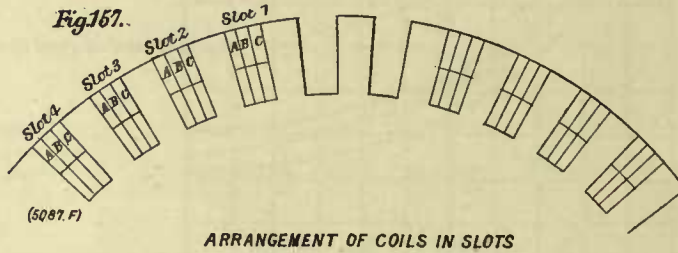
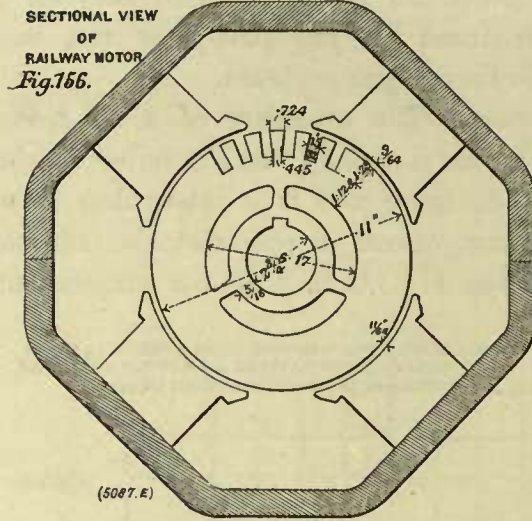

For the position of maximum inductance, the armature was in its frame with the coils under test directly under the pole face. The pole face was built of laminations.

Fig. 157 shows the arrangement of the coils in the slots, and also serves as a key to the combinations of coils taken. Taking slot 1, it was found that the inductance of coils A, B, and C were practically the same.

The results are plotted in Fig. 158. In the curve marked A, the turns are situated in one and the same slot except for the last point (*i.e.*, twenty-four turns), in which case, eighteen turns were in one slot and six turns in the adjacent one. In curve B, the turns were situated six in each slot, (*i.e.*, one coil per slot), the slots being adjacent.

The observations are given below in tabulated form.

TABLE XLVIII.

Amperes.	Impedance.	Mean Impedance.	Reactance.	Cycles per Second.	Inductance in Henrys.	C.G.S. Lines per Ampere Turn and Per Inch Length of Armature.
<i>One Coil of 6 Turns. Position of Minimum Inductance.</i>						
Slot 1, Coil B. Resistance = .0230 ohms.						
15	.0793					
17	.0782	.0786	.0752	97	.0001237	38.2
19	.0784					
<i>Two Coils of 6 Turns per Coil. Position of Minimum Inductance.</i>						
Slot 1, Coils B and C. Resistance = .048 ohms.						
8	.299					
10	.290	.293	.289	97	.000476	36.7
11	.291					
Slot 1, Coil B. Slot 2, Coil B. Resistance = .049 ohms.						
10	.204					
13	.199	.199	.195	96	.000322	24.8
15	.195					
<i>Three Coils of 6 Turns per Coil. Position of Minimum Inductance.</i>						
Slot 1, Coils A, B, and C. Resistance = .0738 ohms.						
9	5.78	.643				
11	6.68	.607	.614	.609	97	.0010
13	7.7	.593				34.3
Slot 1, Coils A and B. Slot 2, Coil B. Resistance = .0722 ohms.						
13	5.26	.404				
15	6.52	.407	.412	.405	96	.000673
17	7.23	.426				23.1
Slot 1, Coil B. Slot 2, Coil B. Slot 3, Coil B. Resistance = .0722 ohms.						
13	4.4	.338				
15	5.08	.339	.338	.330	96	.000548
17	5.72	.336				18.1

TABLE XLVIII.—Continued.

Amperes.	Volts.	Impedance.	Mean Impedance.	Reactance.	Cycles per Second.	Inductance in Henrys.	C. G. S. Lines per Ampere Turn and per Inch Length of Armature.
<i>Four Coils of 6 Turns per Coil. Position of Minimum Inductance.</i>							
Slot 1, Coils A, B, and C. Slot 2, Coil B. Resistance = .0976 ohms.							
13	10.17	.782					
15	11.5	.767	.772	.765	96	.001272	24.6
17	13.08	.769					
Slot 1, Coil A and B. Slot 2, Coils A and B. Resistance = .098 ohms.							
8	6.02	.752					
9.5	6.97	.732	.743	.736	96	.001223	23.6
10.5	7.62	.746	.74				
Slot 1, Coils A and B. Slot 2, Coil B. Slot 3, Coil B. Resistance = .0984 ohms.							
8.5	5.45	.642					
10	6.27	.627	.626	.620	97	.001020	19.7
12	7.30	.608					
Slot 1, Coil B. Slot 2, Coil B. Slot 3, Coil B. Slot 4, Coil B. Resistance = .0984 ohms.							
10	5.25	.525					
13	6.65	.512	.511	.501	97	.000824	15.9
15	7.47	.498					
<i>One Coil of 6 Turns. Position of Maximum Inductance.</i>							
Slot 1, Coil B. Resistance = .0232 ohms.							
15	2.16	.144					
13	1.89	.145	.144	.142	101	.000224	69.2
10	1.42	.142					
<i>Two Coils of 6 Turns per Coil. Position of Maximum Inductance.</i>							
Slot 1, Coils B and C. Resistance = .0469 ohms.							
10	5.6	.56					
9	4.94	.55	.553	.551	100	.000877	67.7
8	4.4	.55					
Slot 1, Coil B. Slot 2, Coil B. Resistance = .0479 ohms.							
10	4.35	.435					
11	4.81	.437	.438	.436	101	.000687	53.0
12	5.32	.443					
<i>Three Coils of 6 Turns per Coil. Position of Maximum Inductance.</i>							
Slot 1, Coils A, B, and C. Resistance = .0735 ohms.							
15	19.2	1.28					
14	18	1.28	1.28	1.28	102	.0020	68.9
13	16.6	1.28					
Slot 1, Coils A and B. Slot 2, Coil B. Resistance = .0748 ohms.							
9	9.6	1.07					
10	10.7	1.07	1.07	1.07	101	.00169	58.3
11	11.85	1.08					

TABLE XLVIII.—Continued.

Amperes.	Volts.	Impedance.	Mean Impedance.	Reactance.	Cycles per Second.	Inductance in Henrys.	C. G. S. Lines per Ampere Turn and per Inch Length of Armature.
Slot 1, Coil B.		Slot 2, Coil B.		Slot 3, Coil B.		Resistance = .0739 ohms.	
11	9.2	.837	.835	.830	97	.00136	46.8
12	10	.834					
13	10.85	.835					
<p><i>Four Coils of 6 Turns per Coil. Position of Maximum Inductance.</i></p> <p>Slot 1, Coils A, B, and C. Slot 2, Coil B. Resistance = .0984 ohms.</p>							
12	23.3	1.94	1.94	1.94	103	.0030	59.2
13	25.3	1.95					
14	27.3	1.95					
Slot 1, Coils A and B.		Slot 2, Coils A and B.		Resistance = .0992 ohms.			
12	22.4	1.87	1.85	1.85	101	.00292	57.6
13	24	1.85					
15	27.6	1.84					
Slot 1, Coils A and B.		Slot 2, Coil B.		Slot 3, Coil B.		Resistance = .101 ohms.	
13	20.7	1.59	1.57	1.57	101	.00247	48.7
15	23.6	1.57					
17	26.5	1.56					
Slot 1, Coil B.		Slot 2, Coil B.		Slot 3, Coil B.		Slot 4, Coil B. Resistance = .0986 ohms.	
15	19.6	1.31	1.31	1.31	101	.00206	40.6
16	20.9	1.31					
17	22.2	1.31					

Eighth Experiment.—These measurements related to an armature of an alternating current dynamo. The considerable number of slots, however, make the results instructive from the standpoint of commutating machines. First, the coils A A and B B of Fig. 159 were connected in series, and the inductance was measured at a periodicity of 30 cycles in the position of minimum and maximum inductance, the position shown in Fig. 159 being, of course, the position of maximum inductance.

The values deduced from the observations were:—

Position of minimum inductance	20. C.G.S. lines per ampere turn and per inch gross length of armature lamination.
„ maximum inductance	35. „ „ „

Then the turns in four adjacent slots were connected in series, and then, as shown in Fig. 160, inductance was measured in the positions

of minimum and maximum inductance. The following results were obtained:—

Position of minimum inductance	13. C.G.S. lines per ampere turn and per inch gross length of armature lamination.
„ maximum inductance	19. „ „ „

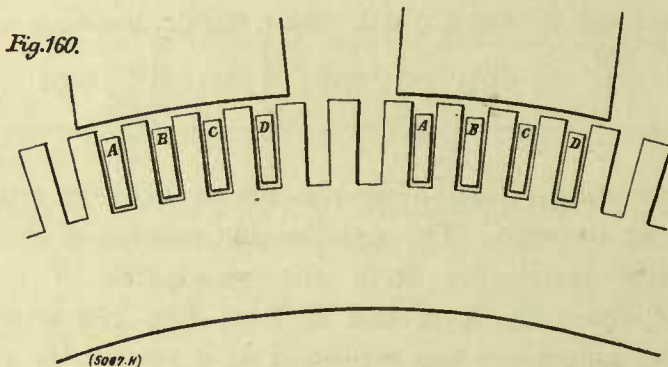
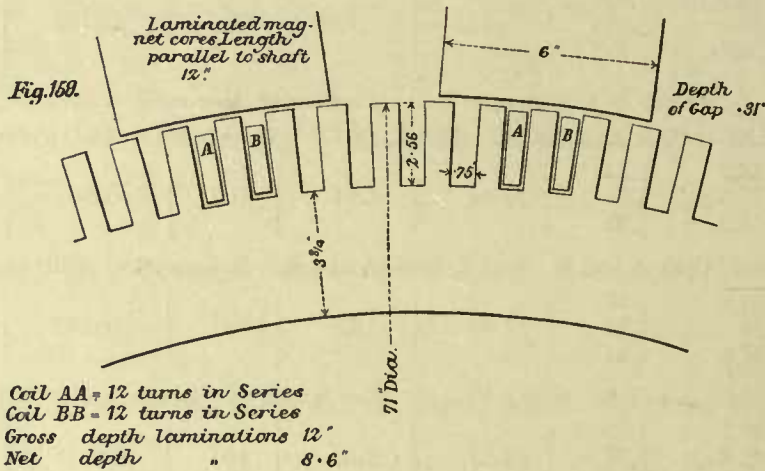

A study of these tests indicates that in projection armatures, it is practicable to so proportion the slots and conductors as to obtain as small a flux as 20 C.G.S. lines per ampere turn and per inch of gross length of armature lamination for the coils in the position of minimum inductance. When the conditions conform approximately to any particular case regarding which more definite experimental data is available, this more exact data should of course be employed.

The experimental data in the possession of other designers relating to the types with which they are accustomed to deal, may lead them to the

use of numerical values for this constant other than those indicated by the preceding tests; but it will be at once admitted that the chief value of such data lies more in the relative results obtained for various machines, than in the absolute results. The method of applying the constant must hold equally for all types, but doubtless the most suitable value to take for the constant will vary to some extent according to the degree of divergence between the types.

ILLUSTRATIONS OF THE CALCULATION OF THE REACTANCE VOLTAGE.

The determination of the inductance having so important a bearing upon the design, the method will be explained by working out several cases; and when in the following sections several complete working designs

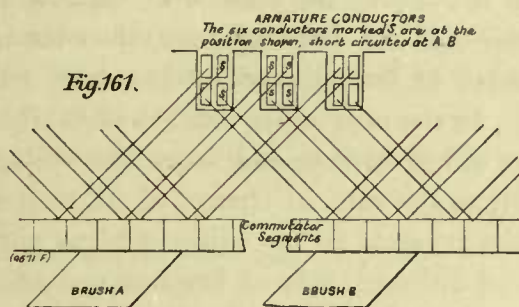

are described, the value of the inductance as related to the general performance of the machine will be considered. All the following cases relate to drum windings:

Case I.—In a four-pole continuous-current dynamo for 200 kilowatts output at 550 volts and a speed of 750 revolutions per minute, the armature is built with a four-circuit single-winding, arranged in 120 slots, with four conductors per slot. The commutator has a diameter of 20 in., and has 240 segments.

The brushes are .75 in. thick. The segments are .26 in. wide; consequently as there is one complete turn per segment, three complete turns is the maximum number undergoing short circuit at one brush at any instant.

Considering a group of adjoining conductors in the slots occupying the commutating zone between two pole tips, six of these conductors, occupying one and one-half slots will be short-circuited, three at one set of brushes

and three at another, as shown diagrammatically in Fig. 161. Now the full-load current of this machine is $\frac{200,000}{550} = 364$ amperes, the current per circuit being $\frac{364}{4} = 91$ amperes. Consequently, while any one coil is short-circuited under the brush, the current of 91 amperes in one direction must be reduced to zero, and there must be built up in it a current of 91 amperes in the other direction by the time it emerges from the position of short circuit under the brush, to join the other side of the circuit. This change is at times occurring simultaneously in a group of six adjacent conductors.

A coil has an inductance of one henry when it is situated in a medium of such permeability, and is so dimensioned that a current of one ampere sets up a magnetic flux of such magnitude that the product of the number of lines linked with the coil by the number of turns in the coil is equal to 100,000,000. If the coil has but one turn, then its inductance becomes 10^{-8} times the number of lines linked by the turn when one ampere is passing through it. In the case under consideration, the coil is of one turn, but the varying flux linked with it, and hence the voltage induced in it is proportional not only to the rate of change of its own current, but to the rate of change of the currents in the adjacent turns simultaneously undergoing commutation at different sets of brushes, and at different points of the surface of the same brushes. In this case five other turns are concerned in determining this varying flux, hence the voltage induced will be six times as great as if the coil had alone been undergoing commutation at the moment. It will not be the *square* of six times as great, since it is the voltage in the one turn that it is required to determine.

Had the six turns *in series* belonged to the one coil undergoing commutation, then the induced voltage would have been the *square* of six times as great as for a one-turn coil.

Gross length of lamination = 10 in.

Flux set up in one turn, per ampere in that turn and per inch of length of armature lamination = 20 C.G.S. lines.

Hence flux of self-inductance = $10 \times 20 = 200$ lines.

Self-inductance = $200 \times 10^{-8} = .0000020$ henrys.

Mutual inductance of one turn with relation to the six turns simultaneously undergoing commutation = $6 \times .0000020 = .000012$ henrys.

Circumference of commutator = $20 \times \pi = 62.8$ in.

Revolutions per second = $750 \div 60 = 12.5$

Peripheral speed of commutator = $62.8 \times 12.5 = 785$ in. per second.

Thickness of radial carbon brush = .75 in.

Current is completely reversed in $\frac{.75}{785} = .00095$ seconds, which is the time of completion of a half-cycle. Consequently, the reversal occurs at an average rate of $\frac{1}{2 \times .00095} = 530$ cycles per second.

We are now prepared to obtain the reactance of the turn, and shall, for want of a better, make the—in this case—very unwarranted assumption of a sine wave rate of variation :

$$\text{Reactance} = 2 \times \pi \times 530 \times .000012 = .040 \text{ ohms.}$$

$$\text{Reactance voltage} = 91 \times .040 = 3.6 \text{ volts.}$$

This is the voltage estimated to be induced in the turn during the process of commutation. In each of the other five turns independently undergoing commutation under other sets of brushes, and under other parts of the bearing surface of the same set of brushes, there is also an induced voltage of 3.5 volts.

In this design, the factors most concerned in the process of commutation are the following :

Reactance voltage of short-circuited coil	3.6 volts
Inductance per commutator segment000012 henrys
Armature ampere turns per pole-piece	5500 ampere turns
Current per armature circuit	91 amperes
Average voltage per commutator segment	9.2 volts

Case II.—A six-pole continuous-current dynamo has a rated output of 200 kilowatts at 600 revolutions per minute and 500 volts.

The armature has a six-circuit winding, arranged in 126 slots, with eight conductors per slot. The commutator has 252 segments. There are two turns in series per segment. The diameter of the commutator is 20 in. and the width of a segment is .24 in. The thickness of the radial bearing carbon brushes is .63 in., consequently the maximum number of coils short-circuited at any time at one set of brushes is three. Hence $3 \times 2 \times 2 = 12$ conductors grouped together in the neutral zone between two pole tips, and occupying one and one-half slots, are simultaneously undergoing commutation, that is, six conductors at one set of brushes and the other six at the next set.

$$\text{Gross length of lamination} = 9 \text{ in.}$$

Flux set up in 12 turns by 1 ampere in those turns, and with 9 in. length of armature lamination = $12 \times 20 \times 9 = 2160$ C.G.S. lines. Mutual inductance of one coil (two turns) with relation to the six coils simultaneously undergoing commutation = $2160 \times 10^{-8} \times 2 = .0000432$ henrys.

Circumference of commutator = 62.8 in.

Revolutions per second = $600 \div 60 = 10$.

Peripheral speed commutator = $62.8 \times 10 = 628$ in. per second.

Thickness of radial bearing carbon brush = .63 in.

Current completely reversed in $\frac{.63}{628} = .0010$ seconds.

Average rate of reversal = $\frac{1}{2 \times .0010} = 500$ cycles per second.

Reactance = $2 \times \pi \times 500 \times .0000432 = .136$ ohms.

Amperes per armature circuit = $\frac{200,000}{500 \times 6} = 66.7$ amperes.

Reactance voltage = $66.7 \times .136 = 9.1$ volts.

(This, of course, is an undesirably high figure, and would only be permissible in connection with especially good constants in other respects.)

Reactance voltage of short-circuited coil	9.1 volts
Inductance per commutator segment000043 henrys
Armature ampere turns per pole-piece	5600 ampere turns
Current per armature circuit	67 amperes
Average voltage per commutator segment	12 volts

Case III.—A 10-pole lightning generator has a rated output of 300 kilowatts at 125 volts and 100 revolutions per minute. It has a 10-circuit, single-winding, arranged, four conductors per slot, in 180 slots. The commutator has 360 segments, one segment per turn. Diameter of commutator is 52 in., and the width of a segment is .45 in.

The thickness of the radial bearing carbon brushes is 1 in., and the maximum number of coils short-circuited at any time at one set of brushes is three. Hence six conductors, grouped together at the neutral zone between any two pole tips, are concerned simultaneously in the commutating process.

Gross length of lamination = 17.6 in.

Flux set up in six turns by one ampere in each of them, and with 17.6 in. length of armature lamination = $6 \times 20 \times 17.6 = 2,110$ C.G.S. lines.

Mutual inductance of one coil of one turn, with relation to the six coils simultaneously undergoing commutation = $2,110 \times 10^{-8} \times 1 = .0000211$ henrys.

Circumference of commutator = $52 \times \pi = 164$ in.

Revolutions per second = $100 \div 60 = 1.67$ revolutions.

Peripheral speed commutator = $164 \times 1.67 = 274$ in. per second.

Thickness of radial bearing carbon brush = 1 in.

Current completely reversed in $\frac{1}{274} = .00365$ seconds.

Average rate of reversal = $\frac{1}{2 \times .00365} = 137$ cycles per second

Reactance = $2 \times \pi \times 137 \times .0000211 = .018$ ohms.

Rated full load current output = $\frac{300,000}{125} = 2400$ amperes.

Current per armature conductor = $\frac{2400}{10} = 240$ amperes.

Reactance voltage = $240 \times .018 = 4.3$ volts.

Reactance voltage of short-circuited coil	4.3 volts
Inductance per commutator segment000021 henrys
Armature ampere turns per pole-piece...	8600 ampere turns
Current per armature circuit	240 amperes
Average voltage per commutator segment	3.5 volts

MODERN CONSTANT POTENTIAL COMMUTATING DYNAMOS.

Direct-Connected, 12-Pole, 1,500-Kilowatt, 600-Volt Railway Generator.
Speed = 75 Revolutions per Minute.—This machine is remarkable in that, at the time it was designed no commutating dynamo of more than a fraction of its capacity had been constructed. Owing to the great weight of the various parts, and the short time in which the machine had to be constructed, it was assembled and tested for the first time at the Columbian Exposition.

It was found that the machine complied with the specification in all particulars as to heating, and that sparking did not occur between the limits of no load and 50 per cent. overload. Mention is made of this, since this was the first of the modern traction generators developed in the United States; and the constants of this machine, which were novel at that time, have since become common in the best practice in designing. Perhaps the most remarkable feature of this machine is the range of load at which sparkless commutation occurs, and the great magnetic strength of the armature as compared with that of the field-magnets. This result

was accomplished, first, by comparatively low inductance of the armature coils; secondly, high magnetisation in the armature projections, which to some extent keeps down distortion of the magnetic field; and, thirdly, by the over-compounding of the machines to suit railway practice: that is, no load volts of 550 and full load volts of 600. The increase of magnetisation corresponding to this increase of voltage is a condition favourable to sparkless commutation; and it will be noted from the particulars given of the machine, that the magnetising force of the series coil at full load is approximately equal to that of the shunt coil at no load.

Drawings are given, Figs. 162 to 166, showing the construction, and in Figs. 167 and 168 are given saturation and compounding curves for this machine. The following specification sets forth the constants of the machine and the steps in the calculations.

SPECIFICATION OF 12-POLE, 1,500-KILOWATT, 600-VOLT GENERATOR, FOR SPEED OF
75 REVOLUTIONS PER MINUTE.

Number of poles	12
Kilowatts... ..	1500
Revolutions per minute	75
Frequency in cycles per second	7.5
Terminal volts, no load	550
" " full load	600
Amperes, full load	2500

DIMENSIONS.

Armature :

Diameter over all	126 in.
Length over conductors	$48\frac{1}{4}$ "
Diameter at bottom of slots	$121\frac{3}{4}$ "
Internal diameter of core	$103\frac{3}{4}$ "
Length of core over all	$33\frac{3}{4}$ "
Effective length, magnetic iron	26.8
Pitch at surface	33 in.
Insulation between sheets	10 per cent.
Thickness of sheets014 in.
Depth of slot	$2\frac{1}{8}$ "
Width of slot at root	$\frac{11}{16}$ "
" " surface	$\frac{3}{8}$ "
Number of slots	348
Minimum width of tooth412 in.
Width of tooth at armature face763 "
" conductor	$\frac{7}{32}$ "
Depth of "	$\frac{3}{4}$ "

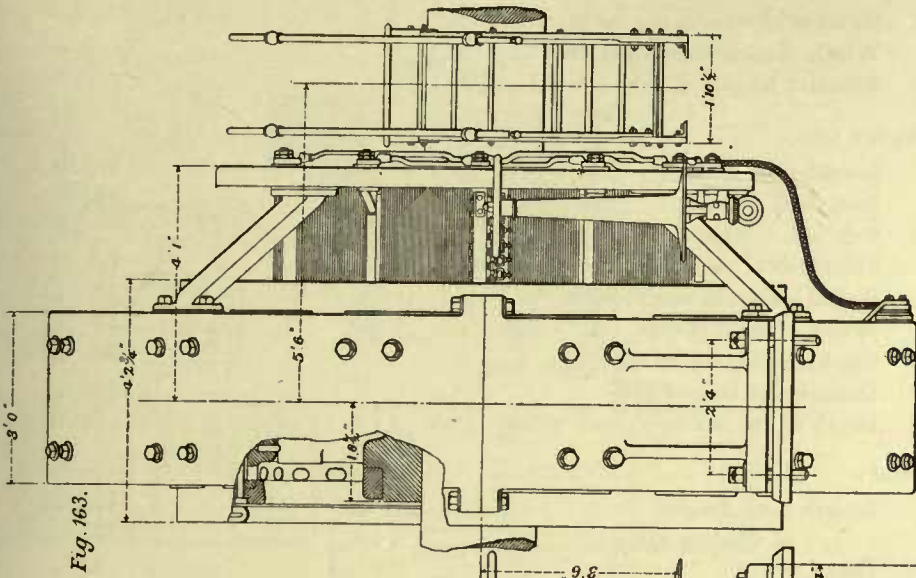

Fig. 163.

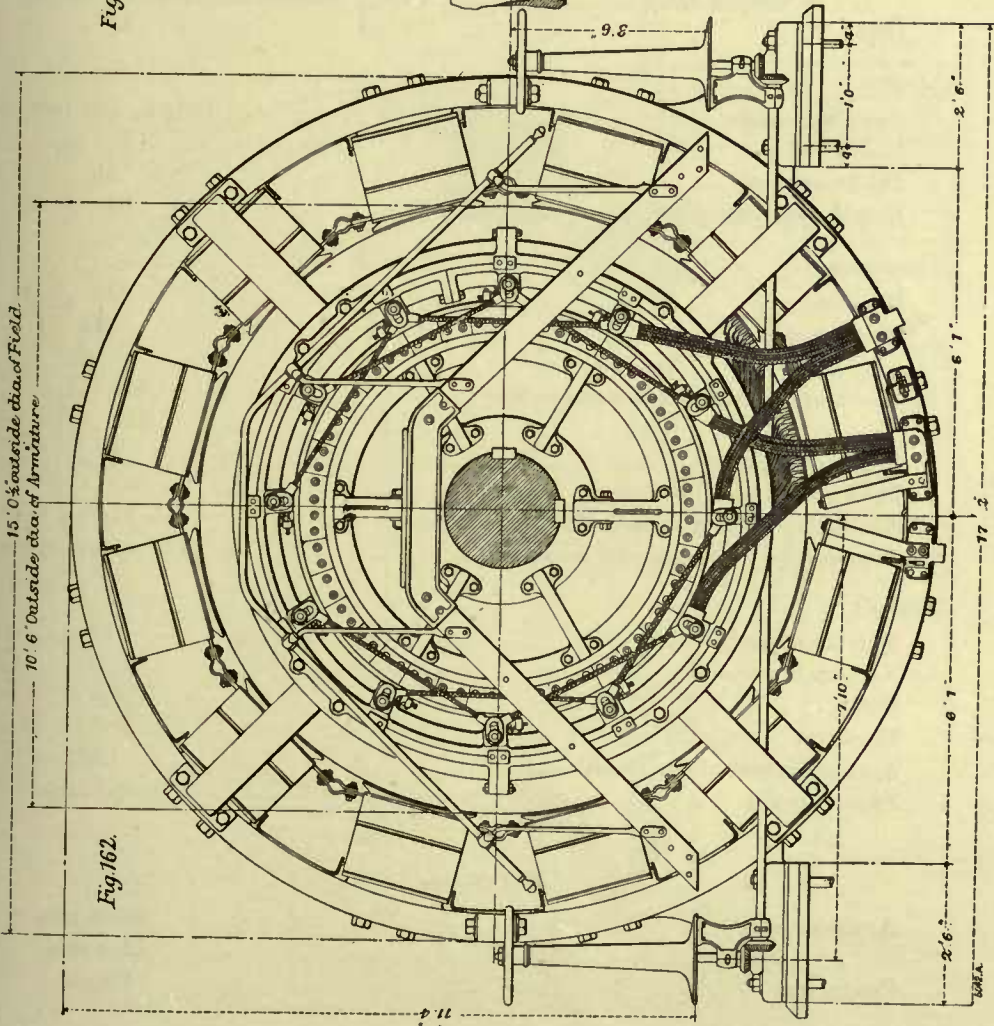

Fig. 162.

Number of ventilating ducts	8
Width of each ventilating duct	$\frac{1}{2}$ in.
Effective length of core \div total length795

Magnet Core :

Length of pole face	$33\frac{3}{4}$ in.
Length of pole arc	$24\frac{1}{4}$ "
Pole arc \div pitch73
Thickness of pole-piece at edge of core... ..	$1\frac{9}{16}$ in.
Radial length of magnet core	18 "
Width of magnet core	14 "
Thickness of magnet core	30 "
Diameter of bore of field	$126\frac{7}{8}$ "
Depth of air gap	$\frac{7}{16}$ "

Spool :

Length over flanges	$17\frac{7}{8}$ in.
" of winding space	$16\frac{7}{8}$ "
Depth " "	$3\frac{7}{8}$ "

Yoke :

Outside diameter	$190\frac{1}{2}$ in. and $180\frac{1}{2}$ in.
Inside "	168 in.
Thickness, body	$6\frac{1}{4}$ "
Length along armature	36 "

Commutator :

Diameter	$86\frac{1}{2}$ "
Number of segments	696
" " per slot	2
Width of segment at commutator face342 in.
" " root313 "
Depth of segment	3 "
Thickness of mica insulation05 "
Available length of surface of segment... ..	$19\frac{7}{8}$ "
Cross-section of commutator leads130 square inches

Brushes :

Number of sets	12
Number in one set	6
Width	2.5
Thickness75
Area of contact of one brush	1.875
Type of brush	Radial carbon

MATERIALS.

Armature core	Sheet iron
" spider	Cast iron
Conductors	Copper

Commutator segments	Copper
„ leads	German silver
Spider	Cast iron
Pole piece	Cast steel
Yoke	„
Magnet core	„
Brushes	Carbon

TECHNICAL DATA.

Armature, no load voltage	550
Number of face conductors	1392
Conductors per slot	4
Number of circuits	12
Style of winding	Single
Gramme ring or drum	Drum
Type construction of winding	Evolute end connections
Mean length one armature turn...	176 in.
Total armature turns	696
Turns in series between brushes...	58
Length between brushes	10,200 in.
Cross-section, one armature conductor161
Ohms per cubic inch at 20 deg. cent.00000068 ohms.
Resistance between brushes at 20 deg. Cent.043 „
„ „ 60 „050 „
Volts drop in armature at 60 deg. Cent.	10.3
„ brush contact	2.5
„ series winding	1.9
Terminal voltage, full load	600
Total internal voltage, full load...	620
Amperes per square inch in armature winding	1290
„ „ commutator connections	3200

Commutation :

Average voltage between commutator segments	10.3
Armature turns per pole...	58
Amperes per turn	208
Armature ampere turns per pole	12,100
Segments lead of brushes	6 $\frac{1}{4}$
Percentage lead of brushes	10.8
„ demagnetizing ampere turns	21.6
„ distorting ampere turns	78.4
Demagnetizing ampere turns per pole	2610
Distorting „ „	9490
Frequency of commutation (cycles per second)	227
Number of coils simultaneously short-circuited per brush	2
Turns per coil	1
Number of conductors per group simultaneously undergoing commutation	4

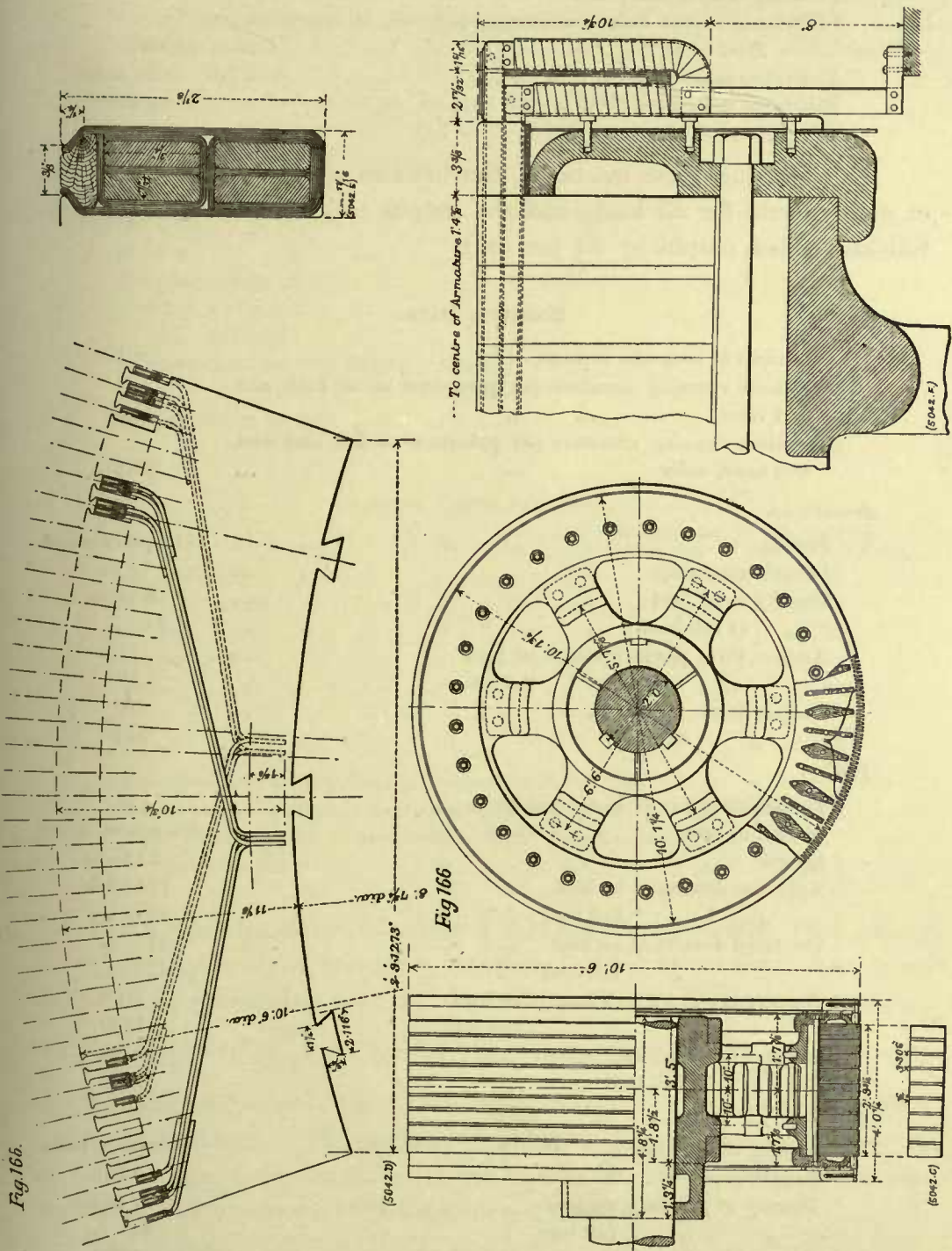

Flux per ampere turn per inch length armature lamination ...	20 (assumed).
Flux linked with four turns = $36.7 \times 20 \times 4$	2700
Inductance in one turn constituting one coil, in henrys =	
$1 \times 2700 \times 10^{-8}$000027
Reactance short-circuited turn0385 ohms
Reactance voltage = $.0385 \times 208$	8.0 volts.

In operating these machines, the brushes are set at a constant lead of $6\frac{1}{4}$ segments for all loads, and the output may temporarily exceed the full load rated output by 50 per cent.

MAGNETIC DATA.

Coefficient of magnetic leakage	1.15
Megalines entering armature per pole-piece at no load and 550 volts	31.6
Megalines entering armature per pole-piece at full load and 620 inter. volts	35.6
<i>Armature :</i>	
Section	241 square inches
Length (magnetic)	19 in.
Density at no load	66 kilols.
" at full load	74 "
Ampere turns per inch length no load	15
" " full load	18
Ampere turns, no load	290
" full load	340
<i>Teeth :</i>	
Transmitting flux from one pole-piece	24
Section at roots	264 square inches
Length	2.125 in.
Apparent density at no load	120 kilols.
" " full load	135 "
Corrected density at no load	116 "
" " full load	126 "
Ampere turns per inch length, no load	1800
" " full load	1400
Ampere turns no load	1700
" full load	3000
<i>Gap :</i>	
Section at pole face	820 square inches
Length gap43 in.
Density at pole face, no load	39 kilols.
" " full load	44 "
Ampere turns, no load	5300
" full load	6000

Magnet Core :

Section	420 square inches
Length (magnetic)	20 in.
Density, no load	87 kilols.
„ full load	98 „
Ampere turns per inch length, no load... ..	67
„ „ full load	160
Ampere turns, no load	1350
„ full load	3200

Magnet Yoke :

Section	225 square inches
Length per pole	27 in.
Density, no load	81 kilols.
„ full load	91 „
Ampere turns per inch length, no load	49
„ „ full load	110
Ampere turns, no load	1320
„ full load	3000

AMPERE TURNS PER SPOOL.

	No Load and 550 Volts.	No Load and 620 Internal Volts.
Armature core	290	340
„ teeth	1700	3000
Air gap	5300	6000
Magnet core	1350	3200
Yoke	1320	3000
	9960	15,540
Demagnetising ampere turns per pole-piece at full load		2600
Allowance for increase in density through distortion		1000
Total ampere turns at full load of 2500 amperes and 600 terminal volts		19,140

If the field rheostat is so adjusted that the shunt winding shall supply the 9,960 ampere turns necessary for the 550 volts at no load, then, when the terminal voltage has risen to 600 volts at full load, the shunt winding will be supplying $\frac{600}{550} \times 9,960 = 10,840$ ampere turns. The series winding must, at full load, supply the remaining excitation, *i.e.*, $19,140 - 10,840 = 8,300$ ampere turns. The armature has 1,392 face conductors, hence the armature strength expressed in ampere turns per pole-piece is, at full load current of 2,500 amperes (208 amperes per circuit) :

$$\frac{1392}{2 \times 12} \times 208 = 12,100 \text{ ampere turns per pole-piece, on armature.}$$

CALCULATION OF SPOOL WINDINGS.

Shunt :

Mean length of one shunt turn	8.5 ft.
Ampere turns per shunt spool at full load	10,840
Ampere feet	92,000
Radiating surface one shunt spool	1130 square inches
Permit .36 watts per square inch at 20 deg. Cent.	
Then shunt watts per spool at 20 deg. Cent.	405
And ,, ,, 60 ,,	468
Pounds copper per coil = $\frac{31 \times 92^2}{405}$ = 650 lb.	

A margin of 16.6 per cent. in the shunt rheostat when coils are hot leaves 83 per cent. of the available 600 volts, or 500 volts, at the terminals

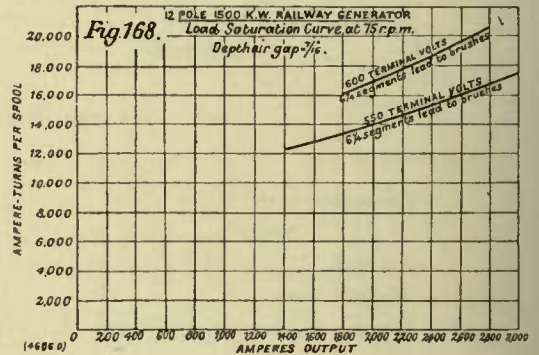
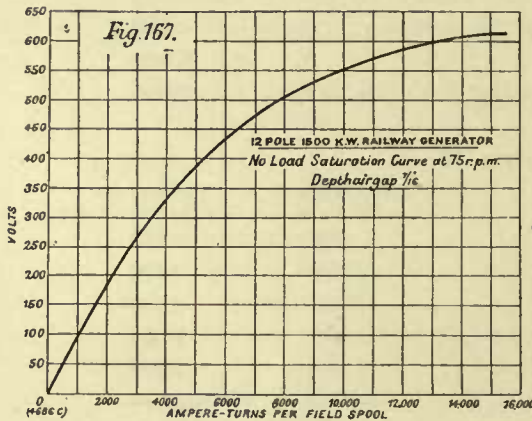

of field spools. This is equivalent to 432 volts, or 36 volts per spool, when spools have a temperature of 20 deg. Cent.

Hence require $\frac{405}{36} = 11.3$ amperes in shunt coils.

Turns per shunt spool = $\frac{10,800}{11.3}$	960
Length of 960 turns	8150 ft.
Pounds per 1000 feet	79.8
No. 6 B. and S. gauge weighs 79.5 lb. per 1000 feet.	
Bare diameter = .162 in. D.C.C.D. = .174 inch.	
Cross section = .0206 square inch.	
Current density = 546 amperes per square inch.	
Length of the portion of winding space available for shunt coil = 9.0 inches.	
Depth of winding, 3.9 inches.	

Series Winding.—The series winding is required to supply 8,300 ampere turns at full load. With 4.5 turns per spool, the full load current

Coefficient of friction3
Peripheral speed of commutator in feet per minute	1700
Brush friction	1040 watts
Stray power lost in commutator	750 "
Total commutator loss	7340 "
Radiating surface commutator	5400 square inches
Watts per square inch of radiating surface	1.36 watts
Rise in temperature at 20 deg. Cent. rise per watt per square inch	27 deg. Cent.

EFFICIENCY CALCULATIONS.

	Watts.
Output at full load	1,500,000
Core loss (estimated)	23,400
C ² R armature at 60 deg. Cent.	25,850
Commutator and brush loss	5,550
Shunt spools C ² R at 60 deg. Cent.	5,650
„ rheostat „ „	1,130
Series spools - C ² R at 60 deg. Cent.	3,380
„ rheostat „ „	1,190
Total input	1,566,150

Commercial efficiency at full load and 60 deg. Cent. = 95.7 per cent.

WEIGHTS (POUNDS).

Armature :

Magnetic core	24,000
Teeth	2,420
Copper	6,360
Commutator, segments	3,100
Twelve magnet cores and pole-pieces	30,000
Yoke	35,000
Twelve shunt coils	7,800
„ series coils	7,800
Total spool copper	15,600

6-POLE 200-KILOWATT RAILWAY GENERATOR.

Figs. 169 to 183 relate to a six-pole railway generator for an output of 200 kilowatts (500 volts and 400 amperes) at a speed of 135 revolutions per minute. The constants of this machine are set forth in the following specification, which also exhibits the steps in the calculation :

Number of poles	6
Kilowatts	200
Revolutions per minute	135
Frequency in cycles per second	6.75
Terminal volts	500
Amperes	400

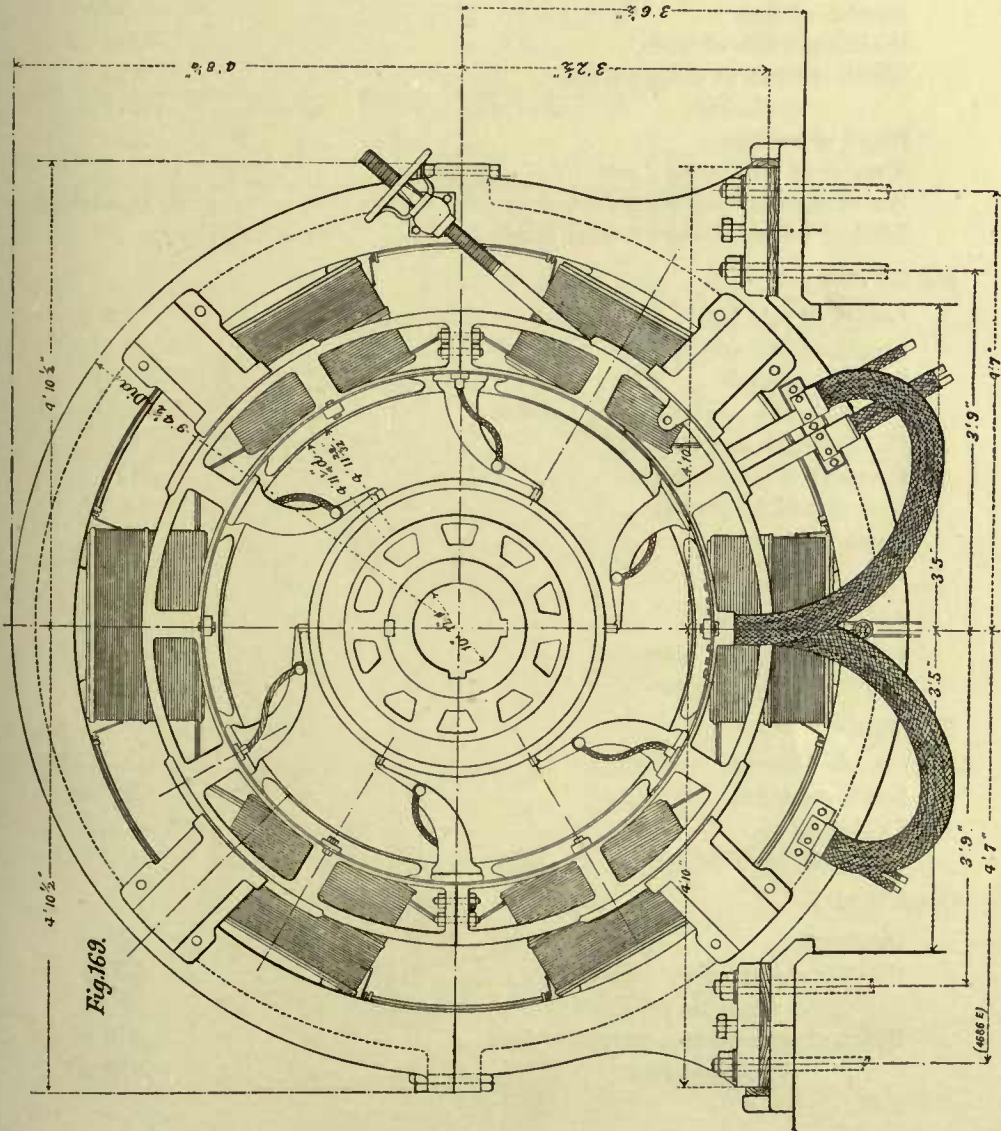
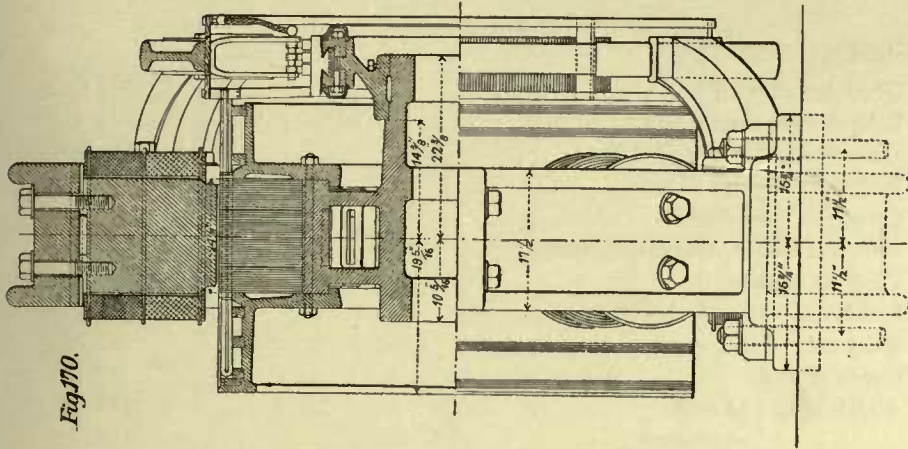

DIMENSIONS.	
<i>Armature :</i>	
Diameter over all	59 $\frac{1}{4}$ in.
Length over conductors	36 $\frac{1}{4}$ "
Diameter at bottom of slots	56 "
Internal diameter of core	38 $\frac{1}{2}$ "
Length of core over all	14 $\frac{1}{4}$ "
Effective length, magnetic iron	9.9 "
Pitch at surface	31.1 "
Insulation between sheets	10 per cent.
Thickness of sheets025 in.
Depth of slot	1 $\frac{5}{8}$ "
Width of slot at root416 "
" at surface416 "
Number of slots	220
Minimum width of tooth... ..	.384 in.
Width of tooth at armature face429 "
" conductor057 "
Depth of conductor658 "
Number of ventilating ducts	5
Width of each ventilating duct	$\frac{7}{16}$ in. and $\frac{3}{8}$ in.
Efficient length of core \div total length... ..	.70
<i>Magnet Core :</i>	
Length of pole face	13. in.
Length of pole arc	23.1 "
Pole arc \div pitch... ..	.74
Thickness of pole-piece at edge of core	1 $\frac{9}{16}$ in.
Radial length magnet core	15 $\frac{1}{8}$ "
Diameter of magnet core	14 $\frac{1}{4}$ "
Bore of field (diameter)	59.9 "
Depth of air gap33 "
<i>Spool :</i>	
Length over flanges	15 $\frac{1}{8}$ "
Length of winding space... ..	14 $\frac{1}{4}$ "
Depth of winding space	2 $\frac{1}{2}$ "
<i>Yoke :</i>	
Outside diameter112 $\frac{1}{2}$ in. and 106 $\frac{1}{2}$ in.
Inside diameter	96 $\frac{1}{2}$ in.
Thickness	8 in. and 5 in.
Length along armature	17 $\frac{1}{2}$ in.
<i>Commutator :</i>	
Diameter	39 "
Number of segments	440
" segments per slot	2
Width of segment at commutator face240 in.
" segment at root210 "

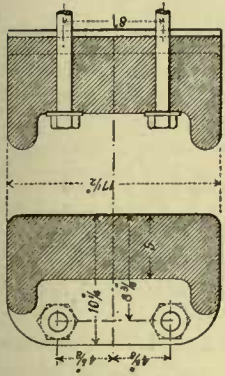

Fig. 174.

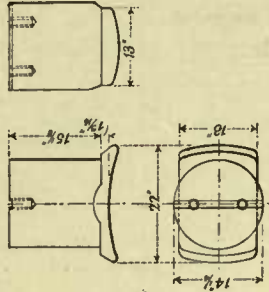

Fig. 175.

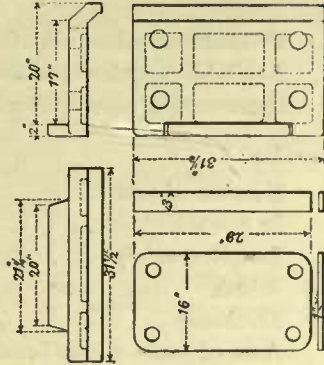

Fig. 176.

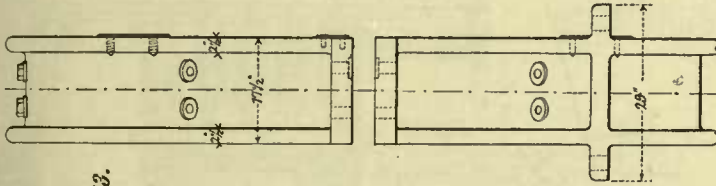

Fig. 173.

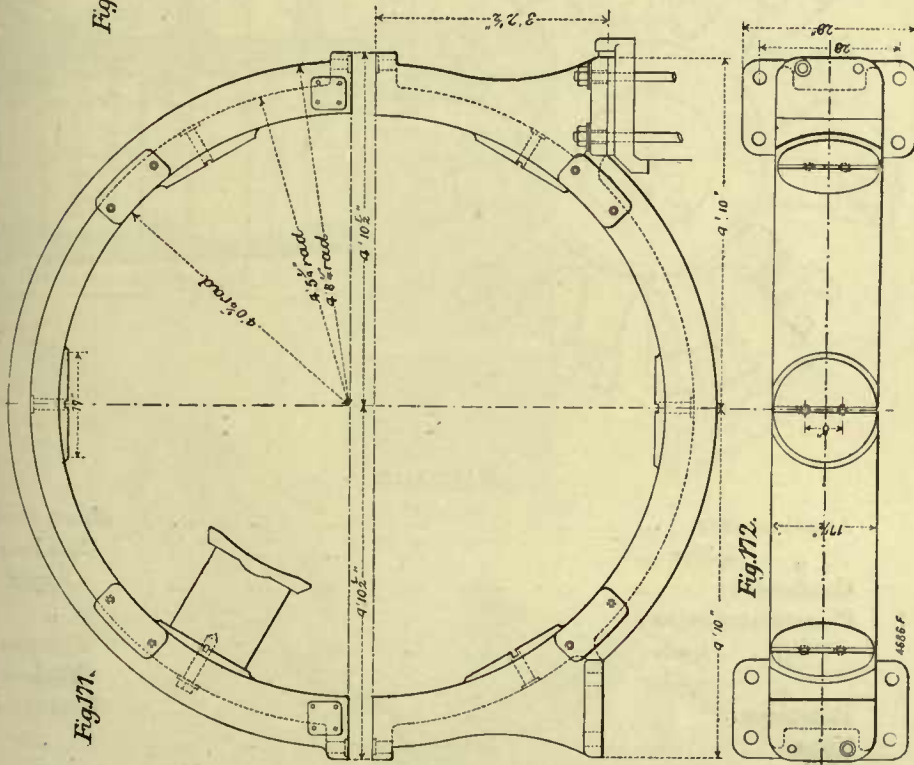

Fig. 171.

Fig. 172.

DIMENSIONS—continued.

Thickness of mica insulation04 in.
Available length of surface of segment...	6 $\frac{3}{8}$ "
Cross-section commutator leads...	.01 square inch

Brushes :

Number of sets	6
In one set	3
Length (radial)	2 in.
Width	2 "
Thickness	$\frac{1}{2}$ "
Area of contact (one brush)	1.00 square inch
Type of brush	Radial carbon

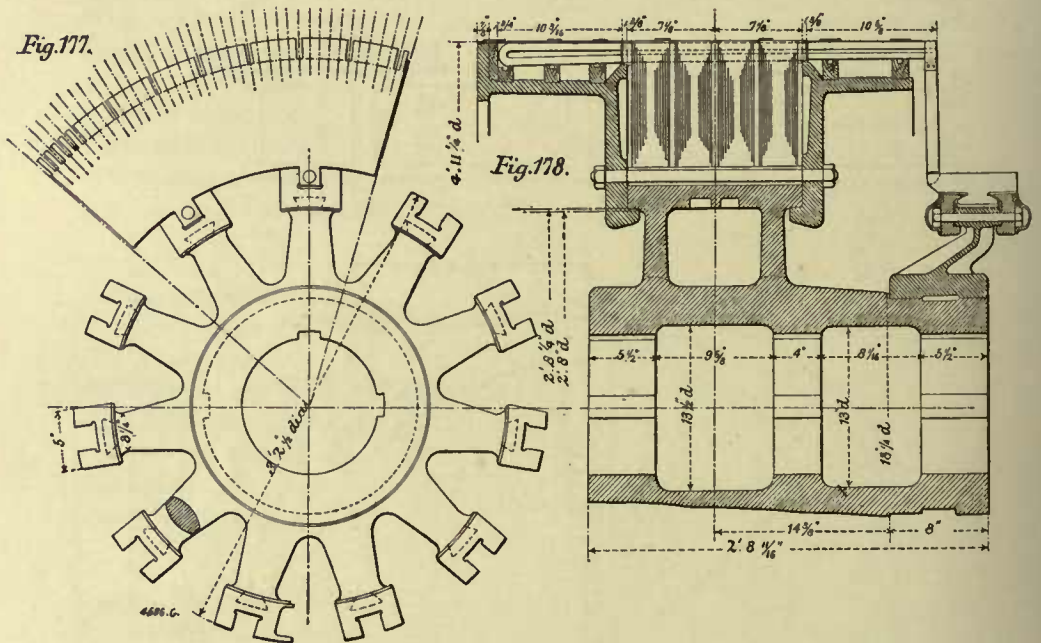

MATERIALS.

Armature core	Sheet Steel
" spider	Cast iron
Conductors	Copper
Commutator segments	"
" leads	Rheotan
" spider	Cast-iron
Pole-piece	Cast steel
Yoke	"
Magnet core	"
Brushes	Carbon

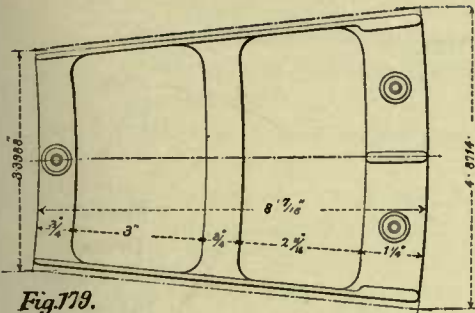

Fig. 179.

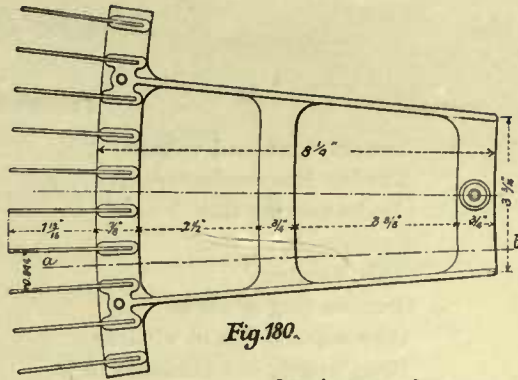

Fig. 180.

Section at a.b.

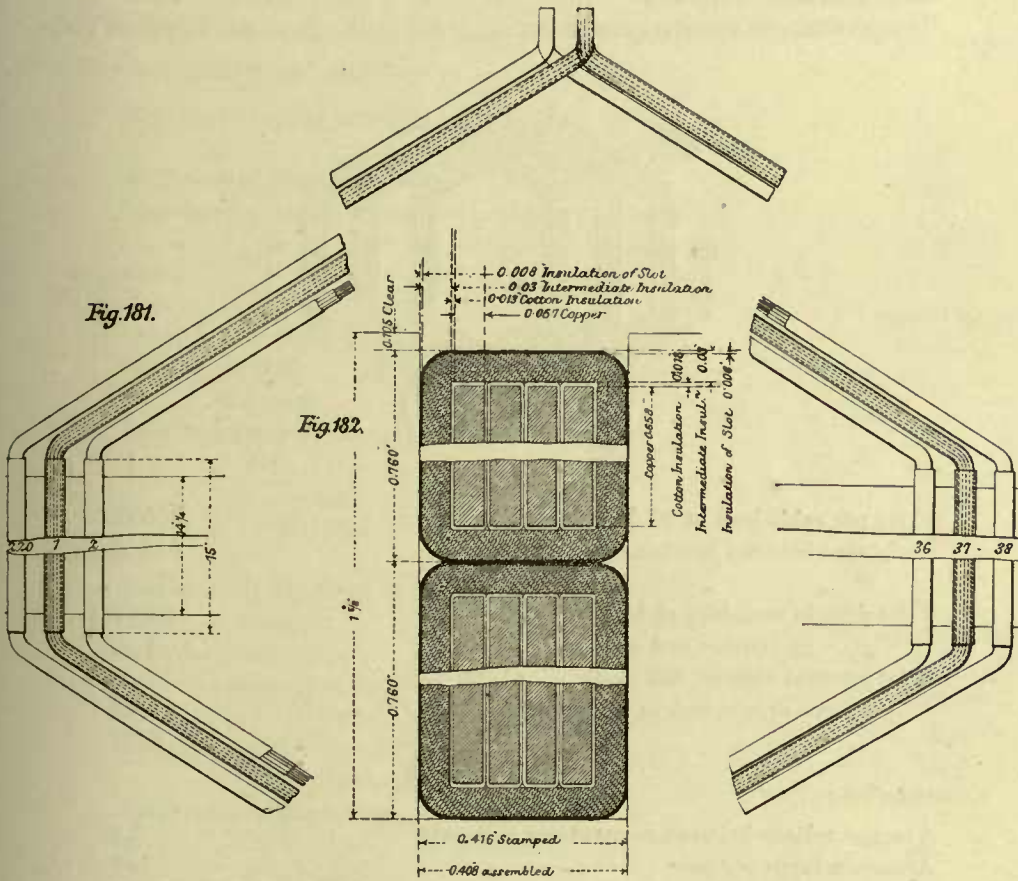
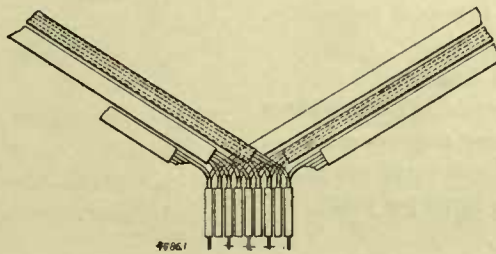

Fig. 181.

Fig. 182.



49861

TECHNICAL DATA.

Armature, no load voltage	500
Number face conductors...	1760
Conductors per slot	8
Number circuits	6
Style winding	Single
Gramme ring or drum	Drum
Type construction of winding	Barrel-wound
Mean length, one armature turn	107 in.
Total armature turns	880
Turns in series between brushes	147
Length between brushes	15,700 in.
Cross-section, one armature conductor0375 square inches

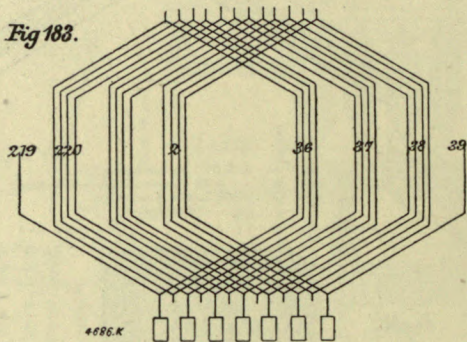

Ohms per cubic inch at 20 deg. Cent.00000068
Resistance between brushes at 20 deg. Cent.048 ohms
" " 60 " "055 "
Volts drop in armature at 60 deg. Cent.	22 volts
" in brushes and contacts	3 "
Total internal voltage, full load	525 "
Amperes per square inch in armature winding...	1780
" " commutator connection	6670

Commutation :

Average voltage between commutator segments	6.8
Armature turns per pole	147
Amperes per turn...	66.7
Armature ampere turns per pole	9800
Segments lead of brushes	7
Percentage lead of brushes	9.6
" demagnetising ampere turns	19.2
" distorting ampere turns	80.8
Demagnetising ampere turns per pole	1880
Distorting ampere turns per pole	7920

Frequency of commutation (cycles per second)...	...	275.
Number of coils simultaneously short-circuited per brush	...	3
Turns per coil	...	2
Number of conductors per group simultancously undergoing commutation...	...	12
Flux per ampere turn per inch length armature lamination	...	20 (assumed)
„ linked with 12 turns with one ampere in those turns =		
14.25 × 20 × 12	...	3420 lines
Inductance of two turns constituting one coil = 2 × 3420 × 10 ⁻⁸000068 henrys
Reactance short-circuited coil118 ohms
„ voltage short-circuited coil	...	7.85 volts

The amount and distribution of the magnetomotive force may be roughly estimated as follows :

Megalines entering armature per pole-piece, no load	...	12.6
„ „ „ full load	...	13.3
Coefficient of magnetic leakage	...	1.15
Megalines in magnet frame, per pole-piece, no load	...	14.5
„ „ „ full load	...	15.3
<i>Armature :</i>		
Section	...	174 square inches
Length, magnetic	...	15 in.
Density, no load	...	72 kilolines
„ full load	...	76 „
Ampere turns per inch length, no load	...	22
„ „ full load	...	26
„ no load	...	330
„ full load	...	390
<i>Teeth :</i>		
Transmitting flux from one pole piece	...	29
Section at roots	...	110 square inches
Length	...	1.6 in.
Apparent density, no load	...	115 kilolines
„ „ full load	...	121 „
Corrected density, no load	...	113 „
„ „ full load	...	118 „
Ampere turns per inch length, no load	...	350
„ „ full load	...	500
„ no load	...	560
„ full load	...	800
<i>Gap :</i>		
Section at pole face	...	300 square inches
Length gap33 in.
Density at pole face, no load	...	42 kilolines
„ „ full load	...	45 „
Ampere turns, no load	...	4500
„ full load	...	4800

Magnet Core :

Section	159 square inches
Length (magnetic)	16.4 in.
Density, no load	91 kilolines
" full load... ..	96 "
Ampere turns per inch length, no load... ..	80
" " full load... ..	100
" no load	1320
" full load	1640

Magnet Yoke :

Section	220 square inches
Length per pole	27 "
Density, no load	66 kilolines
" full load	70 "
Ampere turns per inch length, no load... ..	34
" " full load	40
" no load	920
" full load	1080

AMPERE TURNS PER SPOOL.

	No Load and 500 Volts.	No Load and 525 Internal Volts, Corresponding to a Full Load Terminal Voltage of 500.
Armature core	330	390
" teeth	560	800
Gap	4500	4800
Magnet core	1320	1640
" yoke	920	1080
	<hr/> 7630	<hr/> 8710
Demagnetising ampere turns per pole, at full load ...		1880
Allowance for increase in density through distortion ...		400
		<hr/> 10,990

CALCULATION OF SPOOL WINDINGS.

Shunt :

Mean length one shunt turn = 50 in. = 4.16 ft.
 Ampere turns per spool = 7630.
 " feet = 7630 × 4.25 = 31,800.
 Radiating surface one field spool = 870 square inches.
 Permit .35 watts per square inch at 20 deg. Cent.
 ∴ .35 × 870 = 305 watts per spool.
 Shunt watts per spool $\frac{7,630}{10,990} \times 305 = 212$ watts.
 " copper per spool =

$$\frac{31 \times \left(\frac{\text{ampere feet}}{1000}\right)^2}{\text{watts}} = \frac{31 \times 1010}{212} = 148 \text{ lb.}$$

Of the 500 volts available for excitation, should plan to make use of 90 per cent., or 450 volts at 60 deg. Cent., or 390 volts at 20 deg.

Cent. This is $\frac{390}{6} = 65$ volts per spool at 20 deg. Cent. Hence

$$212 \div 65 = 3.25 \text{ amperes}$$

Consequently turns per shunt spool = $\frac{7630}{3.25} = 2350$ turns

Length of 2350 turns = $2350 \times 4.16 = 9800$ ft.

Pounds per 1000 ft. = 15.2. No. 13 B. and S. has 15.7 lb. per 1000 ft., and has a diameter of .072 in. bare, and .082 in. double cotton covered.

This should be wound in 14 layers of 168 turns each. Cross-section No. 13 = .00407 square inch.

Hence current density in shunt winding = 800 amperes per square inch.

Series Winding.—This must supply $10,990 - 7630 = 3360$ ampere turns at full load of 400 amperes, of which 70 amperes should be carried through a diverting shunt, leaving 330 amperes for the series coils. Hence there must be 10 turns per spool.

Mean length series turn = 53 in.

Total length ten turns = 530 in.

Series C² R. per spool = 93 watts per spool.

Hence resistance per spool = $93 \div 330^2 = .00085$ ohms.

Copper cross-section = .425 square inch.

Series winding per spool may consist of two coils of flat strip copper 7 in. wide and .06 in. thick, wound five turns per coil. Weight series copper one spool = 70 lb.

Current density in series winding = 770 amperes per square inch.

THERMAL CALCULATIONS.

Armature:

C²R loss at 60 deg. Cent. 8800 watts.

Core loss (observed value) 2760 watts.

Total armature loss 11,560 watts.

Observed increased temperature by increased resistance of armature winding = 63 deg. Cent.

Peripheral radiating surface armature = 6800 square inches.

Watts per square inch armature radiating surface = 1.70.

Increased temperature per watt per square inch armature radiating surface = 37 deg. Cent., as determined from resistance measurements.

Peripheral speed armature (feet per minute) = 2030.

Increased temperature of armature by thermometer = 30 deg. Cent.

Ditto, per square inch peripheral radiating surface = 17.7 deg. Cent.

Spool:

Total C²R loss at 60 deg. Cent., per spool, = 353 watts.
 Observed increased temperature by increased resistance of winding = 45 deg. Cent.
 Peripheral radiating surface, one spool = 870 square inches.
 Watts per square inch spool radiating surface = .405.
 Increased temperature per watt per square inch spool radiating surface = 111 deg. Cent., as determined from resistance measurements.
 By thermometer the observed increase in temperature of spool was only 16 deg. Cent.

Commutator:

Area of all positive brushes	9.0 square inch.
Amperes per square inch, brush-bearing surface	44.5
Ohms per square inch bearing surface, carbon brushes03
Brush resistance, positive + negative0067 ohms
Volts drop at brush contacts	2.7
C ² R as brush contacts (watts)	1070
Brush pressure, pounds per square inch	1.25
Total brush pressure, pounds	22.5
Coefficient of friction3
Peripheral speed commutator, feet per minute... ..	1330
Brush friction, watts	270
Stray power lost in commutator, watts... ..	200
Total commutator loss, watts	1540
Radiating surface, square inches	800
Watts per square inch radiating surface	1.92
Observed rise temperature	36 deg. Cent.
Increased temperature per watt per square inch radiating surface	19 deg. Cent.

With further reference to the temperature measurements, the machine on which the increase of temperature was observed, had been run at full load for nine hours, and had probably about reached its maximum temperature. The spool windings were equivalent to, but not identical with, those described in this specification. In all other respects, the construction was substantially that described.

EFFICIENCY CALCULATIONS.

	Watts.
Output at full load	200,000
Core loss	2,760
Commutator and brush loss... ..	1,540
Armature C ² R loss at 60 deg. Cent.	8,800
Shunt spools - C ² R loss at 60 deg. Cent.	1,470
„ rheostat - C ² R loss at 60 deg. Cent.	180
Series spools - C ² R loss at 60 deg. Cent.	640
„ rheostat (diverter) C ² R loss at 60 deg. Cent.	130
Total output	215,520

		WEIGHTS (POUNDS).							
<i>Armature :</i>									
Core magnetic	3,600
Teeth	400
Spider	1,600
Copper	1,150
<i>Commutator :</i>									
Segments	450
Complete without shaft	12,000
<i>Frame :</i>									
Six pole-pieces	750
Six magnet cores	4,100
Yoke	11,000
<i>Field Windings :</i>									
Six shunt coils	890
Six series coils	420
Total spool copper	1,310
Other parts	3,800
Machine complete with base plate	33,000

The results of tests of this machine are given in the curves of Figs. 184 to 188, relating respectively to saturation, compounding, core loss, efficiency, and gap distribution.

10-POLE 300-KILOWATT LIGHTING GENERATOR.

A ten-pole lighting generator, designed by Mr. A. H. Moore, and built in 1897 by the Union Elektricitäts-Gesellschaft, of Berlin, is illustrated in Figs. 189 to 206. Its rated output is 300 kilowatts at 125 volts and 2,400 amperes, and at a speed of 100 revolutions per minute. In Figs. 190 to 193 are given curves of this machine derived from the results of tests and covering the subjects of saturation, core loss, compounding, and efficiency. The most interesting feature of this design is that carbon brushes are used, notwithstanding the low tension and heavy current.

In this instance the commutator is crowded considerably, and, as will be seen in the following specification, the temperature rise at the commutator was largely in excess of that at other parts of the machine. Mr. Moore has modified the design in this respect by lengthening the commutator segments about 25 per cent.

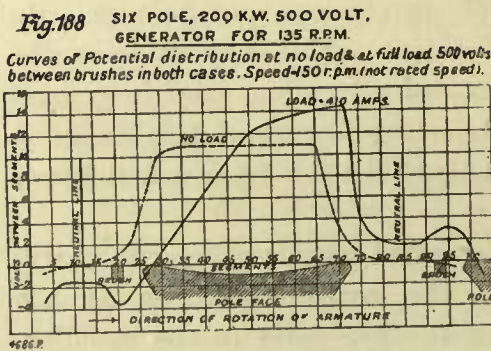
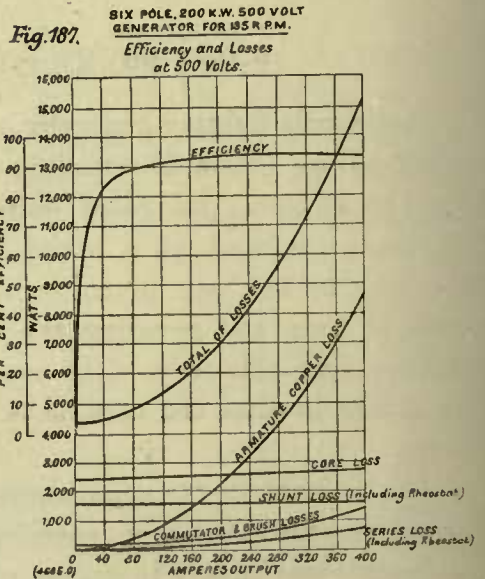
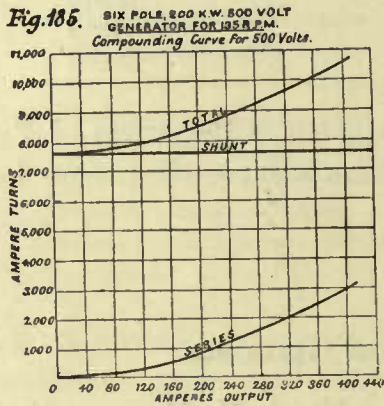
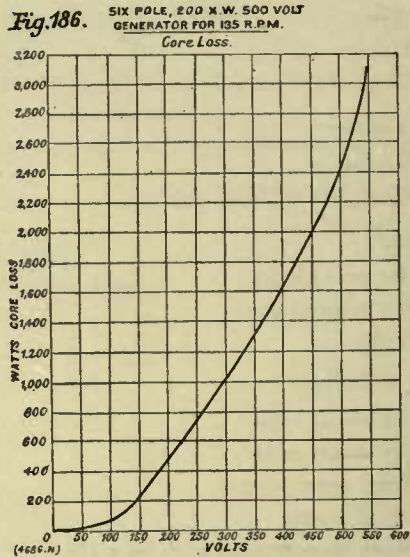
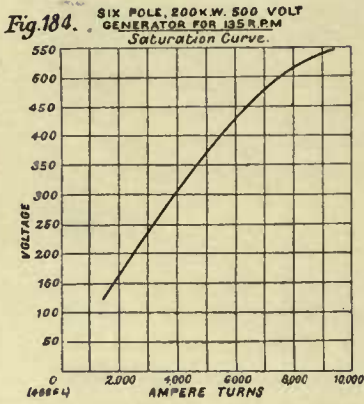

The calculations are arranged below in the form of a specification :

Number of poles	10
Kilowatts	300
Revolutions per minute	100
Frequency in cycles per second	8.33
Terminal volts, no load	110
,, ,, full load	125
Amperes, full load	2400

DIMENSIONS.

Armature :

Diameter over all	65 $\frac{1}{4}$ in.
Length over conductors	33 $\frac{7}{8}$ "
Diameter at bottom of slots	61 $\frac{3}{4}$ "
Internal diameter of core	50 $\frac{7}{8}$ "
Length of core over all	17 $\frac{5}{8}$ "
Effective length, magnetic iron	12.7 "
Pitch at surface	20.5 "
Per cent. insulation between sheets	10
Thickness of sheets025 in.
Depth of slot	1 $\frac{3}{4}$ "
Width of slot at root59 "
,, ,, surface59 "
Number of slots	180
Minimum width of tooth478 in.
Width of tooth at armature face539 "
,, conductor197 "
Depth of conductor650 "
Number of ventilating ducts	7
Width of each ventilating duct	$\frac{1}{2}$ in.
Effective length of core \div total length72

Magnet Core :

Length of pole-face	16 in.
Length of pole arc (average)	13.3 "
Pole arc \div pitch65
Thickness of pole-piece at edge of core	1 $\frac{1}{2}$ in.
Radial length of magnet core	12 $\frac{13}{16}$ "
Diameter of magnet core... ..	13 "
Bore of field (diameter)	65 $\frac{27}{32}$ "
Depth of air gap3 "

Spool :

Length over flanges	12 $\frac{3}{4}$ in.
Length of winding space	11 $\frac{3}{4}$ "
Depth of winding space... ..	2 $\frac{1}{4}$ "

Fig. 180.

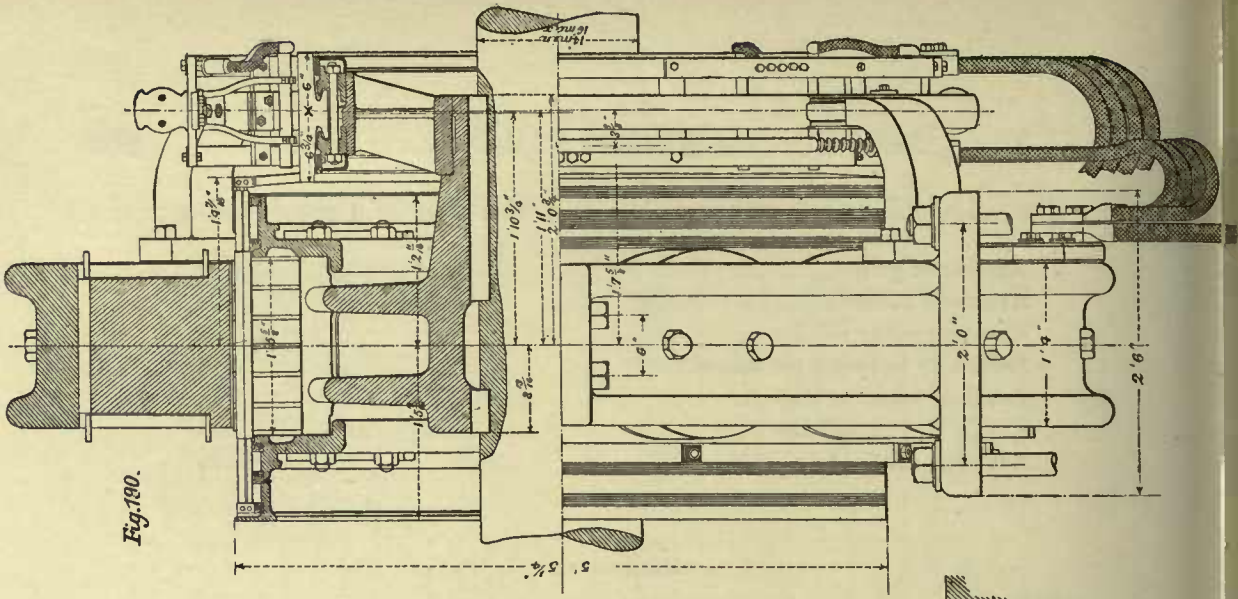

Fig. 189.

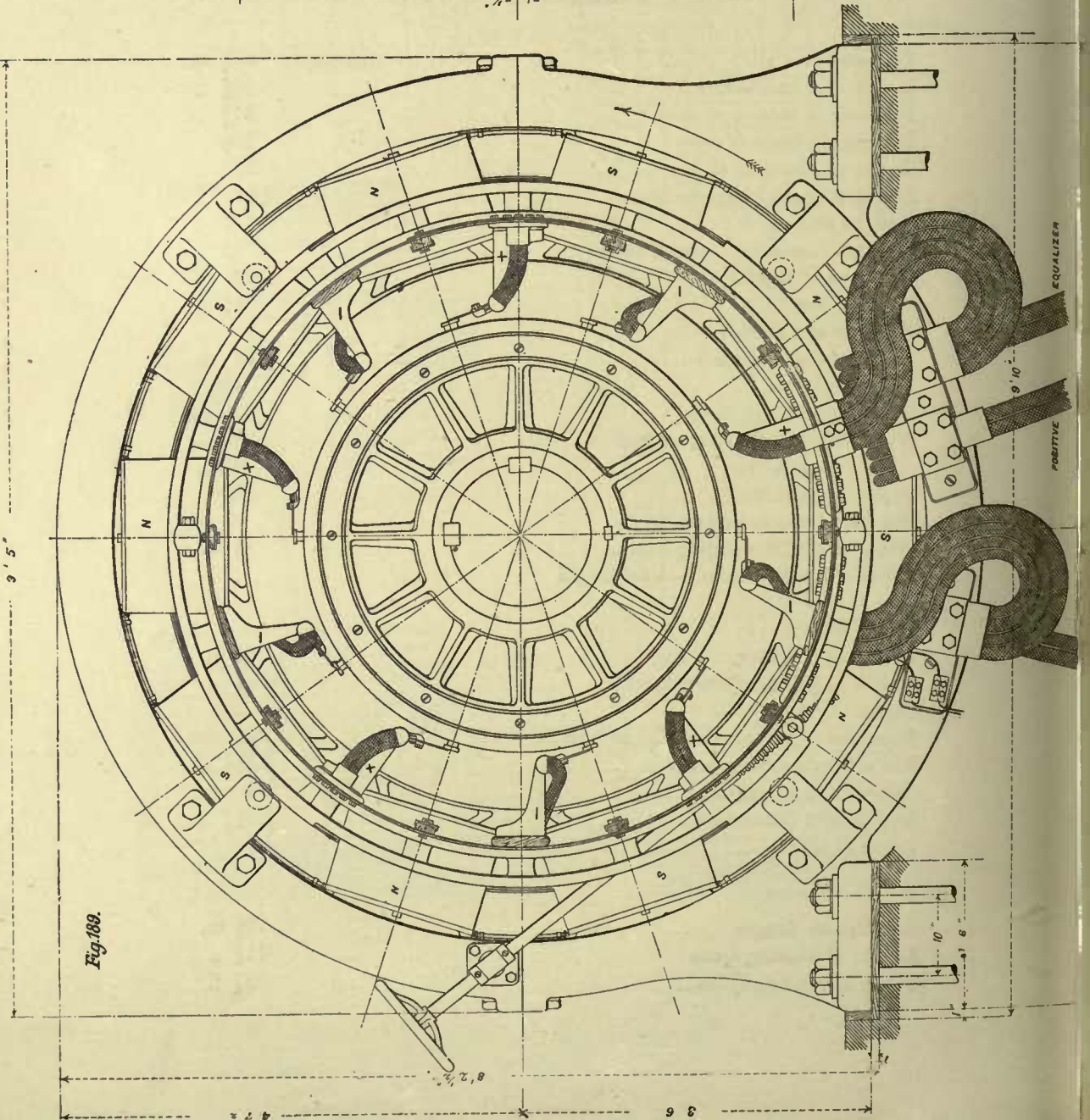

Fig. 191.

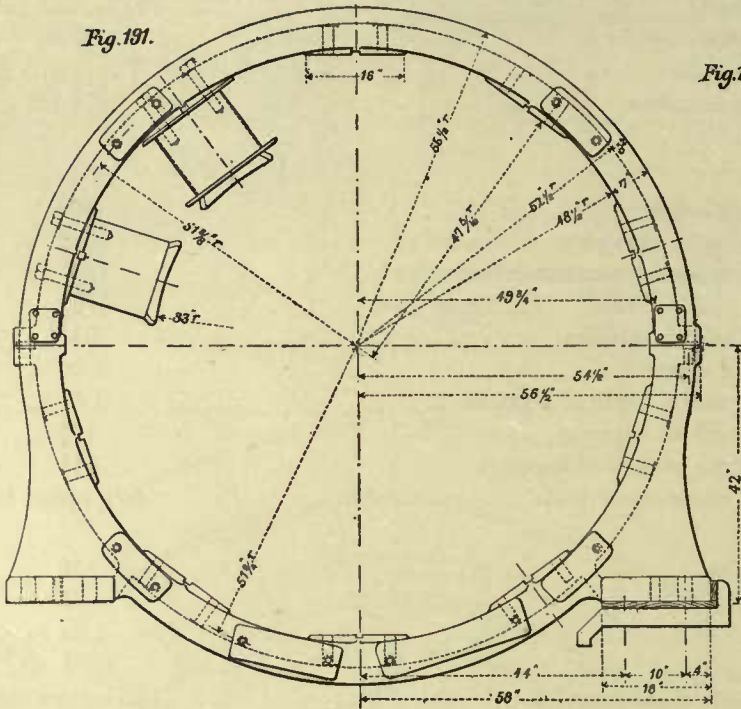

Fig. 192.

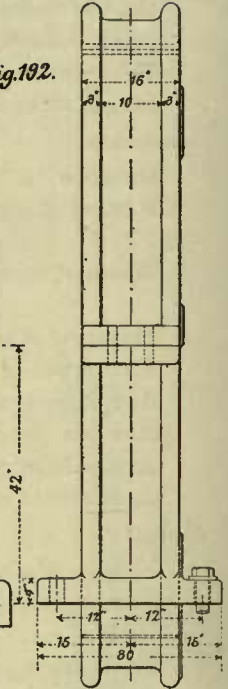

Fig. 193.

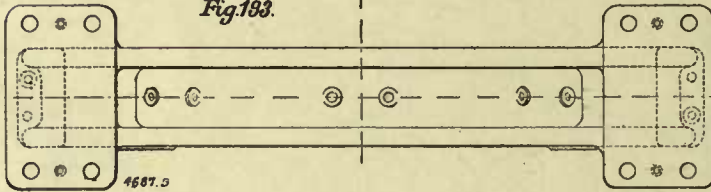

Fig. 194.

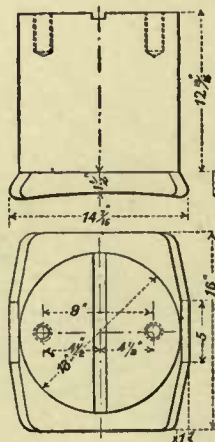
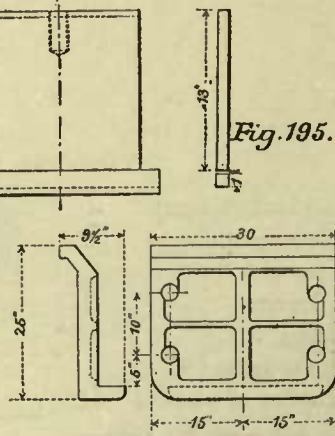

Fig. 195.



Turns in series between brushes... ..	36
Length between brushes... ..	3190 in.
Cross-section one armature conductor128 square inch
Ohms per cubic inch at 20 deg. Cent.00000068 ohms
Resistance between brushes at 20 deg. Cent.00171 "
" " 60 deg. Cent.00198 "
Volts drop in armature at 60 deg. Cent.	4.75
" " brushes and contacts and series winding	3.25
Terminal voltage, full load	125
Total internal voltage, full load	133
Amperes per square inch in armature winding... ..	1880
" " commutator connections	4000

Commutation :

Average voltage between commutator segments	3.5
Armature turns per pole... ..	36
Amperes per turn	240
Armature ampere turns per pole-piece	8650
Segments lead of brushes	3
Percentage lead of brushes	8.3
" demagnetising ampere turns	16.6
" distorting ampere turns	84.4
Demagnetising ampere turns per pole	1450
Distorting " "	7200
Frequency of commutation (cycles per second)... ..	138
Number of coils simultaneously short-circuited per brush	3
Turns per coil	1
Number of conductors per group simultaneously undergoing commutation... ..	6
Flux per ampere turn per inch length armature lamination	20
Flux linked with six turns with 240 amperes in those turns = $17.6 \times 20 \times 6$	2110 lines
Inductance in one turn constituting one coil, in henrys = $1 \times$ 2110×10^{-8}0000211 henrys
Reactance short-circuited turn0183 ohms
" voltage = $.0183 \times 240$	4.4 volts

MAGNETOMOTIVE FORCE CALCULATIONS.

Megalines entering armature, per pole-piece, at no load	9.17
" " " at full load	11.1
Coefficient of magnetic leakage	1.15
Megalines in magnet frame, per pole-piece, at no load	1.05
" " " full load	1.28

Armature :

Section	143 square inches
Length (magnetic)	10 in.

Fig. 196.

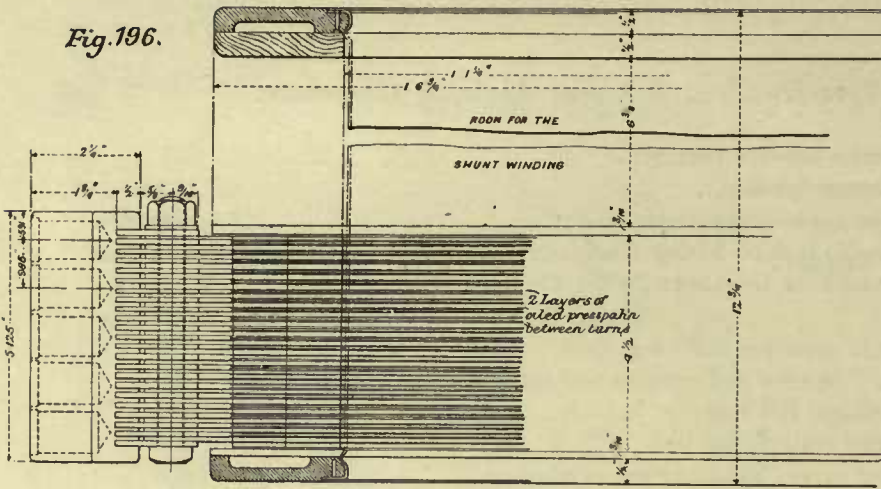

Fig. 197.

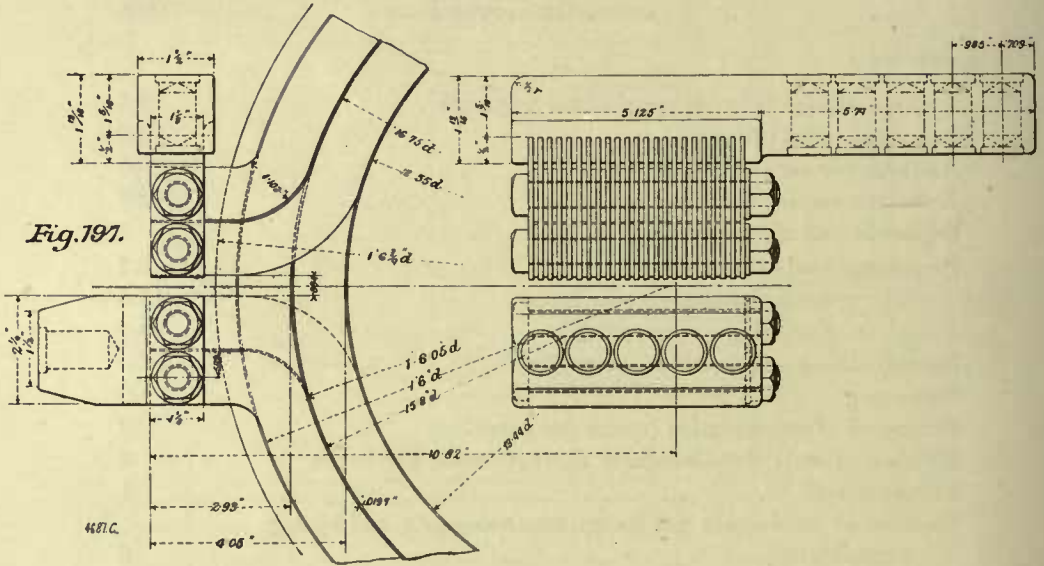

Fig. 198.

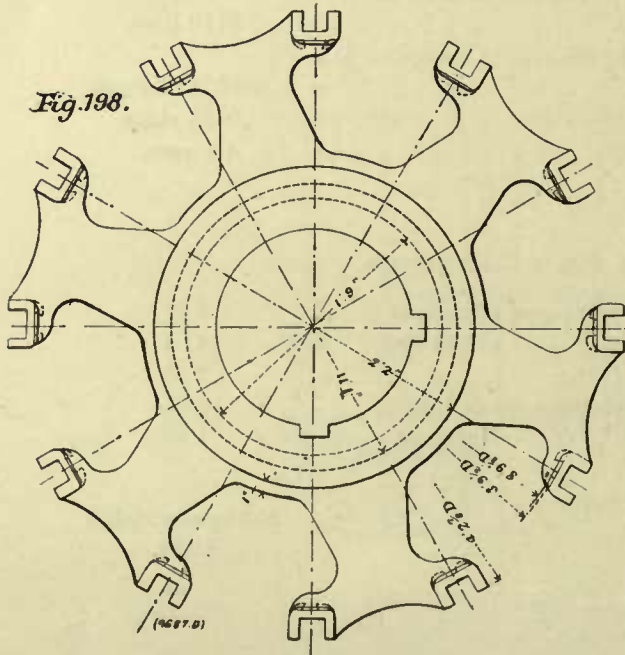
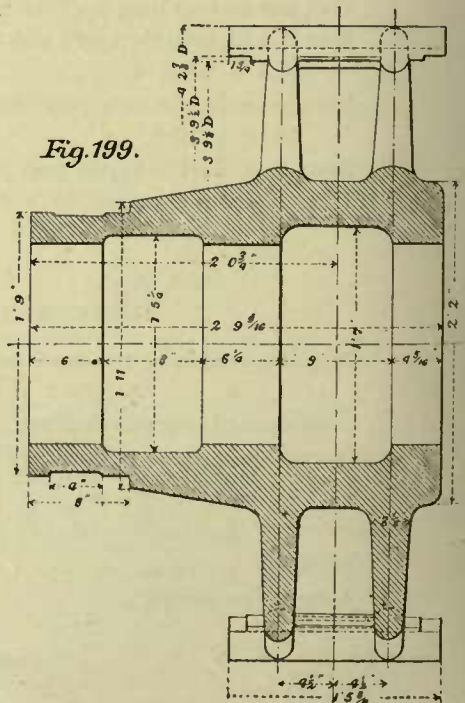

Fig. 199.



Density at no load	63.5 kilols.
„ full load	77.5 „
Ampere turns per inch length, no load	14
„ „ full load	23
Ampere turns, no load	140
„ full load	230

Teeth :

Transmitting flux from one pole-piece	14
Section at roots	8.5 square inches
Length	1.75 in.
Apparent density at no load	108 kilols.
„ „ full load	130 „
Corrected density at no load	106 „
„ „ full load	125 „
Ampere turns per inch length, no load	100
„ „ full load	750
Ampere turns, no load	180
„ full load	1310

Gap :

Section at pole-face	213 square inches
Length3 in.
Density at pole-face, no load	42,800
„ „ full load	52,000
Ampere turns, no load	4,050
Ampere turns, full load	4,900

Magnet Core :

Section	132 square inches
Length (magnetic)	13.5 in.
Density, no load	79.0 kilols.
„ full load	96.5 „
Ampere turns per inch length, no load	48
„ „ full load	93
„ no load	650
„ full load	1250

Magnet Yoke :

Section	156 square inches
Length per pole	15 in.
Density no load	67.0 kilols.
„ full load	82.0 „
Ampere turns per inch length, no load	32
„ „ full load	58
„ no load	480
„ full load	870

AMPERE TURNS PER SPOOL.					No Load and 110 Volts.	No Load and 133 Internal Volts, corres- ponding to 125 Terminal volts at Full Load.
Armature core	140	230
Armature teeth	180	1310
Gap	4050	4900
Magnet core	650	1250
„ yoke	480	870
					<hr style="width: 50%; margin: 0 auto;"/>	<hr style="width: 50%; margin: 0 auto;"/>
					5500	8560
Demagnetising ampere turns per pole-piece, at full load	1450
Allowance for increase in density through distortion	550
					<hr style="width: 50%; margin: 0 auto;"/>	<hr style="width: 50%; margin: 0 auto;"/>
Total ampere turns at full load and 125 terminal volts					=	10,560

If the rheostat in the shunt circuit is adjusted to give 5,500 ampere turns at 110 volts, then, when the terminal voltage is 125, the shunt excitation will amount to $\frac{125}{110} \times 5,500 = 6,250$ ampere turns. $10,560 - 6,250 = 4,310$ ampere turns must be supplied by the series winding.

CALCULATION OF SPOOL WINDINGS.

Shunt:

Mean length of one shunt turn = 51 in. = 4.25 ft.

Ampere turns per shunt spool at full load = 6250.

„ feet = 26,600.

Radiating surface one field spool = 730 square inches.

Permit .36 watts per square inch at 20 deg. Cent.

∴ 263 total watts per spool. This is divided up into 84 watts in series winding and 177 in shunt.

Shunt watts per spool at 60 deg. Cent. = 204.

$$\text{Pounds} = \frac{31 \times \left(\frac{\text{Ampere feet}}{1000}\right)^2}{\text{watts}}$$

∴ Shunt copper per spool = $\frac{31 \times 710}{177} = 125$ lb.

Plan to have 90 per cent. of the available 125 volts, or 113 volts, at the terminals of the field spools when hot, the remainder being consumed in field rheostat.

This is 98 volts at 20 deg. Cent. or 9.8 volts per spool.

Hence require $\frac{177}{9.8} = 18.1$ amperes per spool.

Turns per shunt spool = $\frac{6250}{18.1} = 345$.

Length of 345 turns = 1470 ft.

Pounds per 1000 ft. = 85.

No. 8 B.W.G. has 82.4 lb. per 1000 ft.

Bare diameter = .165 in. D.C.C.D. = .177 in.

Cross-section = .0214 square inches. Current density = 845 amperes per square inch.

Length of the portion of winding space available for shunt winding = $6\frac{3}{8}$ in.

Winding consists of 10 layers of 35 turns each, of No. 8 B.W.G.

Series Winding.—The series winding is required to supply 10,560 — 6250 = 4,310 ampere turns at full load.

With two turns per spool, the full load current will give $2400 \times 2 = 4800$ ampere turns. Consequently, 250 amperes must be diverted through the diverter rheostat, leaving 2,150 amperes in the series winding, giving 4,300 ampere turns.

The two turns consist of flat strips wound on edge spirally, as shown in Figs. 196 and 197. The conductor is made up of 44 strips 1.10 in. by .079 in., making up a total cross-section of 3.8 square inches :

Current density = 630 amperes per square inch.

Mean length of turn = 51 in.

Resistance of ten spools at 20 deg. Cent. = .000183 ohms.

Series $C^2R = 2150^2 \times .000183 = 840$ watts.

Ditto per spool = 84 watts.

At 60 deg. Cent. = 97 watts.

Weight series copper = 1250 lb.

THERMAL CALCULATIONS.

Armature:

C^2R loss at 60 deg. Cent.	11,400 watts
Core loss (observed value)	4,150 ,,
Total armature loss	15,550 ,,
Observed increased temperature by increased resistance of armature winding	64 deg. Cent.
Peripheral radiating surface armature	7,000 square inches
Watts per square inch radiating surface armature	2.22
Increased temperature per watt per square inch armature radiating surface	29 deg.
Peripheral speed armature, feet per minute	1720
Increased temperature of armature by thermometer	29 deg. Cent.
Ditto, per square inch peripheral radiating surface	13 ,,

Spool:

Total C^2R loss at 60 deg. Cent. per spool	301 watts
Observed increased temperature by increased resistance of winding	64 deg. Cent.
Peripheral radiating surface of one spool	730 square inches.
Watts per square inch of spool radiating surface41

Fig 206

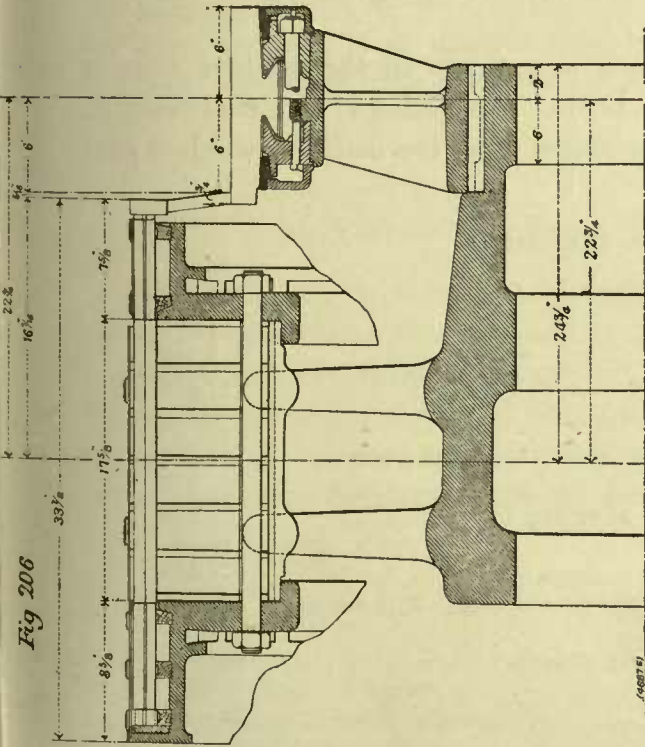

(6687)

Fig. 201

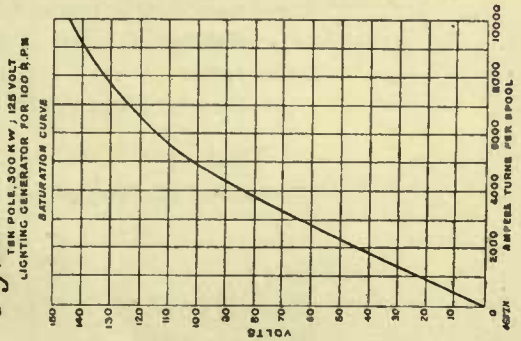

Fig. 208

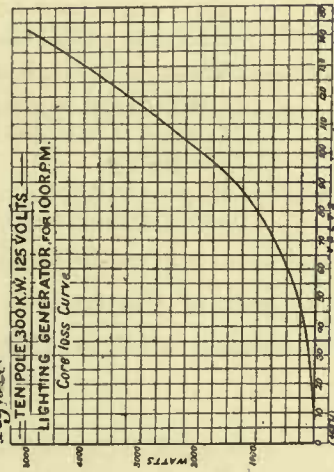

Fig. 210.

TEN POLE 300KW, 125VOLTS LIGHTING GENERATOR FOR 100 R.P.M. Efficiencies and Losses at 66° cent No load Voltage 110, Full load Voltage 125.

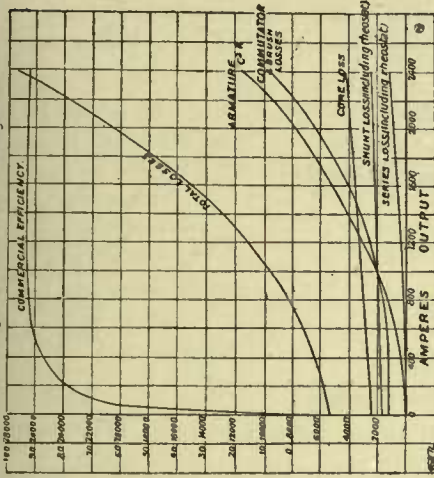
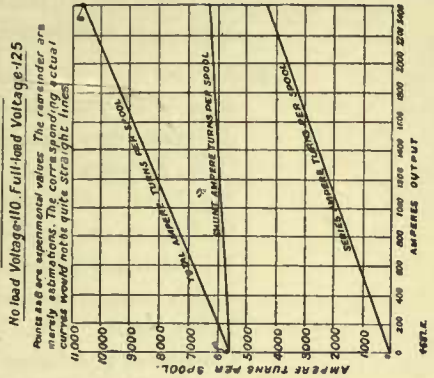

Fig. 209.

TEN POLE 300KW 125VOLT LIGHTING GENERATOR FOR 100R.P.M. COMPOUNDING CURVES



Increased temperature per watt per square inch of spool radiating surface	156 deg. Cent.
By thermometer the increase in temperature of spool was	46 ,,
Ditto, per square inch radiating surface	112 ,,

Commutator :

Area of all positive brushes (bearing surface)	50 square inches
Amperes per square inch of brush bearing surface	48 amperes
Ohms per square inch bearing surface of carbon brushes03 ohms
Brush resistance, positive + negative00120 ohms
Volts drop at brush contacts	2.9 volts
C ² R at brush contacts	6900 watts
Brush pressure, pounds per square inch	1.25 lb.
Ditto, total	125. ,,
Coefficient of friction3
Peripheral speed of commutator in feet per minute	1365
Brush friction	1160 watts
Allowance for stray power lost in commutator	500 ,,
Total commutator loss	8560 ,,
Radiating surface commutator	1920 square inches
Watts per square inch of radiating surface	4.45
Observed rise in temperature	80.5 deg. Cent.
Increase in temperature per watt per square inch of radiating surface	18 deg. Cent.

These temperature observations were made on the machine after it had been run on full load for eight hours. As readings were made only at the end of the test, it cannot be stated that the machine was not still increasing in temperature.

EFFICIENCY CALCULATIONS.

	Watts.
Output at full load	300,000
Core loss	4,150
Commutator and brush loss	8,560
Armature C ² R loss at 60 deg. Cent.	11,400
Shunt spools - C ² R loss at 60 deg. Cent.	2,040
„ rheostat	230
Series spools	970
„ rheostat (diverter) C ² R loss at 60 deg. Cent.	100
Total input	327,450

Commercial efficiency at full load and 60 deg. Cent. = 91.6 per cent.

WEIGHTS (POUNDS).

<i>Armature :</i>	lb.
Magnetic core	3,500
Teeth	560
Spider and flanges	7,000
Copper	1,310

Commutator :

Segments	1,480
Spider and press rings	1,300
Complete armature and commutator without shaft	14,500

Frame :

Ten pole pieces	1,000
„ magnet cores	5,000
Yoke	8,500
Ten-shunt coils	1,250
Ten-series „	1,250
Total spool copper	2,500
Other parts	3,000
Machine complete	34,500

In Figs. 207 and 208, page 213, are given the results of tests of saturation and core loss.

Points A and B of Fig. 209 are experimental values. The curves of Fig. 209 show approximately the ampere turns that would be required for various outputs, if the terminal voltage increased in a straight line from 110 volts at no load, up to 125 volts at full load. This would not automatically increase in a straight line, but the deviation was not tested. Curves of losses and efficiencies are given in Fig. 210.

SIX-POLE 250-KILOWATT ELECTRIC GENERATOR.

The following is one of the latest designs: In Figs. 211 to 224 are given diagrammatical sketches, setting forth the electromagnetic dimensions to which the ultimate designs should correspond. Figs. 225 to 233 show some interesting details of construction of frame, spider, commutator, brush holders, bearing, &c., suggested among other alternative schemes, in the mechanical development of the generator.

SPECIFICATION.

Number of poles	6
Kilowatts	250
Revolutions per minute	320
Frequency in cycles per second	16
Terminal volts, full load	550
„ „ no load	500
Amperes	455

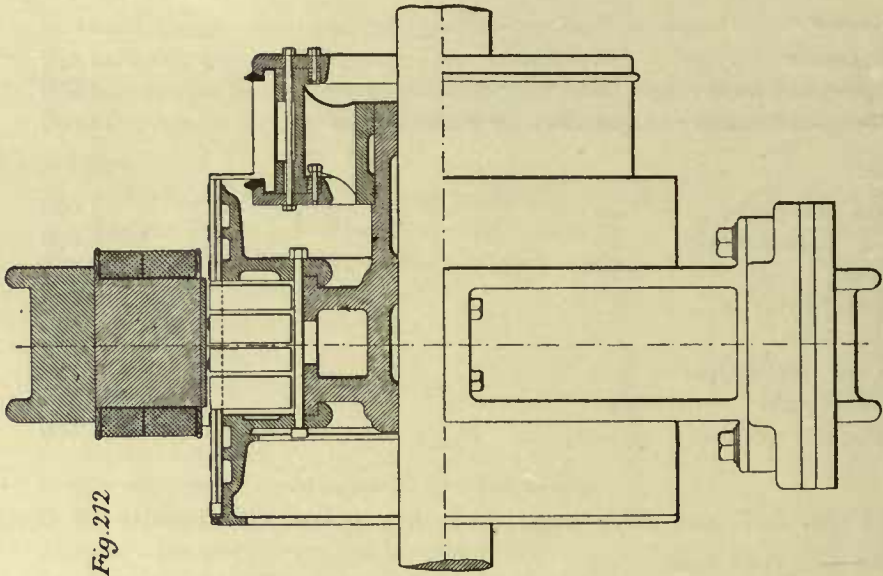

Fig. 212

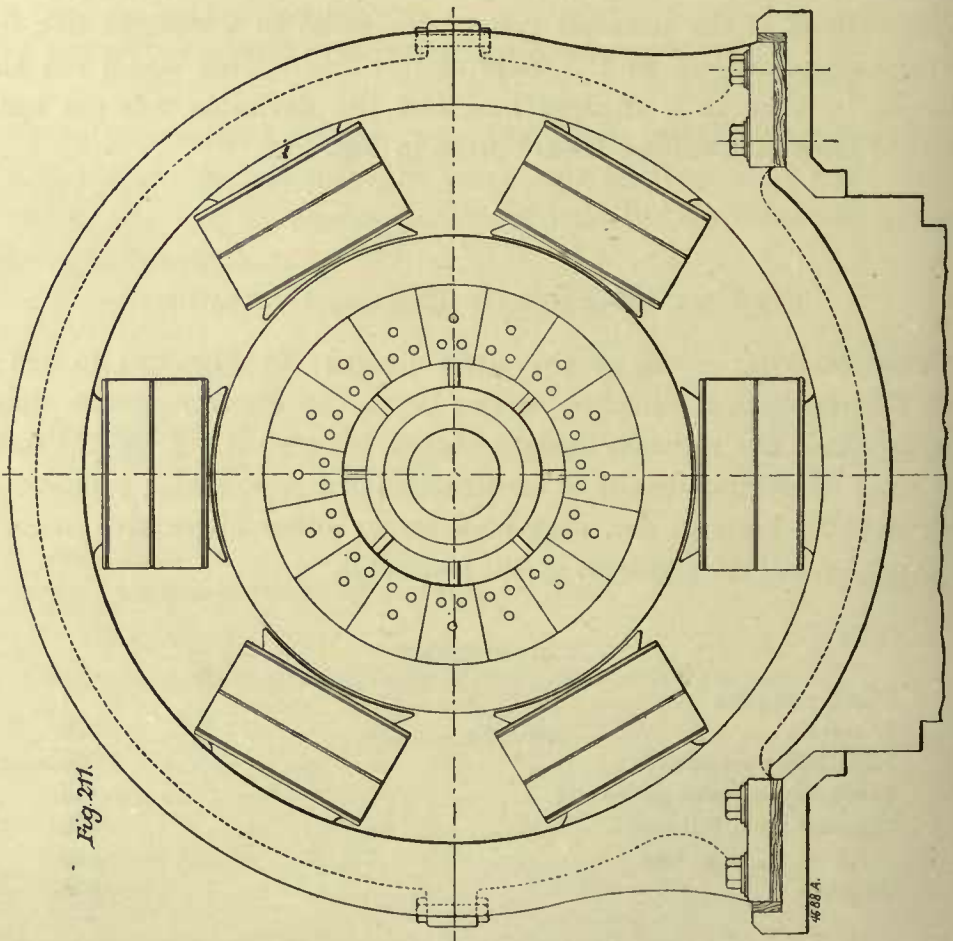

Fig. 211.

42 22 A.

DIMENSIONS.

Armature :

Diameter over all... ..	46 in.
Length over conductors	32.3 ,,
Diameter at bottom of slots	43.4 ,,
Internal diameter of core	30 ,,

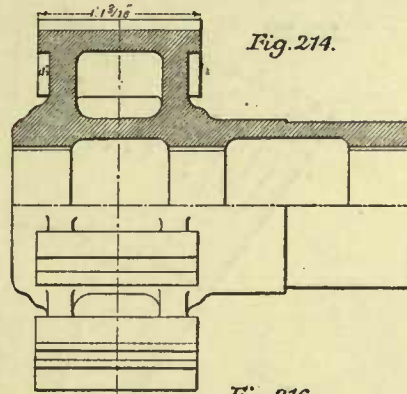
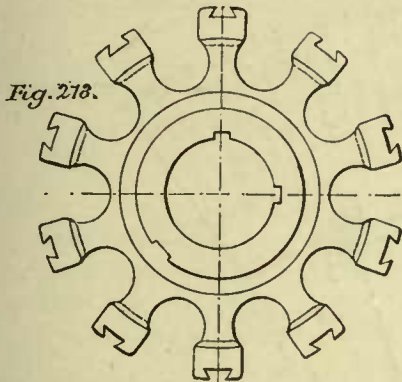

Fig. 214.

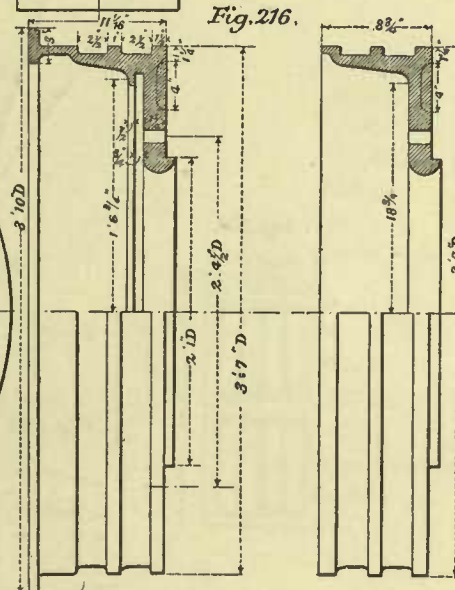
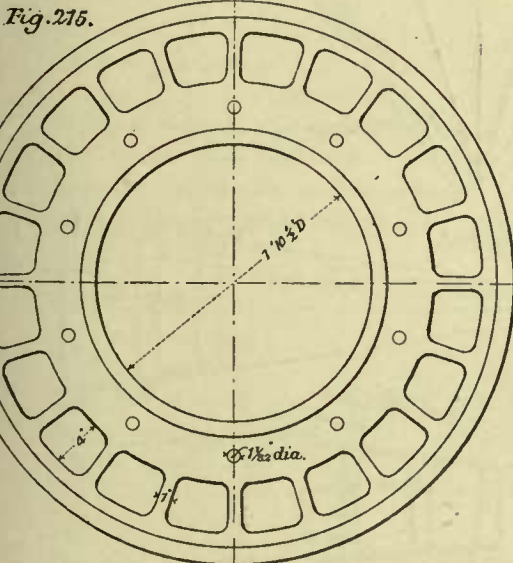
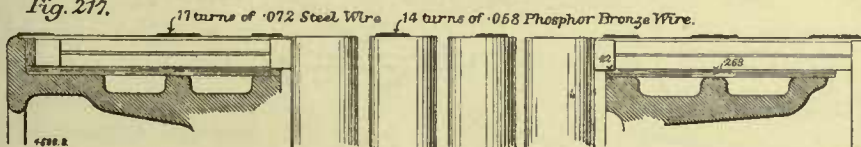

Fig. 216.

Fig. 217.



Length of core over all	12.3 in.
Effective length, magnetic iron	9.9
Pitch at surface	24 ,,
Insulation between sheets	10 per cent.
Thickness of sheets014 in.
	2 F

TECHNICAL DATA.

Armature :

No load voltage	500
Number face conductors... ..	1200
Conductors per slot	8

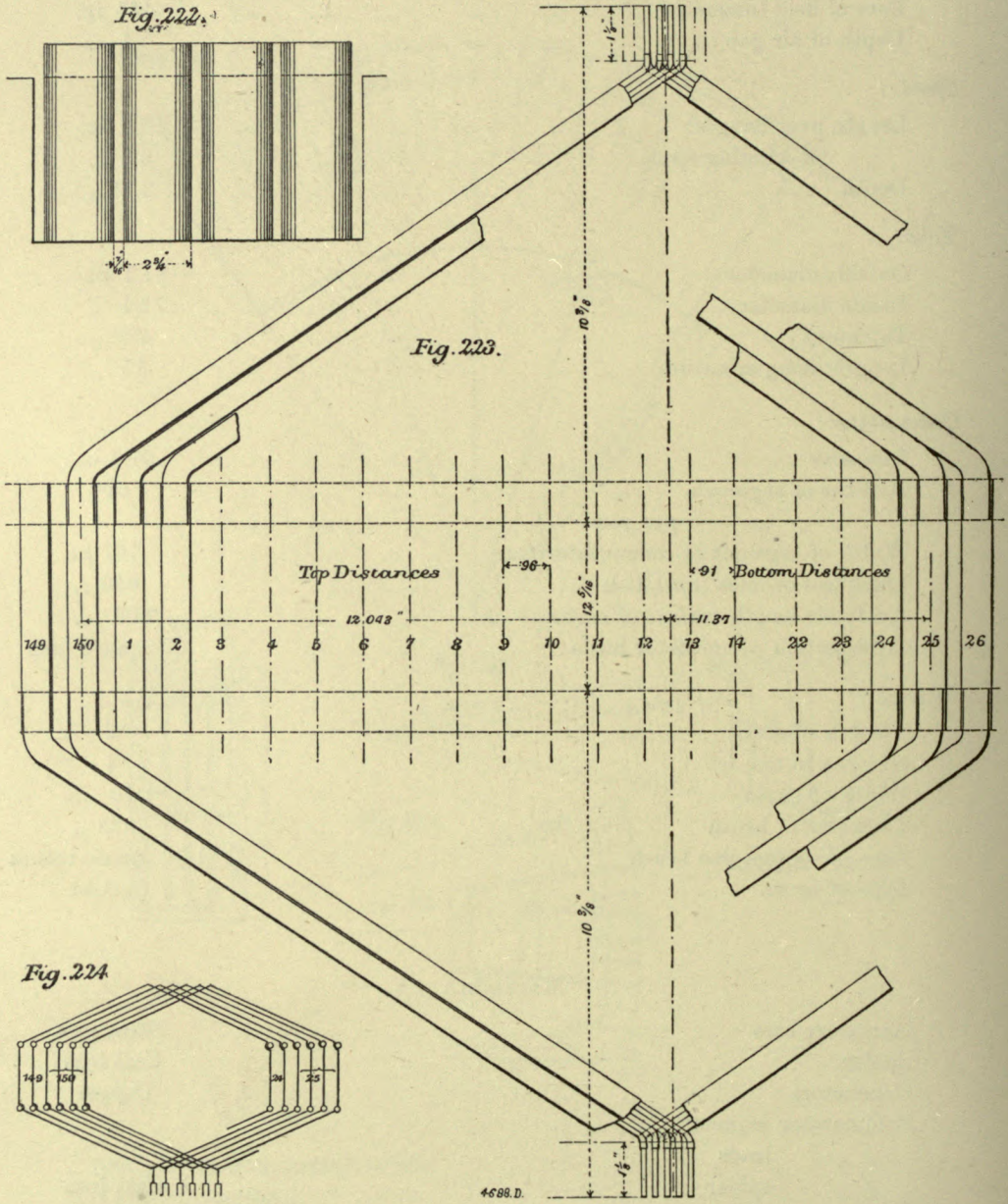

Number of circuits	6
Style winding	Multiple
Gramme ring, or drum	Drum

Type of construction of winding	Barrel-wound
Mean length, one armature turn	84.5 in.
Total armature turns	600
Turns in series between brushes...	100
Length between brushes	8450 in.
Cross-section one armature conductor045 square inch
Ohms per cubic inch at 20 deg. Cent.00000068
Resistances between brushes at 20 deg. Cent.0213 ohms
" " 60 "0245 "
Volts drop in armature at 60 deg. Cent.	11.3
" brushes and contacts	2.1
Total internal voltage, full load...	564
Amperes per square inch in armature winding	1700
" " commutator connections	2500

Commutation:

Average voltage between commutator segments	5.5
Armature turns per pole...	100
Amperes per turn	76
Armature ampere turns per pole	7600
Segments lead of brushes	8
Percentage	8 per cent.
" demagnetising ampere turn	16 "
" distorting " "	84 "
Demagnetising ampere turns per pole	1220
Distorting " "	6380
Frequency of commutation, cycles per second	500
Number of coils simultaneously short-circuited per brush	4
Turns per coil	1
Number of conductors per group simultaneously undergoing commutation...	8
Flux per ampere turn per inch length armature lamination	20
Flux linked with eight turns with one ampere in these turns	1970 lines
Inductance of one turn in henrys = $1 \times 1970 \times 10^{-8}$0000197
Reactance short-circuited coil062 ohms
" voltage short-circuited coil	4.7 volts

MAGNETO-MOTIVE FORCE CALCULATIONS.

Megalines entering armature, per pole piece, no load	7.80
" " " " full load	8.80
Coefficient of magnetic leakage	1.15
Megalines in magnet frame, per pole piece, at no load	8.97
" " " " full load	10.1

Armature:

Section	132 square inch
Length, magnetic	13.0 "

Density, no load	59 kilolines.
„ full load	66 „
Ampere turns per inch length, no load	11
„ „ „ full load	13
„ no load	140
„ full load	179

Teeth :

Transmitting flux from one pole-piece	20
Section at roots	65
Length	1.28
Apparent density, no load	132 kilolines
„ „ full load	148 „
Corrected „ no load	124 „
„ „ full load	134 „
Ampere turns per inch length, no load	700
„ „ „ full load	1250
„ no load	890
„ full load	1600

Gap :

Section at pole-face	210 square inch
Length gap31 in.
Density at pole-face, no load	37.2 kilolines
„ „ full load	42 „
Ampere turns, no load	3640
„ full load	4150

Magnet Core :

Section	119 square inch.
Length (magnetic)	12.75 in.
Density, no load	76 kilolines
„ full load... ..	85 „
Ampere turns per inch length, no load... ..	35
„ „ „ full load	46
„ no load	450
„ full load	590

Magnetic Yoke :

Section	140 square inches
Length per pole	18 in.
Density, no load	64 kilolines
„ full load	72 „
Ampere turns per inch length, no load... ..	25
„ „ full load	32
„ no load	450
„ full load	570

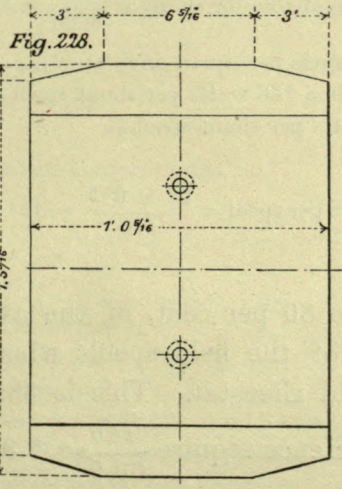
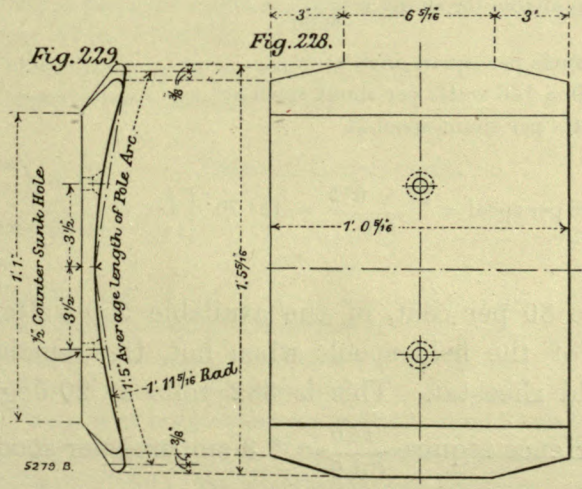
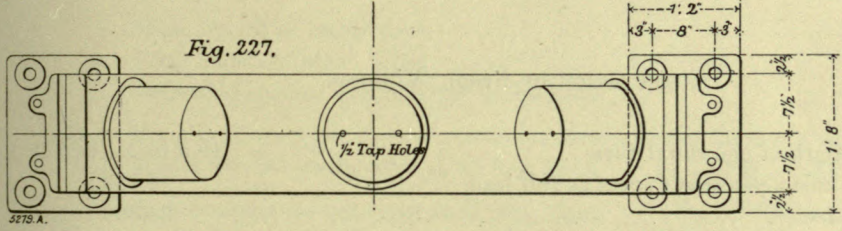
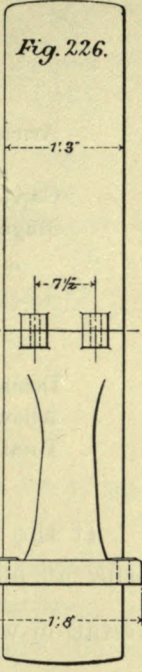
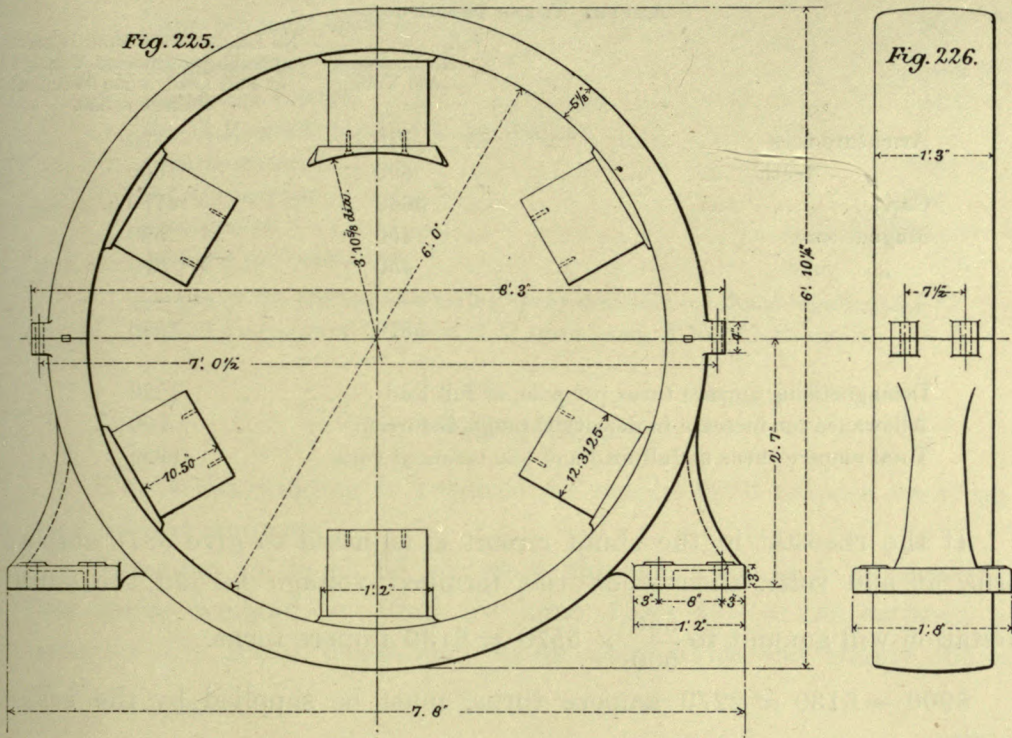

*

AMPERE TURNS PER SPOOL.					No Load and 500 Volts.	No Load and 564 Volts, Corres- ponding to Internal Voltage at Full Load, when Terminal Voltage is 550.
Armature core	140	170
" teeth	890	1600
Gap	3640	4150
Magnet core	450	590
" yoke	450	570
					-----	-----
					5570	7080
Demagnetising ampere turns per pole, at full load		1220
Allowance for increase in density through distortion		700
Total ampere turns at full load and 550 terminal volts		8920

If the rheostat in the shunt circuit is adjusted to give 5570 ampere turns at 500 volts, then when the terminal voltage is 550 the shunt excitation will amount to $\frac{550}{500} \times 5570 = 6130$ ampere turns.

8900 - 6130 = 2270 ampere turns, must be supplied by the series winding.

CALCULATION OF SPOOL WINDING.

Shunt:

Mean length of one shunt turn	= 48.5 in = 4.05 ft
Ampere turns per shunt spool at full load	6,130
Ampere feet	24,800
Total radiating surface of one field spool	530 square inches
Proportion available for shunt = $\frac{6130}{8900} \times 530$	365 ,,
Permit .40 watts per square inch at	20 deg. Cent.
∴ 365 × .40 = 146 watts per shunt spool at	20 ,,
And 168 watts per shunt spool at	60 ,,

$$\text{Shunt copper per spool} = \frac{31 \times 615}{146} = 131 \text{ lb.} \left[\text{Lb.} = \frac{31 \times \left(\frac{\text{amp. feet}}{1000} \right)^2}{\text{watts}} \right]$$

Plan to have 80 per cent. of the available 550 volts, *i.e.*, 440 volts, at the terminals of the field spools when hot, the remainder being consumed in the field rheostat. This is 382 volts at 20 deg. Cent., or 63.5 volts per spool. Hence require $\frac{146}{63.5} = 2.3$ amperes per spool.

Turns per shunt spool = $\frac{6130}{2.3}$	=	2660
Length of 2660 turns	10,800 ft.
Pounds per 1000 ft.	12.1
No. 14 B. and S. has 12.4 lb. per 1000 ft.					
Bare diameter0641 in.
D.C.C. diameter075 "
Cross-section00323 square inch
Amperes per square inch	710

Length of the portion of winding space available for shunt winding, 6.5 in.
 Winding consists of 33 layers of 81 turns each, of No. 14 B. and S.

SERIES WINDING.

The series winding is required to supply 2770 ampere turns at full load of 455 amperes.

Planning to divert 25 per cent. through a rheostat in parallel with the series winding, we find we have $.75 \times 455 = 342$ amperes available for the series excitation; hence each series coil should consist of $\frac{2770}{342} = 8$ turns.

Mean length of series turn	48.5 in.
Total length of eight turns	388 "
Radiating surface available for series spool	165 square inches

Permit .40 watt per square inch in series winding at 20 deg. Cent.

Watts lost per series spool at 20 deg. Cent. = $.40 \times 165 = 66$.

Hence resistance per spool at 20 deg. Cent. = $\frac{66}{342^2} = .00057$ ohms.

Copper cross-section = .46 square inch.

Series winding per spool may consist of eight turns made up of four strips of sheet copper 2.3 in. \times .050 in.

Weight of series copper in one spool = 58 lb.

Current density series winding = 740.

THERMAL CALCULATIONS.

Armature:

C ² R loss at 60 deg. Cent.	5050 watts
Core loss	4000 "
Total armature loss	9050 "
Peripheral radiating surface of armature	4700 square inches
Watts per square inch radiating surface	1.93
Peripheral speed armature feet per minute	3850
Assumed increase of temperature per watt per square inch in radiating surface as measured by increased resistance	=				25 deg. Cent.
Hence estimated total increase temperature of armature	=				48 "

Commutator :

Area of all positive brushes	13.1 square inch
Amperes per square inch brush-bearing surface	35 amperes
Ohms per square inch bearing surface carbon brushes03 ohm.
Brush resistance, positive and negative0046 "
Volts drop at brush contacts	2.1 volts
C ^o R at brush contacts	950 watts
Brush pressure, assumed 1.25 lb. per square inch	32.8 lb.

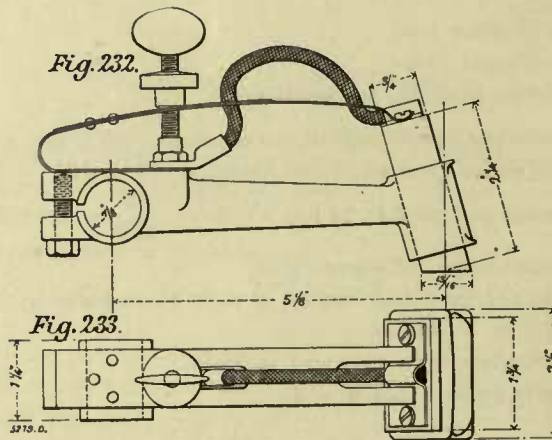
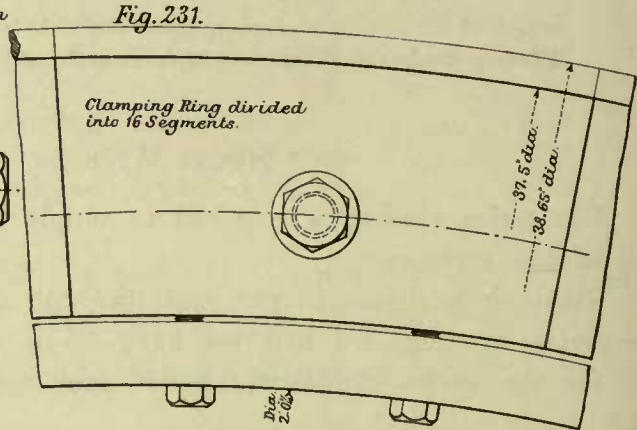
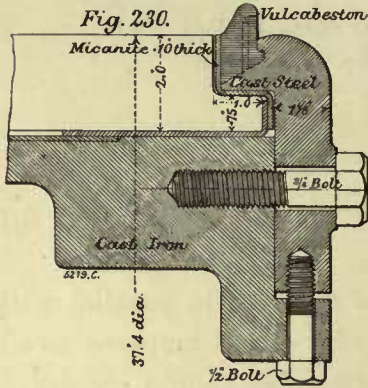

Coefficient friction3
Peripheral speed of commutator, feet per minute	3130
Brush friction	700 watts
Allowance for stray power lost in commutator	150 "
Total commutator loss	1800 "
Radiating surface in square inches	1100
Watts per square inch radiating surface of commutator	1.64
Increase of temperature per watt per square inch radiating surface	20 deg. Cent.
Total estimated increase of temperature of commutator	33 " "

EFFICIENCY CALCULATION.

	Watts.
Output, full load	250,000
Core loss	4,000
Commutator and brush losses	1,800
Armature C ² R at 60 deg. Cent.	5,050
Shunt spools C ² R at 60 deg. Cent.	1,000
„ rheostat at 60 deg. Cent.	250
Series spools C ² R at 60 deg. Cent.	460
„ rheostat at 60 deg. Cent.	150
Friction in bearings, and windage	2,000
	264,710
Commercial efficiency at full load and 60 deg. Cent.	94.4 per cent.

Fig. 234. SIX POLE 250 K.W. 550 VOLT GENERATOR. 320 R.P.M.

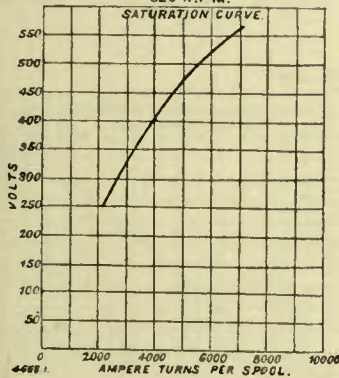
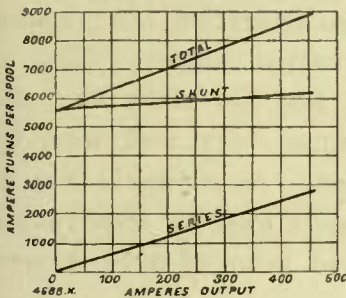
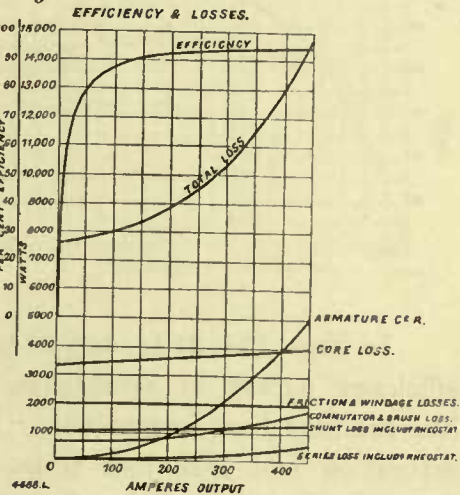

Fig. 234A. SIX POLE 250 K.W. 550 VOLT GENERATOR. 320 R.P.M. COMPENSATING CURVES. NO LOAD VOLTAGE-500. FULL LOAD VOLTAGE-550.



SIX POLE 250 K.W. 550 VOLT GENERATOR. 320 R.P.M.



WEIGHTS.

<i>Armature:</i>		Lb.
Magnetic core		2,100
Teeth		210
Spider		860
Shafting		1,700
End flanges		750
Copper		730

Commutator :

Segments	680
Spider	530
Rings	260
Other parts of armature and commutator	180
Armature complete, including commutator and shaft... ..	8,000

Field :

Six pole-pieces and magnet core... ..	2,400
Magnet yoke	5,000
Six shunt coils	790
Six series coils	350
Total spool copper	1,140
Brush gear	300
Bedplate and bearings	2,600
Machine complete	20,000

Fig. 235.

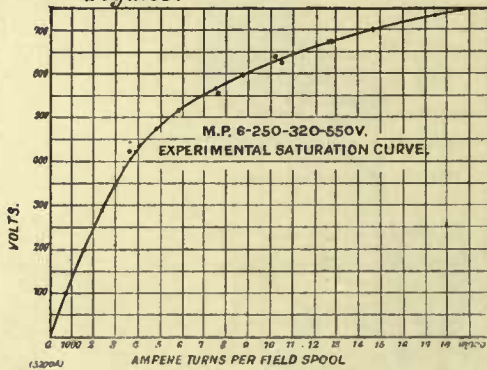
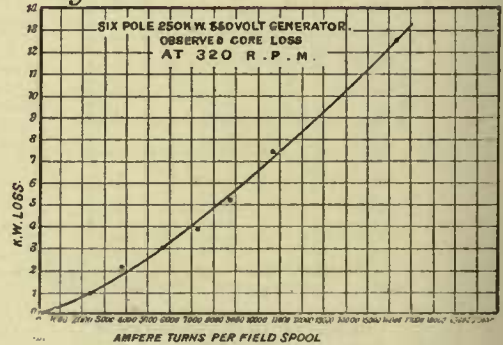

Fig. 236.



In Figs. 234, 234A, and 234B are given saturation, compounding, and efficiency curves in accordance with estimated values. This machine has recently been completed. Figs. 235 and 236 show the results of saturation and core loss tests. They agree very well with the predetermined values of the above specification. As shown in Fig. 235, the excitation required at no load and 500 volts was, by observation, 5400 ampere turns, as against the predetermined value of 5570 ampere turns given in the calculation on page 224.

CORE LOSSES IN MULTIPOLAR COMMUTATING MACHINES.

In determining the core losses of electric generators, it is frequently convenient to resort to empirical devices, as a check upon more theoretical methods, owing to the conditions in practice affecting the results. As

already explained in an earlier section of this series, the machine-work upon the armature, the periodic variations in the magnetic reluctance, with resulting eddy current and hysteric losses in the magnet frame, and the eddy currents in the armature conductors, supports, shields, &c., all tend to introduce uncertain factors.

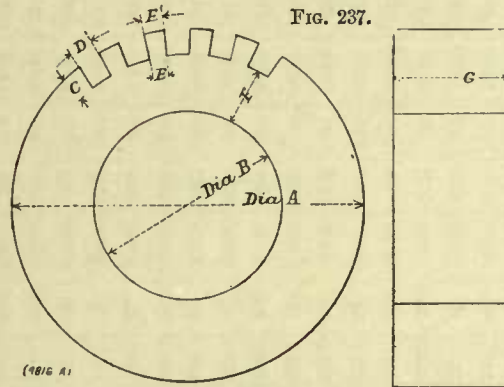
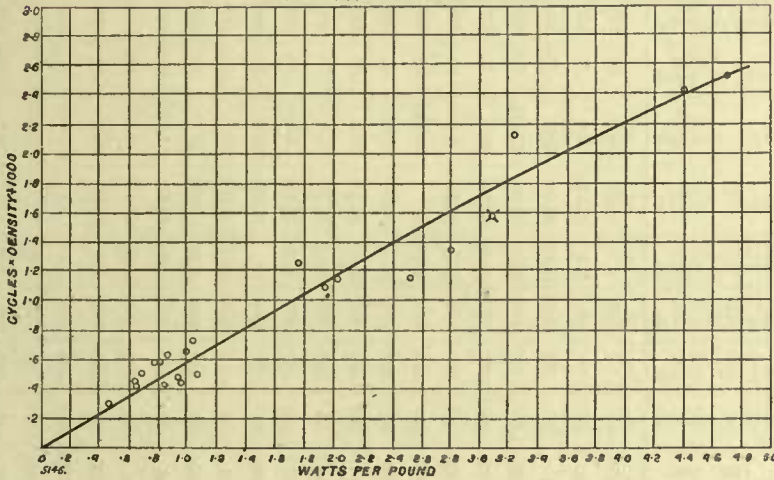

FIG. 237.

FIG. 238.

CURVE EXHIBITING THE RELATION BETWEEN CYCLES PER SECOND X KILOLINES DENSITY BELOW SLOTS=1000 AND WATTS PER POUND IN ARMATURE CORE



In the Table on page 230 are set forth the dimensions and the observed core losses of twenty-three large multipolar commutating machines, in the design of which there was a wide range of periodicities and magnetic densities. The results set forth in this Table are useful in drawing practical conclusions as to the probable core losses of new designs. Although in these designs the rate of dissipation of energy in the teeth is high, the small percentage which the mass in the teeth bears to the total

TABLE LXIX.—DIMENSIONS AND OBSERVED CORE LOSSES OF TWENTY-THREE COMMUTATING GENERATORS.

Number of Poles.	Speed, Revolutions per Minute.	Date of Construction.	External Diameter of Armature (A.)	Internal Diameter of Armature Lamina (B.)	Depth (C.) of Armature Slot.	Width of Arm Slot (D.)	Width of Tooth at Root (E.)	Width of Tooth at Arm Face (F.)	Depth of Lamina below Slot (F.)	Gross Width of Core (G.)	Effective Width of Core.	Ratio of Pole Arc to Pitch.	Number of Slots.	Megajoules Flux Entering Armature per Pole.	Number of Teeth Assumed to Transmit Flux per Pole.	Apparent Density at Root of Teeth in Kilolines.	Density below Slots in Kilolines.	Total Observed Core Loss in Watts.	Weight of Laminae below Slots.	Weight of Teeth.	Total Weight of Laminae.	Watts of Core Loss per Pound.	Cycles per Second = C.	Kilolines of Density below Slots = D.	$\frac{CD}{1000}$	$\frac{CD}{1000} \times K =$
6	100	1897	59.25	38.5	1.688	.58	.467	.586	8.7	21.25	16.9	.68	168	25.6	21	154	87	5,350	6100	660	6,760	.79	5.00	87	.485	1.82
8	85	1898	59.25	42.5	1.75	.49	.507	.573	8.5	18.125	14.6	.67	160	13.9	15	125	56	2,280	4250	626	4,876	.47	5.66	56	.318	1.48
8	90	1898	72	53.15	1.8	.6	.481	.6425	7.625	24.75	18.9	.742	198	23.95	20	137.2	83.2	9,300	7776	965	8,735	1.06	6.00	83.2	.499	2.12
6	120	1898	59.25	38.5	1.625	.416	.382	.4275	8.75	16.25	12.375	.642	220	16.4	26	138	75.7	3,265	4530	493	5,023	.65	6.00	75.7	.454	1.43
8	100	1898	72	53.125	1.762	.368	.321	.357	7.68	25.25	20.0	.73	312	27.3	31	137	89	7,600	8300	1050	9,350	.81	6.66	89	.595	1.36
6	135	1898	59.25	38.5	1.625	.416	.384	.429	8.75	14.25	9.9	.74	220	13.3	29	129	76	2,760	3603	400	4,000	.69	6.75	76	.513	1.35
6	150	1897	53	31.94	1.7	.83	.329	.374	9.08	23	18.238	.76	236	24.04	32	128.2	73	5,270	5720	724	6,444	.794	7.50	73	.547	1.45
6	150	1897	50.25	38.5	1.625	.44	.437	.490	8.75	16.75	12.825	.65	200	13.08	24	100.8	58.3	4,150	4690	545	5,235	.794	7.50	58.3	.437	1.82
10	90	1898	88.5	68.1975	1.8	.666	.445	.490	10.2	18.5	16.3	.69	240	19	19	146	61	9,250	8650	880	9,530	.97	7.50	61	.457	2.12
6	150	1893	43	26.75	1.5	.42	.396	.457	8.125	15.25	11.9	.70	154	12.5	20	133	65	2,510	2350	330	2,680	.94	7.50	65	.487	1.98
8	120	1893	72	53.1	1.73	.445	.346	.386	7.72	27.625	22.05	.76	272	3.09	28	149.5	90.9	10,670	9170	1070	10,240	1.04	8.00	90.9	.727	1.43
8	120	1898	66	46.75	1.625	.44	.383	.424	8	18.125	14.6	.73	240	13.1	25	130	78	5,480	5660	650	6,300	.87	8.00	78	.625	1.39
10	100	1897	32.625	25.44	1.75	.59	.478	.559	5.44	17.625	12.7	.65	180	11.1	14	136	78	4,060	3500	560	4,060	1.00	8.33	78	.669	1.54
8	150	1897	45.125	34.25	1.3125	.45	.354	.405	4.13	12.125	10	.76	167	7.75	18	122	94	3,300	1400	280	1,630	2.02	10.00	94	.940	2.14
10	140	1898	59.25	38.49	1.48	.52	.363	.4075	8.90	14.75	11.925	.699	200	7.91	16	121.1	37.3	3,210	4480	364	4,844	.664	11.70	37.3	.486	1.52
6	250	1897	31.5	19.66	1.5	.44	.374	.453	4.42	12	9.11	.788	110	7.05	16	137	87.6	2,010	860	176	1,086	1.94	12.50	87.6	1.09	1.17
6	300	1896	59.25	37.4	1.625	.58	.465	.524	9.3	14.5	11.6	.67	163	16.6	21	144	77	12,520	4460	511	497	2.52	15.00	77	1.15	2.18
8	230	1898	45.125	34.25	1.3125	.474	.333	.385	4.125	9.5	7.875	.67	165	5.22	16	132	80.3	2,230	1100	170	1,270	1.75	15.35	80.3	1.23	1.42
6	400	1897	45	30.684	1.178	.412	.284	.323	5.98	15	11.8125	.715	192	11.05	24	141	78.3	7,800	2295	240	2,535	3.08	36.00	78.3	1.56	1.96
12	250	1899	84	62	1.25	.44	.449	.475	9.75	12.5	9.9	.722	238	10.4	17	134	54	19,850	6500	500	7,000	2.8	25.0	54	1.35	2.68
6	600	1898	28	17.5	1.6	.342	.258	.335	3.65	7.25	6.1875	.75	130	3.63	13	134.6	80.4	2,335	454	106	530	4.41	36.00	80.4	2.41	1.83
6	600	1898	30	16.65	1.30	.32	.364	.4275	5.423	9	6.75	.733	126	5.16	17	132	70.4	2,725	711	124	835	3.26	36.00	70.4	2.11	1.54
6	600	1897	26.5	17.75	1.312	.37	.280	.296	3.06	8.5	7.88	.68	125	3.75	16	138	83	2,420	455	90	515	4.70	30.00	83	2.49	1.89

mass of the core of the armature, makes it practicable, as shown by the results given in the Table, to draw conclusions from a comparison of the watts per pound of total laminations as related to the periodicity and to the density below slots. But this would not be found to be the case, except when tooth densities are chosen, lying within the limits generally adopted, since the higher the density in the projections, the more considerable is the loss due to eddy currents in the embedded copper conductors, in consequence of the stray field crossing them. Another factor affecting the value of the core loss in commutating dynamos, is the influence of the conditions during commutation of coils, in relation to which the frequency of commutation has an important bearing.

The curve given in Fig. 238 is plotted from the tabulated results, and will be found useful for this type of machine.

Suppose, for example, we wish to predetermine the core loss of a multipolar generator having, say, eight poles and running at 240 revolutions per minute. From previous calculations we find it requires 7000 lb. weight of total laminations, including teeth and core body, allowing a full load working density of 76 kilolines per square inch cross-section area of the core body. Now, eight poles at 240 revolutions per minute would be sixteen cycles per second.

$$\frac{\text{Cycles} \times \text{density in kilolines}}{1000} = \frac{16 \times 76}{1000} = 1.22.$$

According to curve, Fig. 199, we obtain 2.1 watts per pound, and as there is 7,000 lb., the total core loss will be $2.1 \times 7,000 = 14,700$ watts.

For the range of periodicity and flux density covered by the above tabulated machines, an average value of 1.7 is obtained for K. Hence the following approximate rule is derived:—

$$\text{Watts per lb.} = 1.7 \times \text{cycles per second} \times \text{kilolines density.}$$

ELECTRIC TRACTION MOTORS.

Motors for electric traction must, from the nature of their work, be designed to be reversible, and to have the brushes set in a fixed position at a point midway between pole ends. Since the brushes cannot be shifted, the magnetic field cannot be utilised to reverse the current in the short-circuited coil; in fact, whatever impressed magnetic flux is passing through the coil while it is short-circuited under the brush, is in such a direction as to tend to maintain the current in its original direction, instead of assisting to reverse it. The commutation may be termed brush commutation, and the commutating element is in the resistance of the brushes. For satisfactory commutation, traction motors are designed with very high magnetisation at full load. Much higher densities are practicable, as regards the heating limit, than in machines running at constant loads, since the average current intake by a traction motor is not ordinarily above one-fourth of its rated capacity, so that in average work the magnetisation of the air gap and armature core is not very different from that in machines designed for constant load. At rated capacity, however, the magnetisation in the projections and armature core is frequently 50 per cent. higher than in machines designed for constant load, and at rated load the heat generated per square inch of radiating surface is generally more than double that of machines for constant load.

Because of the unfavourable commutating conditions, the armature reaction of railway motors and the reactance voltage of the short-circuited coil, should be comparatively small at rated capacity. This is the more important on account of the desirability of lessening the diameter of the armature, so as to shorten the magnetic circuit and diminish the weight of the motor. Material progress has been made in this direction by putting three or even four, coils in one slot, where in former practice but one, corresponding to one commutator bar, was placed in one slot. This is a condition which would be adverse to satisfactory commutation with reasonable heating, in large generators for constant load; but in the case

of railway motors, on account of the lesser number of projections and consequent less room occupied for insulation, the cross-section of the projections has been increased so that a higher magnetisation in the gap is permissible, under which condition sparking is diminished at heavy loads. A material advance has been made in efficiency at average loads, and in sparking, by greatly increasing the magnetisation of the armature core proper.

It may be fairly said that all efforts to improve commutation have been, first, to increase magnetisation, so that distortion is diminished; and secondly, to diminish the inductance of the armature coils by employing open and wider slots. Machines have been constructed of 300 and 400 horse-power capacity, capable of being reversed in either direction without much sparking. That the commutation is never so perfect as in the case of machines where the reversing field can be utilised, is shown by the gradual roughening of the commutator, which requires more attention than in the case of generators or other non-reversible machines. The remarkable progress that has been made in the design of this class of machinery will be apparent by comparing the drawings and constants of well-known types of machines, with those of machines constructed but a few years ago.

DESCRIPTION OF A GEARED RAILWAY MOTOR FOR A RATED DRAWBAR PULL
OF 800 LB. AT A SPEED OF 11.4 MILES PER HOUR.

This motor has been in extensive use for some years, hence it does not represent the latest developments, except in so far as modifications have been introduced from time to time. The fundamental design, however, is not in accordance with the best examples of recent practice. On account of its established reputation for reliability, it is still, however, built in large numbers. Its constants are set forth below, in specification form, and in Figs. 239 to 254, pages 234, 236, and 240, are given drawings of the motor.

SPECIFICATION.

Number of poles	4
Rated drawbar pull	800 lb.

Under standard conditions at this rating, the field windings are

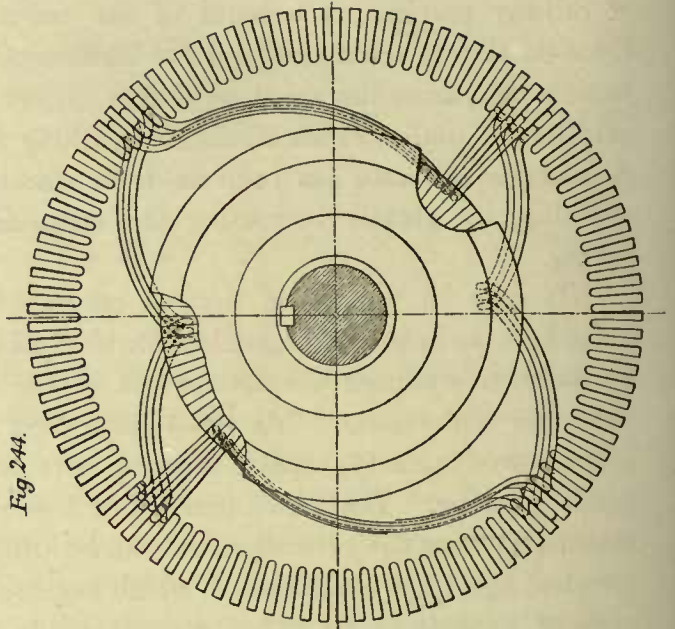
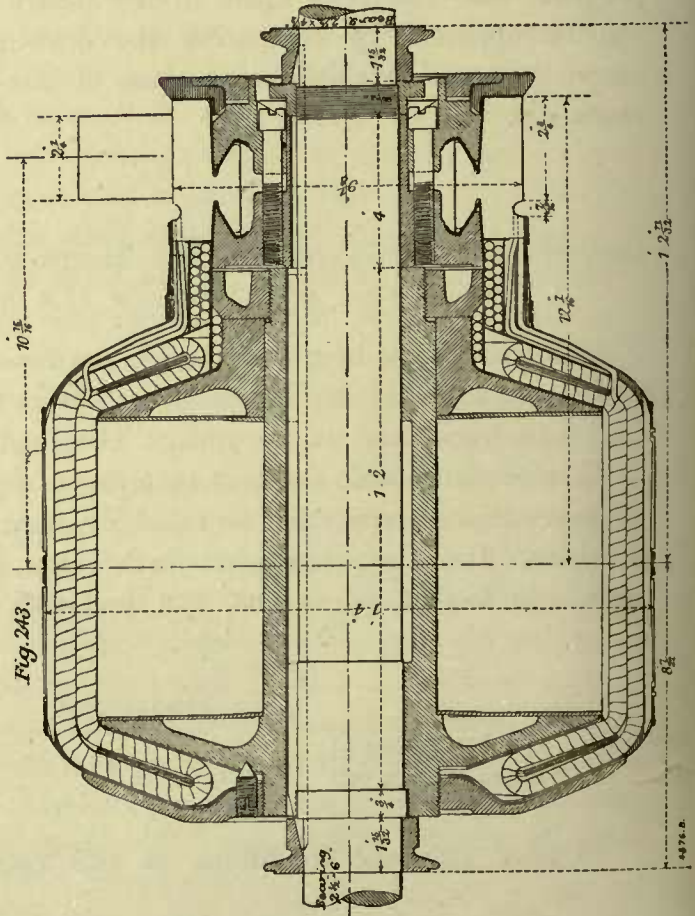
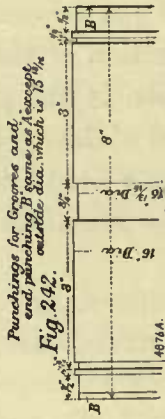
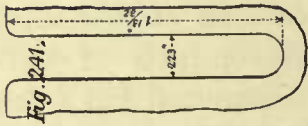
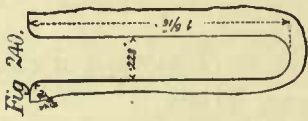
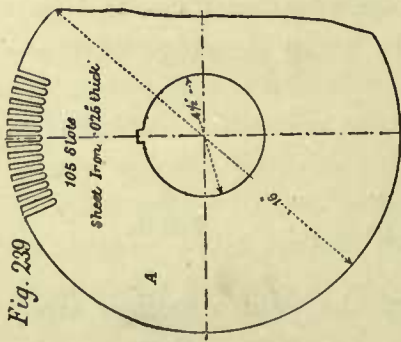

connected in parallel with an external shunt which diverts from the field winding, 30 per cent. of the total current.

Revolutions of armature per minute at this rating	555
Number of teeth on armature pinion	14
" " axle gear	67
Ratio of gear reduction	4.78
Revolutions of axle per minute	116
Speed of car in feet per minute on 33-in. wheels	1000
" miles per hour	11.4
Foot-pounds per minute, output for above drawbar pull and speed	800,000
Horse-power output for above drawbar pull and speed	24.2
Kilowatts output for above drawbar pull and speed	18.1
Efficiency of above rating, motor warm	79.5 per cent.
Corresponding kilowatts input	22.8
" amperes	45.5
Terminal voltage	500
Frequency in cycles per second at rated conditions	18.5

DIMENSIONS.

Armature :

Diameter over all	16 in.
" at bottom of slots	13.2 "
Internal diameter of core	4½ "
Length of core over all	8 "
Effective length, magnetic iron	7.2 "
Pitch at armature surface	12.6 "
Japan insulation between laminations	10 per cent.
Thickness of laminations025 in.
Depth of slot	1.40 "
Width of slot at root, die punch240 "
" " surface, die punch240 "
Number of slots	105
Minimum width of tooth164 in.
Width of tooth at armature face239 "
Size of armature conductor, B. and S. gauge	No. 9
Bare diameter of armature conductor114 in.
Cross-section0102 square inch

Magnet Core :

Length of pole face	8 in.
" arc	8.25 "
Pole arc ÷ pitch655 "
Length of magnet core	8 in.
Width	7.75 "
Diameter of bore of field	16 ⁹ / ₃₂ "
Length of gap clearance above armature	¹ / ₈ "
" " below	⁵ / ₃₂ "

Brushes:

Number of sets	2
„ brushes in one set	1
Length, radial	2 $\frac{3}{8}$ in.
Width	2 $\frac{1}{4}$ „
Thickness5 „
Area of contact of one brush	1.125 square inches
Type of brush	radial carbon

TECHNICAL DATA.

Terminal voltage	500
Number of face conductors	840
Conductors per slot	8
„ coil	4
Number of circuits	2
Style of winding	Single
Gramme ring or drum	Drum
Type of construction of winding... ..	Formed coil winding.
Number of coils	105
Mean length of one armature turn	43 in.
Total armature turns	420
Turns in series between brushes... ..	210
Length between brushes	9000 in.
Cross-section of one armature conductor0102 square inch
Ohms per cubic inch at 20 deg. cent.00000068 ohms.
Resistance between brushes at 20 deg. Cent.305 „
„ „ 95 „394 „
Volts of drop in armature at 95 „	18
Mean length of one field turn	46.5 in.
Field conductor, B. and S. gauge	No. 6
Bare diameter162 in.
Cross-section of field conductor0205 square inch
Turns per field spool	203
Number of field spools	2
Total field turns in series	406
„ length of spool copper	18.800 in.
„ resistance of spool winding at 20 deg. Cent.625 ohm.
„ „ „ 95 „81 „
Thirty per cent. of the main current of 45.5 amperes is diverted from the field winding by a suitable shunt resistance, hence current in field winding is	32 amperes
Volts drop in field winding at 95 deg. Cent.	26 volts
Resistance brush contacts (positive <i>plus</i> negative)055 ohm
Volts drop in brush contacts	2.5 volts
„ armature, field, and brushes	46.5 „
Counter electromotive force of motor	453.5 „
Amperes per square inch in armature winding... ..	2230
„ „ field	1560

Commutation :

Average voltage between commutator segments	18
Armature turns per pole...	105
Amperes per turn	22.8
Armature ampere turns per pole	2400
Frequency of commutation (cycles per second)	250
Number of coils simultaneously short-circuited per brush	3
Turns per coil	4
Number of conductors per group simultaneously undergoing commutation	24
Flux per ampere turn per inch length of armature lamination	20
Flux linked with 24 turns with one ampere in those turns	3840
= $20 \times 8 \times 24 =$	
Inductance of four turns = $4 \times 3840 \times 10^{-8} =$000154 henrys

But in a two-circuit winding with four poles and only two sets of brushes, there are two such four-turn coils in series, being commutated under one brush, and their inductance is = $2 \times .000154 = .000308$ henrys.

Reactance of these two short-circuited coils484 ohm
Amperes in short-circuited coils	22.8
Reactance voltage of short-circuited coils	11 volts

MAGNETOMOTIVE FORCE.

Megalines entering armature, per pole-piece	2.92
Coefficient of magnetic leakage	1.25
Megalines per field-pole	3.65

Armature :

Section	62.8 square inches
Density	46.5 kilols.
Length (magnetic path)	4 in.
Ampere turns per inch of length	8
„ for armature core	30

Teeth :

Transmitting flux from one pole-piece	19
Section at roots	22.5 square inches
Length	1.4 in.
Apparent density at root tooth	130 kilols.
Corrected „ „	125 „
Ampere turns per inch of length	700
„ for teeth	980

Gap :

Section at pole face	66 square inches
Length, average of top and bottom14 in.
Density at pole face	44 kilols.
Ampere turns for gap	1920

Cast-Steel Portion of Circuit :

Average cross-section	52 square inches
Length, magnetic	9 in.
Average density	70 kilols.
Ampere turns per inch of length	35
„ for cast-steel frame, per pole-piece	320

Only two of the four poles carry exciting windings; hence of the 203 turns on one spool, only 101.5 are to be taken as corresponding to one pole-piece. Thirty per cent. of the main current being diverted from the fields, the field exciting current is 32 amperes, and field ampere turns per pole-piece are $32 \times 101.5 = 3250$ ampere turns. These are probably distributed somewhat as follows :

Ampere turns for armature core	30
„ „ teeth	980
„ „ gap	1920
„ „ frame	320
Total ampere turns per pole-piece					3250

THERMAL CONSTANTS.

Armature :

Resistance between brushes at 95 deg. Cent.394 ohm
Amperes input at rated capacity	45.5 amperes
Armature C ² R loss at 95 deg. Cent.	815 watts
Total weight of armature laminations, including teeth	314 lb.
„ observed core loss (only apparently core loss)	800 watts
Watts per pound in armature laminations	2.55 „
Total of armature losses	1615 „
Length of armature (over conductors)	12 in.
Peripheral radiating surface of armature	600 square inches
Watts per square inch peripheral radiating surface	2.7 watts

Field Spools :

Total resistance of the two field spools at 95 deg. Cent.81 ohm
Amperes in spool winding	32 amperes
Spool C ² R loss at 95 deg. Cent.	830 watts

Commutator :

Area of bearing surface of positive brush	1.13 square inches
Amperes per square inch of brush-bearing surface	40 amperes
Ohms per square inch of bearing surface of carbon brushes03 ohm
Brush resistance, positive + negative053 „
Volts drop at brush contacts	2.4 volts
C ² R at brush contacts	110 watts
Brush pressure per square inch	2 lb.
Total brush pressure	4.5 „

Fig 252.

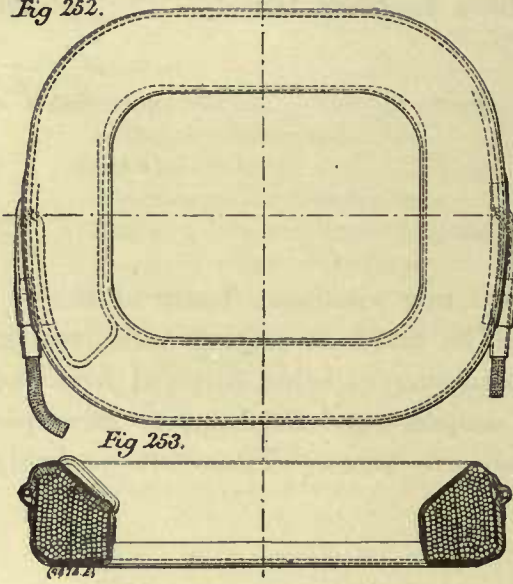

Fig 253.

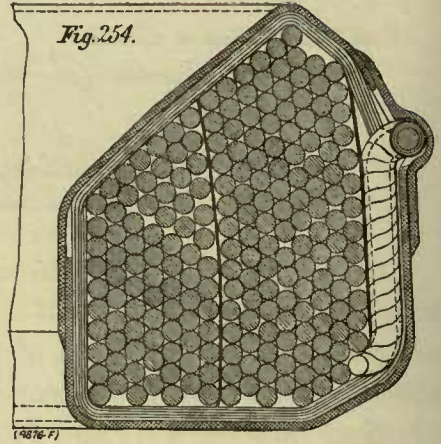
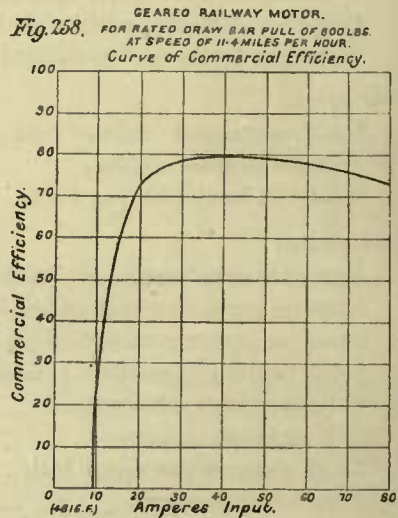
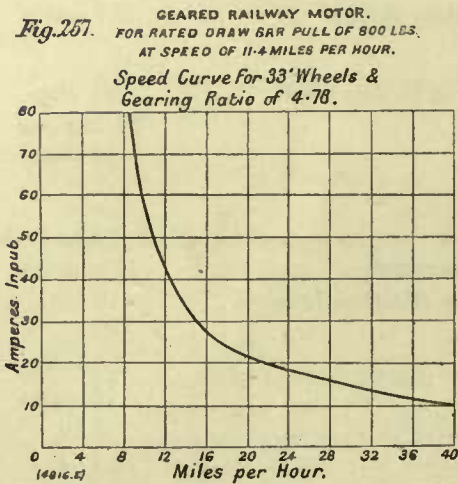
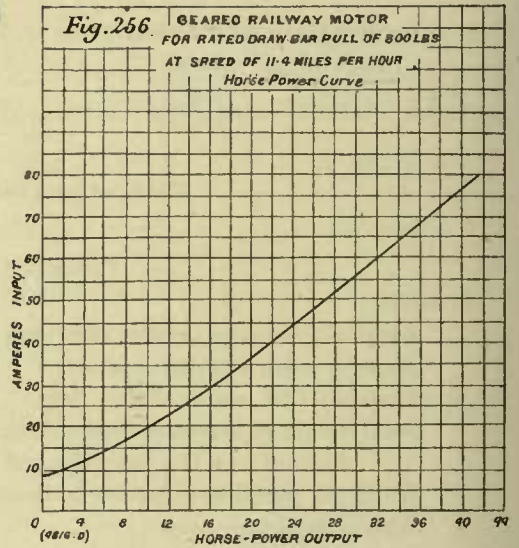
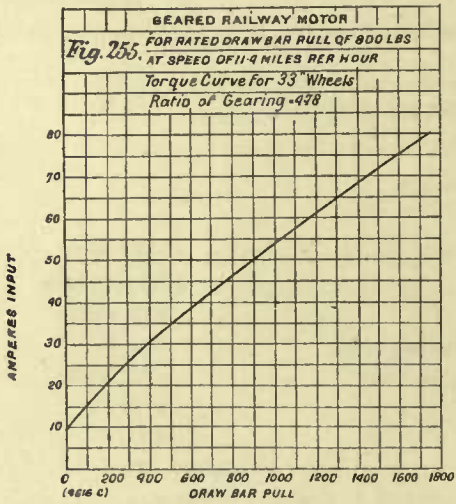

Fig.254.



Coefficient of friction3
Peripheral speed of commutator, feet per minute	1240 ft.
Brush friction	36 watts
Stray power lost in commutator (allowance)	50 "
Total commutator loss	198 "
Peripheral radiating surface	100 square inches
Watts per square inch radiating surface of commutator	2 watts

EFFICIENCY CALCULATIONS.

	Watts.
Output at rated capacity	18,100
Core loss	800
Commutator and brush loss	198
Armature C ² R loss at 95 deg. Cent.	815
Field spool C ² R	830
Gearing friction	2,000
<hr/>	
Total input	22,743

Commercial efficiency at rated capacity and 95 deg. Cent. = 79.5 per cent.¹

WEIGHTS.

	lb.
Armature core (magnetic)	250
" teeth	67
" copper	60
Commutator bars	45
Armature complete	635
Magnet pole	520
Spool copper	129
Machine complete	1525

In Figs. 255, 256, 257, and 258 are given respectively curves of draw-bar pull, output, speed, and efficiency for this motor.

In many of the more modern street-railway motors, the design has followed lines differing in many respects from those of the motor just described. Thus several armature coils are arranged in one slot, largely reducing the number of slots, and the pole-faces are laminated, since otherwise these few wide slots would set up too great an eddy current loss in the pole-face. It has been found preferable to have one field spool per pole-piece, instead of having two salient and two consequent poles. The armature diameter has been largely reduced, and sparking is minimised by running not only the teeth, but also the core, up to extremely high magnetic density; nevertheless, owing to the greatly reduced mass of the

¹ In this result, the loss in the diverting shunt to the field spool winding is not allowed for.

armature iron, the core loss is small. A motor designed on these lines, and of not very different capacity from the one just described, will next be described.

GEARED RAILWAY MOTOR FOR A RATED OUTPUT OF 27 HORSE-POWER AT AN ARMATURE SPEED OF 640 REVOLUTIONS PER MINUTE.

The rating of this motor is in accordance with the now generally accepted standard practice of limiting the temperature rise of field and

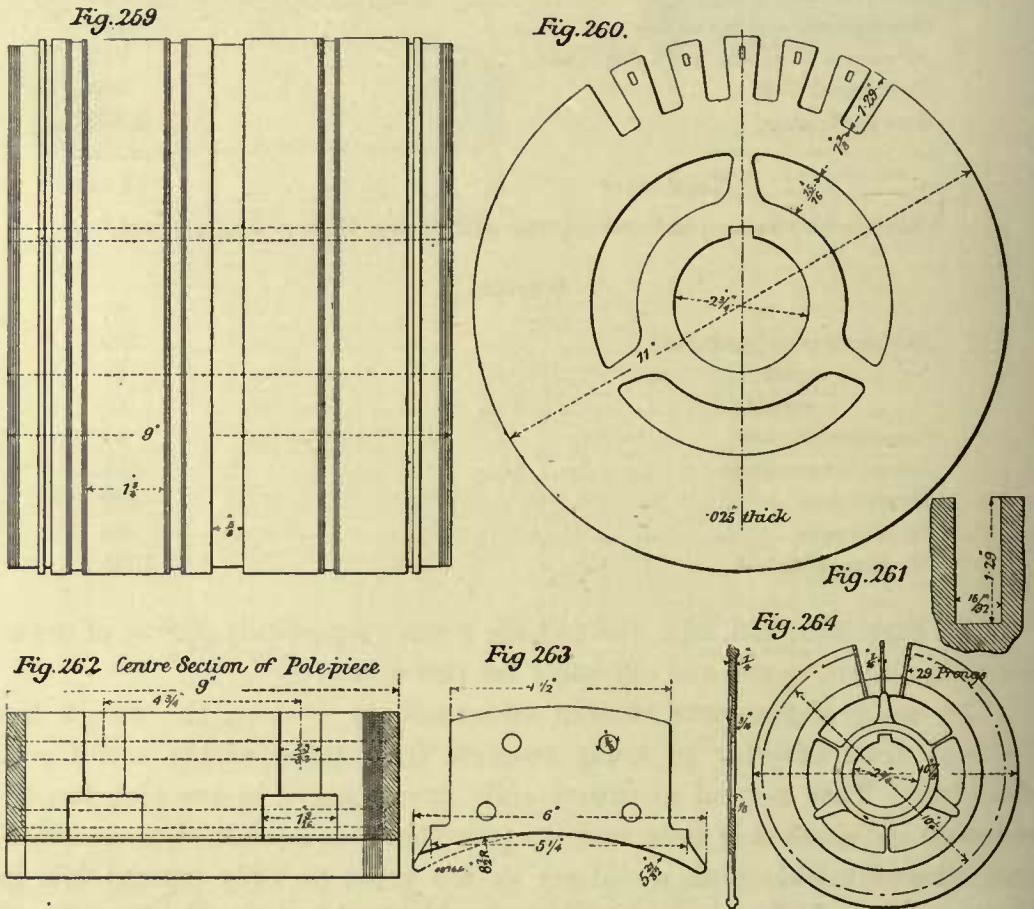

armature to 75 deg. Cent., as measured by thermometer after a full-load run of one hour's duration. The motor is illustrated in Figs. 259 to 277 inclusive.

Applying this same standard permissible temperature rise to runs of different durations, the following Table gives the corresponding ratings at 500 terminal volts :

Length of Run.	Hours.	Amperes.	Horse-Power.
$\frac{1}{2}$...	75	38.2
1	...	51	27
$1\frac{1}{2}$...	39.5	21.3
2	...	32.5	17.5
3	...	23.5	12.5
4	...	17	8.6
5	...	14.5	6.9
6	...	14	6.6

Fig. 265

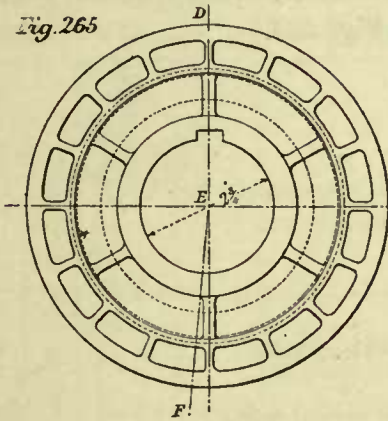

Fig. 266 Section D.E.F.

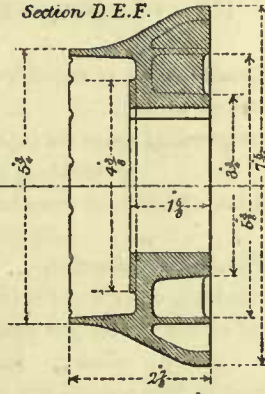

Fig. 267.

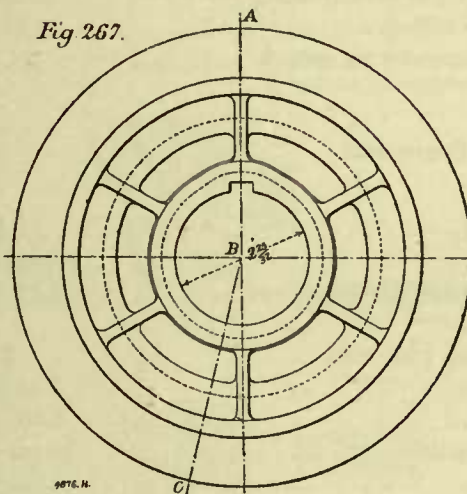
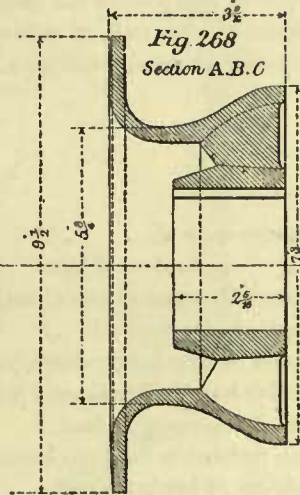

Fig. 268 Section A.B.C



9876. H.

The following specification is prepared on the basis of the rating of 27 horse-power for one hour's continuous operation at full load. In tramway service, of course, the motor is on the average called upon to develop but a small percentage of its full capacity; and hence such a motor, when continuously in service under normal conditions, runs much cooler than the above-quoted temperatures.

SPECIFICATION.

Number of poles	4
Rated horse-power output	27
„ kilowatts	20.2
Efficiency at above rating and at 95 deg Cent... ..	79 per cent.

The efficiency is a little higher at lighter loads, and is at its maximum at about two-thirds full-rated load, so that it is high throughout the entire range of working, that is, from quarter load to heavy overloads. (See efficiency curve in Fig. 282.)

Kilowatts input at rated load	25.6
Terminal voltage	500
Corresponding amperes input	51
„ revolutions per minute of armature	640
Number of teeth on armature pinion	14
„ „ axle gear	67
Ratio of gear reduction	4.78
Revolutions of axle per minute	134
Speed of car in feet per minute, on 33-in. wheels	1160
„ miles „ hour „	13.1
Output in foot-pounds per minute, at normal rating	890,000
Pounds drawbar pull, at normal rating... ..	770
Frequency at rated conditions in cycles per second	21.4

DIMENSIONS.

Armature :

Diameter over all... ..	11 in.
„ at bottom of slots	8.42 „
Internal diameter of useful magnetic portion of core	6.17 „
Length of core over all	9 „
Number of ventilating ducts, each $\frac{1}{4}$ in. wide	3
Effective length of magnetic iron	7.42 in.
Pitch at armature surface	8.65 „
Japan insulation between laminations	10 per cent.
Thickness of laminations... ..	.025 in.
Depth of slot	1.29 „
Width of slot at root	$\frac{15}{32}$ „
„ at surface	$\frac{15}{32}$ „
Number of slots	29
Minimum width of tooth... ..	.445 in.
Width of tooth at armature face724 „
Size of armature conductor, B. and S. gauge	No. 10
Bare diameter of armature conductors102 in.
Cross-section „ „0081 square inches

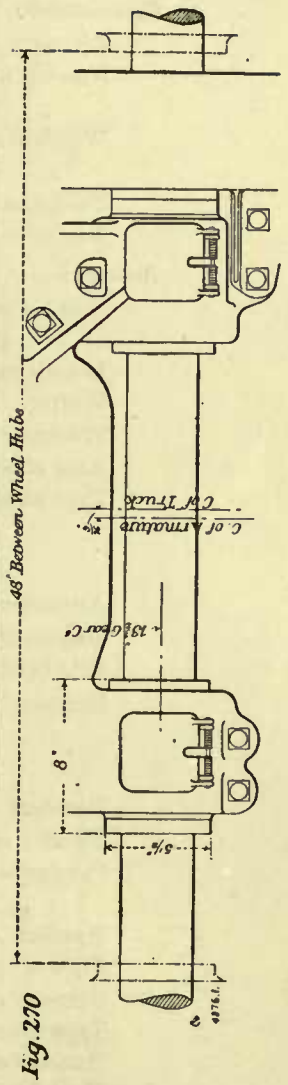
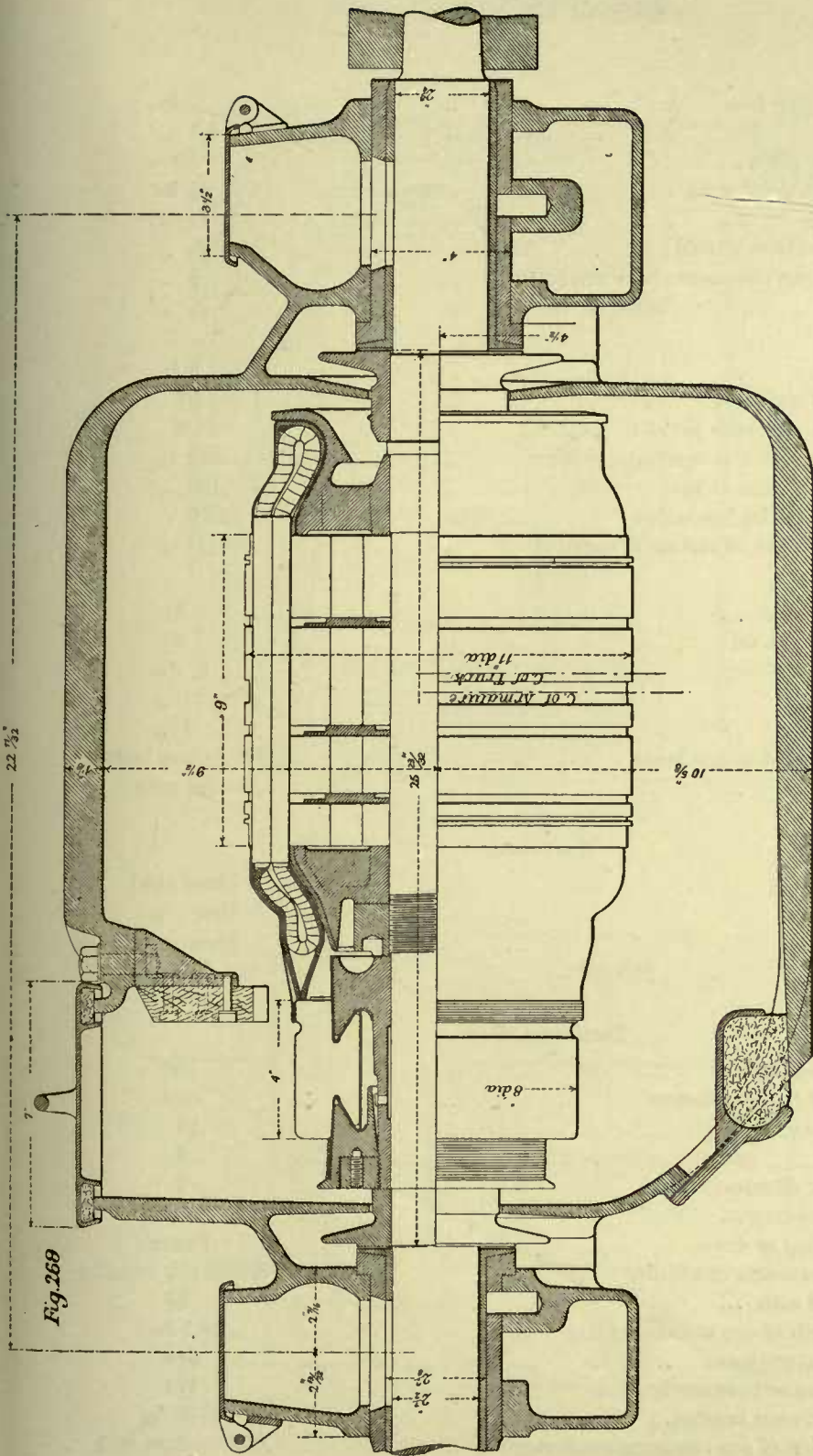
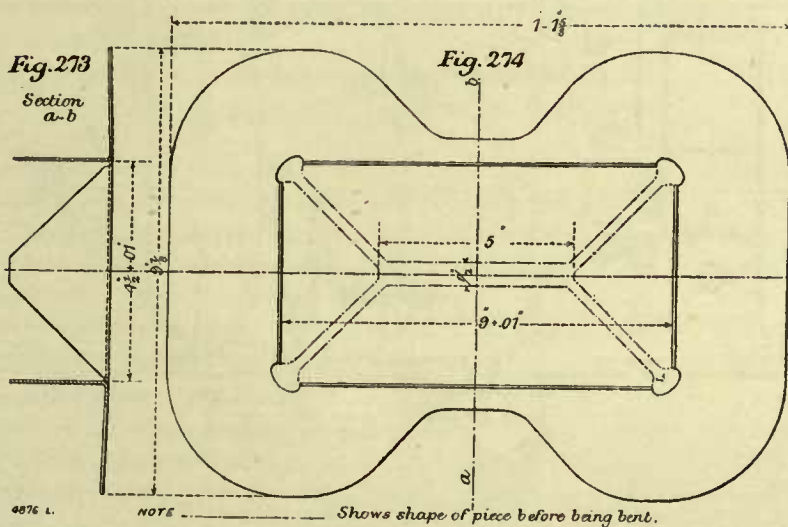
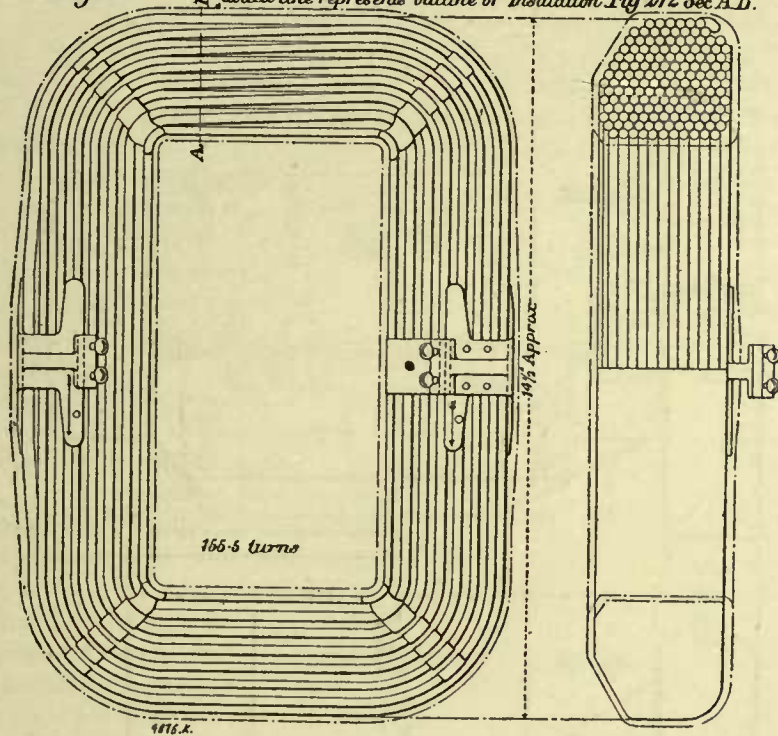
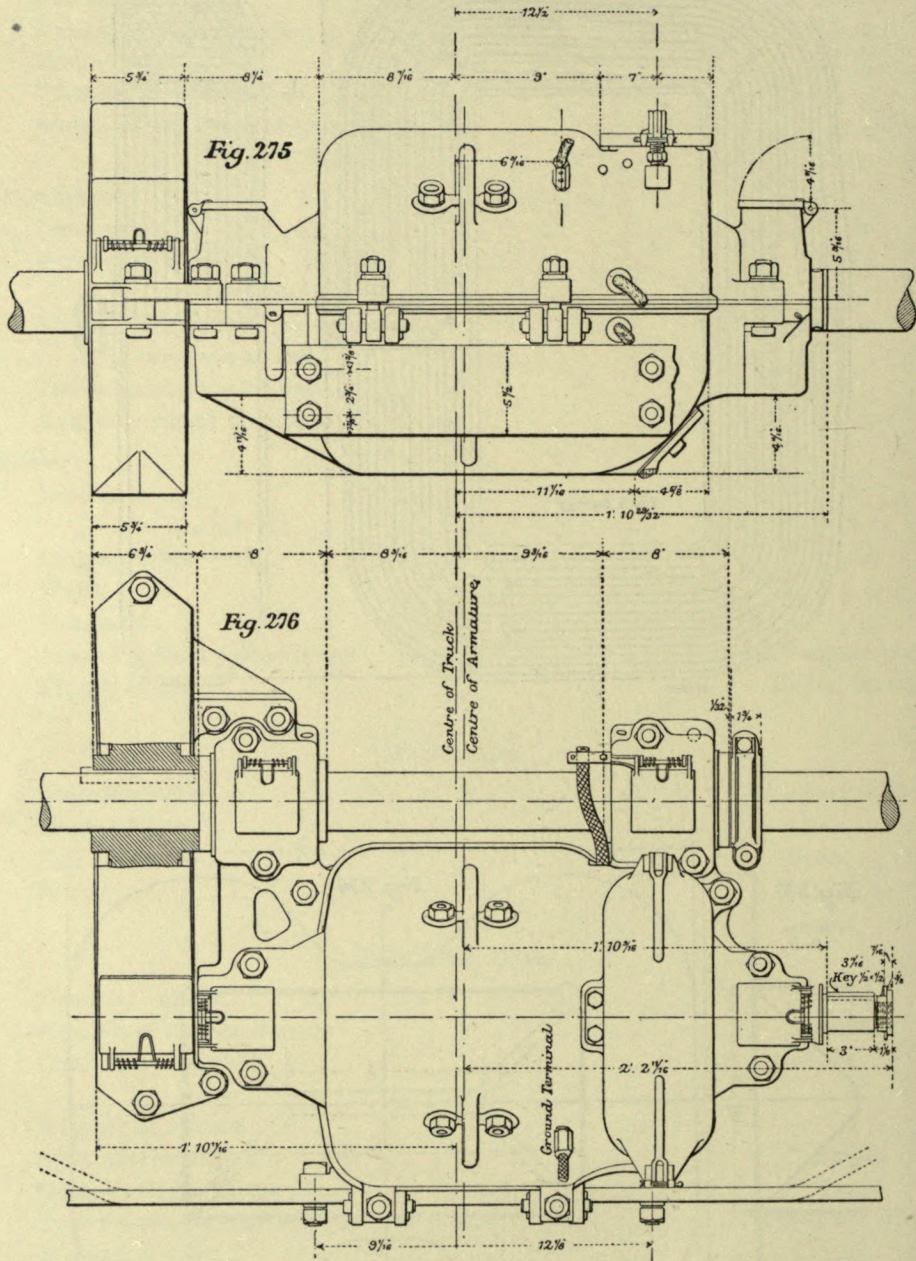

Fig. 271 *dotted line represents outline of Insulation. Fig. 272 Sec. A.B.*





Ohms per cubic inch at 20 deg. Cent.00000068
Resistance between brushes at 20 deg. Cent.28 ohm
" " " 95 " 36 "
Volts drop in armature at 95 deg. Cent.	18.3 volts
Mean length of one field turn	36 in.
Size of field conductor, B. and S. gauge	No. 5
Bare diameter182 in.
Cross-section of field conductor026 square inch
Turns per field spool	156.5
Number of field spools	4
Total field turns in series	626
" length of spool copper	22,000 in.
" resistance spool winding at 20 deg. Cent.59 ohm
" " " 95 " 76 "
Volts drop in field winding at 95 deg. Cent.	38.6 volts
Resistance brush contacts (positive + negative)048 ohm
Volts drop in brush contacts	2.4 volts
" " armature, field, and brushes	59.3 "
Counter electromotive force of motor	441
Amperes per square inch in armature winding	3130
" " " field " 	1920
<i>Commutation :</i>	
Average voltage between commutator segments	21
Armature turns per pole	87
Amperes per turn	25.5
Armature ampere turns per pole	2200
Frequency of commutation, cycles per second	270
Number of coils simultaneously short-circuited, per brush	2
Turns per coil	4
Number of conductors per group, simultaneously undergoing commutation	16
Flux per ampere turn per inch-length of armature lamination	20 lines
" linked with 16 turns with 1 ampere in those turns, = $20 \times 9 \times 16$	2880 "
Inductance of four turns = $4 \times 2880 \times 10^{-8}$000115 henrys
In a four-pole, two-circuit winding, and with only two sets of brushes, there are two such four-turn coils in series, being commutated under the brush, and their inductance is000230 henrys
Reactance of these two short-circuited coils39 ohm
Amperes in short-circuited coils... ..	25.5 amperes
Reactance voltage of short-circuited coils	9.9 volts
<i>Magnetomotive Force Estimations :</i>	
Megalines entering armature, per pole piece	2.96
Coefficient of magnetic leakage	1.25
Megalines per field pole	3.70
<i>Armature :</i>	
Section	16.7 square inches
Density	177 kilols.
	2 K

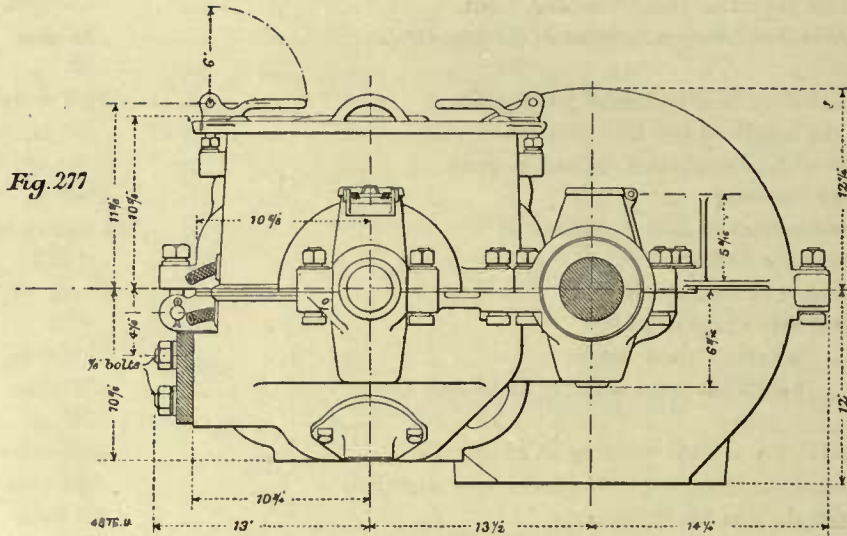

Fig. 277

Fig. 278
GEARED RAILWAY MOTOR.
FOR A RATED OUTPUT OF 27 H.P. AT
AN ARMATURE SPEED OF 640 R.P.M.
Torque Curve for 33" Wheels and
Gear Ratio of 4.78.

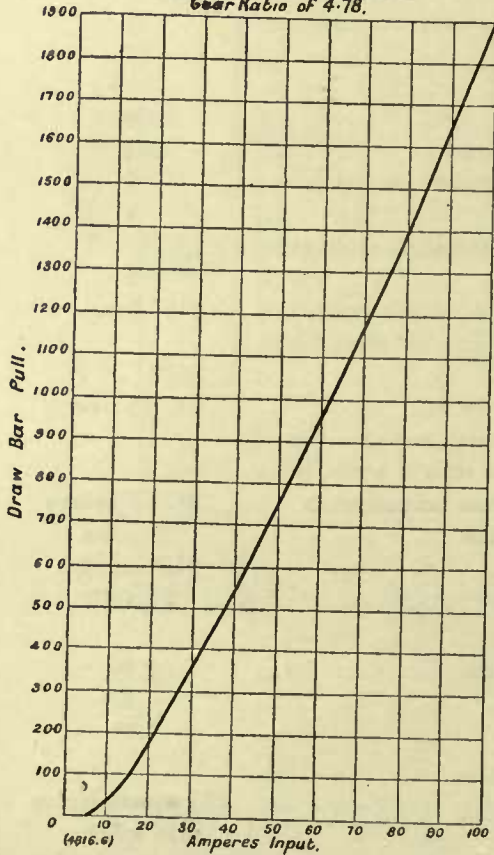
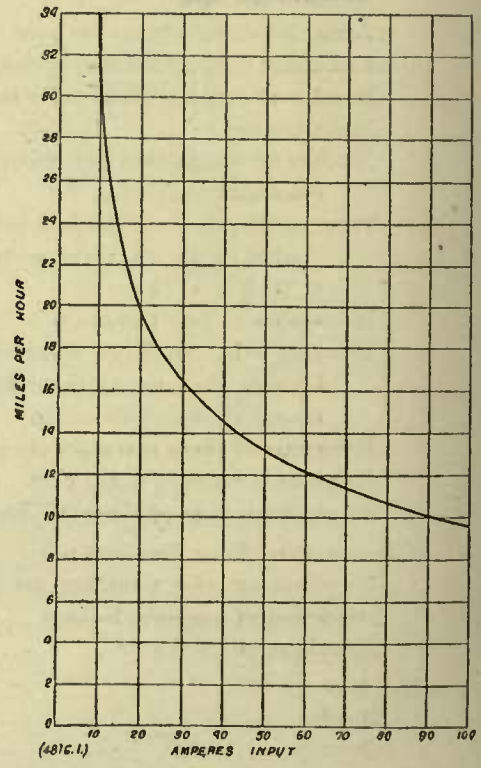

Fig. 279
GEARED RAILWAY MOTOR.
FOR A RATED OUTPUT OF 27 H.P. AT
AN ARMATURE SPEED OF 640 R.P.M.
Speed Curve for 33" Wheels
& Gear Ratio of 4.78.



But, as is evident from the drawing of Fig. 260, many lines will flow through the inner parts of the punchings, and also, to a certain extent, through the shaft, and a corrected density may be taken of, say, 130 kilolines.

Fig. 280 GEARED RAILWAY MOTOR
FOR A RATED OUTPUT OF 27 H.P. AT AN
ARMATURE SPEED OF 640 R.P.M.
Horse Power Curve

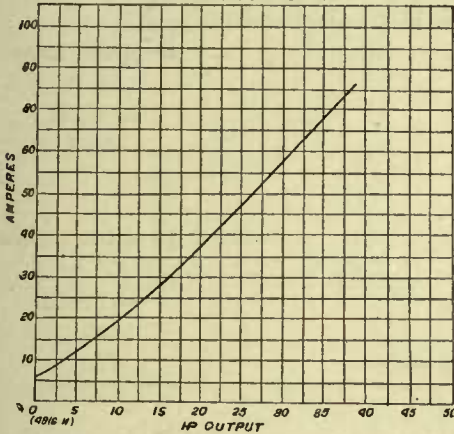

Fig. 281 GEARED RAILWAY MOTOR.
FOR A RATED OUTPUT OF 27 H.P. AT
AN ARMATURE SPEED OF 640 R.P.M.
Core Loss Curve.

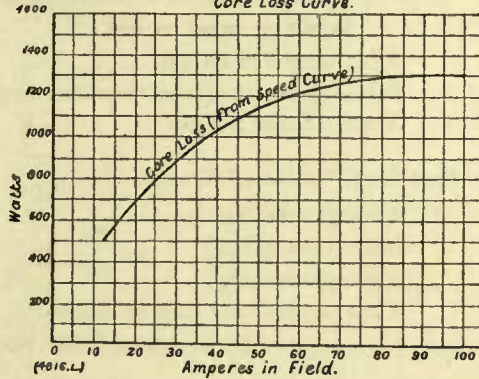

Fig. 282 GEARED RAILWAY MOTOR.
FOR A RATED OUTPUT OF 27 H.P. AT
AN ARMATURE SPEED OF 640 R.P.M.
Curve of Commercial Efficiency.

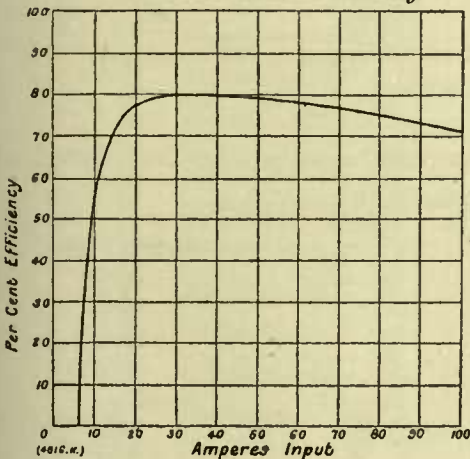
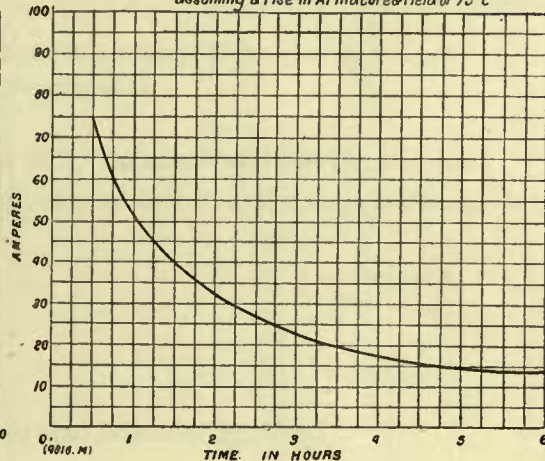

Fig. 283 GEARED RAILWAY MOTOR
FOR A RATED OUTPUT OF 27 H.P. AT AN
ARMATURE SPEED OF 640 R.P.M.
Thermal Characteristic Curve
assuming a rise in Armature & Field of 75°C



Length (magnetic)	3 in.
Ampere turns per inch of length	900
,, for armature core	2700

Teeth :

Transmitting flux from one pole-piece	6
Section at root of six teeth	20 square inches
Length	1.29 in.

Apparent density in root tooth	148
Corrected ,, ,,	138
Ampere turns per inch of length	1300
,, for teeth	1680

Gap :

Section at pole-face	55 square inches
But owing to the special method of constructing the pole-face (see Figs. 262 and 263), whereby the entire surface is not equally effective, a corrected section at pole-face should be taken, equal to, say	45 square inches
Mean length of air gap14 in.
Pole-face density (from corrected section)	66 kilols.
Ampere turns for gap	2900

Cast Steel Portion of Circuit :

Average cross-section	39 square inches
Length (magnetic)	7.5 in.
Average density	96 kilols.
Ampere turns per inch of length	90
,, for cast-steel frame per pole piece	670

Each spool carries 156.6 turns, and in this motor full field is always used, *i.e.*, no portion of the main current is diverted through an auxiliary shunt. Hence

Ampere turns per field spool at full rated load are equal to $156.5 \times 51 = 7950$ ampere turns.

This magnetomotive force of 7,950 ampere turns can be considered to be distributed somewhat in the following manner :

	Ampere Turns.
Armature core	2700
Teeth	1680
Gap	2900
Steel Frame	670
	<hr/>
Total magnetomotive force per pole-piece	7950

It is not intended to convey the impression that any high degree of accuracy is obtainable, in these magnetomotive force estimations in railway motors ; but working from the observed results, and from the known dimensions of the apparatus, and the assumed properties of the material employed, some rough idea of the distribution of the magnetomotive force is obtained.

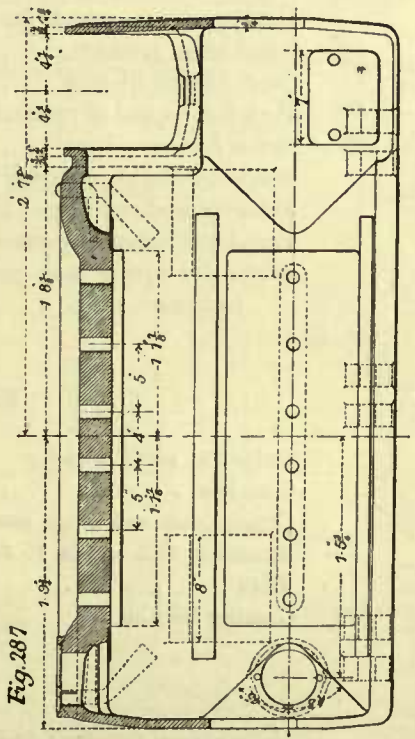
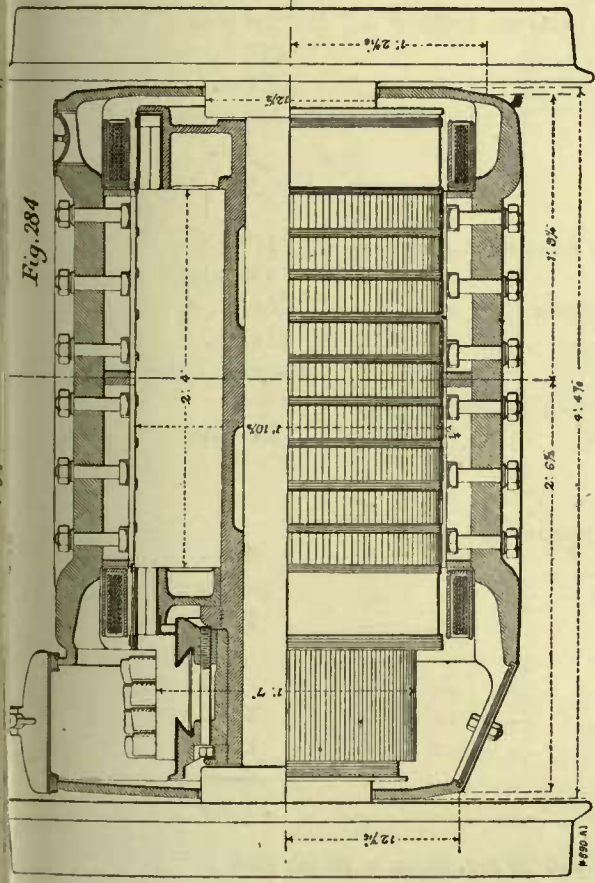
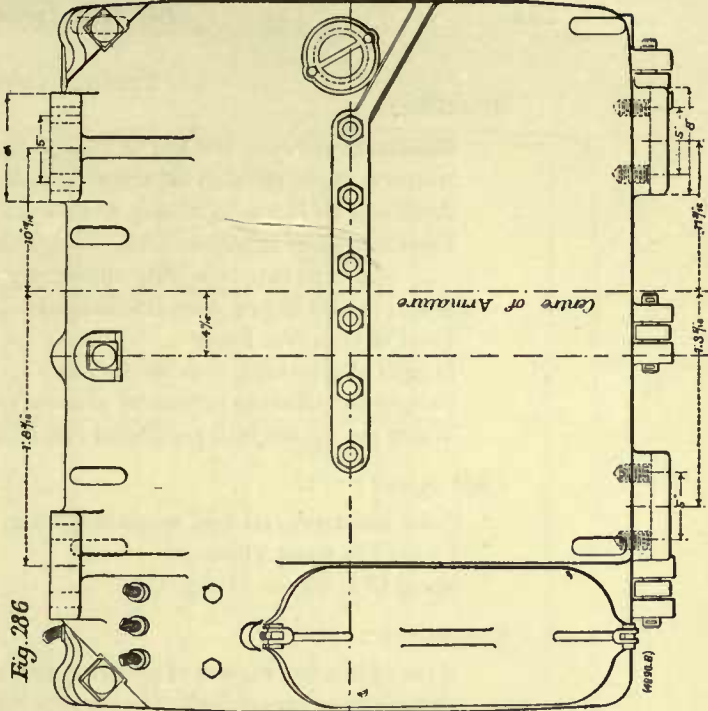
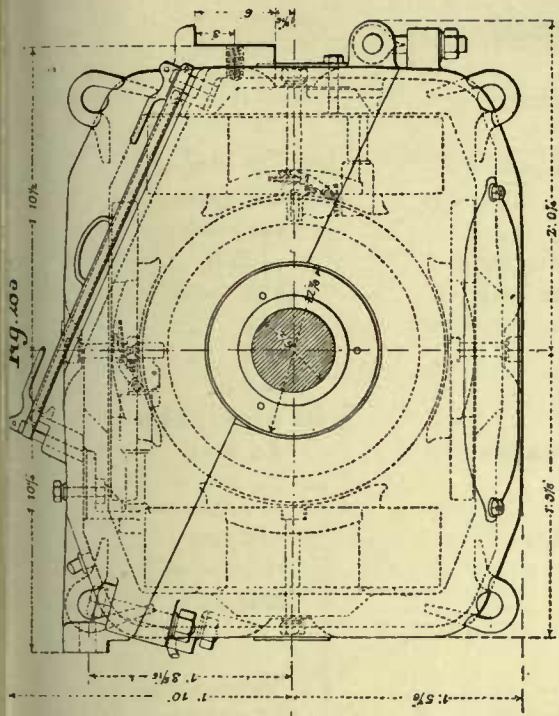

THERMAL CONSTANTS.

Armature :

Resistance between brushes at 95 deg. Cent.36 ohm
Amperes input at rated capacity	51 amperes
Armature C ² R loss at 95 deg. Cent.	925 watts
Total weight of armature laminations including teeth ...	120 lb.
„ observed core loss (only apparently core loss)	1120 watts
Watts per lb. in armature laminations	9.3 „
Total of armature losses	2045 „
Length of armature, over conductors	13.5 in.
Peripheral radiating surface of armature	465 square inches
Watts per square inch peripheral radiating surface	4.4 watts

Field Spools :

Total resistance, all field spools at 95 deg. Cent.76 ohm
Current in spool winding	51 amperes
Spool C ² R loss at 95 deg. Cent.	2000 watts

Commutator :

Area of bearing surface of positive brushes	1.25 square inches
Amperes per square inch of brush-bearing surface	40.5 amperes
Ohms per square inch of bearing surface of carbon brushes03 ohm
Brush resistance, positive + negative048 „
Volts drop at brush contacts	2.4 volts
C ² R at brush contacts (watts)	122 watts
Brush pressure, pounds per square inch	2 lb.
Total brush pressure	5 „
Coefficient of friction3
Peripheral speed of commutator (feet per minute)	1850 ft.
Brush friction	46 watts
Allowance for stray power lost in commutator	50 „
Total commutator loss	216 „
Peripheral radiation surface	95 square inches
Watts per square inch peripheral radiating surface of commutator	2.3 watts

EFFICIENCY ESTIMATIONS.

	Watts.
Output at rated capacity	20,200
Core loss	1,120
Commutator and brush loss	218
Armature C ² R loss at 95 deg. Cent.	925
Field „ „ „	2,000
Gearing friction	1,200
	25,663
Total input	25,663

Commercial efficiency at rated capacity and 95 deg. Cent. = 79 per cent.

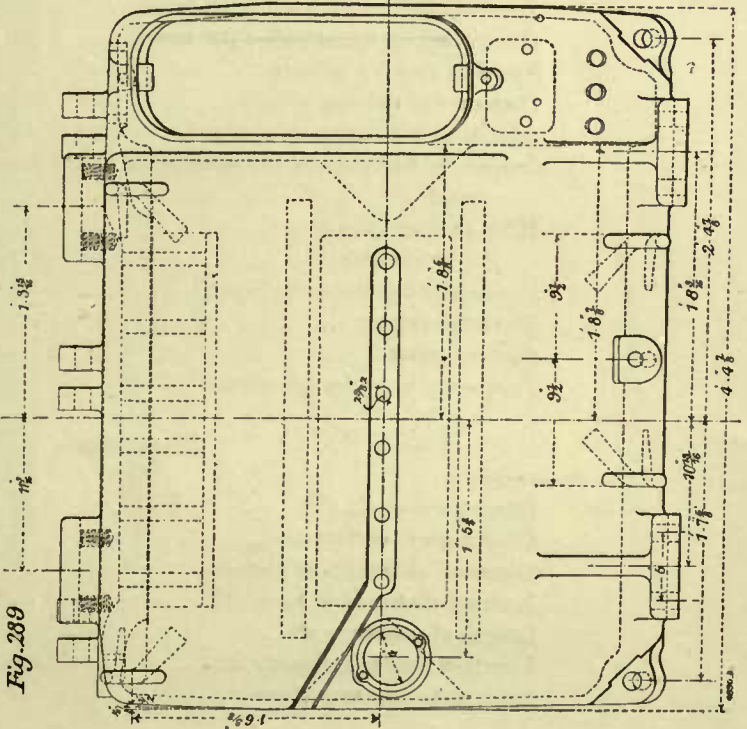
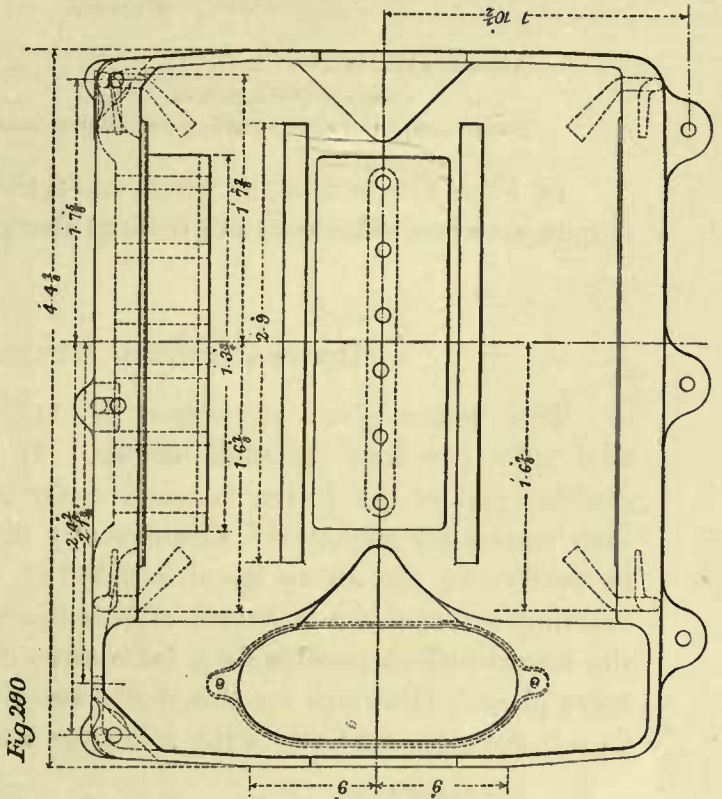
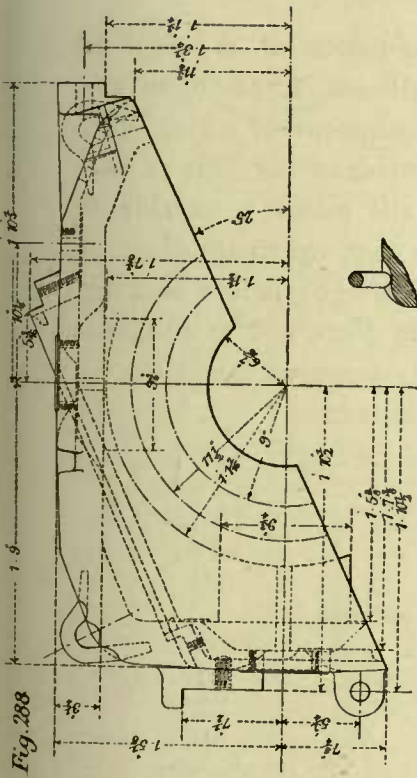

WEIGHTS.

Armature laminations	lb.
=	120
,, complete (with pinion)	= 357
Motor complete (without axle gear and gear case)	= 1460

In Figs. 278 to 283 are given, respectively, curves of D.P.B., speed, output, core loss, efficiency, and thermal characteristics.

DIRECT-CONNECTED RAILWAY MOTOR.

This motor gives an output of 117 horse-power at a speed of 23.8 miles per hour on 42-in. wheels. It contributes 1,840 lb. to the drawbar pull of the 35-ton locomotive, for the equipment of which, four such motors are employed. Consequently the total draw-bar pull of this locomotive at the above speed is 7,350 lb., but the motor is capable of exerting a torque far in excess of this figure; in fact, up to the limit of the tractive effort possible for a locomotive of this weight, before slipping takes place. Drawings for this motor are given in Figs. 284 to 319, and its constants are set forth in the following tabularly-arranged calculation :

Number of poles	4
Drawbar pull at 23.8 miles per hour	1840 lb.
Corresponding speed (miles per hour)	23.8 miles
Speed in feet per minute... ..	2100 ft.
Diameter of driving wheels	42 in.
Armature revolutions per minute	190
Output in foot-pounds per minute for above drawbar pull and speed... ..	3,860,000
Ditto in horse-power	117
,, kilowatts	87.5
Corresponding kilowatts input	95.8
Terminal voltage	500 volts
Current input	192 amperes
Frequency in cycles per second	6.35 cycles

DIMENSIONS.

Armature :

Diameter over all	22½ in.
Length over conductors	45¾ ,,
Diameter at bottom of slots	19.04 ,,
Internal diameter of core	9½ ,,
Length of core over all	28 ,,
Effective length, magnetic iron	25.2 ,,
Pitch at armature surface	17.7 ,,

Japan insulation between laminations	10 per cent.
Thickness of laminations025 in.
Depth of slot	1.73 "
Width ,, at root52 "
,, ,, surface52 "
Number of slots	61
Minimum width of tooth463 in.
Width of tooth at armature face635 "
,, conductor10 "
Depth ,,60 "
Apparent cross-section of armature conductor... ..	.060 square inches
This is a pressed stranded conductor, made up of 49 strands of No. 19 B. and S. gauge. The cross-section of a No. 19 gauge wire is .0101 square inch, hence the cross-section of the 49 strands is $49 \times .0101$	
	.0495 square inch

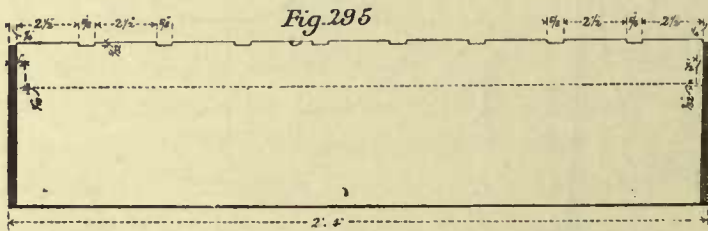

But allowance must also be made for the increased resistance due to the increased length of the individual strands when twisted in the process of forming. Hence the equivalent cross-section of solid copper should be estimated at046 square inches

This was the experimentally-determined value in this case, and is fairly representative of stranded conductors of about these dimensions.

Magnet Core :

Length of pole-face	28 in.
,, arc	13.2 "
Pole arc \div pitch	73 per cent.
Length of magnet core	28 in.
Width ,,	$9\frac{3}{4}$ "
Diameter of bore of field... ..	$23\frac{1}{8}$ "
Length of gap clearance above armature	$\frac{5}{16}$ "
,, ,, below ,,	$\frac{1}{4}$ "

Commutator :

Diameter	19 "
Number of segments	183
,, ,, per slot	3

Width of segment at commutator face286 in.
" " root200 "
Thickness of mica insulation04 "
Available length of surface of segment... ..	8 "

Brushes :

Number of sets	2
" in one set	4
Length (radial)	2½ in.
Width	1¾ "
Thickness	1/16 "
Area of contact of one brush	1.2 square inch
Type of brush	Radial carbon

MATERIALS.

Armature core	Sheet Steel
" spider	No. 3 metal
" flanges	Cast iron
" conductors	Pressed stranded copper
Commutator segments	Copper
" spider	Malleable cast iron
Pole-pieces	Sheet steel
Yoke and magnet cores	Cast "
Brushes	Carbon

TECHNICAL DATA.

Terminal voltage	500 volts
Number of face conductors	366
Conductors per slot	6
Number of circuits	2
Style winding	Single
Gramme ring or drum	Drum
Type construction of winding	Barrel wound
Mean length of one armature turn	103 in.
Total armature turns	183
Turns in series between brushes	91
Length between brushes... ..	9400 in.
Virtual cross-section of one armature conductor046 square inch
Ohms per cubic inch at 20 deg. Cent.00000068
Resistance between brushes at 20 deg. Cent.070 ohms
" " " 70 " 084 "
Volts drop in armature at 70 deg. Cent.	16 volts
Mean length of one field turn	95 in.

The winding on the small spools consists of fifteen turns, whose section is made up of two strips of .050 in. by .875 in., in multiple with

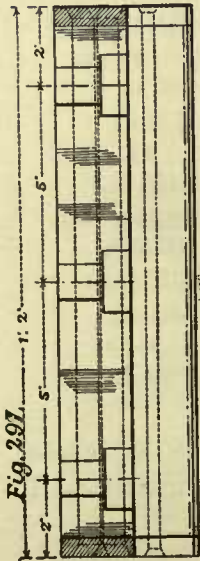

Fig. 291.



Fig. 298.

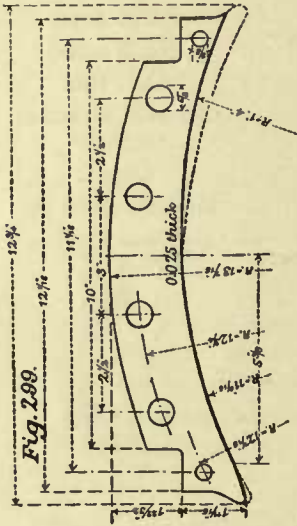

Fig. 299.

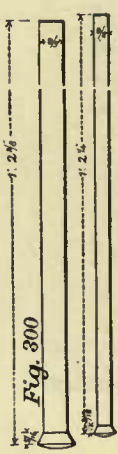

Fig. 300.

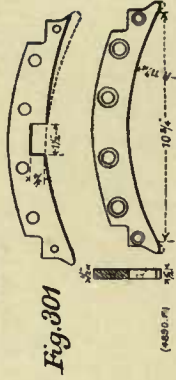

Fig. 301.

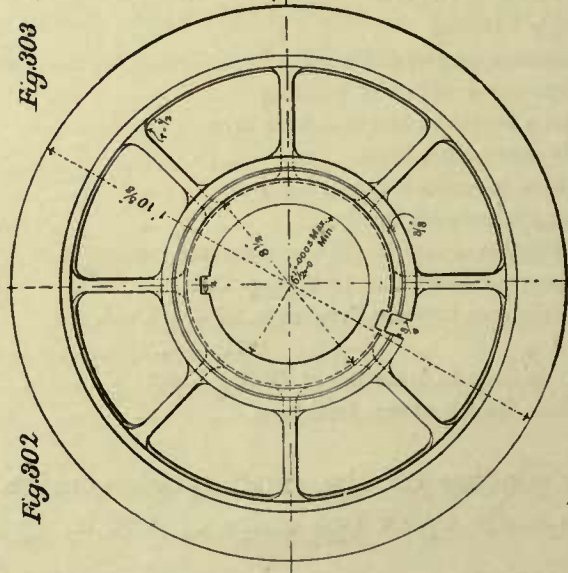

Fig. 302.

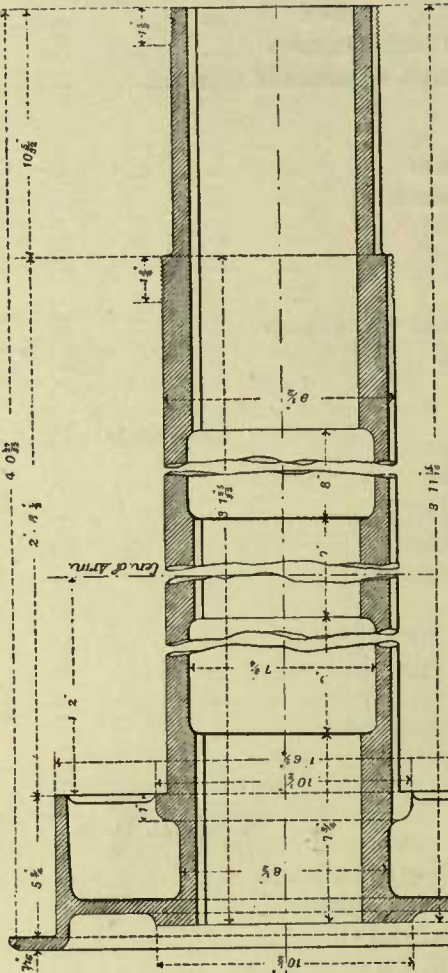

Fig. 303.

Fig. 305.

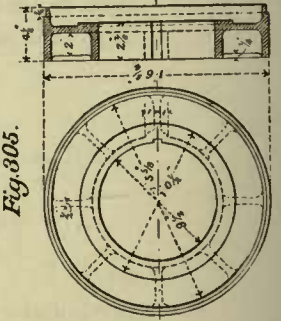

Fig. 304.

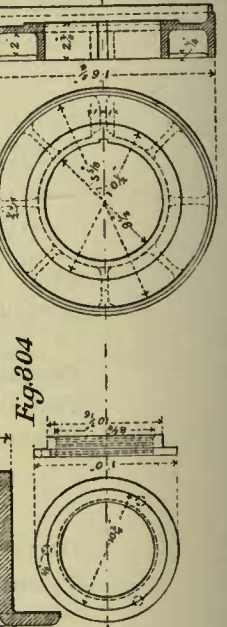
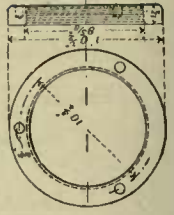
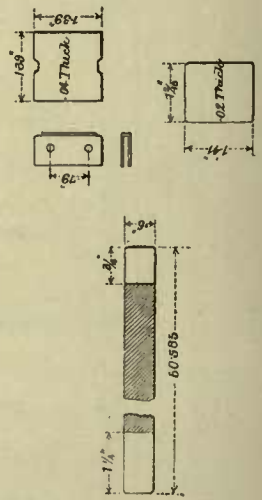
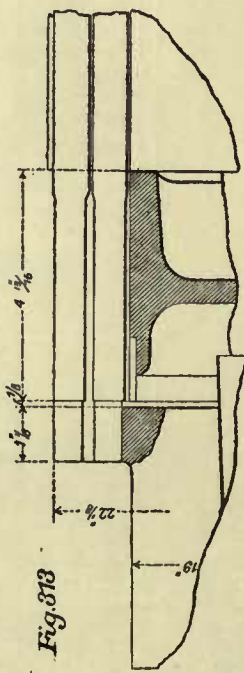
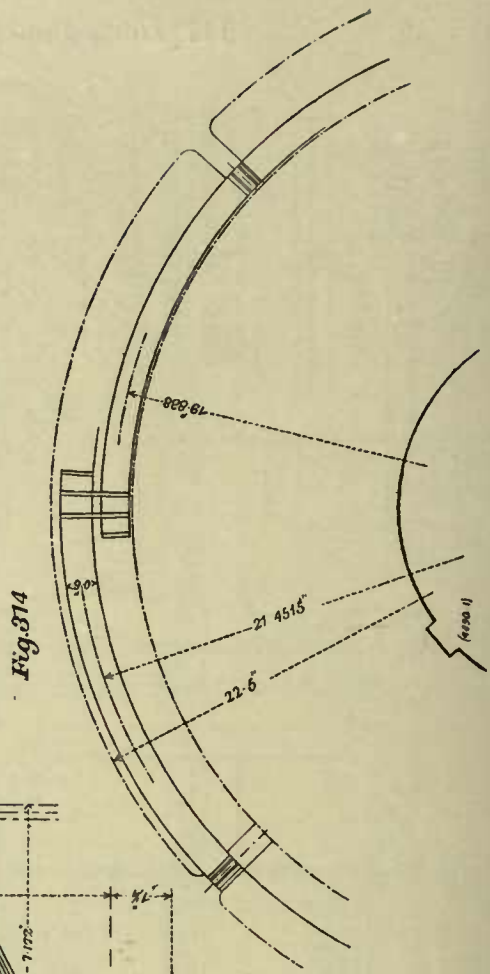
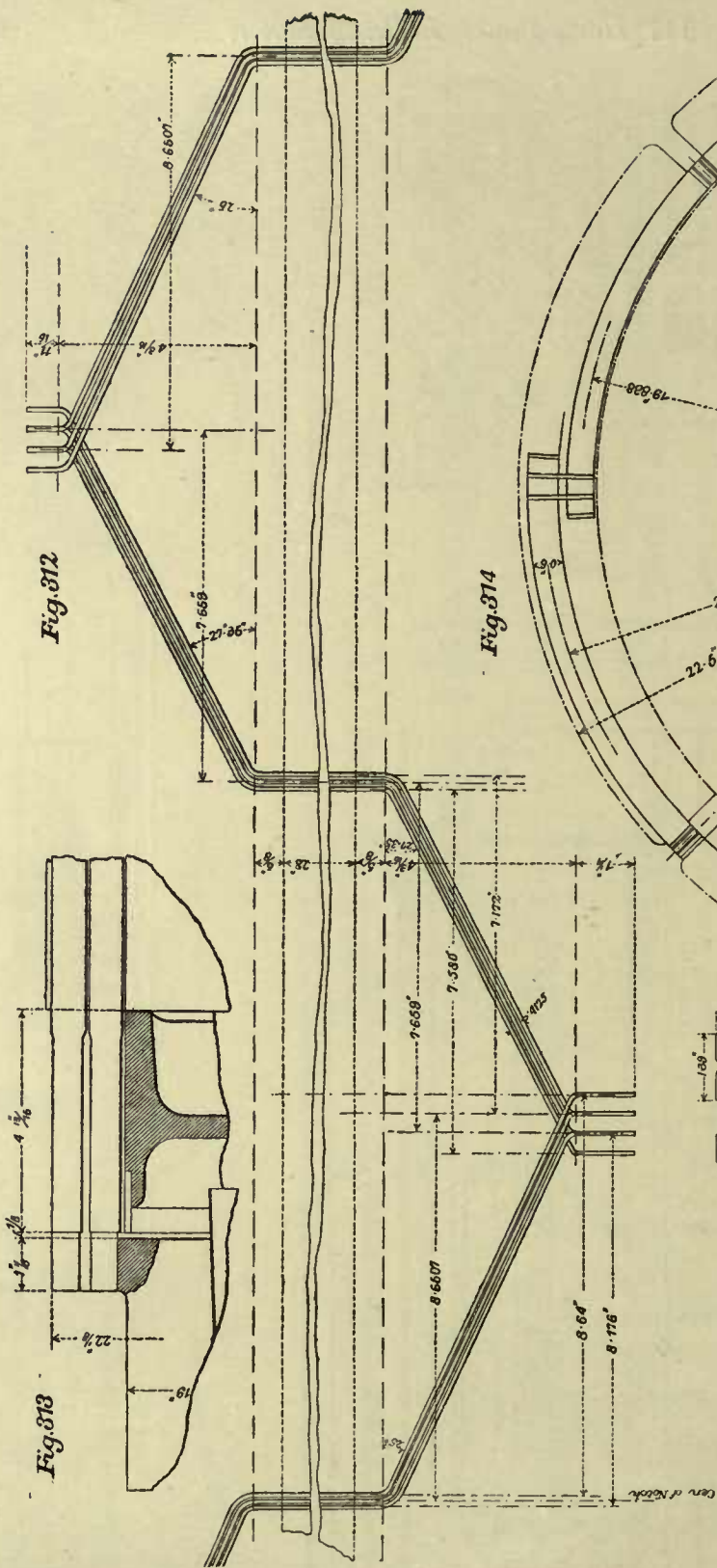

Fig. 306.





two of .060 in. by .875 in. Insulation between turns consists of a thickness of .010 in. of asbestos.

Cross-section of field conductor on small spools193 square inch

The winding on the large spools consists of seventy-six turns, whose section is made up of a strip of .050 in. by $2\frac{1}{8}$ in., in multiple with one of .060 in. by $2\frac{1}{8}$ in.

Cross-section of field conductor on large spools234 square inch
Total turns on all four spools—all are in series	182
Resistance of two small spools at 70 deg. Cent.012 ohm
" " large " "047 "
Total spool resistance at 70 deg. Cent....059 "
Volts of drop in field	11 volts
Resistance of brush contacts (positive + negative)012 ohm
Volts of drop in brush contacts...	2 volts
" " armature, field, and brushes	29 "
Counter electromotive force of motor	471 "
Amperes per square inch in armature winding	2100
" " " winding of small spools	1000
" " " " " large "	820

Commutation:

Average voltage between commutator segments	10.7
Armature turns per pole...	46
Amperes per turn	91
Armature ampere turns per pole	4200
Frequency of commutation, cycles per second	138
Number of coils simultaneously short-circuited per brush	3
Turns per coil	1
Number of conductors per group simultaneously undergoing commutation...	6
Flux per ampere turn per inch of length of armature laminations	20
Flux linked with six turns with one ampere in those turns	3360
Inductance of one turn0000336 henrys
The armature having a two-circuit winding with four poles and only two sets of brushes, there are two such turns in series, being commutated under the brush, and their inductance is000067 henrys
Reactance of short-circuited turns058 ohm
Amperes in	91
Reactance voltage of short-circuited turns	5.3 volts

MAGNETO-MOTIVE FORCE ESTIMATIONS.

Megalines entering armature, per pole piece	20.6
Coefficient of magnetic leakage taken at	1.15
Megalines in magnet frame, per pole-piece	23.8

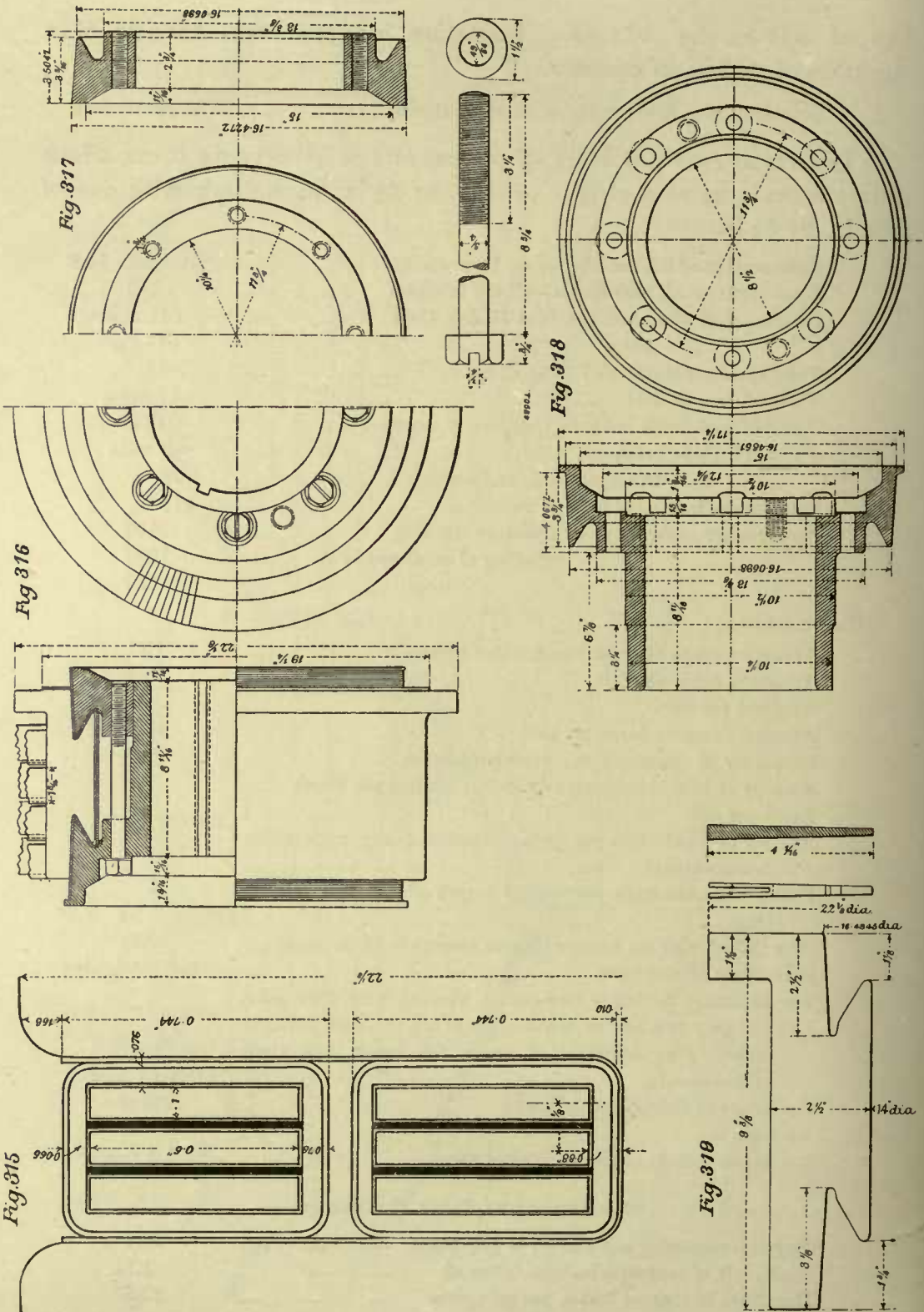

Armature :

Section	240 square inch
Density	86 kilolines
Length, magnetic	6 in.
Ampere turns per inch of length	40
„ for armature core	240

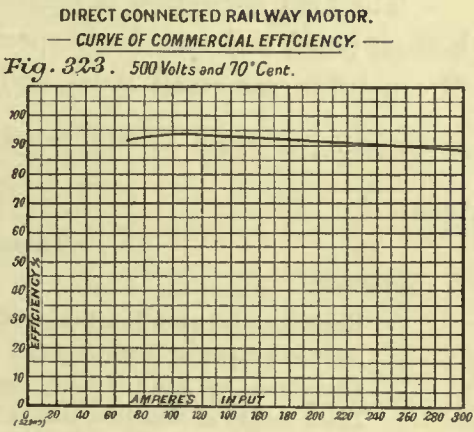
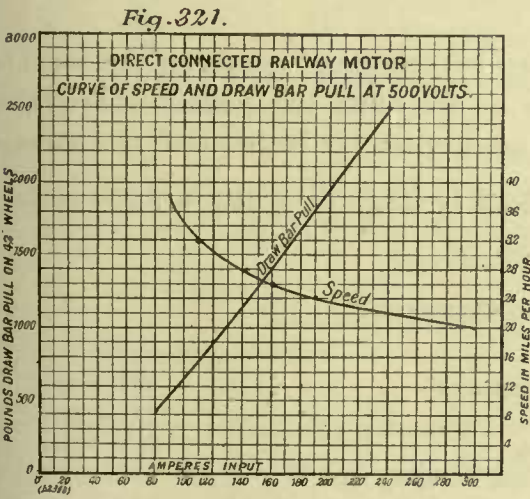
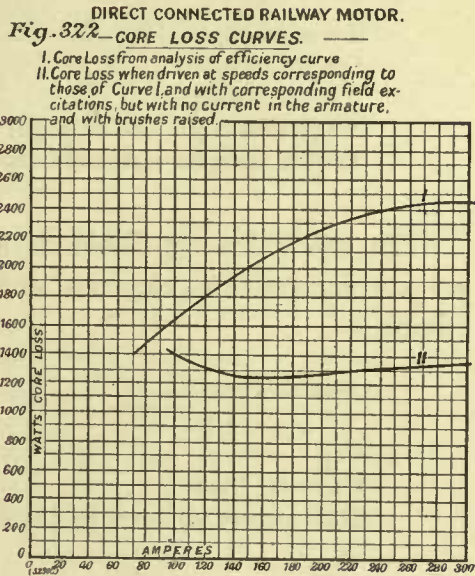
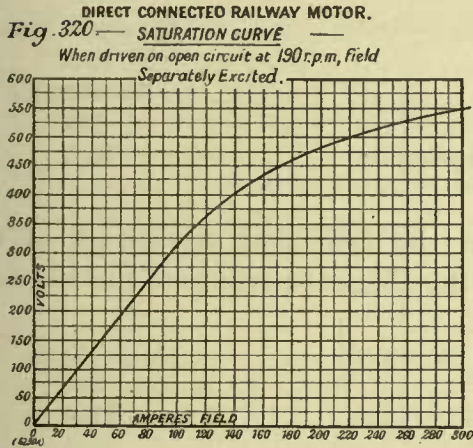

Teeth :

Transmitting flux from one pole-piece	13
Section at roots	152 square inches
Length	1.73 in.
Apparent density at root tooth	137 kilolines
Corrected „ „	127 „
Ampere turns per inch of length	1000
„ for teeth	1730

Gap:

Section at pole-face	370 square inches
Length gap, average of top and bottom28 in.
Density at pole-face	56 kilolines
Ampere turns for gap	5000

Cast-Steel Portion of Circuit:

Average cross-section	240 square inches
Length, magnetic...	17 in.
Average density	102 kilolines
Ampere turns per inch of length	105
Ampere turns for cast-steel frame (per pole-piece)	1780

In the following Table is given the estimated subdivision of the magnetomotive force observed among the different portions of the magnetic circuit:—

	Ampere Turns.
Armature core	240
„ teeth	1730
Gap	5000
Cast-steel frame	1780
Total ampere turns per field spool	8750

The field excitation is furnished by two small spools on the top and bottom poles, and two large spools on the other two poles. There being fifteen turns per small spool, and seventy-six per large spool, the average excitation per spool at full rated load is $\frac{15 + 76}{2} \times 192 = 8,750$ ampere turns.

THERMAL CONSTANTS.

Armature:

Resistance between brushes at 70 deg. Cent.084 ohm
Amperes input at rated capacity	192 amperes
Armature C ² R loss at 70 deg. Cent.	3100 watts
Total weight of armature laminations, including teeth	1900 lb.
Watts per pound in armature laminations	1.15 watts
Total core loss (apparently core-loss)	2200 „
„ of armature losses	5300 „
Peripheral radiating surface of armature	3250 square inches
Watts per square inch peripheral radiating surface	1.63 watts

Field Spools:

Total resistance of four field spools at 70 deg. Cent.059 ohms
Spool C ² R loss at 70 deg. Cent.	2200 watts

Commutator :

Area of bearing surface of all positive brushes	4.8 square inches
Amperes per square inch of brush-bearing surface	40 amperes
Ohms per square inch of bearing surface for carbon brushes03 ohm
Brush resistance, positive + negative0125 "
Volts drop at brush contacts	2.4 volts
C ² R at brush contacts	460 watts
Brush pressure, pounds per square inch	2 lb.
Total brush pressure	19.2 "
Coefficient of friction3
Peripheral speed commutator, feet per minute	915
Brush friction	120 watts
Allowance for stray power lost in commutator	150 "
Total commutator loss	730 "
Radiating surface	510 square inches
Watts per square inch of radiating surface	1.43 watts

EFFICIENCY ESTIMATIONS.

	Watts.
Output at rated capacity	87,500
Core loss	2,200
Commutator and brush loss	730
Armature C ² R loss at 70 deg. Cent.	3,100
Field spool C ² R loss at 70 deg. Cent.	2,200
Total input	95,730

Commercial efficiency at rated capacity and 70 deg. Cent. = 91.3 per cent.

WEIGHTS.

	Lb.
Weight of armature laminations	1,900
Total weight of armature copper	270
" " with commutator	3,000
Total weight of spool copper	1,300
" frame with field coils	9,000
Total weight of motor	12,000

Insulation resistance, measured on 500 volts circuit, was, for the average of several motors, 2 megohms from frame to windings of armature and field, at 20 deg. Cent., and 30,000 ohms at 70 deg. Cent.

The results of experimental tests of efficiency, saturation, speed, torque, and core loss, are given in Figs. 320 to 323.

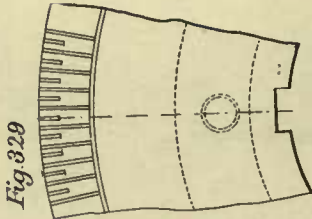

Fig. 329

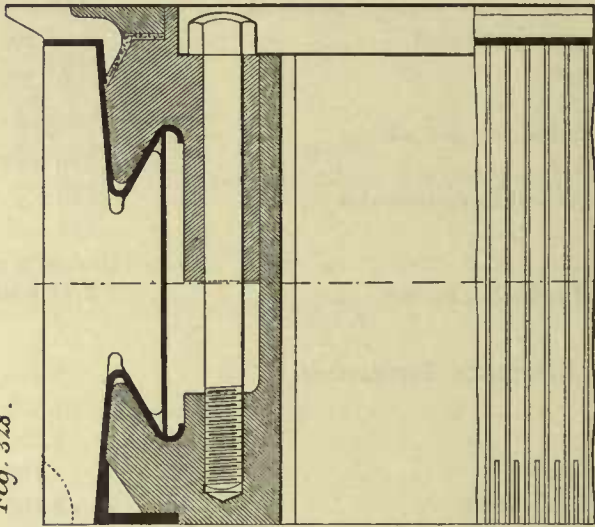

Fig. 325.

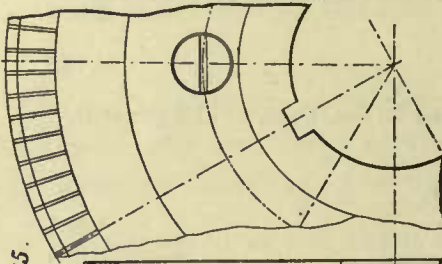

Fig. 325.

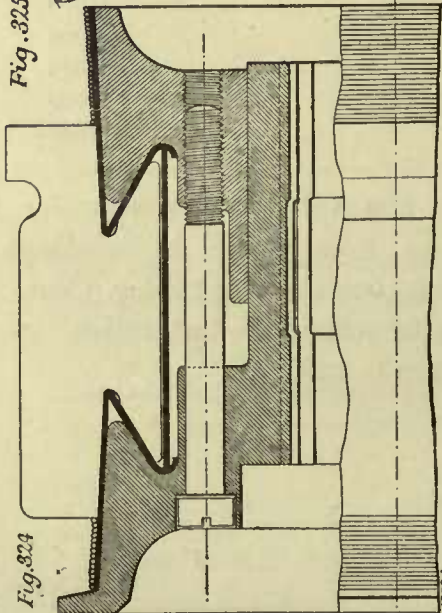

Fig. 324

Fig. 327.

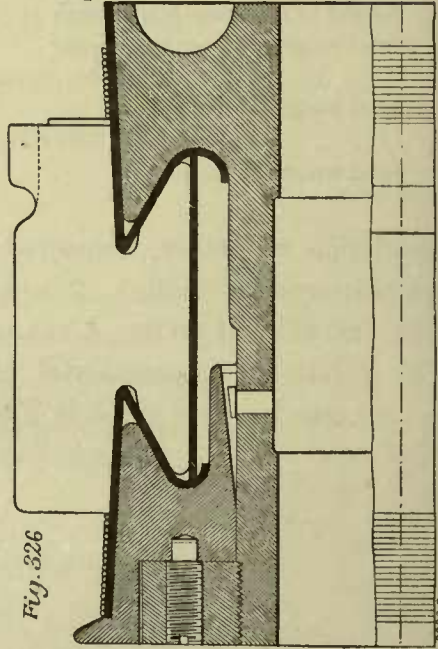
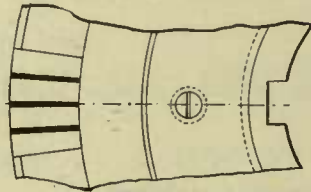
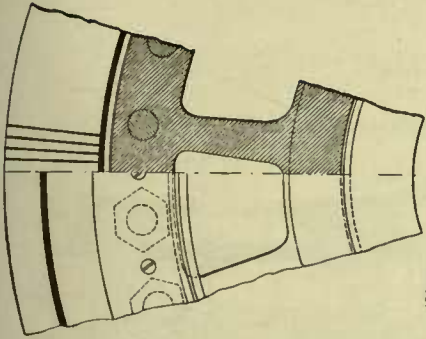

Fig. 326

Fig. 333



(48228 E.)

Fig. 332

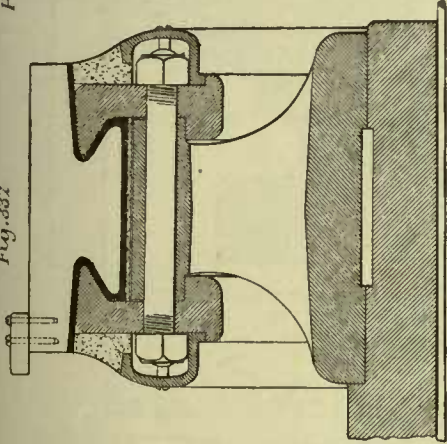
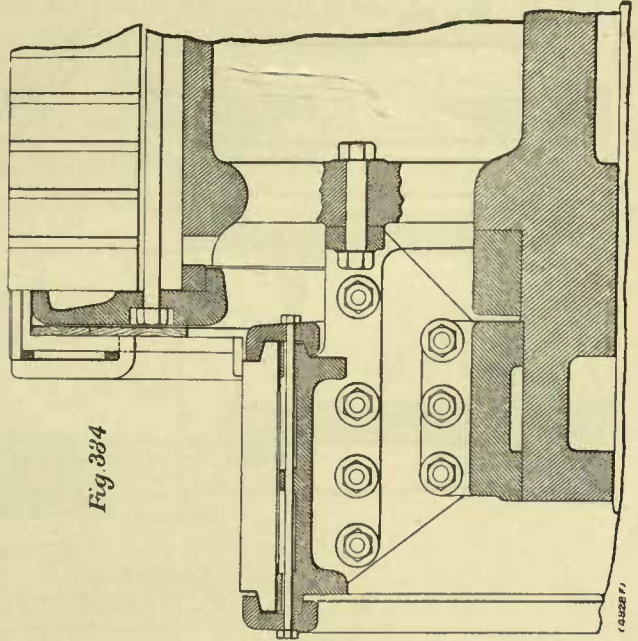

Fig. 334



(48228 F.)

Fig. 331

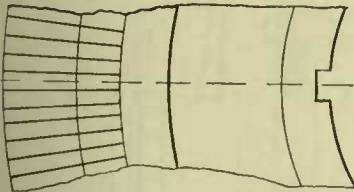
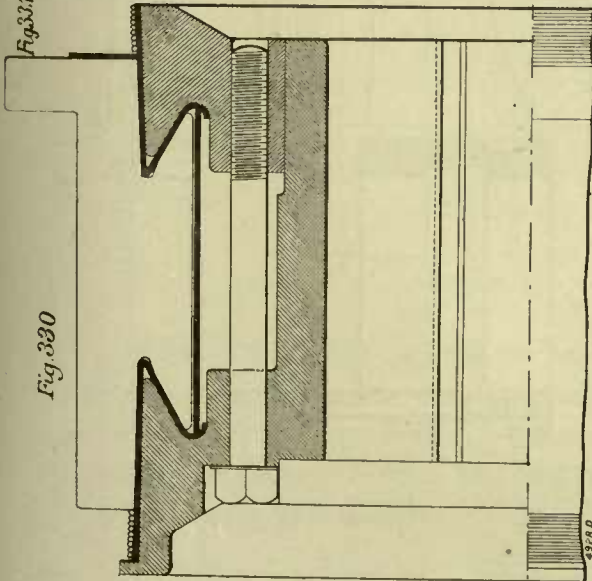
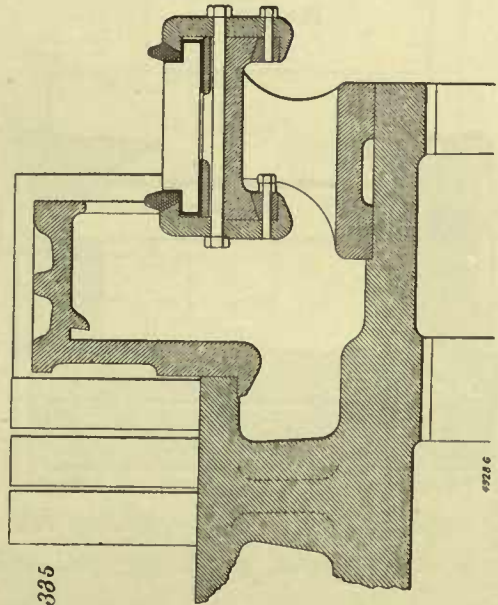

Fig. 330



43280

Fig. 335



4725 C

Fig. 336.

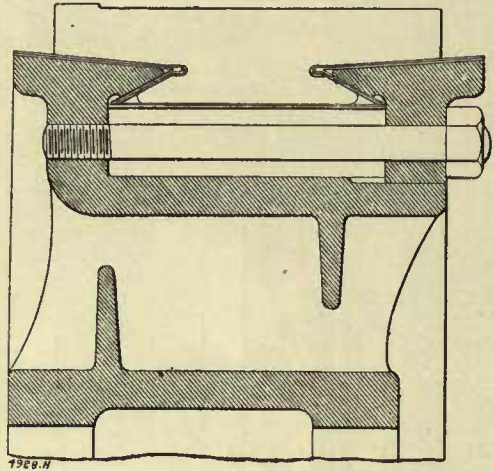

4920.H

Fig. 337.

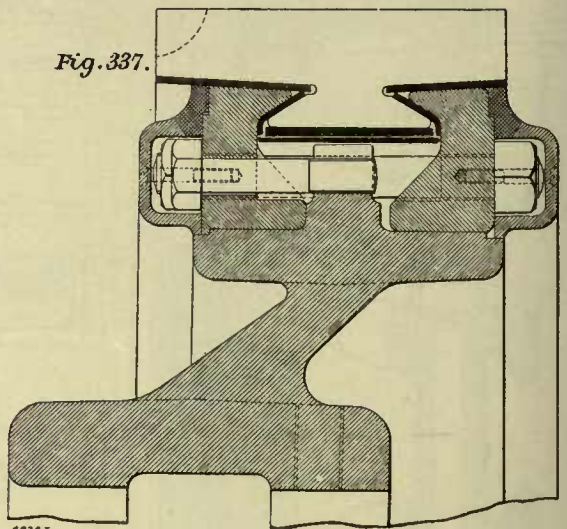

4920.L

Fig. 338

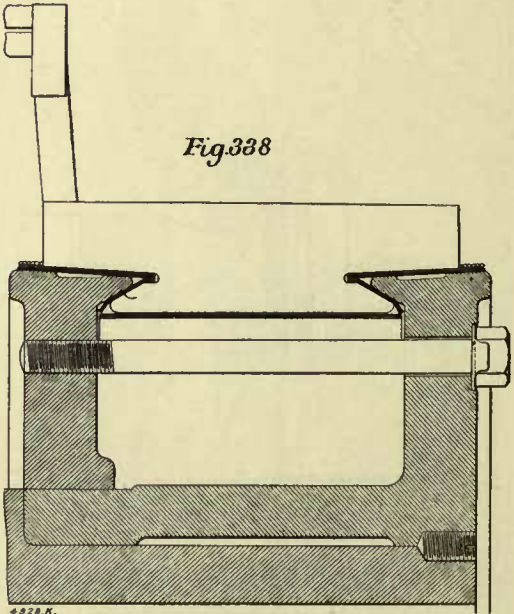

4920.K

Fig. 339

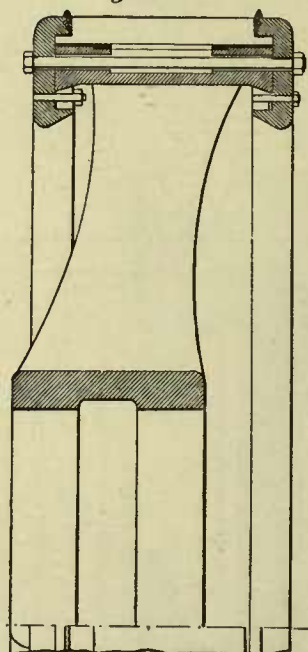

4920.J

Fig. 340.

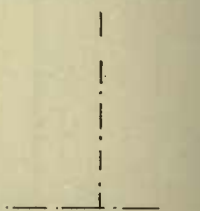
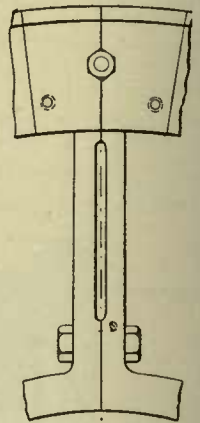

COMMUTATORS AND BRUSH GEAR.

A number of illustrations of various types of commutators are given in Figs. 324 to 340. Figs. 324 to 331 illustrate designs widely employed in traction motors, that of Figs. 330 and 331 being used on a 100 horse-power direct-connected motor, the three former in smaller, geared motors.

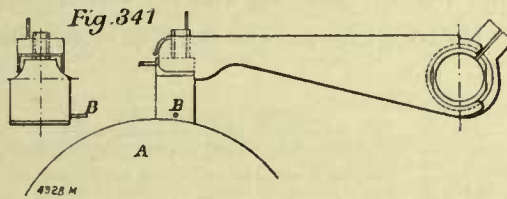

*Moore's Investigation of the Relations between
Resistance of Carbon brush Contacts and Current
Density in Amperes per square Inch of Contact Surface
Arrangement of Apparatus
Resistance measured from A to B.*

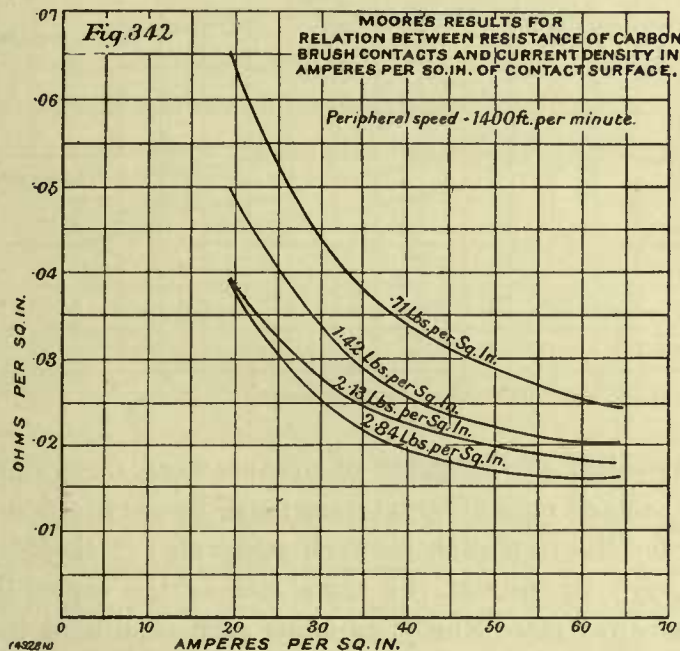

Figs. 332 to 334 give some early designs of Mr. Parshall's, which have been much used with general success in many later machines, especially traction generators. Other useful modifications and alternative designs are shown in Figs. 335 to 340, the last one being employed in a 1,600-kilowatt generator.

Commutator segments should preferably be drawn, although good results have also been attained with drop-forged segments; cast segments have been generally unsatisfactory. It is not on the score of its superior conductivity that wrought-copper segments are necessary, since the loss due to the resistance itself is negligible, but it is of primary importance that the material shall possess the greatest possible uniformity throughout, and freedom from any sort of flaw or inequality. Any such that may develop during the life of the segments will render the commutator unequal to further thoroughly satisfactory service until turned down or

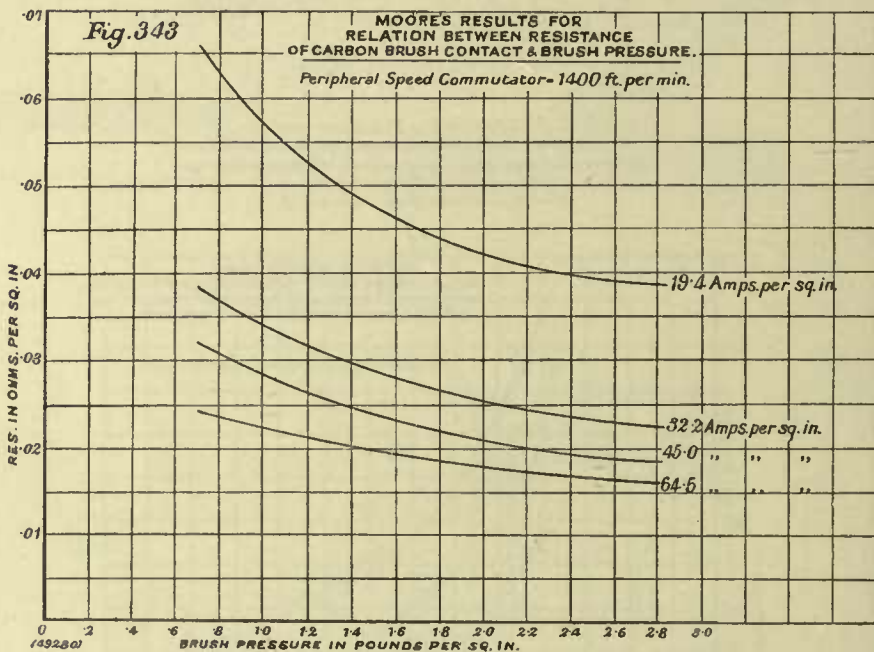

otherwise remedied, as the effect of uneven wear, once started, is cumulative. For similar reasons great care must be exercised in the selection of the mica for the insulation between segments; it should preferably be just soft enough to wear at the same rate as the copper, but should in no event wear away more slowly, as under such conditions the commutator will not continue to present a suitably smooth surface to the brush.

The writers have found the method of predetermining the commutator losses and heating, set forth briefly on page 112, to give very good results, and to amply cover practical determinations. But an intelligent handling of the subject of the relations existing between commutator speeds, brush pressure, and contact resistance, is facilitated

by a study of the results of tests that have been made, showing the dependence of these values upon various conditions.

The most complete and careful tests on carbon brushes at present

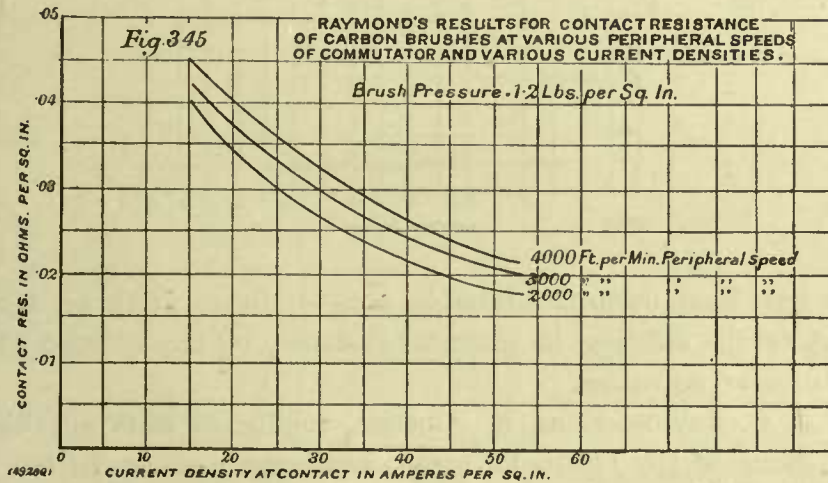
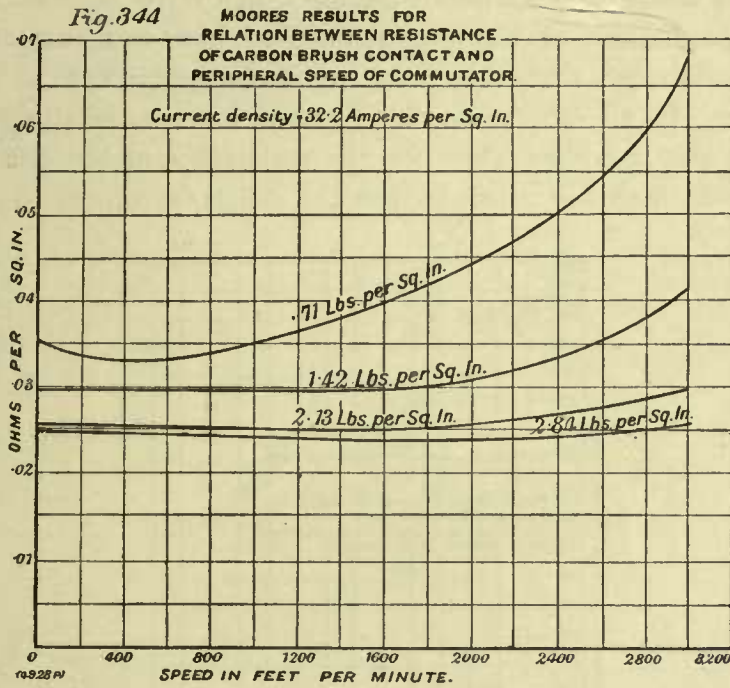

available, appear to be those conducted by Mr. A. H. Moore, in 1898, and the results are graphically represented in Figs. 341 to 344. In Fig. 341 is given a sketch showing the disposition and nature of the parts. A rotating cylinder, A, of 6.8 in. diameter, of cast copper, took the

place of a commutator, and this introduced an element of doubt as to whether a segmental structure of hard-drawn copper segments and mica would have given the same results. But inasmuch as the constants derived from these tests agree with those which have been found to lead to correct predictions of the performance of new commutators, it may be safely concluded that this point of dissimilarity was of no special consequence. In all other respects the tests seem especially good. The set of tests also includes values for the resistances of the brush holders, but with good designs of brush holders the resistance should be negligible;

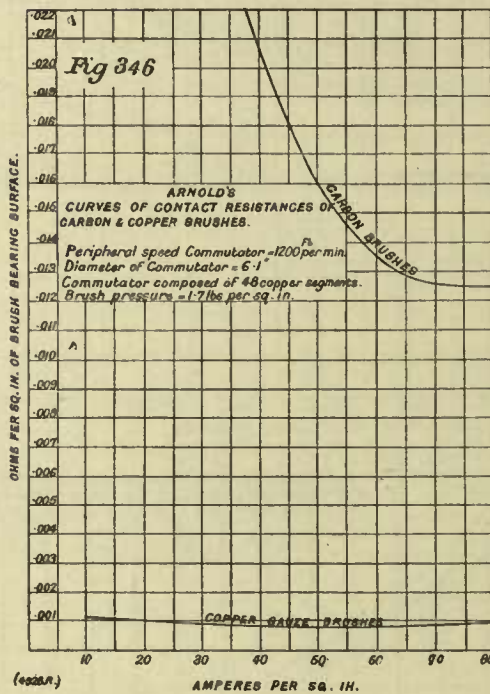

hence it has been deemed advisable not to divert attention from the important results relating to contact resistance, by the addition of these less useful observed values.

Mr. E. B. Raymond has, in America, conducted tests on this same subject. Some of the results for carbon brushes are shown in the curves of Fig. 345, and it will be observed that, for all practical purposes, his results, like Mr. Moore's, lead to the general working constants given on page 112.

Dr. E. Arnold, in the *Elektrotechnische Zeitschrift*, of January 5th, 1899, page 5, described investigations on both copper and carbon brushes,

Fig. 347

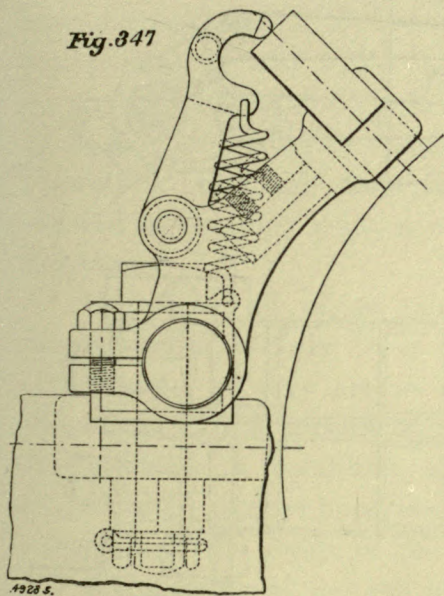

Fig. 348

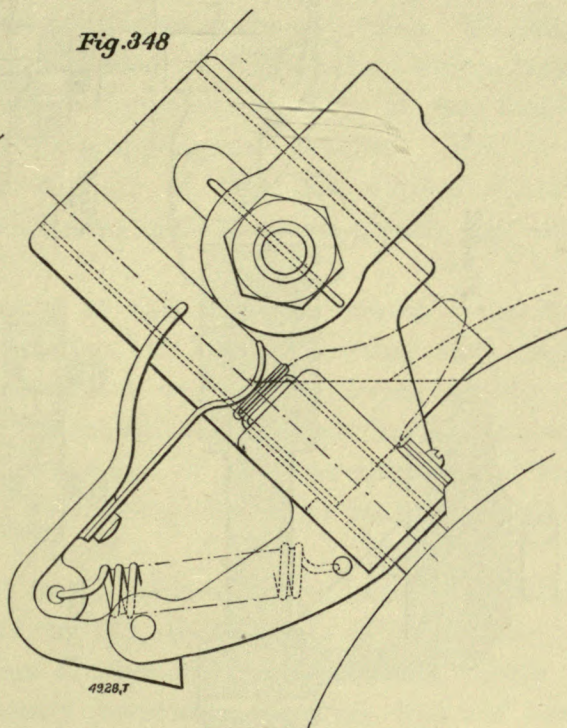

Fig. 349

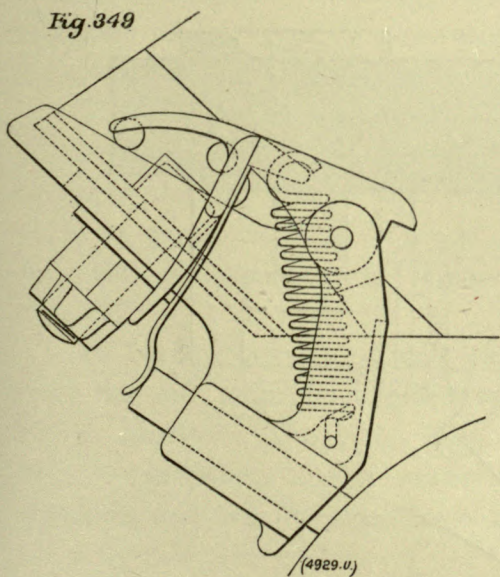
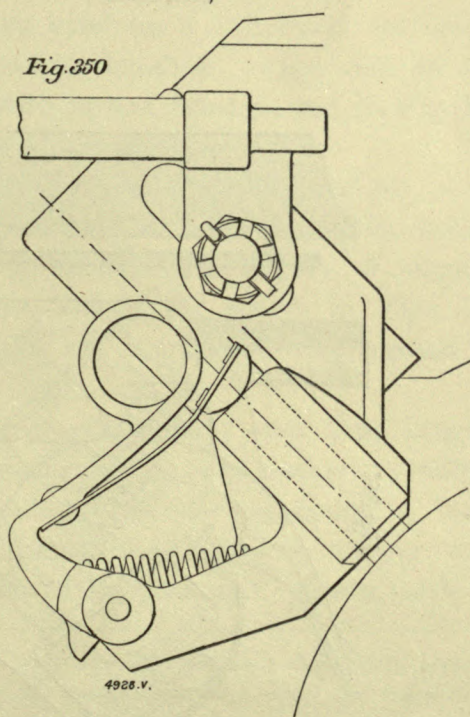

Fig. 350



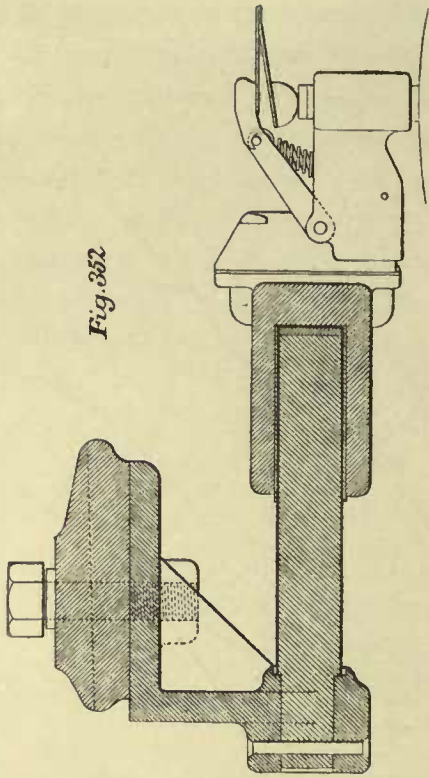

Fig. 352

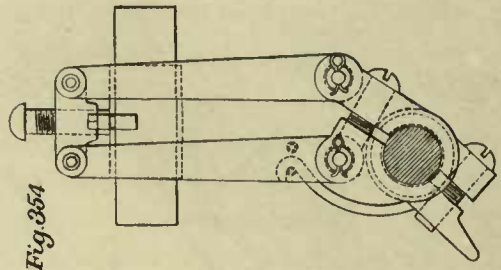

Fig. 354

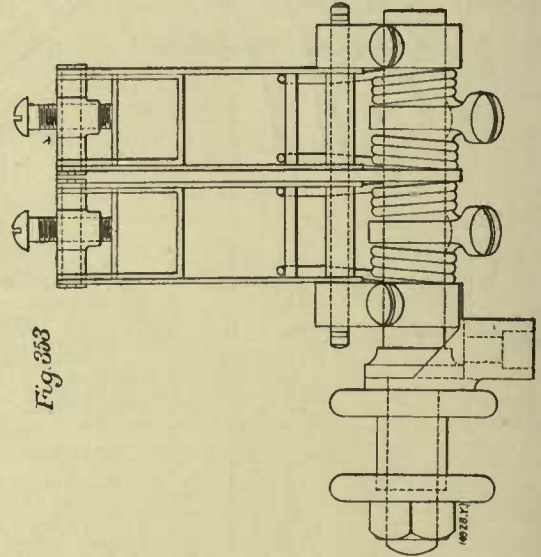

Fig. 358

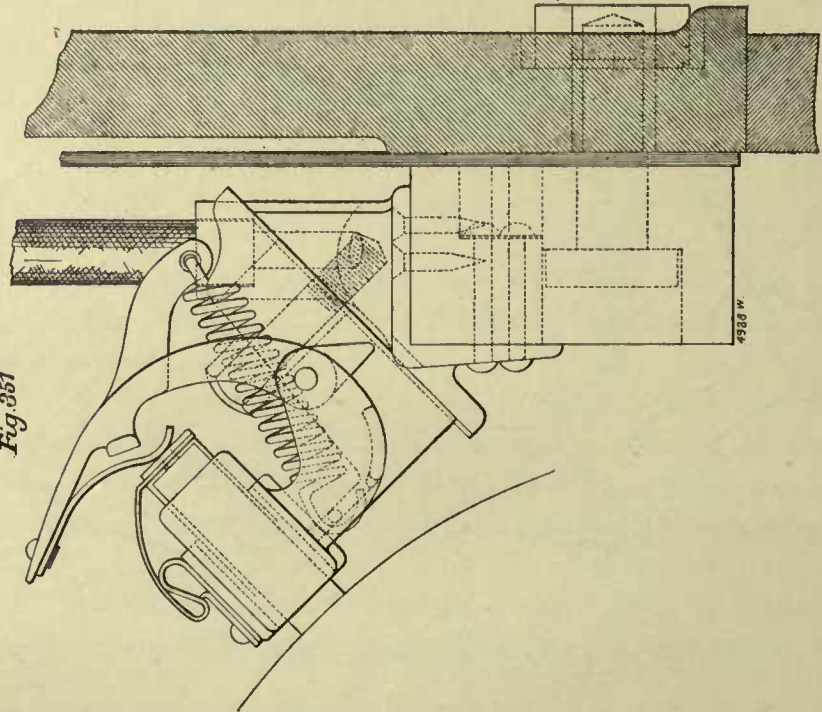

Fig. 351

4928 W.

from which have been derived the curves set forth in Fig. 346, showing the relative values for the contact resistances in the two cases. Dr. Arnold also points out that while the coefficient of friction for carbon brushes on copper commutators is in the neighbourhood of .3, he has found .2 to be a more suitable value for copper-gauze brushes. But in the absence of thorough tests in support of this, the writers would be inclined to continue using a coefficient of .3 for both carbon and copper brushes.

Of course, all values relating to this whole matter of commutator losses must necessarily be, in practice, but little better than very roughly approximate, as they are so dependent upon the material, quality, and adjustment of the brushes, and the condition of their surfaces, as also upon the construction, condition, and material of the commutator and brush holders, and—fully as important as anything else—upon the electromagnetic properties of the design of the dynamo.

A collection of designs of brush holders for generators and railway motors, are given in Figs. 347 to 365, the first six (Figs. 347 to 352) being for use with radial carbon brushes on traction motors, where the direction of running is frequently reversed. In Figs. 353 and 354 is shown a brush holder which has been used on a 3 horse-power launch motor, for reversible running, with carbon brushes. Figs. 355 to 358 illustrate useful types for generators with carbon brushes, and in Fig. 359 is shown a holder designed for a copper-gauze brush.

The Bayliss reaction brush holder, shown in Figs. 360 and 361, is one of the latest and most successful developments in brush-holder design. Another design, where the holder is constructed largely of stamped parts, is given in Figs. 362 and 363. The holder shown in Figs. 364 and 365 is essentially a modification of the design represented in Fig. 357.

Of carbon brushes, a wide range of grades have been used, ranging from the soft, amorphous, graphite brushes, up to hard, rather crystalline, carbon brushes. The latter have the lower specific resistance,¹ a lower contact resistance, and a lower coefficient of friction on copper commutators, and are for most cases much to be preferred. Tests made by

¹ Some types of graphite brushes have a lower specific resistance than some types of carbon brushes. A great deal depends upon the composition and upon the methods of manufacture. By varying these, a wide range of specific resistances may be obtained, both for carbon and for graphite brushes.

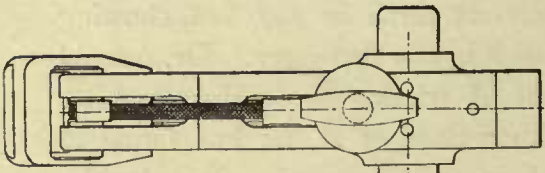

Fig. 356

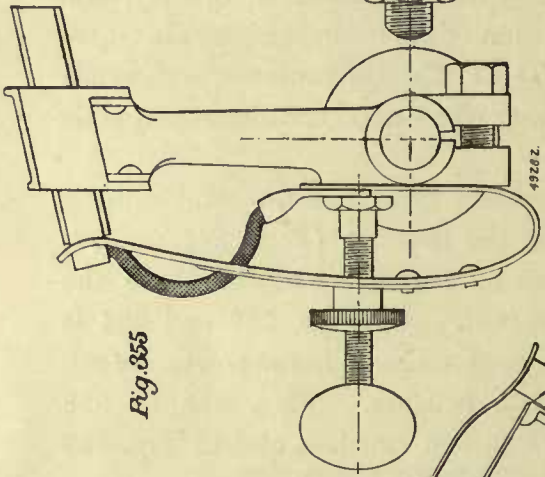

Fig. 355

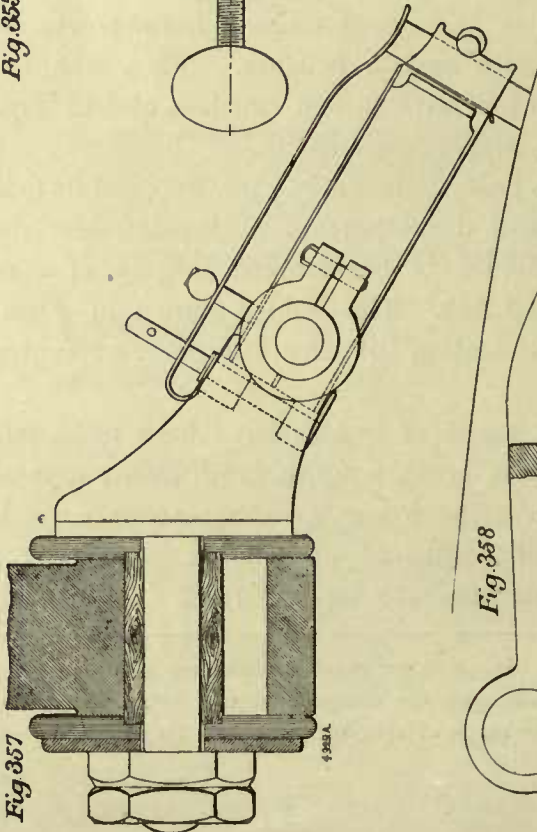

Fig. 357

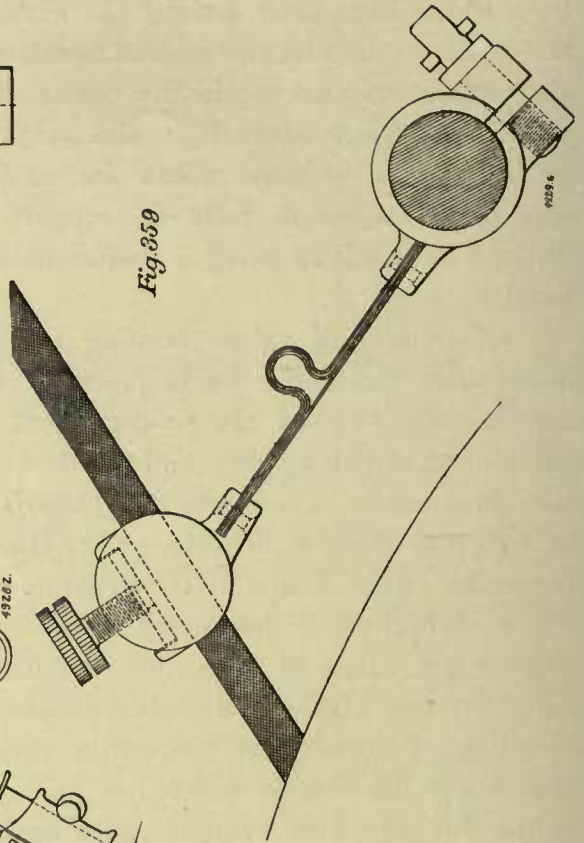

Fig. 359

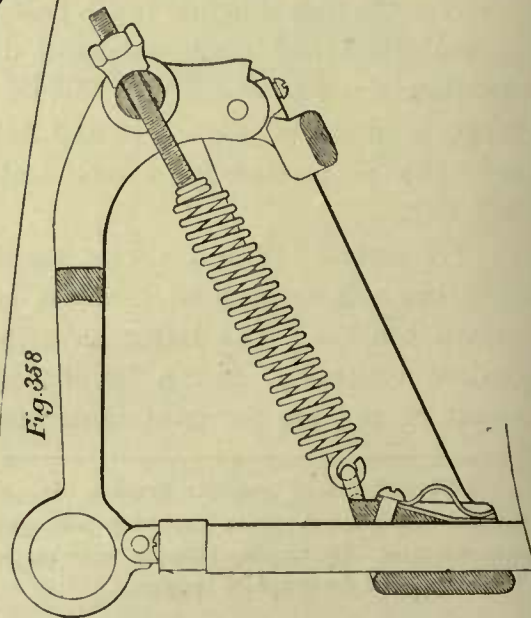
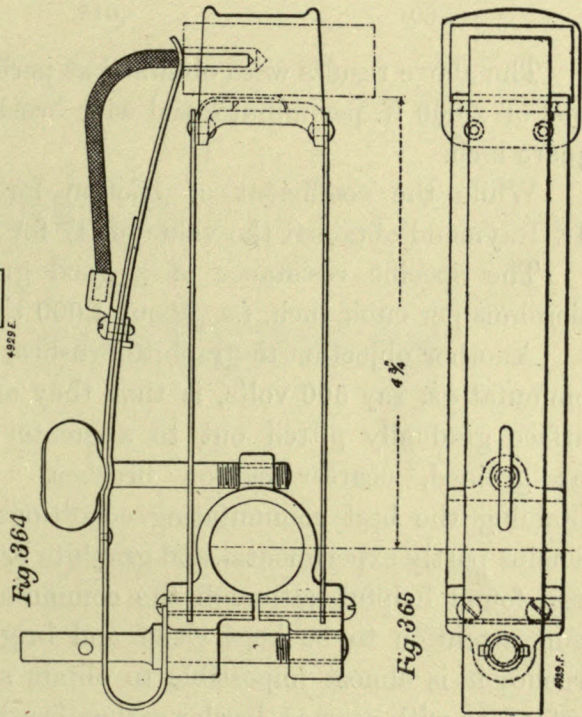
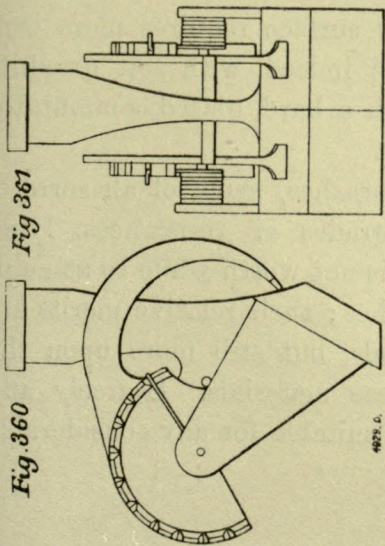
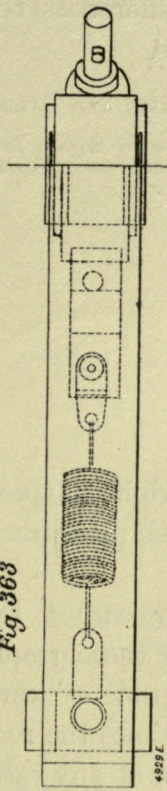
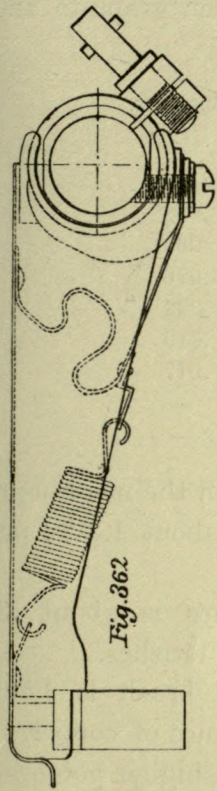

Fig. 358



Mr. Raymond, show the extent of these differences between graphite and carbon brushes of two representative grades.

TABLE L.—RAYMOND'S TESTS ON GRAPHITE AND CARBON BRUSHES.

Amperes per Square Inch of Brush-bearing Surface.	Ohms per Square Inch of Brush-bearing Surface.	
	Graphite.	Carbon.
10	.075	.048
20	.045	.035
30	.033	.026
40	.027	.022
50	.022	.019
60	.019	.017
70	.017	—
80	.015	—

The above results were obtained at peripheral speeds in the neighbourhood of 2,000 ft. per minute, and with brush pressures of about 1.3 lb. per square inch.

While the coefficient of friction for carbon brushes is about .3, Mr. Raymond obtained the value of .47 for these graphite brushes.

The specific resistance of a good grade of carbon brush is 2,500 microhms per cubic inch, *i.e.*, about 4,000 times the resistance of copper.

Another objection to graphite brushes, at any rate on higher potential commutators, say 500 volts, is that they are liable to have their contact surface gradually pitted out to a greater extent than occurs with the hard-grained, coarser carbon brushes. Nevertheless, the matter of obtaining the best commutating conditions for each particular case, still remains partly experimental, and graphite brushes have, in certain instances, been found helpful, although the commutator surface requires more constant attention to be kept clean and bright; indeed, with soft graphite brushes it is almost impossible to obtain such a hard, glazed commutator surface, as with coarser, harder carbon brushes.

There are very many more varieties of brushes, made of all sorts of materials, and giving many intermediate grades of resistances, lying between the limits of carbon and copper. It is not worth while to attempt to classify and describe these varieties of brushes; their relative merits are dependent partly upon the choice of materials, but still more upon the methods of constructing the brush from these materials. Scarcely any one type of brush and grade of resistance, is suitable for any considerable range of variety of dynamo-electric machine.

PART II.

ROTARY CONVERTERS.

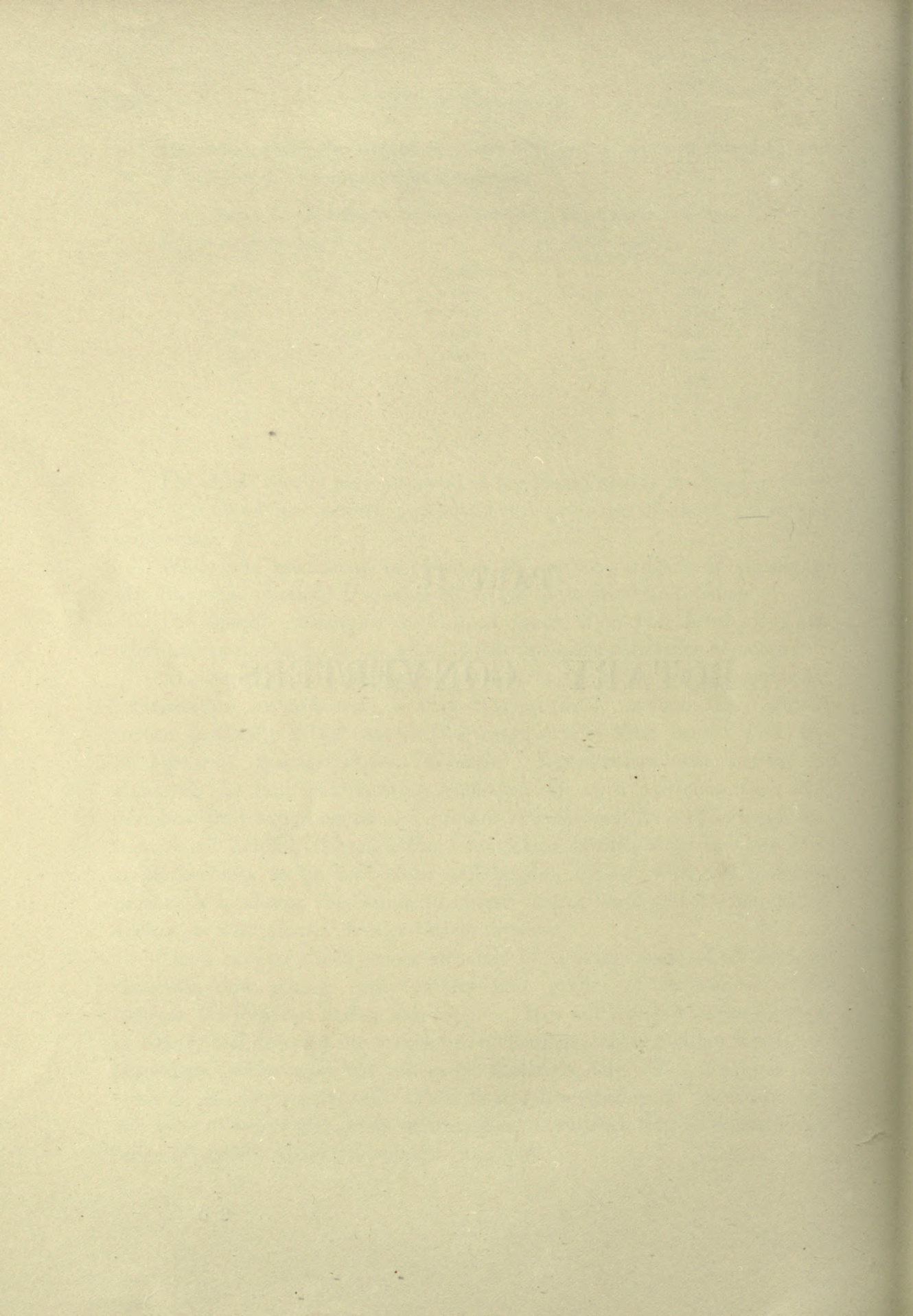

ROTARY CONVERTERS.

A ROTARY converter is, structurally, in many respects similar to a continuous-current generator, the chief outward difference consisting in the addition of a number of collector rings, and in the commutator being very much larger, in comparison with the dimensions of the rest of the machine, than in an ordinary continuous-current dynamo. Under the usual conditions of running, the armature is driven, as in a plain synchronous motor, by alternating current supplied to the collector rings from an external source. Superposed upon this motor current in the armature winding, is the generator current, which is delivered from the commutator to the external circuit, as continuous current. Occasionally rotary converters are used for just the opposite purpose, namely to convert continuous into alternating current. With this latter arrangement, however, some sort of centrifugal cut-off governor should always be used, as the reactions on the field strength occasioned by sudden changes in the alternating current load, may so weaken the field as to cause dangerous increase of speed. But in by far the greater number of cases, the apparatus is employed for transforming from alternating to continuous current.

The most interesting property of a rotary converter, is the overlapping of the motor and generator currents in the armature conductors; in virtue of which, not only may the conductors be of very small cross section for a given output, from the thermal standpoint, but, the armature reactions also being neutralised, large numbers of conductors may be employed on the armature, which permits of a very small flux per pole piece, and a correspondingly small cross section of magnetic circuit. But the commutator must be as large as for a continuous-current generator of the same output, hence a consistently designed rotary converter should be characterised by a relatively large commutator, and small magnetic system. This is best achieved by an armature of fairly large diameter and small axial length; and this, furthermore, gives room for the many, though small, armature conductors, and for the many poles required for obtaining reason-

able speeds at economical periodicities. The mechanical limit imposed by centrifugal force, becomes an important factor in the design of the armature and commutator of a rotary converter, as compared with continuous-current generators.

In some installations, a good deal has been heard of "surging" troubles in operating rotary converters. These were largely due to insufficiently uniform angular velocity of the engine driving the Central Station generators, whose power was ultimately used to operate the rotary converters. This lack of uniformity in angular velocity, had the effect of causing cumulative oscillations in the rotary converters, in their efforts to keep perfectly in synchronism with the direct-driven generators throughout a revolution. This caused especial difficulty when it was attempted to operate several rotary converters at different points in parallel. The true solution for these difficulties is to have engines of such design as to give uniform angular velocity. In describing the proper lines on which to design rotary converters, it will be assumed that this condition, as regards the generating set, has been complied with; otherwise it is necessary to employ auxiliary devices to counteract such causes, and there results a serious loss in economy, through the dissipation of energy in steadying devices.

TABLE LI.—OUTPUT IN TERMS OF OUTPUT OF CONTINUOUS-CURRENT GENERATOR FOR EQUAL C^2R LOSS IN ARMATURE CONDUCTORS FOR UNITY POWER FACTOR AND ON THE ASSUMPTION OF A CONVERSION EFFICIENCY OF 100 PER CENT.

Type of Rotary Converter.	Number of Collector Rings.	Uniform Distribution of Magnetic Flux over Pole-Face Spanning Entire Polar Pitch.	Uniform Distribution of Magnetic Flux over Surface of Pole-Faces Spanning 67 Per Cent. of Entire Polar Pitch.
Single phase ...	2	.85	.88
Three ,, ...	3	1.34	1.38
Four ,, ...	4	1.64	1.67
Six ,, ...	6	1.96	1.98
Twelve ,, ...	12	2.24	2.26

The extent to which the motor and generator currents neutralise one another, and permit of small armature conductors to carry the residual current, varies with the number of phases. Table LI. gives the output of a rotary converter for a given C^2R loss in the armature conductors,

in terms of the output of the same armature when used as a continuous-current generator, this latter being taken at 1.00.

Table LII. shows the extent to which the preceding values have to be modified for power factors other than unity.

TABLE LII.—OUTPUT IN TERMS OF OUTPUT OF CONTINUOUS-CURRENT GENERATOR FOR EQUAL C²R LOSS IN ARMATURE CONDUCTORS FOR 100 PER CENT. EFFICIENCY, AND FOR UNIFORM GAP DISTRIBUTION OF MAGNETIC FLUX OVER A POLE-FACE SPANNING 67 PER CENT. OF THE POLAR PITCH.

Type of Rotary Converter.	Number of Collector Rings.	Power Factor of		
		1.00.	0.90.	0.80.
Single phase	2	.88	.81	.73
Three ,,	3	1.38	1.28	1.17
Four ,,	4	1.67	1.60	1.44
Six ,,	6	1.98	1.92	1.77
Twelve ,,	12	2.26	2.20	2.05

The writers have investigated by graphical and other methods the subject of the C² R loss in the armature of a three-phase rotary converter, in comparison with the C³ R loss for the same load delivered from the commutator when the machine is used in the ordinary way as a mechanically driven continuous-current dynamo. Not only are the results of considerable value, but a study of the graphical method of investigation pursued leads to an understanding of many interesting features of the rotary converter.

As a basis for the analysis, Figs. 366, 367, 368, and 369 were prepared. In Fig. 366 are given sine curves of instantaneous current values in the three sections of the armature winding (as it would be if the alternating currents alone were present), and also the corresponding curves of resultant current in the three lines leading to the collector rings. The first three curves are lettered *a*, *b*, and *c*, and a current clockwise directed about the delta is indicated as positive. The line currents are derived by Kirchhoff's law that the sum of the currents from the common junction of several conductors must always equal zero. Outwardly directed currents are considered positive. These curves of resultant line current are designated in Fig. 366 as *a-b*, *b-c*, and *c-a*. Thirteen ordinates, lettered from A to M, divide one com-

plete cycle up into 30 deg. sections. In Fig. 367 are given diagrams of line and winding currents from each of the ordinates from A to F. The remainder, *i.e.*, from G to M, would merely be a repetition of these. An examination shows that these six diagrams, so far as relates to current magnitudes, are of two kinds, of which A and B are the types. In A, the three current values in the windings, are respectively 0, .867 and $-.867$, whilst these become in B, .5, .5 and -1.00 . Hence it is sufficient for practical purposes to study the current distribution in the armature conductors, corresponding

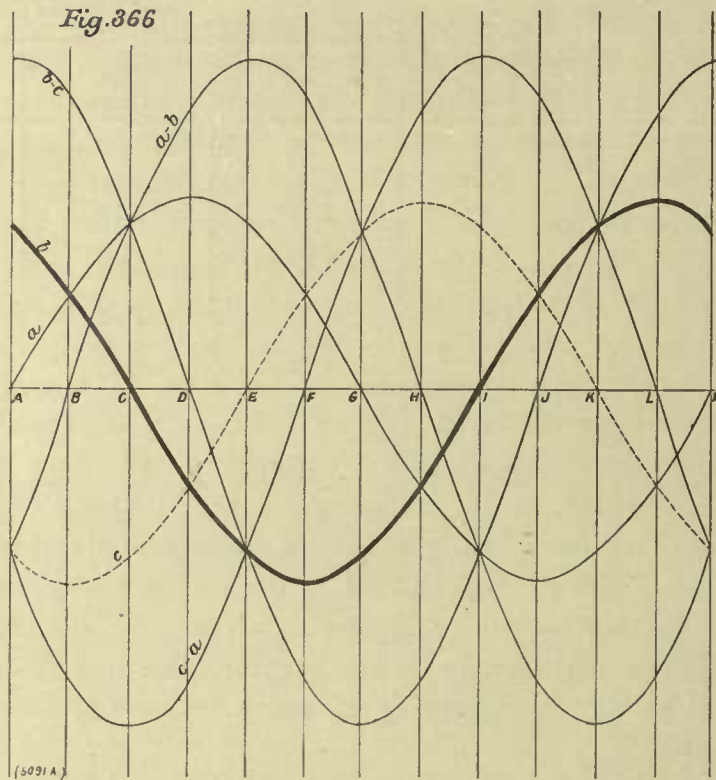

to positions A and B, and to then calculate the average C^2R loss for these two positions. For this purpose, developed diagrams have been mapped out in Figs. 368 and 369, for the winding of a rotary converter, from whose commutator 100 amperes at 100 volts are to be delivered from each pair (positive and negative), of brushes. The number of poles is immaterial. The armature has a multiple-circuit single winding, and it may be assumed that there are two conductors per slot, though this assumption is not necessary. It was thought best to take a fairly large number of conductors, and to take into account, just as it comes, the disturbing influence of the brushes, which somewhat modifies the final result. Of course, this

disturbing influence would vary with the width of the brushes. Comparatively narrow brushes are shown, and this will tend to off-set the number of conductors' being considerably less than would be taken in practice for this voltage.

The assumption is made that the rotary converter is of 100 per cent. efficiency, only calling for an input equal to the output. To supply 100 amperes to the commutator brushes calls for 50 amperes per conductor, so far as the continuous-current end is concerned. This is shown in

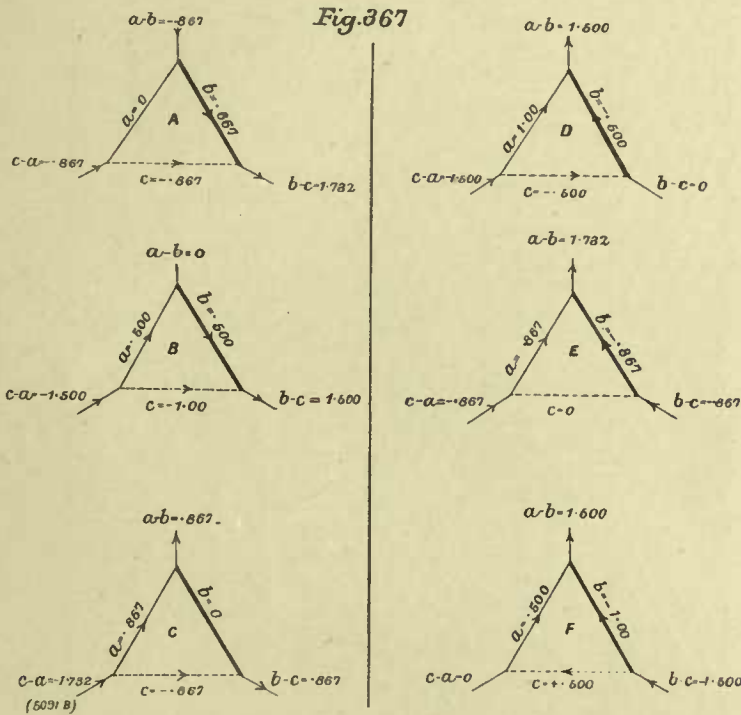

direction and magnitude by arrowheads and figures at the lower ends of the vertical lines representing face-conductors.

100 volts and 100 amperes give 10,000 watts per pair of poles. Therefore, input per phase = 3330 watts. Volts between collector rings = volts per winding = $100 \times .615 = 61.5$ volts.¹ Amperes per winding $\frac{3330}{61.5} = 54$ amperes (effective). In this analysis, which considers

¹ The Estimation of the Electro-Motive Force in Rotary Converters, Tables of Values of the Ratio of the Alternating Voltage between Collector Rings to the Continuous-Current Voltage at the Commutator, and the Estimation of the Effect of the Pole Face Spread upon these Values; have already been given on pages 84, 85, and 86, in the section on Formulæ for Electro-Motive Force.

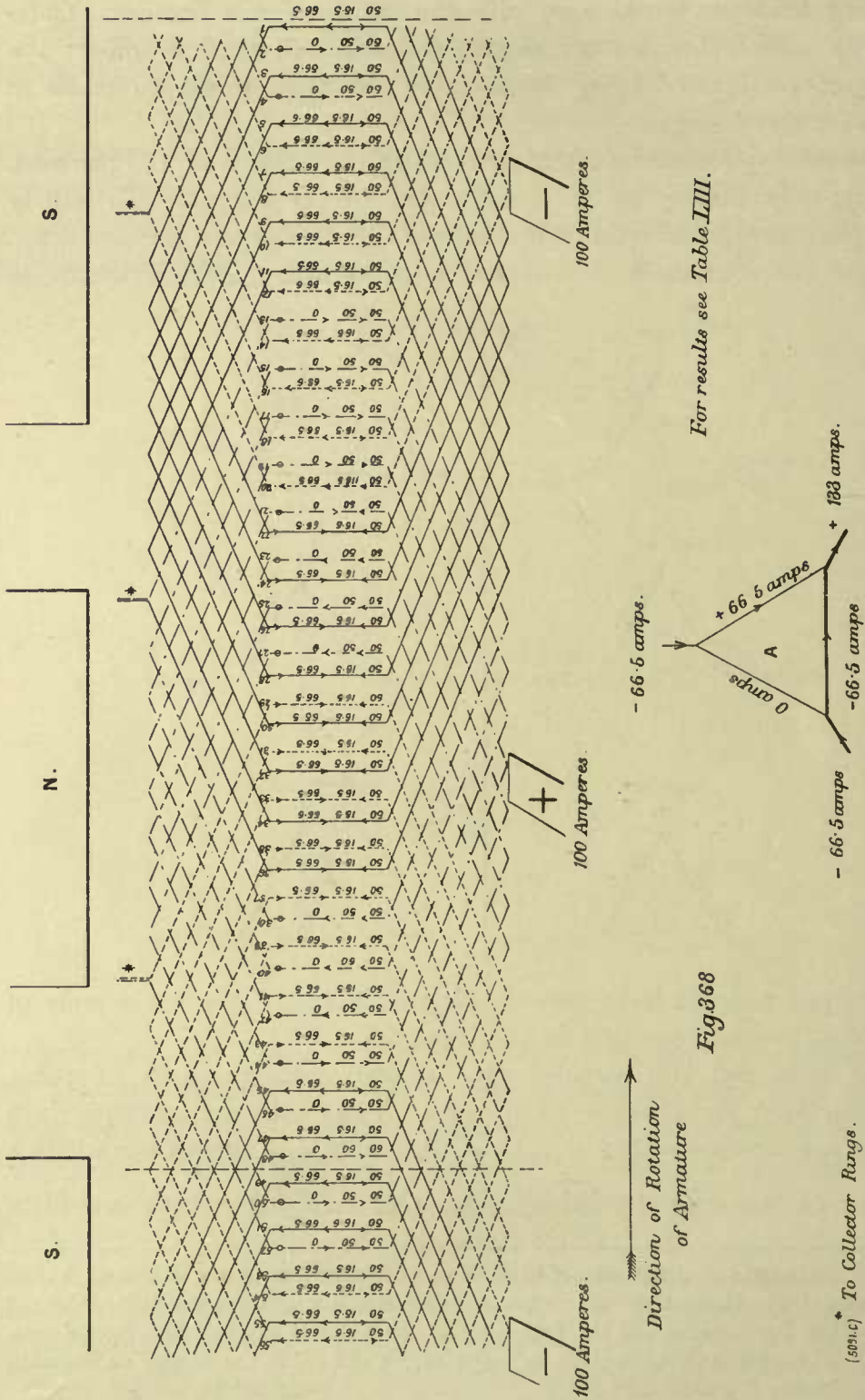

NOTE.—In the above and opposite diagrams (Figs. 368 and 369) the figures on the right hand of the vertical lines should in each case be referred to positions immediately under the arrow heads.

TABLE LIII.

Number of Conductor.	Current in Phase.				Current 30 Deg. out of Phase. Cos. 30 Deg. = .866.					Current 60 Deg. out of Phase. Cos. 60 Deg. = .500.				
	Continuous Current.	Alternating Current.	Resultant Current.	(Current)?	Continuous Current.	Alternating Current, not Considering Power Factor.	Alternating Current ÷ .866	Resultant Current.	(Current)?	Continuous Current.	Alternating Current, not Considering Power Factor.	Alternating Current ÷ .500	Resultant Current.	(Current)?
1	- 50	+ 66.5	+ 16.5	272	- 50	+ 66.5	+ 76.7	+ 26.7	710	- 50	+ 66.5	+ 133	+ 83	6,900
2	- 50	0	- 50	2,500	- 50	+ 66.5	+ 76.7	+ 26.7	710	- 50	+ 66.5	+ 133	+ 83	6,900
3	- 50	+ 66.5	+ 16.5	272	- 50	+ 66.5	+ 76.7	+ 26.7	710	- 50	+ 66.5	+ 133	+ 83	6,900
4	- 50	0	- 50	2,500	- 50	+ 66.5	+ 76.7	+ 26.7	710	- 50	+ 66.5	+ 133	+ 83	6,900
5	- 50	+ 66.5	+ 16.5	272	- 50	+ 66.5	+ 76.7	+ 26.7	710	- 50	0	0	- 50	2,500
6	- 50	+ 66.5	+ 16.5	272	- 50	+ 66.5	+ 76.7	+ 26.7	710	- 50	+ 66.5	+ 133	+ 83	6,900
7	- 50	+ 66.5	+ 16.5	272	- 50	+ 66.5	+ 76.7	+ 26.7	710	- 50	0	0	- 50	2,500
8	- 50	+ 66.5	+ 16.5	272	- 50	+ 66.5	+ 76.7	+ 26.7	710	- 50	+ 66.5	+ 133	+ 83	6,900
9	- 50	+ 66.5	+ 16.5	272	- 50	0	0	- 50	2,500	- 50	0	0	- 50	2,500
10	- 50	+ 66.5	+ 16.5	272	- 50	+ 66.5	+ 76.7	+ 26.7	710	- 50	+ 66.5	+ 133	+ 83	6,900
11	- 50	+ 66.5	+ 16.5	272	- 50	0	0	- 50	2,500	- 50	0	0	- 50	2,500
12	- 50	+ 66.5	+ 16.5	272	- 50	+ 66.5	+ 76.7	+ 26.7	710	- 50	+ 66.5	+ 133	+ 83	6,900
13	- 50	0	- 50	2,500	- 50	0	0	- 50	2,500	- 50	0	0	- 50	2,500
14	- 50	+ 66.5	+ 16.5	272	- 50	+ 66.5	+ 76.7	+ 26.7	710	- 50	- 66.5	- 133	- 183	33,500
15	- 50	0	- 50	2,500	- 50	0	0	- 50	2,500	- 50	0	0	- 50	2,500
16	- 50	+ 66.5	+ 16.5	272	- 50	+ 66.5	+ 76.7	+ 26.7	710	- 50	- 66.5	- 133	- 183	33,500
17	- 50	0	- 50	2,500	- 50	0	0	- 50	2,500	- 50	0	0	- 50	2,500
18	- 50	+ 66.5	+ 16.5	272	- 60	- 66.5	- 76.7	- 126.7	16,000	- 50	- 66.5	- 133	- 183	33,500
19	- 50	0	- 50	2,500	- 50	0	0	- 50	2,500	- 50	0	0	- 50	2,500
20	- 50	+ 66.5	+ 116.5	13,500	+ 50	- 66.5	- 76.7	- 26.7	710	+ 50	- 66.5	- 133	- 83	6,900

21	+ 50	0	- 50	2,500	+ 50	0	0	+ 50	2,500	+ 50	- 66.5	- 133	-	83	6,900
22	+ 50	- 66.5	- 16.5	272	+ 50	- 66.5	- 76.7	- 26.7	710	+ 50	- 66.5	- 133	-	83	6,900
23	+ 50	0	+ 50	2,500	+ 50	0	0	- 50	2,500	+ 50	- 66.5	- 133	-	83	6,900
24	+ 50	- 66.5	- 16.5	272	+ 50	- 66.5	- 76.7	- 26.7	710	+ 50	- 66.5	- 133	-	83	6,900
25	+ 50	0	+ 50	2,500	+ 50	0	- 76.7	- 26.7	710	+ 50	- 66.5	- 133	-	83	6,900
26	+ 50	- 66.5	- 16.5	272	+ 50	- 66.5	- 76.7	- 26.7	710	+ 50	- 66.5	- 133	-	83	6,900
27	+ 50	0	+ 50	2,500	+ 50	0	- 76.7	- 26.7	710	+ 50	- 66.5	- 133	-	83	6,900
28	+ 50	- 66.5	- 16.5	272	+ 50	- 66.5	- 76.7	- 26.7	710	+ 50	- 66.5	- 133	-	83	6,900
29	+ 50	- 66.5	- 16.5	272	+ 50	- 66.5	- 76.7	- 26.7	710	+ 50	- 66.5	- 133	-	83	6,900
30	+ 50	- 66.5	- 16.5	272	+ 50	- 66.5	- 76.7	- 26.7	710	+ 50	- 66.5	- 133	-	83	6,900
31	+ 50	- 66.5	- 16.5	272	+ 50	- 66.5	- 76.7	- 26.7	710	+ 50	0	0	+	50	2,500
32	+ 50	- 66.5	- 16.5	272	+ 50	- 66.5	- 76.7	- 26.7	710	+ 50	- 66.5	- 133	-	83	6,900
33	+ 50	- 66.5	- 16.5	272	+ 50	- 66.5	- 76.7	- 26.7	710	+ 50	0	0	+	50	2,500
34	+ 50	- 66.5	- 16.5	272	+ 50	- 66.5	- 76.7	- 26.7	2,500	+ 50	- 66.5	- 133	-	83	6,900
35	+ 50	- 66.5	- 16.5	272	+ 50	- 66.5	- 76.7	- 26.7	710	+ 50	- 66.5	- 133	-	83	6,900
36	+ 50	- 66.5	- 16.5	272	+ 50	- 66.5	0	+ 50	2,500	+ 50	0	0	+	50	2,500
37	+ 50	- 66.5	- 16.5	272	+ 50	- 66.5	- 76.7	- 26.7	710	+ 50	+ 66.5	+ 133	+	183	33,000
38	+ 50	0	+ 50	2,500	+ 50	0	0	+ 50	2,500	+ 50	0	0	+	50	2,500
39	+ 50	- 66.5	- 16.5	272	+ 50	- 66.5	- 76.7	- 26.7	710	+ 50	+ 66.5	+ 133	+	183	33,500
40	+ 50	0	+ 50	2,500	+ 50	0	0	+ 50	2,500	+ 50	0	0	+	50	2,500
41	+ 50	- 66.5	- 16.5	272	+ 50	- 66.5	+ 76.7	+ 126.7	16,000	+ 50	+ 66.5	+ 133	+	183	33,500
42	+ 50	0	+ 50	2,500	+ 50	0	0	+ 50	2,500	+ 50	0	0	+	50	2,500
43	+ 50	- 66.5	- 16.5	272	+ 50	- 66.5	+ 76.7	+ 126.7	710	+ 50	+ 66.5	+ 133	+	183	33,500
44	- 50	0	- 50	2,500	- 50	0	0	- 50	2,500	- 50	0	0	-	50	2,500
45	- 50	+ 66.5	+ 16.5	272	- 50	+ 66.5	+ 76.7	+ 26.7	710	- 50	+ 66.5	+ 133	+	83	6,900
46	- 50	0	- 50	2,500	- 50	0	0	- 50	2,500	- 50	+ 66.5	+ 133	+	83	6,900
47	- 50	+ 66.5	+ 16.5	272	- 50	+ 66.5	+ 76.7	+ 26.7	710	- 50	+ 66.5	+ 133	+	83	6,900
48	- 50	0	- 50	2,500	- 50	0	0	- 50	2,500	- 50	+ 66.5	+ 133	+	83	6,900

Σ (Current²) = 448,000.
 ∴ C²R is 37.3 per cent.

Σ (Current²) = 108,600.
 ∴ C²R is 90.3 per cent.

Σ (Current²) = 61,900.
 48 × 50² = 48 × 2500 = 120,000.
 ∴ C²R is 51.5 per cent. of that
 of continuous current alone.

TABLE LIV.

Number of Conductor.	Current in Phase.				Current 30 Deg. Out of Phase. Cos. 30 Deg. = .866.				Current 60 Deg. Out of Phase. Cos. 60 Deg. = .500.					
	Continuous Current.	Alternating Current.	Resultant Current.	(Current) %.	Continuous Current.	Alternating Current, not considering Power Factor.	Alternating Current + .866.	Resultant Current.	(Current) %.	Continuous Current.	Alternating Current, not considering Power Factor.	Alternating Current + .500.	Resultant Current.	(Current) %.
1	- 50	+ 38.3	- 11.7	137	- 50	+ 38.3	+ 44.1	- 5.9	35	- 50	+ 38.3	+ 76.5	+ 26.5	700
2	- 50	- 38.3	- 88.3	7800	- 50	+ 76.5	+ 88.2	+ 38.2	1450	- 50	+ 76.5	+ 153	+ 103	10,600
3	- 50	+ 38.3	+ 11.7	137	- 50	+ 38.3	+ 44.1	- 5.9	35	- 50	+ 38.3	+ 76.5	+ 26.5	700
4	- 50	- 38.3	- 88.3	7800	- 50	+ 76.5	+ 88.2	+ 38.2	1450	- 50	+ 76.5	+ 153	+ 103	10,600
5	- 50	+ 38.3	- 11.7	137	- 50	+ 38.3	+ 44.1	- 5.9	35	- 50	+ 38.3	+ 76.5	+ 26.5	700
6	- 50	+ 76.5	+ 26.5	700	- 50	+ 76.5	+ 88.2	+ 38.2	1450	- 50	+ 76.5	+ 153	+ 103	10,600
7	- 50	+ 38.3	- 11.7	137	- 50	+ 38.3	+ 44.1	+ 5.9	35	- 50	+ 38.3	+ 76.5	+ 26.5	700
8	- 50	+ 76.5	+ 26.5	700	- 50	+ 76.5	+ 88.2	+ 38.2	1450	- 50	+ 76.5	+ 153	+ 103	10,600
9	- 50	+ 38.3	- 11.7	137	- 50	+ 38.3	+ 44.1	- 5.9	35	- 50	+ 38.3	+ 76.5	+ 26.5	700
10	- 50	+ 76.5	+ 26.5	700	- 50	+ 76.5	+ 88.2	+ 38.2	1450	- 50	+ 76.5	+ 153	+ 103	10,600
11	- 50	+ 38.3	- 11.7	137	- 50	+ 38.3	+ 44.1	- 5.9	35	- 50	+ 38.3	+ 76.5	+ 26.5	700
12	- 50	+ 76.5	+ 26.5	700	- 50	+ 76.5	+ 88.2	+ 38.2	1450	- 50	+ 76.5	+ 153	+ 103	10,600
13	- 50	+ 38.3	- 11.7	137	- 50	+ 38.3	+ 44.1	- 5.9	35	- 50	+ 38.3	+ 76.5	+ 26.5	700
14	- 50	+ 76.5	+ 26.5	700	- 50	+ 76.5	+ 88.2	+ 38.2	1450	- 50	+ 38.3	+ 76.5	+ 26.5	700
15	- 50	+ 38.3	- 11.7	137	- 50	+ 38.3	+ 44.1	- 5.9	35	- 50	+ 38.3	+ 76.5	+ 26.5	700
16	- 50	+ 76.5	+ 26.5	700	- 50	+ 76.5	+ 88.2	+ 38.2	1450	- 50	- 38.3	- 76.5	- 126.5	16,000
17	- 50	+ 38.3	- 11.7	137	- 50	+ 76.5	+ 88.2	+ 38.2	1450	- 50	+ 38.3	+ 76.5	+ 26.5	700
18	- 50	+ 76.5	+ 26.5	700	- 50	+ 38.3	+ 44.1	- 5.9	35	- 50	+ 38.3	+ 76.5	+ 26.5	700
19	- 50	+ 38.3	- 11.7	137	- 50	+ 38.3	+ 44.1	- 94.1	8900	- 50	- 38.3	- 76.5	- 126.5	16,000
20	- 50	+ 76.5	+ 26.5	700	- 50	- 38.3	+ 44.1	- 94.1	8900	- 50	+ 38.3	+ 76.5	+ 26.5	700

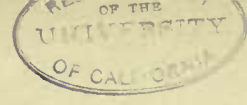

C²R Loss in Armature Conductors of Rotary Converters.

21	- 50	+ 38.3	- 11.7	137	- 50	+ 38.3	+ 44.1	- 5.9	35	- 50	- 76.5	- 153	- 203	41,000
22	- 50	- 38.3	- 88.3	7800	- 50	- 38.3	- 44.1	- 94.1	8900	- 50	+ 38.3	- 76.5	- 126.5	16,000
23	- 50	+ 38.3	- 11.7	137	- 50	+ 38.3	+ 44.1	- 5.9	35	- 50	- 76.5	- 153	- 203	41,000
24	+ 50	- 38.3	+ 11.7	137	+ 50	- 38.3	- 44.1	+ 5.9	35	+ 50	- 38.3	- 76.5	- 26.5	700
25	+ 50	+ 38.3	+ 88.3	7800	+ 50	+ 38.3	- 88.2	- 38.2	1450	+ 50	- 76.5	- 153	- 103	10,600
26	+ 50	- 38.3	+ 11.7	107	+ 50	- 38.3	- 44.1	+ 5.9	35	+ 50	- 38.3	- 76.5	- 26.5	700
27	+ 50	+ 38.3	+ 88.3	7800	+ 50	+ 38.3	- 88.2	- 38.2	1450	+ 50	- 76.5	- 153	- 103	10,600
28	+ 50	- 38.3	+ 11.7	137	+ 50	- 38.3	- 44.1	+ 5.9	35	+ 50	- 38.3	- 76.5	- 26.5	700
29	+ 50	- 76.5	- 26.5	700	+ 50	- 76.5	- 88.2	- 38.2	1450	+ 50	- 76.5	- 153	- 103	10,600
30	+ 50	- 38.3	+ 11.7	137	+ 50	- 38.3	- 44.1	+ 5.9	35	+ 50	- 38.3	- 76.5	- 26.5	700
31	+ 50	- 76.5	- 26.5	700	+ 50	- 76.5	- 88.2	- 38.2	1450	+ 50	- 76.5	- 153	- 103	10,600
32	+ 50	- 38.3	+ 11.7	137	+ 50	- 38.3	- 44.1	+ 5.9	35	+ 50	- 38.3	- 76.5	- 25.6	700
33	+ 50	- 76.5	- 26.5	700	+ 50	- 76.5	- 88.2	- 38.2	1450	+ 50	- 76.5	- 153	- 103	10,600
34	+ 50	- 38.3	+ 11.7	137	+ 50	- 38.3	- 44.1	+ 5.9	35	+ 50	- 38.3	- 76.5	- 26.5	700
35	+ 50	- 76.5	- 26.5	700	+ 50	- 76.5	- 88.2	- 38.2	1450	+ 50	- 76.5	- 153	- 103	10,600
36	+ 50	- 38.3	+ 11.7	137	+ 50	- 38.3	- 44.1	+ 5.9	35	+ 50	- 38.3	- 76.5	- 26.5	700
37	+ 50	- 76.5	- 26.5	700	+ 50	- 76.5	- 88.2	- 38.2	1450	+ 50	- 76.5	- 153	- 103	10,600
38	+ 50	- 38.3	+ 11.7	137	+ 50	- 38.3	- 44.1	+ 5.9	35	+ 50	- 38.3	- 76.5	- 26.5	700
39	+ 50	- 76.5	- 26.5	700	+ 50	- 76.5	- 88.2	- 38.2	1450	+ 50	- 76.5	- 153	- 103	10,600
40	+ 50	- 38.3	+ 11.7	137	+ 50	- 38.3	- 44.1	+ 5.9	35	+ 50	- 38.3	- 76.5	- 26.5	700
41	+ 50	- 76.5	- 26.5	700	+ 50	- 76.5	- 88.2	- 38.2	1450	+ 50	- 76.5	- 153	- 103	10,600
42	+ 50	- 38.3	+ 11.7	137	+ 50	- 38.3	- 44.1	+ 5.9	35	+ 50	- 38.3	- 76.5	- 26.5	700
43	+ 50	- 76.5	- 26.5	700	+ 50	- 76.5	- 88.2	- 38.2	1450	+ 50	- 76.5	- 153	- 103	10,600
44	+ 50	- 38.3	+ 11.7	137	+ 50	- 38.3	- 44.1	+ 5.9	35	+ 50	- 38.3	- 76.5	- 26.5	700
45	+ 50	+ 38.3	+ 88.3	7800	+ 50	+ 38.3	+ 44.1	+ 94.1	8900	+ 50	+ 38.3	+ 76.5	+ 126.5	16,000
46	+ 50	- 38.3	+ 11.7	137	+ 50	- 38.3	- 44.1	+ 5.9	35	+ 50	- 38.3	- 76.5	- 26.5	700
47	+ 50	+ 38.3	+ 88.3	7800	+ 50	+ 38.3	+ 44.1	+ 94.1	8900	+ 50	+ 38.3	+ 76.5	+ 126.5	16,000
48	- 50	- 38.3	- 88.3	7800	- 50	- 38.3	- 44.1	- 94.1	8900	- 50	+ 76.5	+ 153	+ 203	41,000

Σ (Current²) = 451,700.
∴ C²R is 376 per cent.

Σ (Current²) = 95,240.
∴ C²R is 79.5 per cent.

Σ (Current²) = 76,900.
∴ C²R is 64 per cent.

instantaneous values, a sine wave current curve has been assumed, working from the maximum value of $54 \times \sqrt{2} = 76.5$ amperes.

When the current is in phase with the electromotive force, the distribution of things for positions A and B respectively, is as shown in the diagrams of Figs. 368 and 369. There are 48 conductors, corresponding to two poles, and these are numbered from 1 to 48. Any 48 successive conductors will give the same result. The values and arrowheads at the upper part of the lines representing the face conductors, give the instantaneous values and directions of the currents corresponding to the instantaneous conditions. The figures and arrowheads at the middle of these lines give the instantaneous values and directions of the resultant currents. These results are also given in Tables LIII. and LIV., where a current from bottom to top is regarded as positive, and from top to bottom, as negative. There are also given values for lagging currents, the results from which show a rapid rise in C^2R loss.

These results are summed up in Table LV., the figures given being the average for positions A and B:—

TABLE LV.—PER CENT. THAT ARMATURE C^2R LOSS IS OF THAT OF SAME ARMATURE IN A CONTINUOUS-CURRENT GENERATOR FOR THE SAME OUTPUT, ASSUMING 100 PER CENT. CONVERSION EFFICIENCY.

Power Factor.							Per Cent.
1.00	58
.87	85
.50	375
0	∞

Some indefiniteness is introduced by the exact position and width of the brushes under the condition of power factor of unity, the results for this value being higher, in proportion as the number of conductors per pole is low. But for the other values of the power factor, this indefiniteness does not appear. It will be noted that, just before reaching the position of short-circuit under the brush, the current is often the sum of the alternating and continuous currents.

Throwing the results into the above form, brings out forcibly the fact that it is only for comparatively high-power factors that the residual C^2R loss is so greatly decreased.

SINGLE-PHASE ROTARY CONVERTERS.

The winding is connected up to the commutator segments, exactly as for an ordinary continuous-current dynamo. For the alternating-current connections the winding is tapped, for a two-circuit winding, at some one point, to one collector ring. Then after tracing through one-half of the armature conductors, a tap is carried to the other collector ring. This case

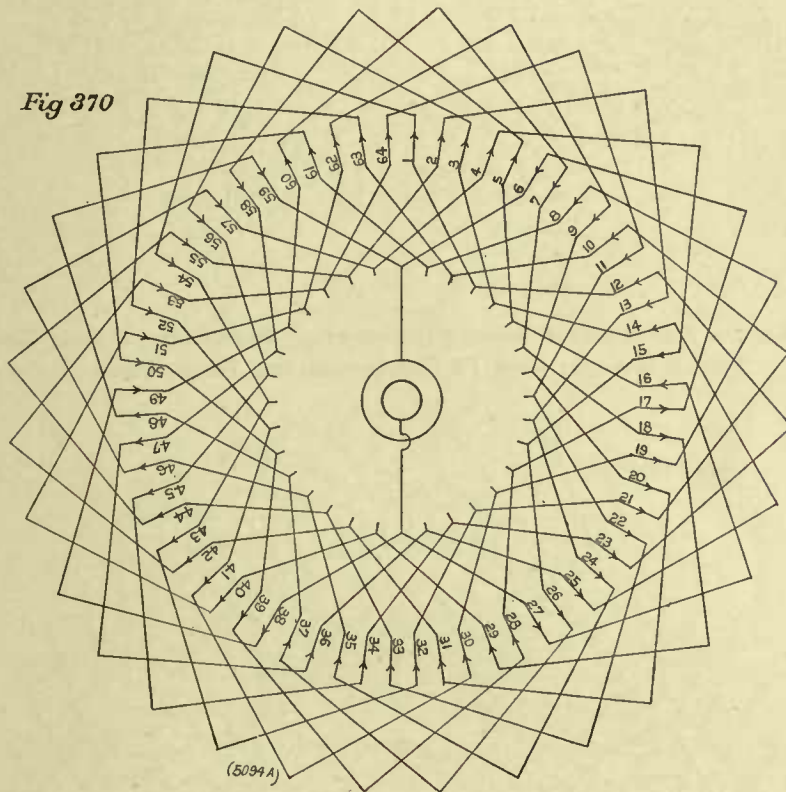

WINDING FOR A SINGLE-PHASE ROTARY CONVERTER. TWO-CIRCUIT SINGLE WINDING WITH 64 CONDUCTORS, SIX POLES, PITCH 11.

of a two-circuit single winding, connected up as a single-phase rotary converter, is illustrated in the winding diagram of Fig. 370, which relates to a six-pole armature with 64 conductors.

In Fig. 371 is given a diagram for a six-pole single-phase rotary converter, with a two-circuit singly re-entrant triple winding. This winding has 72 conductors. Single-phase rotary converters, with two-

Fig. 371

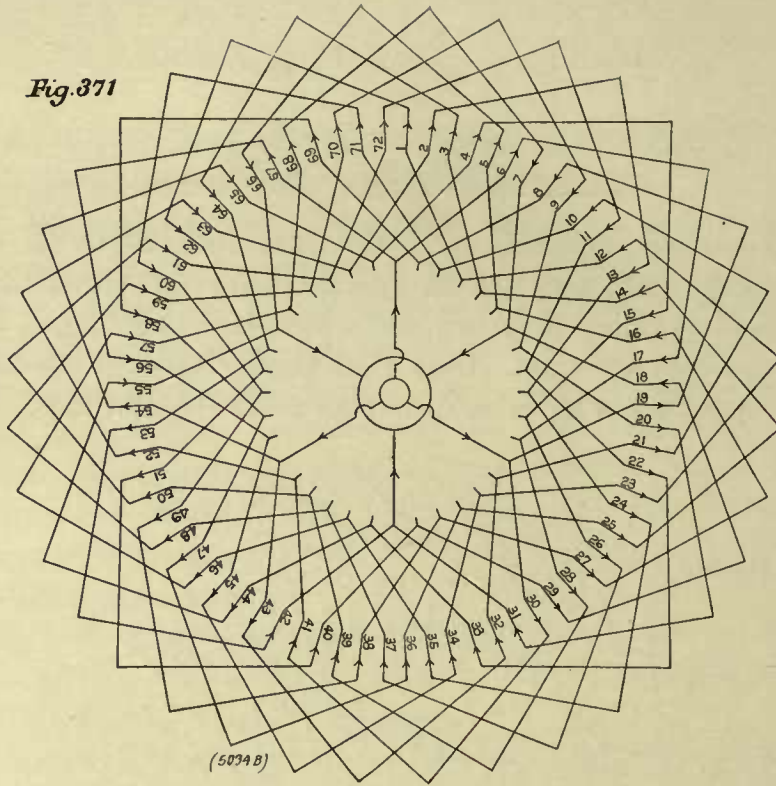

WINDING FOR A SINGLE-PHASE ROTARY CONVERTER. TWO-CIRCUIT SINGLY RE-ENTRANT TRIPLE WINDING WITH 72 CONDUCTORS, SIX POLES, PITCH 11.

Fig. 372

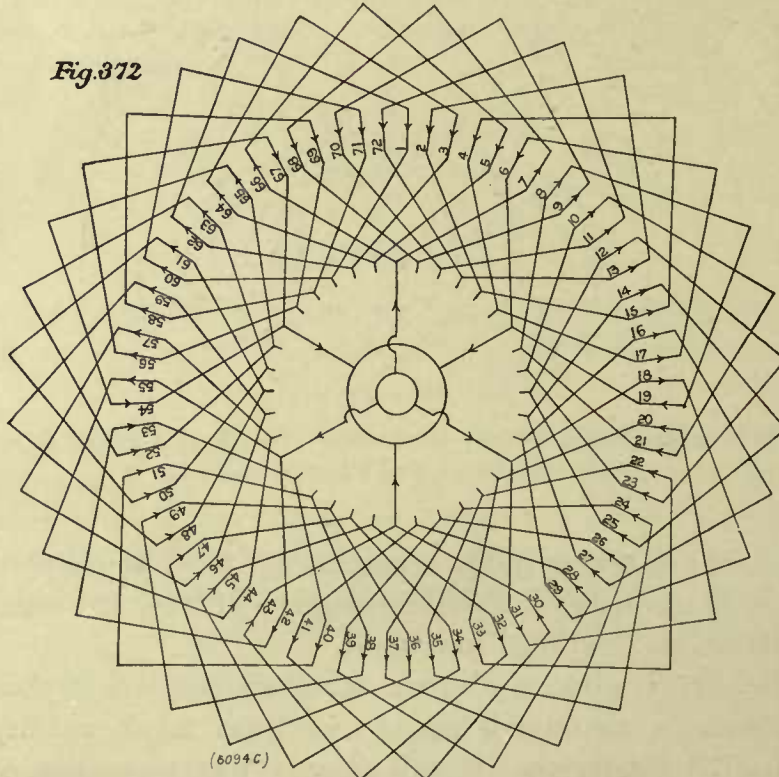

WINDING FOR A SINGLE-PHASE ROTARY CONVERTER. TWO-CIRCUIT SINGLE WINDING WITH 72 CONDUCTORS, SIX POLES, FRONT PITCH 13, BACK PITCH 11.

circuit *multiple* windings, have two taps per winding, hence the two-circuit triple winding of Fig. 371 has $2 \times 3 = 6$ equi-distant taps.

In Fig. 372 a six-circuit single winding, also with 72 conductors, is connected up as a single-phase rotary converter.—For such a winding

Fig. 373.

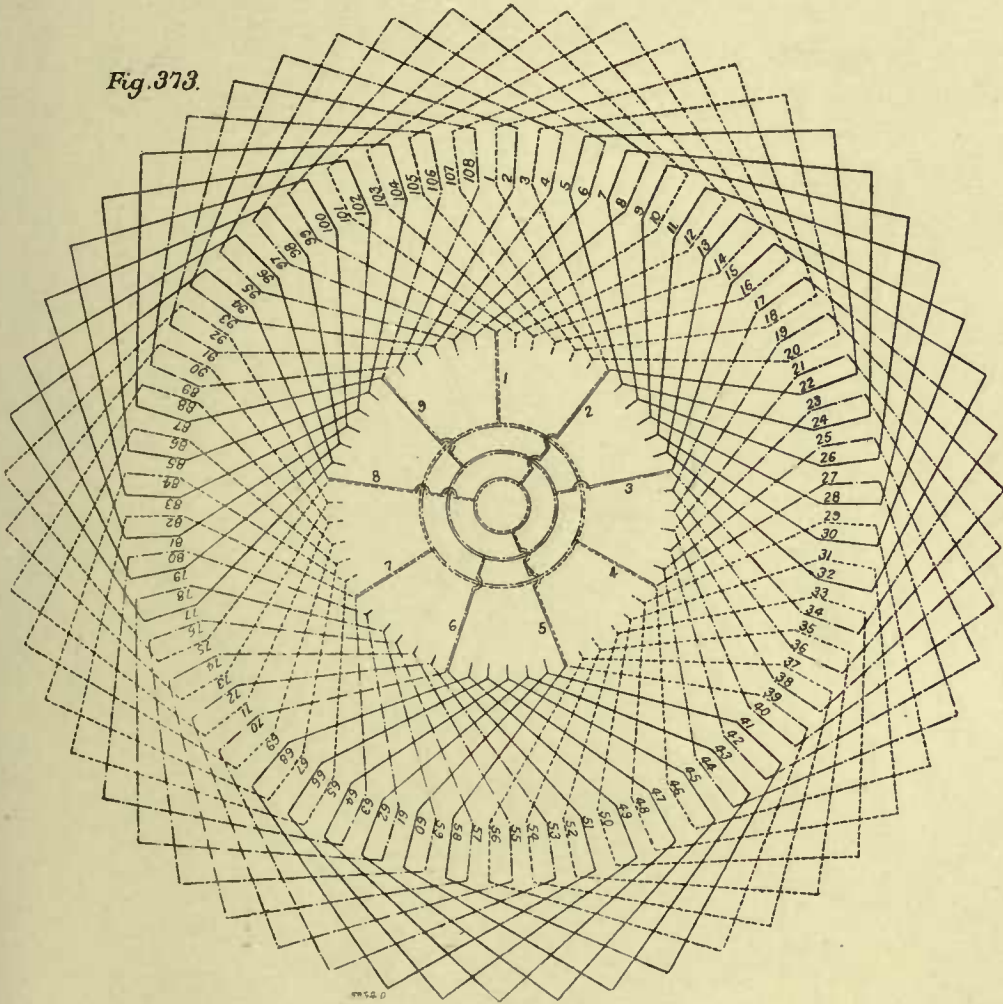

WINDING FOR A THREE-PHASE ROTARY CONVERTER. SIX-CIRCUIT SINGLE WINDING WITH 108 CONDUCTORS, SIX POLES, FRONT PITCH 19, BACK PITCH 17.

there are two taps per pair of poles, hence six taps in all, the winding being divided up into six equal sections of 12 conductors each.

In single-phase rotary converters, the overlapping of the commutator and collector-ring currents is so much less complete than for multiphase, as shown already on pages 284, 285, Tables LI. and LII., as to render their

use very uneconomical, because of the reduced output in a given machine. There is the further disadvantage that a single-phase rotary cannot be run up to synchronism from the alternating-current side. In general, the operation of single-phase rotary converters is distinctly unsatisfactory, and

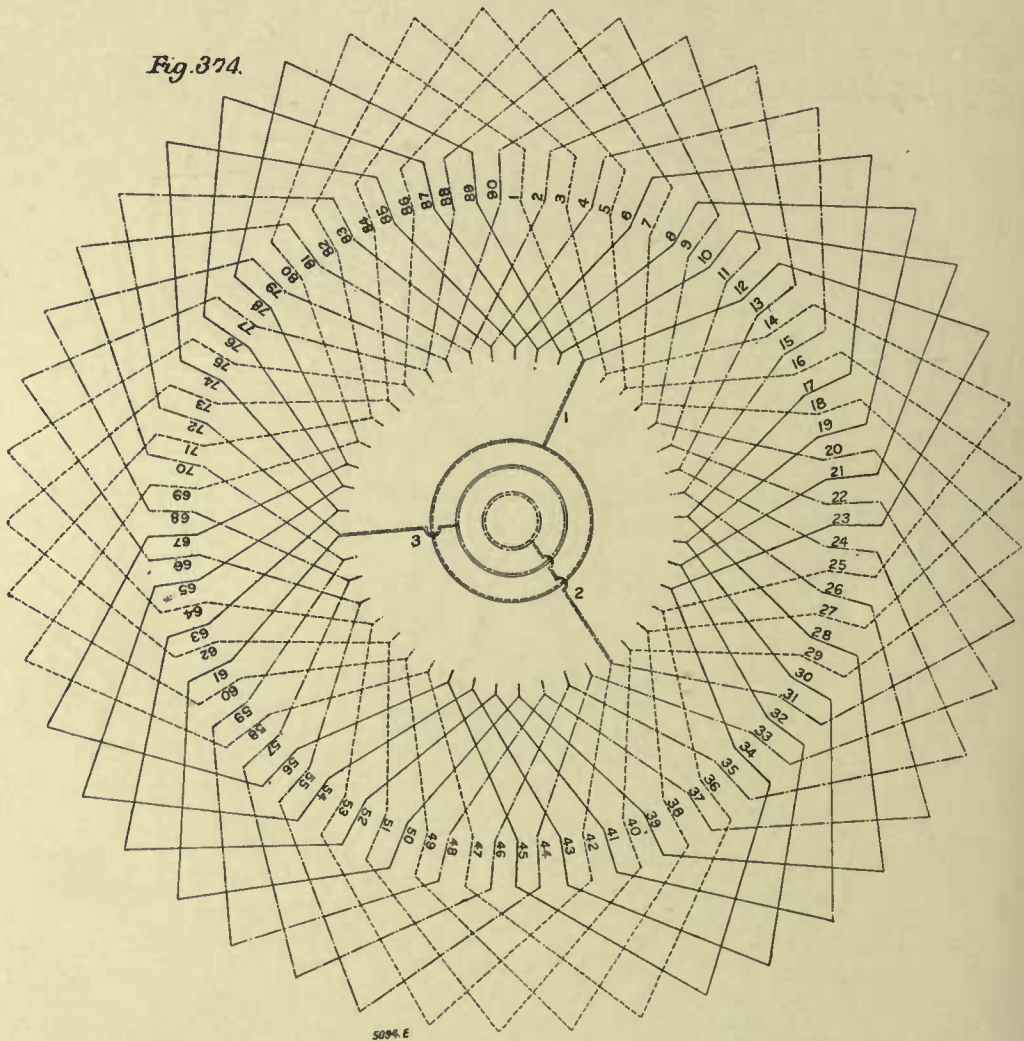

WINDING FOR A THREE-PHASE ROTARY CONVERTER. TWO-CIRCUIT SINGLE WINDING WITH 90 CONDUCTORS, EIGHT POLES, PITCH 11.

they are rarely used except for small capacities. An examination of the windings shows that, due to the distribution of the conductors over the entire peripheral surface, the turns in series between collector rings are never simultaneously linked with the entire magnetic flux; in fact, such a winding used as a pure alternating current single-phase generator, gives

but 71 per cent. as great a voltage at the collector rings as the same machine used as a continuous-current dynamo would give at the commutator.¹ The ratio of the outputs, under such conditions, is for equal loads in the armature conductors, 71:100. It will be seen in the following that this is largely avoided when the winding is subdivided for

Fig. 375

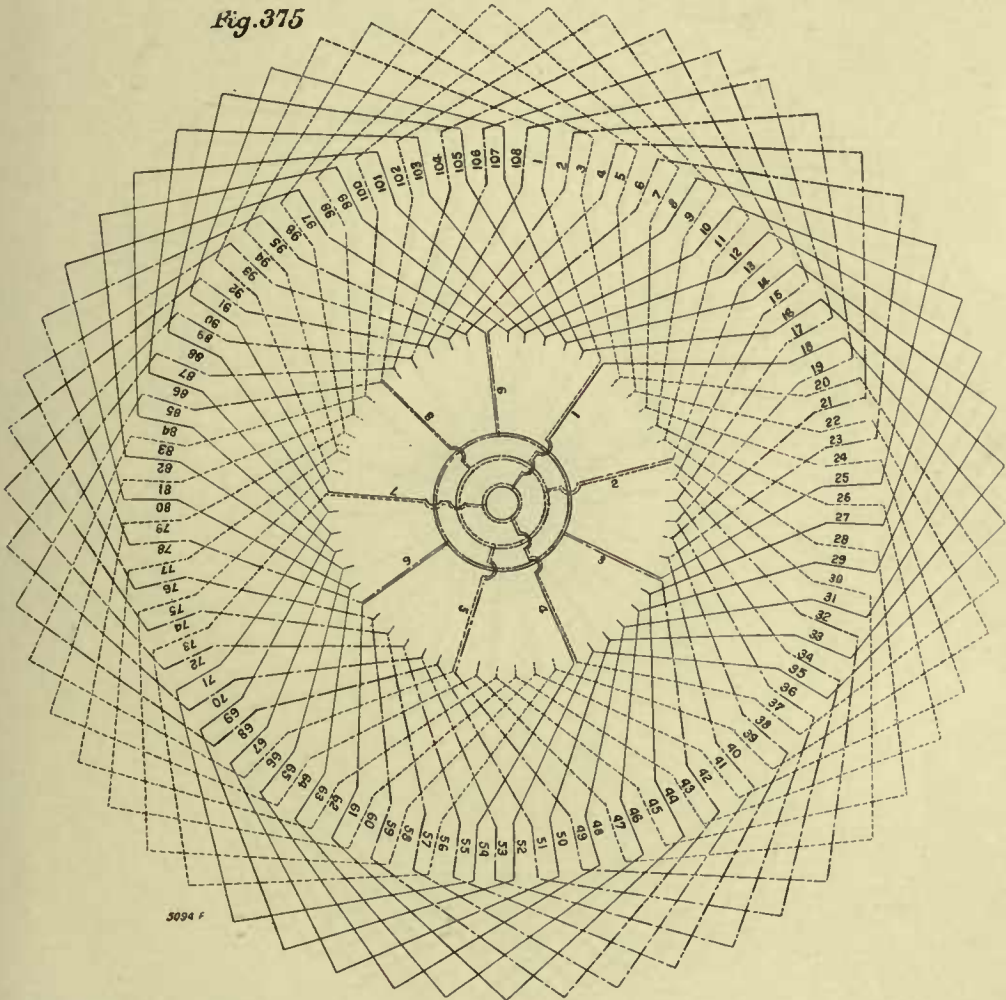

WINDING FOR A THREE-PHASE ROTARY CONVERTER. TWO-CIRCUIT SINGLY RE-ENTRANT TRIPLE WINDING WITH 108 CONDUCTORS, SIX POLES, PITCH 17.

polyphase connections, and the relative advantages of these different polyphase systems is largely dependent upon the extent to which they are free from this objection.

¹ A discussion of the ratio of commutator and collector-ring voltages in rotary converters has already been given on pages 84 to 86, in the section relating to Formulæ for Electromotive Force.

THREE-PHASE ROTARY CONVERTERS.

The earlier rotaries were generally operated as three-phasers, the output for a given C^2R loss in the armature winding being 38 per cent. greater than for the same armature as used in a continuous-current

Fig. 376.

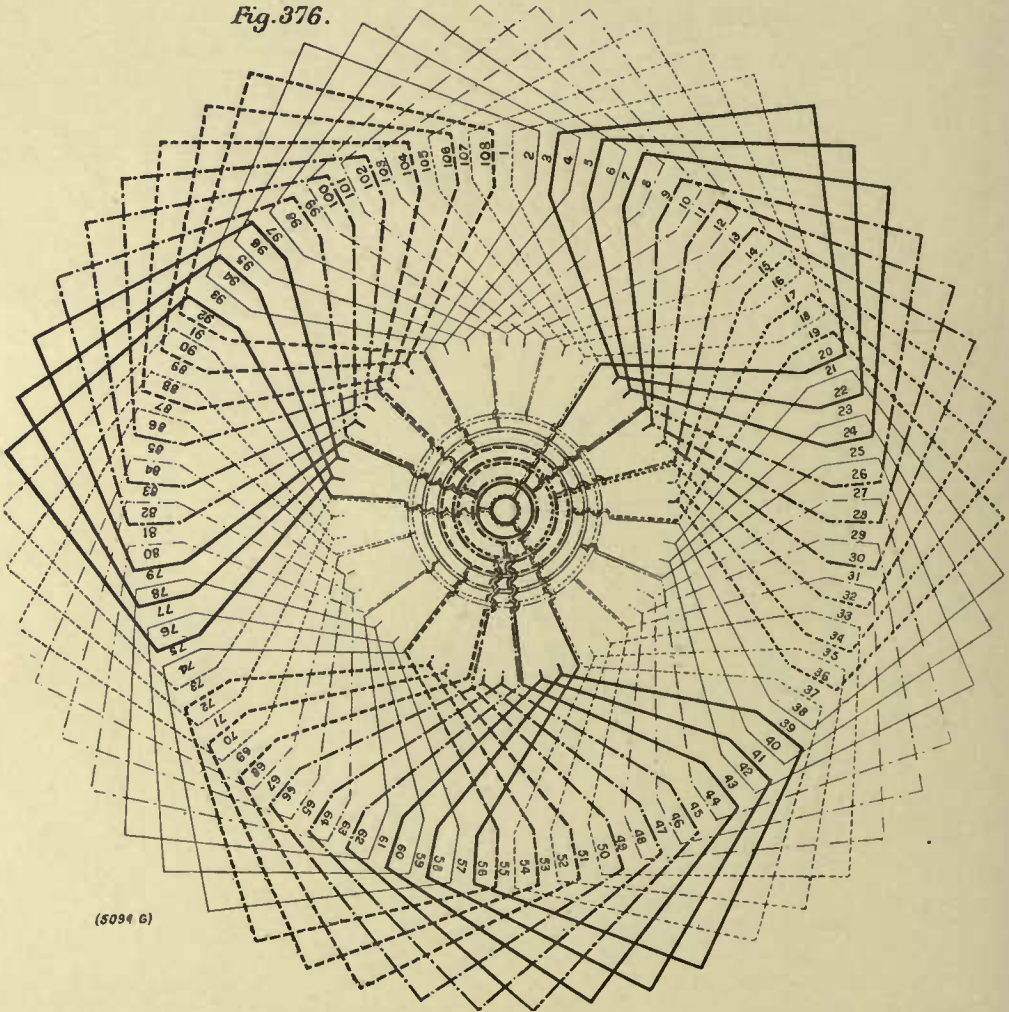

(5034 G)

WINDING FOR A SIX-PHASE ROTARY CONVERTER. SIX-CIRCUIT SINGLE WINDING WITH 108 CONDUCTORS, SIX POLES, PITCH, FRONT 19, BACK 17.

generator. To-day, however, most rotaries are being arranged to be operated either as four or six-phasers, with the still further advantages of 67 per cent. and 98 per cent. increased output respectively, for a given heating in the armature conductors. These are the values given in Table LI.

For three-phase rotary converters, there are three sections per pair of poles in multiple-circuit single windings, and three sections per pair of poles per winding in multiple-circuit multiple windings. There are three sections per winding, regardless of the number of pairs of poles

Fig. 377.

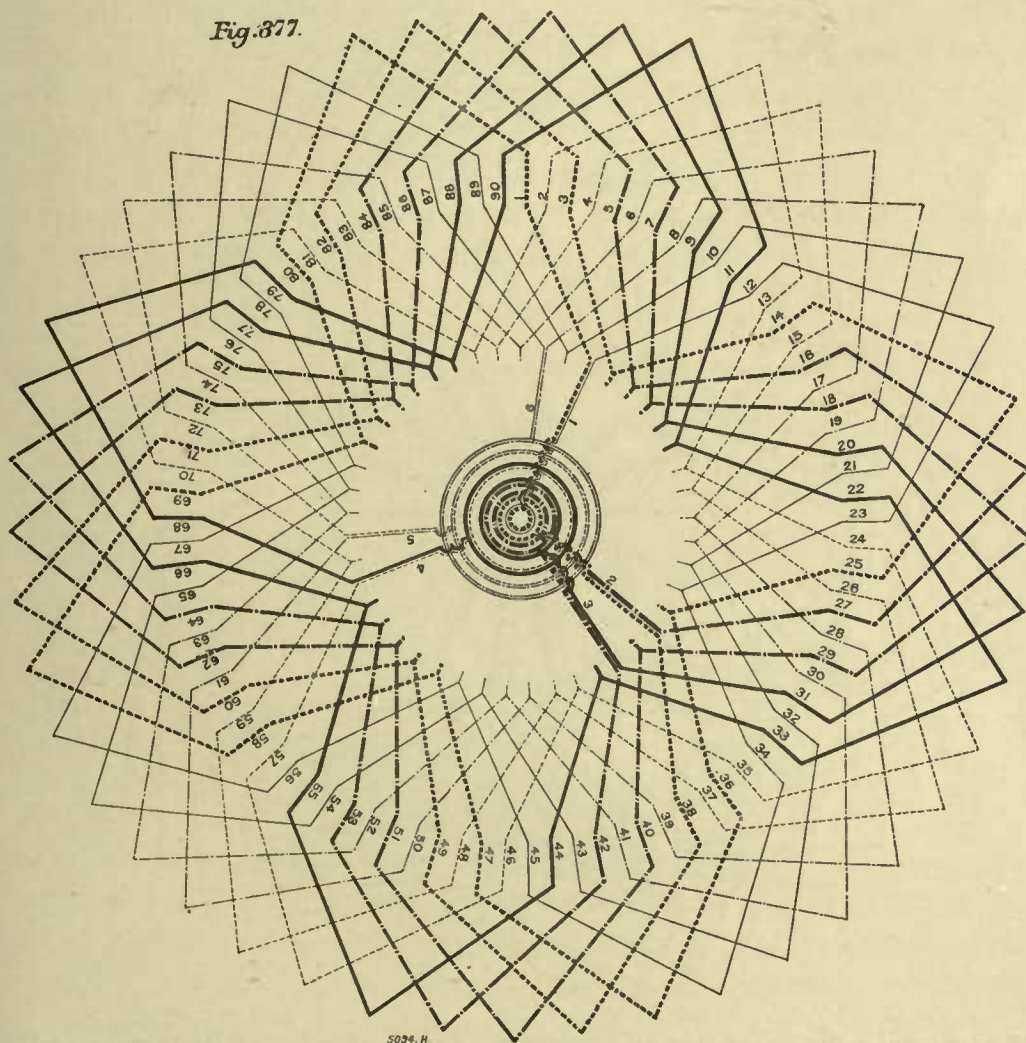

WINDING FOR A SIX PHASE ROTARY CONVERTER. TWO-CIRCUIT SINGLE WINDING WITH 90 CONDUCTORS, EIGHT POLES, PITCH 11.

in two-circuit windings. Thus, a six-pole machine, with a six-circuit triple winding, would have $\frac{6}{2} \times 3 = 9$ sections. At equal ninths through the winding from beginning to end, leads would be carried to collector rings, three leads to each of the three collector rings. But if the armature had had a two-circuit double winding, there would have

been but three sections per winding, regardless of the number of poles; hence, for this two-circuit double winding there would be $2 \times 3 = 6$ sections, and six leads to the three collector rings. In Figs. 373, 374 and 375 are given diagrams of three-phase rotary converter windings, from a

Fig. 378.

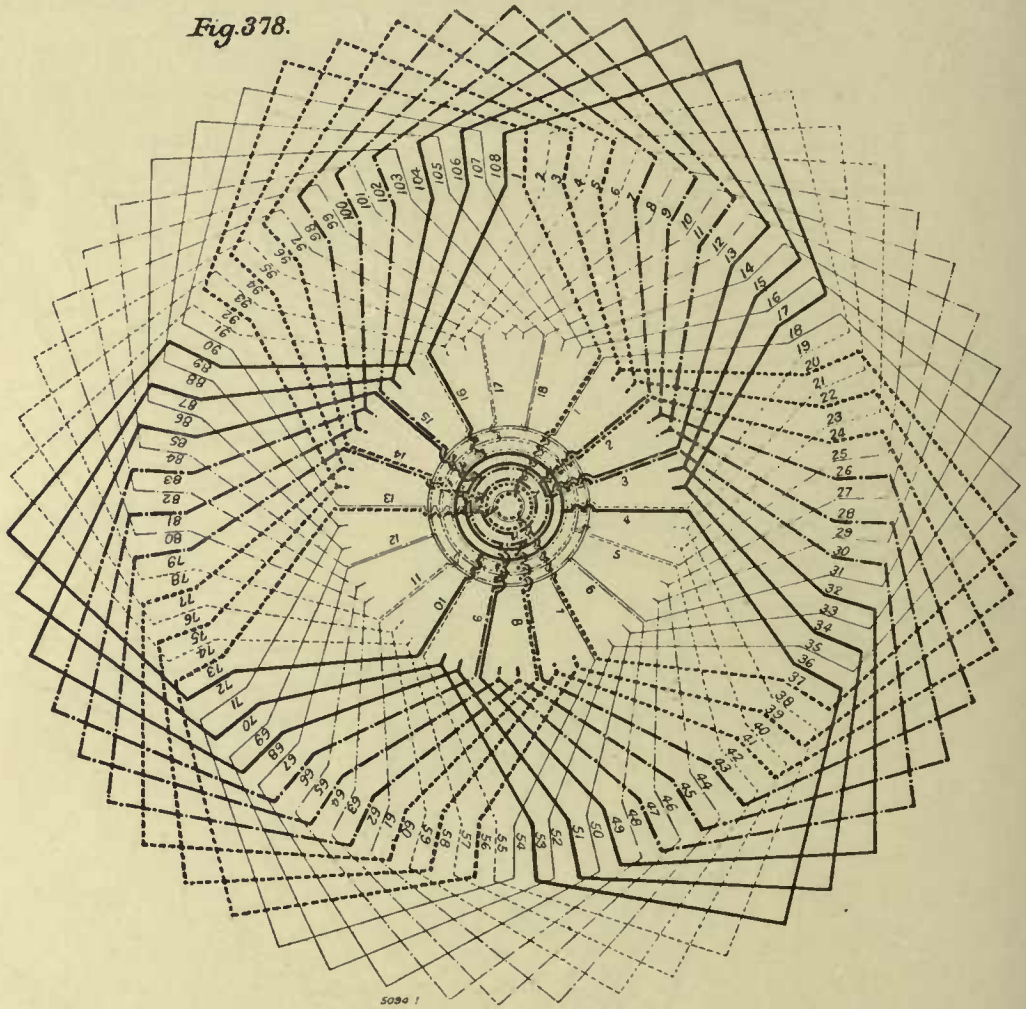

WINDING FOR A SIX-PHASE ROTARY CONVERTER. TWO CIRCUIT SINGLY RE-ENTRANT TRIPLE WINDING WITH 108 CONDUCTORS, SIX POLES, PITCH 17.

study of which familiarity with the inherent characteristics of such windings may be obtained. The most distinctive characteristic is the overlapping distribution of the conductors of the three phases, in consequence of which any one portion of the periphery of the armature carries conductors belonging to two phases. At one portion, the conductors will belong alternately to phases 1 and 2, then to 2 and 3, and then to 3 and 1, then

again to 1 and 2, the repetition occurring once per pair of poles. As a consequence of this property, the conductors of any one phase are distributed over two-thirds of the entire periphery, and when the width of the magnetic flux exceeds one-third of the polar pitch—and it is generally, when spreading is considered, at least three-quarters of the polar pitch—all the turns of one phase will not be simultaneously linked with the entire flux, and the consequence is a lower alternating-current voltage per phase than if simultaneous linkage of all the turns of one phase with the entire flux occurred. Hence, for a given heating, the output is limited, although already, because of more effective linkage of turns and flux, 56 per cent. higher than for single-phase rotaries.

SIX-PHASE ROTARY CONVERTER.

This disadvantage is mainly overcome in the so-called six-phase rotary converter, in which—as will appear later—the conductors of any one

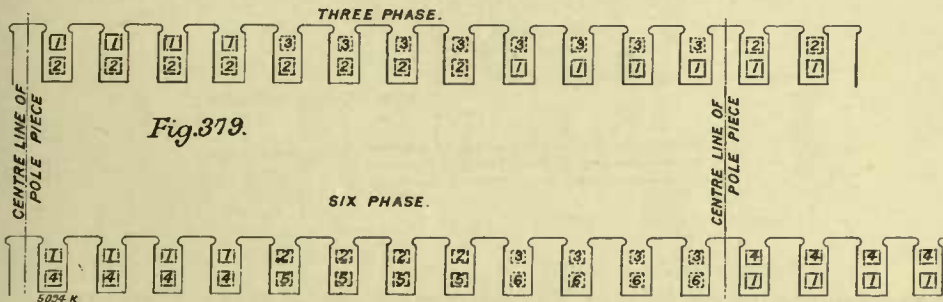

Fig. 379.

phase are distributed over only one-third of the entire periphery, as a result of which an almost simultaneous linkage of all the turns of one phase, with the entire magnetic flux, is obtained. The resultant output of such a machine, for a given heating of the armature conductors, increases, as stated in Table LI. on page 284, in the ratio of 1.38 to 1.98, *i.e.*, by 44 per cent. beyond that of an ordinary three-phase machine. As a matter of fact, this so-called six-phase is only a special case of three-phase arrangement. This distinction will be subsequently made clear.

Figs. 376, 377, and 378 are the same winding diagrams as for Figs. 373, 374, and 375 (pages 297, 298, and 299), but with the connections made for so-called "six-phase," with six collector rings. This requires in each case subdividing the winding up into just twice as many sections as for the case of three-phase windings. A study of these windings will show that

with these connections with six sections (where before there were three), the first and fourth, second and fifth, and third and sixth, taken in pairs, give a distribution of the conductors, suitable for a three-phase winding, each of the above pairs constituting a phase. Furthermore, each portion of the periphery is now occupied exclusively by conductors belonging to one phase, *i.e.*, the first and fourth groups, the second and fifth, or the third and sixth, and in this way is distinguished from the previously described three-phase windings in which the phases overlapped.

This distinction will be made more clear by a study of the diagrams given in Fig. 379.

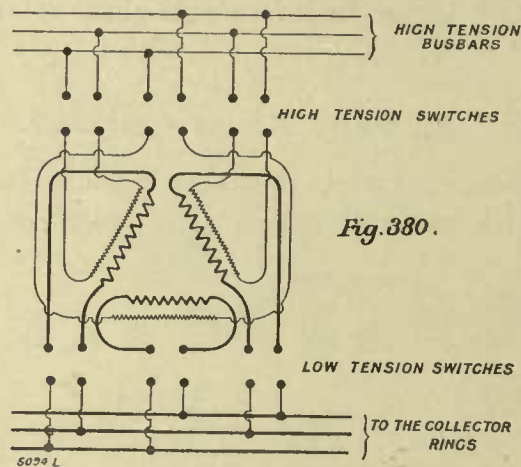

INTERCONNECTION OF STATIC TRANSFORMERS AND ROTARY CONVERTERS.

For three-phase rotary converters, the transformers should preferably be connected in "delta," as this permits the system to be operated with two transformers in case the third has to be cut out of circuit temporarily for repairs.

A satisfactory method of connection is given in Fig. 380.

For six-phase rotary converters, either of two arrangements will be satisfactory. One may be denoted as the "double delta" connection, and the other as the "diametrical" connection. Let the winding be represented by a circle (Fig. 381), and let the six equidistant points on the circumference represent collector rings, then the secondaries of the transformers may be connected up to the collector rings in a "double delta," as in the first diagram, or across diametrical pairs of points as in the second diagram. In the first case it is necessary that each of the three transformers have

two independent secondary coils, as A and A¹, B and B¹, C and C¹, whereas in the second case there is need for but one secondary coil per transformer. The two diagrams (Fig. 382) make this clear.

In the first case, the ratio of collector ring to commutator voltage is the same as for a three-phase rotary converter, it simply consisting of two "delta" systems. In the second case, the ratio is the same as for a single-phase rotary converter, it being analogous to three such systems.

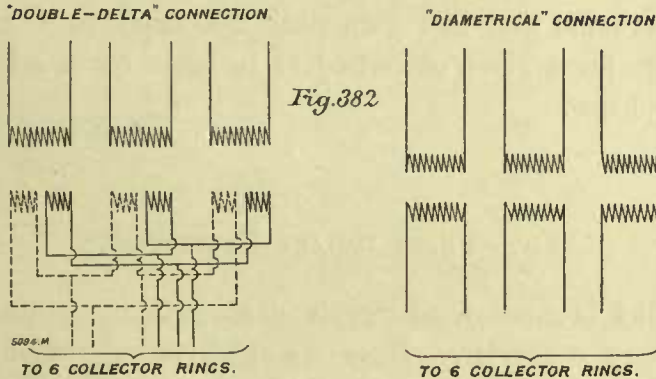
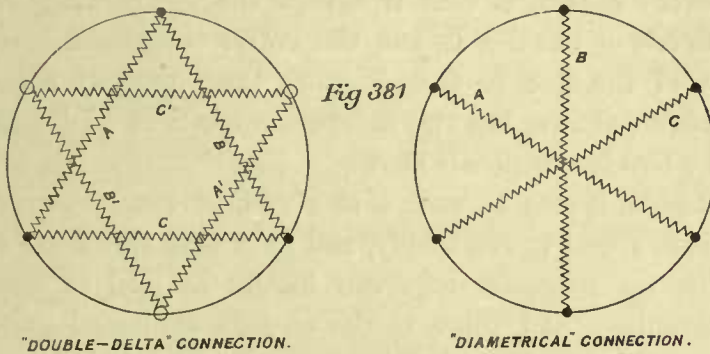

TABLE LVI.

Style of Connection for Six-Phase Rotary Converter.	Ratio of Collector Ring Voltage to Commutator Voltage.
Double-delta connection	.612
Diametrical	.707

The latter—the "diametrical"—connection, is, on the whole, to be preferred. The higher voltage at the collector rings, permits of carrying lighter cables about the station in wiring up from the static transformers to the rotary converter. It also only requires two secondary leads to be brought out—per transformer—and it simplifies the switching arrangements.

A switchboard connection suitable for a plant with four, six-phase rotary converters is given in Fig. 383, where it is arranged that the synchronising shall be done on the high-tension side of the transformer. This method of synchronising avoids the necessity of six-bladed, heavy current, low-tension switches. The switches A and B are more for the purpose of connectors; the line circuits are intended to be made and broken by the high-tension, quick-break switches C. Another feature of the arrangement shown, is that it brings the entire alternating-current system to the left of the line L, and the entire continuous-current system to the right of the line L, thus keeping them entirely separate. The particular scheme shown, has two independent sets of high-tension feeders coming to the two feeder panels shown.

In conclusion, it may be said that six-phase rotary converters have, in practice, been found to run stably, and have been free from surging and flashing. The six collector rings can hardly be said to constitute any serious disadvantage, and there is the already explained gain of 44 per cent. in output from the standpoint of the heating of the armature conductors. This latter is, of course, an important advantage; but it must be kept in mind that this gain does not apply to the commutator, which must be—for a given output—just as large for a six-phase rotary as for a three-phaser.

FOUR-PHASE ROTARY CONVERTERS.

In Fig. 384 is given a six-circuit single winding connected up as a four-phase rotary converter. Here we subdivide the winding into four sections per pair of poles—hence in this case $4 \times \frac{6}{2} = 12$ total sections, and four collector rings.

A two-circuit single winding connected up for a four-phase rotary converter, is shown in Fig. 385. It is subdivided into four sections; the rule for two-circuit windings used as four-phase rotary converters, being that they shall have four sections per winding, independent of the number of poles. Hence, in the two-circuit triple winding shown in Fig. 386, the winding is subdivided into $4 \times 3 = 12$ sections. All these four-phase windings are characterised by the winding per phase having a spread of 50 per cent. of the polar pitch. Sections 1 and 3, as also 2 and 4, are really in the same phase, in this sense such rotary converters are sometimes

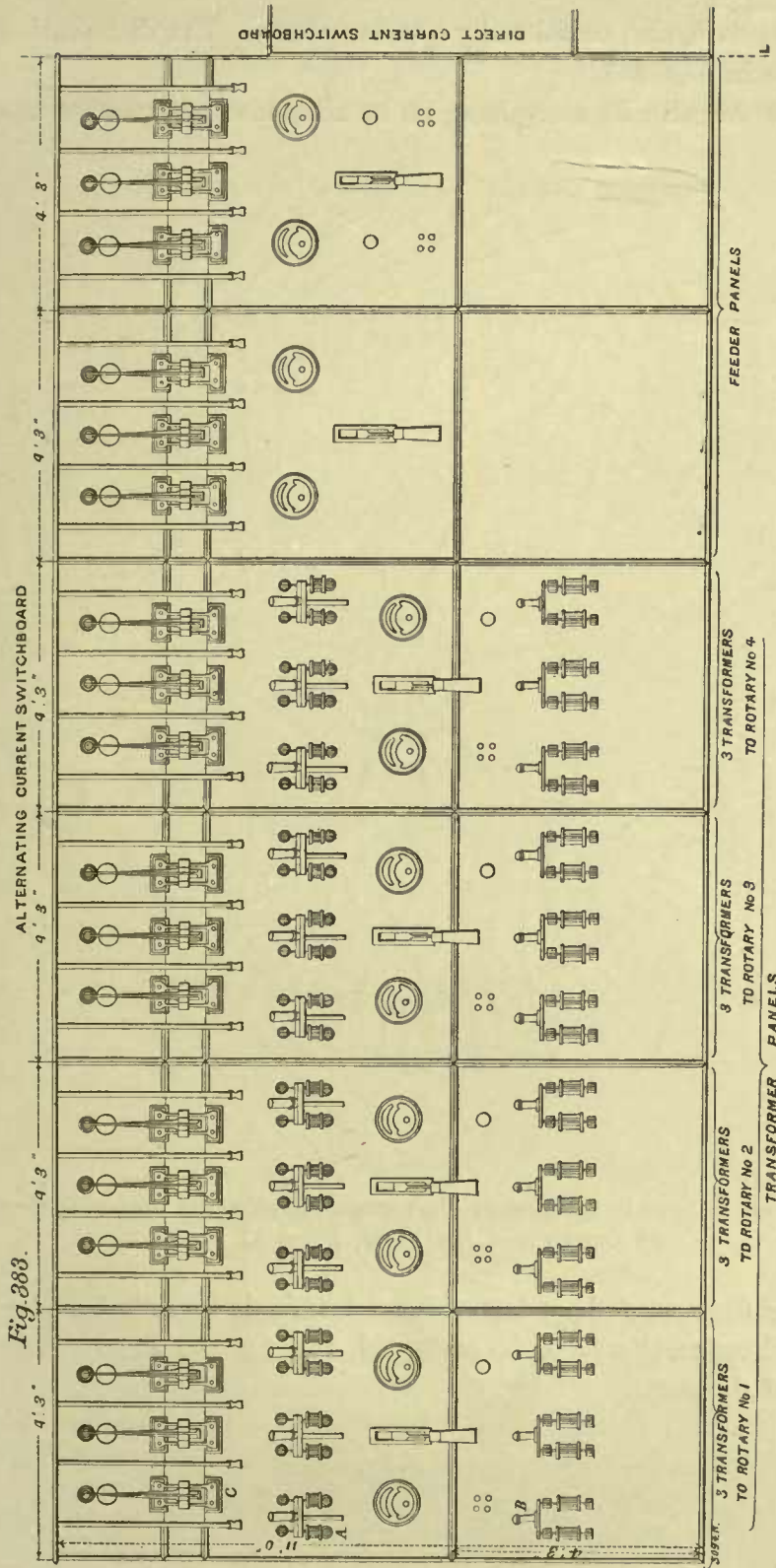

called two-phase, also occasionally quarter-phase. The distribution is also well shown in Fig. 387.

There are also in four-phase, as in six-phase, alternative methods of

Fig 384

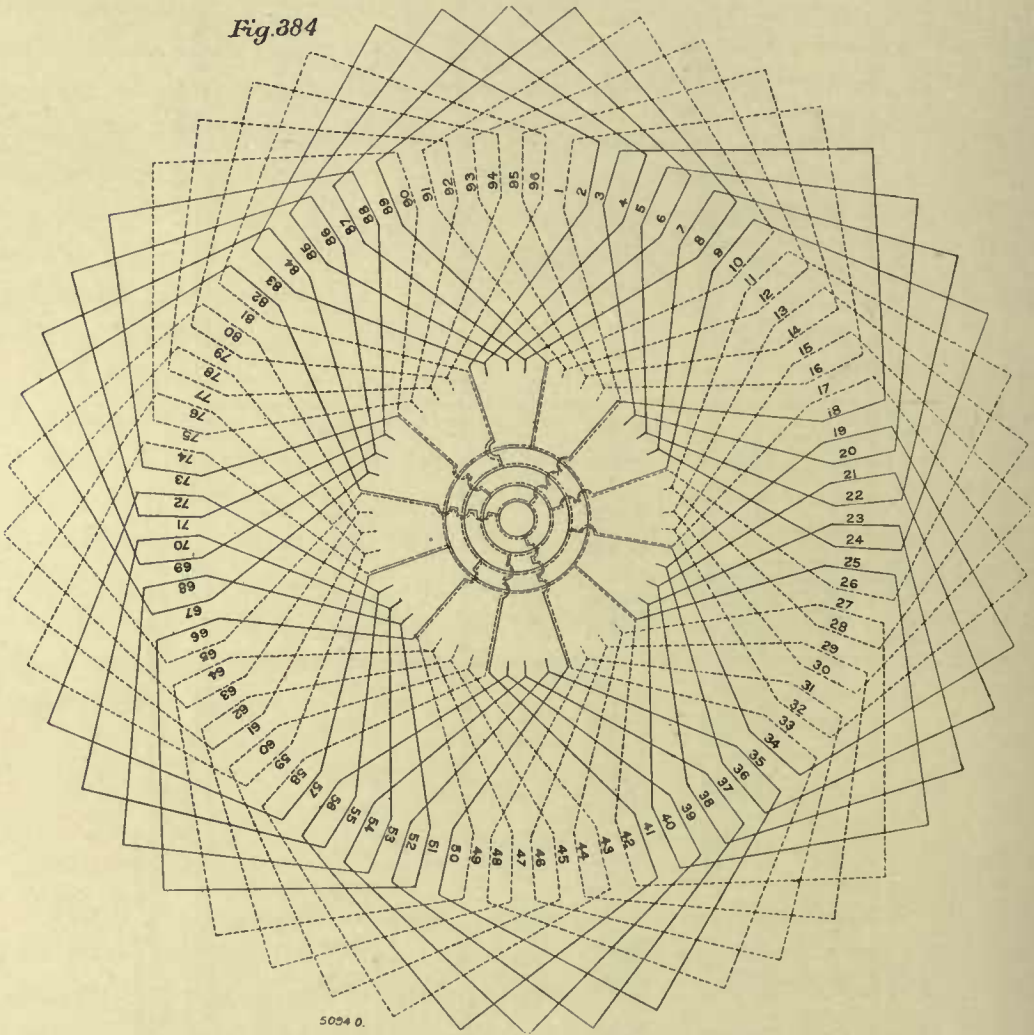

WINDING FOR A FOUR-PHASE ROTARY CONVERTER. SIX-CIRCUIT SINGLE WINDING, WITH 96 CONDUCTORS, SIX POLES, PITCH 17 AND 15.

connecting from secondary transformer terminals to collector rings. The diametrical connection is to be preferred, and for the same reasons as in the case of six-phase.

TWELVE-PHASE ROTARY CONVERTERS.

Another interesting combination of apparatus permits of obtaining the advantages of a 12-phase rotary converter with only two static transformers. Each transformer has one primary and four equal secondary

Fig. 385

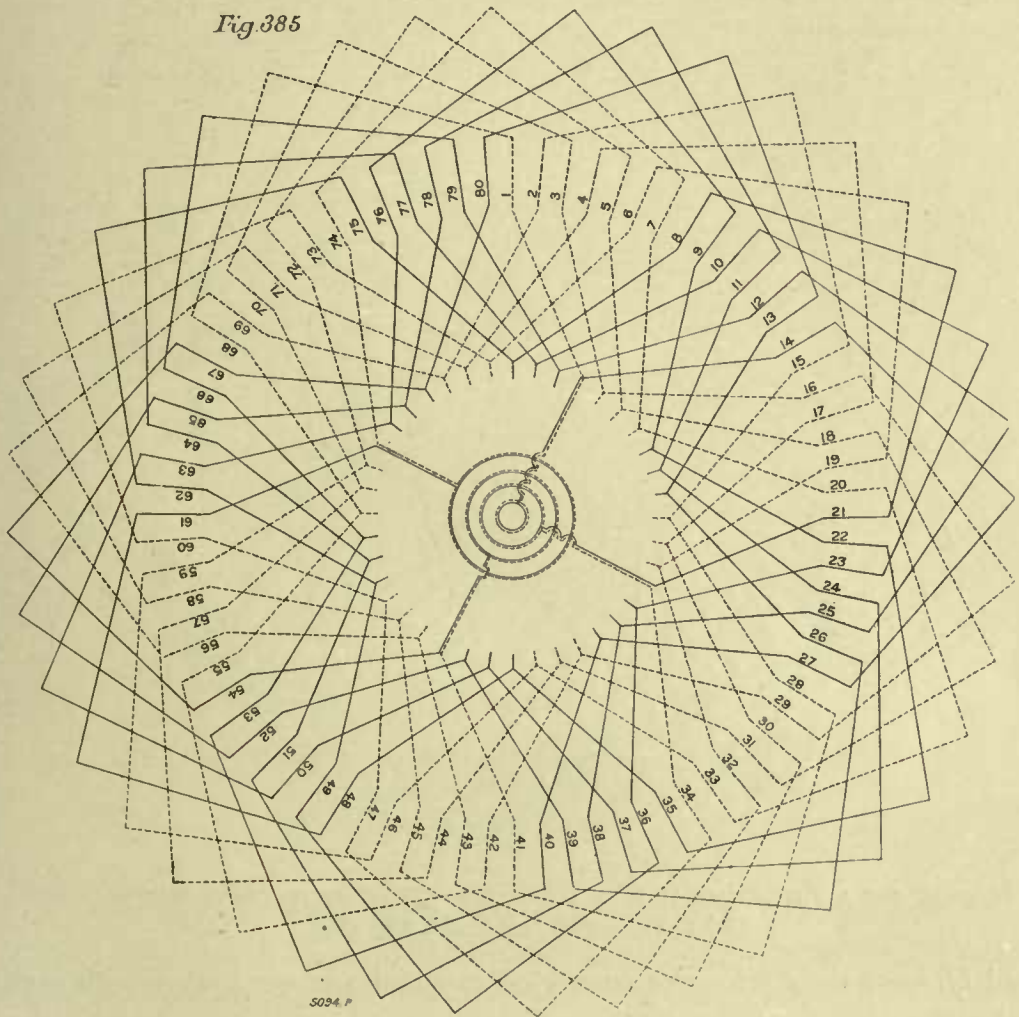

WINDING FOR A FOUR-PHASE ROTARY CONVERTER. TWO-CIRCUIT SINGLE WINDING, WITH 80 CONDUCTORS, SIX POLES, PITCH 13.

coils. The primaries are excited from two circuits in quadrature with each other, and there are twelve tapings into the armature per pair of poles in a multiple-circuit winding, and twelve tapings per winding, independently of the number of poles in two-circuit windings. The diagram, Fig. 388,

sets forth the underlying idea as applied to a bi-polar armature, the circle representing the winding, tapped at the points 1 to 12. Transformers I.

Fig 386

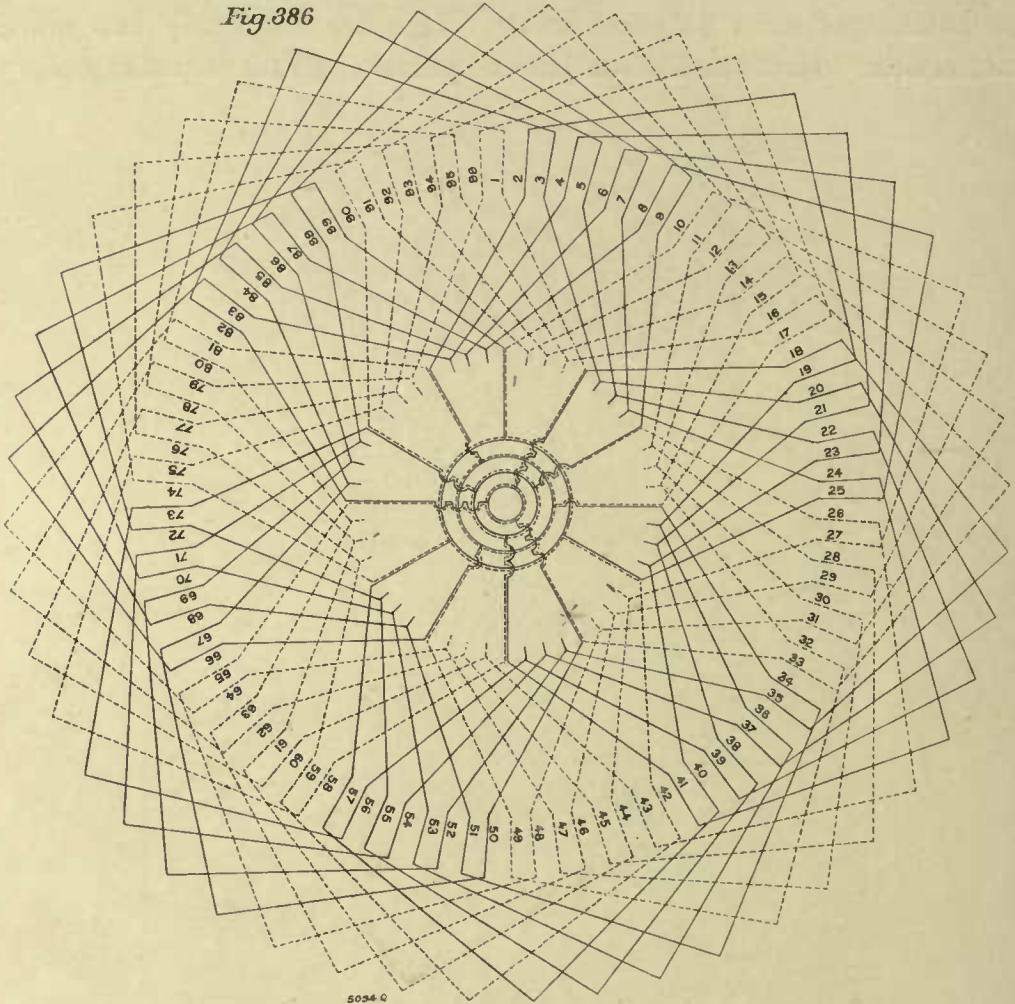

WINDING FOR A FOUR-PHASE ROTARY CONVERTER. TWO-CIRCUIT TRIPLE-WINDING, WITH 96 CONDUCTORS, SIX POLES, PITCH 17.

and II. have their primaries connected to circuits in quadrature with each other.

The 60 deg. chords represent the transformer secondaries 11-9, 3-5,

Fig 387

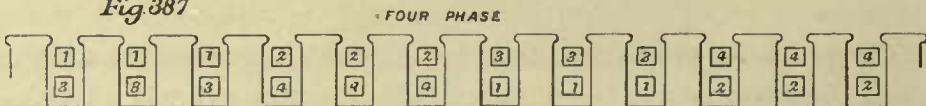

12-2, and 8-6, while the two diameters represent the series-connected pairs of secondaries 1-7 and 10-4. Obviously the whole idea is based on

two inscribed hexagons, the one standing at an angle of 90 deg. from the other. The four equally-wound secondary coils conform to the equality requirement between sides and radii.

By letting the transformer primaries have different windings, the well-known method of changing from three to quarter-phase permits of retaining the greater economy and other advantages of three-phase

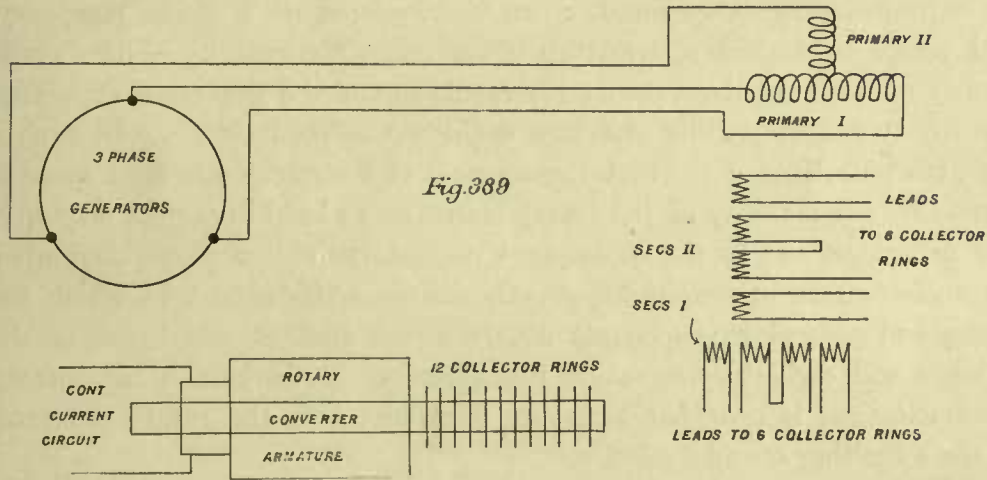
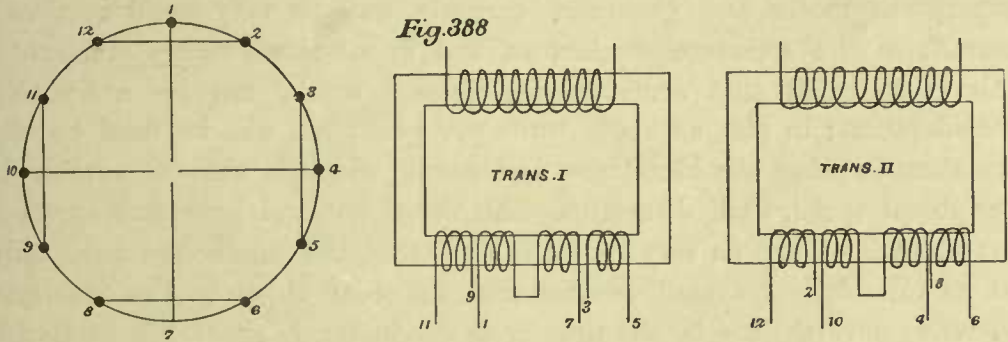

transmission, and these further advantages of only two transformers per rotary, and greatly increased output per rotary. This system is sufficiently indicated in diagram, Fig. 389.

DESIGN OF A SIX-PHASE 400-KILOWATT, 25-CYCLE, 600-VOLT ROTARY CONVERTER.

The first question to decide is the number of poles. The periodicity being given, the speed will be inversely as the number of poles. High speed, and hence as few poles as are consistent with good constants, will generally lead to the best results for a given amount of material.

In considering the design of continuous-current generators, it was shown that the minimum permissible number of poles is determined by the limiting armature interference expressed in armature ampere turns per pole-piece, and by the reactance voltage per commutator segment, for which, in the very first steps of the design, the average voltage per commutator segment is taken. But in polyphase rotary converters, the superposed motor and generator currents leave a very small resultant current in the armature conductors, and in six-phase rotary converters this is so small that armature interference would not be a limiting consideration; in fact, as many turns per pole-piece will be used on the armature as other considerations, first among which is that of permissible peripheral speed, shall determine. As the motor and generator currents cancel each other to a very considerable extent, the conductors have only to be of relatively small cross-section in order to carry the resultant current; nevertheless, by the time each conductor is separately insulated, no extraordinarily large number can be arranged on a given periphery, and hence no excessive armature interference can result. With insufficiently uniform angular velocity per revolution of the generator supplying the rotary converter, this assertion could not safely be made. In such a case, the pulsations of the motor component of the rotary converter current, caused by the inability of the rotary converter to keep in perfect step with the generator, and by the consequent oscillatory motion superposed upon its uniform rate of revolution, greatly decrease the extent to which the motor and generator components neutralise one another, and hence results a large and oscillatory armature interference. But where a satisfactory generating set is provided, armature interference in the rotary converter is not a limiting consideration.

The reactance voltage of the coil under commutation, must be made as low as possible, as one has, in rotary converters, a kind of "forced" commutation," that is, one does not make use of a magnetic field to reverse the current in the short-circuited coil. The brushes remain at the neutral point for all loads, since any alteration in their position from the neutral point would interfere with the proper superposition of the collector ring and commutator currents. Moreover, the collector ring current must continue independently of the commutation going on in the generator component of the resultant current. The process is complicated, and for practical purposes it appears desirable to estimate a nominal reactance voltage based upon that which would be set up in

the short-circuited turns by the reversal of the continuous-current component.

The diameter of the armature is chosen as large as is consistent with retaining the armature conductors in place, using a reasonable amount of binding wire, figured with a conservative factor of safety. Upon this armature is generally placed as large a number of conductors as current

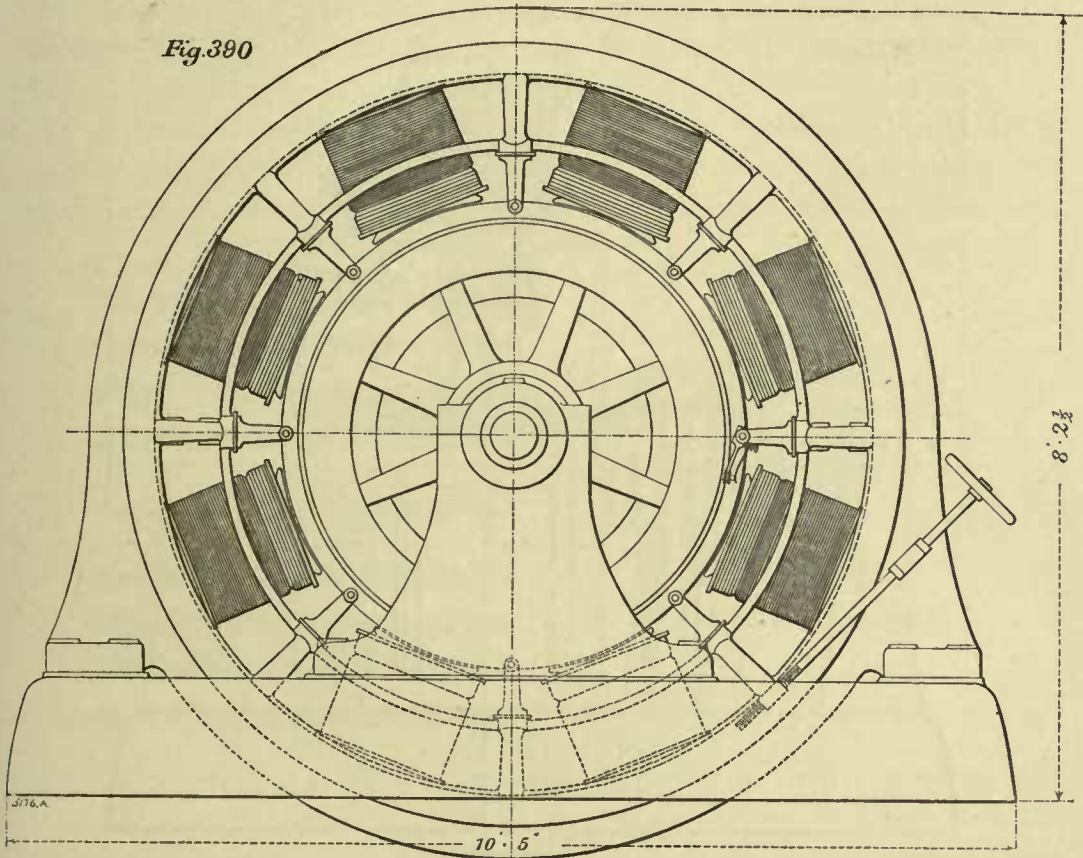

and magnetic flux densities permit. For some ratings, however, a sufficiently low reactance voltage may be obtained without approaching extremes, either of armature diameter or of number of armature conductors. Another limitation often met with in rotary converter design, is that of width of commutator segment at the commutator face. It is not desirable, on machines of several hundred kilowatts output, that the commutator segments should be much less than $\frac{1}{4}$ in. in width. For a given diameter and number of poles, this at once restricts the number of commutator segments, and, on the basis of one turn per commutator segment, also

restricts the number of armature turns. For large rotary converters, two turns per segment would almost always lead to an undesirably high reactance voltage of the coil being commutated.

The speed, expressed in revolutions per minute, is, in rotary converters, generally two or three times as high as for good continuous-current generators of the same output, and with an equal number of

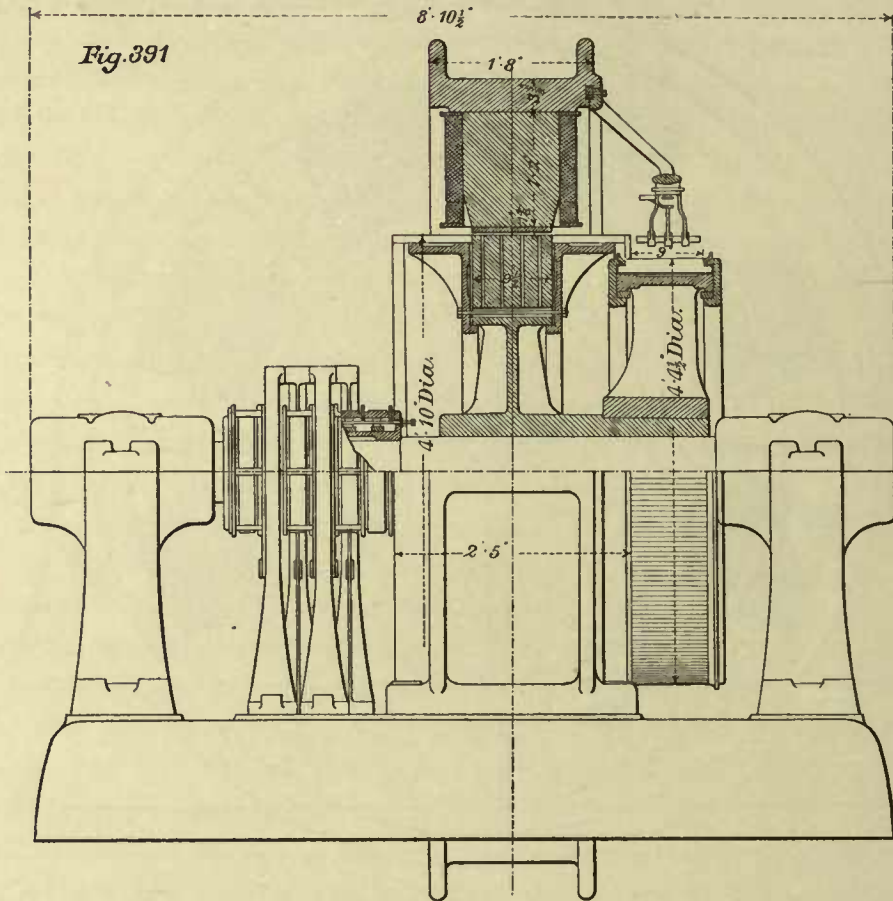

poles. Hence the frequency of commutation is also very high, often from 600 to 1000 complete cycles per second. Consequently the inductance of the short-circuited coil must be correspondingly low, in order not to lead to high reactance voltage.

Rotary converters have been built with two commutators, to escape the limitations referred to, of high peripheral speed, and narrow commutator segments. This method is rather unsatisfactory, since the chief gain would be in connecting the two commutators in series; but by so

doing, the entire current output has to pass through both, and the commutator losses are thereby doubled, while the cost of each commutator is so slightly reduced below that of one, as to render the construction expensive. A parallel connection of the two commutators at once sacrifices the chief gain, there only remaining the advantage of commutating but half the current at each set of brushes; but this will not permit of very great reduction of the number of segments. Moreover, there is the further difficulty that unequal contact resistance at the brushes would bring about an unequal division of the load between the two windings.

In smaller rotary converters, it sometimes becomes practicable to employ multiple windings (*i.e.*, double, or occasionally even triple). In such cases, the tendency to increase the frequency of commutation must

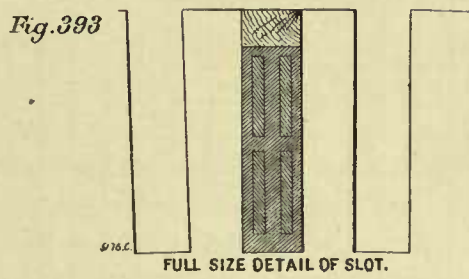
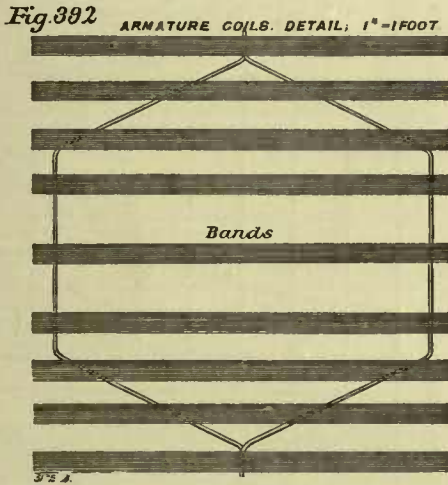

not be overlooked. If, for instance, one uses a double winding, the calculation of the time during which one armature coil is short-circuited, must be made with due regard to the fact that the two terminals of this coil are connected, not to adjacent but to alternative segments, and the intervening segment is, so far as time of short circuit is concerned, to be considered as a wide insulating gap. Hence, for a given width of brush, the time of short circuit is considerably reduced; but as the number of paths through the armature from the positive to the negative brushes has been doubled, the current to be reversed is half what it would be for the equivalent single winding. No general conclusions, however, should be drawn, and the reactance voltage must be estimated for each particular case, from the inductance of the coil, the frequency of its reversal under the brush, and the current to be reversed.

In a similar manner, if one were comparing the relative advantages of, say, four and six poles, one should keep distinctly in mind that while the final effect on the frequency of reversal may not be great (because of the inverse change in speed), the inductance per turn (largely dependent upon the length of the armature), may be quite different, and that the current to be reversed, is, in the case of the larger number of poles, less than in the machine with few poles. It is much safer to make rather complete comparative calculations, as the probability of overlooking the

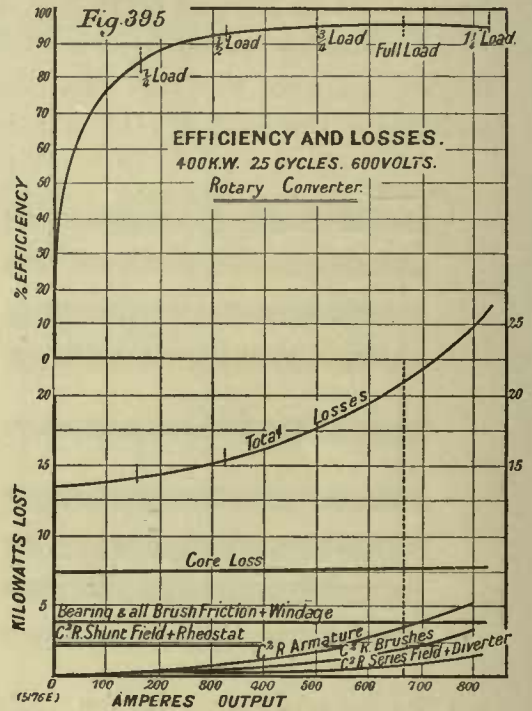
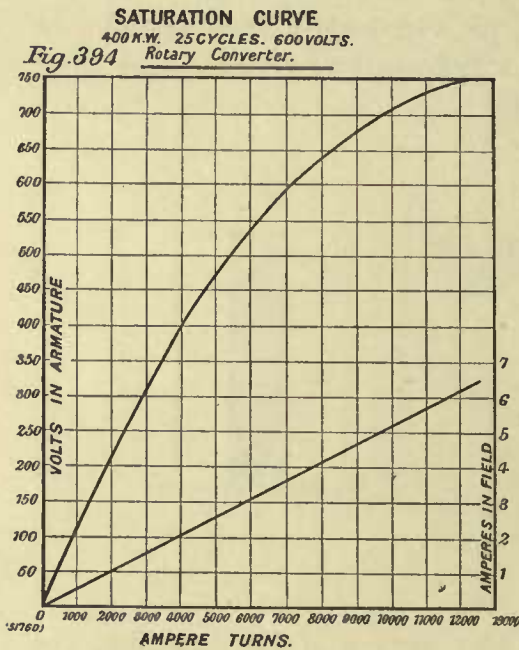

effect of a certain change, on all the constants involved, is very considerable.

As a general rule, it is preferable to arrange the conductors in many slots, thus having but few per slot. It is also necessary to keep as small as possible, the width of slot opening, and it should not be much, if any, greater than the radial depth of the air gap. This is important, because laminated pole-faces should not be used where there is the least possibility of "surging," due to inconstant angular velocity per revolution of the generating set. Where, with laminated pole-pieces this "surging" is present to any extent, it will be diminished, and sometimes prevented, if solid pole-faces of good conductivity, such as wrought-iron forgings of

good quality, are used. The tendency of the superposed oscillations of the armature, and the consequently varying magnetic field, is to set up induced currents in this pole-face, which react, and in turn tend to check these oscillations. This may be accomplished with minimum loss of energy, by suitably arranged copper circuits; but under favourable conditions, the surging will be of small extent, and may be made negligible with but little dissipation of energy in the wrought-iron pole-faces. The magnet cores may be of cast steel, but this has not so high specific conductivity as the best wrought iron, which latter should be employed for the pole-faces. The prevention of the surging will also be more complete, the shorter the air gap, but the high speeds of rotary converters generally render very small clearances undesirable.

Given the output, periodicity, and the voltage, trial calculations made with the foregoing various considerations in mind, lead one very definitely to the choice of a certain number of poles and the corresponding speed, best combining good constants in operation with economy in material. At most, the choice will lie between two successive numbers of pairs of poles, in which case both designs should be thoroughly worked out, and the constants and cost compared.

For a six-phase rotary converter for 400 kilowatts output at 25 cycles, and 600 volts at commutator, the following design is worked out. The number of poles is eight, and the speed is 375 revolutions per minute. A good design with six poles and 500 revolutions per minute could have been obtained, and excellent practice in the application of these principles would be found in working out a corresponding specification for such a machine, and then making a comparison of the costs of material.

The eight-pole design is illustrated in Figs. 390 to 393, inclusive, and in Figs. 394 and 395 are given the estimated saturation and efficiency curves.

TABULATED CALCULATION AND SPECIFICATION FOR A 400-KILOWATT SIX-PHASE ROTARY CONVERTER.

	DESCRIPTION.	
Number of poles		8
Kilowatt output		400
Speed, revolutions per minute		375
Terminal volts, full load		600
Amperes		667
Frequency (cycles per second)		25

Commutator :

Diameter	52.5 in.
Number of segments	600
" " per slot	2
Width of segments at surface23 in.
" " at root21 "
Total depth of segments	2 "
" length of segment	11 "
Available length of segment	9 "
Width of insulation between segments045 "

Collector :

Diameter	15 in.
Number of rings	6
Width of ring	2 in.
" between rings	$\frac{7}{8}$ "
Length over all	22 "

Brushes :

	Continuous Current.	Alternating Current.
Number of sets	8	6
" in one set	4	3
Radial length of brush	2½ in.	
Width of brush	1½ "	1 in.
Thickness of brush63 "	$\frac{1}{2}$ "
Dimensions of bearing surface, one brush	1.5 in. × .75 in.	1 in. × 1 in.
Area of contact, one brush	1.13 square inches	1 square inch.
Type of brush	Radial carbon	Copper.

Insulation :

On core in slots	Oil-treated cardboard about .012 in thick.
Of conductor	Varnished linen tape.

ELECTRICAL.

Armature :

Terminal volts full load	600
Total internal volts	614
Number of circuits	8
Style of winding	Multiple circuit drum.
Times re-entrant	1
Total parallel paths through armature	8
Conductors in series between brushes	150
Type construction of winding	Bar
Number of face conductors	1200
" slots	300
" conductors per slot	4
Arrangement of conductors in slot	2 × 2
Number in parallel making up one conductor	1

Mean length of one armature turn	78 in.
Total number of turns	600
Turns in series between brushes	75
Length of conductor between brushes	5850 in.
Cross-section, one conductor0225 square inch
„ eight conductors in parallel18 „
Ohms per inch cube at 20 deg. Cent.00000068
Per cent. increase in resistance 20 deg. Cent. to 60 deg. Cent.	16
Resistance between brushes, 20 deg. Cent.022 ohm.
Resistance between brushes, 60 deg. Cent.0256

It has already been seen that in six-phase rotaries 1.96 times the output may be taken from the commutator for the same C^2R loss in the armature conductors, as in a continuous-current generator with the same winding. Hence, for a given load, the resultant current in the armature conductors is a little over half that delivered from the commutator. In the present machine, the full load output is 667 amperes. Allowing for efficiency, and not quite unity power factor, we may take the current in the armature conductors at $667 \times .55 = 370$ amperes.

C R drop in armature at 60 deg. Cent.	9.5 volts
„ series coils	1 „
„ brush contact surface	2.2 „
„ not allowed for in above	1.3 in cables and connections
Amperes per square inch, conductor	2050 figured on resultant current
„ „ brush-bearing surface	37 figured on current output from commutator
„ „ shunt windings	980
„ „ series windings	1000

All but the armature current density and drop results are derived later in the specification, but are brought together here for referenee.

SPACE FACTOR.

In transformers, it is the aim to secure as high a ratio as possible of the total section of copper to the space in which it is wound, for a given specified insulation resistance. The same ratio, termed "space factor," is of service in proportioning the conductors and insulation to the armature slots.

Sectional area of slot = $1.25 \times .28 = .35$ square inches.

Sectional area of copper in slot = $4 \times .0225 = .09$ square inches.

"Space factor" = $.09 \div .35 = .26$

i.e., 26 per cent. of the space is occupied by copper, and 74 per cent. by the necessary insulation.

Commutation :

Average volts between commutator segments	8
Armature turns per pole	75
Resultant current per conductor = $\frac{667 \times .55}{8} = 46$ amperes.	
Resultant armature strength per pole = $46 \times 75 = 3450$ ampere turns.	

As the brushes remain at the mechanical neutral point, these exert only a distorting tendency, and do not have any demagnetising effect so long as the power factor of the alternating-current component is unity. It is also to be noted that, while the resultant armature current is 46 amperes, the 3450 corresponding ampere turns are by no means fully effective as magnetomotive force, being positive and negative in successive groups—sometimes even in successive turns—opposite one pole-piece. (See Figs. 368 and 369, pages 288 and 289.)

DETERMINATION OF REACTANCE VOLTAGE OF COIL UNDER COMMUTATION.

Diameter of commutator	52.5 in.
Circumference of commutator	165 "
Revolutions per second	6.25
Peripheral speed, inches per second	1030
Width of brush surface, across segments75 in.
Time of one complete reversal00073 secs.
Frequency of commutation, cycles per second	685
Coils short-circuited together per brush	3
Turns per coil	1
Turns short-circuited together per brush	3
Conductors per group commutated together	6
Flux per ampere turn per inch gross length armature lamination	20
Flux through six turns carrying one ampere	1140
Inductance one coil of one turn0000114 henrys
Reactance of one coil of one turn049 ohm
Current in one coil (continuous-current component)	83.5 amperes
Reactance voltage, one coil	4.1 volts

PROPORTIONING THE BINDING WIRE.

This is an important consideration in machines which must run at the high speeds customary with rotary converters. Cases might easily occur where an otherwise good machine might be designed; but on calculating

the binding wire, it would be found to require a larger portion of the total peripheral surface than could properly be devoted to it.

$$\begin{aligned} \text{Length of conductor between brushes} & \dots \dots \dots = 5850 \text{ in.} \\ \text{Cross-section of conductor between brushes} & \dots \dots \dots = .18 \text{ square inch} \\ \text{Weight of armature copper} & = 5850 \times .18 \times .32 = 340 \text{ lb.} \end{aligned}$$

Every pound of material at the periphery is subject to a centrifugal force of .0000142 $D N^2$ pounds, where

$$\begin{aligned} D &= \text{diameter in inches.} \\ N &= \text{revolutions per minute.} \end{aligned}$$

Hence, in this case, to a force of

$$.0000142 \times 58 \times 375^2 = 115 \text{ lb.}$$

The iron laminations are dovetailed into the spider, so the binding wire need only be proportioned to retain the weight of the copper wire in place.

$$\text{Total centrifugal force} = 340 \times 115 = 39,000 \text{ lb.}$$

$$\text{Force per square inch of armature surface} = \frac{39,000}{29 \times 58 \times \pi} = 7.4 \text{ lb.}$$

$$\text{Total projected area} = 29 \times 58 = 1680 \text{ square inches.}$$

$$\text{Total stress on binding wire} = 1680 \times 7.4 = 12,500 \text{ lb., or } 6250 \text{ lb. per side.}$$

Using phosphor-bronze binding wire, and estimating on the basis of a tensile strength of 100,000 lb. per square inch, with a factor of safety of 10, we require

$$\frac{6250 \times 10}{100,000} = .63 \text{ square inch.}$$

Taking No. 12 Stubbs wire gauge with a diameter of .109 in., and cross-section of .00933 square inch, 72 of these would be required. These should be arranged in nine bands of eight turns each. Three of these bands should be over the laminated body of the armature, and three over each set of end connections. (See Fig. 392 on page 315.)

MAGNETIC CIRCUIT CALCULATIONS.

Megalines <i>from</i> one pole at full load and 600 terminal volts (614 internal volts)	8.20
Coefficient of magnetic leakage	1.15
Megalines <i>in</i> one pole at full load	9.5

Armature :

Core section = $7.75 \times 7.2 \times 2$ = 112 square inches
Length, magnetic 7 in.
Density (kilolines) 73
Ampere turns per inch 20
Ampere turns 140

Teeth :

Number transmitting flux per pole piece 27
Section at face 64 square inches
„ roots 60 „
Mean section 62 „
Length 1.25 in.
Apparent density (kilolines) 132
Width of tooth "a" (mean)32
„ slot "b"28
Ratio "a" \div "b" 1.14
Corrected density 127
Ampere turns per inch 1100
Ampere turns 1370

Gap :

Section at pole face 133 square inches
Length, one side25 in.
Density at pole face (kilolines) 61
Ampere turns ($.313 \times 61,000 \times .25$) 4800

Magnet Core :

Section 113 square inches
Length 14 in.
Density (kilolines) 84
Ampere turns per inch 50
Ampere turns 700

Yoke :

Section - 2×62 124 square inches
Length (per pole) 17 in.
Density (kilolines) 77
Ampere turns per inch 640

SUMMARY OF AMPERE TURNS.

Armature core 140
„ teeth 1370
Gap 4800
Magnet core 700
Yoke 640
Total per spool 7650

Total rise estimated on above basis	42	„
Assumed rise of temperature per watt per square inch by resistance, after 10 hours' run	30	„
Total rise estimated on above basis	63	„

It will be observed that the total weight of iron in armature, *i.e.*, 2555 lb., is multiplied by the "watts core loss per pound" to obtain total core loss. This includes loss in teeth, as the curve (see Fig. 238, page 229) from which the constant was taken, is so proportioned as to allow for core and tooth losses for this type of construction and range of magnetic densities.

COMMUTATOR LOSSES AND HEATING.

Area of all positive brushes	18 square inches
Amperes per square inch contact surface	37
Ohms per square inch contact surface, assumed03
Brush resistance, positive and negative0033
Volts drop at brush contacts	2.2
C ² R loss	„	„	1500 watts
Brush pressure	1.25 lb. per sq. in.
„ „ total	45 lb.
Coefficient of friction3
Peripheral speed	5150 ft. per min.
Brush friction	70,000 ft.-lb. per min.
„ „	1600 watts
Stray watts lost in commutator, assumed	400
Total watts lost in commutator	3500
Diameter of commutator	52.5 in.
Length „ „	9 „
Radiating surface	1500 square inches
Watts per square inch radiating surface	2.3
Assumed rise of temperature per watt per square inch after 10 hours' run	15 deg. Cent.
Total rise estimated on above basis	35 „

COLLECTOR LOSSES AND HEATING.

Total contact area of all brushes	18 square inches
Amperes per square inch contact surface	110
Ohms per square inch contact (assumed)003
Total resistance of brushes per ring001
Volts drop at brush contacts34
C ² R loss at brush contacts per ring	110 watts
„ „ „ in six rings	660 „
Brush pressure, pounds per square inch	1.0
„ „ total pounds	18
Coefficient of friction3

Peripheral speed, feet per minute	1470
Brush friction, foot-pounds per minute	8000
,, ,, watts lost	180
Total watts lost in collector	840
Diameter collector	15 in.
Effective length of radiating surface	12 ,,
Radiating surface	570 square inches
Watts per square inch radiating surface	1.5
Assumed rise of temperature per watt per square inch after 10 hours' run	20 deg. Cent.
Total rise estimated on above basis	30 ,,

SPOOL LOSSES AND HEATING.

Spool:

C ² R loss at 60 deg. Cent. per shunt coil	255 watts
,, ,, per series coil	70 ,,
Total watts lost per spool	325 ,,
Length of winding space, total	14 in.
Circumference of spool	50 ,,
Peripheral radiating surface per spool	700 square inches
Watts per square inch radiating surface465
Assumed rise of temperature per watt per square inch by thermometer, after 10 hours' run	80 deg. Cent.
Total rise estimated on above basis	37 ,,
Assumed rise of temperature per watt per square inch by resistance, after 10 hours' run	120 ,,
Total rise estimated on above basis	56 ,,

EFFICIENCY.

Output, full-load watts	400,000
Core loss	7,700
Armature C ² R loss at 60 deg. Cent.	3,500
Commutator losses	3,500
Collector losses	840
Shunt spools losses	2,040
,, rheostat losses	300
Series spools losses	560
,, diverter losses	190
Friction, bearings and windage	2,000
Input, total	420,630
Commercial efficiency, full load	95 per cent.

MATERIALS.

Armature core	Sheet steel
,, spider	Cast iron
,, conductors	Copper

Rotary Converters.

Commutator segments	Copper
„ leads	Rheotan
„ spider	Cast iron
Pole-piece	Wrought-iron forging
Yoke	Cast steel
Magnet core	„
Brushes	Carbon and copper
Brush-holder	Brass
„ yoke	Gun-metal
Binding wire	Phosphor bronze
Insulation, commutator	Mica
„ armature	Varnished linen tape

WEIGHTS.

<i>Armature :</i>	Lb.
Laminations	2,550
Copper	340
Spider	1,550
Shaft	1,230
Flanges	700
<i>Commutator :</i>	
Segments	1,000
Mica	80
Spider	1,000
Press rings	200
Other parts	300
Collector, complete	700
Armature, commutator, collector, and shaft complete... ..	9,650
<i>Magnet :</i>	
Cores	3,550
Pole-pieces	400
Yoke	5,000
<i>Field :</i>	
Shunt coils	880
Series „	225
Total copper	1,105
Spools complete	1,800
Bedplate, bearings, &c.	6,300
Brush rigging	450
Other parts	1,000
Complete weight rotary converter	30,360

TABULATED CALCULATIONS AND SPECIFICATIONS FOR A 900-KILOWATT THREE-PHASE ROTARY CONVERTER.

The machine is illustrated in Figs. 396, 397 and 398; and curves of its performance are given in Figs. 399 to 402.

DESCRIPTION.	
Number of poles	12
Kilowatt output	900
Speed, revolutions per minute	250
Terminal volts, full load	500
" " no load	500
Amperes, output	1800
Frequency, cycles per second	25
DIMENSIONS.	
<i>Armature :</i>	
Diameter over all	84 in.
Length over conductors	27 "
Diameter of core at periphery	84 "
" " bottom of slots	81½ "
" " " laminations	62 "
Length of core over laminations... ..	12.5 "
Number of ventilating ducts	3
Width, each	½ in.
Effective length, magnetic iron	9.9 "
" " of core ÷ total length79
Length round periphery	264 in.
Pitch at surface <i>of poles</i>	22 "
Insulation between sheets	10 per cent.
Thickness of sheets016 in.
Depth of slot	1.25 "
Width of slot at root44 "
" " surface44 "
Number of slots	288
Gross radial depth of laminations	11 in.
Radial depth below teeth	9.75 in.
Width of tooth at root... ..	.449 "
" " armature face475 "
Size of conductor125 in. by .400 in.
<i>Magnet Core :</i>	
Length of pole-piece along shaft	12 in.
" pole-arc, average	15½ "
Pole-piece and core consists of sheet-iron punchings .04 in. thick, japanned on one side, and built up to a depth of	

Rotary Converters.

12 in. The edges of pole-face are chamfered back 3 in. by $\frac{5}{16}$ in., and a copper bridge 14 in. by $\frac{1}{8}$ in., extending $1\frac{3}{8}$ in. under pole tips, is inserted between poles to prevent "surging."

Pole arc ÷ pitch722
Length of core radial	$9\frac{5}{8}$ in.
Size of magnet core (laminations)	12 in. by 12 in.
Bore of field	$84\frac{3}{8}$ in.
Clearance (magnetic gap)	$\frac{3}{16}$ "

Spool:

Length	$8\frac{7}{16}$ in.
" of shunt-winding space	4.9 "
" " series-winding space... .. .	3.5 "
Depth of winding space	$2\frac{3}{4}$ "

Yoke:

Outside diameter	123 in. & 114 in.
Inside diameter	105 in.
Thickness	$4\frac{1}{2}$ "
Length along armature	22 "
Beyond the 22-in. length along armature, projects on one side a ring $1\frac{1}{4}$ in. wide, which is grooved to receive the brush rocking gear.	

Commutator:

Diameter	54 in.
Number of segments	576
" " per slot	2
Width of " at surface24
" " at root215
Total depth of segment	$2\frac{1}{2}$ in.
" length of segment	$17\frac{1}{2}$ "
Available length of segment	14 "
Width of insulation between segments05 "

Collector:

Diameter	24 in.
Number of rings	3
Width of each ring	$3\frac{1}{2}$ in.
" between rings	$1\frac{1}{2}$ "
Length over all	$18\frac{1}{2}$ in.

Brushes:

	Continuous Current.	Alternating Current.
Number of sets	12	3
Number in one set	8	8
Radial length of brush	2 in.	—
Width of brush	$1\frac{1}{4}$ "	$1\frac{1}{4}$ in.
Thickness of brush	$\frac{3}{4}$ "	6 "
Dimensions of bearing surface (one brush)	1.25 in. by .87 in.	1.25 n. by 1.1 in.
Area of contact (one brush)	1.08 square inch	1.35 square inch
Type of brush	Radial carbon	Copper

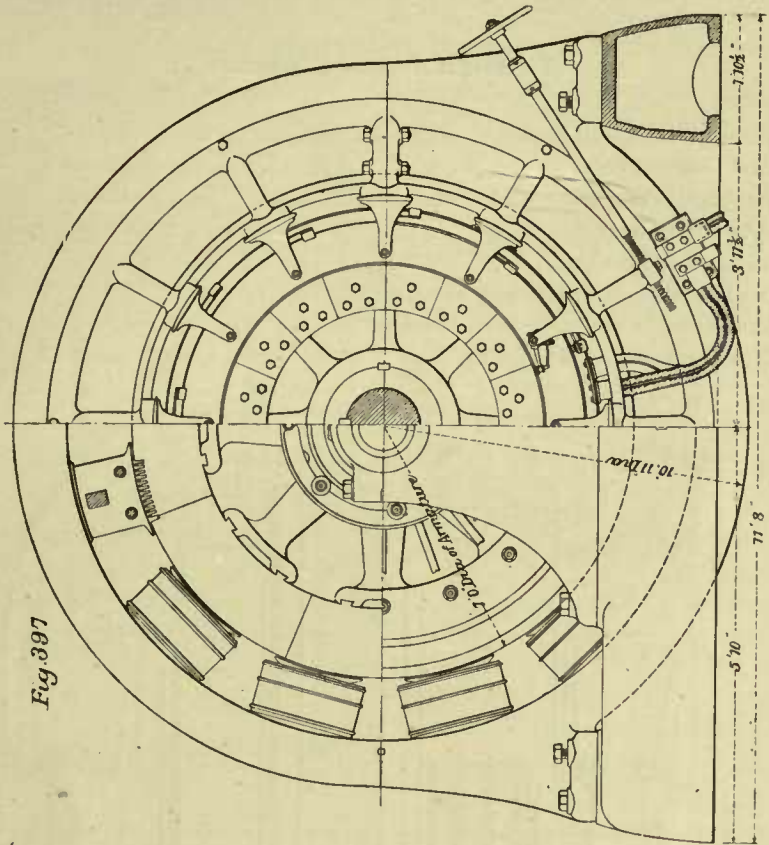

Fig. 397

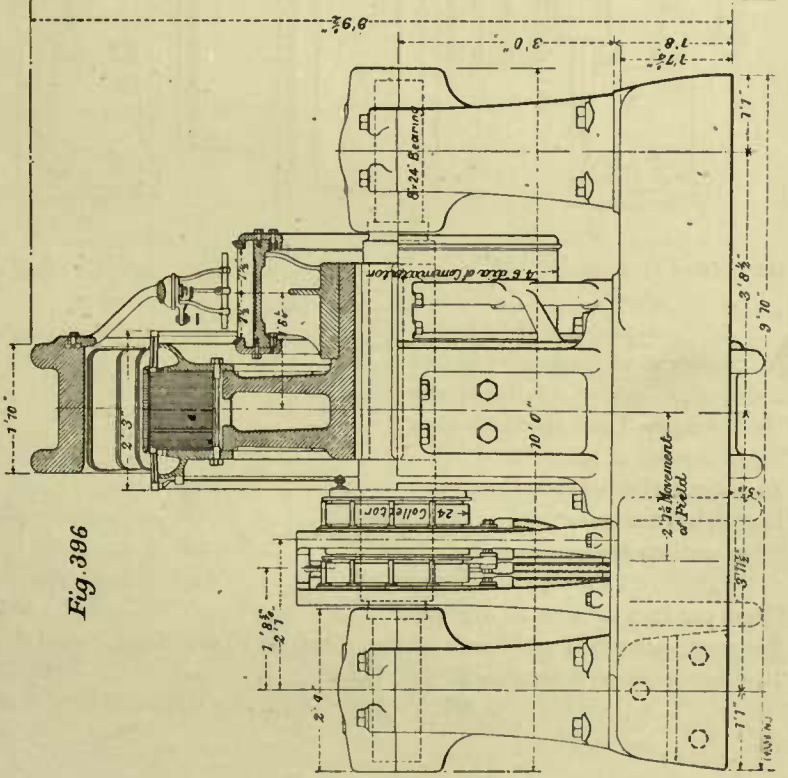
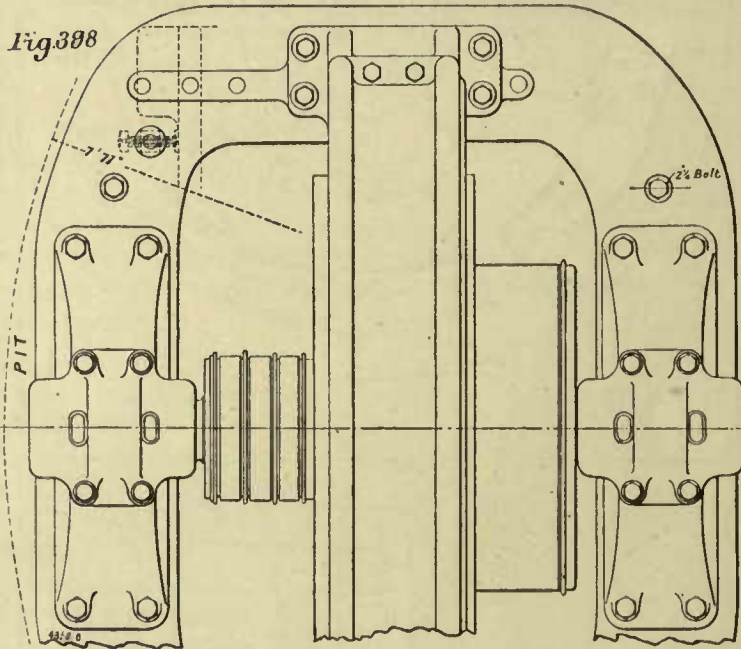

Fig. 396

TECHNICAL DATA.—ELECTRICAL.

Armature :

Terminal volts, full load	500
Total internal volts	513
Number of circuits	12
Style of winding	Multiple-circuit drum
Times re-entrant	1
Total parallel paths through armature	12
Conductors in series between brushes	96
Type construction of winding	Bar



Number of face conductors	1152
„ slots	288
„ conductors per slot	4
Arrangement of conductors in slot	2 by 2
Number in parallel making up one conductor	1
Mean length of one armature turn	78 in.
Total number of turns	576
Turns in series between brushes	48
Length of conductor between brushes	3744 in.
Cross-section, one conductor05 square inch
„ 12 conductors in parallel60 „
Ohms per inch cube at 20 deg. Cent.00000068
Per cent. increase in resistance 20 deg. Cent. to 60 deg. Cent.	16 per cent.
Resistance between brushes 20 deg. Cent.00425
„ „ „ 60 „00493

Assuming the current in three-phase rotary converter armature to be about three-fourths of that for continuous-current generator of same

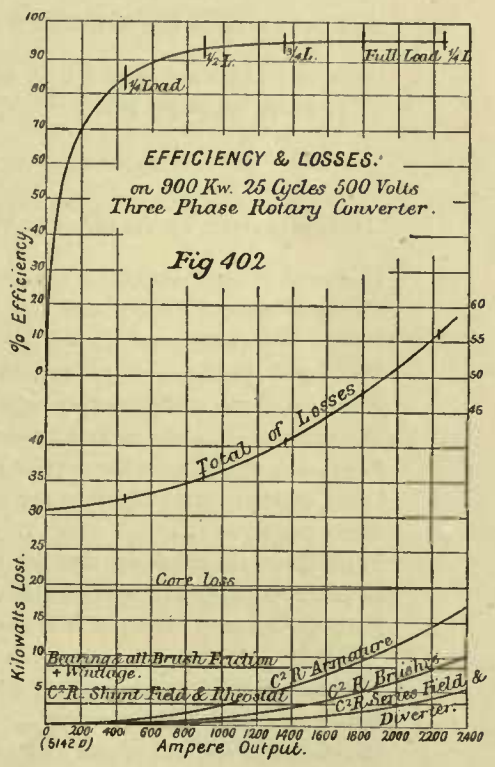
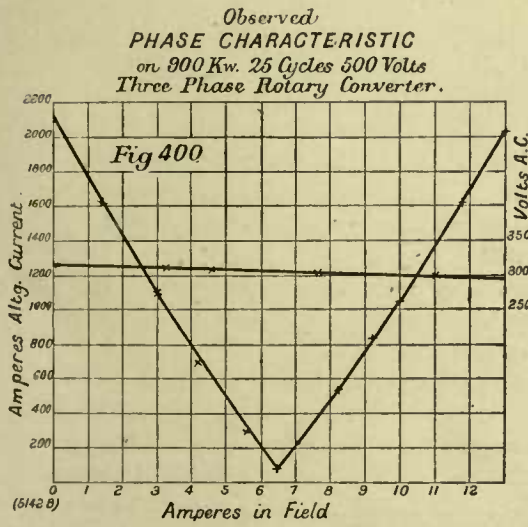
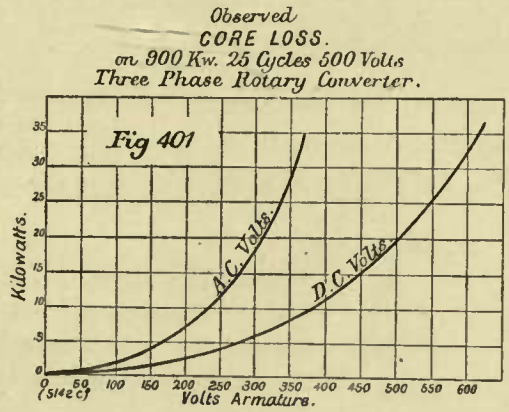
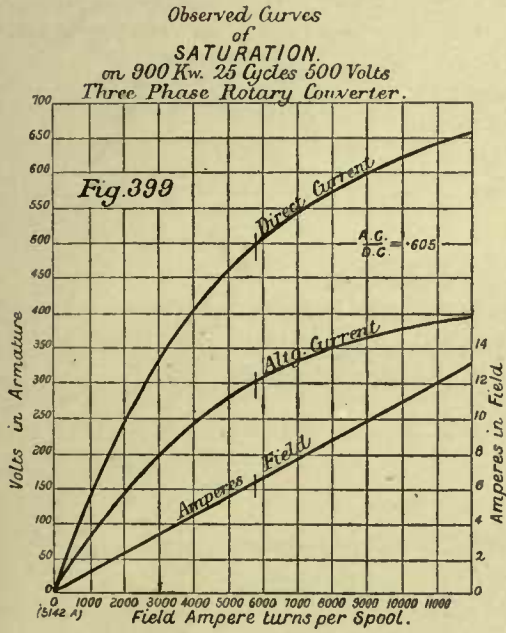

output, and a power factor of not quite unity, we may take current in armature conductor as $1,800 \times .8 = 1,440$ amperes.

CR drop in armature at 60 deg. Cent.	7.1 volts
„ series coils	1.6 „
„ at brush contact surfaces	2.1 „
„ not allowed for in above	1.5 volts for cables and connections; figured on component currents
Amperes per square inch conductor (armature)	2400
„ „ „ brush-bearing surface	34.5
„ „ „ shunt windings	970
„ „ „ series windings	970

Space Factor :

Sectional area of slot = $1.25 \times .44 = .55$ square inch.

„ „ copper in slot = $4 \times .125 \times .4 = .2$ square inch.

“Space factor” = $.2 \div .55 = .364$, or 36.4 per cent. of total space is occupied by copper, leaving 63.6 per cent. for the necessary insulation.

Commutation :

Volts between segments, average 10.4

Armature turns per pole 48

Resultant current per conductor = $\frac{1800 \times .8}{12} = 120$ amperes.

Resultant armature strength = $120 \times 48 = 5800$ armature ampere turns per pole.

DETERMINATION OF REACTANCE VOLTAGE OF COIL UNDER COMMUTATION.

Diameter of commutator	54 in.
Circumference of commutator	170 „
Revolutions per second	4.2
Peripheral speed, inches per second	708
Width of brush surface across segments87 in.
Time of one complete reversal, seconds00123
Frequency of commutation, cycles per second	407
Coils, short-circuited together per brush	3
Turns per coil	1
Turns short-circuited together per brush	3
Conductors per group commutated together	6
Flux per ampere turn per inch gross length armature lamination	20
Flux through six turns carrying one ampere	1500
Inductance one coil of one turn000015 henrys
Reactance of one coil of one turn039 ohms
Current in one coil, amperes	150
					(continuous-current component)
Reactance voltage, one coil	5.8 volts

BINDING WIRE.

Length of conductor between brushes	3774 in.
Cross-section of conductor between brushes6 square inch
Weight of armature copper	$3744 \times .6 \times .32$ = 721 lb.
Centrifugal force... ..	= .0000142 D N ² lb.

Therefore, $.0000142 \times 84 \times 250^2 = 74.7$ lb. exerted as centrifugal force by every pound of copper conductor on armature, and as there are 721 lb. weight of copper conductors, the total centrifugal force = $721 \times 74.7 = 54,000$ lb.

Part of the centrifugal force is resisted by strips of hard wood driven into dovetail grooves running parallel to the length of the shaft at the tops of the slots, while the end projections and connections are held in place by 84 strands of No. 11 B. and S. phosphor-bronze wire arranged over both ends, in bands of six strands each, seven of these bands being employed for each end.

MAGNETIC CIRCUIT CALCULATIONS.

Megalines from one pole at full load and 500 terminal volts (512.5 internal volts)	10.4
Assumed coefficient of magnetic leakage	1.20
Megalines in one pole at full load	12.5

The magnetic reluctance and the *observed* total number of ampere turns per field spool required, were probably distributed approximately as follows:—

Armature :

Core section	$9.9 \times 9.75 \times 2$ = 194 square inches
Length of magnetic circuit	11 in.
Density (kilolines)	54
Ampere turns per inch	16
Ampere turns	180

Teeth :

Number transmitting flux per pole-piece	17
Section at face	76 square inches
„ roots	80 „
Mean section	78 „
Length	1.25 in.
Apparent density (kilolines)	134
Width of tooth (mean) “a”462 in.
„ slot “b”44 „
Ratio of a ÷ b	1.05
Corrected density (kilolines)	128
Ampere turns per inch	1160
Ampere turns	1460

Series :

Ampere turns, full load	3630
Full-load amperes	1800
Amperes diverted	350
" in series spools	1450
Turns per spool	2½
Size of conductor used	2.5 in. by .075 in.
Number in parallel	8
Total cross-section	1.5 square inch
Current density, amperes per square inch	970
Mean length of one turn	4.83 ft.
Total length, all turns on 12 spools	150 ft. = 1800 in.
Resistance of 12 spools at 20 deg. Cent.000816 ohm
Series C²R watts, total at 20 deg. Cent.	1718
" " per spool	143
" " " at 60 deg. Cent.	165
Total weight of series copper, pound	864

CALCULATION OF LOSSES AND HEATING.

Armature :

Resistance between brushes, ohms00493 at 60 deg. Cent.
C²R loss at 60 deg. Cent.	9700
Frequency, cycles per sec. = C =	25
Weight of armature teeth	500 lb.
" " core	6500 "
Total weight of laminations	7000 "
Flux density in teeth, kilolines	128
" " core = D =	54
C.D. ÷ 1000	1.36
Observed core loss per pound, watts	2.8
K = $\frac{\text{watts core loss per pound}}{(\text{C.D.} \div 1000)}$ =	2.05
Total core loss	19,850
" armature losses	29,550
Armature diameter	84 in.
" length	27 "
Peripheral radiating surface	7150 square inches
" speed, feet per minute	5500
Watts per square inch radiating surface	4.1

COMMUTATOR LOSSES AND HEATING.

Commutator :

Area of all positive brushes	51 square inches
Amperes per square inch contact surface	35
Ohms " " " " assumed03
Brush resistance, positive and negative00116 ohm
Drop at brush contacts	2.1 volts
C²R loss at brush contacts	3700 watts

Rotary Converters.

Brush pressure, pounds per square inch	1.15
" " total	117 lb
Coefficient of friction3
Peripheral speed, feet per minute	3550
Brush friction, foot-pounds per minute	124,000
" " watts	2800
Stray watts lost in commutator, assumed	600
Total	7100
Diameter of commutator	54 in.
Available length of commutator	14 "
Radiating surface	2400 square inches
Watts per square inch of radiating surface	2.9
Assumed rise of temperature per watt per square inch, after 10 hours' run	15 deg. Cent.
Total rise estimated on above basis	43 "

COLLECTOR LOSSES AND HEATING.

Total contact area of all brushes	33.5 square inches
Amperes per square inch of contact surface	150
Ohms per square inch of contact (assumed)003
Total resistance of brushes per ring00027
Volts drop at brush contacts48
C ² R loss at brush contacts per ring	850
" " " in three rings	1700
Brush pressure, pounds per square inch	1.6
" " total pounds	54
Coefficient of friction3
Peripheral speed, feet per minute	1,580
Brush friction, pounds per minute	25,500
" " watts lost	600
Total watts lost in collector	2,300
Diameter collector	24 in.
Effective length radiating surface	11 "
Total radiating surface	820 square inches
Watts per square inch radiating surface	2.8
Assumed rise of temperature per watt per square inch, after 10 hours' run	15 deg. Cent.
Total rise estimated on above basis	42 "

Field Spool Losses :

Spool C ² R loss at 60 deg. Cent. per shunt coil	240
C ² R loss at 60 deg. Cent. per series coil	165
Total loss per spool, watts	405
" in 12 spools, watts	4850

EFFICIENCY.

Full load, watts output	900,000
Core loss	19,850

Commutator losses	7,100
Collector losses	2,300
Armature C ² R loss at 60 deg. Cent.	9,700
Shunt spools C ² R loss at 60 deg. Cent.	2,900
Shunt rheostat C ² R loss at 60 deg. Cent.	300
Series spools C ² R loss at 60 deg. Cent.	1,700
Series diverter C ² R loss at 60 deg. Cent.	500
Friction, bearings, and windage	5,100

Total input 949,450

Commercial Efficiency :

Full load 95 per cent.

Materials :

Armature core	Sheet steel
" spider	Cast iron
" conductors	Copper
Commutator segments	"
" leads	Stranded copper
" spider	Cast iron
Pole-piece	Laminated sheet iron
Yoke	Cast steel
Magnet core	Laminated sheet iron
Brushes	Carbon
Brush-holder	Brass
" yoke	Gun-metal
Binding wire	Phosphor-bronze
Insulation, commutator	Mica

WEIGHTS.

<i>Armature :</i>		Lb.
Laminations	...	7,000
Copper	...	720
Spider	...	3,000
Shaft	...	3,000
Flanges	...	800
<i>Commutator :</i>		
Segments	...	2,100
Mica	...	130
Spider	...	1,650
Press rings	...	280
Sundry other parts	...	350
Collector rings, complete	...	1,070
Armature, commutator, collector, and shaft complete	...	20,000
<i>Magnet :</i>		
Yoke	...	13,000
Poles	...	6,000

Field :

Shunt coils, copper	1,320
Series „ „	860
Total copper	2,180
Spools complete, including flanges and all insulation	5,600
Bedplate, bearings, &c.	18,000
Brush gear	1,200
Sundry other parts	2,200
		<hr/>
Total weight of rotary converter	66,000

THE STARTING OF ROTARY CONVERTERS.

The starting and synchronising of rotary converters may be accomplished in any one of several ways. The simplest, at first sight, is to throw the alternating-current terminals of the rotary converter directly on the alternating-current mains; but this, although often practicable, has several disadvantages. By this method, the current rush at the moment of starting is generally in excess of the full-load current input to the rotary converter, and as it lags in phase by a large angle, it causes a serious drop of line voltage, and affects the normal line conditions, to the serious detriment of other apparatus on the line. This large current gradually decreases as the rotary converter's speed increases. The action of the rotary converter, in starting, is analogous to that of an induction motor. The rotating magnetic field set up by the currents entering the armature windings induces—but very ineffectively—secondary currents in the pole-faces, and the mutual action between these secondary currents and the rotating field imparts torque to the armature, which revolves with constantly accelerating speed, up to synchronism. Then the circuit of the rotary converter field spools is closed, and adjusted to bring the current into phase. But when the armature is first starting, the field spools are interlinked with an alternating magnetic flux, generated by the current in the armature windings, and, in normally-proportioned field spools, with several hundreds or thousands of turns per spool, a dangerously high secondary voltage is generated in these spools. Hence they must be insulated better than field spools ordinarily are, not only between layers, but between adjacent turns; and wire with double or triple cotton covering should be used. However, the most frequently-occurring breakdown due to this cause, is from winding to frame, and hence extra insulation should be used between these parts.

The terminals of the different field spools should be connected up to a suitable switch, arranged so that the field winding may be conveniently broken up into several sections; otherwise, if a thousand volts or so are induced in each spool, the strain on the insulation between the ends of these spools in series, and frame is severe.

At starting, this switch must always be open, and must not be closed until the armature has run up to synchronous speed, which is observed by the line current falling to a much smaller value. This special switch is then closed, and afterwards the main field switch, whereupon a still further decrease in the line current occurs, due to improved phase relations, and the process of synchronising is completed.

By means of a compensator, this heavy current on the line at starting

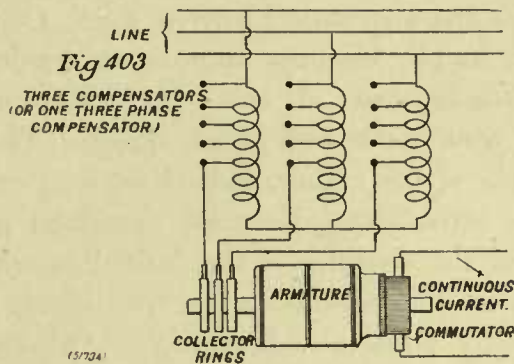

may be dispensed with. The connections for a three-phase rotary with compensator, are as shown in the diagram of Fig. 403.

At the instant of starting, the collector rings are connected to the three lowest contacts, hence receive but a small fraction of the line voltage, and would receive several times the line current; *i.e.*, if the taps into the compensator winding are, say, one-fifth of the way from common connection to line, then the rotary converter has one-fifth the line voltage and five times the line current. As the converter runs up in speed, the terminals are moved along until, at synchronism, the collector is directly on the line.

Another difficulty encountered when the rotary converter is started from the alternating-current end, is the indeterminate polarity at the commutator, when the rotary is made to furnish its own excitation. Unless some independent source of continuous current is available at the rotary converter sub-station, the rotary is dependent for its excitation upon

the polarity that its commutator happens to have at the instant of attaining synchronism. If there are two rotary converters at the sub-station, and the first comes up with the wrong polarity, then it may be allowed to run so, temporarily, till the second one is synchronised. The second one can be given either polarity desired, by using the first as an independent source of continuous current. Then from the second one, the polarity of the first may be reversed into the correct direction, and the second rotary converter shut down. Obviously, however, this indeterminateness of the initial polarity constitutes a further inconvenience and objection to starting rotary converters by throwing them directly on to the alternating-current line. But in the case of large capacity, slow-speed rotary converters, consequently machines with heavy armatures, it has been found practicable to control the polarity of the first machine when it is started up from the alternating current side. One must stand ready by the field switch as the machine approaches synchronism, when the pointer of the continuous-current voltmeter will commence to vibrate rapidly about the zero mark with short swings. These will finally be followed by a couple of fairly slow, indecisive, long swings, in opposite directions from the zero mark. Near the maximum point of whichever of these swings is in the direction of the desired polarity, the field switch should be closed, and the machine will excite itself, provided the field terminals are correctly positive and negative. Otherwise—which might happen on the first run, or after alterations—the field terminals will require to be reversed.

The required line current is greatly reduced by starting generator and rotary converter up simultaneously. The latter is then, from the instant of starting, always in synchronism with its generator, and the conditions of running are arrived at with a minimum strain to the system. But the conditions of routine operation rarely render this plan practicable.

A method sometimes used, is to have a small induction motor direct coupled to the shaft of the rotary converter for the purpose of starting the latter with small line currents. This, however, is an extra expense, and results in an unsightly combination set.

Where there are several rotary converters in a sub-station, a much better way is that described in a recent British patent specification, in which the station is provided with a small auxiliary set consisting of an induction motor direct coupled to a continuous-current dynamo, the latter being only of sufficient capacity to run the rotary converters one at a time

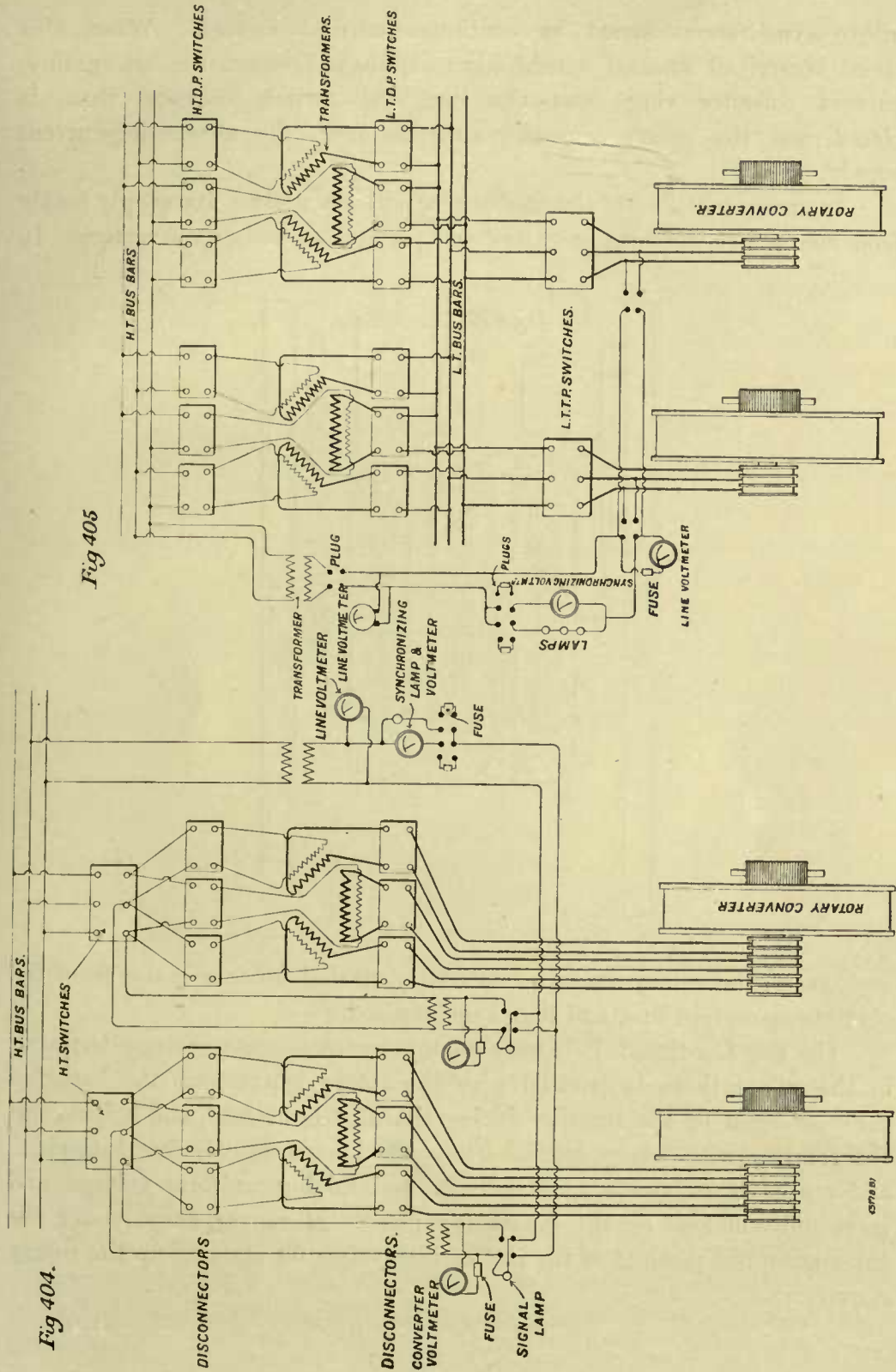
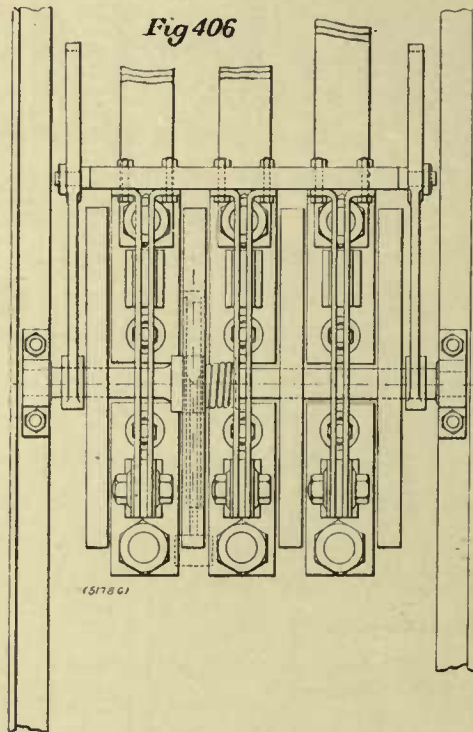

Fig 404.

Fig 405

up to synchronous speed as continuous-current motors. When this speed is arrived at, and synchronism attained, between the alternating-current collector rings and the line, the switch between them is closed, and the rotary converter runs on from the alternating-current supply.

In many cases, a continuous-current system derives its supply partly from continuous-current generators and partly from rotary converters. In



such cases, the rotary converter is simply started up as a motor from the continuous-current line, and then synchronised.

On the Continent it is very customary to operate storage batteries in the sub-stations, in parallel with the rotary converters, the batteries being charged by the rotaries during times of light load, and helping out the rotaries with heavy loads. They are known as "buffer batteries," and are of considerable assistance in maintaining uniform voltage and more uniform load on the generating plant. Moreover, they render the sub-station independent of the rest of the system for starting up the rotary converters.

SYNCHRONISING ROTARY CONVERTERS.

One has the choice of synchronising the rotary converter either by a switch between the collector rings and the low potential side of the step-down transformers, or of considering the step-down transformers and the rotary converter to constitute one system, transforming from low-voltage continuous current to high-voltage alternating current, and synchronising by a switch placed between the high-tension terminals of the transformers and the high-tension transmission line. This latter plan

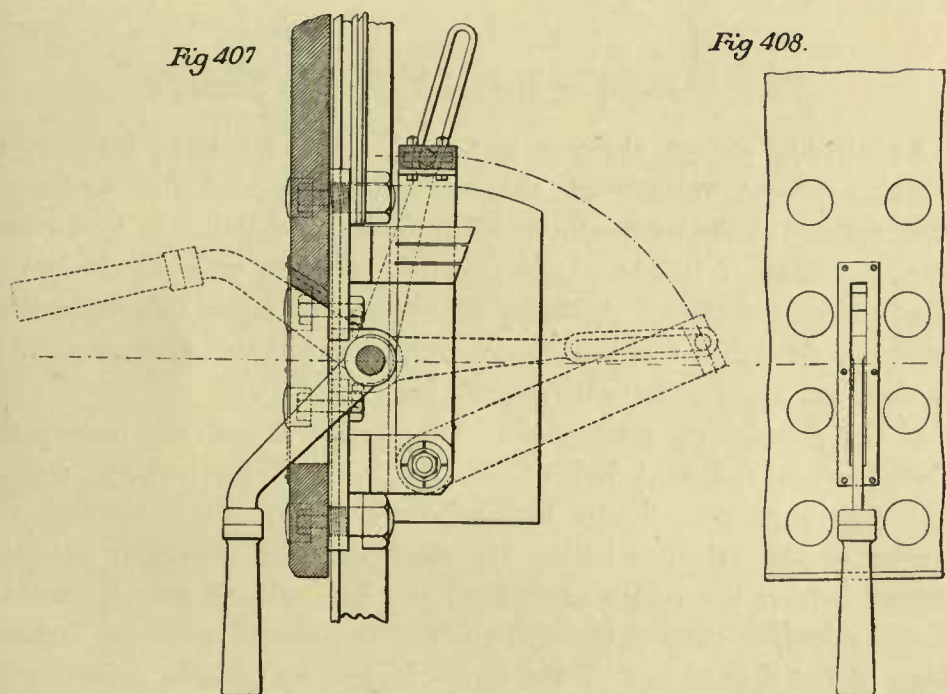

is, perhaps, generally the best; as for the former plan, one requires a switch for rather heavy currents at a potential of often from 300 to 400 volts; and such a switch, to be safely opened, is of much more expensive construction than a high-tension switch for the smaller current. Moreover, for six-phase rotaries, the low-tension switch should preferably have six blades, as against three for the high-tension switch. It is much simpler in six-phase rotary converters to have an arrangement which obviates opening the connections between the low-tension terminals of the transformers and the collector ring terminals, although in such cases some

type of connectors should be provided which may be readily removed when the circuits are not alive, for purposes of testing.

The arrangement shown in Fig. 404 represents a plan for synchronising and switching, on the high-tension circuits, and adapted to six-phase rotaries.

Fig. 405 shows diagrammatically a plan for a three-phase system where the switching is done on the low-tension circuits. The quick-break switch used, which is necessarily of rather elaborate construction, is illustrated in Figs. 406, 407, and 408. This switch was designed by Mr. Samuelson. The switch is designed for the breaks to occur on the back of the board, thus protecting the operator.

VOLTAGE RATIO IN ROTARY CONVERTER SYSTEMS.

As already shown, there is a tolerably definite ratio between the alternating-current voltage at the collector rings and the continuous-current voltage at the commutator. This lack of flexibility is, to a certain degree, a source of inconvenience; hence, methods whereby it may be avoided possess interest. A rotary converter with adjustable commutator voltage, is desirable for the same purposes as an over-compounded generator, and also for charging storage batteries.

If the generators, transmission line, transformers, and rotary converters possess sufficient inductance, the commutator voltage may be varied within certain limits by variations of the field excitation of converter or generator, or both. By weakening the generator excitation or strengthening the rotary excitation, the line current may be made to lead, and a leading current through an inductive circuit causes an increased voltage at the distant end of the line. Hence, by suitable adjustment of the excitation, the voltage at the collector rings of the rotary, and consequently also its commutator voltage, may be increased. Strengthening the generator field or weakening the converter field, or both, causes the current to lag, and results in a decreased commutator voltage. These effects may be intensified by placing inductance coils in series in the circuits.

Another method of controlling the commutator voltage is by equipping the step-down transformers with switches whereby the number of turns in primary or secondary, and hence the ratio of transformation, may be adjusted. A much better method consists in employing an

induction regulator between the transformer secondary terminals and the rotary converter. This consists in a structure like an induction motor. Series windings are put on the one element, say the stator, and potential

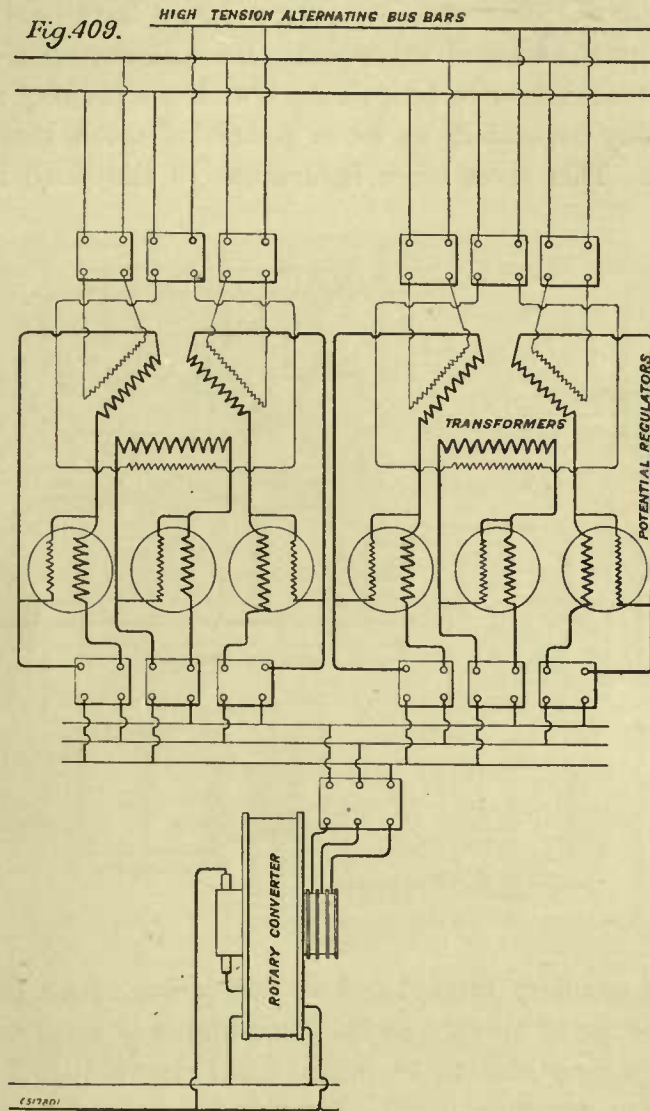

windings on the rotor. The rotor may be progressively advanced through a certain angle, and at each angular position will raise or lower the voltage at the collector rings by a certain amount, by virtue of the mutual action of the series and potential coils. The connections are shown diagrammatically in Fig. 409.

A small auxiliary rotary converter, having a voltage equal to the amount by which it is desired to increase or decrease the commutator voltage of the main rotary, and with a current capacity equal to that of the main rotary, may be employed with its commutator in series with that of the main rotary. The auxiliary rotary should have field coils capable of exerting a great range of excitation. Its collector should be supplied from a special transformer or transformers, with the primary and secondary coils considerably separated, so as to permit of much magnetic leakage between them. This gives large inductance to the small branch circuit

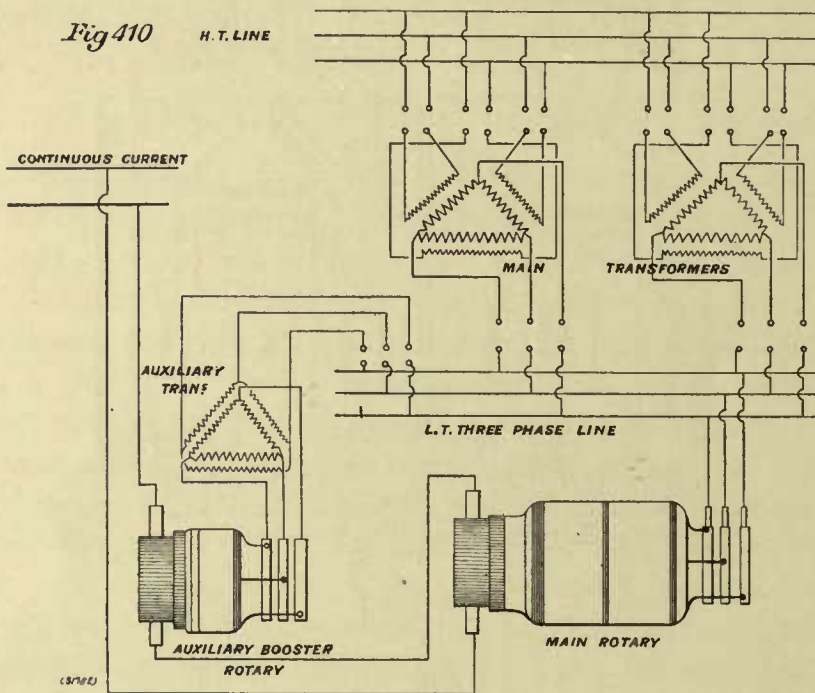

leading to the auxiliary rotary, and by regulation of its field excitation, a very wide range of voltage at its commutator is secured. It has the great advantage over inductance in the main circuit that it gives a wide range of voltage variation for the combined set, consisting of main and auxiliary rotary, without working at low-power factors. This is obviously the case, since the main rotary may be adjusted to work at a power factor of unity, while it is only the relatively small amount of energy consumed by the small capacity auxiliary rotary, which is supplied at a low power factor. The effect on the power factor of the main system, caused by the power factor of the small rotary, may be completely

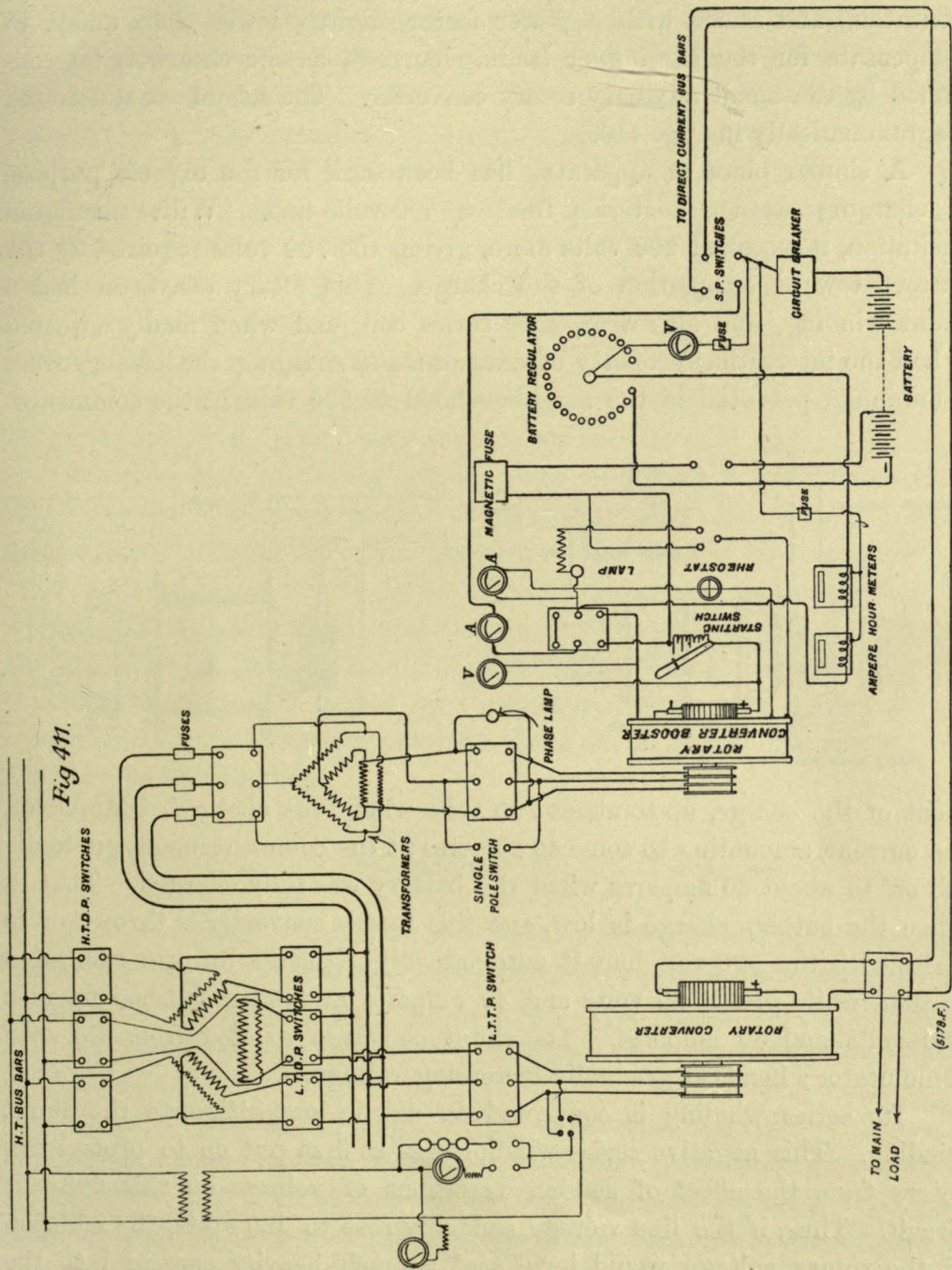

neutralised, and the resultant power factor restored to unity by the simple method of running the large main rotary with a slight over or under excitation, and hence with a power factor slightly lower than unity, to compensate for the lagging or leading current, as the case may be, consumed by the small auxiliary rotary converter. The scheme is illustrated diagrammatically in Fig. 410.

A similar piece of apparatus has been used for the express purpose of charging storage batteries from a 500-volt line. With maximum excitation, it supplied 200 volts more, giving the 700 volts required by the battery toward completion of the charge. This rotary converter had a shunt winding, and also a *negative* series coil, and when finally adjusted it had the interesting property of *automatically* charging the battery from a minimum potential in the neighbourhood of 530 volts at the commence-

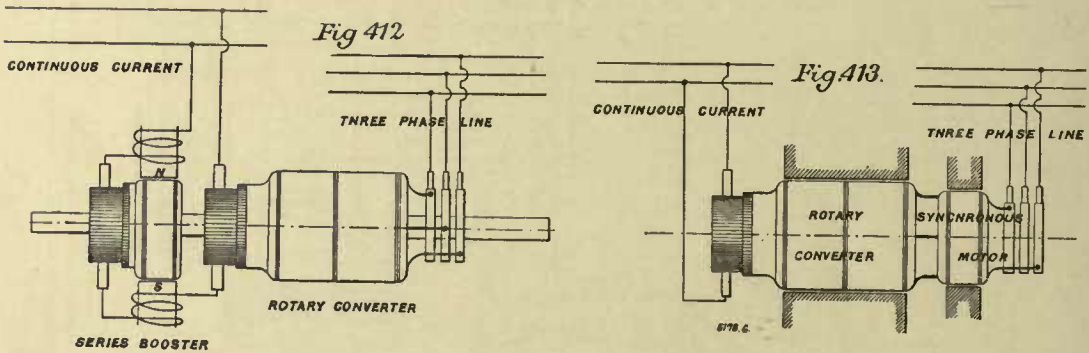

ment of the charge, up to about 700 volts when fully charged. Moreover, the current, amounting to some 40 amperes at the commencement, gradually fell off to about 30 amperes when the battery was fully charged. That is, when the battery charge is low, and this rotary converter is thrown on in series with the 500-volt line, it automatically regulates its own excitation so that, while giving 30 volts and 40 amperes at first, it finished up with 200 volts and 30 amperes. Its shunt coils are excited from its own commutator; hence at gradually increasing voltage.

Its series winding is connected to act in opposition to the shunt winding. This negative series winding was at first put on to protect the rotary from the effect of sudden variations of voltage on this 500-volt circuit. Thus, if the line voltage suddenly rose to 520 volts, the addition of the rotary voltage would have sent a much heavier current into the battery; a negative series winding tended to equalise the resultant voltage in spite of line variations, and proved to contribute very markedly to the

automatic regulation of current and voltage to the varying requirements during the process of charging the storage battery.

In Fig. 411 is given a diagram of its connections.

An alternative scheme to that of a small auxiliary rotary converter, and, perhaps, on the whole, the best arrangement of all, consists in the addition of a small continuous-current machine on an extension of the shaft of the main rotary converter. If its fields are excited in series with the load, and its commutator connected in series with that of the main rotary converter, the combined set may be adjusted to over-compound to any desired extent. Fig. 412 gives a diagram of this scheme.

A great disadvantage of both these last schemes is that the commutator of the auxiliary machine carrying the main current must have substantially as great a radiating surface as the main commutator, and hence is expensive. The commutator losses are also doubled.

Still another interesting arrangement for giving an adjustable ratio of conversion of voltage, is that illustrated in Fig. 413, wherein a small synchronous motor is directly connected on the shaft of the rotary, which requires no collector rings; those of the synchronous motor serving for the set. The synchronous motor has a separate field system, by varying the excitation of which, the percentage of the voltage consumed in the synchronous motor, is varied, and consequently also the total ratio of conversion. This scheme avoids the losses in an extra commutator, and is a very flexible method.

RUNNING CONDITIONS FOR ROTARY CONVERTERS.

The conditions relating to starting rotary converters have been considered on pages 340 to 344. After being finally brought to synchronous speed, there remain various adjustments requisite to secure the most efficient performance, and to adapt them to best fulfil the special requirements.

Phase Characteristic.—The term “phase characteristic” is generally applied to a curve plotted with field excitation (preferably expressed in ampere-turns per field spool), for abscissæ, and with amperes input per collector ring, as ordinates. Such a curve has been given for no load in Fig. 400, on page 333, and from an examination of it, one learns that, at normal voltage between collector rings (310 volts in the machine in question), and a field excitation of 6.4 amperes (5800 ampere-

turns per pole), there was required only about 80 amperes per phase to run the rotary converter unloaded. This is the condition of minimum current input; with weaker field excitation the current lags, and with stronger it leads, in both cases increasing rapidly in amount with the varying field excitation. The curve shows that with no field excitation, the current per phase increases to about 2100 amperes, and it also reaches approximately this same value with twice the normal field excitation.

If the current is in phase at the point of minimum current input, then the volt-amperes will be equal to the sum of the no-load losses.

NO-LOAD LOSSES.

	Watts.
Core and stray losses at normal voltage	= 20,000
Friction and collector C ² R losses... ..	= 8,000
Shunt field self excitation = 6.4 × 500	= 3,200
	= 31,200
Watts per phase	= 10,400
“Y” voltage = $\frac{310}{\sqrt{3}}$	= 180 volts.
Current per phase (i.e., entering each collector ring) = $\frac{10,400}{180}$	= 58 amperes.
Hence we have an unaccounted-for balance of 80 - 58 =	22 amperes.

This is due partly to a difference in the wave forms of the generator and the rotary, but chiefly to so-called “surging” effects, and will be a varying value, depending upon the motive power driving the generating alternator, and upon the methods employed to limit the effect. It will be considered in a subsequent paragraph.

Neglecting the “surging” effect, for a given field excitation, the power factor of the incoming current may be estimated. Thus the curve of Fig. 400 shows that with the excitation of 3.2 amperes (half the normal excitation) there is an incoming current of 1000 amperes per phase. One thousand amperes entering a collecting ring corresponds to $\frac{1000}{\sqrt{3}} = 580$ amperes in the armature conductor.

Resistance of armature between commutator brushes has been given as .005 ohm at 60 deg. Cent. = R. (See page 332.)

Then the resistance of one branch (*i.e.*, one side of the Δ) will be $1.33 R = .0067$ ohm.¹

In each branch there will be a C^2R loss of $580^2 \times .0067 = 2250$ watts, and therefore a total armature C^2R of $3 \times 2250 = 6750$ watts. The field excitation with regulating rheostat losses will be one-half its former value, *i.e.*, 1650 watts. The core loss and friction remain substantially as before, but the collector C^2R loss is increased by 500 watts.

SUMMARY.

	Watts.
Armature C^2R	6,750
Field self-excitation	1,650
Core and stray losses	20,000
Friction and collector C^2R losses	8,500
Total of losses	36,900
Total per phase	12,300
Volt-amperes input phase = $580 \times 310 = 180,000$.	
Hence power factor = $\frac{12.3}{180} = .068$.	

¹ Proof that, if R = armature resistance between commutator brushes, then $1.33 R$ = resistance of one side of the Δ .

Take the case of the present rotary. It has 12 poles, and a multiple-circuit single winding. Therefore, there are 12 paths through the armature from the positive to the negative brushes. There are 576 total turns on the armature. Hence, each of the 12 paths has 48 turns. R = the resistance of the 12 paths in parallel. $\therefore 12 R$ = resistance of one path of 48 turns. But between two collector rings, the 576 total turns are divided into three groups of 192 turns each. One side of the Δ is made up of one such group arranged in six parallel paths of $\frac{192}{6} = 32$ turns each; 32 turns in series will have a resistance of

$$\frac{32}{48} \times 12 R = 8 R,$$

and six paths in parallel will have a resistance of $\frac{8 R}{6} = 1.33 R$, and this equals the resistance of one side of the Δ . *Q.E.D.*

Any difficulties in understanding this subdivision of the winding into groups and parallel paths may be removed by a study of the winding diagram for the multiple-circuit single winding shown in Fig. 373, on page 297. Analogous investigations of two-circuit single windings, and of multiple windings of both the two-circuit and multiple-circuit type, will yield the same result, *i.e.*, that the resistance of one side of the Δ is equal to $1.33 R$, for three-phase rotaries. For an examination of these latter cases, one may make use of the winding diagrams of Figs. 374 and 375, on pages 298 and 299.

Similar calculations for other values of the field excitation, give data for plotting other phase characteristic curves for no load, that is, for no

Fig. 414. NO LOAD PHASE CHARACTERISTICS.
of 900Kw. 25 Cycles 500 Volts
Three Phase Rotary Converter.
Power Factor in terms of Field Excitation.

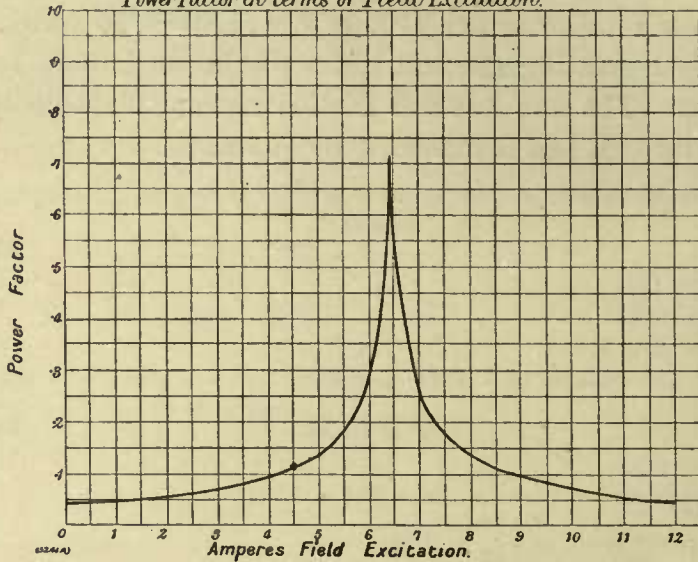
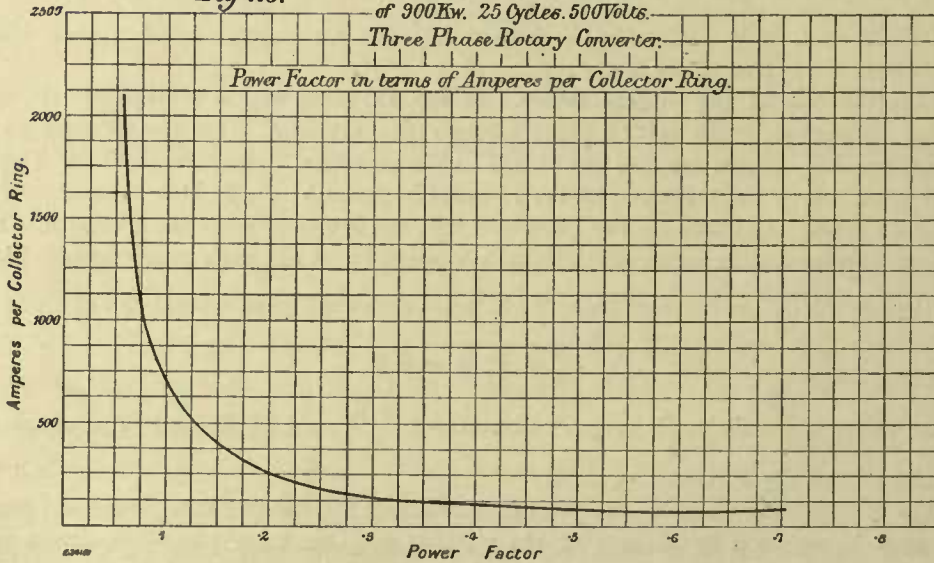

Fig. 415. NO LOAD PHASE CHARACTERISTICS.
of 900Kw. 25 Cycles 500 Volts.
Three Phase Rotary Converter.
Power Factor in terms of Amperes per Collector Ring.



output from the commutator. Thus in Fig. 414 the power factor is plotted in the terms of the field excitation ; and in Fig. 415 in terms of the amperes input per collector ring. These curves have all corresponded to no load,

but other phase characteristic curves may be obtained for various conditions of load.

In Fig. 416 are given phase characteristic curves at no load, half load, and full load for a 125-kilowatt rotary converter. It will be observed that the phase characteristic curves with load possess the same general features as the curve for no load, though less accentuated.

PHASE CHARACTERISTICS.
 of 125 Kw. 30 Cycle. 115 Volt
 Three Phase Rotary Converter.
 Constant Alternating Current Potential of
 75 Volts between rings.

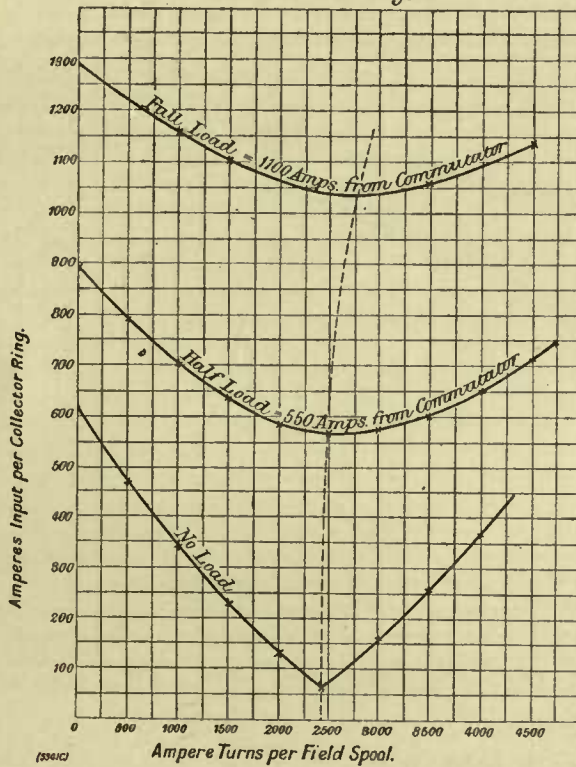

In Fig. 417 these curves are transformed into three others in which the power factors are plotted in terms of field excitation; and in Fig. 418 the power factors are plotted in terms of amperes input per collector ring.

Figs. 414, 416, and 417 show the importance, especially with light loads, of careful adjustment of the excitation. The power factor falls off very rapidly indeed with variations of the field excitation from the normal value. However, with load, the variations are comparatively moderate, and field regulation can then advantageously be employed as a means of phase

control; and through the intermediation of line and armature inductances, sometimes aided by auxiliary inductances employed for the express purpose, a considerable working range of voltage, at the commutator of the rotary converter, may be obtained.

This brief description of the phase characteristic curves permits of now explaining, in a rough, practical way, what causes the current to lag or lead with varying field excitation, and also what controls and determines

PHASE CHARACTERISTICS.
of 125 Kw. 35 Cycle. 115 Volt
Three Phase Rotary Converter.

Fig 417.

Power Factor in terms of Ampere Turns per Field Spool.
Constant Alternating Current Potential of 75 Volts between rings.

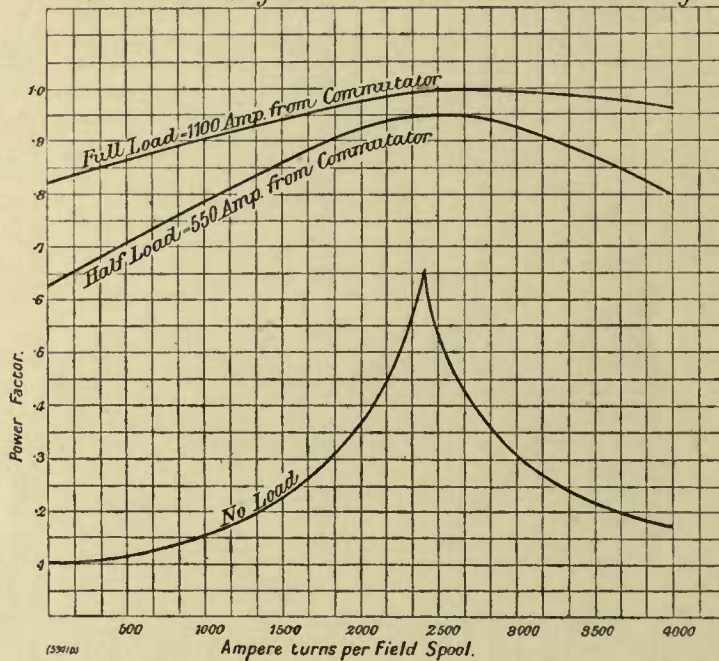

the extent by which it shall lag or lead. Suppose a generator, say by hand regulation of the field excitation, is made to furnish 310 volts, under all conditions of load and phase, to the collector rings of a rotary converter. (Assuming the rotary converter to be of very small capacity relatively to that of the generator, these variations will not materially affect the generator voltage, which will remain approximately constant.)

It has been shown that there will be substantially 500 volts at the commutator when there are 310 volts between collector rings. This is fairly independent of the field excitation. But figuring from the 310 volts

at the collector rings, or the 500 volts at the commutator, the result arrived at is that there is a magnetic flux M per pole-piece, linked with the armature winding turns. When the field excitation is such as to afford the requisite magnetomotive force for impelling this flux M against the reluctance of the magnetic circuit, there will be no current in the armature, or, rather, only the small amount necessary to supply the power represented by the no-load losses. But if the field excitation is weakened, say, to one-half, then, since there is still the same terminal voltage, it follows that there must also be the same flux M impelled through the same magnetic

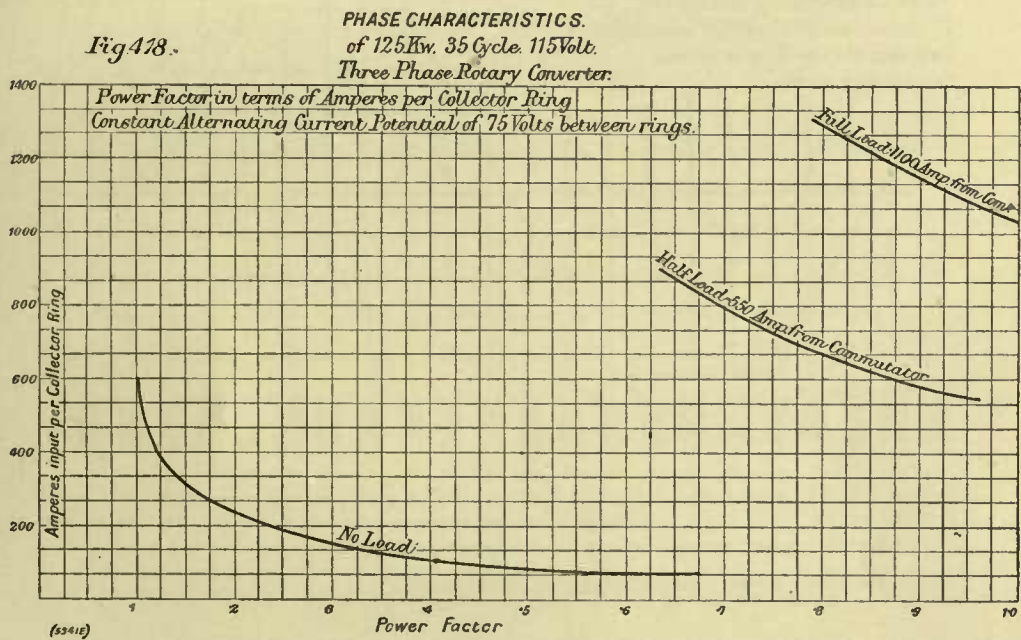

circuit. The remaining part of the required magnetomotive force has, therefore, to be sought for elsewhere. It is, in fact, furnished by a lagging armature current which then flows into the collector rings. This component does no work, hence it is 90 deg. out of phase. The resultant current is composed of the energy component which overcomes the losses, and this wattless current. Thus in the analysis on page 352 of the phase characteristic curve of Fig. 400, it was found that reducing the field excitation from 6.4 amperes, (corresponding to unity power factor), to 3.2 amperes, increased the input from 80 amperes per collector ring to 1,000 amperes per ring. The magnetising component of this 1,000 amperes was $\sqrt{1,000^2 - 80^2}$, and hence scarcely differed for 1,000 amperes. There

are, therefore, $\frac{1,000}{\sqrt{3}} = 580$ amperes per side of the "delta," or $\frac{580}{6} = 97$ amperes per armature conductor. This, assuming a sine wave of incoming current, is $97 \times \sqrt{2} = 138$ maximum amperes. A current of 6.4 amperes in the field corresponded to a magnetomotive force of 5,800 ampere-turns. This, with 3.2 amperes, was reduced to 2,900 ampere-turns, the *remaining* 2,900 ampere-turns per pole-piece being supplied by the lagging current in the armature winding. The 12-pole armature has 576 total turns, or 48 per

Fig. 419.
Three Phase Rotary Converter.
Distribution of resultant armature magnetomotive force over the armature surface.

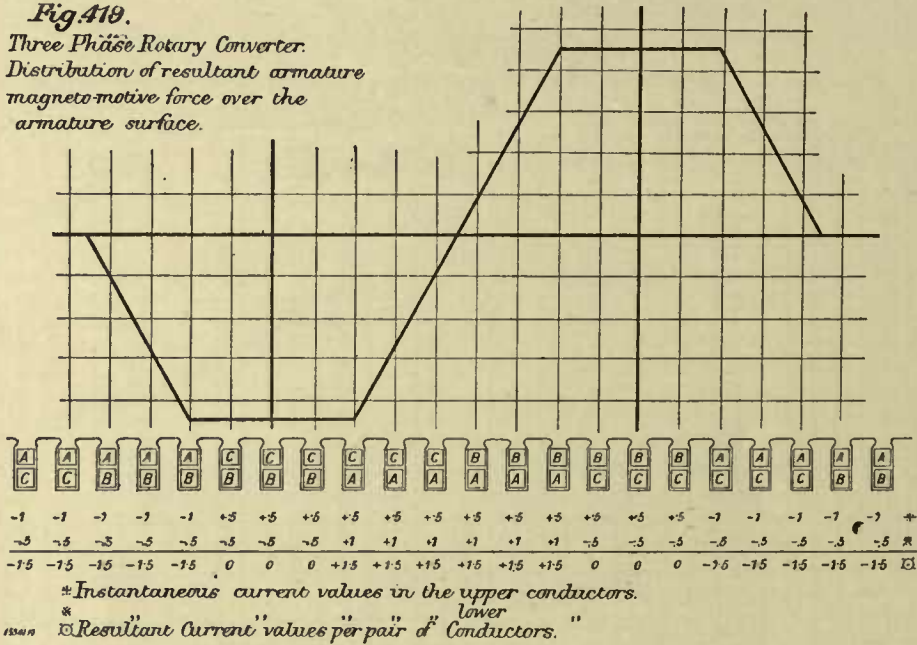

pole-piece; but these 48 turns per pole-piece belong to three different phases, hence there are 16 turns per pole-piece per phase. The maximum ampere-turns per phase are

$$16 \times 138 = 2,200 \text{ ampere turns.}$$

In Figs. 419 and 420 are shown, diagrammatically, the arrangement of the conductors of the different phases in the armature slots of a three-phase rotary, and directly above, the corresponding curve of magnetomotive force due to the currents in the armature conductors. Fig. 419 represents the instant when these relative current values in the phases A, B, and C are, respectively, 1, .5, and .5. In Fig. 420 these have become .867, 0, and .867. Hence it is in Fig. 419, that one phase reaches the maximum value 1, and as there are six conductors per pole-piece per phase,

its maximum magnetomotive force may be represented by 6. But although, in Fig. 419, the corresponding maximum value of the magnetomotive force of the three phases is 9, it becomes 10.4, one-twelfth of a cycle later, at the instant represented by Fig. 420. Hence, in a three-phase rotary converter winding, the maximum magnetomotive force exerted by the armature conductors of all the phases is, per pole-piece, $\frac{10.4}{6} = 1.73$ times as great as the maximum magnetomotive force per pole-piece per phase.

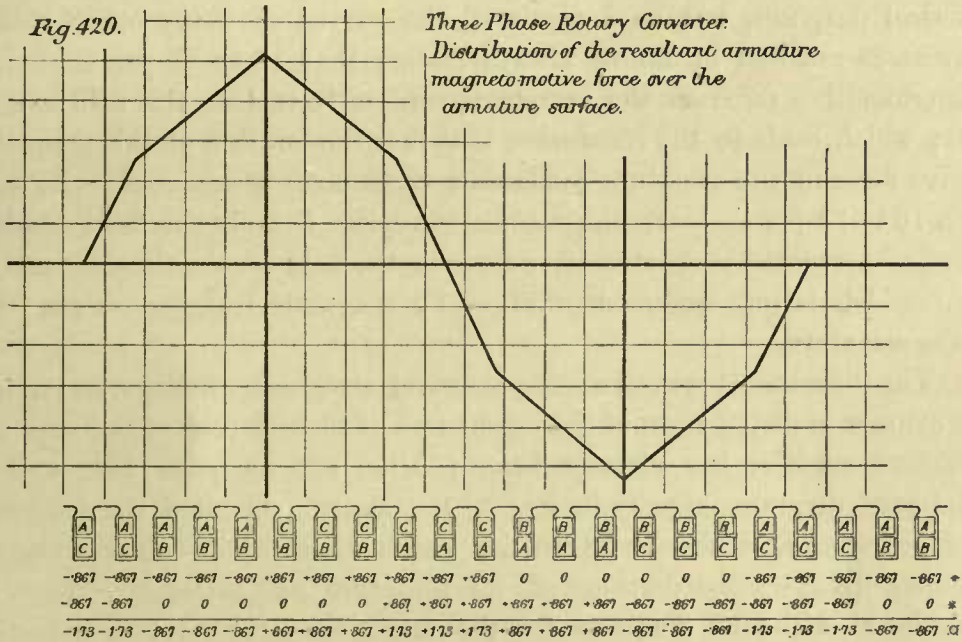

* Instantaneous current values in the upper conductors.

* " " " " " " lower "

□ Resultant current values per pair of conductors.

Now, for the case under consideration (the 900-kilowatt rotary), the value of 2,200 ampere-turns per pole-piece was found for the maximum magnetomotive force per phase. Therefore, the maximum resultant armature reaction for the three phases would be

$$1.73 \times 2,200 = 3,800 \text{ ampere-turns per pole-piece.}$$

But it is only in opposition to the flux at the very centre of the pole-face, that the armature magnetomotive force would exert this strength. Approaching both sides, it shades off towards zero, as may be seen from the

curves of magnetomotive force distribution of Figs. 419 and 420, whereas the field spool against which it reacts, is linked with the entire pole-piece. In practice, these magnetomotive force curves would be smoothed out into something like sine curves. Hence we may take the average magnetomotive force exerted over the whole pole-face as about $\frac{3800}{\sqrt{2}} = 2,700$ ampere-turns. This corresponds fairly well with the 2,900 ampere-turns by which the field excitation was reduced.

At first sight, it would appear that this checks well enough for all practical purposes, but an analysis of the curves of many other rotary converters resulted in almost always finding that 10 to 25 per cent. less magnetomotive force on the armature, suffices to replace the field excitation; which leads to the conclusion that it is the location of this magnetomotive force in the armature conductors themselves which enables it, with from 10 to 25 per cent. less magnitude, to replace the—in this respect—less effectively situated magnetomotive force in the field spools, the flux set up from which latter, suffers diminution, by magnetic leakage, on the way to the armature.

The difference between three-phase and six-phase windings, as regards the manner of distribution of the conductors of the different phases over the armature surface, has already been pointed out on page 303, and is illustrated diagrammatically in Fig. 379. Bearing in mind the difference there explained, it should be further noted that the so-called six-phase winding gives a distribution of its armature magnetomotive force in accordance with the diagrams for the magnetomotive force in induction motors, which were shown and explained on pages 137 to 140. It is there shown that the three phases of such a winding, exert a resultant magnetomotive force, whose maximum value is equal to two times the maximum value of the magnetomotive force per phase. But by Figs. 419 and 420, on pages 358 and 359 *ante*, it has been shown that in the winding of the ordinary three-phase rotary converter (when the windings of the different phases overlap), this maximum value is only 1.73 times the magnetomotive force per phase. A six-phaser will, therefore, give equally effective response to field variations, with but $\frac{1.73}{2.00}$, or 87 per cent. as great an incoming current, as will a three-phase rotary converter. This is a distinct advantage, even for the shunt-wound and for the compound-wound rotary, but it is still more important in the case of the

series rotary, and for the rotary without field excitation (which will shortly be discussed), since the chief objections to these latter types relate to the large incoming current due to absence of control of field excitation, except by means of armature reactions.

The choice of as many turns per pole-piece on the armature, as good constants, in other respects, will permit, is, of course, conducive in all types of rotaries to the best result, from the standpoint of securing the required magnetomotive force from the armature with as little idle current as possible.

By similar methods the magnetomotive force relations may be analysed from the phase characteristics with load. Under these conditions, *i.e.*, with current delivered from the commutator, there are further considerations: The demagnetising influence of the commutated current may be neglected, as the brushes remain at the neutral point, and even the *distorting* influence upon the magnetic distribution may be considered to be substantially offset by the overlapping *energy* component of the incoming alternating current. The main difference appearing in the analysis of the phase characteristic with load, is that the energy component, except with great weakening or strengthening of the normal field, will be a very appreciable component of the total resultant incoming alternating current. Thus, in Fig. 416 (page 355 *ante*), the upper curve represents the phase characteristic with full load output of 1100 amperes at 115 volts from the commutator. At normal field of 2750 ampere-turns, the amperes input per collector ring are 1030. Reducing the field excitation to zero, increases this incoming current to 1290 amperes. The output is 125,000 watts.

The internal losses under these conditions of full-load output and zero field excitation, are approximately as follow:

	Watts.
Total armature C ² R loss	5,000
Bearing and all brush friction	2,700
Core loss	2,700
Brush C ² R losses	3,500
Total internal loss	13,900
Watts output	125,000
Total watts input	138,900
Total watts input per phase	46,300

Voltage per phase	75 volts.
Energy component of current per phase in armature	616 amperes.
Observed current input per collector ring	1,290 „
„ „ in armature winding	745 „
Magnetising component	$= \sqrt{745^2 - 616^2}$	=	406 „
The armature has a six-circuit single winding with 180 total turns; therefore, 10 turns per pole-piece per phase.						
Magnetising current per turn	$= \frac{406}{3}$	=	135	amperes.		
Maximum magnetomotive force per phase	$= \sqrt{2} \times 135 \times 10$	=	1,900	ampere-turns.		
Hence maximum of resultant magnetomotive force of armature per pole-piece	$= 1.73 \times 1,900$	=	3,300	ampere-turns.		
Average value over pole-face	$= \frac{3,300}{\sqrt{2}}$	=	2,300	ampere-turns.		

These serve to set up the same magnetic flux through the armature winding, for which 2,750 ampere-turns per field spool were required. The latter, however, were less favourably situated, there being much magnetic leakage to be deducted from the initial flux set up.

“*Surging*” *Effect*.—Reference has been made to the “surging” effect in rotary converters as being chiefly responsible for the discrepancy between the observed current input, when the field is adjusted for minimum input, and the energy-current input. This additional current is of the nature of an interchanging current amongst the generators and rotary converters. When, in the first place, the source of power driving the generator has not a constant angular effort, the flywheel may not be sufficiently large to make the angular velocity uniform throughout the revolution.

The rotary converter, to remain strictly in synchronism, must respond perfectly to those changes in angular velocity. Of course, it cannot do so perfectly, so the result is that at one instant it lags behind by a more or less small fraction of an alternation, (distance from mid-pole-face position), and takes more current; then it accelerates more rapidly, gains on the generator, and swinging too far forward, on account of its momentum, acts for the instant as a generator, returning current to the source of its supply. This is the nature of the superposed current above referred to.

According to the degree of unevenness of the angular speed of the generator, and to the absolute and relative inertia of the moving parts of the generators and rotary converters, this superposed swinging motion may be more or less great, and may, either between generators and rotary,

or between rotaries, develop into sympathetic swings of considerable magnitude, leading, in some cases, to falling out of phase, but more often to serious and rather destructive sparking at the commutator, due to the pulsations. As already pointed out, these troubles may be remedied in practice by employing copper coils or plates specially located between

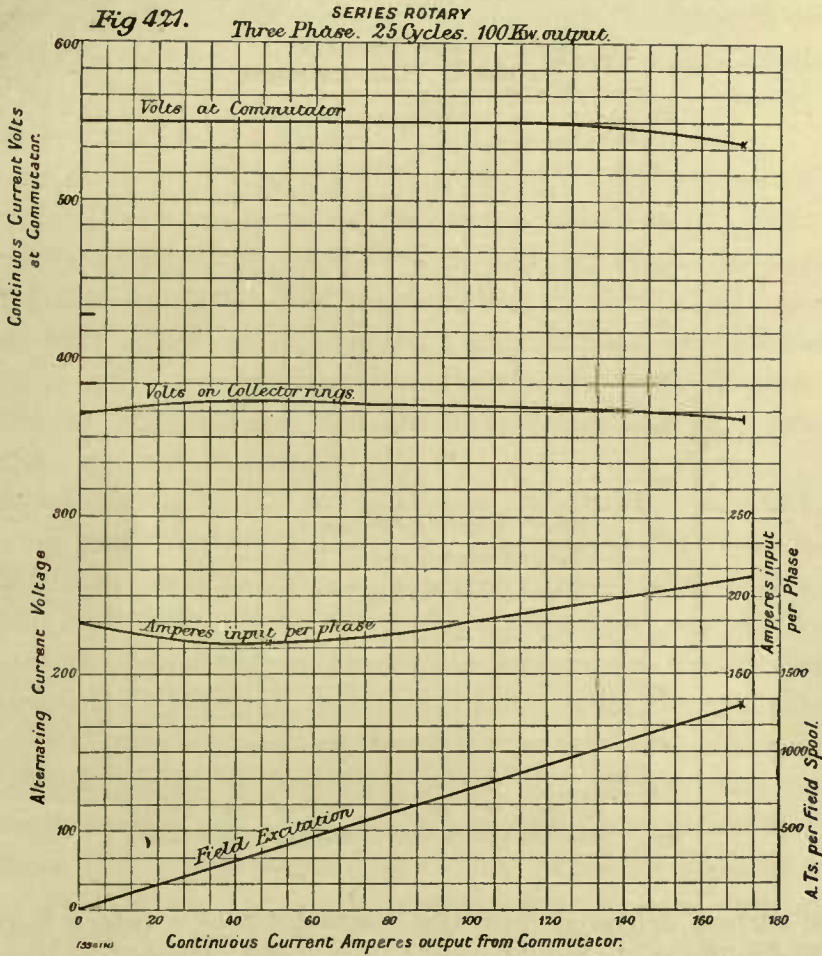

pole-pieces ; or more easily, but less economically and effectively, by using wrought-iron pole-pieces of the highest practicable conductivity, with small clearance between pole-face and armature.

Compound-Wound Rotary.—The purpose of the compounding coil (series winding) has already been set forth (see page 324), and it merely remains to state that in practice it has been found to distinctly diminish the tendency to stability when the “surging” effect is present to any

extent. Nevertheless, it is an aid to automatic phase regulation, being, of course, more especially valuable where quick changes of load are constantly occurring, as in the operation of tramways. For gradually varying load, pure shunt excitation with hand regulation is more satisfactory, unless the generator is driven with an extremely uniform angular motion.

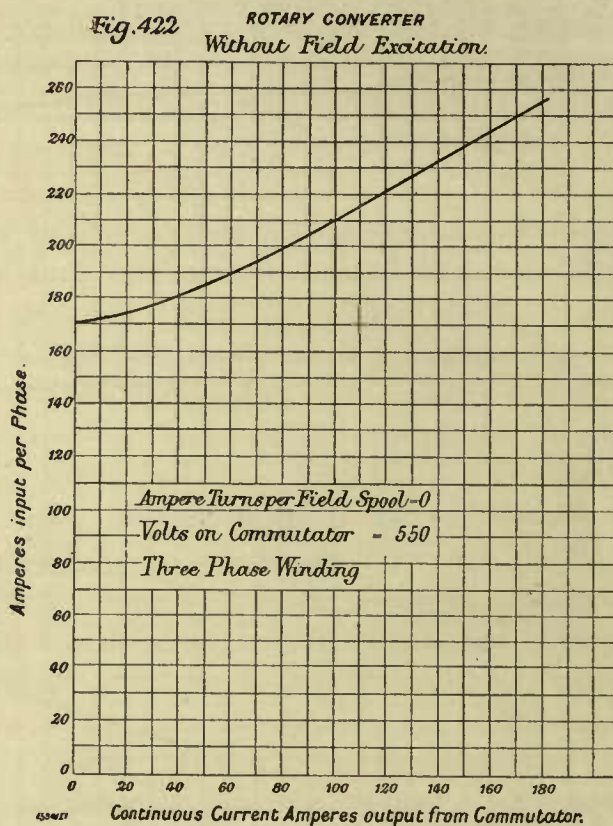

The current delivered from the commutator of a rotary converter is never very uniform; it has always a superposed alternating-current component, which may be readily demonstrated by sending such a commutated current through a reactance coil of sufficient inductance, when there may be observed across the terminals of the coil (by an alternating-current voltmeter) a difference of potential many times in excess of the CR drop.¹ Although this is best observed by means of the drop across it, such a

¹ See *Jour. Inst. Elec. Engrs.*, vol. xxvii., page 710, 1898.

reactance coil tends to eliminate these variations, and they are much less than when no inductance is in circuit. A compound winding will, to a certain degree, have this same effect; and while the difficulties attending its use are probably partly due to this effect, it should, at the same time, in some measure tend to make the commutated current more free from superposed variations. The series winding is cut out when starting up from the continuous-current side, and this is conveniently accomplished by a double-throw switch, which in one position connects the junction of the series winding and the negative brushes to the starting rheostat, and in the other position connects this point with the equalising bar.

Series Rotary.—The shunt winding may be dispensed with altogether in a rotary converter, the excitation being supplied by the series winding alone. The conditions, however, are not satisfactory, as the excitation is controlled entirely by the load current; and from what we have learned by a study of phase characteristics, such wide variation of excitation cannot be made to give an economical power factor for any extended range of load. Curves taken upon a 550-volt, 100-kilowatt rotary, operated in this manner, are given in Fig. 421.

Rotary without Field Excitation.—A rotary with no field winding supplies its excitation by virtue of the magnetising effect of the lagging currents flowing through its armature, and which enter from the collector rings. In Fig. 422 is given a curve of the alternating-current in terms of the continuous-current output for the above-mentioned 100-kilowatt rotary when operated with no field excitation. In this case, the excitation of the generator was raised from 5,500 ampere-turns per spool, when no amperes were delivered from the commutator of the rotary converter, up to 7,000 ampere-turns per spool at full load amperes delivered from the commutator of the rotary converter. This served to maintain the commutator potential of the rotary, constant at 550 volts, throughout the whole range of load. This increased excitation of the generator was necessary, as it also was of only 100-kilowatt capacity, and the large demagnetising magnetomotive force of the lagging armature current acting against its own impressed field, required to be overcome by the increase of field excitation from 5,500 to 7,000 ampere-turns per spool. Such rotaries without field windings have, however, actually been employed commercially.

The advantage of having, for rotaries of this type, a very strong armature, even to the sacrifice of the most favourable values for other

constants, will now be clearly seen. The armature winding will thereby be enabled to supply the required magnetomotive force with less excessive magnetising currents from the source of supply. The use of six collector rings (so-called six-phase), has in this respect an advantage of 14 per cent., for a given armature and winding, over the ordinary method with three rings.

APPENDIX.
TABLE LVI.—PROPERTIES OF COMMERCIAL COPPER WIRE.
BROWN AND SHARPE WIRE GAUGE (B. AND S.).

Gauge Number.	Diameter (Inches).			Cross Section, (Sq. In.)	Gauge Number.	Ohms per 1000 ft.					Gauge Number.	Feet per Ohm at 20 deg. C.	Pounds per Ohm at 20 deg. C.	Feet per Pound.	Pounds per 1000 Ft. (Bare.)		
	Bare.	S. C. C.	D. C. C.			T. C. C.	0 deg. C.	20 deg. C.	40 deg. C.	60 deg. C.						80 deg. C.	100 deg. C.
0000	.460480	.166	0000	.0452	.0489	.0526	.0565	.0606	.0643	0000	20400	13100	1.56	641
000	.410430	.132	000	.0570	.0617	.0663	.0713	.0764	.0812	000	16200	8230	1.97	508
00	.365385	.105	000	.0720	.0778	.0837	.0900	.0963	.102	00	12900	5130	2.48	403
0	.325343	.0829	0	.0609	.0691	.106	.113	.122	.129	0	10200	3260	3.13	320
1	.289	..	.303	.307	.0657	1	.115	.124	.134	.144	.153	.162	1	8080	2050	3.65	258
2	.258	..	.272	.276	.0521	2	.144	.156	.168	.180	.193	.204	2	6410	1290	4.98	201
3	.233	..	.243	.247	.0413	3	.182	.197	.212	.228	.244	.258	3	5080	810	6.28	159
4	.204	..	.216	.220	.0323	4	.230	.243	.268	.288	.307	.325	4	4030	509	7.91	126
5	.182	..	.194	.198	.0260	5	.290	.313	.337	.362	.387	.410	5	3200	320	9.98	100
6	.164	..	.174	.178	.0206	6	.365	.394	.425	.456	.488	.516	6	2540	202	12.6	79.5
7	.144	..	.156	.160	.0164	7	.460	.497	.535	.575	.616	.655	7	2010	127	15.9	63.0
8	.128	..	.140	.144	.0130	8	.580	.627	.675	.725	.777	.825	8	1600	79.7	20.0	50.0
9	.114	..	.126	.130	.0103	9	.732	.791	.852	.915	.979	1.04	9	1270	50.1	25.2	39.6
10	.102	.108	.112	.116	.00815	10	.924	.997	1.08	1.16	1.24	1.32	10	1000	31.5	31.3	31.4
11	.0907	.097	.101	.105	.00647	11	1.17	1.26	1.36	1.47	1.56	1.65	11	795	19.8	40.1	24.9
12	.0808	.087	.091	.095	.00513	12	1.47	1.59	1.71	1.84	1.96	2.08	12	631	12.5	50.6	19.8
13	.0720	.078	.082	.086	.00407	13	1.85	2.00	2.16	2.32	2.48	2.63	13	500	7.84	63.8	15.7
14	.0641	.071	.075	.079	.00323	14	2.33	2.51	2.71	2.92	3.12	3.31	14	397	4.93	80.4	12.4
15	.0571	.063	.067	.071	.00256	15	2.94	3.13	3.32	3.63	3.94	4.13	15	315	3.10	101	9.36
16	.0508	.055	.059	.063	.00203	16	3.72	4.01	4.33	4.65	4.96	5.25	16	249	1.95	7.32	7.32
17	.0453	.049	.053	.057	.00161	17	4.70	5.06	5.45	5.87	6.26	6.62	17	198	1.22	161	6.20
18	.0403	.044	.048	.052	.00128	18	5.90	6.37	6.87	7.38	7.89	8.35	18	157	.772	203	4.82
19	.0359	.039	.043	.047	.00101	19	7.45	8.04	8.66	9.30	9.95	10.6	19	124	.485	257	3.90
20	.0320	.036	.040	.044	.000802	20	9.39	10.1	10.9	11.7	12.6	13.4	20	96.7	.305	323	3.10
21	.0285	.032	.036	.040	.000636	21	11.8	12.8	13.7	14.8	15.8	16.8	21	78.2	.192	403	2.45
22	.0253	.029	.033	.037	.000504	22	15.1	16.3	17.6	18.9	20.0	21.2	22	62.1	.121	514	1.95
23	.0230	.027	.031	.035	.000400	23	18.8	20.3	21.9	23.6	25.2	26.7	23	49.2	.0789	648	1.54
24	.0201	.024	.028	.032	.000317	24	23.7	25.6	27.6	29.6	31.7	33.6	24	39.0	.0477	813	1.22
25	.0179	.022	.026	.030	.000252	25	29.9	32.3	34.8	37.4	40.0	42.4	25	31.0	.0300	1030	.970
26	.0159	.020	.024	..	.000200	26	37.3	40.8	44.0	47.2	50.5	53.5	26	24.5	.0180	1300	.769
27	.0142	.018	.022	..	.000158	27	47.5	51.4	55.3	59.4	63.6	67.9	27	19.5	.0119	1640	.610
28	.0126	.017	.021	..	.000126	28	60.0	64.7	69.7	75.0	80.2	85.0	28	15.4	.00747	2070	.484
29	.0118	.015	.019	..	.000100	29	75.6	81.7	88.0	94.5	101	107	29	12.2	.00470	2610	.384
30	.0100	.014	.018	..	.0000789	30	95.5	103	112	119	128	136	30	9.71	.00295	3290	.304
31	.00893	.01250000626	31	120	130	140	151	161	171	31	7.70	.00186	4150	.241
32	.00795	.01150000496	32	152	164	177	190	203	216	32	6.11	.00117	5290	.191
33	.00708	.01050000394	33	191	207	223	240	256	272	33	4.84	.000735	6690	.152
34	.00631	.00980000312	34	242	261	282	302	323	342	34	3.84	.000462	8310	.120
35	.00562	.00860000248	35	304	328	354	380	407	431	35	3.05	.000231	10500	.0954
36	.00500	.0080	.011	..	.0000196	36	383	414	445	480	513	545	36	2.41	.000183	13200	.0757
37	.00445	.00750000156	37	484	522	564	605	647	686	37	1.92	.000115	16700	.0600
38	.003970000123	38	610	659	710	762	815	865	38	1.52	.0000721	21000	.0476
39	.0035300000979	39	770	830	895	965	1030	1090	39	1.20	.0000455	26500	.0377
40	.0031500000776	40	970	1050	1130	1210	1300	1380	40	.955	.0000286	33400	.0299

TABLE LVII.—PROPERTIES OF COMMERCIAL COPPER WIRE.
BIRMINGHAM WIRE GAUGE (B. W. G.).

Gauge Number.	Diameter (Inches).				Cross Section. (Sq. In.)	Gauge Number.	Ohms per 1000 Ft.				Gauge Number.	Feet per Ohm at 20 deg. C.	Pounds per Ohm at 20 deg. C.	Feet per Pound.	Pounds per 1000 Ft. (Bare).			
	Bare.	S. C. C.		D. C. C.			0 deg. C.	20 deg. C.	40 deg. C.	60 deg. C.						80 deg. C.	100 deg. C.	
		T. C. C.	T. C. C.	T. C. C.														T. C. C.
0000	.454474	.162	0000	.0464	.0502	.0542	.0583	.0622	.0660	0000	19900	12400	1.60	624	
000	.445445	.142	000	.0629	.0573	.0619	.0665	.0710	.0751	000	17800	9640	1.83	547	
00	.380400	.113	00	.0663	.0717	.0775	.0833	.0888	.0943	00	14000	6100	2.29	437	
0	.340358	.0903	0	.0828	.0896	.0970	.104	.111	.118	0	11200	3910	2.86	350	
1	.300318	.0707	1	.107	.115	.124	.133	.142	.152	1	8690	2370	3.67	272	
2	.284	..	.298	.302	.0633	2	.119	.128	.138	.148	.159	.169	2	7790	1900	4.10	244	
3	.259	..	.273	.277	.0527	3	.143	.154	.166	.179	.191	.204	3	6480	1320	4.03	203	
4	.233	..	.252	.256	.0445	4	.169	.183	.197	.212	.226	.240	4	5470	988	5.83	172	
5	.220	..	.234	.238	.0380	5	.198	.214	.231	.248	.265	.282	5	4680	685	6.83	147	
6	.203	..	.215	.219	.0324	6	.232	.251	.271	.291	.311	.330	6	3990	497	8.02	125	
7	.180	..	.192	.196	.0254	7	.296	.324	.352	.380	.408	.436	7	3130	307	10.2	98.1	
8	.165	..	.177	.181	.0214	8	.352	.380	.410	.441	.471	.500	8	2630	217	12.1	82.4	
9	.148	..	.160	.164	.0172	9	.437	.473	.511	.549	.585	.621	9	2120	140	15.1	66.3	
10	.134	..	.146	.150	.0141	10	.534	.577	.624	.670	.714	.760	10	1730	94.3	18.4	54.4	
11	.120	..	.132	.136	.0113	11	.665	.719	.776	.834	.890	.945	11	1390	60.6	22.9	43.6	
12	.109	..	.119	.124	.00933	12	.806	.872	.942	1.01	1.08	1.15	12	1150	41.3	27.8	36.0	
13	.0950	..	.105	.109	.00709	13	1.07	1.15	1.24	1.33	1.42	1.53	13	872	23.8	36.6	27.3	
14	.0830	..	.089	.093	.00541	14	1.39	1.50	1.62	1.74	1.86	1.98	14	665	13.9	48.0	20.0	
15	.0720	..	.078	.082	.00407	15	1.85	2.00	2.16	2.32	2.47	2.64	15	501	7.86	63.7	15.7	
16	.0650	.071	.075	.079	.00322	16	2.27	2.45	2.64	2.84	3.03	3.23	16	408	5.22	78.2	12.8	
17	.0580	.063	.068	.072	.00263	17	2.85	3.08	3.32	3.57	3.81	4.06	17	325	3.31	98.2	10.2	
18	.0490	.054	.057	.061	.00180	18	3.90	4.30	4.66	5.00	5.34	5.68	18	232	1.60	138	7.97	
19	.0430	.047	.050	.054	.00130	19	5.13	5.87	6.34	6.80	7.27	7.72	19	170	.910	187	5.84	
20	.0385	.039	.043	.047	.000962	20	7.80	8.45	9.13	9.80	10.5	11.1	20	118	.439	270	3.71	
21	.0320	.036	.040	.044	.000804	21	9.85	10.1	10.9	11.7	12.5	13.3	21	98.9	.307	323	3.10	
22	.0280	.032	.036	.040	.000616	22	12.2	13.2	14.2	15.3	16.4	17.4	22	75.5	.180	421	2.37	
23	.0250	.029	.033	.037	.000491	23	15.4	16.6	17.9	19.2	20.5	21.9	23	60.4	.114	529	1.89	
24	.0220	.026	.030	.034	.000380	24	19.8	21.4	23.1	24.8	26.5	28.2	24	46.8	.068	683	1.47	
25	.0200	.024	.028	.032	.000314	25	24.0	25.9	28.0	30.0	32.1	34.2	25	33.6	.0468	826	1.21	
26	.0180	.022	.026	.030	.000254	26	29.6	32.0	34.5	37.1	39.6	42.1	26	31.3	.0807	1020	.981	
27	.0160	.020	.024	.028	.000201	27	37.4	40.5	43.7	47.0	50.1	53.2	27	24.7	.0191	1290	.775	
28	.0140	.018	.022	.026	.000154	28	48.8	52.8	57.0	61.3	65.4	69.4	28	18.9	.0112	1690	.593	
29	.0130	.017	.021	.025	.000133	29	56.6	61.3	66.2	71.1	75.9	80.5	29	16.3	.00836	1960	.512	
30	.0120	.016	.020	.024	.000113	30	69.4	71.9	77.5	83.4	89.0	94.5	30	13.9	.00606	2290	.436	
31	.0100	.014	.018	.022	.0000785	31	96.0	104	112	120	128	137	31	9.66	.00292	3300	.303	
32	.00900	.01250000636	32	118	128	138	148	158	168	32	7.82	.00192	4080	.245	
33	.00800	.01150000503	33	150	162	175	188	200	214	33	6.18	.00120	5160	.194	
34	.00700	.01000000385	34	195	211	228	245	262	278	34	4.73	.000702	6740	.148	
35	.00500	.0080	.011	..	.0000196	35	383	414	446	480	513	545	35	2.41	.000183	13200	.0757	
36	.00400	.00700000126	36	595	645	696	749	801	846	36	1.55	.0000748	20700	.0484	

TABLE LVIII.—PROPERTIES OF COMMERCIAL COPPER WIRE.
STANDARD WIRE GAUGE (S. W. G.).

Gauge Number.	Diameter (Inches).			Cross Section. (Sq. In.)	Gauge Number.	Ohms per 1000 Ft.					Gauge Number.	Feet per Ohm at 20 deg. C.	Pounds per Ohm at 20 deg. C.	Feet per Pound.	Pounds per 100 Ft. (Bare).
	Bare.	S. C. C.	D. C. C.			T. C. C.	0 deg. C.	20 deg. C.	40 deg. C.	60 deg. C.					
7/0	500	.520	..	196	7/0	.0383	.0414	.0446	.0480	.515	7/0	13800	1.32	756	
6/0	464	.484	..	169	6/0	.0445	.0480	.0518	.0556	.615	6/0	13600	1.54	651	
5/0	432	.452	..	147	5/0	.0512	.0553	.0597	.0636	.697	5/0	10200	1.77	564	
4/0	400	.420	..	126	4/0	.0597	.0645	.0696	.0747	.802	4/0	7500	2.07	484	
3/0	372	.392	..	109	3/0	.0690	.0746	.0805	.0865	.920	3/0	6000	2.39	419	
2/0	345	.365	..	93	2/0	.0789	.0852	.0920	.0988	1.06	2/0	4300	2.73	366	
1	324	.342	..	81	1	.0914	.0984	.106	.114	1.20	1	3220	3.15	318	
2	300	.318	..	70	2	.107	.115	.124	.133	1.43	2	2320	3.67	272	
3	276	.294	.290	62	3	.126	.136	.147	.157	1.69	3	1700	4.34	230	
4	252	.266	.266	55	4	.151	.163	.176	.189	2.02	4	1180	5.20	192	
5	232	.246	.244	49	5	.173	.192	.207	.222	2.38	5	849	6.14	163	
6	212	.224	.220	44	6	.213	.230	.245	.266	2.86	6	592	7.35	136	
7	192	.204	.203	39	7	.259	.280	.302	.324	3.48	7	398	8.97	112	
8	176	.188	.188	35	8	.310	.334	.360	.387	4.15	8	280	10.7	98.7	
9	160	.172	.172	31	9	.374	.404	.435	.468	5.02	9	200	12.9	77.4	
10	144	.156	.156	28	10	.460	.497	.536	.576	6.18	10	127	15.9	62.7	
11	128	.144	.144	25	11	.553	.600	.648	.700	7.84	11	830	20.2	49.6	
12	116	.131	.126	22	12	.710	.768	.827	.888	9.54	12	530	24.6	40.7	
13	104	.114	.114	19	13	.885	.956	1.03	1.11	1.19	13	342	30.6	32.7	
14	920	.102	.102	17	14	1.13	1.22	1.31	1.41	1.51	14	210	39.1	25.6	
15	800	.086	.086	15	15	1.49	1.61	1.74	1.86	2.00	15	121	51.6	10.4	
16	660	.078	.082	14	16	1.84	1.99	2.15	2.30	2.47	16	79.0	63.8	15.7	
17	560	.070	.074	13	17	2.34	2.52	2.72	2.92	3.13	17	49.1	80.7	12.4	
18	480	.061	.066	12	18	3.06	3.30	3.56	3.82	4.10	18	28.8	105	9.49	
19	400	.053	.056	11	19	4.15	4.49	4.84	5.20	5.58	19	14.3	143	6.97	
20	360	.045	.048	10	20	4.97	5.45	5.96	6.48	7.04	20	7.50	207	4.84	
21	320	.040	.044	9	21	7.37	7.96	8.60	9.23	9.90	21	4.91	255	3.92	
22	280	.036	.040	8	22	9.85	10.1	10.9	11.7	12.5	22	3.07	323	3.10	
23	240	.032	.036	7	23	12.2	13.2	14.2	15.3	16.4	23	1.80	422	2.37	
24	200	.028	.032	6	24	16.6	17.9	19.3	20.7	22.2	24	1.13	574	1.74	
25	180	.024	.028	5	25	19.8	21.4	23.1	24.8	26.6	25	0.685	633	1.46	
26	160	.022	.026	4	26	23.9	25.8	27.8	29.8	32.0	26	0.468	826	1.21	
27	144	.020	.024	3	27	29.6	31.9	34.4	36.9	39.6	27	0.308	1020	0.980	
28	128	.018	.022	2	28	35.6	38.4	41.5	44.5	47.7	28	0.212	1230	0.814	
29	116	.017	.021	1	29	43.6	47.1	50.9	54.6	58.6	29	0.141	1510	0.663	
30	104	.016	.020	0	30	51.7	55.1	60.3	64.8	69.5	30	0.100	1790	0.560	
31	92	.015	.019	0	31	67.1	71.0	76.6	82.7	88.5	31	0.0694	2180	0.465	
32	80	.014	.018	0	32	82.0	86.5	91.5	96.5	103	32	0.0530	2460	0.407	
33	72	.013	.017	0	33	95.3	103	111	119	128	33	0.0399	2830	0.353	
34	64	.012	.016	0	34	113	122	131	141	151	34	0.0294	3310	0.308	
35	56	.012	.015	0	35	135	146	157	169	181	35	0.0210	3910	0.256	
36	48	.011	.014	0	36	166	179	193	207	222	36	0.0147	4680	0.213	
37	40	.010	.013	0	37	207	223	240	258	277	37	0.00875	5720	0.175	
38	36	.0095	.012	0	38	256	287	310	332	356	38	0.00625	7150	0.140	
39	32	.009	.011	0	39	315	353	413	444	476	39	0.00379	9180	0.109	
40	28	.0085	.010	0	40	415	443	483	517	550	40	0.00214	12200	0.0818	
41	24	.008	.0095	0	41	533	563	615	648	683	41	0.00156	14300	0.0697	
42	20	.0075	.009	0	42	645	675	717	747	780	42	0.00110	17100	0.0586	
43	18	.007	.0085	0	43	796	826	869	912	950	43	0.000750	20700	0.0484	
44	16	.0065	.008	0	44	925	1010	1090	1170	1250	44	0.000492	25500	0.0392	
45	14	.006	.0075	0	45	1120	1200	1280	1360	1440	45	0.000306	32900	0.0310	
46	12	.0055	.007	0	46	1380	1460	1540	1620	1700	46	0.000189	42200	0.0237	
47	10	.005	.0065	0	47	1680	1760	1840	1920	2000	47	0.0000975	57400	0.0174	
48	8	.0045	.006	0	48	2080	2160	2240	2320	2400	48	0.0000469	82600	0.0121	
49	6	.004	.0055	0	49	2560	2640	2720	2800	2880	49	0.0000198	120000	0.00774	
50	4	.0035	.005	0	50	3120	3200	3280	3360	3440	50	0.0000095	230000	0.00436	
						3800	3880	3960	4040	4120		0.00000293	331000	0.00303	

Copper (annealed), Matthiessen ..	1.59	.625	9.54	.388	1050	..	8.9	.321	Platinum, 67 per cent.; silver, 33 per cent. (alloy), Matthiessen ..	24.2	9.54	145	.133	
Copper, 50 per cent.; silver, 50 per cent. Abbott ..	1.84	.725	11.1	Platinum, 80 per cent.; iridium, 20 per cent. Dewar and Fleming ..	30.9	12.2	186	.082	
Copper, 96 per cent.; silicon, 4 per cent. Abbott ..	2.11	.890	12.7	Platinoid, Dewar and Fleming ..	41.7	16.4	251	.081	8.8	
Copper, 88 per cent.; silicon, 12 per cent. Abbott ..	2.94	1.16	17.7	Platinoid-martino, Dewar and Fleming ..	43.6	17.2	262	.024	8.8	
Copper, 94.20 per cent.; zinc, 71 per cent. R. Haas ..	1.38	.720	11.0	.373	Platinum (soft annealed pure) ..	8.95	3.24	49.5	..	1775	.082	21.2	
Copper, 90.9 per cent.; zinc, 9.1 per cent. R. Haas ..	3.64	1.43	21.8	.204	Platinum (annealed), Matthiessen ..	8.94	3.53	53.9	.247	1775	.082765	
Zinc, 99.5 per cent.; copper, 5 per cent. R. Haas ..	5.88	2.31	35.3	.385	..	.095	..	7.1	Platinum (pure) wire, .0259 cm. in diam. Dewar and Fleming ..	11.0	4.34	66.0	.35	1775	.082	21.2	
Copper, 68.8 per cent.; zinc, 34.2 per cent. R. Haas ..	6.30	2.48	37.8	.168	Platinum, 90 per cent.; rodium, 10 per cent. Dewar and Fleming ..	21.1	8.30	127	.143	
Cast copper ..	4.68	1.88	27.9	Platinum, 90 per cent.; iridium, 10 per cent. (alloy), Matthiessen ..	21.6	8.50	130	.133	
Copper, 90 per cent.; lead, 10 per cent. Abbott ..	5.28	2.08	31.7	Phosphor-bronze, with 9 per cent. phosphorus. Abbott ..	32.5	12.8	195	8.9
Copper, 97 per cent.; aluminium, 3 per cent. Dewar and Fleming ..	8.84	3.48	53.0	.090	Phosphor-bronze (copper, tin, and phosphorus). Hospitalier ..	1.6	.680	9.6	.394	64,000	8.9	
Copper, 87 per cent.; Ni, 6.5 per cent.; Al, 6.5 per cent. Dewar and Fleming ..	14.9	5.87	89.5	.0645	Phosphor-bronze (copper, tin, and phosphorus). Hospitalier ..	5.6	2.20	33.6	.394	117,000	8.9	
Copper, 90 per cent.; arsenic, 10 per cent. Abbott ..	17.6	6.94	106	Phosphor-bronze, with 10 per cent. of tin. Abbott ..	24.6	9.69	148	
Copper, 75 per cent.; nickel, 25 per cent. Feussner and Lindeck ..	34.2	13.5	205	.019	Pure electrolytic (annealed) silver. Dewar and Fleming ..	1.47	.579	8.82	.400	950	.056	10.5	
German silver, Cu (60); Zn (25); Ni (15). Feussner and Lindeck ..	2.04	.803	12.3	Silver (annealed), Matthiessen ..	1.49	.586	8.94	.377	950	.056	10.5	
Gold (annealed), Matthiessen ..	30.0	11.8	180	.086	Silver, Cu (77), Ni (17), Fe (2), Zn (2), CO (2). Dewar and Fleming ..	2.06	.810	12.4	.285	
Gold, 99.9 per cent. (pure). Dewar and Fleming ..	2.20	.865	13.2	.377	1200	.082	..	18.3	Silver, 80 per cent.; palladium, 20 per cent. Dewar and Fleming ..	15.0	5.90	90.0	
Gold, 90 per cent.; silver, 10 per cent. Dewar and Fleming ..	6.28	2.47	37.7	.124	Silver, 66 per cent.; platinum, 33 per cent. Dewar and Fleming ..	31.6	12.4	190	.0243	
Gold, 67 per cent.; silver, 33 per cent. (alloy), Matthiessen ..	10.8	4.25	64.8	.065	Silico-bronze (copper, tin, and silicon). Hospitalier ..	1.67	.657	10.0	.152	64,000	8.9	
Iron (very pure). Dewar and Fleming ..	9.07	3.57	54.5	.625	..	.113	..	7.8	Silico-bronze (copper, tin, and silicon) Hospitalier ..	2.69	1.06	16.2	93,000	8.9	
Iron with .25 per cent. Mn and .01 per cent. S. Dewar and Fleming ..	10.5	4.14	63.0	.544	..	.113	..	7.8	Silico-bronze (copper, tin, and silicon). Hospitalier ..	5.76	2.27	34.6	107,000	8.9	
White cast iron, C, 2.04; graphite, 0. Mn, .173; S, .467; Si, .764; P, .438. Hopkinson ..	56.6	22.3	340	..	1130	7.20	Silico-bronze (copper, tin, and silicon). Hospitalier ..	7.80	3.07	46.8	143,000	2.9	
Spiegeleisen—C, 4.5 per cent.; Mn, 7.97 per cent.; S traces, Si, .502 per cent.; P, .128 per cent. Hopkinson ..	105	41.4	630	Silicon steel (annealed) C, .685; Mn, .694; S, .024; Si, 3.44; P, .133. Hopkinson ..	61.9	24.3	372	.398	
Grey cast iron—C, 3.46; graphite, 2.08; Mn, .173; S, .049; Si, 2.04; P, .151. Hopkinson ..	114	44.9	634	..	1220	7.20	Thallium (pure). Dewar and Fleming ..	17.6	6.94	106	.440	230	.056	7.3	
Wrought iron (annealed). Hopkinson ..	13.8	5.44	82.8	Tin (pure). Dewar and Fleming ..	13.1	5.16	78.5	.365	7.3	
Lead (compressed), Matthiessen ..	19.5	7.63	117	.387	330	.032	..	11.4	Tungsten steel (annealed) C, 1.36; Mn, .36; S, 0; Si, .043; P, .047; tungsten, 4.65. Hopkinson ..	22.5	8.86	135.0	
Lead (pure). Dewar and Fleming ..	20.4	8.04	123	.411	330	.032	..	11.4	Whitworth soft steel (annealed) C .090; Mn, 153; S, .016; Si, 0; P, .042. Hopkinson ..	10.8	4.25	64.8	7.9	
Magnesium. Dewar and Fleming ..	4.36	1.72	26.2	.381	..	.25	..	1.74	Zinc (very pure). Dewar and Fleming ..	5.75	2.26	34.5	.400	415	.095	7.1	
Manganese steel (annealed), C, .674; Mn, 4.73; S, .023; Si, .603; P, .078. Hopkinson ..	39.8	15.5	236	..	1260	7.8	Zinc (compressed) Matthiessen ..	5.80	2.38	34.8	.365	7.1	

Fig. 126, on page 126, gave a saturation curve for sheet iron at high densities, but for the purposes of that section—investigation of the reluctance of core projections—the curve was plotted in C.G.S. units.

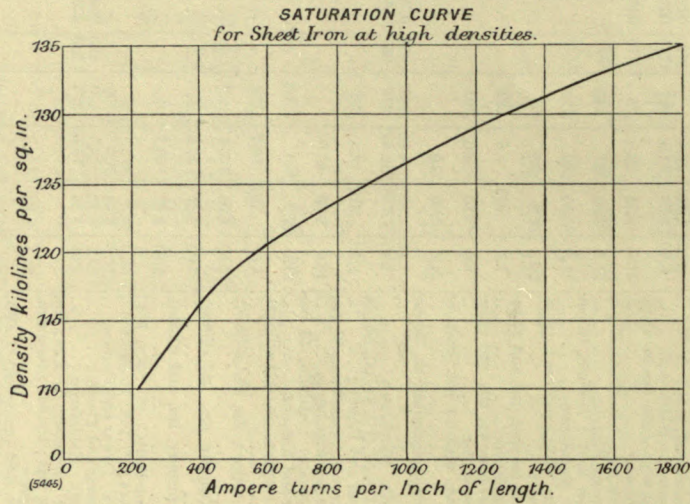

FIG. 423.

As a sheet iron curve for high densities is constantly required for reference, it has been re-plotted in Fig. 423, in the system of units employed throughout the other sections of the work.

INDEX.

- AGEING of iron, 29
 Air-gap reluctance, 121
 Alloys, table of physical and electrical properties, 370
 Alternating current machine windings, 71
 Aluminium steel, magnetic properties of, 24
 Analyses, chemical—
 Cast iron, 19
 Cast steel, 20, 22, 24
 Mitis iron, 24
 Wrought iron, 27
 Annealing sheet iron, effect of, 29
 Armatures—
 Magnetomotive force of, 116
 Radiating surface of, 92
 Armature coils, method of insulating, 57
 Armature core losses, 35
 Armature core reluctance, 119
 Armature, reaction of—
 Alternators, 118
 Continuous-current dynamos, 117
 Continuous-current, constant potential dynamos, 145
 Armature windings—
 For alternating-current machines, 71
 For continuous-current machines, 60
 Gramme ring, 62
 Drum, two-circuit, 66
 Drum-multiple circuit, 62, 68
 For induction motors, 75
 For rotary converters, 70
 Symbols for, 66
- BINDING-WIRE for rotary converters, 321
 Bond-paper, oiled, insulating properties of, 39
 Brushes, carbon—
 Use of, 144
 Contact resistance and friction loss, 273
 Comparative tests of carbon and graphite, 277
 Brush-gear, 271
- CAMBRIC, oiled, insulating properties of, 41
 Cartridge-paper, insulating properties of, 41
 Chemical analysis of—
 Cast iron, 19
 Cast steel, 20, 22, 24
 Mitis iron, 24
 Wrought iron, 27
 Coils, internal and surface temperature of, 93
 Methods of insulating, 57
 Commutation, essential conditions, 152
 Commutators, heating of, 112
 Conductivity tests, 2
 Conductors, watts dissipated in, 101
 Foucault currents in, 103
 Conversion of magnetic units, 4
 Of hysteresis loss units, 9
 Converters. *See* Rotary Converters.
 Copper wire, properties of, 367, 368, 369
 Core losses—
 Estimation of, 35
 In commutating machines, 229
 Correction factor for voltage of distributed winding, 81
 Cotton, oiled, insulating properties of, 41
 Curves, hysteresis, 30, 32, 33, 34
 Permeability, 19, 21, 23, 26 and 126
 Saturation, for high densities, 372
 Tooth density correction, 126
- DETERIORATION of iron, 29
 Drum windings—
 Two-circuit, 66
 Multiple circuit, 62, 68
 Dynamos—
 Continuous-current constant potential, 143
 Influence of armature reaction, 151
 Proportioning of, 150
 1,500 K.W. railway generator, description, 179
 200 K.W. railway generator, description, 190
 300 K.W. lighting generator, description, 201
 250 K.W. railway generator, description, 215

- EDDY current losses—
 In conductors, 103
 In pole faces, 105
 In sheet iron, 35, 105
- Efficiency of—
 Arc dynamos, 111
 Constant potential dynamos, 111
 Railway motors, 111
- Electromotive force—
 In alternating-current dynamos, 80
 In continuous-current dynamos, 78
 In polyphase apparatus, 87
 In rotary converters, 84
 In transformers, 88
- FIBRE, vulcanised, insulating properties of, 39
- Field winding—
 A calculation for shunt dynamo, 128
 Formula for, 127
 Method of insulating, 58
- Flux in transformers, 88
- Forgings, magnetic properties of, 25
- Form factor, 88
- Formulas for—
 Eddy current loss, 35
 Electromotive force, 78
 Field winding, 127
 Magnetomotive force, 3
 Reluctance, 124
 Two-circuit windings, 69
- Foucault currents. *See* Eddy currents.
- Friction loss, 114
- GENERATION of heat, specific rate, 109
- Generators. *See* Dynamos,
- Gramme ring windings, 62
- HEAT, specific rate of generation of, 109
- Heat losses. *See* Losses.
- Heating of—
 Arc dynamos, 111
 Commutators, 112
 Constant potential dynamos, 111
 Railway motors, 111
- Hysteresis—
 Curves of, in actual practice, 34
 Determination of (general), 9
 Effect of pressure on, 32
 In alternating and rotating fields, 10
 In cores, 107
 Method of measurement without ballistic galvanometer, 11
 Testers, 11 and 14
 Variation with magnetisation, 28
- INDUCTANCE—
 Constants, 159
 Experimental tests, 160
 Practical definition of, 160
 Induction motor windings, 75
 Insulating coils, methods of, 57
 Insulation resistance, effect of temperature on, 42
 Insulation testing methods for factories, 43
 Iron, cast—
 Effect of chemical composition on, 16
 Magnetic properties of (general), 14
 Specific resistance, 36
 Iron, malleable cast—
 Effect of chemical composition on, 18
 Iron, Mitis, magnetic properties of, 24
 Iron, Nickel, 25
 Iron, sheet—
 Ageing of, 29
 Eddy current losses, 35
 Magnetic properties of, 25
 Temperature of annealing, 29
 Iron, Swedish—
 Analysis of, 34
 Magnetic properties, 25
 Iron, wrought—
 Analysis of, 27
 Magnetic properties of, 25
 Specific resistance of, 36
- LEAKAGE coefficient, 119
- Leatheroid, insulating properties of; 39
- Limit of output, thermal, 90
- Linen, oiled, insulating properties of, 39
- Linen, shellaced, insulating properties of, 39
- Losses C^2R , 101
 C^2R in rotary converters, 285
 Eddy current, 35, 103
 Friction, 114
 Hysteresis, 9, 28, 32, 107
- MAGNETS, radiating surface of, 92
- Magnet winding—
 A calculation for shunt dynamo, 128
 Formula for, 127
- Magnetic circuit—
 A calculation for, 126
 Design of, 115
 Of the induction motor, 137
 Of transformers, 117, 135
 Reluctance of, 121
 Typical forms of, 129
- Magnetisation of iron and steel, 17

- Magnetomotive force—
 Of armatures, 117
 Of rotary converter armatures, 358
- Malleable cast iron—
 Effect of chemical composition on, 18
- Manilla paper, insulating properties of, 41
- Marble, insulating properties of, 40
- Materials, insulating—
 Effect of temperature on, 42
 Method of testing, 43
 Properties of, 39
- Materials, Magnetic, properties of, 14
- Metals table of physical and electrical properties, 370
- Mica, insulating properties of, 38
- Mica-canvas, insulating properties of, 47
- Mica longcloth, insulating properties of, 50
- Mitis iron, magnetic properties and analysis of, 24
- Motors, railway, 233
 Description of geared 24 horse-power motor, 233
 Description of geared 27 horse-power motor, 242
 Description of direct-connected 117 horse-power motor, 256
- NICKEL iron, magnetic properties of, 25
- Nickel steel, magnetic properties of, 25
- OILED bond paper, insulating properties of, 39
- Oiled cambric, insulating properties of, 41
- Oiled cotton, insulating properties of, 41
- Oiled linen, insulating properties of, 39
- Oiled paper, insulating properties of, 41
- Output, thermal limit of, 90
- Oven, vacuum, for drying coils, 58
- PAPER, Insulating properties of different makes, 41
- Permeability, curves, 19, 21, 23, 26, 126, 372
 Bridges, 6, 8
 Effect of pressure on, 32
 Tests with ballistic galvanometer, 3,
 Tests without ballistic galvanometer, 5
- Phase characteristics of rotary converters, 351,
- Poles, determination of number for given output, 152
- Press-board, insulating properties of, 39
- Pressure, effect of, on permeability and hysteresis, 32
- Proportioning of dynamos, 150
- RAILWAY generators. *See* Dynamos.
- Railway motors. *See* Motors.
- Reactance voltage, calculation of, 175
- Reluctance of—
 Air-gap, 121
 Armature core, 119, 123
 Complete magnetic circuit, 121
 Core projections, 123
- Resistance, insulation—
 Effect of temperature on, 42
- Resistance, specific, of iron and steel, 36
- Ring windings, 62
- Rope-paper, red, insulating properties of, 41
- Rotary converters, general, 283
 Advantages of polyphase over single phase, 297
 Compound-wound, 363
 C²R loss in armatures of, 285
 Four-phase, 306
 Interconnection with static transformers, 304
 Magnetomotive force of armatures, 358
 Output with different number of phases, 284
 Phase characteristics of, 351
 Running conditions for, 351
 Series-wound, 365
 Single phase, 295
 Six phase, 303
 Six phase, 400 K. W., description of, 311
 Starting of, 340
 Surging effect of, 284, 352, 362
 Synchronising of, 345
 Three phase, 300
 Three phase, 900 K. W., description of, 329
 Twelve phase, 309
 Winding of, 75
 Without field excitation, 365
- Rotary converter systems—
 Adjusting voltage ratio in, 347
 Proportioning binding wire, 321
 Space factor, 320
- Rubber, hard, insulating properties of, 40
- SATURATION curve for high densities, 372
- Sheet iron—
 Ageing of, 29
 Eddy current losses in, 35
 Magnetic properties of, 25
 Temperature of annealing, 29
- Sheet steel—
 Ageing of, 29
 Eddy current losses in, 35
 Magnetic properties of, 25
 Temperature of annealing, 29
- Shellaced linen, insulating properties of, 39
- Shellaced paper, insulating properties of, 41
- Slate, insulating properties of, 40
- Space-factor in rotary converters, 320
- Specific resistance of iron and steel, 36

- Steel, aluminum, magnetic properties of, 24
- Steel, cast—
 Effect of chemical composition, 20
 Magnetic properties of, 14
 Specific resistance of, 36
- Steel, nickel, magnetic properties of, 25
- Steel, sheet—
 Ageing of, 29
 Eddy current losses in, 35
 Magnetic properties, 25
 Temperature of annealing, 29
- Surging effect in rotary converters, 284, 352, 362
- Swedish iron—
 Analysis of, 34
 Magnetic properties of, 25
- Switch for synchronising rotary converters, 345
- Switchboard for six-phase rotary converters, 307
- Symbols, winding, 66
- Synchronising of rotary converters, 345
- TEMPERATURE—
 Effect on disruptive voltage, 49, 53
 Effect on insulation resistance, 42
 Of annealing sheet iron, 29
- Temperature rise in dynamos, 90
 Estimation of, 93
 Of commutators, 112
 Influence of peripheral speed, 97
- Temperature rise in transformers, 109
- Tests, ageing, 31
 Conductivity, 2
 Heat, 95
 Hysteresis, 11, 13, 14
 Inductance, 160
 Insulation, 46
 Permeability, 2, 5
- Thermal limit of output, 90
- Tooth-density correction curves, 126
- Traction generators. *See* Dynamos.
- Traction motors. *See* Motors.
- Transformers—
 Electromotive force and flux in, 88
 For insulation testing, 45
 Interconnection with rotary converters, 304
- UNITS, conversion of hysteresis loss units, 4
 Conversion of magnetic units, 9
- VACUUM oven for drying coils, 58
- Voltage of—
 Alternating-current dynamos, 80
 Continuous-current dynamos, 78
 Polyphase apparatus, 87
 Rotary converters, 84
 Transformers, 88
- Voltage per commutator segment as related to inductance, 157
- Vulcabeston, insulating properties of, 40
- Vulcanised fibre, insulating properties of, 39
- WINDAGE loss, 114
- Windings, armature—
 For alternating-current machines, 71
 For continuous-current machines, 60
 Gramme ring, 62
 Drum, two-circuit, 66
 Drum, multiple-circuit, 62, 68
 For induction motors, 75
 For rotary converters, 70
 Symbols for, 66
- Windings, field—
 A calculation for shunt dynamo, 128
 Formula, 127
- Wood, insulating properties of, 40
- Wrought iron—
 Analysis of, 27
 Magnetic properties of, 25
 Specific resistance of, 36



THIS BOOK IS DUE ON THE LAST DATE
STAMPED BELOW

AN INITIAL FINE OF 25 CENTS
WILL BE ASSESSED FOR FAILURE TO RETURN
THIS BOOK ON THE DATE DUE. THE PENALTY
WILL INCREASE TO 50 CENTS ON THE FOURTH
DAY AND TO \$1.00 ON THE SEVENTH DAY
OVERDUE.

OCT 28 1937

DEC 2 1937

FEB 24 1938
26 Apr '55 LT

APR 12 1955 LU

YE 01945

85388

TK2411

P2

UNIVERSITY OF CALIFORNIA LIBRARY

