

RESTRICTED

AAF MANUAL 200-1

MANUAL FOR

*Fighter Gun
Harmonization*



30 JANUARY 1945

HEADQUARTERS, ARMY AIR FORCES
WASHINGTON, D.C.

RESTRICTED

FOREWORD

This Manual contains harmonization data supplemental to that issued in technical orders and consolidated simplified aircraft ballistic data extracted from aircraft firing tables. The harmonization patterns were compiled at the proving ground command to facilitate the conduct of service tests on aircraft weapons. The ballistic data was supplied by the Chief of Ordnance, Ballistics Branch. These types of data are combined in a single publication for general use by Army Air Forces officers. Further work by the Proving Ground Command and other field installations will be disseminated in revisions to this Manual. The patterns for harmonization contained herein are indorsed by Army Air Forces but may be amended by each individual station in accordance with local conditions to obtain effective fire power.

TABLE OF CONTENTS

Section A.....Harmonization Notes

Section B.....Boresighting Procedure

Section C.....Sample of Harmonization Computations

Section D.....Present Range Ballistic Tables

Section E.....Future Range Ballistic Tables

Section F.....Plotted Trajectory Curves

Section G.....Miscellaneous Data

Section H.....Fighter Harmonization Charts

Section J.....Miscellaneous Harmonization Charts

INTRODUCTION

1. The maximum range for harmonization used in this Manual is 2000 feet. Although the effective range for actual firing is 1200 feet maximum, a harmonization based on 1200 feet would result in the same bullet patterns as for 2000-foot harmonization, and the latter has the added advantage of the aircraft being harmonized for the extra 800 feet should the tactical requirements necessitate firing at the longer range.
2. The phase "angle of attack" (αp) referred to herein is defined as that angle between the fuselage leveling lugs and the flight path of the aircraft. The data on angle of attack used were derived from the following sources, from which the lift coefficient curves were computed and the angle of attack figures worked out for the various weights, speeds, and "g's" required.
 - a. Wright Field.
 - b. Technical Orders.
 - c. Manufacturer's Data.
3. The boresight targets shown are for 1000 inches and for 500 feet. If the demand for targets at longer ranges presents itself, these additional targets will be furnished at a later date.
4. All ballistic data were obtained from Ballistic Research Laboratory, Aberdeen Proving Ground, Aberdeen, Md., and any questions or discrepancies concerning these data should be referred to that source.
5. The ballistic characteristics of caliber 0.50 M2 and A.P.I. M8 ammunition are essentially the same, and even though the harmonization charts are computed for M2, the A.P.I. M8 can be used. However, new data will be supplied based on A.P.I. M8 at a later date.
6. Section C is included primarily as a technical explanation of the method used in computing the harmonization charts, and is not intended to be used in the field unless a specific duty of harmonization is made.

SECTION A

HARMONIZATION NOTES

1. INTRODUCTION.

a. The following study shows the method used to arrive at a practical arrangement of fixed guns on fighter aircraft. The data and results obtained are derived from various sources including Technical Orders, test reports, ballistics from Aberdeen, flight missions, discussions with gunnery officers, and the experience of combat pilots.

2. TYPES OF HARMONIZATION.

a. It is found that the type known as "Point Harmonization" does not make the most efficient use of the available fire power. In its place, it is recommended that "Pattern Harmonization" be used; that is, that the fixed guns be boresighted so that their trajectories produce a desirable pattern as near uniform as possible in shape and projectile density over the entire range of fire. A range of 2000 feet is considered maximum for harmonization.

b. This harmonization is such that the sight line is always approximately in the center of the projectile pattern throughout the 2000-foot range, when flying at the Basic Harmonization. Consequently the pilot is relieved of any mental calculation of range versus projectile drop.

c. The necessity for computing the proper "lead" is not eliminated by this harmonization. The subject of lead is well covered by other sources and, therefore, will not be considered here.

3. BALLISTIC DATA.

a. Ballistic data are procured from Aberdeen Proving Ground, but interpolation is necessary in some cases to obtain the necessary ballistic curves for specific altitudes or air speeds not covered by Aberdeen. This interpolation can readily be computed to an accuracy sufficient for all practical purposes and will serve as a mathematical basis for figuring harmonization.

b. In the use of published ballistic data, a complete understanding of phraseology is required. The data under the phrases "Present Range" or "Air to Ground" should be used for forward firing fixed guns, and can be interpolated from data under "Future Range" or "Air to Air."

4. ANGLE OF ATTACK.*

a. The angle of attack of the fighter aircraft for all speeds, loading conditions, and "g's" should be found as accurately as possible. The angle of attack is the angle between the fuselage leveling lugs and the flight path. The harmonization data in this Manual is based on the best available data on angle of attack.

*For harmonization purposes.

b. Since the guns on the fighter aircraft are fixed in relation to the fuselage leveling lugs, the angle of attack therefore governs the angle the guns make with the flight path. This angle in turn determines the "Effective Bore" and is, therefore, a critical factor in figuring the harmonization of the sight line and the projectile patterns.

5. EFFECTIVE BORE.

a. When a fixed gun is so set as to make an angle with the flight path, the projectile has two forces acting upon it. One is the muzzle velocity, or the force with which the powder explosion sends the projectile from the muzzle, and the other force is the forward velocity of the firing aircraft. These two forces resolve into one which is the resultant, and is known as the "Effective Bore." In order to harmonize correctly, this effective bore must be computed. This action holds true in both vertical and plan harmonization.

6. PROJECTILE DROP.

a. When harmonization is figured, the projectile drop due to gravity to be used is based on the desired speed and altitude for this harmonization. Then, if the aircraft fires at some other speed or altitude, there is naturally a difference in projectile drop between that used for the harmonization and that at the other speed or altitude. But this difference is of a negligible quantity, the magnitude of the error in caliber 0.50 A.P. M2 being $\frac{1}{2}$ mil at 1000-foot range.

b. When the firing aircraft is in a dive and the wing tips are parallel to the earth, the drop of the projectile measured at right angles to the extended bore is approximately equal to the drop in level flight multiplied by the cosine of the angle of dive. This change is of such small magnitude up to 30-degree dive that it may be disregarded.

c. No matter what the attitude of the firing aircraft, the projectile drop is in a vertical plane perpendicular to the earth, measured from the extended effective bore.

d. Projectile drop itself is not affected by the aircraft pulling "g's." But any action of the aircraft that changes its angle of attack, that is, changes in indicated air speed or number of "g's," affects the angle between the gun bore and flight path and brings into play the "Effective Bore" action previously discussed, and this indirectly causes the trajectory shift in relation to the sight line.

7. BASIC HARMONIZATION.

a. Basic harmonization is figured for altitude, air speed, aircraft weight, and number of "g's" which con-

stitute the average condition at which combat firing will probably occur. In basic harmonization it is of vital importance to obtain as great an angle of visibility as possible over the nose of the aircraft. To accomplish this, the sight line has to be raised to its maximum, limited only by the amount that the guns can be elevated. The guns are elevated to their maximum and the sight is set so as to harmonize with the effective trajectory curve. This method will give the sight its greatest angle over the nose of the aircraft. From this basic harmonization, the mil angle of trajectory shift, shown as " μ " in the harmonization charts, and which is due to flying under any other condition that causes a change in angle of attack, can be computed.

8. GENERAL.

a. It is recommended that for most cases the included harmonization charts be used, unless specific tactical requirements necessitate a deviation. All possible care should be taken to align the guns as accurately as possible to the boresight targets, and all mounts, etc., checked so as to eliminate any error due to movement of guns.

b. Even though the aircraft is harmonized perfectly, there is no substitute for accuracy in shooting and estimating lead. Pattern boresighting will be a great help in deflection shooting and firing at longer ranges, and yet will be just as satisfactory for the close-range shots.

SECTION B

A BORESIGHTING PROCEDURE FOR FIXED GUNS IN FIGHTER AIRCRAFT

(A) BY USE OF THE 1000-INCH BORESIGHT TARGET

1. Select a level strip of ground and place a boresight target 1000 inches (83 feet, 4 inches) from the approximate mean of the gun trunnion bolts of the aircraft.
2. Level the aircraft on both axes and fix firmly by the means of weights, jacks, etc. (Level fuselage by placing level on fuselage leveling lugs.)
3. Draw a vertical line on the target, in line with the center line of the aircraft, by attaching plumb bobs to the aircraft centers and sighting along the plumb bob cords. On aircrafts with nose wheels, allowances must be made for the plumb bobs not being on the center line of the aircraft.
4. Place a sight line level indicator on gun-sight glass reflector and, without turning on reticle light, project a level point from sight to target. Draw a horizontal line on 1000-inch target through this point and through the vertical line as found in step 3. This intersection will be a point from sight parallel to fuselage leveling lugs.
5. With the point found in step 4 already located on boresight board as a starting point, mark off to proper dimensions the points where the fixed sight line and

guns are to be aimed, copying data from included harmonization diagram, or from data figured by a responsible officer.

6. With sight line level indicator removed from gun sight, next turn on reticle light and adjust sight so that reticle pip points to mark on boresight target for sight pip. The gun sight will now be aligned in azimuth and zenith for the basic harmonization.
7. With boresight tool, align the guns to point at their respective targets.

(B) BY THE USE OF THE 500-FOOT BORESIGHT AND FIRE-IN TARGET

8. In using the 500-foot target the same procedure as outlined in steps 1 through 7 is to be followed, with the exception that the target is to be 500 feet from the aircraft.
9. Fire a burst of 10 rounds. The center of impact of these hits should fall on the predicted center of impact previously marked on the target, thus giving the correct boresighting. If these points do not coincide, adjust the guns until such is accomplished.
10. Either the 1000-inch boresight target or the 500-foot boresight and fire-in target may be used, but the 500-foot target method is found to be more accurate.

SECTION C HARMONIZATION

The Following Is an Example of the Computations and Method Used in Harmonizing a P-51D Airplane

1. DATA NEEDED.

a. Basic harmonization condition, or the average that the aircraft will fly during combat:

Calibrated indicated air speed = 300 miles per hour.

True air speed = ± 373 miles per hour.

Altitude = 15000 feet.

Level flight, or 1 "g."

Average combat weight = 9500 pounds.

Angle of attack = $\alpha p = +13$ mils.

b. Location of the guns: side and plan dimensions in reference to the optical sight and the aircraft center line.

c. Maximum angle the guns will elevate in respect to the fuselage leveling lugs. (From the Technical Orders = $10+$ mils.)

d. Find angle of attack of aircraft in reference to the fuselage leveling lugs for all speeds in which the aircraft might fire in level flight, 1 to 4 "g's," and in 30-degree dive or climb, 1 to 4 "g's."

e. Find the trajectory curve for the projectile to be used for the speed and altitude of the basic harmonization. The data can be interpolated from Aberdeen Proving Ground publications.

f. Formulae Used:

$$\epsilon = \frac{Vf (\alpha ge)}{Vm}$$

$$\epsilon = \frac{Vf (\alpha gf)}{Vf + Vm}$$

$$\epsilon_1 = \frac{Vf_1 (\alpha gf_1)}{Vf_1 + Vm}$$

$$\alpha gf_1 = \alpha p_1 - \alpha p + \alpha gf$$

$$\mu = \epsilon_1 - \epsilon$$

When:

ϵ = Mil angle between the effective bore line and the fixed bore line, under the basic condition.

ϵ_1 = Mil angle between the effective bore line and the fixed bore line, condition in question.

Vf = True air speed of firing aircraft in feet per second, basic condition.

Vf_1 = True air speed of firing aircraft in feet per second, condition in question.

Vm = Muzzle velocity of projectile in feet per second.

αge = Mil angle between the flight path and the effective bore line, basic condition.

αgf = Mil angle between the flight path and the fixed bore line, basic condition.

αgf_1 = Mil angle between the flight path and the fixed bore line, condition in question.

αp = Angle of attack or the mil angle between the fuselage leveling lugs and the flight path, basic condition.

αp_1 = Angle of attack or the mil angle between the fuselage leveling lugs and the flight path, condition in question.

μ = Mil angle between the fixed sight line and the projectile pattern or a corrected sight line, condition in question.

2. PLOTTING TRAJECTORIES.

a. SKETCH "A."—Draw trajectory curve from data found in "1.e." (Scale recommended: horizontal, 1 inch = 100 feet; vertical, 1 inch = 20 feet.) Locate the sight in relation to the guns. Draw in separate sight line for each gun, harmonizing each around the projectile path as desired.

b. SKETCH "B."—Redraw "A" so that each of the three sight lines fall in one line and by measuring the drop from each sight line lay out the trajectory curve of all guns. At a convenient range, 1000 feet, measure the distance the projectile is above or below the sight line for each gun. This distance, known as "A," will be used later. The completed drawing will be the side pattern of the projectiles while flying at the basic harmonization.

c. SKETCH "C."—Draw a plan of the projectile paths. Make each intersect the projected center line of the aircraft at the range desired.

d. By plotting from the sketches B and C a projectile pattern can be drawn for any range up to 2000 feet. Changes will undoubtedly have to be made in the gun arrangement in order to achieve the desired patterns.

3. BASIC HARMONIZATION—TO SIGHT LINE—SIDE.

a. Find the mil angle of the effective bore line in relation to the fixed sight line for each gun, in side view.

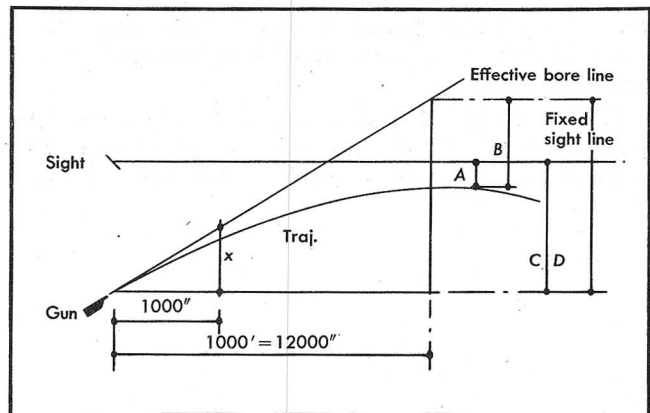

A = Distance in inches between projectile and sight line.

B = Projectile drop in inches at 1000 feet.

C = Vertical distance in inches, at aircraft, between sight and gun trunnion.

2. Plotting Trajectories:

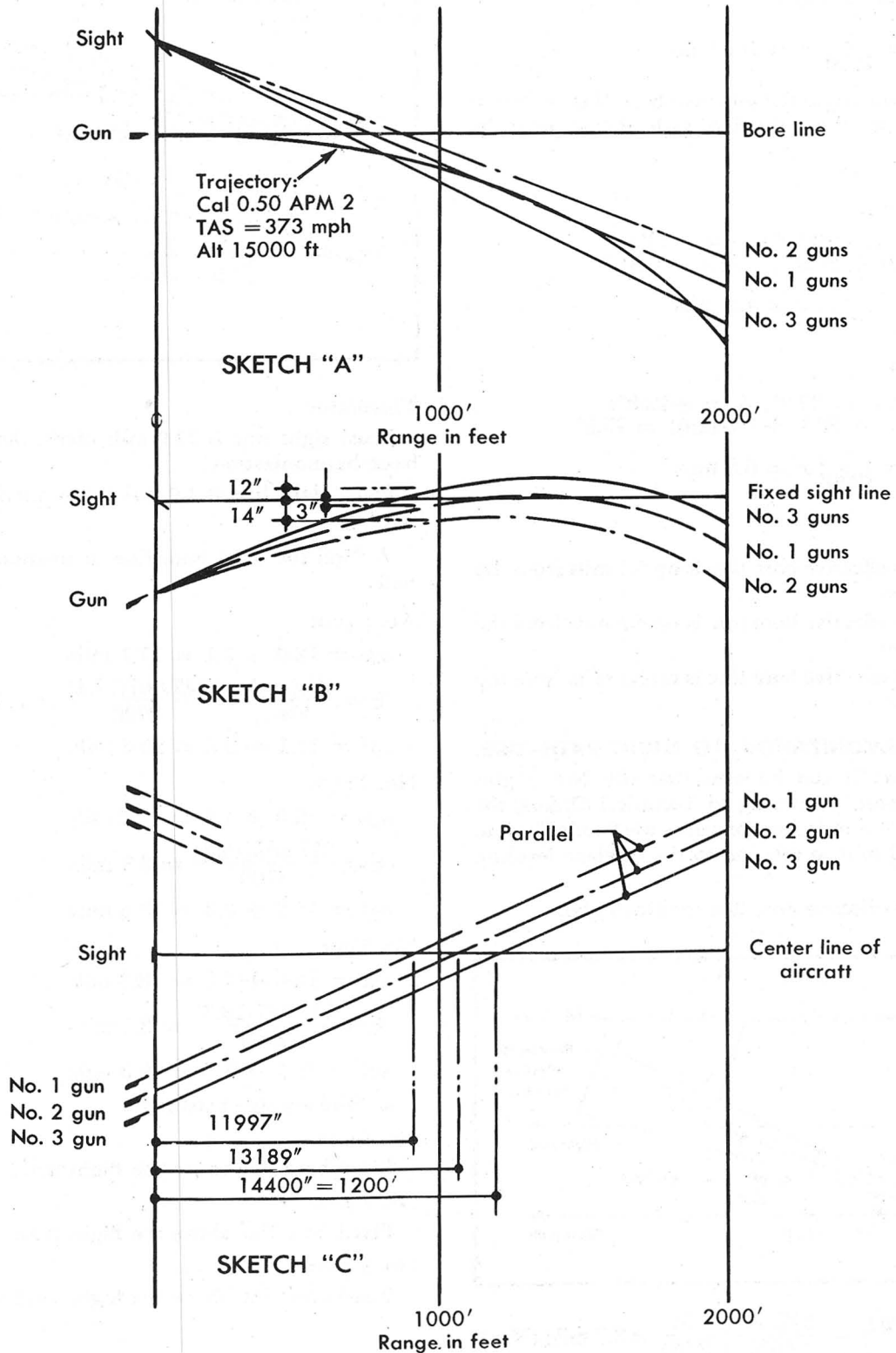

For No. 1 gun:

$$D = C + B + (A) ; C = 44.7'' ; B = 20.0'' ;$$

$$A = -3'' ; D = 44.7 + 20.0 + (-3) = 61.7''$$

Then by similar triangles:

$$\frac{61.7}{1000(12)} = \frac{x}{1000} ; x = 5.1 \text{ mils}$$

(This is the mil angle the effective bore line of No. 1 gun should point above the fixed sight line to properly harmonize.)

For No. 2 gun:

$$C = 44.0'' ; B = 20.0'' ; A = -14'' ;$$

$$D = 44.0 + 20.0 + (-14) = 50.0''$$

$$\frac{50.0}{1000(12)} = \frac{x}{1000} ; x = 4.2 \text{ mils}$$

For No. 3 gun:

$$C = 43.5'' ; B = 20.0'' ; A = +12.0'' ;$$

$$D = 43.5 + 20.0 + (+12.0) = 75.5''$$

$$\frac{75.5}{1000(12)} = \frac{x}{1000} ; x = 6.3 \text{ mils}$$

Therefore:

No. 1 gun's effective bore line is up 5.1 mils from the fixed sight line.

No. 2 gun's effective bore line is up 4.2 mils from the fixed sight line.

No. 3 gun's effective bore line is up 6.3 mils from the fixed sight line.

4. BASIC HARMONIZATION—TO FLIGHT PATH—SIDE.

a. From 3.a., it can be seen that the No. 3 gun elevates the most. According to Technical Orders, the guns elevate 10+ mils, but for safety use 9 mils. Elevate No. 3 gun 9.0 mils in relation to the fuselage leveling lugs.

b. Find the effective bore line for No. 3 gun:

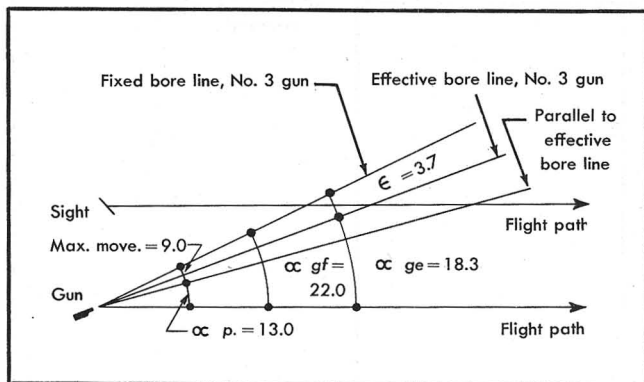

$$\epsilon = \frac{V_f(\alpha_{gf})}{V_f + V_m} = \frac{547.067(22.0)}{547.067 + 2700} = 3.7 \text{ mils (No. 3 gun)}$$

$$\alpha_{ge} = 22.0 - 3.7 = 18.3 \text{ mils (No. 3 gun)}$$

c. Find location of fixed sight line:

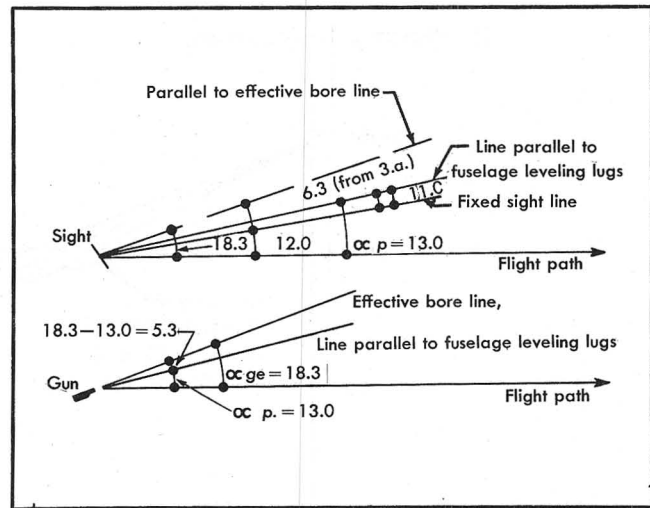

Therefore:

Fixed sight line is 12.0 mils above the flight path—basic harmonization.

Fixed sight line is 1.0 mil below the fuselage leveling lugs.

d. Find the fixed bore line in relation to the flight path:

No. 1 gun:

$$\alpha_{ge} = 12.0 + 5.1 = 17.1 \text{ mils}$$

$$\epsilon = \frac{V_f(\alpha_{ge})}{V_m} = \frac{547.067(17.1)}{2700} = 3.5 \text{ mils}$$

$$\alpha_{gf} = 17.1 + 3.5 = 20.6 \text{ mils}$$

No. 2 gun:

$$\alpha_{ge} = 12.0 + 4.2 = 16.2 \text{ mils}$$

$$\epsilon = \frac{547.067(16.2)}{2700} = 3.3 \text{ mils}$$

$$\alpha_{gf} = 16.2 + 3.3 = 19.5 \text{ mils}$$

No. 3 gun:

$$\alpha_{ge} = 12.0 + 6.3 = 18.3 \text{ mils}$$

$$\epsilon = \frac{547.067(18.3)}{2700} = 3.7 \text{ mils}$$

$$\alpha_{gf} = 18.3 + 3.7 = 22.0 \text{ mils}$$

e. Find average fixed bore:

No. 1 gun:

$$\text{Fixed bore line above the flight path} = 21.6 \text{ mils}$$

No. 2 gun:

$$\text{Fixed bore line above the flight path} = 19.5 \text{ mils}$$

No. 3 gun:

$$\text{Fixed bore line above the flight path} = 22.0 \text{ mils}$$

$$\frac{3)62.1 \text{ mils}}{20.7 \text{ mils}} =$$

α_{gf} (average) = average fixed bore line above the flight path—basic harmonization.

5. TRAJECTORY SHIFT.

a. Find μ , or the mil angle the projectile pattern moves from the fixed sight line while flying at other than basic conditions:

IAS = 250 mph; TAS = 250 mph; Altitude = 0'; "1g"; $\alpha p_1 = 30$ mils.

$$\alpha g f_1 = \alpha p_1 - \alpha p + \alpha g f = 30.0 - 13.0 + 20.7 = 37.7 \text{ mils}$$

$$\epsilon_1 = \frac{V f_1 (\alpha g f)}{V f_1 + V m} = \frac{366.67 (37.7)}{366.67 + 2700} = 4.5 \text{ mils}$$

$$\epsilon = \frac{V f (\alpha g f)}{V f + V m} = \frac{547.067 (20.7)}{547.067 + 2700} = 3.5 \text{ mils}$$

(Average ϵ)

$$\mu = \epsilon_1 - \epsilon$$

$$\mu = 4.5 - 3.5 = +1.0 \text{ mils}$$

Continue the same method for " μ " for all conditions.

6. FIGURING THE BORESIGHT TARGETS:

a. Vertical Dimension—1000-inch Target:

From 4.e. can be found the mil angle the fixed bore line makes with the flight path. From this subtract the mil angle of attack for the basic harmonization. The answer will be the mil angle between the fixed bore line and the fuselage leveling lugs.

Therefore:

No. 1 guns: $20.6 - 13.0 = 7.6$ mils

No. 2 guns: $19.5 - 13.0 = 6.5$ mils

No. 3 guns: $22.0 - 13.0 = 9.0$ mils

No. 1 guns: $44.7 - 7.6 = 37.1''$ (Vertical distance, at 1000-inch target, from a point from the sight parallel to the fuselage leveling lugs, to the extended bore.)

No. 2 guns: $44.0 - 6.5 = 37.5''$ (Vertical distance, at 1000-inch target, from a point from the sight parallel to the fuselage leveling lugs, to the extended bore.)

No. 3 guns: $43.5 - 9.0 = 34.5''$ (Vertical distance, at 1000-inch target, from a point from the sight parallel to the fuselage leveling lugs, to the extended bore.)

b. Vertical Dimension—500-foot Target:

By similar triangles:

No. 1 guns:

$$\frac{7.6}{1000} = \frac{x}{500(12)}; x = 45.6$$

$44.7 - 45.6 = -0.9''$ (Vertical distance, at 500-foot target, from a point from the sight parallel to the fuselage leveling lugs, to the extended bore.)

No. 2 guns:

$$\frac{6.5}{1000} = \frac{x}{500(12)}; x = 39.0; 44.0 - 39.0 = +5.0'' - 1000\text{-inch target.}$$

No. 3 guns:

$$\frac{9.0}{1000} = \frac{x}{500(12)}; x = 54.0''; 43.5 - 54.0 = -10.5'' - 1000\text{-inch target.}$$

c. Horizontal Dimensions—1000-inch Target.

From 2.c, can be found the points where the effective bore line, in plan, crosses the center line of the aircraft.

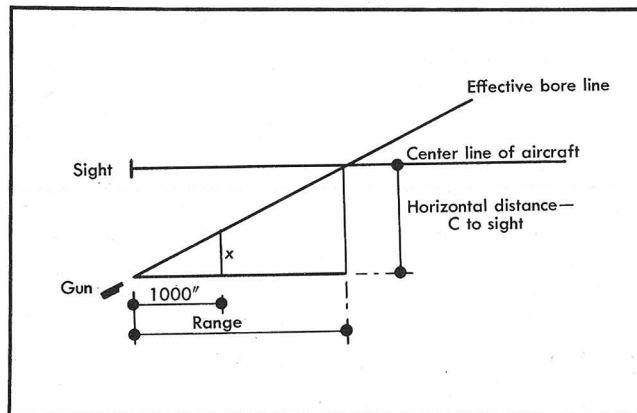

No. 1 guns:

By similar triangles:

$$\frac{x}{1000} = \frac{79.1}{11997}; x = 6.6 \text{ mils} = \alpha g e$$

$$\epsilon = \frac{V f (\alpha g e)}{V m} = \frac{547.067 (6.6)}{2700} = 1.3 \text{ mils}$$

$$\alpha g f = 6.6 + 1.3 = 7.9 \text{ mils}$$

$79.1 - 7.9 = 71.2''$ (Horizontal distance, at 1000-inch target, from center line of aircraft to extended bore.)

No. 2 guns:

$$\frac{x}{1000} = \frac{87.1}{13189}; x = 6.6 \text{ mils}$$

$$\epsilon = \frac{547.067 (6.6)}{2700} = 1.3 \text{ mils}$$

$$\alpha g f = 6.6 + 1.3 = 7.9 \text{ mils}$$

$$87.1 - 7.9 = 79.2'' - 1000\text{-inch target}$$

No. 3 guns:

$$\frac{x}{1000} = \frac{95.1}{14400}; x = 6.6 \text{ mils}$$

$$\epsilon = \frac{547.067 (6.6)}{2700} = 1.3 \text{ mils}$$

$$\alpha g f = 6.6 + 1.3 = 7.9 \text{ mils}$$

$$95.1 - 7.9 = 87.2'' - 1000\text{-inch target}$$

d. Horizontal Harmonization—500-foot Target:

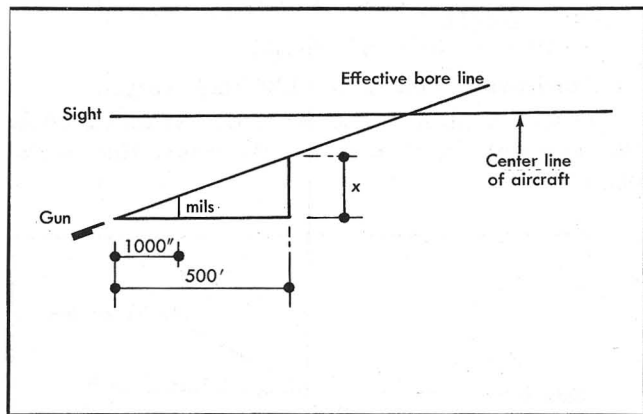

No. 1 guns:

By similar triangles:

$$\frac{7.9}{1000} = \frac{x}{500(12)}; x = 47.4''$$

$$79.1 - 47.4 = +31.7''$$

(Horizontal distance, at 500-foot target, from center of aircraft to the extended bore.)

No. 2 guns:

$$\frac{7.9}{1000} = \frac{x}{500(12)}; x = 47.4''$$

$$87.1 - 47.4 = 39.7'' = 500\text{-foot target}$$

No. 3 guns:

$$\frac{7.9}{1000} = \frac{x}{500(12)}; x = 47.4''$$

$$95.1 - 47.4 = 47.7'' = 500\text{-foot target}$$

SECTION D
PRESENT RANGE BALLISTIC TABLES

0.50 CALIBER

A.P. M2 PROJECTILE

M.V. = 2,700 ft/sec

PRESENT RANGE FORWARD FIRE

TOP LINE: VERTICAL DEFLECTION IN INCHES

BOTTOM LINE: TIME OF FLIGHT IN SECONDS

AUTHORITY:

Aberdeen Data FT. 50-AC-M-1; and
1st Ind. to letter from Ord. Dept.
Eglin Field, Fla. 15 April, 1944 to
Chief of Ord. Washington, D.C.

Altitude in Feet	True Air Speed	Cal. Ind. Air Speed	RANGE IN FEET									
			200	400	600	800	1000	1200	1400	1600	1800	2000
0	0	0	(1) .08	5 .16	(11) .24	19 .32	(30) .40	43 .49	(60) .58	80 .67	(104) .77	132 .87
0	150	150	(1) .07	4 .15	(9) .22	16 .30	(26) .38	38 .46	(53) .54	70 .63	(90) .72	114 .81
0	300	300	(1) .06	3 .13	(7) .20	13 .27	(21) .34	31 .41	(43) .49	58 .57	(76) .66	96 .74
0	450	450	(1) .06	3 .13	(7) .19	12 .25	(19) .32	28 .39	(39) .46	51 .53	(66) .61	83 .69
7000	150	135	(1) .07	4 .15	(9) .22	16 .30	(25) .37	37 .45	(51) .53	67 .61	(86) .70	108 .78
7000	300	271	(1) .06	3 .13	(7) .20	13 .27	(21) .34	31 .41	(43) .48	57 .56	(73) .64	91 .71
7000	450	409	(1) .06	3 .13	(7) .19	12 .25	(19) .32	28 .39	(38) .45	50 .52	(64) .59	80 .67
15000	150	119	(1) .07	4 .14	(9) .22	16 .29	(25) .37	36 .44	(49) .52	65 .60	(83) .68	104 .76
15000	300	240	(1) .06	3 .13	(7) .20	13 .27	(21) .34	31 .41	(42) .48	56 .55	(71) .62	89 .70
15000	450	364	(1) .06	3 .13	(7) .19	12 .25	(19) .31	27 .38	(37) .44	48 .51	(62) .58	77 .65
30000	150	92	(1) .07	4 .14	(9) .21	15 .28	(24) .36	35 .43	(48) .51	63 .58	(80) .66	99 .73
30000	300	187	(1) .06	3 .13	(7) .20	13 .26	(21) .33	30 .40	(41) .47	54 .54	(69) .61	86 .68
30000	450	284	(1) .06	3 .12	(7) .19	12 .25	(18) .31	26 .37	(36) .43	47 .50	(60) .56	74 .63
50000	150	58	(1) .07	4 .14	(9) .21	15 .28	(23) .35	34 .42	(47) .50	61 .57	(77) .64	95 .71
50000	300	119	(1) .06	3 .13	(7) .19	13 .26	(20) .32	29 .39	(40) .46	52 .52	(66) .59	82 .66
50000	450	183	(1) .06	3 .11	(6) .17	11 .23	(17) .29	25 .36	(34) .42	45 .48	(57) .55	71 .61

Figures in parentheses are from graphic tabulations

0.50 CALIBER

APPLIED BALLISTIC AND DESIGN SECTION, PROOF DIVISION, A.A.F.P.G.C., EGLIN FIELD, FLA. DWG. No. B-T44 DATE: 6-10-44

CALIBER 0.50

A. P. M2
M. V.=2,700 ft per sec

"PRESENT RANGE" or Range is the distance from a stationary point (the muzzle of the gun at time of fire) to the projectile at every instant.
AZIMUTH=0 Mils ZENITH=1,600 Mils
Guns mounted in aircraft in horizontal flight.

TOP LINE: VERTICAL DEFLECTION IN INCHES BOTTOM LINE: TIME OF FLIGHT IN SECONDS

Air Density	True Air Speed	RANGE IN FEET														
		200	400	600	800	1000	1200	1400	1600	1800	2000	2200	2400	2600	2800	3000
1.0	0	1	4	10	18	29	43	60	80	104	132	164	200	241	287	339
		0.07	0.15	0.23	0.31	0.40	0.49	0.58	0.67	0.77	0.87	0.98	1.09	1.20	1.32	1.44
1.0	150	1	4	9	16	25	37	51	69	89	112	139	169	203	242	285
		0.07	0.13	0.22	0.29	0.37	0.45	0.53	0.62	0.71	0.80	0.90	1.00	1.10	1.21	1.32
1.0	300	1	4	8	14	22	32	45	60	77	97	119	145	174	207	244
		0.06	0.13	0.20	0.27	0.34	0.42	0.50	0.58	0.66	0.74	0.83	0.92	1.01	1.11	1.21
1.0	450	1	3	7	12	19	28	39	52	67	84	104	127	152	180	212
		0.06	0.13	0.19	0.26	0.32	0.39	0.46	0.53	0.61	0.69	0.77	0.86	0.95	1.04	1.13
0.8	150	1	4	9	16	25	36	50	66	85	107	132	160	191	226	264
		0.07	0.14	0.21	0.28	0.36	0.44	0.52	0.60	0.69	0.78	0.87	0.96	1.05	1.15	1.25
0.8	300	1	4	8	14	21	31	43	57	74	93	114	138	165	194	227
		0.07	0.13	0.20	0.27	0.34	0.41	0.48	0.56	0.64	0.72	0.81	0.89	0.97	1.06	1.15
0.8	450	1	3	7	12	19	27	37	50	64	80	99	120	143	169	198
		0.06	0.12	0.18	0.24	0.31	0.38	0.45	0.52	0.60	0.68	0.75	0.83	0.91	0.99	1.07
0.6	150	1	4	9	16	24	35	48	64	82	102	125	151	180	211	246
		0.07	0.14	0.21	0.28	0.35	0.43	0.51	0.59	0.67	0.75	0.84	0.92	1.01	1.09	1.18
0.6	300	1	4	8	14	22	31	42	56	71	89	109	131	156	182	212
		0.07	0.13	0.20	0.27	0.33	0.40	0.47	0.54	0.62	0.70	0.77	0.85	0.93	1.01	1.10
0.6	450	1	3	7	12	19	27	37	49	62	77	95	114	135	159	185
		0.06	0.12	0.18	0.24	0.31	0.38	0.45	0.51	0.58	0.65	0.72	0.79	0.86	0.94	1.02
0.4	150	1	4	8	15	23	34	47	62	79	98	119	143	169	198	230
		0.07	0.14	0.21	0.28	0.35	0.42	0.49	0.57	0.65	0.73	0.80	0.88	0.96	1.04	1.13
0.4	300	1	4	8	14	21	30	41	54	69	86	105	126	149	173	200
		0.07	0.13	0.20	0.27	0.33	0.40	0.47	0.54	0.61	0.68	0.76	0.82	0.90	0.97	1.05
0.4	450	1	3	7	12	19	27	36	47	60	75	91	109	129	150	174
		0.06	0.12	0.18	0.24	0.31	0.37	0.43	0.50	0.56	0.63	0.70	0.77	0.84	0.92	0.97
0.2	150	1	4	8	15	24	34	47	61	78	96	116	138	162	189	217
		0.07	0.14	0.21	0.28	0.35	0.42	0.49	0.56	0.63	0.70	0.78	0.85	0.93	1.00	1.08
0.2	300	1	4	8	14	22	31	42	55	69	85	102	121	142	166	191
		0.07	0.13	0.20	0.26	0.33	0.39	0.46	0.52	0.59	0.66	0.72	0.79	0.86	0.93	1.00
0.2	450	1	3	8	13	19	27	37	48	61	75	90	107	125	145	166
		0.06	0.12	0.18	0.24	0.30	0.36	0.42	0.49	0.55	0.61	0.68	0.74	0.80	0.87	0.93

RESTRICTED

RESTRICTED
AAF MANUAL 200-1

CALIBER 0.50

API M8
M. V.=2,870 ft per sec

"PRESENT RANGE" or Range is the distance from a stationary point (the muzzle of the gun at time of fire) to the projectile at every instant.
AZIMUTH=0 Mils ZENITH=1,600 Mils
Guns mounted in aircraft in horizontal flight.

		TOP LINE: VERTICAL DEFLECTION IN INCHES								BOTTOM LINE: TIME OF FLIGHT IN SECONDS							
Air Density	True Air Speed	RANGE IN FEET															
		200	400	600	800	1000	1200	1400	1600	1800	2000	2200	2400	2600	2800	3000	
1.0	0	1	4	9	17	26	39	54	72	93	118	146	179	216	257	304	
		0.07	0.14	0.22	0.30	0.38	0.46	0.55	0.64	0.73	0.83	0.93	1.03	1.14	1.25	1.37	
1.0	150	1	4	8	14	22	33	46	62	80	101	125	153	184	219	258	
		0.07	0.13	0.20	0.27	0.35	0.43	0.51	0.59	0.67	0.76	0.85	0.95	1.05	1.15	1.25	
1.0	300	1	3	7	12	19	28	39	53	69	87	108	131	158	188	221	
		0.06	0.12	0.19	0.26	0.33	0.40	0.47	0.55	0.63	0.71	0.79	0.88	0.97	1.06	1.16	
1.0	450	1	3	6	11	17	25	35	46	60	76	94	114	137	163	192	
		0.06	0.12	0.18	0.24	0.30	0.37	0.44	0.51	0.58	0.66	0.74	0.82	0.90	0.99	1.08	
0.8	150	1	4	8	14	22	32	44	59	76	96	119	144	172	203	238	
		0.07	0.13	0.20	0.27	0.35	0.42	0.49	0.57	0.65	0.73	0.82	0.91	1.00	1.09	1.19	
0.8	300	1	3	6	12	19	28	39	51	66	83	102	124	148	175	205	
		0.06	0.13	0.19	0.26	0.32	0.39	0.46	0.54	0.61	0.68	0.76	0.84	0.92	1.01	1.10	
0.8	450	1	3	6	10	16	24	34	45	58	73	89	108	129	153	179	
		0.06	0.12	0.18	0.24	0.30	0.36	0.43	0.50	0.57	0.64	0.71	0.78	0.86	0.94	1.02	
0.6	150	1	4	8	14	21	31	43	57	73	92	113	136	162	190	221	
		0.07	0.13	0.20	0.27	0.34	0.41	0.48	0.56	0.63	0.71	0.79	0.87	0.95	1.03	1.12	
0.6	300	1	3	6	11	18	27	38	50	64	80	98	118	140	165	192	
		0.06	0.13	0.19	0.25	0.32	0.38	0.45	0.52	0.59	0.66	0.74	0.81	0.89	0.96	1.04	
0.6	450	1	3	6	11	17	24	33	44	56	70	86	103	122	144	167	
		0.05	0.11	0.17	0.23	0.29	0.36	0.42	0.49	0.55	0.62	0.69	0.76	0.83	0.90	0.97	
0.4	150	1	4	8	14	22	31	42	56	71	88	108	129	153	179	207	
		0.07	0.13	0.20	0.27	0.33	0.40	0.47	0.54	0.62	0.69	0.77	0.84	0.92	0.99	1.07	
0.4	300	1	3	6	11	18	27	37	48	61	76	93	112	132	155	179	
		0.06	0.12	0.18	0.24	0.31	0.38	0.44	0.51	0.57	0.64	0.71	0.78	0.85	0.92	0.99	
0.4	450	1	3	6	10	16	23	32	42	54	67	82	98	116	136	157	
		0.06	0.11	0.17	0.23	0.29	0.35	0.41	0.48	0.54	0.60	0.67	0.73	0.80	0.86	0.93	
0.2	150	1	3	7	13	21	30	41	54	68	84	102	122	144	167	193	
		0.07	0.13	0.20	0.27	0.33	0.40	0.47	0.53	0.60	0.67	0.74	0.81	0.88	0.95	1.02	
0.2	300	1	3	6	11	18	26	36	46	59	73	89	106	125	146	168	
		0.06	0.12	0.18	0.24	0.31	0.37	0.43	0.50	0.56	0.62	0.69	0.75	0.82	0.88	0.95	
0.2	450	1	3	6	10	16	23	31	41	52	64	78	93	110	127	147	
		0.06	0.11	0.17	0.23	0.29	0.35	0.41	0.46	0.52	0.58	0.64	0.70	0.76	0.83	0.89	

RESTRICTED

RESTRICTED
AAF MANUAL 200-1

Section D

20 MM

AIRCRAFT GUN M1 & M2
H.E.I. Mk. I
PROJECTILE
M.V.=2,700 ft/sec

PRESENT RANGE FORWARD FIRE

TOP LINE: VERTICAL DEFLECTION IN INCHES
BOTTOM LINE: TIME OF FLIGHT IN SECONDS

AUTHORITY: ABERDEEN
PROVING GROUND
10 AUGUST 1944
FT. 20 AC-B-3
EGLIN FIELD

Altitude in Feet	True Air Speed	Cal. Ind. Air Speed	RANGE IN FEET									
			400	800	1200	1600	2000	2400	2800	3200	3600	4000
0	0	0	5 .16	20 .33	48 .52	92 .73	156 .96	245 1.23	364 1.52	521 1.85	724 2.21	980 2.60
0	150	150	4 .14	17 .30	41 .48	78 .67	132 .88	206 1.12	305 1.39	436 1.70	607 2.03	824 2.39
0	300	300	4 .13	15 .28	35 .44	67 .62	112 .82	175 1.04	259 1.28	370 1.56	513 1.86	698 2.20
0	450	450	3 .12	13 .26	31 .41	58 .57	97 .76	151 .96	223 1.18	317 1.44	439 1.72	597 2.04
7000	150	135	4 .14	17 .30	39 .46	73 .64	121 .84	185 1.05	268 1.28	375 1.54	510 1.82	677 2.12
7000	300	271	4 .13	14 .27	34 .43	63 .59	104 .77	158 .97	229 1.18	319 1.41	432 1.67	574 1.95
7000	450	409	3 .12	12 .26	29 .40	55 .55	90 .72	137 .90	198 1.09	275 1.31	372 1.54	492 1.80
15000	150	119	4 .14	16 .29	37 .45	69 .62	113 .80	170 .99	242 1.19	331 1.41	440 1.65	573 1.90
15000	300	240	3 .13	14 .27	32 .42	60 .57	97 .74	145 .91	207 1.10	283 1.30	376 1.52	488 1.75
15000	450	364	3 .12	12 .25	28 .39	52 .53	84 .69	126 .85	179 1.02	245 1.21	325 1.41	421 1.62
30000	150	92	4 .14	15 .28	35 .43	64 .59	103 .75	152 .92	213 1.09	286 1.27	372 1.46	472 1.66
30000	300	187	3 .13	13 .26	31 .40	56 .55	89 .70	131 .85	183 1.01	246 1.18	319 1.35	405 1.53
30000	450	284	3 .12	12 .25	27 .38	48 .51	77 .65	114 .79	159 .94	214 1.10	277 1.26	352 1.43
50000	150	58	4 .14	15 .28	34 .42	61 .57	97 .72	141 .87	195 1.03	258 1.18	331 1.35	414 1.51
50000	300	119	3 .13	13 .26	29 .39	53 .53	84 .67	122 .81	168 .95	222 1.10	285 1.25	357 1.40
50000	450	183	3 .12	11 .24	26 .37	46 .49	73 .62	106 .76	146 .89	194 1.03	248 1.16	311 1.31

APPLIED BALLISTICS AND DESIGN SECTION, PROOF DIVISION
A.A.F.P.G.C., EGLIN FIELD, FLA. DWG. #B-T44 DATE: 10-16-44

"PRESENT RANGE" or Range is the distance from a stationary point (the muzzle of the gun at time of fire) to the projectile at every instant.

20 MM T23
M. V.=2,750 ft per sec

AZIMUTH=0 Mils ZENITH=1,600 Mils
Guns mounted in aircraft in horizontal flight.

		TOP LINE: VERTICAL DEFLECTION IN INCHES										BOTTOM LINE: TIME OF FLIGHT IN SECONDS										
Air Density	True Air Speed	RANGE IN FEET																				
		200	400	600	800	1000	1200	1400	1600	1800	2000	2200	2400	2600	2800	3000	3200	3400	3600	3800	4000	4200
1.0	0	1	4	10	18	29	43	60	81	105	133	166	204	247	296	351	413	482	560	646	743	850
		0.07	0.15	0.23	0.31	0.40	0.49	0.58	0.68	0.78	0.89	1.00	1.11	1.23	1.35	1.48	1.62	1.76	1.91	2.07	2.23	2.40
1.0	150	1	3	8	15	24	36	50	68	88	112	139	171	207	249	295	346	404	468	540	619	706
		0.07	0.14	0.21	0.29	0.37	0.45	0.54	0.63	0.72	0.82	0.92	1.02	1.13	1.23	1.35	1.47	1.60	1.74	1.88	2.03	2.19
1.0	300	1	3	7	13	21	31	43	58	76	96	120	147	178	212	251	294	343	397	457	523	597
		0.07	0.13	0.20	0.27	0.34	0.42	0.50	0.58	0.66	0.75	0.84	0.94	1.04	1.14	1.25	1.36	1.48	1.60	1.73	1.86	2.00
1.0	450	1	3	6	11	18	27	37	50	65	82	103	126	153	183	216	252	293	338	389	445	507
		0.06	0.12	0.18	0.25	0.32	0.39	0.46	0.53	0.61	0.69	0.77	0.87	0.96	1.05	1.15	1.25	1.36	1.47	1.59	1.71	1.84
0.8	150	1	3	8	15	25	37	51	67	86	108	133	162	194	230	270	315	364	418	477	541	612
		0.07	0.14	0.21	0.28	0.36	0.44	0.52	0.60	0.69	0.78	0.87	0.97	1.07	1.17	1.27	1.38	1.49	1.60	1.72	1.85	1.98
0.8	300	1	3	7	12	20	29	41	55	72	91	113	137	165	196	230	267	308	353	403	458	518
		0.07	0.13	0.20	0.27	0.34	0.41	0.48	0.56	0.64	0.72	0.81	0.89	0.98	1.07	1.17	1.27	1.37	1.48	1.59	1.70	1.81
0.8	450	1	2	6	11	18	27	37	49	63	79	98	119	143	169	198	230	265	304	347	393	444
		0.06	0.12	0.18	0.24	0.31	0.38	0.45	0.52	0.59	0.67	0.75	0.83	0.91	0.99	1.08	1.17	1.26	1.36	1.46	1.56	1.67
0.6	150	1	3	8	15	23	34	47	63	81	101	124	150	179	211	246	285	328	374	424	478	536
		0.07	0.14	0.21	0.28	0.35	0.43	0.51	0.59	0.67	0.75	0.83	0.92	1.01	1.10	1.19	1.28	1.38	1.48	1.58	1.69	1.80
0.6	300	1	3	7	13	20	29	40	53	68	86	107	130	155	182	212	245	281	320	362	408	457
		0.06	0.12	0.19	0.26	0.33	0.40	0.47	0.55	0.62	0.70	0.77	0.85	0.93	1.01	1.10	1.19	1.28	1.37	1.46	1.56	1.66
0.6	450	1	3	6	11	17	25	35	47	61	75	92	112	134	158	184	212	243	277	314	354	396
		0.06	0.12	0.18	0.24	0.30	0.37	0.44	0.51	0.58	0.65	0.72	0.79	0.86	0.94	1.02	1.10	1.19	1.27	1.35	1.44	1.53
0.4	150	1	4	8	14	23	33	46	61	78	97	118	142	168	197	228	262	299	339	382	427	476
		0.07	0.14	0.21	0.28	0.35	0.42	0.50	0.57	0.65	0.73	0.80	0.88	0.96	1.04	1.12	1.20	1.29	1.38	1.47	1.56	1.65
0.4	300	1	3	7	13	20	29	40	53	67	83	102	122	144	169	196	225	257	291	327	366	408
		0.06	0.13	0.19	0.26	0.32	0.39	0.46	0.53	0.60	0.67	0.75	0.82	0.89	0.97	1.04	1.12	1.20	1.28	1.36	1.44	1.52
0.4	450	1	3	6	11	17	25	34	46	58	72	87	104	124	145	169	195	222	252	284	317	353
		0.06	0.12	0.18	0.24	0.31	0.37	0.43	0.50	0.56	0.63	0.69	0.76	0.83	0.90	0.97	1.04	1.12	1.19	1.27	1.34	1.42
0.2	150	1	4	8	14	22	32	44	58	74	92	111	133	157	183	211	241	274	309	346	385	427
		0.07	0.13	0.20	0.27	0.34	0.41	0.48	0.56	0.63	0.70	0.77	0.84	0.91	0.99	1.06	1.14	1.21	1.29	1.37	1.44	1.52
0.2	300	1	3	7	12	19	28	38	50	64	79	96	115	136	158	182	208	236	266	298	332	368
		0.06	0.13	0.19	0.25	0.32	0.38	0.45	0.51	0.58	0.65	0.71	0.78	0.85	0.92	0.99	1.06	1.13	1.20	1.27	1.34	1.41
0.2	450	1	3	6	11	17	24	33	44	56	70	85	101	119	138	159	182	206	232	260	289	320
		0.06	0.12	0.18	0.24	0.30	0.36	0.42	0.48	0.54	0.60	0.67	0.73	0.79	0.86	0.92	0.99	1.05	1.12	1.19	1.25	1.32

RESTRICTED

RESTRICTED
AAF MANUAL 200-1

Section D

37 MM

AUTHORITY: ABERDEEN
PROVING GROUND
10 AUGUST 1944
FT. 37 AC-AO-1
EGLIN FIELD

AIRCRAFT GUN M4
H.E. SHELL M54
FUZE M56
M.V. = 2,000 ft/sec

PRESENT RANGE FORWARD FIRE

TOP LINE: VERTICAL DEFLECTION IN INCHES
BOTTOM LINE: TIME OF FLIGHT IN SECONDS

Altitude in Feet	True Air Speed	Cal. Ind. Air Speed	RANGE IN FEET									
			600	1200	1800	2400	3000	3600	4200	4800	5400	6000
0	0	0	19 .31	79 .65	188 1.02	354 1.12	590 1.87	910 2.35	1330 2.88	1868 3.46	2539 4.06	3356 4.69
0	150	150	15 .28	64 .59	151 .92	285 1.28	473 1.67	727 2.10	1059 2.57	1486 3.09	2085 3.64	2693 4.24
0	300	300	13 .26	52 .53	124 .83	234 1.15	387 1.50	593 1.89	861 2.31	1205 2.77	1638 3.27	2179 3.82
0	450	450	11 .23	44 .49	104 .76	195 1.05	322 1.37	492 1.72	713 2.09	994 2.50	1348 2.96	1780 3.45
7000	150	135	15 .28	62 .58	146 .89	271 1.23	444 1.59	671 1.98	961 2.40	1324 2.85	1772 3.34	2318 3.86
7000	300	271	12 .25	51 .52	120 .81	223 1.11	364 1.44	549 1.79	785 2.16	1079 2.56	1440 3.00	1879 3.46
7000	450	409	10 .23	43 .48	100 .74	186 1.02	304 1.32	458 1.63	653 1.97	895 2.33	1192 2.72	1552 3.14
15000	150	119	15 .28	61 .57	141 .87	259 1.20	420 1.53	627 1.89	886 2.27	1202 2.66	1584 3.09	2038 3.53
15000	300	240	12 .25	50 .51	116 .79	214 1.08	345 1.39	515 1.71	726 2.04	984 2.40	1294 2.78	1662 3.18
15000	450	364	10 .23	42 .47	98 .73	179 .99	289 1.27	430 1.56	606 1.87	820 2.19	1077 2.53	1380 2.89
30000	150	92	14 .28	59 .56	135 .85	246 1.15	392 1.46	576 1.78	802 2.11	1071 2.45	1386 2.80	1751 3.17
30000	300	187	12 .25	49 .51	112 .77	203 1.04	323 1.32	475 1.61	660 1.91	881 2.22	1139 2.53	1438 2.86
30000	450	284	10 .23	41 .46	94 .71	170 .96	271 1.21	398 1.48	552 1.75	736 2.03	952 2.32	1200 2.61
50000	150	58	14 .27	58 .55	131 .83	236 1.12	372 1.41	542 1.71	746 2.00	985 2.31	1261 2.62	1574 2.93
50000	300	119	12 .25	48 .50	108 .75	195 1.01	308 1.28	447 1.54	615 1.81	813 2.09	1040 2.37	1298 2.66
50000	450	183	10 .23	40 .46	91 .69	164 .93	258 1.17	376 1.42	517 1.67	682 1.92	872 2.17	1088 2.44

APPLIED BALLISTICS AND DESIGN SECTION, PROOF DIVISION,
A.A.F.P.G.C., EGLIN FIELD, FLA. DWG. No. B-T44 DATE: 10-11-44

37 MM

AUTHORITY: ABERDEEN
PROVING GROUND
10 AUGUST 1944
FT. 37 AC-BF-1
EGLIN FIELD

GUN M9
H.E. SHELL M54
FUZE M56
M.V.=2,550 ft/sec

PRESENT RANGE FORWARD FIRE

TOP LINE: VERTICAL DEFLECTION IN INCHES

BOTTOM LINE: TIME OF FLIGHT IN SECONDS

Altitude in Feet	True Air Speed	Cal.Ind. Air Speed	RANGE IN FEET									
			600	1200	1800	2400	3000	3600	4200	4800	5400	6000
0	0	0	12 .24	48 .51	114 .79	213 1.10	353 1.43	539 1.80	782 2.20	1092 2.63	1484 3.11	1972 3.63
0	150	150	10 .22	40 .47	96 .73	179 1.01	296 1.31	451 1.64	653 2.00	909 2.39	1231 2.82	1631 3.30
0	300	300	8 .21	35 .43	82 .67	153 .93	252 1.21	384 1.51	554 1.84	770 2.20	1039 2.58	1373 3.01
0	450	450	7 .19	30 .40	71 .62	132 .86	218 1.12	331 1.40	477 1.70	661 2.03	890 2.38	1173 2.77
7000	150	135	10 .22	40 .46	92 .71	171 .98	279 1.26	420 1.56	599 1.88	821 2.23	1091 2.60	1419 2.99
7000	300	271	8 .21	34 .43	79 .66	146 .90	238 1.16	358 1.44	510 1.73	697 2.05	926 2.38	1201 2.75
7000	450	409	7 .19	29 .40	69 .61	127 .84	206 1.08	309 1.34	440 1.61	600 1.90	796 2.21	1031 2.54
15000	150	119	10 .22	39 .45	90 .70	165 .95	266 1.22	395 1.49	556 1.79	753 2.10	987 2.42	1265 2.76
15000	300	240	8 .21	33 .42	77 .64	141 .88	227 1.12	338 1.38	475 1.65	642 1.93	841 2.23	1076 2.54
15000	450	364	7 .19	29 .39	67 .60	122 .82	196 1.04	292 1.28	410 1.53	554 1.79	725 2.06	927 2.35
30000	150	92	9 .22	38 .45	86 .68	157 .92	249 1.16	366 1.42	508 1.68	677 1.94	875 2.22	1103 2.50
30000	300	187	8 .21	32 .42	74 .63	134 .85	214 1.08	314 1.31	435 1.55	580 1.80	748 2.05	943 2.32
30000	450	284	7 .19	28 .38	64 .58	116 .79	185 1.00	272 1.22	377 1.44	502 1.67	647 1.91	815 2.15
50000	150	58	9 .22	37 .44	84 .66	151 .89	238 1.12	346 1.36	476 1.60	628 1.84	803 2.09	1002 2.33
50000	300	119	8 .20	32 .41	72 .62	129 .83	204 1.04	297 1.26	408 1.48	538 1.71	688 1.93	858 2.16
50000	450	183	7 .19	28 .38	62 .58	112 .77	177 .96	257 1.17	354 1.38	466 1.59	596 1.80	744 2.01

APPLIED BALLISTICS AND DESIGN SECTION, PROOF DIVISION,
A.A.F.P.G.C., EGLIN FIELD, FLA. DWG. No. B-T44 DATE: 10-11-44

75 MM

PRESENT RANGE FORWARD FIRE

DATA FIGURED AND
INTERPOLATED FROM
ABERDEEN DATA
FT. 75 AC-AR-1

GUN M4
SHELL M48
M.V.=1,950 ft/sec

TOP LINE: VERTICAL DEFLECTION IN FEET
BOTTOM LINE: TIME OF FLIGHT IN SECONDS

Altitude	Indicated Air Speed	RANGE IN FEET									
		500	1000	1500	2000	2500	3000	3500	4000	4500	5000
3000'	200	0.9 0.24	3.0 0.47	7.5 0.70	14.2 0.96	22.4 1.20	31.8 1.44	42.9 1.70	56.8 1.97	82.9 2.19	91.4 2.45
3000'	225	0.8 0.23	2.9 0.46	7.2 0.69	14.2 0.93	21.3 1.18	30.1 1.41	40.9 1.66	54.3 1.92	80.3 2.15	88.3 2.41
3000'	250	0.7 0.22	2.8 0.45	6.8 0.68	13.2 0.91	20.5 1.15	28.6 1.38	38.9 1.62	52.3 1.87	67.8 2.12	85.0 2.37
3000'	275	0.6 0.21	2.7 0.44	6.5 0.66	12.6 0.88	19.6 1.13	27.0 1.35	36.7 1.59	49.8 1.83	65.5 2.08	83.0 2.33
3000'	300	0.5 0.20	2.5 0.43	6.2 0.65	11.6 0.86	18.1 1.10	25.4 1.32	34.8 1.56	47.5 1.79	63.5 2.04	80.8 2.29

Altitude	Indicated Air Speed	RANGE IN FEET (Con't.)									
		5500	6000	6500	7000	7500	8000	8500	9000	9500	10000
3000'	200	112.4 2.73	134.9 3.00	160.2 3.28	188.2 3.56	218.5 3.85	252.2 4.14	288.5 4.46	326.6 4.77	368.6 5.08	414.5 5.42
3000'	225	108.5 2.69	130.4 2.95	155.5 3.22	182.0 3.50	211.1 3.78	243.4 4.07	278.6 4.38	315.5 4.68	357.0 4.99	401.3 5.32
3000'	250	104.7 2.64	126.3 2.90	150.7 3.16	176.1 3.44	204.4 3.72	233.5 4.00	269.0 4.30	305.2 4.60	346.8 4.90	390.2 5.22
3000'	275	102.1 2.60	122.1 2.85	145.4 3.11	170.3 3.38	197.1 3.66	227.0 3.93	261.3 4.23	295.5 4.52	314.1 4.82	378.1 5.13
3000'	300	99.0 2.56	118.3 2.80	140.2 3.06	165.0 3.33	191.0 3.62	220.5 3.87	252.0 4.16	286.7 4.45	326.2 4.74	365.5 5.04

Altitude	Indicated Air Speed	RANGE IN FEET (Con't.)									
		10500	11000	11500	12000	12500	13000	13500	14000	14500	15000
3000'	200	464.0 5.74	518.1 6.09	573.1 6.43	629.4 6.77	692.2 7.15	761.6 7.53	836.9 7.88	916.6 8.28	999.1 8.67	1083. 9.07
3000'	225	448.5 5.63	500.0 5.97	554.2 6.31	610.7 6.65	673.0 7.01	738.8 7.38	808.6 7.73	883.1 8.12	963.3 8.51	1046. 8.90
3000'	250	435.0 5.53	486.0 5.85	539.3 6.19	594.0 6.53	653.7 6.87	718.1 7.23	784.8 7.59	856.6 7.96	933.8 8.35	1011. 8.74
3000'	275	422.0 5.43	472.2 5.75	524.1 6.08	578.8 6.41	637.5 6.75	699.5 7.10	762.6 7.45	832.0 7.72	905.1 8.20	979.4 8.58
3000'	300	410.0 5.34	458.4 5.65	511.3 5.97	564.2 6.30	622.5 6.63	681.0 6.97	741.8 7.31	808.1 7.68	877.8 7.05	949.8 8.42

APPLIED BALLISTIC AND DESIGN SECTION, PROOF DIVISION,
A.A.F.P.G.C., EGLIN FIELD, FLORIDA. DATE: 8-8-44

GUN M5A1
SHELL M48
P. D. FUZE M57
M. V. = 1,950 ft/sec

75 MM
DENSITY 1.0 FORWARD FIRE
PRESENT HORIZONTAL RANGE

FROM DATA
ON WHICH
FT. 75-AC-AW-1
ARE BASED.

		TOP LINE: VERTICAL DEFLECTION IN FEET BOTTOM LINE: TIME OF FLIGHT IN SECONDS									
True Air Speed	HORIZONTAL RANGE IN YARDS										
	200	400	600	800	1000	1200	1400	1600	1800	2000	
250	1.2	4.5	10.2	18.6	29.4	43.2	60.0	79.8	102.9	129.3	
	0.26	0.53	0.81	1.09	1.38	1.68	1.99	2.31	2.63	2.96	
350	0.9	3.9	9.0	16.5	26.1	38.1	52.8	70.5	90.9	114.3	
	0.25	0.50	0.76	1.03	1.30	1.58	1.87	2.16	2.47	2.78	
True Air Speed	HORIZONTAL RANGE IN YARDS										
	2200	2400	2600	2800	3000	3200	3400	3600	3800	4000	
250	159.9	194.1	232.2	275.1	322.5	374.7	432.3	495.6	564.6	639.9	
	3.31	3.66	4.03	4.40	4.79	5.18	5.59	6.02	6.45	6.90	
350	141.0	171.0	204.6	242.1	283.8	329.7	380.1	435.3	495.6	564.3	
	3.10	3.43	3.77	4.12	4.48	4.85	5.24	5.63	6.03	6.45	
True Air Speed	HORIZONTAL RANGE IN YARDS										
	4200	4400	4600	4800	5000						
250	721.8	810.6	907.2	1011.3	1124.1						
	7.36	7.83	8.32	8.83	9.35						
350	632.7	710.4	794.4	885.6	984.0						
	6.88	7.32	7.78	8.25	8.73						

Letter 00 063.2/3105, 1st Ind.,
Incl 3

Ballistic Research Laboratory
Aberdeen Proving Ground, Md.
December 1944

SECTION E
FUTURE RANGE BALLISTICS TABLES

75 MM

GUN M4
SHELL M48
M.V. = 1,950 ft/sec

FUTURE RANGE FORWARD FIRE

DATA FIGURED AND
INTERPOLATED FROM
ABERDEEN.
DATA FT. 75 AC-AR-1

TOP LINE: VERTICAL DEFLECTION IN INCHES
BOTTOM LINE: TIME OF FLIGHT IN SECONDS

Altitude	Indicated Air Speed	RANGE IN FEET										
		1200	2400	3600	4800	6000	7200	8400	9600	10800	12000	
3000'	150	70.7 0.63	311 1.30	763 2.01	1356 2.76	2262 3.56	3392 4.41	4851 5.33	6667 6.31	8820 7.37	11562 8.51	
3000'	250	70.7 0.63	311 1.31	763 2.03	1413 2.80	2333 3.62	3562 4.51	5049 5.48	7119 6.53	9576 7.68	12690 8.96	
3000'	350	70.7 0.64	311 1.32	763 2.05	1469 2.84	2404 3.69	3731 4.62	5346 5.65	7571 6.79	10332 8.07	14241 9.52	
15000'	150	70.7 0.63	311 1.28	721 1.96	1300 2.66	2121 3.39	3138 4.15	4356 4.95	5876 5.78	7686 6.65	8970 7.57	
15000'	250	70.7 0.63	311 1.28	721 1.97	1356 2.68	2121 3.44	3222 4.22	4554 5.05	6102 5.92	8064 6.84	10434 7.81	
15000'	350	70.7 0.63	311 1.29	721 1.99	1356 2.72	2192 3.49	3307 4.30	4752 5.16	6441 6.08	8636 7.06	11139 8.11	
27000'	150	70.7 0.62	311 1.26	678 1.92	1243 2.59	1980 3.29	2968 4.00	4059 4.72	5424 5.47	6930 6.25	8883 7.04	
27000'	200	70.7 0.62	311 1.26	721 1.92	1243 2.60	2050 3.30	2968 4.02	4158 4.76	5537 5.52	7056 6.31	9024 7.12	
27000'	250	70.7 0.63	311 1.27	721 1.93	1300 2.62	2050 3.30	3053 4.05	4252 4.80	5650 5.58	7308 6.38	9306 7.21	
39000'	150	70.7 0.62	311 1.25	678 1.90	1243 2.55	1980 3.22	2883 3.90	3960 4.59	5198 5.29	6552 6.01	8319 6.74	
39000'	200	70.7 0.62	311 1.25	678 1.90	1243 2.56	1980 3.23	2883 3.92	3960 4.62	5198 5.33	6678 6.06	8460 6.88	
39000'	250	70.7 0.62	311 1.26	678 1.91	1243 2.57	1980 3.25	2883 3.94	4059 4.65	5311 5.37	6804 6.11	8601 6.86	

APPLIED BALLISTIC AND DESIGN SECTION, PROOF DIVISION,
A.A.F.P.G.C., EGLIN FIELD, FLA. DWG. NO. B-T44 DATE: 8-11-44

SECTION F
PLOTTED TRAJECTORY CURVES

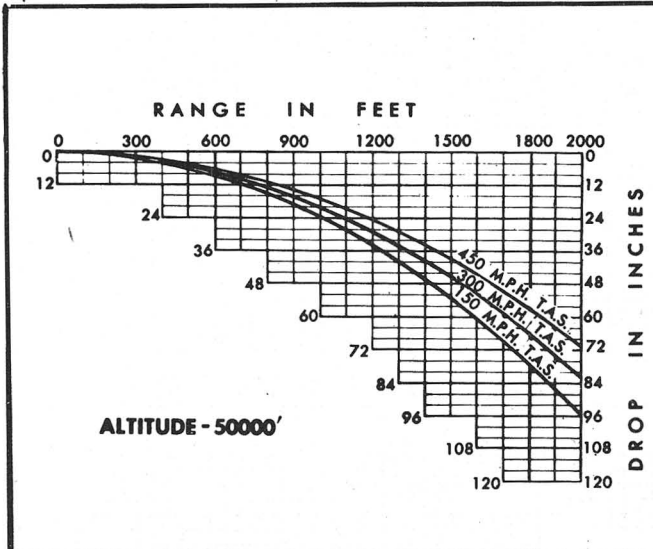

Alt. Feet	T.A.S. M.P.H.	RANGE IN FEET									
		200	400	600	800	1000	1200	1400	1600	1800	2000
0	0	.08	.16	.24	.32	.40	.49	.58	.67	.77	.87
0	150	.07	.15	.22	.30	.38	.46	.54	.63	.72	.81
0	300	.06	.13	.20	.27	.34	.41	.49	.57	.66	.74
0	450	.06	.13	.19	.25	.32	.39	.46	.53	.61	.69
7000	150	.07	.15	.22	.30	.37	.45	.53	.61	.70	.78
7000	300	.06	.13	.20	.27	.34	.41	.48	.56	.64	.71
7000	450	.06	.13	.19	.25	.32	.39	.45	.52	.59	.67
15000	150	.07	.14	.22	.29	.37	.44	.52	.60	.68	.76
15000	300	.06	.13	.20	.27	.34	.41	.48	.55	.62	.70
15000	450	.06	.13	.19	.25	.31	.38	.44	.51	.58	.65
30000	150	.07	.14	.21	.28	.36	.43	.51	.58	.66	.73
30000	300	.06	.13	.20	.26	.33	.40	.47	.54	.61	.68
30000	450	.06	.12	.19	.25	.31	.37	.43	.50	.56	.63
50000	150	.07	.14	.21	.28	.35	.42	.50	.57	.64	.71
50000	300	.06	.13	.19	.26	.32	.39	.46	.52	.59	.66
50000	450	.06	.11	.17	.23	.29	.36	.42	.48	.55	.61

TIME OF FLIGHT IN SECONDS

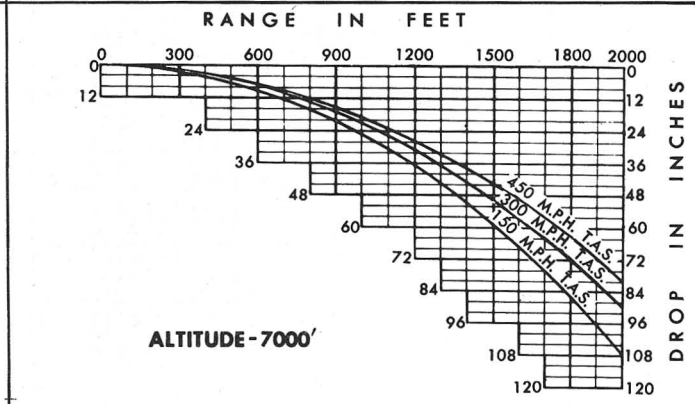
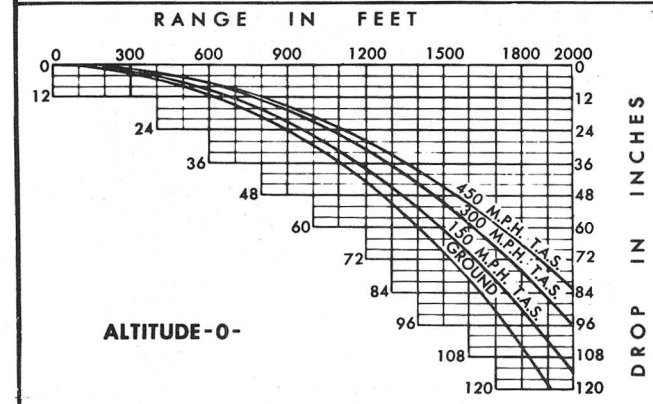
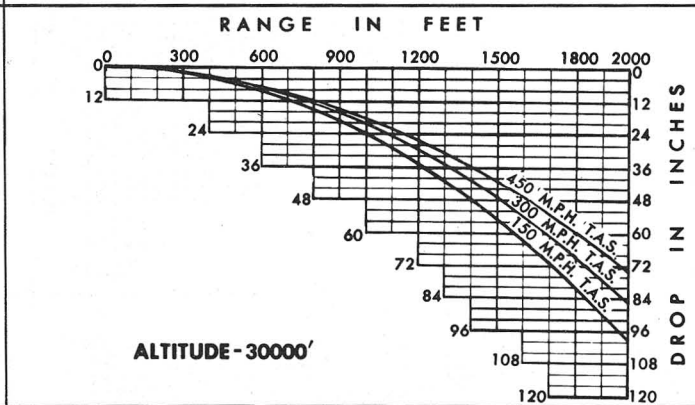
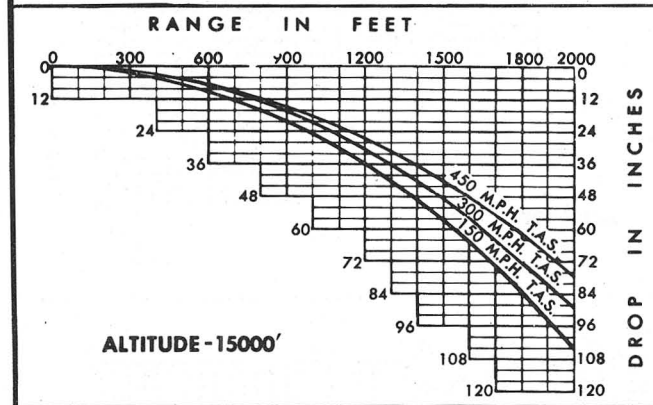

DATA AFFECTING CURVES

AP M2 Ammunition
Muzzle Velocity—2700 Ft./Sec.
Azimuth=0 Mills
Zenith=1600 Mills

Derived from Aberdeen Data Ft. 50-AC-M-1;
and 1st. Ind. to Letter from Ord. Dept., Elgin
Field, Fla. 15 April 1944 to Chief of Ord.
Washington, D. C.

CALIBER 0.50
TRAJECTORY CURVES

PRESENT RANGE
FORWARD FIRE

APPLIED BALLISTICS AND DESIGN SECTION
PROOF DIVISION, A.A.F.P.G.C., ELGIN FIELD, FLA.
DATE: 8-8-44.

MISCELLANEOUS DATA

Weight of Gun & Feed..... 61.4 Lb.
Weight of Fixed Round..... 2571 Lb.
Weight of Projectile..... 1015 Lb.
Weight of 100 Rounds-Linked... 30.25 Lb.
Rate of Fire-Rounds/Min.-Syn.=650-Free=
750-850
Approx. Velocity at 1800 Ft.... 1915'/Sec.
Striking Energy at 1800 Ft.-Syn.=61500-
Free=80861 Ft./Lbs./Sec./Gun (Approx)

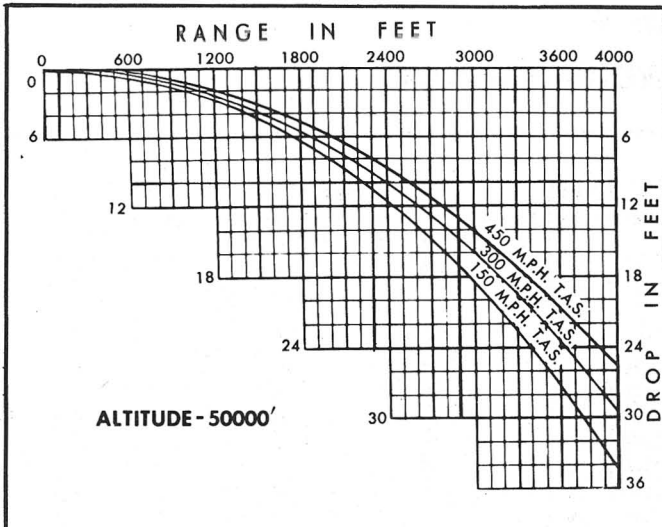

Alt. Feet	T.A.S. M.P.H.	RANGE IN FEET									
		400	800	1200	1600	2000	2400	2800	3200	3600	4000
0	0	.16	.33	.52	.73	.96	1.23	1.52	1.85	2.21	2.60
0	150	.14	.30	.48	.67	.88	1.12	1.39	1.70	2.03	2.39
0	300	.13	.28	.44	.62	.82	1.04	1.28	1.56	1.86	2.20
0	450	.12	.26	.41	.57	.76	.96	1.18	1.44	1.72	2.04
7000	150	.14	.30	.46	.64	.84	1.05	1.28	1.54	1.82	2.12
7000	300	.13	.27	.43	.59	.77	.97	1.18	1.41	1.67	1.95
7000	450	.12	.26	.40	.55	.72	.90	1.09	1.31	1.54	1.80
15000	150	.14	.29	.45	.62	.80	.99	1.19	1.41	1.65	1.90
15000	300	.13	.27	.42	.57	.74	.91	1.10	1.30	1.52	1.75
15000	450	.12	.25	.39	.53	.69	.85	1.02	1.21	1.41	1.62
30000	150	.14	.28	.43	.59	.75	.92	1.09	1.27	1.46	1.66
30000	300	.13	.26	.40	.55	.70	.85	1.01	1.18	1.35	1.53
30000	450	.12	.25	.38	.51	.65	.79	.94	1.10	1.26	1.43
50000	150	.14	.28	.42	.57	.72	.87	1.03	1.18	1.35	1.51
50000	300	.13	.26	.39	.53	.67	.81	.95	1.10	1.25	1.40
50000	450	.12	.24	.37	.49	.62	.76	.89	1.03	1.16	1.31

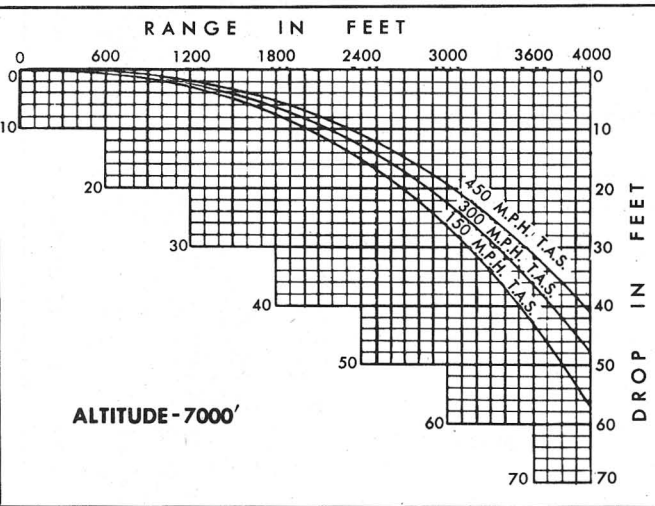
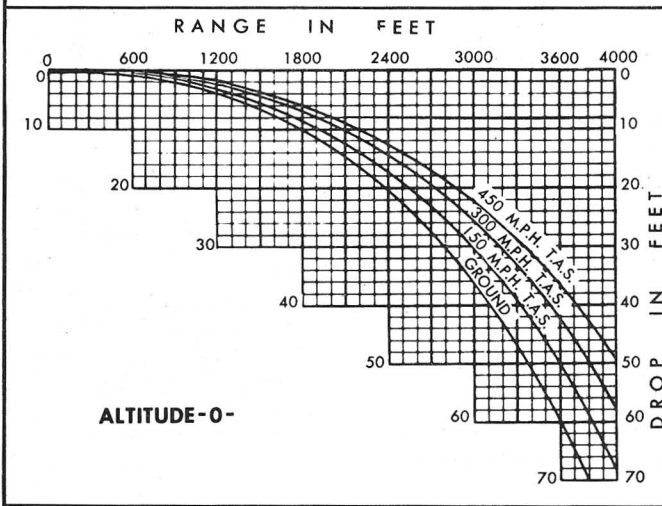
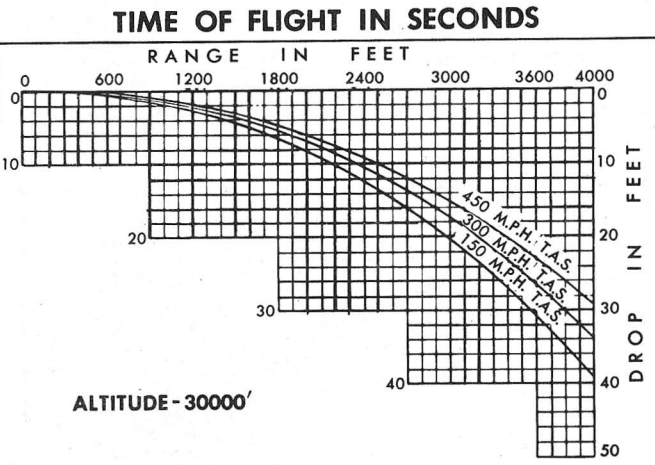
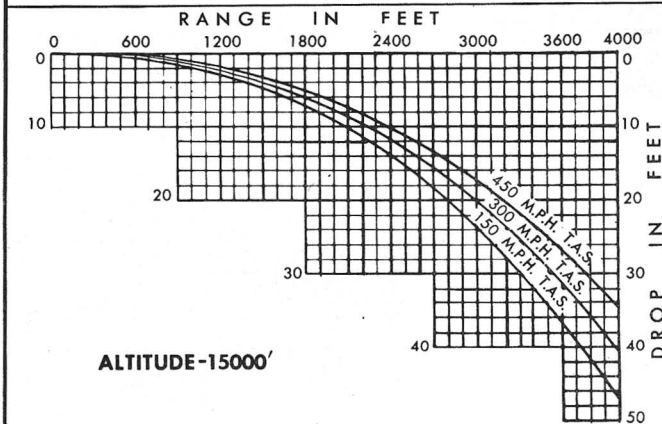

DATA AFFECTING CURVES
 Gun Ml. 8:M2.
 H.E.I. Mk. I Projectile.
 Muzzle Velocity—2700 Ft./Sec.
 Azimuth=0 Mils.
 Zenith=1600 Mils.
 Authority: Aberdeen Proving Ground.
 10 August 1944, Ft. 20 AC-B-3 Elgin Field.

20 MM
TRAJECTORY CURVES
 PRESENT RANGE
 FORWARD FIRE

APPLIED BALLISTICS AND DESIGN SECTION
 PROOF DIVISION—A.A.F.P.G.C.—ELGIN FIELD, FLA.
 DATE: 28 SEPT., 1944

MISCELLANEOUS DATA
 Weight of Gun & Feed..... 132 Lb.
 (M2 Gun)
 (W/AN Ml Feed)
 Weight of Fixed Round..... 57 Lb.
 Weight of Projectile..... 29 Lb.
 Rate of Fire—Rounds/Min..... 600-700.
 Approx. Velocity at 1800
 Ft..... 1625-1700'/Sec.
 Striking Energy at 1800 Ft. (Approx.)—
 138,217 Ft./Lb./Sec./Gun.

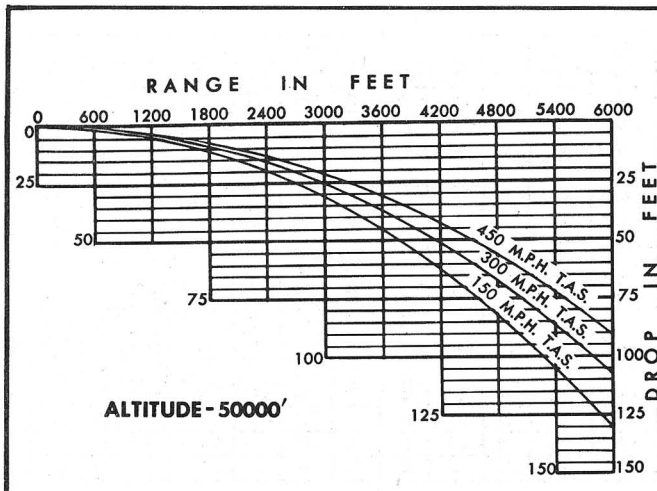

Alt. Feet	T.A.S. M.P.H.	RANGE IN FEET									
		600	1200	1800	2400	3000	3600	4200	4800	5400	6000
0	0	.31	.65	1.02	1.42	1.87	2.35	2.88	3.46	4.06	4.69
0	150	.28	.59	.92	1.28	1.67	2.10	2.57	3.09	3.64	4.24
0	300	.26	.53	.83	1.15	1.50	1.89	2.31	2.77	3.27	3.82
0	450	.23	.49	.76	1.05	1.37	1.72	2.09	2.50	2.96	3.45
7000	150	.28	.58	.89	1.23	1.59	1.98	2.40	2.85	3.34	3.86
7000	300	.25	.52	.81	1.11	1.44	1.79	2.16	2.56	3.00	3.46
7000	450	.23	.48	.74	1.02	1.32	1.63	1.97	2.33	2.72	3.14
15000	150	.28	.57	.87	1.20	1.53	1.89	2.27	2.66	3.09	3.53
15000	300	.25	.51	.79	1.08	1.39	1.71	2.04	2.40	2.78	3.18
15000	450	.23	.47	.73	.99	1.27	1.56	1.87	2.19	2.53	2.89
30000	150	.28	.56	.85	1.15	1.46	1.78	2.11	2.45	2.80	3.17
30000	300	.25	.51	.77	1.04	1.32	1.61	1.91	2.22	2.53	2.86
30000	450	.23	.46	.71	.96	1.21	1.48	1.75	2.03	2.32	2.61
50000	150	.27	.55	.83	1.12	1.41	1.71	2.00	2.31	2.62	2.93
50000	300	.25	.50	.75	1.01	1.28	1.54	1.81	2.09	2.37	2.66
50000	450	.23	.46	.69	.93	1.17	1.42	1.67	1.92	2.17	2.44

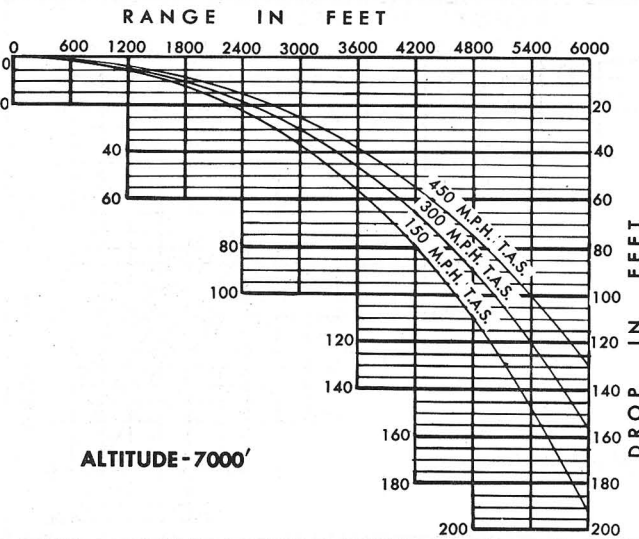
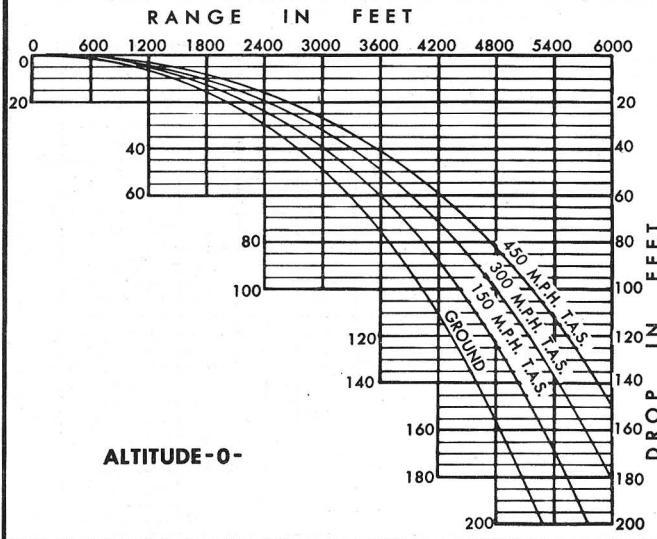
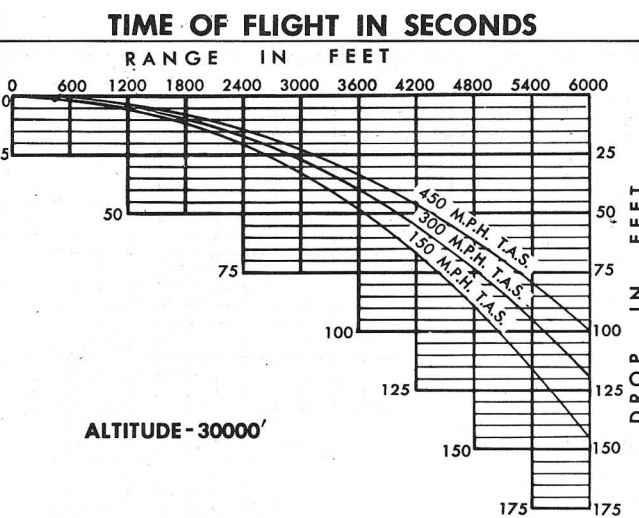
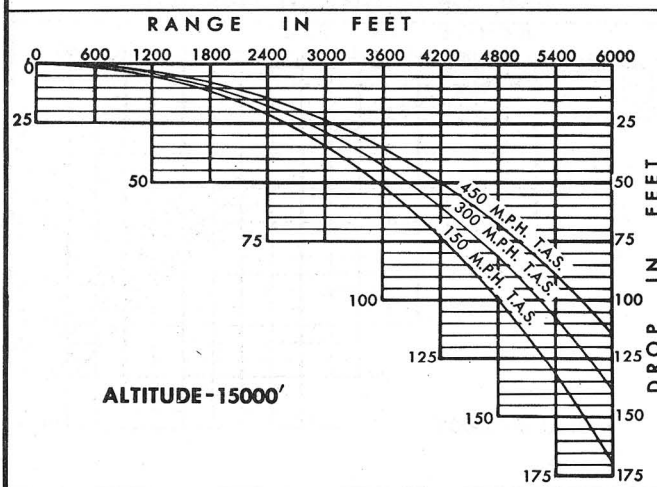

DATA AFFECTING CURVES
Aircraft Gun M 4
H. E. Shell M54, Fuse M56
Muzzle Velocity—2000 Ft/Sec.
Azimuth=0 Mils.
Zenith=1600 Mils.
Authority: Aberdeen Proving Ground
10 August 1944, Ft 37 AC-AO-1, Elgin Field.

37 MM - M4
TRAJECTORY CURVES
PRESENT RANGE
FORWARD FIRE

MISCELLANEOUS DATA
Weight of Gun & Feed..... 248 Lb.
Weight of Fixed Round..... 1.93 Lb.
Weight of Projectile..... 1.34 Lb.
Rate of Fire—Rounds/Min..... 150
Approx. Velocity at 1800 Ft. 1564'/Sec.
Striking Energy at 1800 Ft. (Approx.)
127,242 Ft./Lbs./Sec./Gun

APPLIED BALLISTICS AND DESIGN SECTION
PROOF DIVISION, A.A.F.P.G.C., ELGIN FIELD, FLA.
DATE: 9-29-44

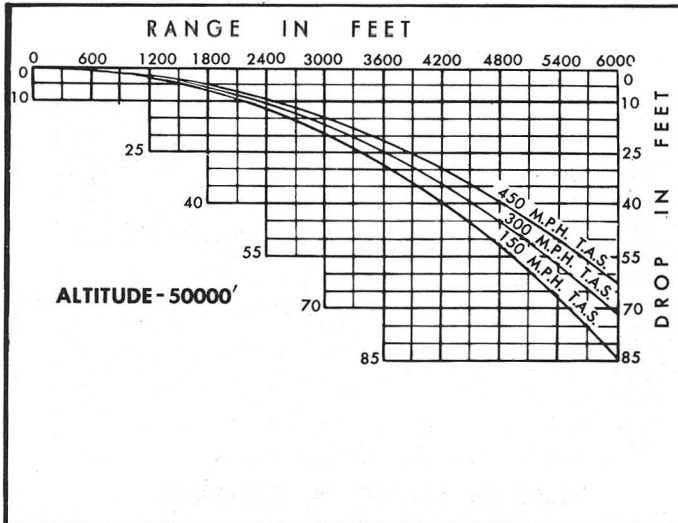

Alt. Feet	T.A.S. M.P.H.	RANGE IN FEET									
		600	1200	1800	2400	3000	3600	4200	4800	5400	6000
0	0	.24	.51	.79	1.10	1.43	1.80	2.20	2.63	3.11	3.63
0	150	.22	.47	.73	1.01	1.31	1.64	2.00	2.39	2.82	3.30
0	300	.21	.43	.67	.93	1.21	1.51	1.84	2.20	2.58	3.01
0	450	.19	.40	.62	.86	1.12	1.40	1.70	2.03	2.38	2.77
7000	150	.22	.46	.71	.98	1.26	1.56	1.88	2.23	2.60	2.99
7000	300	.21	.43	.66	.90	1.16	1.44	1.73	2.05	2.38	2.75
7000	450	.19	.40	.61	.84	1.08	1.34	1.61	1.90	2.21	2.54
15000	150	.22	.45	.70	.95	1.22	1.49	1.79	2.10	2.42	2.76
15000	300	.21	.42	.64	.88	1.12	1.38	1.65	1.93	2.23	2.54
15000	450	.19	.39	.60	.82	1.04	1.28	1.53	1.79	2.06	2.35
30000	150	.22	.45	.68	.92	1.16	1.42	1.68	1.94	2.22	2.50
30000	300	.21	.42	.63	.85	1.08	1.31	1.55	1.80	2.05	2.32
30000	450	.19	.38	.58	.79	1.00	1.22	1.44	1.67	1.91	2.15
50000	150	.22	.44	.66	.89	1.12	1.36	1.60	1.84	2.09	2.33
50000	300	.20	.41	.62	.83	1.04	1.26	1.48	1.71	1.93	2.16
50000	450	.19	.38	.58	.77	.96	1.17	1.38	1.59	1.80	2.01

TIME OF FLIGHT IN SECONDS

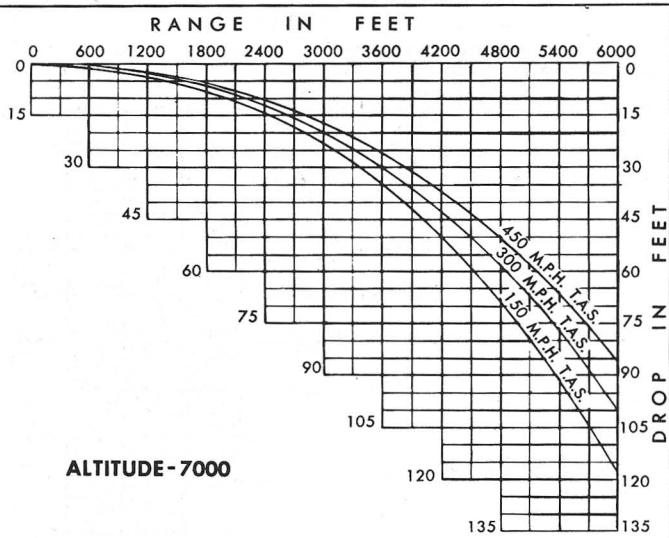
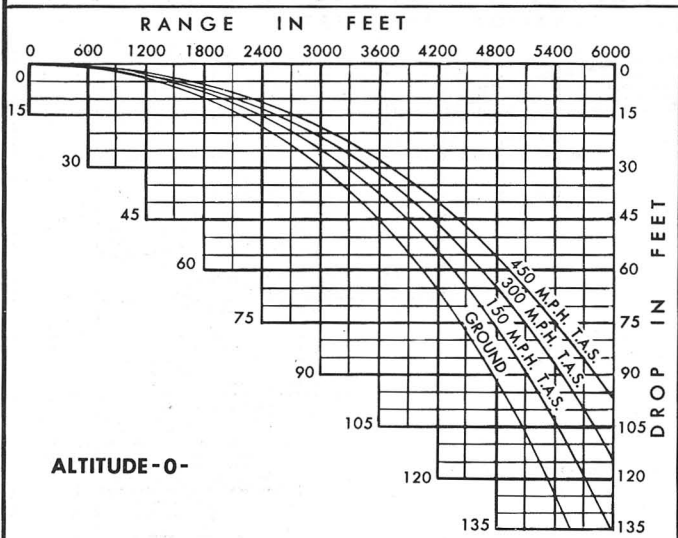
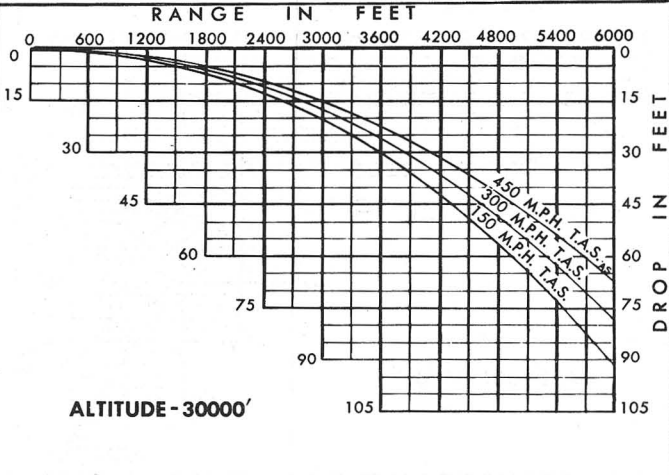
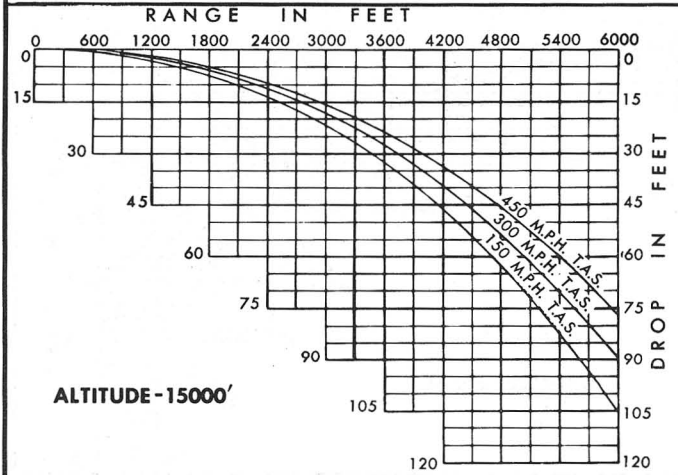

DATA AFFECTING CURVES
 Gun M9; HE Shell M.54
 Muzzle Velocity—2550 Ft./Sec.
 Azimuth=0 Mills.
 Zenith=1600 Mills.
 Authority: Aberdeen Proving Ground
 10 August 1944, Ft. 37 AC-AO-1, Elgin Field.

37 MM M9
TRAJECTORY CURVES
 PRESENT RANGE
 FORWARD FIRE

APPLIED BALLISTICS AND DESIGN SECTION
 PROOF DIVISION, A.A.F.P.G.C., ELGIN FIELD, FLA.
 DATE: 10-10-44

MISCELLANEOUS DATA
 Weight of Gun & Feed.....398 Lb.
 Weight of Fixed Round.....2.6 Lb.
 Weight of Projectile.....1.34 Lb.
 Weight of 100 Rounds-Linked.....288 Lb.
 Rate of Fire-Rounds/Min.....140.
 Approx. Velocity at 1800 Ft.. .2065'/Sec.
 Striking Energy at 1800 Ft. (Approx.)-
 199,968 Ft./Lbs./Sec./Gun.

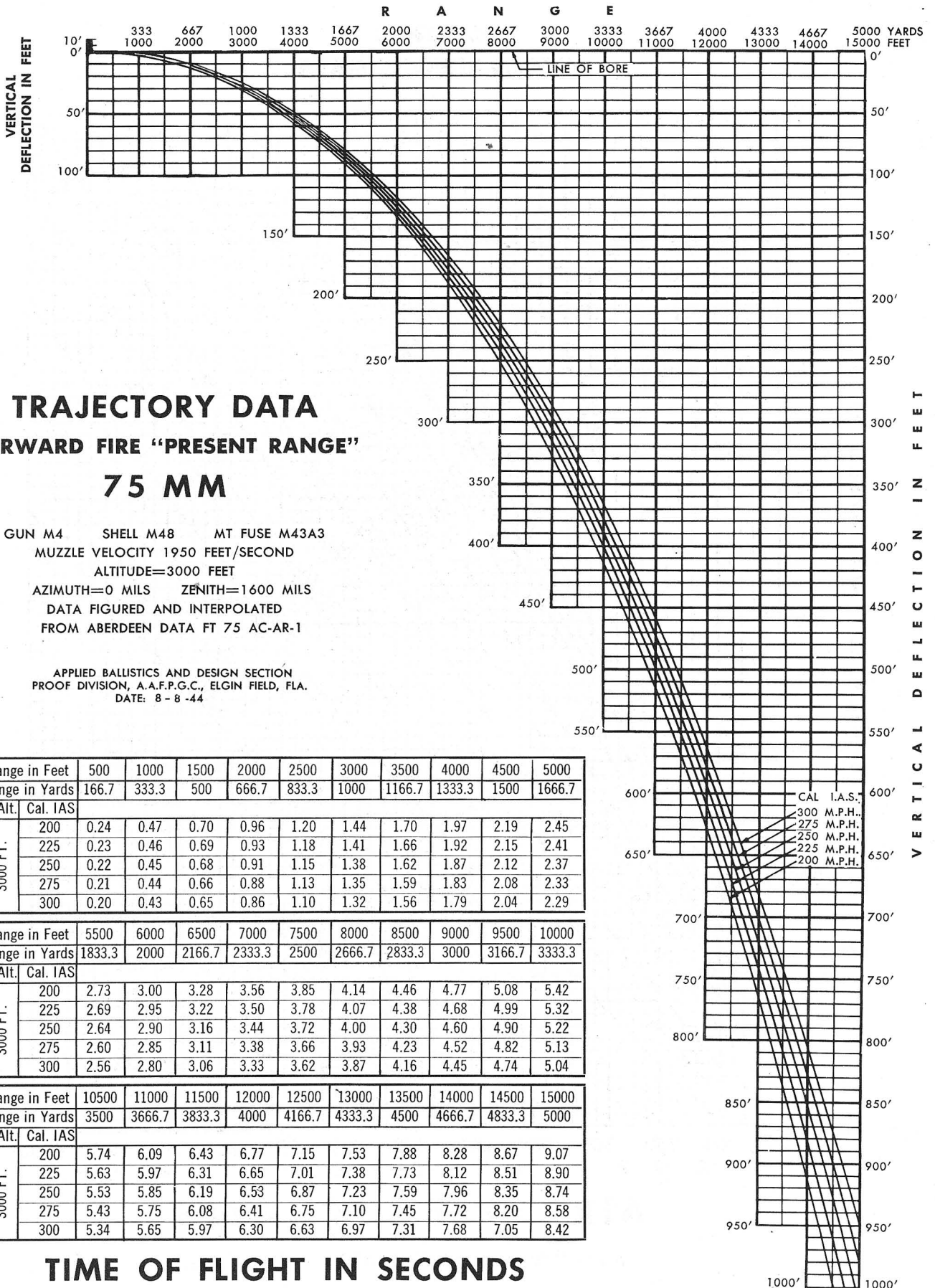

TRAJECTORY DATA
FORWARD FIRE "PRESENT RANGE"
75 MM

GUN M4 SHELL M48 MT FUSE M43A3
MUZZLE VELOCITY 1950 FEET/SECOND
ALTITUDE=3000 FEET
AZIMUTH=0 MILS ZENITH=1600 MILS
DATA FIGURED AND INTERPOLATED
FROM ABERDEEN DATA FT 75 AC-AR-1

APPLIED BALLISTICS AND DESIGN SECTION
PROOF DIVISION, A.A.F.P.G.C., ELGIN FIELD, FLA.
DATE: 8-8-44

Range in Feet	500	1000	1500	2000	2500	3000	3500	4000	4500	5000	
Range in Yards	166.7	333.3	500	666.7	833.3	1000	1166.7	1333.3	1500	1666.7	
Alt. Cal. IAS											
3000 FT.	200	0.24	0.47	0.70	0.96	1.20	1.44	1.70	1.97	2.19	2.45
	225	0.23	0.46	0.69	0.93	1.18	1.41	1.66	1.92	2.15	2.41
	250	0.22	0.45	0.68	0.91	1.15	1.38	1.62	1.87	2.12	2.37
	275	0.21	0.44	0.66	0.88	1.13	1.35	1.59	1.83	2.08	2.33
	300	0.20	0.43	0.65	0.86	1.10	1.32	1.56	1.79	2.04	2.29

Range in Feet	5500	6000	6500	7000	7500	8000	8500	9000	9500	10000	
Range in Yards	1833.3	2000	2166.7	2333.3	2500	2666.7	2833.3	3000	3166.7	3333.3	
Alt. Cal. IAS											
3000 FT.	200	2.73	3.00	3.28	3.56	3.85	4.14	4.46	4.77	5.08	5.42
	225	2.69	2.95	3.22	3.50	3.78	4.07	4.38	4.68	4.99	5.32
	250	2.64	2.90	3.16	3.44	3.72	4.00	4.30	4.60	4.90	5.22
	275	2.60	2.85	3.11	3.38	3.66	3.93	4.23	4.52	4.82	5.13
	300	2.56	2.80	3.06	3.33	3.62	3.87	4.16	4.45	4.74	5.04

Range in Feet	10500	11000	11500	12000	12500	13000	13500	14000	14500	15000	
Range in Yards	3500	3666.7	3833.3	4000	4166.7	4333.3	4500	4666.7	4833.3	5000	
Alt. Cal. IAS											
3000 FT.	200	5.74	6.09	6.43	6.77	7.15	7.53	7.88	8.28	8.67	9.07
	225	5.63	5.97	6.31	6.65	7.01	7.38	7.73	8.12	8.51	8.90
	250	5.53	5.85	6.19	6.53	6.87	7.23	7.59	7.96	8.35	8.74
	275	5.43	5.75	6.08	6.41	6.75	7.10	7.45	7.72	8.20	8.58
	300	5.34	5.65	5.97	6.30	6.63	6.97	7.31	7.68	7.95	8.42

TIME OF FLIGHT IN SECONDS

SECTION G
MISCELLANEOUS DATA

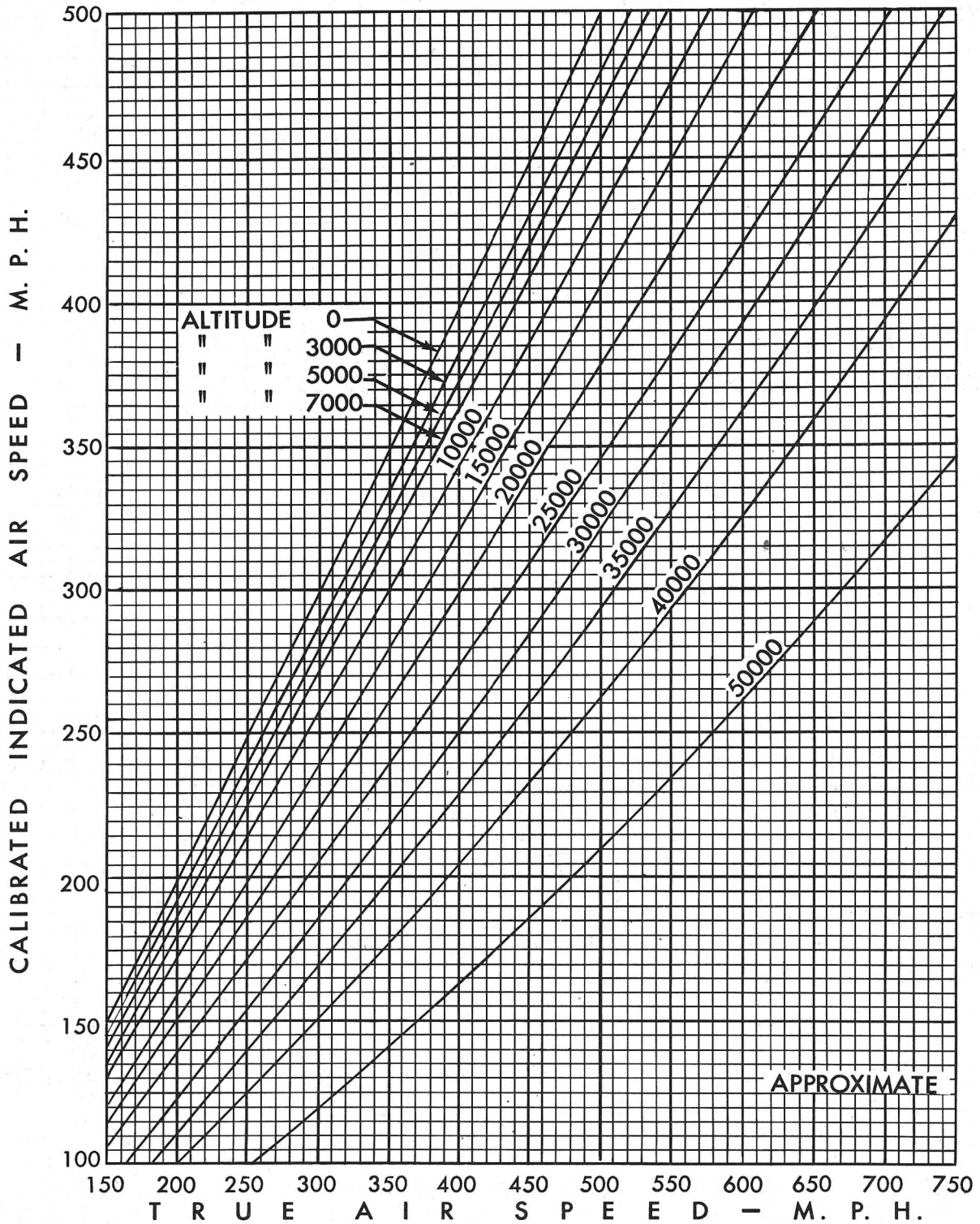

AIR SPEED CURVES
CALIBRATED INDICATED - VS - TRUE

CONVERSION CHART

Mils to Inches

MIL USED IS "MILIRADIAN"

There are 6283.1854 mils in 360 degrees.

One Mil = 0.057296 Degrees

One Mil = 3.43775 Minutes

One Mil = 206.26477 Seconds

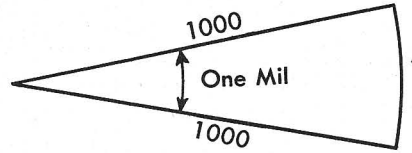

One Degree = 17.45329 Mils

One Minute = 0.290888 Mils

One Second = 0.004848 Mils

MIL ANGLE IN INCHES AT RANGE GIVEN

Mil	RANGE IN FEET									
	100	200	300	400	500	600	700	800	900	1000
1	1.2	2.4	3.6	4.8	6.0	7.2	8.4	9.6	10.8	12.0
2	2.4	4.8	7.2	9.6	12.0	14.4	16.8	19.2	21.6	24.0
3	3.6	7.2	10.8	14.4	18.0	21.6	25.2	28.8	32.4	36.0
4	4.8	9.6	14.4	19.2	24.0	28.8	33.6	38.4	43.2	48.0
5	6.0	12.0	18.0	24.0	30.0	36.0	42.0	48.0	54.0	60.0
6	7.2	14.4	21.6	28.8	36.0	43.2	50.4	57.6	64.8	72.0
7	8.4	16.8	25.2	33.6	42.0	50.4	58.8	67.2	75.6	84.0
8	9.6	19.2	28.8	38.4	48.0	57.6	67.2	76.8	86.4	96.0
9	10.8	21.6	32.4	43.2	54.0	64.8	75.6	86.4	97.2	108
10	12.0	24.0	36.0	48.0	60.0	72.0	84.0	96.0	108	120

CONVERSION CHART

Mils to Inches

MIL USED IS "ARTILLERY" MIL

There are 6400 mils in 360 degrees.

One Mil = 0.05625 Degrees

One Mil = 3.375 Minutes

One Mil = 202.50 Seconds

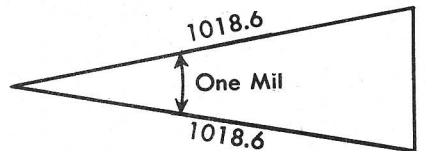

One Degree = 17.7778 Mils

One Minute = 0.29629 Mils

One Second = 0.00494 Mils

MIL ANGLE IN INCHES AT RANGE GIVEN

Mil	RANGE IN FEET									
	100	200	300	400	500	600	700	800	900	1000
1	1.2	2.4	3.5	4.7	5.9	7.1	8.3	9.4	10.6	11.8
2	2.4	4.7	7.1	9.4	11.8	14.1	16.5	18.8	21.2	23.6
3	3.5	7.1	10.6	14.1	17.7	21.2	24.7	28.2	31.8	35.3
4	4.7	9.4	14.1	18.8	23.6	28.3	33.0	37.7	42.4	47.1
5	5.9	11.8	17.7	23.6	29.5	35.3	41.2	47.1	53.0	58.9
6	7.1	14.1	21.2	28.3	35.3	42.4	49.5	56.6	63.6	70.7
7	8.3	16.5	24.7	33.0	41.3	49.5	57.7	66.0	74.2	82.5
8	9.4	18.8	28.3	37.7	47.1	56.5	65.9	75.4	84.8	94.2
9	10.6	21.2	31.8	42.4	53.0	63.6	74.2	84.8	95.4	106
10	11.8	23.6	35.3	47.1	58.9	70.7	82.5	94.2	106	118

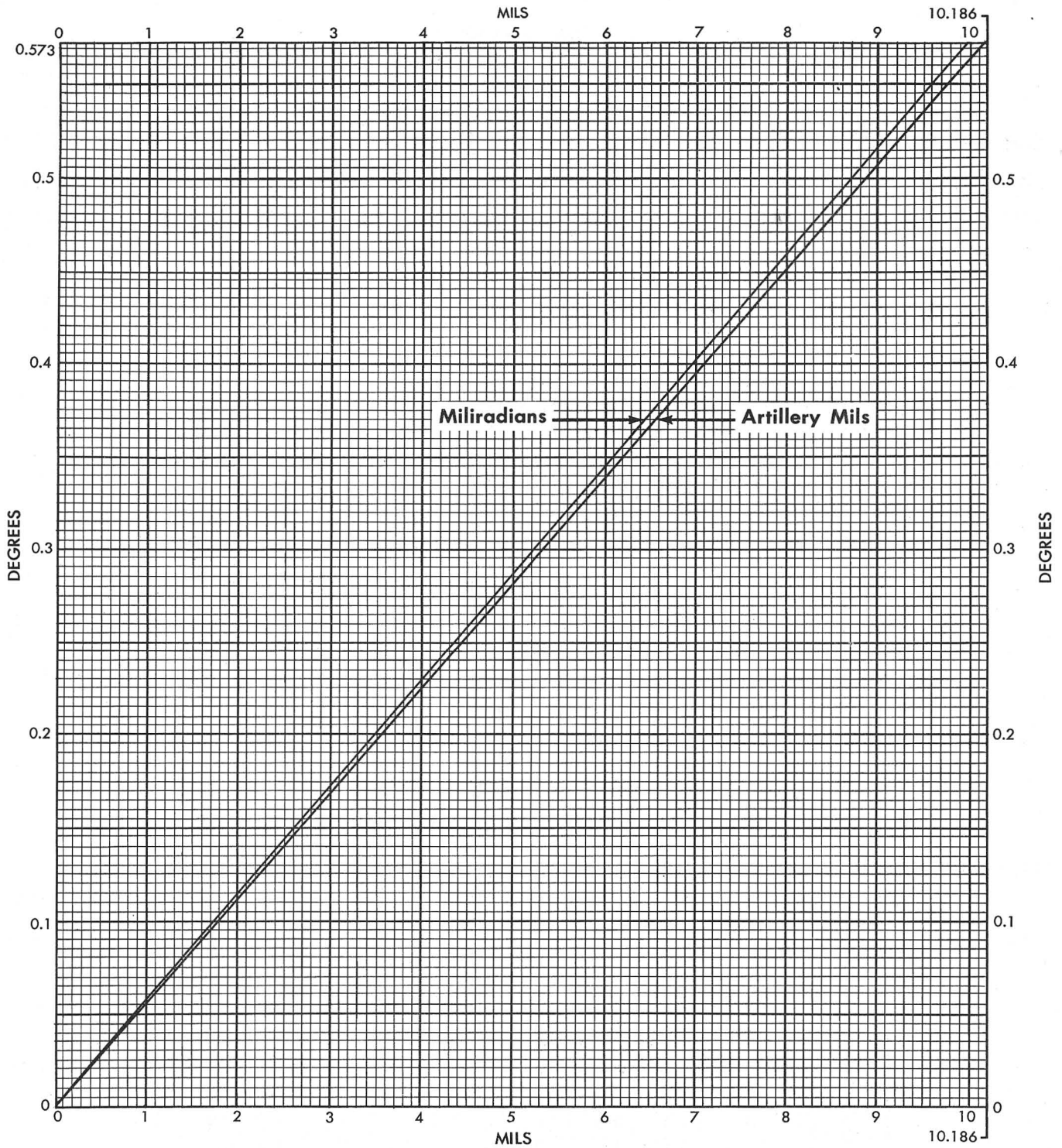

CONVERSION CHART
MILIRADIANS-ARTILLERY MILS-DEGREES

THIS CHART IS APPLICABLE IN MULTIPLES OF TEN.

APPLIED BALLISTICS AND DESIGN SECTION
PROOF DIVISION, A.A.F.P.G.C. EGLIN FIELD, FLA.
DATE: 27 NOV. 1944

Trigonometric Formulae			Find	Given	Formula	Find	Given	Formula
			Cosec A	Sides a-c	c/a	Side a	Sides bc	$\sqrt{c^2 - b^2}$
				Sin A	$\frac{1}{\sin A}$		Side c Sin A	$c \sin A$
				Sec A Cot A	$\sec A \times \cot A$		Side b Tan A	$b \tan A$
				Sec A, Tan A	$\frac{\sec A}{\tan A}$		Side b, Cot A	$\frac{b}{\cot A}$
				Cot A, Cos A	$\frac{\cot A}{\cos A}$		Side c, Cosec A	$\frac{c}{\operatorname{cosec} A}$
				Cotan A	$\sqrt{(\cot A)^2 + 1}$			
Cotangent A	Side b	Sides b, c	$\frac{c-b}{c}$	Secant A	Sides bc	c/b		
		Cosine A	$1 - \cos A$		Cos A	$\frac{1}{\cos A}$		
		Sides c, a	$\sqrt{c^2 - a^2}$		Cosec A, Tan A	$\operatorname{cosec} A - \tan A$		
		Side c, Cos A	$C - \cos A$		Tan A, Sin A	$\frac{\tan A}{\sin A}$		
		Side a, Cot A	$a \cot A$		Cosec A, Cot A	$\frac{\operatorname{cosec} A}{\cot A}$		
		Side a, Tan A	$\frac{a}{\tan A}$		Tan A	$\sqrt{(\tan A)^2 + 1}$		
Cotangent A	Side c	Side c, Sec A	$\frac{c}{\sec A}$	Tangent A	Sides ab	a/b		
		Sides a, b	$\sqrt{a^2 + b^2}$		Cotan A	$1/\cot A$		
		Side b, Sec A	$b - \sec A$		Sec A, Sin A	$\sec A \times \sin A$		
		Side a, Cosec A	$a - \operatorname{cosec} A$		Sin A, Cos A	$\frac{\sin A}{\cos A}$		
		Side a, Sin A	$\frac{a}{\sin A}$		Sec A Cosec A	$\frac{\sec A}{\operatorname{cosec} A}$		
		Side b, Cos A	$\frac{b}{\cos A}$		Secant A	$\sqrt{(\sec A)^2 - 1}$		
Cotangent A	Side c	Sides b Versed c Sin A	$\frac{c-b}{\sin A}$	Sine A	Sides ac	a/c		
		Sides a Covers c Sin A	$\frac{c-a}{\sin A}$		Cosec A	$\frac{1}{\operatorname{cosec} A}$		
		Side b, Cos A	$\frac{b}{\cos A}$		Tan A, Cos A	$\tan A \times \cos A$		
		Side b, Sec A	$b - \sec A$		Tan A, Sec A	$\frac{\tan A}{\sec A}$		
		Side a, Cosec A	$a - \operatorname{cosec} A$		Cos A, Cot A	$\frac{\cos A}{\cot A}$		
		Side a, Sin A	$\frac{a}{\sin A}$		Cosine A	$\sqrt{1 - (\cos A)^2}$		
Area	Sides a, b	$\frac{ab}{2}$	Chord	Side b Sin A	$2b \sin A/2$	Sine A	Sides ac	a/c

Find	Given	Formula	Find	Given	Formula	Find	Given	Formula
A	BC	$180^\circ - (B+C)$	Tan C	bcA	$\frac{C \sin A}{b - (C - \cos A)}$	Tan C	acB	$\frac{C \sin B}{a - (C - \cos B)}$
Tan A	abC	$\frac{a \sin c}{b - a - \cos C}$	Sin C	bcB	$\frac{C \sin B}{b}$	Cos C	abc	$\frac{a^2 + b^2 - C^2}{2ab}$
Cos A	abc	$\frac{b^2 + c^2 - a^2}{2bc}$	Tan C	acB	$\frac{C \sin B}{a - (C - \cos B)}$	c	aAC	$\frac{a \sin C}{\sin A}$
Sin A	acC	$\frac{a \sin c}{C}$	Cos C	abc	$\frac{a^2 + b^2 - C^2}{2ab}$	C	abc	$\sqrt{a^2 + b^2 - (2ab \cos C)}$
Sin A	abB	$\frac{a \sin B}{b}$	c	aAC	$\frac{a \sin C}{\sin A}$	c	bBC	$\frac{b \sin C}{\sin B}$
Tan A	acB	$\frac{a \sin B}{C - (a - \cos B)}$	a	caC	$\frac{C \sin A}{\sin C}$	Area	abC	$\frac{a - b \sin C}{2}$
B	AC	$180^\circ - (A+C)$	a	baB	$\frac{b \sin A}{\sin B}$	s = a + b + c	abc	$\sqrt{s(s-a)(s-b)(s-c)}$
Sin B	abA	$\frac{b \sin A}{a}$	a	bcA	$\sqrt{b^2 + c^2 - (2bc \cos A)}$	Cosine of Bearing × Distance = Latitude Sine of Bearing × Distance = Departure		
Cos B	abc	$\frac{c^2 + a^2 - b^2}{2ac}$	Sin C	acA	$\frac{C \sin A}{a}$			

Acceleration	
$V = V_0 + at$	V = Velocity
$S = V_0t + \frac{1}{2}at^2$	V_0 = Initial Vel.
$V^2 = V_0^2 + 2as$	S = Distance
$S = (V_0 + V)t/2$	a = 32.2
	t = Time

Miscellaneous
9/5 C + 32 = fahrenheit (f)
(f - 32) × 5/9 = Centigrade (C)
1° = 17.78 mils
Deflection of 1° at 100' = 1.75'
Earth Curvature & Refraction = .574 × (Dist. in miles)²

Weights	
1 gal gasoline	6 lb
1 gal water (fresh)	8.3 lb
1 qt oil	1.87 lb
1 gal Eth. glycol	9.34 lb

1.466 × MPH = Ft/sec. Temp. Decrease w/alt. = - 1° for each rise of 330' in altitude.

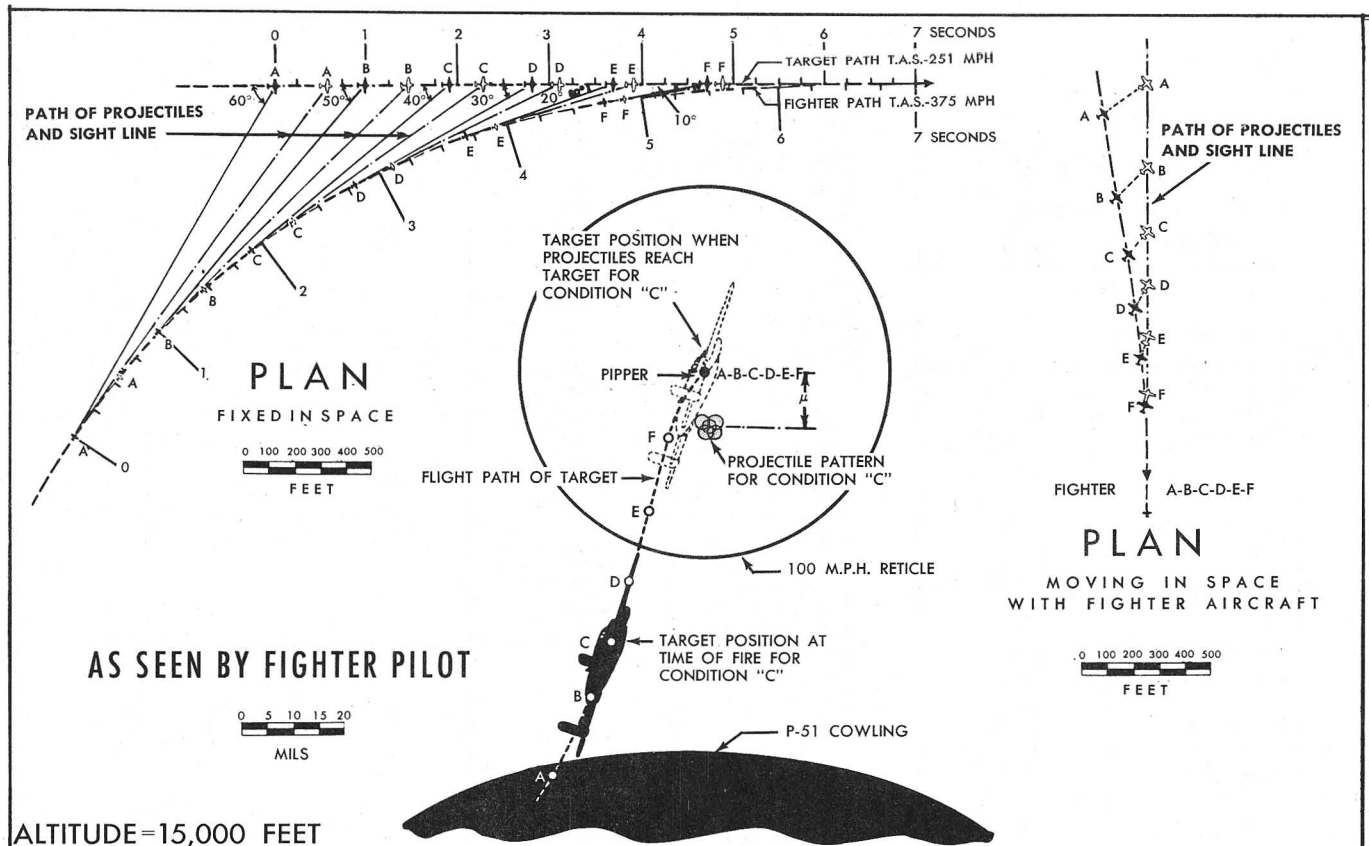

a	b		c		d		e		f		g		h		i		Fighter		Target		j		k		l		m		n		
	Deg.	Deg.	Feet	Feet	Feet	Feet	Sec.	Mils	IAS	TAS	IAS	TAS	Feet	"g"	Deg.	Mils	Deg.														
A	60	54.00	1642	1758	215	319	.583	116.9	300	373	200	251	3227	3.05	70.85	13.8	9.71														
B	50	44.90	1298	1409	172	255	.466	93.0	300	373	200	251	2969	3.29	72.28	15.5	10.56														
C	40	35.80	1053	1148	139	207	.378	77.4	300	373	200	251	2914	3.35	72.60	15.8	10.76														
D	30	26.80	834	925	111	165	.302	60.1	300	373	200	251	3047	3.21	71.85	14.9	10.29														
E	20	17.80	635	710	84	125	.228	40.4	300	373	200	251	3455	2.87	69.61	12.6	9.07														
F	10	8.85	421	475	55	82	.150	20.2	300	373	200	251	4579	2.26	63.77	8.5	6.85														
1	30	24.66	600	719	125	125	.229	87.2	300	373	300	373	1724	5.48	79.48	30.2	18.17														
2	20	16.75	600	721	128	128	.233	61.5	300	373	300	373	2505	3.85	74.92	19.2	12.51														
3	10	8.25	600	726	129	129	.235	30.7	300	373	300	373	5024	2.10	61.62	7.4	6.21														
4	0	0	600	729	129	129	.236	0	300	373	300	373	0	1	0	0	0														
5	30	26.60	600	670	79	118	.215	59.0	300	373	200	251	2224	4.30	76.55	22.3	14.10														
6	20	17.70	600	675	80	119	.217	40.4	300	373	200	251	3296	2.99	70.47	13.4	9.51														
7	10	8.83	600	678	80	119	.218	20.9	300	373	200	251	6545	1.74	54.87	5.0	4.79														
8	0	0	600	680	80	119	.218	0	300	373	200	251	0	1	0	0	0														
9	45	37.77	900	1039	187	187	.341	127.3	300	373	300	373	1696	5.57	79.67	30.8	18.48														
10	30	24.87	900	1070	193	193	.352	89.1	300	373	300	373	2546	3.78	74.68	18.7	12.31														
11	20	15.50	900	1068	195	195	.357	58.1	300	373	300	373	4059	2.50	66.40	10.2	7.72														
12	10	8.28	900	1090	196	196	.358	31.2	300	373	300	373	5958	1.58	57.33	4.0	4.11														
13	0	0	900	1096	196	196	.359	0	300	373	300	373	0	1	0	0	0														
14	45	40.20	900	986	119	177	.323	85.3	300	373	200	251	2272	4.21	76.27	21.6	13.79														
15	30	26.56	900	1007	121	180	.329	60.5	300	373	200	251	3343	2.95	70.22	13.1	9.34														
16	20	17.63	900	1016	122	182	.332	41.3	300	373	200	251	4997	2.11	61.73	7.5	6.27														
17	10	8.82	900	1019	123	182	.333	21.2	300	373	200	251	9888	1.37	43.78	2.5	1.00														
18	0	0	900	1022	123	183	.334	0	300	373	200	251	0	1	0	0	0														
19	60	50.85	1200	1340	246	246	.449	159.4	300	373	300	373	1728	5.47	79.47	30.1	18.14														
20	45	37.62	1200	1390	252	252	.461	129.3	300	373	300	373	2278	4.20	75.97	21.6	13.73														
21	30	24.80	1200	1431	260	260	.475	91.0	300	373	300	373	3417	2.90	69.82	12.7	9.17														
22	15	12.31	1200	1457	265	265	.484	47.1	300	373	300	373	6835	1.69	53.67	4.6	4.59														
23	0	0	1200	1466	266	266	.486	0	300	373	300	373	0	1	0	0	0														
24	60	53.85	1200	1287	157	233	.425	104.6	300	373	200	251	2371	4.05	75.68	20.6	13.22														
25	45	40.00	1200	1320	161	239	.436	86.1	300	373	200	251	3047	3.21	71.85	15.0	10.29														
26	30	26.53	1200	1345	164	244	.446	61.2	300	373	200	251	4469	2.31	64.32	8.8	7.01														
27	15	13.17	1200	1363	166	146	.450	31.5	300	373	200	251	8853	1.45	46.38	3.0	3.54														
28	0	0	1200	1366	166	247	.451	0	300	373	200	251	0	1	0	0	0														
29																															
30																															

- a = Condition.
- b = Angle in degrees the Target is off from the Fighter.
- c = Angle in degrees the Aim Point is off from Fighter at time of fire.
- d = Feet distance between Target and Fighter at time of fire.
- e = Feet distance between Aim Point and Fighter at time of fire.
- f = Feet distance Target travels between time of fire and time when projectile hits Target.
- g = Feet distance Fighter travels between time of fire and time when projectile hits Target.
- h = Projectile time of flight in Seconds.
- i = Mils lead required.
- j = Radius of Pursuit Curve in feet.
- k = Resultant or "Seat of Pants" g.
- l = Angle in degrees-between the Fighter's wingtips and horizontal.
- m = Mil angle the projectile Patterns shifts.
- μ = See Page 5A, Section H, "Miscellaneous Data on Aircraft Harmonization and Ballistics," compiled by Applied Ballistics and Design Section.
- n = Rate of turn expressed in degrees per Second. Divide by three to get "needle width."

PURSUIT CURVES

THIS CHART IS APPLICABLE IN A HORIZONTAL PLANE ONLY

APPLIED BALLISTICS AND DESIGN SECTION
PROOF DIVISION, A.A.F.P.G.C., EGLIN FIELD, FLA.
DATE 11-24-44

"g" = RESULTANT ACCELERATION

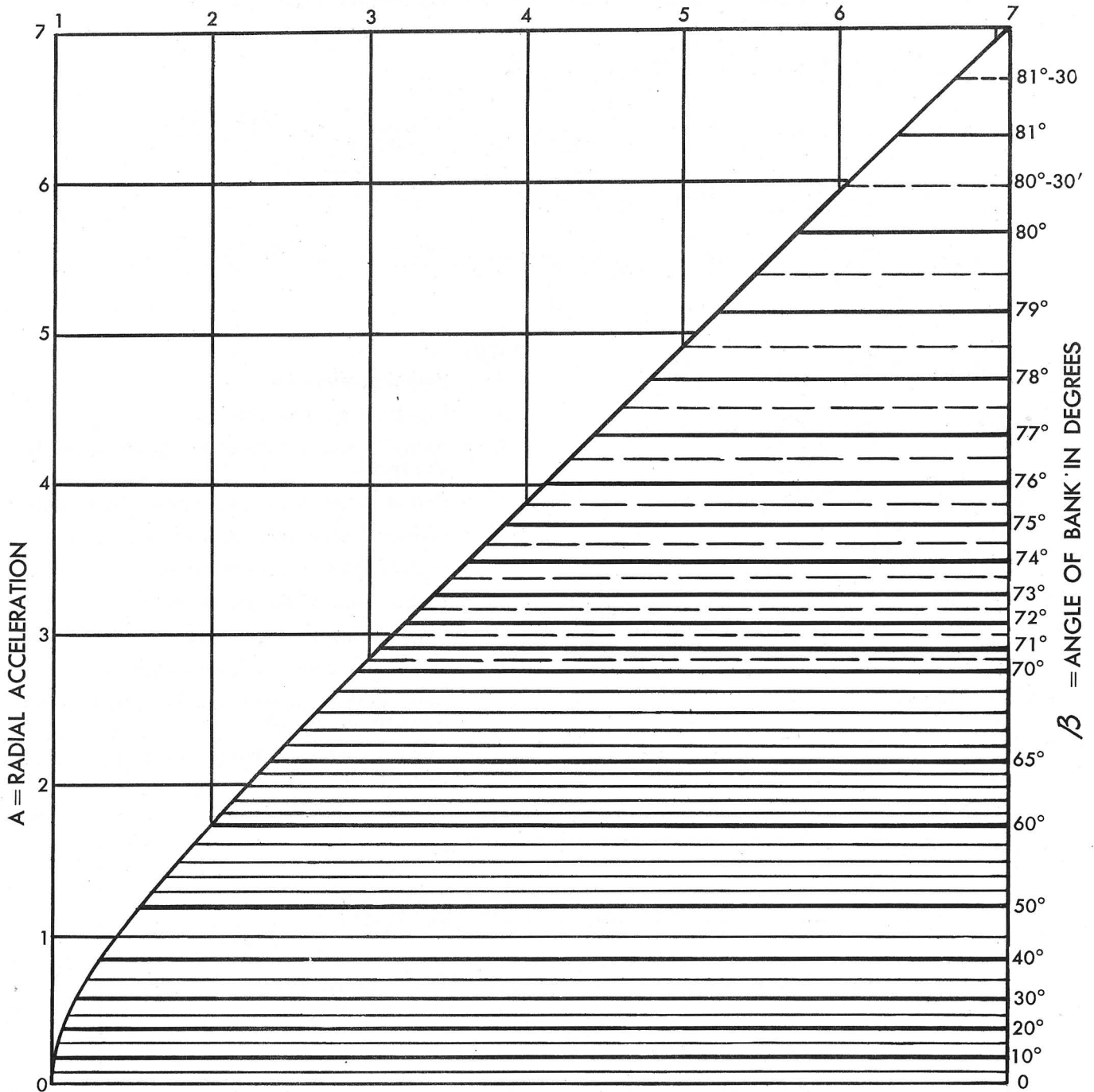

THIS CHART APPLIES TO ACTION IN A HORIZONTAL PLANE ONLY.

APPROXIMATE

APPLIED BALLISTICS AND DESIGN SECTION
PROOF DIV., A.A.F.P.G.C. EGLIN FIELD, FLA.
DATE: 17 NOV '44

**FORMULAE FOR COMPUTING THE FORCES ON AN AIRCRAFT
WHEN IN A PURSUIT CURVE IN HORIZONTAL FLIGHT**

$$A = \frac{(V_f)(V_t)(\sin \phi)}{(32.2)(R)}; A = \sqrt{g^2 - 1}; A = \frac{V_f^2}{(32.2)(r)}$$

$$A = (V_f)(W_n)(.001626); W_n = \frac{A}{(V_f)(.001626)}; W = \frac{(3)(A)}{(V_f)(.001626)} = \frac{(1845.02)(A)}{(V_f)}$$

$$W_n = \frac{\sqrt{g^2 - 1}}{(V_f)(.001626)}; W = \frac{(3)(\sqrt{g^2 - 1})}{(V_f)(.001626)} = \frac{(1845.02)(\sqrt{g^2 - 1})}{(V_f)}$$

$$A = (.000795)(W)(V_{fm}); W = \frac{A}{(.000795)(V_{fm})} = \frac{\sqrt{g^2 - 1}}{(.000795)(V_{fm})} = \frac{(1257.9)(\sqrt{g^2 - 1})}{V_{fm}}$$

$$W_n = (3)(W); W = \frac{W_n}{3}$$

$$g = \sqrt{A^2 + 1}; g = \sqrt{\left(\frac{(V_f)^2}{(32.2)(r)}\right)^2 + 1}$$

$$r = \frac{(V_f)^2}{(32.2)(\sqrt{g^2 - 1})}; r = \frac{(V_f)^2}{(32.2)(A)}$$

$$\text{Tangent } \beta = \frac{(V_f)^2}{(32.2)(r)}$$

THESE FORMULAE ARE APPLICABLE FOR FLIGHT IN A HORIZONTAL PLANE ONLY

APP. Ballistics & Design Sect.
Proof Div. A.A.F.P.G.C.
Eglin Field, Fla.

WHEN

A = Radial acceleration

g = Resultant acceleration

R = Range in feet at time of fire, from fighter to aim point

r = Radius in feet of pursuit curve at time of fire

V_f = Fighter TAS in feet per second

V_{fm} = Fighter TAS in miles per hour

V_t = Target TAS in feet per second

W = Degrees turn in one second

W_n = One needle width = 3° per second

β = Angle in degrees, between the fighter's wing tips and horizontal

φ = Angle in degrees, fighter to aim point to target

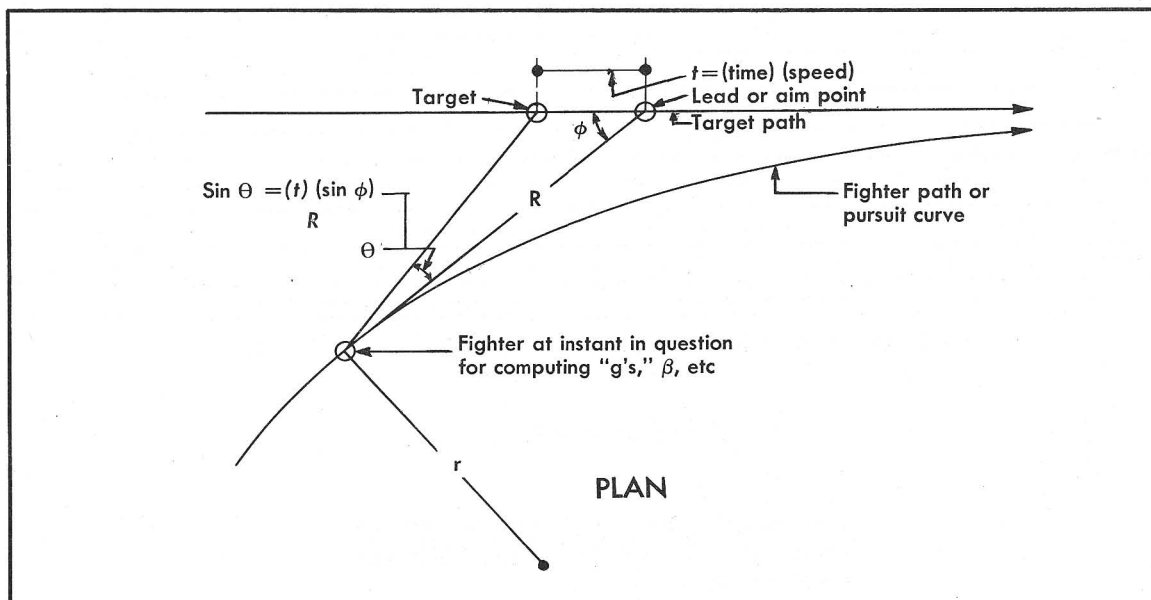

SECTION H FIGHTER HARMONIZATION CHARTS

SIDE VIEW OF
TRAJECTORIES



PLAN VIEW OF
TRAJECTORIES

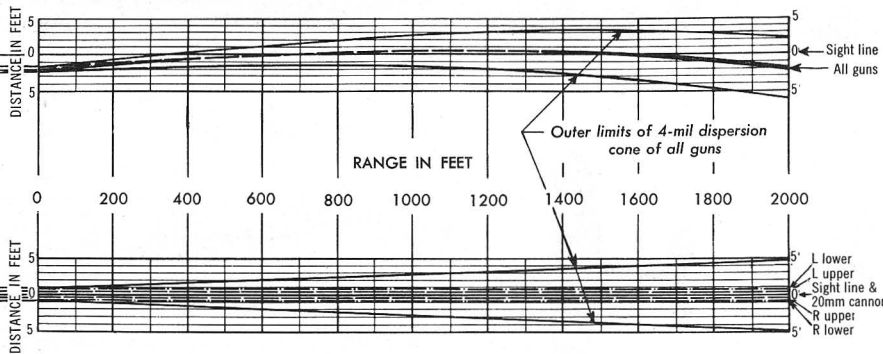
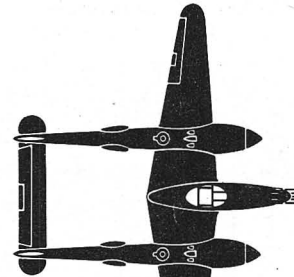

DISPERSION
PATTERNS

Based on 4-mil
dispersion cone

SIGHT PIP

CAMERA
OR CENTER OF
PICTURE FRAME

NOTE

Dotted circles are
bullet patterns of
1000-ft range when
firing is done at
various "gs" shown

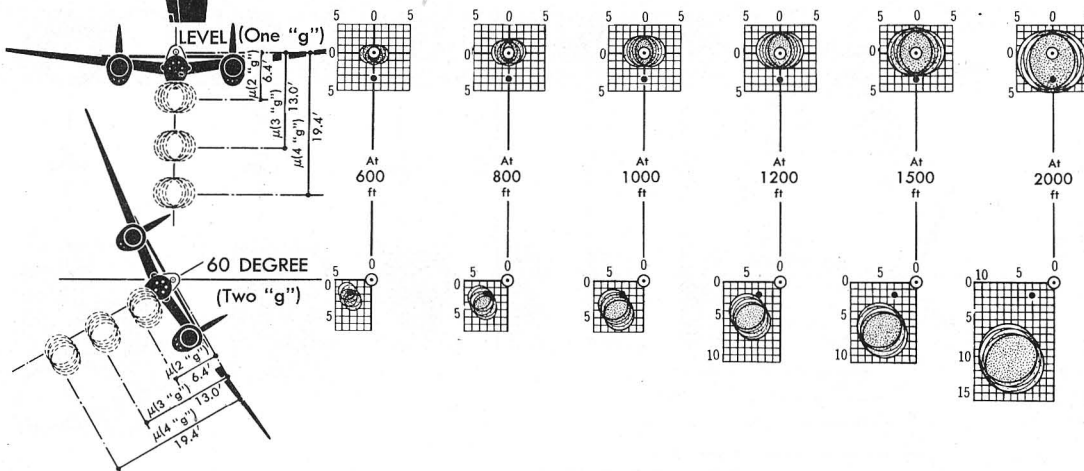

1000-IN. BORESIGHT TARGET

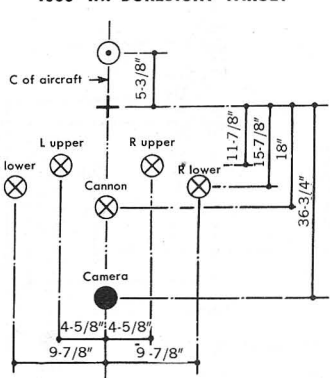

Gun Location at Aircraft

Vert* Horiz†
50 cal L&R upr guns 21.94° 4.53°
50 cal L&R lwr guns 26.44 9.94
20mm cannon 28.95 0
Camera 42.16 0
*From sight. †From plane center line.

Targets shown are for harmonization
under the following conditions (basic
harmonization):

Cal IAS: 300 mph Alt: 15,000 ft
TAS: ±373 mph Wt: 14,700±250 lb
Angle of attack (α): 4 mils nose down
Level flight: (1 "g")

- ⊕ Mark where line from sight is parallel to fuselage leveling lugs.
- ⊙ Mark where sight pip is aimed for harmonization with bullet patterns (sight setting for harmonization).
- ⊗ Mark where bore is aimed for 1000-in. and 500-ft. targets.
- Mark for center of impact of 10 rounds at 500-ft. target.
- Mark where camera is aimed making camera parallel to sight line. This point represents the center of the picture frame.

Applied Ballistics & Design Sec., Proof Div., A.A.F.P.G.C., Eglin Field, Fla. Date: 8-8-44.

TRAJECTORY DATA
Forward Fire

Gun: 20mm Cal. 50
Am: HE T23 PD, fuse T71E4 AMP-2
Muz vel, ft/sec: 2750 2700
Authority: Aberdeen data FT. 20 AC-1-1; FT. 50 AC-M-1, and 1st ind. to letter from Ord. Desig. Eglin Field, Fla., April 15, 1944, to Chief of Ordnance, Washington, D.C.

BASIC HARMONIZATION
300 mph Cal IAS

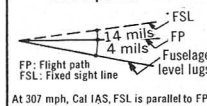

At 307 mph, Cal IAS, FSL is parallel to FP

500-FT. FIRE-IN AND BORESIGHT TARGET

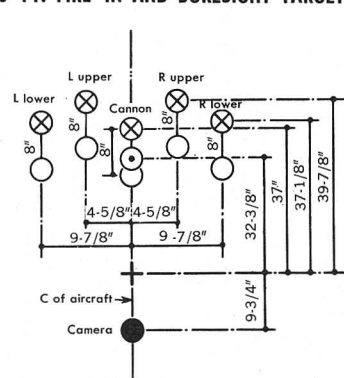

Flight Angle: LEVEL FLIGHT						
Alt.	Cal IAS	TAS	Mil Angle "μ"			
			1 "g"	2 "g"	3 "g"	4 "g"
0'	250	250	+1.7	+8.3	+15.0	+21.6
	300	300	-0.2	+5.1	+10.6	+15.9
	350	350	-1.5	+2.8	+7.3	+11.5
	400	400	-2.8	+1.0	+4.9	+8.6
	450	450	-3.9	-0.6	+2.7	+5.1
7000'	200	222	+4.8	+14.1	+23.3	—
	250	276	+2.0	+9.1	+16.4	+23.6
	300	331	-0.1	+5.7	+11.6	+17.4
	350	386	-1.5	+3.2	+8.0	+12.5
	400	440	-2.9	+1.1	+5.4	+9.4
15000'	200	251	+5.5	+15.8	+26.1	—
	250	313	+2.3	+10.3	+18.5	+26.5
	300	373	0	+6.4	+13.0	+19.4
	350	434	-1.6	+3.6	+8.9	+13.9
	400	493	-3.1	+1.4	+6.0	+10.4
30000'	150	242	+13.0	—	—	—
	200	320	+7.0	+19.7	+32.5	—
	250	398	+3.1	+12.9	+22.8	+32.6
	300	471	+0.2	+8.0	+15.9	+23.8
	350	543	-1.6	+4.5	+10.9	+16.8

Flight Angle: LEVEL FLIGHT				
Cal IAS	αp (Wt.=14700 Lbs.)			
	1 "g"	2 "g"	3 "g"	4 "g"
150	+111	—	—	—
200	+44	+130	+216	—
250	+13	+68	+124	+179
300	-4	+34	+73	+111
350	-13	+14	+42	+68
400	-20	+1	+23	+44
450	-25	-8	+9	+26

Flight Angle: 30° DIVE OR CLIMB				
Cal IAS	αp (Wt.=14700 Lbs.)			
	1 "g"	2 "g"	3 "g"	4 "g"
150	+90	+223	—	—
200	+32	+107	+181	—
250	+7	+57	+108	+155
300	-9	+24	+57	+90
350	-18	+7	+31	+55
400	-24	-5	+14	+32
450	-27	-13	+2	+17

αp=Mil angle between the fuselage leveling lugs and the flight path. This data is derived from the best available angle of attack charts, but is not guaranteed. The boresight targets and μ angles are based on this angle of the attack chart.
μ=Mil angle between the sight line and the projectiles at any range out to 20000 feet. When the mil angle is minus the projectiles are above the sight line; when plus they are below. This mil angle acts along the vertical axis of the sight. The mil angle μ is only applicable when the aircraft is harmonized as shown in the above boresight and fire-in targets.

Harmonization Chart: P-38J Airplane

Flight Angle: 30° DIVE OR CLIMB						
Alt.	Cal IAS	TAS	Mil Angle "μ"			
			1 "g"	2 "g"	3 "g"	4 "g"
7000'	250	250	+1.0	+7.0	+13.1	+18.7
	300	300	-0.9	+3.7	+8.4	+13.0
	350	350	-2.3	+1.7	+5.5	+9.4
	400	400	-3.5	-0.1	+3.3	+6.5
	450	450	-4.5	-1.6	+2.0	+4.3
15000'	200	222	+3.5	+11.6	+19.5	—
	250	276	+1.2	+7.7	+14.4	+20.5
	300	331	-0.9	+4.2	+9.2	+14.2
	350	386	-2.4	+2.0	+6.1	+10.3
	400	440	-3.7	0	+3.6	+7.1
30000'	150	242	+10.6	+26.0	—	—
	200	320	+5.2	+16.3	-27.3	+23.0
	250	398	+2.0	+10.9	+20.0	+28.3
	300	471	-0.8	+5.9	+12.7	+19.4
	350	543	-2.8	+2.9	+8.4	+13.8

SIDE VIEW OF TRAJECTORIES

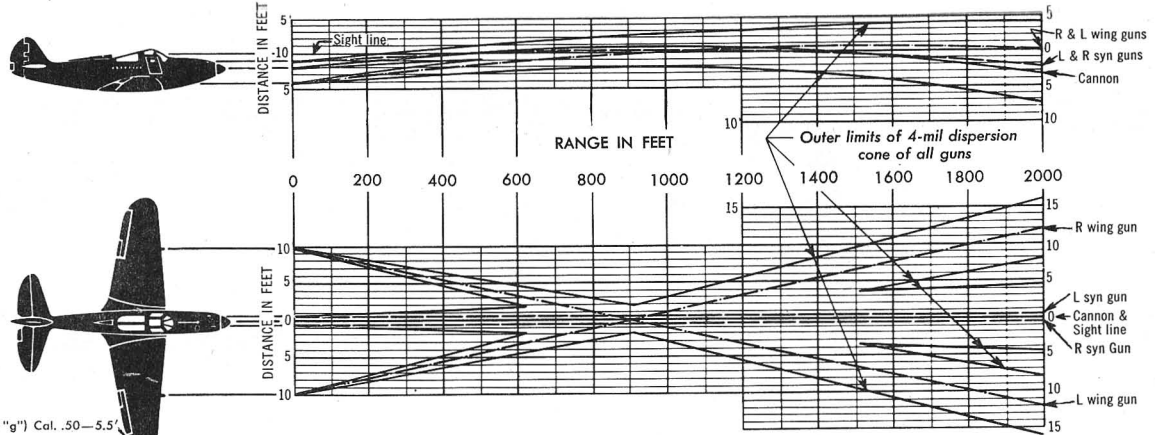

PLAN VIEW OF TRAJECTORIES

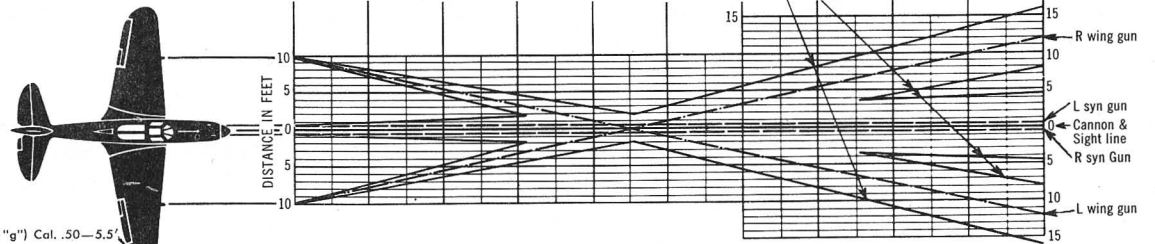

DISPERSION PATTERNS

Based on 4-mil dispersion cone

○ SIGHT PIP
● CAMERA OR CENTER OF PICTURE FRAME

NOTE
Dotted circles are bullet patterns of 1000-ft range when firing is done at various "gs" shown

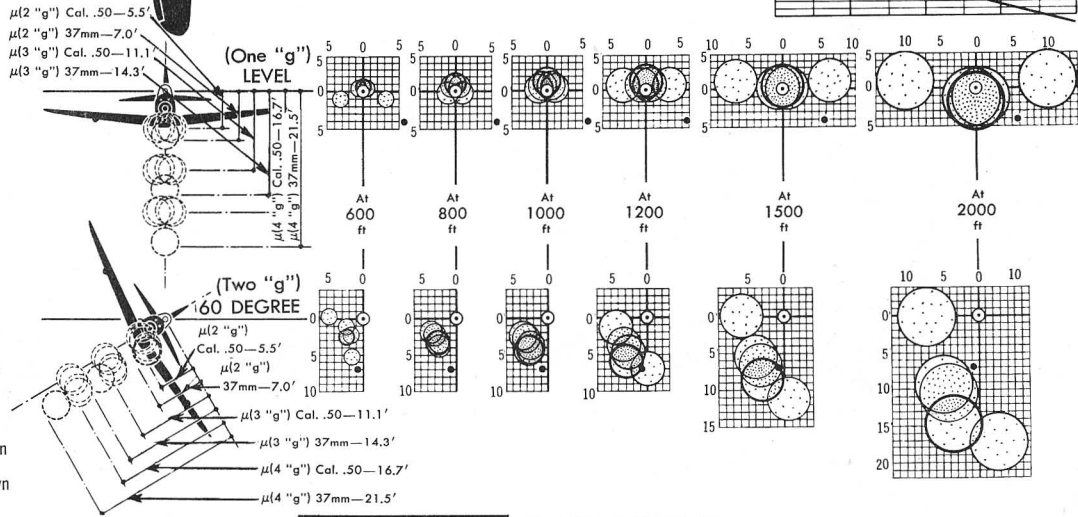

1000-IN. BORESIGHT TARGET

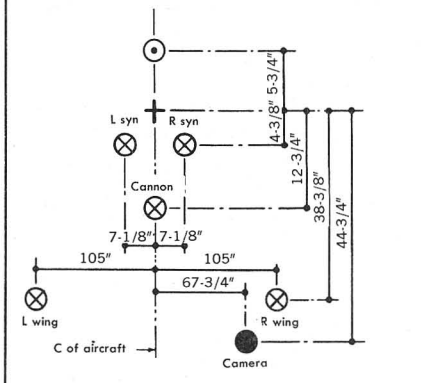

Gun Location at Aircraft

Vert*	Horiz†
L&R wing guns 50.705"	117.939"
L&R syn guns 12.906"	7.215"
Cannon 24.781"	0"
Camera 50.5"	67.8"

*From sight. †From plane center line.

- ⊕ Mark where line from sight is parallel to fuselage leveling lugs.
- ⊙ Mark where sight pip is aimed for harmonization with bullet patterns (sight setting for harmonization).
- ⊗ Mark where bore is aimed for 1000-in. and 500-ft. targets.
- Mark for center of impact of 10 rounds at 500-ft target.
- Mark where camera is aimed making camera parallel to sight line. This point represents the center of the picture frame.

TRAJECTORY DATA
Forward Fire

Gun: 37mm M4 Cal. 50
Am: HE M54, fuse M56 APM-2
Muz vel, ft./sec: 2000 2700
Authority: Aberdeen data FT. 37 AC.
AO-1; Ft. 50 AC-M-1; and 1st ind. to letter from Ord. Dept. Eglin Field, Fla., April 15, 1944, to Chief of Ordnance, Washington, D.C.

Targets shown are for harmonization under the following conditions (basic harmonization):
Cal IAS: 300 mph Alt: 7,000 ft
TAS: ±331 mph Wt: 7,500±200 lb
Angle of attack (exp): 12 mils nose down
Level flight: (1 "g")

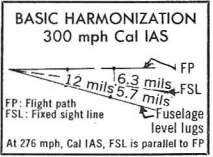

500-FT. FIRE-IN AND BORESIGHT TARGET

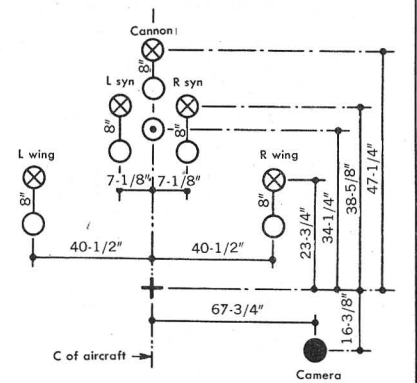

Flight Angle: LEVEL FLIGHT

Alt.	Cal IAS	Mil Angle				"μ" 37 MM				
		1 "g"	2 "g"	3 "g"	4 "g"	1 "g"	2 "g"	3 "g"	4 "g"	
0'	250	+1.9	+8.3	+14.5	+20.8	+2.5	+10.7	+18.	+27.0	
	300	0	+5.0	+10.2	+15.4	0	+6.5	+13.2	+19.8	
	350	-1.5	+2.7	+7.0	+11.3	-1.8	+3.5	+9.0	+14.5	
	400	-2.9	+0.8	+4.4	+7.8	-3.6	+1.1	+5.7	+10.0	
	450	-4.0	-0.9	+2.5	+5.6	-5.0	-1.0	+3.2	+7.2	
700'	200	+2.2	+13.8	+22.7	+29.5	+6.4	+17.9	+29.5	—	
	250	+27.2	+9.0	+15.8	+22.7	+2.7	+11.6	+20.4	+29.3	
	300	331	0	+5.5	+11.1	+16.7	0	+7.0	+14.3	+21.5
	350	386	-1.6	+2.9	+7.6	+12.2	-2.0	+3.7	+9.7	+15.7
	400	440	-3.2	+0.9	+4.7	+8.4	-3.9	+1.2	+6.1	+10.7
1500'	150	189	+10.2	+23.9	—	+13.3	+31.2	—	—	
	200	251	+5.5	+15.4	+25.3	+7.1	+19.9	+32.8	—	
	250	313	+2.3	+10.0	+17.6	+3.0	+12.9	+22.6	+32.5	
	300	373	-0.1	+6.0	+12.2	+18.5	0	+7.7	+15.7	+23.6
	350	434	-1.8	+3.2	+8.3	+13.5	-2.2	+4.1	+10.6	+17.1
2000'	150	242	+12.7	+29.8	—	+16.4	+38.6	—	—	
	200	320	+6.8	+18.9	+31.2	+8.7	+24.3	+40.1	—	
	250	398	+2.8	+12.2	+21.4	+30.9	+3.6	+15.6	+27.3	+39.3
	300	471	-0.1	+7.2	+14.8	+22.3	0	+9.2	+18.7	+28.2
	350	543	-2.2	+3.7	+9.9	+16.0	-2.6	+4.8	+12.5	+20.2

Flight Angle: LEVEL FLIGHT

Cal IAS	exp (Wt.=7500 Lbs.)			
	1 "g"	2 "g"	3 "g"	4 "g"
150	+97	+244	—	—
200	+34	+116	+199	—
250	+4	+57	+109	+162
300	-12	+24	+61	+98
350	+21	+5	+32	+59
400	-28	-7	+13	+32
450	-32	-16	+1	+17

Flight Angle: 30° DIVE OR CLIMB

Cal IAS	exp (Wt.=7500 Lbs.)			
	1 "g"	2 "g"	3 "g"	4 "g"
150	+78	+205	—	—
200	+23	+94	+165	+237
250	-3	+43	+89	+134
300	-17	+15	+46	+77
350	-26	-2	+21	+44
400	-31	-13	+5	+23
450	-35	-21	-6	+8

α_p = Mil angle between the fuselage leveling lugs and the flight path. This data is derived from the best available angle of attack charts, but is not guaranteed. The boresight targets and μ angles are based on this angle of the attack chart.
 μ = Mil angle between the sight line and the projectiles at any range out to 2000 feet. When the mil angle is minus the projectiles are above the sight line; when plus they are below. This mil angle acts along the vertical axis of the sight. The mil angle μ is only applicable when the aircraft is harmonized as shown in the above boresight and fire-in targets.

Harmonization Chart: P-39Q Airplane

Flight Angle: 30° DIVE OR CLIMB

Alt.	Cal IAS	Mil Angle "μ" 37 MM				
		1 "g"	2 "g"	3 "g"	4 "g"	
0'	250	+1.1	+6.6	+12.1	+17.5	
	300	0	+3.8	+8.1	+12.5	
	350	-1.5	+1.6	+5.2	+8.9	
	400	-2.9	+0.2	+3.0	+6.2	
	450	-4.0	-0.9	+1.1	+3.8	
700'	200	+3.8	+11.4	+19.1	+26.8	
	250	276	+1.2	+7.2	+13.2	+19.0
	300	331	-0.8	+4.1	+8.7	+13.5
	350	386	-2.5	+1.7	+5.7	+9.6
	400	440	-3.8	-0.3	+3.2	+6.7
1500'	150	189	+8.4	+20.3	—	+11.0
	200	251	+4.2	+12.7	+21.3	+29.9
	250	313	+1.3	+8.0	+14.7	+21.2
	300	373	-0.9	+4.5	+9.7	+14.9
	350	434	-2.8	+1.8	+6.2	+10.6
2000'	150	242	+10.5	+25.2	—	+13.6
	200	320	+5.2	+15.7	+26.2	+36.9
	250	398	+1.5	+9.7	+17.9	+25.9
	300	471	-1.1	+5.4	+11.7	+18.0
	350	543	-3.3	+2.1	+7.4	+12.6

SIDE VIEW OF TRAJECTORIES

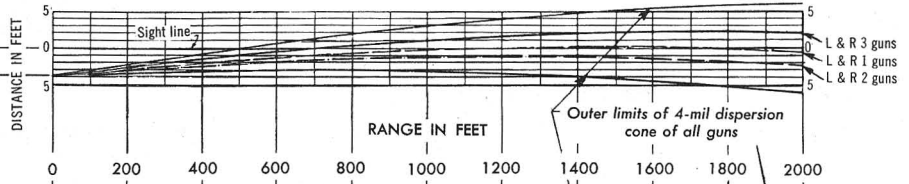

PLAN VIEW OF TRAJECTORIES

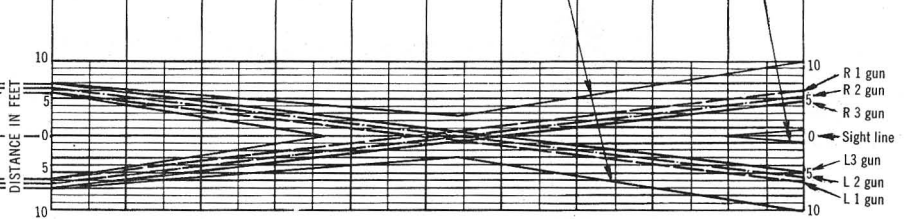

DISPERSION PATTERNS

Based on 4-mil dispersion cone

- SIGHT PIP
- CAMERA OR CENTER OF PICTURE FRAME

NOTE

Dotted circles are bullet patterns of 1000-ft range when firing is done at various "gs" shown

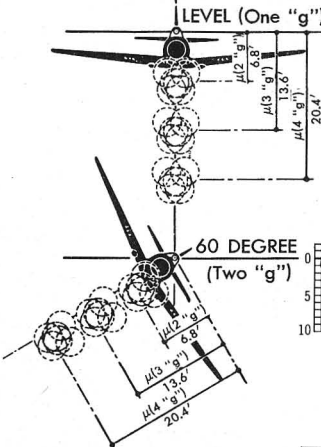

1000-IN. BORESIGHT TARGET

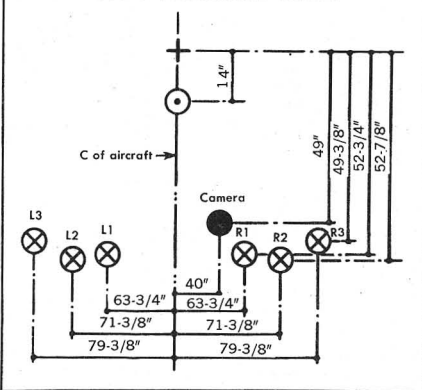

Gun Location at Aircraft

Cal	0.50	Vert*	Horiz†
L&R No. 1 guns	45.43"	69.58"	69.58"
L&R No. 2 guns	44.39	77.18	77.18
L&R No. 3 guns	43.39	85.16	85.16
Camera	35.0	40.0	40.0

*From sight. †From plane center line.

Targets shown are for harmonization under the following conditions (basic harmonization):
Cal IAS: 250 mph Alt: 7,000 ft
TAS: ±276 mph Wt: 8,500±200 lb
Angle of attack (α): 15 mils nose up
Level flight: (1 "g")

- ⊕ Mark where line from sight is parallel to fuselage leveling lugs.
- ⊙ Mark where sight pip is aimed for harmonization with bullet patterns (sight setting for harmonization).
- ⊗ Mark where bore is aimed for 1000-in. and 500-ft. targets.
- ⊙ Mark for center of impact of 10 rounds at 500-ft. target.
- Mark where camera is aimed making camera parallel to sight line. This point represents the center of the picture frame.

Applied Ballistics & Design Sec., Proof Div., A.A.F.P.G.C., Eglin Field, Fla. Date: 8-8-44.

TRAJECTORY DATA
Forward Fire

Gun: Cal. 50
Ammunition: APM-2
Muz vel, ft/sec: 2700
Authority: Aberdeen data FT. 50 AC-M-1; and 1st ind. to letter from Ord. Dept., Eglin Field, Fla., April 15, 1944, to Chief of Ordnance, Washington, D. C.

BASIC HARMONIZATION
250 mph Cal IAS

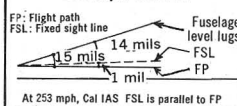

500-FT. FIRE-IN AND BORESIGHT TARGET

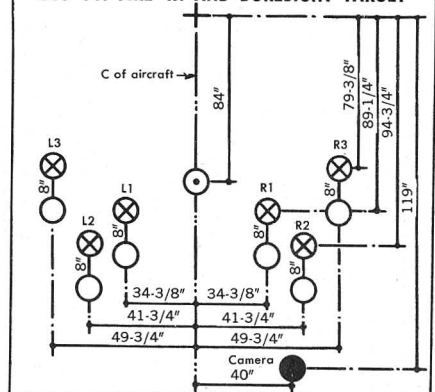

Flight Angle: LEVEL FLIGHT						
Alt.	Cal IAS	TAS	Mil Angle "μ"			
			1 "g"	2 "g"	3 "g"	4 "g"
0'	200	200	+2.6	+10.5	+18.5	—
	250	250	-0.1	+6.1	+12.4	+18.6
	300	300	-2.0	+3.0	+8.1	+13.1
	350	350	-3.6	+0.4	+4.4	+8.4
	400	400	-5.0	-1.4	+2.2	+5.6
7000'	200	222	+3.0	+11.7	+20.4	—
	250	276	0	+6.8	+13.6	+20.4
	300	331	-2.1	+3.4	+8.9	+14.4
	350	386	-3.8	+0.5	+4.9	+9.2
	400	440	-5.3	-1.4	+2.4	+6.1
15000'	150	189	+8.1	+22.1	—	—
	200	251	+3.4	+13.1	+22.9	—
	250	333	+0.1	+7.7	+15.2	+22.8
	300	373	-2.2	+3.9	+9.9	+16.0
	350	434	-4.1	+0.7	+5.4	+10.2
30000'	150	242	+10.4	+27.8	—	—
	200	320	+4.4	+16.4	+28.4	—
	250	398	+0.4	+10.5	+18.9	+28.1
	300	471	-3.5	+4.9	+12.2	+19.5
	350	543	-4.7	+1.0	+6.7	+12.4

Flight Angle: LEVEL FLIGHT

Cal	exp (Wt.—8500 Lbs.)			
	1 "g"	2 "g"	3 "g"	4 "g"
150	+105	+255	—	—
200	+44	+125	+206	—
250	+15	+67	+119	+171
300	0	+36	+72	+108
350	-9	+16	+41	+66
400	-15	+5	+25	+44

Flight Angle: 30° DIVE OR CLIMB

Cal	exp (Wt.—8500 Lbs.)			
	1 "g"	2 "g"	3 "g"	4 "g"
150	+89	+216	—	—
200	+32	+102	+172	+241
250	+9	+54	+99	+144
300	-5	+26	+56	+86
350	-13	+8	+29	+50
400	-19	-3	+14	+31

α, β = Mil angle between the fuselage leveling lugs and the flight path. This data is derived from the best available angle of attack charts, but is not guaranteed. The boresight targets and μ angles are based on this angle of the attack chart.

μ = Mil angle between the sight line and the projectiles at any range out to 2000 feet. When the mil angle is minus the projectiles are above the sight line; when plus they are below. This mil angle acts along the vertical axis of the sight. The mil angle μ is only applicable when the aircraft is harmonized as shown in the above boresight and fire-in targets.

Flight Angle: 30° DIVE OR CLIMB

Alt.	Cal IAS	TAS	Mil Angle "μ"			
			1 "g"	2 "g"	3 "g"	4 "g"
0'	200	200	+1.4	+8.3	+15.1	+21.9
	250	250	-0.8	+4.6	+10.0	+15.4
	300	300	-2.7	+1.6	+5.8	+10.0
	350	350	-4.2	-0.9	+2.5	+5.8
	400	400	-5.7	-2.8	+0.2	+3.2
7000'	200	222	+1.7	+9.2	+16.7	+24.2
	250	276	-0.8	+5.1	+11.0	+16.8
	300	331	-2.9	+1.9	+6.4	+11.0
	350	386	-4.5	-0.9	+2.8	+6.4
	400	440	-6.1	-3.0	+0.3	+3.6
15000'	150	189	+6.6	+18.4	—	—
	200	251	+2.0	+10.4	+18.8	+27.1
	250	313	-0.7	+5.8	+12.3	+18.9
	300	373	-3.1	+2.2	+7.2	+12.3
	350	434	-4.9	-0.8	+3.2	+7.2
30000'	150	242	+8.5	+23.3	—	—
	200	320	+2.7	+13.0	+23.4	+33.6
	250	398	-0.7	+7.3	+15.3	+23.3
	300	471	-3.5	+2.8	+8.9	+15.1
	350	543	-5.6	-0.8	+4.0	+8.7

Harmonization Chart: P-40 Airplane

RESTRICTED
AAF MANUAL 200-1

SIDE VIEW OF TRAJECTORIES



PLAN VIEW OF TRAJECTORIES

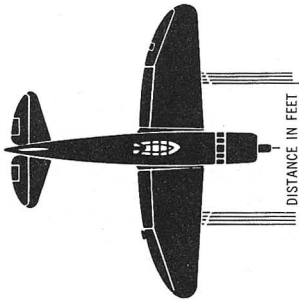

DISPERSION PATTERNS

Based on 4-mil dispersion cone

- SIGHT PIP
- CAMERA OR CENTER OF PICTURE FRAME

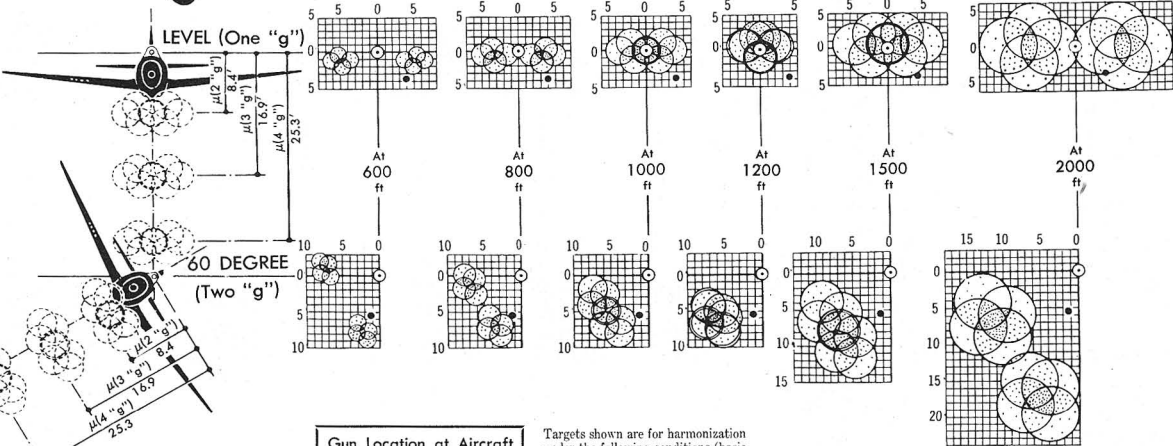

NOTE

Dotted circles are bullet patterns of 1000-ft range when firing is done at various "gs" shown

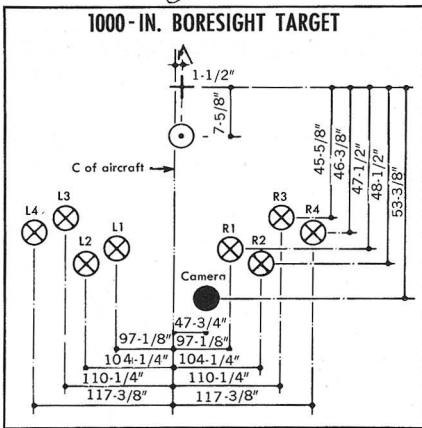

Gun Location at Aircraft

Cal 0.50	Vert	Horiz
L&R No. 1 guns	47.344"	107.875"
L&R No. 2 guns	46.969"	113.844"
L&R No. 3 guns	46.594"	119.813"
L&R No. 4 guns	46.219"	125.782"
Camera	45.750"	47.813"

*From sight. †From plane center line.

Targets shown are for harmonization under the following conditions (basic harmonization):
Cal IAS: 300 mph Alt: 15,000 ft
TAS: ±373 mph Wt: 14,000±250 lb
Angle of attack (α): 11 mils nose up
Level flight: (1 "g")

- ⊕ Mark where line from sight is parallel to fuselage leveling lugs.
 - ⊙ Mark where sight pip is aimed for harmonization with bullet patterns (sight setting for harmonization).
 - ⊗ Mark where bore is aimed for 1000-in. and 500-ft. targets.
 - Mark for center of impact of 10 rounds at 500-ft target.
 - Mark where camera is aimed making camera parallel to sight line. This point represents the center of the picture frame.
- Applied Ballistics & Design Sec., Proof Div., A.A.F.P.G.C., Eglin Field, Fla. Date: 8-8-44.

TRAJECTORY DATA
Forward Fire

Gun:	Cal .50
Ammunition:	APM-2
Muz vel, ft/sec:	2700

Authority: Aberdeen data FT. 50 AC-16-1, and 1st ind. to letter from Ord. Dept., Eglin Field, Fla., April 15, 1944, to Chief of Ordnance, Washington, D.C.

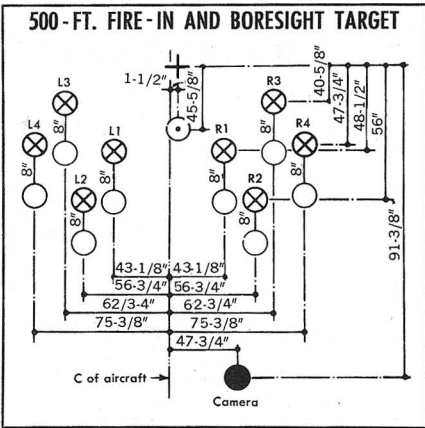
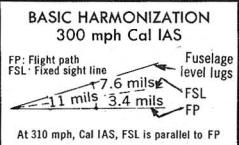

Flight Angle: LEVEL FLIGHT

Alt.	Cal IAS	TAS	Mil Angle "μ"			
			1 "g"	2 "g"	3 "g"	4 "g"
0'	250	250	+2.1	+10.7	+19.2	+27.8
	300	300	-0.3	+6.8	+13.7	+20.7
	350	350	-2.2	+3.8	+9.5	+15.4
	400	400	-3.8	+0.9	+6.2	+11.2
	450	450	-5.0	-0.7	+3.7	+8.0
7000'	200	222	+6.1	+18.1	-	-
	250	276	+2.5	+11.9	+21.1	+30.5
	300	331	-0.2	+7.5	+15.1	+22.7
	350	386	-2.2	-4.2	+10.5	+16.7
15000'	200	251	+7.1	+20.4	-	-
	250	313	+3.0	+13.4	+23.7	+34.2
	300	373	0	+8.4	+16.9	+25.3
	350	434	-2.2	+4.8	+11.7	+18.8
30000'	200	242	+16.9	-	-	-
	250	320	+9.1	+25.6	-	-
	300	398	+4.0	+16.8	+29.5	+42.3
	350	471	+0.4	+10.6	+20.8	+31.0

Flight Angle: LEVEL FLIGHT
exp (Wt=14000 Lbs.)

Cal IAS	1 "g"	2 "g"	3 "g"	4 "g"
150	+161	-	-	-
200	+74	+185	-	-
250	+33	+105	+176	+248
300	+11	+61	+111	+161
350	-2	+35	+71	+108
400	-11	+15	+45	+73
450	-16	+6	+28	+50

Flight Angle: 30° DIVE OR CLIMB
exp (Wt=14000 Lbs.)

Cal IAS	1 "g"	2 "g"	3 "g"	4 "g"
150	+131	-	-	-
200	+59	+155	+251	-
250	+23	+86	+148	+207
300	+5	+48	+92	+134
350	-7	+25	+56	+89
400	-14	+10	+34	+59
450	-19	0	+19	+38

α = Mil angle between the fuselage leveling lugs and the flight path. This data is derived from the best available angle of attack charts, but is not guaranteed. The boresight targets and μ angles are based on this angle of the attack chart.
μ = Mil angle between the sight line and the projectiles at any range out to 2000 feet. When the mil angle is minus the projectiles are above the sight line; when plus they are below. This mil angle acts along the vertical axis of the sight. The mil angle μ is only applicable when the aircraft is harmonized as shown in the above boresight and fire-in targets.

Flight Angle: 30° DIVE OR CLIMB

Alt.	Cal IAS	TAS	Mil Angle "μ"			
			1 "g"	2 "g"	3 "g"	4 "g"
0'	250	250	+0.9	+8.5	+15.9	+22.9
	300	300	-1.1	+4.9	+11.1	+16.9
	350	350	-3.0	+2.2	+7.3	+12.4
	400	400	-4.3	-0.1	+4.2	+8.7
	450	450	-5.6	+1.8	+1.9	+5.6
7000'	200	222	+4.5	+14.9	+25.2	-
	250	276	+1.2	+9.4	+17.5	+25.2
	300	331	-1.1	+5.5	+12.2	+18.6
	350	386	-3.0	+2.5	+8.0	+13.6
15000'	200	251	+5.3	+16.8	+28.3	-
	250	313	+1.5	+10.7	+19.7	+28.3
	300	373	-1.0	+6.3	+13.7	+20.7
	350	434	-3.2	+2.9	+9.0	+15.1
30000'	200	242	+13.4	-	-	-
	250	320	+6.9	+21.1	+35.3	+42.3
	300	398	+2.3	+13.5	+24.5	+35.0
	350	471	-3.4	+3.8	+11.1	+18.4

Harmonization Chart P-47 Airplane

SIDE VIEW OF TRAJECTORIES



PLAN VIEW OF TRAJECTORIES

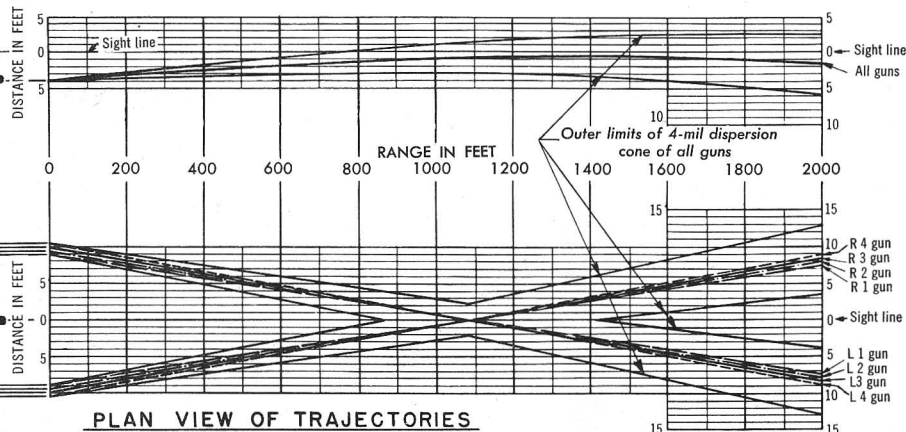
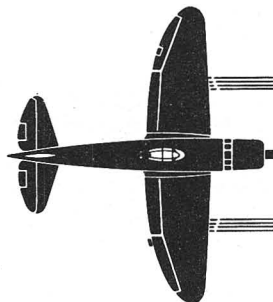

DISPERSION PATTERNS

Based on 4-mil dispersion cone

- SIGHT PIP
- CAMERA OR CENTER OF PICTURE FRAME

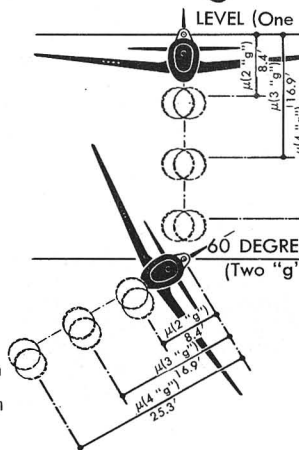

NOTE

Dotted circles are bullet patterns of 1000-ft range when firing is done at various "gs" shown

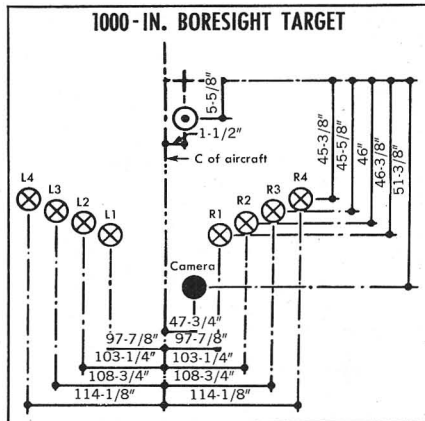

Gun Location at Aircraft
Cal 0.50 Vert[†] Horiz
L&R No. 1 guns 47.344" 107.875"
L&R No. 2 guns 46.969 113.844
L&R No. 3 guns 46.594 119.813
L&R No. 4 guns 46.219 125.78
Camera 45.750 47.813
*From sight. †From plane center line.

Targets shown are for harmonization under the following conditions (basic harmonization):
Cal IAS: 300 mph Alt: 15,000 ft
TAS: ±373 mph Wt: 14,000±250 lb
Angle of attack (α): 11 mils nose up
Level flight: (1 "g")

- ⊕ Mark where line from sight is parallel to fuselage leveling lugs.
- ⊗ Mark where sight pip is aimed for harmonization with bullet patterns (sight setting for harmonization).
- ⊙ Mark where bore is aimed for 1000-in. and 900-ft. targets.
- Mark for center of impact of 10 rounds at 900-ft. target.
- Mark where camera is aimed making camera parallel to sight line.

This point represents the center of the picture frame.
Applied Ballistics & Design Sec., Proof Div., A.A.F.P.G.C., Eglin Field, Fla. Date: 8-8-44.

TRAJECTORY DATA
Forward Fire

Gun: Cal .50
Ammunition: APM-2
Muz vel, ft/sec: 2700
Authority: Aberdeen data Ft. 50 AC-M-1; and 1st ind. to letter from Ord. Dept., Eglin Field, Fla., April 15, 1944 to Chief of Ordnance, Washington, D.C.

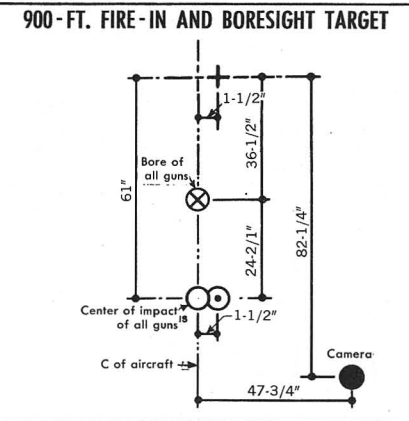

Alt.	Cal	IAS	TAS	Mil Angle "μ"			
				1 "g"	2 "g"	3 "g"	4 "g"
0'	250	250	±2.1	+10.7	+19.2	+27.8	
	300	300	-0.3	+6.7	+13.7	+20.7	
	350	350	-2.2	+3.8	+9.5	+15.4	
	400	400	-4.0	+0.9	+6.2	+11.2	
	450	450	-4.9	-0.6	+3.7	+8.0	
7000'	200	222	+6.1	+18.0			
	250	276	+2.4	+11.8	+21.1	+30.5	
	300	331	-0.2	+7.4	+15.1	+22.7	
	350	386	-2.2	+4.2	+10.5	+16.9	
	400	440	-4.0	+1.1	+6.9	+12.3	
15000'	200	251	+7.0	+20.3			
	250	313	+2.9	+13.4	+23.7	+34.2	
	300	373	0	+8.4	+16.9	+25.3	
	350	434	-2.2	+4.9	+11.7	+18.8	
	400	493	-4.0	+1.4	+7.7	+13.6	
30000'	150	242	+16.8				
	200	320	+9.1	+25.5			
	250	398	+4.0	+16.8	+29.5	+42.3	
	300	471	+0.4	+10.6	+20.8	+31.0	
	350	543	-2.2	+6.2	+14.4	+22.8	

Cal	exp (Wt.=14000 Lbs.)	Mil Angle "μ"			
		1 "g"	2 "g"	3 "g"	4 "g"
150	+161				
200	+74	+185			
250	+33	+105	+176	+248	
300	+11	+61	+111	+161	
350	-2	+35	+71	+108	
440	-11	+15	+45	+73	
450	-16	+6	+28	+50	

Cal	exp (Wt.=14000 Lbs.)	Mil Angle "μ"			
		1 "g"	2 "g"	3 "g"	4 "g"
150	+131				
200	+59	+155	+251		
250	+23	+86	+148	+207	
300	+5	+48	+92	+134	
350	-7	+25	+56	+89	
400	-14	+10	+34	+59	
450	-19	0	+19	+38	

α = Mil angle between the fuselage leveling lugs and the flight path. This data is derived from the best available angle of attack charts, but is not guaranteed. The boresight targets and μ angles are based on this angle of the attack chart.
μ = Mil angle between the sight line and the projectiles at any range out to 2000 feet. When the mil angle is minus the projectiles are above the sight line; when plus they are below. This mil angle acts along the vertical axis of the sight. The mil angle μ is only applicable when the aircraft is harmonized as shown in the above boresight and fire-in targets.

Harmonization Chart: P-47 Airplane

Alt.	Cal	IAS	TAS	Mil Angle "μ"			
				1 "g"	2 "g"	3 "g"	4 "g"
0'	250	250	±0.9	+8.4	+15.8	+22.9	
	300	300	-1.2	+4.9	+11.0	+16.9	
	350	350	-3.0	+2.2	+7.3	+17.4	
	400	400	-4.3	0	+4.2	+8.7	
	450	450	-5.5	-1.8	+1.9	+5.7	
7000'	200	222	+4.5	+14.8	+25.1		
	250	276	+1.1	+9.3	+17.4	+25.1	
	300	331	-1.1	+5.5	+12.2	+18.6	
	350	386	-3.0	+2.5	+8.1	+13.6	
	400	440	-4.5	-0.1	+4.8	+9.6	
15000'	200	251	+5.2	+16.7	+28.2		
	250	313	+1.5	+10.6	+19.7	+28.2	
	300	373	-1.0	+6.3	+13.7	+20.7	
	350	434	-3.1	+3.0	+9.1	+15.2	
	400	493	-4.7	+0.3	+5.4	+10.7	
30000'	150	242	+13.3				
	200	320	+6.9	+21.1	+35.3		
	250	398	+2.3	+13.5	+24.5	+35.0	
	300	471	-0.8	+8.0	+16.9	+25.5	
	350	543	-3.4	+3.9	+11.2	+18.5	

SIDE VIEW OF TRAJECTORIES



PLAN VIEW OF TRAJECTORIES

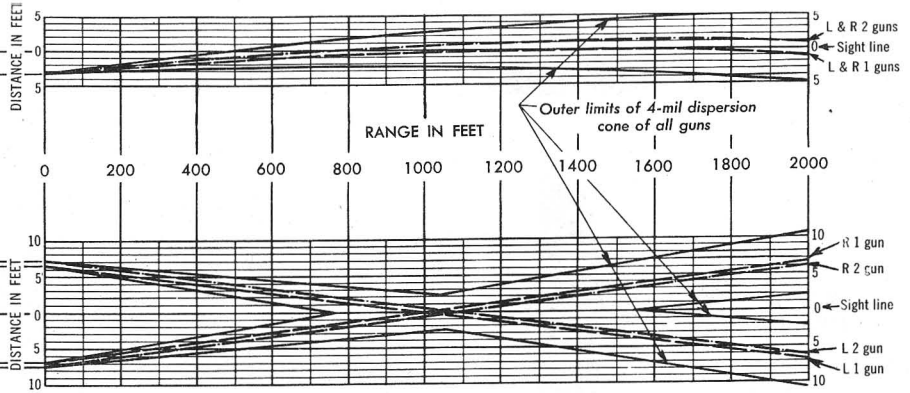
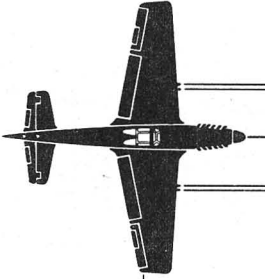

DISPERSION PATTERNS

Based on 4-mil dispersion cone

○ SIGHT PIP

● CAMERA OR CENTER OF PICTURE FRAME

NOTE

Dotted circles are bullet patterns of 1000-ft range when firing is done at various "gs" shown

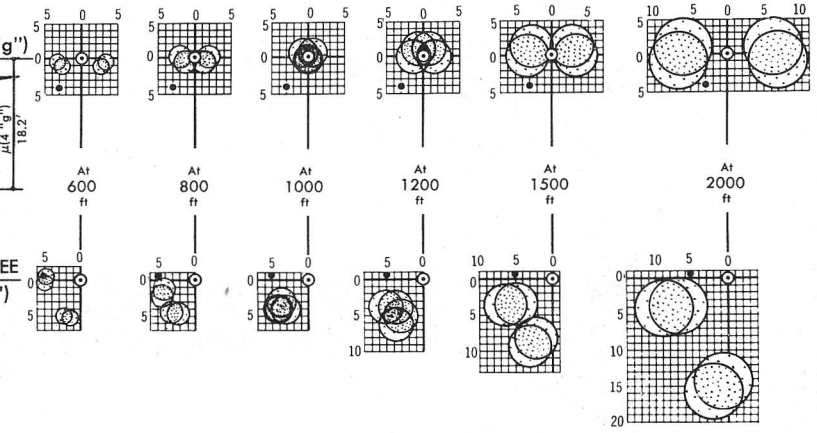
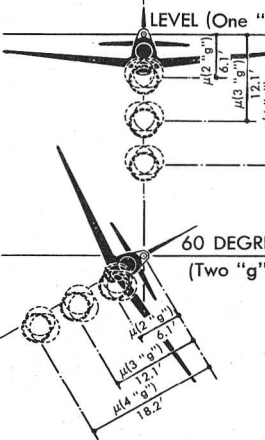

1000-IN. BORESIGHT TARGET

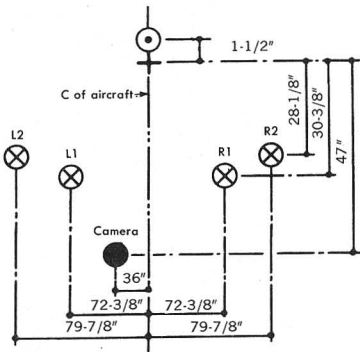

Gun Location at Aircraft

Cal 0.50	Vert*	Horiz†
L&R No. 1 guns	40.238"	80.508"
L&R No. 2 guns	40.124	87.998
Gun Camera	48.543	35.953

*From sight. †From plane center line.

Targets shown are for harmonization under the following conditions (basic harmonization):

Cal IAS: 300 mph Alt: 15,000 ft
TAS: ± 373 mph Wt: 9,500 ± 200 lb
Angle of attack (α): 12 mils nose up
Level flight: (1 "g")

- ⊕ Mark where line from sight is parallel to fuselage leveling lugs.
- ⊙ Mark where sight pip is aimed for harmonization with bullet patterns (sight setting for harmonization).
- ⊗ Mark where bore is aimed for 1000-in. and 500-ft. targets.
- ⊙ Mark for center of impact of 10 rounds at 500-ft target.
- Mark where camera is aimed making camera parallel to sight line. This point represents the center of the picture frame.

Applied Ballistics & Design Sec., Proof Div., A.A.F.P.G.C., Eglin Field, Fla. Date: 8-8-44.

TRAJECTORY DATA
Forward Fire

Gun:	Cal. 50
Ammunition:	APM-2
Muz vel, ft/sec:	2700
Authority:	Aberdeen data FT. 50 AC-M-1, and 1st ind. to letter from Ord. Dept., Eglin Field, Fla., April 15, 1944, to Chief of Ordnance, Washington, D.C.

BASIC HARMONIZATION
300 mph Cal IAS

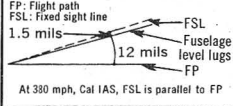

500-FT. FIRE-IN AND BORESIGHT TARGET

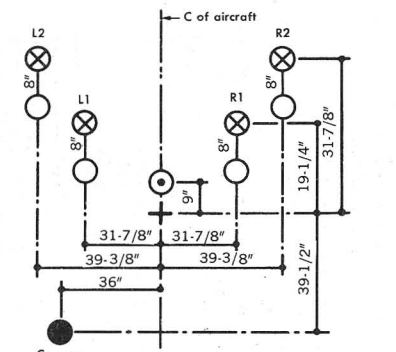

Flight Angle: LEVEL FLIGHT						
Alt.	Cal IAS	TAS	Mil Angle "μ"			
			1 "g"	2 "g"	3 "g"	4 "g"
0°	250	250	+0.8	+7.0	+13.1	+19.2
	300	300	-0.6	+4.4	+9.4	+14.5
	350	350	-1.6	+2.5	+6.7	+11.0
	400	400	-2.6	+1.1	+4.7	+8.2
	450	450	-3.3	-0.2	+3.2	+6.1
7000'	200	222	+3.5	+12.1	+20.7	-
	250	276	+1.2	+8.0	+14.6	+21.3
	300	331	-0.4	+5.1	+10.6	+16.1
	350	386	-1.5	+3.0	+7.6	+12.2
	400	440	-2.5	+1.5	+5.4	+9.2
15000'	200	251	+4.3	+13.9	+23.5	-
	250	313	+1.8	+9.4	+16.8	+24.2
	300	373	0	+6.1	+12.1	+18.2
	350	434	-1.2	+3.7	+8.7	+13.8
	400	493	-2.4	+2.0	+6.2	+10.5
30000'	150	242	+11.2	+27.9	-	-
	200	320	+6.2	+18.0	+29.9	-
	250	398	+3.0	+12.3	+21.4	+30.4
	300	471	+0.8	+8.1	+15.5	+22.8
	350	543	-0.7	+5.2	+11.1	+17.3

Flight Angle: LEVEL FLIGHT					
Cal IAS	α (Wt.=9500 Lbs.)				
	1 "g"	2 "g"	3 "g"	4 "g"	μ
150	+119	+262	-	-	-
200	+57	+137	+217	-	-
250	+28	+80	+131	+182	-
300	+12	+48	+84	+120	-
350	+3	+29	+55	+82	-
400	-4	+17	+37	+57	-
450	-8	+8	+25	+40	-

α, μ = Mil angle between the fuselage leveling lugs and the flight path. This data is derived from the best available angle of attack charts, but is not guaranteed. The boresight targets and μ angles are based on this angle of the attack chart.

μ = Mil angle between the sight line and the projectiles at any range out to 2000 feet. When the mil angle is minus the projectiles are above the sight line; when plus they are below. This mil angle acts along the vertical axis of the sight. The mil angle μ is only applicable when the aircraft is harmonized as shown in the above boresight and fire-in targets.

Flight Angle: 30° DIVE OR CLIMB					
Cal IAS	α (Wt.=9500 Lbs.)				
	1 "g"	2 "g"	3 "g"	4 "g"	μ
150	+100	+224	-	-	-
200	+46	+115	+185	+254	-
250	+21	+66	+111	+155	-
300	+7	+38	+69	+100	-
350	-1	+22	+45	+68	-
400	-6	+11	+29	+46	-
450	-10	+4	+18	+32	-

Flight Angle: 30° DIVE OR CLIMB						
Alt.	Cal IAS	TAS	Mil Angle "μ"			
			1 "g"	2 "g"	3 "g"	4 "g"
0°	250	250	0	+5.3	+10.7	+16.0
	300	300	-1.3	+3.0	+7.3	+11.7
	350	350	-2.3	+1.4	+5.1	+8.7
	400	400	-3.0	0	+3.3	+6.3
	450	450	-3.8	-1.0	+1.8	+4.5
7000'	200	222	+2.3	+9.7	+17.2	+24.7
	250	276	+0.3	+6.2	+12.0	+17.8
	300	331	-1.1	+3.6	+8.3	+13.0
	350	386	-2.2	+1.8	+5.8	+9.8
	400	440	-3.0	+0.3	+3.8	+7.1
15000'	200	251	+3.0	+11.3	+19.7	+27.9
	250	313	+0.8	+7.3	+13.3	+20.2
	300	373	-0.9	+4.4	+9.6	+14.8
	350	434	-2.0	+2.4	+6.8	+11.2
	400	493	-2.8	+0.7	+4.5	+8.1
30000'	150	242	+9.0	+23.4	-	-
	200	320	+4.6	+14.8	+25.2	+35.4
	250	398	+1.8	+9.8	+17.8	+25.6
	300	471	-0.2	+6.1	+12.4	+18.7
	350	543	-1.6	+3.6	+8.8	+14.1

Harmonization Chart: P-51B & C Airplanes

SIDE VIEW OF TRAJECTORIES

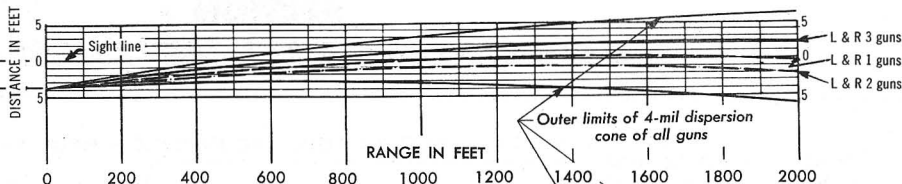

PLAN VIEW OF TRAJECTORIES

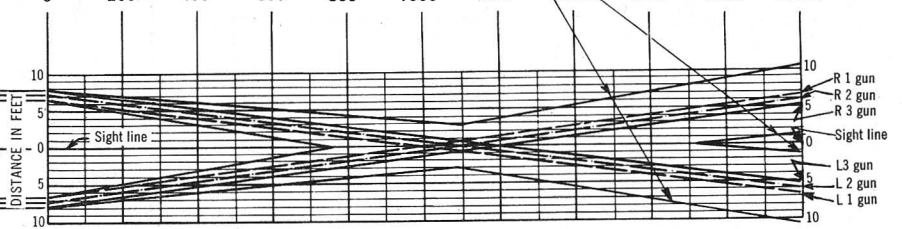

DISPERSION PATTERNS

Based on 4-mil dispersion cone

SIGHT PIP

CAMERA OR CENTER OF PICTURE FRAME

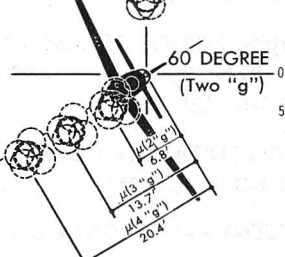
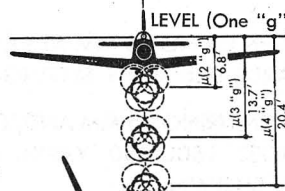

NOTE

Dotted circles are bullet patterns of 1000-ft range when firing is done at various 'gs' shown

1000-IN. BORESIGHT TARGET

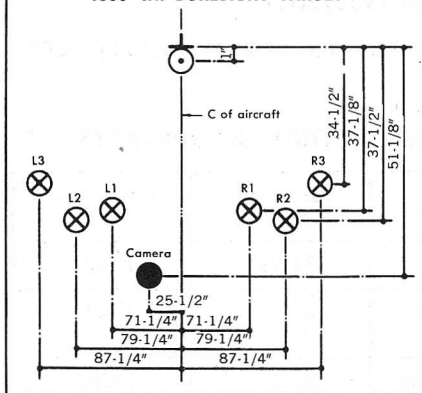

Gun Location at Aircraft

Cal 0.50	Vert*	Horiz†
L&R No. 1 guns	44.732"	79.123"
L&R No. 2 guns	44.002"	87.091"
L&R No. 3 guns	43.493"	95.076"
Camera	50.140"	25.561"

Targets shown are for harmonization under the following conditions (basic harmonization):
Cal IAS: 300 mph Alt: 15,000 ft
TAS: ±373 mph Wt: 9,500±200 lb
Angle of attack (exp): 13 mils nose up
Level flight: (1 "g")

- ⊕ Mark where line from sight is parallel to fuselage leveling lugs.
- ⊗ Mark where sight pip is aimed for harmonization with bullet patterns (sight setting for harmonization).
- ⊙ Mark where bore is aimed for 1000-in. and 500-ft. targets.
- Mark for center of impact of 10 rounds at 500-ft. target.
- Mark where camera is aimed making camera parallel to sight line. This point represents the center of the picture frame.

Applied Ballistics & Design Sec., Proof Div., A.A.F.P.G.C., Eglin Field, Fla. Date: 8-8-44.

TRAJECTORY DATA
Forward Fire

Gun: Cal. 50
Ammunition: APM-2
Muz vel, ft/sec: 2700
Authority: Aberdeen data F1
50 KC-W-1 and 1st ind. to letter from Ord. Dept., Eglin Field, Fla., April 15, 1944, to Chief of Ordnance, Washington, D.C.

BASIC HARMONIZATION
300 mph Cal IAS

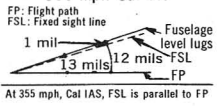

500-FT. FIRE-IN AND BORESIGHT TARGET

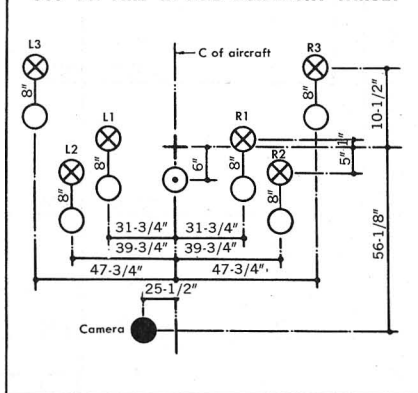

Flight Angle: LEVEL FLIGHT							
Alt.	Cal	IAS	TAS	Mil Angle "μ"			4 "g"
				1 "g"	2 "g"	3 "g"	
0'	250	250	+1.0	+8.1	+15.0	+22.1	
	300	300	-0.6	+5.0	+10.8	+16.4	
	350	350	-1.9	+2.9	+7.5	+12.3	
	400	400	-3.1	+1.1	+5.1	+9.2	
	450	450	-3.9	-0.4	+3.2	+6.7	
7000'	200	222	+4.1	+14.0	+23.8		
	250	276	+1.5	+9.1	+16.7	+24.4	
	300	331	-0.3	+5.8	+12.0	+18.1	
	350	386	-1.8	+3.4	+8.5	+13.7	
	400	440	-3.1	+1.5	+5.8	+10.2	
15000'	200	251	+5.0	+16.1	+27.0		
	250	313	+2.0	+10.6	+19.0	+27.6	
	300	373	0	+6.8	+13.7	+20.4	
	350	434	-1.6	+4.1	+9.5	+15.4	
	400	493	-3.1	+2.0	+6.6	+11.5	
30000'	150	242	+13.0	+31.8			
	200	320	+7.0	+20.6	+34.1		
	250	398	+3.3	+13.7	+24.1	+34.5	
	300	471	+0.8	+8.9	+17.3	+25.4	
	350	543	-1.3	+5.6	+12.2	+19.0	

Flight Angle: LEVEL FLIGHT						
Cal	exp (Wt.=9500 Lbs.)	Mil Angle "μ"				
		1 "g"	2 "g"	3 "g"	4 "g"	
150	+134	+296				
200	+63	+155	+246			
250	+30	+89	+147	+206		
300	+13	+53	+94	+134		
350	+2	+32	+61	+91		
400	-6	+18	+40	+63		
450	-10	+8	+26	+44		

Flight Angle: 30° DIVE OR CLIMB						
Cal	exp (Wt.=9500 Lbs.)	Mil Angle "μ"				
		1 "g"	2 "g"	3 "g"	4 "g"	
150	+112	+252				
200	+51	+130	+210	+288		
250	+23	+73	+124	+175		
300	+7	+42	+77	+113		
350	-2	+24	+50	+76		
400	-9	+12	+31	+51		
450	-13	+3	+19	+34		

α=μ Mil angle between the fuselage leveling lugs and the flight path. This data is derived from the best available angle of attack charts, but is not guaranteed. The boresight targets and μ angles are based on this angle of the attack chart.
μ=3 Mil angle between the sight line and the projectiles at any range out to 2000 feet. When the mil angle μ is minus the sight angle α along the vertical axis of the sight. The mil angle μ is only applicable when the aircraft is harmonized as shown in the above boresight and fire-in targets.

Harmonization Chart: P-51D Airplane

Flight Angle: 30° DIVE OR CLIMB							
Alt.	Cal	IAS	TAS	Mil Angle "μ"			4 "g"
				1 "g"	2 "g"	3 "g"	
0'	250	250	+0.2	+6.2	+12.3	+18.4	
	300	300	-1.4	+3.5	+8.4	+13.5	
	350	350	-2.5	+1.6	+5.8	+9.9	
	400	400	-3.7	+0.2	+3.5	+7.0	
	450	450	-4.9	-1.3	+1.8	+4.7	
7000'	200	222	+2.8	+11.4	+20.0	+28.4	
	250	276	+0.5	+7.1	+13.7	+20.4	
	300	331	-1.2	+4.1	+9.5	+14.9	
	350	386	-2.5	+2.0	+6.6	+11.1	
	400	440	-3.7	+0.4	+4.0	+7.9	
15000'	200	251	+3.6	+13.1	+22.9	+32.0	
	250	313	+1.0	+8.3	+15.7	+23.1	
	300	373	-1.0	+4.9	+10.8	+16.9	
	350	434	-2.4	+2.6	+7.6	+12.5	
	400	493	-3.7	+0.7	+4.7	+9.0	
30000'	150	242	+10.4	+26.7			
	200	320	+5.2	+16.9	+28.8	+39.1	
	250	398	+2.0	+10.9	+20.0	+29.0	
	300	471	-0.4	+6.7	+13.8	+21.2	
	350	543	-2.1	+3.8	+9.7	+15.6	

SECTION J
MISCELLANEOUS HARMONIZATION CHARTS

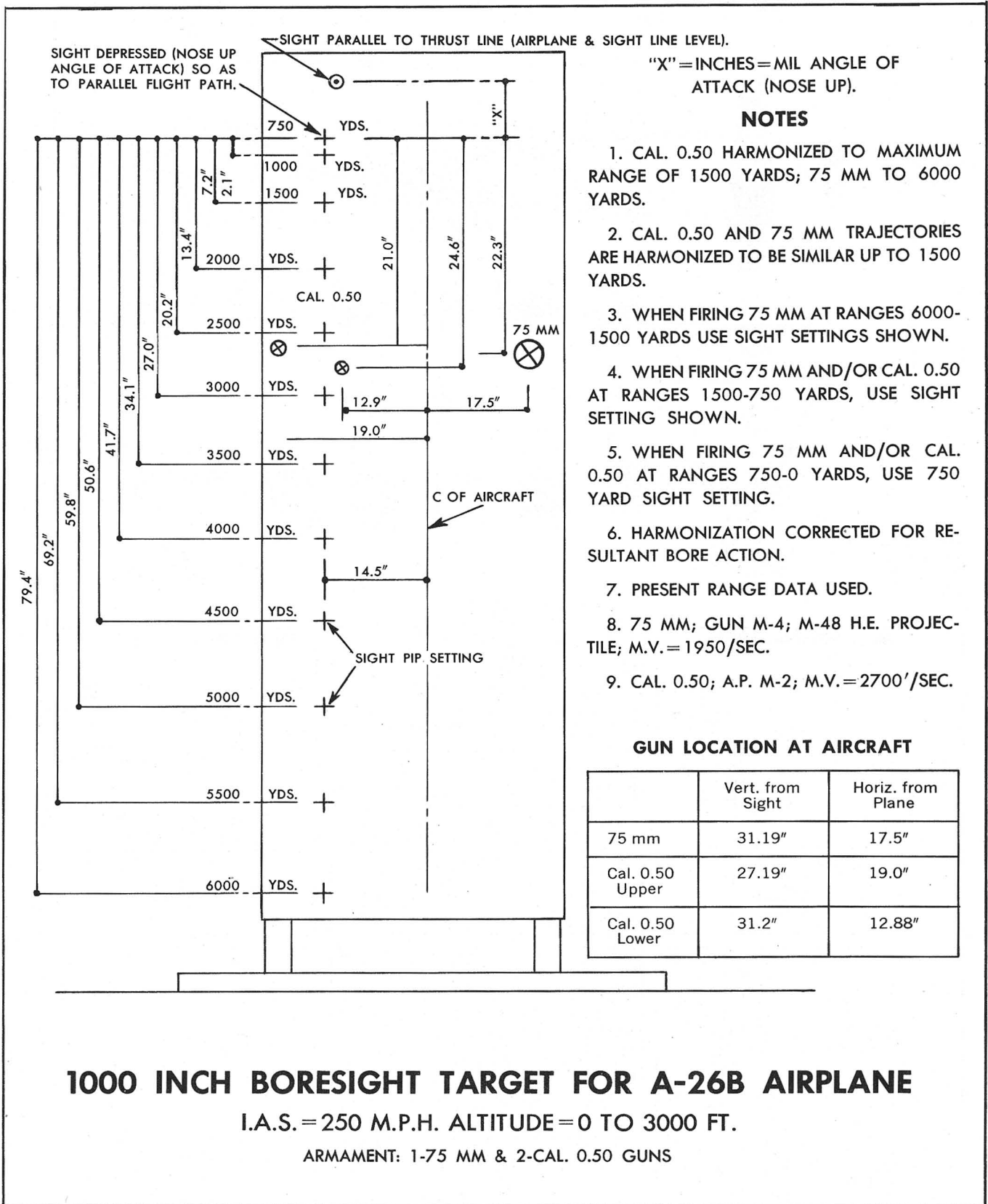

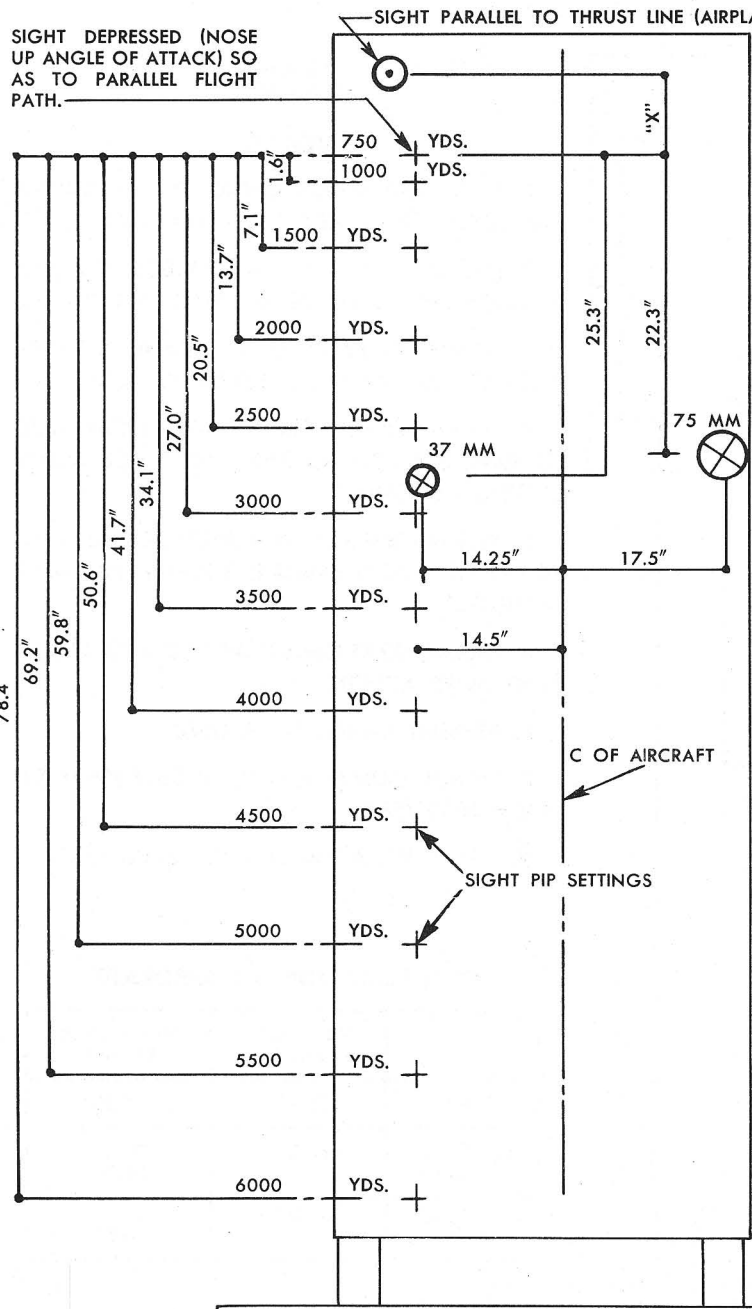

NOTES

1. 37 MM HARMONIZED TO MAXIMUM RANGE OF 2500 YARDS. 75 MM TO 6000 YARDS.
2. THE 75 MM & 37 MM TRAJECTORIES ARE HARMONIZED TO BE SIMILAR UP TO 2500 YARDS.
3. WHEN FIRING 75 MM FOR RANGE 6000 TO 2500 YARDS, USE SIGHT SETTINGS SHOWN.
4. WHEN FIRING 75 MM AND/OR 37 MM AT RANGES 2500-750 YARDS USE SIGHT SETTINGS SHOWN.
5. WHEN FIRING 75 MM AND/OR 37 MM AT RANGES 750-0 YARDS USE 750 YARD SIGHT SETTING.
6. HARMONIZATION CORRECTED FOR RESULTANT BORE ACTION.
7. PRESENT RANGE DATA USED.
8. 75 MM GUN M 4; M 48 H.E. PROJECTILE; M.V. = 1950'/SEC.
9. 37 MM GUN M 9-SHELL M 56 FUSE M 54; M.V. = 2550'/SEC.

GUN LOCATION AT AIRCRAFT

	Vert. from Sight	Horiz. from Plane C
75 mm	31.19"	17.5"
37 mm	32.7"	14.25"

1000 INCH BORESIGHT TARGET FOR A-26B AIRPLANE

I.A.S. = 250 M.P.H. ALTITUDE = 0 TO 3000 FT.

ARMAMENT: 1-75 MM AND 1-37 MM

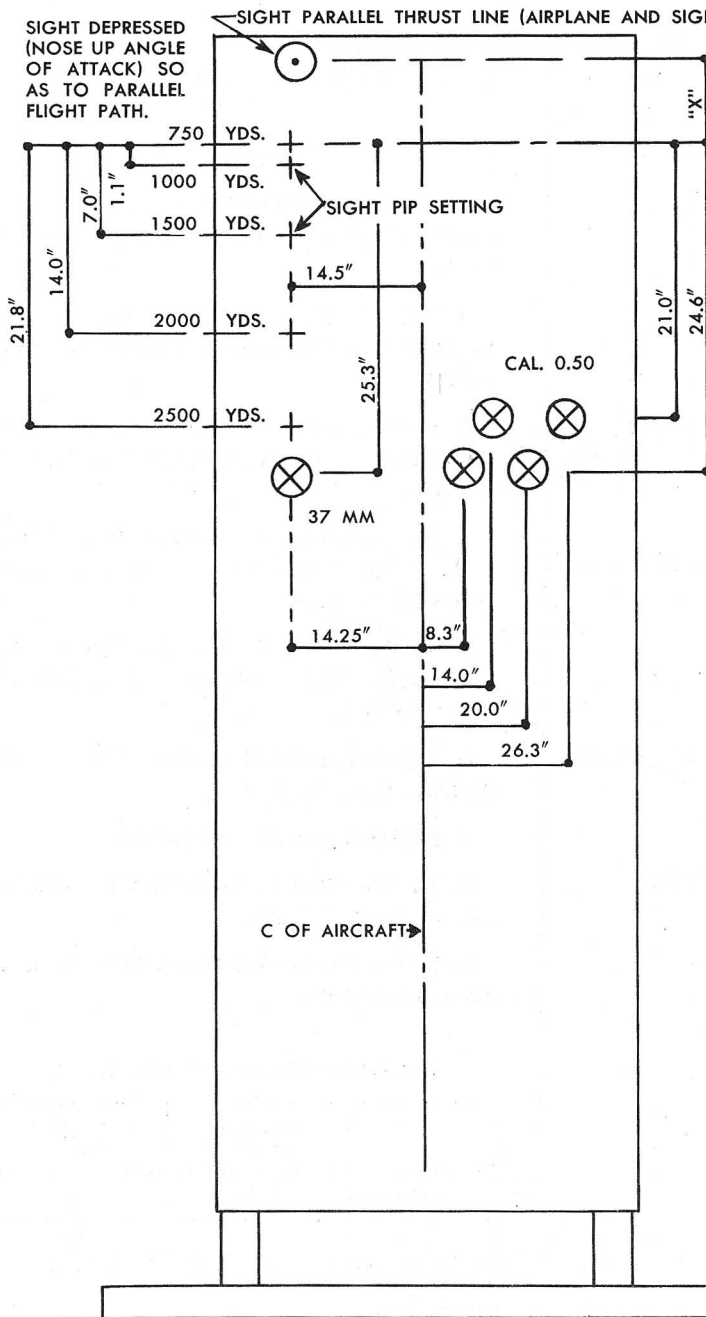

"X" = INCHES = MIL ANGLE OF ATTACK
(NOSE UP)

NOTES

1. CAL. 0.50 HARMONIZED TO MAXIMUM RANGE OF 1500 YARDS. 37 MM TO 2500 YARDS.
2. CAL. 0.50 AND 37 MM TRAJECTORIES ARE HARMONIZED TO BE SIMILAR UP TO 1500 YARDS.
3. WHEN FIRING 37 MM FOR RANGES 2500-1500 YARDS, USE SIGHT SETTINGS SHOWN.
4. WHEN FIRING 37 MM AND/OR CAL. 0.50 AT RANGES 1500 TO 750 YARDS USE SIGHT SETTINGS SHOWN.
5. WHEN FIRING 37 MM AND/OR CAL. 0.50 AT RANGES 750-0 YARDS USE 750 YARD SETTINGS.
6. HARMONIZATION CORRECTED FOR RESULTANT BORE ACTION.
7. PRESENT RANGE DATA USED.
8. 37 MM; GUN M-9; SHELL M-56; FUSE M-54; M.V. = 2550' / SEC.
9. CAL. 0.50; A.P.M.-2; M.V. = 2700' / SEC.

GUN LOCATION AT AIRCRAFT

	Vert. from Sight	Horiz. from Plane C
37 mm	32.7"	14.25"
Cal. 0.50 Upper	27.19"	26.25" 14.0"
Cal. 0.50 Lower	31.2"	20.0" 8.25"

1000 INCH BORESIGHT TARGET FOR A-26B AIRPLANE

I.A.S. = 250 M.P.H. ALTITUDE = 0 TO 3000 FT.

ARMAMENT: 1-37 MM & 4-CAL. 0.50 GUNS

1 2 3 4 5 6 7 8 9 10 11 12 13 14 15 16 17 18 19 20 21 22 23 24 25 26 27 28 29 30

9482

RECEIVED

O. O. AAFPGC

EGLIN FIELD

FLORIDA